

Traffic Capacity Analysis

R-2553

US 70 Kinston Bypass

Lenoir and Jones Counties, North Carolina

Prepared For:

North Carolina Department of Transportation



Prepared By:

AECOM Technical Services of North Carolina

Traffic Capacity Analysis Report
US 70 Kinston Bypass
(NCDOT STIP R-2553)

**An Analysis of 2015 No-Build Alternative,
2040 No-Build Alternative, and 2040 Build Alternatives**

For:

North Carolina Department of Transportation

By:

AECOM Technical Services of North Carolina

November 2017

AECOM Technical Services of North Carolina, Inc. (NC Firm License: F-0342)

701 Corporate Center Drive, #475, Raleigh, North Carolina 27607



AECOM

This page left intentionally blank

TABLE OF CONTENTS

1.0	INTRODUCTION	1
2.0	SCOPE	1
3.0	EXISTING CONDITIONS	5
4.0	METHOD OF ANALYSIS	7
4.1	Traffic Volume Assumptions	7
4.2	Capacity Analysis	7
4.2.1	FREEVAL-E Methodology	8
4.2.2	HCS Methodology	10
4.2.3	At-Grade Intersection Methodology	10
5.0	RESULTS	12
5.1	2015 No-Build Alternative	12
5.2	2040 No-Build Alternative	23
5.3	2040 Build Alternative 1 – Upgrade US 70	34
5.4	2040 Build Alternative 1 – Shallow Southern Bypass	48
5.5	2040 Build Alternative 11	61
5.6	2040 Build Alternative 12	71
5.7	2040 Build Alternative 31	81
5.8	2040 Build Alternative 32	90
5.9	2040 Build Alternative 63	99
5.10	2040 Build Alternative 65	108
5.11	2040 Build Alternative 51	117
5.12	2040 Build Alternative 52	126
5.13	2040 Build Alternative 35	135
5.14	2040 Build Alternative 36	144
5.15	2040 Representative Build Alternative 1 – Shallow Southern Bypass	153
5.16	2040 Representative Build Alternative 65	158
6.0	CONCLUSIONS & RECOMMENDATIONS	164
6.1	2015 No-Build Alternative	164
6.2	2040 No-Build Alternative	164
6.3	2040 Build Alternative 1 – Upgrade US 70	164
6.4	2040 Build Alternative 1 – Shallow Southern Bypass	164
6.5	2040 Build Alternative 11	165
6.6	2040 Build Alternative 12	165
6.7	2040 Build Alternative 31	165
6.8	2040 Build Alternative 32	165
6.9	2040 Build Alternative 63	166
6.10	2040 Build Alternative 65	166

TABLE OF CONTENTS (Continued)

6.11 2040 Build Alternative 51	166
6.12 2040 Build Alternative 52	166
6.13 2040 Build Alternative 35	166
6.14 2040 Build Alternative 36	167
6.15 2040 Representative Build Alternative 1 – Shallow Southern Bypass	167
6.16 2040 Representative Build Alternative 65	167

LIST OF TABLES

1	Level of Service (LOS) Index	8
2	Acceleration/Deceleration Lane Length Index	10
3	2015 No-Build Alternative – Intersection Level of Service	12
4	2040 No-Build Alternative – Intersection Level of Service	23
5A	2040 Build Alternative 1 – Upgrade US 70 – Intersection Level of Service	34
5B	2040 Build Alternative 1 – Upgrade US 70 – Freeway Level of Service	41
5C	2040 Build Alternative 1 – Upgrade US 70 – Queuing and Recommended Storage	45
6A	2040 Build Alternative 1 – Shallow Southern Bypass – Intersection Level of Service	48
6B	2040 Build Alternative 1 – Shallow Southern Bypass – Freeway Level of Service	54
6C	2040 Build Alternative 1 – Shallow Southern Bypass – Queuing and Recommended Storage	58
7A	2040 Build Alternative 11 – Intersection Level of Service	61
7B	2040 Build Alternative 11 – Freeway Level of Service	66
7C	2040 Build Alternative 11 – Queuing and Recommended Storage	69
8A	2040 Build Alternative 12 – Intersection Level of Service	71
8B	2040 Build Alternative 12 – Freeway Level of Service	76
8C	2040 Build Alternative 12 – Queuing and Recommended Storage	79
9A	2040 Build Alternative 31 – Intersection Level of Service	81
9B	2040 Build Alternative 31 – Freeway Level of Service	85
9C	2040 Build Alternative 31 – Queuing and Recommended Storage	88
10A	2040 Build Alternative 32 – Intersection Level of Service	90
10B	2040 Build Alternative 32 – Freeway Level of Service	94
10C	2040 Build Alternative 32 – Queuing and Recommended Storage	97
11A	2040 Build Alternative 63 – Intersection Level of Service	99
11B	2040 Build Alternative 63 – Freeway Level of Service	103
11C	2040 Build Alternative 63 – Queuing and Recommended Storage	106
12A	2040 Build Alternative 65 – Intersection Level of Service	108
12B	2040 Build Alternative 65 – Freeway Level of Service	112
12C	2040 Build Alternative 65 – Queuing and Recommended Storage	115
13A	2040 Build Alternative 51 – Intersection Level of Service	117
13B	2040 Build Alternative 51 – Freeway Level of Service	122
13C	2040 Build Alternative 51 – Queuing and Recommended Storage	124
14A	2040 Build Alternative 52 – Intersection Level of Service	126
14B	2040 Build Alternative 52 – Freeway Level of Service	131
14C	2040 Build Alternative 52 – Queuing and Recommended Storage	133
15A	2040 Build Alternative 35 – Intersection Level of Service	135
15B	2040 Build Alternative 35 – Freeway Level of Service	140
15C	2040 Build Alternative 35 – Queuing and Recommended Storage	142

LIST OF TABLES (Continued)

16A	2040 Build Alternative 36 – Intersection Level of Service	144
16B	2040 Build Alternative 36 – Freeway Level of Service	149
16C	2040 Build Alternative 36 – Queuing and Recommended Storage	151
17	2040 Representative Build Alternative 1 – Shallow Southern Bypass – Intersection Level of Service	153
18	2040 Representative Build Alternative 65 – Intersection Level of Service	158

LIST OF EXHIBITS

1	R-2553 Project Location	3
2	R-2553 Build Alternatives	4

LIST OF FIGURES

1A – 1H	2015 No-Build Alternative – Peak Hour Volumes
1I – 1P	2015 No-Build Alternative – LOS and Laneage
2A – 2H	2040 No-Build Alternative – Peak Hour Volumes
2I – 2P	2040 No-Build Alternative – LOS and Laneage
3A – 3G	2040 Build Alternative 1 – Upgrade US 70 – Peak Hour Volumes
3H – 3N	2040 Build Alternative 1 – Upgrade US 70 – LOS and Laneage
4A – 4F	2040 Build Alternative 1 – Shallow Southern Bypass – Peak Hour Volumes
4G – 4L	2040 Build Alternative 1 – Shallow Southern Bypass – LOS and Laneage
5A – 5F	2040 Build Alternative 11 – Peak Hour Volumes
5G – 5L	2040 Build Alternative 11 – LOS and Laneage
6A – 6F	2040 Build Alternative 12 – Peak Hour Volumes
6G – 6L	2040 Build Alternative 12 – LOS and Laneage
7A – 7G	2040 Build Alternative 31 – Peak Hour Volumes
7H – 7N	2040 Build Alternative 31 – LOS and Laneage
8A – 8G	2040 Build Alternative 32 – Peak Hour Volumes
8H – 8N	2040 Build Alternative 32 – LOS and Laneage
9A – 9G	2040 Build Alternative 63 – Peak Hour Volumes
9H – 9N	2040 Build Alternative 63 – LOS and Laneage
10A – 10G	2040 Build Alternative 65 – Peak Hour Volumes
10H – 10N	2040 Build Alternative 65 – LOS and Laneage
11A – 11F	2040 Build Alternative 51 – Peak Hour Volumes
11G – 11L	2040 Build Alternative 51 – LOS and Laneage
12A – 12F	2040 Build Alternative 52 – Peak Hour Volumes
12G – 12L	2040 Build Alternative 52 – LOS and Laneage
13A – 13F	2040 Build Alternative 35 – Peak Hour Volumes
13G – 13L	2040 Build Alternative 35 – LOS and Laneage
14A – 14F	2040 Build Alternative 36 – Peak Hour Volumes
14G – 14L	2040 Build Alternative 36 – LOS and Laneage
15A – 15C	2040 Representative Build Alternative 1 – Shallow Southern Bypass – Peak Hour Volumes
15D – 15F	2040 Representative Build Alternative 1 – Shallow Southern Bypass – LOS and Laneage
16A – 16E	2040 Representative Build Alternative 65 – Peak Hour Volumes
16F – 16J	2040 Representative Build Alternative 65 – LOS and Laneage

LIST OF APPENDICES

- A R-2553 Traffic Forecast
- B 2015 No-Build Alternative – Peak Hour Traffic Volume Development and Synchro & SimTraffic Reports
- C 2040 No-Build Alternative – Peak Hour Traffic Volume Development and Synchro & SimTraffic Reports
- D 2040 Build Alternative 1 – Upgrade US 70 – Peak Hour Traffic Volume Development and FREEVAL-E, HCS, Synchro & SimTraffic Reports
- E 2040 Build Alternative 1 – Shallow Southern Bypass – Peak Hour Traffic Volume Development and FREEVAL-E, HCS, Synchro & SimTraffic Reports
- F 2040 Build Alternative 11 – Peak Hour Traffic Volume Development and FREEVAL-E, Synchro & SimTraffic Reports
- G 2040 Build Alternative 12 – Peak Hour Traffic Volume Development and FREEVAL-E, Synchro & SimTraffic Reports
- H 2040 Build Alternative 31 – Peak Hour Traffic Volume Development and FREEVAL-E, Synchro & SimTraffic Reports
- I 2040 Build Alternative 32 – Peak Hour Traffic Volume Development and FREEVAL-E, Synchro & SimTraffic Reports
- J 2040 Build Alternative 63 – Peak Hour Traffic Volume Development and FREEVAL-E, Synchro & SimTraffic Reports
- K 2040 Build Alternative 65 – Peak Hour Traffic Volume Development and FREEVAL-E, Synchro & SimTraffic Reports
- L 2040 Build Alternative 51 – Peak Hour Traffic Volume Development and FREEVAL-E, Synchro & SimTraffic Reports
- M 2040 Build Alternative 52 – Peak Hour Traffic Volume Development and FREEVAL-E, Synchro & SimTraffic Reports
- N 2040 Build Alternative 35 – Peak Hour Traffic Volume Development and FREEVAL-E, Synchro & SimTraffic Reports
- O 2040 Build Alternative 36 – Peak Hour Traffic Volume Development and FREEVAL-E, Synchro & SimTraffic Reports
- P 2040 Representative Build Alternative 1 – Shallow Southern Bypass – Peak Hour Traffic Volume Development and Synchro & SimTraffic Reports
- Q 2040 Representative Build Alternative 65 – Peak Hour Traffic Volume Development and Synchro & SimTraffic Reports

1.0 INTRODUCTION

This report summarizes the capacity analysis findings for North Carolina Department of Transportation (NCDOT) State Transportation Improvement Program (STIP) Project R-2553. Project R-2553 seeks to construct a bypass of US 70 to the south of Kinston, NC, beginning east of NC 903 near LaGrange in Lenoir County, and ending near Dover, NC in Jones County. In the vicinity of the project, US 70 serves as a primary east-west route connecting multiple towns and communities along the corridor.

The Build Alternatives include upgrading the existing US 70 corridor, as well as a series of bypass options of varying distances south of existing US 70.

2.0 SCOPE

This report includes an evaluation of the following alternatives:

- 2015 No-Build Alternative
- 2040 No-Build Alternative
- 2040 Build Alternative 1 – Upgrade US 70
- 2040 Build Alternative 1 – Shallow Southern Bypass
- 2040 Build Alternative 11
- 2040 Build Alternative 12
- 2040 Build Alternative 31
- 2040 Build Alternative 32
- 2040 Build Alternative 63
- 2040 Build Alternative 65
- 2040 Build Alternative 51
- 2040 Build Alternative 52
- 2040 Build Alternative 35
- 2040 Build Alternative 36

The 2040 build alternatives have been listed based on the distance to the south of Kinston their route takes, shortest to longest. This is also how the results of the 2040 build alternatives appear throughout this memorandum.

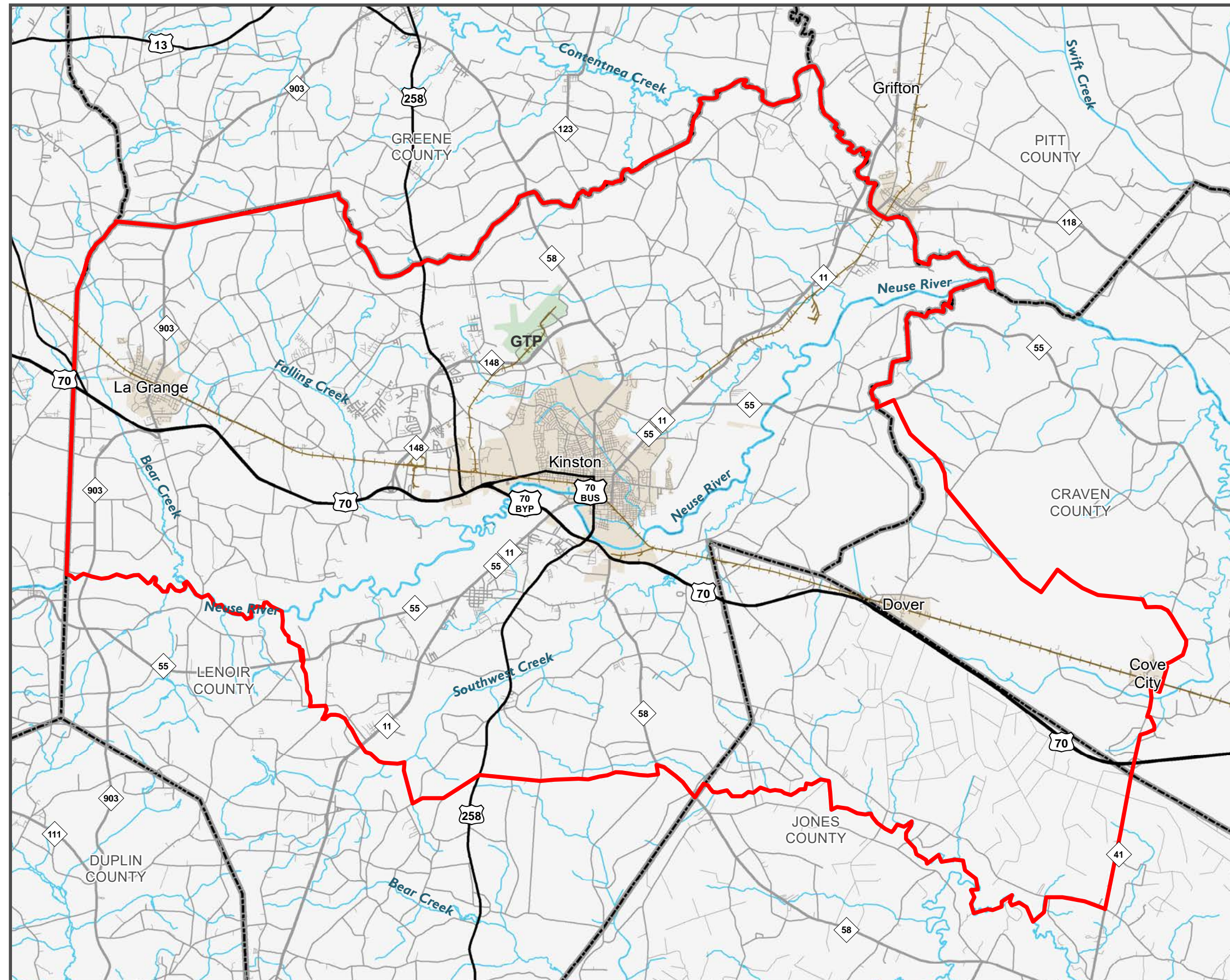
In addition to the evaluation of the alternatives, an evaluation was performed for the existing US 70 roadway, to show how it would operate in concurrence with the inclusion of the new US 70 bypass. Two 2040 Representative Build Alternatives were selected for this evaluation:

- 2040 Representative Build 1 – Shallow Southern Bypass
- 2040 Representative Build 65

The project area may be found below in **Exhibit 1**, and the various build alternative centerlines may be found in **Exhibit 2**. Using the traffic forecast information provided by the NCDOT (dated November 2016) and located in **Appendix A**, a Synchro, SimTraffic, FREEVAL-E, and Highway Capacity Software (HCS) capacity analysis was performed. Per the current scope of the project, the analysis included no-build conditions as well as build conditions with recommendations on future improvements.

This page left intentionally blank

Exhibit 1 — R-2553 Project Location



- Legend**
- Project Study Area
 - Railroad
 - US Highway
 - NC Highway
 - State Road
 - Local Road
 - Stream/River
 - Global TransPark (GTP)
 - Municipal Boundary
 - County Boundary




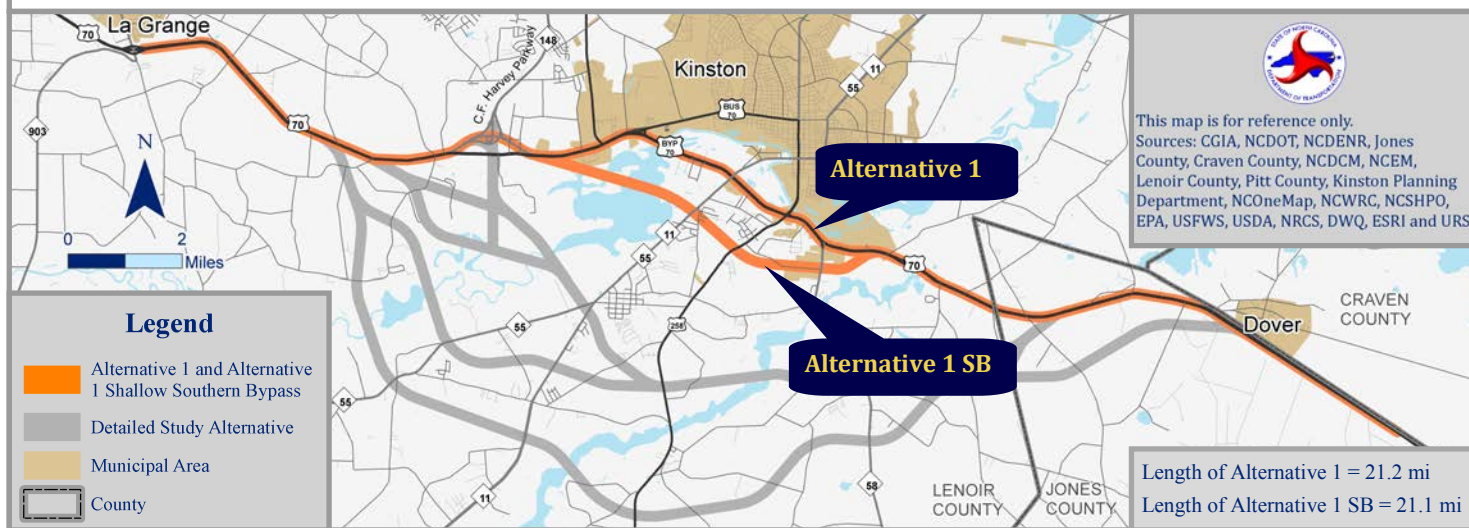

This map is for reference only.
Sources: CGIA, NCDOT, NCDENR,
Craven County, NCDCM, NCEM, Lenoir County,
Jones County, Kinston Planning Department,
NCOneMap, NCWRC, NCSHPO, EPA, USFWS,
USDA, NRCS, DWR, ESRI and AECOM

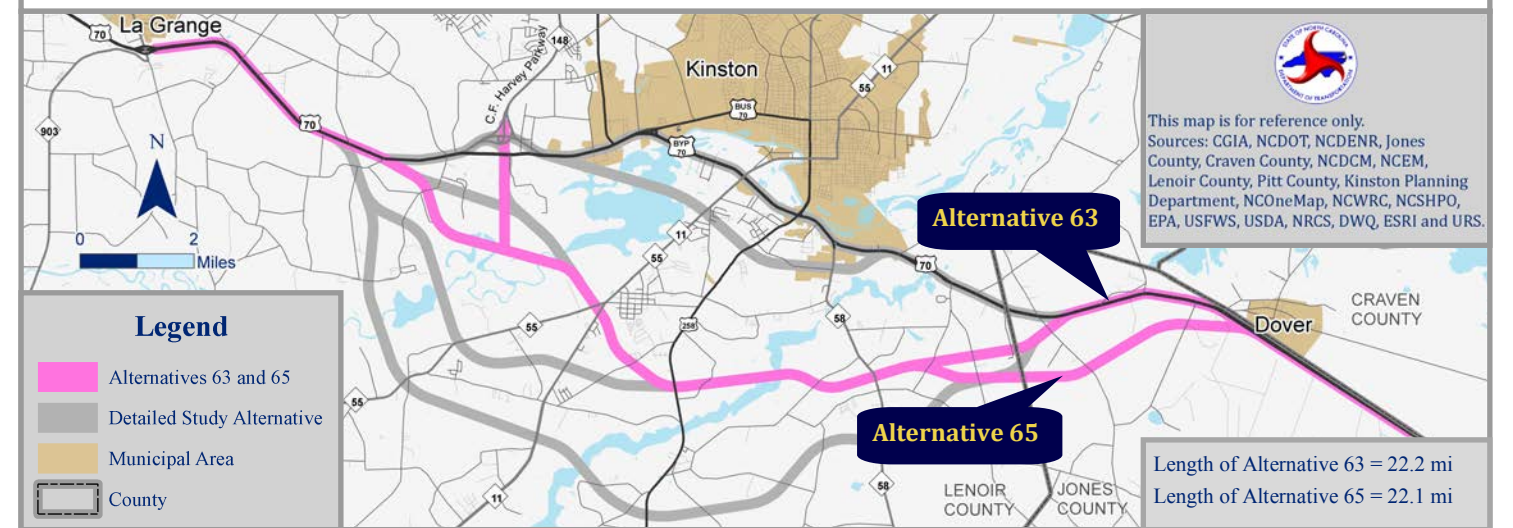


Exhibit 2 — R-2553 Build ALTERNATIVES

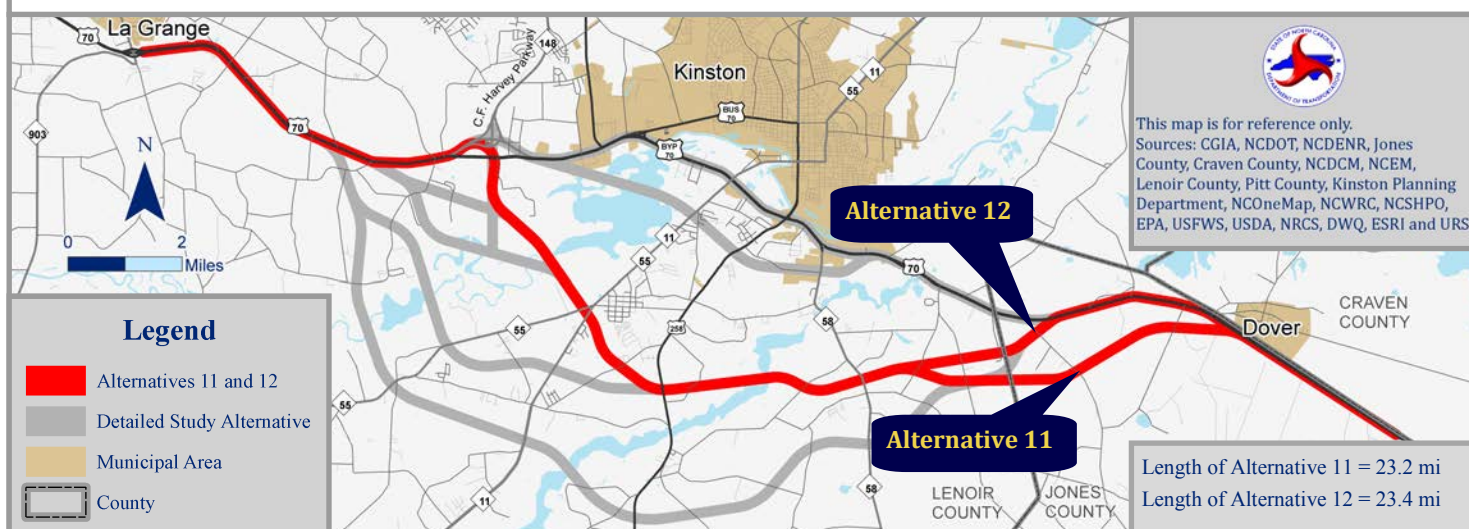
ORANGE ALIGNMENTS—ALTERNATIVES 1 & 1 SHALLOW SOUTHERN BYPASS



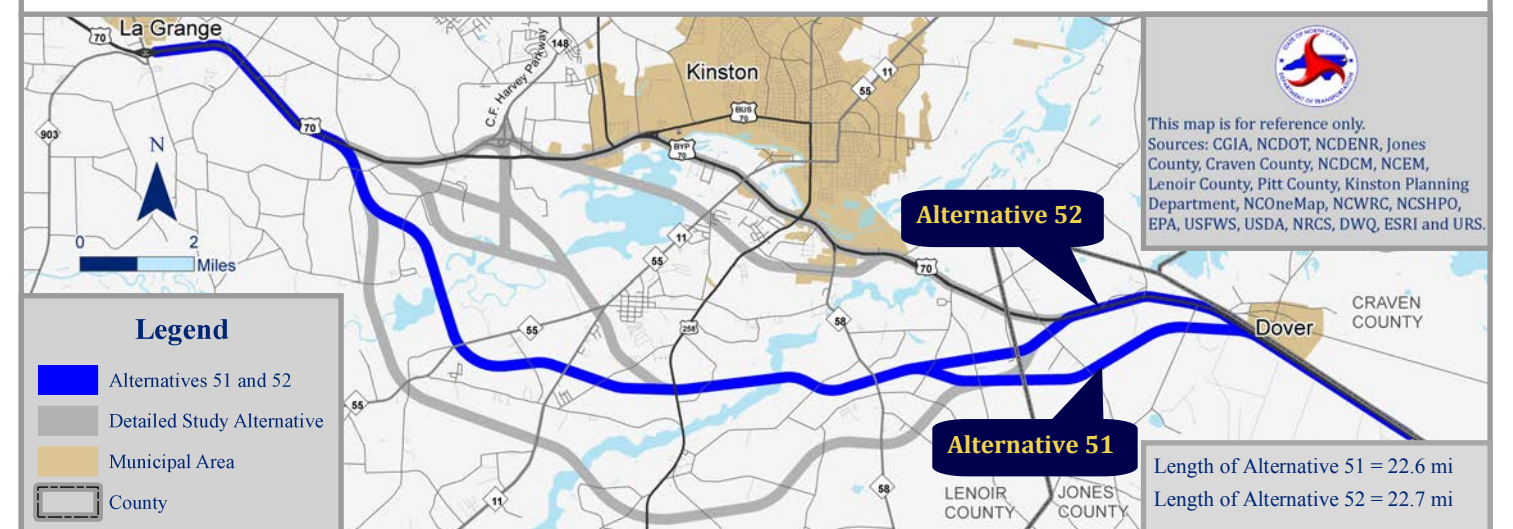
PINK ALIGNMENTS—ALTERNATIVES 63 & 65



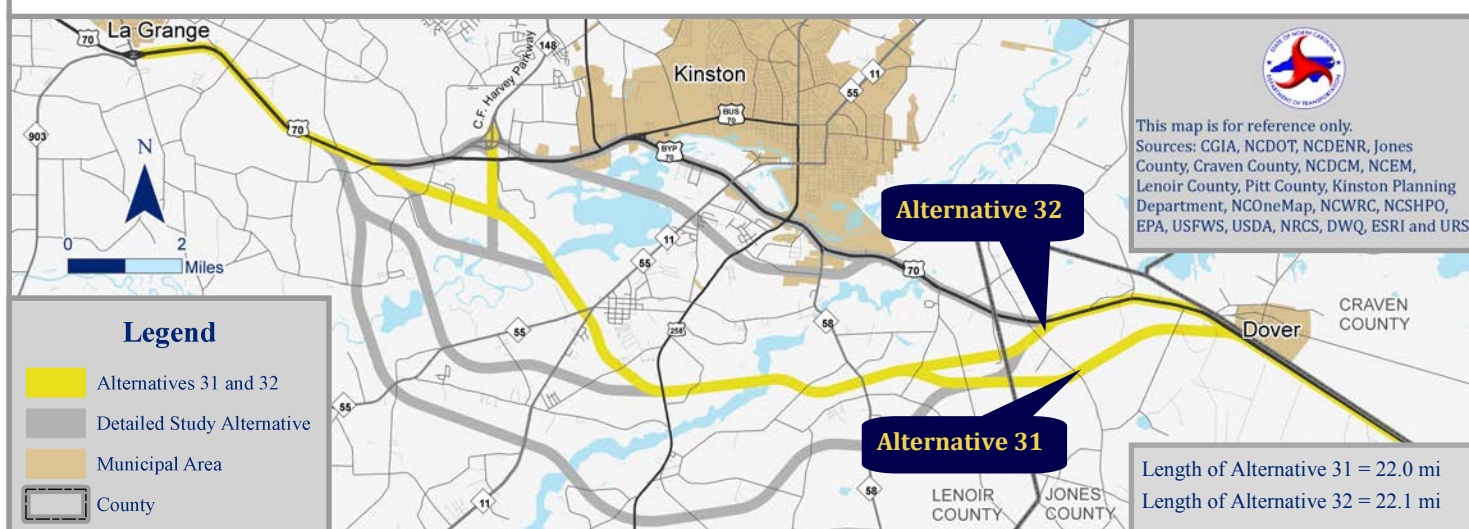
RED ALIGNMENTS—ALTERNATIVES 11 & 12



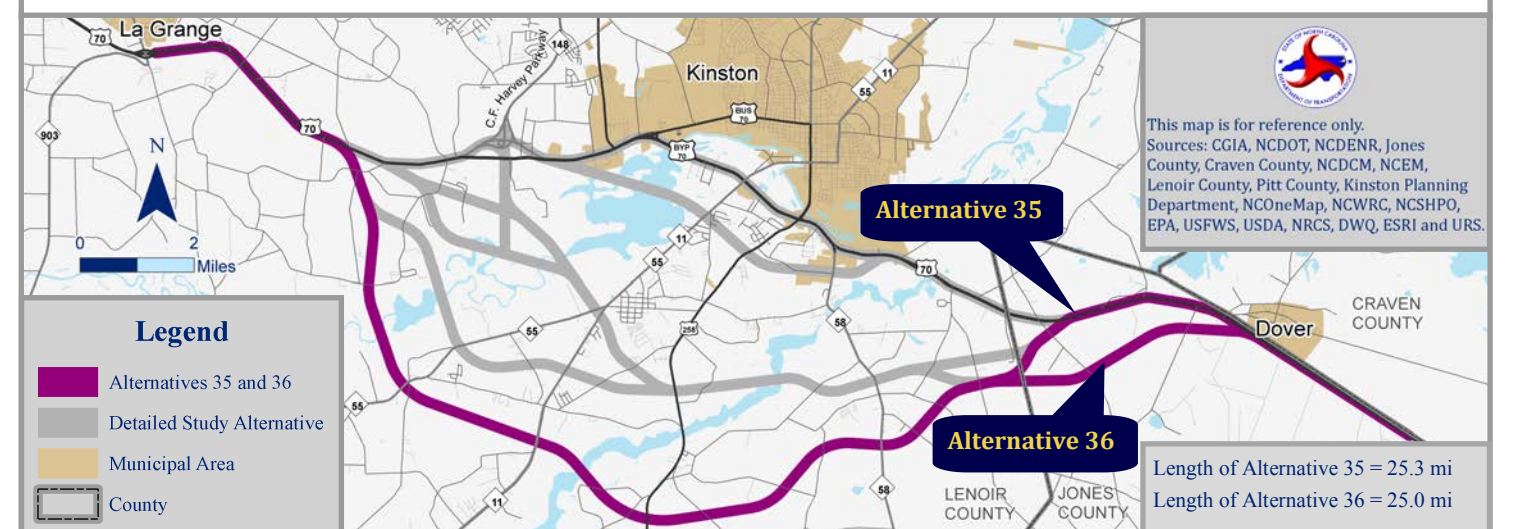
BLUE ALIGNMENTS—ALTERNATIVES 51 & 52



YELLOW ALIGNMENTS—ALTERNATIVES 31 & 32



PURPLE ALIGNMENTS—ALTERNATIVES 35 & 36



3.0 EXISTING CONDITIONS

US 70 is a primary east-west corridor. Within the nearby region of the project, US 70 provides connections between Raleigh, Goldsboro, and points west, and New Bern, Havelock, and points east. In the project vicinity, US 70 may be split into three regions:

- From the western terminus of the project to the interchange with NC 148 (CF Harvey Pkwy), US 70 is a four-lane divided rural expressway. In this section, US 70 carries 16,600 vehicles per day (VPD) west of NC 903, increasing to 21,200 VPD west of NC 148 (CF Harvey Pkwy). The speed limit in this area varies between 55 miles per hour (mph) and 70 mph, and approximately 12-15% of the traffic is heavy vehicles.
- From NC 148 (CF Harvey Pkwy) to NC 58/Trenton Hwy, US 70 operates as a four-lane divided urban corridor. In this section, US 70 carries 19,800 VPD east of NC 148 (CF Harvey Pkwy), rising to 40,000 VPD west of US 70 Bus, and dropping to 25,600 VPD west of NC 58/Trenton Hwy. The speed limit in this area varies between 45 mph and 55 mph, and approximately 9-14% of the traffic is heavy vehicles.
- From NC 58/Trenton Hwy to the eastern terminus of the project, US 70 reverts to a four-lane divided rural expressway. In this section, US 70 carries 16,400 VPD east of NC 58/Trenton Hwy, decreasing to 11,100 VPD east of SR 1005 (Kornegay St). The speed limit in this area varies between 45 mph and 55 mph, and approximately 15-21% of the traffic is heavy vehicles.

NC 903 is a two-lane undivided north-south roadway providing connections to La Grange and residential areas. It carries 4,000 VPD north of US 70, and 1,800 VPD south of SR 1002. The speed limit is 55 mph, and approximately 7-9% of the traffic is heavy vehicles.

NC 148 (CF Harvey Pkwy) is a four-lane divided north-south freeway providing access to residential communities. It carries 2,800 VPD north of US 70. The speed limit is 70 mph, and approximately 14% of the traffic is heavy vehicles.

US 258 is a primary north-south corridor providing connections to businesses and residential communities in the study area – US 258 connects with NC 148 (CF Harvey Pkwy) to the north of US 70, co-routes with US 70 for approximately 3.7 miles, and then departs to the south:

- North of US 70, US 258 is a five-lane undivided urban roadway. In this section, US 258 carries 11,800 VPD north of US 70, increasing to 14,000 VPD north of SR 1546 (Banks School Rd). The speed limit in this area is 45 mph, and approximately 7-11% of the traffic is heavy vehicles.
- South of US 70, US 258 is a two-lane undivided rural roadway. In this section, US 258 carries 10,600 VPD south of US 70, decreasing to 5,000 VPD south of SR 1139 (Clarence Potter Rd). The speed limit in this area varies between 45 mph and 55 mph, and approximately 9-13% of the traffic is heavy vehicles.

US 70 Business is a five-lane undivided east-west corridor providing access to Kinston. It carries 19,800 VPD at the western interchange with US 70, and 15,000 VPD at the eastern intersection with US 70 and US 258. Near existing US 70, the speed limit is 45 mph, and approximately 5-7% of the traffic is heavy vehicles.

NC 11/NC 55 is a five-lane undivided north-south roadway providing access to businesses and residential communities. NC 11/NC 55 carries 13,000 VPD north of US 70, and 17,000 VPD south of US 70, decreasing to 12,600 VPD north of the NC 11/NC 55 split. West of NC 11, NC 55 carries 4,800 VPD, while NC 11 carries 10,400 VPD. The speed limit varies between 45mph and 55 mph, and approximately 8-16% of the traffic is heavy vehicles.

NC 58/Trenton Hwy is a two-lane north south corridor providing access to residential communities. Trenton Hwy carries 3,400 VPD north of US 70, while NC 58 carries 11,400 VPD south of US 70, dropping to 4,900 VPD south of SR 1913 (Elijah Loftin Rd). The speed limit varies between 25 mph and 55 mph, and approximately 6-12% of the traffic is heavy vehicles.

Numerous other secondary routes access US 70 throughout the study corridor, chiefly serving to provide connectivity to residential and rural areas of Lenoir and Jones Counties. Multiple businesses and private driveways also intersect US 70. In sum, the study area spans some 21 miles through Lenoir and Jones Counties.

4.0 METHOD OF ANALYSIS

4.1 Traffic Volume Assumptions

The traffic forecast used for this project was conducted and furnished to AECOM by NCDOT (dated November 2016), as shown in **Appendix A**. Using this forecast and NCDOT's Intersection Analysis Utility (IAU) tool, AM and PM peak hour volumes were developed for all of the alternatives being evaluated. The NCDOT 2018-2027 STIP was reviewed, and one adjacent fiscally constrained project is assumed to be in place:

- R-5813 – SR 1722 (Jim Sutton Road)/SR 1252 (Willie Measley Road). Convert at-grade intersection to interchange.

The project limits of the R-2553 Project include those of the R-5813 Project. As part of the analysis for R-2553, a conversion from an at-grade intersection to an interchange is assumed, and has been evaluated in the same manner as the rest of the R-2553 Project. It is assumed that the R-5813 Project will use design recommendations from this memorandum, and will become its own standalone project from that point forward.

The IAU spreadsheets for all scenarios may be found in their respective alternative appendices, **Appendices B – Q**. Additionally, several alternatives required volume redistributions, based on existing or proposed geometries; these volume calculations and final redistributions may be found in their respective appendices.

4.2 Capacity Analysis

The highway capacity analyses performed were based on methodologies from the *Highway Capacity Manual (HCM 2010)*. Traffic modeling software used in the capacity analyses were *Synchro 9.1* and *SimTraffic 9.1 (Build 910, Rev 24)*, *FREEVAL-E Version 1.00*, and *HCS 2010 Version 6.80*. The analyses were conducted in accordance with the latest NCDOT Congestion Management Unit's *Capacity Analysis Guidelines for TIP projects*, dated July 2015.

The traffic carrying ability of a roadway is described by levels of service (LOS) that range from LOS A to LOS F. **Table 1** defines the traffic flow conditions and approximate driver comfort level at each level of service for signalized and unsignalized intersections, as well as basic freeway segments and ramp merges/diverges. Note that the delays associated with LOS for signalized intersections are different from those associated with unsignalized intersections. *HCM 2010* explains that drivers perceive that a signalized intersection is designed to carry higher traffic volumes, and therefore expect to experience greater delays at signalized intersections. A signalized intersection is described by a single LOS. Unsignalized intersections are assigned a LOS for each minor movement. Basic freeway segments and ramps are described by density (passenger cars per mile per lane (pc/mi/ln)) or volume-to-capacity (v/c) ratios.

Table 1 Level of Service (LOS) Index					
LOS	Traffic Flow Conditions	Delay (sec) Signalized Intersections	Delay (sec) Unsignalized Intersections	Basic Freeway Segment Density (pc/mi/ln)	Ramp Merge/Diverge/Weave Density (pc/mi/ln)
A	Progression is extremely favorable and most vehicles do not stop at all.	≤ 10	≤ 10	≤ 11	≤ 10
B	Good progression, some delay.	> 10 - 20	> 10 - 15	> 11 - 18	> 10 - 20
C	Fair progression, higher delay.	> 20 - 35	> 15 - 25	> 18 - 26	> 20 - 28
D	Unfavorable progression, congestion becomes apparent.	> 35 - 55	> 25 - 35	> 26 - 35	> 28 - 35
E	Poor progression, substantial delay.	> 55 - 80	> 35 - 50	> 35 - 45	> 35, and v/c < 1.0
F	Poor progression, extreme delay.	> 80	> 50	> 45, or v/c > 1.0	v/c > 1.0

Source: HCM 2010

Where practical, design elements from the current functional designs were utilized to perform the analysis. However, in order to provide as much analytical latitude to the capacity analysis as possible, several general default assumptions were used. All analysis default values and assumptions are detailed below.

The interchange configurations used in the analysis were determined by attempting to avoid and/or minimize human and natural environment resources. Where possible, partial cloverleaf interchanges were assumed to minimize impacts in two of the four interchange quadrants. Typically, the partial cloverleaf interchanges consisted of utilizing quadrants A and D, or quadrants B and C. By doing this, all ramps would be located on one side of the crossing street, leaving the other side with no impacts due to ramps.

4.2.1 FREEVAL-E Methodology

To complete the analysis of the US 70 freeway mainline, FREEVAL-E was utilized. FREEVAL-E allows all same-direction freeway elements to be analyzed concurrently in one continuous file, based on standards outlined in the HCM. FREEVAL-E does not use a Peak Hour Factor (PHF) to adjust the peak hour volumes to reflect the peak 15-minute period. Additionally, FREEVAL-E requires balanced peak hour mainline volumes, since only the beginning freeway segment

and subsequent ramps have volume inputs. Detailed volume development methodology for each alternative may be found in the respective alternative appendices.

It should be noted that the freeway mainline volumes at each end of US 70 may be slightly different in FREEVAL-E than what is shown in the peak hour volume figures (1 to 2 vehicles). This is expected, and is due to rounding during the calculations. These slight differences do not have an effect of the operations of the proposed network. Default values and assumptions for the FREEVAL-E analysis are listed below:

- Segment Length:
 - 1-lane On Ramps and Off Ramps: 1,500 feet (influence area defined in the HCM)
 - Exception: if the required acceleration or deceleration distance is longer than 1,500 feet, the segment length is assumed to be the acceleration or deceleration length
 - 2-lane On Ramps and Off Ramps: 2,500 feet (minimum length required by AASHTO)
 - Basic Freeway Segments between interchanges: distance shown between ramps in the functional designs, minus the adjacent ramp segment distances
 - Basic Freeway Segments within interchanges: 1,500 feet for partial cloverleaf interchanges, 3,000 feet for diamond interchanges, measured within system interchanges
- Terrain: Level
- Number of Mainline US 70 Lanes: 2 in each direction, unless additional are deemed necessary by the analysis
- Number of Mainline CF Harvey Parkway Extension Lanes: 2 in each direction, unless additional are deemed necessary by the analysis
- Number of lanes on ramp: determined by functional designs
- Free Flow Speed:
 - Mainline: 70 mph
 - Flyover Ramps: 60 mph
 - Directional Ramps: 45 mph
 - Loop Ramps: 25 mph
- Single Unit Truck and Bus Percentage: determined by traffic forecast – (Duals + TT-STs) / 2 (NCDOT Standard)
 - Mainline: determined by mainline Duals and TT-STs
 - Ramps: determined by Y-line Duals and TT-STs
- Driver Population Factor: 1
- Acceleration/Deceleration Length: see **Table 2**

Table 2 Acceleration/Deceleration Lane Length Index					
Freeway FFS (mph)	Ramp FFS (mph)	Taper length (ft)	Accel/Decel Length (ft)	Gore to "A" Distance (Assumed) (ft)	Distance for Analysis (ft)
Acceleration Lanes					
70	25 (loop)	300	1,420	100	1,620
70	45 (ramp)	300	820	200	920
Deceleration Lanes					
70	25 (loop)	300	550	100	750
70	45 (ramp)	300	390	200	490

Source: AASHTO Green Book (2011), Chapter 10

4.2.2 HCS Methodology

While FREEVAL-E was used for the majority of the freeway network analyses, several alternatives required the use of HCS, either due to volume or geometric issues. HCS utilizes a PHF – for the purpose of this analysis, 0.90 – to calculate peak 15-minute volumes. HCS is also able to perform analysis calculations without the need to balance the freeway network. Because of this, no volume adjustments or balancing were necessary along the portion of US 70 where HCS was utilized.

When possible for the HCS analysis, standard diverge and merge ramp types were considered, in which a deceleration or acceleration lane develops, followed by a lane departing from or adding to the freeway, respectively. These interactions result with the same number of lanes on the freeway before and after the ramp, and HCS will report LOS

Some of the geometries in the build alternative networks could not be analyzed using FREEVAL-E or HCS. Some ramp and freeway interactions occur too closely together for to be analyzed as separate segments, or certain segments have only one lane. To capture the impact of traffic on such segments, v/c checks were performed to compare how many vehicles use the segment to the number of available ramp lanes; v/c ratios are reported as two-digit decimals, with anything greater than 1.00 considered over capacity, and anything less than 0.85 considered to be acceptable from a capacity standpoint

4.2.3 At-Grade Intersection Methodology

To complete the analysis of the at-grade intersections at the ramp terminals and intersections within 1,000 feet of ramp terminals, Synchro 9 and SimTraffic 9 were utilized. These software tools allow the input of a PHF, and do not require balanced peak hour volumes; therefore, no peak-hour volume adjustments were

necessary. Generally, NCDOT Congestion Management Unit's *Capacity Analysis Guidelines for TIP projects* (dated July 2015) were used to provide framework for the analysis:

- Signal System Type: Coordinated (based on zone grouping, generally interchanges and adjacent intersections are placed in the same zone)
- Right Turn on Red: Not allowed
- Total Lost Time: 5 seconds
- Yellow Time: 5 seconds
- All Red Time: 2 seconds
- Minimum Initial Green:
 - Major street through movement: 10 – 14 seconds, depending on speed
 - All other movements: 7 seconds
- Minimum Cycle Length:
 - 2 phases: 60 seconds
 - 3 phases: 90 seconds
 - 4+ phases: 120 seconds
- Maximum Cycle Length: 180 seconds
- Saturation Flow Rate: 1,900 pc/hr/ln
- Left-Turn Treatment: Protected

A couple of deviations from the NCDOT Congestion Management Unit's *Capacity Analysis Guidelines for TIP projects* (dated July 2015) were taken in order to provide an equal comparison between all alternatives. For the purposes of this analysis, it is assumed that all intersections at interchange ramp terminals will be signalized, and that all left turns will be provided a protected phase. Once a preferred alternative is selected, a signal warrant analysis should be conducted for all intersections in the study area, and the NCDOT Congestion Management Unit's *Capacity Analysis Guidelines for TIP projects* (dated July 2015) should be utilized to determine if a left turn should be protected or permitted. Further studies may also be conducted to determine if alternative traffic control methods could be utilized, such as roundabouts.

For the queue analysis, simulation runs (using SimTraffic) were performed to analyze the queuing and blocking problems. The queue reported is the greater of the SimTraffic maximum queue and the Synchro 95th percentile queue.

5.0 RESULTS

5.1 2015 No-Build Alternative

A capacity analysis was performed for 2015 No-Build Alternative AM and PM peak periods for all of the study intersections. The existing analyses were based on signal design plans and congestion management guidelines from NCDOT (confirmed by observations in the field). This alternative serves to show how the existing roadway operates currently. As this is a no-build alternative, no freeway analysis was necessary; additionally, no storage lengths will be recommended for turn bays at intersections.

Intersection levels of service are summarized in **Table 3**, while traffic volumes are shown in **Figures 1A – 1H**, and LOS and laneage are shown in **Figures 1I – 1P**. Peak hour traffic volume development, and Synchro and SimTraffic reports are located in **Appendix B**.

Table 3 2015 No-Build Alternative Intersection Level of Service			
#	Intersection	Level of Service	
		AM Peak	PM Peak
401	Jenny Lind Rd at NC 903	-	-
	Eastbound Left / Right	B	B
	Northbound Left / Through	A	A
402	US 70 EB Ramps at NC 903	-	-
	Eastbound Left / Through	B	B
	Southbound Left	A	A
403	US 70 WB Ramps at NC 903	-	-
	Westbound Left / Through	B	B
	Northbound Left	A	A
404	US 70 at Washington St	-	-
	Eastbound Left	A	B
	Southbound Left / Right	D	D

Movements with zero delay were omitted

Table 3 (Continued) 2015 No-Build Alternative Intersection Level of Service			
#	Intersection	Level of Service	
		AM Peak	PM Peak
405	Jim Sutton Road / Willie Measley Rd at US 70	B	B
	Eastbound Left	D	D
	Eastbound Through	B	B
	Eastbound Right	B	A
	Westbound Left	D	D
	Westbound Through	B	B
	Westbound Right	B	B
	Northbound Left / Through / Right	C	C
	Southbound Left / Through / Right	D	D
406	Willie Measley Rd at Fields Station Rd	-	-
	Eastbound Left / Through / Right	B	B
	Westbound Left / Through / Right	B	B
	Northbound Left / Through / Right	A	A
	Southbound Left / Through / Right	A	A
407	Ken's Grill / Norbert Hill Rd at US 70	-	-
	Eastbound Left	A	B
	Westbound Left	B	A
	Northbound Left / Through / Right	C	C
	Southbound Left / Through / Right	C	C
408	Harold Sutton Rd at Barwick Station Rd	-	-
	Eastbound Left / Through	A	A
	Southbound Left / Right	A	A
409	Barwick Station Rd at US 70	-	-
	Westbound Left	B	A
	Northbound Left / Right	C	B
410	US 70 at Albert Sugg Rd	-	-
	Eastbound Left	A	B
	Southbound Left / Right	C	C

Movements with zero delay were omitted

Table 3 (Continued) 2015 No-Build Alternative Intersection Level of Service			
#	Intersection	Level of Service	
		AM Peak	PM Peak
411	Albert Sugg Rd at Fields Station Rd	-	-
	Eastbound Left / Through / Right	A	A
	Westbound Left / Through / Right	A	A
	Northbound Left / Through / Right	A	A
	Southbound Left / Through / Right	A	A
412	Harold Sutton Rd at US 70	-	-
	Westbound Left	B	B
	Northbound Left / Right	B	B
413	Kennedy Home Rd / Eason Rd at US 70	-	-
	Eastbound Left	B	B
	Westbound Left	B	B
	Northbound Left / Through / Right	C	C
	Southbound Left / Through / Right	D	E
414	US 70 at Banks School Rd	-	-
	Eastbound Left	B	B
	Southbound Right	B	B
415	US 70 at Innovation Way	-	-
	Southbound Right	B	B
416	Industrial Dr at Sanderson Way	-	-
	Eastbound Left / Through	A	A
	Westbound Left / Through / Right	A	A
	Northbound Left / Through	C	B
	Northbound Right	A	A
	Southbound Left	C	C
	Southbound Through / Right	C	B
417	Industrial Dr at Innovation Way	-	-
	Eastbound Left / Right	B	B
	Northbound Left	A	A
418	Industrial Dr at Smithfield Way	-	-
	Westbound Left / Through	A	A
	Northbound Left / Right	A	A

Movements with zero delay were omitted

Table 3 (Continued) 2015 No-Build Alternative Intersection Level of Service			
#	Intersection	Level of Service	
		AM Peak	PM Peak
419	Sanderson Way at US 70	-	-
	Northbound Right	B	C
420	Shopping Center Dr / Pinelawn Cemetery Dr at US 70	-	-
	Eastbound Left	A	A
	Westbound Left	B	C
	Northbound Left / Through	C	C
	Southbound Left / Through / Right	D	F
421	Sussex St / Hill Farm Rd at US 70	C	C
	Eastbound Left	B	B
	Eastbound Through	C	C
	Eastbound Right	B	B
	Westbound Left	B	C
	Westbound Through	C	C
	Westbound Right	C	B
	Northbound Left / Through	D	D
	Northbound Right	E	E
	Southbound Left	E	E
	Southbound Left / Through	E	E
	Southbound Right	C	C
422	Hill Farm Rd at Smithfield Way	-	-
	Eastbound Left / Through	B	B
	Westbound Left / Through / Right	C	B
	Northbound Left	A	A
	Southbound Left	A	A
423	Hill Farm Rd at Banks School Rd	-	-
	Westbound Left	A	A
	Northbound Left	C	C
	Northbound Right	B	B

Movements with zero delay were omitted

Table 3 (Continued) 2015 No-Build Alternative Intersection Level of Service			
#	Intersection	Level of Service	
		AM Peak	PM Peak
424	Sheffield Dr / Walmart Dr at US 70	-	-
	Eastbound Left	B	B
	Westbound Left	B	B
	Northbound Right	A	A
	Southbound Right	C	B
425	US 70 at US 258	B	B
	Eastbound Left	D	D
	Eastbound Through	A	A
	Westbound U-Turn	D	D
	Westbound Through	B	B
	Westbound Right	A	A
	Southbound Left	D	D
	Southbound Right	A	A
426	US 258 at A St	-	-
	Westbound Left	C	C
	Westbound Right	A	B
	Southbound Left	A	A
427	US 258 at Banks School Rd / Sand Clay Rd	C	C
	Eastbound Left	D	D
	Eastbound Through	C	B
	Eastbound Right	B	B
	Westbound Left	C	B
	Westbound Through / Right	C	B
	Northbound Left	D	D
	Northbound Through / Right	B	B
	Southbound Left	D	D
	Southbound Through	B	C
Southbound Right	C	C	

Movements with zero delay were omitted

Table 3 (Continued) 2015 No-Build Alternative Intersection Level of Service			
#	Intersection	Level of Service	
		AM Peak	PM Peak
428	Ruby Tuesday / Driveway at US 70	-	-
	Eastbound Left	C	B
	Westbound Left	C	C
	Northbound Right	B	B
	Southbound Right	A	A
429	US 70 at Mt Vernon Park Dr	A	A
	Eastbound Left	D	D
	Eastbound Through	A	A
	Westbound U-Turn	D	D
	Westbound Through / Right	A	A
	Southbound Left / Right	D	D
430	Hillcrest Rd at US 70 Bus	C	C
	Eastbound Left	D	D
	Eastbound Through / Right	C	C
	Westbound Left	E	E
	Westbound Through / Right	B	B
	Northbound Left / Through	D	D
	Northbound Right	E	E
	Southbound Left / Through	E	E
	Southbound Right	D	D
431	NC 55 at Green Haynes Rd	-	-
	Westbound Left / Right	B	B
	Southbound Left / Through	A	A
432	NC 55 at N Croom Bland Rd	-	-
	Eastbound Left / Right	B	B
	Northbound Left / Through	A	A
433	NC 11 at Leslie R Stroud Rd	-	-
	Eastbound Left / Right	B	B
	Northbound Left	A	A

Movements with zero delay were omitted

Table 3 (Continued) 2015 No-Build Alternative Intersection Level of Service			
#	Intersection	Level of Service	
		AM Peak	PM Peak
434	NC 11 at Green Haynes Rd / Albrittons Rd	-	-
	Eastbound Left / Through / Right	C	C
	Westbound Left / Through / Right	C	C
	Northbound Left	A	A
	Southbound Left	A	A
435	NC 11 at NC 55 / Tyree Rd	C	C
	Eastbound Left / Through	D	D
	Eastbound Right	C	C
	Westbound Left	D	D
	Westbound Through	D	D
	Westbound Right	D	C
	Northbound Left	B	B
	Northbound Through / Right	B	B
	Southbound Left	B	B
	Southbound Through / Right	B	B
436	NC 11 at Central Ave	-	-
	Westbound Left / Right	C	B
	Southbound Left	B	A
437	NC 11 at Edgewood Dr / Mary Beth Rd	-	-
	Eastbound Left / Through / Right	E	E
	Westbound Left / Through / Right	D	D
	Northbound Left	A	B
	Southbound Left	B	A
438	NC 11 at Old Asphalt Rd	-	-
	Westbound Left / Right	D	C
	Southbound Left	B	A

Movements with zero delay were omitted

Table 3 (Continued) 2015 No-Build Alternative Intersection Level of Service			
#	Intersection	Level of Service	
		AM Peak	PM Peak
439	NC 11 at US 70	D	D
	Eastbound Left	E	E
	Eastbound Through	C	D
	Eastbound Right	A	B
	Westbound Left	E	E
	Westbound Through	D	D
	Westbound Right	A	A
	Northbound Left	D	D
	Northbound Through / Right	D	D
	Southbound Left	D	D
	Southbound Through	E	D
	Southbound Right	C	C
440	US 258 at Clarence Potter Rd	-	-
	Eastbound Left / Right	B	B
	Northbound Left / Through	A	A
441	US 258 at Albrittons Rd	-	-
	Eastbound Left / Right	B	B
	Northbound Left	A	A
442	US 258 at Ferguson Ln / Collier Loftin Rd	-	-
	Eastbound Left / Through / Right	C	C
	Westbound Left / Through / Right	C	C
	Northbound Left	A	A
	Southbound Left	A	A
443	US 258 at Old Asphalt Rd	-	-
	Eastbound Left / Right	C	C
	Northbound Left	A	A

Movements with zero delay were omitted

Table 3 (Continued) 2015 No-Build Alternative Intersection Level of Service			
#	Intersection	Level of Service	
		AM Peak	PM Peak
444	US 258 / US 70 Bus at US 70	C	C
	Eastbound Left	E	D
	Eastbound Through	C	C
	Eastbound Right	A	A
	Westbound Left	E	E
	Westbound Through	B	B
	Westbound Right	A	A
	Northbound Left	D	D
	Northbound Through	D	D
	Northbound Right	B	C
	Southbound Left	D	D
	Southbound Through / Right	D	D
445	Meadowbrook Dr / Family Dollar Driveway at US 70	A	A
	Eastbound Left	A	A
	Eastbound Through / Right	A	A
	Westbound Left	A	A
	Westbound Through / Right	A	A
	Northbound Left	E	E
	Northbound Through / Right	D	D
	Southbound Left / Through / Right	D	D
446	NC 58 at Elijah Loftin Rd	-	-
	Eastbound Left / Through / Right	B	B
	Westbound Left / Through / Right	B	B
	Northbound Left / Through / Right	A	A
	Southbound Left / Through / Right	A	A
447	NC 58 at Woodington Rd	-	-
	Eastbound Left / Right	B	B
	Northbound Left	A	A
448	NC 58 at Will Baker Rd	-	-
	Eastbound Left / Right	B	B
	Northbound Left	A	A

Movements with zero delay were omitted

Table 3 (Continued) 2015 No-Build Alternative Intersection Level of Service			
#	Intersection	Level of Service	
		AM Peak	PM Peak
449	NC 58 at Collier Loftin Rd	-	-
	Eastbound Left	C	C
	Northbound Left	A	A
450	NC 58 at Lenoir CC Southern Driveway	-	-
	Southbound Left	A	A
451	NC 58 at Lenoir CC Northern Driveway	-	-
	Westbound Left	C	C
	Westbound Right	B	B
452	NC 58 / Trenton Hwy at US 70	C	C
	Eastbound Left	B	A
	Eastbound Through	B	A
	Eastbound Right	B	B
	Westbound Left	E	E
	Westbound Through / Right	C	B
	Northbound Left	E	E
	Northbound Left / Through	E	E
	Northbound Right	C	D
	Southbound Left / Through	D	E
	Southbound Right	E	E
453	US 70 at Lenoir CC Driveway	-	-
	Westbound Left	A	A
	Northbound Right	B	B
454	US 70 at Neuse Rd	-	-
	Eastbound Left	A	A
	Southbound Left / Right	B	B
455	Whaley Rd at US 70	-	-
	Westbound Left	A	A
	Northbound Left / Right	C	C

Movements with zero delay were omitted

Table 3 (Continued) 2015 No-Build Alternative Intersection Level of Service			
#	Intersection	Level of Service	
		AM Peak	PM Peak
456	US 70 at British Rd	-	-
	Eastbound Left	A	A
	Southbound Left / Right	B	B
457	Wyse Fork Rd / Caswell Rd at US 70	-	-
	Eastbound Left	A	A
	Westbound Left	A	A
	Northbound Left / Through / Right	C	C
	Southbound Left / Through / Right	B	B
458	Caswell Rd at British Rd	-	-
	Eastbound Left / Through / Right	A	A
	Westbound Left / Through / Right	A	A
	Northbound Left / Through / Right	A	A
	Southbound Left / Through / Right	A	A
459	US 70 at Tilghman Rd	-	-
	Eastbound Left	A	A
	Southbound Left / Right	B	B
460	Burkett Rd at US 70	-	-
	Westbound Left	A	A
	Northbound Left / Right	B	B
461	US 70 at Kornegay St	-	-
	Eastbound Left	A	A
	Westbound Left	A	A
	Northbound Left / Through / Right	B	B
	Southbound Left / Through / Right	B	B
462	N West St at Kornegay St	-	-
	Eastbound Left / Through / Right	A	A
	Westbound Left / Through / Right	A	A
	Northbound Left / Through / Right	A	A
	Southbound Left / Through / Right	A	A
1430	US 70 at Hillcrest Rd	-	-
	Southbound Left	F	F

Movements with zero delay were omitted

5.2 2040 No-Build Alternative

A capacity analysis was performed for 2040 No-Build Alternative AM and PM peak periods for all of the study intersections. The no-build analyses were based on signal design plans and congestion management guidelines from NCDOT. This alternative serves to show how the existing roadway will operate in the future if no improvements are made in the project area. As this is a no-build alternative, no freeway analysis was necessary; additionally, no storage lengths will be recommended for turn bays at intersections.

Intersection levels of service are summarized in **Table 4**, while traffic volumes are shown in **Figures 2A – 2H**, and LOS and laneage are shown in **Figures 2I – 2P**. Peak hour traffic volume development, and Synchro and SimTraffic reports are located in **Appendix C**.

Table 4 2040 No-Build Alternative Intersection Level of Service			
#	Intersection	Level of Service	
		AM Peak	PM Peak
401	Jenny Lind Rd at NC 903	-	-
	Eastbound Left / Right	B	B
	Northbound Left / Through	A	A
402	US 70 EB Ramps at NC 903	-	-
	Eastbound Left / Through	B	B
	Southbound Left	A	A
403	US 70 WB Ramps at NC 903	-	-
	Westbound Left / Through	B	B
	Northbound Left	A	A
404	US 70 at Washington St	-	-
	Eastbound Left	B	C
	Southbound Left / Right	F	F

Movements with zero delay were omitted

Table 4 (Continued) 2040 No-Build Alternative Intersection Level of Service			
#	Intersection	Level of Service	
		AM Peak	PM Peak
405	Jim Sutton Road / Willie Measley Rd at US 70	C	C
	Eastbound Left	E	F
	Eastbound Through	C	B
	Eastbound Right	A	A
	Westbound Left	D	D
	Westbound Through	C	C
	Westbound Right	B	A
	Northbound Left / Through / Right	D	E
	Southbound Left / Through / Right	F	F
406	Willie Measley Rd at Fields Station Rd	-	-
	Eastbound Left / Through / Right	B	B
	Westbound Left / Through / Right	B	B
	Northbound Left / Through / Right	A	A
	Southbound Left / Through / Right	A	A
407	Ken's Grill / Norbert Hill Rd at US 70	-	-
	Eastbound Left	C	C
	Westbound Left	C	C
	Northbound Left / Through / Right	F	F
	Southbound Left / Through / Right	F	F
408	Harold Sutton Rd at Barwick Station Rd	-	-
	Eastbound Left / Through	A	A
	Southbound Left / Right	A	A
409	Barwick Station Rd at US 70	-	-
	Westbound Left	C	C
	Northbound Left / Right	E	D
410	US 70 at Albert Sugg Rd	-	-
	Eastbound Left	C	C
	Southbound Left / Right	D	E

Movements with zero delay were omitted

Table 4 (Continued) 2040 No-Build Alternative Intersection Level of Service			
#	Intersection	Level of Service	
		AM Peak	PM Peak
411	Albert Sugg Rd at Fields Station Rd	-	-
	Eastbound Left / Through / Right	A	A
	Westbound Left / Through / Right	A	A
	Northbound Left / Through / Right	A	A
	Southbound Left / Through / Right	A	A
412	Harold Sutton Rd at US 70	-	-
	Westbound Left	C	C
	Northbound Left / Right	D	C
413	Kennedy Home Rd / Eason Rd at US 70	-	-
	Eastbound Left	C	C
	Westbound Left	D	C
	Northbound Left / Through / Right	F	F
	Southbound Left / Through / Right	F	F
414	US 70 at Banks School Rd	-	-
	Eastbound Left	C	D
	Southbound Right	D	D
415	US 70 at Innovation Way	-	-
	Southbound Right	C	C
416	Industrial Dr at Sanderson Way	-	-
	Eastbound Left / Through	A	A
	Westbound Left / Through / Right	A	A
	Northbound Left / Through	D	C
	Northbound Right	A	A
	Southbound Left	D	C
	Southbound Through / Right	C	B
417	Industrial Dr at Innovation Way	-	-
	Eastbound Left / Right	B	B
	Northbound Left	A	A

Movements with zero delay were omitted

Table 4 (Continued) 2040 No-Build Alternative Intersection Level of Service			
#	Intersection	Level of Service	
		AM Peak	PM Peak
418	Industrial Dr at Smithfield Way	-	-
	Westbound Left / Through	A	A
	Northbound Left / Right	B	A
419	Sanderson Way at US 70	-	-
	Northbound Right	D	F
420	Shopping Center Dr / Pinelawn Cemetery Dr at US 70	-	-
	Eastbound Left	B	B
	Westbound Left	C	D
	Northbound Left / Through	F	F
	Southbound Left / Through / Right	F	F
421	Sussex St / Hill Farm Rd at US 70	D	D
	Eastbound Left	F	E
	Eastbound Through	C	D
	Eastbound Right	B	B
	Westbound Left	E	F
	Westbound Through	D	C
	Westbound Right	B	B
	Northbound Left / Through	E	E
	Northbound Right	F	F
	Southbound Left	F	F
	Southbound Left / Through	F	F
	Southbound Right	D	C
422	Hill Farm Rd at Smithfield Way	-	-
	Eastbound Left / Through	B	B
	Westbound Left / Through / Right	C	B
	Northbound Left	A	A
	Southbound Left	A	A
423	Hill Farm Rd at Banks School Rd	-	-
	Westbound Left	A	A
	Northbound Left	D	C
	Northbound Right	B	B

Movements with zero delay were omitted

Table 4 (Continued) 2040 No-Build Alternative Intersection Level of Service			
#	Intersection	Level of Service	
		AM Peak	PM Peak
424	Sheffield Dr / Walmart Dr at US 70	-	-
	Eastbound Left	C	C
	Westbound Left	B	B
	Northbound Right	B	B
	Southbound Right	D	B
425	US 70 at US 258	C	B
	Eastbound Left	D	D
	Eastbound Through	A	A
	Westbound U-Turn	D	D
	Westbound Through	D	C
	Westbound Right	A	A
	Southbound Left	F	D
	Southbound Right	A	A
426	US 258 at A St	-	-
	Westbound Left	C	C
	Westbound Right	B	B
	Southbound Left	A	A
427	US 258 at Banks School Rd / Sand Clay Rd	C	C
	Eastbound Left	D	D
	Eastbound Through	C	B
	Eastbound Right	B	B
	Westbound Left	C	B
	Westbound Through / Right	C	B
	Northbound Left	D	D
	Northbound Through / Right	B	B
	Southbound Left	D	D
	Southbound Through	B	C
	Southbound Right	C	C

Movements with zero delay were omitted

Table 4 (Continued) 2040 No-Build Alternative Intersection Level of Service			
#	Intersection	Level of Service	
		AM Peak	PM Peak
428	Ruby Tuesday / Driveway at US 70	-	-
	Eastbound Left	C	C
	Westbound Left	C	E
	Northbound Right	B	B
	Southbound Right	B	A
429	US 70 at Mt Vernon Park Dr	B	B
	Eastbound Left	D	E
	Eastbound Through	B	B
	Westbound U-Turn	D	E
	Westbound Through / Right	A	A
	Southbound Left / Right	D	F
430	Hillcrest Rd at US 70 Bus	D	C
	Eastbound Left	D	D
	Eastbound Through / Right	D	C
	Westbound Left	E	D
	Westbound Through / Right	B	B
	Northbound Left / Through	D	D
	Northbound Right	E	E
	Southbound Left / Through	F	E
	Southbound Right	D	D
431	NC 55 at Green Haynes Rd	-	-
	Westbound Left / Right	B	B
	Southbound Left / Through	A	A
432	NC 55 at N Croom Bland Rd	-	-
	Eastbound Left / Right	B	B
	Northbound Left / Through	A	A
433	NC 11 at Leslie R Stroud Rd	-	-
	Eastbound Left / Right	B	C
	Northbound Left	A	B

Movements with zero delay were omitted

Table 4 (Continued) 2040 No-Build Alternative Intersection Level of Service			
#	Intersection	Level of Service	
		AM Peak	PM Peak
434	NC 11 at Green Haynes Rd / Albrittons Rd	-	-
	Eastbound Left / Through / Right	E	E
	Westbound Left / Through / Right	D	D
	Northbound Left	A	B
	Southbound Left	B	A
435	NC 11 at NC 55 / Tyree Rd	C	C
	Eastbound Left / Through	D	D
	Eastbound Right	C	C
	Westbound Left	D	D
	Westbound Through	D	D
	Westbound Right	D	D
	Northbound Left	B	B
	Northbound Through / Right	C	B
	Southbound Left	B	B
	Southbound Through / Right	B	C
436	NC 11 at Central Ave	-	-
	Westbound Left / Right	D	C
	Southbound Left	B	A
437	NC 11 at Edgewood Dr / Mary Beth Rd	-	-
	Eastbound Left / Through / Right	F	F
	Westbound Left / Through / Right	F	F
	Northbound Left	A	B
	Southbound Left	B	A
438	NC 11 at Old Asphalt Rd	-	-
	Westbound Left / Right	F	D
	Southbound Left	B	B

Movements with zero delay were omitted

Table 4 (Continued) 2040 No-Build Alternative Intersection Level of Service			
#	Intersection	Level of Service	
		AM Peak	PM Peak
439	NC 11 at US 70	E	E
	Eastbound Left	F	E
	Eastbound Through	D	E
	Eastbound Right	A	C
	Westbound Left	F	F
	Westbound Through	E	C
	Westbound Right	A	A
	Northbound Left	E	E
	Northbound Through / Right	F	F
	Southbound Left	E	D
	Southbound Through	F	F
	Southbound Right	E	C
440	US 258 at Clarence Potter Rd	-	-
	Eastbound Left / Right	B	B
	Northbound Left / Through	A	A
441	US 258 at Albrittons Rd	-	-
	Eastbound Left / Right	C	C
	Northbound Left	A	A
442	US 258 at Ferguson Ln / Collier Loftin Rd	-	-
	Eastbound Left / Through / Right	D	D
	Westbound Left / Through / Right	D	E
	Northbound Left	A	A
	Southbound Left	A	A
443	US 258 at Old Asphalt Rd	-	-
	Eastbound Left / Right	D	D
	Northbound Left	A	A

Movements with zero delay were omitted

Table 4 (Continued) 2040 No-Build Alternative Intersection Level of Service			
#	Intersection	Level of Service	
		AM Peak	PM Peak
444	US 258 / US 70 Bus at US 70	D	D
	Eastbound Left	F	E
	Eastbound Through	C	C
	Eastbound Right	A	A
	Westbound Left	E	F
	Westbound Through	C	B
	Westbound Right	A	A
	Northbound Left	F	E
	Northbound Through	E	E
	Northbound Right	C	D
	Southbound Left	E	E
	Southbound Through / Right	E	E
445	Meadowbrook Dr / Family Dollar Driveway at US 70	A	A
	Eastbound Left	A	A
	Eastbound Through / Right	A	A
	Westbound Left	A	A
	Westbound Through / Right	A	A
	Northbound Left	E	E
	Northbound Through / Right	D	D
	Southbound Left / Through / Right	D	D
446	NC 58 at Elijah Loftin Rd	-	-
	Eastbound Left / Through / Right	B	B
	Westbound Left / Through / Right	B	B
	Northbound Left / Through / Right	A	A
	Southbound Left / Through / Right	A	A
447	NC 58 at Woodington Rd	-	-
	Eastbound Left / Right	B	B
	Northbound Left	A	A
448	NC 58 at Will Baker Rd	-	-
	Eastbound Left / Right	C	B
	Northbound Left	A	A

Movements with zero delay were omitted

Table 4 (Continued) 2040 No-Build Alternative Intersection Level of Service			
#	Intersection	Level of Service	
		AM Peak	PM Peak
449	NC 58 at Collier Loftin Rd	-	-
	Eastbound Left	C	C
	Northbound Left	A	A
450	NC 58 at Lenoir CC Southern Driveway	-	-
	Southbound Left	A	A
451	NC 58 at Lenoir CC Northern Driveway	-	-
	Westbound Left	C	C
	Westbound Right	C	B
452	NC 58 / Trenton Hwy at US 70	D	C
	Eastbound Left	E	C
	Eastbound Through	D	B
	Eastbound Right	D	C
	Westbound Left	E	F
	Westbound Through / Right	C	C
	Northbound Left	E	F
	Northbound Left / Through	E	E
	Northbound Right	D	E
	Southbound Left / Through	E	F
	Southbound Right	E	E
453	US 70 at Lenoir CC Driveway	-	-
	Westbound Left	B	B
	Northbound Right	B	C
454	US 70 at Neuse Rd	-	-
	Eastbound Left	B	B
	Southbound Left / Right	C	C
455	Whaley Rd at US 70	-	-
	Westbound Left	B	B
	Northbound Left / Right	E	D

Movements with zero delay were omitted

Table 4 (Continued) 2040 No-Build Alternative Intersection Level of Service			
#	Intersection	Level of Service	
		AM Peak	PM Peak
456	US 70 at British Rd	-	-
	Eastbound Left	B	B
	Southbound Left / Right	C	C
457	Wyse Fork Rd / Caswell Rd at US 70	-	-
	Eastbound Left	B	B
	Westbound Left	B	B
	Northbound Left / Through / Right	E	E
	Southbound Left / Through / Right	D	D
458	Caswell Rd at British Rd	-	-
	Eastbound Left / Through / Right	A	A
	Westbound Left / Through / Right	A	A
	Northbound Left / Through / Right	A	A
	Southbound Left / Through / Right	A	A
459	US 70 at Tilghman Rd	-	-
	Eastbound Left	B	B
	Southbound Left / Right	C	C
460	Burkett Rd at US 70	-	-
	Westbound Left	B	B
	Northbound Left / Right	C	C
461	US 70 at Kornegay St	-	-
	Eastbound Left	B	B
	Westbound Left	B	B
	Northbound Left / Through / Right	C	C
	Southbound Left / Through / Right	D	C
462	N West St at Kornegay St	-	-
	Eastbound Left / Through / Right	A	A
	Westbound Left / Through / Right	A	A
	Northbound Left / Through / Right	A	A
	Southbound Left / Through / Right	A	A
1430	US 70 at Hillcrest Rd	-	-
	Southbound Left	F	F

Movements with zero delay were omitted

5.3 2040 Build Alternative 1 – Upgrade US 70

A capacity analysis was performed for 2040 Build Alternative 1 – Upgrade US 70 AM and PM peak periods for all of the study intersections and freeway elements. This alternative would upgrade existing US 70 to freeway standards with new interchanges at main crossing highways.

Intersection levels of service are summarized in **Table 5A**, freeway levels of service are summarized in **Table 5B**, and queuing and recommended storage are summarized in **Table 5C**. Traffic volumes are shown in **Figures 3A – 3G**, and LOS and laneage are shown in **Figures 3H – 3N**. Peak hour traffic volume development, and FREEVAL-E, HCS, Synchro, and SimTraffic reports are located in **Appendix D**.

Table 5A 2040 Build Alternative 1 – Upgrade US 70 Intersection Level of Service			
#	Intersection	Level of Service	
		AM Peak	PM Peak
401	Jim Sutton Rd at Service Rd	-	-
	Eastbound Left / Through / Right	B	B
	Westbound Left / Through / Right	A	A
	Northbound Left	A	A
	Southbound Left	A	A
402	US 70 EB Ramps at Jim Sutton Rd / Willie Measley Rd	C	C
	Westbound Left	D	D
	Westbound Right	B	B
	Northbound Through	B	B
	Northbound Right	A	A
	Southbound Left	C	C
	Southbound Through	A	A
403	US 70 WB Ramps at Jim Sutton Rd / Willie Measley Rd	B	B
	Westbound Left	D	D
	Westbound Right	C	C
	Northbound Through	B	B
	Northbound Right	A	A
	Southbound Left	D	C
	Southbound Through	A	A

Movements with zero delay were omitted

Table 5A (Continued)			
2040 Build Alternative 1 – Upgrade US 70			
Intersection Level of Service			
#	Intersection	Level of Service	
		AM Peak	PM Peak
404	Willie Measley Rd at Washington St / Service Rd	-	-
	Eastbound Left / Through / Right	B	B
	Westbound Left / Through / Right	D	E
	Northbound Left	A	A
	Southbound Left	A	A
405	Barwick Station Rd at Sanderson Way / Service Rd	-	-
	Eastbound Left / Through / Right	B	B
	Westbound Left / Through / Right	B	B
	Northbound Left	A	A
	Southbound Left	A	A
406	US 70 EB Ramps at Barwick Station Rd / Albert Sugg Rd	B	B
	Westbound Left	D	D
	Westbound Right	B	C
	Northbound Through	B	B
	Northbound Right	A	A
	Southbound Left	C	C
	Southbound Through	A	A
407	US 70 WB Ramps at Barwick Station Rd / Albert Sugg Rd	B	C
	Westbound Left	D	D
	Westbound Right	B	B
	Northbound Through	A	B
	Northbound Right	A	A
	Southbound Left	D	D
	Southbound Through	A	A
408	Albert Sugg Rd at Service Rd	-	-
	Eastbound Left / Through / Right	A	A
	Westbound Left / Through / Right	B	B
	Northbound Left	A	A
	Southbound Left	A	A

Movements with zero delay were omitted

Table 5A (Continued)			
2040 Build Alternative 1 – Upgrade US 70			
Intersection Level of Service			
#	Intersection	Level of Service	
		AM Peak	PM Peak
409	Industrial Dr / Sanderson Farms at Sanderson Way	-	-
	Eastbound Left	A	A
	Northbound Left / Through	B	A
	Southbound Through / Right	A	A
410	US 70 EB Ramps at Shopping Center Dr	-	-
	Eastbound Left / Through / Right	A	A
	Northbound Through / Left	B	B
	Southbound Left / Through	B	B
411	US 70 WB Ramps at Pinelawn Cemetery Dr	-	-
	Westbound Left / Through / Right	A	A
	Northbound Left / Through	A	B
	Southbound Through / Left	A	A
412	US 70 EB Ramps at Shopping Center Dr	-	-
	Eastbound Left / Right	A	A
413	US 70 WB Ramps at Hill Farm Rd	-	-
	Northbound Left / Right	A	A
414	Hill Farm Rd at Service Rd	-	-
	Westbound Left / Right	C	C
	Southbound Left / Through	A	A
415	US 70 EB Ramps at US 258 / Sussex St	B	B
	Westbound Left	C	C
	Westbound Right	B	A
	Northbound Through	B	C
	Northbound Right	A	B
	Southbound Left	C	C
	Southbound Through	A	A

Movements with zero delay were omitted

Table 5A (Continued)			
2040 Build Alternative 1 – Upgrade US 70			
Intersection Level of Service			
#	Intersection	Level of Service	
		AM Peak	PM Peak
416	US 70 WB Ramps at US 258	C	C
	Westbound Left	B	C
	Westbound Through / Right	D	D
	Northbound Left	C	C
	Northbound Through	C	A
	Southbound Through	C	C
	Southbound Right	C	C
417	US 258 at Service Rd	D	D
	Eastbound Through	E	F
	Eastbound Right	C	D
	Westbound Left	E	E
	Westbound Through	D	D
	Northbound Left	E	E
	Northbound Through	C	B
	Southbound Left	E	E
Southbound Through	C	D	
418	NC 11/ NC 55 at Service Rd	B	B
	Eastbound Left / Through / Right	E	E
	Westbound Left / Through / Right	E	E
	Northbound Left	D	D
	Northbound Through / Right	B	B
	Southbound Left	D	D
	Southbound Through / Right	A	A
419	US 70 EB Ramps at NC 11 / NC 55	B	C
	Eastbound Left	D	E
	Eastbound Right	B	C
	Northbound Left	C	C
	Northbound Through	A	A
	Southbound Through	C	D
	Southbound Right	A	A

Movements with zero delay were omitted

Table 5A (Continued)			
2040 Build Alternative 1 – Upgrade US 70			
Intersection Level of Service			
#	Intersection	Level of Service	
		AM Peak	PM Peak
420	US 70 WB Ramps at NC 11 / NC 55 / Service Rd	C	C
	Eastbound Left / Through / Right	D	D
	Westbound Left	D	E
	Westbound Through / Right	D	D
	Northbound Left	D	D
	Northbound Through	C	B
	Northbound Right	B	A
	Southbound Left	E	E
	Southbound Through / Right	B	C
421	US 70 EB Ramps at US 258	C	D
	Eastbound Left	C	B
	Eastbound Through	D	D
	Eastbound Right	D	D
	Westbound Left	E	E
	Westbound Right	C	C
	Northbound Through	D	D
	Northbound Right	B	C
	Southbound Left	C	C
	Southbound Through	A	B
422	US 70 WB Ramps at US 258 / NC 58	C	C
	Westbound Left	B	C
	Westbound Through	C	C
	Westbound Right	D	D
	Northbound Left	D	C
	Northbound Through	B	A
	Southbound Through	D	C
	Southbound Right	D	C

Movements with zero delay were omitted

Table 5A (Continued)			
2040 Build Alternative 1 – Upgrade US 70			
Intersection Level of Service			
#	Intersection	Level of Service	
		AM Peak	PM Peak
423	US 70 EB Ramps at NC 58	C	C
	Eastbound Left	C	B
	Eastbound Through	D	D
	Eastbound Right	B	B
	Northbound Left	D	C
	Northbound Through / Right	C	C
	Southbound Left	D	C
	Southbound Through / Right	C	C
424	US 70 WB Ramps at NC 58	C	C
	Westbound Left	B	B
	Westbound Through	D	C
	Westbound Right	B	B
	Northbound Through	C	C
	Northbound Right	A	A
	Southbound Left	D	C
	Southbound Through	D	C
425	US 70 EB Ramps at Wyse Fork Rd / Caswell Rd	B	C
	Westbound Left	D	D
	Westbound Right	B	B
	Northbound Through	B	B
	Northbound Right	A	A
	Southbound Left	C	C
	Southbound Through	A	A
	426	US 70 WB Ramps at Wyse Fork Rd / Caswell Rd	B
Eastbound Left		D	D
Eastbound Right		B	B
Northbound Left		C	C
Northbound Through		A	A
Southbound Through		B	B
Southbound Right		A	A

Movements with zero delay were omitted

Table 5A (Continued) 2040 Build Alternative 1 – Upgrade US 70 Intersection Level of Service			
#	Intersection	Level of Service	
		AM Peak	PM Peak
427	Burkett Rd at Wyse Fork Connector	-	-
	Eastbound Left / Through	A	A
	Southbound Left / Right	A	A
428	US 70 EB Ramps at Kornegay St	C	C
	Eastbound Left / Through	D	D
	Eastbound Right	D	D
	Northbound Through	A	A
	Northbound Right	A	A
	Southbound Left	D	D
	Southbound Through	A	A
429	US 70 Bus at Kornegay St / Service Rd	B	B
	Westbound Left / Through	D	D
	Westbound Right	D	D
	Northbound Left	C	C
	Northbound Through	A	A
	Southbound Through	A	A
	Southbound Right	A	A

Movements with zero delay were omitted

**Table 5B
2040 Build Alternative 1 – Upgrade US 70
Freeway Level of Service**

US 70 Eastbound				
#	Segment	Type	AM Peak	PM Peak
1E	W of Jim Sutton / Willie Measley	Freeway	B	B
2E	To Jim Sutton / Willie Measley	Off-Ramp	B	B
3E	Within Jim Sutton / Willie Measley Int	Freeway	B	B
4E	From Jim Sutton / Willie Measley	On-Ramp	B	B
5E	Jim Sutton / Willie Measley to Albert Sugg/Barwick Station	Freeway	B	B
6E	To Albert Sugg / Barwick Station	Off-Ramp	B	B
7E	Within Albert Sugg / Barwick Station Int	Freeway	B	B
8E	From Albert Sugg / Barwick Station	On-Ramp	B	B
9E	Albert Sugg / Barwick Station to CF Harvey Pkwy	Freeway	B	B
10E	To CF Harvey Pkwy	Off-Ramp	A	A
11E	Within CF Harvey Pkwy Int	Freeway	B	B
12E	From CF Harvey Pkwy	On-Ramp	A	A
13E	CF Harvey Pkwy to Hill Farm	Freeway	B	B
14E	To Hill Farm	Off-Ramp	B	B
15E	Ramp to Hill Farm to US 70 Bus / US 258	Freeway	B	A
16E	To US 70 Bus / US 258	Off-Ramp	B	B
17E	Within US 70 Bus / US 258	Freeway	A	A
18E	From US 70 Bus / US 258	On-Ramp	A	A
19E	US 70 Bus / US 258 to NC 11 / NC 55	Freeway	B	B
20E	To NC 11 / NC 55	Off-Ramp	B	C
21E	Within NC 11 / NC 55 Int	Freeway	A	A
22E	From NC 11 / NC 55	On-Ramp	A	B
23E	NC 11 / NC 55 to US 258 / NC 58	Freeway	A	B
24E	To US 258 / NC 58	Off-Ramp	B	B
25E	Within US 258 / NC 58 Int	Freeway	A	A
26E	From US 258	On-Ramp	A	B
27E	NC 58 to Wyse Fork	Freeway	A	A
28E	To Wyse Fork	Off-Ramp	A	B
29E	Within Wyse Fork Int	Freeway	A	A
30E	From Wyse Fork	On-Ramp	A	A
31E	Wyse fork to Kornegay	Freeway	A	A
32E	To Kornegay	Off-Ramp	A	B
33E	Within Kornegay Int	Freeway	A	A

Table 5B (Continued) 2040 Build Alternative 1 – Upgrade US 70 Freeway Level of Service				
US 70 Eastbound (Continued)				
#	Segment	Type	AM Peak	PM Peak
34E	From Kornegay	On-Ramp	A	A
35E	E of Kornegay	Freeway	A	A
US 70 Westbound				
#	Segment	Type	AM Peak	PM Peak
1W	E of Kornegay	Freeway	A	A
2W	To Kornegay	Off-Ramp	A	A
3W	Within Kornegay Int	Freeway	A	A
4W	From Kornegay	On-Ramp	A	A
5W	Kornegay to Wyse Fork	Freeway	A	A
6W	To Wyse Fork	Off-Ramp	A	A
7W	Within Wyse Fork Int	Freeway	A	A
8W	From Wyse Fork	On-Ramp	B	A
9W	Wyse Fork to US 258 / NC 58	Freeway	A	A
10W	To US 258 / NC 58	Off-Ramp	B	B
11W	Within US 258 / NC 58 Int	Freeway	A	A
12W	From US 258 / NC 58	On-Ramp	B	B
13W	US 258 / NC 58 to NC 11 / NC 55	Freeway	B	A
14W	To NC 11 / NC 55	Off-Ramp	B	B
15W	Within NC 11 / NC 55 In	Freeway	A	A
16W	From NC 11 / NC 55	On-Ramp	B	B
17W	NC 11 / NC 55 to US 70 Bus	Freeway	B	B
18W	To US 70 Bus	Off-Ramp	C	B
19W	Within US 70 Bus	Freeway	B	A
20W	US 70 Bus to US 258	Weave	B	B
21W	Within US 258 Int	Freeway	A	A
22W	From US 258	On-Ramp	B	B
23W	US 258 to Ramp to Hill Farm	Freeway	A	B
24W	From Hill Farm	On-Ramp	B	B
25W	Hill Farm to CF Harvey Pkwy	Freeway	B	B
26W	To CF Harvey Pkwy	Off-Ramp	B	B
27W	Within CF Harvey Pkwy Int	Freeway	B	B

Table 5B (Continued) 2040 Build Alternative 1 – Upgrade US 70 Freeway Level of Service				
US 70 Westbound (Continued)				
#	Segment	Type	AM Peak	PM Peak
28W	From CF Harvey Pkwy	On-Ramp	A	A
29W	CF Harvey Pkwy to Albert Sugg / Barwick Station	Freeway	B	B
30W	To Albert Sugg / Barwick Station	Off-Ramp	B	B
31W	Within Albert Sugg / Barwick Station Int	Freeway	B	B
32W	From Albert Sugg / Barwick Station	On-Ramp	A	B
33W	Albert Sugg / Barwick Station to Jim Sutton / Willie Measley	Freeway	B	B
34W	To Jim Sutton / Willie Measley	Off-Ramp	B	B
35W	Within Jim Sutton / Willie Measley Int	Freeway	B	B
36W	From Jim Sutton / Willie Measley	On-Ramp	A	B
37W	W of Jim Sutton / Willie Measley	Freeway	B	B
CF Harvey Parkway Northbound				
#	Segment	Type	AM Peak	PM Peak
1N	South of US 70	Freeway	A	A
2N	From US 70 WB	On-Ramp	A	A
3N	North of US 70	Freeway	A	A
CF Harvey Parkway Southbound (LOS and v/c Ratio Reported)				
#	Segment	Type	AM Peak	PM Peak
1S	North of US 70 Bus	Freeway	A	A
2S	To US 70 WB	Off-Ramp	A	A
3S	Ramp to US 70 WB to Ramp to US 70 EB	Isolated Ramp	0.04	0.05
US 258 / US 70 Business Eastbound Collector – Distributor (v/c Ratio Reported)				
#	Segment	Type	AM Peak	PM Peak
1CDE	Ramp from US 258 / Sussex St	Isolated Ramp	0.13	0.08
2CDE	Ramp to US 258 / Sussex St to US 70 EB	Isolated Ramp	0.20	0.17

Table 5B (Continued) 2040 Build Alternative 1 – Upgrade US 70 Freeway Level of Service				
US 258 / US 70 Business Eastbound Collector – Distributor (Continued) (v/c Ratio Reported)				
#	Segment	Type	AM Peak	PM Peak
3CDE	Ramp to US 70 EB to Ramp from US 70 EB	Isolated Ramp	0.12	0.18
4CDE	Ramp to Ramp from US 70 Bus	Isolated Ramp	0.27	0.45
5CDE	Ramp from US 70 EB to Ramp to US 70 EB	Isolated Ramp	0.32	0.35
6CDE	Ramp to Ramp from US 258 / Sussex St	Isolated Ramp	0.22	0.25

Table 5C 2040 Build Alternative 1 – Upgrade US 70 Queueing and Recommended Storage					
#	Intersection	Movement	Queue (feet)		Recommended Storage (feet)
			AM Peak	PM Peak	
401	Jim Sutton Rd at Service Rd	NBL	4	4	100
		SBL	20	8	100
402	US 70 EB Ramps at Jim Sutton Rd / Willie Measley Rd	WBL	75	116	Continuous
		WBR	157	196	200
		NBR	58	58	100
		SBL	292	267	300
403	US 70 WB Ramps at Jim Sutton Rd / Willie Measley Rd	WBL	77	93	Continuous
		WBR	237	305	325
		NBR	74	53	100
		SBL	180	160	200
404	William Measley Rd at Washington St / Service Rd	NBL	65	57	100
		SBL	16	9	100
405	Barwick Station Rd at Sanderson Way/ Service Rd	NBL	-	-	100
		SBL	38	37	100
406	US 70 EB Ramps at Barwick Station Rd / Albert Sugg Rd	WBL	107	118	Continuous
		WBR	133	172	175
		NBR	85	59	100
		SBL	152	133	175
407	US 70 WB Ramps at Barwick Station Rd / Albert Sugg Rd	WBL	140	197	Continuous
		WBR	101	134	150
		NBR	50	38	100
		SBL	152	145	175
408	Albert Sugg Rd at Service Rd	NBL	16	16	100
		SBL	8	4	100
409	Industrial Dr / Sanderson Farms at Sanderson Way	EBL	67	50	Continuous
		EBR	65	66	100
410	US 70 EB Ramps at Shopping Center Dr	EBLTR	4	-	Continuous
		NBTR	56	72	Continuous
		SBLT	30	30	Continuous
411	US 70 WB Ramps at Pinelawn Cemetery Dr	NBLT	56	68	Continuous
		SBTR	28	28	Continuous
412	US 70 EB Ramps at Sussex St	EBLR	63	56	Continuous
413	US 70 WB Ramps at Hill Farm Rd	NBLT	33	42	Continuous
414	Hill Farm Rd at Service Rd	WBLR	156	141	Continuous

The queue reported is the greater of the SimTraffic maximum queue and the Synchro 95th percentile queue.

Table 5C (Continued)					
2040 Build Alternative 1 – Upgrade US 70					
Queueing and Recommended Storage					
#	Intersection	Movement	Queue (feet)		Recommended Storage (feet)
			AM Peak	PM Peak	
415	US 70 EB Ramps at US 258 / Sussex St	WBL	91	48	100
		WBR	174	117	Continuous
		NBR	189	329	350
		SBL	205	323	325
416	US 70 WB Ramps at US 258	WBL	536	260	550
		NBL	48	82	100
		SBT	354	303	375
		SBR	137	202	225
417	US 258 at Service Rd	EBR	102	224	225
		WBL	99	153	175
		NBL	324	225	325
		SBL	152	81	175
418	NC 11 / NC 55 at Service Rd	NBL	65	30	100
		SBL	128	173	175
419	US 70 EB Ramps at NC 11 / NC 55	EBL	331	283	350
		EBR	301	695	Continuous
		NBL	282	251	300
		SBR	62	106	125
420	US 70 WB Ramps at NC 11 / NC 55 / Service Rd	WBL	213	288	300
		NBL	32	29	100
		NBR	259	292	300
		SBL	269	372	375
421	US 70 EB Ramps at US 258	EBL	143	60	150
		EBR	236	305	325
		WBL	119	133	Continuous
		WBR	130	91	150
		NBT	457	399	475
		NBR	81	97	100
		SBL	170	176	Continuous
422	US 70 WB Ramps at NC 58	WBL	98	133	150
		WBR	508	428	525
		NBL	178	172	Continuous
		SBT	286	425	450
		SBR	37	30	100

The queue reported is the greater of the SimTraffic maximum queue and the Synchro 95th percentile queue.

Table 5C (Continued)					
2040 Build Alternative 1 – Upgrade US 70					
Queueing and Recommended Storage					
#	Intersection	Movement	Queue (feet)		Recommended Storage (feet)
			AM Peak	PM Peak	
423	US 70 EB Ramps at NC 58	EBL	239	287	300
		EBR	424	502	Continuous
		NBL	156	119	225*
		NBT	214	152	225
		SBL	142	175	200
424	US 70 WB Ramps at Trenton Hwy	WBL	139	150	175
		WBR	154	108	175
		NBL	346	275	Continuous
		SBR	196	201	225
425	US 70 EB Ramps at Wyse Fork Rd / Caswell Rd	WBL	179	190	Continuous
		WBR	80	105	125
		NBR	38	42	100
		SBL	105	87	125
426	US 70 WB Ramps at Wyse Fork Rd / Caswell Rd	EBL	75	86	Continuous
		EBR	77	86	100
		NBL	196	172	200
		SBR	61	53	100
427	Burkett Rd at Wyse Fork Connector	SBLR	44	52	Continuous
428	US 70 EB Ramps at Kornegay St	EBR	79	100	125
		NBR	26	22	100
		SBL	55	61	100
429	US 70 WB Ramps at Kornegay St	WBR	65	65	100
		NBL	95	74	100
		SBR	78	46	100

The queue reported is the greater of the SimTraffic maximum queue and the Synchro 95th percentile queue.

*At Intersection 423, extra NBT lanes serve as extended queue storage for the NBL lanes at Intersection 424. The greater queue of the NBL and NBT was used to determine storage for both movements.

5.4 2040 Build Alternative 1 – Shallow Southern Bypass

A capacity analysis was performed for 2040 Build Alternative 1 – Shallow Southern Bypass AM and PM peak periods for all of the study intersections and freeway elements. This alternative would realign US 70 just south of its current alignment, departing from existing US 70 at the interchange with NC 148 (CF Harvey Parkway), and reconnecting with US 70 just east of NC 58.

Intersection levels of service are summarized in **Table 6A**, freeway levels of service are summarized in **Table 6B**, and queuing and recommended storage are summarized in **Table 6C**. Traffic volumes are shown in **Figures 4A – 4F**, and LOS and laneage are shown in **Figures 4G – 4L**. Peak hour traffic volume development, and FREEVAL-E, HCS, Synchro, and SimTraffic reports are located in **Appendix E**.

Table 6A			
2040 Build Alternative 1 – Shallow Southern Bypass			
Intersection Level of Service			
#	Intersection	Level of Service	
		AM Peak	PM Peak
401	Jim Sutton Rd at Service Rd	-	-
	Eastbound Left / Through / Right	B	B
	Westbound Left / Through / Right	A	A
	Northbound Left	A	A
	Southbound Left	A	A
402	US 70 EB Ramps at Jim Sutton Rd / Willie Measley Rd	C	C
	Westbound Left	D	D
	Westbound Right	B	B
	Northbound Through	B	B
	Northbound Right	A	A
	Southbound Left	C	C
	Southbound Through	A	A
403	US 70 WB Ramps at Jim Sutton Rd / Willie Measley Rd	B	B
	Westbound Left	D	D
	Westbound Right	C	C
	Northbound Through	B	B
	Northbound Right	A	A
	Southbound Left	D	C
	Southbound Through	A	A

Movements with zero delay were omitted

Table 6A (Continued)			
2040 Build Alternative 1 – Shallow Southern Bypass			
Intersection Level of Service			
#	Intersection	Level of Service	
		AM Peak	PM Peak
404	Willie Measley Rd at Washington St / Service Rd	-	-
	Eastbound Left / Through / Right	B	B
	Westbound Left / Through / Right	D	E
	Northbound Left	A	A
	Southbound Left	A	A
405	Barwick Station Rd at Sanderson Way / Service Rd	-	-
	Eastbound Left / Through / Right	B	B
	Westbound Left / Through / Right	A	A
	Northbound Left	A	A
	Southbound Left	A	A
406	US 70 EB Ramps at Barwick Station Rd / Albert Sugg Rd	B	B
	Westbound Left	D	D
	Westbound Right	C	C
	Northbound Through	B	B
	Northbound Right	A	A
	Southbound Left	C	C
	Southbound Through	A	A
407	US 70 WB Ramps at Barwick Station Rd / Albert Sugg Rd	B	B
	Westbound Left	D	D
	Westbound Right	C	C
	Northbound Through	A	A
	Northbound Right	A	A
	Southbound Left	D	D
	Southbound Through	A	A
408	Albert Sugg Rd at Service Rd	-	-
	Eastbound Left / Through / Right	A	A
	Westbound Left / Through / Right	B	B
	Northbound Left	A	A
	Southbound Left	A	A

Movements with zero delay were omitted

Table 6A (Continued)			
2040 Build Alternative 1 – Shallow Southern Bypass			
Intersection Level of Service			
#	Intersection	Level of Service	
		AM Peak	PM Peak
409	US 70 EB Ramp at Sanderson Way	-	-
	Westbound Left	A	A
	Northbound Right	B	B
410	US 70 Bus / CF Harvey Pkwy at Sanderson Way	-	-
	Westbound Left / Through	A	A
	Northbound Left	B	C
411	US 70 Bus at Innovation Way	-	-
	Southbound Right	A	A
412	US 70 Bus at Industrial Dr / Sanderson Way	-	-
	Eastbound Left	A	A
	Westbound Left	A	A
	Northbound Left	F	F
	Northbound Through / Right	E	C
	Southbound Left	F	F
	Southbound Through / Right	C	E
413	US 70 WB Ramps at US 70 Bus	A	A
	Eastbound Left	C	C
	Eastbound Through	A	A
	Westbound Through	A	A
	Westbound Right	A	A
	Southbound Right	C	C
414	US 70 EB Ramps at NC 11 / NC 55	C	C
	Westbound Left	D	D
	Westbound Right	B	A
	Northbound Through	C	C
	Northbound Right	A	A
	Southbound Left	D	D
	Southbound Through	A	C

Movements with zero delay were omitted

Table 6A (Continued)			
2040 Build Alternative 1 – Shallow Southern Bypass			
Intersection Level of Service			
#	Intersection	Level of Service	
		AM Peak	PM Peak
415	US 70 WB Ramps at NC 11 / NC 55	C	C
	Westbound Left	E	D
	Westbound Right	C	B
	Northbound Through	C	B
	Northbound Right	A	A
	Southbound Left	E	D
	Southbound Through	A	B
416	US 258 at Service Rd	-	-
	Westbound Left / Right	C	C
	Southbound Left / Through	A	A
417	US 70 EB Ramps at US 258	C	C
	Westbound Left	D	D
	Westbound Right	C	B
	Northbound Through	C	C
	Northbound Right	A	A
	Southbound Left	D	D
	Southbound Through	A	A
418	US 70 WB Ramps at US 258	B	B
	Westbound Left	D	D
	Westbound Right	C	B
	Northbound Through	B	B
	Northbound Right	A	A
	Southbound Left	D	D
	Southbound Through	A	A
419	US 70 EB Ramps at NC 58	B	B
	Westbound Left	C	D
	Westbound Right	B	B
	Northbound Through	B	B
	Northbound Right	A	A
	Southbound Left	D	D
	Southbound Through	A	A

Movements with zero delay were omitted

Table 6A (Continued)			
2040 Build Alternative 1 – Shallow Southern Bypass			
Intersection Level of Service			
#	Intersection	Level of Service	
		AM Peak	PM Peak
420	US 70 WB Ramps at NC 58	A	A
	Westbound Left	D	D
	Westbound Right	C	C
	Northbound Through	A	A
	Northbound Right	A	A
	Southbound Left	C	D
	Southbound Through	A	A
421	US 70 EB Ramps at Wyse Fork Rd / Caswell Rd	B	C
	Westbound Left	D	D
	Westbound Right	B	B
	Northbound Through	B	B
	Northbound Right	A	A
	Southbound Left	C	C
	Southbound Through	A	A
422	US 70 WB Ramps at Wyse Fork Rd / Caswell Rd	C	C
	Eastbound Left	D	D
	Eastbound Right	B	B
	Northbound Left	C	C
	Northbound Through	A	A
	Southbound Through	B	B
	Southbound Right	A	A
423	Burkett Rd at Wyse Fork Connector	-	-
	Eastbound Left / Through	A	A
	Southbound Left / Right	A	A
424	US 70 EB Ramps at Burkett / Kornegay St	C	C
	Eastbound Left / Through	D	D
	Eastbound Right	D	D
	Northbound Through	A	A
	Northbound Right	A	A
	Southbound Left	C	D
	Southbound Through	A	A

Movements with zero delay were omitted

Table 6A (Continued) 2040 Build Alternative 1 – Shallow Southern Bypass Intersection Level of Service			
#	Intersection	Level of Service	
		AM Peak	PM Peak
425	US 70 WB Ramps at Burkett / Kornegay St	B	B
	Westbound Left / Through	D	D
	Westbound Right	D	D
	Northbound Left	C	B
	Northbound Through	A	A
	Southbound Through	A	A
	Southbound Right	A	A

Movements with zero delay were omitted

**Table 6B
2040 Build Alternative 1 – Shallow Southern Bypass
Freeway Level of Service**

US 70 Eastbound				
#	Segment	Type	AM Peak	PM Peak
1E	W of Jim Sutton / Willie Measley	Freeway	B	B
2E	To Jim Sutton / Willie Measley	Off-Ramp	B	B
3E	Within Jim Sutton / Willie Measley Int	Freeway	B	A
4E	From Jim Sutton / Willie Measley	On-Ramp	B	B
5E	Jim Sutton / Willie Measley to Albert Sugg / Barwick Station	Freeway	B	B
6E	To Albert Sugg / Barwick Station	Off-Ramp	B	B
7E	Within Albert Sugg / Barwick Station Int	Freeway	B	B
8E	From Albert Sugg / Barwick Station	On-Ramp	B	B
9E	Albert Sugg / Barwick Station to Ramp to US 70 Bus / Sanderson Way	Freeway	B	B
10E	To US 70 Bus / Sanderson Way	Off-Ramp	B	B
11E	Ramp to US 70 Bus / Sanderson Way to Ramp to CF Harvey Pkwy NB	Freeway	A	A
12E	To CF Harvey Pkwy NB	Off-Ramp	A	A
13E	Ramp to CF Harvey Pkwy NB to Ramp from CF Harvey Pkwy SB	Freeway	A	A
14E	From CF Harvey Pkwy SB	On-Ramp	A	A
15E	CF Harvey Pkwy to Ramp from US 70 Bus WB	Freeway	A	A
16E	To US 70 Bus WB	Off-Ramp	A	A
17E	Ramp from US 70 Bus WB to Ramp from US 70 Bus EB	Freeway	A	A
18E	From US 70 Bus EB	On-Ramp	B	B
19E	US 70 Bus to NC 11 / NC 55	Freeway	A	B
20E	To NC 11 / NC 55	Off-Ramp	A	B
21E	Within NC 11 / NC 55 Int	Freeway	A	A
22E	From NC 11 / NC 55	On-Ramp	A	B
23E	NC 11 / NC 55 to US 258	Freeway	A	A
24E	To US 258	Off-Ramp	A	B
25E	Within US 258 Int	Freeway	A	A
26E	From US 258	On-Ramp	A	A
27E	US 258 to NC 58	Freeway	A	A
28E	To NC 58	Off-Ramp	A	A
29E	Within NC 58 Int	Freeway	A	A
30E	From NC 58	On-Ramp	A	A

Table 6B (Continued) 2040 Build Alternative 1 – Shallow Southern Bypass Freeway Level of Service				
US 70 Eastbound (Continued)				
#	Segment	Type	AM Peak	PM Peak
31E	NC 58 to US 70 Bus	Freeway	A	A
32E	To US 70 Bus	Off-Ramp	A	A
33E	Within US 70 Bus In	Freeway	A	A
34E	From US 70 Bus	On-Ramp	A	A
35E	US 70 Bus to Wyse Fork	Freeway	A	A
36E	To Wyse Fork	Off-Ramp	A	A
37E	Within Wyse Fork Int	Freeway	A	A
38E	From Wyse Fork	On-Ramp	A	A
39E	Wyse Fork to Burkett / Kornegay	Freeway	A	A
40E	To Burkett / Kornegay	Off-Ramp	A	B
41E	Within Burkett / Kornegay Int	Freeway	A	A
42E	From Burkett / Kornegay	On-Ramp	A	A
43E	E of Burkett / Kornegay	Freeway	A	A
US 70 Westbound				
#	Segment	Type	AM Peak	PM Peak
1W	E of Burkett / Kornegay	Freeway	A	A
2W	To Burkett / Kornegay	Off-Ramp	B	A
3W	Within Burkett / Kornegay Int	Freeway	A	A
4W	From Burkett / Kornegay	On-Ramp	A	A
5W	Burkett / Kornegay to Wyse Fork	Freeway	A	A
6W	To Wyse Fork	Off-Ramp	A	A
7W	Within Wyse Fork Int	Freeway	A	A
8W	From Wyse Fork	On-Ramp	B	A
9W	Wyse Fork to US 70 Bus	Freeway	A	A
10W	To US 70 Bus	Off-Ramp	B	A
11W	Within US 70 Bus Int	Freeway	A	A
12W	From US 70 Bus	On-Ramp	A	A
13W	US 70 Bus to NC 58	Freeway	A	A
14W	To NC 58	Off-Ramp	A	A
15W	Within NC 58 Int	Freeway	A	A
16W	From NC 58	On-Ramp	A	A
17W	NC 58 to US 258	Freeway	A	A

Table 6B (Continued) 2040 Build Alternative 1 – Shallow Southern Bypass Freeway Level of Service				
US 70 Westbound (Continued)				
#	Segment	Type	AM Peak	PM Peak
18W	To US 258	Off-Ramp	A	A
19W	Within US 258 Int	Freeway	A	A
20W	From US 258	On-Ramp	A	A
21W	US 258 to NC 11 / NC 55	Freeway	A	A
22W	To NC 11 / NC 55	Off-Ramp	B	B
23W	Within NC 11 / NC 55 Int	Freeway	A	A
24W	From NC 11 / NC 55	On-Ramp	A	A
25W	NC 11 to US 70 Bus	Freeway	B	A
26W	To US 70 Bus EB	Off-Ramp	B	B
27W	To US 70 Bus WB	Off-Ramp	A	A
28W	Within US 70 Bus Int	Freeway	A	A
29W	From US 70 Bus	On-Ramp	B	B
30W	US 70 Bus to CF Harvey Pkwy	Freeway	B	A
31W	To CF Harvey Pkwy NB	Off-Ramp	B	B
32W	Ramp from CF Harvey Pkwy NB to Ramp from CF Harvey Pkwy NB	Freeway	A	A
33W	From CF Harvey Pkwy NB	On-Ramp	A	A
34W	Ramp from CF Harvey Pkwy NB to Ramp from CF Harvey Pkwy SB	Freeway	A	A
35W	From CF Harvey Pkwy SB	On-Ramp	A	A
36W	CF Harvey Pkwy to Albert Sugg / Barwick Station	Freeway	B	B
37W	To Albert Sugg / Barwick Station	Off-Ramp	B	B
38W	Within Albert Sugg / Barwick Station Int	Freeway	A	B
39W	From Albert Sugg / Barwick Station	On-Ramp	A	B
40W	Albert Sugg / Barwick Station to Jim Sutton / Willie Measley	Freeway	B	B
41W	To Jim Sutton / Willie Measley	Off-Ramp	B	B
42W	Within Jim Sutton / Willie Measley Int	Freeway	A	B
43W	From Jim Sutton / Willie Measley	On-Ramp	A	B
44W	W of Jim Sutton / Willie Measley	Freeway	B	B

Table 6B (Continued) 2040 Build Alternative 1 – Shallow Southern Bypass Freeway Level of Service				
CF Harvey Parkway Northbound (v/c Ratio Reported)				
#	Segment	Type	AM Peak	PM Peak
1N	Ramp from US 70 WB to Ramp to US 70 Bus EB	Isolated Ramp	0.04	0.04
2N	Ramp to US 70 Bus EB	Isolated Ramp	0.03	0.04
3N	Ramp to US 70 Bus EB to CF Harvey Pkwy Ext NB	Isolated Ramp	0.06	0.04
4N	Ramp from US 70 Bus WB to Ramp from US 70 WB	Isolated Ramp	0.21	0.10
5N	North of US 70 / US 70 Bus	Isolated Segment	0.22	0.12
CF Harvey Parkway Southbound (LOS and v/c Ratio Reported)				
#	Segment	Type	AM Peak	PM Peak
1S	North of US 70 Bus	Freeway	A	A
2S	To US 70 WB	Ramp	A	A
3S	To US 70 EB	Isolated Ramp	0.05	0.11
4S	Ramp to US 70 EB to US 70 Bus	Isolated Segment	0.02	0.03

Table 6C					
2040 Build Alternative 1 – Shallow Southern Bypass					
Queueing and Recommended Storage					
#	Intersection	Movement	Queue (feet)		Recommended Storage (feet)
			AM Peak	PM Peak	
401	Jim Sutton Rd at Service Rd	NBL	4	11	100
		SBL	12	16	100
402	US 70 EB Ramps at Jim Sutton Rd / Willie Measley Rd	WBL	86	88	Continuous
		WBR	169	164	175
		NBR	56	49	100
		SBL	290	224	300
403	US 70 WB Ramps at Jim Sutton Rd / Willie Measley Rd	WBL	81	98	Continuous
		WBR	198	271	275
		NBR	76	50	100
		SBL	176	185	200
404	William Measley Rd at Washington St / Service Rd	NBL	72	46	100
		SBL	20	7	100
405	Barwick Station Rd at Sanderson Way / Service Rd	NBL	11	7	100
		SBL	23	32	100
406	US 70 EB Ramps at Barwick Station Rd / Albert Sugg Rd	WBL	95	117	Continuous
		WBR	136	151	175
		NBR	61	54	100
		SBL	183	99	200
407	US 70 WB Ramps at Barwick Station Rd / Albert Sugg Rd	WBL	94	130	Continuous
		WBR	112	167	175
		NBR	67	36	100
		SBL	192	142	200
408	Albert Sugg Rd at Service Rd	NBL	13	8	100
		SBL	8	15	100
409	US 70 EB Ramp at Sanderson Way	WBL	47	55	Continuous
		NBR	58	48	Continuous
410	US 70 Bus / CF Harvey Pkwy at Sanderson Way	NBL	28	23	Continuous
		NBR	168	258	275
411	US 70 Bus at Innovation Way	SBR	1	1	Continuous
412	US 70 Bus at Industrial Dr / Sanderson Farms	EBL	51	43	100
		EBTR	11	16	100
		WBL	45	65	100
		NBL	91	66	100
		SBL	71	128	150
413	US 70 WB Ramps at US 70 Bus	EBL	91	92	100
		WBR	191	160	200
		SBR	103	79	Continuous

The queue reported is the greater of the SimTraffic maximum queue and the Synchro 95th percentile queue.

Table 6C (Continued)					
2040 Build Alternative 1 – Shallow Southern Bypass					
Queueing and Recommended Storage					
#	Intersection	Movement	Queue (feet)		Recommended Storage (feet)
			AM Peak	PM Peak	
414	US 70 EB Ramps at NC 11 / NC 55	WBL	311	518	Continuous
		WBR	214	181	225
		NBR	123	92	125
		SBL	211	267	275
415	US 70 WB Ramps at NC 11 / NC 55 / Service Rd	WBL	232	249	Continuous
		WBR	306	156	325
		NBR	190	92	Continuous
		SBL	279	247	300
416	US 258 at Service Rd	WBLR	22	23	Continuous
417	US 70 EB Ramps at US 258	WBL	265	370	Continuous
		WBR	223	200	225
		NBR	49	65	100
		SBL	104	158	175
418	US 70 WB Ramps at US 258	WBL	93	96	Continuous
		WBR	129	128	150
		NBR	157	117	175
		SBL	238	263	275
419	US 70 EB Ramps at NC 58	WBL	106	131	Continuous
		WBR	69	61	100
		NBR	66	50	100
		SBL	120	147	150
420	US 70 WB Ramps at NC 58	WBL	104	138	Continuous
		WBR	164	92	175
		NBR	42	28	100
		SBL	62	69	100
421	US 70 EB Ramps at Wyse Fork Rd / Caswell Rd	WBL	133	179	Continuous
		WBR	55	82	100
		NBR	30	38	100
		SBL	100	95	125
422	US 70 WB Ramps at Wyse Fork Rd / Caswell Rd	EBL	95	109	Continuous
		EBR	89	86	100
		NBL	181	167	200
		SBR	54	38	100
423	Burkett Rd at Wyse Fork Connector	SBLR	43	46	Continuous
424	US 70 EB Ramps at Kornegay St	EBR	62	104	125
		NBR	30	22	100
		SBL	105	70	125

The queue reported is the greater of the SimTraffic maximum queue and the Synchro 95th percentile queue.

Table 6C (Continued) 2040 Build Alternative 1 – Shallow Southern Bypass Queueing and Recommended Storage					
#	Intersection	Movement	Queue (feet)		Recommended Storage (feet)
			AM Peak	PM Peak	
425	US 70 WB Ramps at Kornegay St	WBR	69	84	100
		NBL	96	80	100
		SBR	58	52	100

The queue reported is the greater of the SimTraffic maximum queue and the Synchro 95th percentile queue.

5.5 2040 Build Alternative 11

A capacity analysis was performed for 2040 Build Alternative 11 AM and PM peak periods for all of the study intersections and freeway elements. Intersection levels of service are summarized in **Table 7A**, freeway levels of service are summarized in **Table 7B**, and queuing and recommended storage are summarized in **Table 7C**. Traffic volumes are shown in **Figures 5A – 5F**, and LOS and laneage are shown in **Figures 5G – 5L**. Peak hour traffic volume development, and FREEVAL-E, Synchro, and SimTraffic reports are located in **Appendix F**.

Table 7A 2040 Build Alternative 11 Intersection Level of Service			
#	Intersection	Level of Service	
		AM Peak	PM Peak
401	Jim Sutton Rd at Service Rd	-	-
	Eastbound Left / Through / Right	B	B
	Westbound Left / Through / Right	A	A
	Northbound Left	A	A
	Southbound Left	A	A
402	US 70 EB Ramps at Jim Sutton Rd / Willie Measley Rd	C	C
	Westbound Left	D	D
	Westbound Right	B	B
	Northbound Through	B	B
	Northbound Right	A	A
	Southbound Left	C	C
	Southbound Through	A	A
403	US 70 WB Ramps at Jim Sutton Rd / Willie Measley Rd	B	B
	Westbound Left	D	D
	Westbound Right	C	C
	Northbound Through	B	B
	Northbound Right	A	A
	Southbound Left	D	C
	Southbound Through	A	A

Movements with zero delay were omitted

Table 7A (Continued) 2040 Build Alternative 11 Intersection Level of Service			
#	Intersection	Level of Service	
		AM Peak	PM Peak
404	Willie Measley Rd at Washington St / Service Rd	-	-
	Eastbound Left / Through / Right	B	B
	Westbound Left / Through / Right	D	E
	Northbound Left	A	A
	Southbound Left	A	A
405	Barwick Station Rd at Sanderson Way / Service Rd	-	-
	Eastbound Left / Through / Right	B	B
	Westbound Left / Through / Right	A	A
	Northbound Left	A	A
	Southbound Left	A	A
406	US 70 EB Ramps at Barwick Station Rd / Albert Sugg Rd	B	B
	Westbound Left	D	D
	Westbound Right	C	C
	Northbound Through	B	A
	Northbound Right	A	A
	Southbound Left	C	C
	Southbound Through	A	A
407	US 70 WB Ramps at Barwick Station Rd / Albert Sugg Rd	B	C
	Westbound Left	D	D
	Westbound Right	B	B
	Northbound Through	A	A
	Northbound Right	A	A
	Southbound Left	D	D
	Southbound Through	A	A
408	Albert Sugg Rd at Service Rd	-	-
	Eastbound Left / Through / Right	A	A
	Westbound Left / Through / Right	B	B
	Northbound Left	A	A
	Southbound Left	A	A

Movements with zero delay were omitted

Table 7A (Continued) 2040 Build Alternative 11 Intersection Level of Service			
#	Intersection	Level of Service	
		AM Peak	PM Peak
409	US 70 Bus at Innovation Way	-	-
	Southbound Right	B	B
410	NC 11 at NC 55	C	B
	Eastbound Left	E	E
	Eastbound Right	C	C
	Northbound Left	E	D
	Northbound Through	C	A
	Southbound Through	B	B
	Southbound Right	A	A
411	US 70 EB Ramps at NC 11 / NC 55	D	B
	Westbound Left	F	D
	Westbound Right	D	B
	Northbound Through	D	B
	Northbound Right	A	A
	Southbound Left	E	C
	Southbound Through	A	B
412	US 70 WB Ramps at NC 11 / NC 55	B	C
	Eastbound Left	E	D
	Eastbound Right	D	C
	Northbound Left	D	D
	Northbound Through	A	A
	Southbound Through	C	C
	Southbound Right	B	A
413	US 70 EB Ramps at US 258	C	C
	Westbound Left	D	D
	Westbound Right	B	B
	Northbound Through	B	C
	Northbound Right	A	A
	Southbound Left	D	D
	Southbound Through	A	A

Movements with zero delay were omitted

Table 7A (Continued) 2040 Build Alternative 11 Intersection Level of Service			
#	Intersection	Level of Service	
		AM Peak	PM Peak
414	US 70 WB Ramps at US 258	A	B
	Northbound Left	C	D
	Southbound Left	B	B
	Northbound Through	A	A
	Northbound Right	A	A
	Northbound Left	D	D
	Southbound Left	A	A
415	NC 58 at SR 1913 (Elijah Loftin Rd)	-	-
	Eastbound Left / Through / Right	B	B
	Westbound Left / Through / Right	B	B
	Northbound Left	A	A
	Southbound Left	A	A
416	US 70 EB Ramps at NC 58	A	A
	Eastbound Left	D	D
	Eastbound Right	C	C
	Northbound Left	D	D
	Northbound Through	A	A
	Southbound Through	A	A
	Southbound Right	A	A
417	US 70 WB Ramps at NC 58	A	A
	Eastbound Left	D	D
	Eastbound Right	C	C
	Northbound Left	D	D
	Northbound Through	A	A
	Southbound Through	A	A
	Southbound Right	A	A

Movements with zero delay were omitted

Table 7A (Continued) 2040 Build Alternative 11 Intersection Level of Service			
#	Intersection	Level of Service	
		AM Peak	PM Peak
418	US 70 EB Ramps at Wyse Fork Rd	B	B
	Eastbound Left	D	D
	Eastbound Right	C	C
	Northbound Left	D	D
	Northbound Through	A	A
	Southbound Through	A	A
	Southbound Right	A	A
419	US 70 WB Ramps at Wyse Fork Rd	B	B
	Eastbound Left	D	D
	Eastbound Right	C	C
	Northbound Left	C	C
	Northbound Through	A	A
	Southbound Through	A	A
	Southbound Right	A	A
420	US 70 Bus at Kornegay St / Service Rd	-	-
	Eastbound Left	A	A
	Westbound Left	A	A
	Northbound Left / Through / Right	C	C
	Southbound Left / Through / Right	C	C

Movements with zero delay were omitted

Table 7B 2040 Build Alternative 11 Freeway Level of Service				
US 70 Eastbound				
#	Segment	Type	AM Peak	PM Peak
1E	W of Jim Sutton / Willie Measley	Freeway	B	B
2E	To Jim Sutton / Willie Measley	Off-Ramp	B	B
3E	Within Jim Sutton / Willie Measley Int	Freeway	B	A
4E	From Jim Sutton / Willie Measley	On-Ramp	B	B
5E	Jim Sutton / Willie Measley to Albert Sugg / Barwick Station	Freeway	B	B
6E	To Albert Sugg / Barwick Station	Off-Ramp	B	B
7E	Within Albert Sugg / Barwick Station Int	Freeway	B	B
8E	From Albert Sugg / Barwick Station	On-Ramp	B	B
9E	Albert Sugg / Barwick Station to US 70 Bus / CF Harvey Pkwy	Freeway	B	B
10E	To US 70 Bus / CF Harvey Pkwy	Off-Ramp	A	A
11E	Within US 70 Bus / CF Harvey Pkwy	Freeway	A	A
12E	From US 70 Bus / CF Harvey Pkwy	On-Ramp	A	A
13E	US 70 Bus / CF Harvey Pkwy to NC 11	Freeway	A	A
14E	To NC 11	Off-Ramp	A	A
15E	Within NC 11 Int	Freeway	A	A
16E	From NC 11	On-Ramp	A	A
17E	NC 11 to US 258	Freeway	A	A
18E	To US 258	Off-Ramp	A	A
19E	Within US 258 Int	Freeway	A	A
20E	From US 258	On-Ramp	A	A
21E	US 258 to NC 58	Freeway	A	A
22E	To NC 58	Off-Ramp	A	A
23E	Within NC 58 Int	Freeway	A	A
24E	From NC 58	On-Ramp	A	A
25E	NC 58 to Wyse Fork	Freeway	A	A
26E	To Wyse Fork	Off-Ramp	A	A
27E	Within Wyse Fork Int	Freeway	A	A
28E	From Wyse Fork	On-Ramp	A	A
29E	Wyse fork to US 70 Bus (E)	Freeway	A	A
30E	To US 70 Bus (E)	Off-Ramp	A	A
31E	Within US 70 Bus (E) Int	Freeway	A	A

Table 7B (Continued) 2040 Build Alternative 11 Freeway Level of Service				
US 70 Eastbound (Continued)				
#	Segment	Type	AM Peak	PM Peak
32E	From US 70 Bus (E)	On-Ramp	A	A
33E	E of US 70 Bus (E)	Freeway	A	A
US 70 Westbound				
#	Segment	Type	AM Peak	PM Peak
1W	E of US 70 Bus (E)	Freeway	A	A
2W	To US 70 Bus (E)	Off-Ramp	A	A
3W	Within US 70 Bus (E) Int	Freeway	A	A
4W	From US 70 Bus (E)	On-Ramp	A	A
5W	US 70 Bus (E) to Wyse Fork	Freeway	A	A
6W	To Wyse Fork	Off-Ramp	A	A
7W	Within Wyse Fork Int	Freeway	A	A
8W	From Wyse Fork	On-Ramp	A	A
9W	Wyse Fork to NC 58	Freeway	A	A
10W	To NC 58	Off-Ramp	A	A
11W	Within NC 58 Int	Freeway	A	A
12W	From NC 58	On-Ramp	A	A
13W	NC 58 to US 258	Freeway	A	A
14W	To US 258	Off-Ramp	A	A
15W	Within US 258 Int	Freeway	A	A
16W	From US 258	On-Ramp	A	A
17W	US 258 to NC 11	Freeway	A	A
18W	To NC 11	Off-Ramp	A	A
19W	Within NC 11 Int	Freeway	A	A
20W	From NC 11	On-Ramp	A	A
21W	NC 11 to US 70 Bus / CF Harvey Pkwy	Freeway	A	A
22W	To US 70 Bus / CF Harvey Pkwy	Off-Ramp	A	A
23W	Within US 70 Bus / CF Harvey Pkwy Int	Freeway	A	A
24W	From US 70 Bus / CF Harvey Pkwy	On-Ramp	A	A
25W	US 70 Bus / CF Harvey Pkwy to Albert Sugg / Barwick Station	Freeway	B	B
26W	To Albert Sugg / Barwick Station	Off-Ramp	B	B
27W	Within Albert Sugg / Barwick Station Int	Freeway	B	B

Table 7B (Continued) 2040 Build Alternative 11 Freeway Level of Service				
US 70 Westbound (Continued)				
#	Segment	Type	AM Peak	PM Peak
28W	From Albert Sugg / Barwick Station	On-Ramp	A	B
29W	Albert Sugg / Barwick Station to Jim Sutton / Willie Measley	Freeway	B	B
30W	To Jim Sutton / Willie Measley	Off-Ramp	B	B
31W	Within Jim Sutton / Willie Measley Int	Freeway	A	B
32W	From Jim Sutton / Willie Measley	On-Ramp	A	A
33W	W of Jim Sutton / Willie Measley	Freeway	B	B
CF Harvey Parkway Northbound (v/c Ratio Reported)				
#	Segment	Type	AM Peak	PM Peak
1N	Ramp from US 70 WB to Ramp to US 70 Bus EB	Isolated Ramp	0.09	0.05
2N	Ramp to US 70 Bus EB	Isolated Ramp	0.11	0.08
3N	Ramp to US 70 Bus EB to CF Harvey Pkwy Ext NB	Isolated Ramp	0.06	0.03
4N	Ramp from US 70 Bus WB to Ramp from US 70 WB	Isolated Ramp	0.18	0.10
5N	North of US 70/US 70 Bus	Isolated Segment	0.21	0.11
CF Harvey Parkway Southbound				
#	Segment	Type	AM Peak	PM Peak
1S	North of US 70 Bus	Freeway	A	A
2S	To US 70 WB	Off-Ramp	A	A
3S	Ramp to US 70 WB to US 70 Bus Weave	Freeway	A	A
4S	US 70 Bus Weave	Weave	A	A
5S	US 70 Bus Weave to US 70 EB	Freeway	A	A

Table 7C 2040 Build Alternative 11 Queueing and Recommended Storage					
#	Intersection	Movement	Queue (feet)		Recommended Storage (feet)
			AM Peak	PM Peak	
401	Jim Sutton Rd at Service Rd	NBL	-	8	100
		SBL	20	17	100
402	US 70 EB Ramps at Jim Sutton Rd / Willie Measley Rd	WBL	72	109	Continuous
		WBR	150	179	200
		NBR	56	48	100
		SBL	286	251	300
403	US 70 WB Ramps at Jim Sutton Rd / Willie Measley Rd	WBL	60	117	Continuous
		WBR	229	269	275
		NBR	69	62	100
		SBL	173	167	175
404	William Measley Rd at Washington St / Service Rd	NBL	59	71	100
		SBL	15	12	100
405	Barwick Station Rd at Sanderson Way/ Service Rd	NBL	-	10	100
		SBL	37	47	100
406	US 70 EB Ramps at Barwick Station Rd / Albert Sugg Rd	WBL	98	106	Continuous
		WBR	125	177	200
		NBR	92	79	100
		SBL	132	117	150
407	US 70 WB Ramps at Barwick Station Rd / Albert Sugg Rd	WBL	141	201	Continuous
		WBR	117	140	150
		NBR	31	31	100
		SBL	176	148	200
408	Albert Sugg Rd at Service Rd	NBL	33	14	100
		SBL	14	24	100
409	US 70 Bus at Innovation Way	WBR	-	-	300
		SBR	36	27	Continuous
410	NC 11 at NC 55	EBL	454	260	Continuous
		EBR	50	31	100
		NBL	49	38	100
		SBR	59	84	100
411	US 70 EB Ramps at NC 11 / NC 55	WBL	413	370	Continuous
		WBR	134	95	150
		NBR	59	96	100
		SBL	84	94	100

The queue reported is the greater of the SimTraffic maximum queue and the Synchro 95th percentile queue.

Table 7C (Continued) 2040 Build Alternative 11 Queueing and Recommended Storage					
#	Intersection	Movement	Queue (feet)		Recommended Storage (feet)
			AM Peak	PM Peak	
412	S 70 WB Ramps at NC 11 / NC 55	EBL	129	78	Continuous
		EBR	232	195	250
		NBL	454	286	475
		SBR	79	76	100
413	US 70 EB Ramps at US 258	WBL	255	304	Continuous
		WBR	133	107	150
		NBR	39	42	100
		SBL	54	78	100
414	US 70 WB Ramps at US 258	WBL	85	97	Continuous
		WBR	55	53	100
		NBR	149	117	150
		SBL	147	167	175
415	NC 58 at SR 1913 (Elijah Loftin Rd)	NBL	12	20	100
		SBL	21	23	100
416	US 70 EB Ramps at NC 58	EBL	57	59	Continuous
		EBR	66	72	100
		NBL	60	67	100
		SBR	4	28	100
417	US 70 WB Ramps at NC 58	EBL	34	34	Continuous
		EBR	64	69	100
		NBL	86	66	100
		SBR	20	31	100
418	US 70 EB Ramps at Wyse Fork Rd	EBL	43	38	Continuous
		EBR	53	61	100
		NBL	52	45	100
		SBR	20	21	100
419	US 70 WB Ramps at Wyse Fork Rd	EBL	51	37	Continuous
		EBR	57	55	100
		NBL	74	56	100
		SBR	5	12	100
420	US 70 Bus at Kornegay St	EBL	53	58	100
		WBL	19	12	100

The queue reported is the greater of the SimTraffic maximum queue and the Synchro 95th percentile queue.

5.6 2040 Build Alternative 12

A capacity analysis was performed for 2040 Build Alternative 12 AM and PM peak periods for all of the study intersections and freeway elements. Intersection levels of service are summarized in **Table 8A**, freeway levels of service are summarized in **Table 8B**, and queuing and recommended storage are summarized in **Table 8C**. Traffic volumes are shown in **Figures 6A – 6F**, and LOS and laneage are shown in **Figures 6G – 6L**. Peak hour traffic volume development, and FREEVAL-E, Synchro, and SimTraffic reports are located in **Appendix G**.

Table 8A 2040 Build Alternative 12 Intersection Level of Service			
#	Intersection	Level of Service	
		AM Peak	PM Peak
401	Jim Sutton Rd at Service Rd	-	-
	Eastbound Left / Through / Right	B	B
	Westbound Left / Through / Right	A	A
	Northbound Left	A	A
	Southbound Left	A	A
402	US 70 EB Ramps at Jim Sutton Rd / Willie Measley Rd	C	C
	Westbound Left	D	D
	Westbound Right	B	B
	Northbound Through	B	B
	Northbound Right	A	A
	Southbound Left	C	C
	Southbound Through	A	A
403	US 70 WB Ramps at Jim Sutton Rd / Willie Measley Rd	B	B
	Westbound Left	D	D
	Westbound Right	C	C
	Northbound Through	B	B
	Northbound Right	A	A
	Southbound Left	D	C
	Southbound Through	A	A

Movements with zero delay were omitted

Table 8A (Continued)			
2040 Build Alternative 12			
Intersection Level of Service			
#	Intersection	Level of Service	
		AM Peak	PM Peak
404	Willie Measley Rd at Washington St / Service Rd	-	-
	Eastbound Left / Through / Right	B	B
	Westbound Left / Through / Right	D	E
	Northbound Left	A	A
	Southbound Left	A	A
405	Barwick Station Rd at Sanderson Way / Service Rd	-	-
	Eastbound Left / Through / Right	B	B
	Westbound Left / Through / Right	A	A
	Northbound Left	A	A
	Southbound Left	A	A
406	US 70 EB Ramps at Barwick Station Rd / Albert Sugg Rd	B	B
	Westbound Left	D	D
	Westbound Right	C	C
	Northbound Through	B	A
	Northbound Right	A	A
	Southbound Left	C	C
	Southbound Through	A	A
407	US 70 WB Ramps at Barwick Station Rd / Albert Sugg Rd	B	C
	Westbound Left	D	D
	Westbound Right	B	B
	Northbound Through	A	A
	Northbound Right	A	A
	Southbound Left	D	D
	Southbound Through	A	A
408	Albert Sugg Rd at Service Rd	-	-
	Eastbound Left / Through / Right	A	A
	Westbound Left / Through / Right	B	B
	Northbound Left	A	A
	Southbound Left	A	A

Movements with zero delay were omitted

Table 8A (Continued) 2040 Build Alternative 12 Intersection Level of Service			
#	Intersection	Level of Service	
		AM Peak	PM Peak
409	US 70 Bus at Innovation Way	-	-
	Southbound Right	B	B
410	NC 11 at NC 55	C	B
	Eastbound Left	E	E
	Eastbound Right	C	C
	Northbound Left	E	D
	Northbound Through	C	A
	Southbound Through	B	B
	Southbound Right	A	A
411	US 70 EB Ramps at NC 11 / NC 55	D	B
	Westbound Left	F	D
	Westbound Right	D	B
	Northbound Through	D	B
	Northbound Right	A	A
	Southbound Left	E	C
	Southbound Through	A	B
412	US 70 WB Ramps at NC 11 / NC 55	B	C
	Eastbound Left	E	D
	Eastbound Right	D	C
	Northbound Left	D	D
	Northbound Through	A	A
	Southbound Through	C	C
	Southbound Right	B	A
413	US 70 EB Ramps at US 258	C	C
	Westbound Left	D	D
	Westbound Right	B	B
	Northbound Through	B	C
	Northbound Right	A	A
	Southbound Left	D	D
	Southbound Through	A	A

Movements with zero delay were omitted

Table 8A (Continued)			
2040 Build Alternative 12			
Intersection Level of Service			
#	Intersection	Level of Service	
		AM Peak	PM Peak
414	US 70 WB Ramps at US 258	A	B
	Northbound Left	C	D
	Southbound Left	B	B
	Northbound Through	A	A
	Northbound Right	A	A
	Northbound Left	D	D
	Southbound Left	A	A
415	NC 58 at SR 1913 (Elijah Loftin Rd)	-	-
	Eastbound Left / Through / Right	B	B
	Westbound Left / Through / Right	B	B
	Northbound Left	A	A
	Southbound Left	A	A
416	US 70 EB Ramps at NC 58	A	A
	Eastbound Left	D	D
	Eastbound Right	C	C
	Northbound Left	D	D
	Northbound Through	A	A
	Southbound Through	A	A
	Southbound Right	A	A
417	US 70 WB Ramps at NC 58	A	A
	Eastbound Left	D	D
	Eastbound Right	C	C
	Northbound Left	D	D
	Northbound Through	A	A
	Southbound Through	A	A
	Southbound Right	A	A
418	US 70 Bus at SR 1002 (Wyse Fork Rd)	-	-
	Westbound Left	A	A
	Northbound Left / Right	B	B

Movements with zero delay were omitted

Table 8A (Continued) 2040 Build Alternative 12 Intersection Level of Service			
#	Intersection	Level of Service	
		AM Peak	PM Peak
419	Burkett Rd at Wyse Fork Connector	-	-
	Eastbound Left / Through	A	A
	Southbound Left / Right	A	A
420	US 70 EB Ramps at Burkett / Kornegay St	C	C
	Eastbound Left / Through	D	D
	Eastbound Right	C	C
	Northbound Through	A	A
	Northbound Right	A	A
	Southbound Left	D	C
	Southbound Through	A	A
421	US 70 WB Ramps at Burkett / Kornegay St	B	A
	Westbound Left / Through	D	D
	Westbound Right	D	D
	Northbound Left	C	B
	Northbound Through	A	A
	Southbound Through	A	A
	Southbound Right	A	A

Movements with zero delay were omitted

Table 8B 2040 Build Alternative 12 Freeway Level of Service				
US 70 Eastbound				
#	Segment	Type	AM Peak	PM Peak
1E	W of Jim Sutton / Willie Measley	Freeway	B	B
2E	To Jim Sutton / Willie Measley	Off-Ramp	B	B
3E	Within Jim Sutton / Willie Measley Int	Freeway	B	A
4E	From Jim Sutton / Willie Measley	On-Ramp	B	B
5E	Jim Sutton / Willie Measley to Albert Sugg / Barwick Station	Freeway	B	B
6E	To Albert Sugg / Barwick Station	Off-Ramp	B	B
7E	Within Albert Sugg / Barwick Station Int	Freeway	B	B
8E	From Albert Sugg / Barwick Station	On-Ramp	B	B
9E	Albert Sugg / Barwick Station to US 70 Bus / CF Harvey Pkwy	Freeway	B	B
10E	To US 70 Bus / CF Harvey Pkwy	Off-Ramp	A	A
11E	Within US 70 Bus / CF Harvey Pkwy Int	Freeway	A	A
12E	From US 70 Bus / CF Harvey Pkwy	On-Ramp	A	A
13E	US 70 Bus / CF Harvey Pkwy to NC 11	Freeway	A	A
14E	To NC 11	Off-Ramp	A	A
15E	Within NC 11 Int	Freeway	A	A
16E	From NC 11	On-Ramp	A	A
17E	NC 11 to US 258	Freeway	A	A
18E	To US 258	Off-Ramp	A	A
19E	Within US 258 Int	Freeway	A	A
20E	From US 258	On-Ramp	A	A
21E	US 258 to NC 58	Freeway	A	A
22E	To NC 58	Off-Ramp	A	A
23E	Within NC 58 Int	Freeway	A	A
24E	From NC 58	On-Ramp	A	A
25E	NC 58 to US 70 Bus (E)	Freeway	A	A
26E	To US 70 Bus (E)	Off-Ramp	A	A
27E	Within US 70 Bus (E) Int	Freeway	A	A
28E	From US 70 Bus (E)	On-Ramp	A	A
29E	US 70 Bus (E) to Burkett / Kornegay	Freeway	A	A
30E	To Burkett / Kornegay	Off-Ramp	A	B
31E	Within Burkett / Kornegay Int	Freeway	A	A

Table 8B (Continued) 2040 Build Alternative 12 Freeway Level of Service				
US 70 Eastbound (Continued)				
#	Segment	Type	AM Peak	PM Peak
32E	From Burkett / Kornegay	On-Ramp	A	A
33E	E of Burkett / Kornegay	Freeway	A	A
US 70 Westbound				
#	Segment	Type	AM Peak	PM Peak
1W	E of Burkett / Kornegay	Freeway	A	A
2W	To Burkett / Kornegay	Off-Ramp	A	A
3W	Within Burkett / Kornegay Int	Freeway	A	A
4W	From Burkett / Kornegay	On-Ramp	A	A
5W	Burkett / Kornegay to US 70 Bus (E)	Freeway	A	A
6W	To US 70 Bus (E)	Off-Ramp	B	A
7W	Within US 70 Bus (E) Int	Freeway	A	A
8W	From US 70 Bus (E)	On-Ramp	A	A
9W	US 70 Bus (E) to NC 58	Freeway	A	A
10W	To NC 58	Off-Ramp	A	A
11W	Within NC 58 Int	Freeway	A	A
12W	From NC 58	On-Ramp	A	A
13W	NC 58 to US 258	Freeway	A	A
14W	To US 258	Off-Ramp	A	A
15W	Within US 258 Int	Freeway	A	A
16W	From US 258	On-Ramp	A	A
17W	US 258 to NC 11	Freeway	A	A
18W	To NC 11	Off-Ramp	A	A
19W	Within NC 11 Int	Freeway	A	A
20W	From NC 11	On-Ramp	A	A
21W	NC 11 to US 70 Bus / CF Harvey Pkwy	Freeway	A	A
22W	To US 70 Bus / CF Harvey Pkwy	Off-Ramp	A	A
23W	Within US 70 Bus / CF Harvey Pkwy Int	Freeway	A	A
24W	From US 70 Bus / CF Harvey Pkwy	On-Ramp	A	A
25W	US 70 Bus / CF Harvey Pkwy to Albert Sugg / Barwick Station	Freeway	B	B
26W	To Albert Sugg / Barwick Station	Off-Ramp	B	B
27W	Within Albert Sugg / Barwick Station Int	Freeway	B	B

Table 8B (Continued) 2040 Build Alternative 12 Freeway Level of Service				
US 70 Westbound (Continued)				
#	Segment	Type	AM Peak	PM Peak
28W	From Albert Sugg / Barwick Station	On-Ramp	A	B
29W	Albert Sugg / Barwick Station to Jim Sutton / Willie Measley	Freeway	B	B
30W	To Jim Sutton / Willie Measley	Off-Ramp	B	B
31W	Within Jim Sutton / Willie Measley Int	Freeway	A	B
32W	From Jim Sutton / Willie Measley	On-Ramp	A	A
33W	W of Jim Sutton / Willie Measley	Freeway	B	B
CF Harvey Parkway Northbound (v/c Ratio Reported)				
#	Segment	Type	AM Peak	PM Peak
1N	Ramp from US 70 WB to Ramp to US 70 Bus EB	Isolated Ramp	0.09	0.05
2N	Ramp to US 70 Bus EB	Isolated Ramp	0.11	0.08
3N	Ramp to US 70 Bus EB to CF Harvey Pkwy Ext NB	Isolated Ramp	0.06	0.03
4N	Ramp from US 70 Bus WB to Ramp from US 70 WB	Isolated Ramp	0.18	0.10
5N	North of US 70/US 70 Bus	Isolated Segment	0.21	0.11
CF Harvey Parkway Southbound				
#	Segment	Type	AM Peak	PM Peak
1S	North of US 70 Bus	Freeway	A	A
2S	To US 70 WB	Off-Ramp	A	A
3S	Ramp to US 70 WB to US 70 Bus Weave	Freeway	A	A
4S	US 70 Bus Weave	Weave	A	A
5S	US 70 Bus Weave to US 70 EB	Freeway	A	A

Table 8C 2040 Build Alternative 12 Queueing and Recommended Storage					
#	Intersection	Movement	Queue (feet)		Recommended Storage (feet)
			AM Peak	PM Peak	
401	Jim Sutton Rd at Service Rd	NBL	-	8	100
		SBL	20	17	100
402	US 70 EB Ramps at Jim Sutton Rd / Willie Measley Rd	WBL	72	109	Continuous
		WBR	150	179	200
		NBR	56	48	100
		SBL	286	251	300
403	US 70 WB Ramps at Jim Sutton Rd / Willie Measley Rd	WBL	60	117	Continuous
		WBR	229	269	275
		NBR	69	62	100
		SBL	173	167	175
404	William Measley Rd at Washington St / Service Rd	NBL	59	71	100
		SBL	15	12	100
405	Barwick Station Rd at Sanderson Way/ Service Rd	NBL	-	10	100
		SBL	37	47	100
406	US 70 EB Ramps at Barwick Station Rd / Albert Sugg Rd	WBL	98	106	Continuous
		WBR	125	177	200
		NBR	92	79	100
		SBL	132	117	150
407	US 70 WB Ramps at Barwick Station Rd / Albert Sugg Rd	WBL	141	201	Continuous
		WBR	117	140	150
		NBR	31	31	100
		SBL	176	148	200
408	Albert Sugg Rd at Service Rd	NBL	33	14	100
		SBL	14	24	100
409	US 70 Bus at Innovation Way	WBR	-	-	300
		SBR	36	27	Continuous
410	NC 11 at NC 55	EBL	454	260	Continuous
		EBR	50	31	100
		NBL	49	38	100
		SBR	59	84	100
411	US 70 EB Ramps at NC 11 / NC 55	WBL	413	370	Continuous
		WBR	134	95	150
		NBR	59	96	100
		SBL	84	94	100

The queue reported is the greater of the SimTraffic maximum queue and the Synchro 95th percentile queue.

Table 8C (Continued) 2040 Build Alternative 12 Queueing and Recommended Storage					
#	Intersection	Movement	Queue (feet)		Recommended Storage (feet)
			AM Peak	PM Peak	
412	S 70 WB Ramps at NC 11 / NC 55	EBL	129	78	Continuous
		EBR	232	195	250
		NBL	454	286	475
		SBR	79	76	100
413	US 70 EB Ramps at US 258	WBL	255	304	Continuous
		WBR	133	107	150
		NBR	39	42	100
		SBL	54	78	100
414	US 70 WB Ramps at US 258	WBL	85	97	Continuous
		WBR	55	53	100
		NBR	149	117	150
		SBL	147	167	175
415	NC 58 at SR 1913 (Elijah Loftin Rd)	NBL	12	20	100
		SBL	21	23	100
416	US 70 EB Ramps at NC 58	EBL	57	59	Continuous
		EBR	66	72	100
		NBL	60	67	100
		SBR	4	28	100
417	US 70 WB Ramps at NC 58	EBL	34	34	Continuous
		EBR	64	69	100
		NBL	86	66	100
		SBR	20	31	100
418	US 70 Bus at Wyse Fork Rd	EBR	4	-	100
		WBL	50	54	100
419	Burkett Rd at Wyse Fork Connector	SBLR	47	40	Continuous
420	US 70 EB Ramps at Burkett Rd / Kornegay St	EBR	32	65	100
		NBR	22	18	100
		SBL	65	41	100
421	US 70 WB Ramps at Burkett Rd / Kornegay St	WBR	65	73	100
		NBL	64	55	100
		SBR	78	58	100

The queue reported is the greater of the SimTraffic maximum queue and the Synchro 95th percentile queue.

5.7 2040 Build Alternative 31

A capacity analysis was performed for 2040 Build Alternative 31 AM and PM peak periods for all of the study intersections and freeway elements. Intersection levels of service are summarized in **Table 9A**, freeway levels of service are summarized in **Table 9B**, and queuing and recommended storage are summarized in **Table 9C**. Traffic volumes are shown in **Figures 7A – 7G**, and LOS and laneage are shown in **Figures 7H – 7N**. Peak hour traffic volume development, and FREEVAL-E, Synchro, and SimTraffic reports are located in **Appendix H**.

Table 9A 2040 Build Alternative 31 Intersection Level of Service			
#	Intersection	Level of Service	
		AM Peak	PM Peak
401	Jim Sutton Rd at Service Rd	-	-
	Eastbound Left / Through / Right	B	B
	Westbound Left / Through / Right	A	A
	Northbound Left	A	A
	Southbound Left	A	A
402	US 70 EB Ramps at Jim Sutton Rd / Willie Measley Rd	C	C
	Westbound Left	D	D
	Westbound Right	B	B
	Northbound Through	B	B
	Northbound Right	A	A
	Southbound Left	C	C
	Southbound Through	A	A
403	US 70 WB Ramps at Jim Sutton Rd / Willie Measley Rd	B	B
	Westbound Left	D	D
	Westbound Right	C	C
	Northbound Through	B	B
	Northbound Right	A	A
	Southbound Left	C	C
	Southbound Through	A	A

Movements with zero delay were omitted

Table 9A (Continued)			
2040 Build Alternative 31			
Intersection Level of Service			
#	Intersection	Level of Service	
		AM Peak	PM Peak
404	Willie Measley Rd at Washington St / Service Rd	-	-
	Eastbound Left / Through / Right	B	B
	Westbound Left / Through / Right	E	E
	Northbound Left	A	A
	Southbound Left	A	A
405	US 70 Bus at Innovation Way	-	-
	Southbound Right	B	B
406	NC 11 at NC 55	C	B
	Eastbound Left	E	E
	Eastbound Right	C	C
	Northbound Left	E	D
	Northbound Through	C	A
	Southbound Through	B	B
	Southbound Right	A	A
407	US 70 EB Ramps at NC 11 / NC 55	C	B
	Westbound Left	F	D
	Westbound Right	D	B
	Northbound Through	D	B
	Northbound Right	A	A
	Southbound Left	E	C
	Southbound Through	A	A
408	US 70 WB Ramps at NC 11 / NC 55	B	C
	Eastbound Left	E	D
	Eastbound Right	D	C
	Northbound Left	D	D
	Northbound Through	A	A
	Southbound Through	B	C
	Southbound Right	A	A

Movements with zero delay were omitted

Table 9A (Continued)			
2040 Build Alternative 31			
Intersection Level of Service			
#	Intersection	Level of Service	
		AM Peak	PM Peak
409	US 70 EB Ramps at US 258	C	C
	Westbound Left	D	D
	Westbound Right	B	B
	Northbound Through	B	B
	Northbound Right	A	A
	Southbound Left	D	C
	Southbound Through	A	A
410	US 70 WB Ramps at US 258	B	B
	Northbound Left	C	D
	Southbound Left	B	B
	Northbound Through	A	A
	Northbound Right	A	A
	Northbound Left	D	D
	Southbound Left	A	A
411	NC 58 at SR 1913 (Elijah Loftin Rd)	-	-
	Eastbound Left / Through / Right	B	B
	Westbound Left / Through / Right	B	B
	Northbound Left	A	A
	Southbound Left	A	A
412	US 70 EB Ramps at NC 58	A	A
	Eastbound Left	D	D
	Eastbound Right	C	C
	Northbound Left	D	D
	Northbound Through	A	A
	Southbound Through	A	A
	Southbound Right	A	A

Movements with zero delay were omitted

Table 9A (Continued)			
2040 Build Alternative 31			
Intersection Level of Service			
#	Intersection	Level of Service	
		AM Peak	PM Peak
413	US 70 WB Ramps at NC 58	A	A
	Eastbound Left	D	D
	Eastbound Right	C	C
	Northbound Left	D	D
	Northbound Through	A	A
	Southbound Through	A	A
	Southbound Right	A	A
414	US 70 EB Ramps at Wyse Fork Rd	B	B
	Eastbound Left	D	D
	Eastbound Right	C	C
	Northbound Left	D	D
	Northbound Through	A	A
	Southbound Through	A	A
	Southbound Right	A	A
415	US 70 WB Ramps at Wyse Fork Rd	B	B
	Eastbound Left	D	D
	Eastbound Right	C	C
	Northbound Left	C	C
	Northbound Through	A	A
	Southbound Through	A	A
	Southbound Right	A	A
416	US 70 Bus at Kornegay St / Service Rd	-	-
	Eastbound Left	A	A
	Westbound Left	A	A
	Northbound Left / Through / Right	C	C
	Southbound Left / Through / Right	C	C

Movements with zero delay were omitted

Table 9B 2040 Build Alternative 31 Freeway Level of Service				
US 70 Eastbound				
#	Segment	Type	AM Peak	PM Peak
1E	W of Jim Sutton / Willie Measley	Freeway	B	B
2E	To Jim Sutton / Willie Measley	Off-Ramp	B	B
3E	Within Jim Sutton / Willie Measley Int	Freeway	B	A
4E	From Jim Sutton / Willie Measley	On-Ramp	B	B
5E	Jim Sutton / Willie Measley to US 70 Bus (W)	Freeway	B	B
6E	To US 70 Bus (W)	Off-Ramp	A	A
7E	US 70 Bus (W) to CF Harvey Pkwy	Freeway	A	A
8E	From CF Harvey Pkwy	On-Ramp	A	A
9E	CF Harvey Pkwy to NC 11	Freeway	A	A
10E	To NC 11	Off-Ramp	A	A
11E	Within NC 11 Int	Freeway	A	A
12E	From NC 11	On-Ramp	A	A
13E	NC 11 to US 258	Freeway	A	A
14E	To US 258	Off-Ramp	A	A
15E	Within US 258 Int	Freeway	A	A
16E	From US 258	On-Ramp	A	A
17E	US 258 to NC 58	Freeway	A	A
18E	To NC 58	Off-Ramp	A	A
19E	Within NC 58 Int	Freeway	A	A
20E	From NC 58	On-Ramp	A	A
21E	NC 58 to Wyse Fork	Freeway	A	A
22E	To Wyse Fork	Off-Ramp	A	A
23E	Within Wyse Fork Int	Freeway	A	A
24E	From Wyse Fork	On-Ramp	A	A
25E	Wyse fork to US 70 Bus (E)	Freeway	A	A
26E	To US 70 Bus (E)	Off-Ramp	A	A
27E	Within US 70 Bus (E) Int	Freeway	A	A
28E	From US 70 Bus (E)	On-Ramp	A	A
29E	E of US 70 Bus (E)	Freeway	A	A

Table 9B (Continued) 2040 Build Alternative 31 Freeway Level of Service				
US 70 Westbound				
#	Segment	Type	AM Peak	PM Peak
1W	E of US 70 Bus (E)	Freeway	A	A
2W	To US 70 Bus (E)	Off-Ramp	A	A
3W	Within US 70 Bus (E) Int	Freeway	A	A
4W	From US 70 Bus (E)	On-Ramp	A	A
5W	US 70 Bus (E) to Wyse Fork	Freeway	A	A
6W	To Wyse Fork	Off-Ramp	A	A
7W	Within Wyse Fork Int	Freeway	A	A
8W	From Wyse Fork	On-Ramp	A	A
9W	Wyse Fork to NC 58	Freeway	A	A
10W	To NC 58	Off-Ramp	A	A
11W	Within NC 58 Int	Freeway	A	A
12W	From NC 58	On-Ramp	A	A
13W	NC 58 to US 258	Freeway	A	A
14W	To US 258	Off-Ramp	A	A
15W	Within US 258 Int	Freeway	A	A
16W	From US 258	On-Ramp	A	A
17W	US 258 to NC 11	Freeway	A	A
18W	To NC 11	Off-Ramp	A	A
19W	Within NC 11 Int	Freeway	A	A
20W	From NC 11	On-Ramp	A	A
21W	NC 11 to CF Harvey Pkwy	Freeway	A	A
22W	To CF Harvey Pkwy	Off-Ramp	B	A
23W	CF Harvey Pkwy to US 70 Bus (W)	Freeway	A	A
24W	From US 70 Bus (W)	On-Ramp	B	B
25W	US 70 Bus (W) to Jim Sutton / Willie Measley	Freeway	B	B
26W	To Jim Sutton / Willie Measley	Off-Ramp	B	B
27W	Within Jim Sutton / Willie Measley Int	Freeway	A	B
28W	From Jim Sutton / Willie Measley	On-Ramp	A	B
29W	W of Jim Sutton / Willie Measley	Freeway	B	B

Table 9B (Continued) 2040 Build Alternative 31 Freeway Level of Service				
CF Harvey Parkway Northbound				
#	Segment	Type	AM Peak	PM Peak
1N	US 70 to US 70 Bus	Freeway	A	A
2N	To US 70 Bus EB	Off-Ramp	A	A
3N	Ramp to US 70 EB to Ramp to US 70 Bus WB	Freeway	A	A
4N	To US 70 Bus WB	Off-Ramp	A	A
5N	Ramp to US 70 Bus WB to Ramp from US 70 Bus	Freeway	A	A
6N	From US 70 Bus	On-Ramp	A	A
7N	North of US 70 Bus	Freeway	A	A
CF Harvey Parkway Southbound				
#	Segment	Type	AM Peak	PM Peak
1S	North of US 70 Bus	Freeway	A	A
2S	To US 70 Bus WB	Off-Ramp	A	A
3S	Ramp to US 70 Bus WB to US 70 Bus Weave	Freeway	A	A
4S	US 70 Bus Weave	Weave	A	A
5S	US 70 Bus Weave to Ramp from US 70 Bus EB	Freeway	A	A
6S	From US 70 Bus EB	On-Ramp	A	A
7S	US 70 Bus to US 70	Freeway	A	A

Table 9C 2040 Build Alternative 31 Queueing and Recommended Storage					
#	Intersection	Movement	Queue (feet)		Recommended Storage (feet)
			AM Peak	PM Peak	
401	Jim Sutton Rd at Service Rd	NBL	4	4	100
		SBL	24	16	100
402	US 70 EB Ramps at Jim Sutton Rd / Willie Measley Rd	WBL	65	112	Continuous
		WBR	171	174	175
		NBR	78	61	100
		SBL	310	260	325
403	US 70 WB Ramps at Jim Sutton Rd / Willie Measley Rd	WBL	86	115	Continuous
		WBR	267	269	275
		NBR	73	43	100
		SBL	188	159	200
404	William Measley Rd at Washington St / Service Rd	NBL	62	70	100
		SBL	16	16	100
405	US 70 Bus at Innovation Way	WBR	-	-	300
		SBR	30	23	Continuous
406	NC 11 at NC 55	EBL	412	246	Continuous
		EBR	63	82	100
		NBL	277	71	300
		SBR	62	89	100
407	US 70 EB Ramps at NC 11 / NC 55	WBL	361	324	Continuous
		WBR	166	87	175
		NBR	55	93	100
		SBL	63	82	100
408	US 70 WB Ramps at NC 11 / NC 55	EBL	69	67	Continuous
		EBR	215	176	225
		NBL	399	266	400
		SBR	65	71	100
409	US 70 EB Ramps at US 258	WBL	222	332	Continuous
		WBR	137	88	150
		NBR	29	37	100
		SBL	69	89	100
410	US 70 WB Ramps at US 258	WBL	92	95	Continuous
		WBR	75	37	100
		NBR	162	106	175
		SBL	135	168	175
411	NC 58 at SR 1913 (Elijah Loftin Rd)	NBL	15	28	100
		SBL	24	24	100

The queue reported is the greater of the SimTraffic maximum queue and the Synchro 95th percentile queue.

Table 9C (Continued) 2040 Build Alternative 31 Queueing and Recommended Storage					
#	Intersection	Movement	Queue (feet)		Recommended Storage (feet)
			AM Peak	PM Peak	
412	US 70 EB Ramps at NC 58	EBL	57	52	Continuous
		EBR	65	84	100
		NBL	79	61	100
		SBR	19	17	100
413	US 70 WB Ramps at NC 58	EBL	52	33	Continuous
		EBR	65	77	100
		NBL	74	71	100
		SBR	30	22	100
414	US 70 EB Ramps at Wyse Fork Rd	EBL	61	33	Continuous
		EBR	49	54	100
		NBL	54	42	100
		SBR	20	36	100
415	US 70 WB Ramps at Wyse Fork Rd	EBL	47	34	Continuous
		EBR	49	53	100
		NBL	57	36	100
		SBR	7	16	100
416	US 70 Bus at Kornegay St	EBL	64	74	100
		WBL	15	19	100

The queue reported is the greater of the SimTraffic maximum queue and the Synchro 95th percentile queue.

5.8 2040 Build Alternative 32

A capacity analysis was performed for 2040 Build Alternative 32 AM and PM peak periods for all of the study intersections and freeway elements. Intersection levels of service are summarized in **Table 10A**, freeway levels of service are summarized in **Table 10B**, and queuing and recommended storage are summarized in **Table 10C**. Traffic volumes are shown in **Figures 8A – 8G**, and LOS and laneage are shown in **Figures 8H – 8N**. Peak hour traffic volume development, and FREEVAL-E, Synchro, and SimTraffic reports are located in **Appendix I**.

Table 10A 2040 Build Alternative 32 Intersection Level of Service			
#	Intersection	Level of Service	
		AM Peak	PM Peak
401	Jim Sutton Rd at Service Rd	-	-
	Eastbound Left / Through / Right	B	B
	Westbound Left / Through / Right	A	A
	Northbound Left	A	A
	Southbound Left	A	A
402	US 70 EB Ramps at Jim Sutton Rd / Willie Measley Rd	C	C
	Westbound Left	D	D
	Westbound Right	B	B
	Northbound Through	B	B
	Northbound Right	A	A
	Southbound Left	C	C
	Southbound Through	A	A
403	US 70 WB Ramps at Jim Sutton Rd / Willie Measley Rd	B	B
	Westbound Left	D	D
	Westbound Right	C	C
	Northbound Through	B	B
	Northbound Right	A	A
	Southbound Left	C	C
	Southbound Through	A	A

Movements with zero delay were omitted

Table 10A (Continued)			
2040 Build Alternative 32			
Intersection Level of Service			
#	Intersection	Level of Service	
		AM Peak	PM Peak
404	Willie Measley Rd at Washington St / Service Rd	-	-
	Eastbound Left / Through / Right	B	B
	Westbound Left / Through / Right	E	E
	Northbound Left	A	A
	Southbound Left	A	A
405	US 70 Bus at Innovation Way	-	-
	Southbound Right	B	B
406	NC 11 at NC 55	C	B
	Eastbound Left	E	E
	Eastbound Right	C	C
	Northbound Left	E	D
	Northbound Through	C	A
	Southbound Through	B	B
	Southbound Right	A	A
407	US 70 EB Ramps at NC 11 / NC 55	C	B
	Westbound Left	F	D
	Westbound Right	D	B
	Northbound Through	D	B
	Northbound Right	A	A
	Southbound Left	E	C
	Southbound Through	A	A
408	US 70 WB Ramps at NC 11 / NC 55	B	C
	Eastbound Left	E	D
	Eastbound Right	D	C
	Northbound Left	D	D
	Northbound Through	A	A
	Southbound Through	B	C
	Southbound Right	A	A

Movements with zero delay were omitted

Table 10A (Continued)			
2040 Build Alternative 32			
Intersection Level of Service			
#	Intersection	Level of Service	
		AM Peak	PM Peak
409	US 70 EB Ramps at US 258	C	C
	Westbound Left	D	D
	Westbound Right	B	B
	Northbound Through	B	B
	Northbound Right	A	A
	Southbound Left	D	C
	Southbound Through	A	A
410	US 70 WB Ramps at US 258	B	B
	Northbound Left	C	D
	Southbound Left	B	B
	Northbound Through	A	A
	Northbound Right	A	A
	Northbound Left	D	D
	Southbound Left	A	A
411	NC 58 at SR 1913 (Elijah Loftin Rd)	-	-
	Eastbound Left / Through / Right	B	B
	Westbound Left / Through / Right	B	B
	Northbound Left	A	A
	Southbound Left	A	A
412	US 70 EB Ramps at NC 58	A	A
	Eastbound Left	D	D
	Eastbound Right	C	C
	Northbound Left	D	D
	Northbound Through	A	A
	Southbound Through	A	A
	Southbound Right	A	A

Movements with zero delay were omitted

Table 10A (Continued)			
2040 Build Alternative 32			
Intersection Level of Service			
#	Intersection	Level of Service	
		AM Peak	PM Peak
413	US 70 WB Ramps at NC 58	A	A
	Eastbound Left	D	D
	Eastbound Right	C	C
	Northbound Left	D	D
	Northbound Through	A	A
	Southbound Through	A	A
	Southbound Right	A	A
414	US 70 Bus at SR 1002 (Wyse Fork Rd)	-	-
	Westbound Left	A	A
	Northbound Left / Right	B	B
415	Burkett Rd at Wyse Fork Connector	-	-
	Eastbound Left / Through	A	A
	Southbound Left / Right	A	A
416	US 70 EB Ramps at Burkett / Kornegay St	C	C
	Eastbound Left / Through	D	D
	Eastbound Right	C	C
	Northbound Through	A	A
	Northbound Right	A	A
	Southbound Left	D	C
	Southbound Through	A	A
417	US 70 WB Ramps at Burkett / Kornegay St	B	A
	Westbound Left / Through	D	D
	Westbound Right	D	D
	Northbound Left	C	B
	Northbound Through	A	A
	Southbound Through	A	A
	Southbound Right	A	A

Movements with zero delay were omitted

Table 10B 2040 Build Alternative 32 Freeway Level of Service				
US 70 Eastbound				
#	Segment	Type	AM Peak	PM Peak
1E	W of Jim Sutton / Willie Measley	Freeway	B	B
2E	To Jim Sutton / Willie Measley	Off-Ramp	B	B
3E	Within Jim Sutton / Willie Measley Int	Freeway	B	A
4E	From Jim Sutton / Willie Measley	On-Ramp	B	B
5E	Jim Sutton / Willie Measley to US 70 Bus (W)	Freeway	B	B
6E	To US 70 Bus (W)	Off-Ramp	A	A
7E	US 70 Bus (W) to CF Harvey Pkwy	Freeway	A	A
8E	From CF Harvey Pkwy	On-Ramp	A	A
9E	CF Harvey Pkwy to NC 11	Freeway	A	A
10E	To NC 11	Off-Ramp	A	A
11E	Within NC 11 Int	Freeway	A	A
12E	From NC 11	On-Ramp	A	A
13E	NC 11 to US 258	Freeway	A	A
14E	To US 258	Off-Ramp	A	A
15E	Within US 258 Int	Freeway	A	A
16E	From US 258	On-Ramp	A	A
17E	US 258 to NC 58	Freeway	A	A
18E	To NC 58	Off-Ramp	A	A
19E	Within NC 58 Int	Freeway	A	A
20E	From NC 58	On-Ramp	A	A
21E	NC 58 to US 70 Bus (E)	Freeway	A	A
22E	To US 70 Bus (E)	Off-Ramp	A	A
23E	Within US 70 Bus (E) Int	Freeway	A	A
24E	From US 70 Bus (E)	On-Ramp	A	A
25E	US 70 Bus (E) to Burkett / Kornegay	Freeway	A	A
26E	To Burkett / Kornegay	Off-Ramp	A	B
27E	Within Burkett / Kornegay Int	Freeway	A	A
28E	From Burkett / Kornegay	On-Ramp	A	A
29E	E of Burkett / Kornegay	Freeway	A	A

Table 10B (Continued) 2040 Build Alternative 32 Freeway Level of Service				
US 70 Westbound				
#	Segment	Type	AM Peak	PM Peak
1W	E of Burkett / Kornegay	Freeway	A	A
2W	To Burkett / Kornegay	Off-Ramp	A	A
3W	Within Burkett / Kornegay Int	Freeway	A	A
4W	From Burkett / Kornegay	On-Ramp	A	A
5W	Burkett / Kornegay to US 70 Bus (E)	Freeway	A	A
6W	To US 70 Bus (E)	Off-Ramp	B	A
7W	Within US 70 Bus (E) Int	Freeway	A	A
8W	From US 70 Bus (E)	On-Ramp	A	A
9W	US 70 Bus (E) to NC 58	Freeway	A	A
10W	To NC 58	Off-Ramp	A	A
11W	Within NC 58 Int	Freeway	A	A
12W	From NC 58	On-Ramp	A	A
13W	NC 58 to US 258	Freeway	A	A
14W	To US 258	Off-Ramp	A	A
15W	Within US 258 Int	Freeway	A	A
16W	From US 258	On-Ramp	A	A
17W	US 258 to NC 11	Freeway	A	A
18W	To NC 11	Off-Ramp	A	A
19W	Within NC 11 Int	Freeway	A	A
20W	From NC 11	On-Ramp	A	A
21W	NC 11 to CF Harvey Pkwy	Freeway	A	A
22W	To CF Harvey Pkwy	Off-Ramp	B	A
23W	CF Harvey Pkwy to US 70 Bus (W)	Freeway	A	A
24W	From US 70 Bus (W)	On-Ramp	B	B
25W	US 70 Bus (W) to Jim Sutton / Willie Measley	Freeway	B	B
26W	To Jim Sutton / Willie Measley	Off-Ramp	B	B
27W	Within Jim Sutton / Willie Measley Int	Freeway	A	B
28W	From Jim Sutton / Willie Measley	On-Ramp	A	B
29W	W of Jim Sutton / Willie Measley	Freeway	B	B

Table 10B (Continued) 2040 Build Alternative 32 Freeway Level of Service				
CF Harvey Parkway Northbound				
#	Segment	Type	AM Peak	PM Peak
1N	US 70 to US 70 Bus	Freeway	A	A
2N	To US 70 Bus EB	Off-Ramp	A	A
3N	Ramp to US 70 EB to Ramp to US 70 Bus WB	Freeway	A	A
4N	To US 70 Bus WB	Off-Ramp	A	A
5N	Ramp to US 70 Bus WB to Ramp from US 70 Bus	Freeway	A	A
6N	From US 70 Bus	On-Ramp	A	A
7N	North of US 70 Bus	Freeway	A	A
CF Harvey Parkway Southbound				
#	Segment	Type	AM Peak	PM Peak
1S	North of US 70 Bus	Freeway	A	A
2S	To US 70 Bus WB	Off-Ramp	A	A
3S	Ramp to US 70 Bus WB to US 70 Bus Weave	Freeway	A	A
4S	US 70 Bus Weave	Weave	A	A
5S	US 70 Bus Weave to Ramp from US 70 Bus EB	Freeway	A	A
6S	From US 70 Bus EB	On-Ramp	A	A
7S	US 70 Bus to US 70	Freeway	A	A

Table 10C 2040 Build Alternative 32 Queueing and Recommended Storage					
#	Intersection	Movement	Queue (feet)		Recommended Storage (feet)
			AM Peak	PM Peak	
401	Jim Sutton Rd at Service Rd	NBL	4	4	100
		SBL	24	16	100
402	US 70 EB Ramps at Jim Sutton Rd / Willie Measley Rd	WBL	65	112	Continuous
		WBR	171	174	175
		NBR	78	61	100
		SBL	310	260	325
403	US 70 WB Ramps at Jim Sutton Rd / Willie Measley Rd	WBL	86	115	Continuous
		WBR	267	269	275
		NBR	73	43	100
		SBL	188	159	200
404	William Measley Rd at Washington St / Service Rd	NBL	62	70	100
		SBL	16	16	100
405	US 70 Bus at Innovation Way	WBR	-	-	300
		SBR	30	23	Continuous
406	NC 11 at NC 55	EBL	412	246	Continuous
		EBR	63	82	100
		NBL	277	71	300
		SBR	62	89	100
407	US 70 EB Ramps at NC 11 / NC 55	WBL	361	324	Continuous
		WBR	166	87	175
		NBR	55	93	100
		SBL	63	82	100
408	US 70 WB Ramps at NC 11 / NC 55	EBL	69	67	Continuous
		EBR	215	176	225
		NBL	399	266	400
		SBR	65	71	100
409	US 70 EB Ramps at US 258	WBL	222	332	Continuous
		WBR	137	88	150
		NBR	29	37	100
		SBL	69	89	100
410	US 70 WB Ramps at US 258	WBL	92	95	Continuous
		WBR	75	37	100
		NBR	162	106	175
		SBL	135	168	175
411	NC 58 at SR 1913 (Elijah Loftin Rd)	NBL	15	28	100
		SBL	24	24	100

The queue reported is the greater of the SimTraffic maximum queue and the Synchro 95th percentile queue.

Table 10C (Continued) 2040 Build Alternative 32 Queueing and Recommended Storage					
#	Intersection	Movement	Queue (feet)		Recommended Storage (feet)
			AM Peak	PM Peak	
412	US 70 EB Ramps at NC 58	EBL	57	52	Continuous
		EBR	65	84	100
		NBL	79	61	100
		SBR	19	17	100
413	US 70 WB Ramps at NC 58	EBL	52	33	Continuous
		EBR	65	77	100
		NBL	74	71	100
		SBR	30	22	100
414	US 70 Bus at Wyse Fork Rd	EBR	4	-	100
		WBL	50	54	100
415	Burkett Rd at Wyse Fork Connector	SBLR	47	40	Continuous
416	US 70 EB Ramps at Burkett Rd / Kornegay St	EBR	32	65	100
		NBR	22	18	100
		SBL	65	41	100
417	US 70 WB Ramps at Burkett Rd / Kornegay St	WBR	65	73	100
		NBL	64	55	100
		SBR	78	58	100

The queue reported is the greater of the SimTraffic maximum queue and the Synchro 95th percentile queue.

5.9 2040 Build Alternative 63

A capacity analysis was performed for 2040 Build Alternative 63 AM and PM peak periods for all of the study intersections and freeway elements. Intersection levels of service are summarized in **Table 11A**, freeway levels of service are summarized in **Table 11B**, and queuing and recommended storage are summarized in **Table 11C**. Traffic volumes are shown in **Figures 9A – 9G**, and LOS and laneage are shown in **Figures 9H – 9N**. Peak hour traffic volume development, and FREEVAL-E, Synchro, and SimTraffic reports are located in **Appendix J**.

Table 11A 2040 Build Alternative 63 Intersection Level of Service			
#	Intersection	Level of Service	
		AM Peak	PM Peak
401	Jim Sutton Rd at Service Rd	-	-
	Eastbound Left / Through / Right	B	B
	Westbound Left / Through / Right	A	A
	Northbound Left	A	A
	Southbound Left	A	A
402	US 70 EB Ramps at Jim Sutton Rd / Willie Measley Rd	C	C
	Westbound Left	D	D
	Westbound Right	B	B
	Northbound Through	B	B
	Northbound Right	A	A
	Southbound Left	C	C
	Southbound Through	A	A
403	US 70 WB Ramps at Jim Sutton Rd / Willie Measley Rd	B	B
	Westbound Left	D	D
	Westbound Right	C	C
	Northbound Through	B	B
	Northbound Right	A	A
	Southbound Left	C	C
	Southbound Through	A	A

Movements with zero delay were omitted

Table 11A (Continued) 2040 Build Alternative 63 Intersection Level of Service			
#	Intersection	Level of Service	
		AM Peak	PM Peak
404	Willie Measley Rd at Washington St / Service Rd	-	-
	Eastbound Left / Through / Right	B	B
	Westbound Left / Through / Right	E	E
	Northbound Left	A	A
	Southbound Left	A	A
405	US 70 Bus at Innovation Way	-	-
	Southbound Right	B	B
406	NC 11 at NC 55	C	B
	Eastbound Left	F	E
	Eastbound Right	D	C
	Northbound Left	F	D
	Northbound Through	C	A
	Southbound Through	B	B
	Southbound Right	A	A
407	US 70 EB Ramps at NC 11 / NC 55	D	B
	Westbound Left	F	E
	Westbound Right	D	B
	Northbound Through	D	B
	Northbound Right	A	A
	Southbound Left	E	C
	Southbound Through	A	A
408	US 70 WB Ramps at NC 11 / NC 55	B	C
	Eastbound Left	F	D
	Eastbound Right	D	C
	Northbound Left	D	D
	Northbound Through	A	A
	Southbound Through	C	C
	Southbound Right	B	A

Movements with zero delay were omitted

Table 11A (Continued) 2040 Build Alternative 63 Intersection Level of Service			
#	Intersection	Level of Service	
		AM Peak	PM Peak
409	US 70 EB Ramps at US 258	C	C
	Westbound Left	D	D
	Westbound Right	B	B
	Northbound Through	B	C
	Northbound Right	A	A
	Southbound Left	D	C
	Southbound Through	A	A
410	US 70 WB Ramps at US 258	B	B
	Northbound Left	C	D
	Southbound Left	B	B
	Northbound Through	A	A
	Northbound Right	A	A
	Northbound Left	D	D
	Southbound Left	A	A
411	NC 58 at SR 1913 (Elijah Loftin Rd)	-	-
	Eastbound Left / Through / Right	B	B
	Westbound Left / Through / Right	B	B
	Northbound Left	A	A
	Southbound Left	A	A
412	US 70 EB Ramps at NC 58	A	A
	Eastbound Left	D	D
	Eastbound Right	C	C
	Northbound Left	D	D
	Northbound Through	A	A
	Southbound Through	A	A
	Southbound Right	A	A

Movements with zero delay were omitted

Table 11A (Continued)			
2040 Build Alternative 63			
Intersection Level of Service			
#	Intersection	Level of Service	
		AM Peak	PM Peak
413	US 70 WB Ramps at NC 58	A	A
	Eastbound Left	D	D
	Eastbound Right	C	C
	Northbound Left	D	D
	Northbound Through	A	A
	Southbound Through	A	A
	Southbound Right	A	A
414	US 70 Bus at SR 1002 (Wyse Fork Rd)	-	-
	Westbound Left	A	A
	Northbound Left / Right	B	B
415	Burkett Rd at Wyse Fork Connector	-	-
	Eastbound Left / Through	A	A
	Southbound Left / Right	A	A
416	US 70 EB Ramps at Burkett / Kornegay St	C	C
	Eastbound Left / Through	D	D
	Eastbound Right	C	C
	Northbound Through	A	A
	Northbound Right	A	A
	Southbound Left	D	C
	Southbound Through	A	A
417	US 70 WB Ramps at Burkett / Kornegay St	B	A
	Westbound Left / Through	D	D
	Westbound Right	D	D
	Northbound Left	C	B
	Northbound Through	A	A
	Southbound Through	A	A
	Southbound Right	A	A

Movements with zero delay were omitted

Table 11B 2040 Build Alternative 63 Freeway Level of Service				
US 70 Eastbound				
#	Segment	Type	AM Peak	PM Peak
1E	W of Jim Sutton / Willie Measley	Freeway	B	B
2E	To Jim Sutton / Willie Measley	Off-Ramp	B	B
3E	Within Jim Sutton / Willie Measley Int	Freeway	B	A
4E	From Jim Sutton / Willie Measley	On-Ramp	B	B
5E	Jim Sutton / Willie Measley to US 70 Bus (W)	Freeway	B	B
6E	To US 70 Bus (W)	Off-Ramp	A	A
7E	US 70 Bus (W) to CF Harvey Pkwy	Freeway	A	A
8E	From CF Harvey Pkwy	On-Ramp	A	A
9E	CF Harvey Pkwy to NC 11	Freeway	A	A
10E	To NC 11	Off-Ramp	A	A
11E	Within NC 11 Int	Freeway	A	A
12E	From NC 11	On-Ramp	A	A
13E	NC 11 to US 258	Freeway	A	A
14E	To US 258	Off-Ramp	A	A
15E	Within US 258 Int	Freeway	A	A
16E	From US 258	On-Ramp	A	A
17E	US 258 to NC 58	Freeway	A	A
18E	To NC 58	Off-Ramp	A	A
19E	Within NC 58 Int	Freeway	A	A
20E	From NC 58	On-Ramp	A	A
21E	NC 58 to US 70 Bus (E)	Freeway	A	A
22E	To US 70 Bus (E)	Off-Ramp	A	A
23E	Within US 70 Bus (E) Int	Freeway	A	A
24E	From US 70 Bus (E)	On-Ramp	A	A
25E	US 70 Bus (E) to Burkett / Kornegay	Freeway	A	A
26E	To Burkett / Kornegay	Off-Ramp	A	B
27E	Within Burkett / Kornegay Int	Freeway	A	A
28E	From Burkett / Kornegay	On-Ramp	A	A
29E	E of Burkett / Kornegay	Freeway	A	A

Table 11B (Continued) 2040 Build Alternative 63 Freeway Level of Service				
US 70 Westbound				
#	Segment	Type	AM Peak	PM Peak
1W	E of Burkett/Kornegay	Freeway	A	A
2W	To Burkett/Kornegay	Off-Ramp	A	A
3W	Within Burkett/Kornegay Int	Freeway	A	A
4W	From Burkett/Kornegay	On-Ramp	A	A
5W	Burkett/Kornegay to US 70 Bus (E)	Freeway	A	A
6W	To US 70 Bus (E)	Off-Ramp	B	A
7W	Within US 70 Bus (E) Int	Freeway	A	A
8W	From US 70 Bus (E)	On-Ramp	A	A
9W	US 70 Bus (E) to NC 58	Freeway	A	A
10W	To NC 58	Off-Ramp	A	A
11W	Within NC 58 Int	Freeway	A	A
12W	From NC 58	On-Ramp	A	A
13W	NC 58 to US 258	Freeway	A	A
14W	To US 258	Off-Ramp	A	A
15W	Within US 258 Int	Freeway	A	A
16W	From US 258	On-Ramp	A	A
17W	US 258 to NC 11	Freeway	A	A
18W	To NC 11	Off-Ramp	A	A
19W	Within NC 11 Int	Freeway	A	A
20W	From NC 11	On-Ramp	B	A
21W	NC 11 to CF Harvey Pkwy	Freeway	A	A
22W	To CF Harvey Pkwy	Off-Ramp	B	B
23W	CF Harvey Pkwy to US 70 Bus (W)	Freeway	A	A
24W	From US 70 Bus (W)	On-Ramp	B	B
25W	US 70 Bus (W) to Jim Sutton/Willie Measley	Freeway	B	B
26W	To Jim Sutton/Willie Measley	Off-Ramp	B	B
27W	Within Jim Sutton/Willie Measley Int	Freeway	A	B
28W	From Jim Sutton/Willie Measley	On-Ramp	A	B
29W	W of Jim Sutton/Willie Measley	Freeway	B	B

Table 11B (Continued) 2040 Build Alternative 63 Freeway Level of Service				
CF Harvey Parkway Northbound				
#	Segment	Type	AM Peak	PM Peak
1N	US 70 to US 70 Bus	Freeway	A	A
2N	To US 70 Bus EB	Off-Ramp	A	A
3N	Ramp to US 70 EB to Ramp to US 70 Bus WB	Freeway	A	A
4N	To US 70 Bus WB	Off-Ramp	A	A
5N	Ramp to US 70 Bus WB to Ramp from US 70 Bus	Freeway	A	A
6N	From US 70 Bus	On-Ramp	A	A
7N	North of US 70 Bus	Freeway	A	A
CF Harvey Parkway Southbound				
#	Segment	Type	AM Peak	PM Peak
1S	North of US 70 Bus	Freeway	A	A
2S	To US 70 Bus WB	Off-Ramp	A	A
3S	Ramp to US 70 Bus WB to US 70 Bus Weave	Freeway	A	A
4S	US 70 Bus Weave	Weave	A	A
5S	US 70 Bus Weave to Ramp from US 70 Bus EB	Freeway	A	A
6S	From US 70 Bus EB	On-Ramp	A	A
7S	US 70 Bus to US 70	Freeway	A	A

Table 11C 2040 Build Alternative 63 Queueing and Recommended Storage					
#	Intersection	Movement	Queue (feet)		Recommended Storage (feet)
			AM Peak	PM Peak	
401	Jim Sutton Rd at Service Rd	NBL	4	4	100
		SBL	24	16	100
402	US 70 EB Ramps at Jim Sutton Rd / Willie Measley Rd	WBL	65	112	Continuous
		WBR	171	174	175
		NBR	78	61	100
		SBL	310	260	325
403	US 70 WB Ramps at Jim Sutton Rd / Willie Measley Rd	WBL	86	115	Continuous
		WBR	267	269	275
		NBR	73	43	100
		SBL	188	159	200
404	William Measley Rd at Washington St / Service Rd	NBL	62	70	100
		SBL	16	16	100
405	US 70 Bus at Innovation Way	WBR	-	-	300
		SBR	32	25	Continuous
406	NC 11 at NC 55	EBL	458	293	Continuous
		EBR	72	83	100
		NBL	83	72	100
		SBR	66	113	125
407	US 70 EB Ramps at NC 11 / NC 55	WBL	434	383	Continuous
		WBR	168	115	175
		NBR	158	114	175
		SBL	72	76	100
408	US 70 WB Ramps at NC 11 / NC 55	EBL	76	55	Continuous
		EBR	264	174	275
		NBL	449	328	450
		SBR	67	98	100
409	US 70 EB Ramps at US 258	WBL	303	375	Continuous
		WBR	124	95	125
		NBR	45	41	100
		SBL	59	100	125
410	US 70 WB Ramps at US 258	WBL	90	108	Continuous
		WBR	58	55	100
		NBR	164	90	175
		SBL	148	167	175
411	NC 58 at SR 1913 (Elijah Loftin Rd)	NBL	15	28	100
		SBL	24	24	100

The queue reported is the greater of the SimTraffic maximum queue and the Synchro 95th percentile queue.

Table 11C (Continued) 2040 Build Alternative 63 Queueing and Recommended Storage					
#	Intersection	Movement	Queue (feet)		Recommended Storage (feet)
			AM Peak	PM Peak	
412	US 70 EB Ramps at NC 58	EBL	57	52	Continuous
		EBR	65	84	100
		NBL	79	61	100
		SBR	19	17	100
413	US 70 WB Ramps at NC 58	EBL	52	33	Continuous
		EBR	65	77	100
		NBL	74	71	100
		SBR	30	22	100
414	US 70 Bus at Wyse Fork Rd	EBR	4	-	100
		WBL	50	54	100
415	Burkett Rd at Wyse Fork Connector	SBLR	47	40	Continuous
416	US 70 EB Ramps at Burkett Rd / Kornegay St	EBR	32	65	100
		NBR	22	18	100
		SBL	65	41	100
417	US 70 WB Ramps at Burkett Rd / Kornegay St	WBR	65	73	100
		NBL	64	55	100
		SBR	78	58	100

The queue reported is the greater of the SimTraffic maximum queue and the Synchro 95th percentile queue.

5.10 2040 Build Alternative 65

A capacity analysis was performed for 2040 Build Alternative 65 AM and PM peak periods for all of the study intersections and freeway elements. Intersection levels of service are summarized in **Table 12A**, freeway levels of service are summarized in **Table 12B**, and queuing and recommended storage are summarized in **Table 12C**. Traffic volumes are shown in **Figures 10A – 10G**, and LOS and laneage are shown in **Figures 10H – 10N**. Peak hour traffic volume development, and FREEVAL-E, Synchro, and SimTraffic reports are located in **Appendix K**.

Table 12A 2040 Build Alternative 65 Intersection Level of Service			
#	Intersection	Level of Service	
		AM Peak	PM Peak
401	Jim Sutton Rd at Service Rd	-	-
	Eastbound Left / Through / Right	B	B
	Westbound Left / Through / Right	A	A
	Northbound Left	A	A
	Southbound Left	A	A
402	US 70 EB Ramps at Jim Sutton Rd / Willie Measley Rd	C	C
	Westbound Left	D	D
	Westbound Right	B	B
	Northbound Through	B	B
	Northbound Right	A	A
	Southbound Left	C	C
	Southbound Through	A	A
403	US 70 WB Ramps at Jim Sutton Rd / Willie Measley Rd	B	B
	Westbound Left	D	D
	Westbound Right	C	C
	Northbound Through	B	B
	Northbound Right	A	A
	Southbound Left	C	C
	Southbound Through	A	A

Movements with zero delay were omitted

Table 12A (Continued)			
2040 Build Alternative 65			
Intersection Level of Service			
#	Intersection	Level of Service	
		AM Peak	PM Peak
404	Willie Measley Rd at Washington St / Service Rd	-	-
	Eastbound Left / Through / Right	B	B
	Westbound Left / Through / Right	E	E
	Northbound Left	A	A
	Southbound Left	A	A
405	US 70 Bus at Innovation Way	-	-
	Southbound Right	B	B
406	NC 11 at NC 55	C	B
	Eastbound Left	F	E
	Eastbound Right	D	C
	Northbound Left	F	D
	Northbound Through	C	A
	Southbound Through	B	B
	Southbound Right	A	A
407	US 70 EB Ramps at NC 11 / NC 55	D	B
	Westbound Left	F	E
	Westbound Right	D	B
	Northbound Through	D	B
	Northbound Right	A	A
	Southbound Left	E	C
	Southbound Through	A	A
408	US 70 WB Ramps at NC 11 / NC 55	B	C
	Eastbound Left	F	D
	Eastbound Right	D	C
	Northbound Left	D	D
	Northbound Through	A	A
	Southbound Through	C	C
	Southbound Right	B	A

Movements with zero delay were omitted

Table 12A (Continued)			
2040 Build Alternative 65			
Intersection Level of Service			
#	Intersection	Level of Service	
		AM Peak	PM Peak
409	US 70 EB Ramps at US 258	C	C
	Westbound Left	D	D
	Westbound Right	B	B
	Northbound Through	B	C
	Northbound Right	A	A
	Southbound Left	D	C
	Southbound Through	A	A
410	US 70 WB Ramps at US 258	B	B
	Northbound Left	C	D
	Southbound Left	B	B
	Northbound Through	A	A
	Northbound Right	A	A
	Northbound Left	D	D
	Southbound Left	A	A
411	NC 58 at SR 1913 (Elijah Loftin Rd)	-	-
	Eastbound Left / Through / Right	B	B
	Westbound Left / Through / Right	B	B
	Northbound Left	A	A
	Southbound Left	A	A
412	US 70 EB Ramps at NC 58	A	A
	Eastbound Left	D	D
	Eastbound Right	C	C
	Northbound Left	D	D
	Northbound Through	A	A
	Southbound Through	A	A
	Southbound Right	A	A

Movements with zero delay were omitted

Table 12A (Continued) 2040 Build Alternative 65 Intersection Level of Service			
#	Intersection	Level of Service	
		AM Peak	PM Peak
413	US 70 WB Ramps at NC 58	A	A
	Eastbound Left	D	D
	Eastbound Right	C	C
	Northbound Left	D	D
	Northbound Through	A	A
	Southbound Through	A	A
	Southbound Right	A	A
414	US 70 EB Ramps at Wyse Fork Rd	B	B
	Eastbound Left	D	D
	Eastbound Right	C	C
	Northbound Left	D	D
	Northbound Through	A	A
	Southbound Through	A	A
	Southbound Right	A	A
415	US 70 WB Ramps at Wyse Fork Rd	B	B
	Eastbound Left	D	D
	Eastbound Right	C	C
	Northbound Left	C	C
	Northbound Through	A	A
	Southbound Through	A	A
	Southbound Right	A	A
416	US 70 Bus at Kornegay St / Service Rd	-	-
	Eastbound Left	A	A
	Westbound Left	A	A
	Northbound Left / Through / Right	C	C
	Southbound Left / Through / Right	C	C

Movements with zero delay were omitted

Table 12B 2040 Build Alternative 65 Freeway Level of Service				
US 70 Eastbound				
#	Segment	Type	AM Peak	PM Peak
1E	W of Jim Sutton / Willie Measley	Freeway	B	B
2E	To Jim Sutton / Willie Measley	Off-Ramp	B	B
3E	Within Jim Sutton / Willie Measley Int	Freeway	B	A
4E	From Jim Sutton / Willie Measley	On-Ramp	B	B
5E	Jim Sutton / Willie Measley to US 70 Bus (W)	Freeway	B	B
6E	To US 70 Bus (W)	Off-Ramp	A	A
7E	US 70 Bus (W) to CF Harvey Pkwy	Freeway	A	A
8E	From CF Harvey Pkwy	On-Ramp	A	A
9E	CF Harvey Pkwy to NC 11	Freeway	A	A
10E	To NC 11	Off-Ramp	A	A
11E	Within NC 11 Int	Freeway	A	A
12E	From NC 11	On-Ramp	A	A
13E	NC 11 to US 258	Freeway	A	A
14E	To US 258	Off-Ramp	A	A
15E	Within US 258 Int	Freeway	A	A
16E	From US 258	On-Ramp	A	A
17E	US 258 to NC 58	Freeway	A	A
18E	To NC 58	Off-Ramp	A	A
19E	Within NC 58 Int	Freeway	A	A
20E	From NC 58	On-Ramp	A	A
21E	NC 58 to Wyse Fork	Freeway	A	A
22E	To Wyse Fork	Off-Ramp	A	A
23E	Within Wyse Fork Int	Freeway	A	A
24E	From Wyse Fork	On-Ramp	A	A
25E	Wyse fork to US 70 Bus (E)	Freeway	A	A
26E	To US 70 Bus (E)	Off-Ramp	A	A
27E	Within US 70 Bus (E) Int	Freeway	A	A
28E	From US 70 Bus (E)	On-Ramp	A	A
29E	E of US 70 Bus (E)	Freeway	A	A

Table 12B (Continued) 2040 Build Alternative 65 Freeway Level of Service				
US 70 Westbound				
#	Segment	Type	AM Peak	PM Peak
1W	E of US 70 Bus (E)	Freeway	A	A
2W	To US 70 Bus (E)	Off-Ramp	A	A
3W	Within US 70 Bus (E) Int	Freeway	A	A
4W	From US 70 Bus (E)	On-Ramp	A	A
5W	US 70 Bus (E) to Wyse Fork	Freeway	A	A
6W	To Wyse Fork	Off-Ramp	A	A
7W	Within Wyse Fork Int	Freeway	A	A
8W	From Wyse Fork	On-Ramp	A	A
9W	Wyse Fork to NC 58	Freeway	A	A
10W	To NC 58	Off-Ramp	A	A
11W	Within NC 58 Int	Freeway	A	A
12W	From NC 58	On-Ramp	A	A
13W	NC 58 to US 258	Freeway	A	A
14W	To US 258	Off-Ramp	A	A
15W	Within US 258 Int	Freeway	A	A
16W	From US 258	On-Ramp	A	A
17W	US 258 to NC 11	Freeway	A	A
18W	To NC 11	Off-Ramp	A	A
19W	Within NC 11 Int	Freeway	A	A
20W	From NC 11	On-Ramp	B	A
21W	NC 11 to CF Harvey Pkwy	Freeway	A	A
22W	To CF Harvey Pkwy	Off-Ramp	B	B
23W	CF Harvey Pkwy to US 70 Bus (W)	Freeway	A	A
24W	From US 70 Bus (W)	On-Ramp	B	B
25W	US 70 Bus (W) to Jim Sutton / Willie Measley	Freeway	B	B
26W	To Jim Sutton / Willie Measley	Off-Ramp	B	B
27W	Within Jim Sutton / Willie Measley Int	Freeway	A	B
28W	From Jim Sutton / Willie Measley	On-Ramp	A	B
29W	W of Jim Sutton / Willie Measley	Freeway	B	B

Table 12B (Continued) 2040 Build Alternative 65 Freeway Level of Service				
CF Harvey Parkway Northbound				
#	Segment	Type	AM Peak	PM Peak
1N	US 70 to US 70 Bus	Freeway	A	A
2N	To US 70 Bus EB	Off-Ramp	A	A
3N	Ramp to US 70 EB to Ramp to US 70 Bus WB	Freeway	A	A
4N	To US 70 Bus WB	Off-Ramp	A	A
5N	Ramp to US 70 Bus WB to Ramp from US 70 Bus	Freeway	A	A
6N	From US 70 Bus	On-Ramp	A	A
7N	North of US 70 Bus	Freeway	A	A
CF Harvey Parkway Southbound				
#	Segment	Type	AM Peak	PM Peak
1S	North of US 70 Bus	Freeway	A	A
2S	To US 70 Bus WB	Off-Ramp	A	A
3S	Ramp to US 70 Bus WB to US 70 Bus Weave	Freeway	A	A
4S	US 70 Bus Weave	Weave	A	A
5S	US 70 Bus Weave to Ramp from US 70 Bus EB	Freeway	A	A
6S	From US 70 Bus EB	On-Ramp	A	A
7S	US 70 Bus to US 70	Freeway	A	A

Table 12C 2040 Build Alternative 65 Queueing and Recommended Storage					
#	Intersection	Movement	Queue (feet)		Recommended Storage (feet)
			AM Peak	PM Peak	
401	Jim Sutton Rd at Service Rd	NBL	4	4	100
		SBL	24	16	100
402	US 70 EB Ramps at Jim Sutton Rd / Willie Measley Rd	WBL	65	112	Continuous
		WBR	171	174	175
		NBR	78	61	100
		SBL	310	260	325
403	US 70 WB Ramps at Jim Sutton Rd / Willie Measley Rd	WBL	86	115	Continuous
		WBR	267	269	275
		NBR	73	43	100
		SBL	188	159	200
404	William Measley Rd at Washington St / Service Rd	NBL	62	70	100
		SBL	16	16	100
405	US 70 Bus at Innovation Way	WBR	-	-	300
		SBR	32	25	Continuous
406	NC 11 at NC 55	EBL	458	293	Continuous
		EBR	72	83	100
		NBL	83	72	100
		SBR	66	113	125
407	US 70 EB Ramps at NC 11 / NC 55	WBL	434	383	Continuous
		WBR	168	115	175
		NBR	158	114	175
		SBL	72	76	100
408	US 70 WB Ramps at NC 11 / NC 55	EBL	76	55	Continuous
		EBR	264	174	275
		NBL	449	328	450
		SBR	67	98	100
409	US 70 EB Ramps at US 258	WBL	303	375	Continuous
		WBR	124	95	125
		NBR	45	41	100
		SBL	59	100	125
410	US 70 WB Ramps at US 258	WBL	90	108	Continuous
		WBR	58	55	100
		NBR	164	90	175
		SBL	148	167	175
411	NC 58 at SR 1913 (Elijah Loftin Rd)	NBL	15	28	100
		SBL	24	24	100

The queue reported is the greater of the SimTraffic maximum queue and the Synchro 95th percentile queue.

Table 12C (Continued)					
2040 Build Alternative 65					
Queueing and Recommended Storage					
#	Intersection	Movement	Queue (feet)		Recommended Storage (feet)
			AM Peak	PM Peak	
412	US 70 EB Ramps at NC 58	EBL	57	52	Continuous
		EBR	65	84	100
		NBL	79	61	100
		SBR	19	17	100
413	US 70 WB Ramps at NC 58	EBL	52	33	Continuous
		EBR	65	77	100
		NBL	74	71	100
		SBR	30	22	100
414	US 70 EB Ramps at Wyse Fork Rd	EBL	61	33	Continuous
		EBR	49	54	100
		NBL	54	42	100
		SBR	20	36	100
415	US 70 WB Ramps at Wyse Fork Rd	EBL	47	34	Continuous
		EBR	49	53	100
		NBL	57	36	100
		SBR	7	16	100
416	US 70 Bus at Kornegay St	EBL	64	74	100
		WBL	15	19	100

The queue reported is the greater of the SimTraffic maximum queue and the Synchro 95th percentile queue.

5.11 2040 Build Alternative 51

A capacity analysis was performed for 2040 Build Alternative 51 AM and PM peak periods for all of the study intersections and freeway elements. Intersection levels of service are summarized in **Table 13A**, freeway levels of service are summarized in **Table 13B**, and queuing and recommended storage are summarized in **Table 13C**. Traffic volumes are shown in **Figures 11A – 11F**, and LOS and laneage are shown in **Figures 11G – 11L**. Peak hour traffic volume development, and FREEVAL-E, Synchro, and SimTraffic reports are located in **Appendix L**.

Table 13A 2040 Build Alternative 51 Intersection Level of Service			
#	Intersection	Level of Service	
		AM Peak	PM Peak
401	Jim Sutton Rd at Service Rd	-	-
	Eastbound Left / Through / Right	B	B
	Westbound Left / Through / Right	A	A
	Northbound Left	A	A
	Southbound Left	A	A
402	US 70 EB Ramps at Jim Sutton Rd / Willie Measley Rd	C	C
	Westbound Left	D	D
	Westbound Right	B	B
	Northbound Through	B	B
	Northbound Right	A	A
	Southbound Left	C	C
	Southbound Through	A	A
403	US 70 WB Ramps at Jim Sutton Rd / Willie Measley Rd	B	B
	Westbound Left	D	D
	Westbound Right	C	C
	Northbound Through	B	B
	Northbound Right	A	A
	Southbound Left	C	C
	Southbound Through	A	A

Movements with zero delay were omitted

Table 13A (Continued)			
2040 Build Alternative 51			
Intersection Level of Service			
#	Intersection	Level of Service	
		AM Peak	PM Peak
404	Willie Measley Rd at Washington St / Service Rd	-	-
	Eastbound Left / Through / Right	B	B
	Westbound Left / Through / Right	E	E
	Northbound Left	A	A
	Southbound Left	A	A
405	US 70 Bus at Harold Sutton Rd / Albert Sugg Rd	-	-
	Eastbound Left	A	B
	Westbound Left	B	A
	Northbound Left / Through / Right	C	C
	Southbound Left / Through / Right	C	D
406	NC 55 at N Croom Bland Rd	-	-
	Eastbound Left / Through / Right	B	B
	Westbound Left / Through / Right	B	B
	Northbound Left	A	A
	Southbound Left	A	A
407	US 70 EB Ramps at NC 55	A	B
	Eastbound Through	A	A
	Eastbound Right	A	A
	Westbound Left	D	D
	Westbound Through	A	A
	Northbound Left	D	D
	Northbound Right	C	C
408	US 70 WB Ramps at NC 55	A	A
	Eastbound Through	A	A
	Eastbound Right	A	A
	Westbound Left	D	D
	Westbound Through	A	A
	Northbound Left	D	D
	Northbound Right	C	C

Movements with zero delay were omitted

Table 13A (Continued)			
2040 Build Alternative 51			
Intersection Level of Service			
#	Intersection	Level of Service	
		AM Peak	PM Peak
409	US 70 EB Ramps at NC 11	B	B
	Eastbound Left	D	D
	Eastbound Right	C	C
	Northbound Left	D	E
	Northbound Through	A	A
	Southbound Through	A	B
	Southbound Right	A	A
410	US 70 WB Ramps at NC 11	A	B
	Eastbound Left	D	D
	Eastbound Right	C	D
	Northbound Left	C	D
	Northbound Through	A	A
	Southbound Through	B	B
	Southbound Right	A	A
411	US 70 EB Ramps at US 258	B	B
	Westbound Left	D	D
	Westbound Right	C	B
	Northbound Through	B	B
	Northbound Right	A	A
	Southbound Left	D	C
	Southbound Through	A	A
412	US 70 WB Ramps at US 258	A	A
	Westbound Left	D	D
	Westbound Right	C	B
	Northbound Through	A	A
	Northbound Right	A	A
	Southbound Left	D	D
	Southbound Through	A	A

Movements with zero delay were omitted

Table 13A (Continued)			
2040 Build Alternative 51			
Intersection Level of Service			
#	Intersection	Level of Service	
		AM Peak	PM Peak
413	NC 58 at Elijah Loftin Rd	-	-
	Eastbound Left / Through / Right	B	B
	Westbound Left / Through / Right	B	B
	Northbound Left	A	A
	Southbound Left	A	A
414	US 70 EB Ramps at NC 58	A	A
	Eastbound Left	D	D
	Eastbound Right	C	C
	Northbound Left	D	D
	Northbound Through	A	A
	Southbound Through	A	A
	Southbound Right	A	A
415	US 70 WB Ramps at NC 58	A	A
	Eastbound Left	D	D
	Eastbound Right	C	C
	Northbound Left	D	D
	Northbound Through	A	A
	Southbound Through	A	A
	Southbound Right	A	A
416	US 70 EB Ramps at Wyse Fork Rd	B	B
	Eastbound Left	D	D
	Eastbound Right	C	C
	Northbound Left	D	D
	Northbound Through	A	A
	Southbound Through	A	A
	Southbound Right	A	A

Movements with zero delay were omitted

Table 13A (Continued) 2040 Build Alternative 51 Intersection Level of Service			
#	Intersection	Level of Service	
		AM Peak	PM Peak
417	US 70 WB Ramps at Wyse Fork Rd	B	B
	Eastbound Left	D	D
	Eastbound Right	C	C
	Northbound Left	C	C
	Northbound Through	A	A
	Southbound Through	A	A
	Southbound Right	A	A
418	US 70 Bus at Kornegay St / Service Rd	-	-
	Eastbound Left	A	A
	Westbound Left	A	A
	Northbound Left / Through / Right	C	C
	Southbound Left / Through / Right	C	C

Movements with zero delay were omitted

Table 13B 2040 Build Alternative 51 Freeway Level of Service				
US 70 Eastbound				
#	Segment	Type	AM Peak	PM Peak
1E	W of Jim Sutton / Willie Measley	Freeway	B	B
2E	To Jim Sutton / Willie Measley	Off-Ramp	B	B
3E	Within Jim Sutton / Willie Measley Int	Freeway	B	A
4E	From Jim Sutton / Willie Measley	On-Ramp	B	B
5E	Jim Sutton / Willie Measley to US 70 Bus (W)	Freeway	B	B
6E	To US 70 Bus (W)	Off-Ramp	A	A
7E	Within US 70 Bus (W) Int	Freeway	A	A
8E	From US 70 Bus (W)	On-Ramp	A	A
9E	US 70 Bus (W) to NC 55	Freeway	A	A
10E	To NC 55	Off-Ramp	A	A
11E	Within NC 55 Int	Freeway	A	A
12E	From NC 55	On-Ramp	A	A
13E	NC 55 to NC 11	Freeway	A	A
14E	To NC 11	Off-Ramp	A	A
15E	Within NC 11 Int	Freeway	A	A
16E	From NC 11	On-Ramp	A	A
17E	NC 11 to US 258	Freeway	A	A
18E	To US 258	Off-Ramp	A	A
19E	Within US 258 Int	Freeway	A	A
20E	From US 258	On-Ramp	A	A
21E	US 258 to NC 58	Freeway	A	A
22E	To NC 58	Off-Ramp	A	A
23E	Within NC 58 Int	Freeway	A	A
24E	From NC 58	On-Ramp	A	A
25E	NC 58 to Wyse Fork	Freeway	A	A
26E	To Wyse Fork	Off-Ramp	A	A
27E	Within Wyse Fork Int	Freeway	A	A
28E	From Wyse Fork	On-Ramp	A	A
29E	Wyse fork to US 70 Bus (E)	Freeway	A	A
30E	To US 70 Bus (E)	Off-Ramp	A	A
31E	Within US 70 Bus (E) Int	Freeway	A	A
32E	From US 70 Bus (E)	On-Ramp	A	A
33E	E of US 70 Bus (E)	Freeway	A	A

Table 13B (Continued) 2040 Build Alternative 51 Freeway Level of Service				
US 70 Westbound				
#	Segment	Type	AM Peak	PM Peak
1W	E of US 70 Bus (E)	Freeway	A	A
2W	To US 70 Bus (E)	Off-Ramp	A	A
3W	Within US 70 Bus (E) Int	Freeway	A	A
4W	From US 70 Bus (E)	On-Ramp	A	A
5W	US 70 Bus (E) to Wyse Fork	Freeway	A	A
6W	To Wyse Fork	Off-Ramp	A	A
7W	Within Wyse Fork Int	Freeway	A	A
8W	From Wyse Fork	On-Ramp	A	A
9W	Wyse Fork to NC 58	Freeway	A	A
10W	To NC 58	Off-Ramp	A	A
11W	Within NC 58 Int	Freeway	A	A
12W	From NC 58	On-Ramp	A	A
13W	NC 58 to US 258	Freeway	A	A
14W	To US 258	Off-Ramp	A	A
15W	Within US 258 Int	Freeway	A	A
16W	From US 258	On-Ramp	A	A
17W	US 258 to NC 11	Freeway	A	A
18W	To NC 11	Off-Ramp	A	A
19W	Within NC 11 Int	Freeway	A	A
20W	From NC 11	On-Ramp	A	A
21W	NC 11 to NC 55	Freeway	A	A
22W	To NC 55	Off-Ramp	A	A
23W	Within NC 55 Int	Freeway	A	A
24W	From NC 55	On-Ramp	A	A
25W	NC 55 to US 70 Bus (W)	Freeway	A	A
26W	To US 70 Bus (W)	Off-Ramp	A	A
27W	Within US 70 Bus (W) Int	Freeway	A	A
28W	From US 70 Bus (W)	On-Ramp	B	B
29W	US 70 Bus (W) to Jim Sutton / Willie Measley	Freeway	B	B
30W	To Jim Sutton / Willie Measley	Off-Ramp	B	B
31W	Within Jim Sutton / Willie Measley Int	Freeway	A	B
32W	From Jim Sutton / Willie Measley	On-Ramp	A	B
33W	W of Jim Sutton / Willie Measley	Freeway	B	B

Table 13C 2040 Build Alternative 51 Queueing and Recommended Storage					
#	Intersection	Movement	Queue (feet)		Recommended Storage (feet)
			AM Peak	PM Peak	
401	Jim Sutton Rd at Service Rd	NBL	4	8	100
		SBL	16	20	100
402	US 70 EB Ramps at Jim Sutton Rd / Willie Measley Rd	WBL	74	88	Continuous
		WBR	158	202	225
		NBR	70	59	100
		SBL	268	256	275
403	US 70 WB Ramps at Jim Sutton Rd / Willie Measley Rd	WBL	98	119	Continuous
		WBR	239	280	300
		NBR	62	45	100
		SBL	199	152	200
404	William Measley Rd at Washington St / Service Rd	NBL	62	58	100
		SBL	16	4	100
405	US 70 Bus at Harold Sutton Rd / Albert Sugg Rd	EBL	18	54	100
		EBR	-	-	100
		WBL	37	51	100
406	NC 55 at N Croom Bland Rd	NBL	4	16	100
		SBL	34	28	100
407	US 70 EB Ramps at NC 55	EBR	28	30	100
		WBL	48	64	100
		NBL	88	124	Continuous
		NBR	69	98	100
408	US 70 WB Ramps at NC 55	EBR	51	50	100
		WBL	80	88	100
		NBL	83	91	Continuous
		NBR	56	45	100
409	US 70 EB Ramps at NC 11	EBL	80	53	Continuous
		EBR	119	114	125
		NBL	154	243	250
		SBR	19	32	100
410	US 70 WB Ramps at NC 11	EBL	64	42	Continuous
		EBR	147	153	175
		NBL	114	123	125
		SBR	43	52	100
411	US 70 EB Ramps at US 258	WBL	143	182	Continuous
		WBR	132	137	150
		NBR	35	29	100
		SBL	68	89	100

The queue reported is the greater of the SimTraffic maximum queue and the Synchro 95th percentile queue.

Table 13C (Continued) 2040 Build Alternative 51 Queueing and Recommended Storage					
#	Intersection	Movement	Queue (feet)		Recommended Storage (feet)
			AM Peak	PM Peak	
412	US 70 WB Ramps at US 258	WBL	63	62	Continuous
		WBR	65	61	100
		NBR	69	78	100
		SBL	128	156	175
413	NC 58 at Elijah Loftin Rd	NBL	17	24	100
		SBL	16	24	100
414	US 70 EB Ramps at NC 58	EBL	49	52	Continuous
		EBR	60	80	100
		NBL	80	66	100
		SBR	24	31	100
415	US 70 WB Ramps at NC 58	EBL	40	27	Continuous
		EBR	68	72	100
		NBL	80	56	100
		SBR	23	30	100
416	US 70 EB Ramps at Wyse Fork Rd	EBL	51	42	Continuous
		EBR	47	56	100
		NBL	54	56	100
		SBR	26	20	100
417	US 70 WB Ramps at Wyse Fork Rd	EBL	41	27	Continuous
		EBR	63	45	100
		NBL	58	54	100
		SBR	20	28	100
418	US 70 Bus at Kornegay St / Service Rd	EBL	64	65	100
		WBL	15	22	100

The queue reported is the greater of the SimTraffic maximum queue and the Synchro 95th percentile queue.

5.12 2040 Build Alternative 52

A capacity analysis was performed for 2040 Build Alternative 52 AM and PM peak periods for all of the study intersections and freeway elements. Intersection levels of service are summarized in **Table 14A**, freeway levels of service are summarized in **Table 14B**, and queuing and recommended storage are summarized in **Table 14C**. Traffic volumes are shown in **Figures 12A – 12F**, and LOS and laneage are shown in **Figures 12G – 12L**. Peak hour traffic volume development, and FREEVAL-E, Synchro, and SimTraffic reports are located in **Appendix M**.

Table 14A 2040 Build Alternative 52 Intersection Level of Service			
#	Intersection	Level of Service	
		AM Peak	PM Peak
401	Jim Sutton Rd at Service Rd	-	-
	Eastbound Left / Through / Right	B	B
	Westbound Left / Through / Right	A	A
	Northbound Left	A	A
	Southbound Left	A	A
402	US 70 EB Ramps at Jim Sutton Rd / Willie Measley Rd	C	C
	Westbound Left	D	D
	Westbound Right	B	B
	Northbound Through	B	B
	Northbound Right	A	A
	Southbound Left	C	C
	Southbound Through	A	A
403	US 70 WB Ramps at Jim Sutton Rd / Willie Measley Rd	B	B
	Westbound Left	D	D
	Westbound Right	C	C
	Northbound Through	B	B
	Northbound Right	A	A
	Southbound Left	C	C
	Southbound Through	A	A

Movements with zero delay were omitted

Table 14A (Continued) 2040 Build Alternative 52 Intersection Level of Service			
#	Intersection	Level of Service	
		AM Peak	PM Peak
404	Willie Measley Rd at Washington St / Service Rd	-	-
	Eastbound Left / Through / Right	B	B
	Westbound Left / Through / Right	E	E
	Northbound Left	A	A
	Southbound Left	A	A
405	US 70 Bus at Harold Sutton Rd / Albert Sugg Rd	-	-
	Eastbound Left	A	B
	Westbound Left	B	A
	Northbound Left / Through / Right	C	C
	Southbound Left / Through / Right	C	D
406	NC 55 at N Croom Bland Rd	-	-
	Eastbound Left / Through / Right	B	B
	Westbound Left / Through / Right	B	B
	Northbound Left	A	A
	Southbound Left	A	A
407	US 70 EB Ramps at NC 55	A	B
	Eastbound Through	A	A
	Eastbound Right	A	A
	Westbound Left	D	D
	Westbound Through	A	A
	Northbound Left	D	D
	Northbound Right	C	C
408	US 70 WB Ramps at NC 55	A	A
	Eastbound Through	A	A
	Eastbound Right	A	A
	Westbound Left	D	D
	Westbound Through	A	A
	Northbound Left	D	D
	Northbound Right	C	C

Movements with zero delay were omitted

Table 14A (Continued)			
2040 Build Alternative 52			
Intersection Level of Service			
#	Intersection	Level of Service	
		AM Peak	PM Peak
409	US 70 EB Ramps at NC 11	B	B
	Eastbound Left	D	D
	Eastbound Right	C	C
	Northbound Left	D	E
	Northbound Through	A	A
	Southbound Through	A	B
	Southbound Right	A	A
410	US 70 WB Ramps at NC 11	A	B
	Eastbound Left	D	D
	Eastbound Right	C	D
	Northbound Left	C	D
	Northbound Through	A	A
	Southbound Through	B	B
	Southbound Right	A	A
411	US 70 EB Ramps at US 258	B	B
	Westbound Left	D	D
	Westbound Right	C	B
	Northbound Through	B	B
	Northbound Right	A	A
	Southbound Left	D	C
	Southbound Through	A	A
412	US 70 WB Ramps at US 258	A	A
	Westbound Left	D	D
	Westbound Right	C	B
	Northbound Through	A	A
	Northbound Right	A	A
	Southbound Left	D	D
	Southbound Through	A	A

Movements with zero delay were omitted

Table 14A (Continued)			
2040 Build Alternative 52			
Intersection Level of Service			
#	Intersection	Level of Service	
		AM Peak	PM Peak
413	NC 58 at Elijah Loftin Rd	-	-
	Eastbound Left / Through / Right	B	B
	Westbound Left / Through / Right	B	B
	Northbound Left	A	A
	Southbound Left	A	A
414	US 70 EB Ramps at NC 58	A	A
	Eastbound Left	D	D
	Eastbound Right	C	C
	Northbound Left	D	D
	Northbound Through	A	A
	Southbound Through	A	A
	Southbound Right	A	A
415	US 70 WB Ramps at NC 58	A	A
	Eastbound Left	D	D
	Eastbound Right	C	C
	Northbound Left	D	D
	Northbound Through	A	A
	Southbound Through	A	A
	Southbound Right	A	A
416	US 70 BUS at Wyse Fork Rd	-	-
	Westbound Left	A	A
	Northbound Left / Right	B	B
417	Burkett Rd at Wyse Fork Connector	-	-
	Eastbound Left / Through	A	A
	Southbound Left / Right	A	A

Movements with zero delay were omitted

Table 14A (Continued) 2040 Build Alternative 52 Intersection Level of Service			
#	Intersection	Level of Service	
		AM Peak	PM Peak
418	US 70 EB Ramps at Burkett Rd / Kornegay St	C	C
	Eastbound Left / Through	D	D
	Eastbound Right	C	C
	Northbound Through	A	A
	Northbound Right	A	A
	Southbound Left	D	C
	Southbound Through	A	A
419	US 70 WB Ramps at Burkett Rd / Kornegay St	B	A
	Westbound Left / Through	D	D
	Westbound Right	D	D
	Northbound Left	C	B
	Northbound Through	A	A
	Southbound Through	A	A
	Southbound Right	A	A

Movements with zero delay were omitted

Table 14B 2040 Build Alternative 52 Freeway Level of Service				
US 70 Eastbound				
#	Segment	Type	AM Peak	PM Peak
1E	W of Jim Sutton / Willie Measley	Freeway	B	B
2E	To Jim Sutton / Willie Measley	Off-Ramp	B	B
3E	Within Jim Sutton / Willie Measley Int	Freeway	B	A
4E	From Jim Sutton / Willie Measley	On-Ramp	B	B
5E	Jim Sutton / Willie Measley to US 70 Bus (W)	Freeway	B	B
6E	To US 70 Bus (W)	Off-Ramp	A	A
7E	Within US 70 Bus (W) Int	Freeway	A	A
8E	From US 70 Bus (W)	On-Ramp	A	A
9E	US 70 Bus (W) to NC 55	Freeway	A	A
10E	To NC 55	Off-Ramp	A	A
11E	Within NC 55 Int	Freeway	A	A
12E	From NC 55	On-Ramp	A	A
13E	NC 55 to NC 11	Freeway	A	A
14E	To NC 11	Off-Ramp	A	A
15E	Within NC 11 Int	Freeway	A	A
16E	From NC 11	On-Ramp	A	A
17E	NC 11 to US 258	Freeway	A	A
18E	To US 258	Off-Ramp	A	A
19E	Within US 258 Int	Freeway	A	A
20E	From US 258	On-Ramp	A	A
21E	US 258 to NC 58	Freeway	A	A
22E	To NC 58	Off-Ramp	A	A
23E	Within NC 58 Int	Freeway	A	A
24E	From NC 58	On-Ramp	A	A
25E	NC 58 to US 70 Bus (E)	Freeway	A	A
26E	To US 70 Bus (E)	Off-Ramp	A	A
27E	Within US 70 Bus (E) Int	Freeway	A	A
28E	From US 70 Bus (E)	On-Ramp	A	A
29E	US 70 Bus (E) to Burkett / Kornegay	Freeway	A	A
30E	To Burkett / Kornegay	Off-Ramp	A	B
31E	Within Burkett / Kornegay Int	Freeway	A	A
32E	From Burkett / Kornegay	On-Ramp	A	A
33E	E of Burkett / Kornegay	Freeway	A	A

Table 14B (Continued) 2040 Build Alternative 52 Freeway Level of Service				
US 70 Westbound				
#	Segment	Type	AM Peak	PM Peak
1W	E of Burkett / Kornegay	Freeway	A	A
2W	To Burkett / Kornegay	Off-Ramp	A	A
3W	Within Burkett / Kornegay Int	Freeway	A	A
4W	From Burkett / Kornegay	On-Ramp	A	A
5W	Burkett / Kornegay to US 70 Bus (E)	Freeway	A	A
6W	To US 70 Bus (E)	Off-Ramp	B	A
7W	Within US 70 Bus (E) Int	Freeway	A	A
8W	From US 70 Bus (E)	On-Ramp	A	A
9W	US 70 Bus (E) to NC 58	Freeway	A	A
10W	To NC 58	Off-Ramp	A	A
11W	Within NC 58 Int	Freeway	A	A
12W	From NC 58	On-Ramp	A	A
13W	NC 58 to US 258	Freeway	A	A
14W	To US 258	Off-Ramp	A	A
15W	Within US 258 Int	Freeway	A	A
16W	From US 258	On-Ramp	A	A
17W	US 258 to NC 11	Freeway	A	A
18W	To NC 11	Off-Ramp	A	A
19W	Within NC 11 Int	Freeway	A	A
20W	From NC 11	On-Ramp	A	A
21W	NC 11 to NC 55	Freeway	A	A
22W	To NC 55	Off-Ramp	A	A
23W	Within NC 55 Int	Freeway	A	A
24W	From NC 55	On-Ramp	A	A
25W	NC 55 to US 70 Bus (W)	Freeway	A	A
26W	To US 70 Bus (W)	Off-Ramp	A	A
27W	Within US 70 Bus (W) Int	Freeway	A	A
28W	From US 70 Bus (W)	On-Ramp	B	B
29W	US 70 Bus (W) to Jim Sutton / Willie Measley	Freeway	B	B
30W	To Jim Sutton / Willie Measley	Off-Ramp	B	B
31W	Within Jim Sutton / Willie Measley Int	Freeway	A	B
32W	From Jim Sutton / Willie Measley	On-Ramp	A	B
33W	W of Jim Sutton / Willie Measley	Freeway	B	B

Table 14C 2040 Build Alternative 52 Queueing and Recommended Storage					
#	Intersection	Movement	Queue (feet)		Recommended Storage (feet)
			AM Peak	PM Peak	
401	Jim Sutton Rd at Service Rd	NBL	4	8	100
		SBL	16	20	100
402	US 70 EB Ramps at Jim Sutton Rd / Willie Measley Rd	WBL	74	88	Continuous
		WBR	158	202	225
		NBR	70	59	100
		SBL	268	256	275
403	US 70 WB Ramps at Jim Sutton Rd / Willie Measley Rd	WBL	98	119	Continuous
		WBR	239	280	300
		NBR	62	45	100
		SBL	199	152	200
404	William Measley Rd at Washington St / Service Rd	NBL	62	58	100
		SBL	16	4	100
405	US 70 Bus at Harold Sutton Rd / Albert Sugg Rd	EBL	18	54	100
		EBR	-	-	100
		WBL	37	51	100
406	NC 55 at N Croom Bland Rd	NBL	4	16	100
		SBL	34	28	100
407	US 70 EB Ramps at NC 55	EBR	28	30	100
		WBL	48	64	100
		NBL	88	124	Continuous
		NBR	69	98	100
408	US 70 WB Ramps at NC 55	EBR	51	50	100
		WBL	80	88	100
		NBL	83	91	Continuous
		NBR	56	45	100
409	US 70 EB Ramps at NC 11	EBL	80	53	Continuous
		EBR	119	114	125
		NBL	154	243	250
		SBR	19	32	100
410	US 70 WB Ramps at NC 11	EBL	64	42	Continuous
		EBR	147	153	175
		NBL	114	123	125
		SBR	43	52	100
411	US 70 EB Ramps at US 258	WBL	143	182	Continuous
		WBR	132	137	150
		NBR	35	29	100
		SBL	68	89	100

The queue reported is the greater of the SimTraffic maximum queue and the Synchro 95th percentile queue.

Table 14C (Continued)					
2040 Build Alternative 52					
Queueing and Recommended Storage					
#	Intersection	Movement	Queue (feet)		Recommended Storage (feet)
			AM Peak	PM Peak	
412	US 70 WB Ramps at US 258	WBL	63	62	Continuous
		WBR	65	61	100
		NBR	69	78	100
		SBL	128	156	175
413	US 70 Bus at Wyse Fork Rd	NBL	17	24	100
		SBL	16	24	100
414	US 70 EB Ramps at NC 58	EBL	49	52	Continuous
		EBR	60	80	100
		NBL	80	66	100
		SBR	24	31	100
415	US 70 WB Ramps at NC 58	EBL	40	27	Continuous
		EBR	68	72	100
		NBL	80	56	100
		SBR	23	30	100
416	US 70 Bus at Wyse Fork Rd	EBR	8	4	100
		WBL	35	66	100
417	Burkett Rd at Wyse Fork Connector	SBLR	44	47	Continuous
418	US 70 EB Ramps at Burkett Rd / Kornegay St	EBR	37	69	100
		NBR	36	18	100
		SBL	63	60	100
419	US 70 WB Ramps at Burkett Rd / Kornegay St	WBR	59	73	100
		NBL	62	48	100
		SBR	72	48	100

The queue reported is the greater of the SimTraffic maximum queue and the Synchro 95th percentile queue.

5.13 2040 Build Alternative 35

A capacity analysis was performed for 2040 Build Alternative 35 AM and PM peak periods for all of the study intersections and freeway elements. Intersection levels of service are summarized in **Table 15A**, freeway levels of service are summarized in **Table 15B**, and queuing and recommended storage are summarized in **Table 15C**. Traffic volumes are shown in **Figures 13A – 13F**, and LOS and laneage are shown in **Figures 13G – 13L**. Peak hour traffic volume development, and FREEVAL-E, Synchro, and SimTraffic reports are located in **Appendix N**.

Table 15A 2040 Build Alternative 35 Intersection Level of Service			
#	Intersection	Level of Service	
		AM Peak	PM Peak
401	Jim Sutton Rd at Service Rd	-	-
	Eastbound Left / Through / Right	B	B
	Westbound Left / Through / Right	A	A
	Northbound Left	A	A
	Southbound Left	A	A
402	US 70 EB Ramps at Jim Sutton Rd / Willie Measley Rd	C	C
	Westbound Left	D	D
	Westbound Right	B	B
	Northbound Through	B	B
	Northbound Right	A	A
	Southbound Left	C	C
	Southbound Through	A	A
403	US 70 WB Ramps at Jim Sutton Rd / Willie Measley Rd	B	B
	Westbound Left	D	D
	Westbound Right	C	C
	Northbound Through	B	B
	Northbound Right	A	A
	Southbound Left	C	C
	Southbound Through	A	A

Movements with zero delay were omitted

Table 15A (Continued)			
2040 Build Alternative 35			
Intersection Level of Service			
#	Intersection	Level of Service	
		AM Peak	PM Peak
404	Willie Measley Rd at Washington St / Service Rd	-	-
	Eastbound Left / Through / Right	B	B
	Westbound Left / Through / Right	E	E
	Northbound Left	A	A
	Southbound Left	A	A
405	US 70 Bus at Harold Sutton Rd / Albert Sugg Rd	-	-
	Eastbound Left	B	C
	Westbound Left	B	B
	Northbound Left / Through / Right	E	D
	Southbound Left / Through / Right	D	E
406	US 70 EB Ramps at NC 55	B	B
	Eastbound Through	A	A
	Eastbound Right	A	A
	Westbound Left	D	C
	Westbound Through	A	A
	Northbound Left	D	D
	Northbound Right	C	C
407	US 70 WB Ramps at NC 55	B	B
	Eastbound Through	A	A
	Eastbound Right	A	A
	Westbound Left	D	D
	Westbound Through	A	A
	Northbound Left	D	D
	Northbound Right	C	C
408	NC 11 at Service Rd	-	-
	Westbound Left / Right	D	D
	Southbound Left	B	A

Movements with zero delay were omitted

Table 15A (Continued)			
2040 Build Alternative 35			
Intersection Level of Service			
#	Intersection	Level of Service	
		AM Peak	PM Peak
409	US 70 EB Ramps at NC 11	B	B
	Westbound Left	D	D
	Westbound Right	C	C
	Northbound Through	D	D
	Northbound Right	A	A
	Southbound Left	A	A
	Southbound Through	A	A
410	US 70 WB Ramps at NC 11	B	B
	Westbound Left	D	D
	Westbound Right	C	C
	Northbound Through	C	D
	Northbound Right	A	A
	Southbound Left	B	B
	Southbound Through	A	A
411	US 258 at Clarence Potter Rd / Service Rd	-	-
	Eastbound Left / Through / Right	B	B
	Westbound Left / Through / Right	B	B
	Northbound Left	A	A
	Southbound Left	A	A
412	US 70 EB Ramps at US 258	B	B
	Eastbound Left	D	D
	Eastbound Right	C	B
	Northbound Left	B	B
	Northbound Through	A	A
	Southbound Through	D	C
	Southbound Right	A	A

Movements with zero delay were omitted

Table 15A (Continued)			
2040 Build Alternative 35			
Intersection Level of Service			
#	Intersection	Level of Service	
		AM Peak	PM Peak
413	US 70 WB Ramps at US 258	A	A
	Eastbound Left	D	D
	Eastbound Right	C	C
	Northbound Left	A	A
	Northbound Through	A	A
	Southbound Through	D	D
	Southbound Right	A	A
414	US 70 EB Ramps at NC 58	A	A
	Westbound Left	D	D
	Westbound Right	C	C
	Northbound Through	A	A
	Northbound Right	A	A
	Southbound Left	D	D
	Southbound Through	A	A
415	US 70 WB Ramps at NC 58	A	A
	Westbound Left	D	D
	Westbound Right	C	C
	Northbound Through	A	A
	Northbound Right	A	A
	Southbound Left	D	D
	Southbound Through	A	A
416	US 70 BUS at Wyse Fork Rd	-	-
	Westbound Left	A	B
	Northbound Left / Right	C	C
417	Burkett Rd at Wyse Fork Connector	-	-
	Eastbound Left / Through	A	A
	Southbound Left / Right	A	A

Movements with zero delay were omitted

Table 15A (Continued) 2040 Build Alternative 35 Intersection Level of Service			
#	Intersection	Level of Service	
		AM Peak	PM Peak
418	US 70 EB Ramps at Burkett Rd / Kornegay St	C	C
	Eastbound Left / Through	D	D
	Eastbound Right	C	C
	Northbound Through	A	A
	Northbound Right	A	A
	Southbound Left	D	C
	Southbound Through	A	A
419	US 70 WB Ramps at Burkett Rd / Kornegay St	B	A
	Westbound Left / Through	D	D
	Westbound Right	D	D
	Northbound Left	C	B
	Northbound Through	A	A
	Southbound Through	A	A
	Southbound Right	A	A

Movements with zero delay were omitted

Table 15B 2040 Build Alternative 35 Freeway Level of Service				
US 70 Eastbound				
#	Segment	Type	AM Peak	PM Peak
1E	W of Jim Sutton / Willie Measley	Freeway	B	B
2E	To Jim Sutton / Willie Measley	Off-Ramp	B	B
3E	Within Jim Sutton / Willie Measley Int	Freeway	B	A
4E	From Jim Sutton / Willie Measley	On-Ramp	B	B
5E	Jim Sutton / Willie Measley to US 70 Bus (W)	Freeway	B	B
6E	To US 70 Bus (W)	Off-Ramp	A	A
7E	Within US 70 Bus (W) Int	Freeway	A	A
8E	From US 70 Bus (W)	On-Ramp	A	A
9E	US 70 Bus (W) to NC 55	Freeway	A	A
10E	To NC 55	Off-Ramp	A	A
11E	Within NC 55 Int	Freeway	A	A
12E	From NC 55	On-Ramp	A	A
13E	NC 55 to NC 11	Freeway	A	A
14E	To NC 11	Off-Ramp	A	A
15E	Within NC 11 Int	Freeway	A	A
16E	From NC 11	On-Ramp	A	A
17E	NC 11 to US 258	Freeway	A	A
18E	To US 258	Off-Ramp	A	A
19E	Within US 258 Int	Freeway	A	A
20E	From US 258	On-Ramp	A	A
21E	US 258 to NC 58	Freeway	A	A
22E	To NC 58	Off-Ramp	A	A
23E	Within NC 58 Int	Freeway	A	A
24E	From NC 58	On-Ramp	A	A
25E	NC 58 to US 70 Bus (E)	Freeway	A	A
26E	To US 70 Bus (E)	Off-Ramp	A	A
27E	Within US 70 Bus (E) Int	Freeway	A	A
28E	From US 70 Bus (E)	On-Ramp	A	A
29E	US 70 Bus (E) to Burkett / Kornegay	Freeway	A	A
30E	To Burkett / Kornegay	Off-Ramp	A	B
31E	Within Burkett / Kornegay Int	Freeway	A	A
32E	From Burkett / Kornegay	On-Ramp	A	A
33E	E of Burkett / Kornegay	Freeway	A	A

Table 15B (Continued) 2040 Build Alternative 35 Freeway Level of Service				
US 70 Westbound				
#	Segment	Type	AM Peak	PM Peak
1W	E of Burkett / Kornegay	Freeway	A	A
2W	To Burkett / Kornegay	Off-Ramp	A	A
3W	Within Burkett / Kornegay Int	Freeway	A	A
4W	From Burkett / Kornegay	On-Ramp	A	A
5W	Burkett / Kornegay to US 70 Bus (E)	Freeway	A	A
6W	To US 70 Bus (E)	Off-Ramp	B	A
7W	Within US 70 Bus (E) Int	Freeway	A	A
8W	From US 70 Bus (E)	On-Ramp	A	A
9W	US 70 Bus (E) to NC 58	Freeway	A	A
10W	To NC 58	Off-Ramp	A	A
11W	Within NC 58 Int	Freeway	A	A
12W	From NC 58	On-Ramp	A	A
13W	NC 58 to US 258	Freeway	A	A
14W	To US 258	Off-Ramp	A	A
15W	Within US 258 Int	Freeway	A	A
16W	From US 258	On-Ramp	A	A
17W	US 258 to NC 11	Freeway	A	A
18W	To NC 11	Off-Ramp	A	A
19W	Within NC 11 Int	Freeway	A	A
20W	From NC 11	On-Ramp	A	A
21W	NC 11 to NC 55	Freeway	A	A
22W	To NC 55	Off-Ramp	A	A
23W	Within NC 55 Int	Freeway	A	A
24W	From NC 55	On-Ramp	A	A
25W	NC 55 to US 70 Bus (W)	Freeway	A	A
26W	To US 70 Bus (W)	Off-Ramp	A	A
27W	Within US 70 Bus (W) Int	Freeway	A	A
28W	From US 70 Bus (W)	On-Ramp	B	B
29W	US 70 Bus (W) to Jim Sutton / Willie Measley	Freeway	B	B
30W	To Jim Sutton / Willie Measley	Off-Ramp	B	B
31W	Within Jim Sutton / Willie Measley Int	Freeway	A	B
32W	From Jim Sutton / Willie Measley	On-Ramp	A	B
33W	W of Jim Sutton / Willie Measley	Freeway	B	B

Table 15C 2040 Build Alternative 35 Queueing and Recommended Storage					
#	Intersection	Movement	Queue (feet)		Recommended Storage (feet)
			AM Peak	PM Peak	
401	Jim Sutton Rd at Service Rd	NBL	-	8	100
		SBL	20	12	100
402	US 70 EB Ramps at Jim Sutton Rd / Willie Measley Rd	WBL	74	92	Continuous
		WBR	171	164	175
		NBR	78	58	100
		SBL	328	259	350
403	US 70 WB Ramps at Jim Sutton Rd / Willie Measley Rd	WBL	104	150	Continuous
		WBR	240	284	300
		NBR	45	39	100
		SBL	191	165	200
404	Willie Measley Rd at Washington St / Service Rd	NBL	64	69	100
		SBL	24	12	100
405	US 70 Bus at Harold Sutton Rd / Albert Sugg Rd	EBL	42	54	100
		EBR	-	-	100
		WBL	46	54	100
406	US 70 EB Ramps at NC 55	EBR	35	39	100
		WBL	48	57	100
		NBL	137	146	Continuous
		NBR	104	86	125
407	US 70 WB Ramps at NC 55	EBR	53	54	100
		WBL	97	110	125
		NBL	112	92	Continuous
		NBR	57	63	100
408	NC 11 at Service Rd	NBR	161	-	175
		SBL	48	32	100
409	US 70 EB Ramps at NC 11	EBL	158	107	Continuous
		EBR	96	130	150
		NBL	153	142	175
		SBR	43	57	100
410	US 70 WB Ramps at NC 11	EBL	136	129	Continuous
		EBR	120	139	150
		NBL	139	109	150
		SBR	51	83	100
411	US 258 at Clarence Potter Rd / Service Rd	NBL	18	12	100
		SBL	16	13	100
412	US 70 EB Ramps at US 258	WBL	169	185	Continuous
		WBR	133	98	150
		NBR	28	58	100
		SBL	44	56	100

The queue reported is the greater of the SimTraffic maximum queue and the Synchro 95th percentile queue.

Table 15C (Continued)					
2040 Build Alternative 35					
Queueing and Recommended Storage					
#	Intersection	Movement	Queue (feet)		Recommended Storage (feet)
			AM Peak	PM Peak	
413	US 70 WB Ramps at US 258	WBL	63	67	Continuous
		WBR	49	37	100
		NBR	83	59	100
		SBL	119	116	125
414	US 70 EB Ramps at NC 58	WBL	62	80	Continuous
		WBR	59	68	100
		NBR	28	20	100
		SBL	34	47	100
415	US 70 WB Ramps at NC 58	WBL	59	60	Continuous
		WBR	40	17	100
		NBR	37	27	100
		SBL	60	57	100
416	US 70 Bus at Wyse Fork Rd	EBR	-	7	100
		WBL	63	53	100
417	Burkett Rd at Wyse Fork Connector	SBLR	50	45	Continuous
418	US 70 EB Ramps at Burkett Rd / Kornegay St	EBR	44	67	100
		NBR	21	21	100
		SBL	64	64	100
419	US 70 WB Ramps at Burkett Rd / Kornegay St	WBR	67	56	100
		NBL	62	48	100
		SBR	50	54	100

The queue reported is the greater of the SimTraffic maximum queue and the Synchro 95th percentile queue.

5.14 2040 Build Alternative 36

A capacity analysis was performed for 2040 Build Alternative 36 AM and PM peak periods for all of the study intersections and freeway elements. Intersection levels of service are summarized in **Table 16A**, freeway levels of service are summarized in **Table 16B**, and queuing and recommended storage are summarized in **Table 16C**. Traffic volumes are shown in **Figures 14A – 14F**, and LOS and laneage are shown in **Figures 14G – 14L**. Peak hour traffic volume development, and FREEVAL-E, Synchro, and SimTraffic reports are located in **Appendix O**.

Table 16A 2040 Build Alternative 36 Intersection Level of Service			
#	Intersection	Level of Service	
		AM Peak	PM Peak
401	Jim Sutton Rd at Service Rd	-	-
	Eastbound Left / Through / Right	B	B
	Westbound Left / Through / Right	A	A
	Northbound Left	A	A
	Southbound Left	A	A
402	US 70 EB Ramps at Jim Sutton Rd / Willie Measley Rd	C	C
	Westbound Left	D	D
	Westbound Right	B	B
	Northbound Through	B	B
	Northbound Right	A	A
	Southbound Left	C	C
	Southbound Through	A	A
403	US 70 WB Ramps at Jim Sutton Rd / Willie Measley Rd	B	B
	Westbound Left	D	D
	Westbound Right	C	C
	Northbound Through	B	B
	Northbound Right	A	A
	Southbound Left	C	C
	Southbound Through	A	A

Movements with zero delay were omitted

Table 16A (Continued) 2040 Build Alternative 36 Intersection Level of Service			
#	Intersection	Level of Service	
		AM Peak	PM Peak
404	Willie Measley Rd at Washington St / Service Rd	-	-
	Eastbound Left / Through / Right	B	B
	Westbound Left / Through / Right	E	E
	Northbound Left	A	A
	Southbound Left	A	A
405	US 70 Bus at Harold Sutton Rd / Albert Sugg Rd	-	-
	Eastbound Left	B	C
	Westbound Left	B	B
	Northbound Left / Through / Right	E	D
	Southbound Left / Through / Right	D	E
406	US 70 EB Ramps at NC 55	B	B
	Eastbound Through	A	A
	Eastbound Right	A	A
	Westbound Left	D	C
	Westbound Through	A	A
	Northbound Left	D	D
	Northbound Right	C	C
407	US 70 WB Ramps at NC 55	B	B
	Eastbound Through	A	A
	Eastbound Right	A	A
	Westbound Left	D	D
	Westbound Through	A	A
	Northbound Left	D	D
	Northbound Right	C	C
408	NC 11 at Service Rd	-	-
	Westbound Left / Right	D	D
	Southbound Left	B	A

Movements with zero delay were omitted

Table 16A (Continued)			
2040 Build Alternative 36			
Intersection Level of Service			
#	Intersection	Level of Service	
		AM Peak	PM Peak
409	US 70 EB Ramps at NC 11	B	B
	Eastbound Left	D	D
	Eastbound Right	C	C
	Northbound Left	D	D
	Northbound Through	A	A
	Southbound Through	A	A
	Southbound Right	A	A
410	US 70 WB Ramps at NC 11	B	B
	Eastbound Left	D	D
	Eastbound Right	C	C
	Northbound Left	C	D
	Northbound Through	A	A
	Southbound Through	B	B
	Southbound Right	A	A
411	US 258 at Clarence Potter Rd / Service Rd	-	-
	Eastbound Left / Through / Right	B	B
	Westbound Left / Through / Right	B	B
	Northbound Left	A	A
	Southbound Left	A	A
412	US 70 EB Ramps at US 258	B	B
	Westbound Left	D	D
	Westbound Right	C	B
	Northbound Through	B	B
	Northbound Right	A	A
	Southbound Left	D	D
	Southbound Through	A	A

Movements with zero delay were omitted

Table 16A (Continued)			
2040 Build Alternative 36			
Intersection Level of Service			
#	Intersection	Level of Service	
		AM Peak	PM Peak
413	US 70 WB Ramps at US 258	A	A
	Westbound Left	D	D
	Westbound Right	C	C
	Northbound Through	A	A
	Northbound Right	A	A
	Southbound Left	D	D
	Southbound Through	A	A
414	US 70 EB Ramps at NC 58	A	A
	Westbound Left	D	D
	Westbound Right	C	C
	Northbound Through	A	A
	Northbound Right	A	A
	Southbound Left	D	D
	Southbound Through	A	A
415	US 70 Bus at NC 58	A	A
	Westbound Left	D	D
	Westbound Right	C	C
	Northbound Through	A	A
	Northbound Right	A	A
	Southbound Left	D	D
	Southbound Through	A	A
416	US 70 EB Ramps at Wyse Fork Rd	B	B
	Eastbound Left	D	D
	Eastbound Right	C	C
	Northbound Left	D	D
	Northbound Through	A	A
	Southbound Through	A	A
	Southbound Right	A	A

Movements with zero delay were omitted

Table 16A (Continued) 2040 Build Alternative 36 Intersection Level of Service			
#	Intersection	Level of Service	
		AM Peak	PM Peak
417	US 70 WB Ramps at Wyse Fork Rd	B	B
	Eastbound Left	D	D
	Eastbound Right	C	C
	Northbound Left	C	C
	Northbound Through	A	A
	Southbound Through	A	A
	Southbound Right	A	A
418	US 70 Bus at Kornegay St / Service Rd	-	-
	Eastbound Left	B	A
	Westbound Right	A	A
	Northbound Left / Through / Right	C	C
	Southbound Left / Through / Right	C	C

Movements with zero delay were omitted

Table 16B 2040 Build Alternative 36 Freeway Level of Service				
US 70 Eastbound				
#	Segment	Type	AM Peak	PM Peak
1E	W of Jim Sutton / Willie Measley	Freeway	B	B
2E	To Jim Sutton / Willie Measley	Off-Ramp	B	B
3E	Within Jim Sutton / Willie Measley Int	Freeway	B	A
4E	From Jim Sutton / Willie Measley	On-Ramp	B	B
5E	Jim Sutton / Willie Measley to US 70 Bus (W)	Freeway	B	B
6E	To US 70 Bus (W)	Off-Ramp	A	A
7E	Within US 70 Bus (W) Int	Freeway	A	A
8E	From US 70 Bus (W)	On-Ramp	A	A
9E	US 70 Bus (W) to NC 55	Freeway	A	A
10E	To NC 55	Off-Ramp	A	A
11E	Within NC 55 Int	Freeway	A	A
12E	From NC 55	On-Ramp	A	A
13E	NC 55 to NC 11	Freeway	A	A
14E	To NC 11	Off-Ramp	A	A
15E	Within NC 11 Int	Freeway	A	A
16E	From NC 11	On-Ramp	A	A
17E	NC 11 to US 258	Freeway	A	A
18E	To US 258	Off-Ramp	A	A
19E	Within US 258 Int	Freeway	A	A
20E	From US 258	On-Ramp	A	A
21E	US 258 to NC 58	Freeway	A	A
22E	To NC 58	Off-Ramp	A	A
23E	Within NC 58 Int	Freeway	A	A
24E	From NC 58	On-Ramp	A	A
25E	NC 58 to Wyse Fork	Freeway	A	A
26E	To Wyse Fork	Off-Ramp	A	A
27E	Within Wyse Fork Int	Freeway	A	A
28E	From Wyse Fork	On-Ramp	A	A
29E	Wyse fork to US 70 Bus (E)	Freeway	A	A
30E	To US 70 Bus (E)	Off-Ramp	A	A
31E	Within US 70 Bus (E) Int	Freeway	A	A
32E	From US 70 Bus (E)	On-Ramp	A	A
33E	E of US 70 Bus (E)	Freeway	A	A

Table 16B (Continued) 2040 Build Alternative 36 Freeway Level of Service				
US 70 Westbound				
#	Segment	Type	AM Peak	PM Peak
1W	E of US 70 Bus (E)	Freeway	A	A
2W	To US 70 Bus (E)	Off-Ramp	B	A
3W	Within US 70 Bus (E) Int	Freeway	A	A
4W	From US 70 Bus (E)	On-Ramp	A	A
5W	US 70 Bus (E) to Wyse Fork	Freeway	A	A
6W	To Wyse Fork	Off-Ramp	A	A
7W	Within Wyse Fork Int	Freeway	A	A
8W	From Wyse Fork	On-Ramp	A	A
9W	Wyse Fork to NC 58	Freeway	A	A
10W	To NC 58	Off-Ramp	A	A
11W	Within NC 58 Int	Freeway	A	A
12W	From NC 58	On-Ramp	A	A
13W	NC 58 to US 258	Freeway	A	A
14W	To US 258	Off-Ramp	A	A
15W	Within US 258 Int	Freeway	A	A
16W	From US 258	On-Ramp	A	A
17W	US 258 to NC 11	Freeway	A	A
18W	To NC 11	Off-Ramp	A	A
19W	Within NC 11 Int	Freeway	A	A
20W	From NC 11	On-Ramp	A	A
21W	NC 11 to NC 55	Freeway	A	A
22W	To NC 55	Off-Ramp	A	A
23W	Within NC 55 Int	Freeway	A	A
24W	From NC 55	On-Ramp	A	A
25W	NC 55 to US 70 Bus (W)	Freeway	A	A
26W	To US 70 Bus (W)	Off-Ramp	A	A
27W	Within US 70 Bus (W) Int	Freeway	A	A
28W	From US 70 Bus (W)	On-Ramp	B	B
29W	US 70 Bus (W) to Jim Sutton / Willie Measley	Freeway	B	B
30W	To Jim Sutton / Willie Measley	Off-Ramp	B	B
31W	Within Jim Sutton / Willie Measley Int	Freeway	A	B
32W	From Jim Sutton / Willie Measley	On-Ramp	A	B
33W	W of Jim Sutton / Willie Measley	Freeway	B	B

Table 16C 2040 Build Alternative 36 Queueing and Recommended Storage					
#	Intersection	Movement	Queue (feet)		Recommended Storage (feet)
			AM Peak	PM Peak	
401	Jim Sutton Rd at Service Rd	NBL	-	8	100
		SBL	25	22	100
402	US 70 EB Ramps at Jim Sutton Rd / Willie Measley Rd	WBL	76	93	Continuous
		WBR	171	182	200
		NBR	64	65	100
		SBL	363	272	375
403	US 70 WB Ramps at Jim Sutton Rd / Willie Measley Rd	WBL	101	162	Continuous
		WBR	208	238	250
		NBR	46	46	100
		SBL	180	187	200
404	William Measley Rd at Washington St / Service Rd	NBL	77	57	100
		SBL	12	8	100
405	US 70 Bus at Harold Sutton Rd / Albert Sugg Rd	EBL	44	54	100
		EBR	-	7	100
		WBL	56	50	100
406	US 70 EB Ramps at NC 55	EBR	36	61	100
		WBL	57	68	100
		NBL	113	155	Continuous
		NBR	98	83	100
407	US 70 WB Ramps at NC 55	EBR	64	53	100
		WBL	105	114	125
		NBL	102	131	Continuous
		NBR	68	41	100
408	NC 11 at Service Rd	NBR	-	-	100
		SBL	43	28	100
409	US 70 EB Ramps at NC 11	EBL	112	120	Continuous
		EBR	127	105	150
		NBL	149	157	175
		SBR	53	70	100
410	US 70 WB Ramps at NC 11	EBL	136	102	Continuous
		EBR	120	143	150
		NBL	139	103	150
		SBR	57	59	100
411	US 258 at Clarence Potter Rd / Service Rd	NBL	16	24	100
		SBL	16	4	100

The queue reported is the greater of the SimTraffic maximum queue and the Synchro 95th percentile queue.

Table 16C (Continued)					
2040 Build Alternative 36					
Queueing and Recommended Storage					
#	Intersection	Movement	Queue (feet)		Recommended Storage (feet)
			AM Peak	PM Peak	
412	US 70 EB Ramps at US 258	WBL	156	185	Continuous
		WBR	136	145	150
		NBR	32	40	100
		SBL	64	49	100
413	US 70 WB Ramps at US 258	WBL	63	83	Continuous
		WBR	59	51	100
		NBR	78	68	100
		SBL	130	130	150
414	US 70 EB Ramps at NC 58	WBL	56	68	Continuous
		WBR	71	77	100
		NBR	16	24	100
		SBL	48	52	100
415	US 70 WB Ramps at NC 58	WBL	47	57	Continuous
		WBR	70	54	100
		NBR	28	33	100
		SBL	48	60	100
416	US 70 EB Ramps at Wyse Fork Rd	EBL	54	28	Continuous
		EBR	59	66	100
		NBL	59	54	100
		SBR	20	12	100
417	US 70 WB Ramps at Wyse Fork Rd	EBL	49	53	Continuous
		EBR	65	70	100
		NBL	70	46	100
		SBR	20	8	100
418	US 70 Bus at Kornegay St / Service Rd	EBL	71	73	100
		WBR	6	12	100

The queue reported is the greater of the SimTraffic maximum queue and the Synchro 95th percentile queue.

5.15 2040 Representative Build Alternative 1 – Shallow Southern Bypass

A capacity analysis was performed for 2040 Representative Build Alternative 1 – Shallow Southern Bypass AM and PM peak periods for all of the study intersections. The purpose of the representative build is to determine how the existing US 70 mainline – to be renamed US 70 Bus – performs after the bypass pulls traffic away. As this is a representative build alternative, no freeway analysis was necessary; additionally, no storage lengths will be recommended for turn bays at intersections.

Intersection levels of service are summarized in **Table 17**, while traffic volumes are shown in **Figures 15A – 15C**, and LOS and laneage are shown in **Figures 15D – 15F**. Peak hour traffic volume development, and Synchro and SimTraffic reports are located in **Appendix P**.

Table 17			
2040 Representative Build Alternative 1 – Shallow Southern Bypass			
Intersection Level of Service			
#	Intersection	Level of Service	
		AM Peak	PM Peak
401	Jenny Lind Rd at NC 903	-	-
	Eastbound Left / Right	B	B
	Northbound Left / Through	A	A
402	US 70 EB Ramps at NC 903	-	-
	Eastbound Left / Through	B	B
	Southbound Left	A	A
403	US 70 WB Ramps at NC 903	-	-
	Westbound Left / Through	B	B
	Northbound Left	A	A
404	Shopping Center Dr / Pinelawn Cemetery Dr at US 70 Bus	-	-
	Eastbound Left	A	A
	Westbound Left	B	B
	Northbound Left / Through	C	C
	Southbound Left / Through / Right	C	C

Movements with zero delay were omitted

Table 17 (Continued)			
2040 Representative Build Alternative 1 – Shallow Southern Bypass			
Intersection Level of Service			
#	Intersection	Level of Service	
		AM Peak	PM Peak
405	Sussex St / Hill Farm Rd at US 70 Bus	D	D
	Eastbound Left	E	E
	Eastbound Through	C	C
	Eastbound Right	C	C
	Westbound Left	E	E
	Westbound Through	C	C
	Westbound Right	C	C
	Northbound Left / Through	E	E
	Northbound Right	D	E
	Southbound Left	E	E
	Southbound Left / Through	E	E
	Southbound Right	C	C
406	Sheffield Dr / Walmart Dr at US 70 Bus	-	-
	Eastbound Left	B	A
	Westbound Left	A	B
	Northbound Right	B	A
	Southbound Right	B	B
407	US 70 Bus at US 258	B	B
	Eastbound Left	D	D
	Eastbound Through	A	A
	Westbound U-Turn	D	D
	Westbound Through	A	B
	Westbound Right	A	A
	Southbound Left	D	D
	Southbound Right	A	A
408	Ruby Tuesday / Driveway at US 70 Bus	-	-
	Eastbound Left	B	A
	Westbound Left	A	B
	Northbound Right	B	B
	Southbound Right	A	A

Movements with zero delay were omitted

Table 17 (Continued)			
2040 Representative Build Alternative 1 – Shallow Southern Bypass			
Intersection Level of Service			
#	Intersection	Level of Service	
		AM Peak	PM Peak
409	US 70 Bus at Mt Vernon Park Dr	A	A
	Eastbound Left	D	D
	Eastbound Through	A	A
	Westbound U-Turn	D	D
	Westbound Through / Right	A	A
	Southbound Left / Right	D	D
410	Hillcrest Rd at US 70 Bus / Old US 70 Bus	D	C
	Eastbound Left	D	D
	Eastbound Through / Right	C	C
	Westbound Left	E	E
	Westbound Through / Right	C	B
	Northbound Left / Through	D	D
	Northbound Right	E	E
	Southbound Left / Through	F	E
	Southbound Right	D	D
411	NC 11 at US 70 Bus	D	D
	Eastbound Left	E	E
	Eastbound Through	D	D
	Eastbound Right	A	B
	Westbound Left	E	E
	Westbound Through	D	D
	Westbound Right	A	A
	Northbound Left	C	D
	Northbound Through / Right	D	D
	Southbound Left	D	C
	Southbound Through	E	D
	Southbound Right	C	B

Movements with zero delay were omitted

Table 17 (Continued)			
2040 Representative Build Alternative 1 – Shallow Southern Bypass			
Intersection Level of Service			
#	Intersection	Level of Service	
		AM Peak	PM Peak
412	US 258 / Old US 70 Bus at US 70 Bus	C	C
	Eastbound Left	E	E
	Eastbound Through	D	C
	Eastbound Right	C	B
	Westbound Left	D	C
	Westbound Through	C	B
	Westbound Right	B	A
	Northbound Left	E	E
	Northbound Through	D	D
	Northbound Right	B	B
	Southbound Left	C	D
	Southbound Through / Right	C	D
413	Meadowbrook Dr / Family Dollar Driveway at US 70 Bus	A	A
	Eastbound Left	A	A
	Eastbound Through / Right	A	A
	Westbound Left	A	A
	Westbound Through / Right	A	A
	Northbound Left	E	E
	Northbound Through / Right	D	D
	Southbound Left / Through / Right	D	D
414	NC 58 / Trenton Hwy at US 70 Bus	D	C
	Eastbound Left	D	C
	Eastbound Through	B	B
	Eastbound Right	C	B
	Westbound Left	E	E
	Westbound Through / Right	C	C
	Northbound Left	E	E
	Northbound Left / Through	E	E
	Northbound Right	D	E
	Southbound Left / Through	E	E
	Southbound Right	D	D

Movements with zero delay were omitted

Table 17 (Continued) 2040 Representative Build Alternative 1 – Shallow Southern Bypass Intersection Level of Service			
#	Intersection	Level of Service	
		AM Peak	PM Peak
415	US 70 Bus at Lenoir CC Driveway	-	-
	Westbound Left	A	A
	Northbound Right	B	B
416	US 70 Bus at Neuse Rd	-	-
	Eastbound Left	A	A
	Southbound Left / Right	B	B
1410	US 70 Bus at Hillcrest Rd	-	-
	Southbound Left	C	B

Movements with zero delay were omitted

5.16 2040 Representative Build Alternative 65

A capacity analysis was performed for 2040 Representative Build Alternative 65 AM and PM peak periods for all of the study intersections. The purpose of the representative build is to determine how the existing US 70 mainline – to be renamed US 70 Bus – performs after the bypass pulls traffic away. As this is a representative build alternative, no freeway analysis was necessary; additionally, no storage lengths will be recommended for turn bays at intersections.

Intersection levels of service are summarized in **Table 18**, while traffic volumes are shown in **Figures 16A – 16E**, and LOS and laneage are shown in **Figures 16F – 16J**. Peak hour traffic volume development, and Synchro and SimTraffic reports are located in **Appendix Q**.

Table 18 2040 Representative Build Alternative 65 Intersection Level of Service			
#	Intersection	Level of Service	
		AM Peak	PM Peak
401	Jenny Lind Rd at NC 903	-	-
	Eastbound Left / Right	B	B
	Northbound Left / Through	A	A
402	US 70 EB Ramps at NC 903	-	-
	Eastbound Left / Through	B	B
	Southbound Left	A	A
403	US 70 WB Ramps at NC 903	-	-
	Westbound Left / Through	B	B
	Northbound Left	A	A
404	Kennedy Home Rd / Eason Rd at US 70 Bus	-	-
	Eastbound Left	A	B
	Westbound Left	B	B
	Northbound Left / Through / Right	C	C
	Southbound Left / Through / Right	E	E
405	US 70 Bus at Banks School Rd	-	-
	Eastbound Left	A	B
	Southbound Right	B	C

Movements with zero delay were omitted

Table 18 (Continued)			
2040 Representative Build Alternative 65			
Intersection Level of Service			
#	Intersection	Level of Service	
		AM Peak	PM Peak
406	Industrial Dr at Sanderson Way	-	-
	Eastbound Left / Through	A	A
	Westbound Left / Through / Right	A	A
	Northbound Left / Through	D	C
	Northbound Right	A	A
	Southbound Left	D	C
	Southbound Through / Right	C	B
407	Sanderson Way at US 70 Bus	-	-
	Northbound Right	B	C
408	Shopping Center Dr / Pinelawn Cemetery Dr at US 70 Bus	-	-
	Eastbound Left	A	A
	Westbound Left	B	B
	Northbound Left / Through	C	C
	Southbound Left / Through / Right	C	C
409	Sussex St / Hill Farm Rd at US 70 Bus	D	D
	Eastbound Left	E	E
	Eastbound Through	C	D
	Eastbound Right	C	C
	Westbound Left	E	E
	Westbound Through	C	C
	Westbound Right	C	C
	Northbound Left / Through	E	E
	Northbound Right	E	E
	Southbound Left	D	D
	Southbound Left / Through	D	D
	Southbound Right	C	C

Movements with zero delay were omitted

Table 18 (Continued)			
2040 Representative Build Alternative 65			
Intersection Level of Service			
#	Intersection	Level of Service	
		AM Peak	PM Peak
410	Sheffield Dr / Walmart Dr at US 70 Bus	-	-
	Eastbound Left	B	B
	Westbound Left	B	B
	Northbound Right	A	A
	Southbound Right	B	B
411	US 70 Bus at US 258	B	B
	Eastbound Left	D	D
	Eastbound Through	A	A
	Westbound U-Turn	D	D
	Westbound Through	B	B
	Westbound Right	A	A
	Southbound Left	D	D
	Southbound Right	A	A
412	Ruby Tuesday / Driveway at US 70 Bus	-	-
	Eastbound Left	B	B
	Westbound Left	B	B
	Northbound Right	B	B
	Southbound Right	A	A
413	US 70 Bus at Mt Vernon Park Dr	A	A
	Eastbound Left	D	D
	Eastbound Through	A	A
	Westbound U-Turn	D	D
	Westbound Through / Right	A	A
	Southbound Left / Right	D	D

Movements with zero delay were omitted

Table 18 (Continued)			
2040 Representative Build Alternative 65			
Intersection Level of Service			
#	Intersection	Level of Service	
		AM Peak	PM Peak
414	Hillcrest Rd at Old US 70 Bus	D	C
	Eastbound Left	D	E
	Eastbound Through / Right	D	C
	Westbound Left	E	E
	Westbound Through / Right	C	B
	Northbound Left / Through	D	D
	Northbound Right	E	E
	Southbound Left / Through	F	E
	Southbound Right	D	D
415	NC 11 at US 70 Bus	D	D
	Eastbound Left	E	E
	Eastbound Through	D	D
	Eastbound Right	A	B
	Westbound Left	E	E
	Westbound Through	D	D
	Westbound Right	A	A
	Northbound Left	C	D
	Northbound Through / Right	D	D
	Southbound Left	D	D
	Southbound Through	D	E
	Southbound Right	C	C

Movements with zero delay were omitted

**Table 18 (Continued)
2040 Representative Build Alternative 65
Intersection Level of Service**

#	Intersection	Level of Service	
		AM Peak	PM Peak
416	US 258 / US 70 Bus at US 70 Bus	D	C
	Eastbound Left	E	E
	Eastbound Through	C	D
	Eastbound Right	A	B
	Westbound Left	E	E
	Westbound Through	C	C
	Westbound Right	B	A
	Northbound Left	D	D
	Northbound Through	D	D
	Northbound Right	C	C
	Southbound Left	D	D
	Southbound Through / Right	D	D
417	Meadowbrook Dr / Family Dollar Driveway at US 70 Bus	A	A
	Eastbound Left	A	A
	Eastbound Through / Right	A	A
	Westbound Left	A	A
	Westbound Through / Right	A	A
	Northbound Left	E	E
	Northbound Through / Right	D	D
	Southbound Left / Through / Right	D	D
418	NC 58 / Trenton Hwy at US 70 Bus	D	D
	Eastbound Left	B	B
	Eastbound Through	B	B
	Eastbound Right	B	D
	Westbound Left	E	D
	Westbound Through / Right	C	D
	Northbound Left	D	D
	Northbound Left / Through	D	D
	Northbound Right	D	E
	Southbound Left / Through	E	E
Southbound Right	E	D	

Movements with zero delay were omitted

Table 18 (Continued)			
2040 Representative Build Alternative 65			
Intersection Level of Service			
#	Intersection	Level of Service	
		AM Peak	PM Peak
419	US 70 Bus at Lenoir CC Driveway	-	-
	Westbound Left	A	A
	Northbound Right	B	B
420	US 70 Bus at Neuse Rd	-	-
	Eastbound Left	A	A
	Southbound Left / Right	B	B
421	Whaley Rd at US 70 Bus	-	-
	Westbound Left	A	A
	Northbound Left / Right	C	C
422	US 70 Bus at British Rd	-	-
	Eastbound Left	A	A
	Southbound Left / Right	B	B
423	Wyse Fork Rd / Caswell Rd at US 70 Bus	-	-
	Eastbound Left	A	A
	Westbound Left	A	A
	Northbound Left / Through / Right	C	C
	Southbound Left / Through / Right	C	C
424	US 70 Bus at Tilghman Rd	-	-
	Eastbound Left	A	A
	Southbound Left / Right	B	B
425	Burkett Rd at US 70 Bus	-	-
	Westbound Left	A	A
	Northbound Left / Right	B	B
1414	US 70 Bus at Hillcrest Rd	-	-
	Southbound Left	D	D

Movements with zero delay were omitted

6.0 CONCLUSIONS & RECOMMENDATIONS

Sections 6.1 through 6.16 summarize the findings and recommendations of the capacity analyses.

6.1 2015 No-Build Alternative

In the 2015 No-Build Alternative, 59 out of the 63 intersections analyzed perform at LOS D or better in both peak hours. Four (4) intersections exhibit poor LOS (LOS E or F) in at least one peak hour: Kennedy Home Rd/Eason Rd at US 70, Shopping Center Dr/Pinelawn Cemetery Dr at US 70, NC 11 at Edgewood Dr/Mary Beth Rd, and Hillcrest Rd at US 70. These intersections are all unsignalized and the delay stems from the minor side street movements.

6.2 2040 No-Build Alternative

In the 2040 No-Build Alternative, 47 out of the 63 intersections analyzed perform at LOS D or better in both peak hours, down from 59 in the 2015 No-Build Alternative. Sixteen (16) intersections exhibit poor LOS (LOS E or F) in at least one peak hour, including one signalized intersection: NC 11 at US 70. The remaining failing intersections are unsignalized and the delay stems from the minor side street movements, with one exception: the westbound US 70 left turn at Ruby Tuesday operates at LOS E in the PM peak hour.

6.3 2040 Build Alternative 1 – Upgrade US 70

In the 2040 Build Alternative 1 – Upgrade US 70, 28 out of the 29 intersections analyzed perform at LOS D or better in both peak hours. One (1) intersection exhibits poor LOS (LOS E or F) in one peak hour: Willie Measley Rd at Washington St/Service Rd. This failing intersection is unsignalized and the delay stems from the minor side street movement.

All freeway elements operate at LOS C or better, or with a v/c ratio of 0.45 or better in both peak hours.

6.4 2040 Build Alternative 1 – Shallow Southern Bypass

In the 2040 Build Alternative 1 – Shallow Southern Bypass, 23 out of the 25 intersections analyzed perform at LOS D or better in both peak hours. Two (2) intersections exhibit poor LOS (LOS E or F) in at least one peak hour: Willie Measley Rd at Washington St/Service Rd, and US 70 Bus at Industrial Dr/Sanderson Way. These failing intersections are unsignalized and the delay stems from the minor side street movements.

All freeway elements operate at LOS B or better, or with a v/c ratio of 0.22 or better in both peak hours.

6.5 2040 Build Alternative 11

In the 2040 Build Alternative 11, nineteen (19) out of the twenty (20) intersections analyzed perform at LOS D or better in both peak hours. One (1) intersection exhibits poor LOS (LOS E or F) in the PM peak hour: Willie Measley Rd at Washington St/Service Rd. This failing intersection is unsignalized and the delay stems from the minor side street movements.

All freeway elements operate at LOS B or better, or with a v/c ratio of 0.21 or better in both peak hours.

6.6 2040 Build Alternative 12

In the 2040 Build Alternative 12, twenty (20) out of the 21 intersections analyzed perform at LOS D or better in both peak hours. One (1) intersection exhibits poor LOS (LOS E or F) in the PM peak hour: Willie Measley Rd at Washington St/Service Rd. This failing intersection is unsignalized and the delay stems from the minor side street movements.

All freeway elements operate at LOS B or better, or with a v/c ratio of 0.21 or better in both peak hours.

6.7 2040 Build Alternative 31

In the 2040 Build Alternative 31, fifteen (15) out of the sixteen (16) intersections analyzed perform at LOS C or better in both peak hours. One (1) intersection exhibits poor LOS (LOS E or F) in both peak hours: Willie Measley Rd at Washington St/Service Rd. This failing intersection is unsignalized and the delay stems from the minor side street movements.

All freeway elements operate at LOS B or better in both peak hours.

6.8 2040 Build Alternative 32

In the 2040 Build Alternative 32, sixteen (16) out of the seventeen (17) intersections analyzed perform at LOS C or better in both peak hours. One (1) intersection exhibits poor LOS (LOS E or F) in both peak hours: Willie Measley Rd at Washington St/Service Rd. This failing intersection is unsignalized and the delay stems from the minor side street movements.

All freeway elements operate at LOS B or better in both peak hours.

6.9 2040 Build Alternative 63

In the 2040 Build Alternative 63, sixteen (16) out of the seventeen (17) intersections analyzed perform at LOS D or better in both peak hours. One (1) intersection exhibits poor LOS (LOS E or F) in both peak hours: Willie Measley Rd at Washington St/Service Rd. This failing intersection is unsignalized and the delay stems from the minor side street movements.

All freeway elements operate at LOS B or better in both peak hours.

6.10 2040 Build Alternative 65

In the 2040 Build Alternative 65, fifteen (15) out of the sixteen (16) intersections analyzed perform at LOS D or better in both peak hours. One (1) intersection exhibits poor LOS (LOS E or F) in both peak hours: Willie Measley Rd at Washington St/Service Rd. This failing intersection is unsignalized and the delay stems from the minor side street movements.

All freeway elements operate at LOS B or better in both peak hours.

6.11 2040 Build Alternative 51

In the 2040 Build Alternative 51, fifteen (15) out of the sixteen (16) intersections analyzed perform at LOS C or better in both peak hours. One (1) intersection exhibits poor LOS (LOS E or F) in both peak hours: Willie Measley Rd at Washington St/Service Rd. This failing intersection is unsignalized and the delay stems from the minor side street movements.

All freeway elements operate at LOS B or better in both peak hours.

6.12 2040 Build Alternative 52

In the 2040 Build Alternative 52, eighteen (18) out of the nineteen (19) intersections analyzed perform at LOS D or better in both peak hours. One (1) intersection exhibits poor LOS (LOS E or F) in both peak hours: Willie Measley Rd at Washington St/Service Rd. This failing intersection is unsignalized and the delay stems from the minor side street movements.

All freeway elements operate at LOS B or better in both peak hours.

6.13 2040 Build Alternative 35

In the 2040 Build Alternative 35, seventeen (17) out of the nineteen (19) intersections analyzed perform at LOS D or better in both peak hours. Two (2) intersections exhibit poor LOS (LOS E or F) in both peak hours: Willie Measley Rd at Washington St/Service Rd, and US 70 Bus at Harold Sutton Rd/Albert Sugg Rd. These failing intersections are unsignalized and the delay stems from the minor side street movements.

All freeway elements operate at LOS B or better in both peak hours.

6.14 2040 Build Alternative 36

In the 2040 Build Alternative 36, sixteen (16) out of the eighteen (18) intersections analyzed perform at LOS D or better in both peak hours. Two (2) intersections exhibit poor LOS (LOS E or F) in both peak hours: Willie Measley Rd at Washington St/Service Rd, and US 70 Bus at Harold Sutton Rd/Albert Sugg Rd. These failing intersections are unsignalized and the delay stems from the minor side street movements.

All freeway elements operate at LOS B or better in both peak hours.

6.15 2040 Representative Build Alternative 1 – Shallow Southern Bypass

In the 2040 Representative Build Alternative 1 – Shallow Southern Bypass, seventeen (17) of the seventeen (17) intersections analyzed perform at LOS D or better in both peak hours.

6.16 2040 Representative Build Alternative 65

In the 2040 Representative Build Alternative 65, 25 of the 26 intersections analyzed perform at LOS D or better in both peak hours. One (1) intersection exhibits poor LOS (LOS E or F) in both peak hours: Kennedy Home Rd/Eason Rd at US 70 Bus. This failing intersection is unsignalized and the delay stems from the minor side street movements.

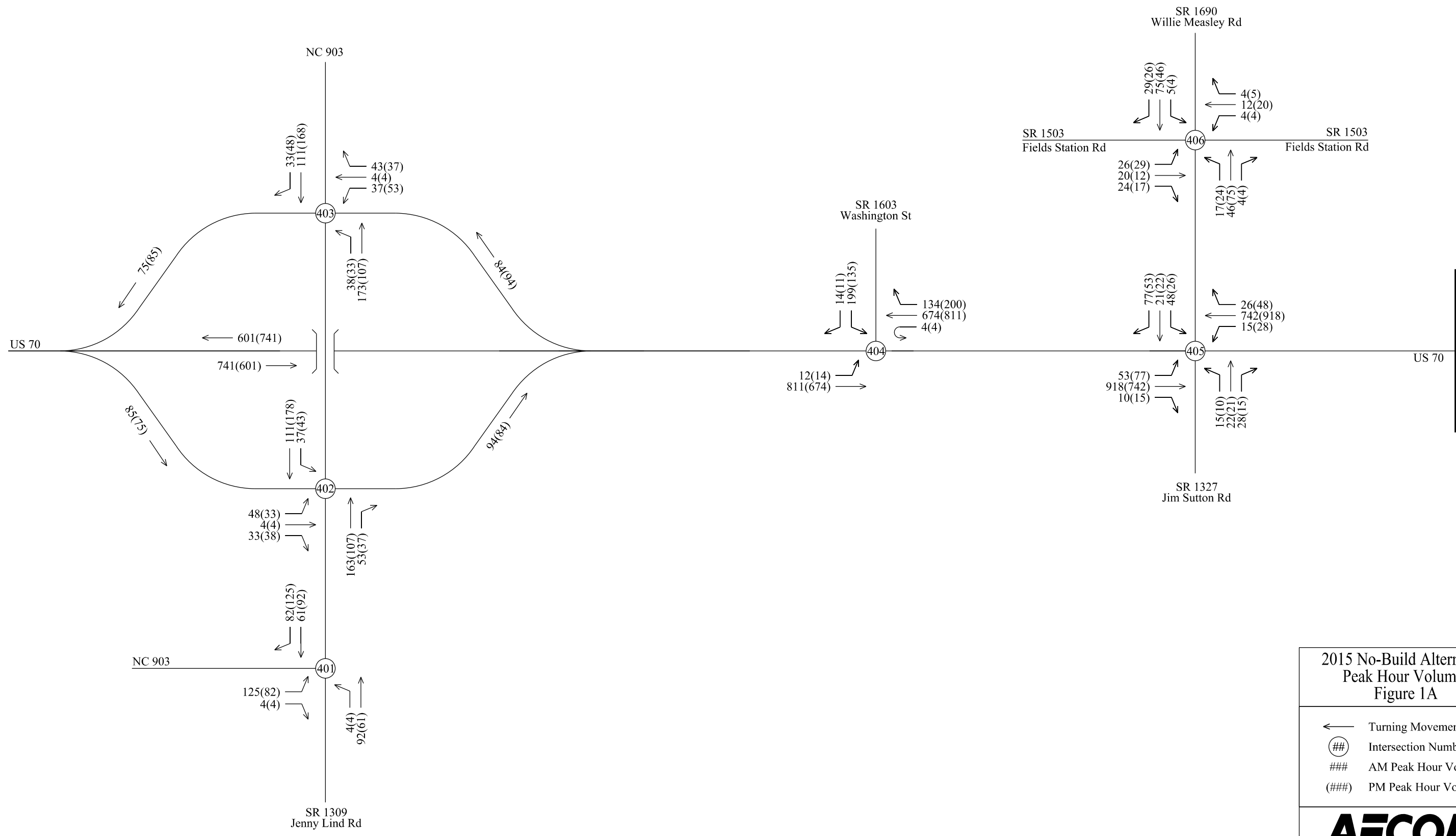
This page left intentionally blank

FIGURE SECTION

This page left intentionally blank

**2015 No-Build Alternative
Peak Hour Volume Figures**

This page left intentionally blank

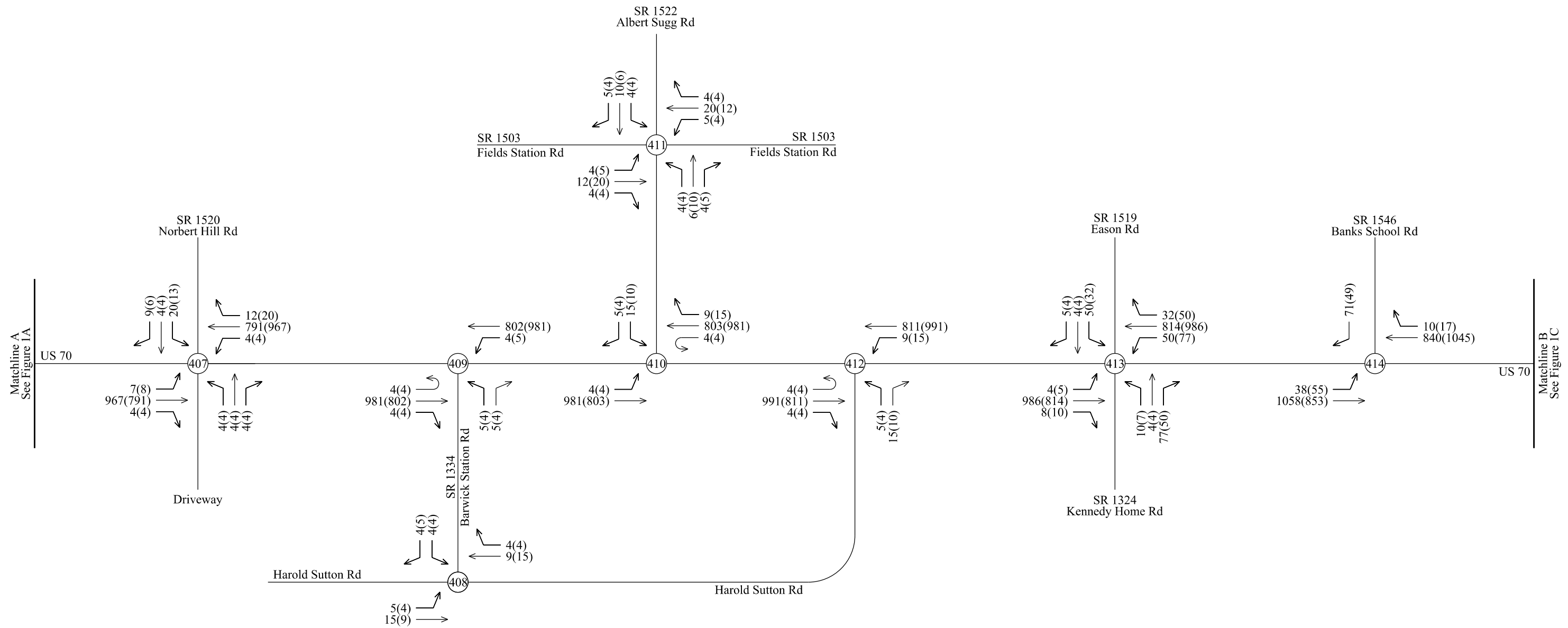


Matchline A
See Figure 1B

2015 No-Build Alternative
Peak Hour Volumes
Figure 1A

- ← Turning Movement
- ⊙ Intersection Number
- ### AM Peak Hour Volumes
- (###) PM Peak Hour Volumes

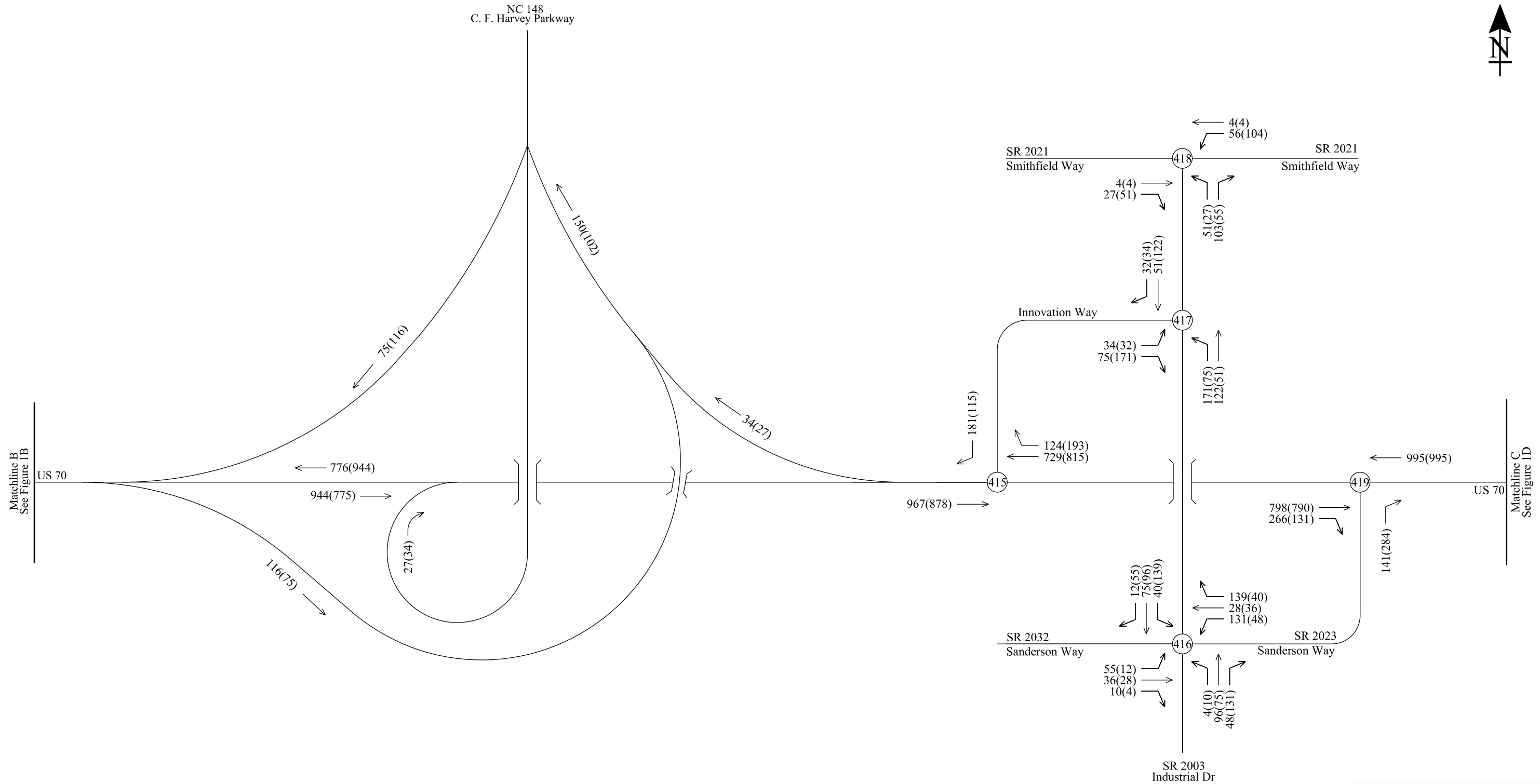




2015 No-Build Alternative
Peak Hour Volumes
Figure 1B

← Turning Movement
⊙ Intersection Number
AM Peak Hour Volumes
(###) PM Peak Hour Volumes





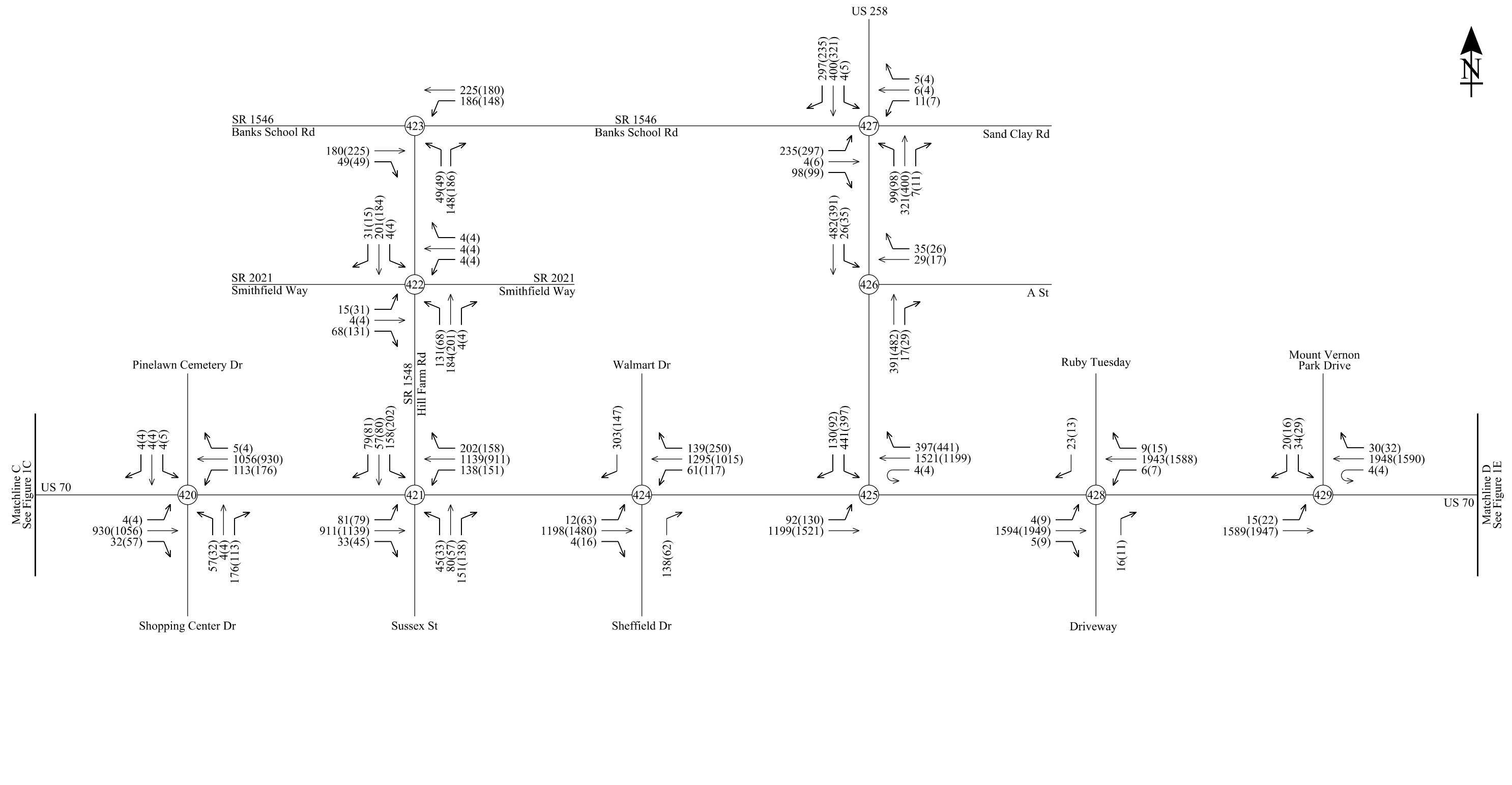
Matchline B
See Figure 1B

Matchline C
See Figure 1D

2015 No-Build Alternative
Peak Hour Volumes
Figure 1C

← Turning Movement
⊙ Intersection Number
AM Peak Hour Volumes
(###) PM Peak Hour Volumes





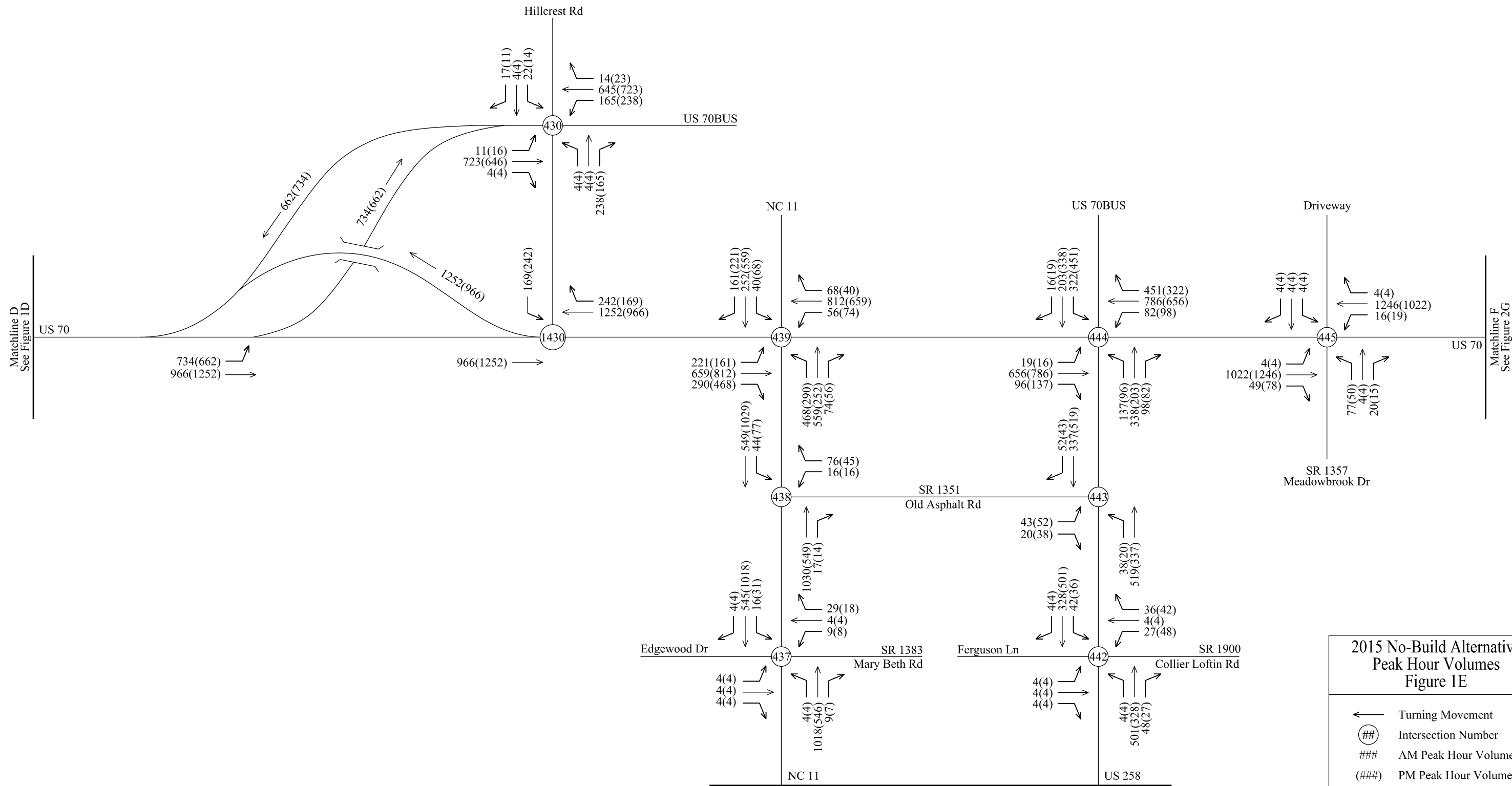
Matchline C
See Figure 1C

Matchline D
See Figure 1E

2015 No-Build Alternative
Peak Hour Volumes
Figure 1D

- ← Turning Movement
- ⊙ Intersection Number
- ### AM Peak Hour Volumes
- (###) PM Peak Hour Volumes





Matchline D
See Figure 1D

Matchline F
See Figure 2G

Matchline E
See Figure 1F

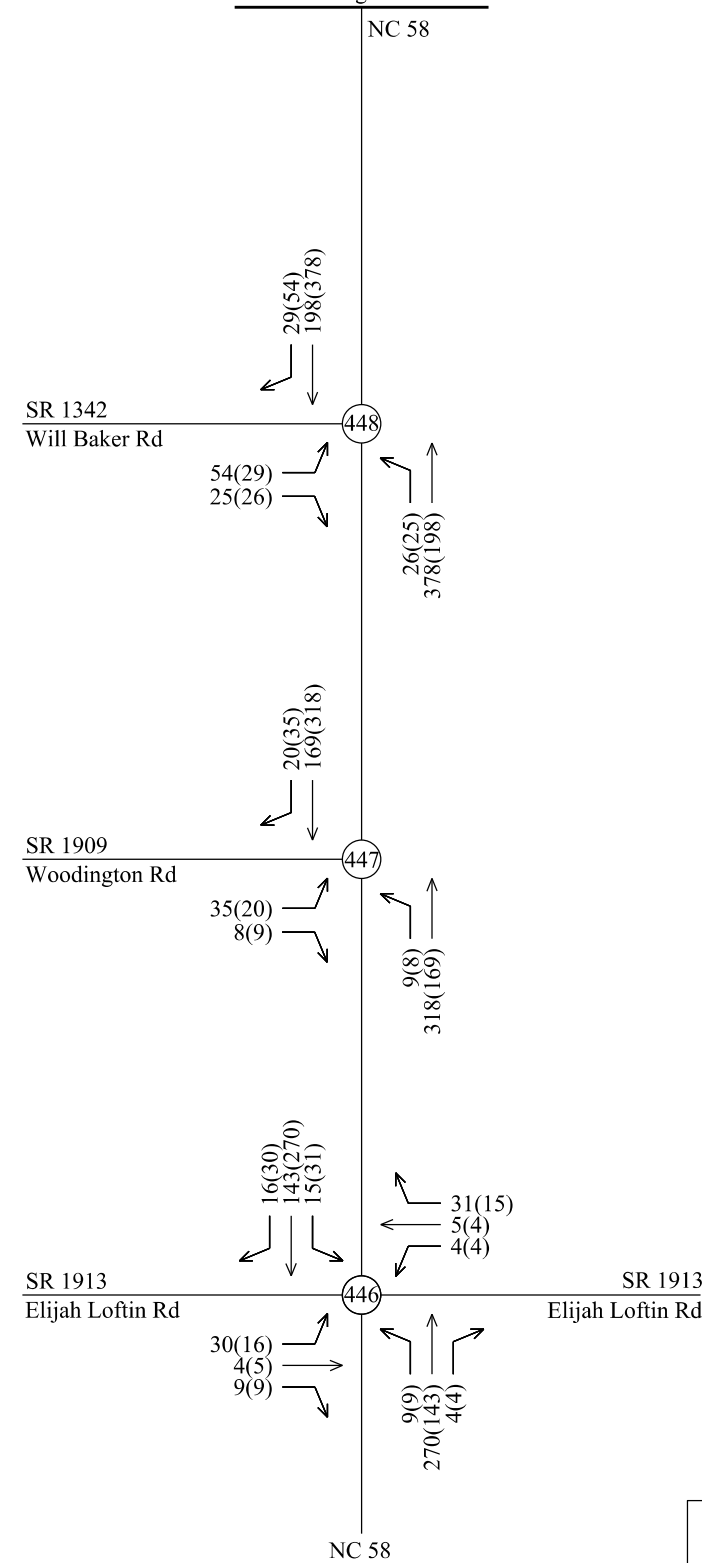
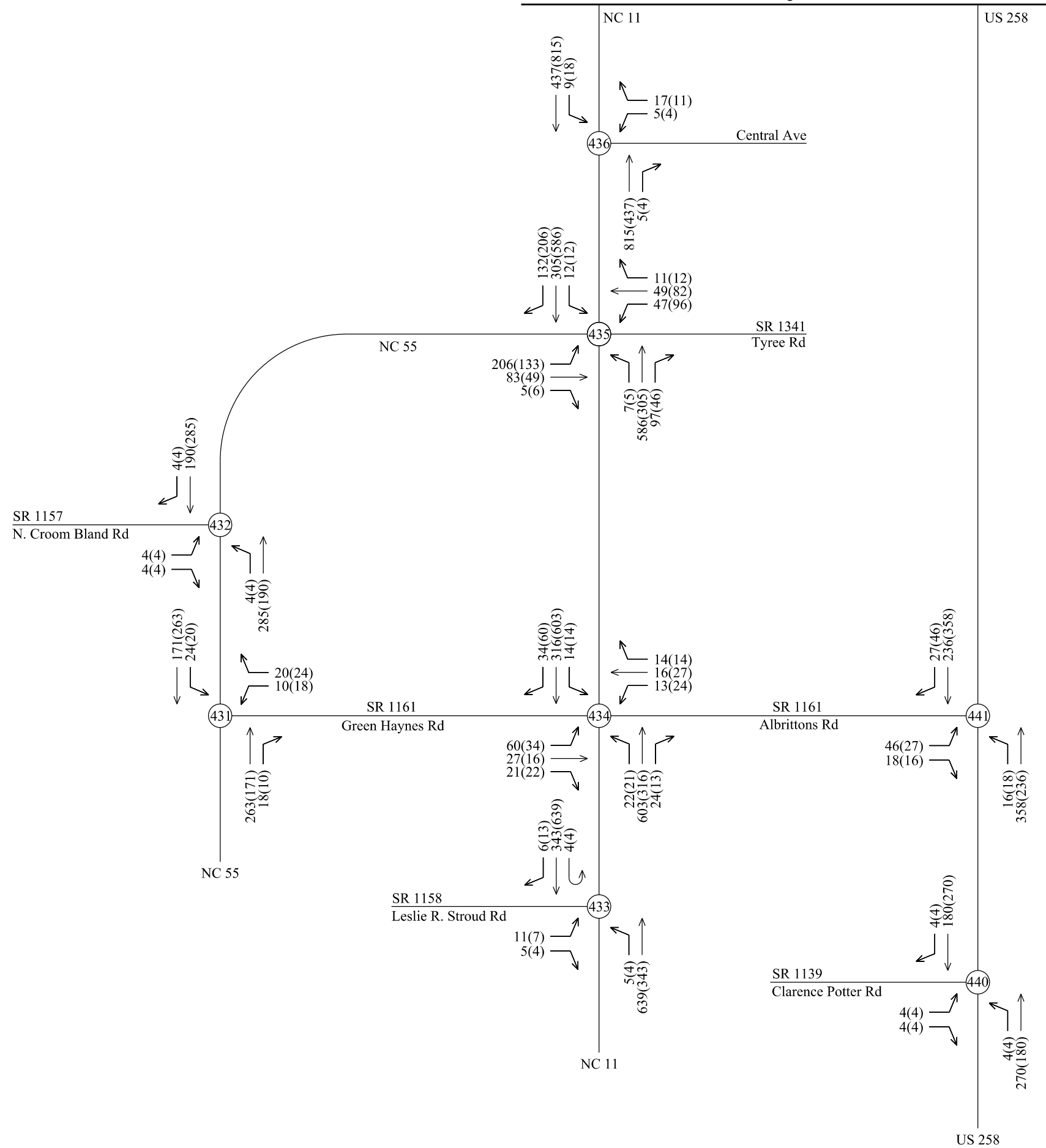
2015 No-Build Alternative
Peak Hour Volumes
Figure 1E

- ← Turning Movement
- ⊙ Intersection Number
- ### AM Peak Hour Volumes
- (###) PM Peak Hour Volumes



Matchline E
See Figure 1E

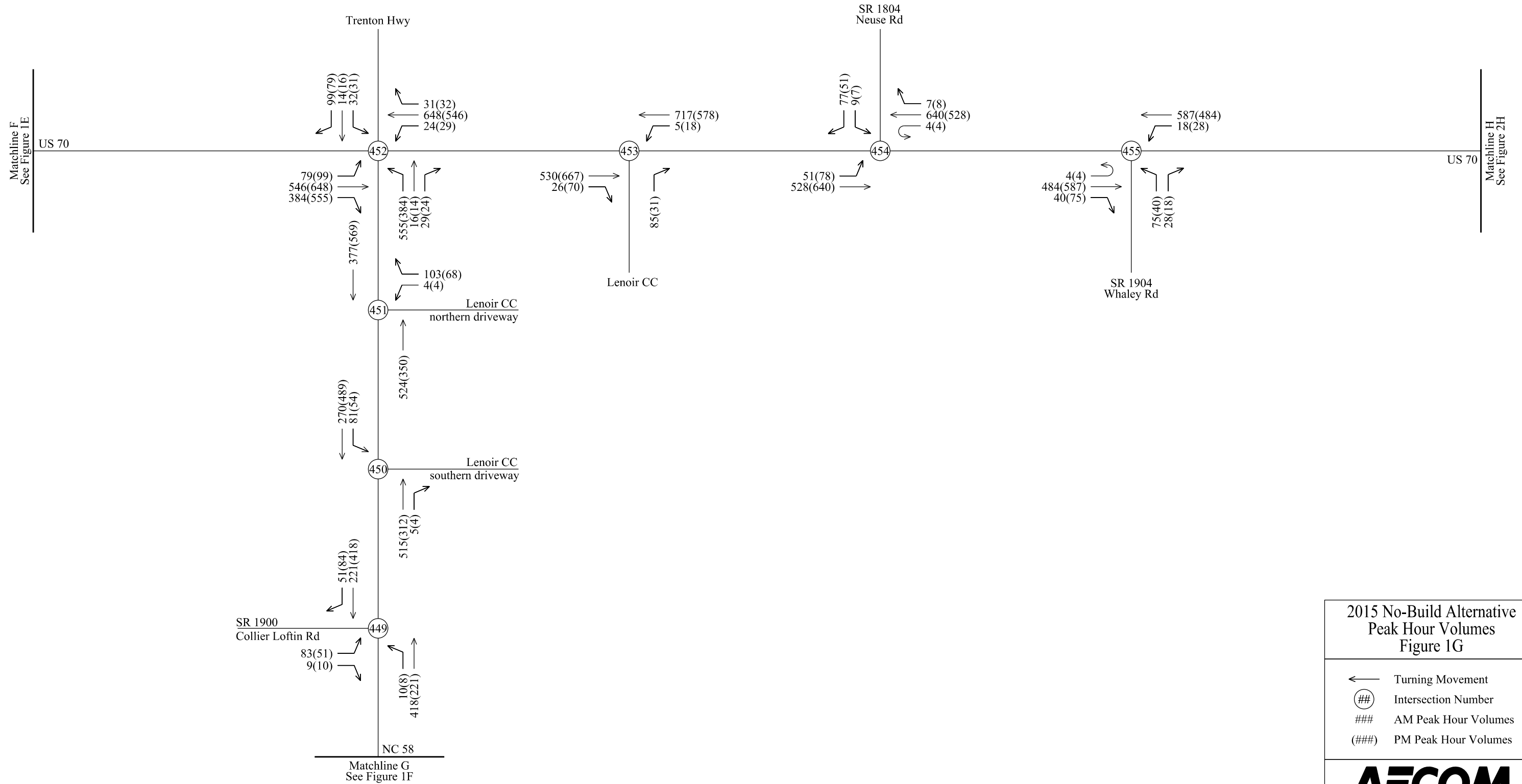
Matchline G
See Figure 1G



2015 No-Build Alternative
Peak Hour Volumes
Figure 1F

- ← Turning Movement
- ⊙ Intersection Number
- ### AM Peak Hour Volumes
- (###) PM Peak Hour Volumes

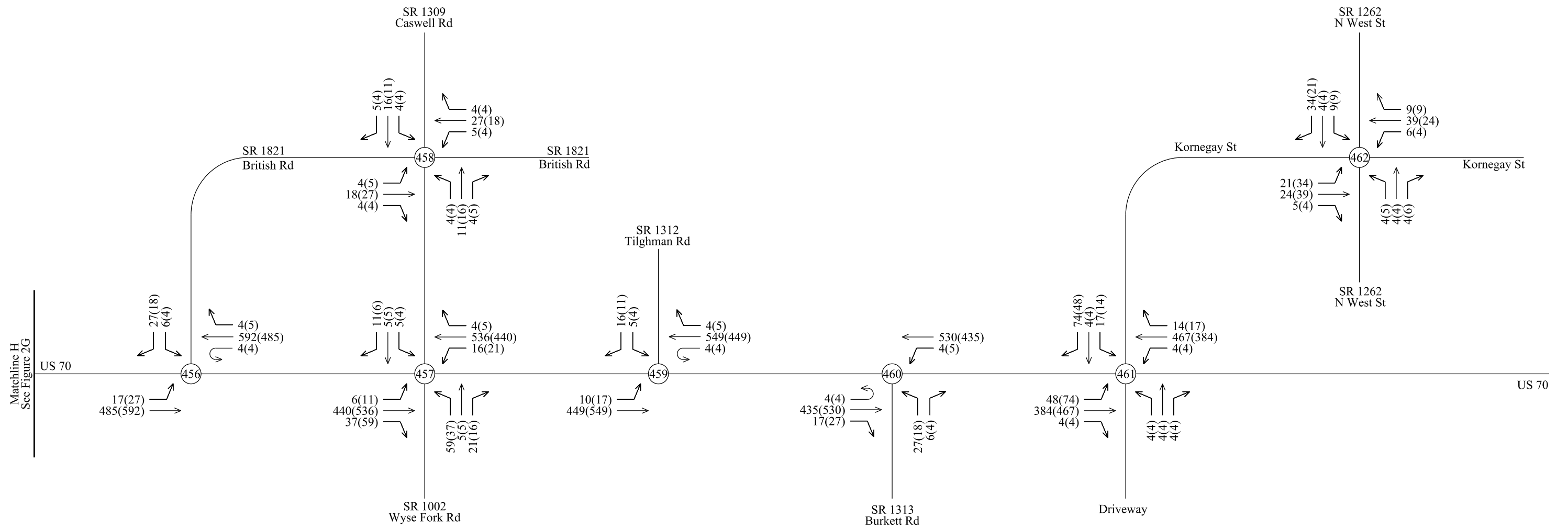




2015 No-Build Alternative
Peak Hour Volumes
Figure 1G

- ← Turning Movement
- ⊙ Intersection Number
- ### AM Peak Hour Volumes
- (###) PM Peak Hour Volumes





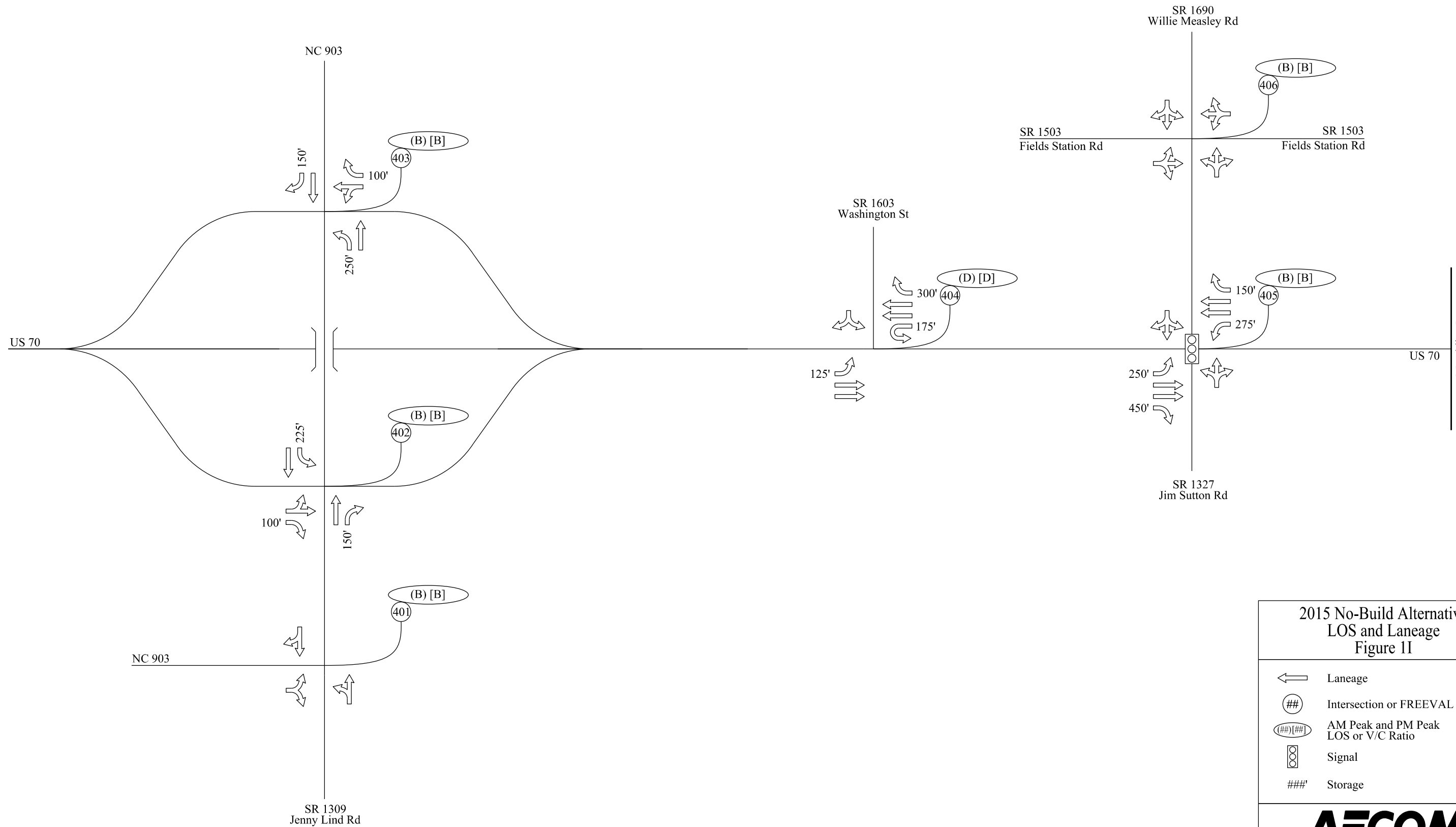
2015 No-Build Alternative
Peak Hour Volumes
Figure 1H

← Turning Movement
⊙ Intersection Number
AM Peak Hour Volumes
(###) PM Peak Hour Volumes








**2015 No-Build Alternative
LOS and Laneage Figures**

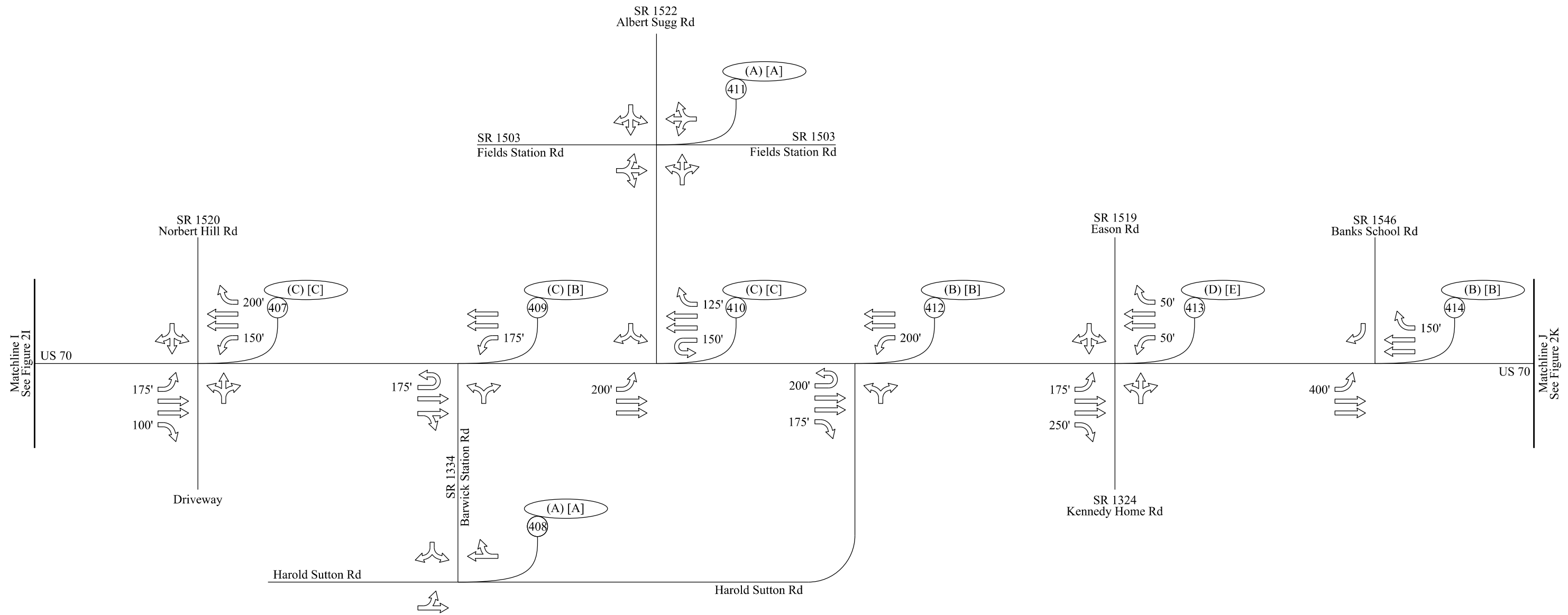
This page left intentionally blank



2015 No-Build Alternative
LOS and Laneage
Figure 1I

-  Laneage
-  Intersection or FREEVAL Number
-  AM Peak and PM Peak
LOS or V/C Ratio
-  Signal
-  Storage

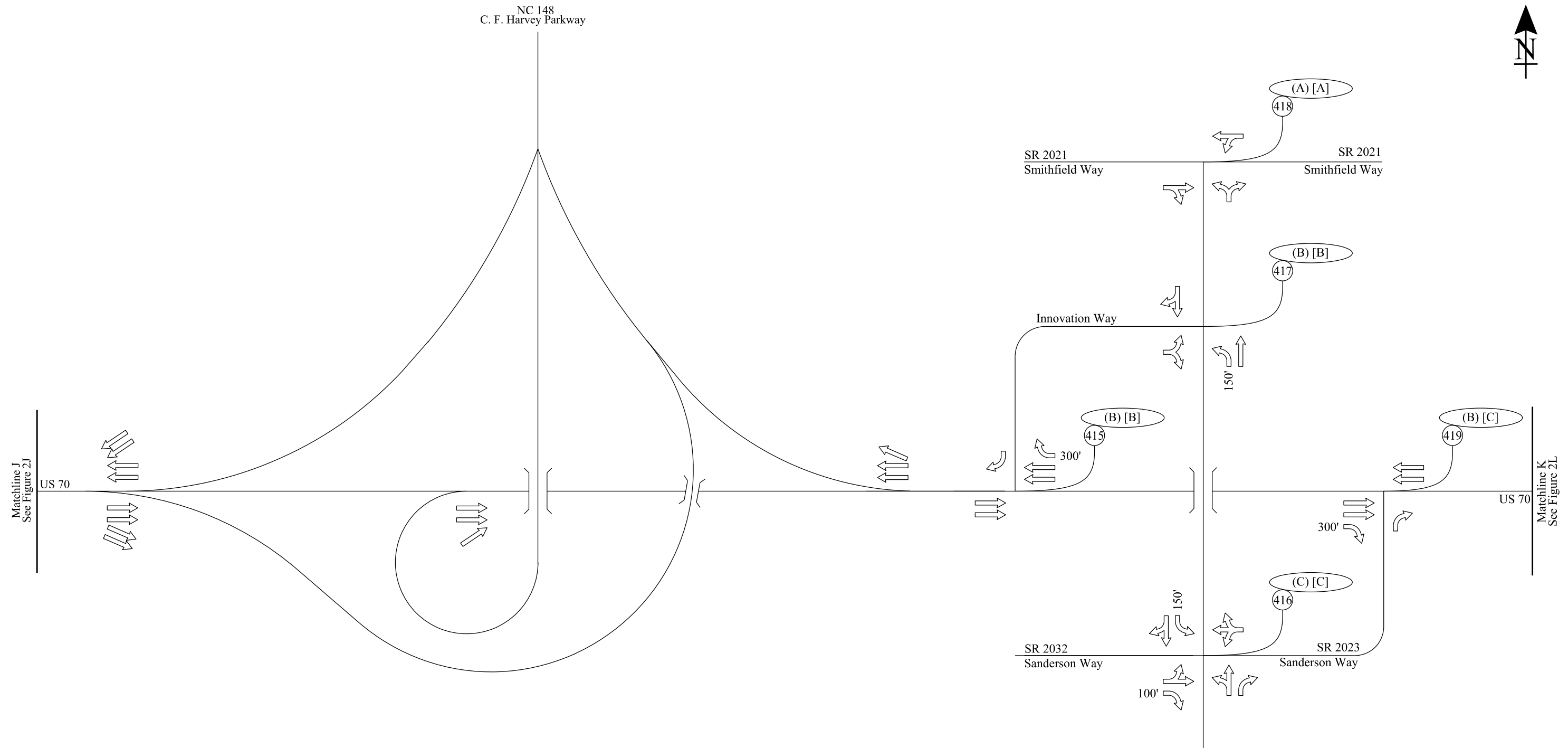




2015 No-Build Alternative
LOS and Laneage
Figure 1J

- Laneage
- Intersection or FREEVAL Number
- AM Peak and PM Peak LOS or V/C Ratio
- Signal
- Storage





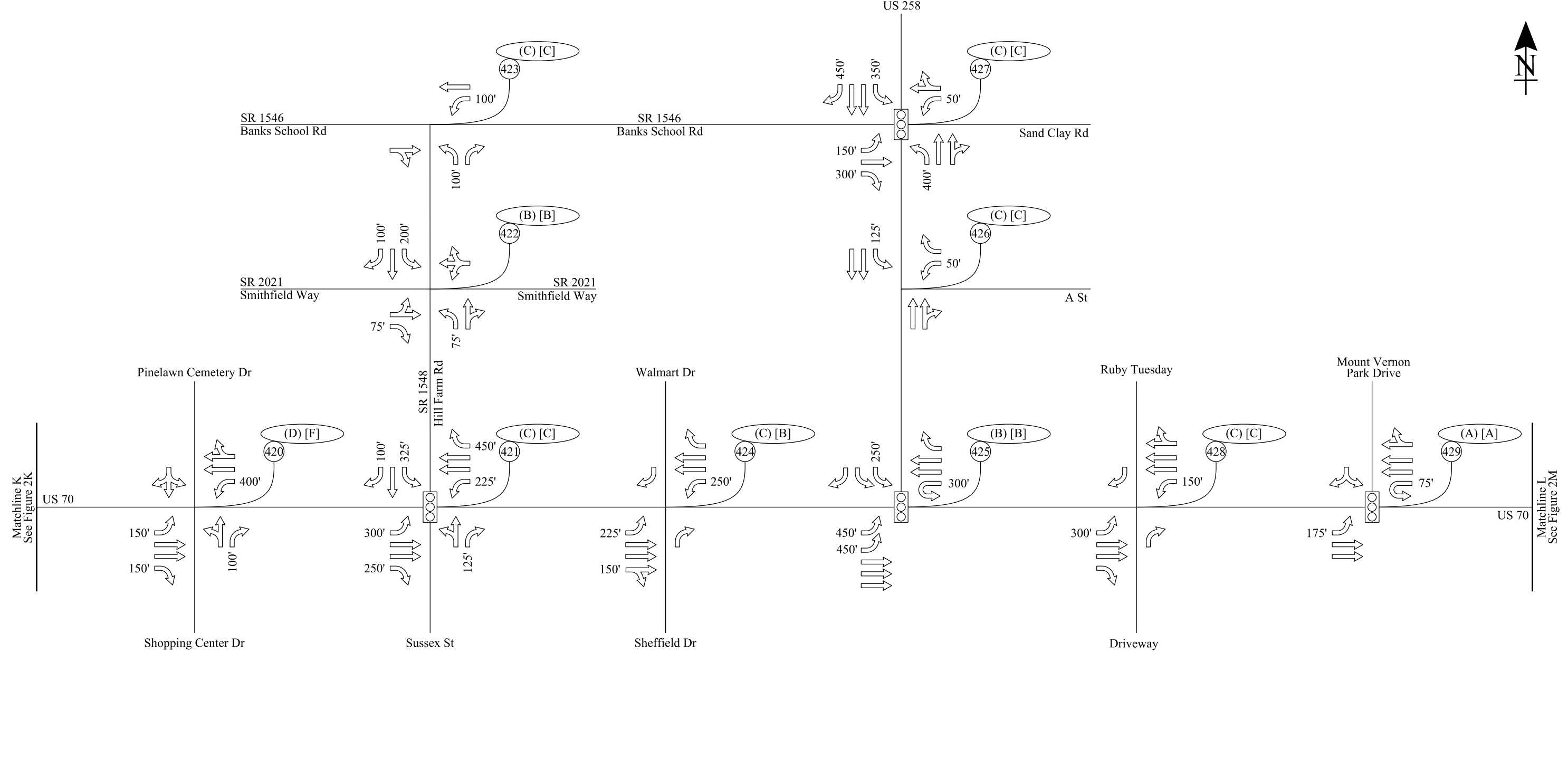
Matchline J
See Figure 2J

Matchline K
See Figure 2L

**2015 No-Build Alternative
LOS and Laneage
Figure 1K**

- Laneage
- Intersection or FREEVAL Number
- AM Peak and PM Peak LOS or V/C Ratio
- Signal
- Storage










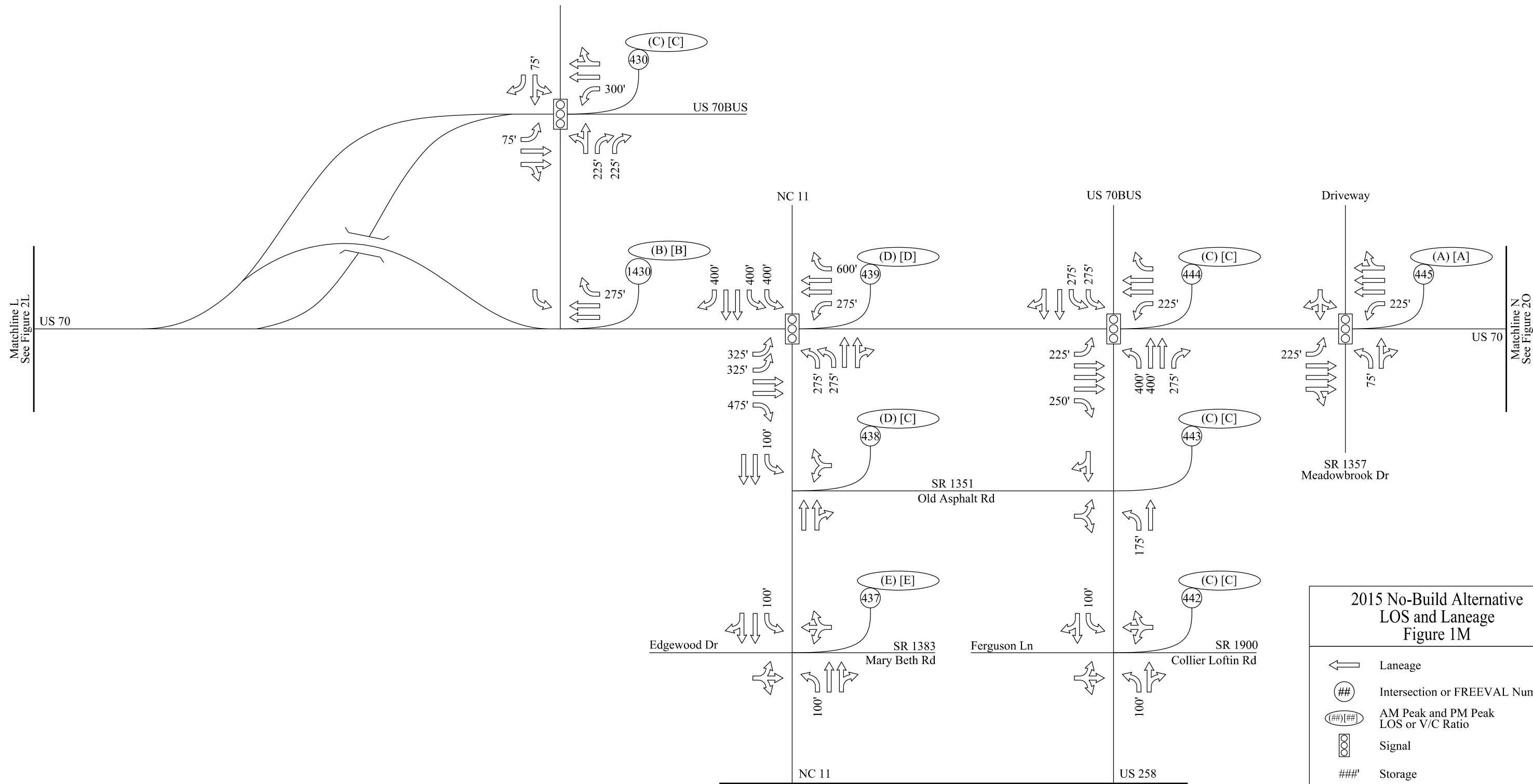
Matchline K
See Figure 2K

Matchline L
See Figure 2M

2015 No-Build Alternative LOS and Laneage Figure 1L

-  Laneage
-  Intersection or FREEVAL Number
-  AM Peak and PM Peak
LOS or V/C Ratio
-  Signal
-  Storage





Matchline L
See Figure 2L

Matchline N
See Figure 2O

Matchline M
See Figure 2N

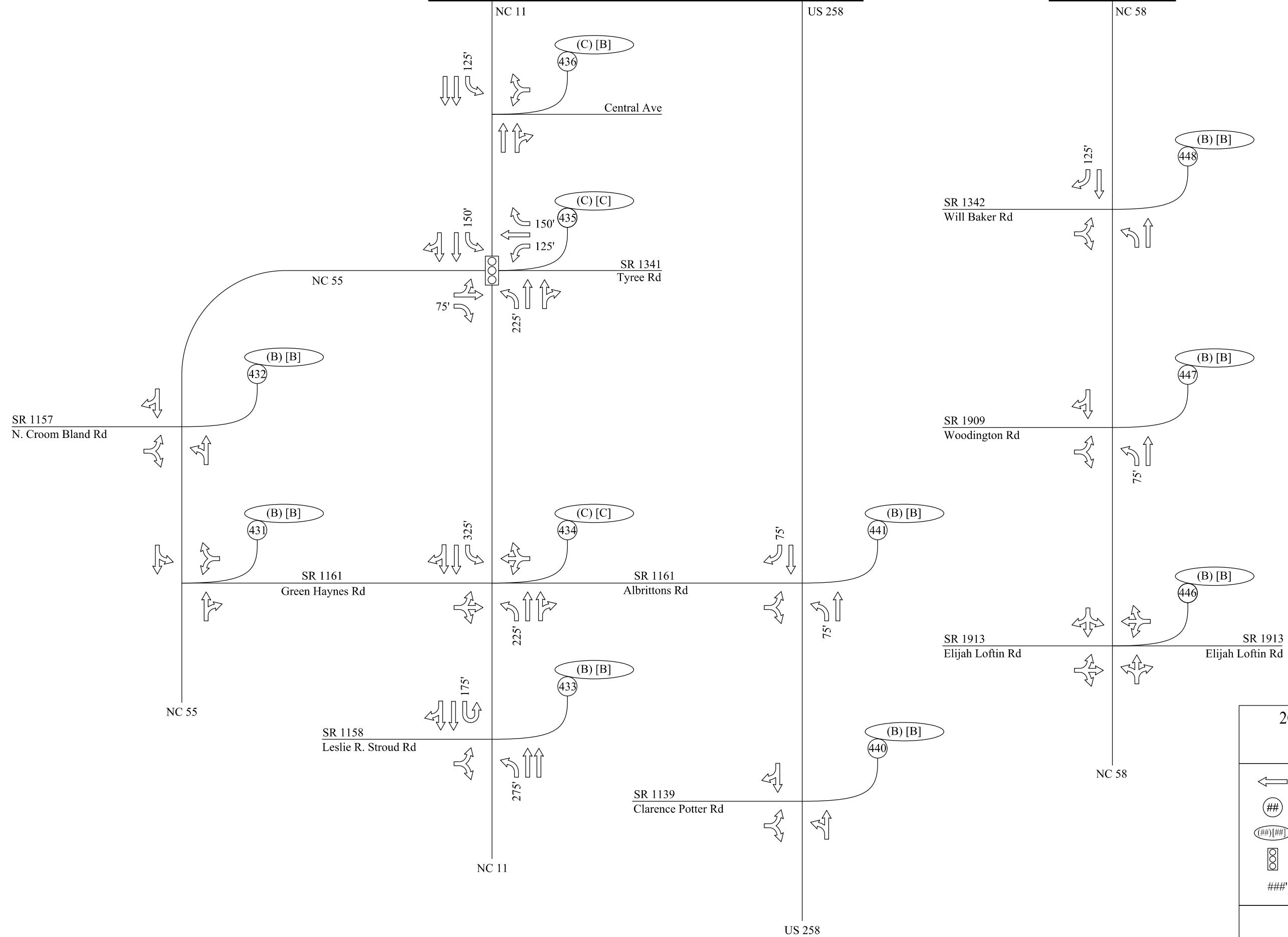
**2015 No-Build Alternative
LOS and Laneage
Figure 1M**

- Laneage
- Intersection or FREEVAL Number
- AM Peak and PM Peak LOS or V/C Ratio
- Signal
- Storage



Matchline M
See Figure 2M

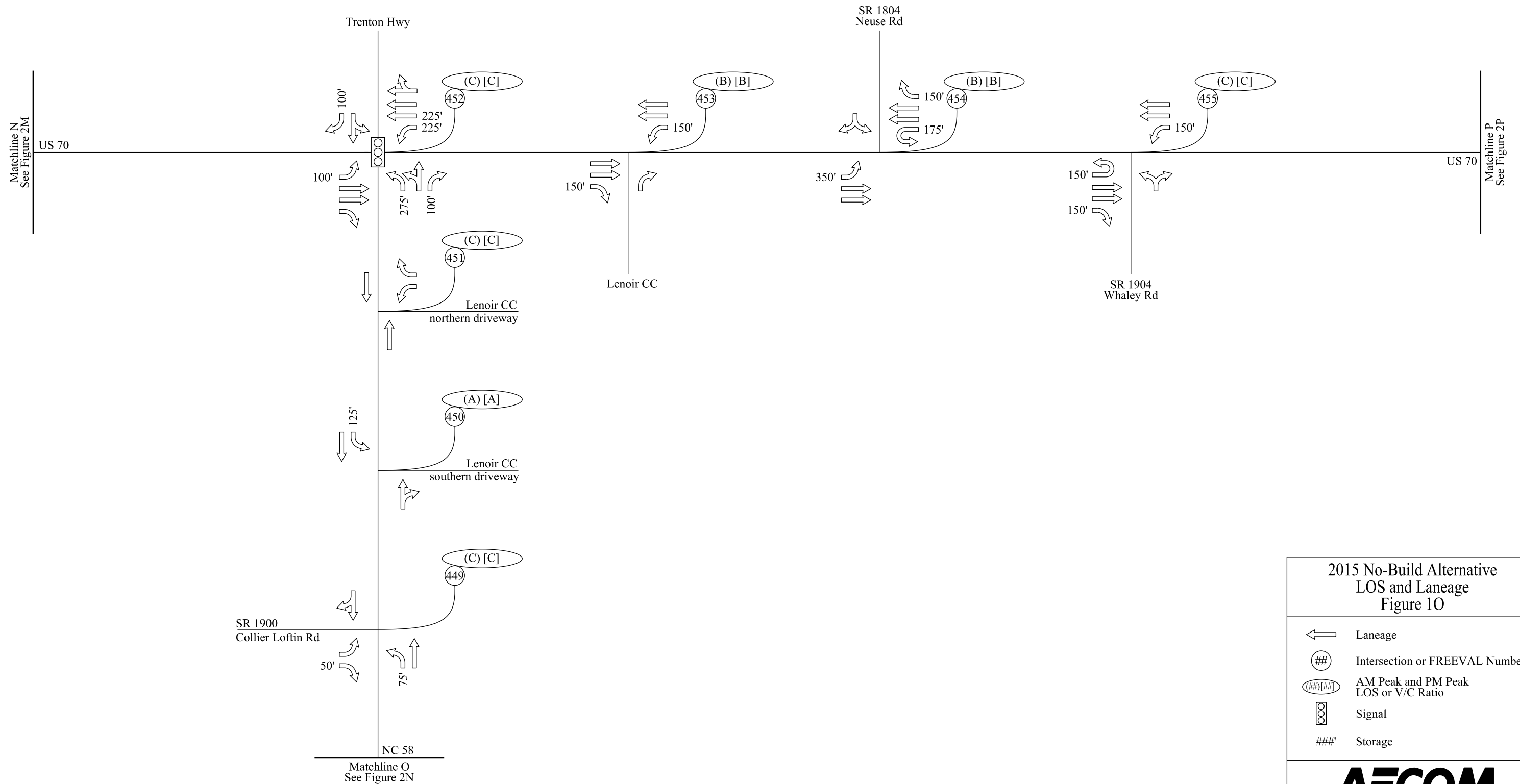
Matchline O
See Figure 2O



**2015 No-Build Alternative
LOS and Laneage
Figure 1N**

- Laneage
- Intersection or FREEVAL Number
- AM Peak and PM Peak LOS or V/C Ratio
- Signal
- Storage

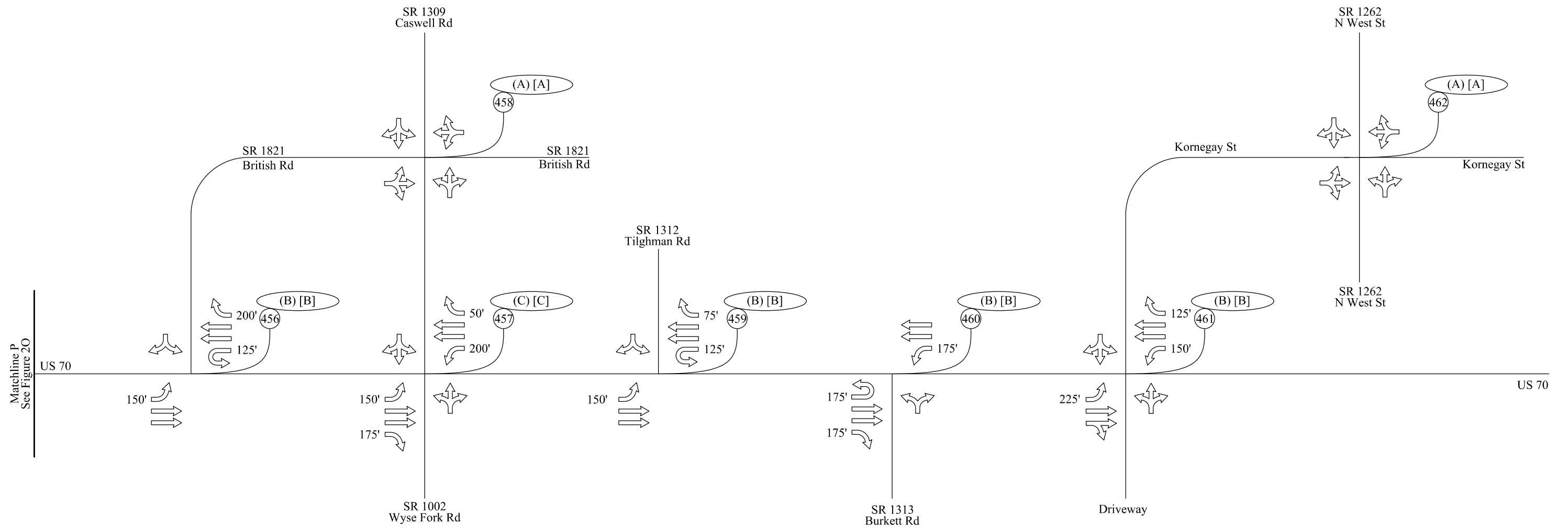




2015 No-Build Alternative
LOS and Laneage
Figure 10

- Laneage
- Intersection or FREEVAL Number
- AM Peak and PM Peak LOS or V/C Ratio
- Signal
- Storage





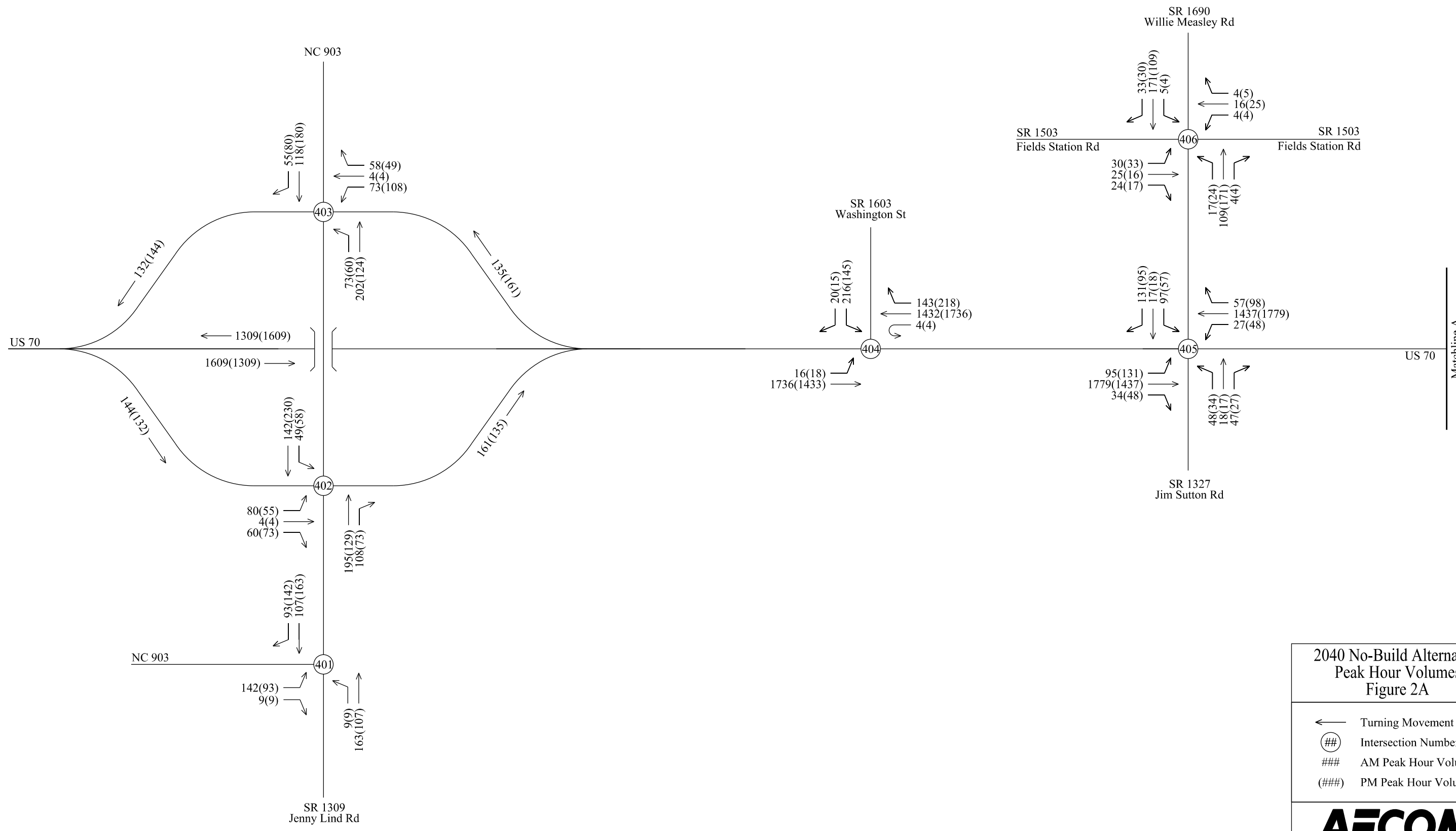
2015 No-Build Alternative
LOS and Laneage
Figure 1P

- Laneage
- Intersection or FREEVAL Number
- AM Peak and PM Peak
LOS or V/C Ratio
- Signal
- Storage



**2040 No-Build Alternative
Peak Hour Volume Figures**

This page left intentionally blank

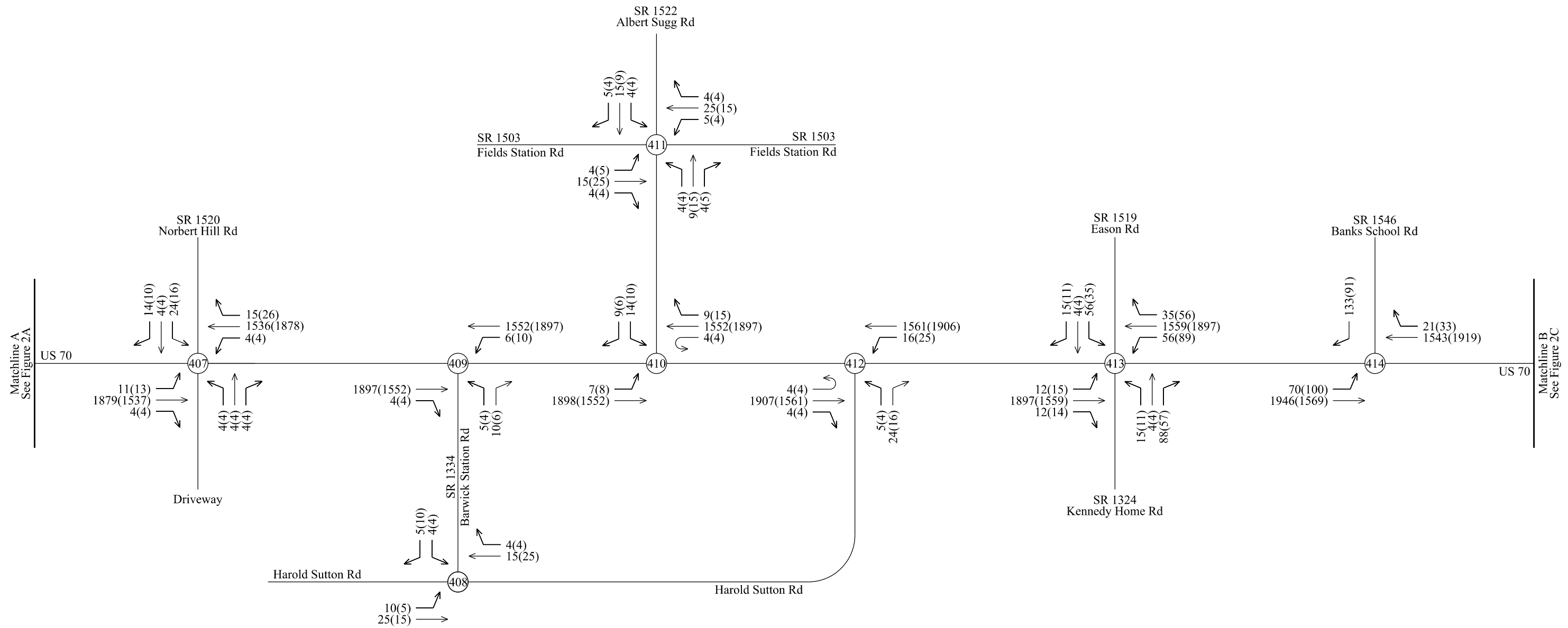


Matchline A
See Figure 2B

2040 No-Build Alternative
Peak Hour Volumes
Figure 2A

- ← Turning Movement
- ⊙ Intersection Number
- ### AM Peak Hour Volumes
- (###) PM Peak Hour Volumes

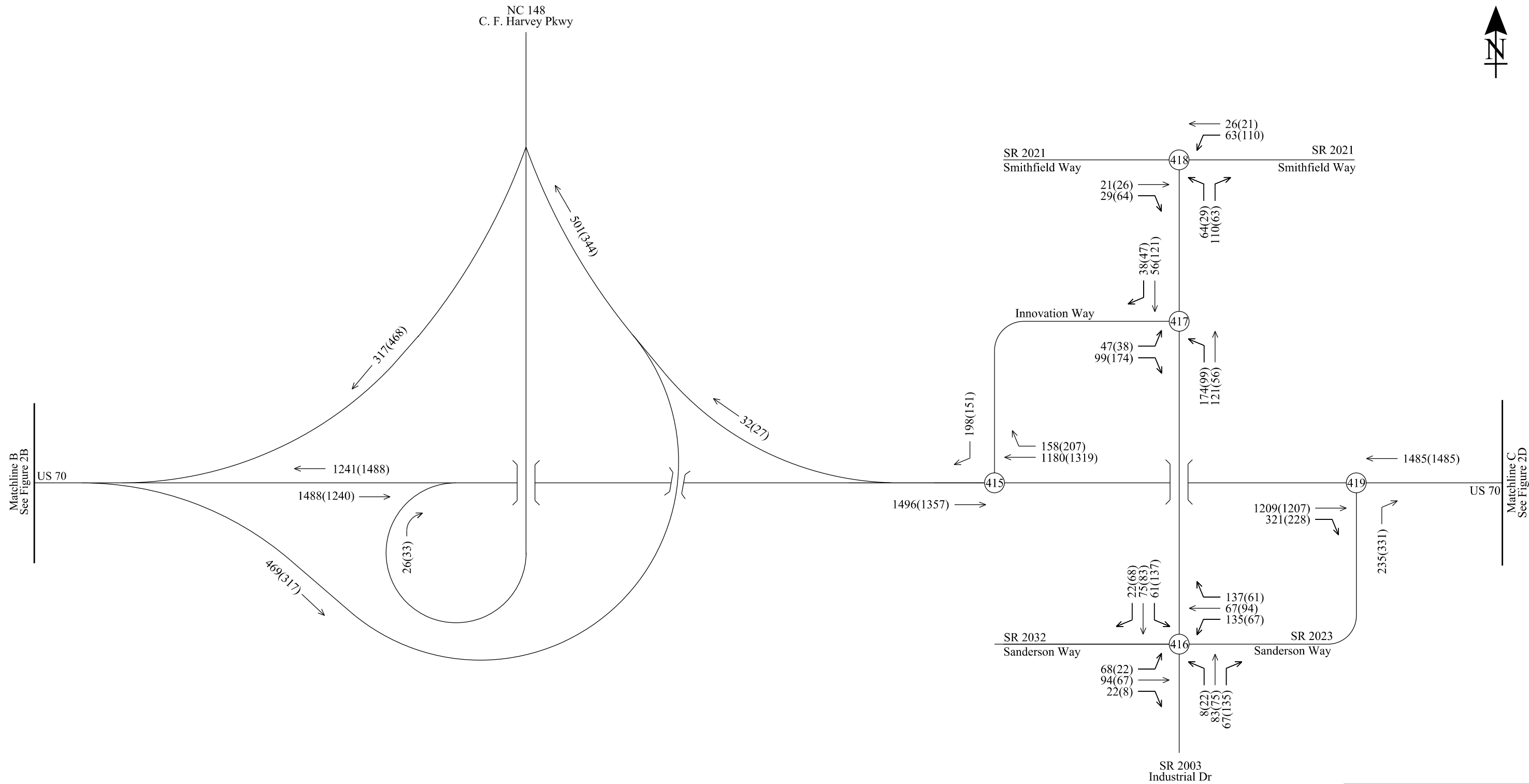




2040 No-Build Alternative
Peak Hour Volumes
Figure 2B

- ← Turning Movement
- ⊙ Intersection Number
- ### AM Peak Hour Volumes
- (###) PM Peak Hour Volumes

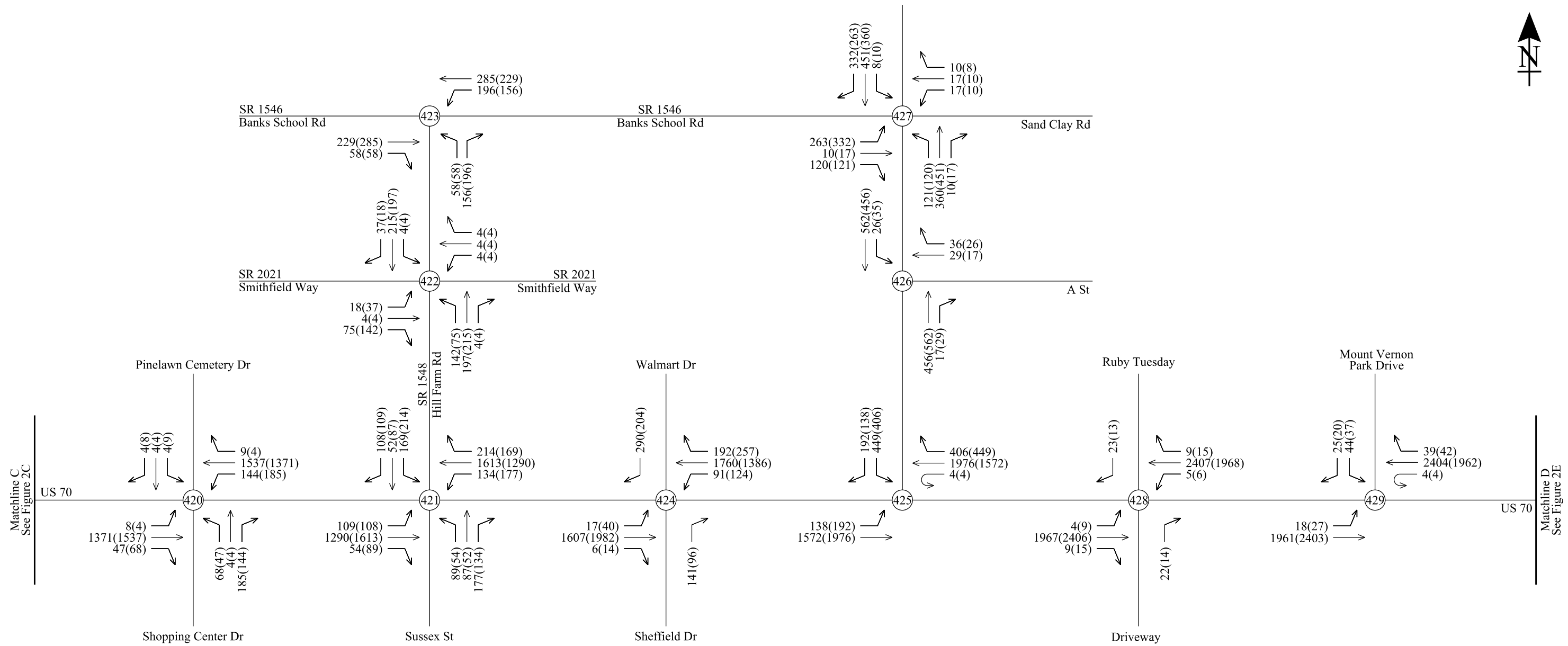




2040 No-Build Alternative
Peak Hour Volumes
Figure 2C

- ← Turning Movement
- ⊙ Intersection Number
- ### AM Peak Hour Volumes
- (###) PM Peak Hour Volumes

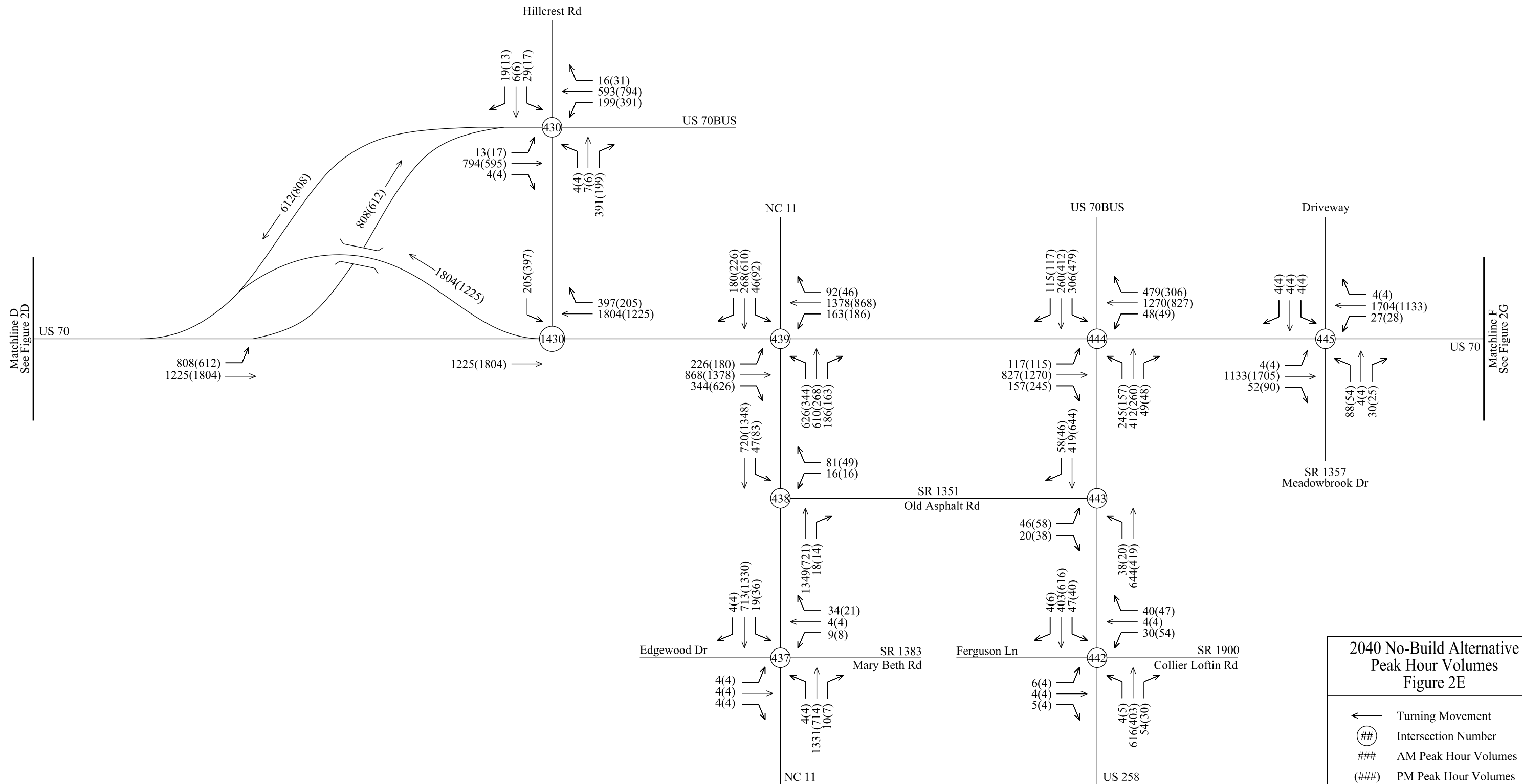




2040 No-Build Alternative
Peak Hour Volumes
Figure 2D

- ← Turning Movement
- ⊙ Intersection Number
- ### AM Peak Hour Volumes
- (###) PM Peak Hour Volumes





**2040 No-Build Alternative
Peak Hour Volumes
Figure 2E**

← Turning Movement

⊕ Intersection Number

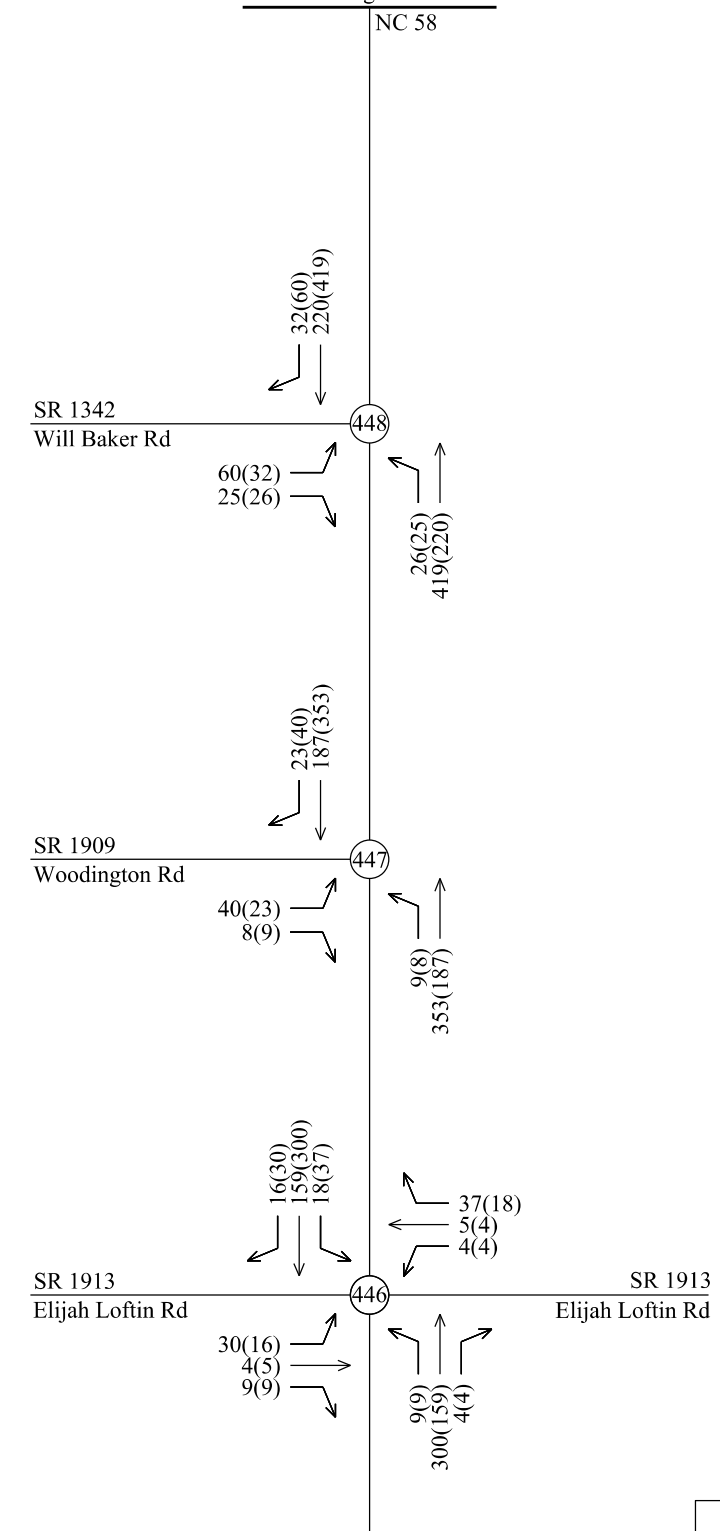
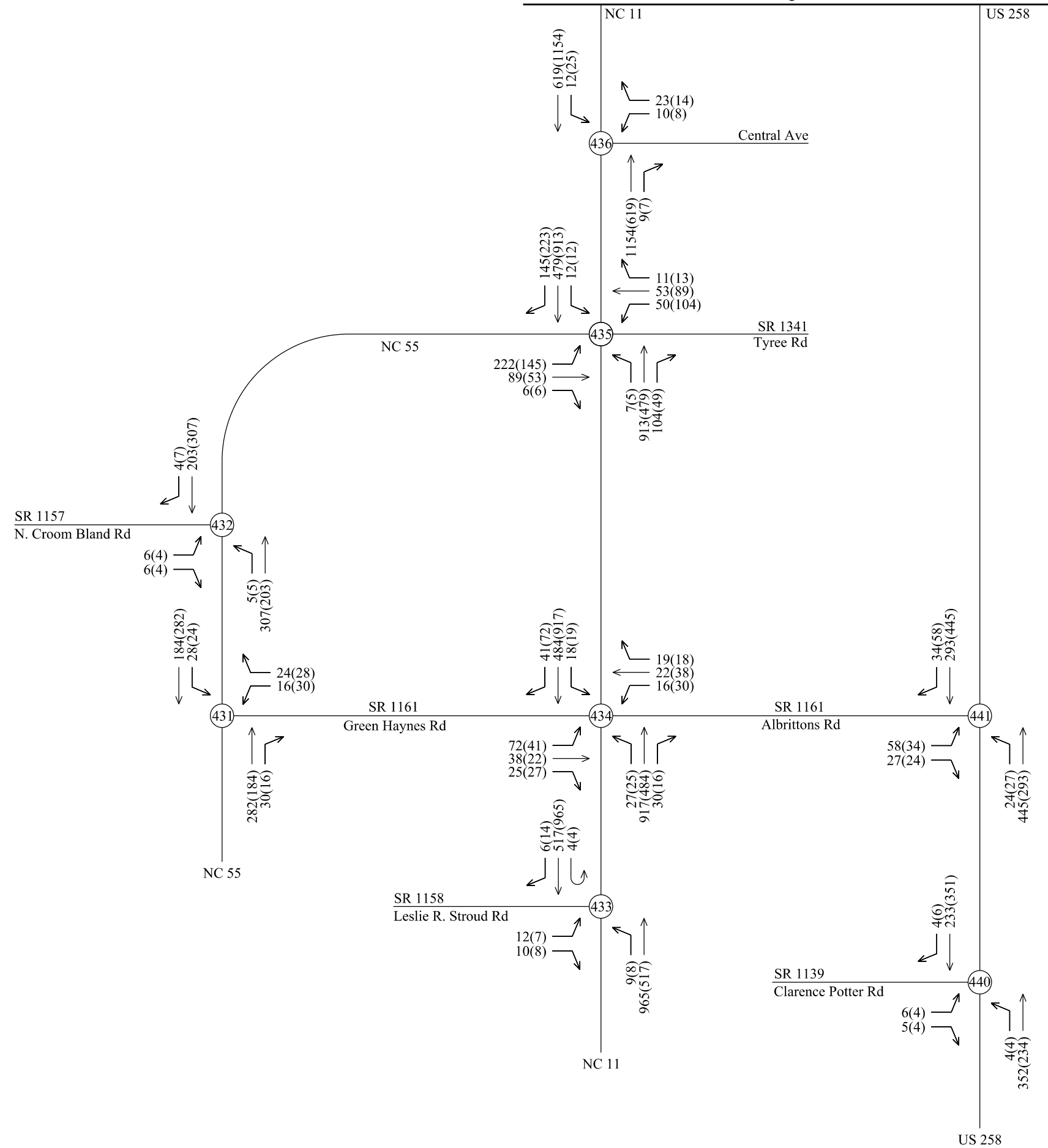
AM Peak Hour Volumes

(###) PM Peak Hour Volumes



Matchline E
See Figure 2E

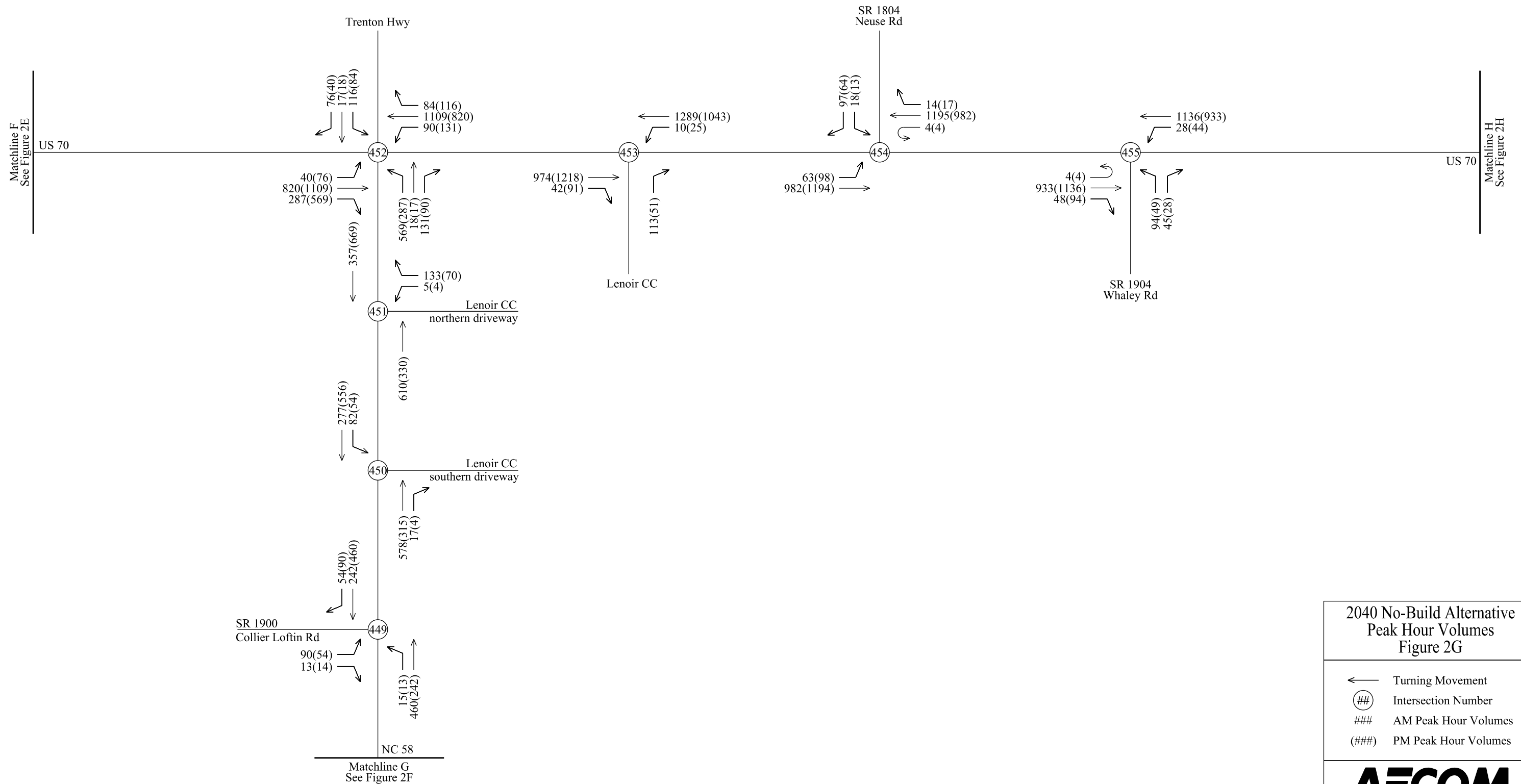
Matchline G
See Figure 2G



2040 No-Build Alternative
Peak Hour Volumes
Figure 2F

- ← Turning Movement
- ⊙ Intersection Number
- ### AM Peak Hour Volumes
- (###) PM Peak Hour Volumes

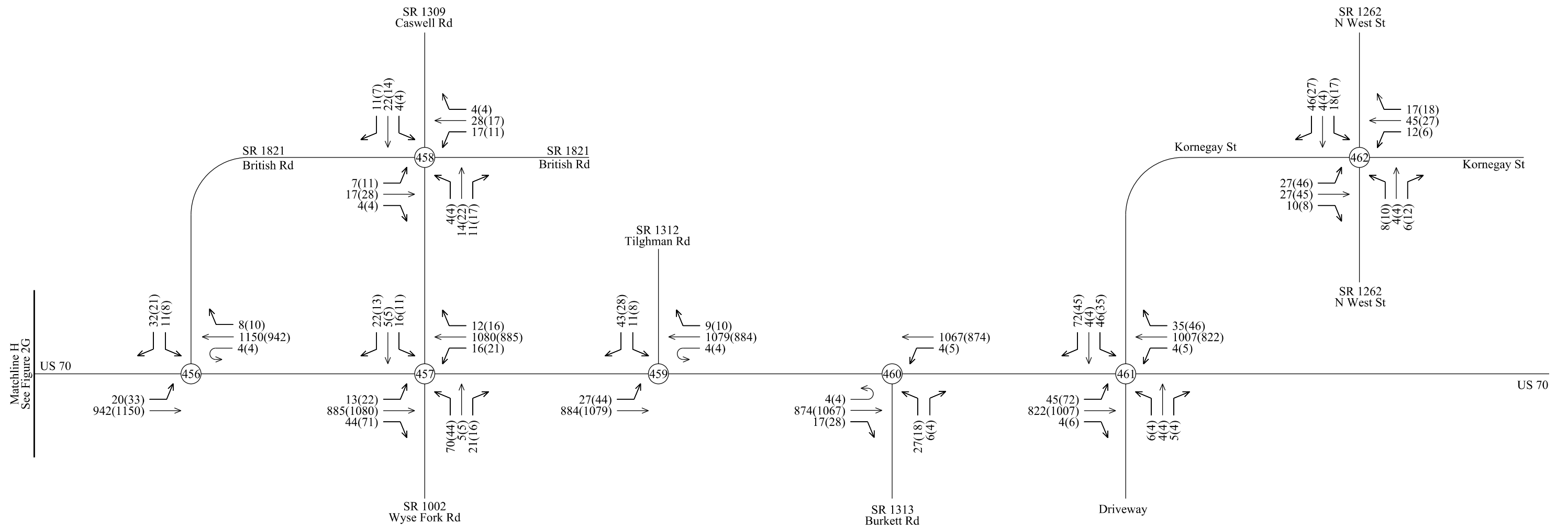




2040 No-Build Alternative
Peak Hour Volumes
Figure 2G

- ← Turning Movement
- ⊙ Intersection Number
- ### AM Peak Hour Volumes
- (###) PM Peak Hour Volumes





Matchline H
See Figure 2G

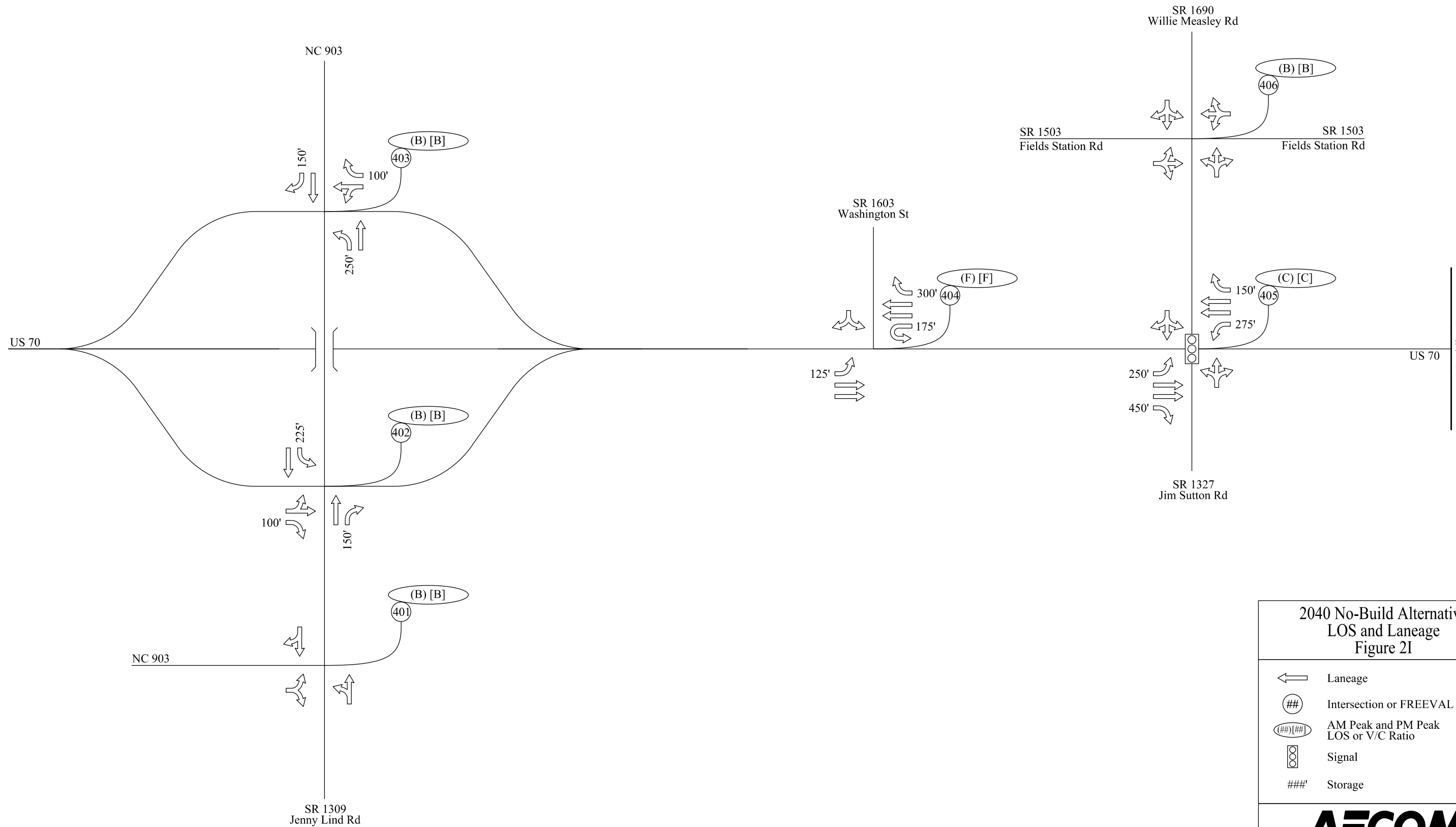
2040 No-Build Alternative
Peak Hour Volumes
Figure 2H

← Turning Movement
⊙ Intersection Number
AM Peak Hour Volumes
(###) PM Peak Hour Volumes



**2040 No-Build Alternative
LOS and Laneage Figures**

This page left intentionally blank

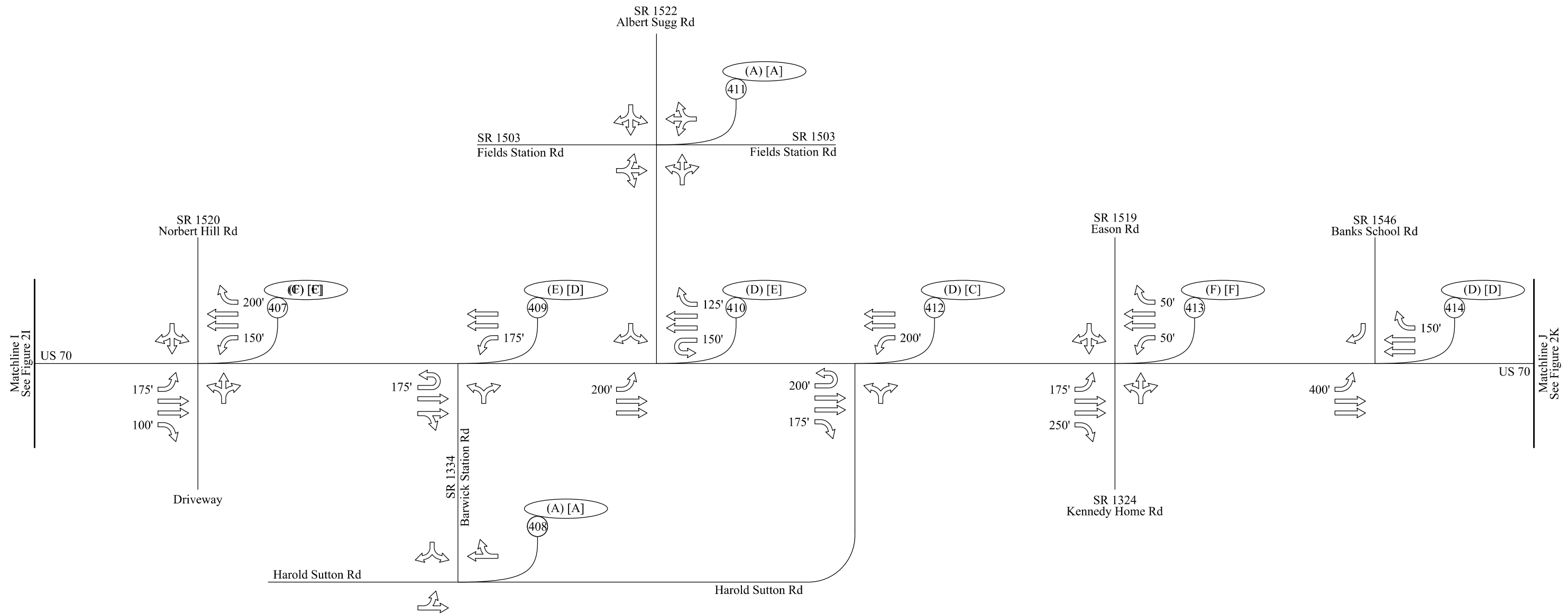


Matchline 1
See Figure 2J

2040 No-Build Alternative LOS and Laneage Figure 2I

- Laneage
- Intersection or FREEVAL Number
- AM Peak and PM Peak LOS or V/C Ratio
- Signal
- Storage

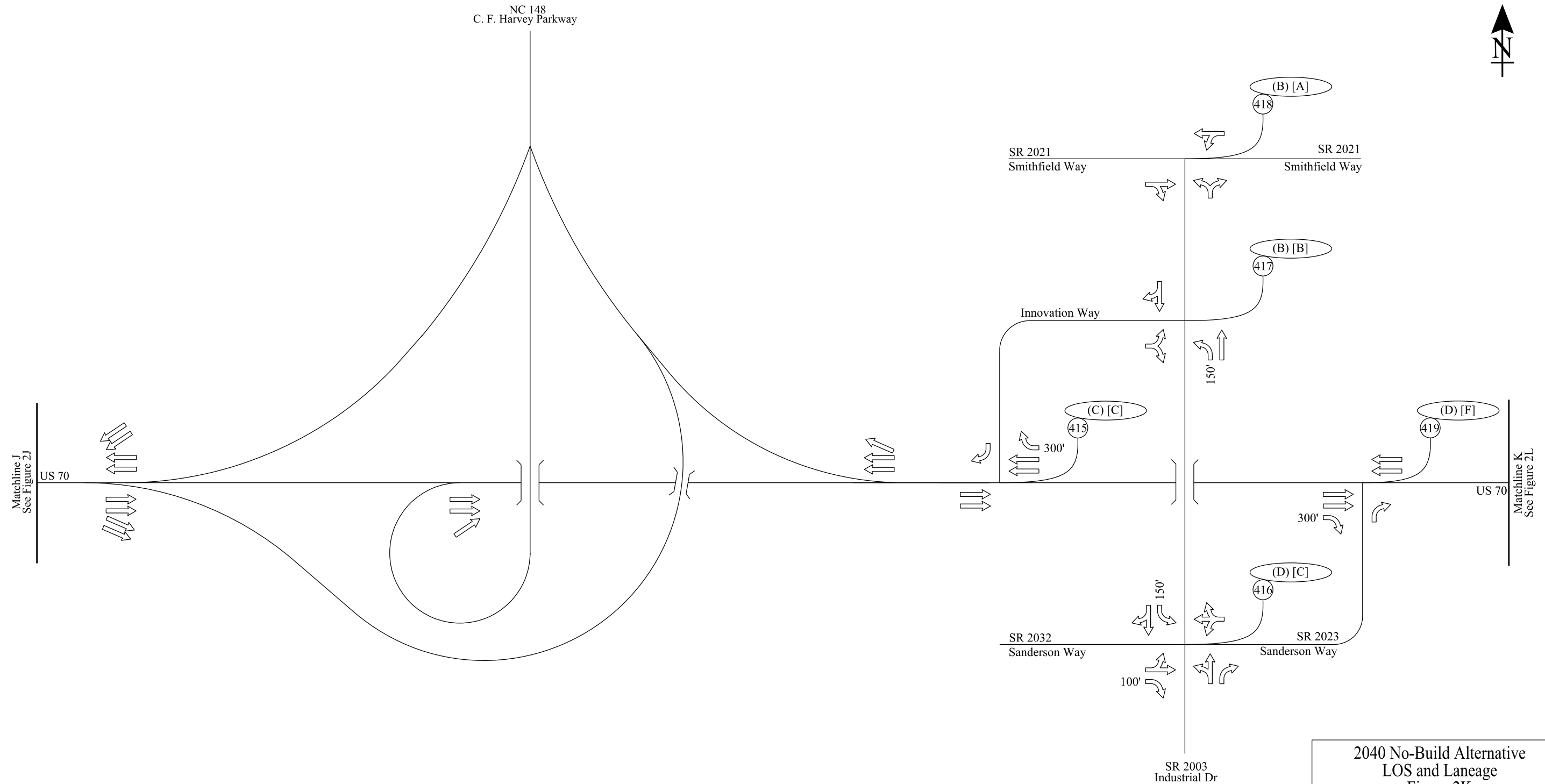




2040 No-Build Alternative
LOS and Laneage
Figure 2J

- Laneage
- Intersection or FREEVAL Number
- AM Peak and PM Peak LOS or V/C Ratio
- Signal
- Storage

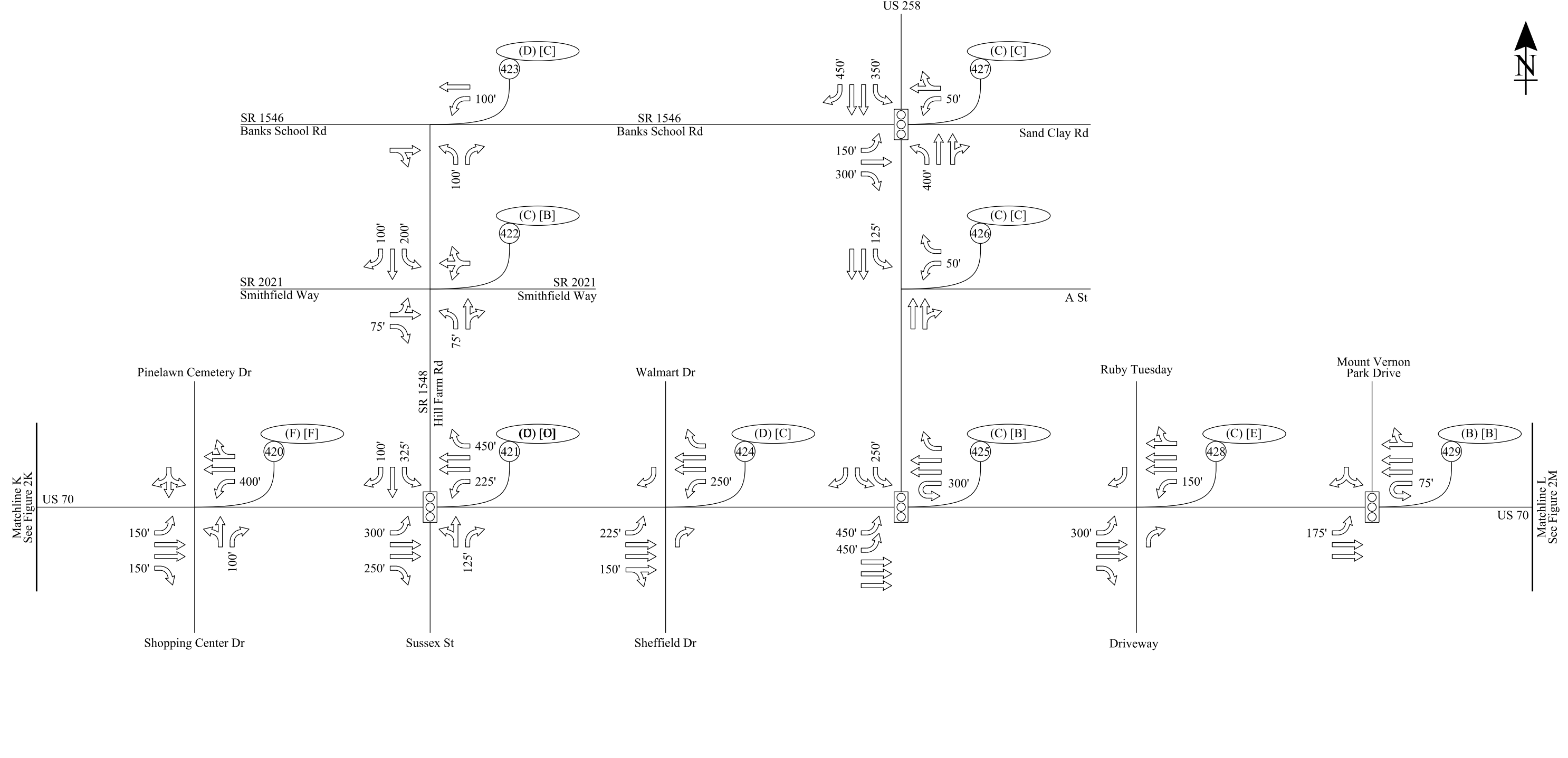




2040 No-Build Alternative
LOS and Laneage
Figure 2K

- Laneage
- Intersection or FREEVAL Number
- AM Peak and PM Peak LOS or V/C Ratio
- Signal
- Storage



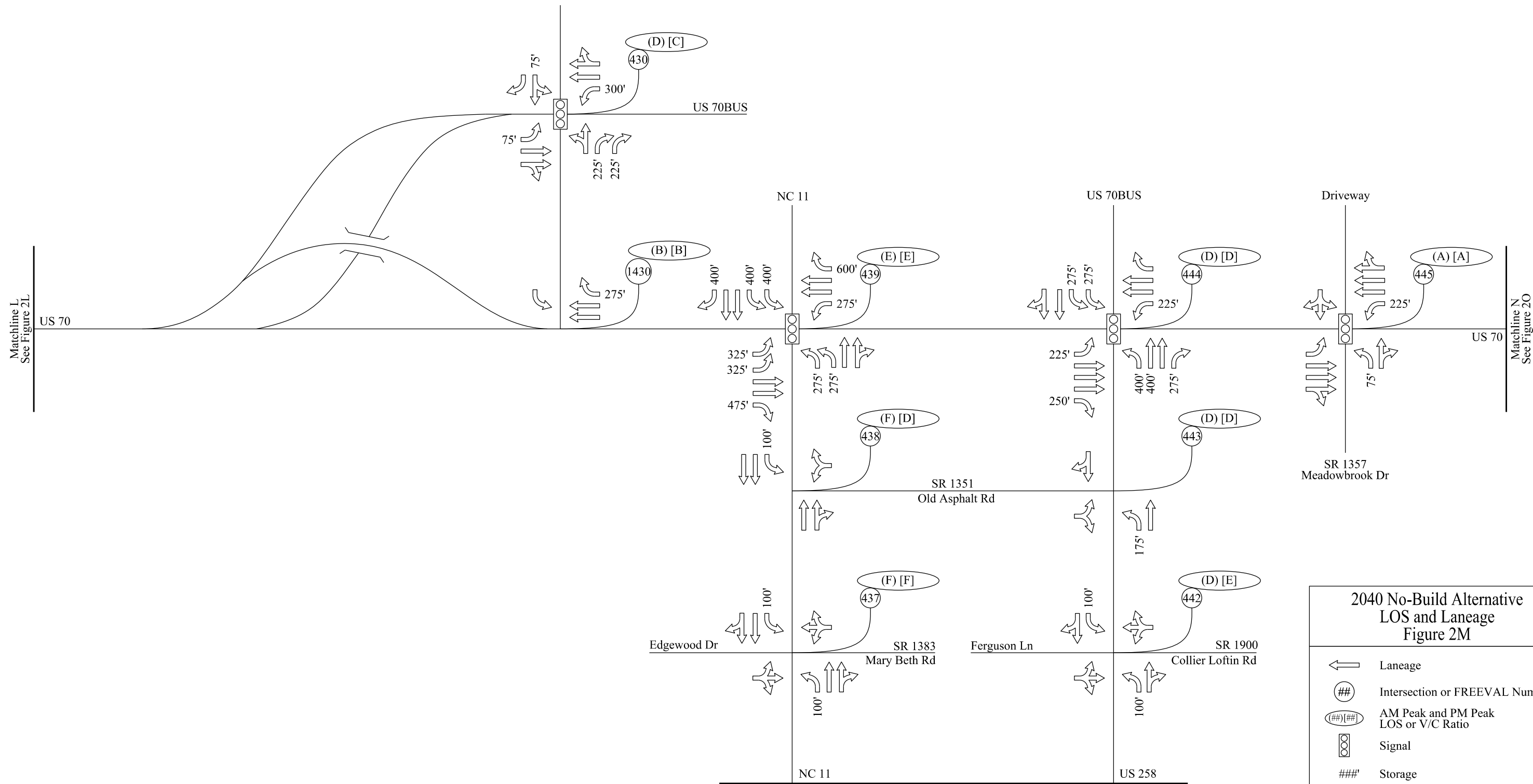


Matchline K
See Figure 2K

Matchline L
See Figure 2M

2040 No-Build Alternative LOS and Laneage Figure 2L	
	Laneage
	Intersection or FREEVAL Number
	AM Peak and PM Peak LOS or V/C Ratio
	Signal
	Storage





Matchline L
See Figure 2L

Matchline N
See Figure 2O

Matchline M
See Figure 2N

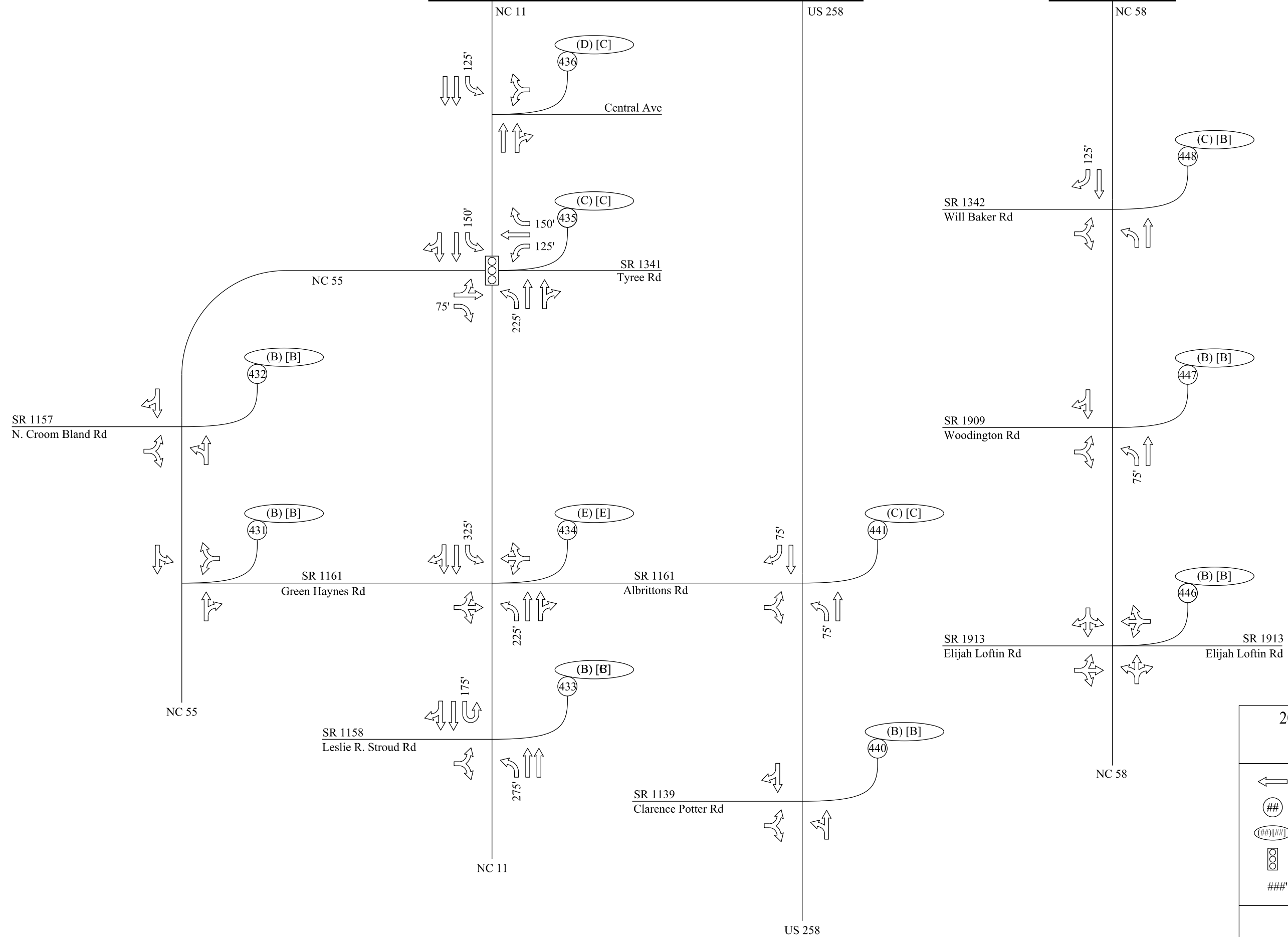
**2040 No-Build Alternative
LOS and Laneage
Figure 2M**

- Laneage
- Intersection or FREEVAL Number
- AM Peak and PM Peak LOS or V/C Ratio
- Signal
- Storage



Matchline M
See Figure 2M

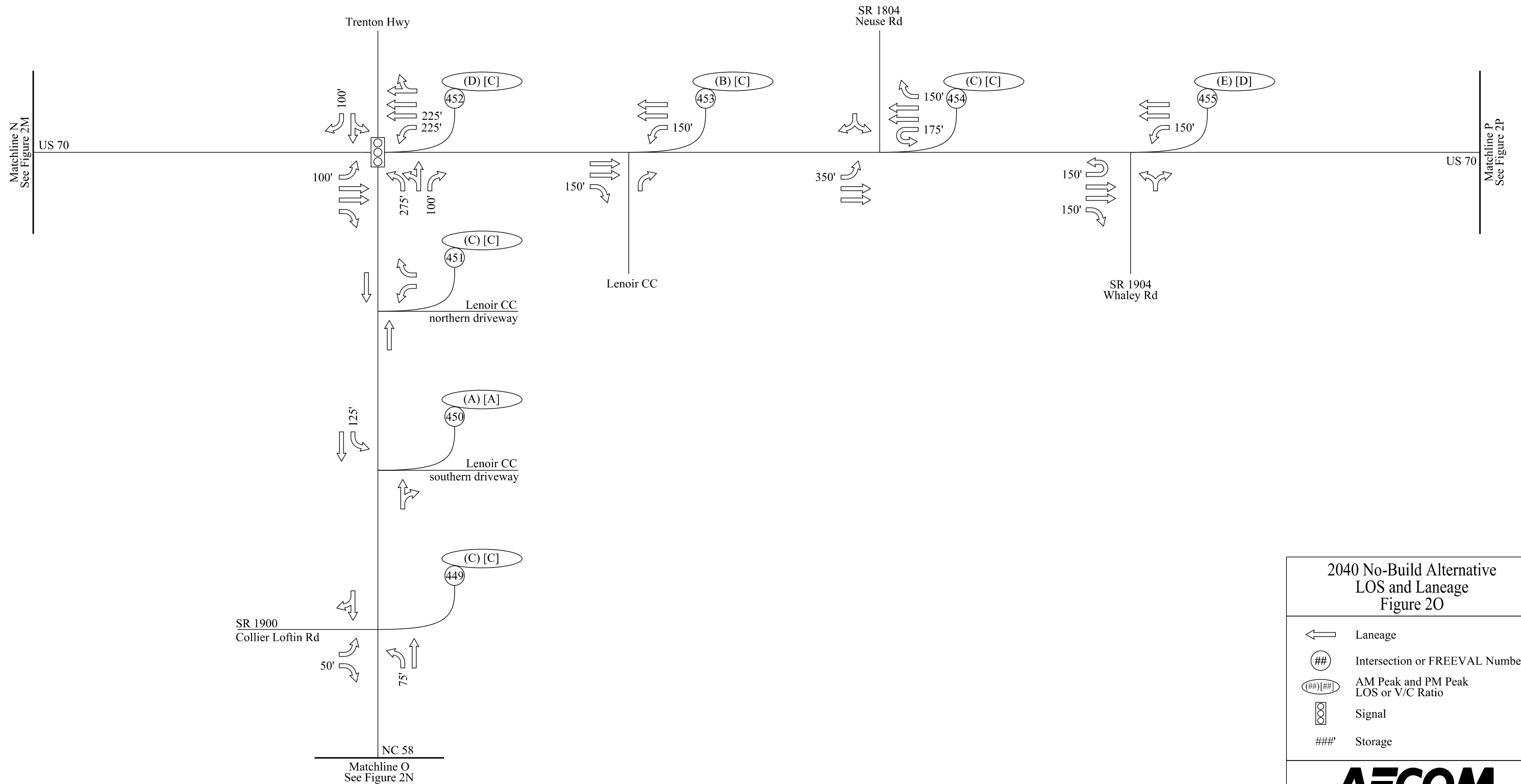
Matchline O
See Figure 2O



**2040 No-Build Alternative
LOS and Laneage
Figure 2N**

	Laneage
	Intersection or FREEVAL Number
	AM Peak and PM Peak LOS or V/C Ratio
	Signal
	Storage

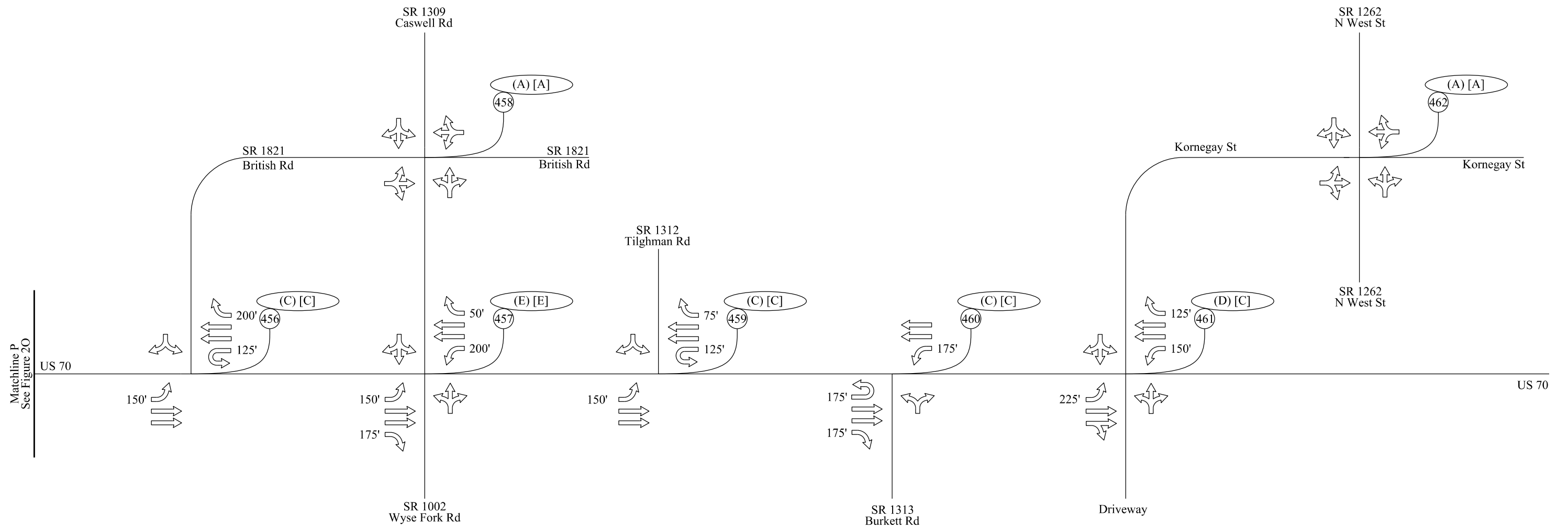




2040 No-Build Alternative
LOS and Laneage
Figure 20






- Laneage
- Intersection or FREEVAL Number
- AM Peak and PM Peak LOS or V/C Ratio
- Signal
- Storage





Matchline P
See Figure 2O

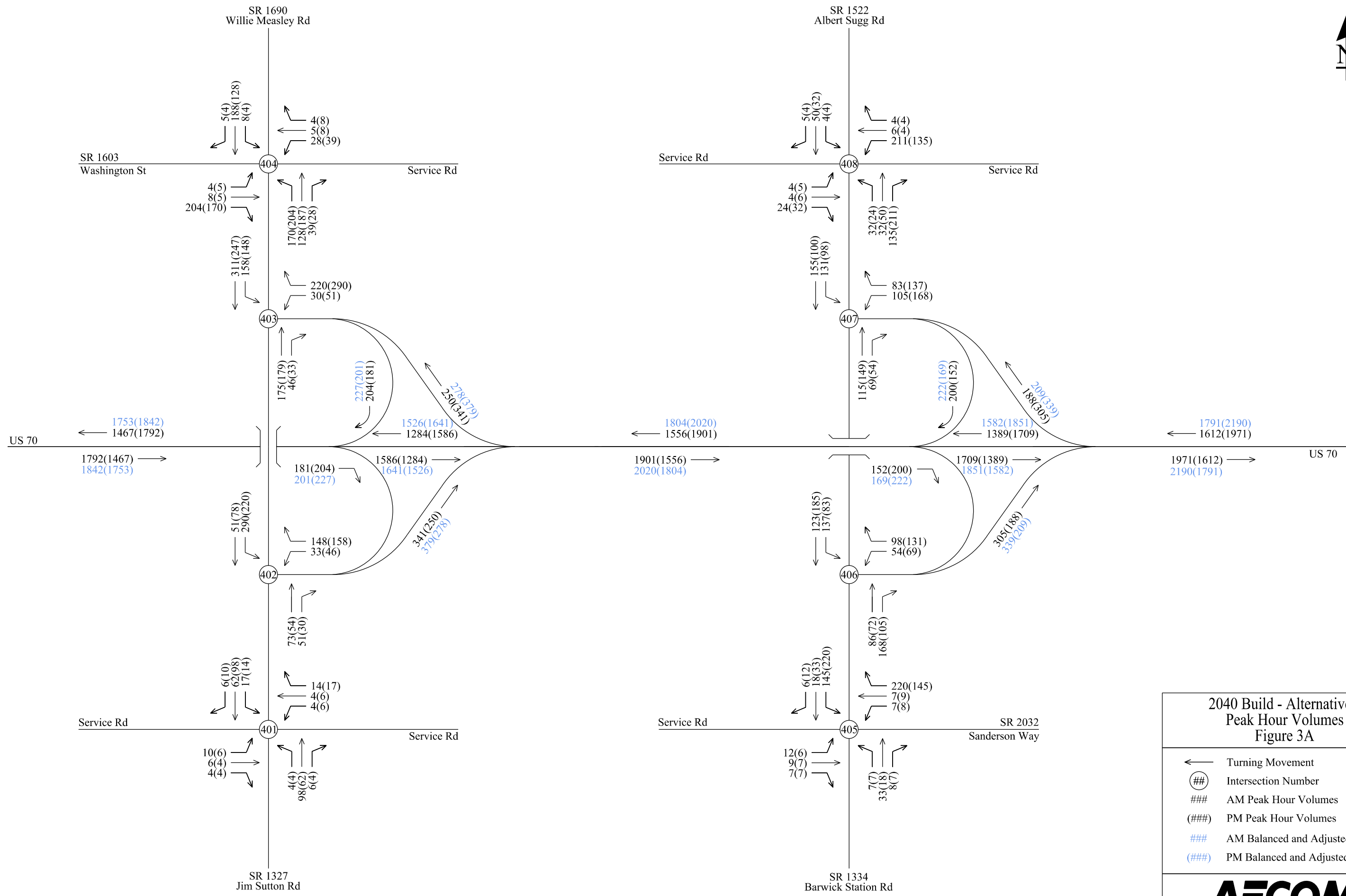
2040 No-Build Alternative
LOS and Laneage
Figure 2P

-  Laneage
-  Intersection or FREEVAL Number
-  AM Peak and PM Peak
LOS or V/C Ratio
-  Signal
-  Storage



**2040 Build Alternative 1
Peak Hour Volume Figures**

This page left intentionally blank



Matchline A
See Figure 3B

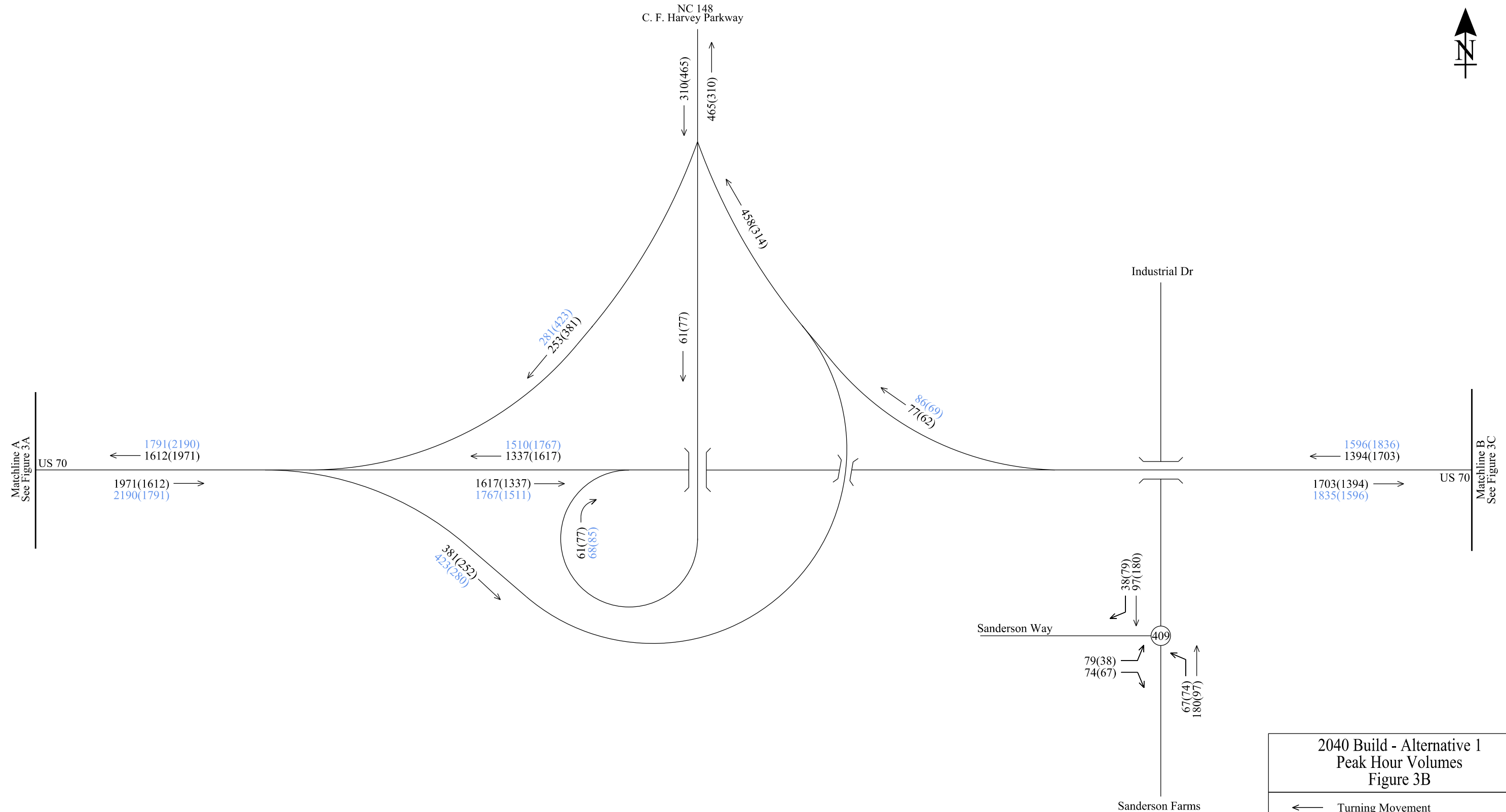
2040 Build - Alternative 1
Peak Hour Volumes
Figure 3A

- ← Turning Movement
- ⓪ Intersection Number
- ### AM Peak Hour Volumes
- (###) PM Peak Hour Volumes
- ### AM Balanced and Adjusted Volumes
- (###) PM Balanced and Adjusted Volumes





NC 148
C. F. Harvey Parkway



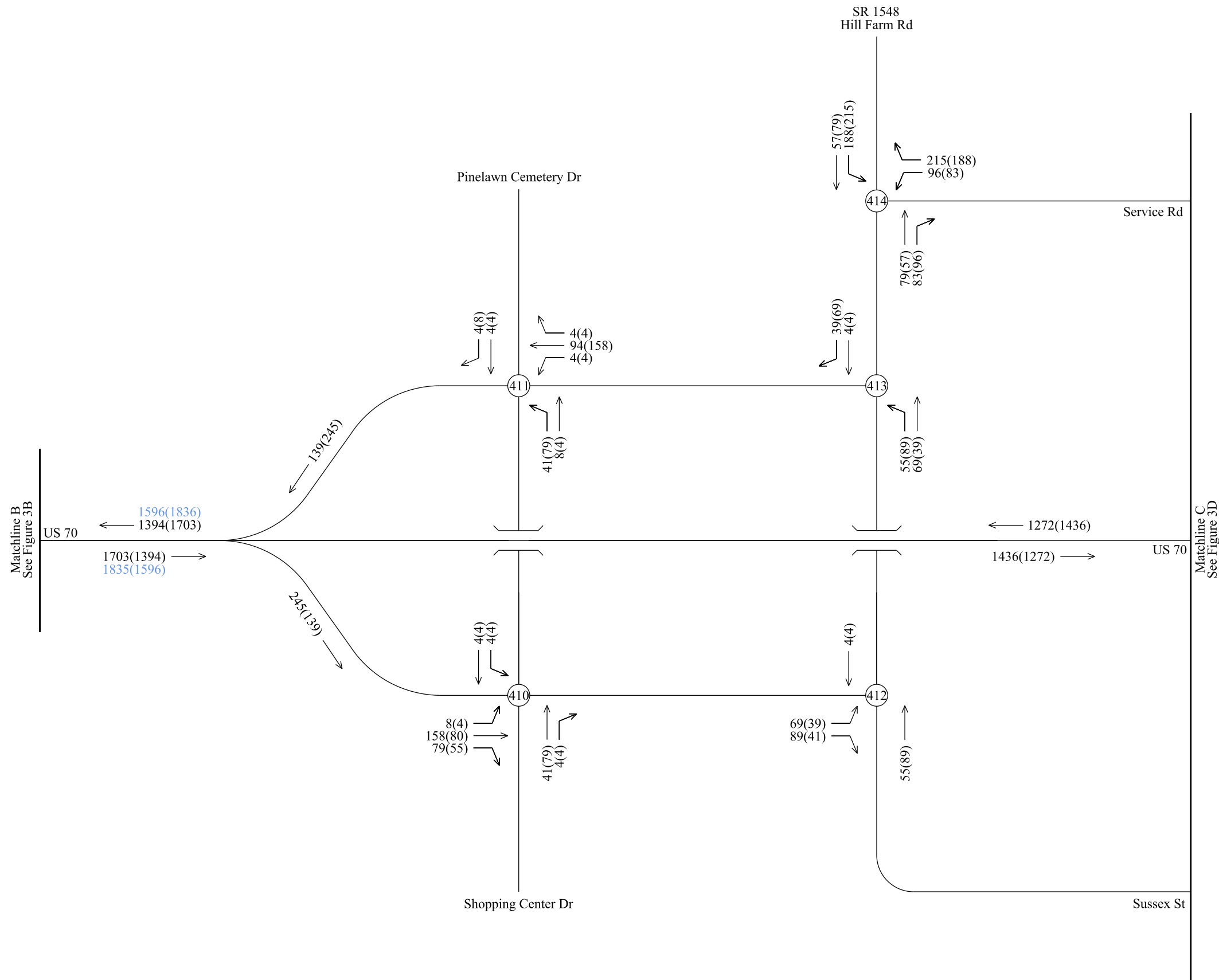
Matchline A
See Figure 3A

Matchline B
See Figure 3C

2040 Build - Alternative 1
Peak Hour Volumes
Figure 3B

- ← Turning Movement
- ⊙ Intersection Number
- ### AM Peak Hour Volumes
- (###) PM Peak Hour Volumes
- ### AM Balanced and Adjusted Volumes
- (###) PM Balanced and Adjusted Volumes

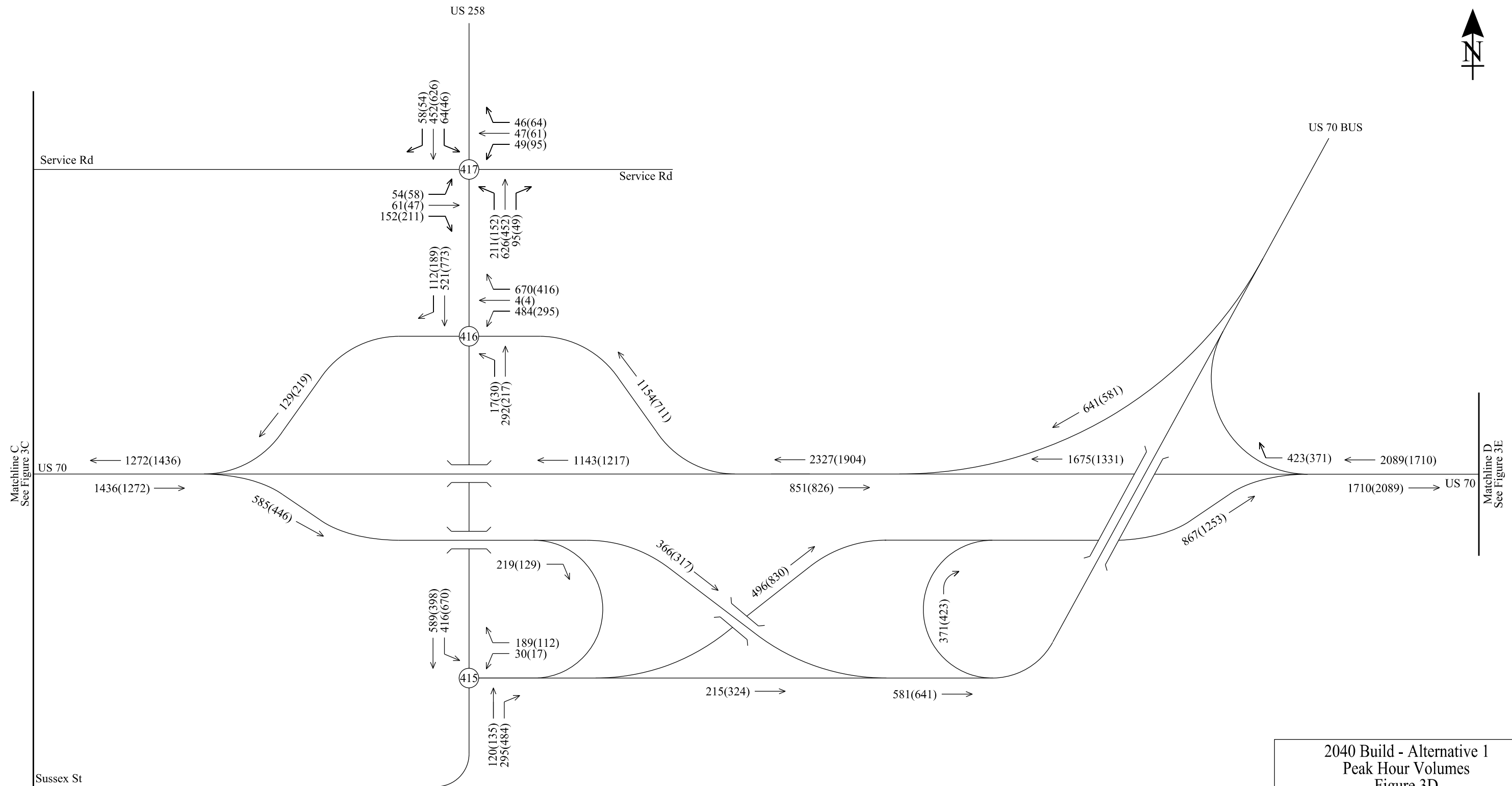




2040 Build - Alternative 1
Peak Hour Volumes
Figure 3C

- ← Turning Movement
- ⊙ Intersection Number
- ### AM Peak Hour Volumes
- (###) PM Peak Hour Volumes
- ### AM Balanced and Adjusted Volumes
- (###) PM Balanced and Adjusted Volumes

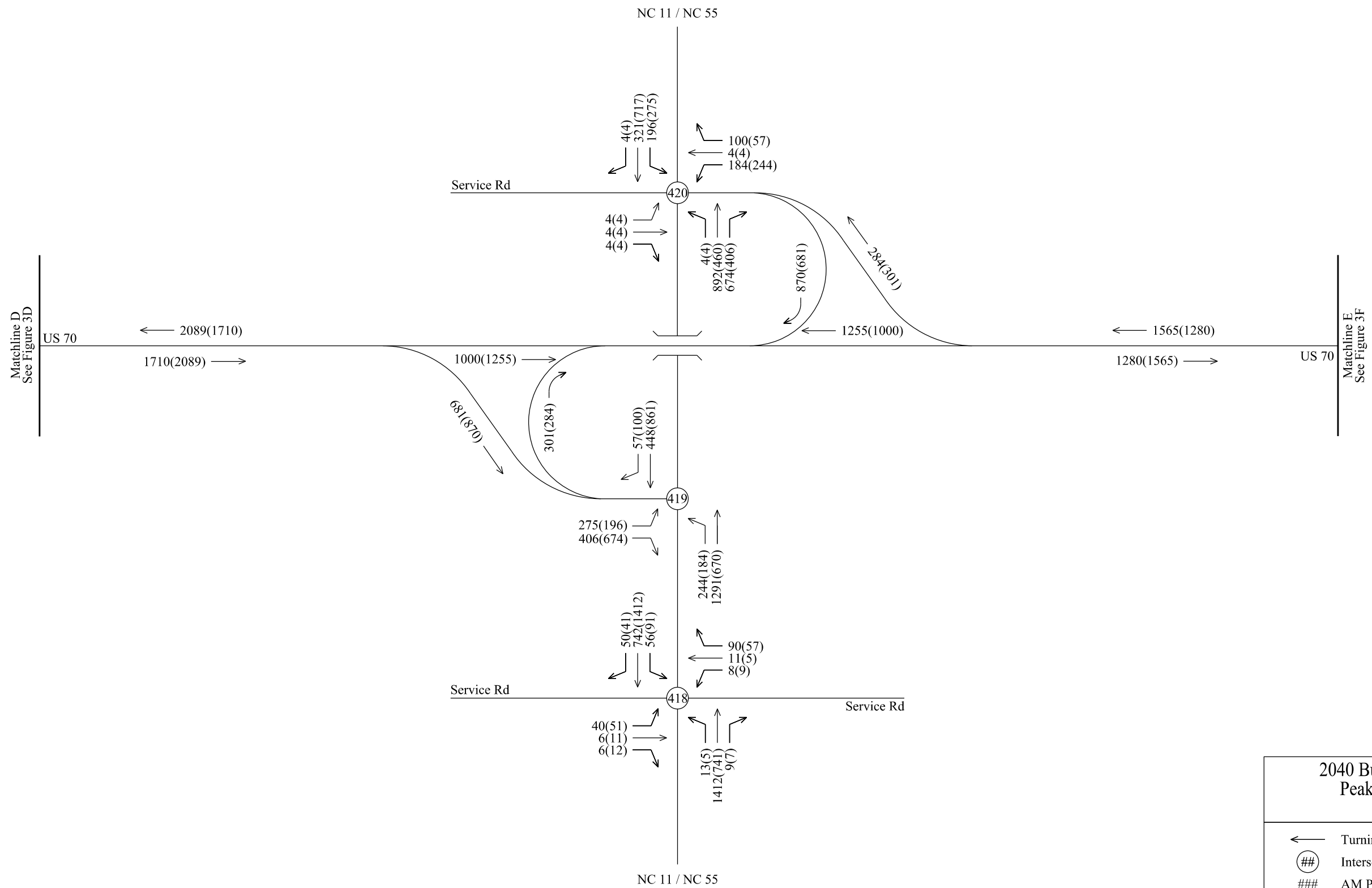




2040 Build - Alternative 1
Peak Hour Volumes
Figure 3D

- ← Turning Movement
- ⊕ Intersection Number
- ### AM Peak Hour Volumes
- (###) PM Peak Hour Volumes
- ### AM Balanced and Adjusted Volumes
- (###) PM Balanced and Adjusted Volumes





2040 Build - Alternative 1
Peak Hour Volumes
Figure 3E

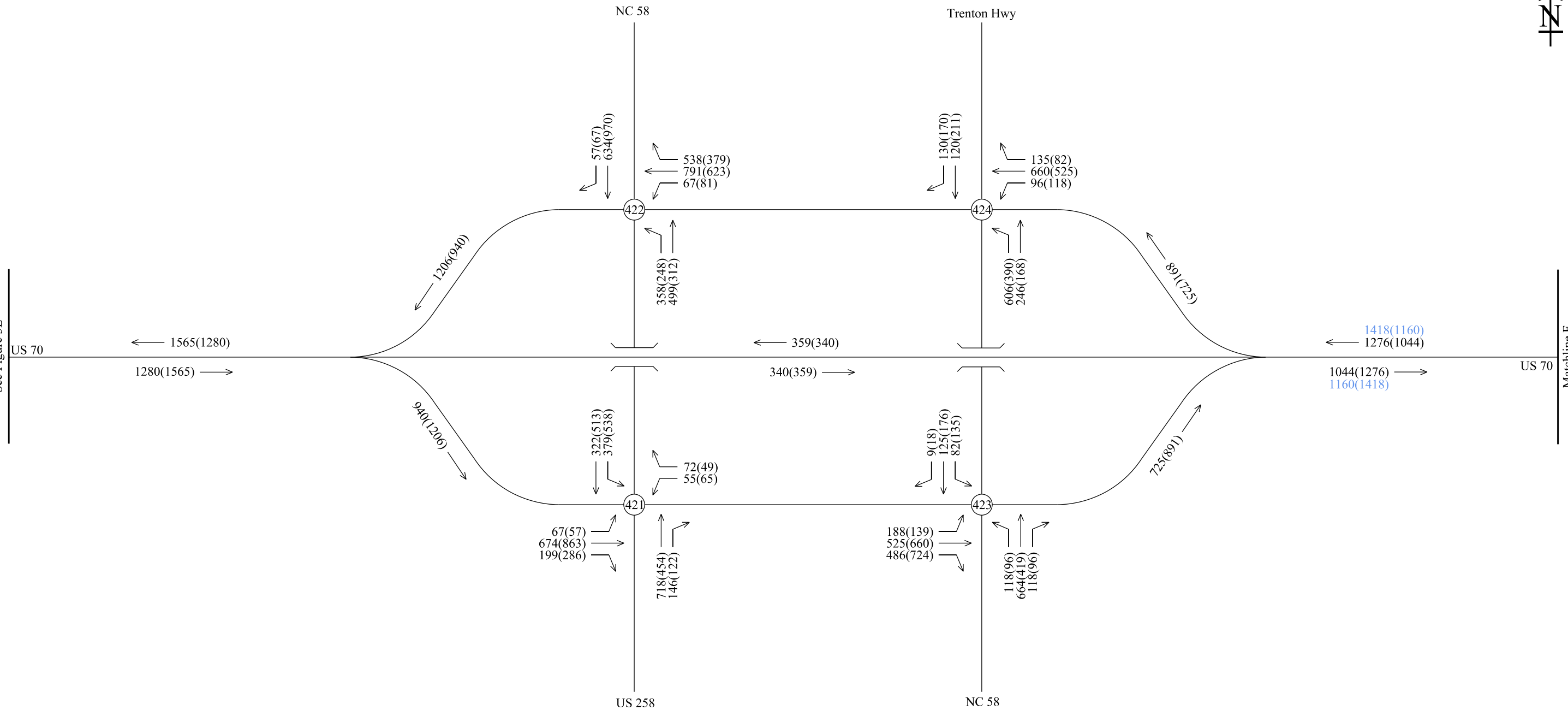
- ← Turning Movement
- ⊕ Intersection Number
- ### AM Peak Hour Volumes
- (###) PM Peak Hour Volumes
- ### AM Balanced and Adjusted Volumes
- (###) PM Balanced and Adjusted Volumes





Matchline E
See Figure 3E

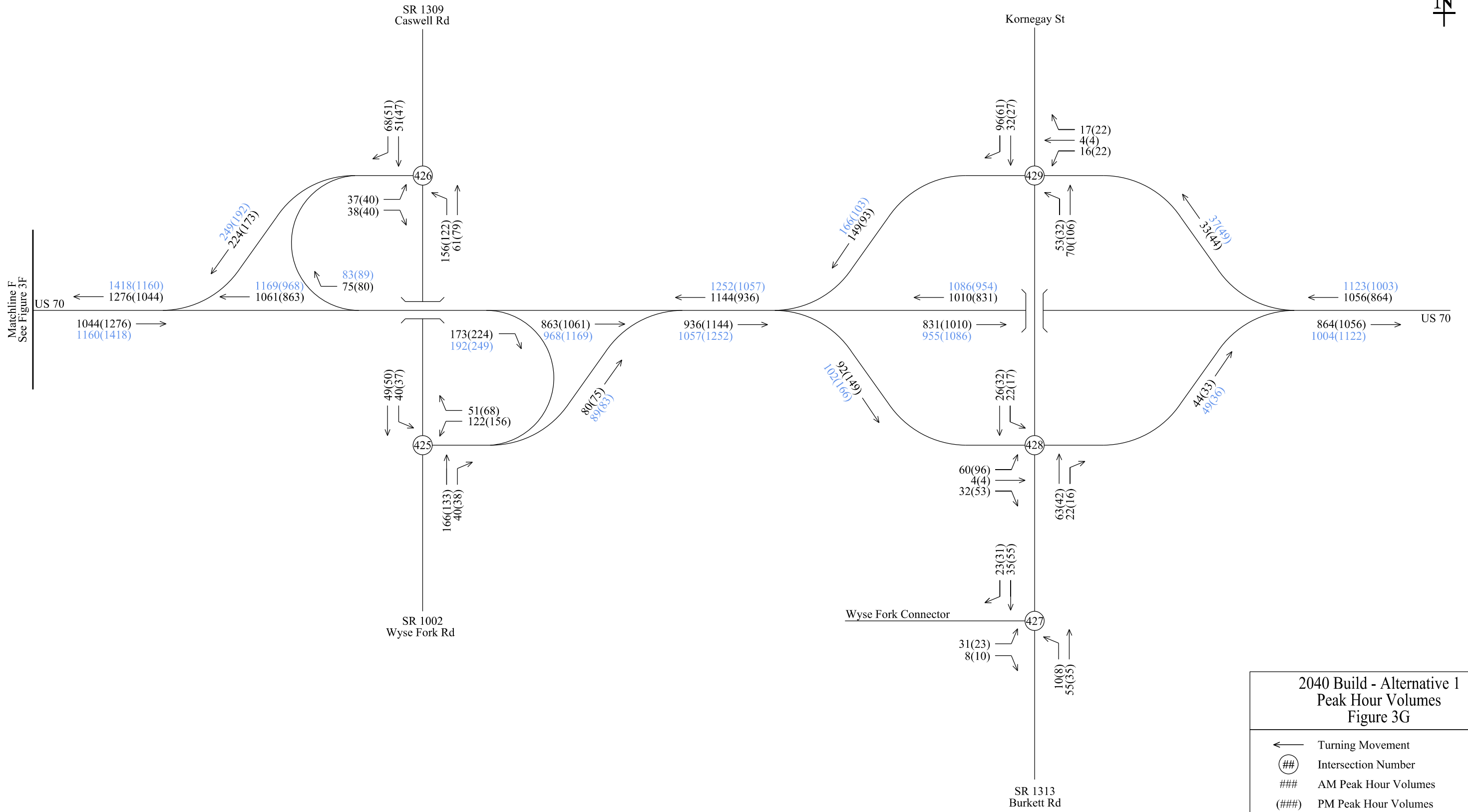
Matchline F
See Figure 3G



2040 Build - Alternative 1
Peak Hour Volumes
Figure 3F

- ← Turning Movement
- ⊙ Intersection Number
- ### AM Peak Hour Volumes
- (###) PM Peak Hour Volumes
- ### AM Balanced and Adjusted Volumes
- (###) PM Balanced and Adjusted Volumes





Matchline F
See Figure 3F

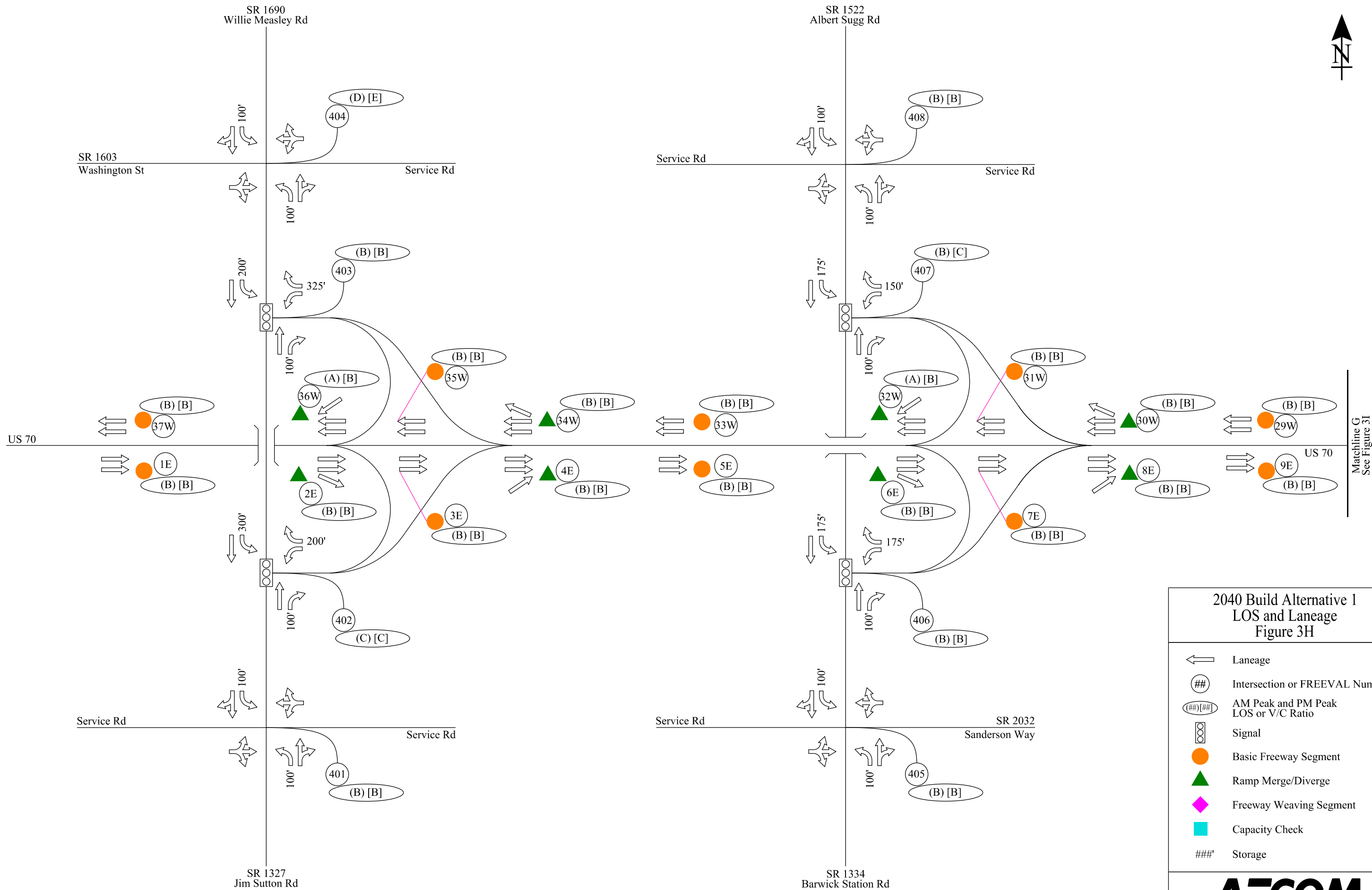
2040 Build - Alternative 1 Peak Hour Volumes Figure 3G	
←	Turning Movement
⊙##	Intersection Number
###	AM Peak Hour Volumes
(###)	PM Peak Hour Volumes
###	AM Balanced and Adjusted Volumes
(###)	PM Balanced and Adjusted Volumes



This page left intentionally blank










**2040 Build Alternative 1
LOS and Laneage Figures**

This page left intentionally blank



Matchline G
See Figure 3I

2040 Build Alternative 1 LOS and Laneage Figure 3H

-  Laneage
-  Intersection or FREEVAL Number
-  AM Peak and PM Peak LOS or V/C Ratio
-  Signal
-  Basic Freeway Segment
-  Ramp Merge/Diverge
-  Freeway Weaving Segment
-  Capacity Check
-  Storage





NC 148
C. F. Harvey Parkway

Matchline G
See Figure 3H

Matchline H
See Figure 3J

US 70

US 70










Industrial Dr

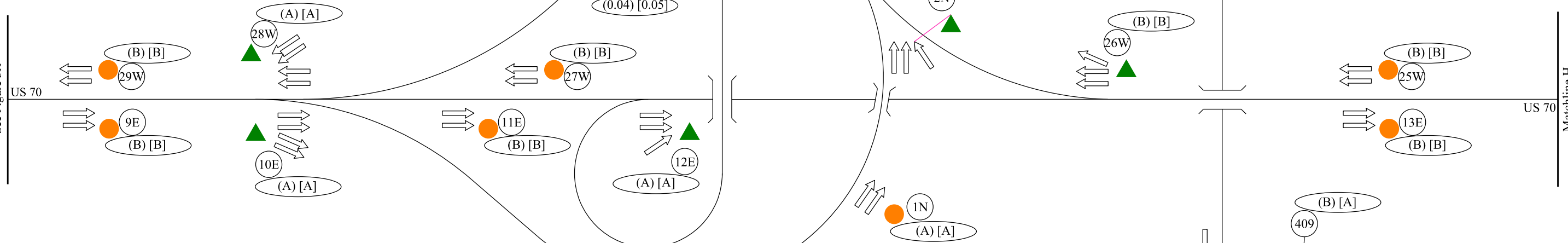
Sanderson Way

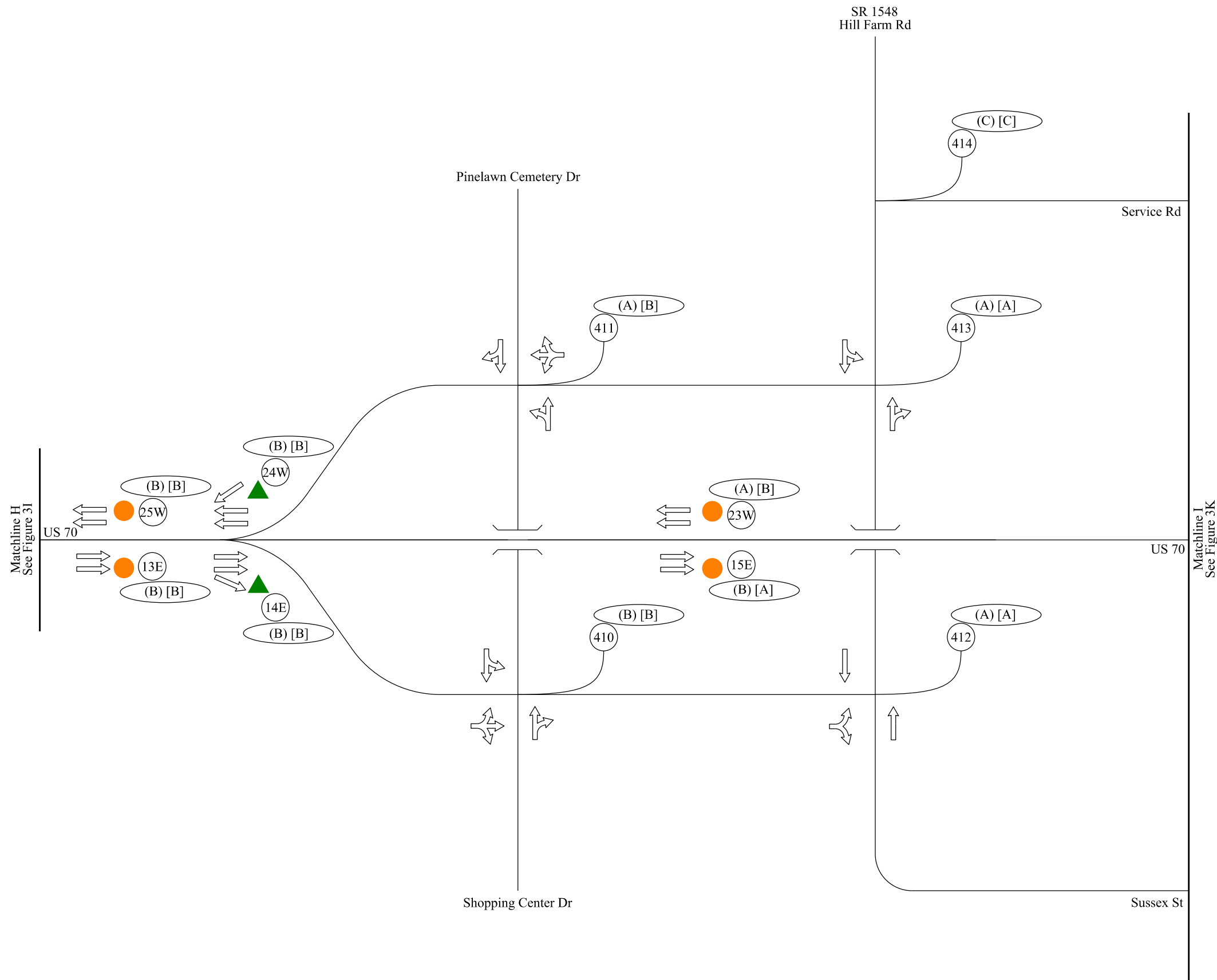
100'

Sanderson Farms

2040 Build Alternative 1
LOS and Laneage
Figure 3I

-  Laneage
-  Intersection or FREEVAL Number
-  AM Peak and PM Peak
LOS or V/C Ratio
-  Signal
-  Basic Freeway Segment
-  Ramp Merge/Diverge
-  Freeway Weaving Segment
-  Capacity Check
-  Storage

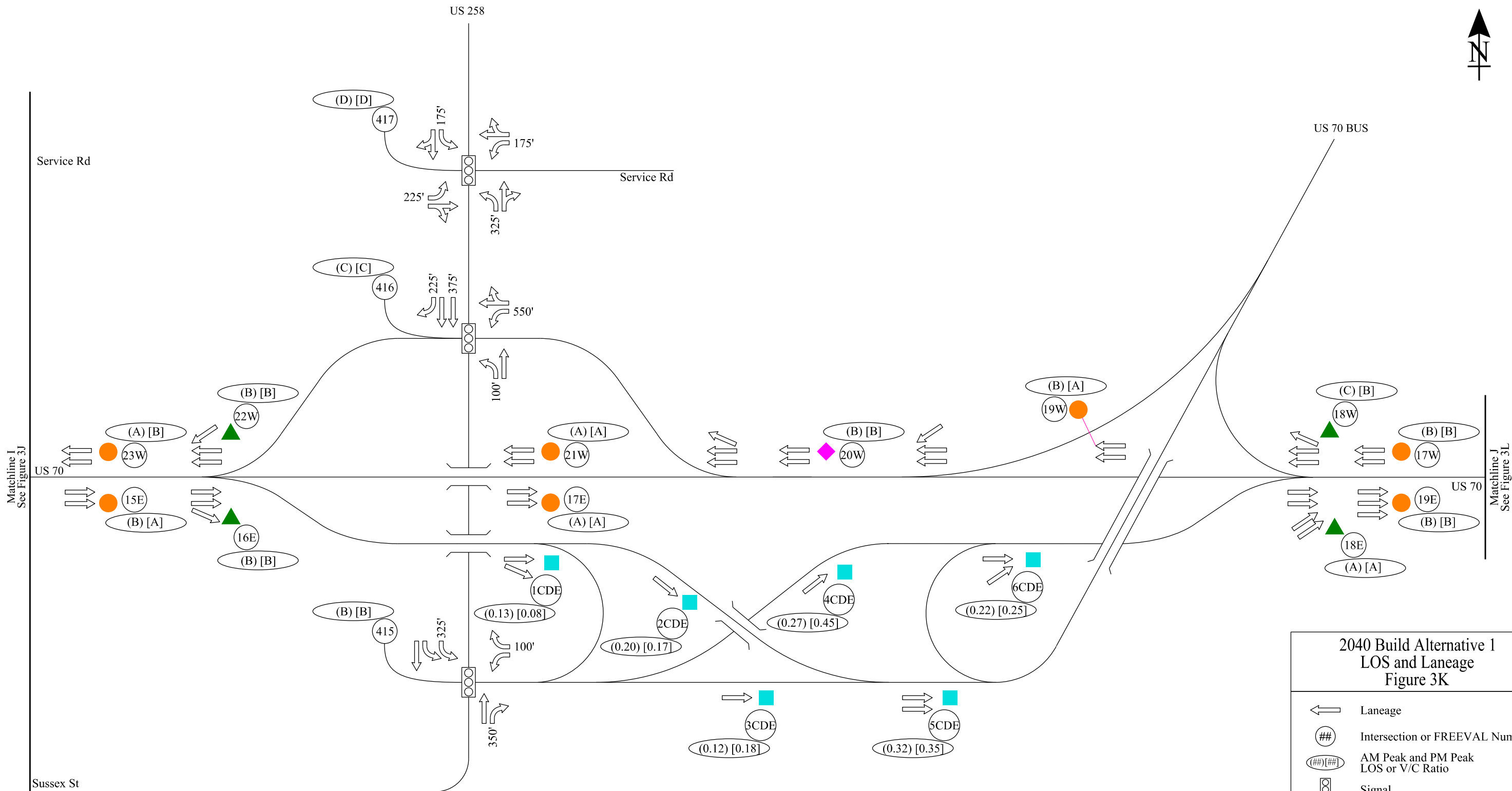




2040 Build Alternative 1
LOS and Laneage
Figure 3J

	Laneage
	Intersection or FREEVAL Number
	AM Peak and PM Peak LOS or V/C Ratio
	Signal
	Basic Freeway Segment
	Ramp Merge/Diverge
	Freeway Weaving Segment
	Capacity Check
	Storage





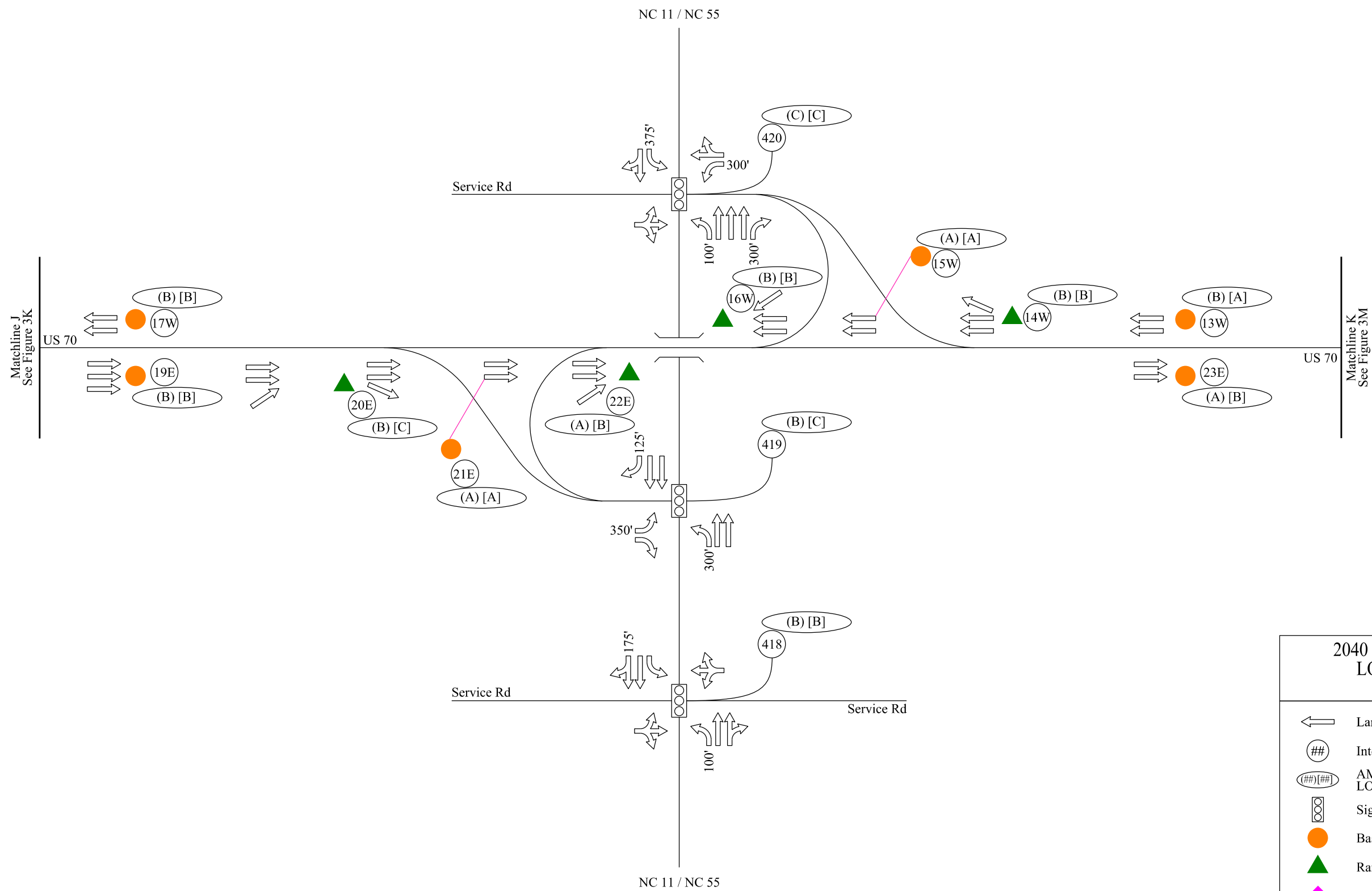
Matchline I
See Figure 3J

Matchline J
See Figure 3L










**2040 Build Alternative 1
LOS and Laneage
Figure 3K**

- Laneage
- Intersection or FREEVAL Number
- AM Peak and PM Peak LOS or V/C Ratio
- Signal
- Basic Freeway Segment
- Ramp Merge/Diverge
- Freeway Weaving Segment
- Capacity Check
- Storage





2040 Build Alternative 1
LOS and Laneage
Figure 3L

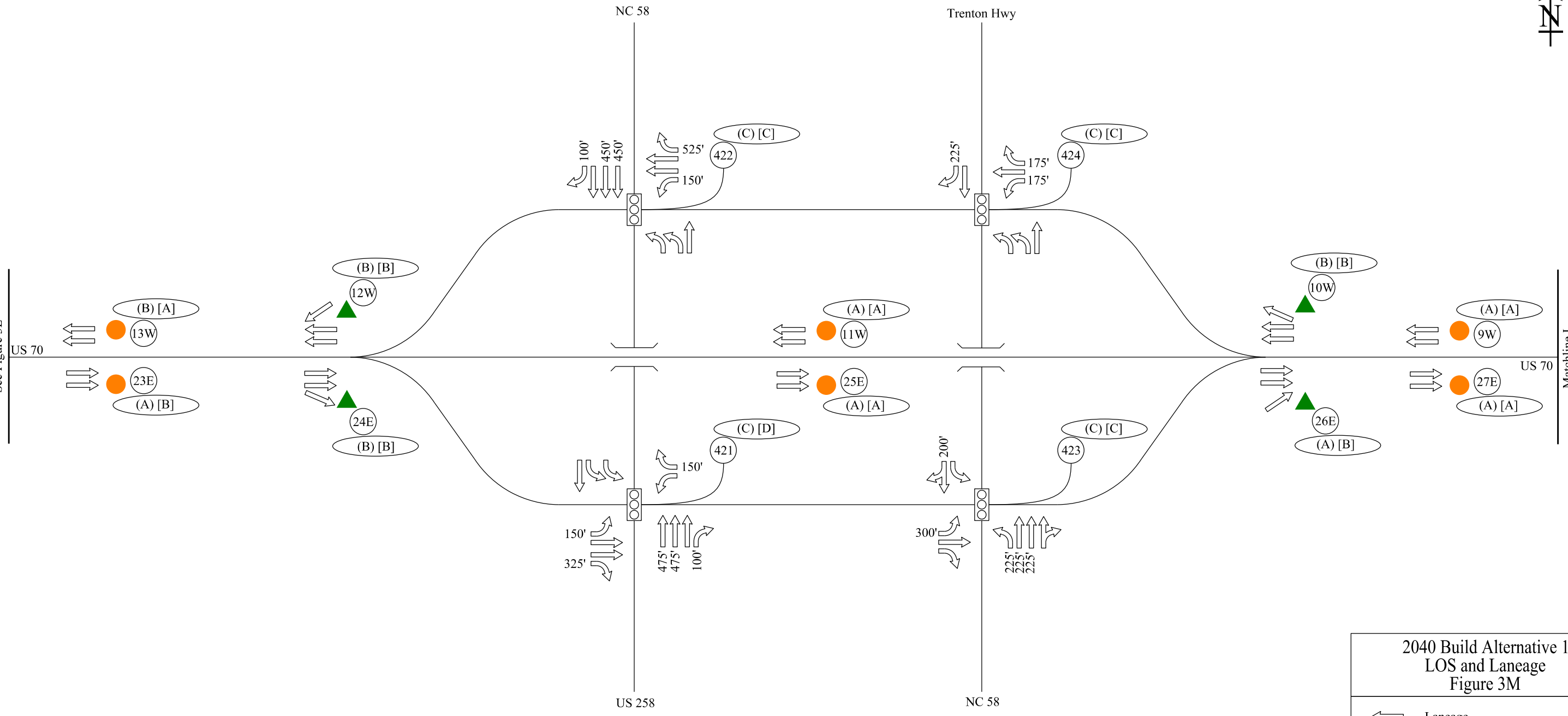
-  Laneage
-  Intersection or FREEVAL Number
-  AM Peak and PM Peak
LOS or V/C Ratio
-  Signal
-  Basic Freeway Segment
-  Ramp Merge/Diverge
-  Freeway Weaving Segment
-  Capacity Check
-  Storage





Matchline K
See Figure 3L

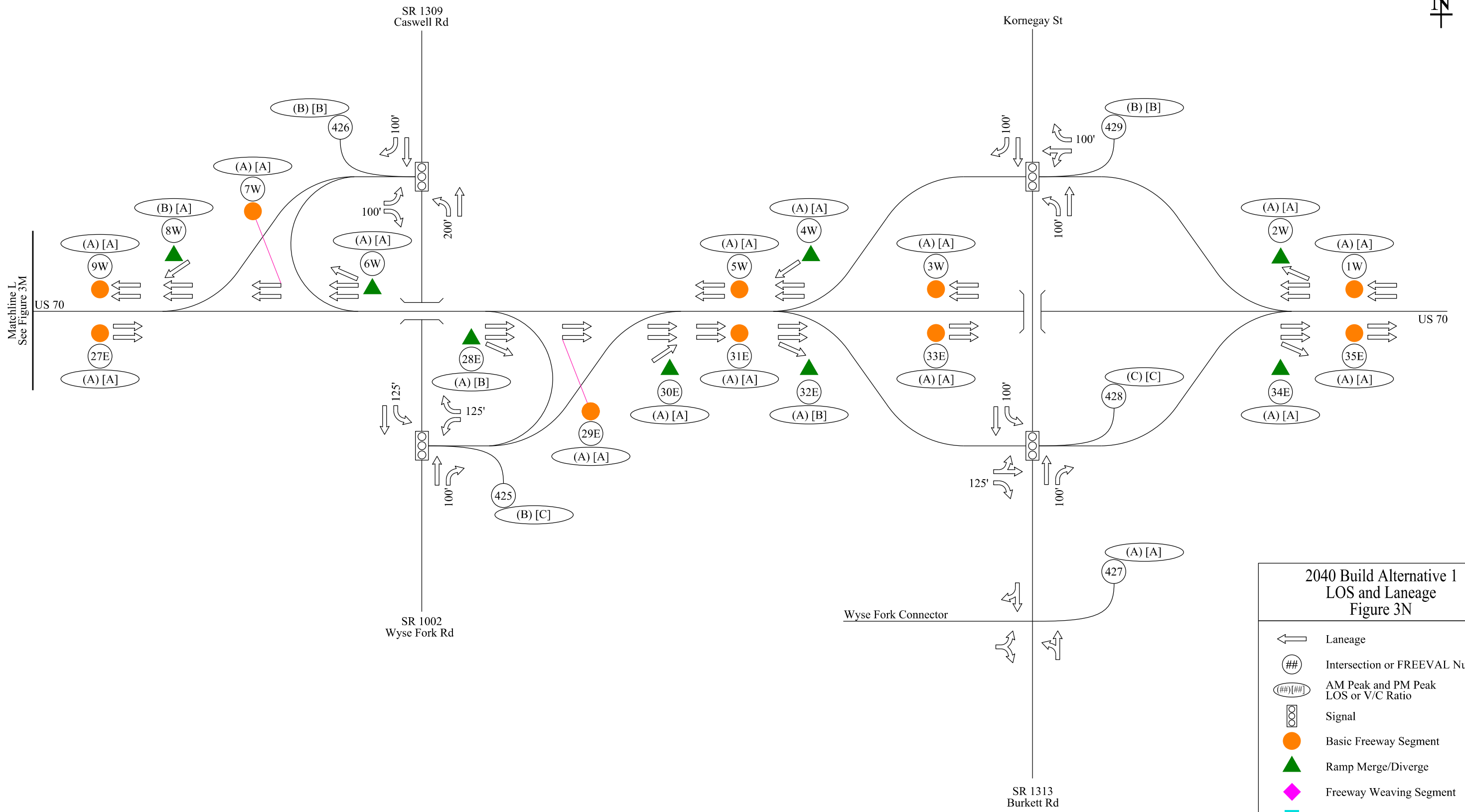
Matchline L
See Figure 3N



2040 Build Alternative 1
LOS and Laneage
Figure 3M

- Laneage
- Intersection or FREEVAL Number
- AM Peak and PM Peak LOS or V/C Ratio
- Signal
- Basic Freeway Segment
- Ramp Merge/Diverge
- Freeway Weaving Segment
- Capacity Check
- Storage





Matchline L
See Figure 3M

**2040 Build Alternative 1
LOS and Laneage
Figure 3N**

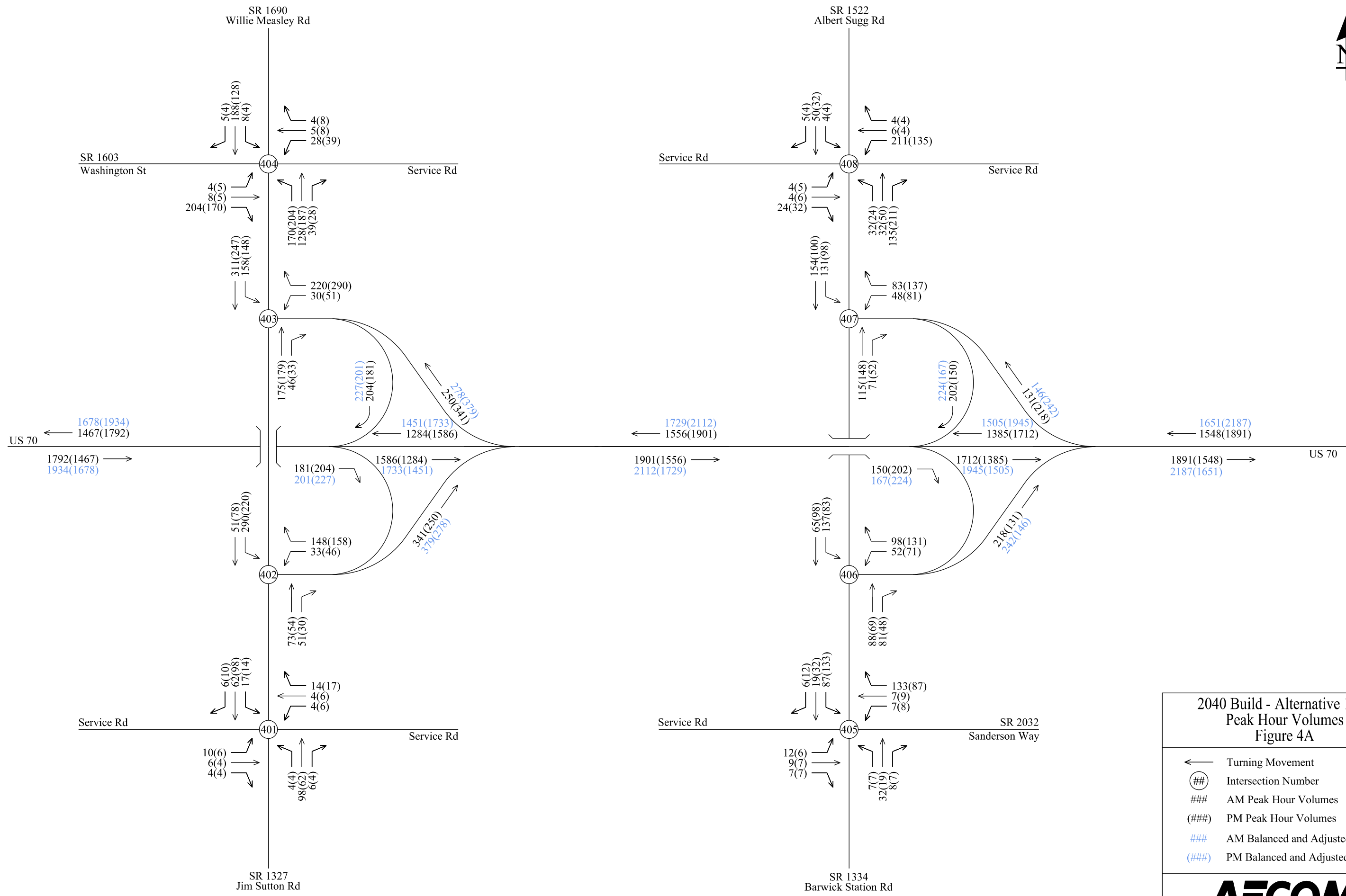
- Laneage
- Intersection or FREEVAL Number
- AM Peak and PM Peak LOS or V/C Ratio
- Signal
- Basic Freeway Segment
- Ramp Merge/Diverge
- Freeway Weaving Segment
- Capacity Check
- Storage



This page left intentionally blank

**2040 Build Alternative 1 SB
Peak Hour Volume Figures**

This page left intentionally blank

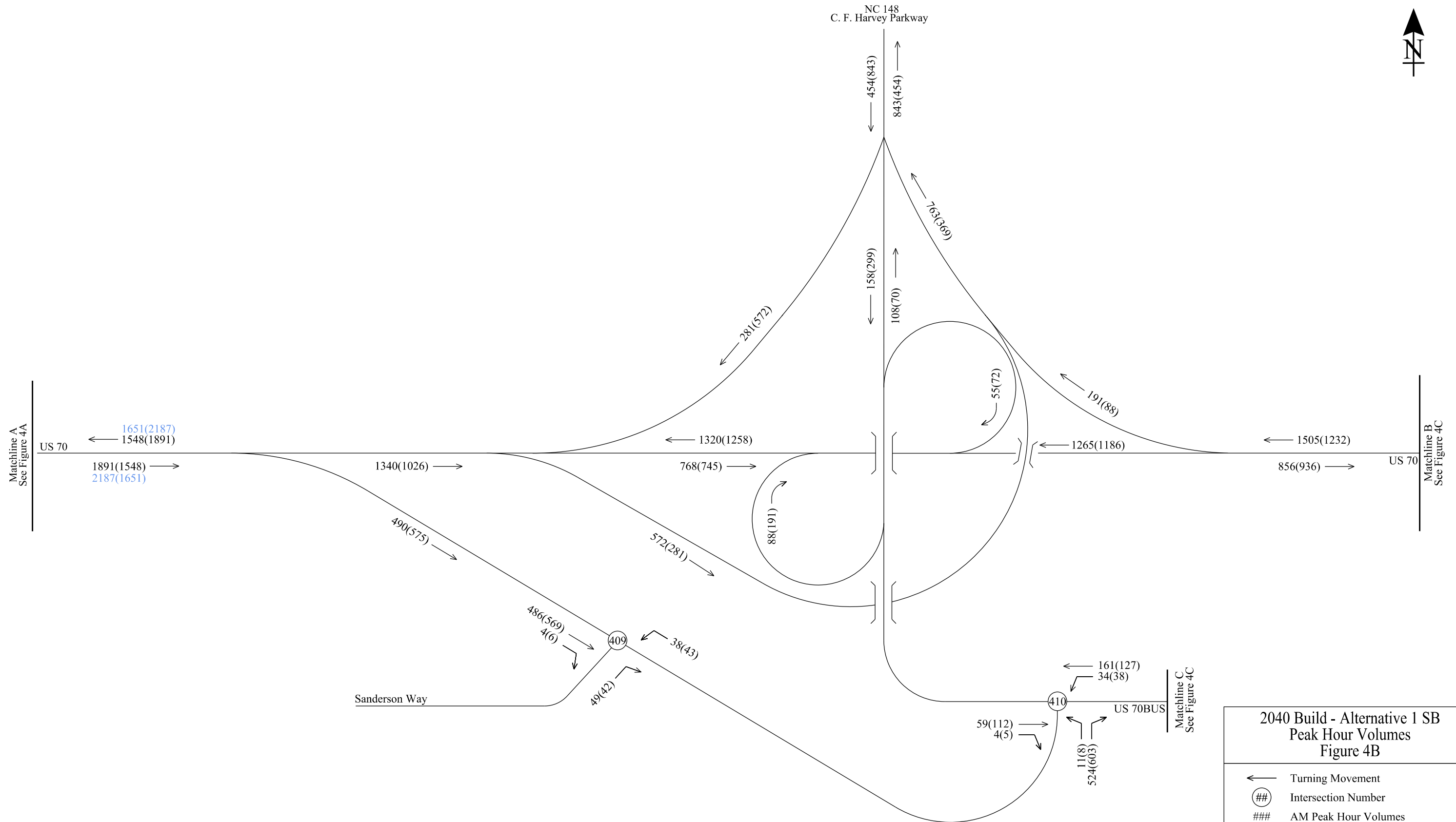


Matchline A
See Figure 4B

2040 Build - Alternative 1 SB
Peak Hour Volumes
Figure 4A

- ← Turning Movement
- ⊙ Intersection Number
- ### AM Peak Hour Volumes
- (###) PM Peak Hour Volumes
- ### AM Balanced and Adjusted Volumes
- (###) PM Balanced and Adjusted Volumes

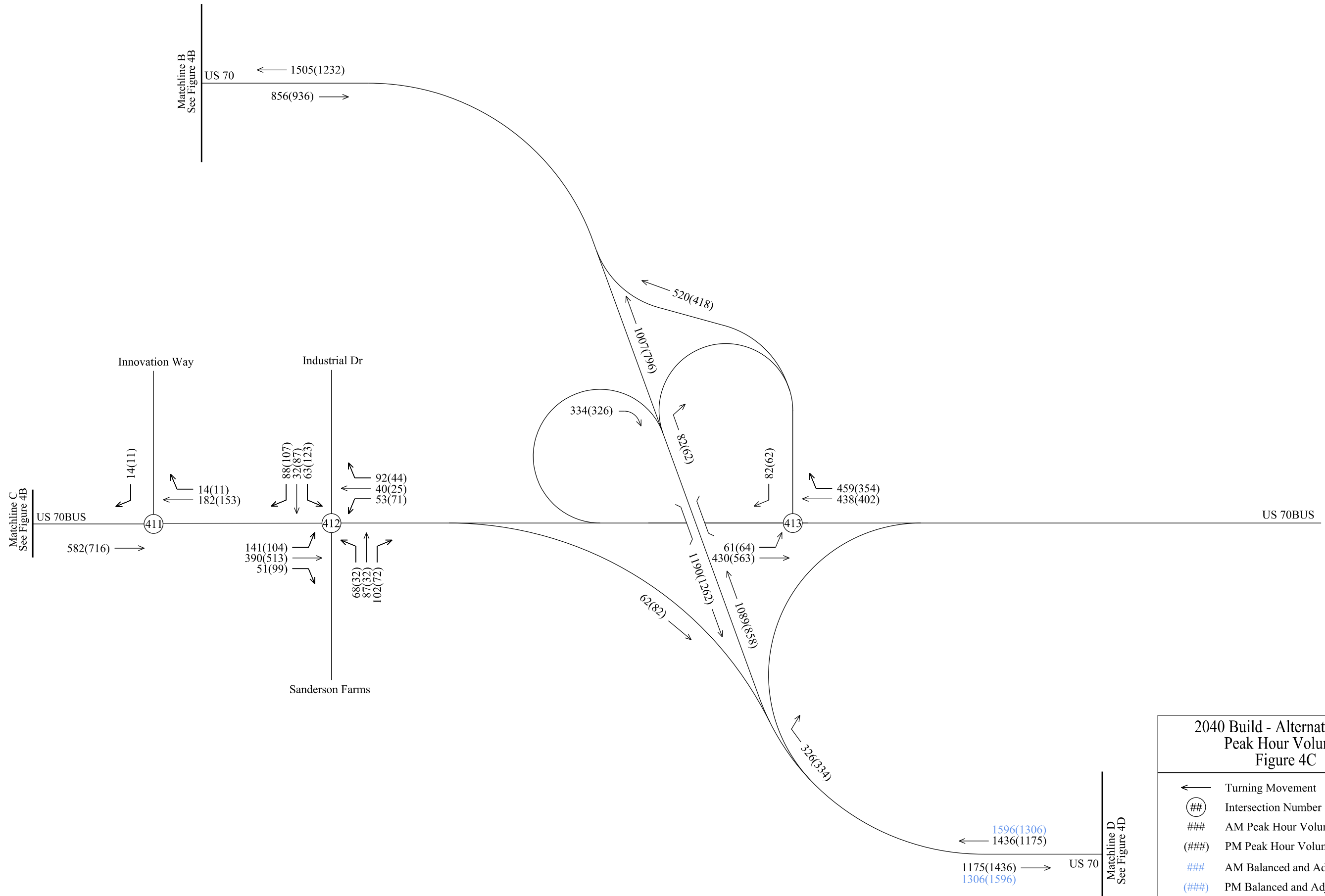




2040 Build - Alternative 1 SB
Peak Hour Volumes
Figure 4B

- ← Turning Movement
- ⊙## Intersection Number
- ### AM Peak Hour Volumes
- (###) PM Peak Hour Volumes
- ### AM Balanced and Adjusted Volumes
- (###) PM Balanced and Adjusted Volumes





Matchline C
See Figure 4B

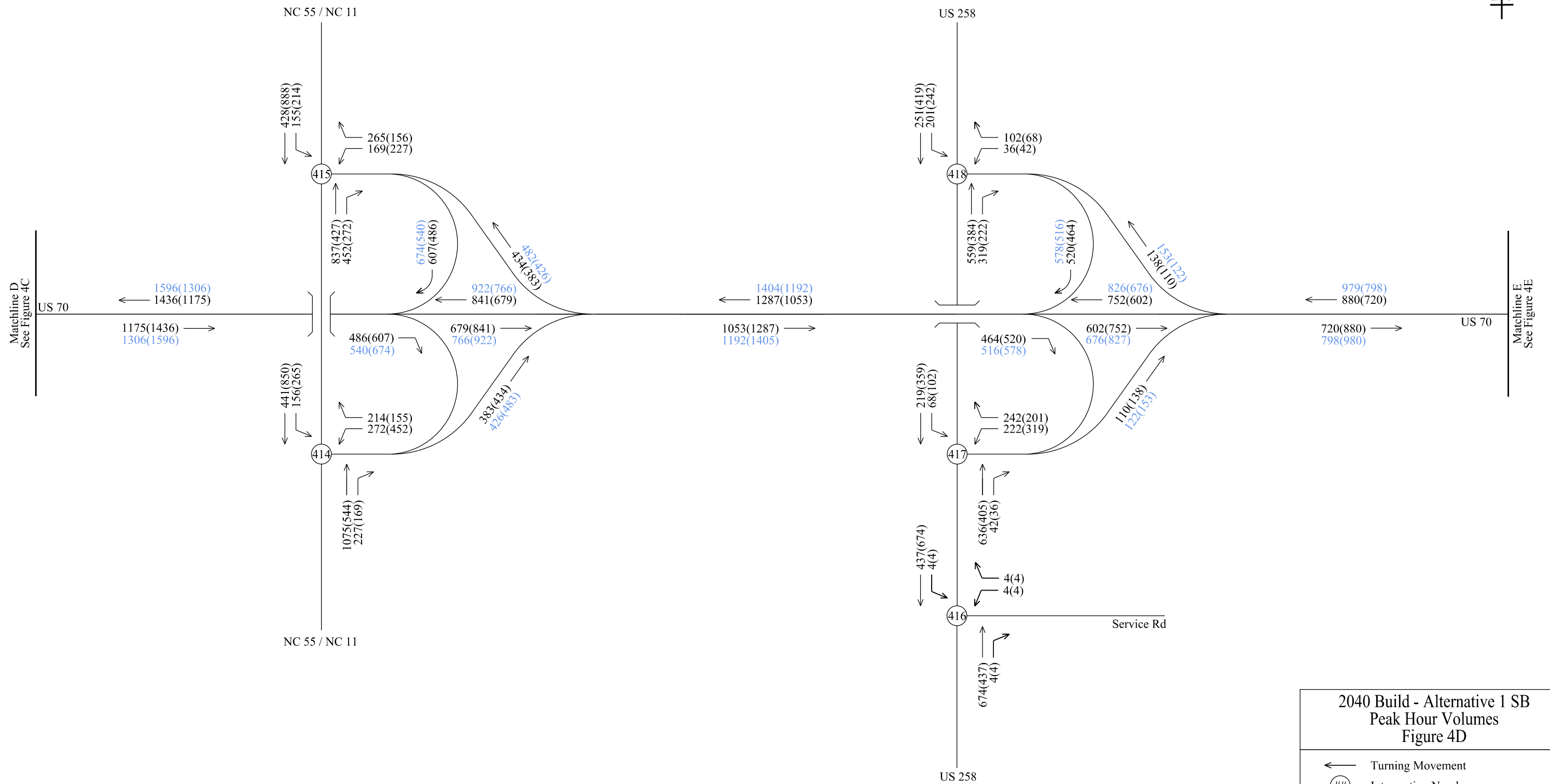
Matchline B
See Figure 4B

Matchline D
See Figure 4D

2040 Build - Alternative 1 SB
Peak Hour Volumes
Figure 4C

- ← Turning Movement
- ⊙ Intersection Number
- ### AM Peak Hour Volumes
- (###) PM Peak Hour Volumes
- ### AM Balanced and Adjusted Volumes
- (###) PM Balanced and Adjusted Volumes

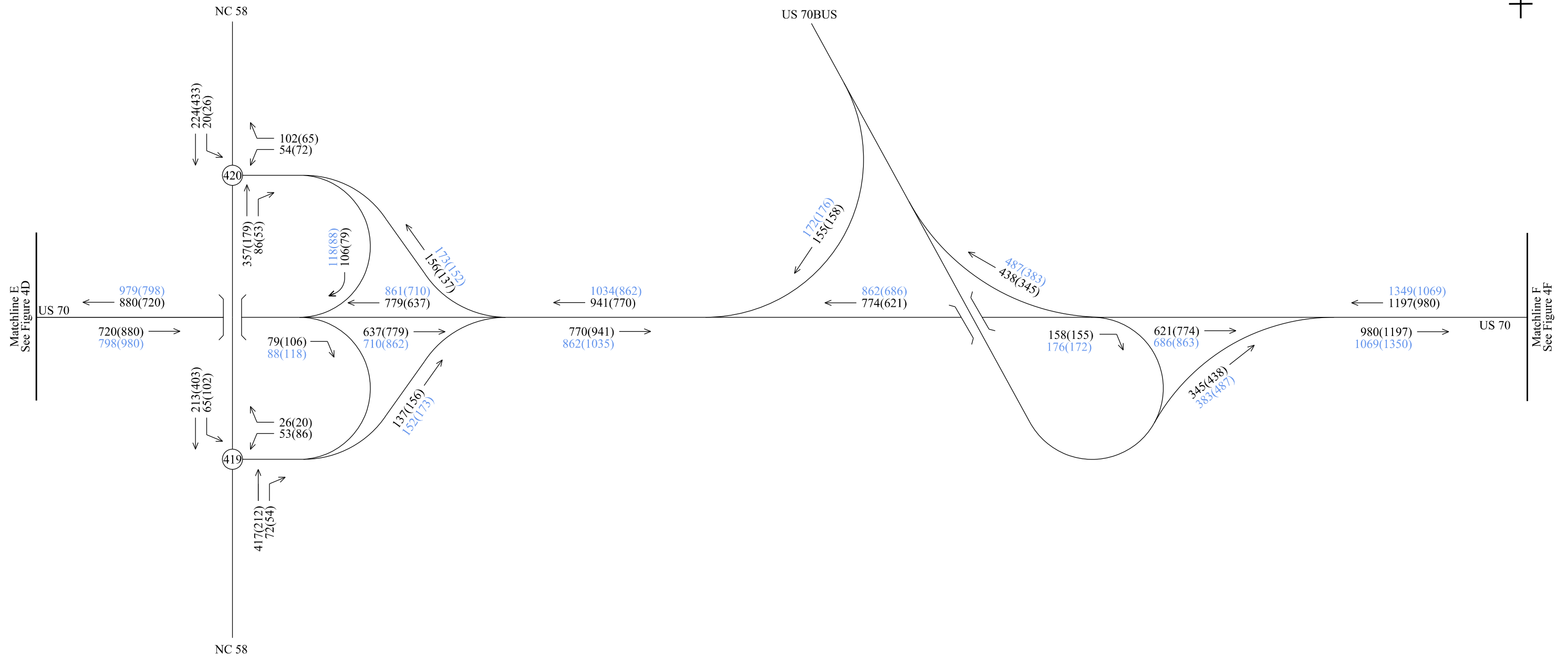




2040 Build - Alternative 1 SB
Peak Hour Volumes
Figure 4D

- ← Turning Movement
- ⊙ Intersection Number
- ### AM Peak Hour Volumes
- (###) PM Peak Hour Volumes
- ### AM Balanced and Adjusted Volumes
- (###) PM Balanced and Adjusted Volumes

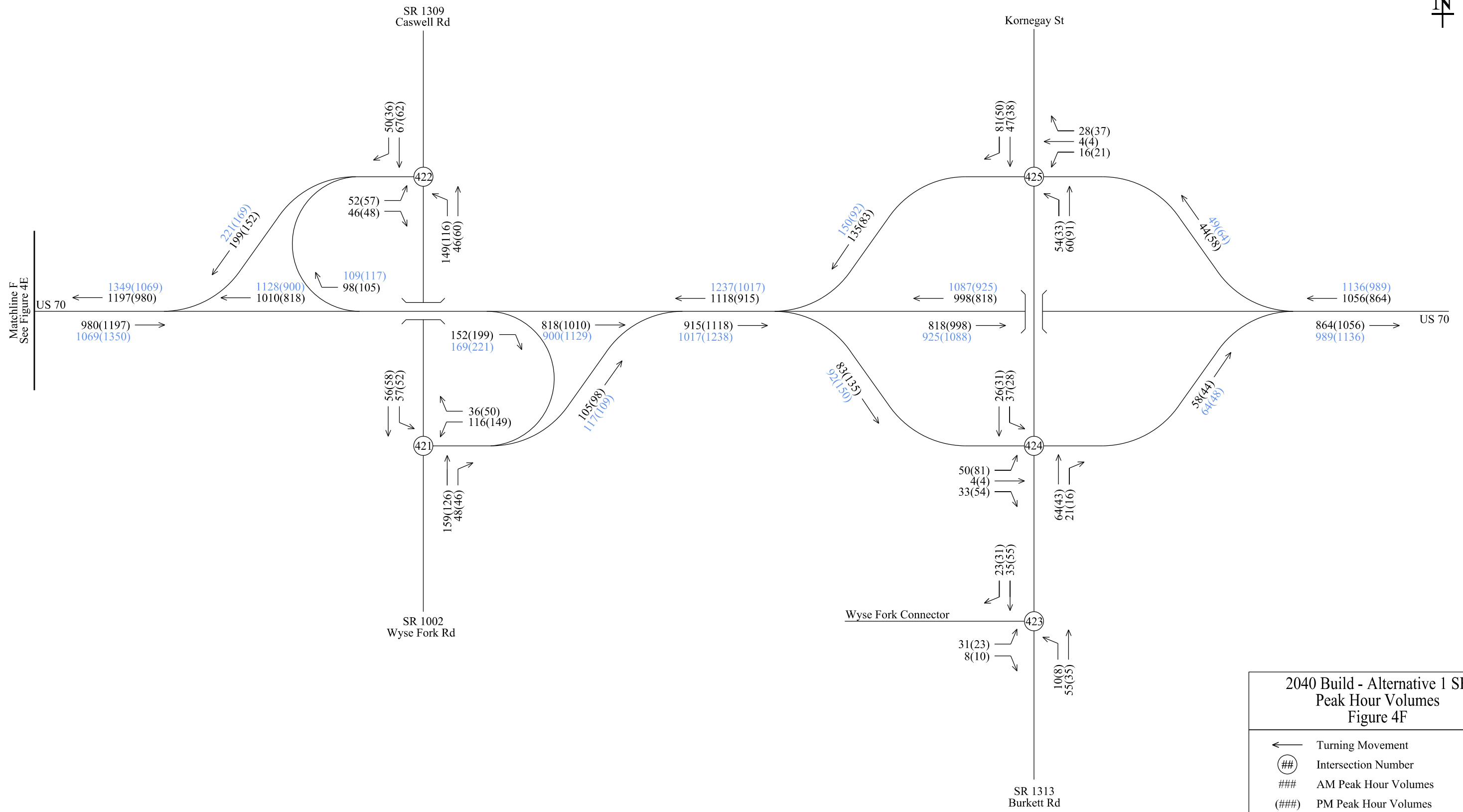




2040 Build - Alternative 1 SB
Peak Hour Volumes
Figure 4E

- ← Turning Movement
- ⊙ Intersection Number
- ### AM Peak Hour Volumes
- (###) PM Peak Hour Volumes
- ### AM Balanced and Adjusted Volumes
- (###) PM Balanced and Adjusted Volumes





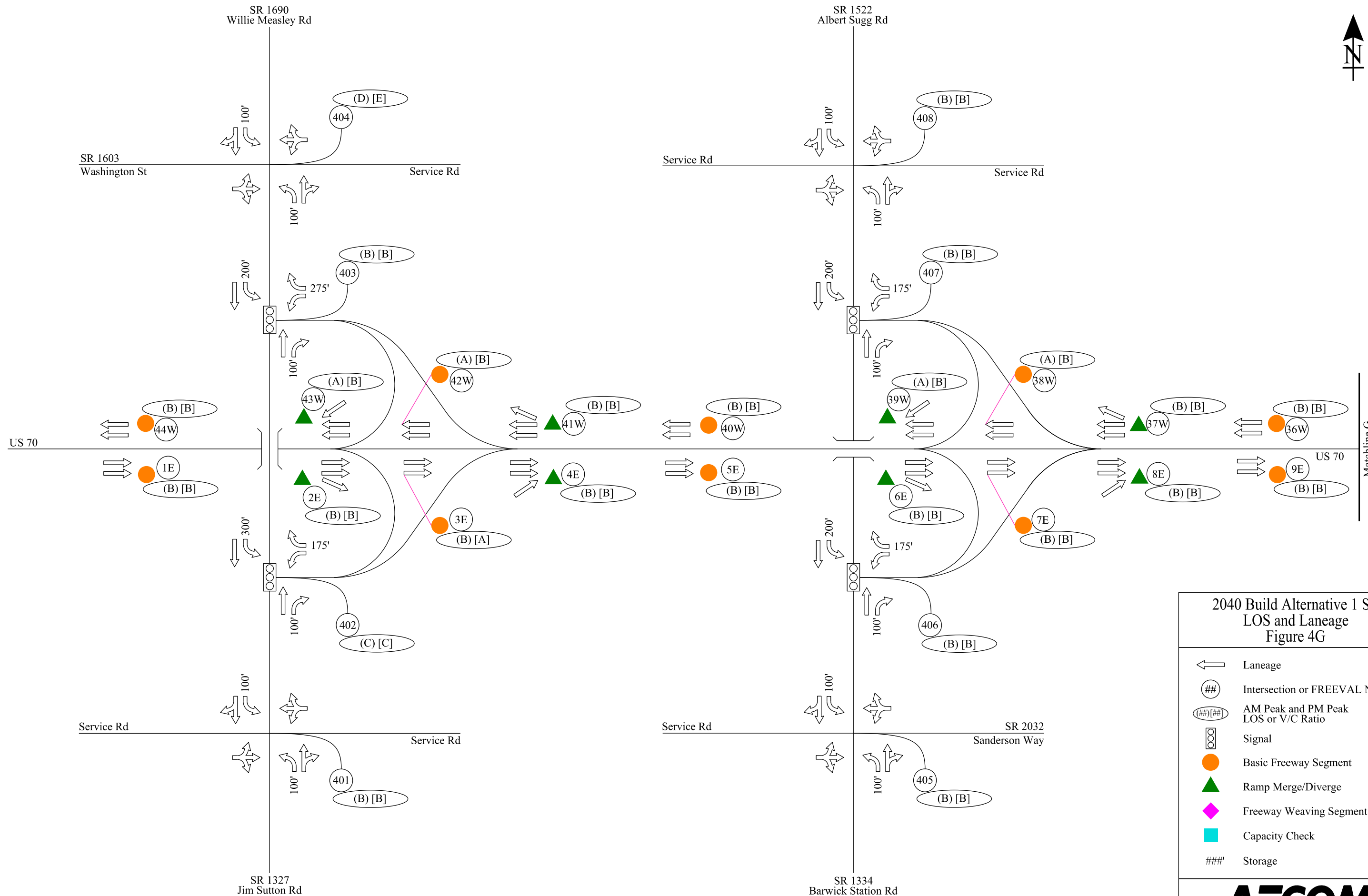
2040 Build - Alternative 1 SB
Peak Hour Volumes
Figure 4F

← Turning Movement
⊕ Intersection Number
AM Peak Hour Volumes
PM Peak Hour Volumes
AM Balanced and Adjusted Volumes
PM Balanced and Adjusted Volumes



**2040 Build Alternative 1 SB
LOS and Laneage Figures**

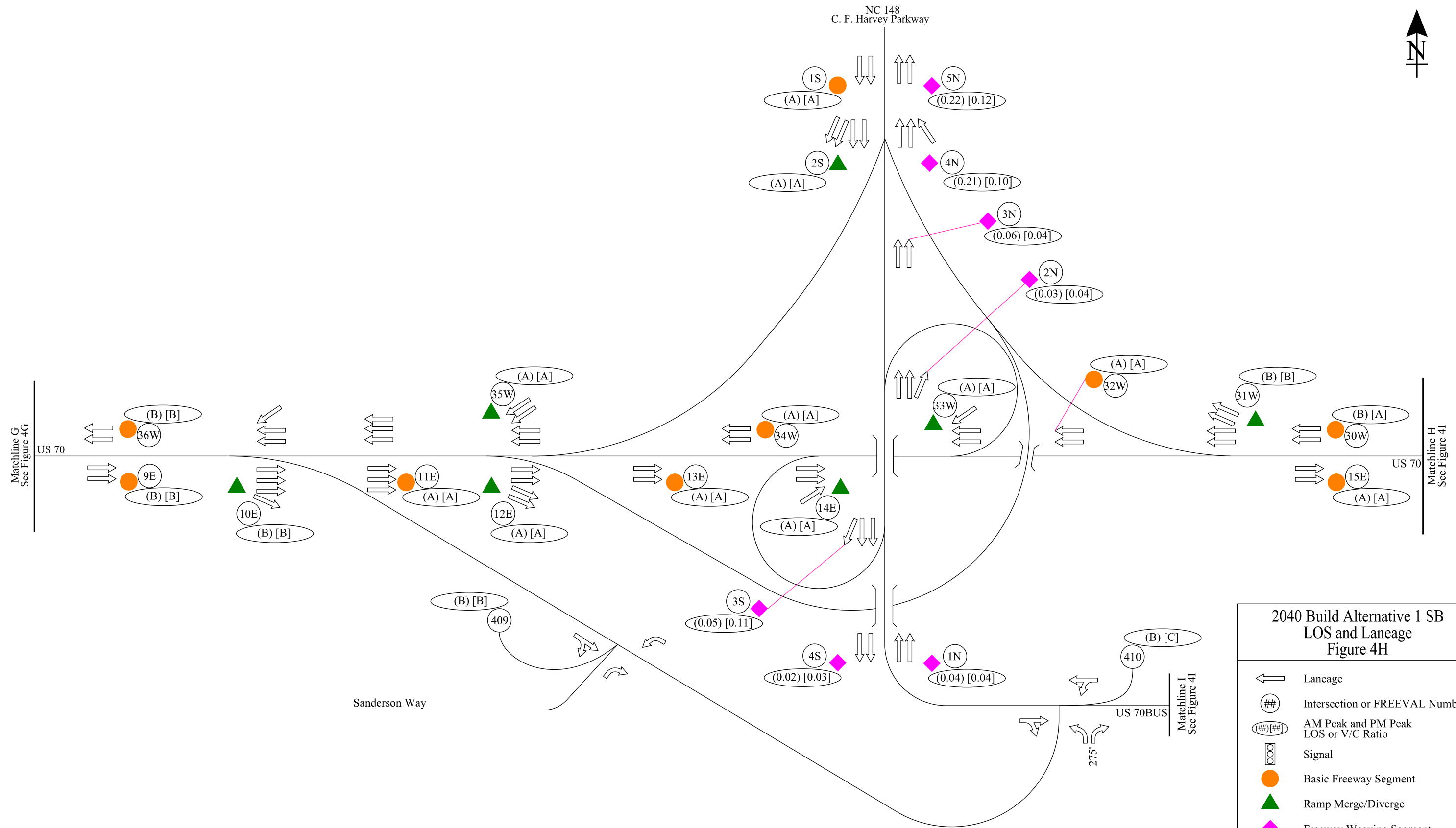
This page left intentionally blank












2040 Build Alternative 1 SB
LOS and Laneage
Figure 4G

- Laneage
- Intersection or FREEVAL Number
- AM Peak and PM Peak LOS or V/C Ratio
- Signal
- Basic Freeway Segment
- Ramp Merge/Diverge
- Freeway Weaving Segment
- Capacity Check
- Storage

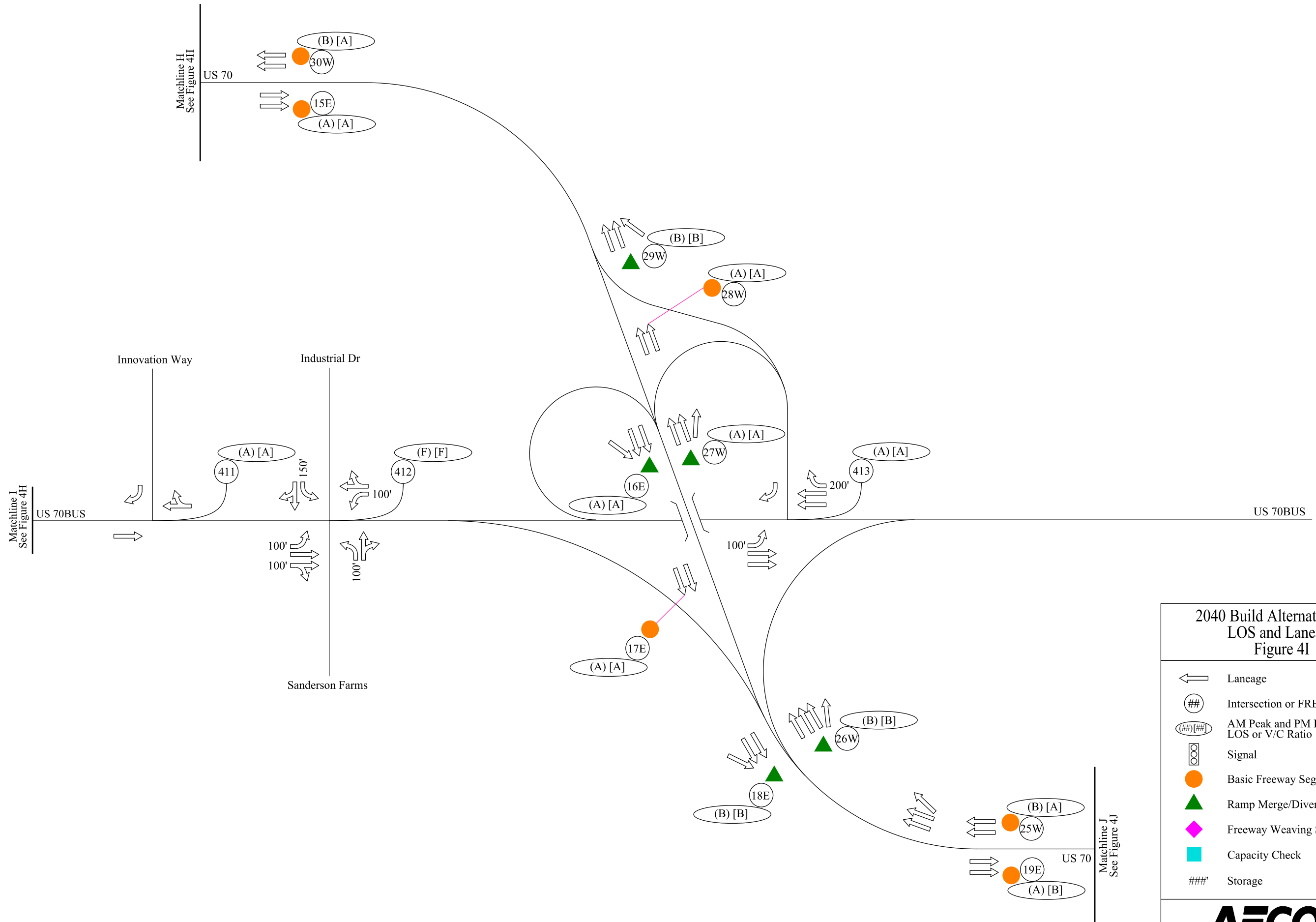




2040 Build Alternative 1 SB
LOS and Laneage
Figure 4H

-  Laneage
-  Intersection or FREEVAL Number
-  AM Peak and PM Peak LOS or V/C Ratio
-  Signal
-  Basic Freeway Segment
-  Ramp Merge/Diverge
-  Freeway Weaving Segment
-  Capacity Check
-  Storage

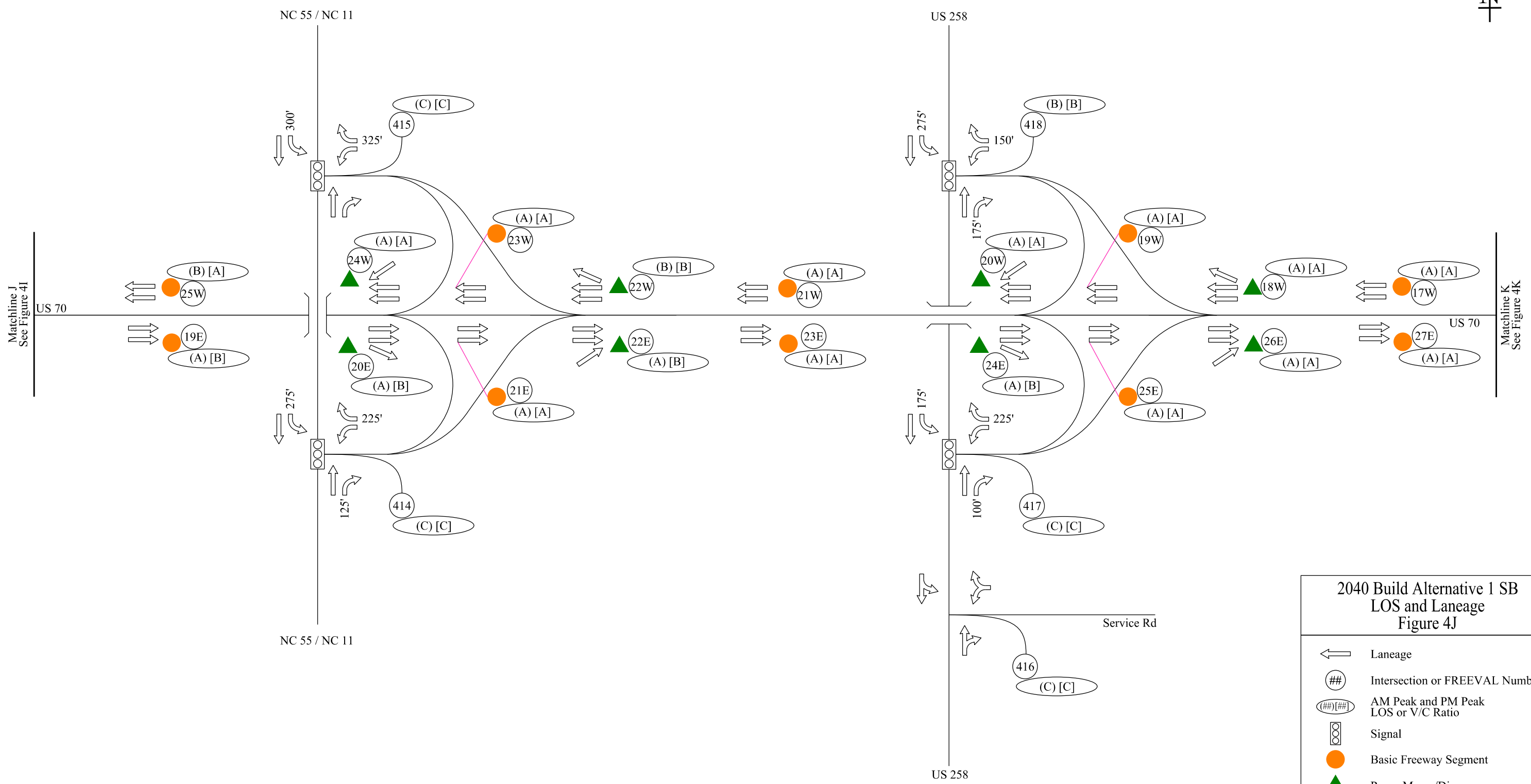




2040 Build Alternative 1 SB
LOS and Laneage
Figure 4I

	Laneage
	Intersection or FREEVAL Number
	AM Peak and PM Peak LOS or V/C Ratio
	Signal
	Basic Freeway Segment
	Ramp Merge/Diverge
	Freeway Weaving Segment
	Capacity Check
	Storage





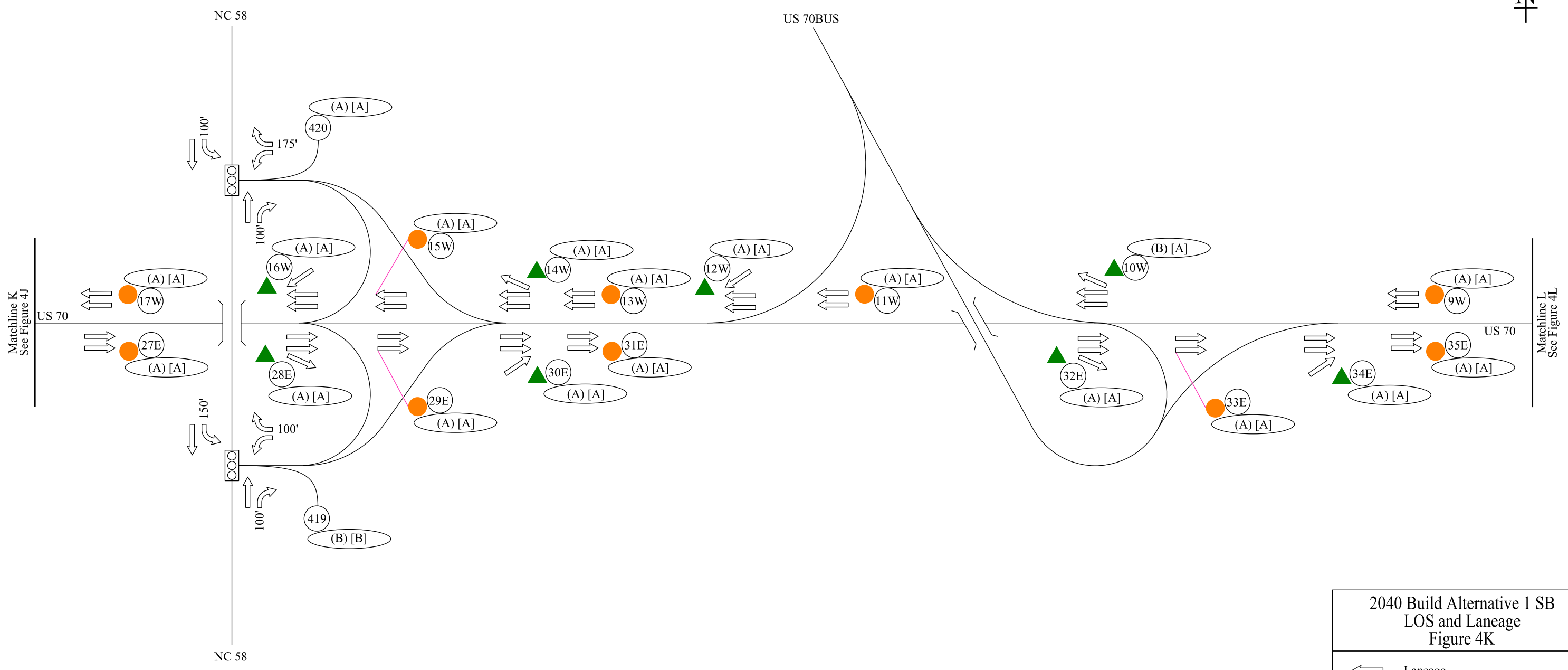
Matchline J
See Figure 4I

Matchline K
See Figure 4K

2040 Build Alternative 1 SB
LOS and Laneage
Figure 4J

	Laneage
	Intersection or FREEVAL Number
	AM Peak and PM Peak LOS or V/C Ratio
	Signal
	Basic Freeway Segment
	Ramp Merge/Diverge
	Freeway Weaving Segment
	Capacity Check
	Storage














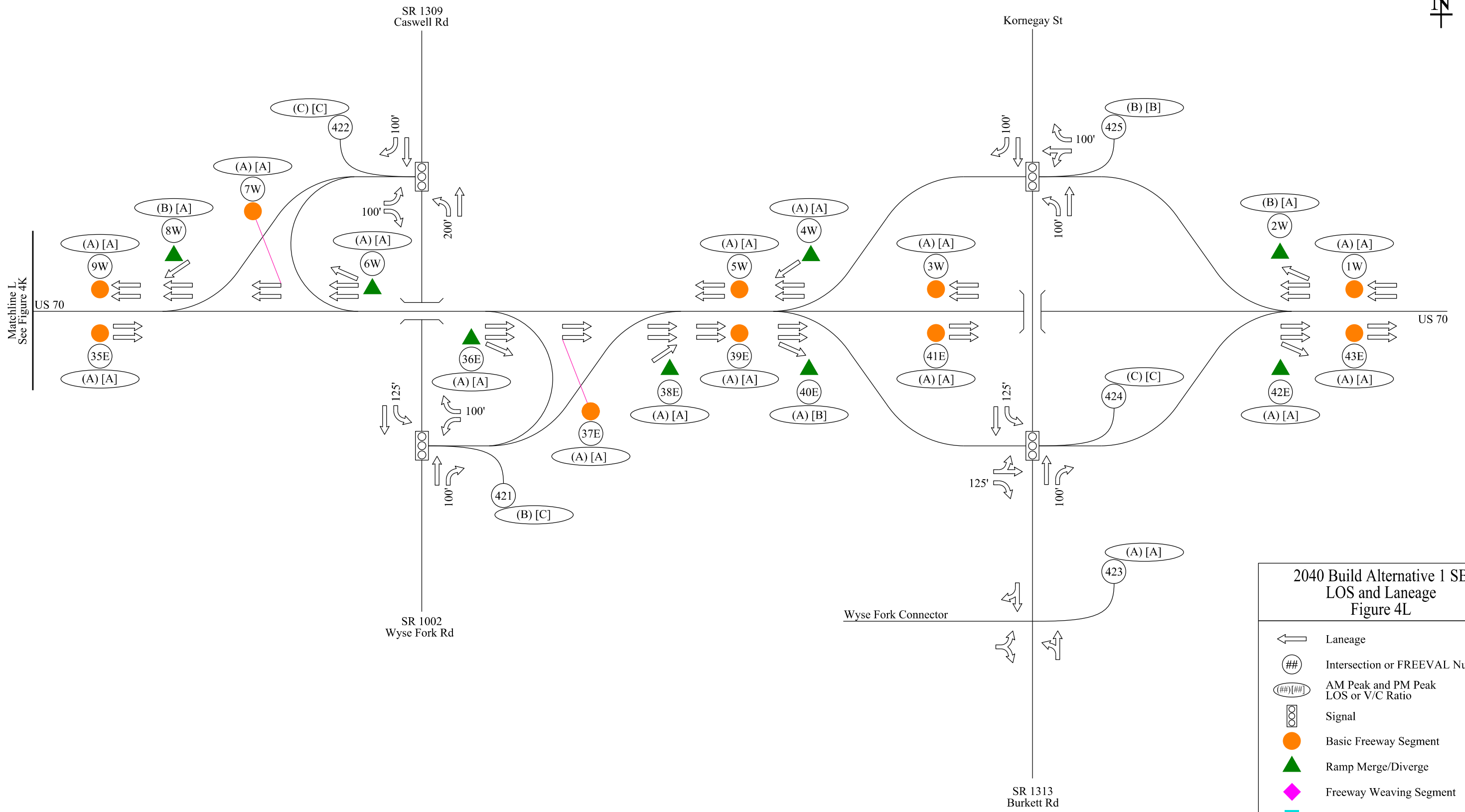
Matchline K
See Figure 4J

Matchline L
See Figure 4L

2040 Build Alternative 1 SB
LOS and Laneage
Figure 4K










-  Laneage
-  Intersection or FREEVAL Number
-  AM Peak and PM Peak
LOS or V/C Ratio
-  Signal
-  Basic Freeway Segment
-  Ramp Merge/Diverge
-  Freeway Weaving Segment
-  Capacity Check
-  Storage





Matchline L
See Figure 4K

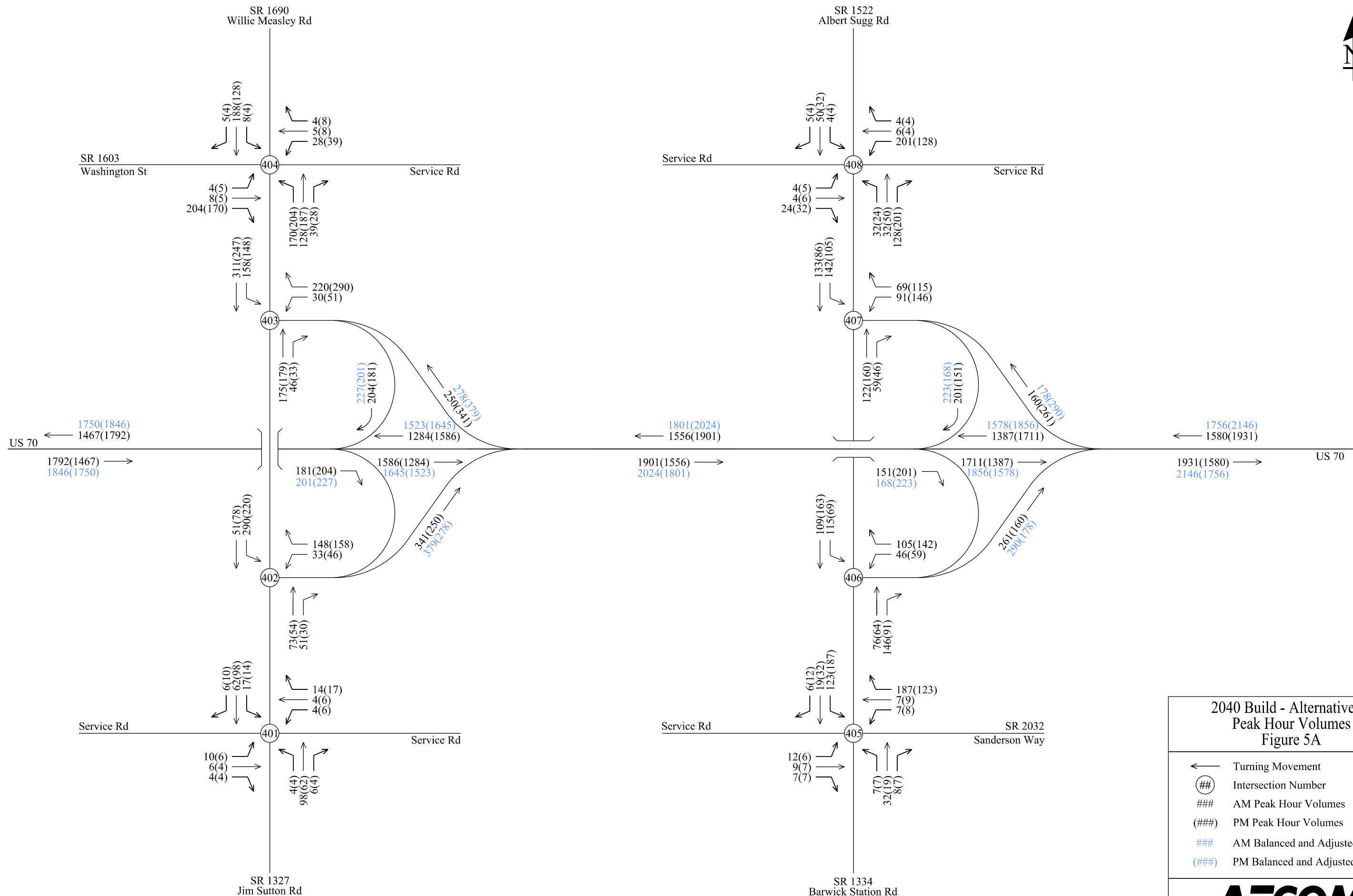
2040 Build Alternative 1 SB
LOS and Laneage
Figure 4L

-  Laneage
-  Intersection or FREEVAL Number
-  AM Peak and PM Peak LOS or V/C Ratio
-  Signal
-  Basic Freeway Segment
-  Ramp Merge/Diverge
-  Freeway Weaving Segment
-  Capacity Check
-  Storage



**2040 Build Alternative 11
Peak Hour Volume Figures**

This page left intentionally blank



Matchline A
See Figure 5B

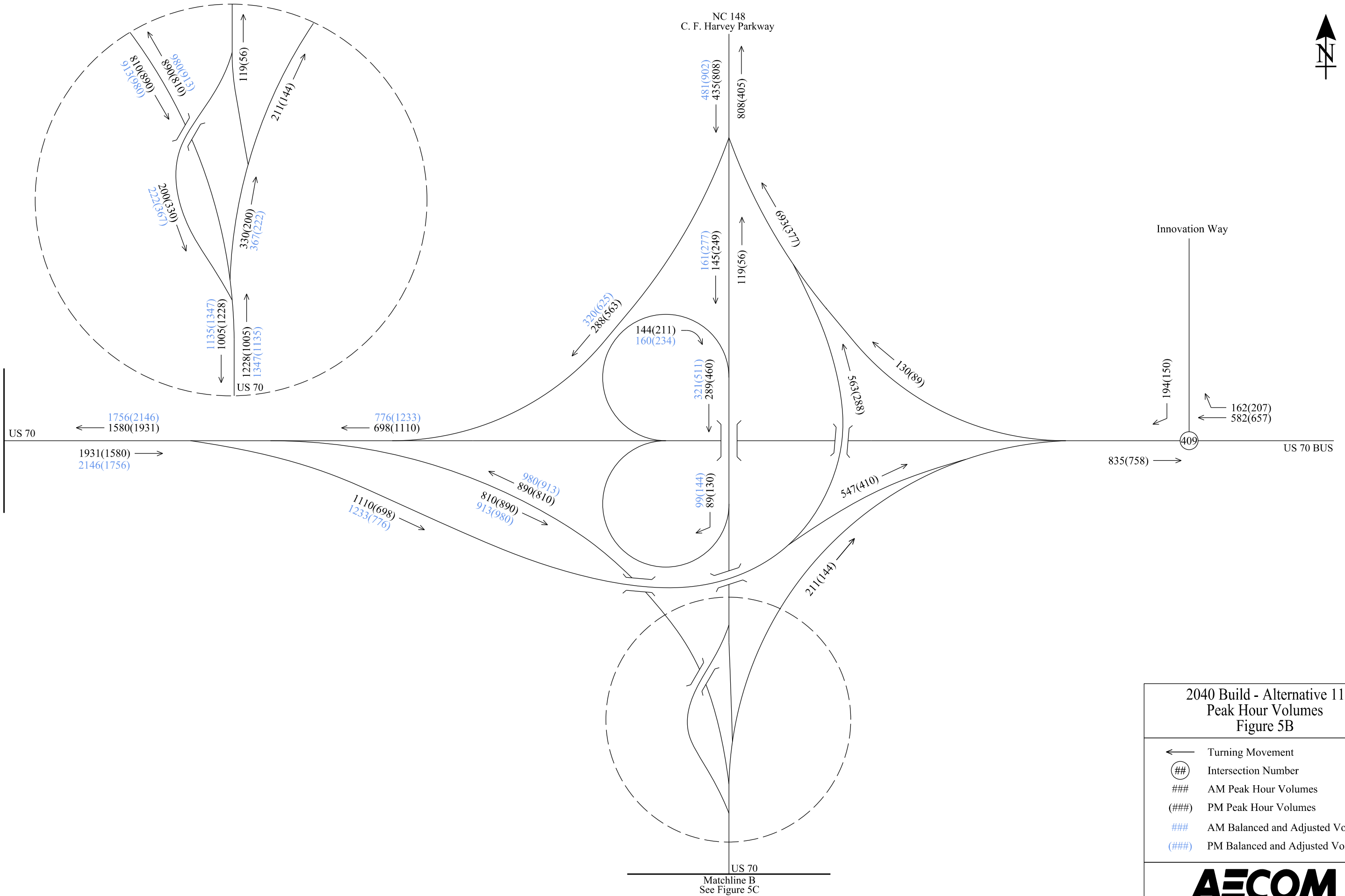
2040 Build - Alternative 11
Peak Hour Volumes
Figure 5A

- ← Turning Movement
- ⊙ Intersection Number
- ### AM Peak Hour Volumes
- (###) PM Peak Hour Volumes
- ### AM Balanced and Adjusted Volumes
- (###) PM Balanced and Adjusted Volumes





Matchline A
See Figure 5A



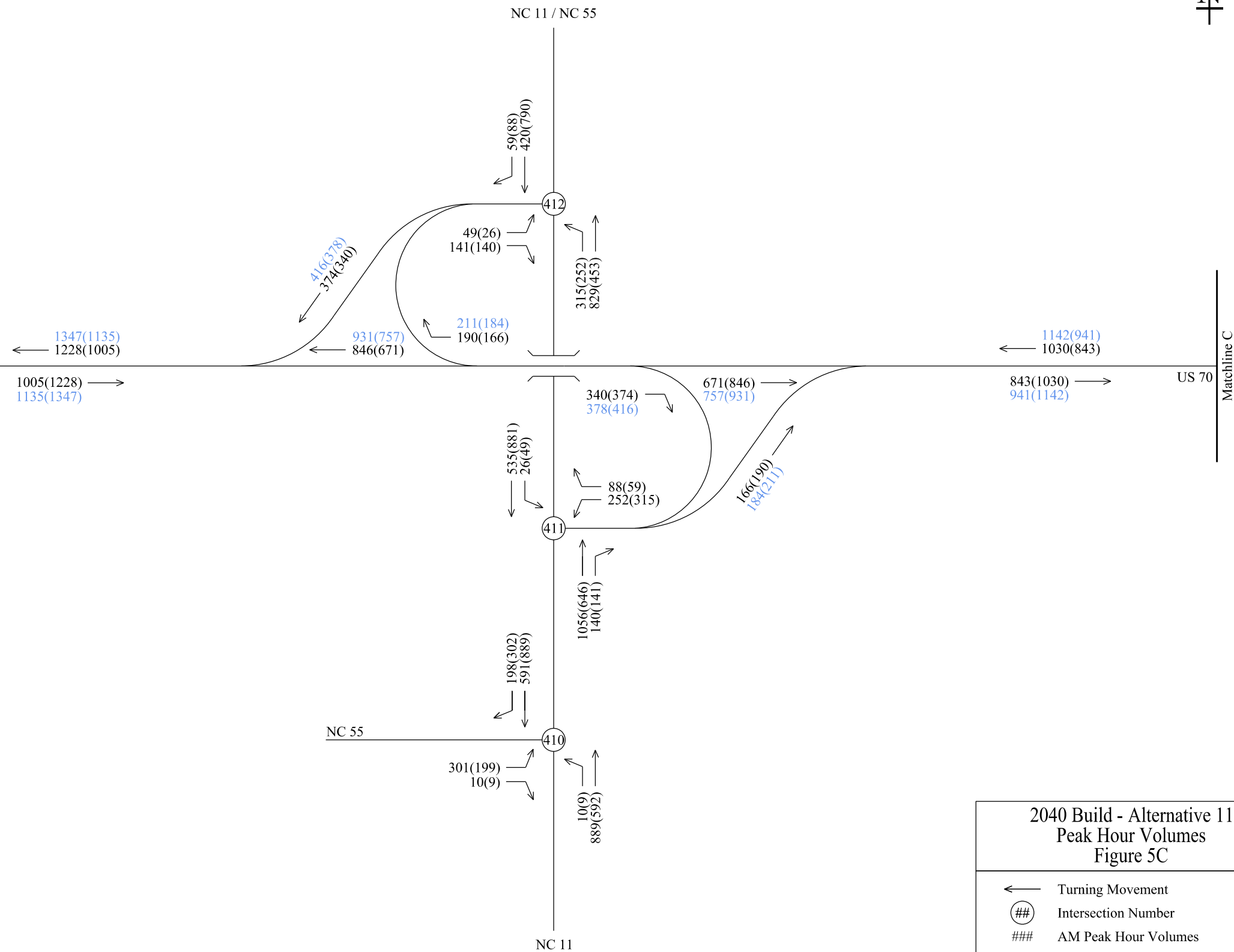
2040 Build - Alternative 11
Peak Hour Volumes
Figure 5B

- ← Turning Movement
- ⊙ Intersection Number
- ### AM Peak Hour Volumes
- (###) PM Peak Hour Volumes
- ### AM Balanced and Adjusted Volumes
- (###) PM Balanced and Adjusted Volumes





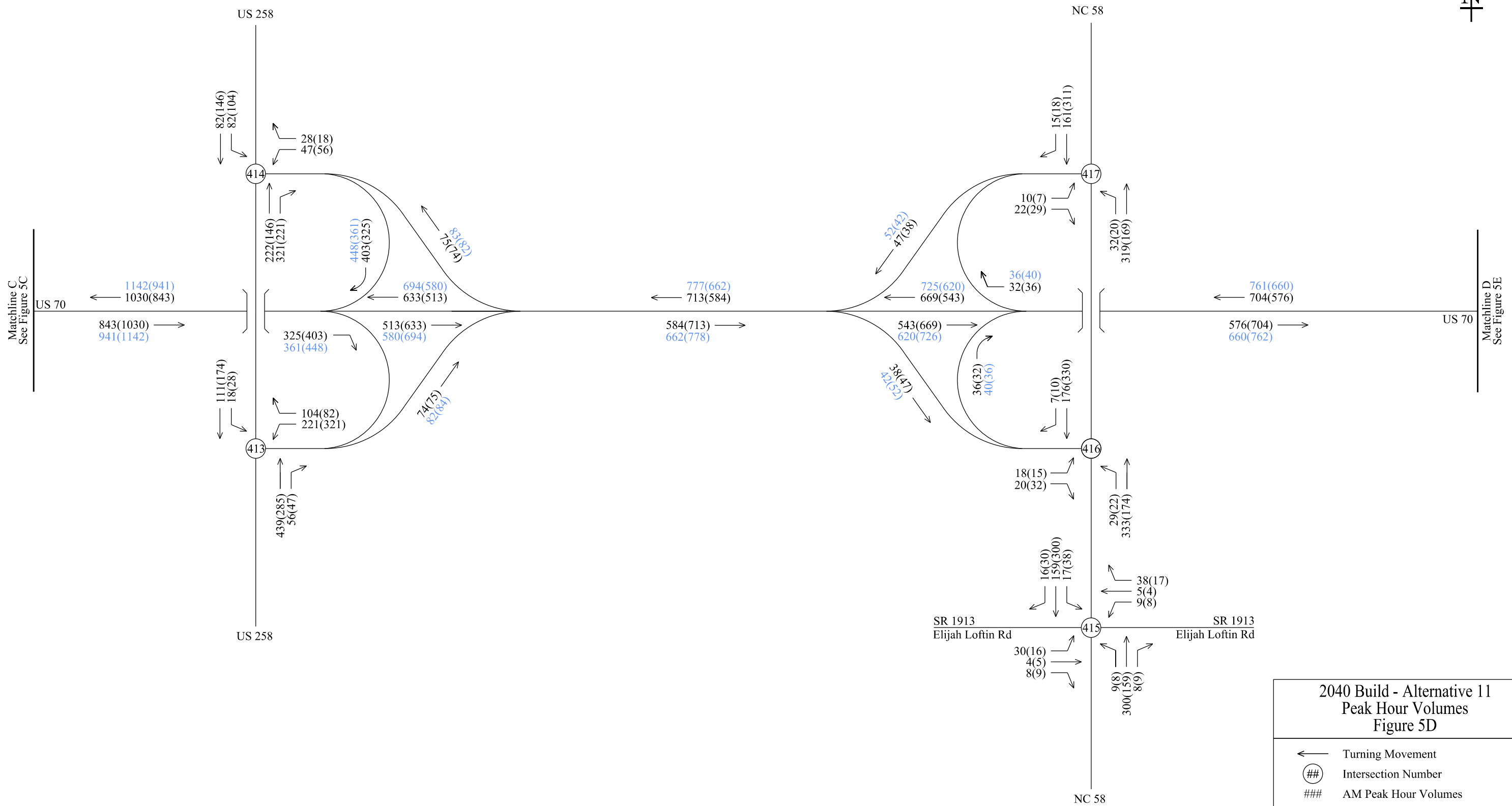
Matchline B
See Figure 5B
US 70



2040 Build - Alternative 11
Peak Hour Volumes
Figure 5C

- ← Turning Movement
- ⊕ Intersection Number
- ### AM Peak Hour Volumes
- (###) PM Peak Hour Volumes
- ### AM Balanced and Adjusted Volumes
- (###) PM Balanced and Adjusted Volumes

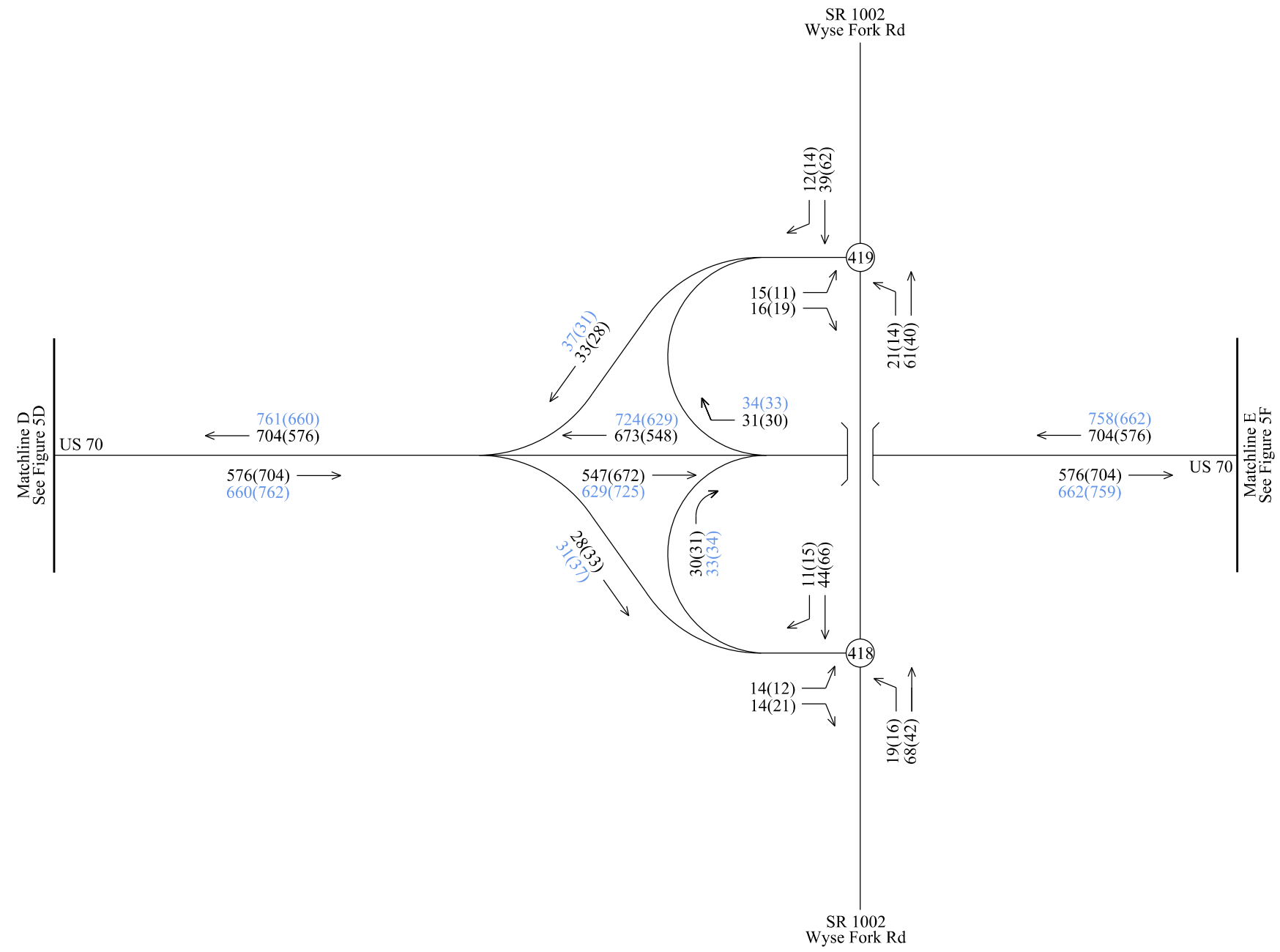




2040 Build - Alternative 11
Peak Hour Volumes
Figure 5D

- ← Turning Movement
- ⊙ Intersection Number
- ### AM Peak Hour Volumes
- (###) PM Peak Hour Volumes
- ### AM Balanced and Adjusted Volumes
- (###) PM Balanced and Adjusted Volumes

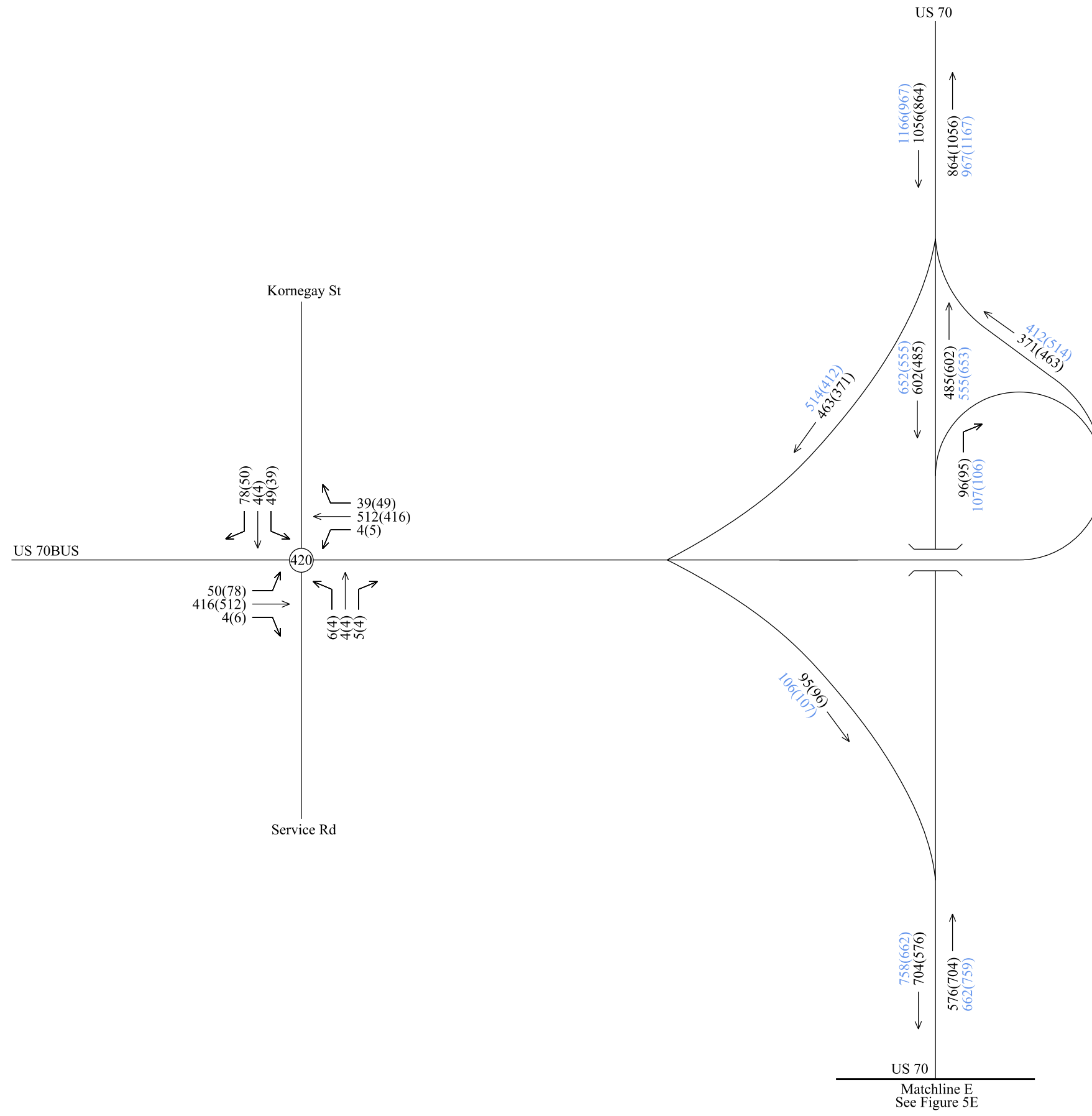




2040 Build - Alternative 11
Peak Hour Volumes
Figure 5E

- ← Turning Movement
- ⊕ Intersection Number
- ### AM Peak Hour Volumes
- (###) PM Peak Hour Volumes
- ### AM Balanced and Adjusted Volumes
- (###) PM Balanced and Adjusted Volumes





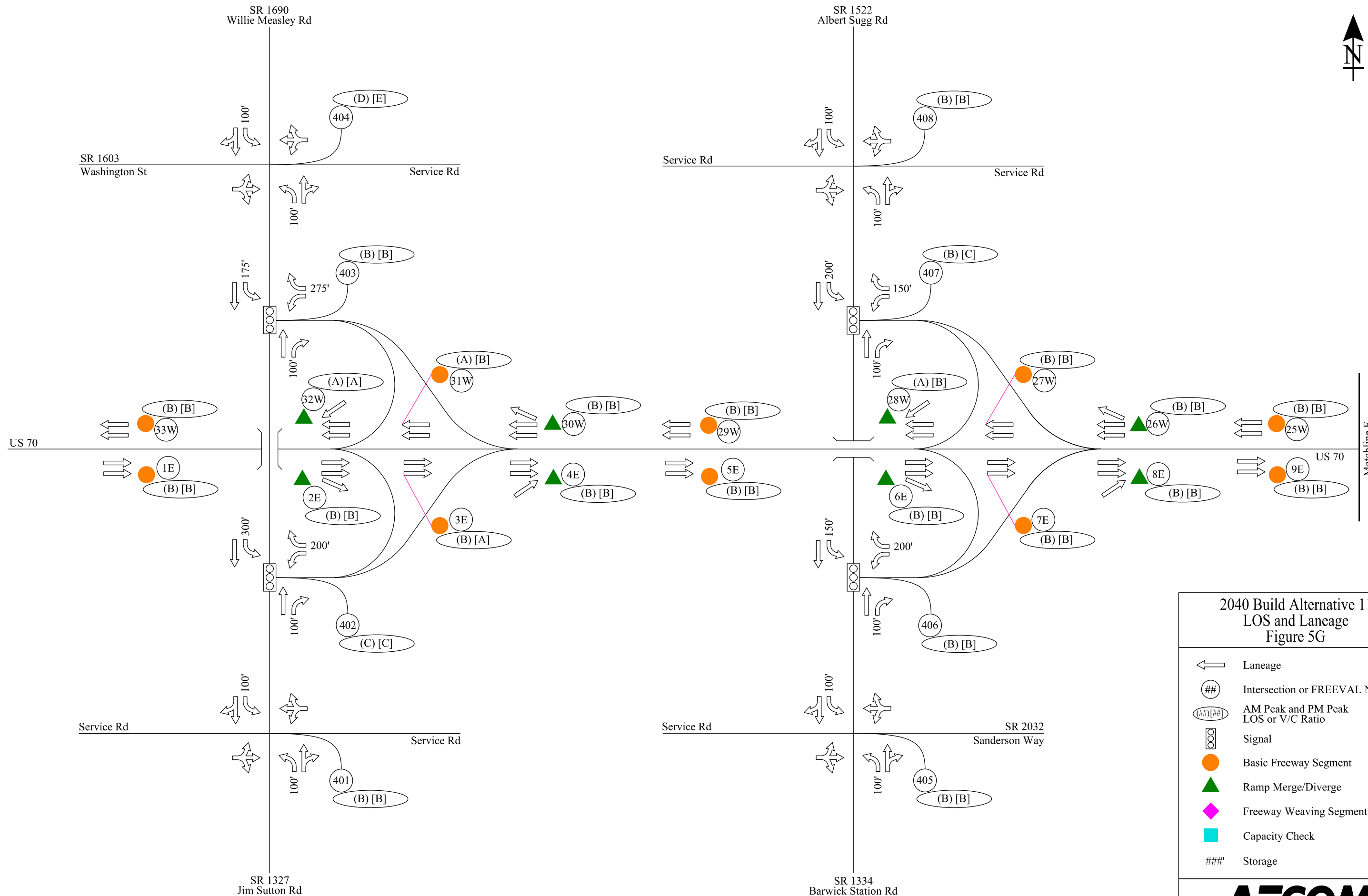
2040 Build - Alternative 11
Peak Hour Volumes
Figure 5F

- ← Turning Movement
- ⊙ Intersection Number
- ### AM Peak Hour Volumes
- (###) PM Peak Hour Volumes
- ### AM Balanced and Adjusted Volumes
- (###) PM Balanced and Adjusted Volumes



**2040 Build Alternative 11
LOS and Laneage Figures**

This page left intentionally blank

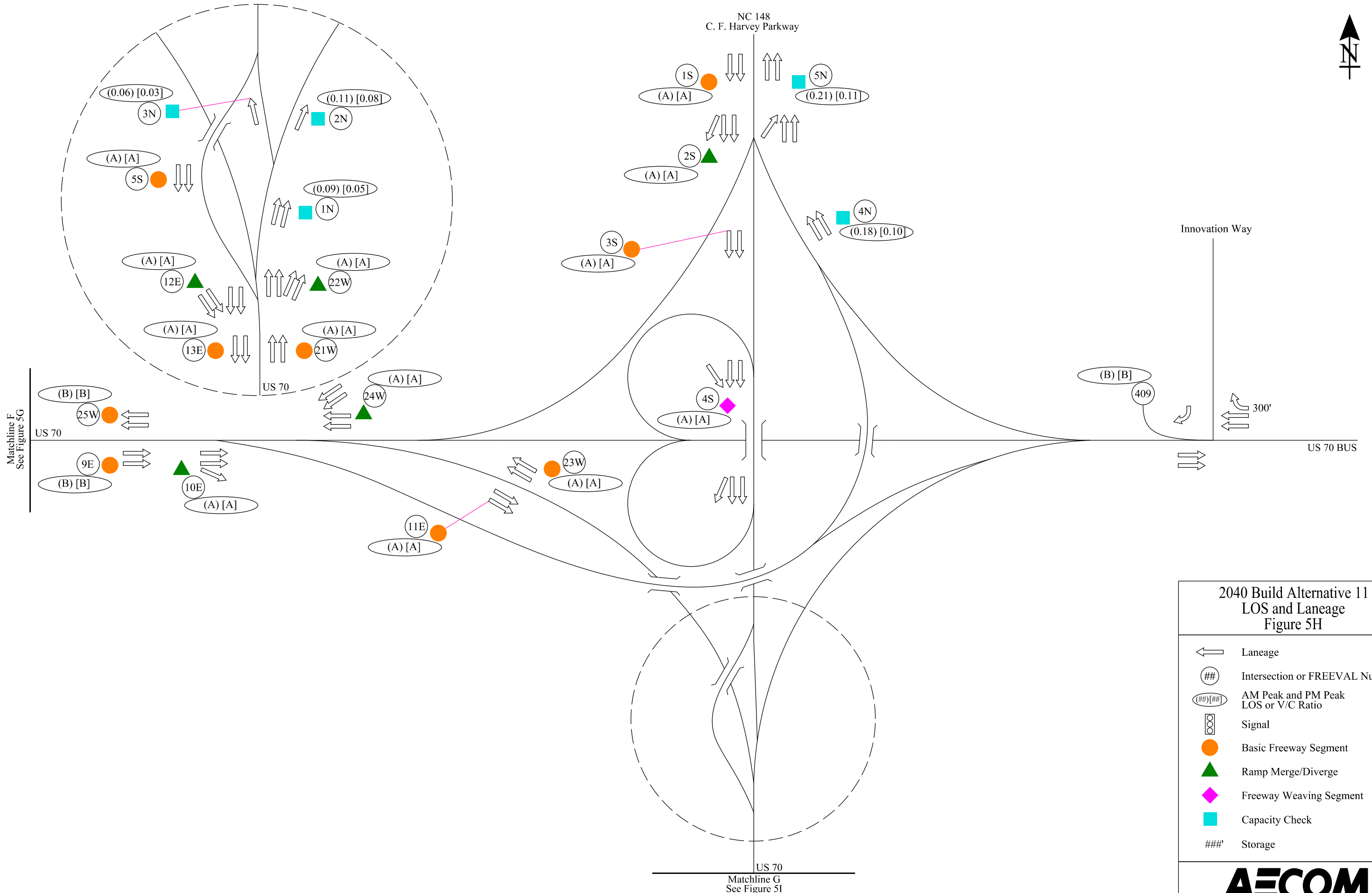


2040 Build Alternative 11
LOS and Laneage
Figure 5G

- Laneage
- Intersection or FREEVAL Number
- AM Peak and PM Peak LOS or V/C Ratio
- Signal
- Basic Freeway Segment
- Ramp Merge/Diverge
- Freeway Weaving Segment
- Capacity Check
- Storage



Matchline F
See Figure 5H



Matchline F
See Figure 5G

US 70
Matchline G
See Figure 5I

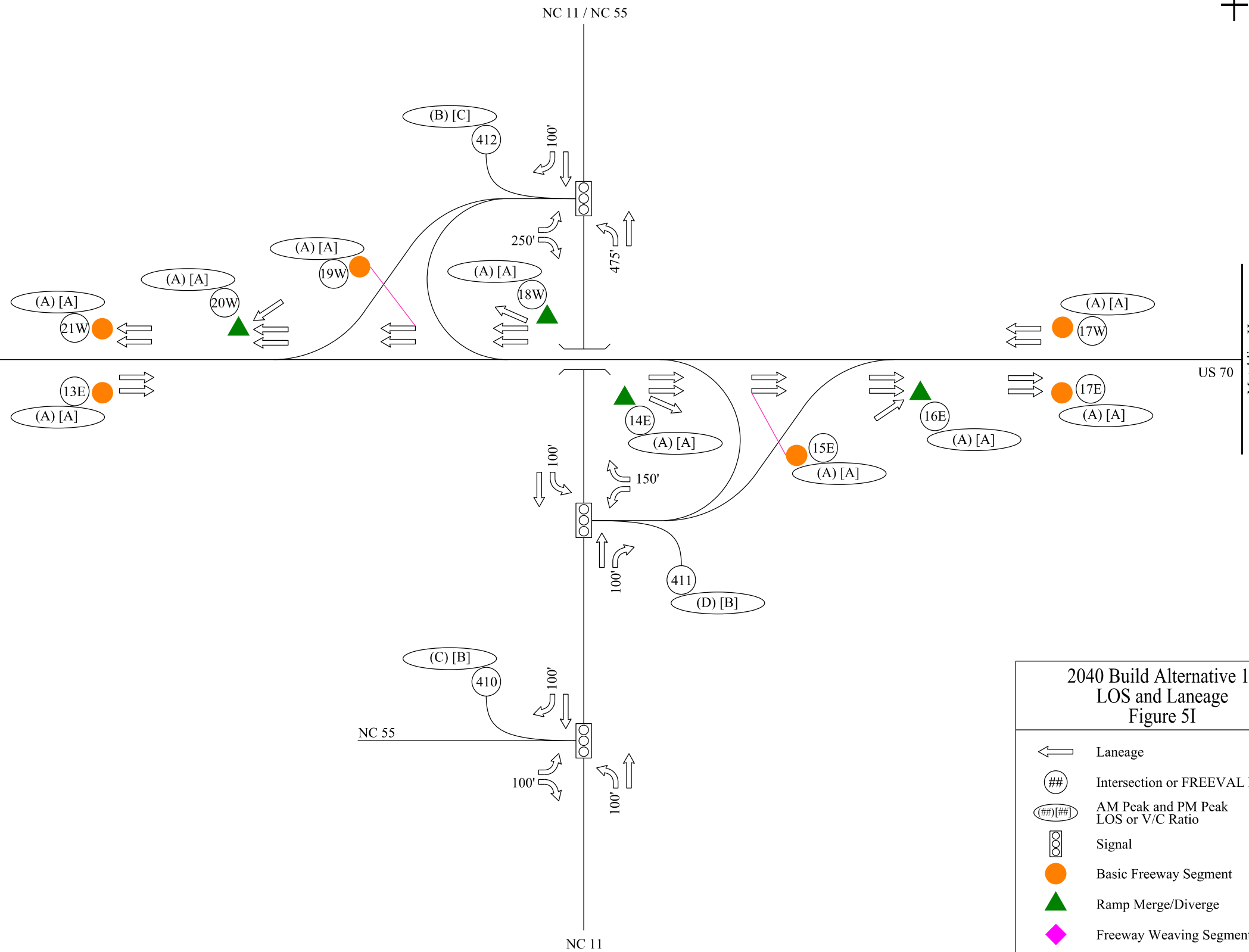
**2040 Build Alternative 11
LOS and Laneage
Figure 5H**

- Laneage
- Intersection or FREEVAL Number
- AM Peak and PM Peak LOS or V/C Ratio
- Signal
- Basic Freeway Segment
- Ramp Merge/Diverge
- Freeway Weaving Segment
- Capacity Check
- Storage





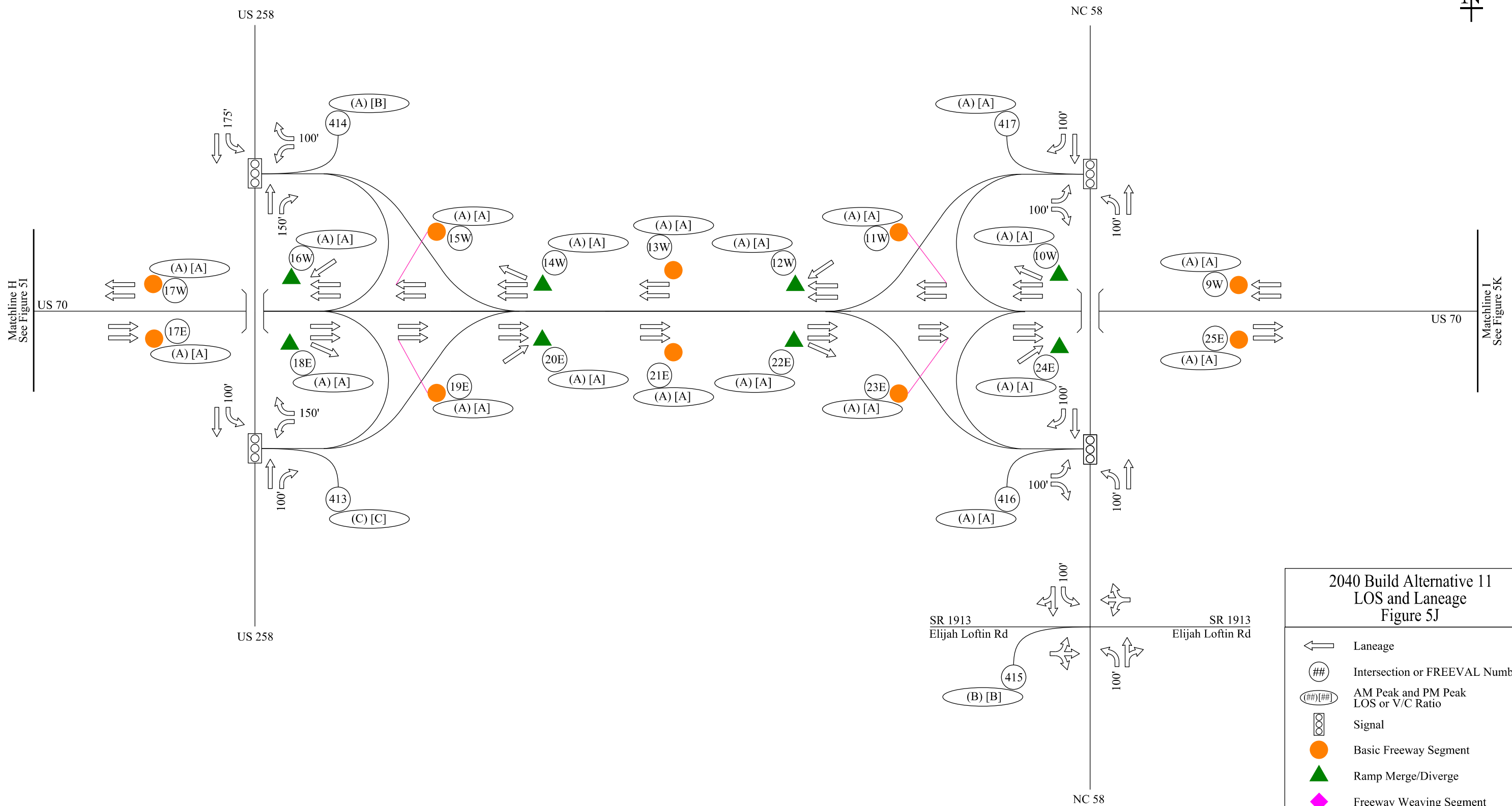
Matchline G
See Figure 5H
US 70



Matchline H
See Figure 5J

	Laneage
	Intersection or FREEVAL Number
	AM Peak and PM Peak LOS or V/C Ratio
	Signal
	Basic Freeway Segment
	Ramp Merge/Diverge
	Freeway Weaving Segment
	Capacity Check
	Storage





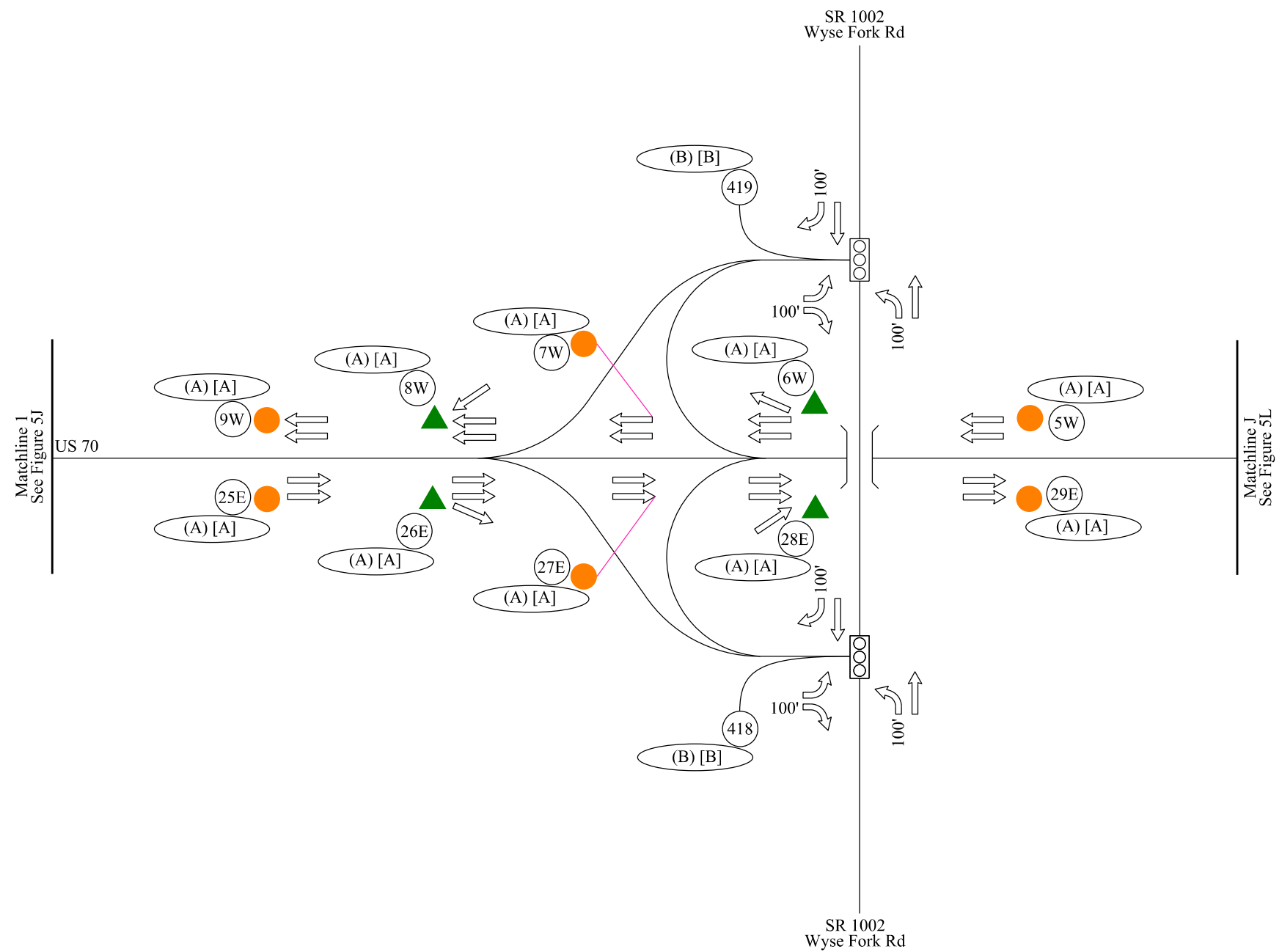
Matchline H
See Figure 5I

Matchline I
See Figure 5K










**2040 Build Alternative 11
LOS and Laneage
Figure 5J**

	Laneage
	Intersection or FREEVAL Number
	AM Peak and PM Peak LOS or V/C Ratio
	Signal
	Basic Freeway Segment
	Ramp Merge/Diverge
	Freeway Weaving Segment
	Capacity Check
	Storage

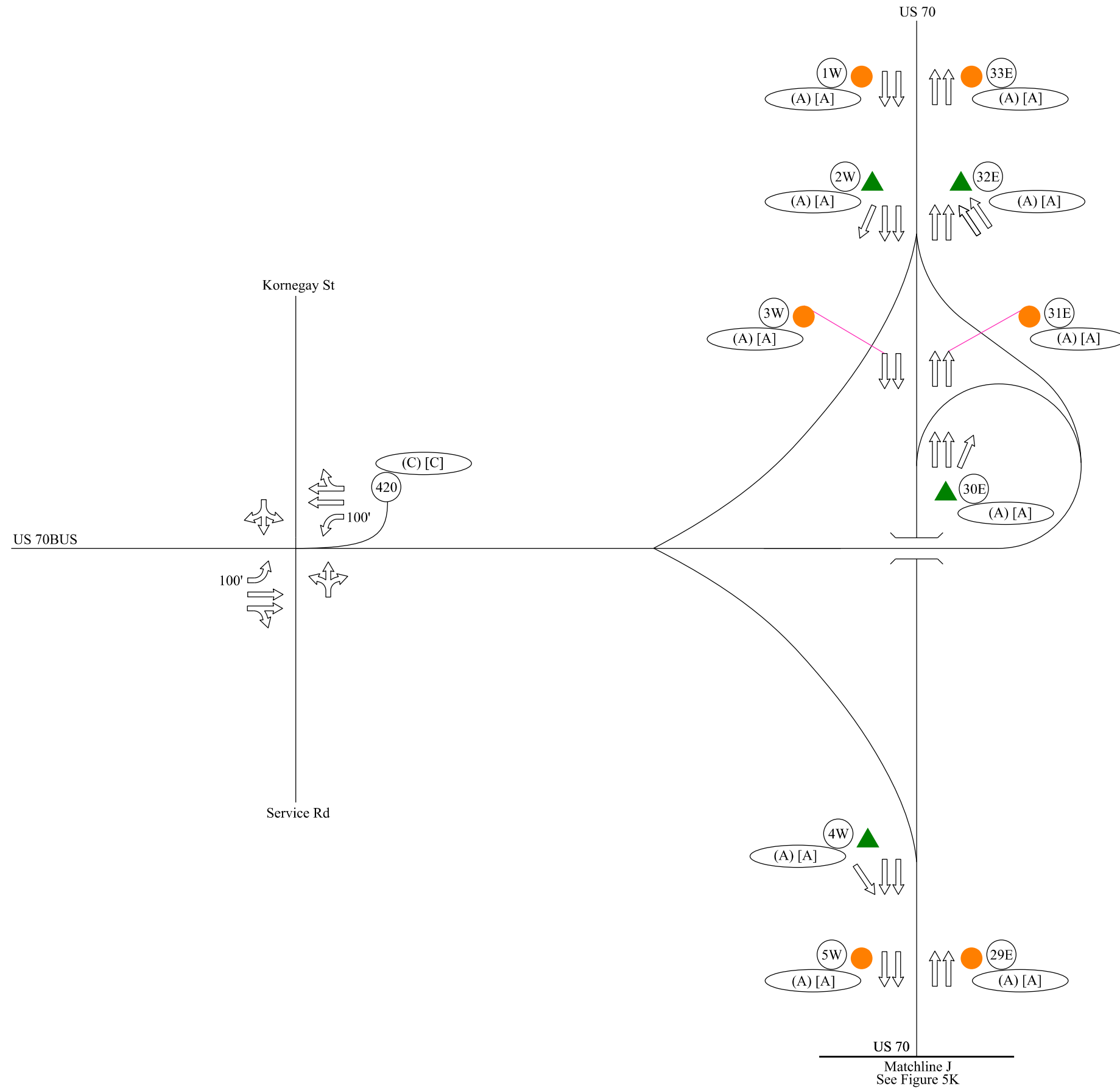




2040 Build Alternative 11
LOS and Laneage
Figure 5K

-  Laneage
-  Intersection or FREEVAL Number
-  AM Peak and PM Peak LOS or V/C Ratio
-  Signal
-  Basic Freeway Segment
-  Ramp Merge/Diverge
-  Freeway Weaving Segment
-  Capacity Check
-  Storage



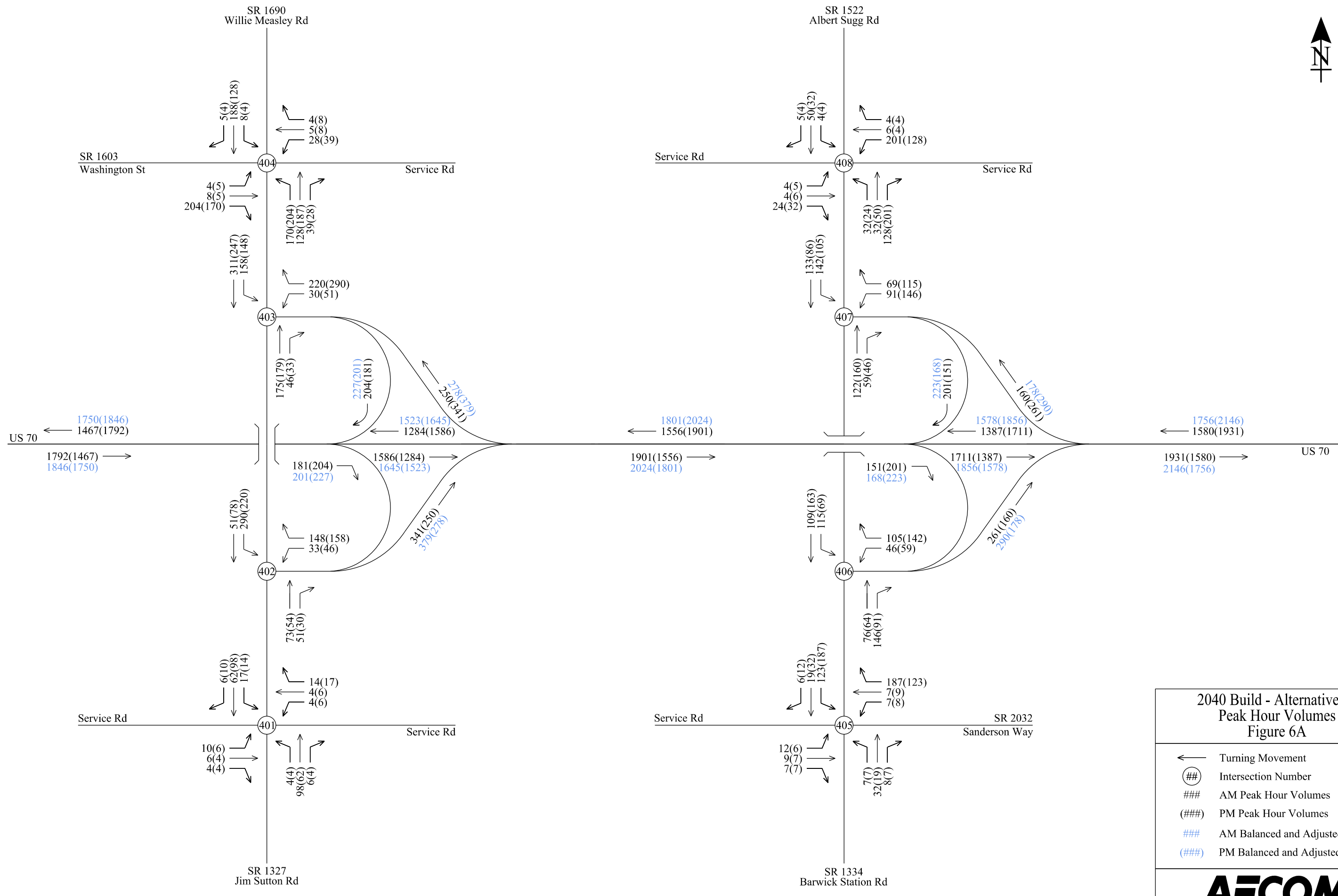


2040 Build Alternative 11
LOS and Laneage
Figure 5L

- Laneage
- Intersection or FREEVAL Number
- AM Peak and PM Peak LOS or V/C Ratio
- Signal
- Basic Freeway Segment
- Ramp Merge/Diverge
- Freeway Weaving Segment
- Capacity Check
- Storage

**2040 Build Alternative 12
Peak Hour Volume Figures**

This page left intentionally blank



Matchline A
See Figure 6B

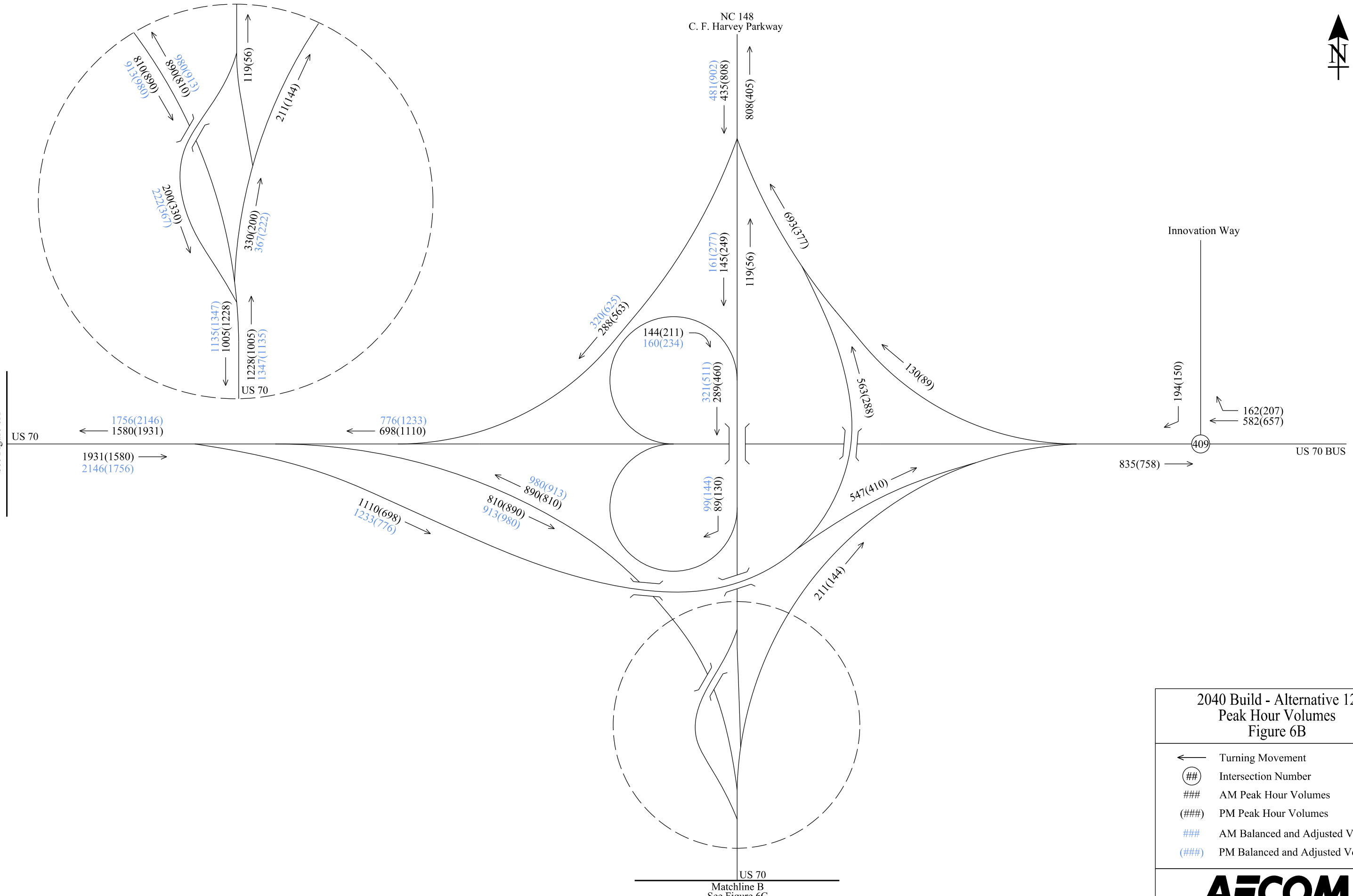
2040 Build - Alternative 12
Peak Hour Volumes
Figure 6A

- ← Turning Movement
- Ⓜ Intersection Number
- ### AM Peak Hour Volumes
- (###) PM Peak Hour Volumes
- ### AM Balanced and Adjusted Volumes
- (###) PM Balanced and Adjusted Volumes





Matchline A
See Figure 6A



2040 Build - Alternative 12
Peak Hour Volumes
Figure 6B

← Turning Movement
⊕ Intersection Number
AM Peak Hour Volumes
PM Peak Hour Volumes
AM Balanced and Adjusted Volumes
PM Balanced and Adjusted Volumes



NC 148
C. F. Harvey Parkway

Innovation Way

409

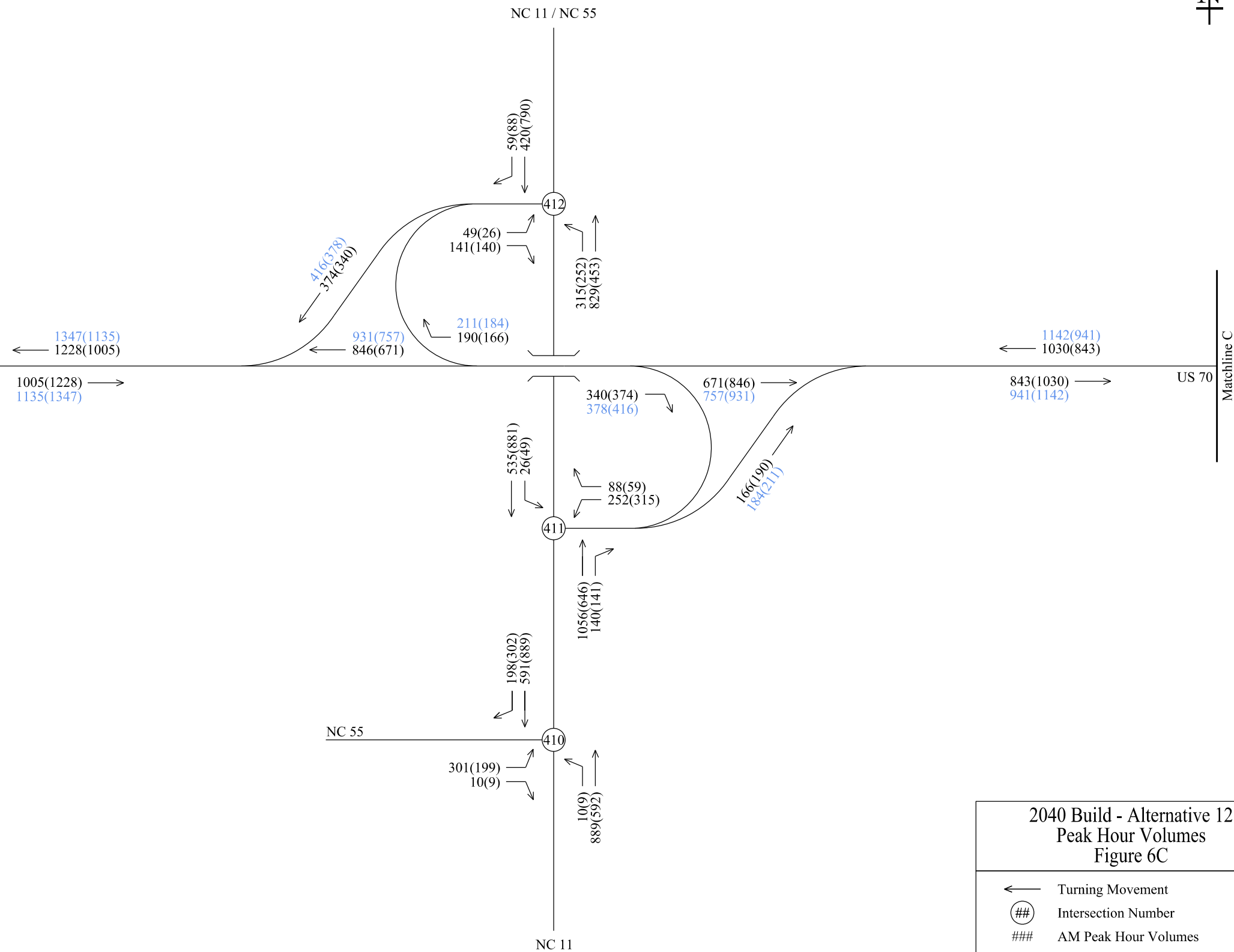
US 70 BUS

US 70

Matchline B
See Figure 6C



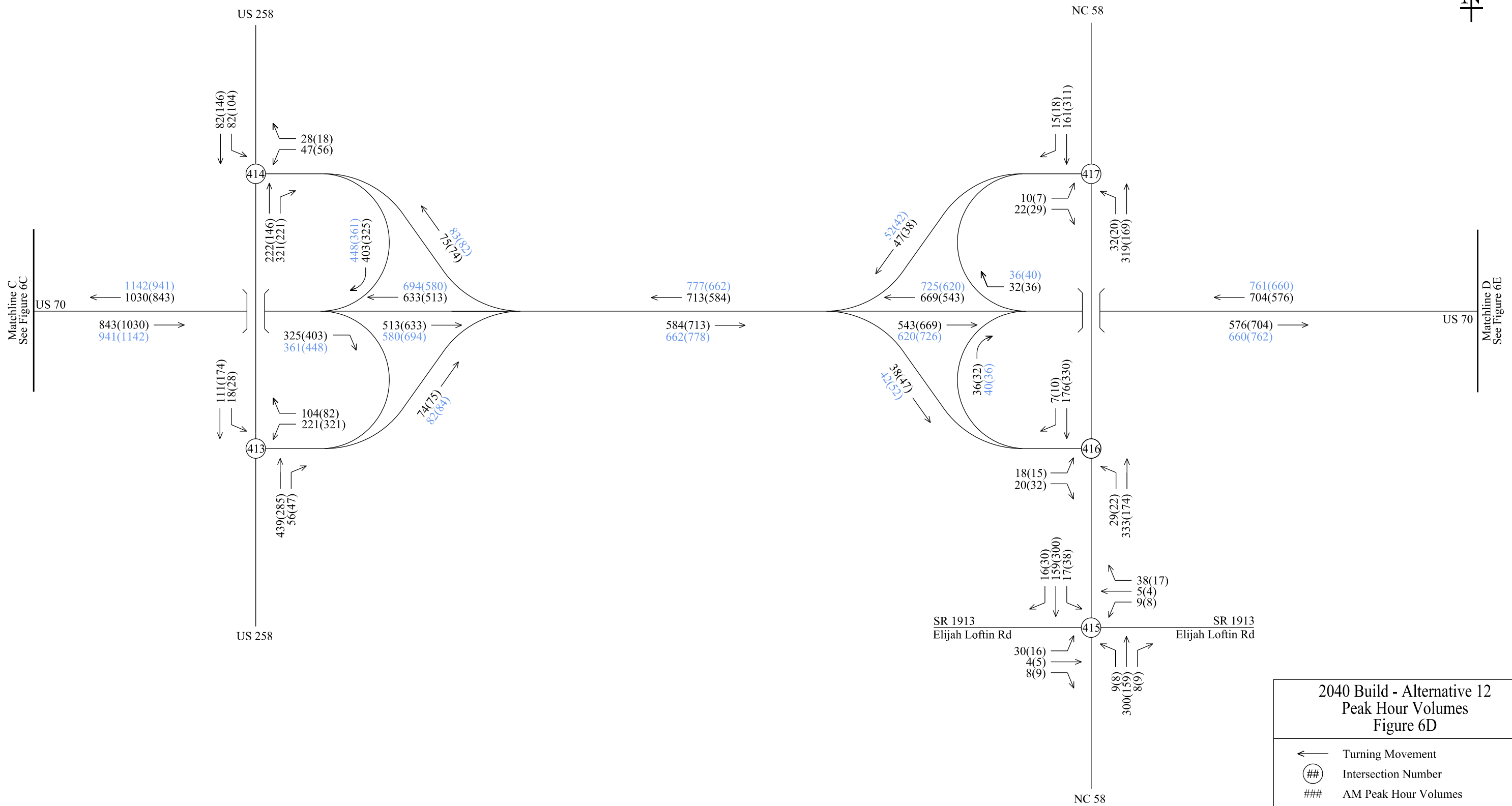
Matchline B
See Figure 6B
US 70



2040 Build - Alternative 12
Peak Hour Volumes
Figure 6C

- ← Turning Movement
- ⊕ Intersection Number
- ### AM Peak Hour Volumes
- (###) PM Peak Hour Volumes
- ### AM Balanced and Adjusted Volumes
- (###) PM Balanced and Adjusted Volumes

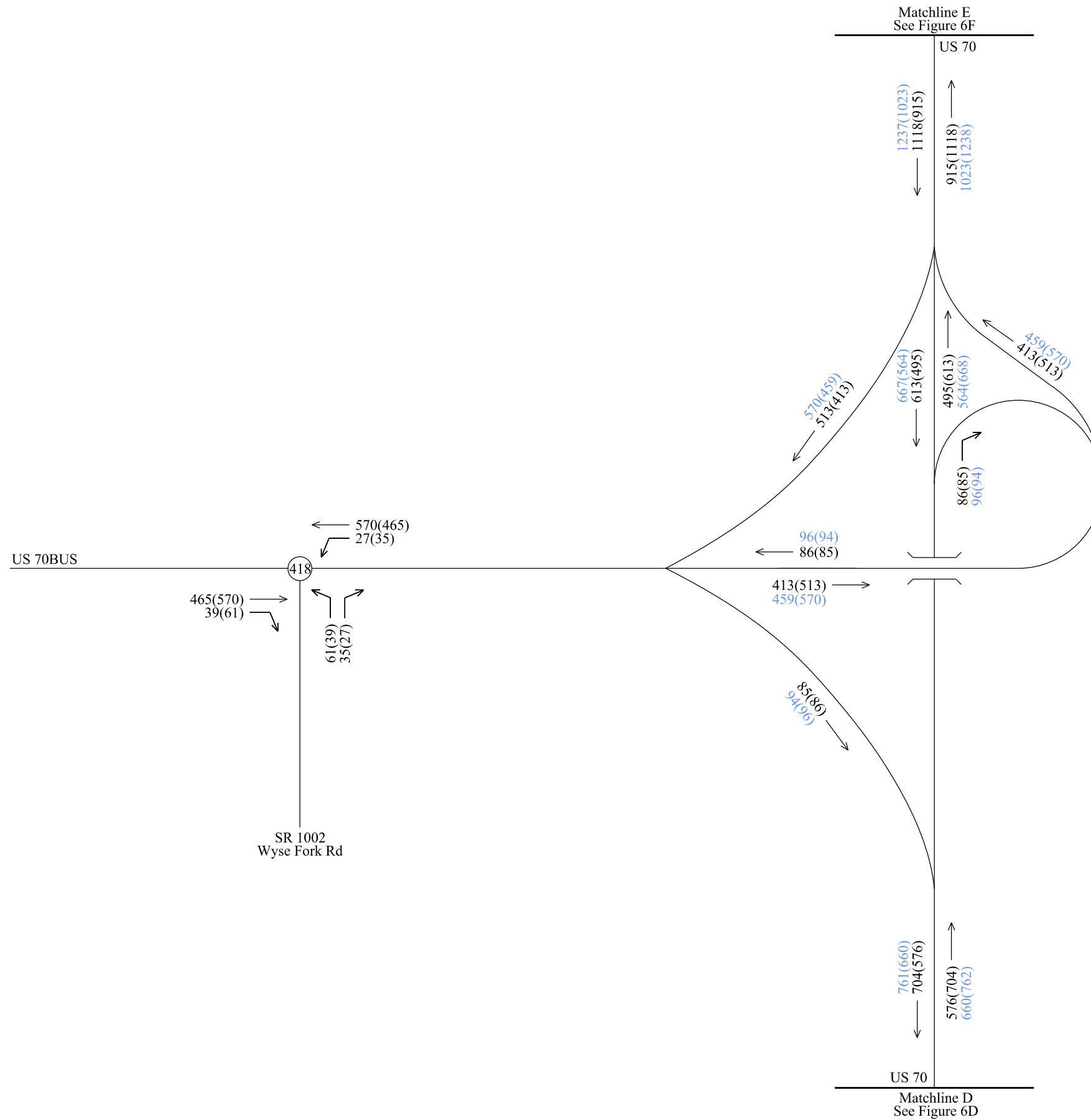




2040 Build - Alternative 12
Peak Hour Volumes
Figure 6D

- ← Turning Movement
- ⊙ Intersection Number
- ### AM Peak Hour Volumes
- (###) PM Peak Hour Volumes
- ### AM Balanced and Adjusted Volumes
- (###) PM Balanced and Adjusted Volumes

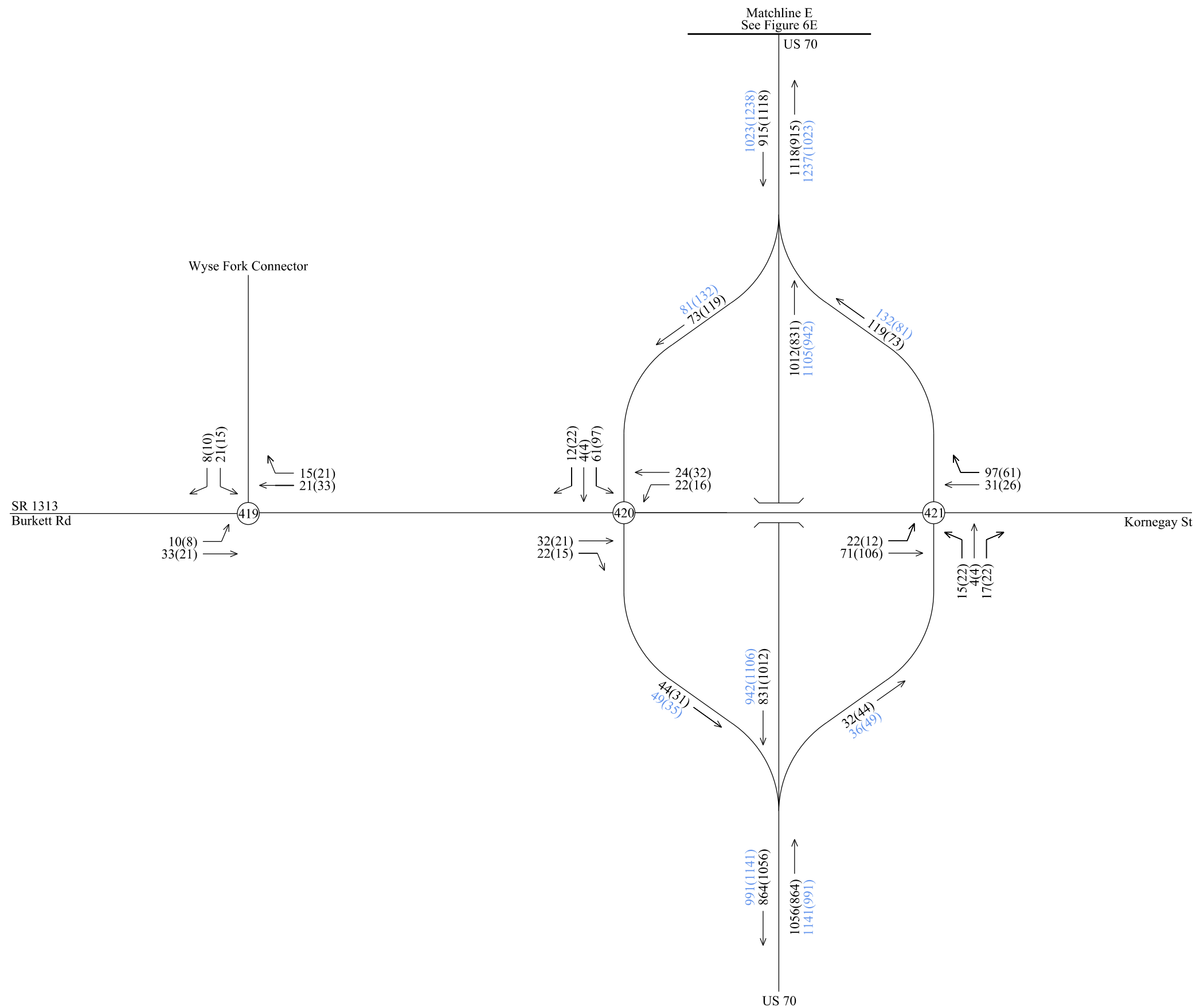




2040 Build - Alternative 12
Peak Hour Volumes
Figure 6E

- ← Turning Movement
- ⊙ Intersection Number
- ### AM Peak Hour Volumes
- (###) PM Peak Hour Volumes
- ### AM Balanced and Adjusted Volumes
- (###) PM Balanced and Adjusted Volumes





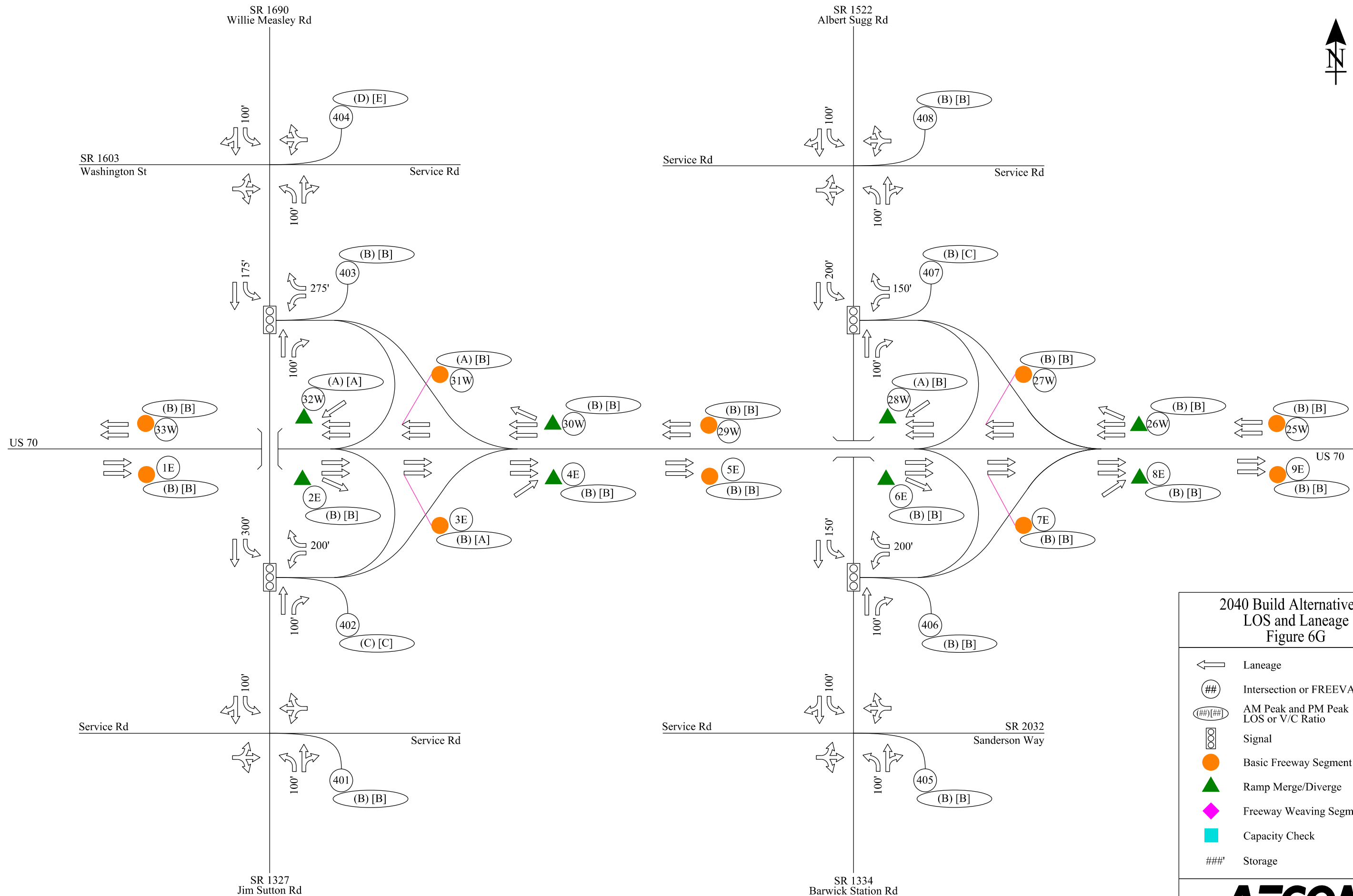
2040 Build - Alternative 12
Peak Hour Volumes
Figure 6F

- ← Turning Movement
- ⊙ Intersection Number
- ### AM Peak Hour Volumes
- (###) PM Peak Hour Volumes
- ### AM Balanced and Adjusted Volumes
- (###) PM Balanced and Adjusted Volumes



**2040 Build Alternative 12
LOS and Laneage Figures**

This page left intentionally blank

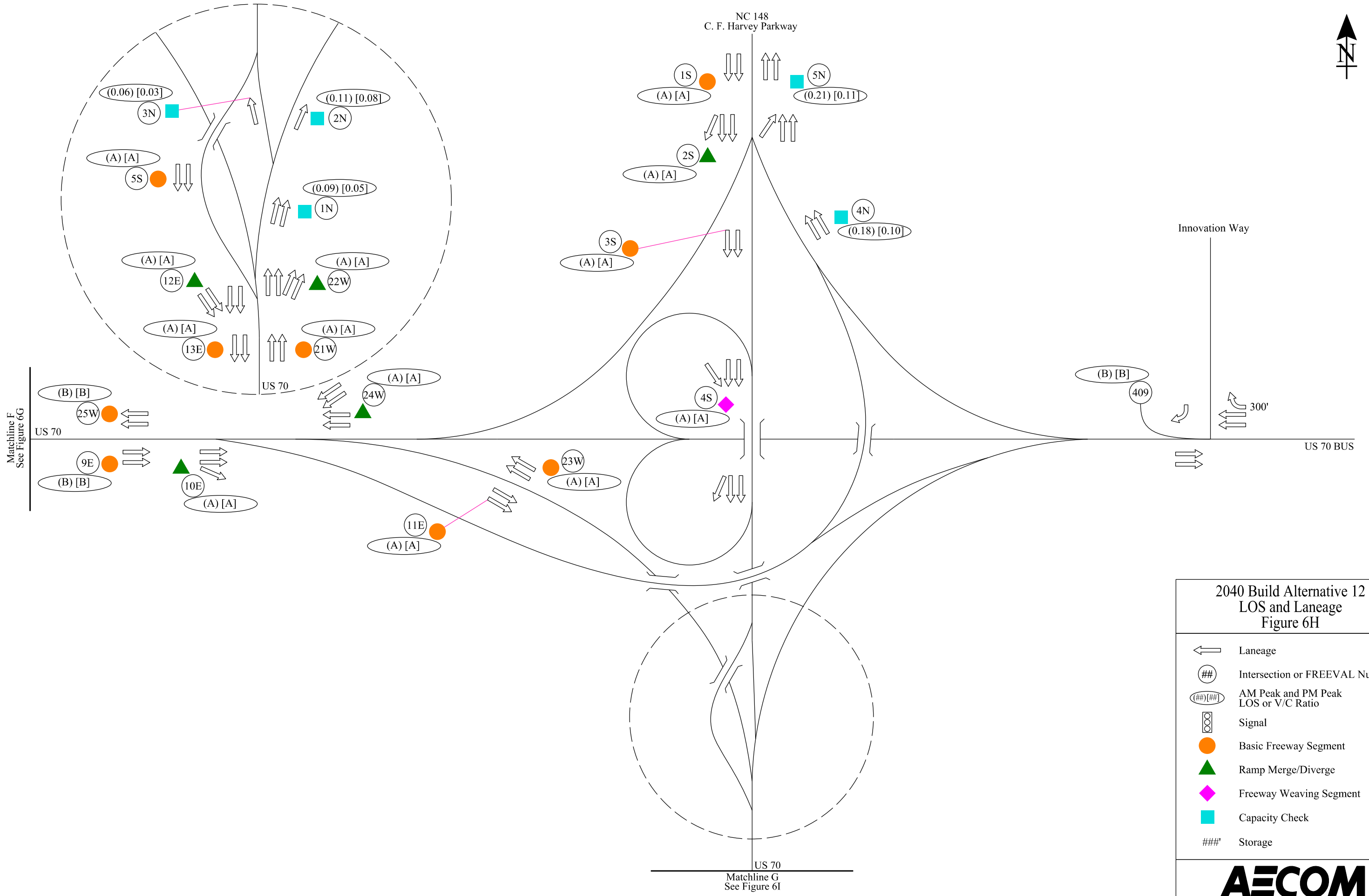


Matchline F
See Figure 6H

**2040 Build Alternative 12
LOS and Laneage
Figure 6G**

- Laneage
- Intersection or FREEVAL Number
- AM Peak and PM Peak LOS or V/C Ratio
- Signal
- Basic Freeway Segment
- Ramp Merge/Diverge
- Freeway Weaving Segment
- Capacity Check
- Storage





Matchline F
See Figure 6G

US 70
Matchline G
See Figure 6I

**2040 Build Alternative 12
LOS and Laneage
Figure 6H**

	Laneage
	Intersection or FREEVAL Number
	AM Peak and PM Peak LOS or V/C Ratio
	Signal
	Basic Freeway Segment
	Ramp Merge/Diverge
	Freeway Weaving Segment
	Capacity Check
	Storage

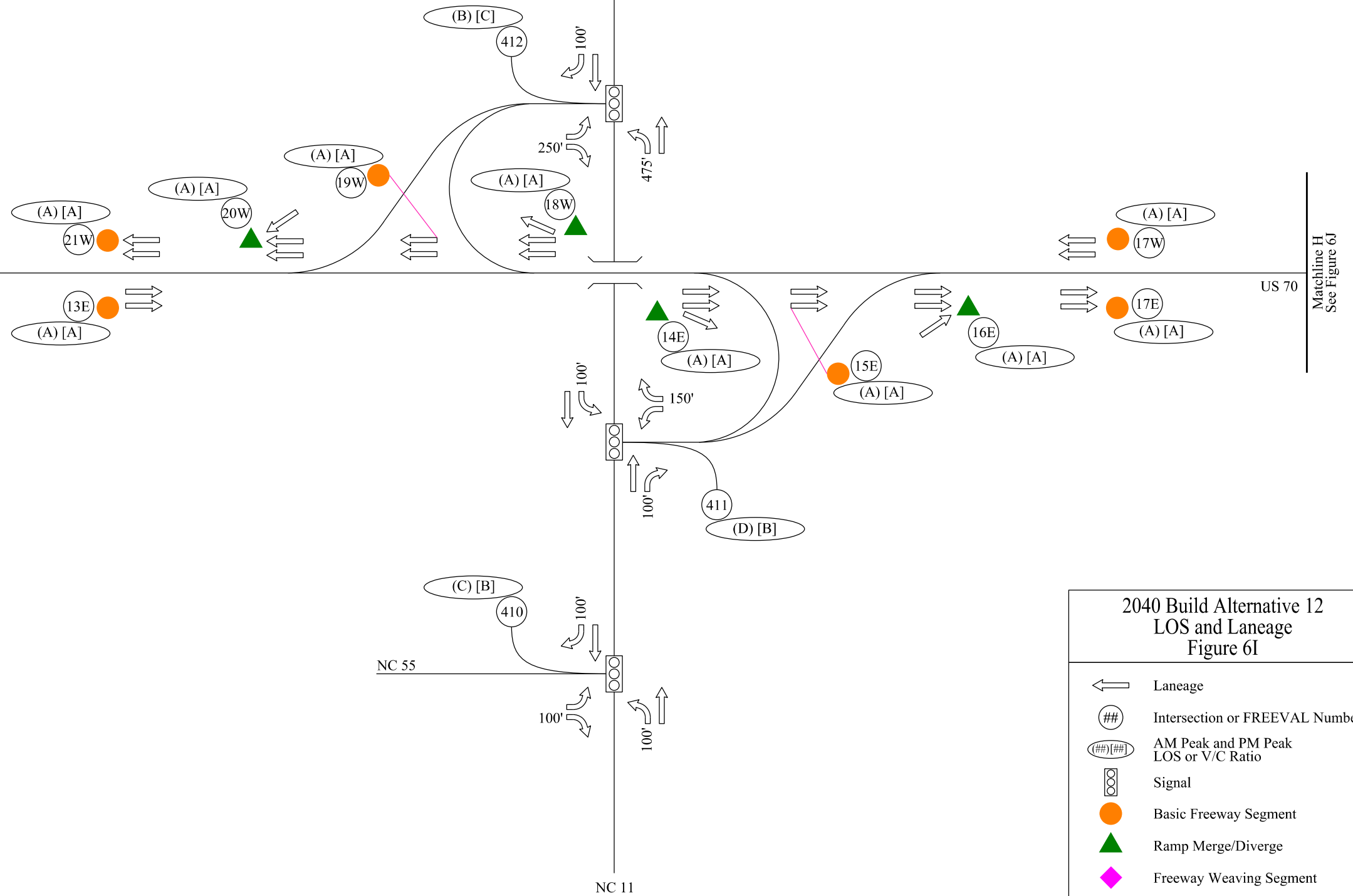




Matchline G
See Figure 6H

US 70

NC 11 / NC 55












Matchline H
See Figure 6J

US 70

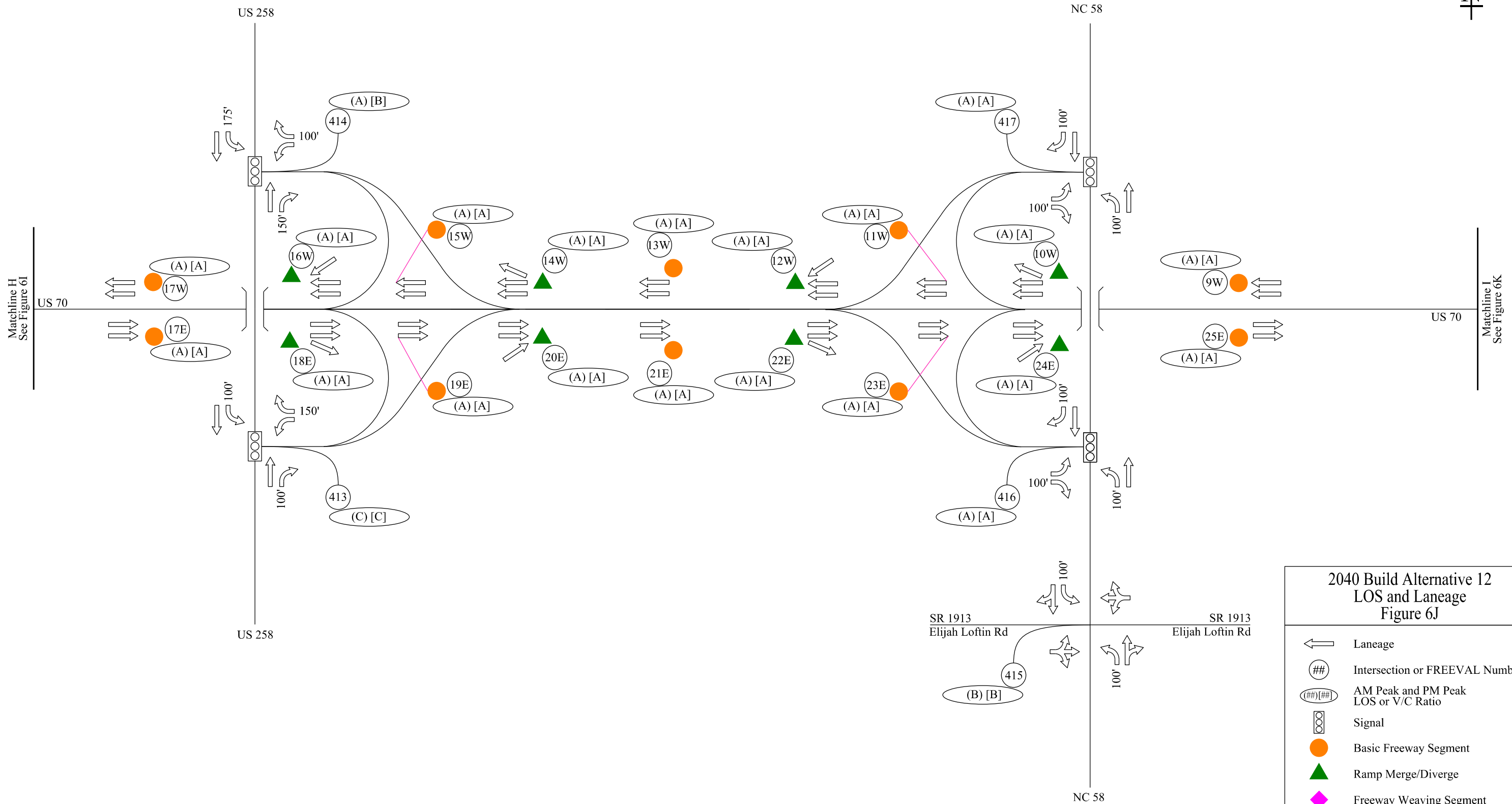
NC 55

NC 11

2040 Build Alternative 12 LOS and Laneage Figure 6I

-  Laneage
-  Intersection or FREEVAL Number
-  AM Peak and PM Peak
LOS or V/C Ratio
-  Signal
-  Basic Freeway Segment
-  Ramp Merge/Diverge
-  Freeway Weaving Segment
-  Capacity Check
-  Storage





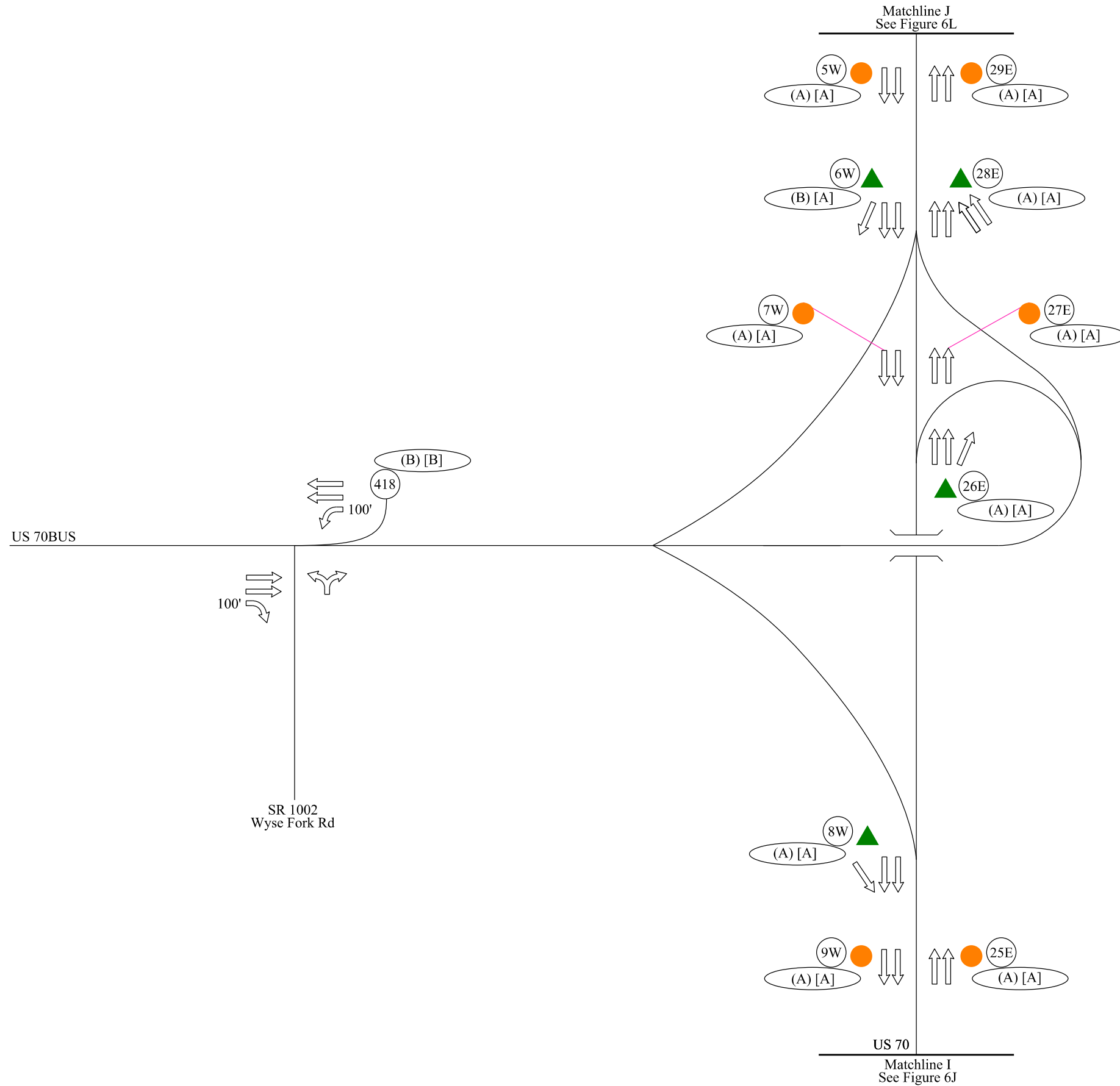
Matchline H
See Figure 6I

Matchline I
See Figure 6K










**2040 Build Alternative 12
LOS and Laneage
Figure 6J**

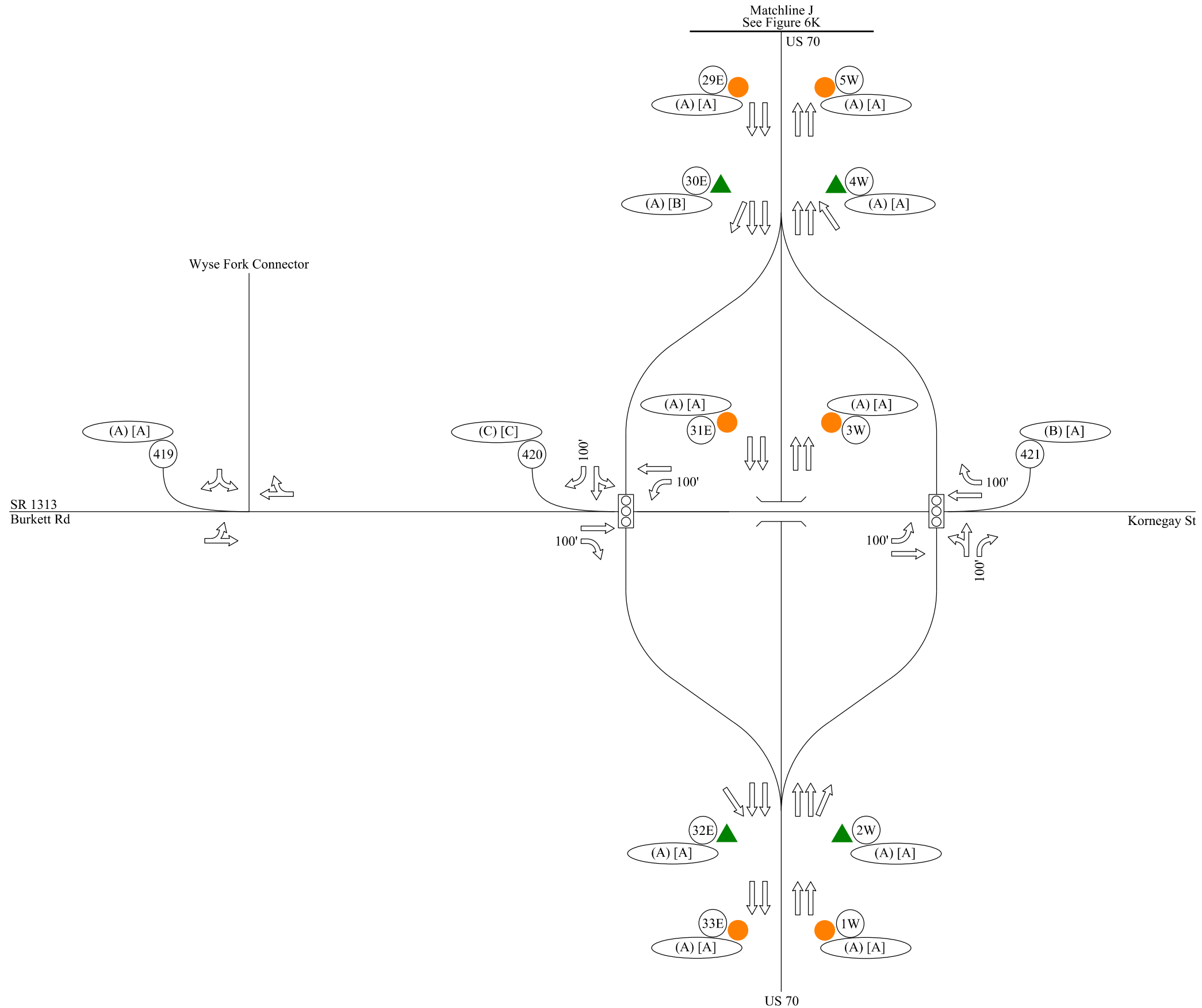
	Laneage
	Intersection or FREEVAL Number
	AM Peak and PM Peak LOS or V/C Ratio
	Signal
	Basic Freeway Segment
	Ramp Merge/Diverge
	Freeway Weaving Segment
	Capacity Check
	Storage





2040 Build Alternative 12
LOS and Laneage
Figure 6K

-  Laneage
-  Intersection or FREEVAL Number
-  AM Peak and PM Peak
LOS or V/C Ratio
-  Signal
-  Basic Freeway Segment
-  Ramp Merge/Diverge
-  Freeway Weaving Segment
-  Capacity Check
-  Storage



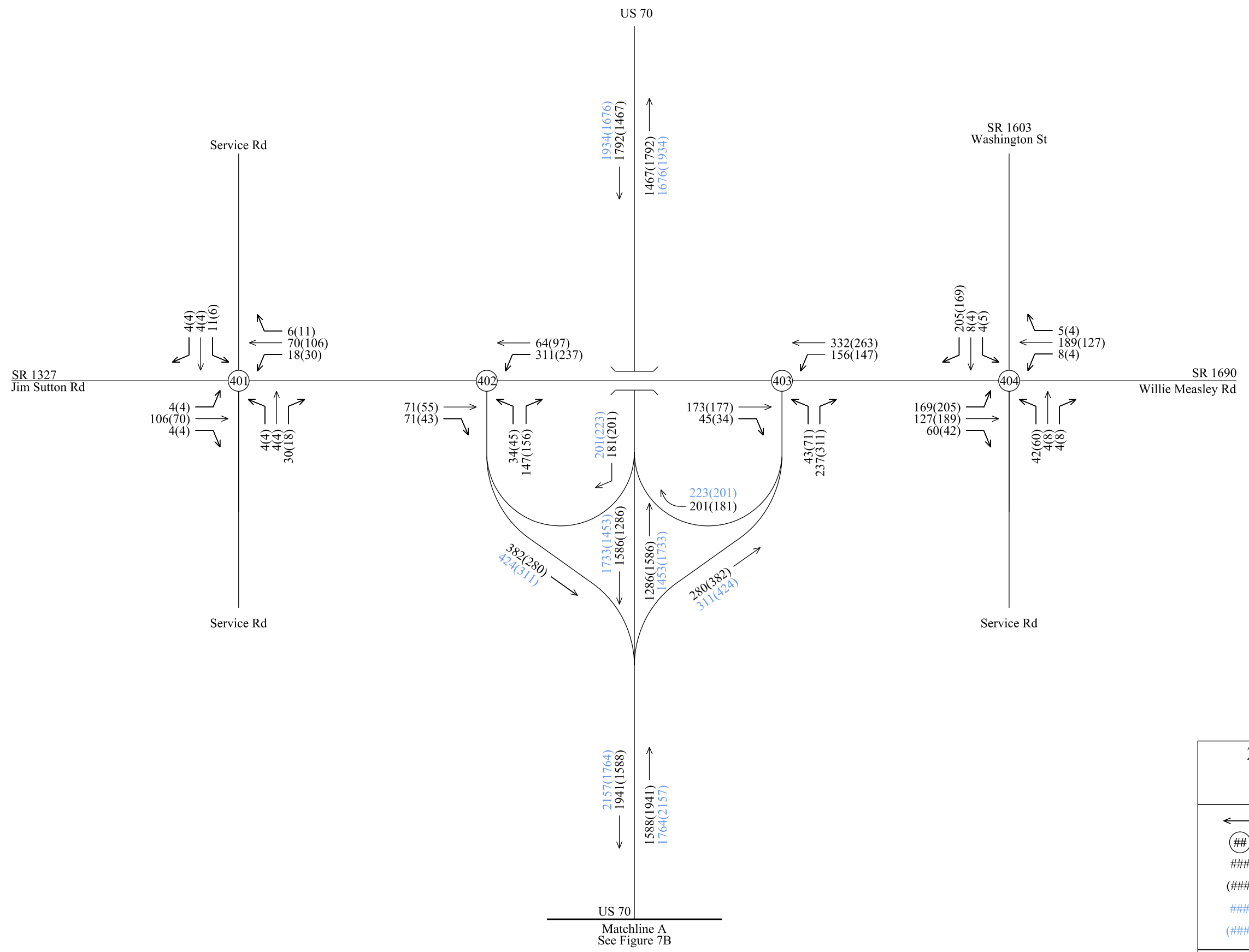
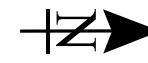
2040 Build Alternative 12
LOS and Laneage
Figure 6L

	Laneage
	Intersection or FREEVAL Number
	AM Peak and PM Peak LOS or V/C Ratio
	Signal
	Basic Freeway Segment
	Ramp Merge/Diverge
	Freeway Weaving Segment
	Capacity Check
	Storage



**2040 Build Alternative 31
Peak Hour Volume Figures**

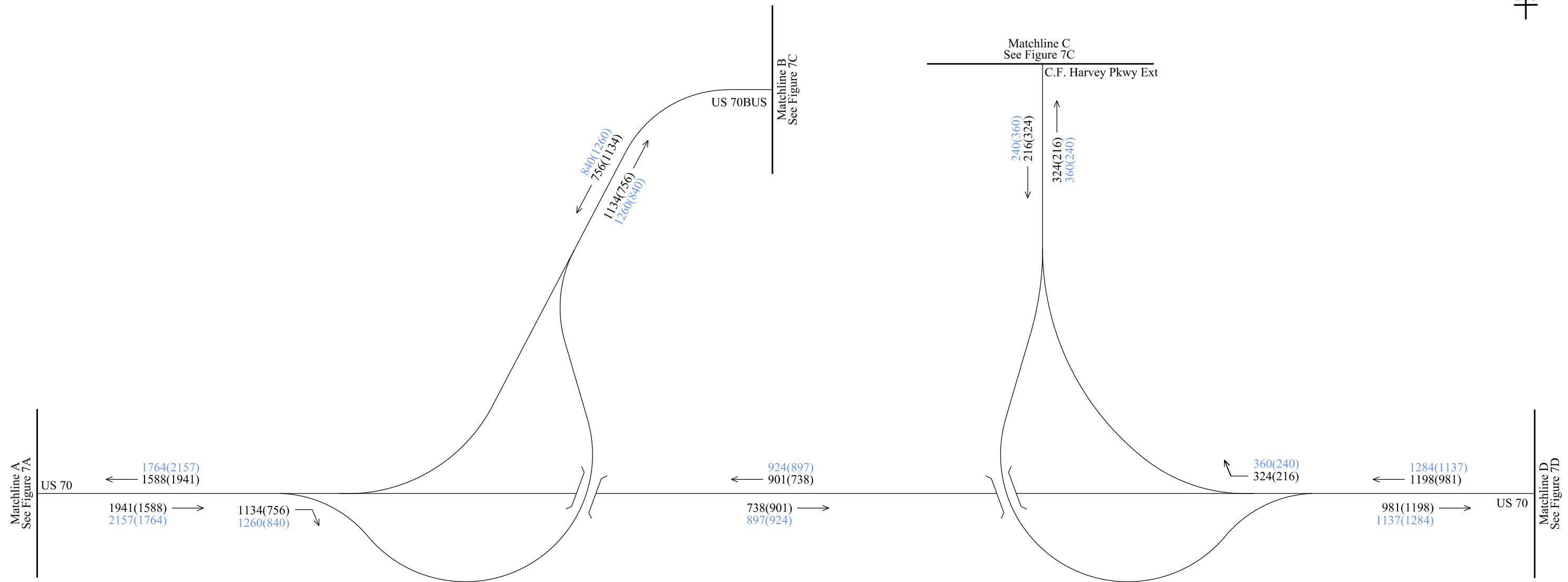
This page left intentionally blank



2040 Build - Alternative 31
Peak Hour Volumes
Figure 7A

- ← Turning Movement
- (##) Intersection Number
- ### AM Peak Hour Volumes
- (###) PM Peak Hour Volumes
- ### AM Balanced and Adjusted Volumes
- (###) PM Balanced and Adjusted Volumes

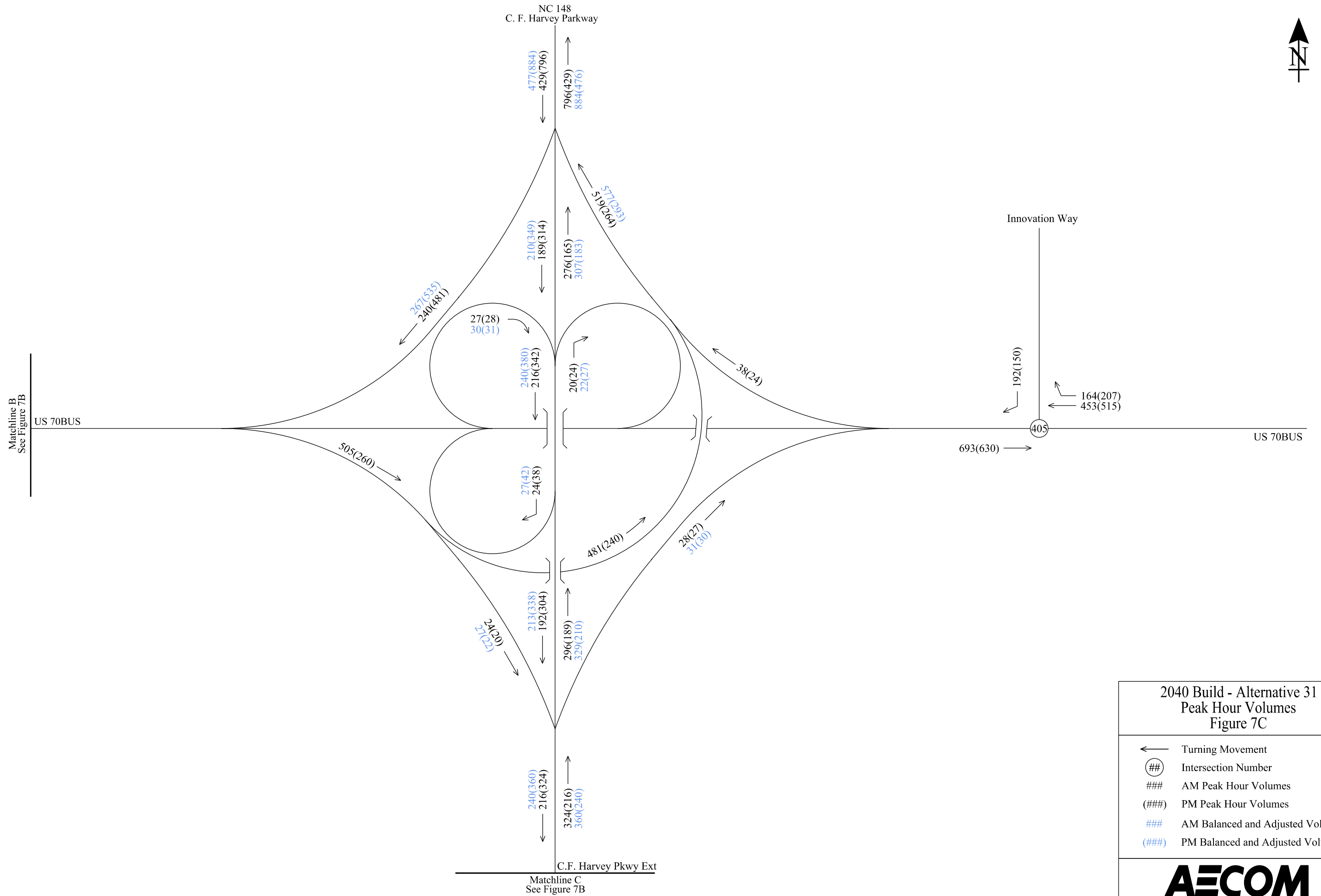




2040 Build - Alternative 31
Peak Hour Volumes
Figure 7B

- ← Turning Movement
- Ⓜ Intersection Number
- ### AM Peak Hour Volumes
- (###) PM Peak Hour Volumes
- ### AM Balanced and Adjusted Volumes
- (###) PM Balanced and Adjusted Volumes

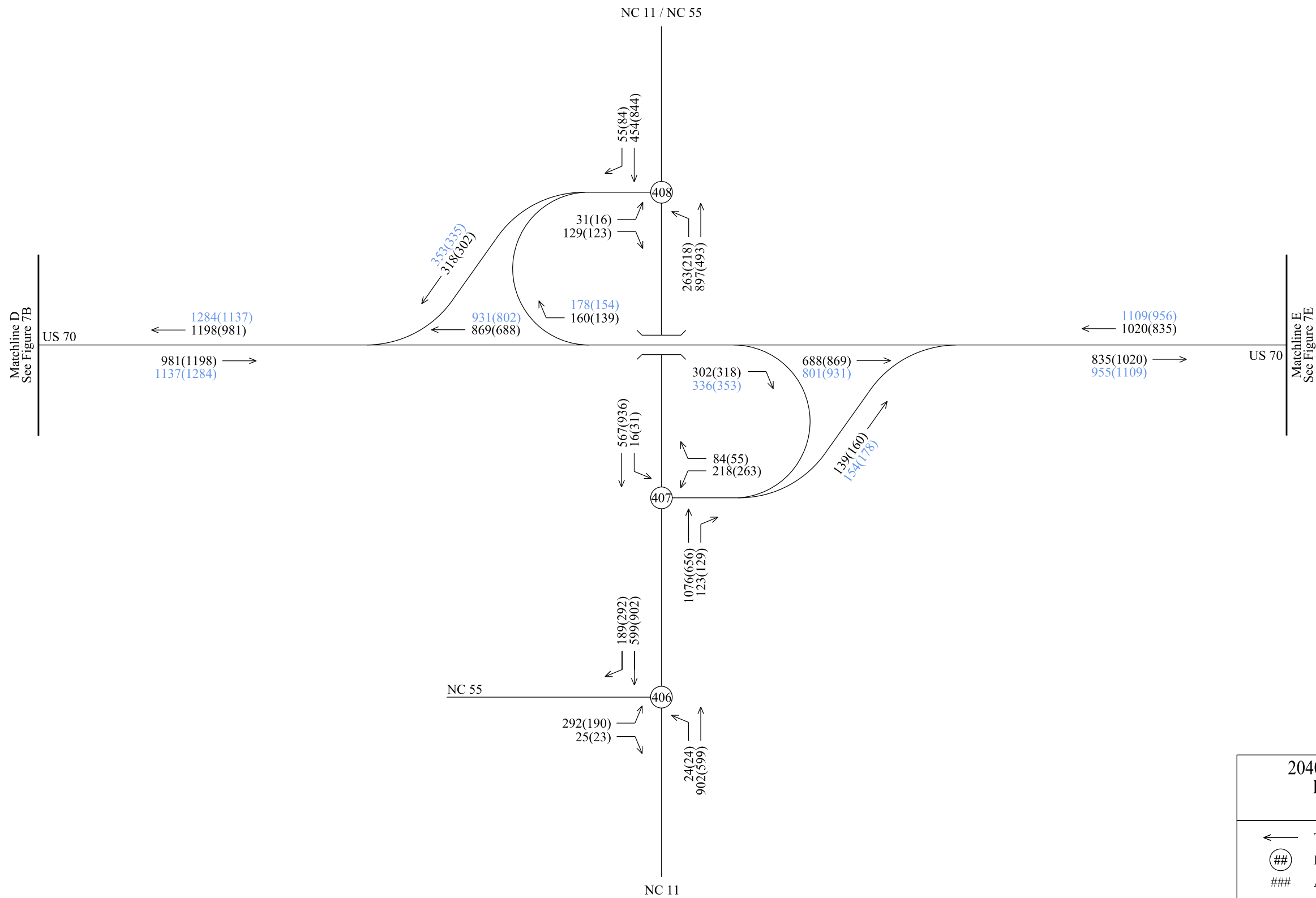




2040 Build - Alternative 31
Peak Hour Volumes
Figure 7C

- ← Turning Movement
- ⊕ Intersection Number
- ### AM Peak Hour Volumes
- (###) PM Peak Hour Volumes
- ### AM Balanced and Adjusted Volumes
- (###) PM Balanced and Adjusted Volumes

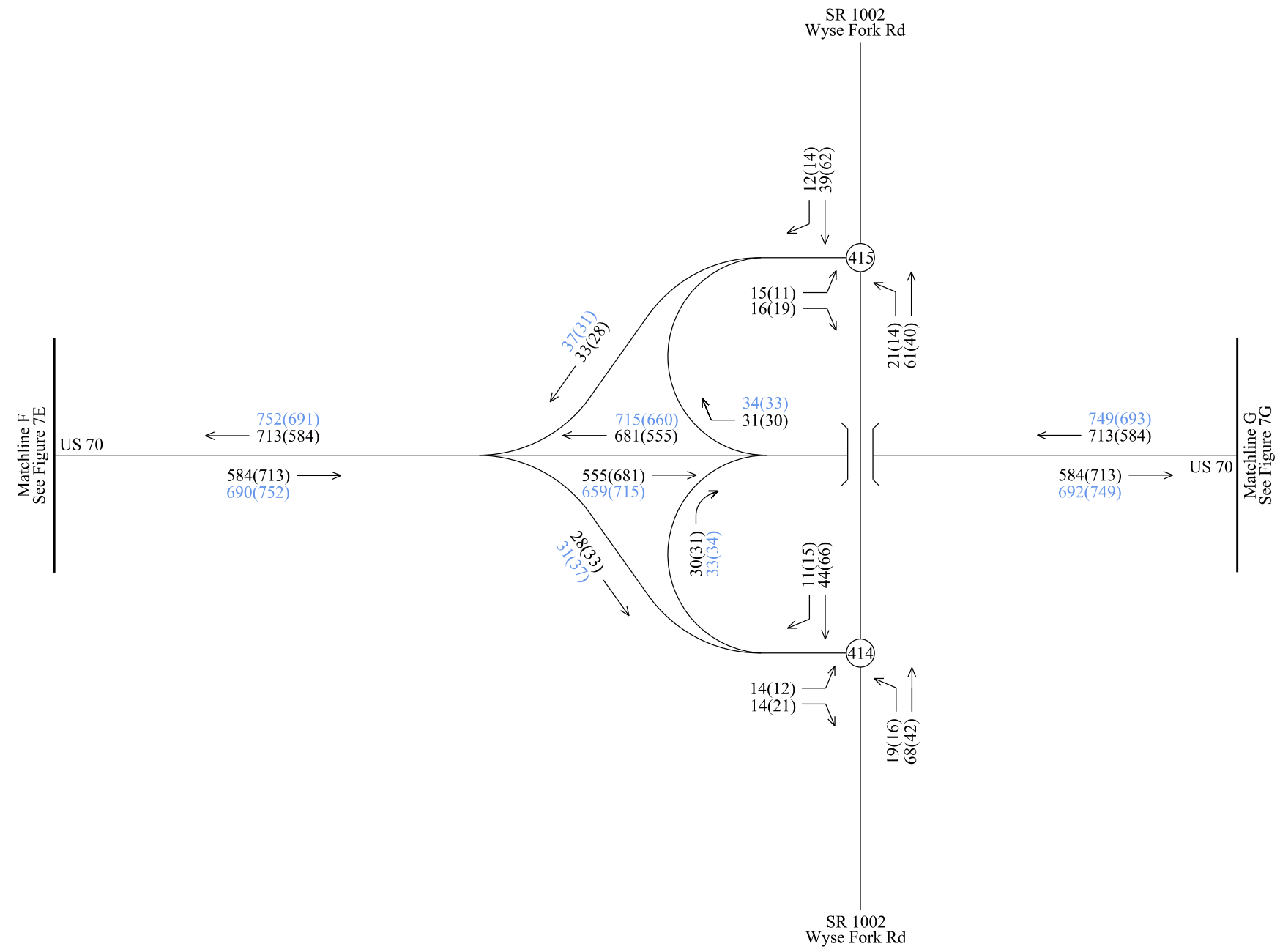




2040 Build - Alternative 31
Peak Hour Volumes
Figure 7D

- ← Turning Movement
- ⊙ Intersection Number
- ### AM Peak Hour Volumes
- (###) PM Peak Hour Volumes
- ### AM Balanced and Adjusted Volumes
- (###) PM Balanced and Adjusted Volumes

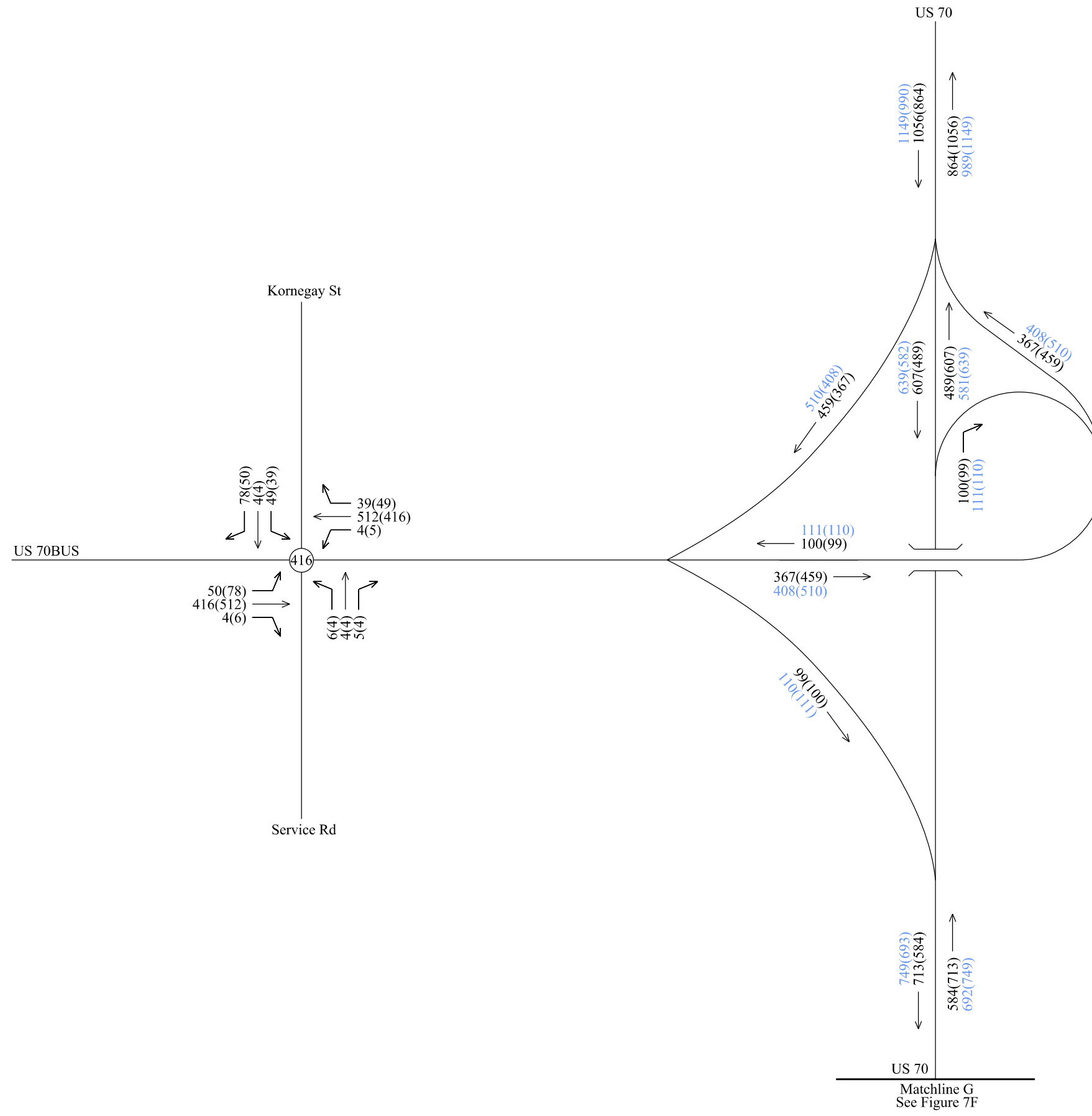




2040 Build - Alternative 31
Peak Hour Volumes
Figure 7F

- ← Turning Movement
- ⊕ Intersection Number
- ### AM Peak Hour Volumes
- (###) PM Peak Hour Volumes
- ### AM Balanced and Adjusted Volumes
- (###) PM Balanced and Adjusted Volumes





2040 Build - Alternative 31
Peak Hour Volumes
Figure 7G

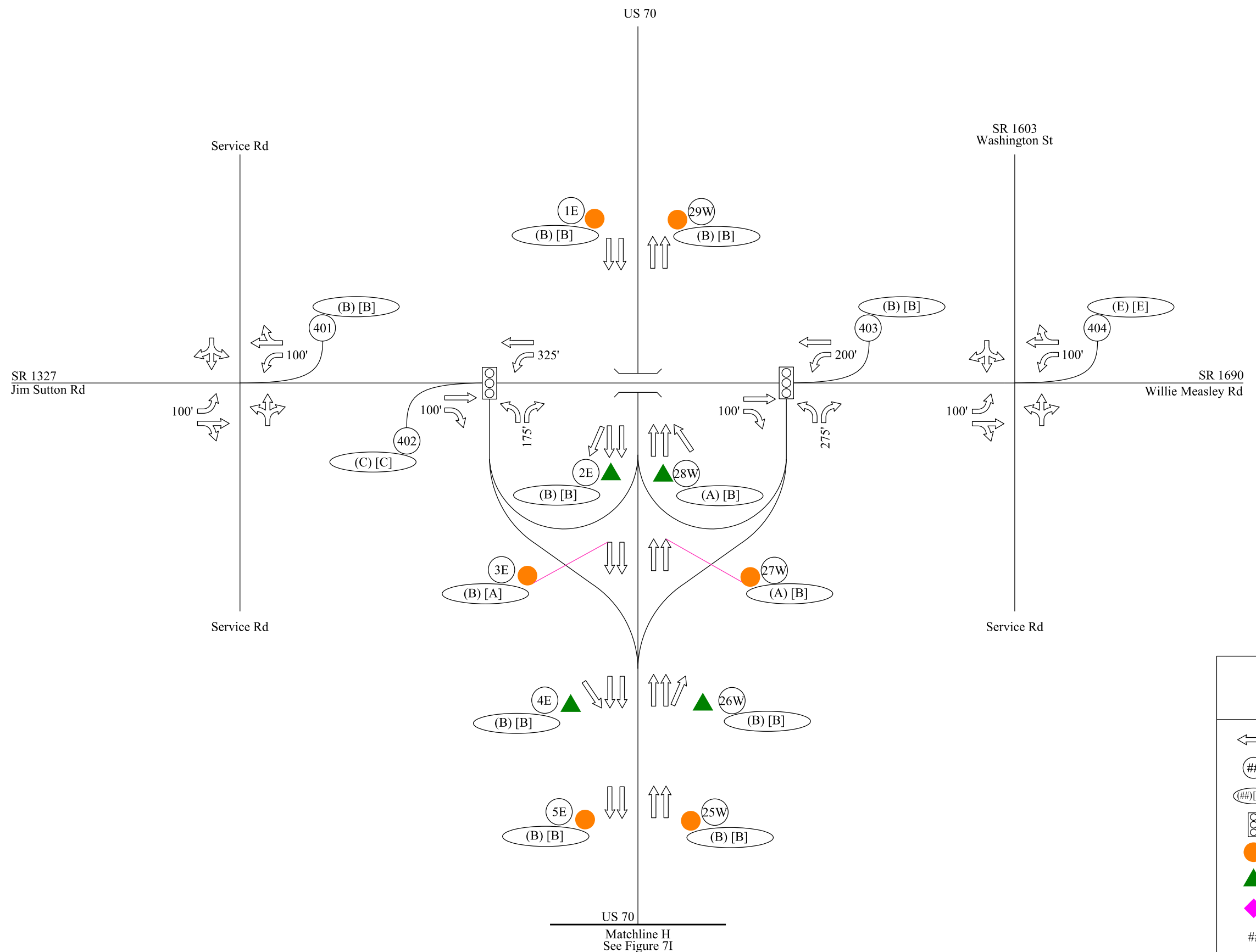
- ← Turning Movement
- ⊙ Intersection Number
- ### AM Peak Hour Volumes
- (###) PM Peak Hour Volumes
- ### AM Balanced and Adjusted Volumes
- (###) PM Balanced and Adjusted Volumes



This page left intentionally blank

**2040 Build Alternative 31
LOS and Laneage Figures**

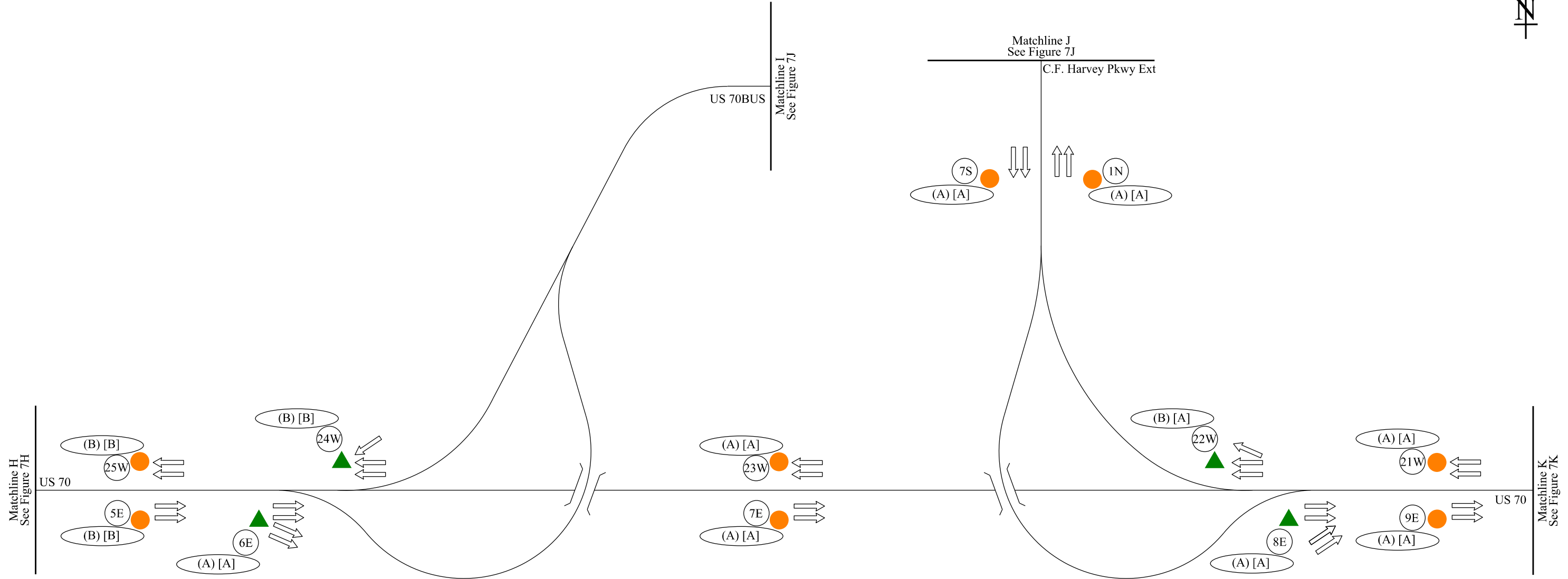
This page left intentionally blank



2040 Build Alternative 31
LOS and Laneage
Figure 7H

- ← Laneage
- ## Intersection or FREEVAL Number
- (##)(##) AM Peak and PM Peak LOS
- ⓧ Signal
- Basic Freeway Segment
- ▲ Ramp Merge/Diverge
- ◆ Freeway Weaving Segment
- ### Storage





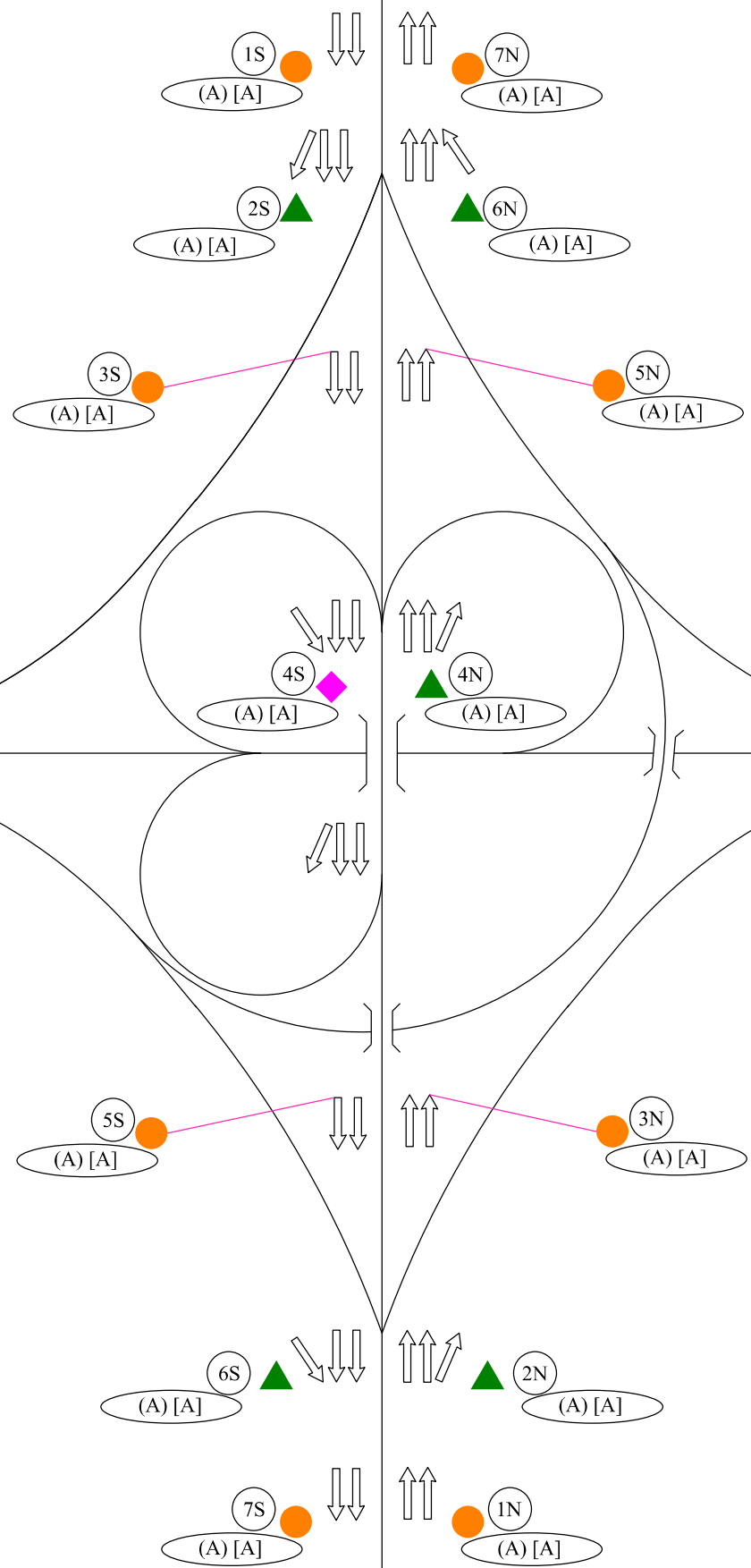
2040 Build Alternative 31
LOS and Laneage
Figure 7I

- ← Laneage
- ## Intersection or FREEVAL Number
- (##)(##) AM Peak and PM Peak LOS
- ⊞ Signal
- Basic Freeway Segment
- ▲ Ramp Merge/Diverge
- ◆ Freeway Weaving Segment
- ### Storage





NC 148
C. F. Harvey Parkway



Matchline I
See Figure 7I

US 70BUS









Innovation Way

US 70BUS

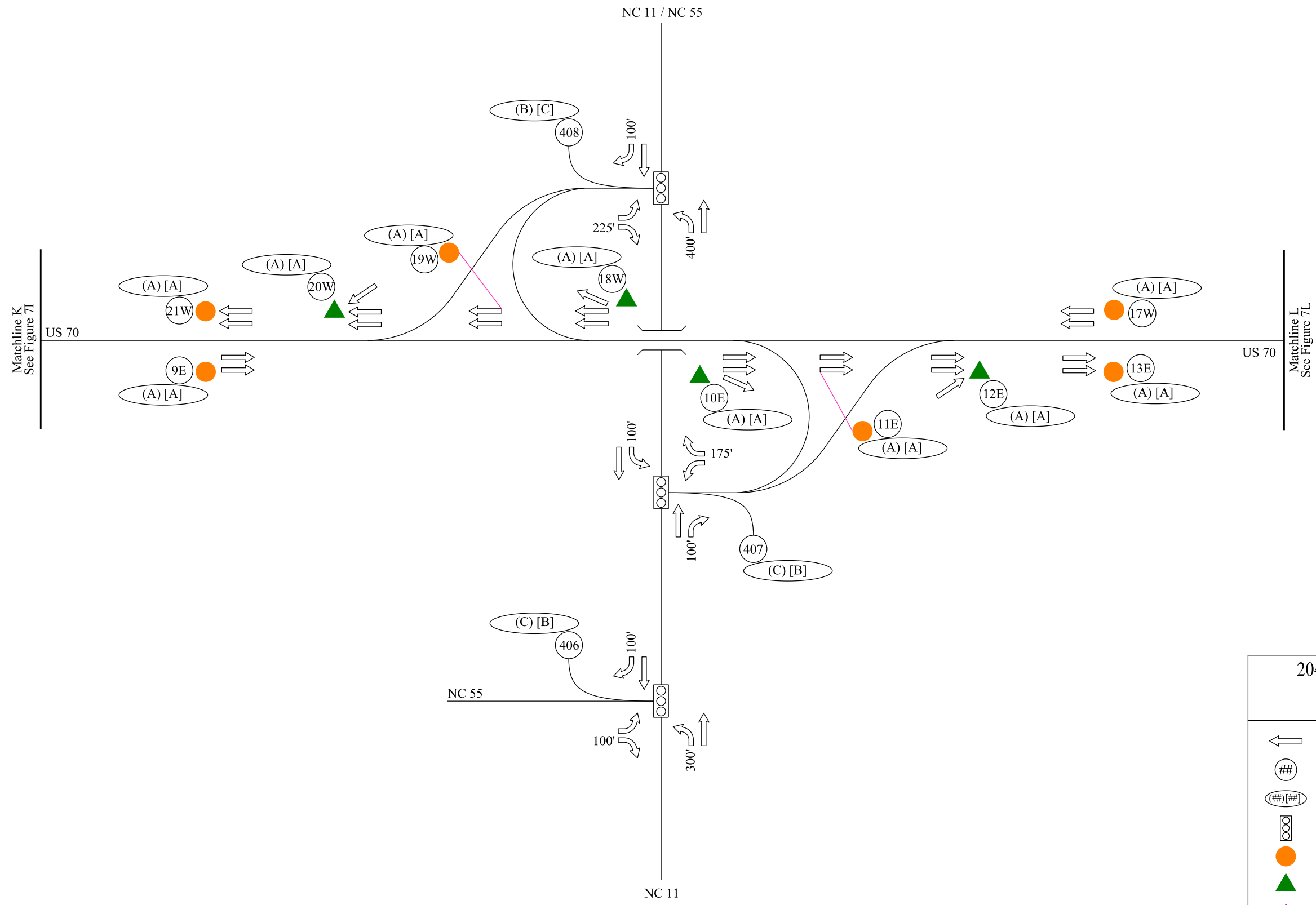
C.F. Harvey Pkwy Ext

Matchline J
See Figure 7I

2040 Build Alternative 31 LOS and Laneage Figure 7J

-  Laneage
-  Intersection or FREEVAL Number
-  AM Peak and PM Peak LOS
-  Signal
-  Basic Freeway Segment
-  Ramp Merge/Diverge
-  Freeway Weaving Segment
-  Storage

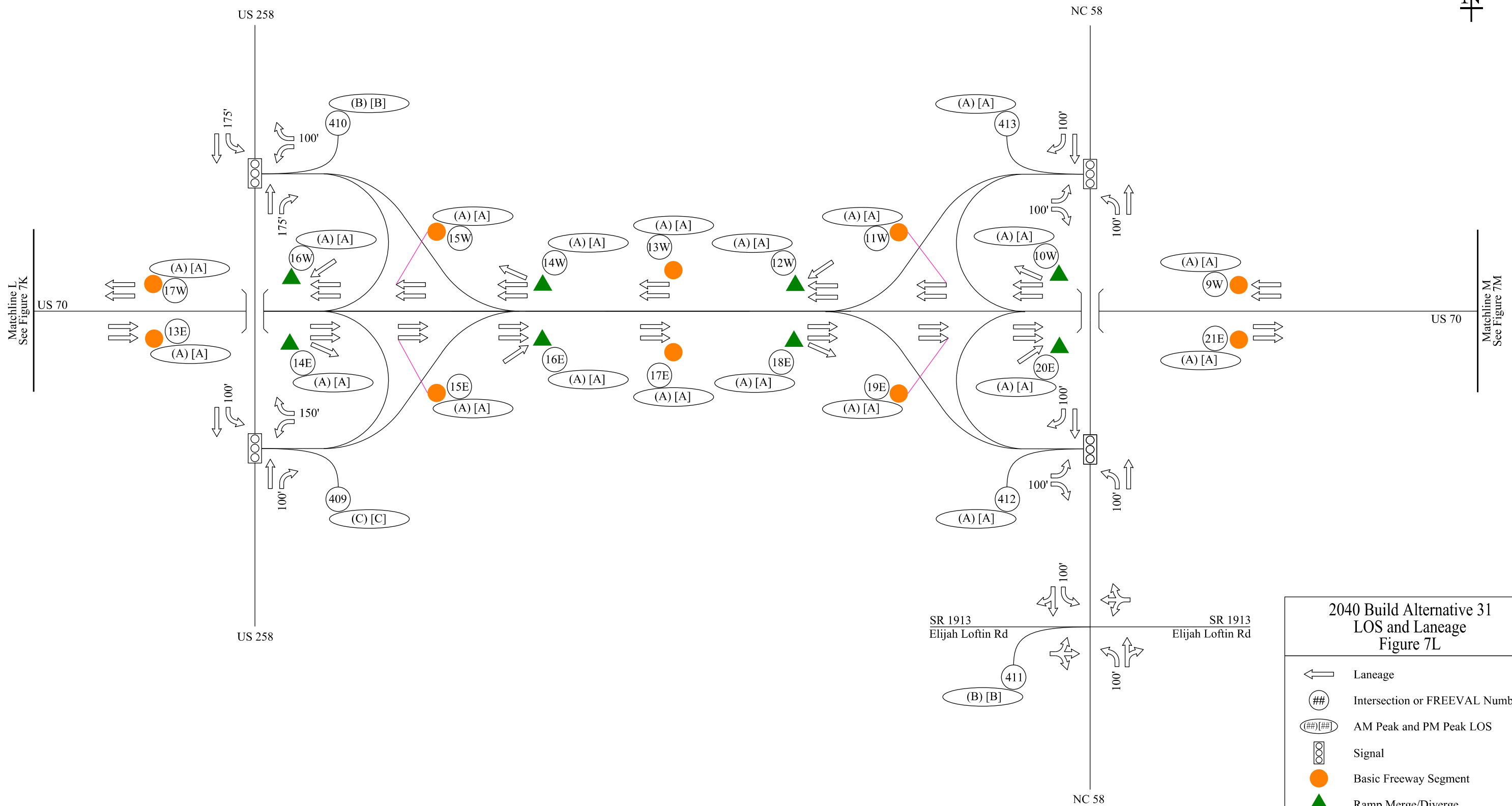












2040 Build Alternative 31
LOS and Laneage
Figure 7K

- Laneage
- Intersection or FREEVAL Number
- AM Peak and PM Peak LOS
- Signal
- Basic Freeway Segment
- Ramp Merge/Diverge
- Freeway Weaving Segment
- Storage

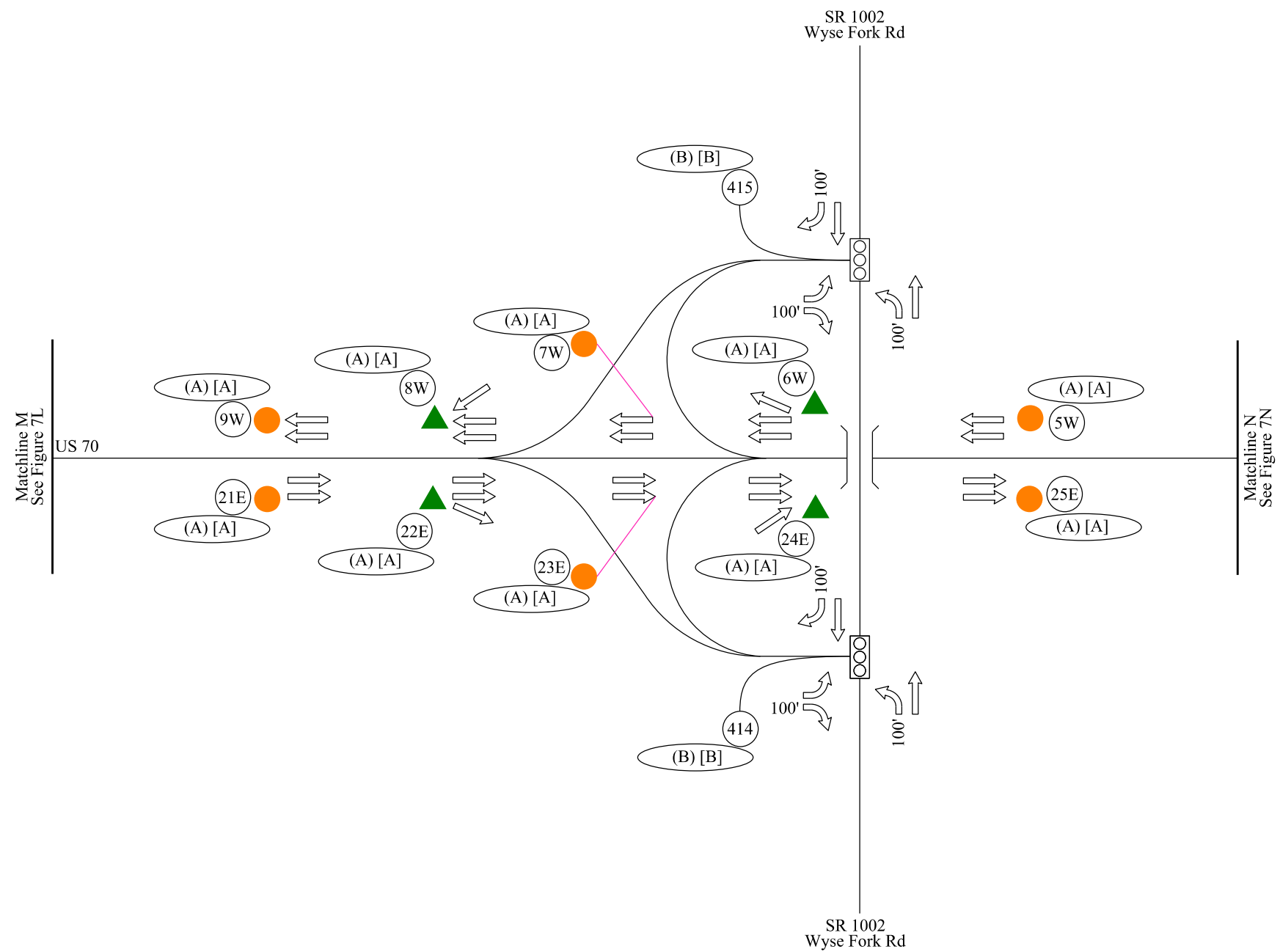












2040 Build Alternative 31
LOS and Laneage
Figure 7L

-  Laneage
-  Intersection or FREEVAL Number
-  AM Peak and PM Peak LOS
-  Signal
-  Basic Freeway Segment
-  Ramp Merge/Diverge
-  Freeway Weaving Segment
-  Storage

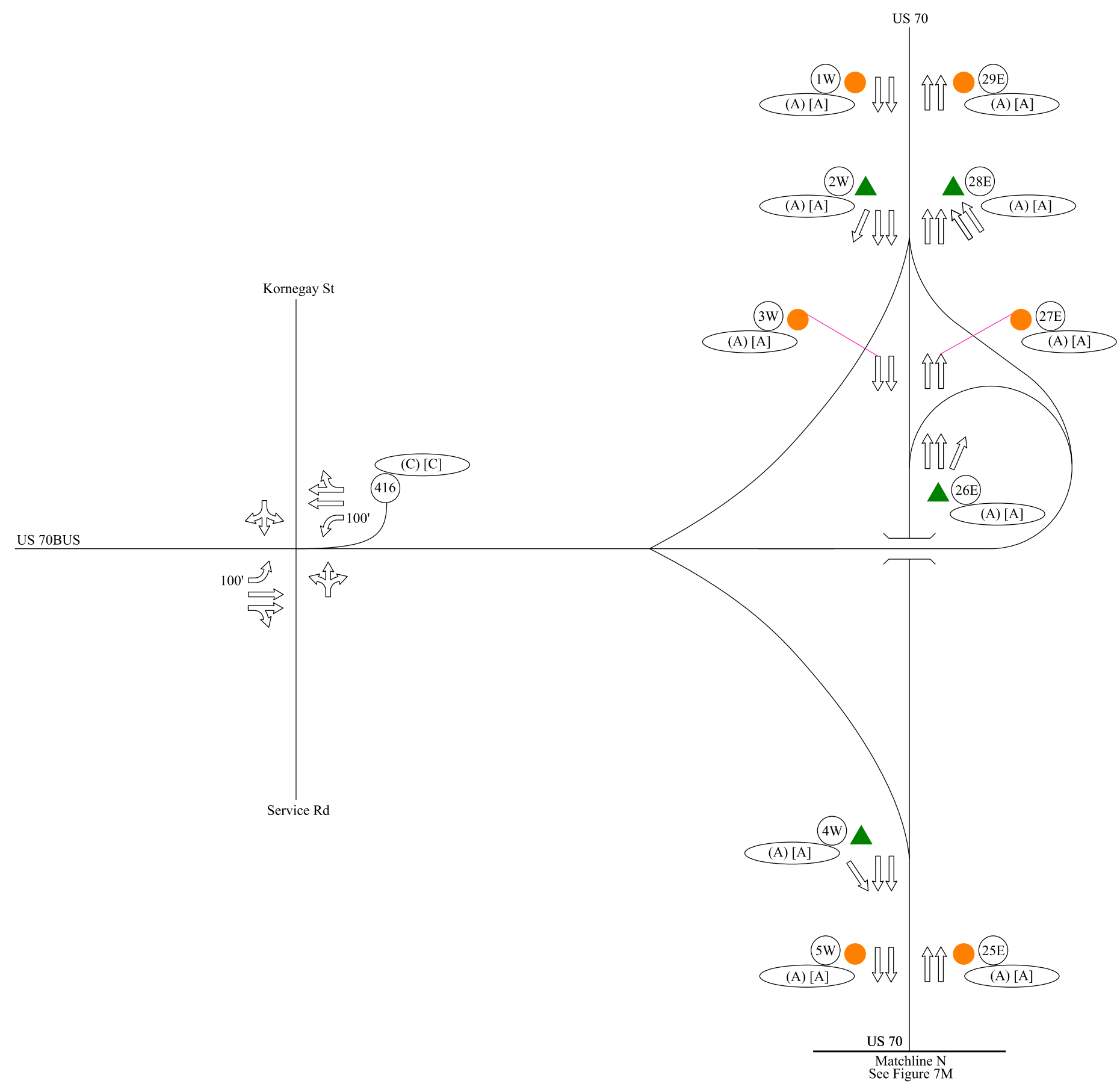




2040 Build Alternative 31
LOS and Laneage
Figure 7M

-  Laneage
-  Intersection or FREEVAL Number
-  AM Peak and PM Peak LOS
-  Signal
-  Basic Freeway Segment
-  Ramp Merge/Diverge
-  Freeway Weaving Segment
-  Storage





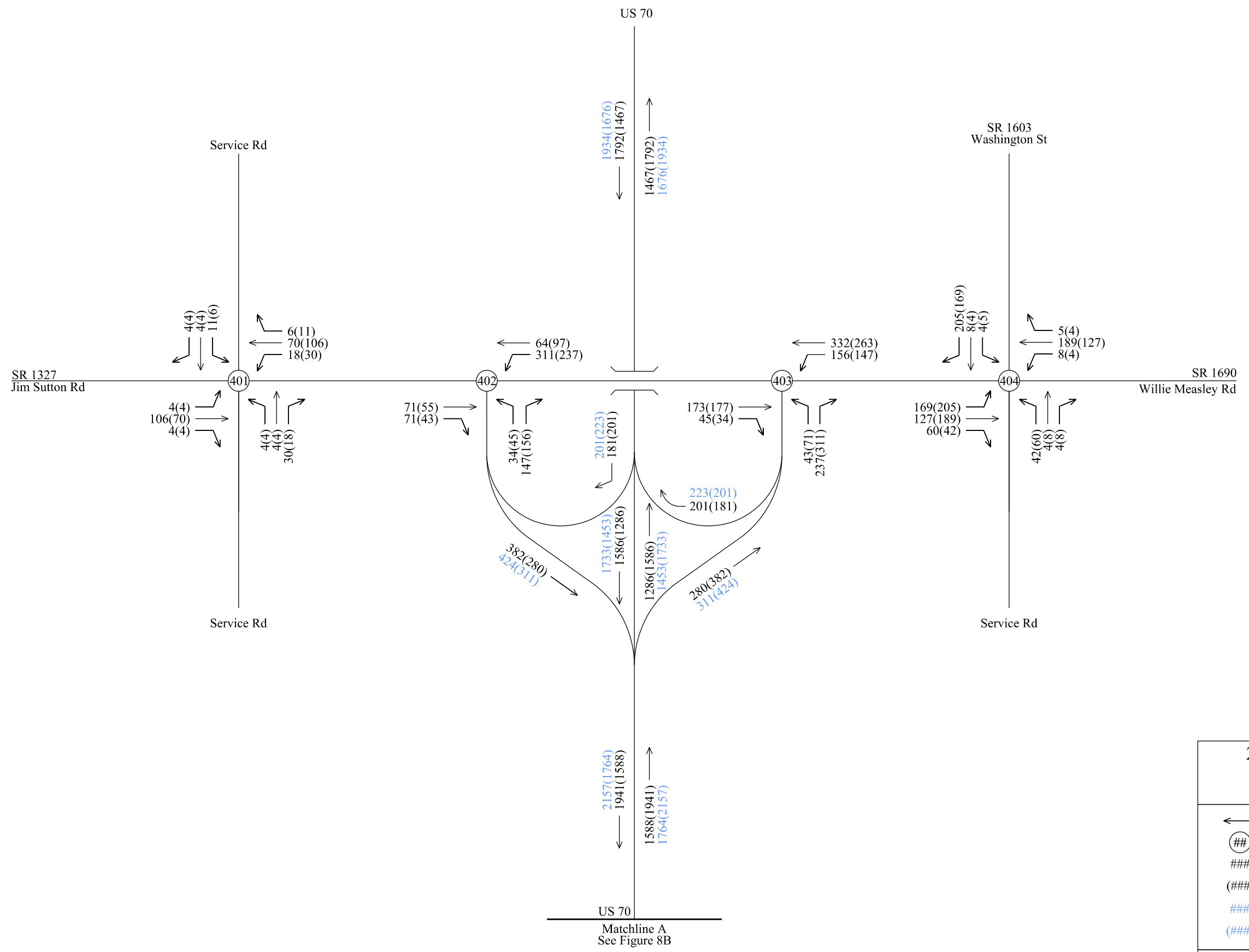
2040 Build Alternative 31 LOS and Laneage Figure 7N	
	Laneage
	Intersection or FREEVAL Number
	AM Peak and PM Peak LOS
	Signal
	Basic Freeway Segment
	Ramp Merge/Diverge
	Freeway Weaving Segment
	Storage



This page left intentionally blank

**2040 Build Alternative 32
Peak Hour Volume Figures**

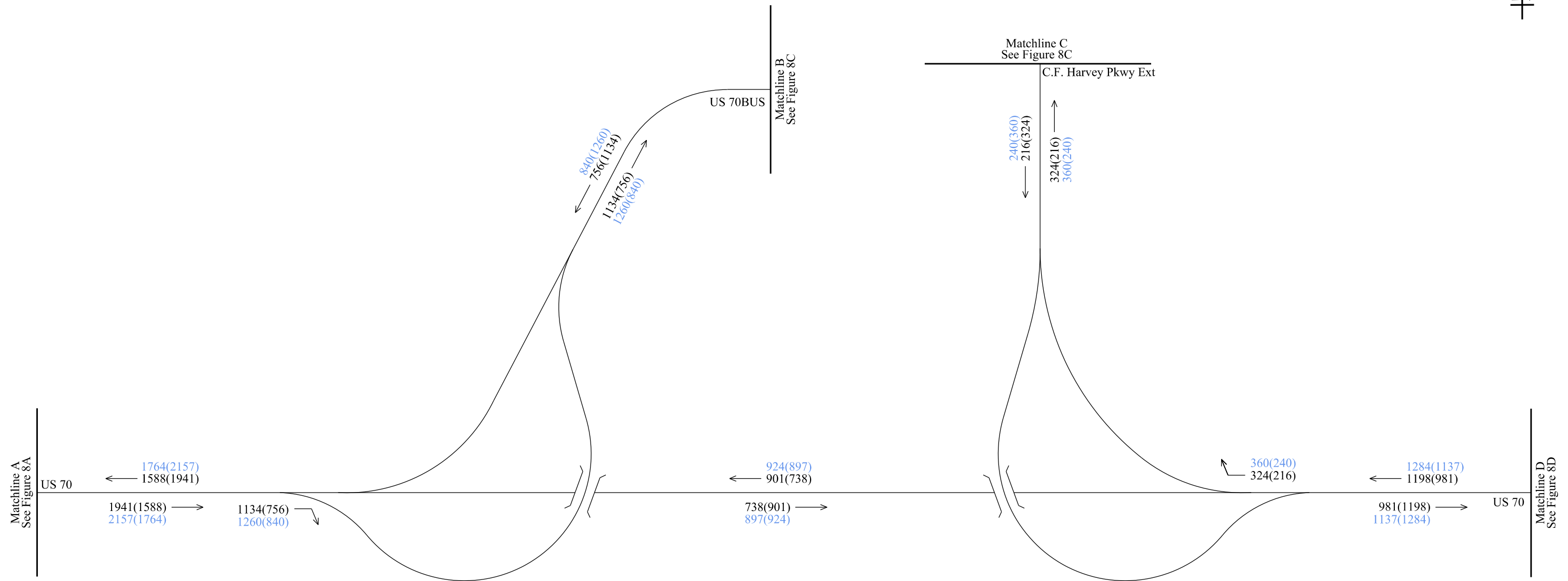
This page left intentionally blank



2040 Build - Alternative 32
Peak Hour Volumes
Figure 8A

- ← Turning Movement
- ⊙ Intersection Number
- ### AM Peak Hour Volumes
- (###) PM Peak Hour Volumes
- ### AM Balanced and Adjusted Volumes
- (###) PM Balanced and Adjusted Volumes

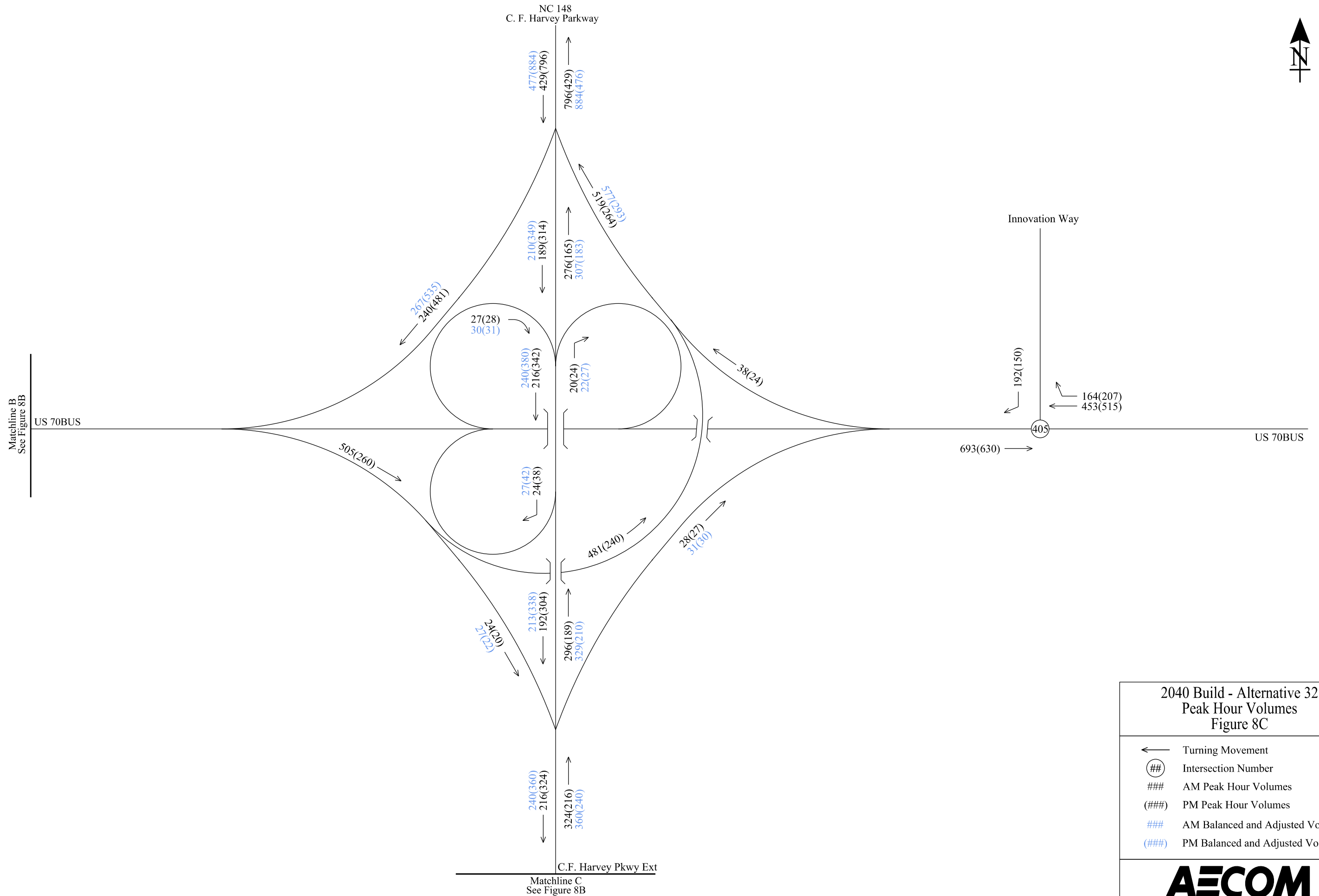




2040 Build - Alternative 32
Peak Hour Volumes
Figure 8B

- ← Turning Movement
- ⊙ Intersection Number
- ### AM Peak Hour Volumes
- (###) PM Peak Hour Volumes
- ### AM Balanced and Adjusted Volumes
- (###) PM Balanced and Adjusted Volumes

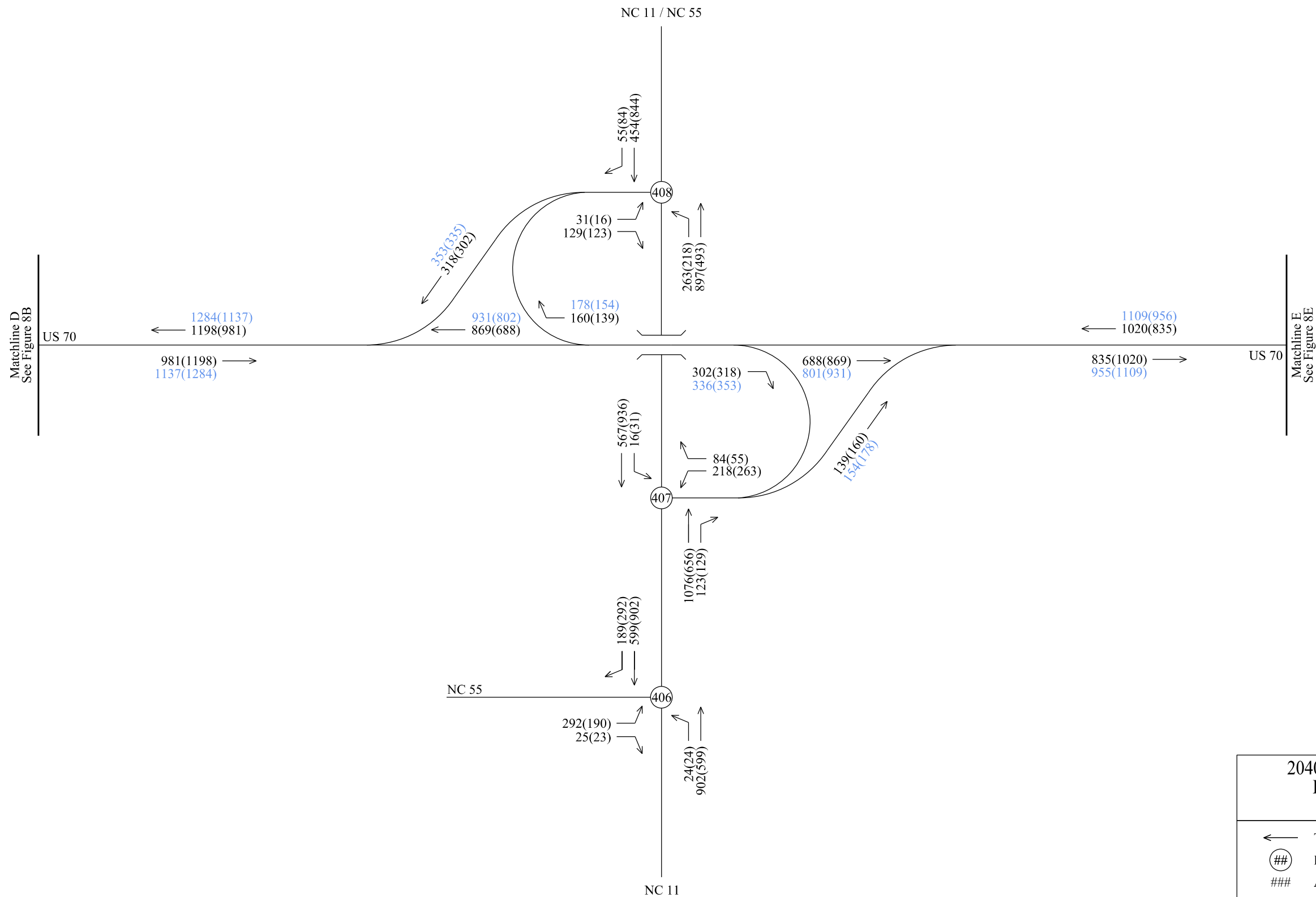




2040 Build - Alternative 32
Peak Hour Volumes
Figure 8C

- ← Turning Movement
- ⊙ Intersection Number
- ### AM Peak Hour Volumes
- (###) PM Peak Hour Volumes
- ### AM Balanced and Adjusted Volumes
- (###) PM Balanced and Adjusted Volumes

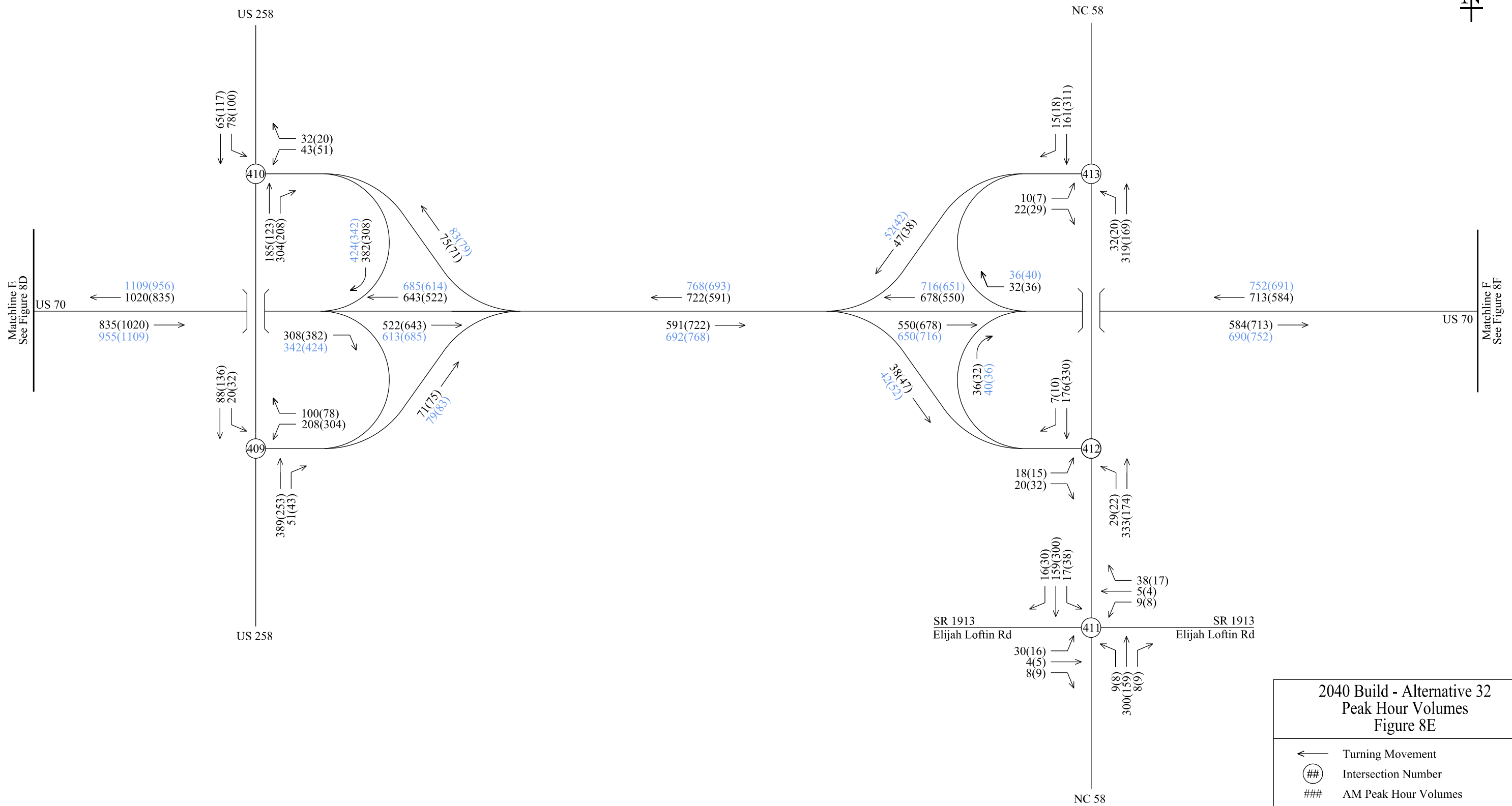




2040 Build - Alternative 32
Peak Hour Volumes
Figure 8D

- ← Turning Movement
- ⊕ Intersection Number
- ### AM Peak Hour Volumes
- (###) PM Peak Hour Volumes
- ### AM Balanced and Adjusted Volumes
- (###) PM Balanced and Adjusted Volumes

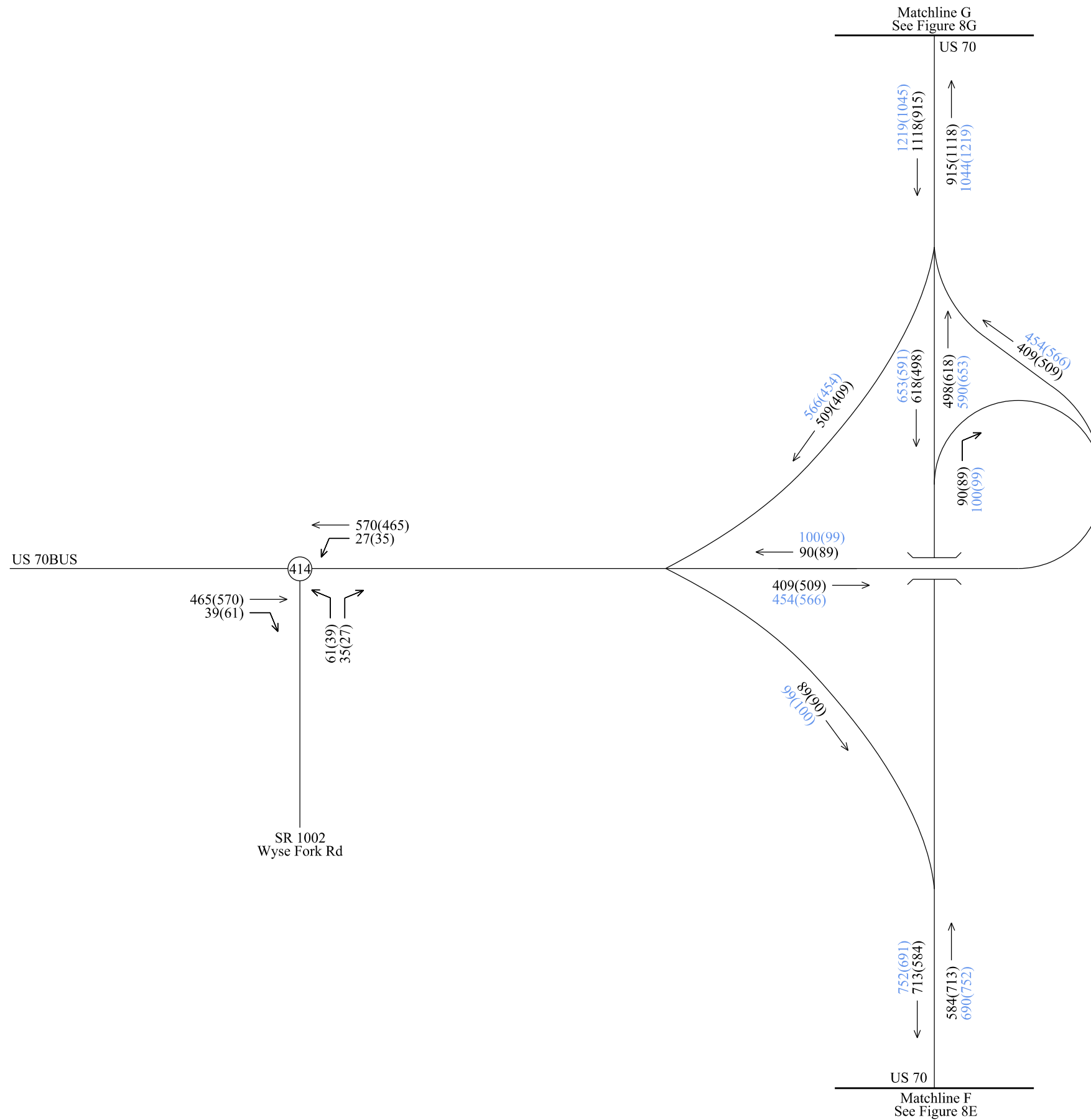




2040 Build - Alternative 32
Peak Hour Volumes
Figure 8E

- ← Turning Movement
- ⊙ Intersection Number
- ### AM Peak Hour Volumes
- (###) PM Peak Hour Volumes
- ### AM Balanced and Adjusted Volumes
- (###) PM Balanced and Adjusted Volumes

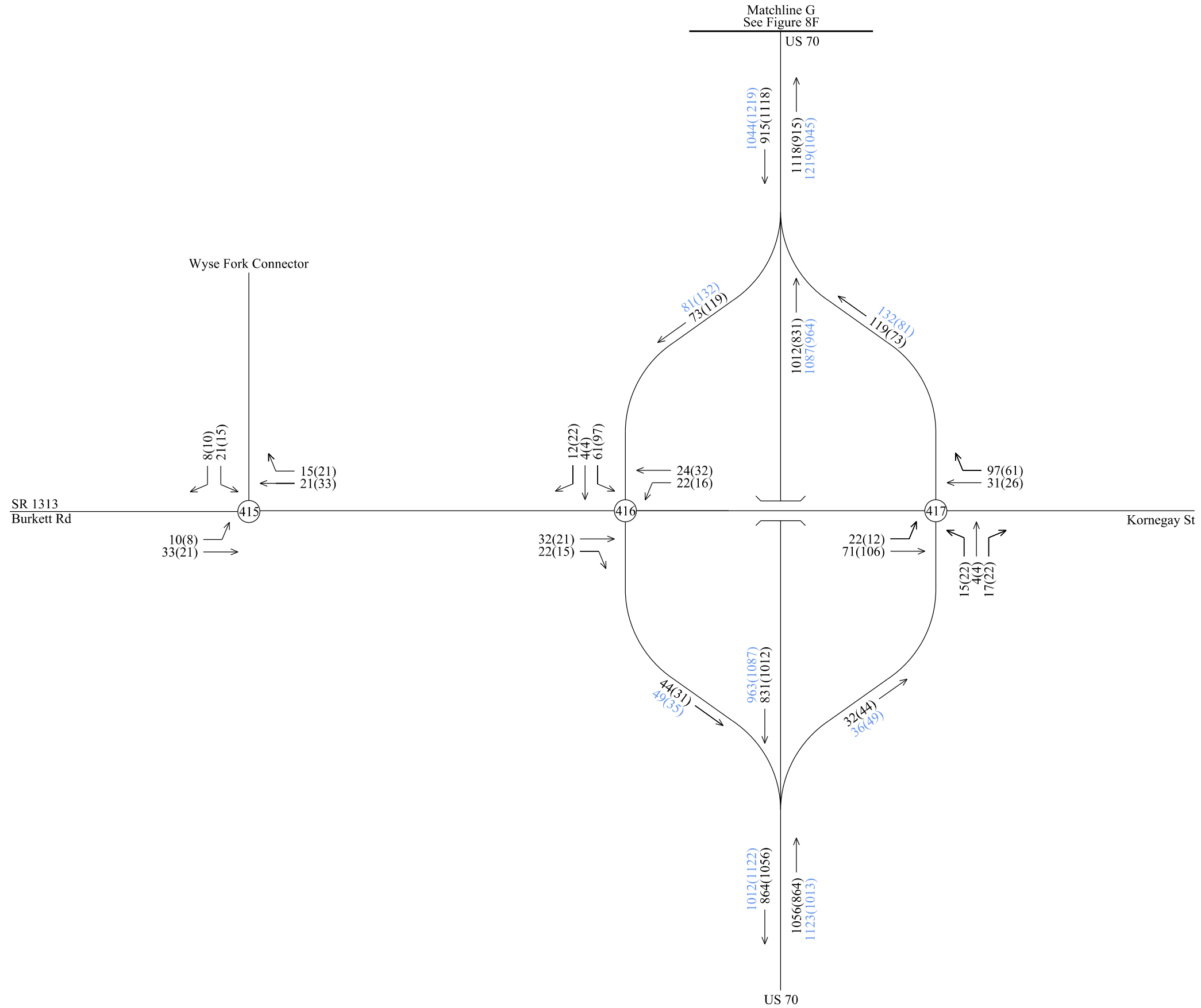




2040 Build - Alternative 32
Peak Hour Volumes
Figure 8F

- ← Turning Movement
- ⊙ Intersection Number
- ### AM Peak Hour Volumes
- (###) PM Peak Hour Volumes
- ### AM Balanced and Adjusted Volumes
- (###) PM Balanced and Adjusted Volumes





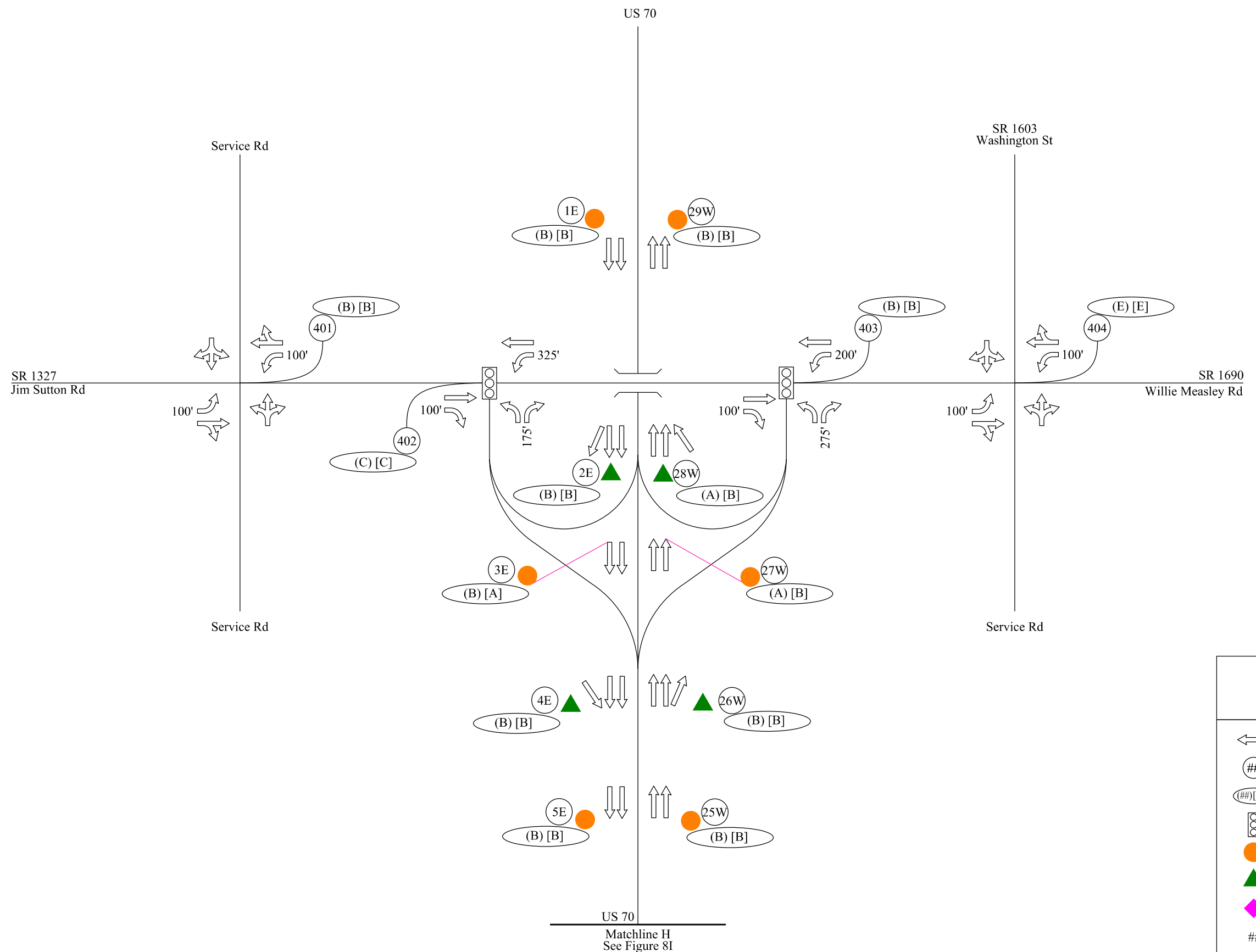
2040 Build - Alternative 32
Peak Hour Volumes
Figure 8G

- ← Turning Movement
- ⊙ Intersection Number
- ### AM Peak Hour Volumes
- (###) PM Peak Hour Volumes
- ## AM Balanced and Adjusted Volumes
- (##) PM Balanced and Adjusted Volumes

This page left intentionally blank

**2040 Build Alternative 32
LOS and Laneage Figures**

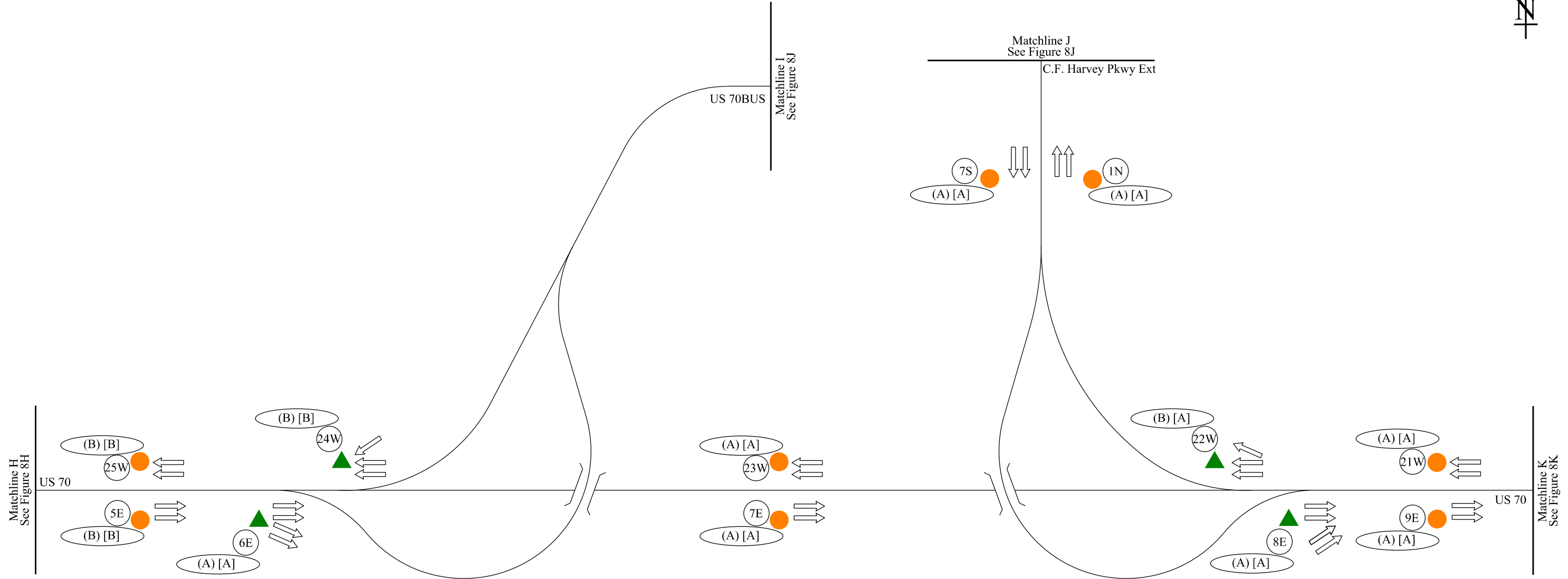
This page left intentionally blank



2040 Build Alternative 32
LOS and Laneage
Figure 8H

- Laneage
- Intersection or FREEVAL Number
- AM Peak and PM Peak LOS
- Signal
- Basic Freeway Segment
- Ramp Merge/Diverge
- Freeway Weaving Segment
- Storage





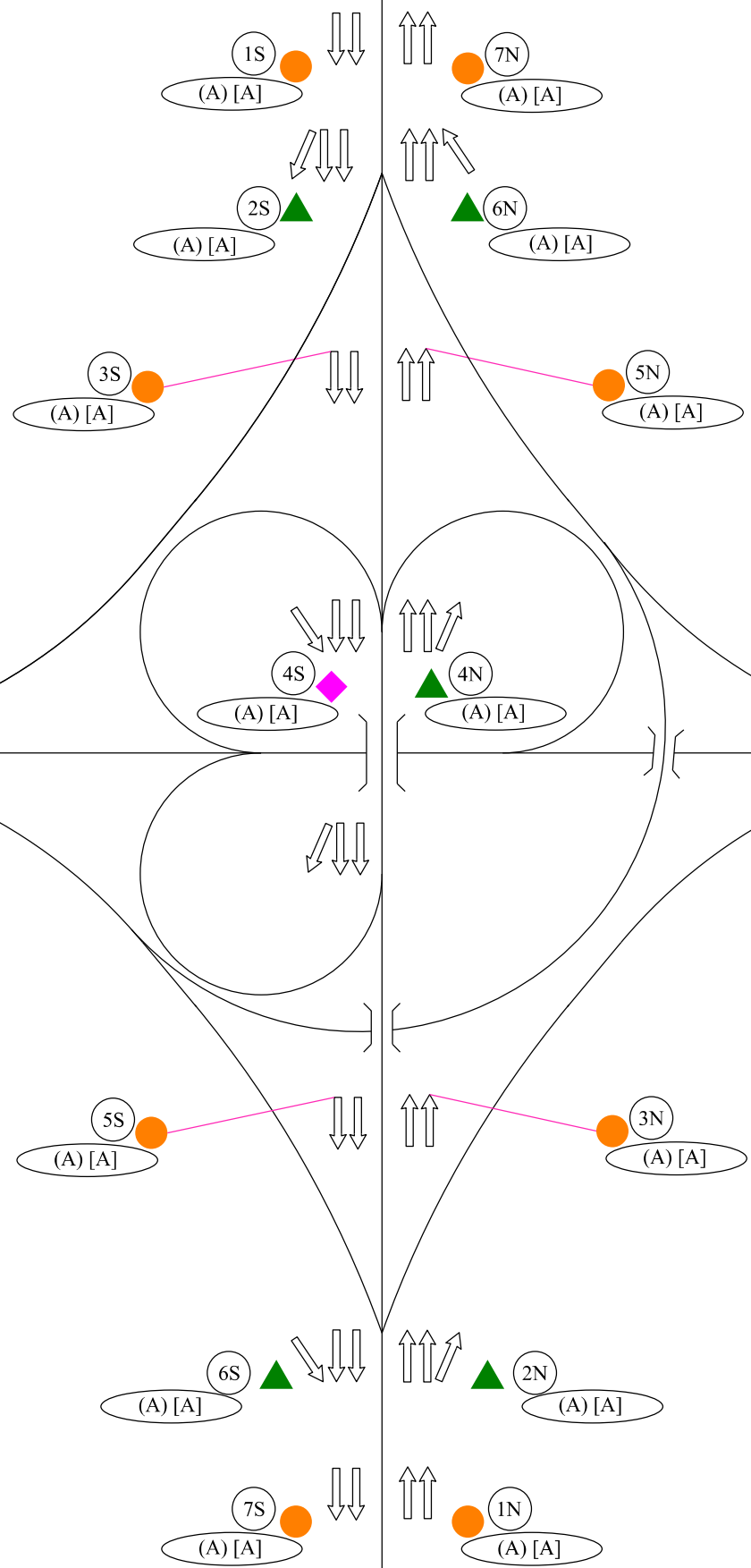
2040 Build Alternative 32
LOS and Laneage
Figure 8I

- ← Laneage
- ## Intersection or FREEVAL Number
- (##)(##) AM Peak and PM Peak LOS
- ⓧ Signal
- Basic Freeway Segment
- ▲ Ramp Merge/Diverge
- ◆ Freeway Weaving Segment
- ### Storage





NC 148
C. F. Harvey Parkway



Innovation Way

300'

Matchline I
See Figure 8I









US 70BUS

US 70BUS

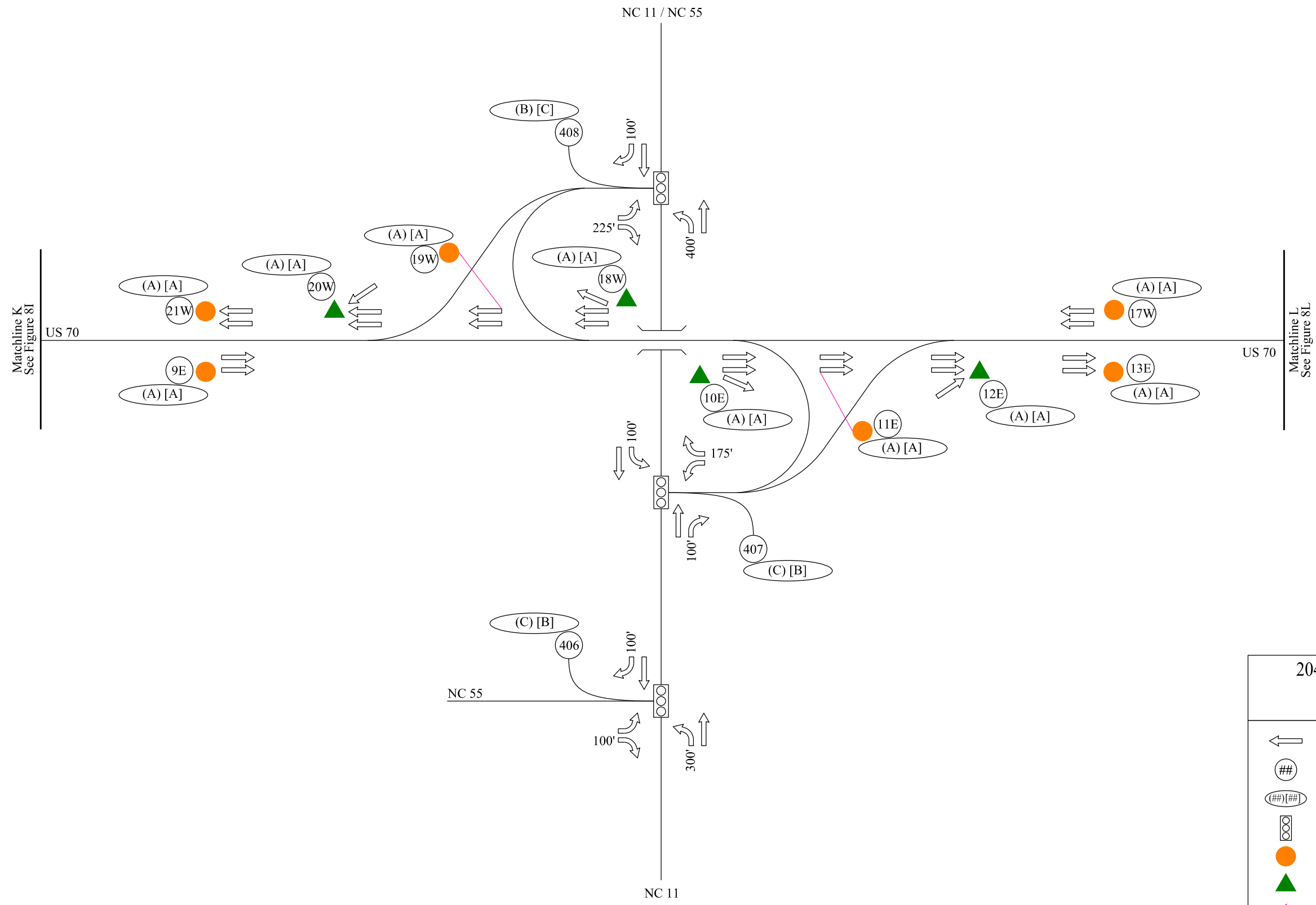
C.F. Harvey Pkwy Ext

Matchline J
See Figure 8I

2040 Build Alternative 32
LOS and Laneage
Figure 8J

-  Laneage
-  Intersection or FREEVAL Number
-  AM Peak and PM Peak LOS
-  Signal
-  Basic Freeway Segment
-  Ramp Merge/Diverge
-  Freeway Weaving Segment
-  Storage













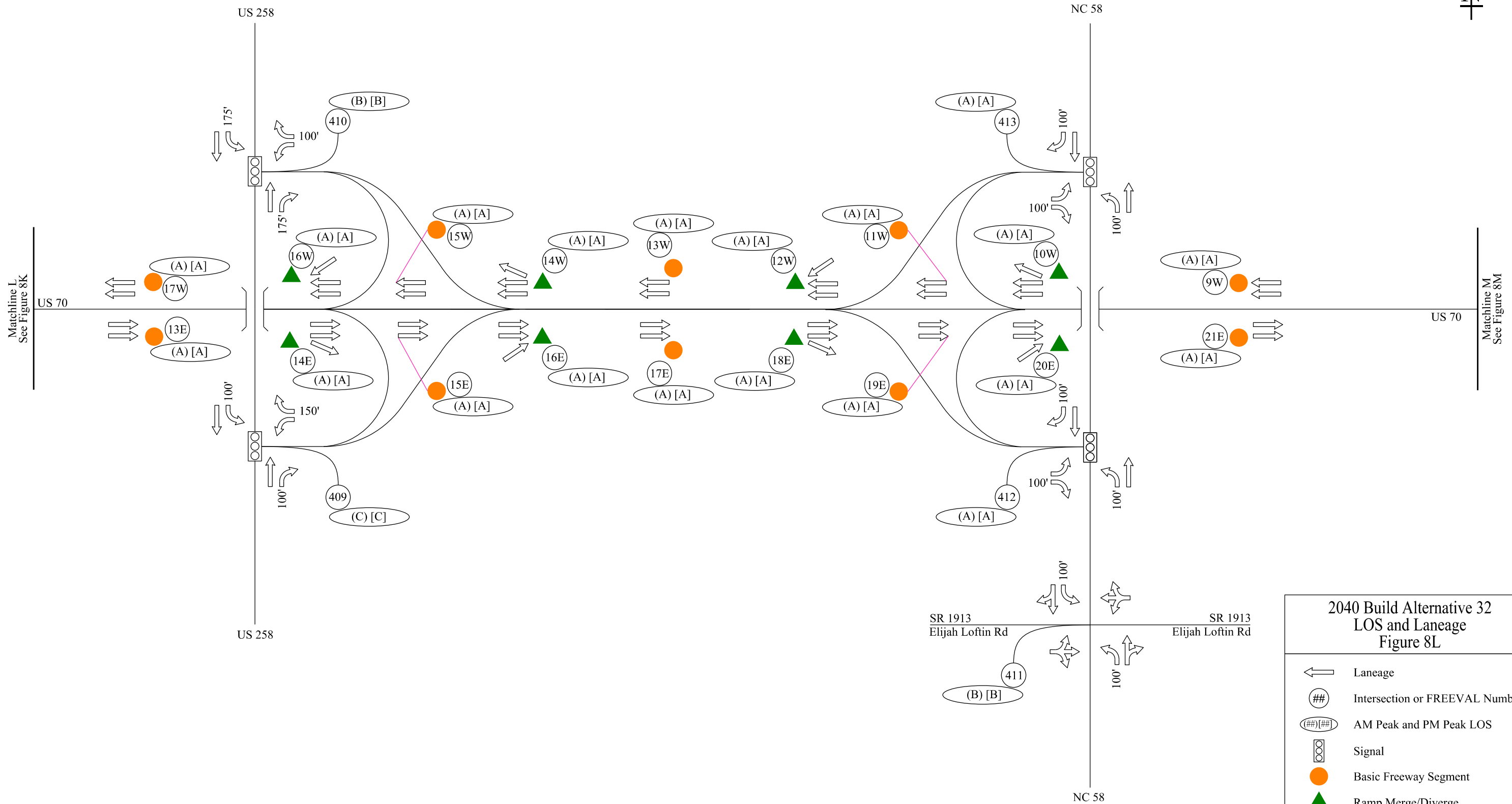
Matchline K
See Figure 8I

Matchline L
See Figure 8L

2040 Build Alternative 32
LOS and Laneage
Figure 8K

-  Laneage
-  Intersection or FREEVAL Number
-  AM Peak and PM Peak LOS
-  Signal
-  Basic Freeway Segment
-  Ramp Merge/Diverge
-  Freeway Weaving Segment
-  Storage





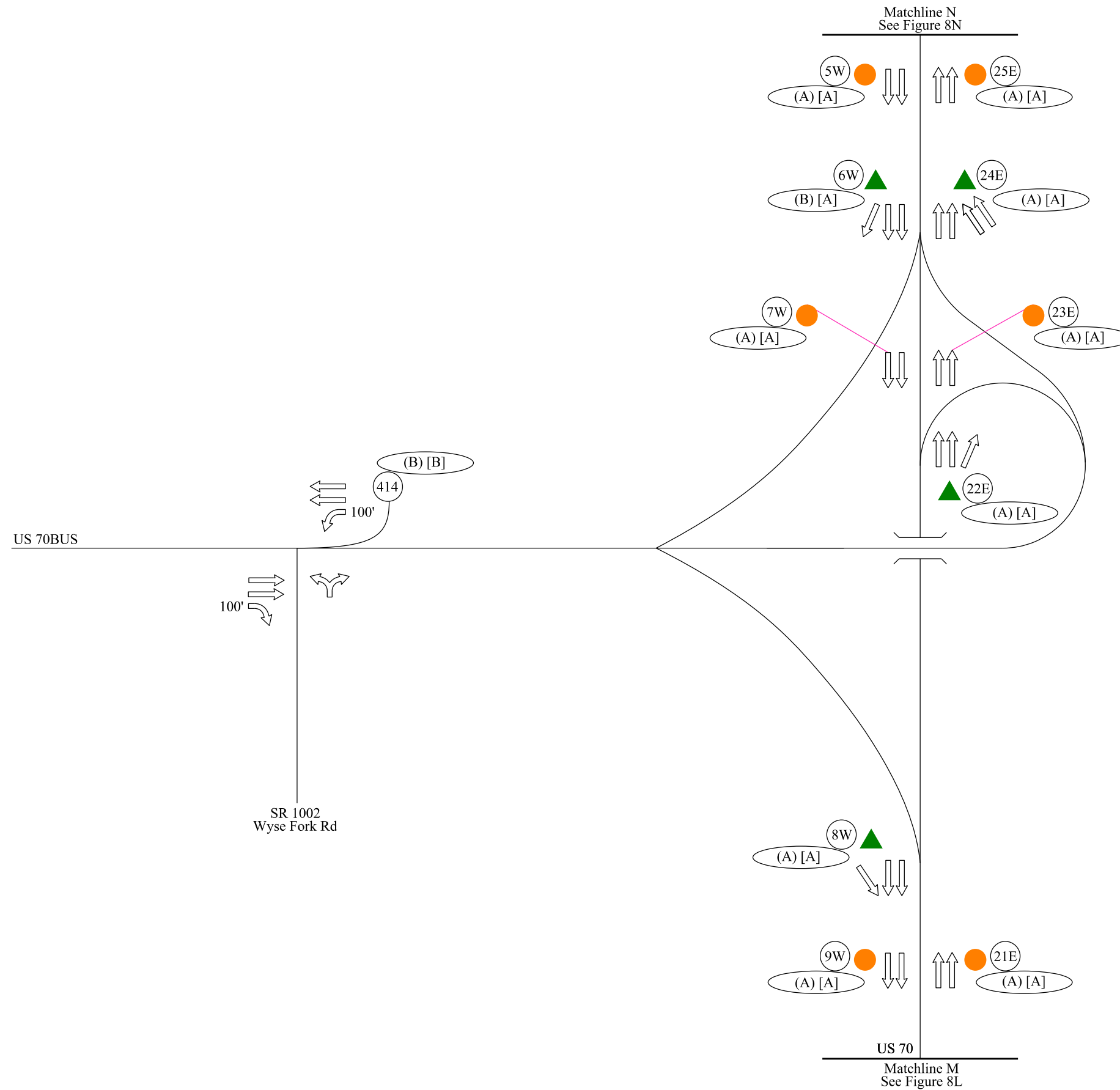
Matchline L
See Figure 8K

Matchline M
See Figure 8M









**2040 Build Alternative 32
LOS and Laneage
Figure 8L**

- Laneage
- Intersection or FREEVAL Number
- AM Peak and PM Peak LOS
- Signal
- Basic Freeway Segment
- Ramp Merge/Diverge
- Freeway Weaving Segment
- Storage

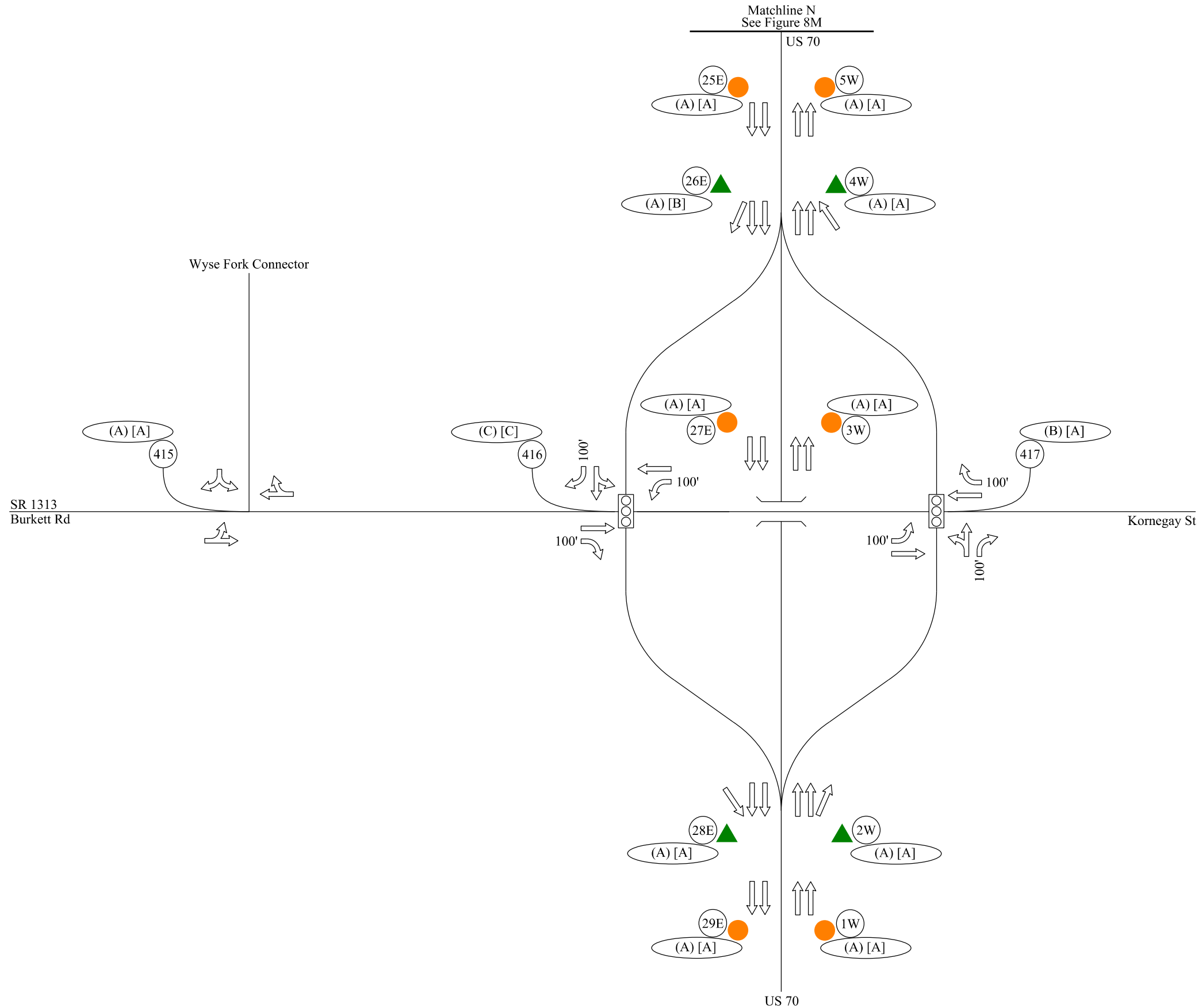




2040 Build Alternative 32
LOS and Laneage
Figure 8M

-  Laneage
-  Intersection or FREEVAL Number
-  AM Peak and PM Peak LOS
-  Signal
-  Basic Freeway Segment
-  Ramp Merge/Diverge
-  Freeway Weaving Segment
-  Storage





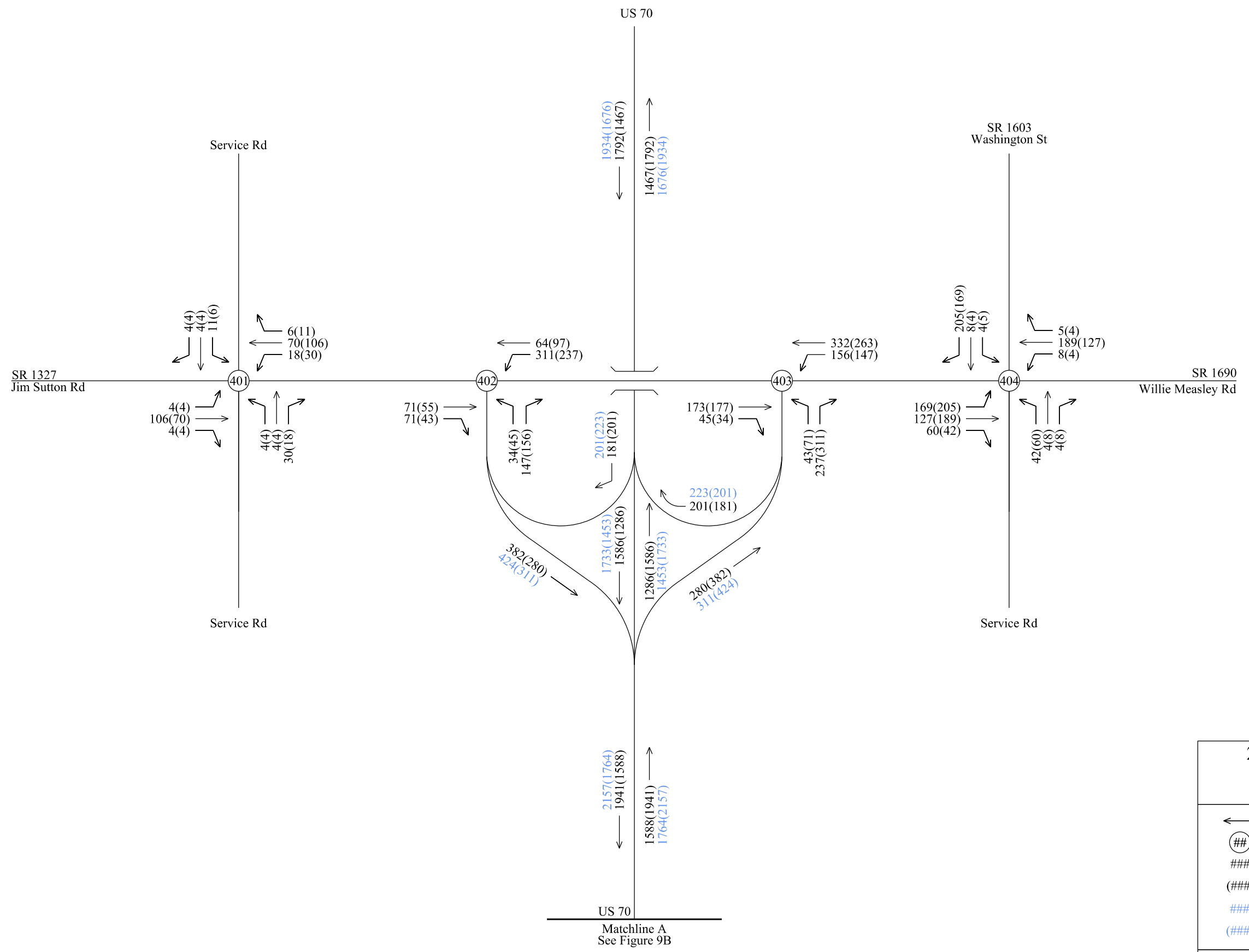
2040 Build Alternative 32 LOS and Laneage Figure 8N	
	Laneage
	Intersection or FREEVAL Number
	AM Peak and PM Peak LOS
	Signal
	Basic Freeway Segment
	Ramp Merge/Diverge
	Freeway Weaving Segment
	Storage



This page left intentionally blank

**2040 Build Alternative 63
Peak Hour Volume Figures**

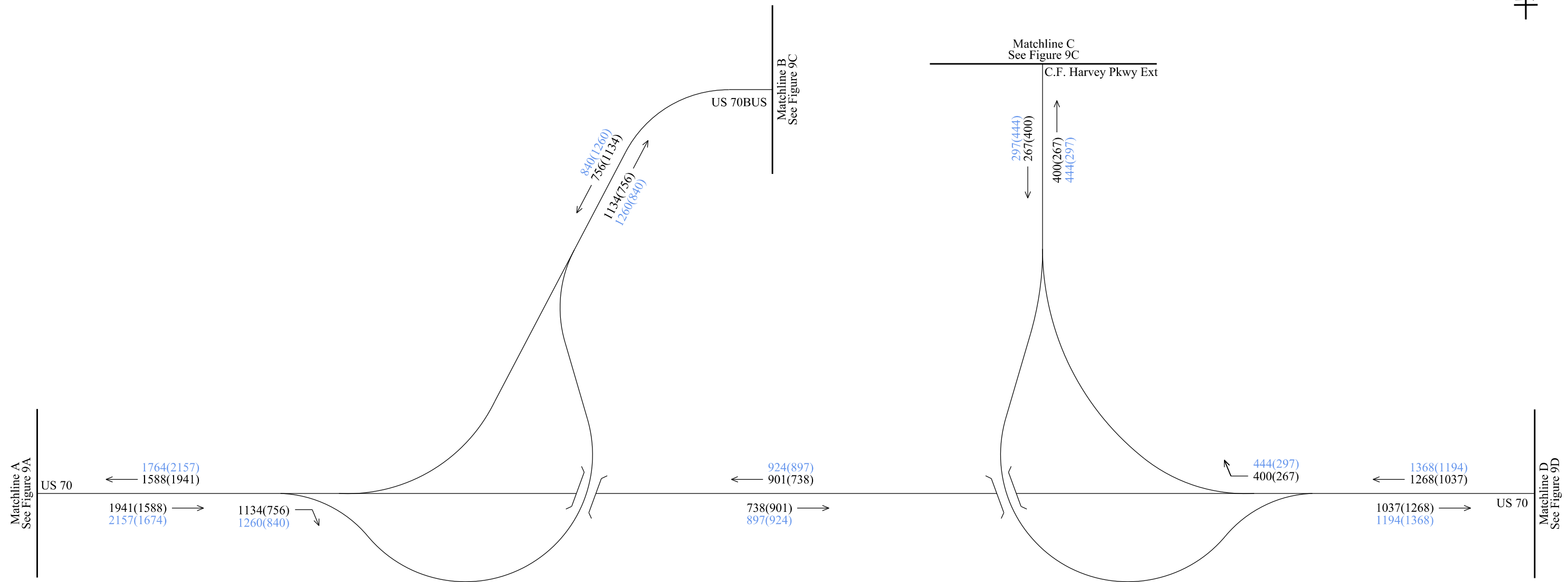
This page left intentionally blank



2040 Build - Alternative 63
Peak Hour Volumes
Figure 9A

- ← Turning Movement
- ⊙ Intersection Number
- ### AM Peak Hour Volumes
- (###) PM Peak Hour Volumes
- ### AM Balanced and Adjusted Volumes
- (###) PM Balanced and Adjusted Volumes





2040 Build - Alternative 63
Peak Hour Volumes
Figure 9B

- ← Turning Movement
- ⊕ Intersection Number
- ### AM Peak Hour Volumes
- (###) PM Peak Hour Volumes
- ### AM Balanced and Adjusted Volumes
- (###) PM Balanced and Adjusted Volumes





NC 148
C. F. Harvey Parkway

475(890)
429(796)

796(429)
890(474)

206(357)
185(319)

296(171)
332(190)

287(447)
258(400)

20(23)
22(26)

16(25)
14(22)

271(422)
244(378)

316(194)
354(216)

297(444)
267(400)

400(267)
444(297)

C.F. Harvey Pkwy Ext

Matchline C
See Figure 9B

Innovation Way

193(150)

163(207)
505(572)

750(681)

405

US 70BUS

US 70BUS

Matchline B
See Figure 9B

503(262)

269(533)
242(480)

267(222)
23(20)

480(242)

81(73)
90(81)

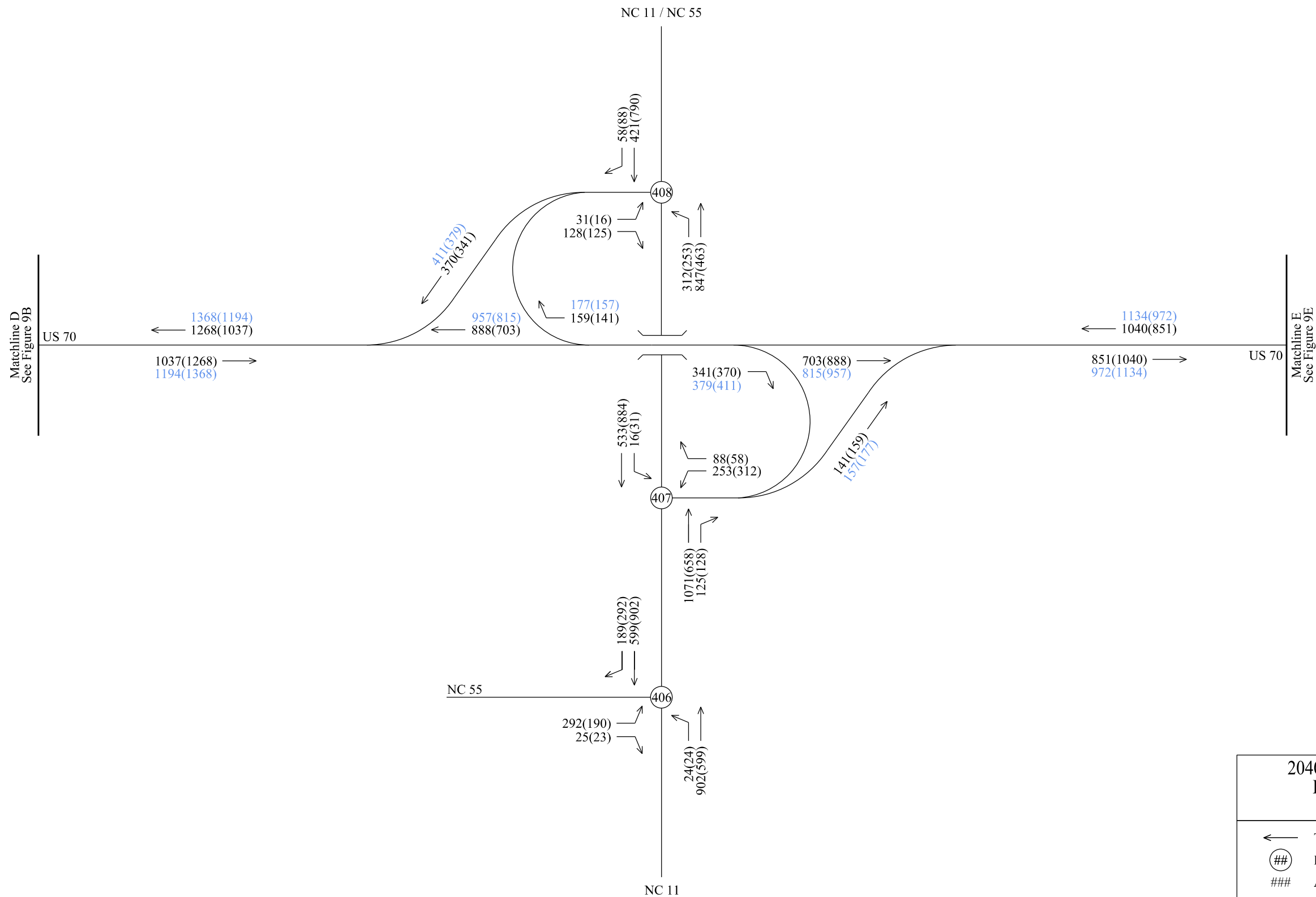
22(14)

558(284)
502(256)

2040 Build - Alternative 63
Peak Hour Volumes
Figure 9C

- ← Turning Movement
- ⊙ Intersection Number
- ### AM Peak Hour Volumes
- (###) PM Peak Hour Volumes
- ### AM Balanced and Adjusted Volumes
- (###) PM Balanced and Adjusted Volumes

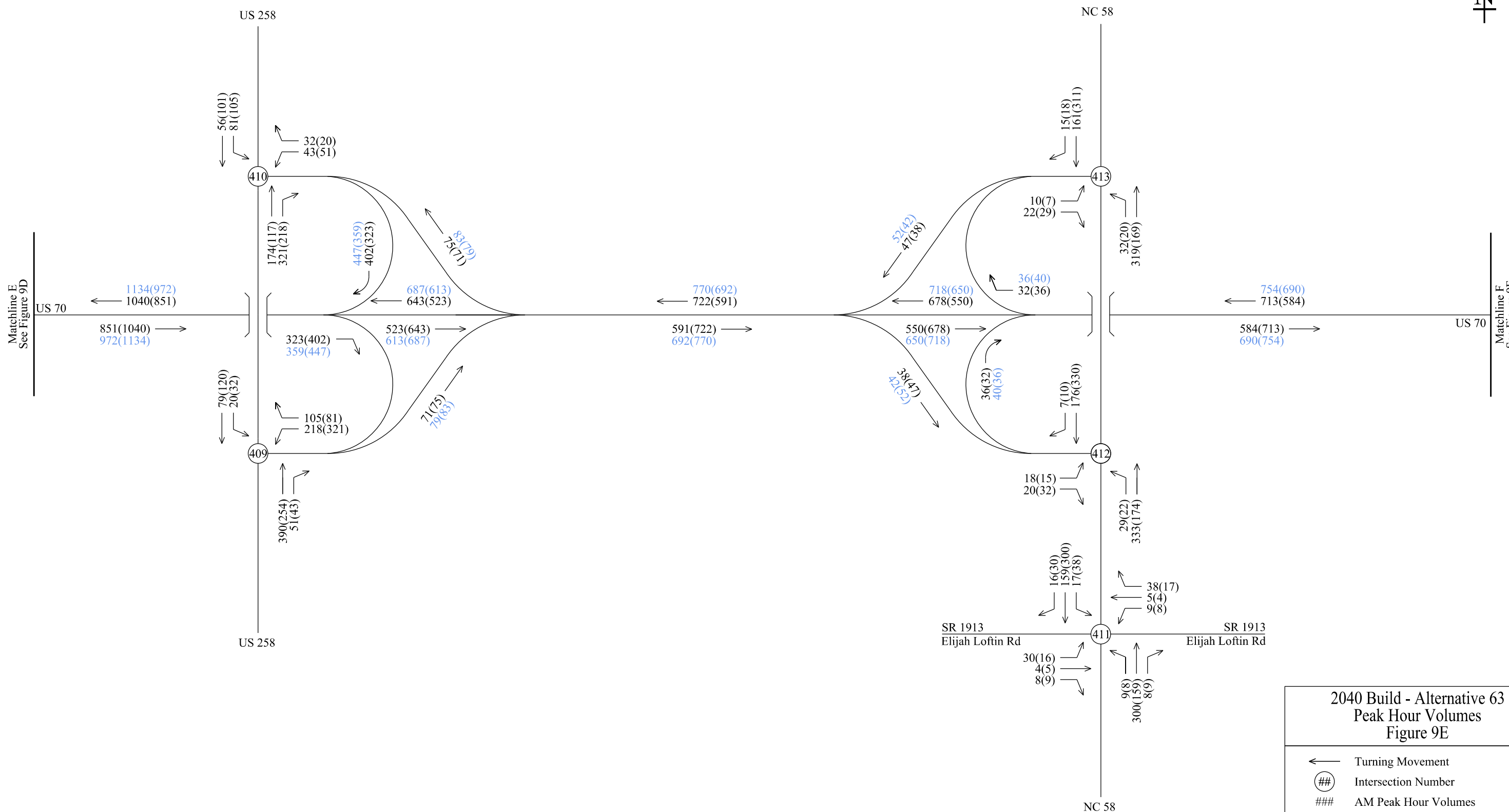




2040 Build - Alternative 63
Peak Hour Volumes
Figure 9D

- ← Turning Movement
- ⊙ Intersection Number
- ### AM Peak Hour Volumes
- (###) PM Peak Hour Volumes
- ### AM Balanced and Adjusted Volumes
- (###) PM Balanced and Adjusted Volumes

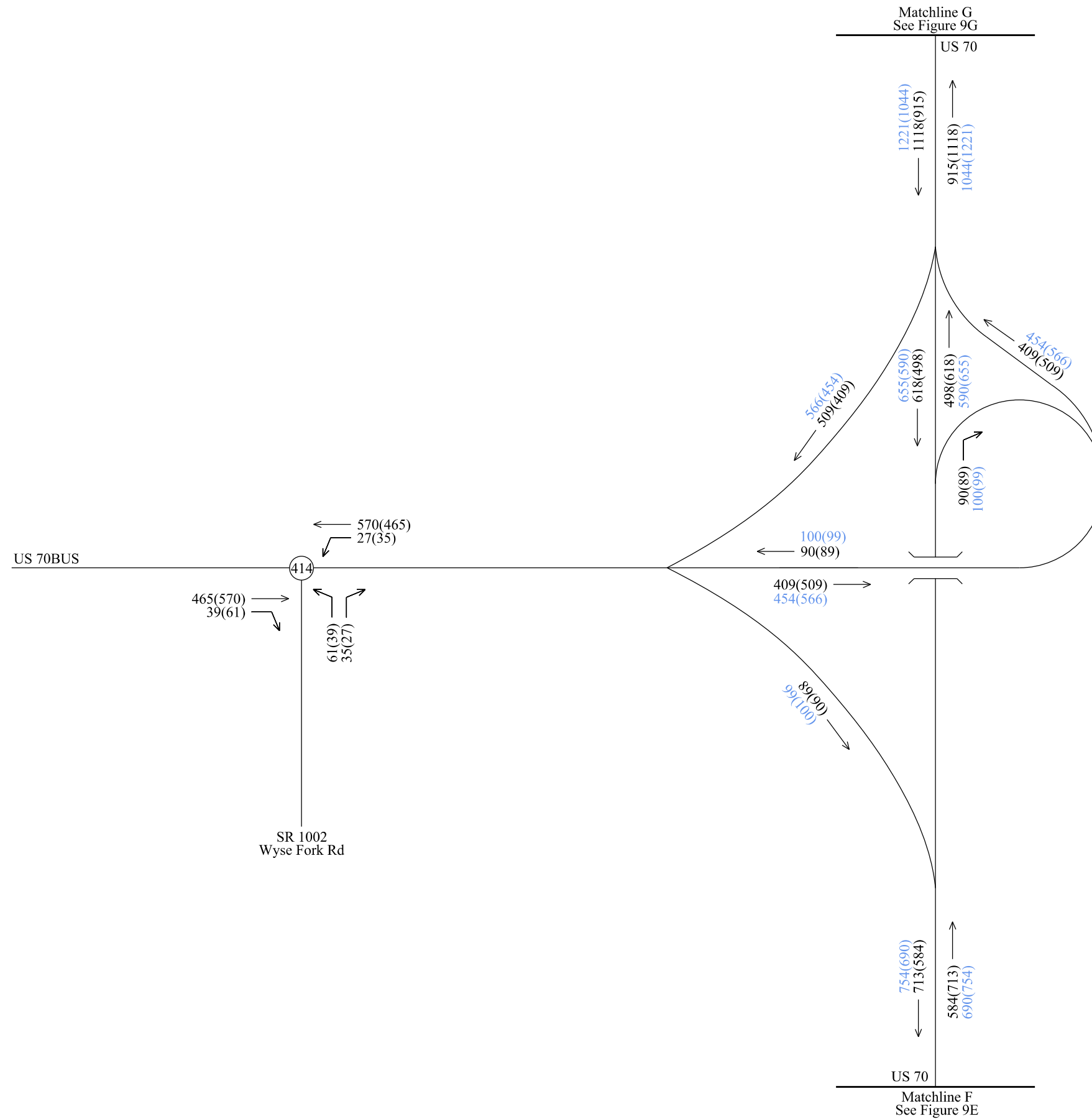




**2040 Build - Alternative 63
Peak Hour Volumes
Figure 9E**

←	Turning Movement
⊕	Intersection Number
###	AM Peak Hour Volumes
(###)	PM Peak Hour Volumes
###	AM Balanced and Adjusted Volumes
(###)	PM Balanced and Adjusted Volumes

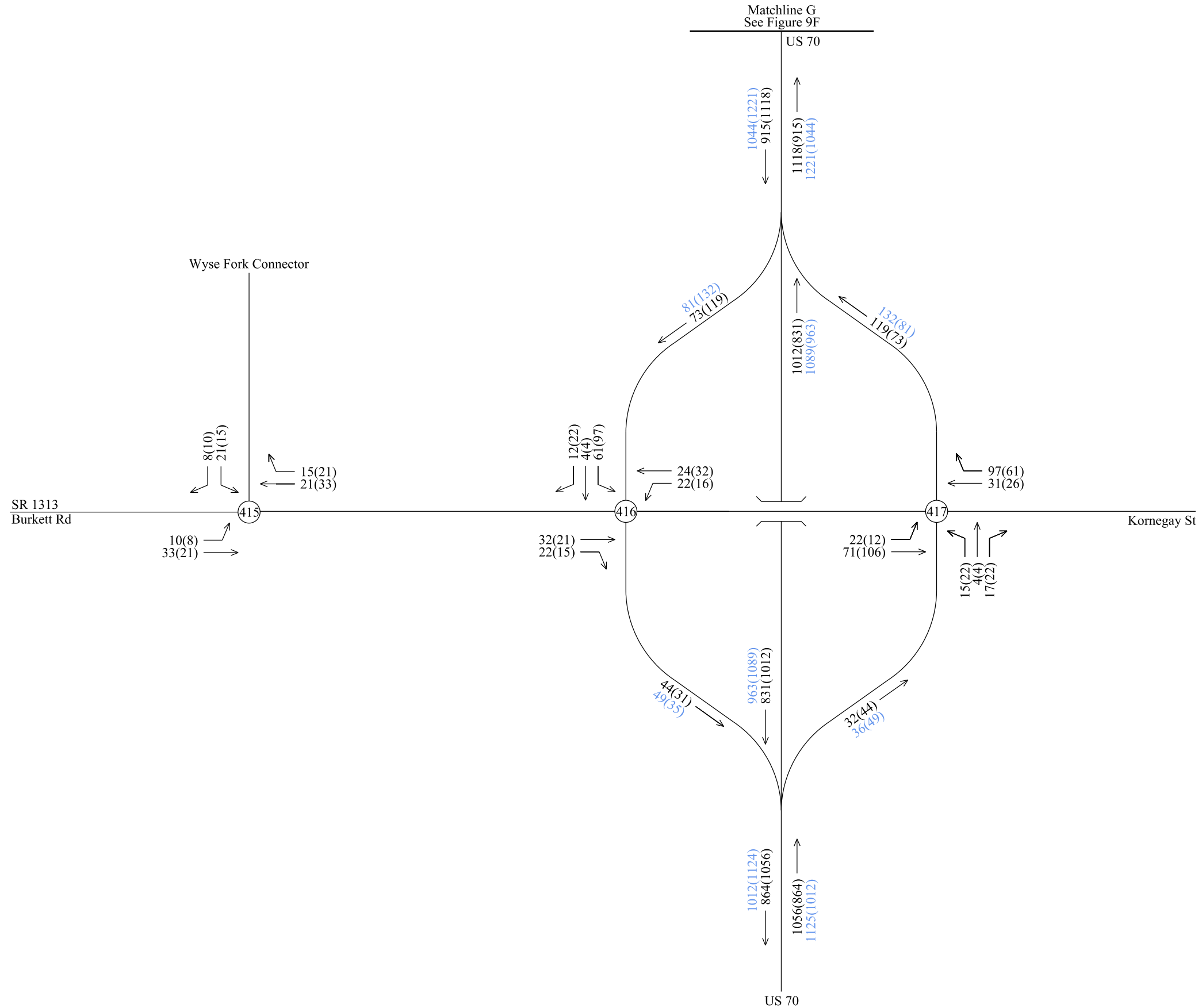
AECOM



2040 Build - Alternative 63
Peak Hour Volumes
Figure 9F

- ← Turning Movement
- ⊙ Intersection Number
- ### AM Peak Hour Volumes
- (###) PM Peak Hour Volumes
- ### AM Balanced and Adjusted Volumes
- (###) PM Balanced and Adjusted Volumes





2040 Build - Alternative 63
Peak Hour Volumes
Figure 9G

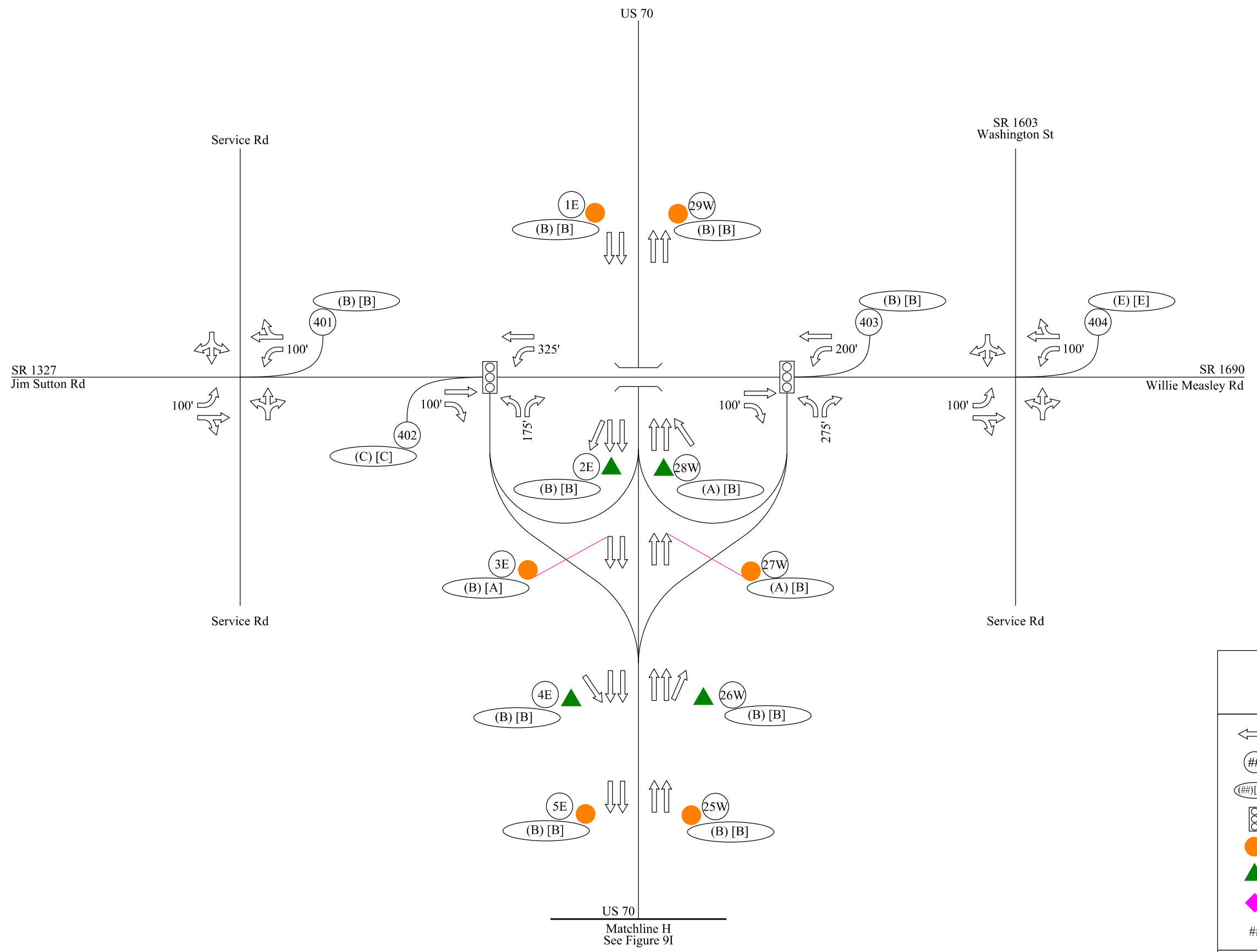
- ← Turning Movement
- ⊙ Intersection Number
- ### AM Peak Hour Volumes
- (###) PM Peak Hour Volumes
- ### AM Balanced and Adjusted Volumes
- (###) PM Balanced and Adjusted Volumes











This page left intentionally blank

**2040 Build Alternative 63
LOS and Laneage Figures**

This page left intentionally blank

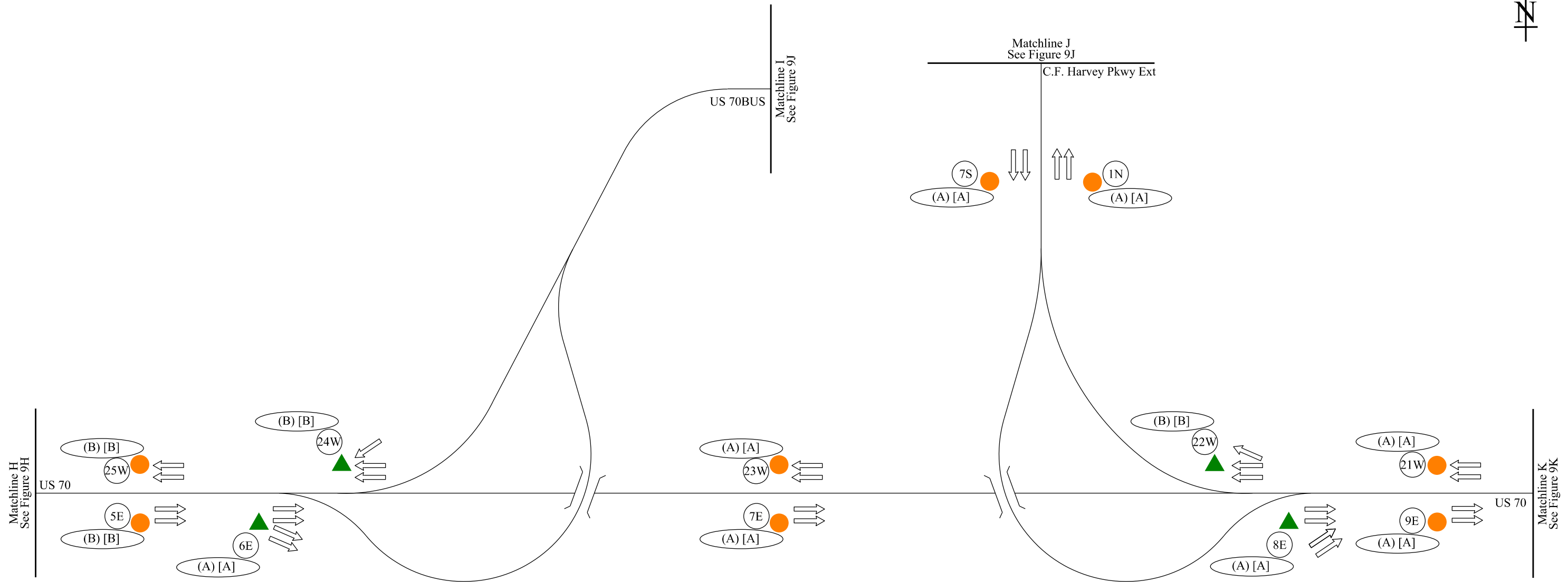


2040 Build Alternative 63
LOS and Laneage
Figure 9H

-  Laneage
-  Intersection or FREEVAL Number
-  AM Peak and PM Peak LOS
-  Signal
-  Basic Freeway Segment
-  Ramp Merge/Diverge
-  Freeway Weaving Segment
-  Storage



US 70
Matchline H
See Figure 9I



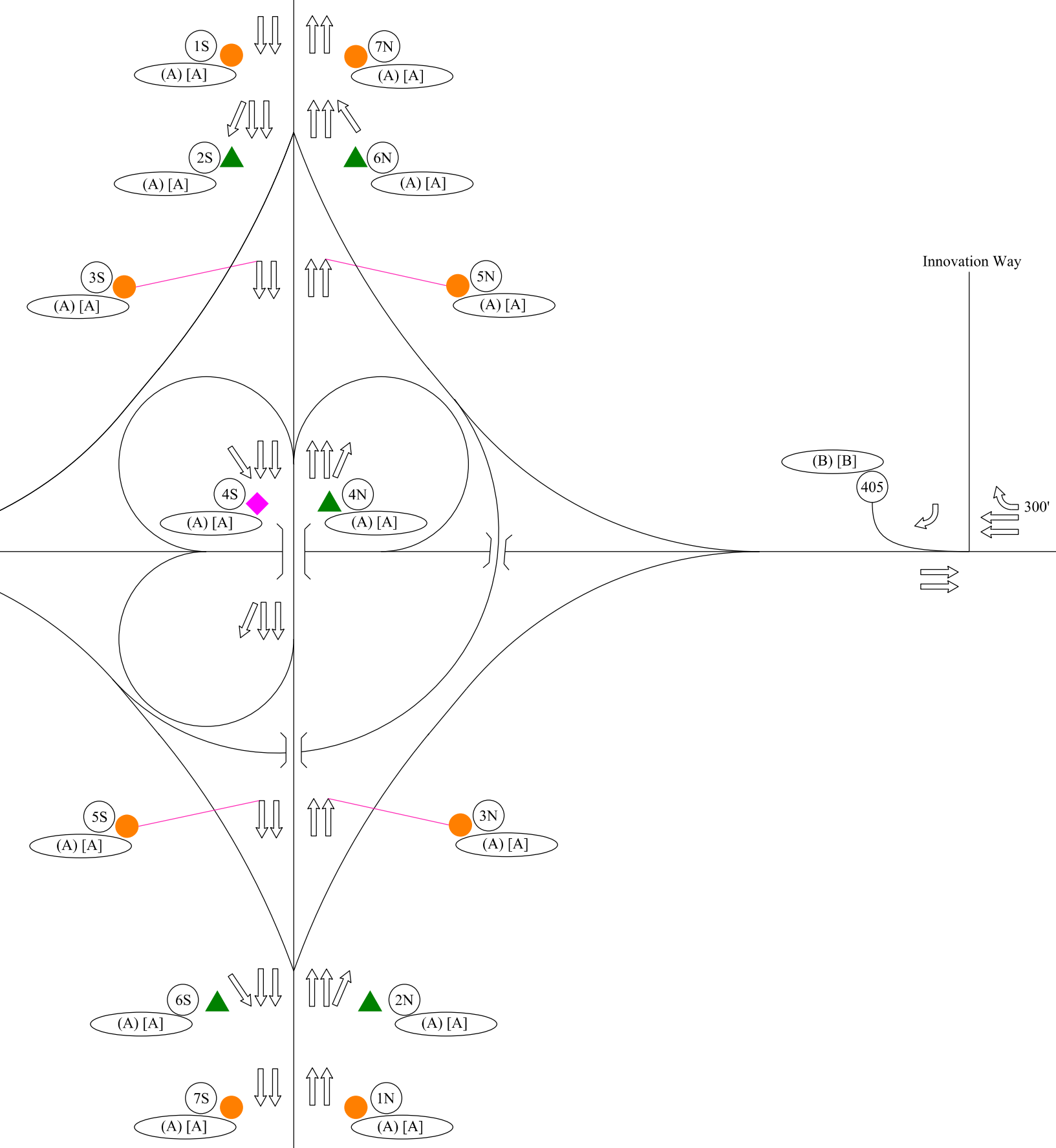
2040 Build Alternative 63
LOS and Laneage
Figure 9I

- Laneage
- Intersection or FREEVAL Number
- AM Peak and PM Peak LOS
- Signal
- Basic Freeway Segment
- Ramp Merge/Diverge
- Freeway Weaving Segment
- Storage





NC 148
C. F. Harvey Parkway



Matchline I
See Figure 9I









US 70BUS

US 70BUS

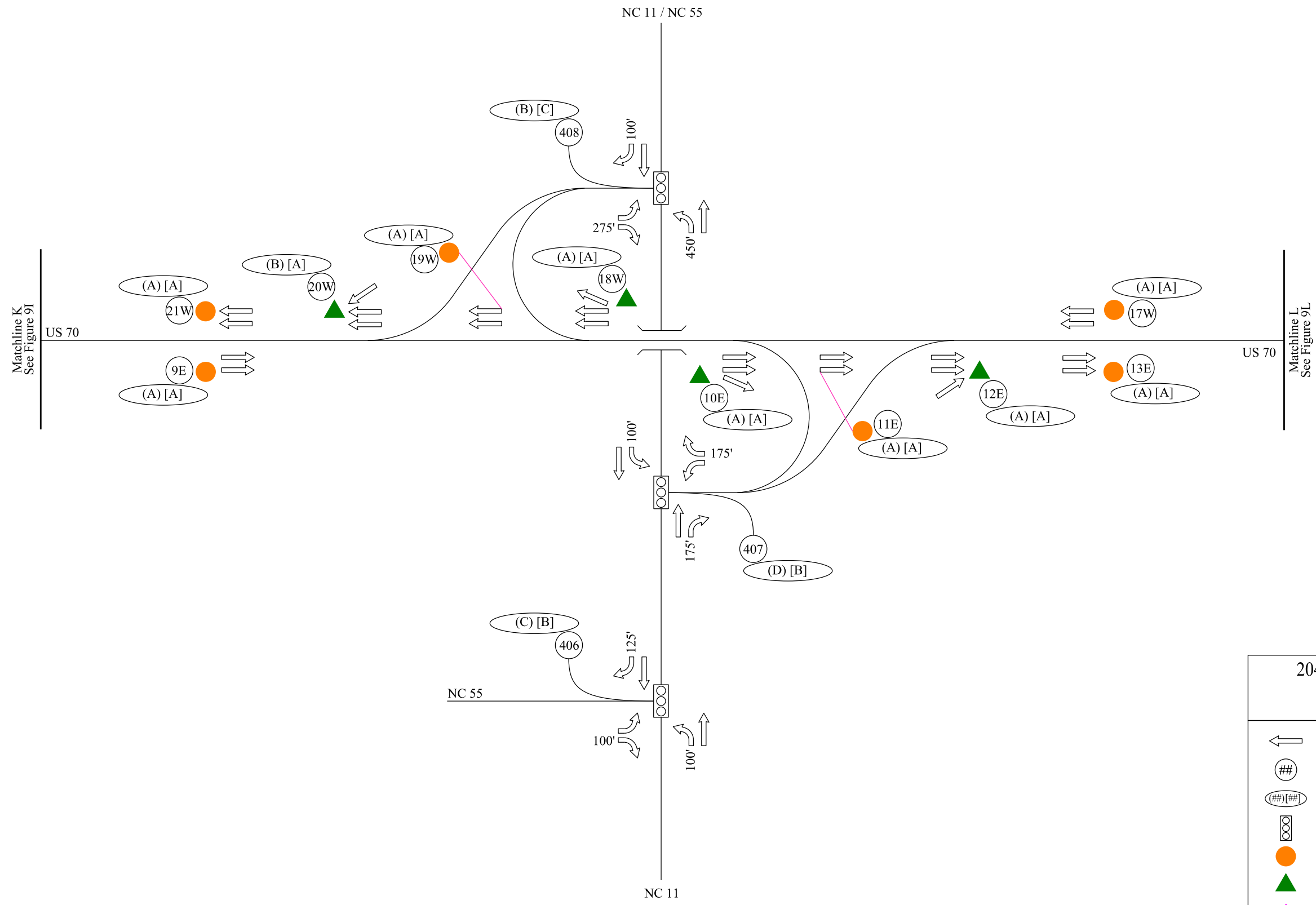
C.F. Harvey Pkwy Ext

Matchline J
See Figure 9I









2040 Build Alternative 63
LOS and Laneage
Figure 9J

-  Laneage
-  Intersection or FREEVAL Number
-  AM Peak and PM Peak LOS
-  Signal
-  Basic Freeway Segment
-  Ramp Merge/Diverge
-  Freeway Weaving Segment
-  Storage

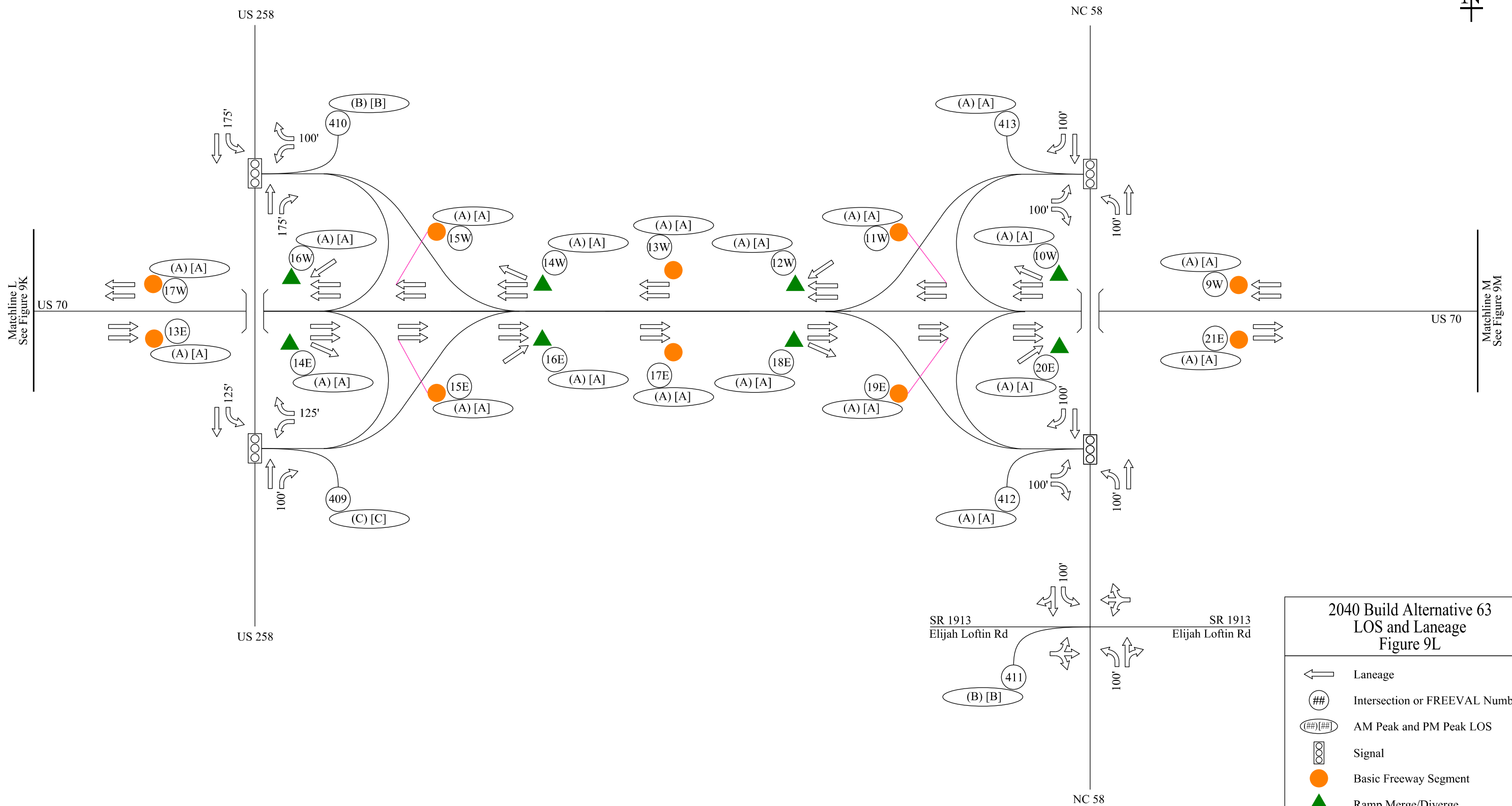












2040 Build Alternative 63
LOS and Laneage
Figure 9K

-  Laneage
-  Intersection or FREEVAL Number
-  AM Peak and PM Peak LOS
-  Signal
-  Basic Freeway Segment
-  Ramp Merge/Diverge
-  Freeway Weaving Segment
-  Storage

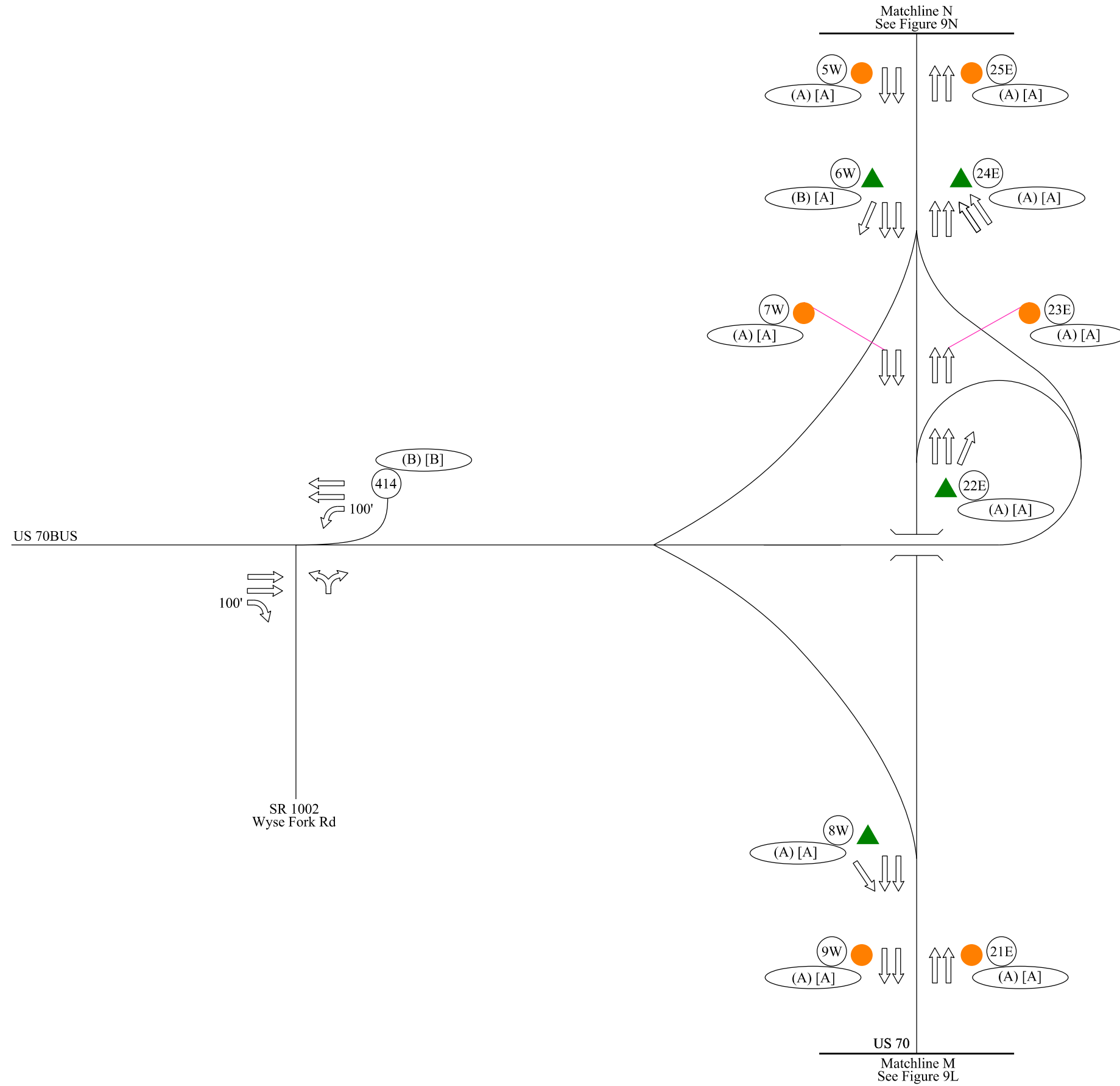




2040 Build Alternative 63
LOS and Laneage
Figure 9L

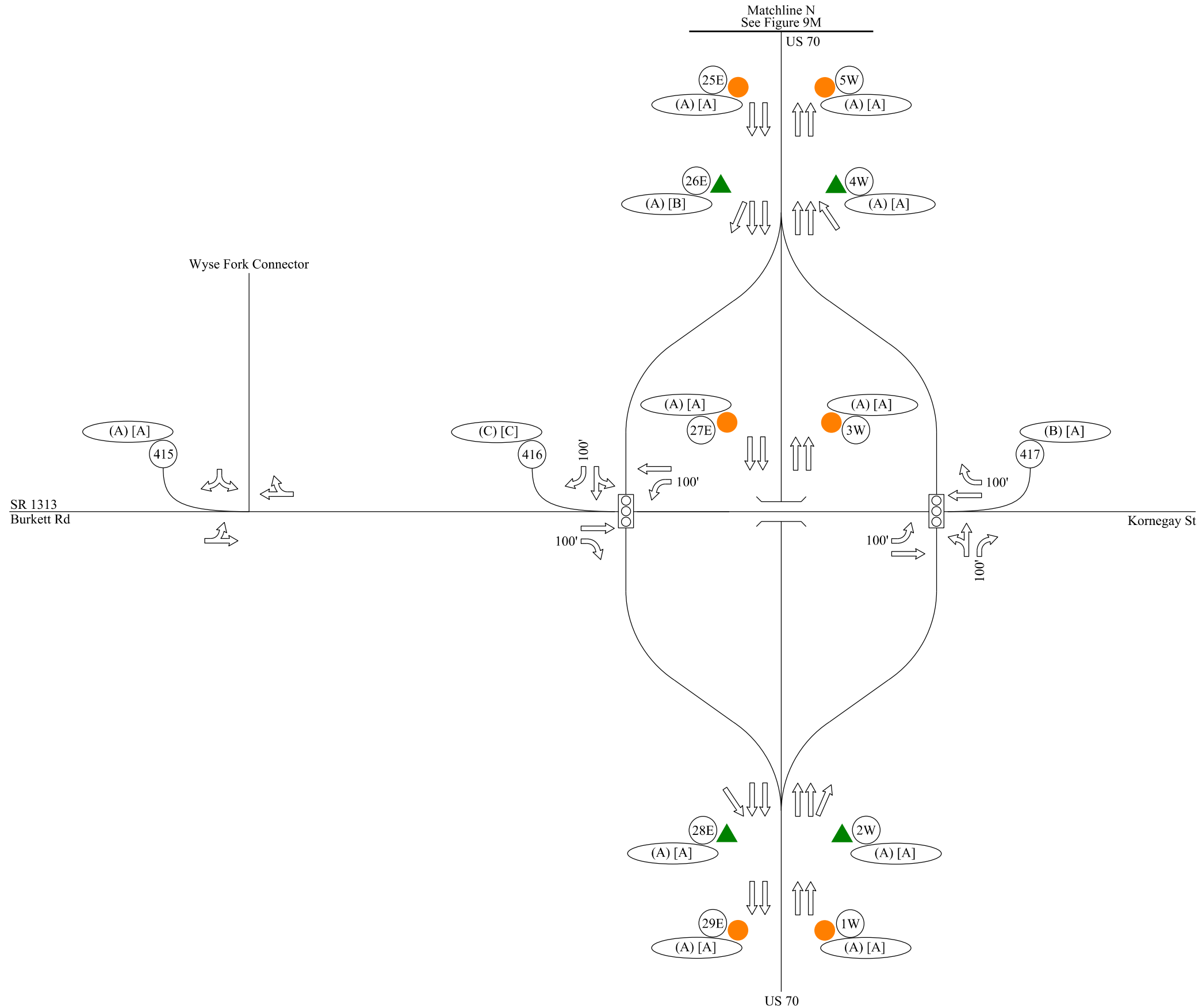
-  Laneage
-  Intersection or FREEVAL Number
-  AM Peak and PM Peak LOS
-  Signal
-  Basic Freeway Segment
-  Ramp Merge/Diverge
-  Freeway Weaving Segment
-  Storage





2040 Build Alternative 63 LOS and Laneage Figure 9M	
	Laneage
	Intersection or FREEVAL Number
	AM Peak and PM Peak LOS
	Signal
	Basic Freeway Segment
	Ramp Merge/Diverge
	Freeway Weaving Segment
	Storage





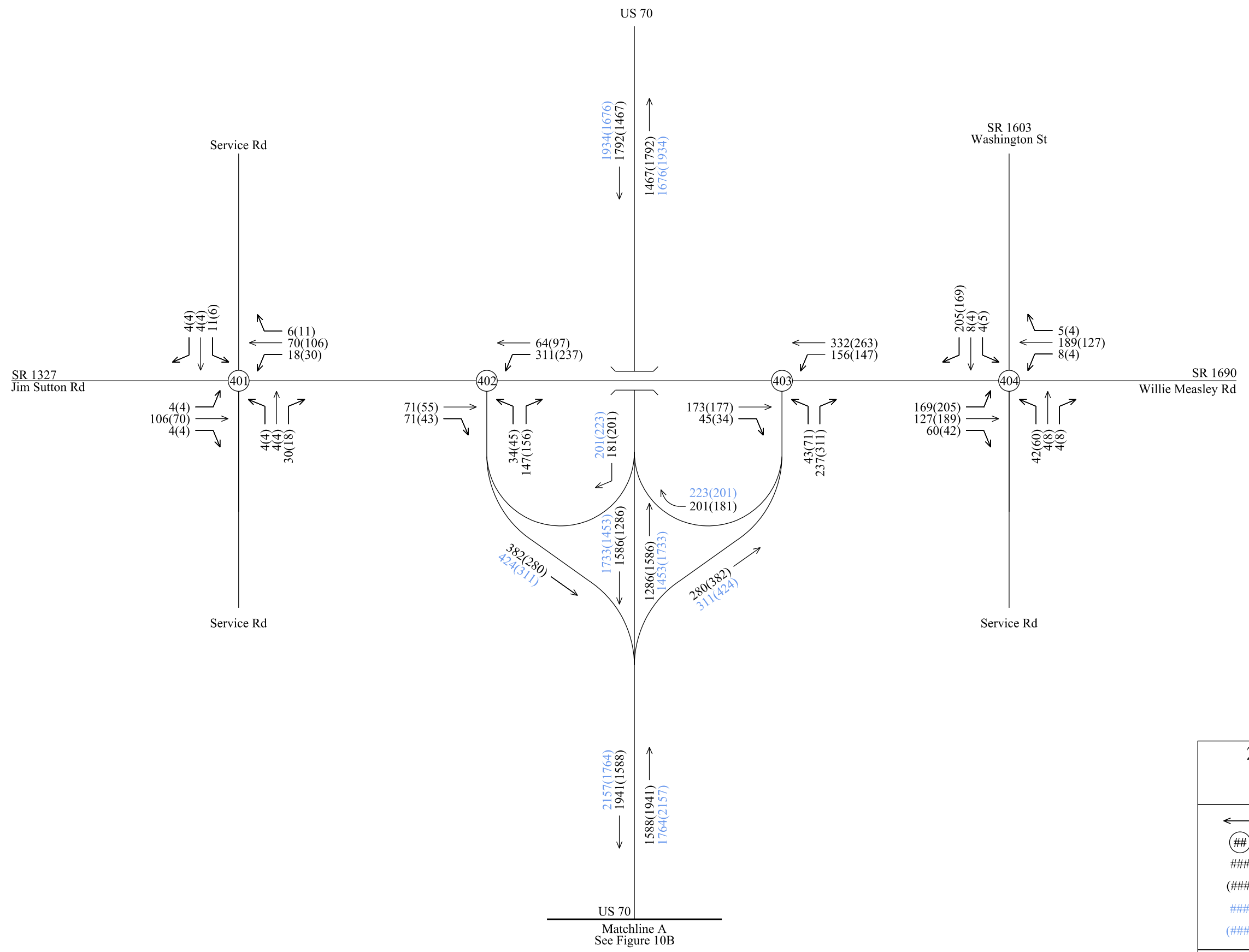
2040 Build Alternative 63 LOS and Laneage Figure 9N	
	Laneage
	Intersection or FREEVAL Number
	AM Peak and PM Peak LOS
	Signal
	Basic Freeway Segment
	Ramp Merge/Diverge
	Freeway Weaving Segment
	Storage



This page left intentionally blank

**2040 Build Alternative 65
Peak Hour Volume Figures**

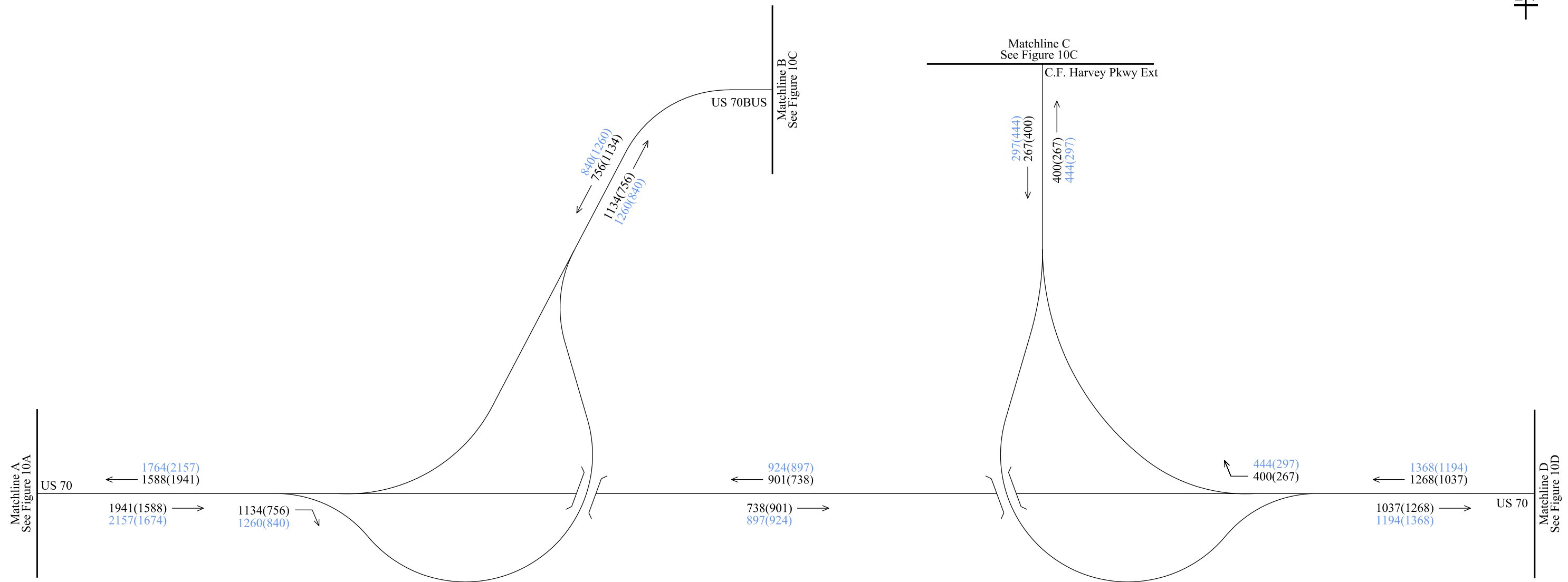
This page left intentionally blank



2040 Build - Alternative 65
Peak Hour Volumes
Figure 10A

- ← Turning Movement
- (##) Intersection Number
- ### AM Peak Hour Volumes
- (###) PM Peak Hour Volumes
- ### AM Balanced and Adjusted Volumes
- (###) PM Balanced and Adjusted Volumes





2040 Build - Alternative 65
Peak Hour Volumes
Figure 10B

- ← Turning Movement
- Ⓜ Intersection Number
- ### AM Peak Hour Volumes
- (###) PM Peak Hour Volumes
- ### AM Balanced and Adjusted Volumes
- (###) PM Balanced and Adjusted Volumes





NC 148
C. F. Harvey Parkway

C.F. Harvey Pkwy Ext

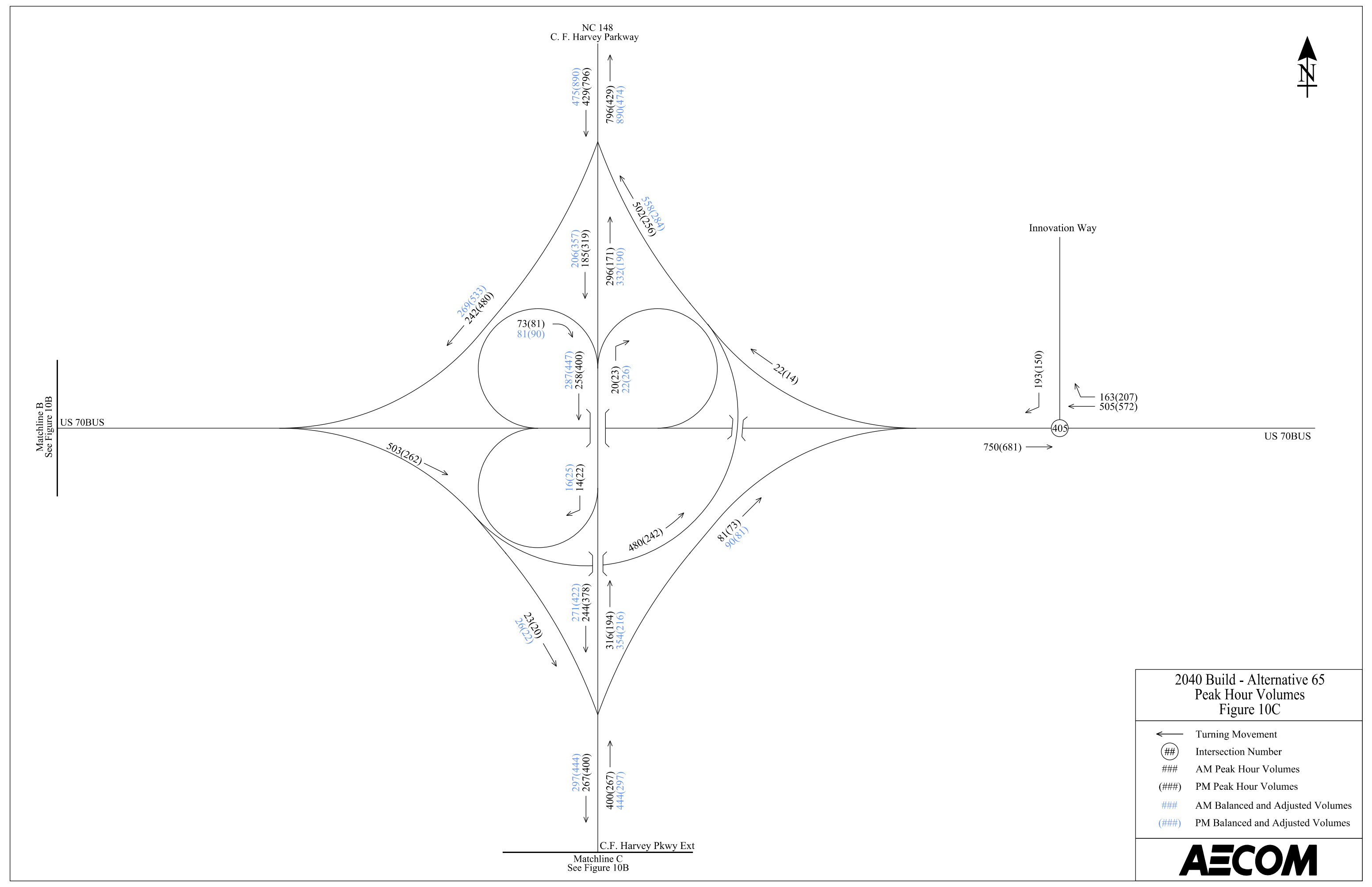
Innovation Way

US 70BUS

US 70BUS

Matchline C
See Figure 10B

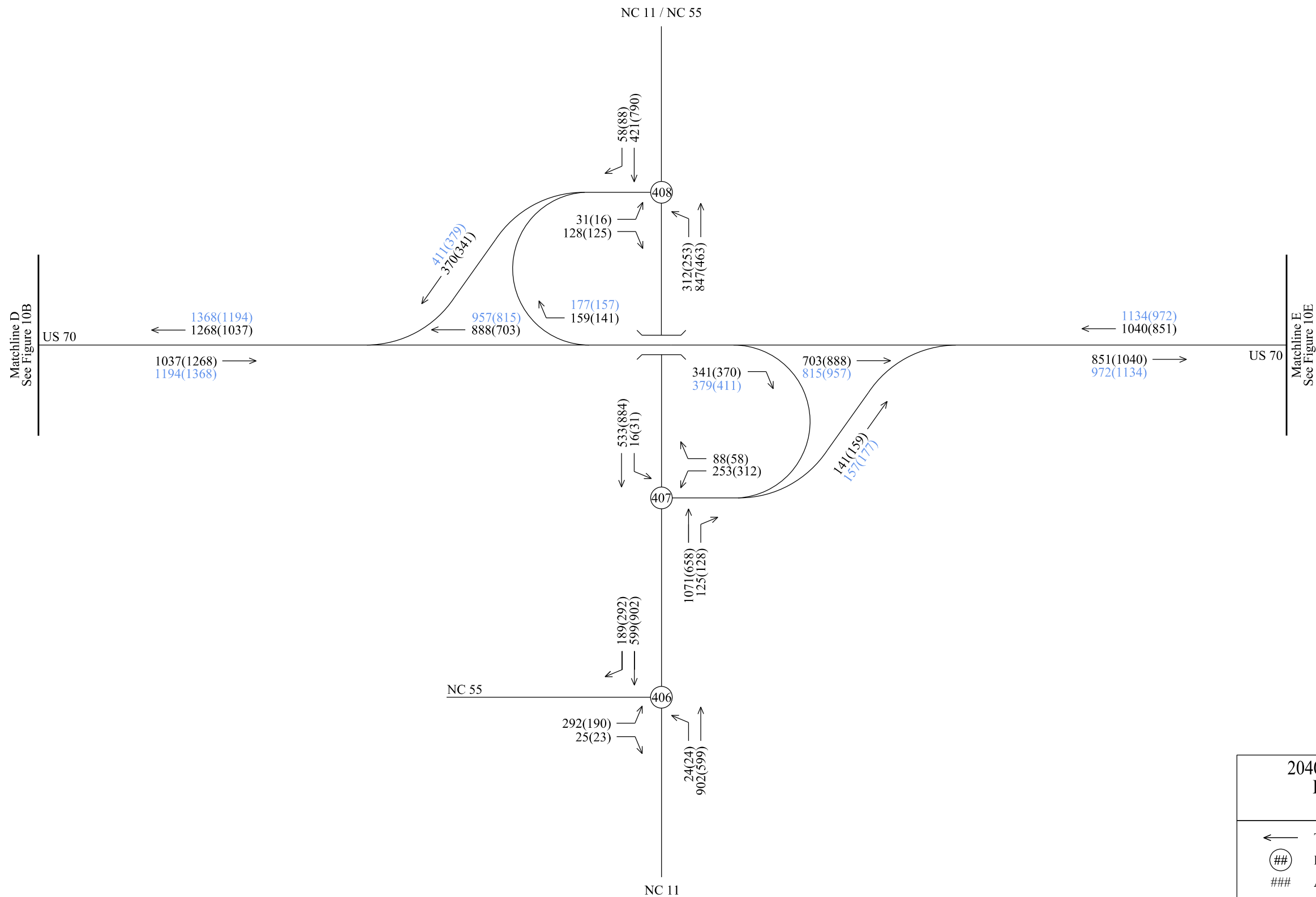
Matchline B
See Figure 10B



2040 Build - Alternative 65
Peak Hour Volumes
Figure 10C

- ← Turning Movement
- ⊙ Intersection Number
- ### AM Peak Hour Volumes
- (###) PM Peak Hour Volumes
- ### AM Balanced and Adjusted Volumes
- (###) PM Balanced and Adjusted Volumes

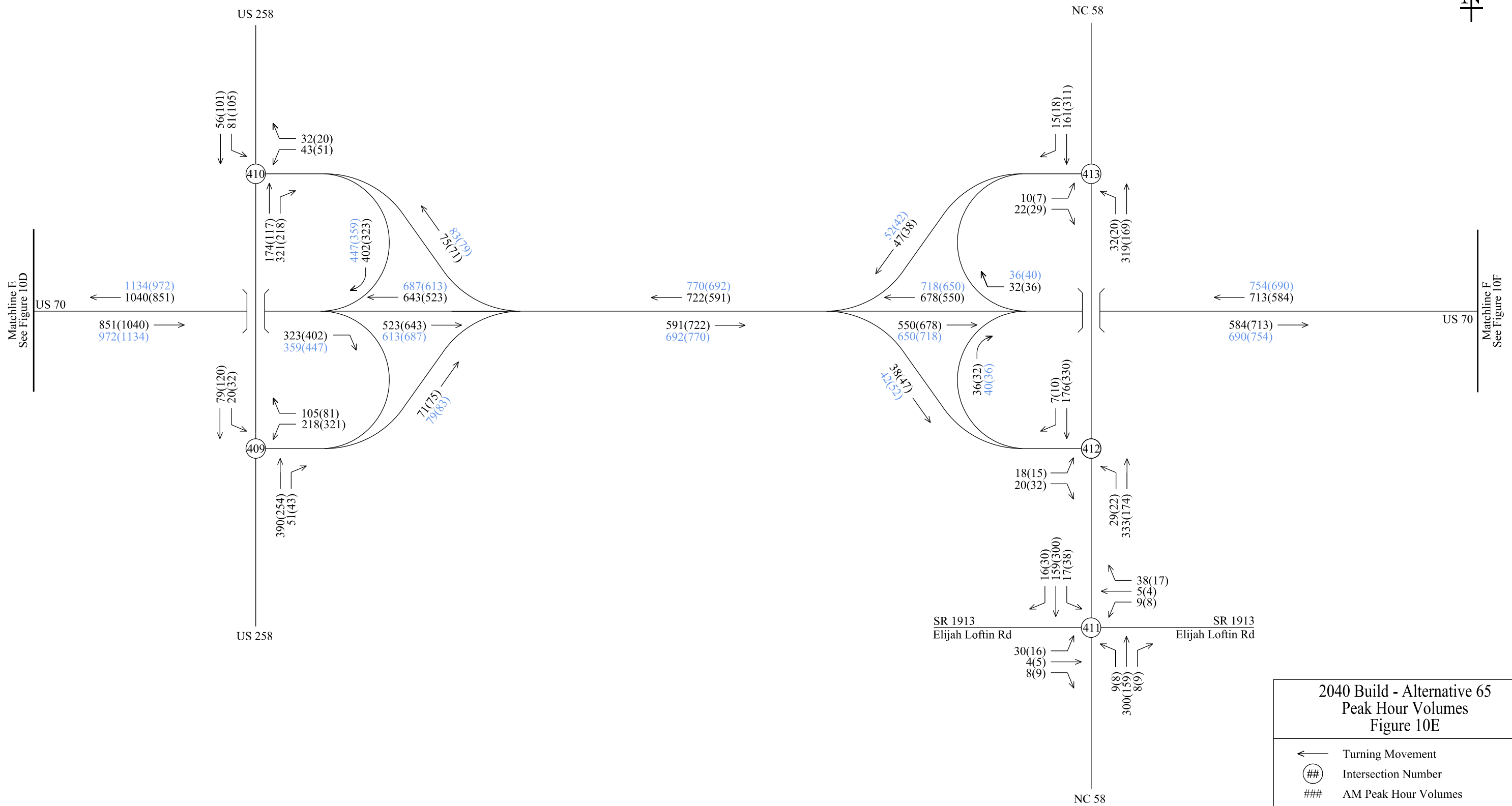




2040 Build - Alternative 65
Peak Hour Volumes
Figure 10D

- ← Turning Movement
- ⊕ Intersection Number
- ### AM Peak Hour Volumes
- (###) PM Peak Hour Volumes
- ### AM Balanced and Adjusted Volumes
- (###) PM Balanced and Adjusted Volumes

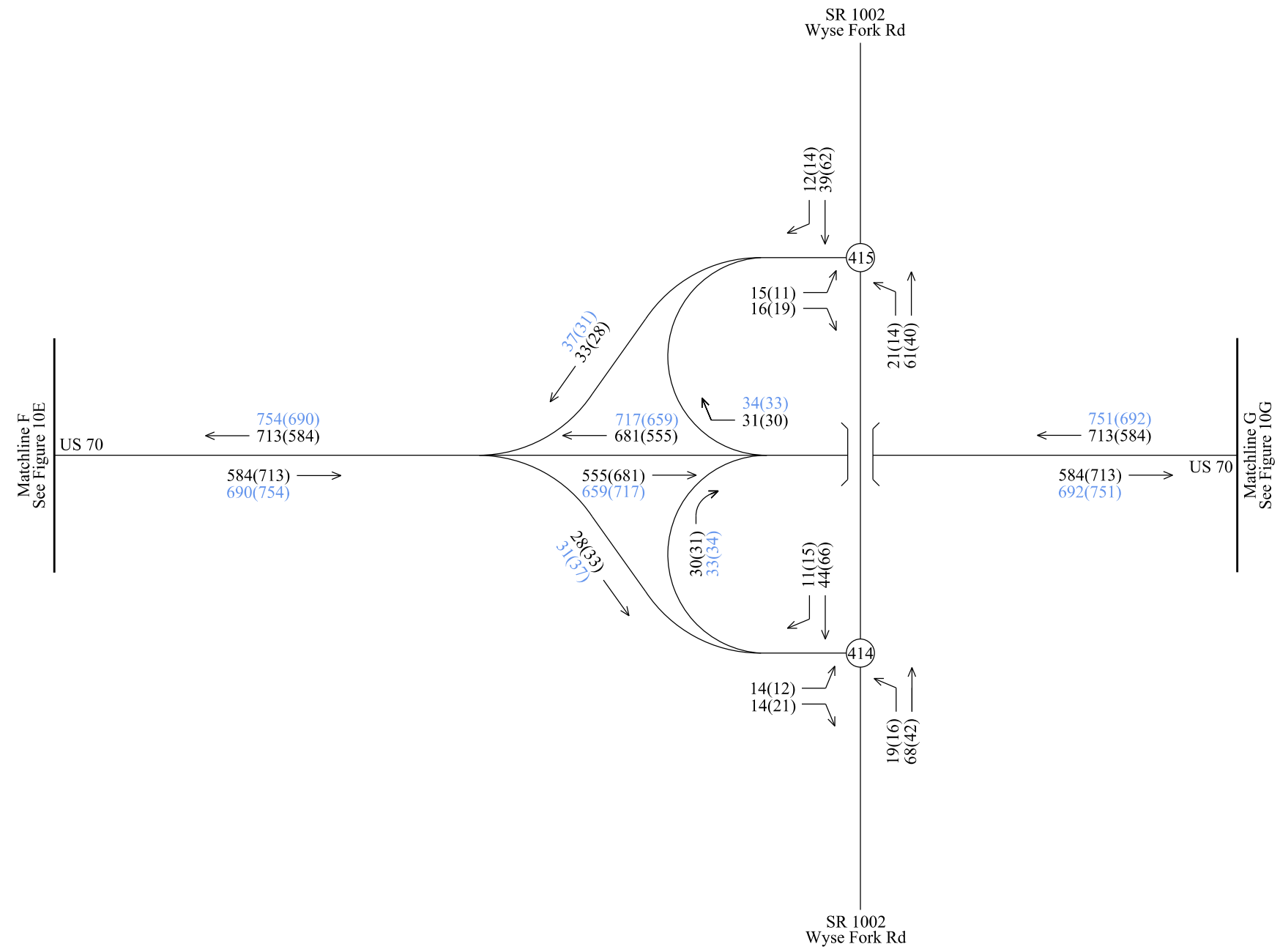




2040 Build - Alternative 65
Peak Hour Volumes
Figure 10E

- ← Turning Movement
- ⊙ Intersection Number
- ### AM Peak Hour Volumes
- #### PM Peak Hour Volumes
- ### AM Balanced and Adjusted Volumes
- #### PM Balanced and Adjusted Volumes

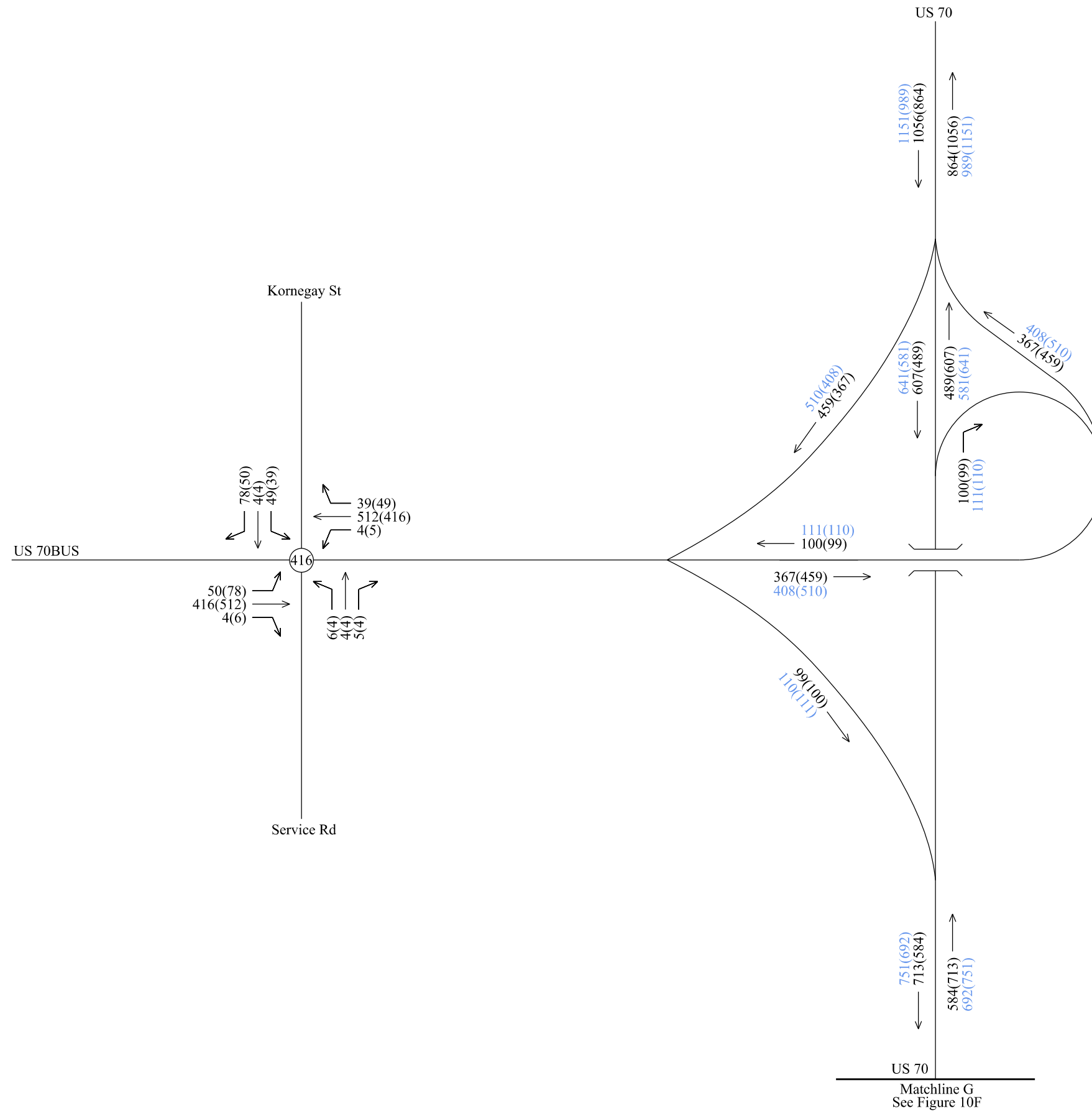




2040 Build - Alternative 65
Peak Hour Volumes
Figure 10F

- ← Turning Movement
- ⊕ Intersection Number
- ### AM Peak Hour Volumes
- (###) PM Peak Hour Volumes
- ### AM Balanced and Adjusted Volumes
- (###) PM Balanced and Adjusted Volumes





2040 Build - Alternative 65
Peak Hour Volumes
Figure 10G

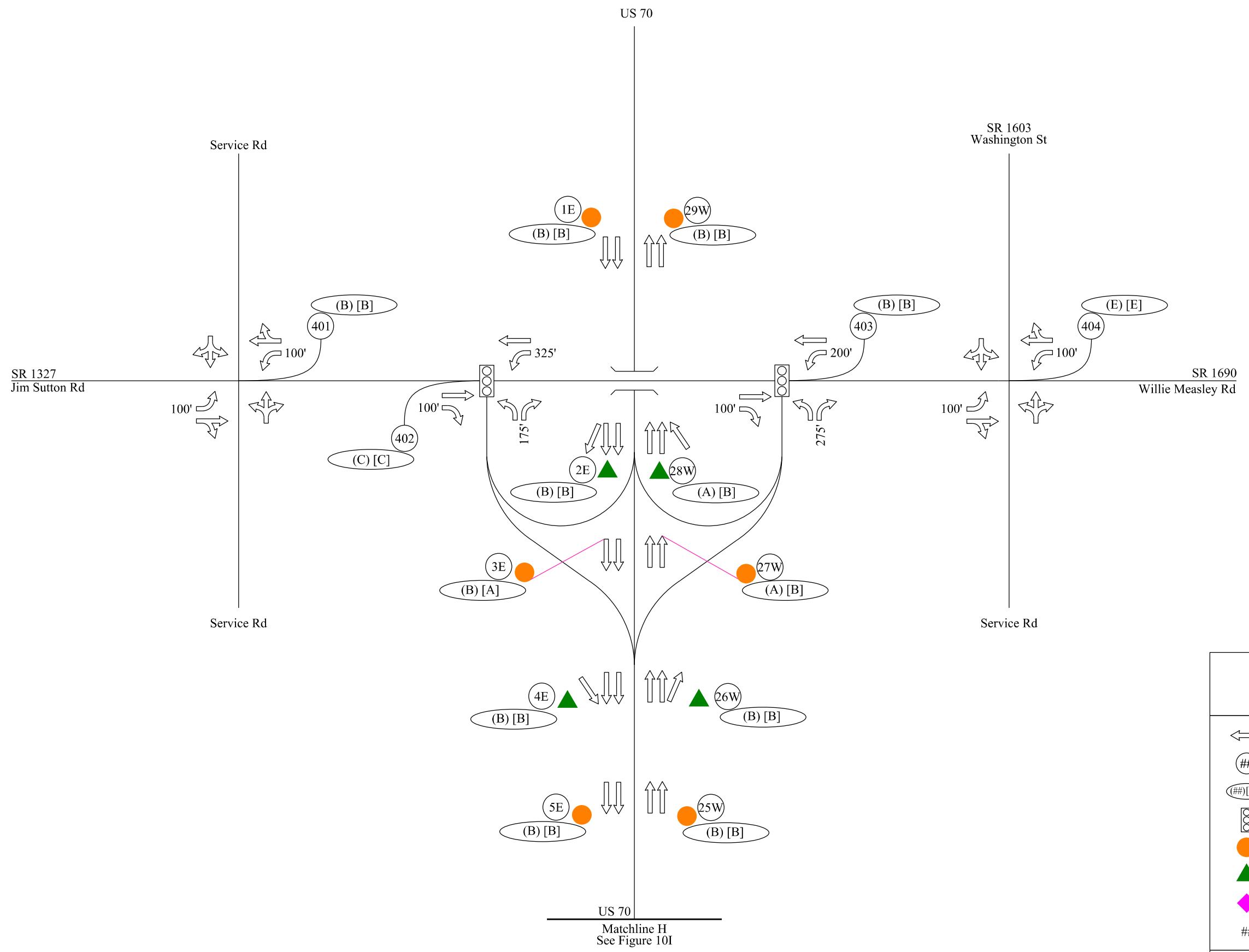
- ← Turning Movement
- ⊕ Intersection Number
- ### AM Peak Hour Volumes
- (###) PM Peak Hour Volumes
- ### AM Balanced and Adjusted Volumes
- (###) PM Balanced and Adjusted Volumes











This page left intentionally blank

**2040 Build Alternative 65
LOS and Laneage Figures**

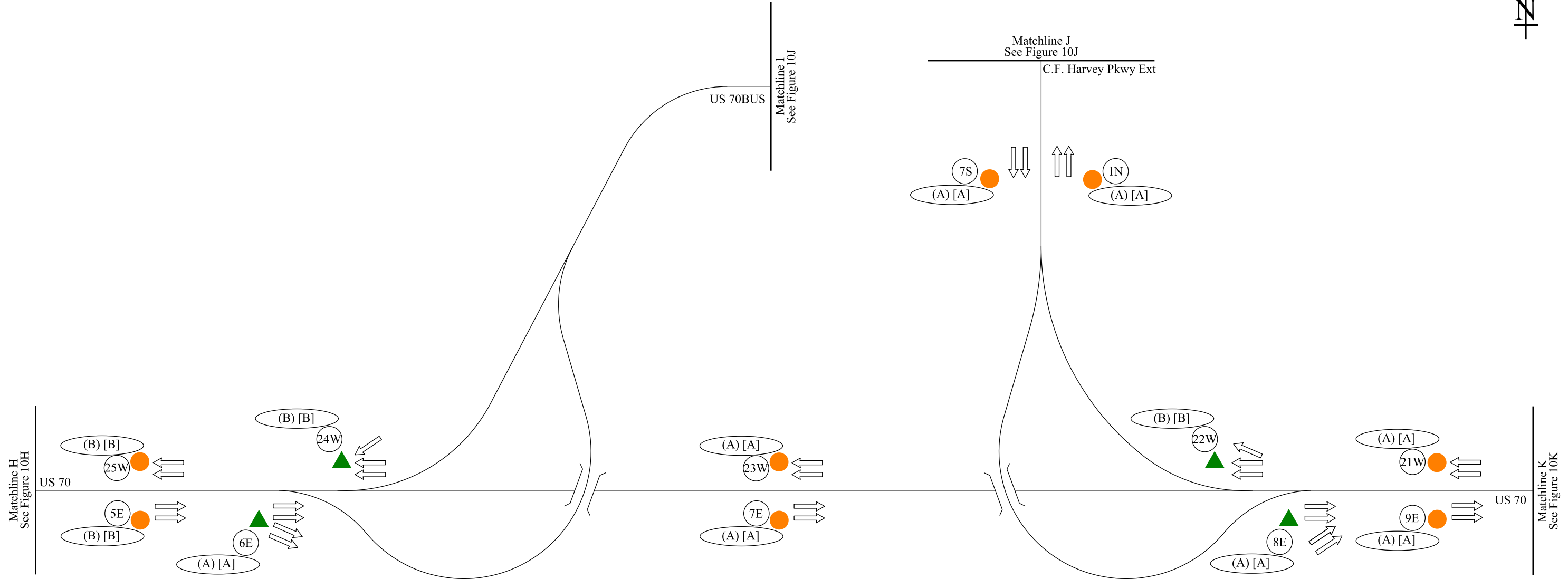
This page left intentionally blank



2040 Build Alternative 65
LOS and Laneage
Figure 10H

-  Laneage
-  Intersection or FREEVAL Number
-  AM Peak and PM Peak LOS
-  Signal
-  Basic Freeway Segment
-  Ramp Merge/Diverge
-  Freeway Weaving Segment
-  Storage





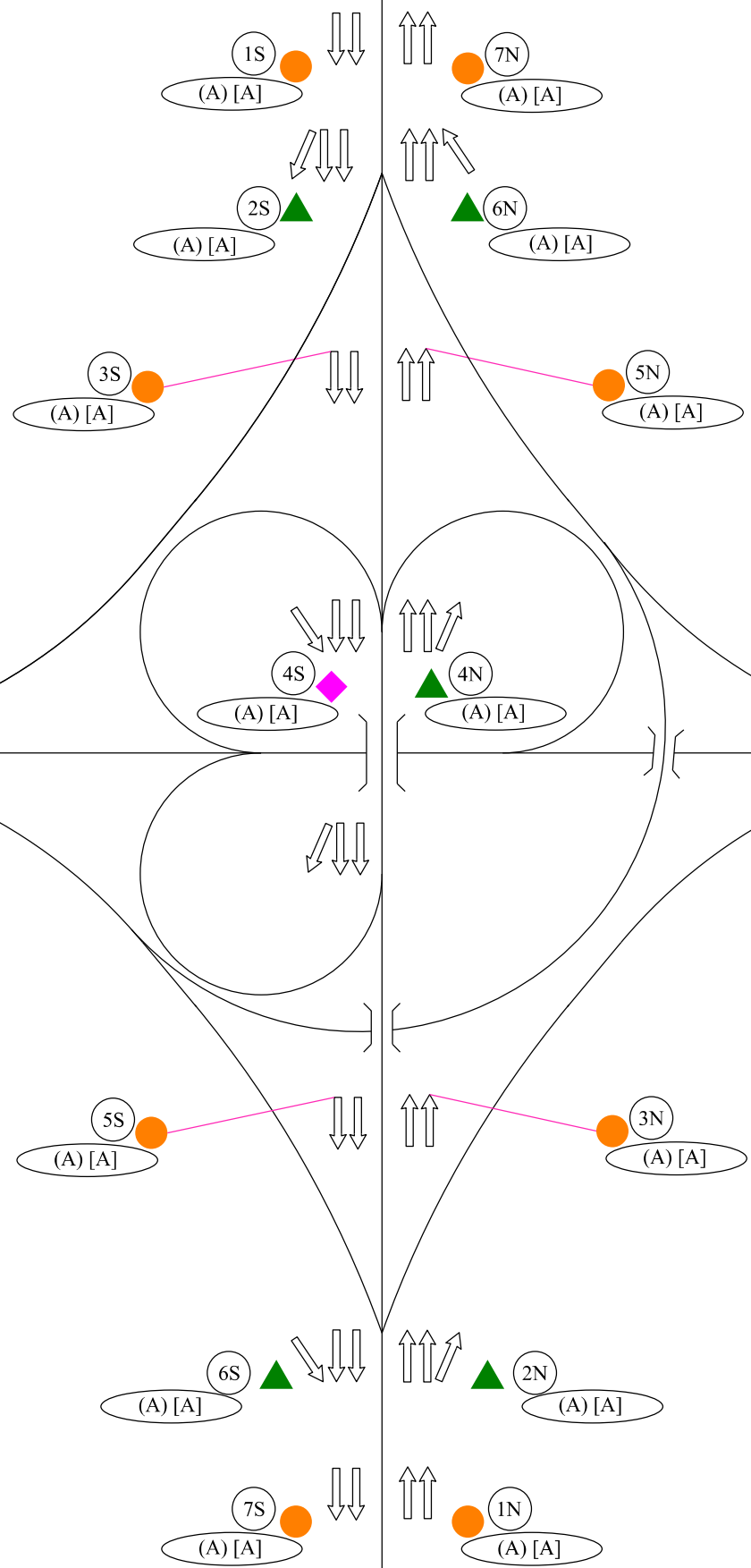
2040 Build Alternative 65
LOS and Laneage
Figure 10I

- ← Laneage
- ## Intersection or FREEVAL Number
- (##)(##) AM Peak and PM Peak LOS
- ⊞ Signal
- Basic Freeway Segment
- ▲ Ramp Merge/Diverge
- ◆ Freeway Weaving Segment
- ### Storage





NC 148
C. F. Harvey Parkway



Innovation Way

(B) [B]
405

300'

US 70BUS









US 70BUS

C.F. Harvey Pkwy Ext

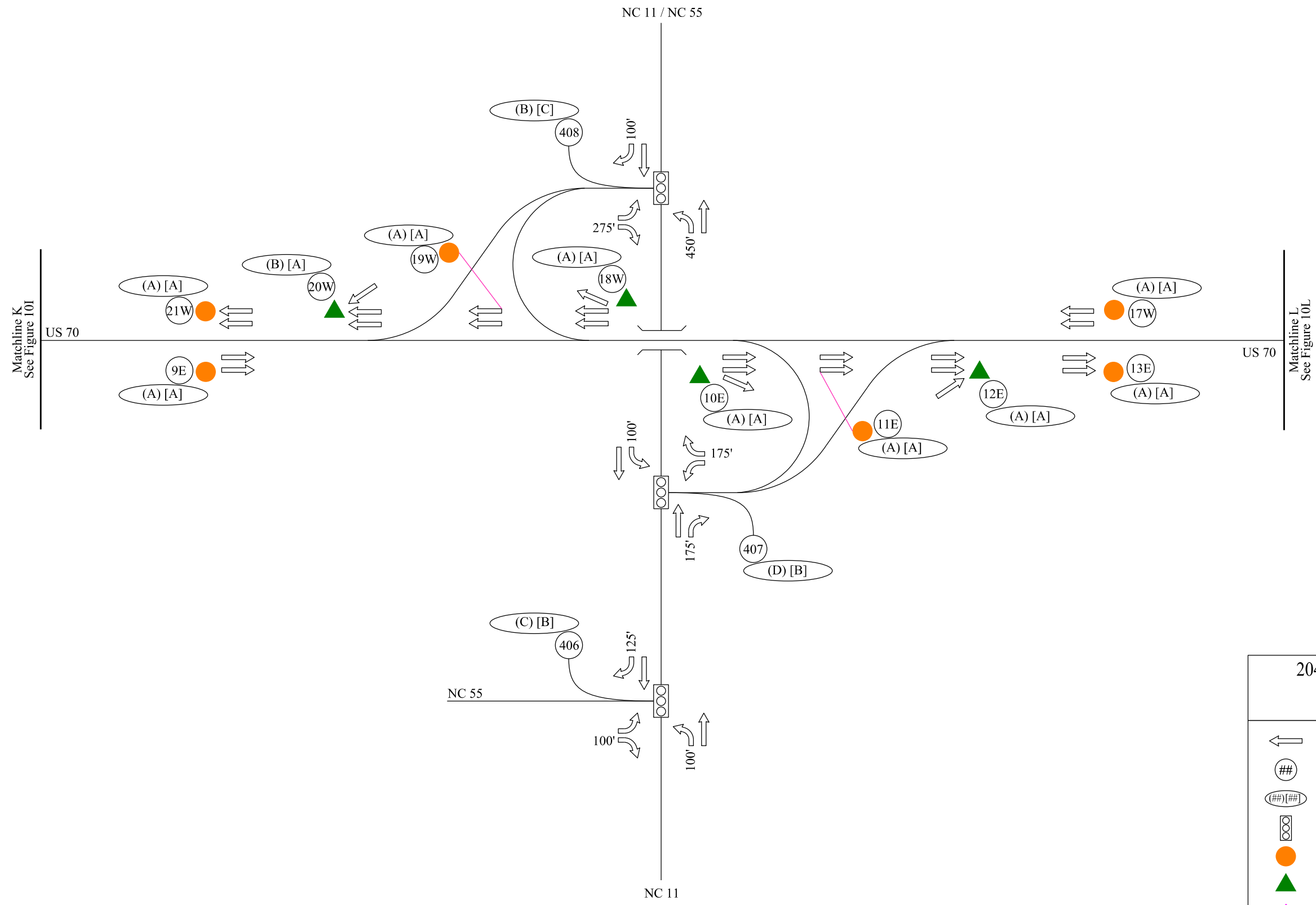
Matchline J
See Figure 101

Matchline I
See Figure 101









2040 Build Alternative 65 LOS and Laneage Figure 10J

-  Laneage
-  Intersection or FREEVAL Number
-  AM Peak and PM Peak LOS
-  Signal
-  Basic Freeway Segment
-  Ramp Merge/Diverge
-  Freeway Weaving Segment
-  Storage

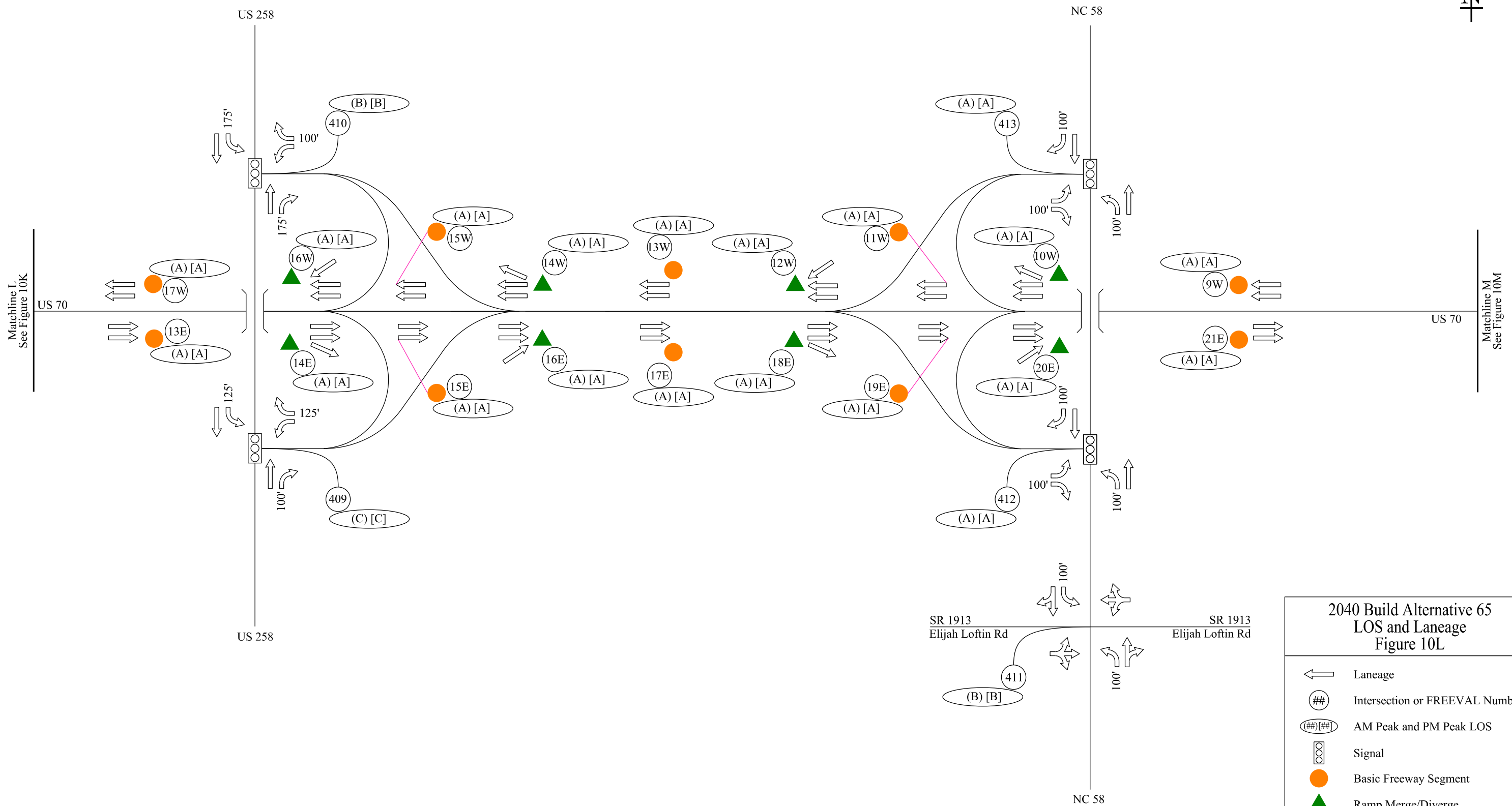












2040 Build Alternative 65
LOS and Laneage
Figure 10K

-  Laneage
-  Intersection or FREEVAL Number
-  AM Peak and PM Peak LOS
-  Signal
-  Basic Freeway Segment
-  Ramp Merge/Diverge
-  Freeway Weaving Segment
-  Storage

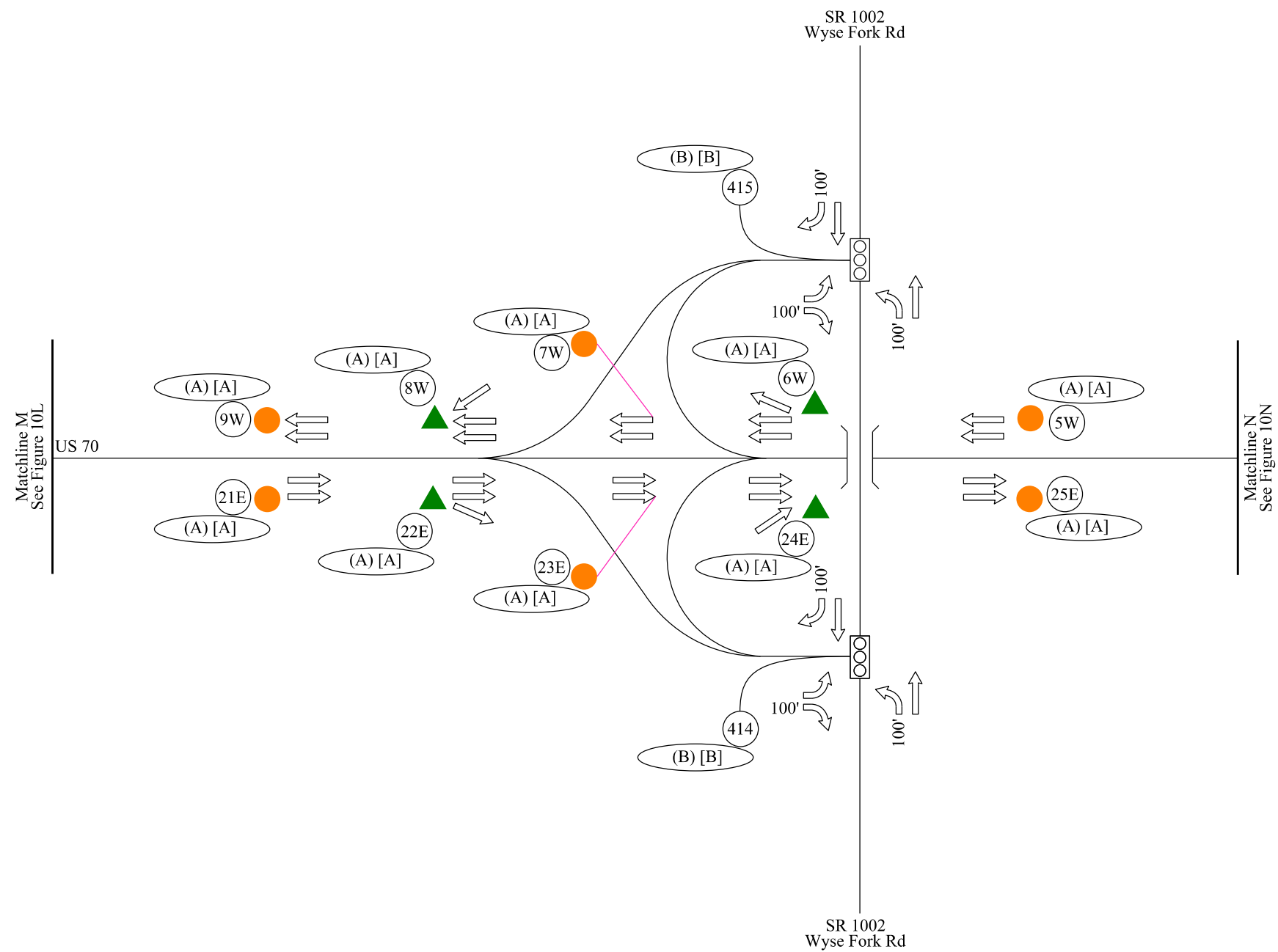












2040 Build Alternative 65
LOS and Laneage
Figure 10L

-  Laneage
-  Intersection or FREEVAL Number
-  AM Peak and PM Peak LOS
-  Signal
-  Basic Freeway Segment
-  Ramp Merge/Diverge
-  Freeway Weaving Segment
-  Storage

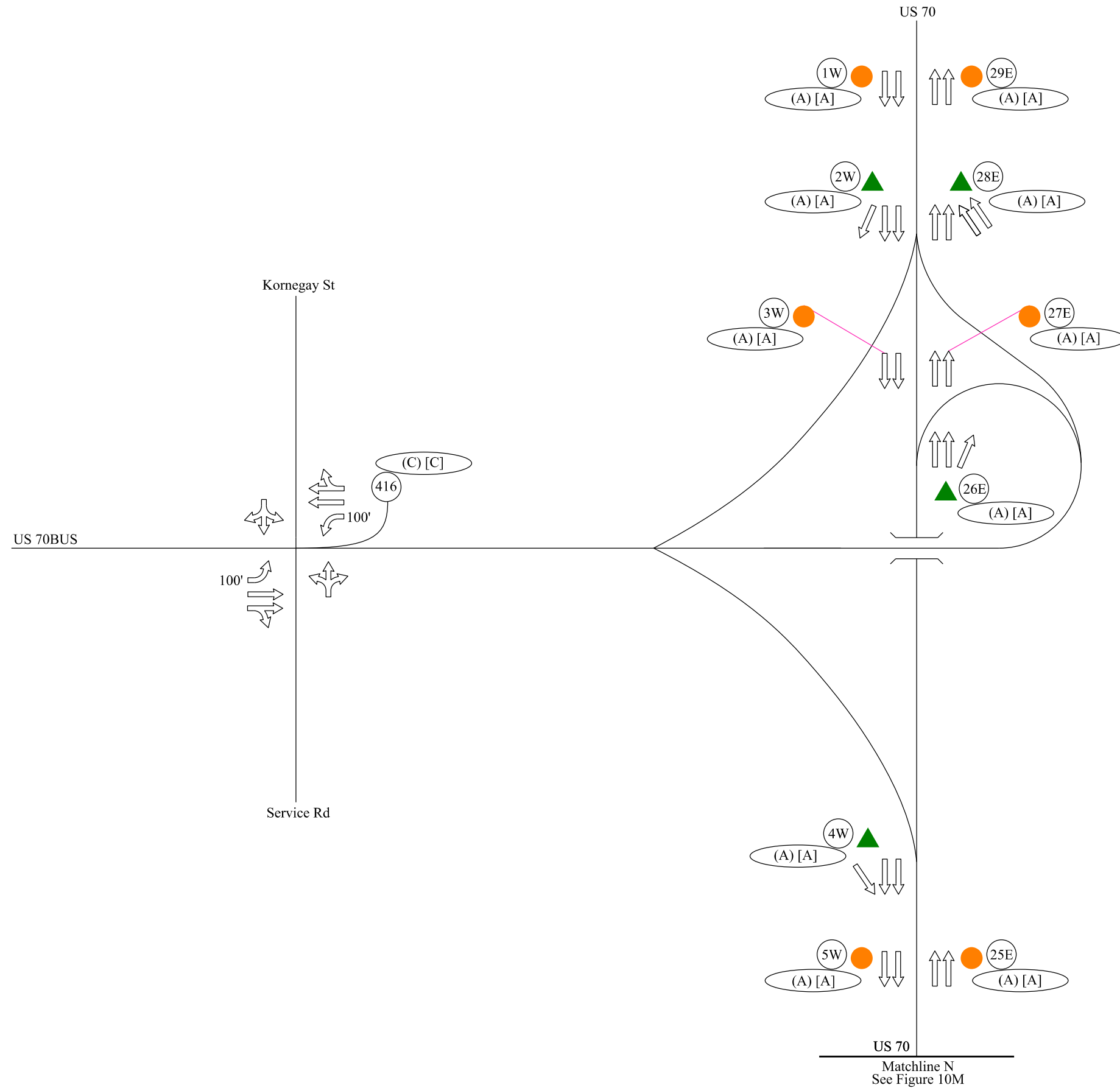












2040 Build Alternative 65
LOS and Laneage
Figure 10M

-  Laneage
-  Intersection or FREEVAL Number
-  AM Peak and PM Peak LOS
-  Signal
-  Basic Freeway Segment
-  Ramp Merge/Diverge
-  Freeway Weaving Segment
-  Storage





2040 Build Alternative 65
LOS and Laneage
Figure 10N

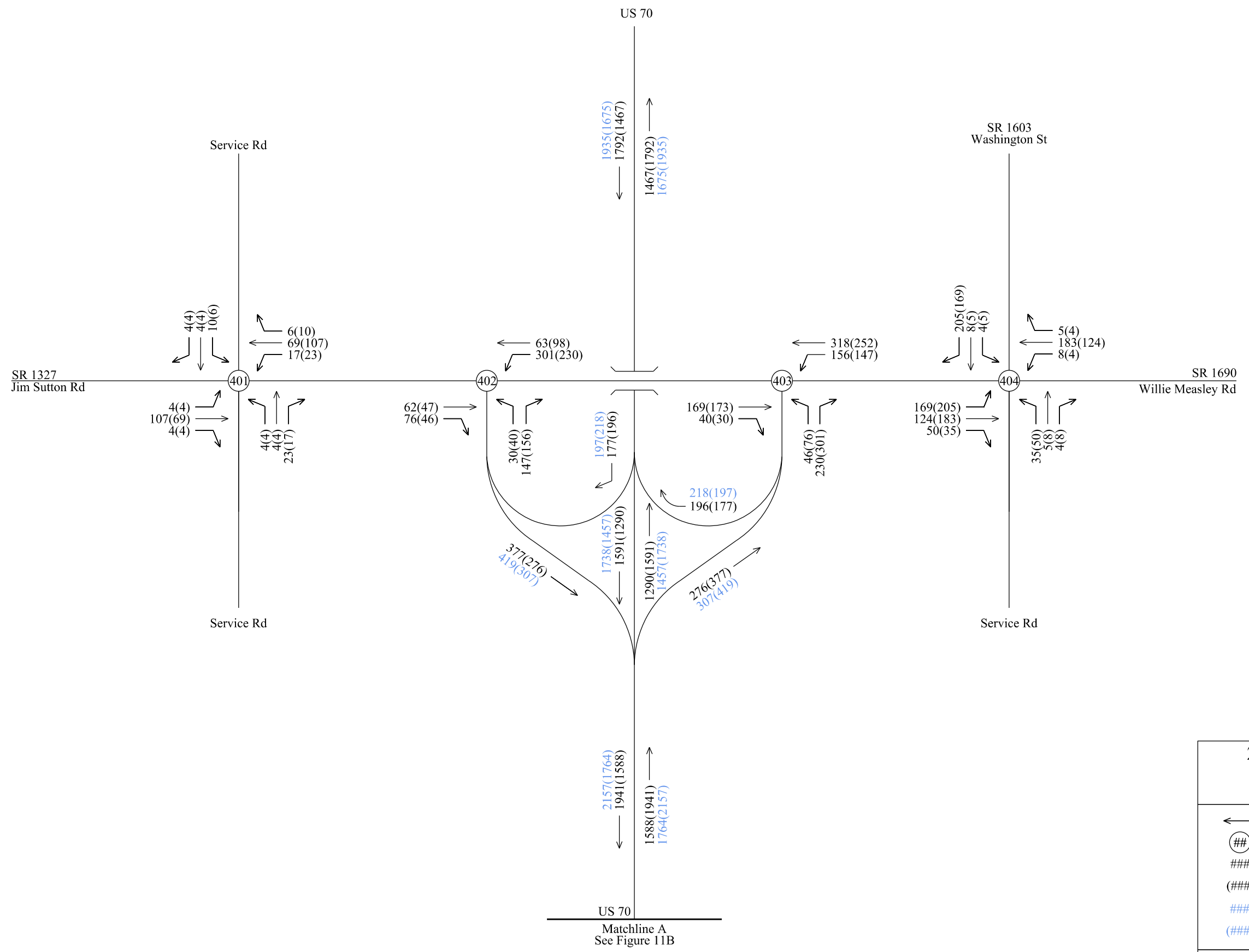
-  Laneage
-  Intersection or FREEVAL Number
-  AM Peak and PM Peak LOS
-  Signal
-  Basic Freeway Segment
-  Ramp Merge/Diverge
-  Freeway Weaving Segment
-  Storage



This page left intentionally blank

**2040 Build Alternative 51
Peak Hour Volume Figures**

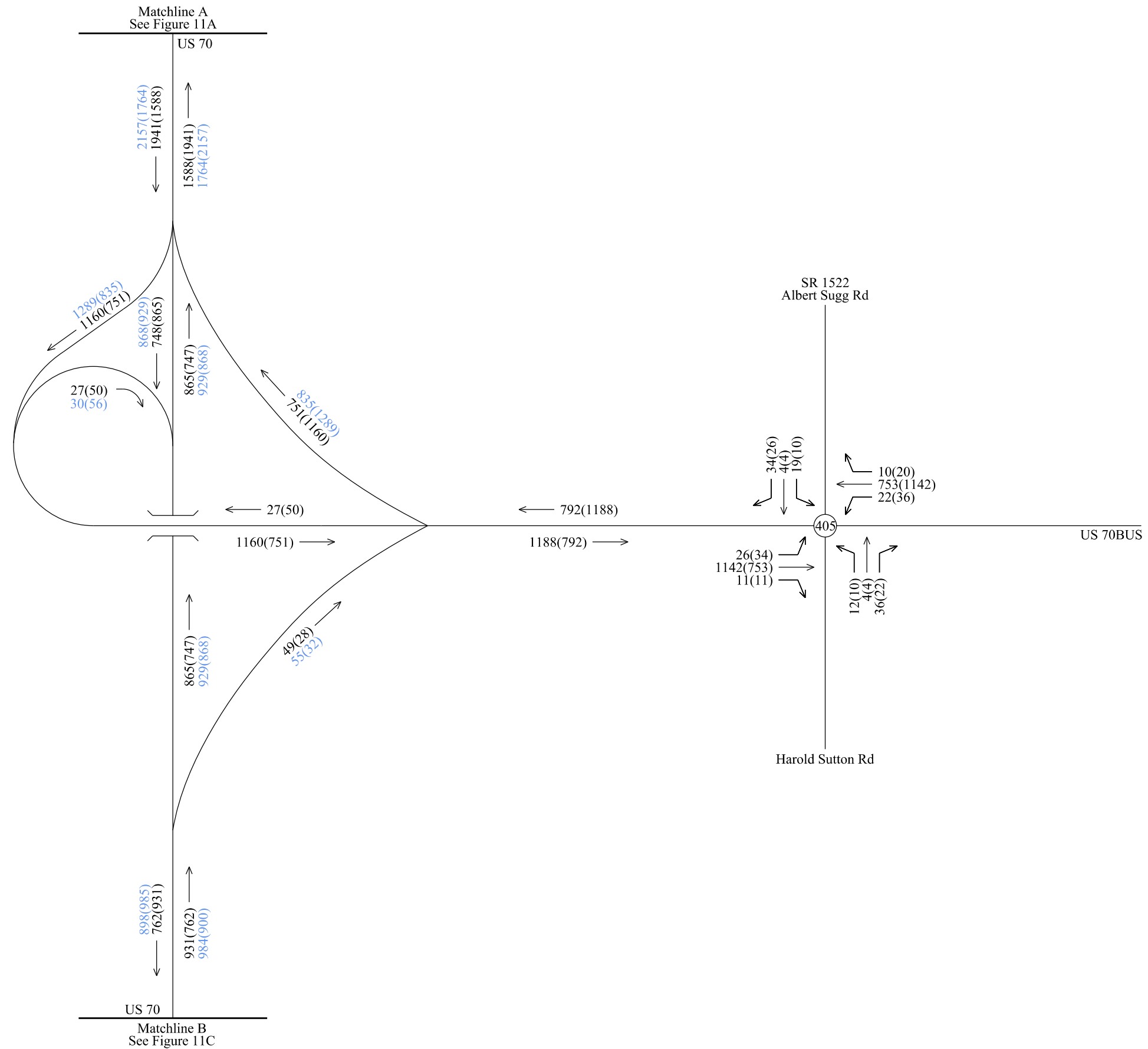
This page left intentionally blank



2040 Build - Alternative 51
Peak Hour Volumes
Figure 11A

- ← Turning Movement
- ⊙ Intersection Number
- ### AM Peak Hour Volumes
- (###) PM Peak Hour Volumes
- ### AM Balanced and Adjusted Volumes
- (###) PM Balanced and Adjusted Volumes

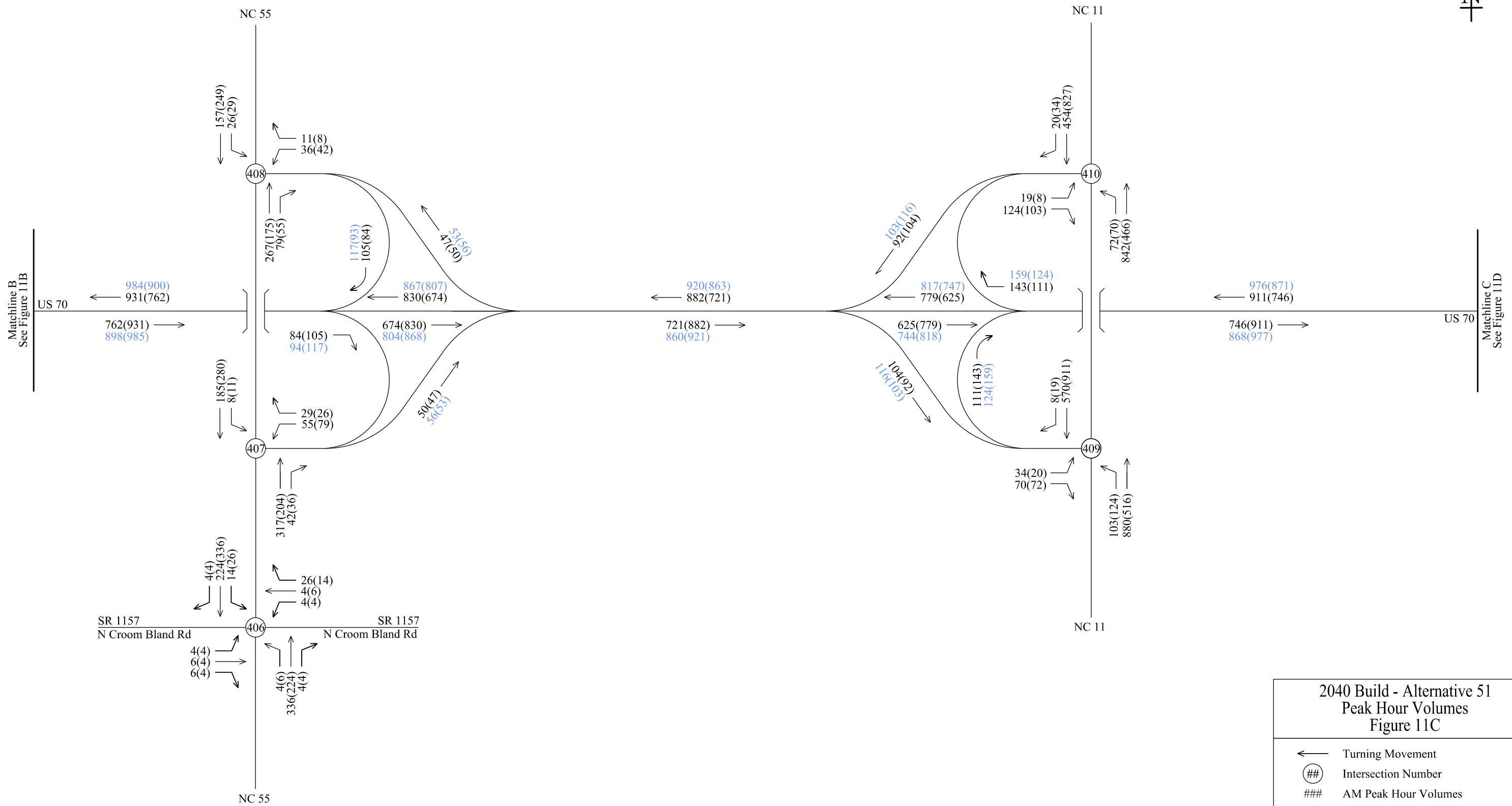




2040 Build - Alternative 51
Peak Hour Volumes
Figure 11B

- ← Turning Movement
- ⊙ Intersection Number
- ### AM Peak Hour Volumes
- (###) PM Peak Hour Volumes
- ### AM Balanced and Adjusted Volumes
- (###) PM Balanced and Adjusted Volumes

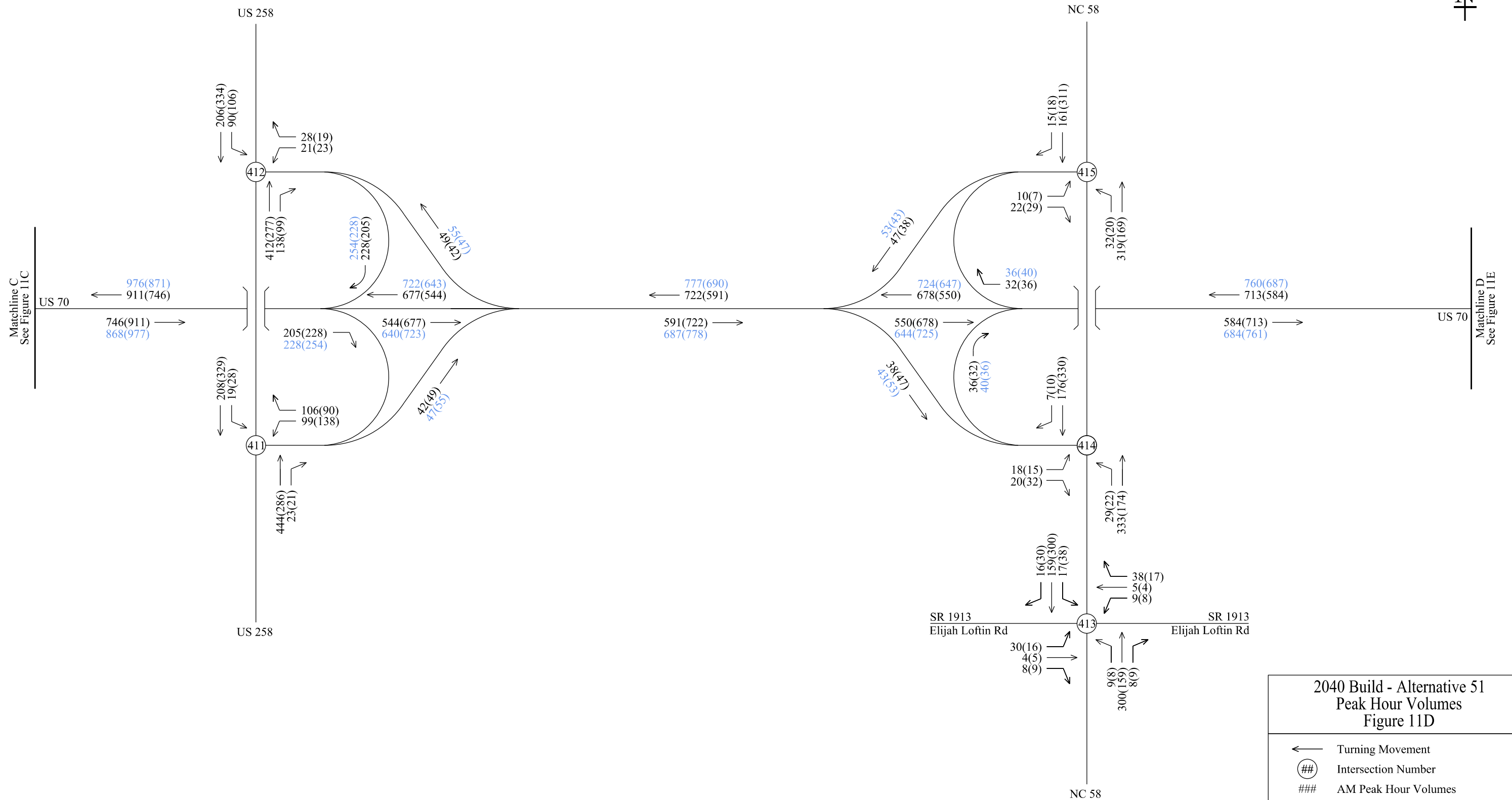




2040 Build - Alternative 51
Peak Hour Volumes
Figure 11C

- ← Turning Movement
- ⊙ Intersection Number
- ### AM Peak Hour Volumes
- (###) PM Peak Hour Volumes
- ### AM Balanced and Adjusted Volumes
- (###) PM Balanced and Adjusted Volumes

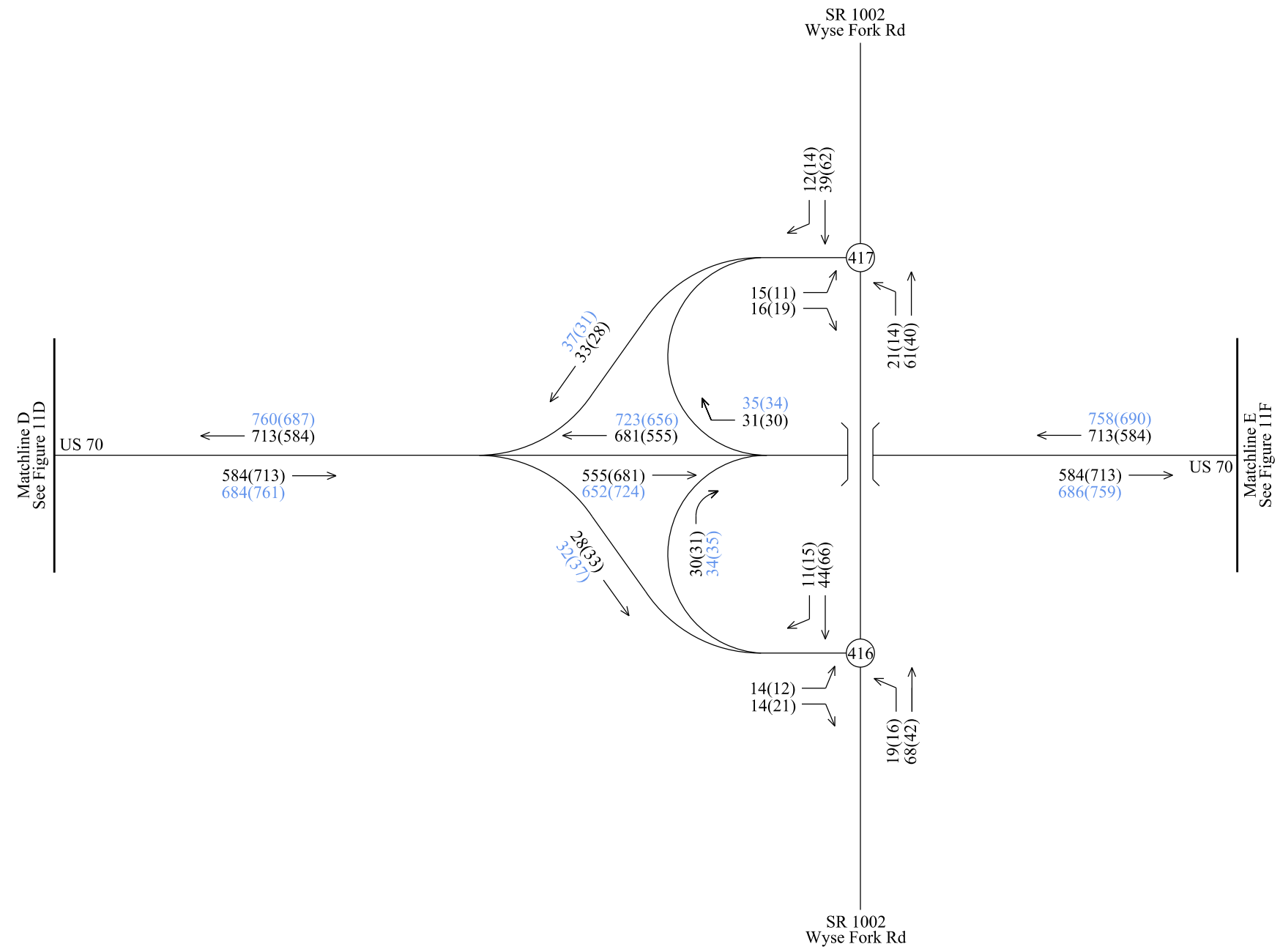




2040 Build - Alternative 51
Peak Hour Volumes
Figure 11D

- ← Turning Movement
- ⊙ Intersection Number
- ### AM Peak Hour Volumes
- (###) PM Peak Hour Volumes
- ### AM Balanced and Adjusted Volumes
- (###) PM Balanced and Adjusted Volumes

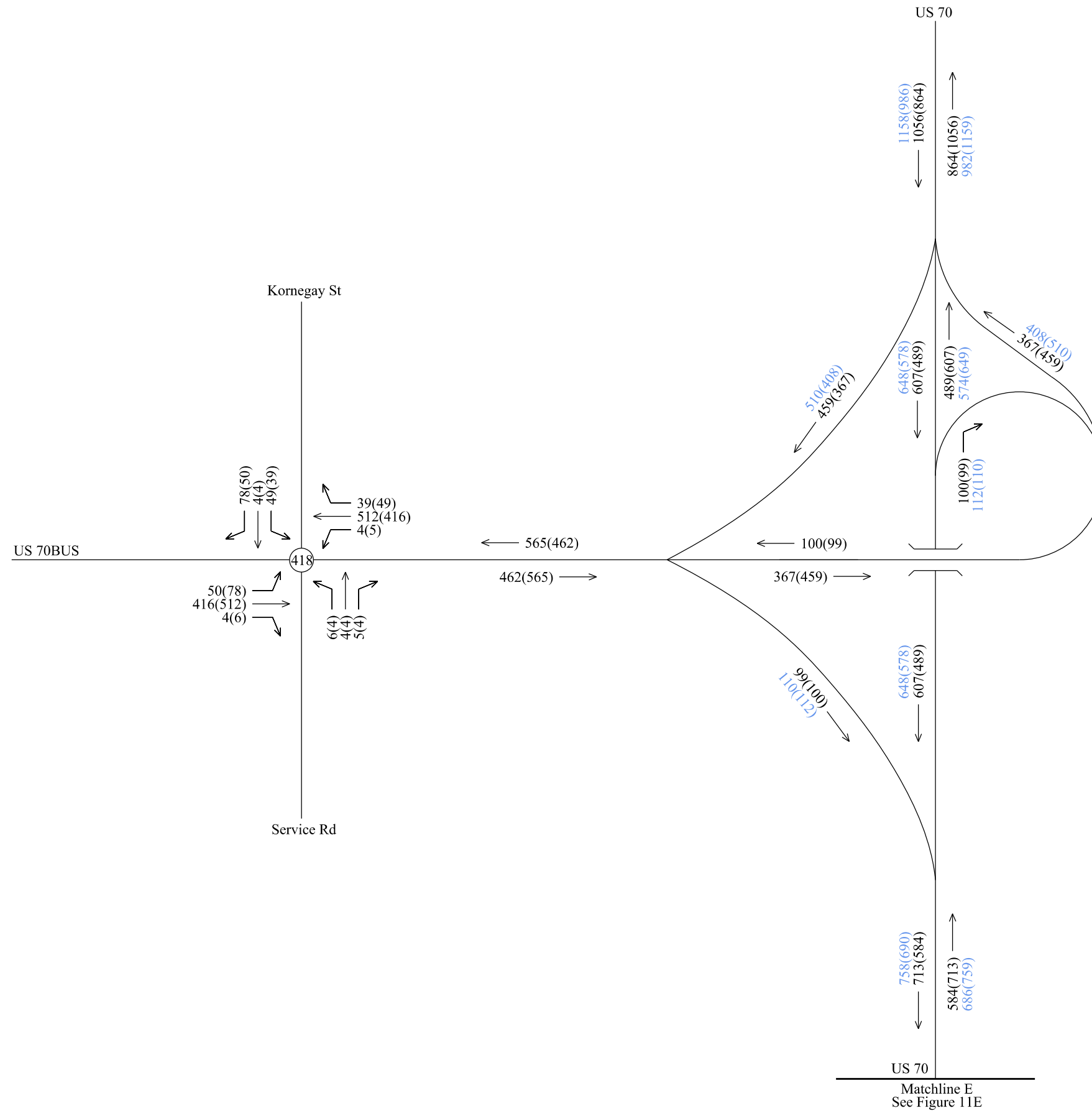




2040 Build - Alternative 51
Peak Hour Volumes
Figure 11E

- ← Turning Movement
- ⊕ Intersection Number
- ### AM Peak Hour Volumes
- (###) PM Peak Hour Volumes
- ### AM Balanced and Adjusted Volumes
- (###) PM Balanced and Adjusted Volumes





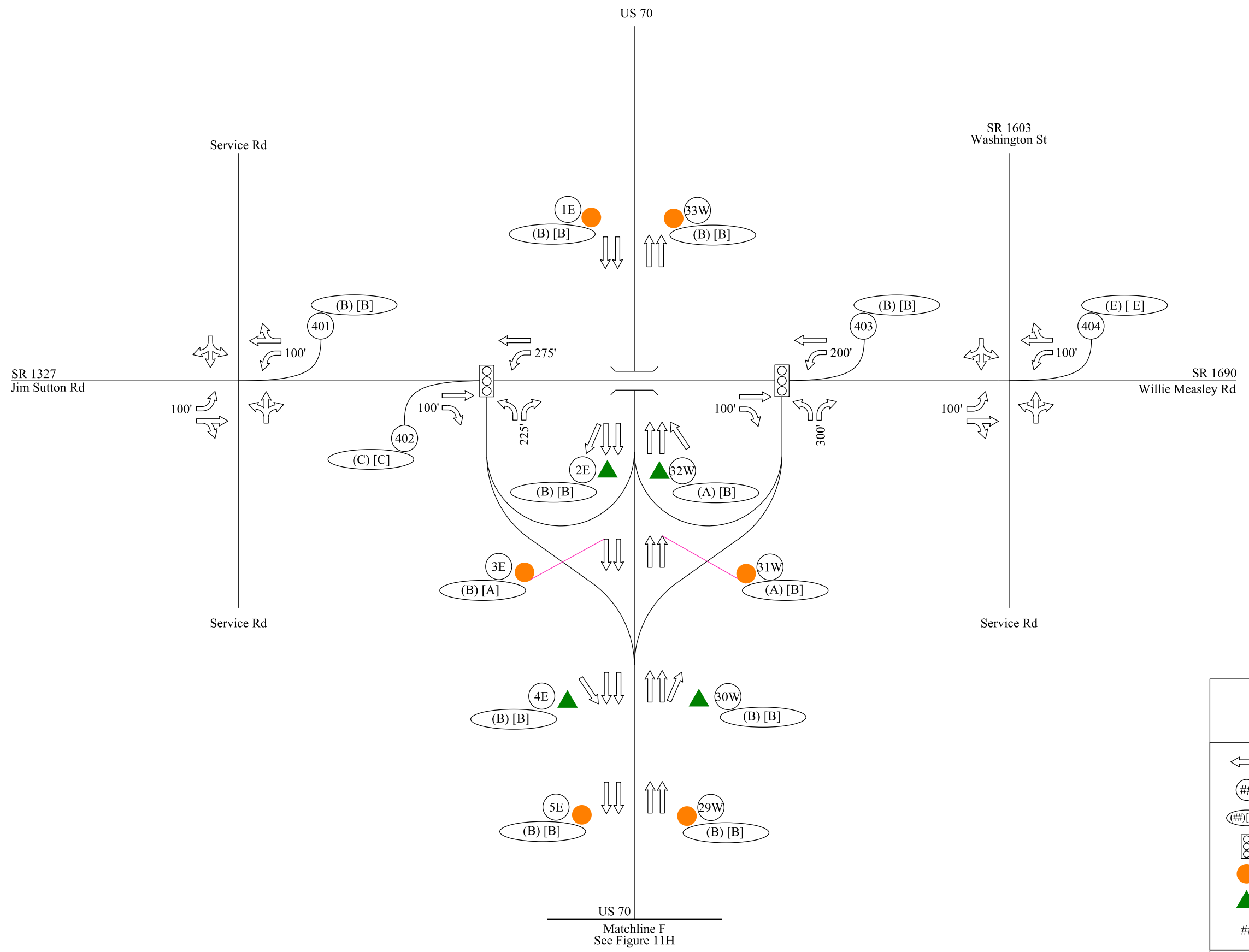
2040 Build - Alternative 51
Peak Hour Volumes
Figure 11F

- ← Turning Movement
- ⊙ Intersection Number
- ### AM Peak Hour Volumes
- (###) PM Peak Hour Volumes
- ### AM Balanced and Adjusted Volumes
- (###) PM Balanced and Adjusted Volumes



**2040 Build Alternative 51
LOS and Laneage Figures**

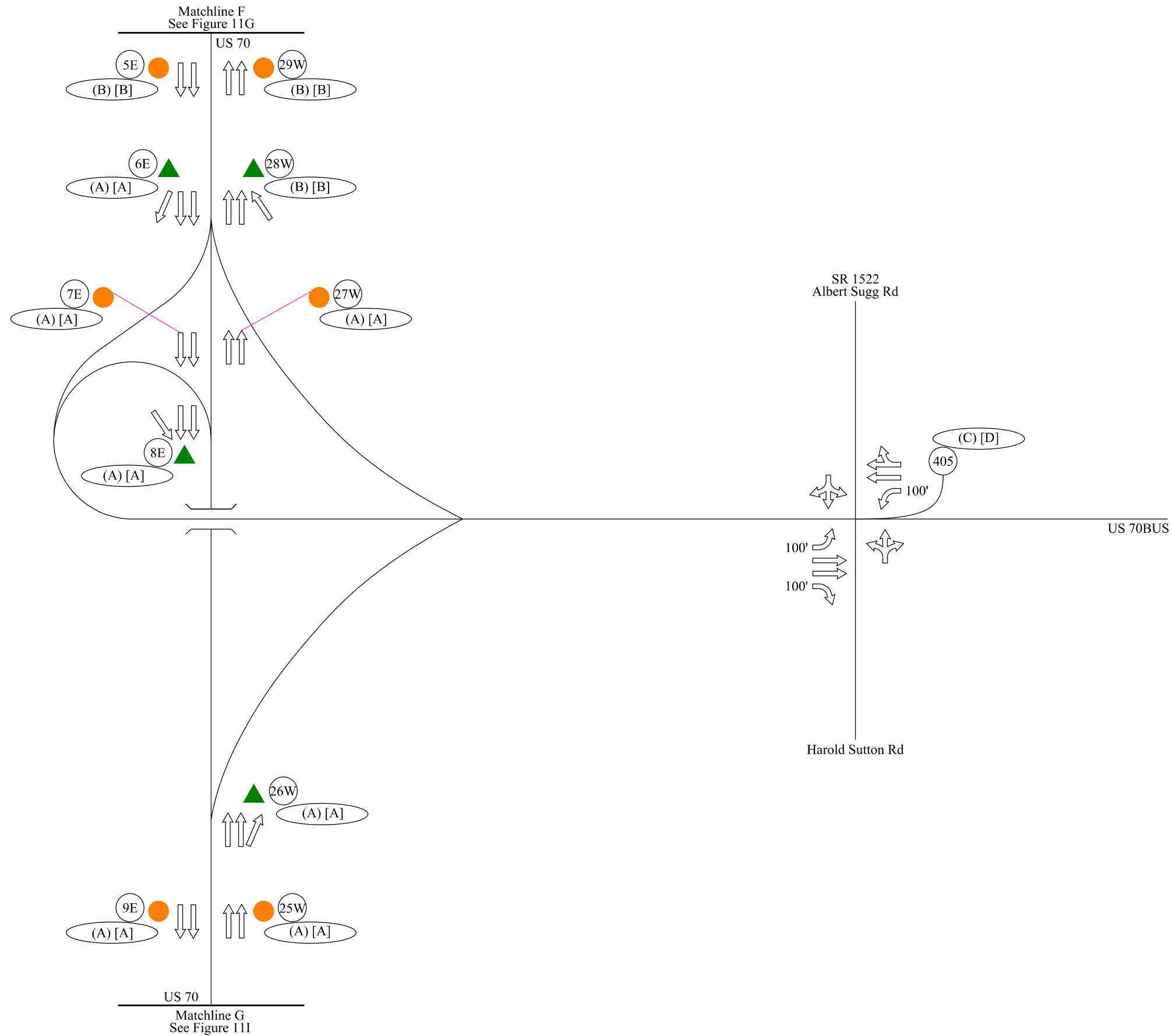
This page left intentionally blank



2040 Build Alternative 51
LOS and Laneage
Figure 11G

	Laneage
	Intersection or FREEVAL Number
	AM Peak and PM Peak LOS
	Signal
	Basic Freeway Segment
	Ramp Merge/Diverge
	Storage

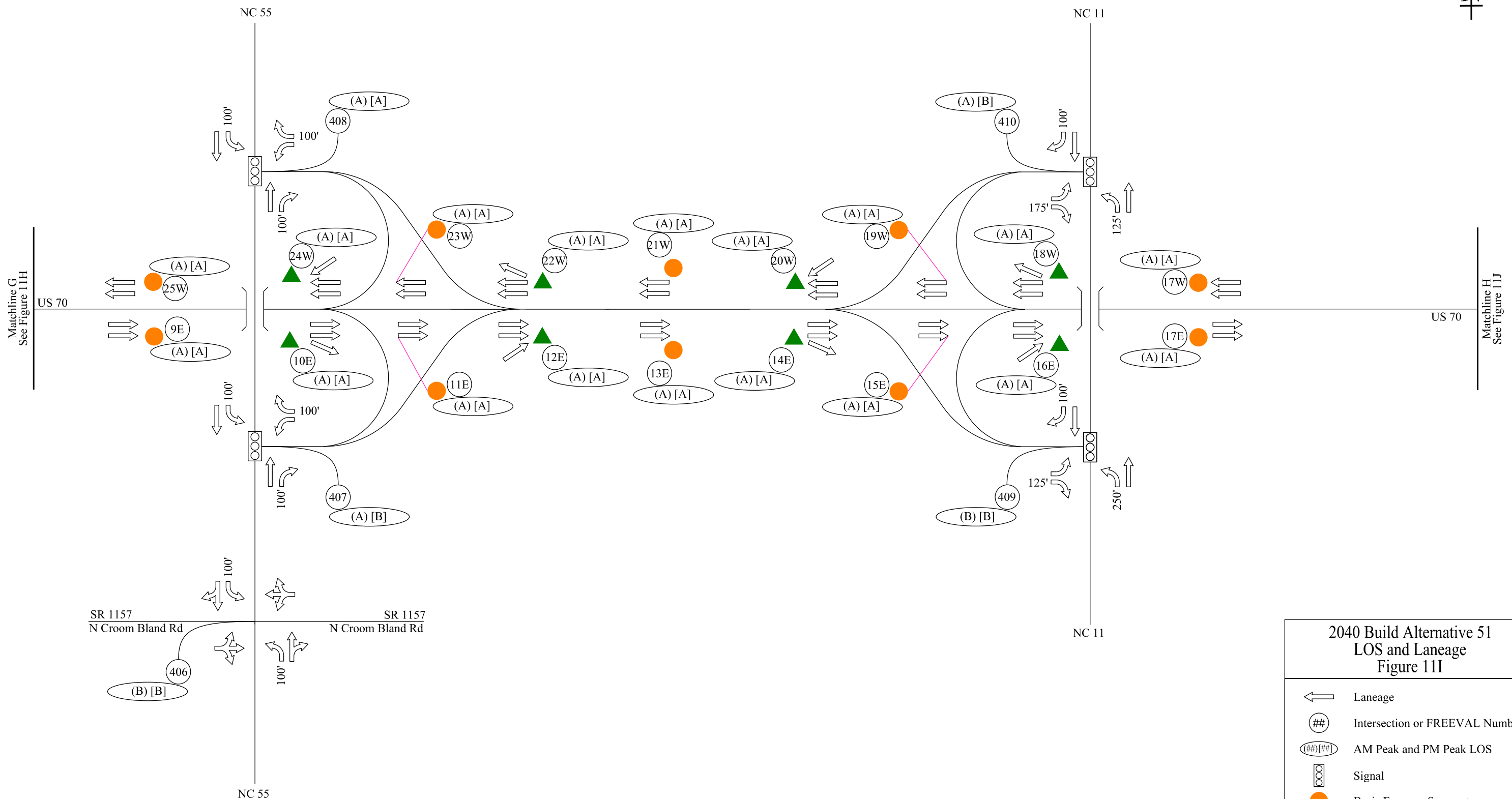











2040 Build Alternative 51
LOS and Laneage
Figure 11H

- ← Laneage
- ## Intersection or FREEVAL Number
- (##)(##) AM Peak and PM Peak LOS
- ⓧ Signal
- Basic Freeway Segment
- ▲ Ramp Merge/Diverge
- ### Storage

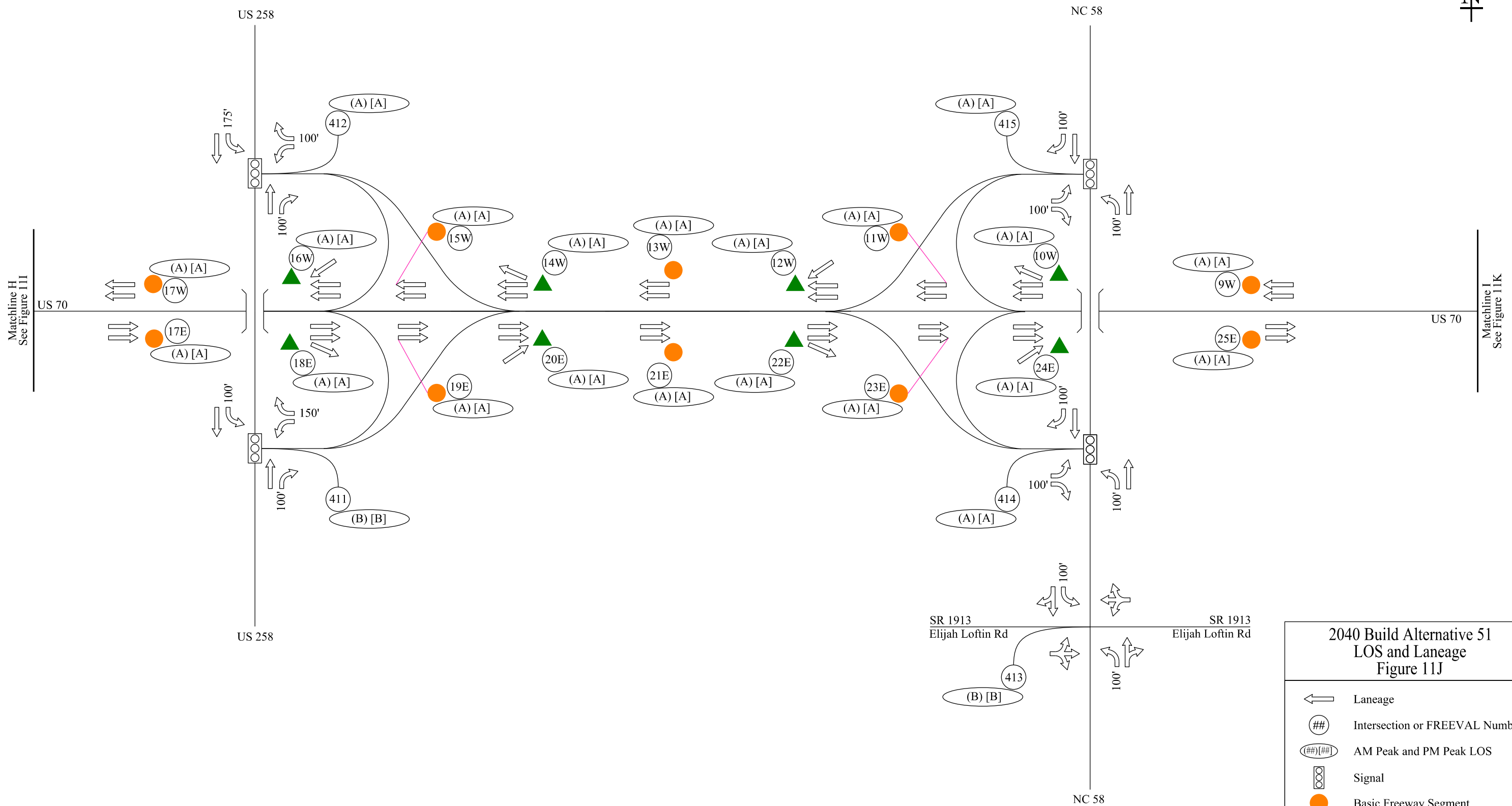




2040 Build Alternative 51
LOS and Laneage
Figure 11I

-  Laneage
-  Intersection or FREEVAL Number
-  AM Peak and PM Peak LOS
-  Signal
-  Basic Freeway Segment
-  Ramp Merge/Diverge
-  Storage

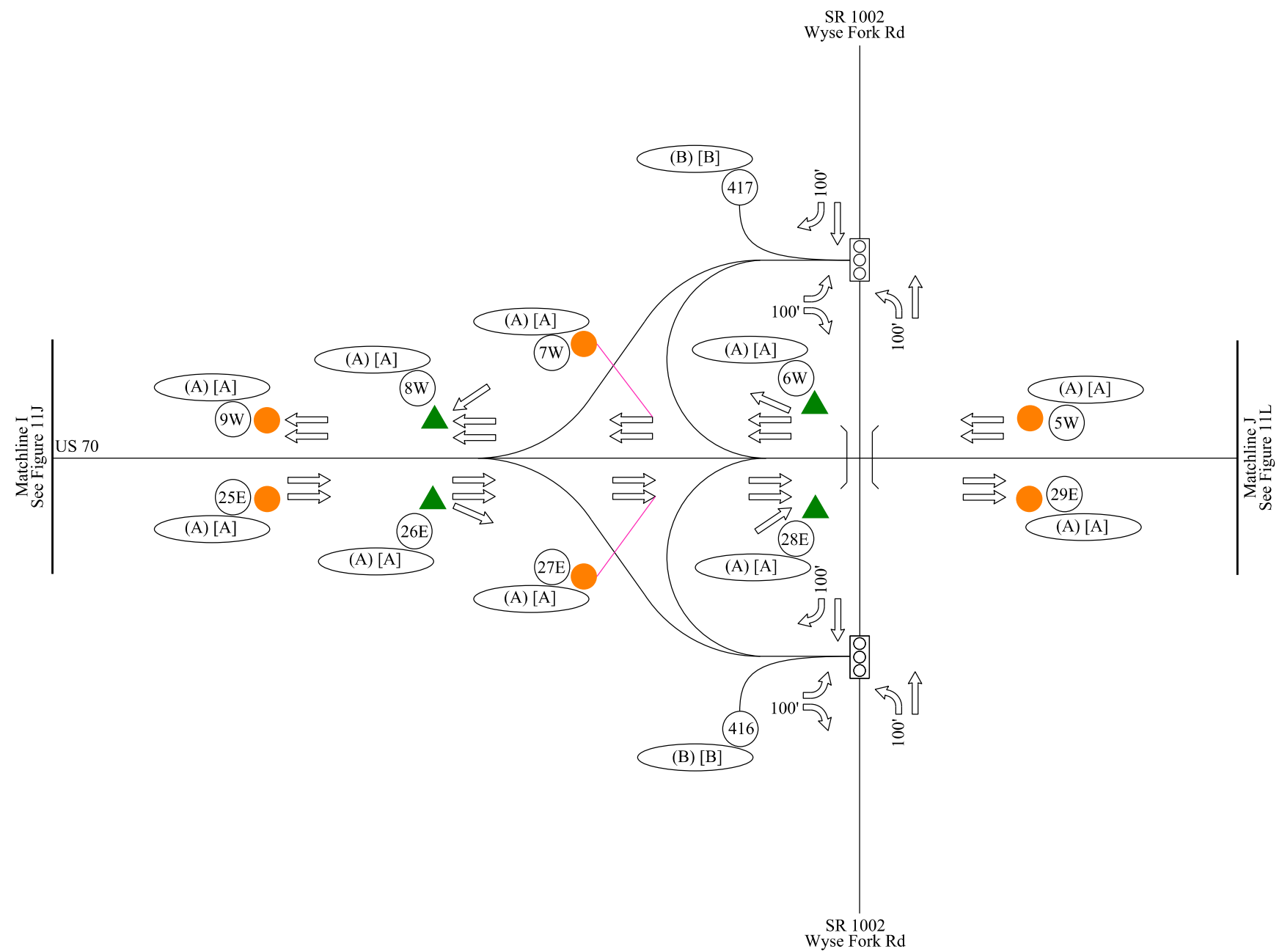











**2040 Build Alternative 51
LOS and Laneage
Figure 11J**

- Laneage
- Intersection or FREEVAL Number
- AM Peak and PM Peak LOS
- Signal
- Basic Freeway Segment
- Ramp Merge/Diverge
- Storage

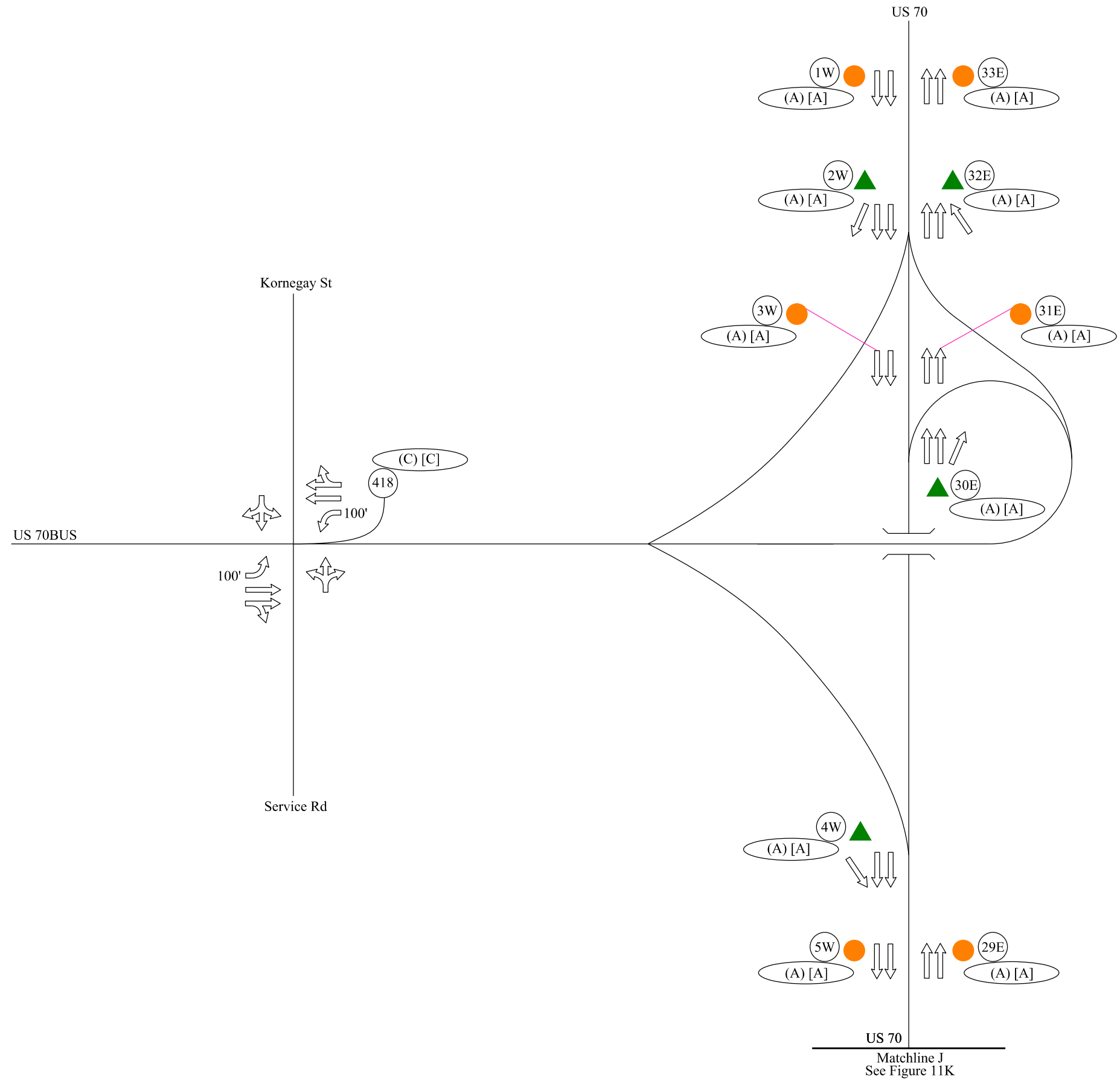




2040 Build Alternative 51
LOS and Laneage
Figure 11K

-  Laneage
-  Intersection or FREEVAL Number
-  AM Peak and PM Peak LOS
-  Signal
-  Basic Freeway Segment
-  Ramp Merge/Diverge
-  Storage





**2040 Build Alternative 51
LOS and Laneage
Figure 11L**

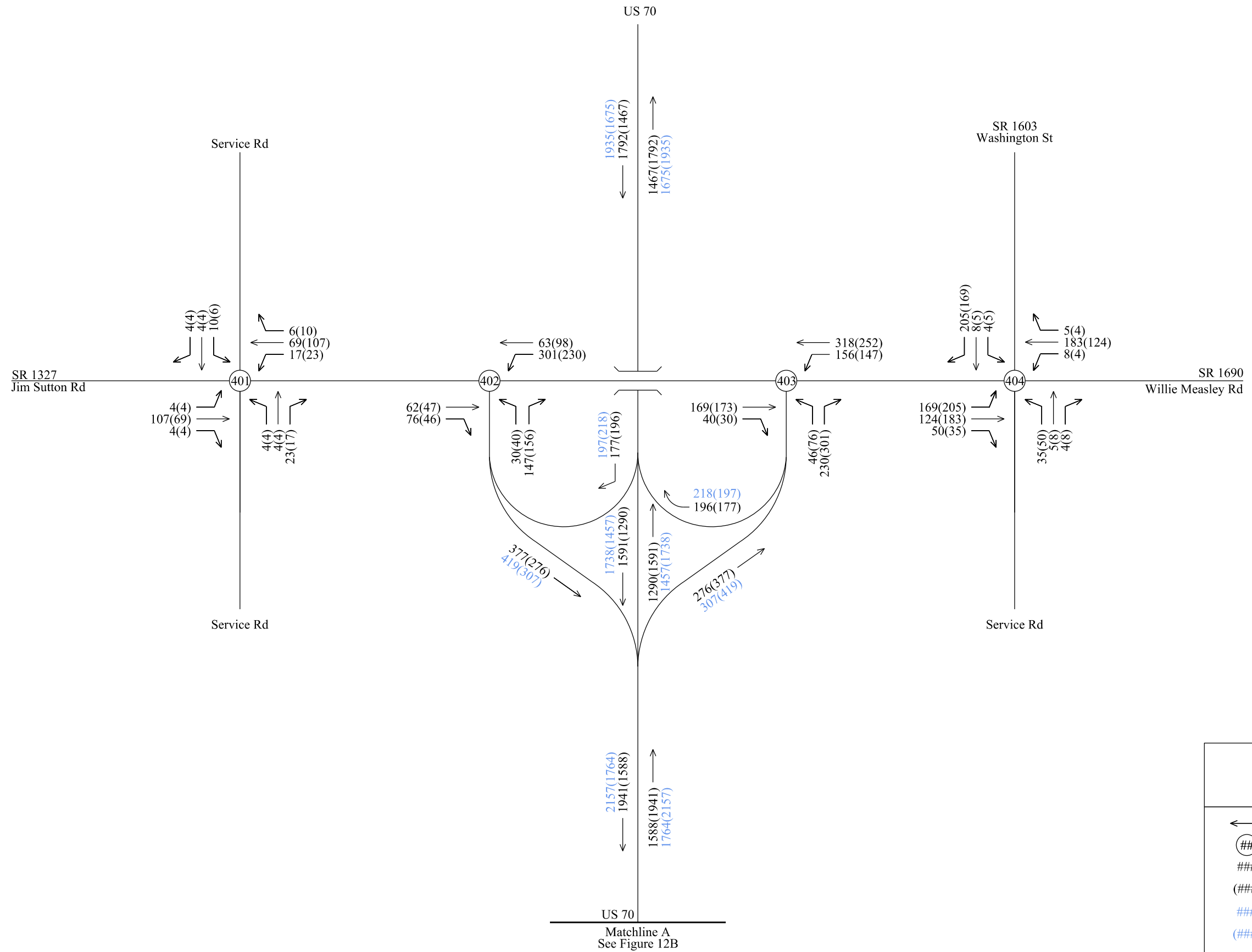
	Laneage
	Intersection or FREEVAL Number
	AM Peak and PM Peak LOS
	Signal
	Basic Freeway Segment
	Ramp Merge/Diverge
	Storage

US 70
Matchline J
See Figure 11K



**2040 Build Alternative 52
Peak Hour Volume Figures**

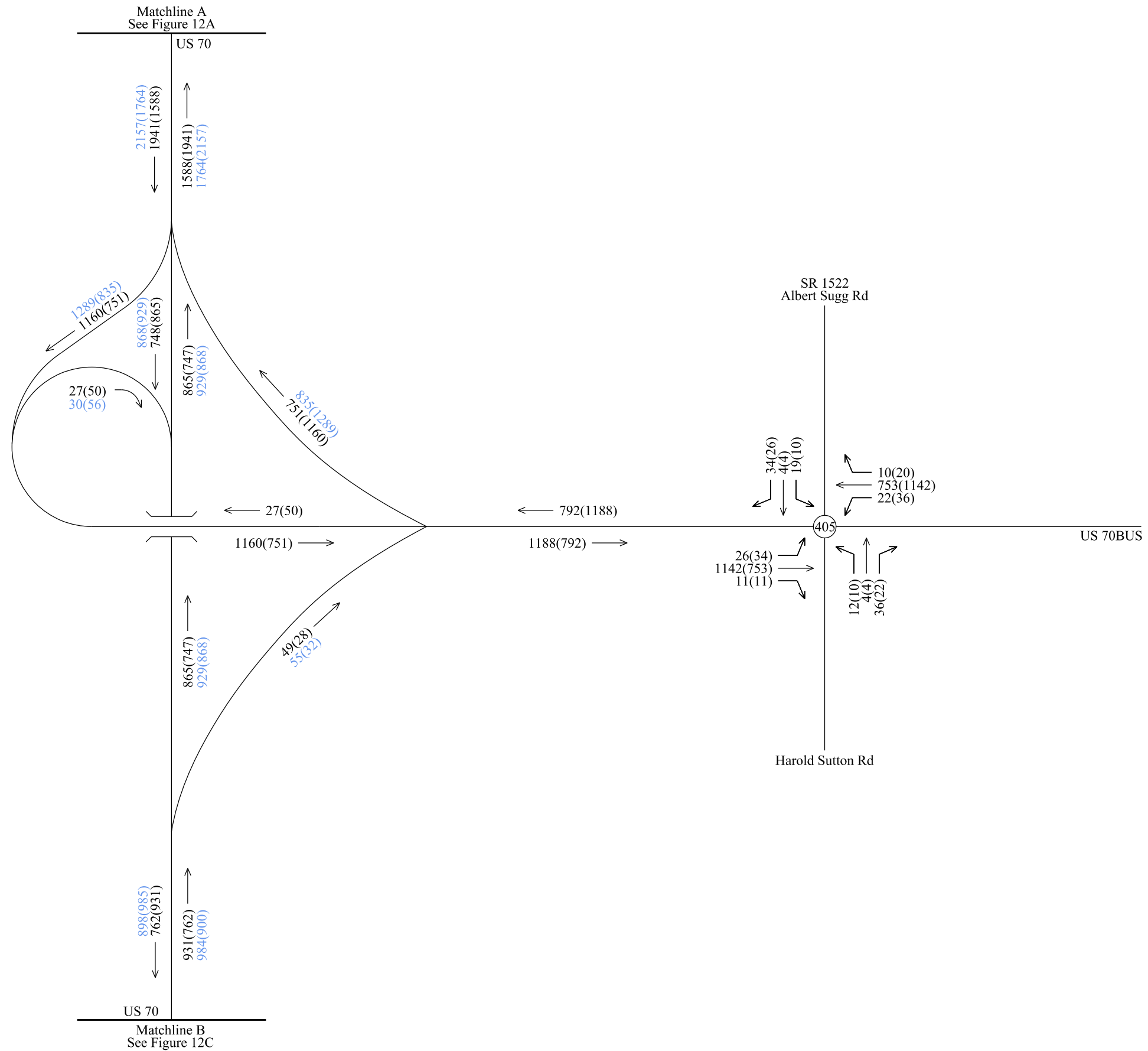
This page left intentionally blank



2040 Build - Alternative 52
Peak Hour Volumes
Figure 12A

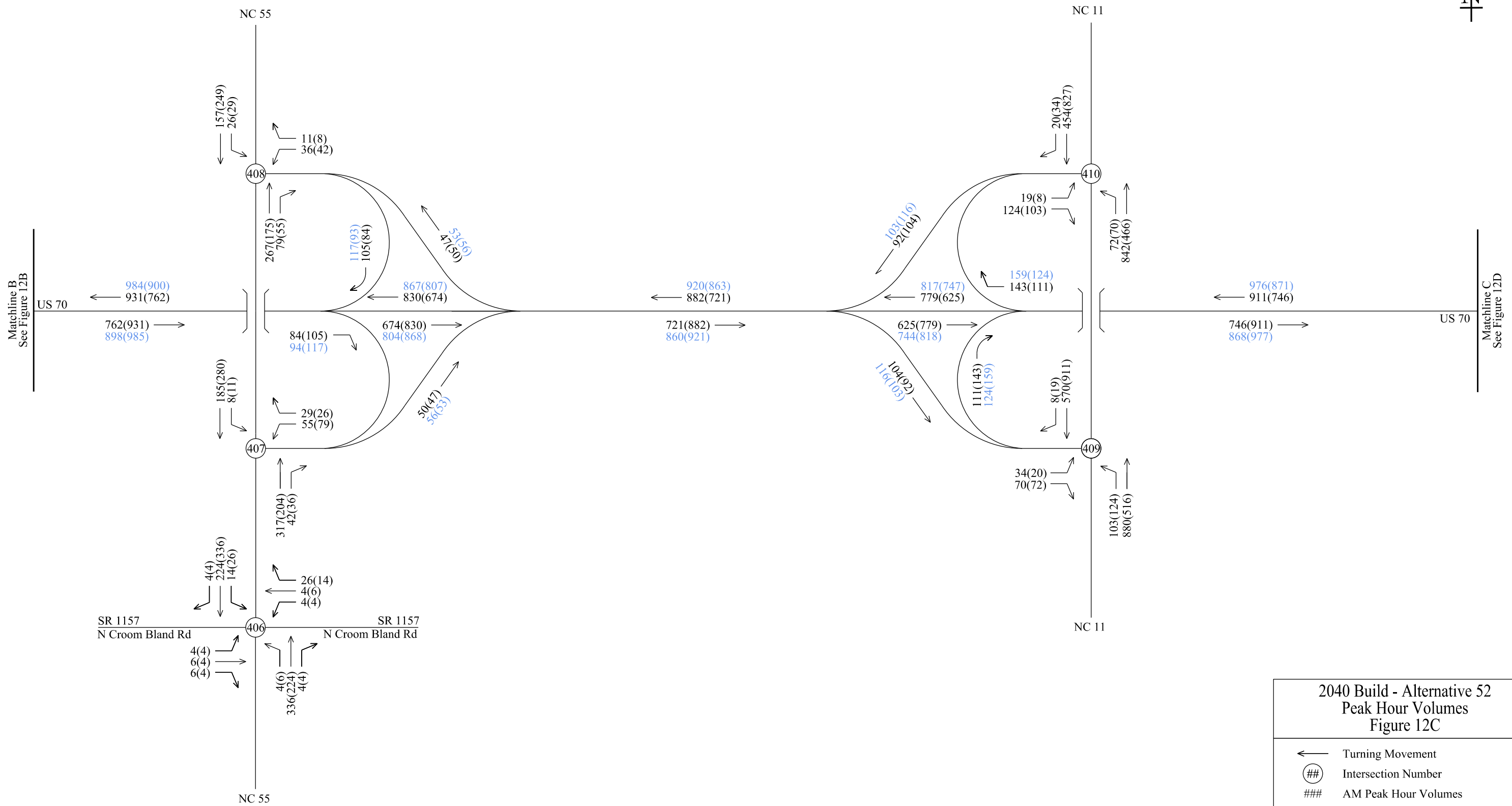
- ← Turning Movement
- (##) Intersection Number
- ### AM Peak Hour Volumes
- (###) PM Peak Hour Volumes
- ### AM Balanced and Adjusted Volumes
- (###) PM Balanced and Adjusted Volumes





2040 Build - Alternative 52
Peak Hour Volumes
Figure 12B

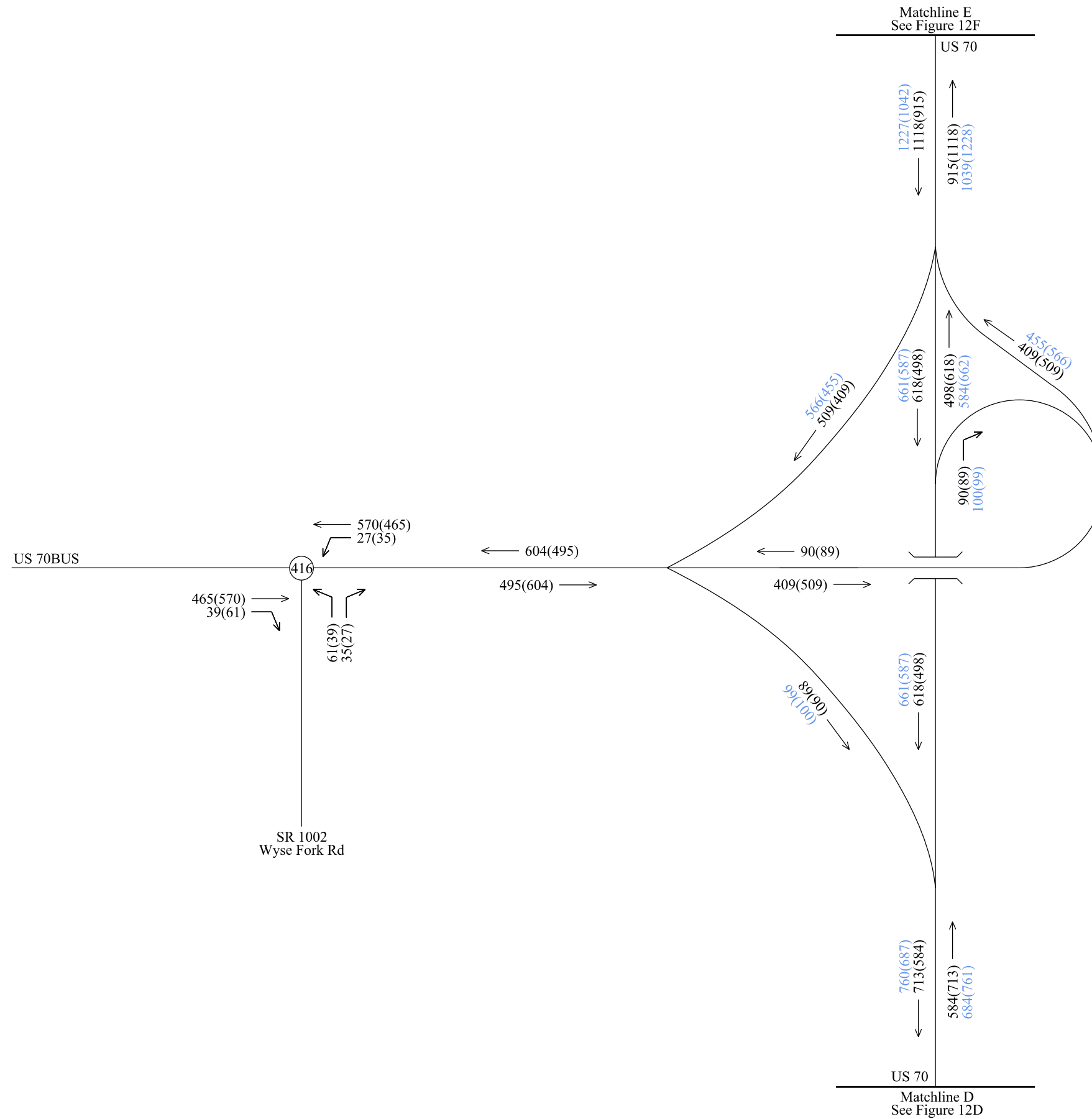
- ← Turning Movement
- ⊙ Intersection Number
- ### AM Peak Hour Volumes
- (###) PM Peak Hour Volumes
- ### AM Balanced and Adjusted Volumes
- (###) PM Balanced and Adjusted Volumes



2040 Build - Alternative 52
Peak Hour Volumes
Figure 12C

- ← Turning Movement
- ⊙ Intersection Number
- ### AM Peak Hour Volumes
- (###) PM Peak Hour Volumes
- ### AM Balanced and Adjusted Volumes
- (###) PM Balanced and Adjusted Volumes

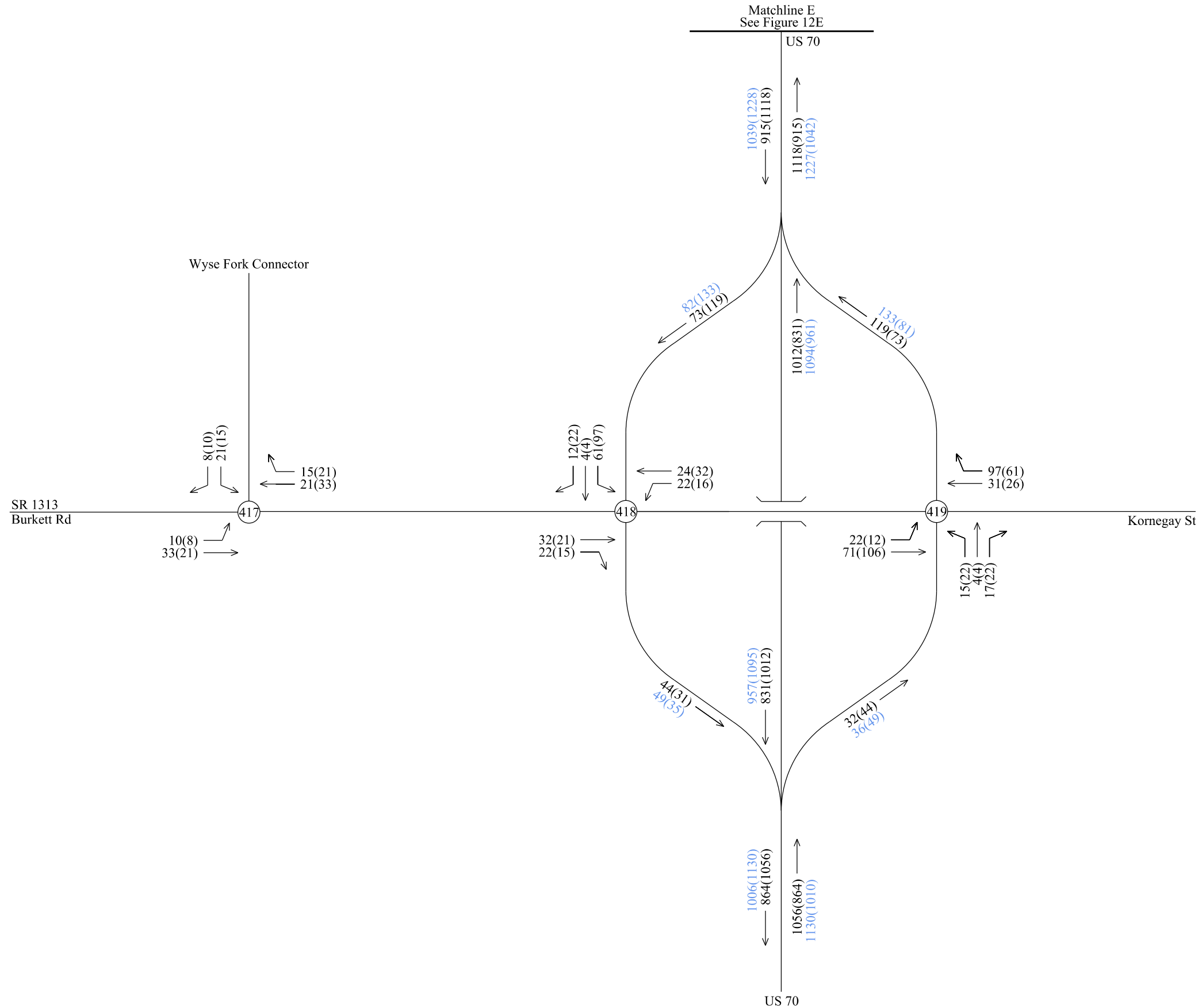




2040 Build - Alternative 52
Peak Hour Volumes
Figure 12E

- ← Turning Movement
- ⊙ Intersection Number
- ### AM Peak Hour Volumes
- (###) PM Peak Hour Volumes
- ### AM Balanced and Adjusted Volumes
- (###) PM Balanced and Adjusted Volumes





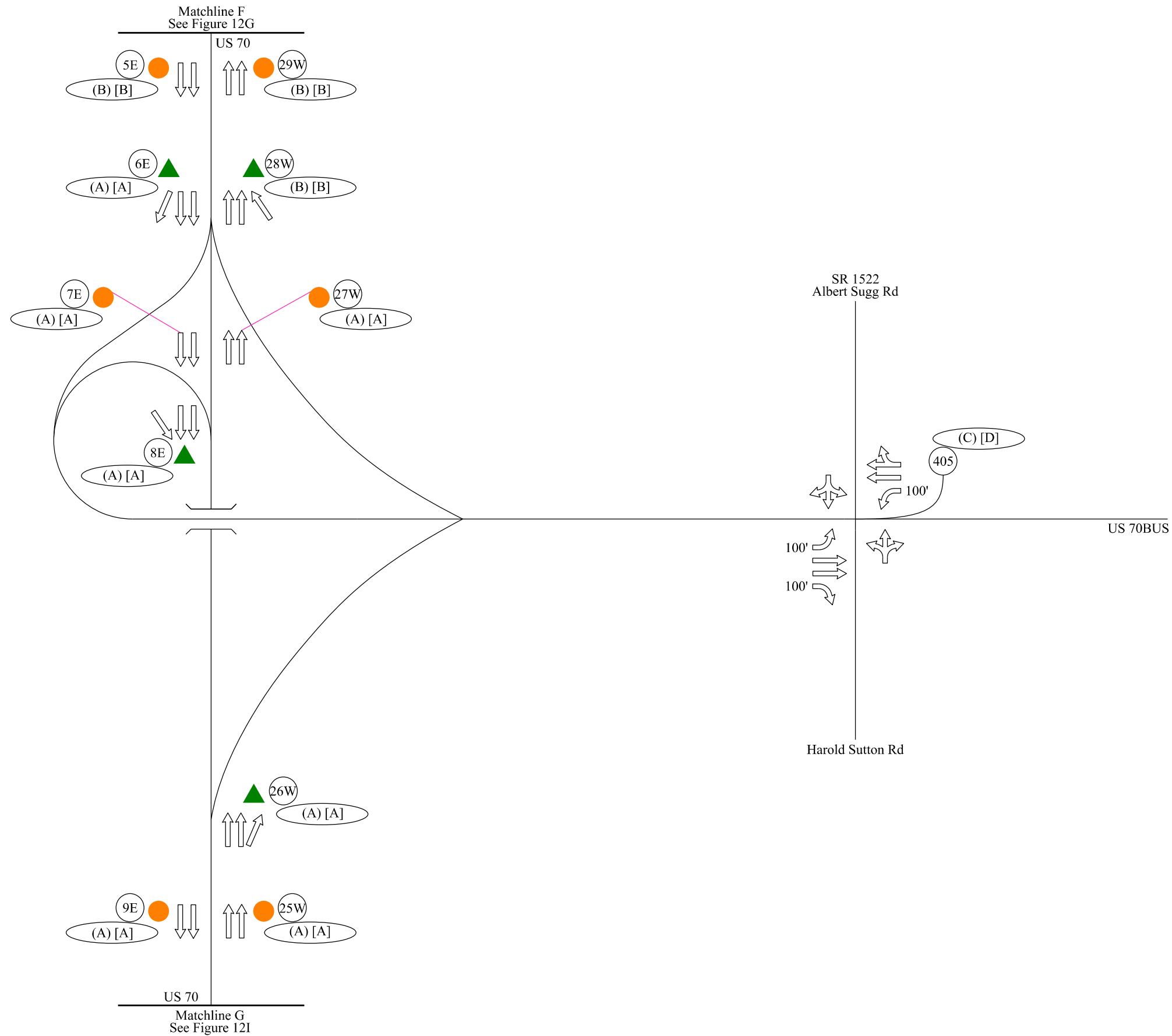
2040 Build - Alternative 52
Peak Hour Volumes
Figure 12F

- ← Turning Movement
- ⊙ Intersection Number
- ### AM Peak Hour Volumes
- (###) PM Peak Hour Volumes
- ### AM Balanced and Adjusted Volumes
- (###) PM Balanced and Adjusted Volumes










**2040 Build Alternative 52
LOS and Laneage Figures**

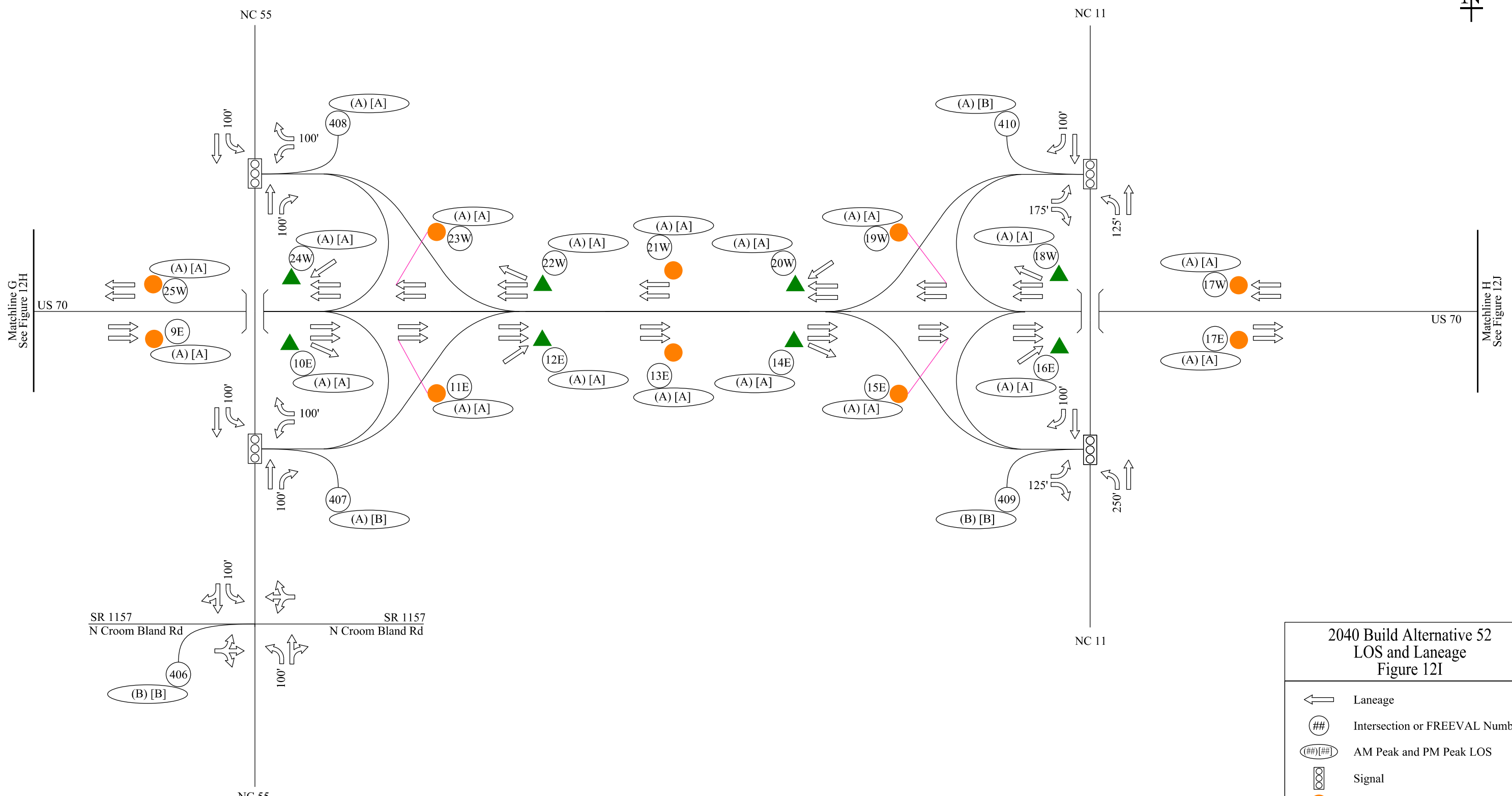
This page left intentionally blank



2040 Build Alternative 52
LOS and Laneage
Figure 12H

-  Laneage
-  Intersection or FREEVAL Number
-  AM Peak and PM Peak LOS
-  Signal
-  Basic Freeway Segment
-  Ramp Merge/Diverge
-  Storage





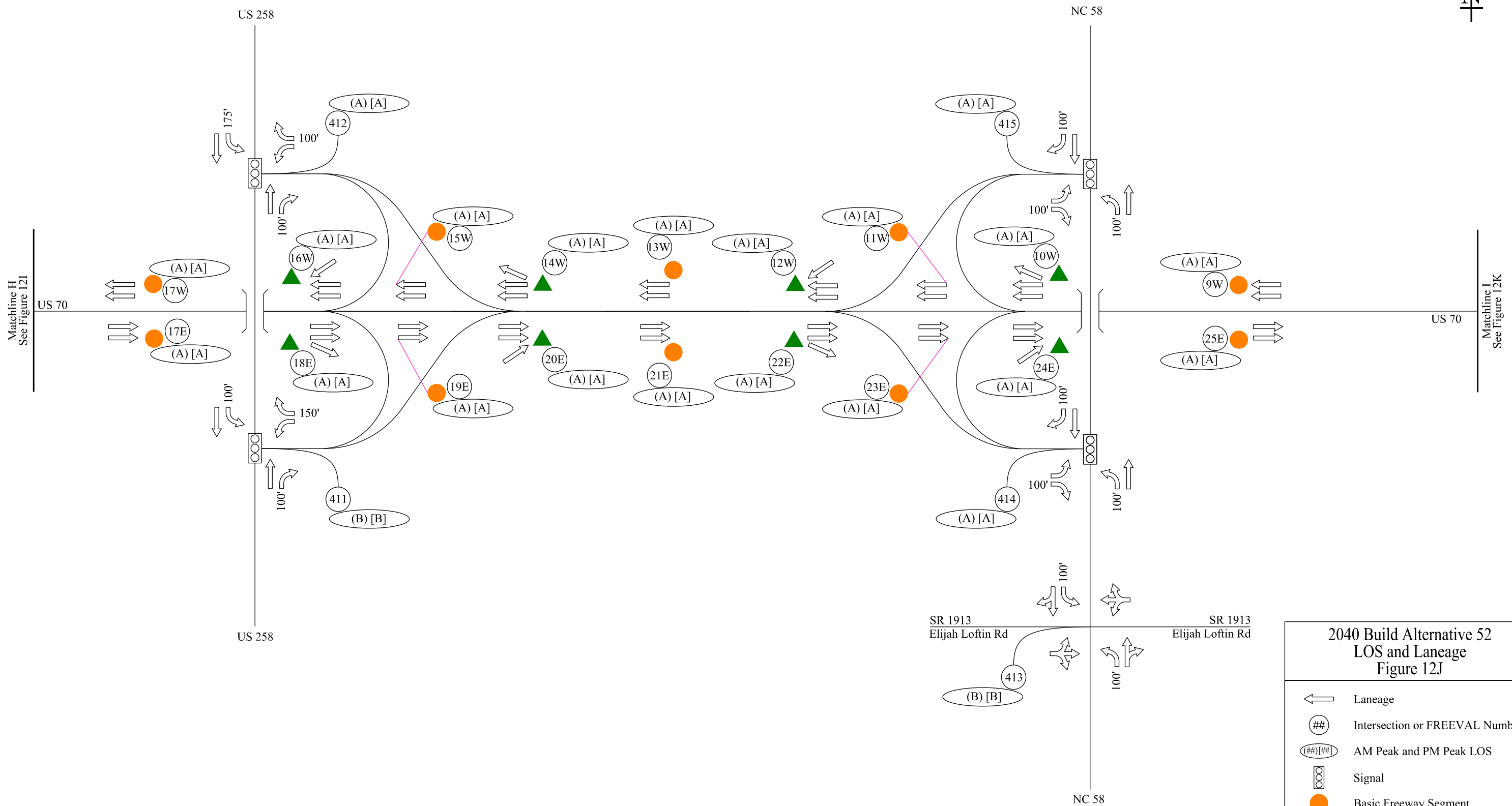
Matchline G
See Figure 12H

Matchline H
See Figure 12J

2040 Build Alternative 52
LOS and Laneage
Figure 12I

- Laneage
- Intersection or FREEVAL Number
- AM Peak and PM Peak LOS
- Signal
- Basic Freeway Segment
- Ramp Merge/Diverge
- Storage





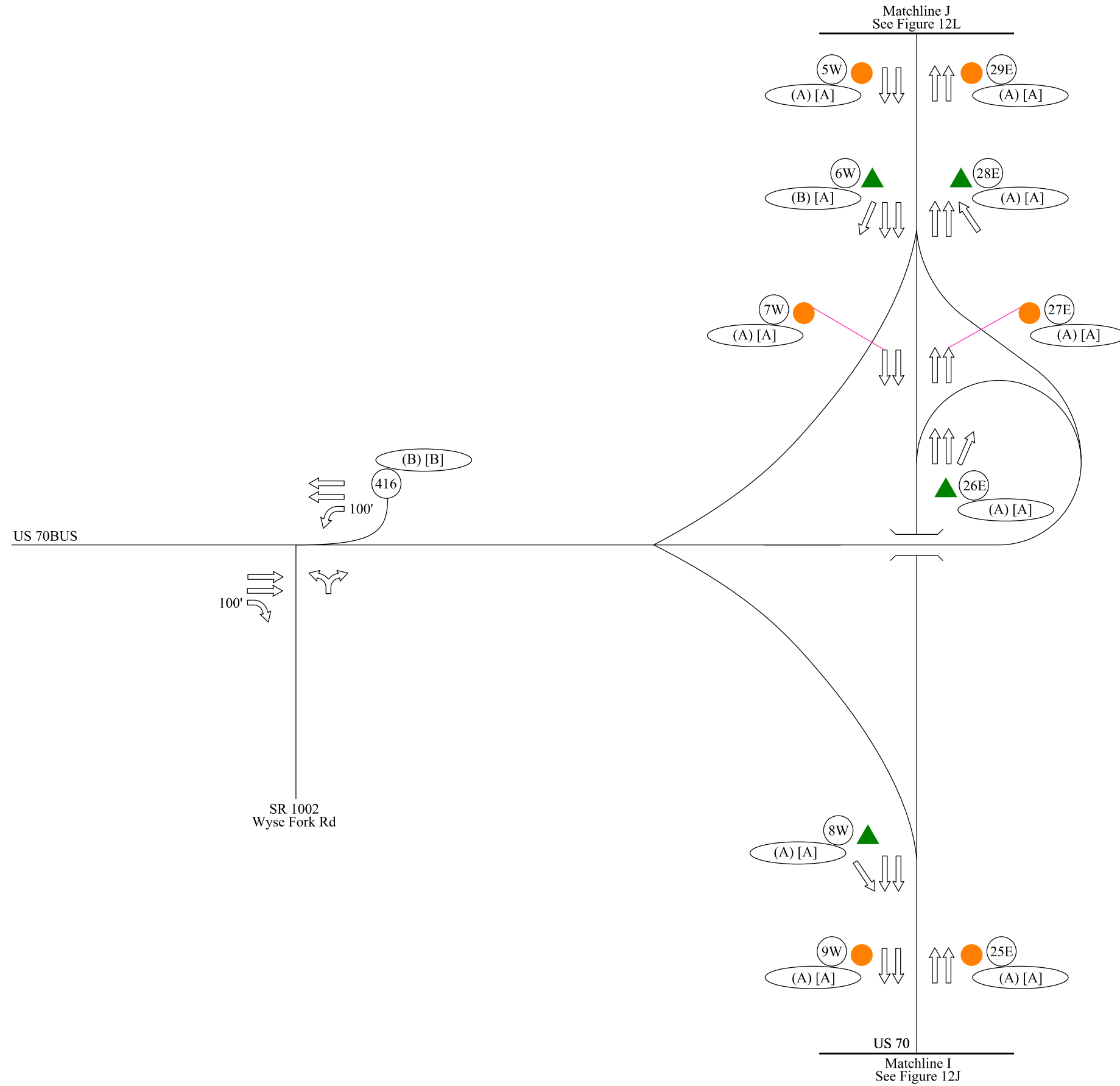
Matchline H
See Figure 12I

Matchline I
See Figure 12K

**2040 Build Alternative 52
LOS and Laneage
Figure 12J**

	Laneage
	Intersection or FREEVAL Number
	AM Peak and PM Peak LOS
	Signal
	Basic Freeway Segment
	Ramp Merge/Diverge
	Storage

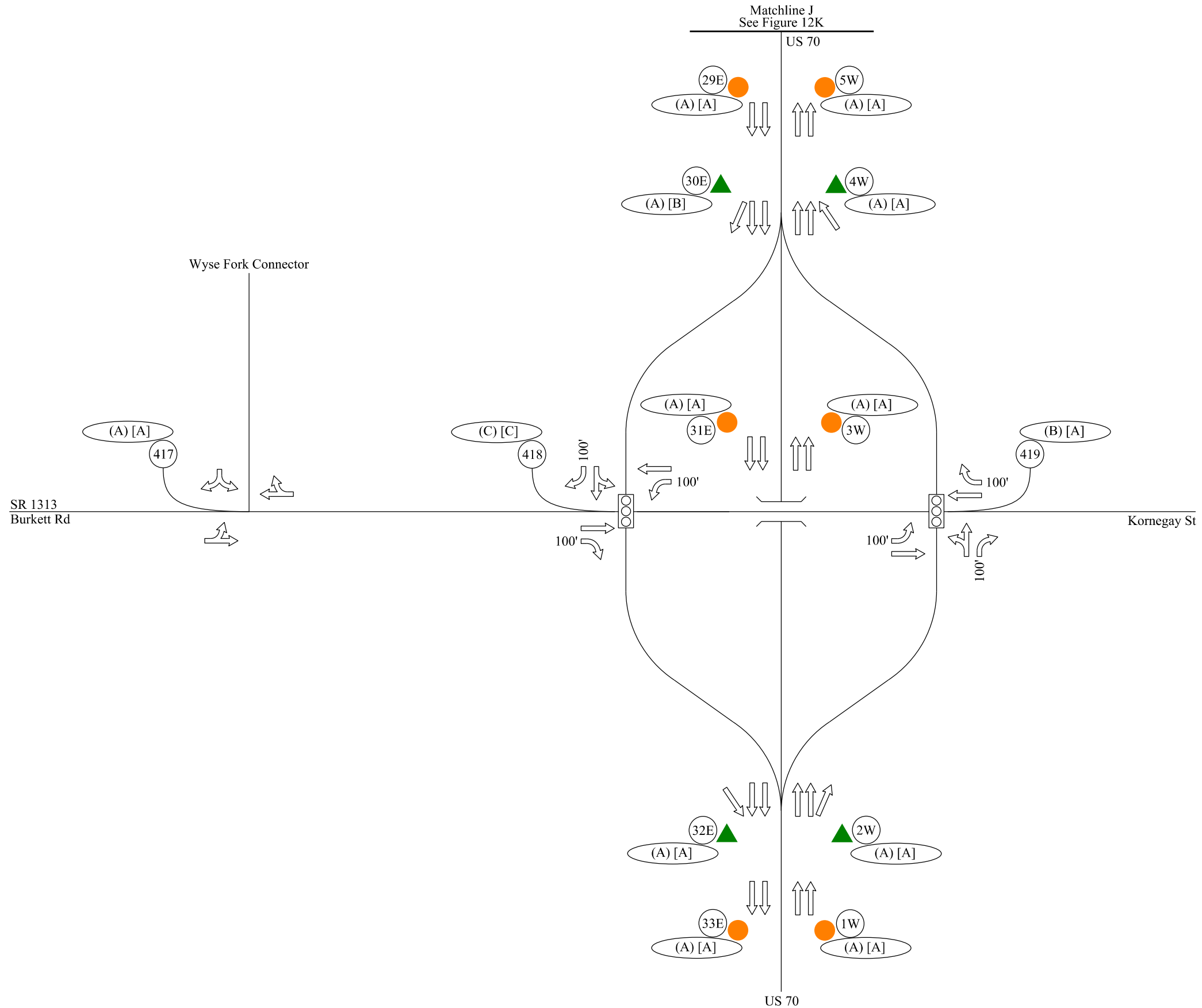




2040 Build Alternative 52
LOS and Laneage
Figure 12K

	Laneage
	Intersection or FREEVAL Number
	AM Peak and PM Peak LOS
	Signal
	Basic Freeway Segment
	Ramp Merge/Diverge
	Storage





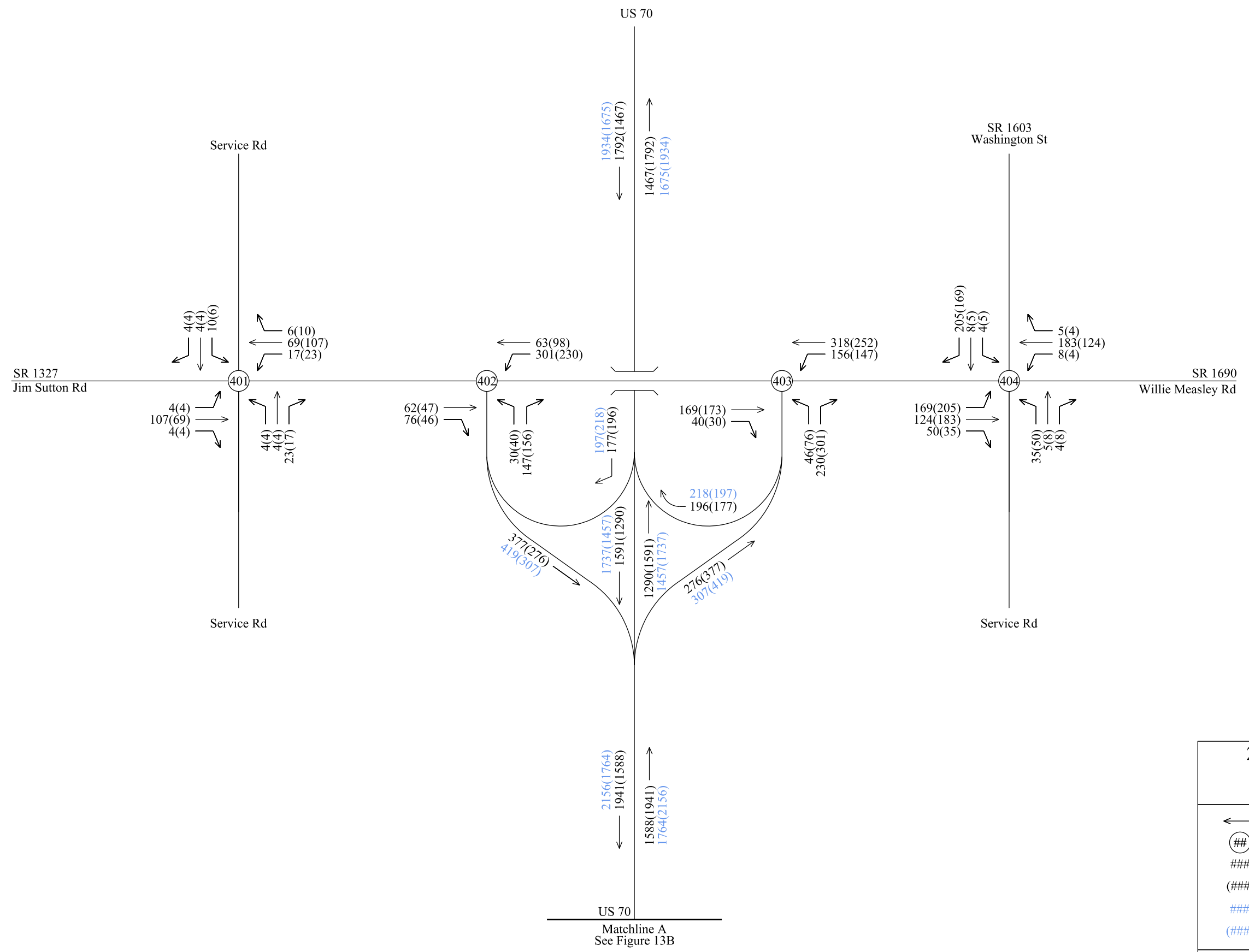
2040 Build Alternative 52
LOS and Laneage
Figure 12L

	Laneage
	Intersection or FREEVAL Number
	AM Peak and PM Peak LOS
	Signal
	Basic Freeway Segment
	Ramp Merge/Diverge
	Storage



**2040 Build Alternative 35
Peak Hour Volume Figures**

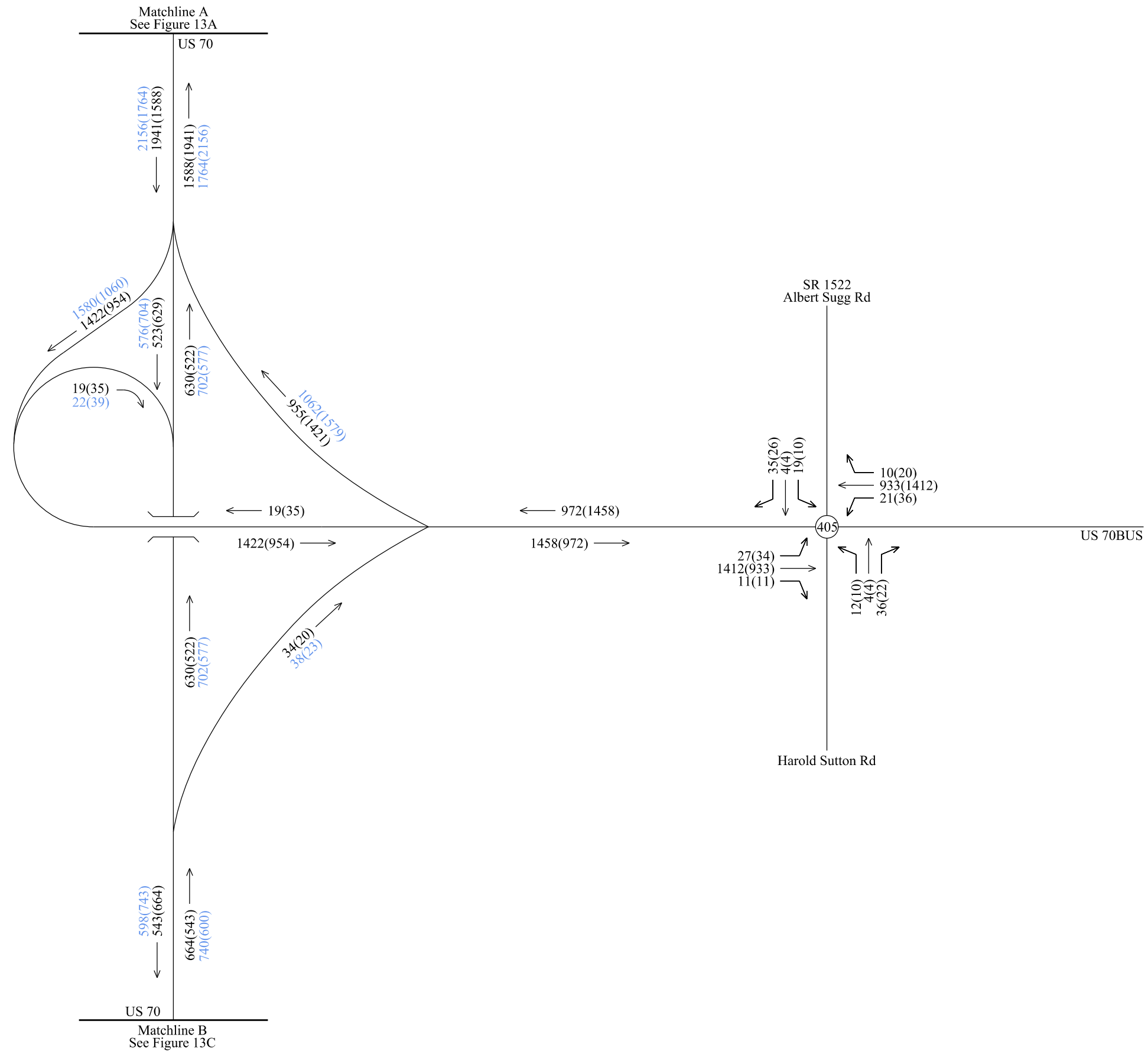
This page left intentionally blank



2040 Build - Alternative 35
Peak Hour Volumes
Figure 13A

- \leftarrow Turning Movement
- $\textcircled{\# \#}$ Intersection Number
- $\# \# \#$ AM Peak Hour Volumes
- $(\# \# \#)$ PM Peak Hour Volumes
- $\# \# \#$ AM Balanced and Adjusted Volumes
- $(\# \# \#)$ PM Balanced and Adjusted Volumes

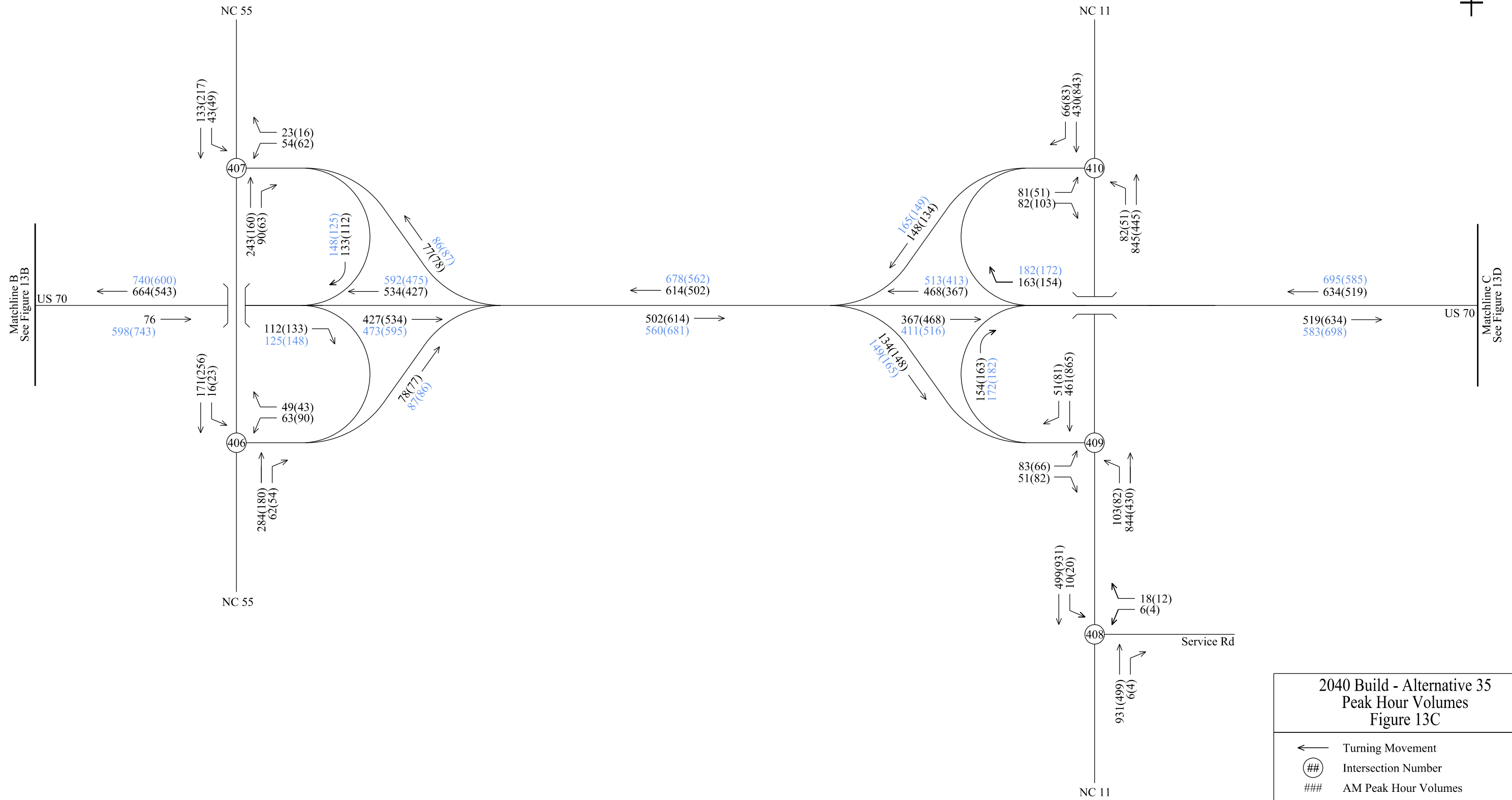




2040 Build - Alternative 35
Peak Hour Volumes
Figure 13B

- ← Turning Movement
- ⊙ Intersection Number
- ### AM Peak Hour Volumes
- (###) PM Peak Hour Volumes
- ### AM Balanced and Adjusted Volumes
- (###) PM Balanced and Adjusted Volumes

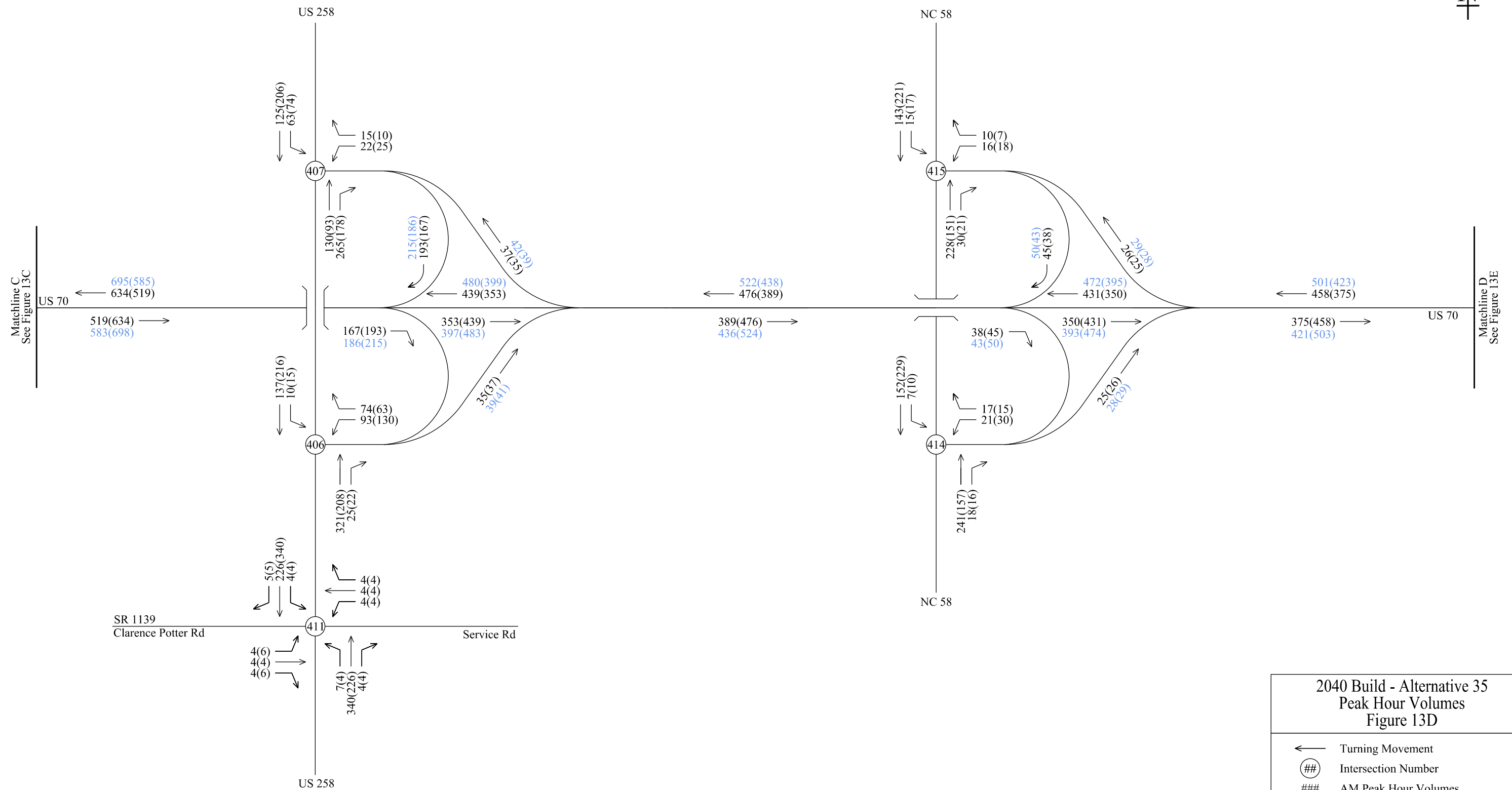




2040 Build - Alternative 35
Peak Hour Volumes
Figure 13C

- ← Turning Movement
- ⊙ Intersection Number
- ### AM Peak Hour Volumes
- (###) PM Peak Hour Volumes
- ### AM Balanced and Adjusted Volumes
- (###) PM Balanced and Adjusted Volumes

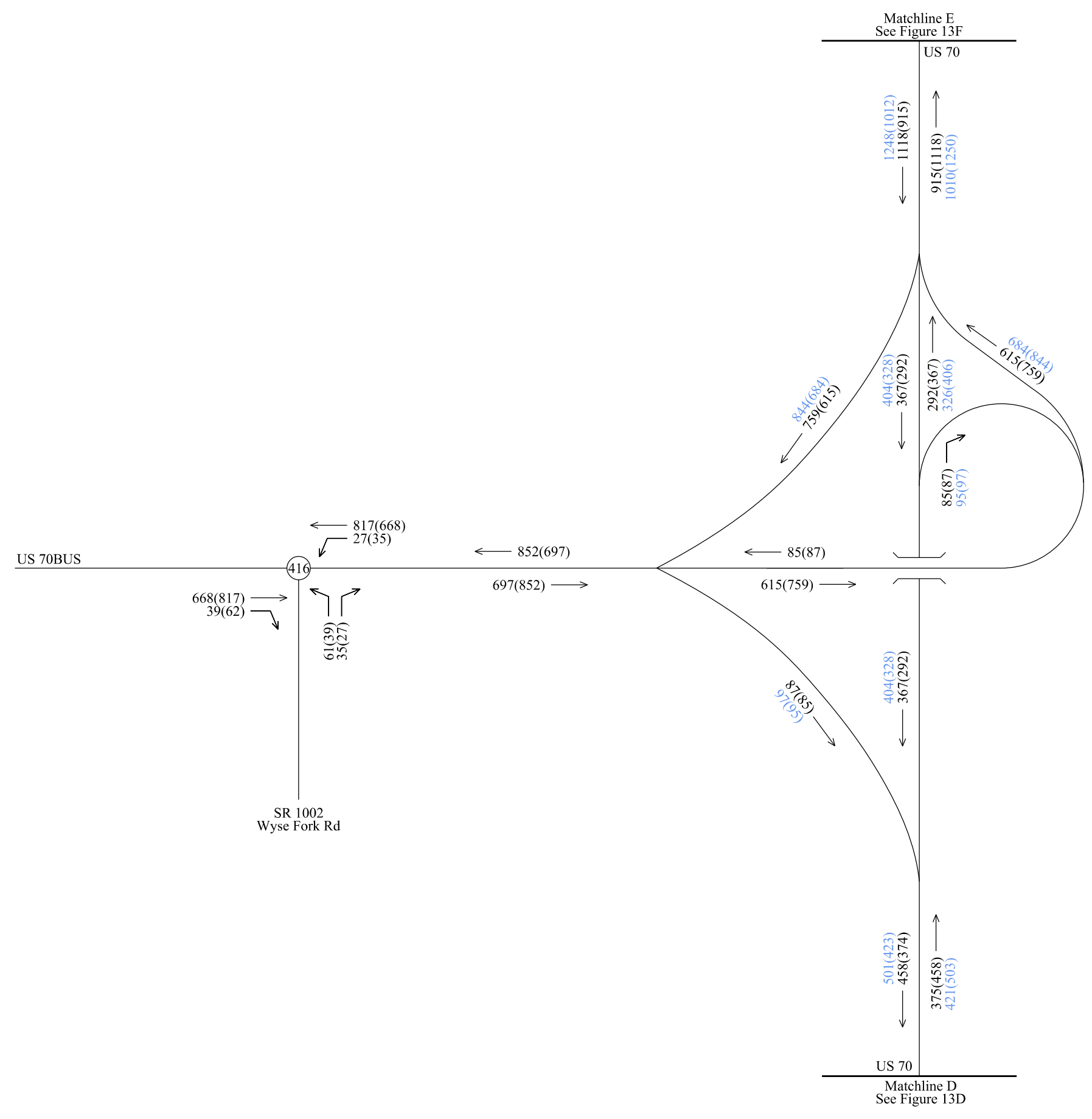




2040 Build - Alternative 35
Peak Hour Volumes
Figure 13D

- ← Turning Movement
- ⊙ Intersection Number
- ### AM Peak Hour Volumes
- (###) PM Peak Hour Volumes
- ### AM Balanced and Adjusted Volumes
- (###) PM Balanced and Adjusted Volumes

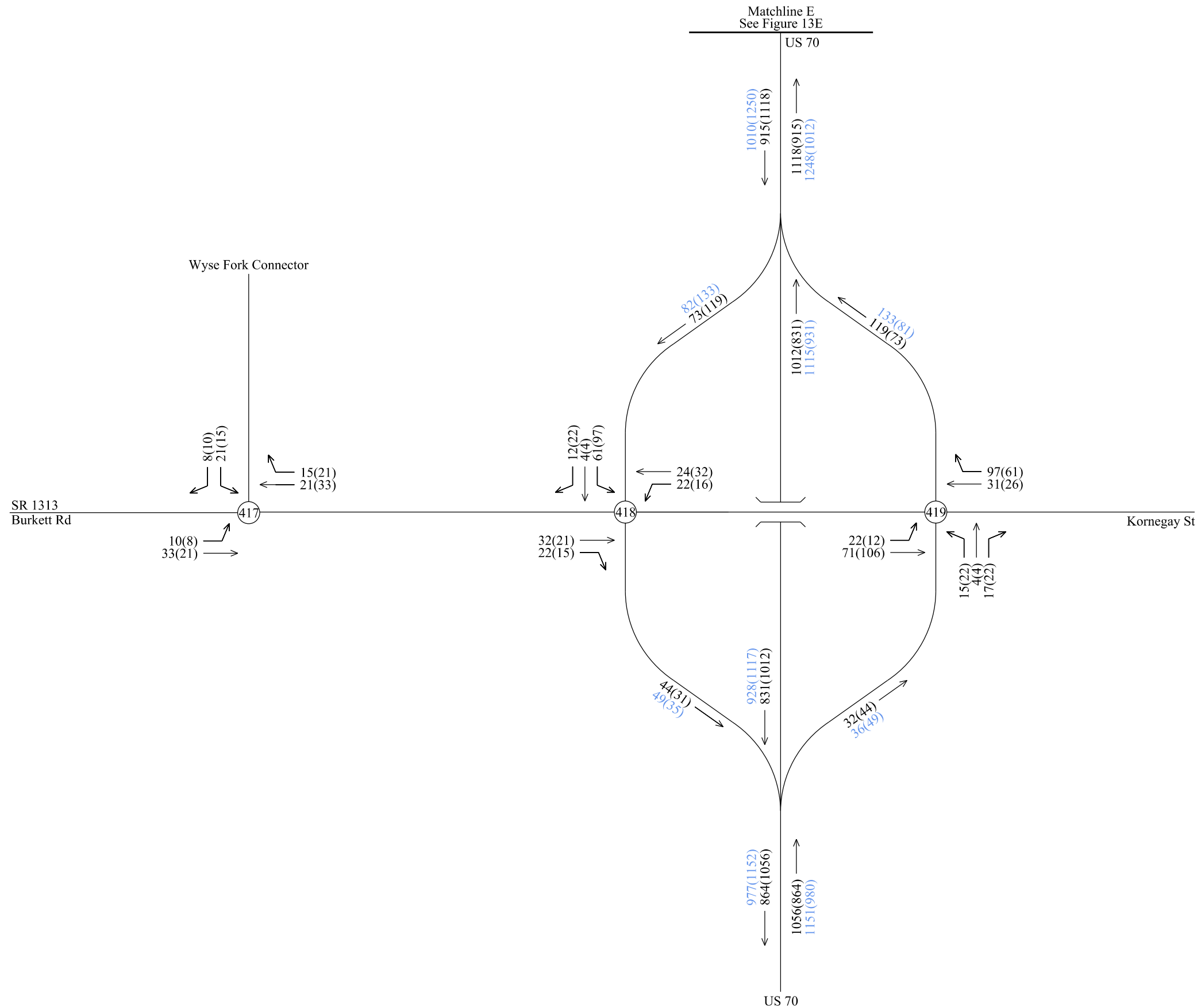




2040 Build - Alternative 35
Peak Hour Volumes
Figure 13E

- ← Turning Movement
- ⊙ Intersection Number
- ### AM Peak Hour Volumes
- (###) PM Peak Hour Volumes
- ### AM Balanced and Adjusted Volumes
- (###) PM Balanced and Adjusted Volumes





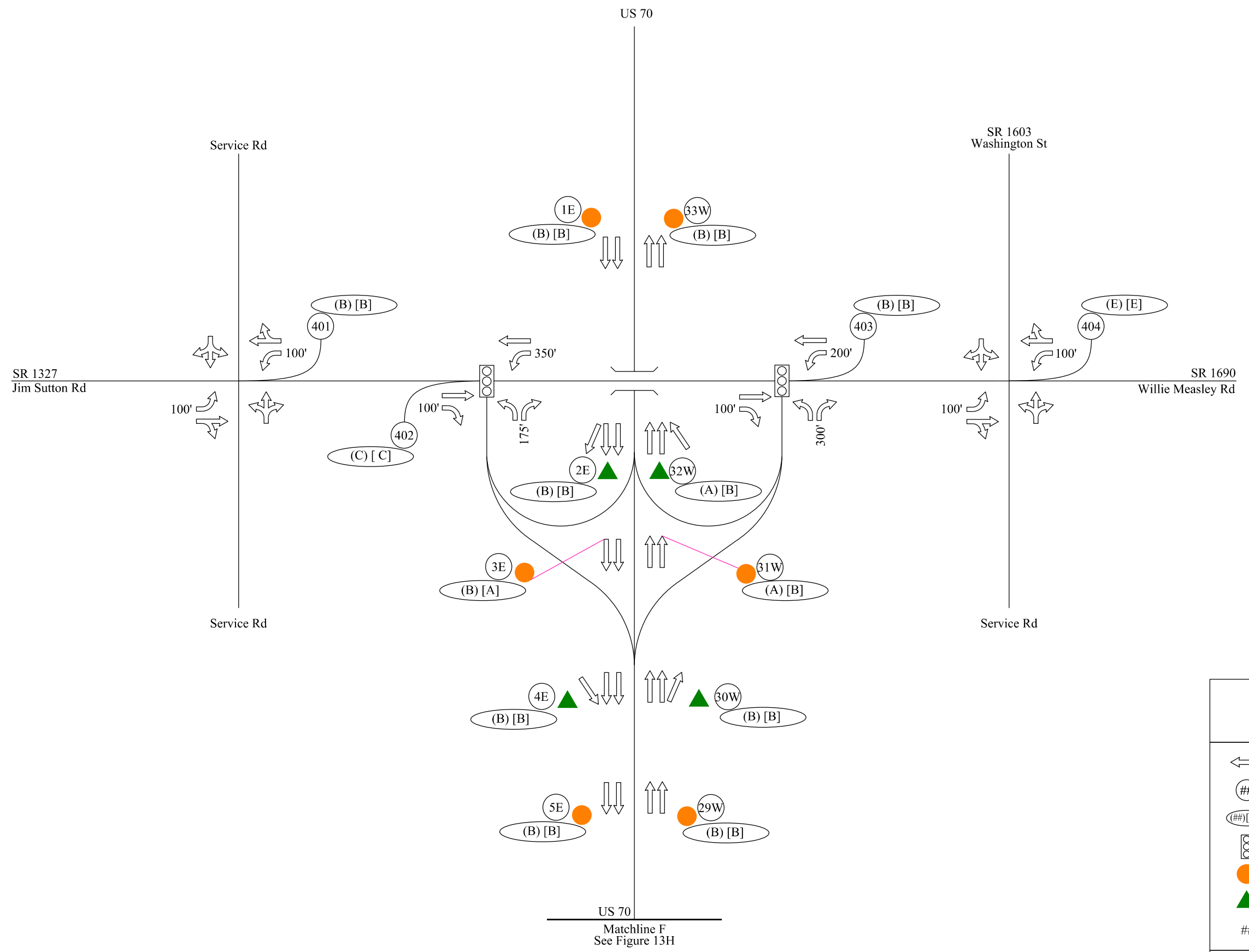
2040 Build - Alternative 35
Peak Hour Volumes
Figure 13F

- ← Turning Movement
- ⊙ Intersection Number
- ### AM Peak Hour Volumes
- (###) PM Peak Hour Volumes
- ### AM Balanced and Adjusted Volumes
- (###) PM Balanced and Adjusted Volumes



**2040 Build Alternative 35
LOS and Laneage Figures**

This page left intentionally blank

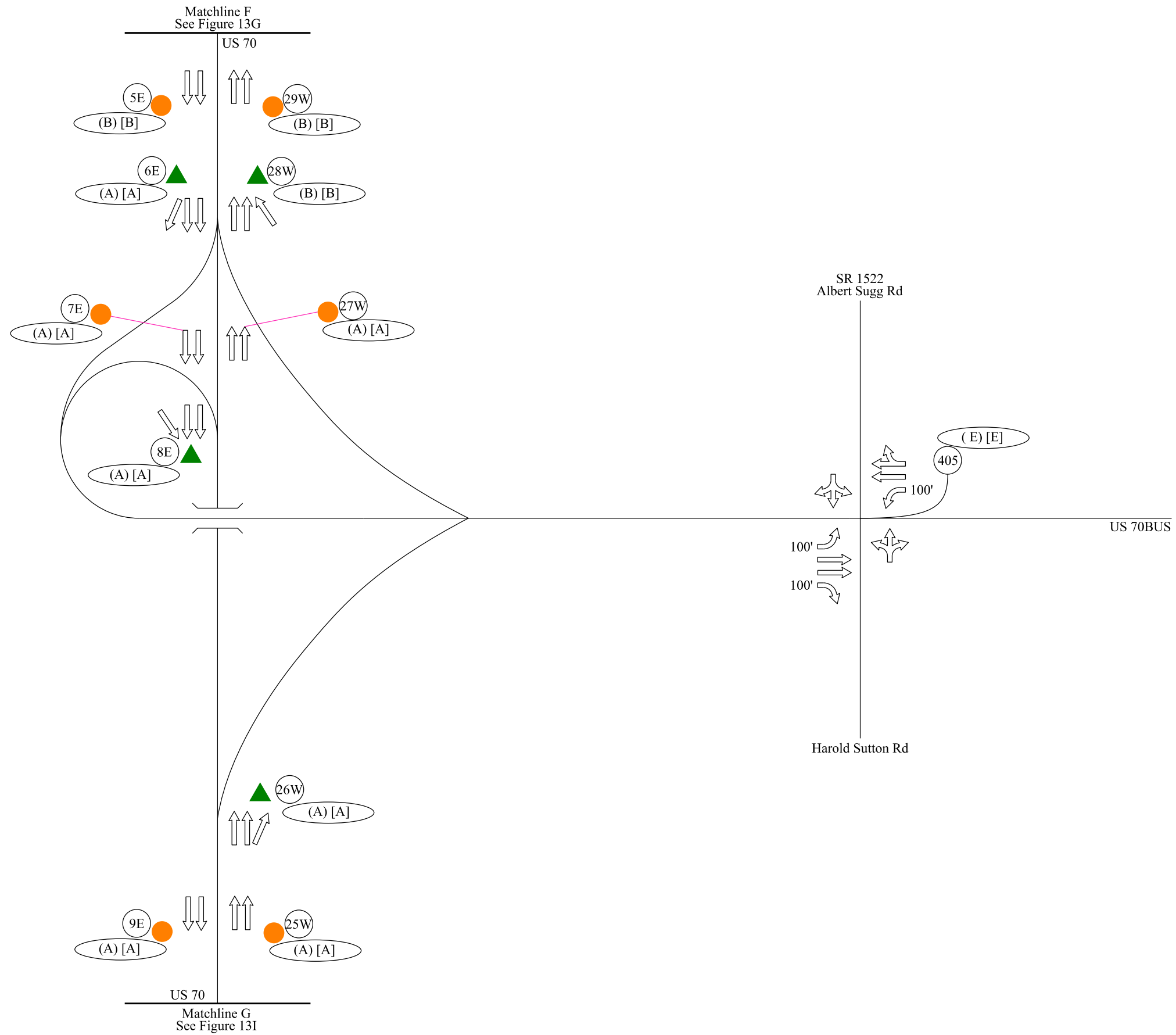


US 70
Matchline F
See Figure 13H

2040 Build Alternative 35
LOS and Laneage
Figure 13G

	Laneage
	Intersection or FREEVAL Number
	AM Peak and PM Peak LOS
	Signal
	Basic Freeway Segment
	Ramp Merge/Diverge
	Storage

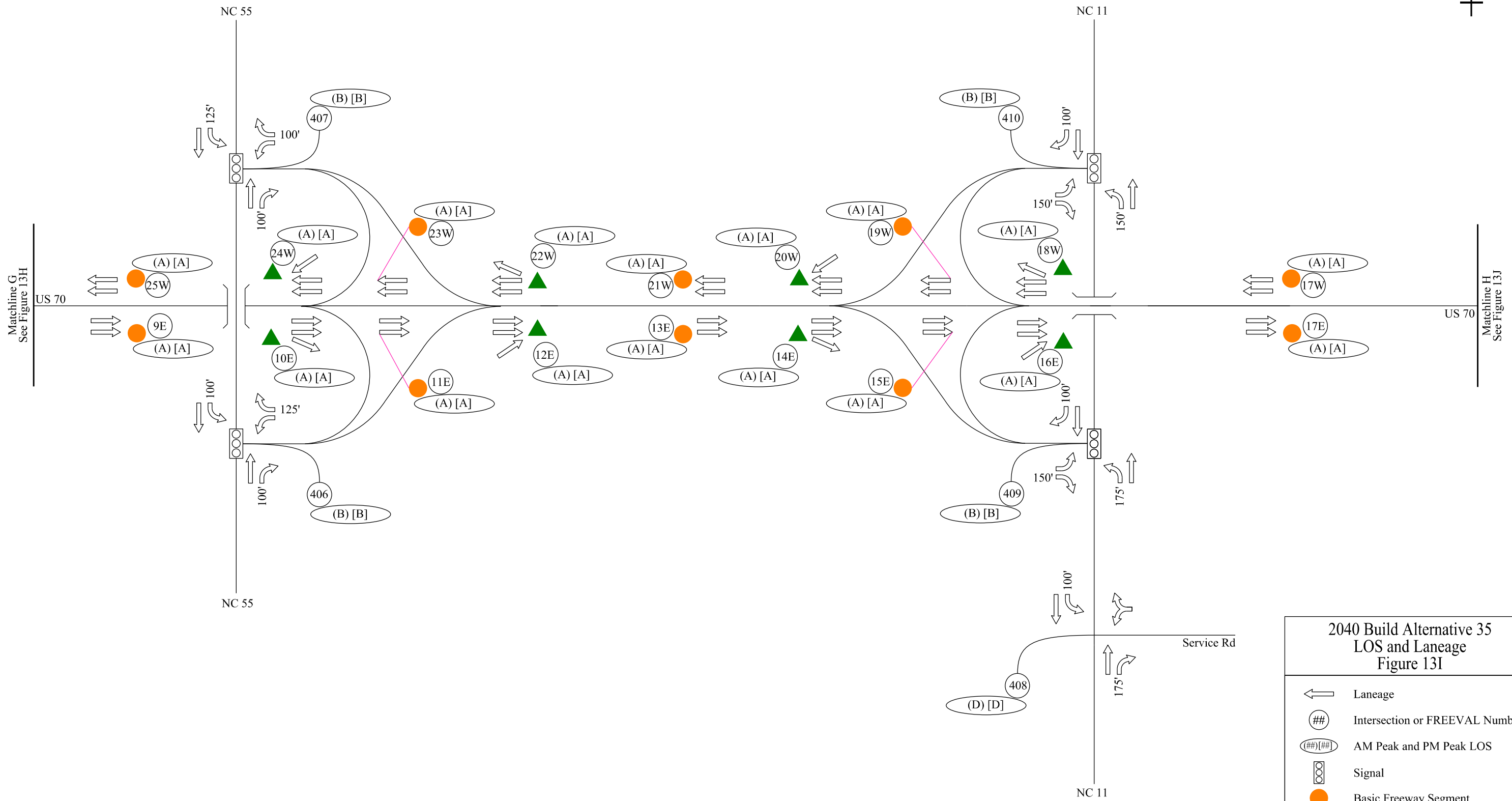




**2040 Build Alternative 35
LOS and Laneage
Figure 13H**

	Laneage
	Intersection or FREEVAL Number
	AM Peak and PM Peak LOS
	Signal
	Basic Freeway Segment
	Ramp Merge/Diverge
	Storage





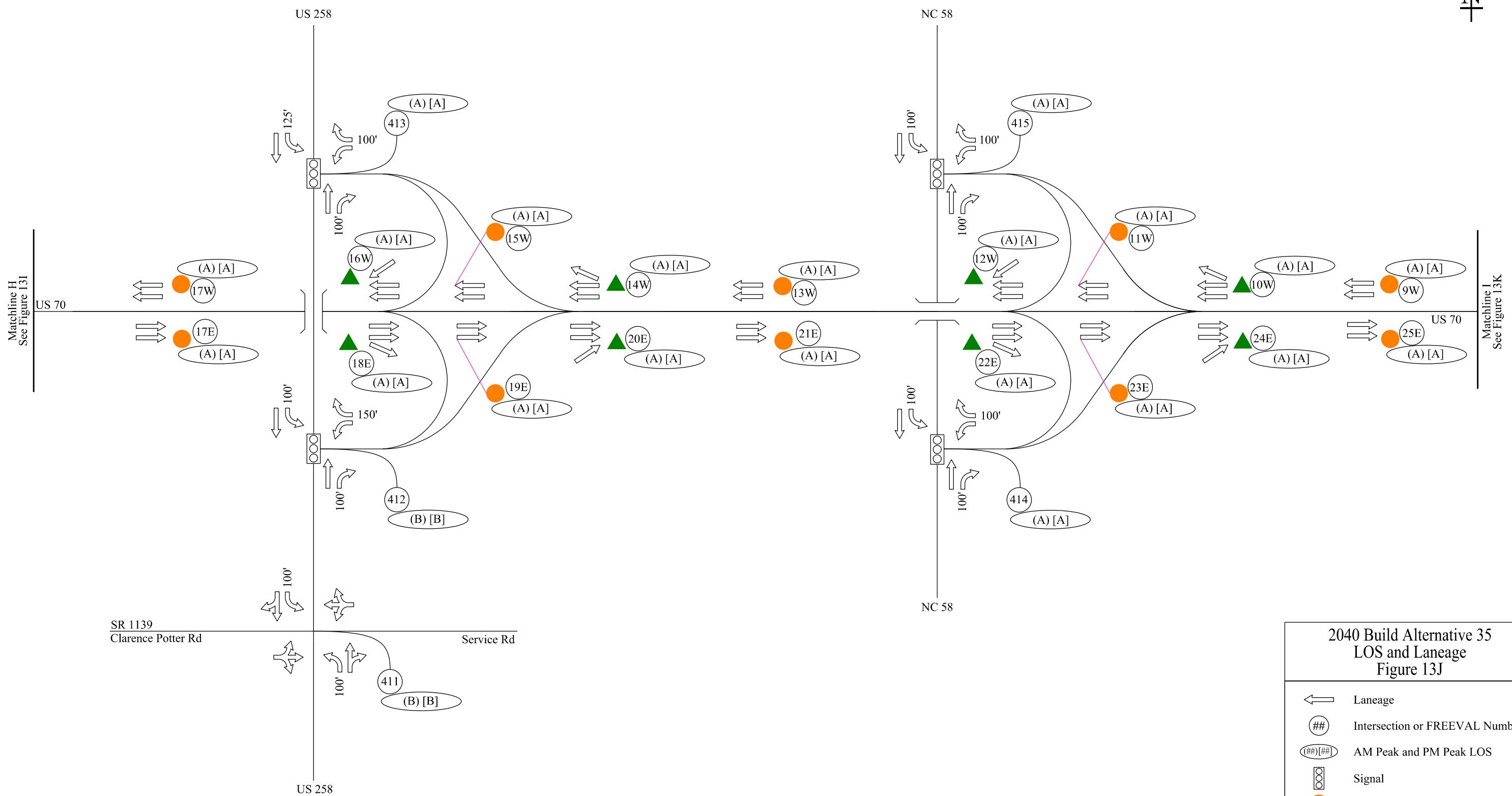
Matchline G
See Figure 13H

Matchline H
See Figure 13J

**2040 Build Alternative 35
LOS and Laneage
Figure 13I**

	Laneage
	Intersection or FREEVAL Number
	AM Peak and PM Peak LOS
	Signal
	Basic Freeway Segment
	Ramp Merge/Diverge
	Storage





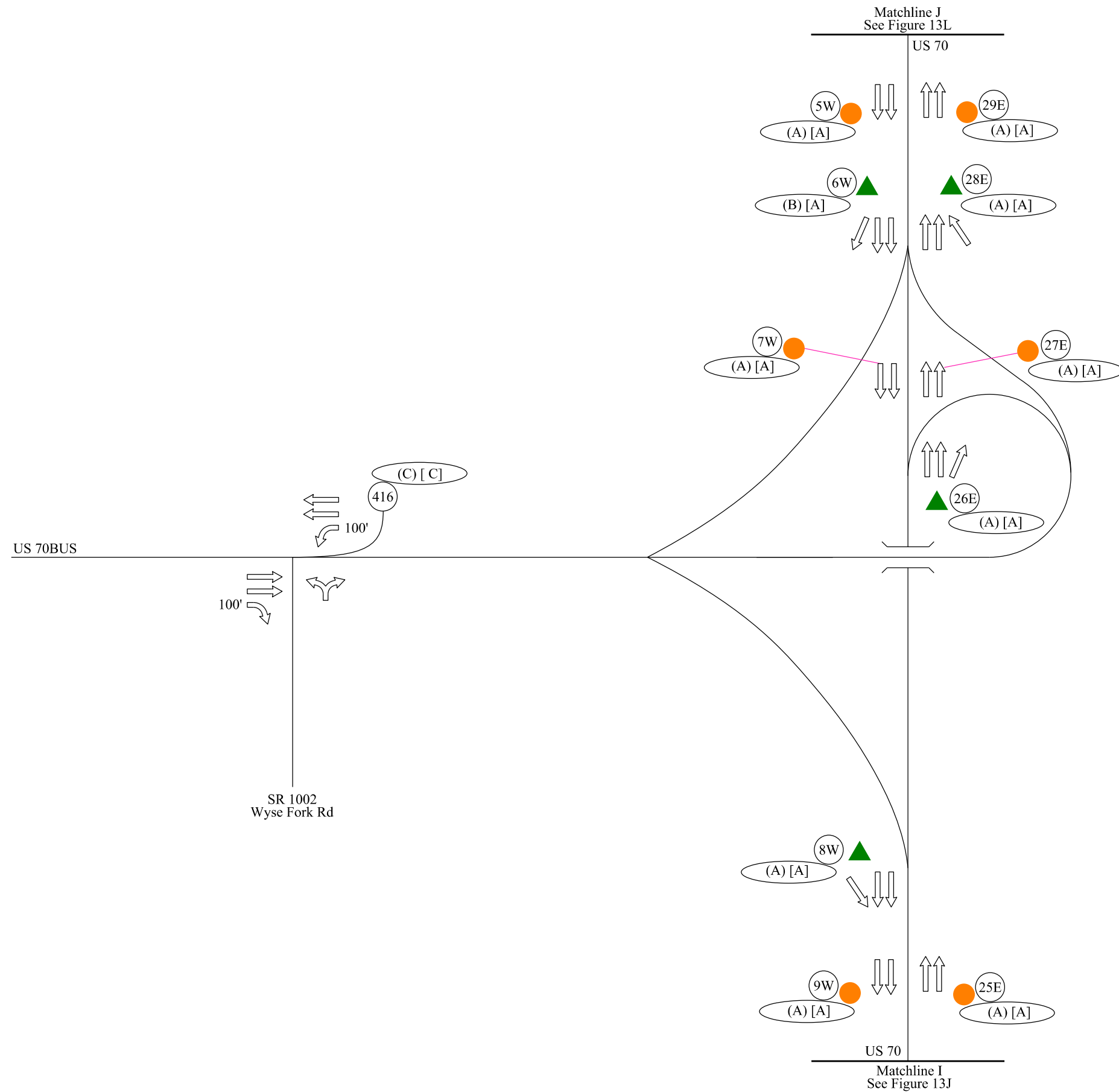
Matchline H
See Figure 13I

Matchline I
See Figure 13K

2040 Build Alternative 35
LOS and Laneage
Figure 13J

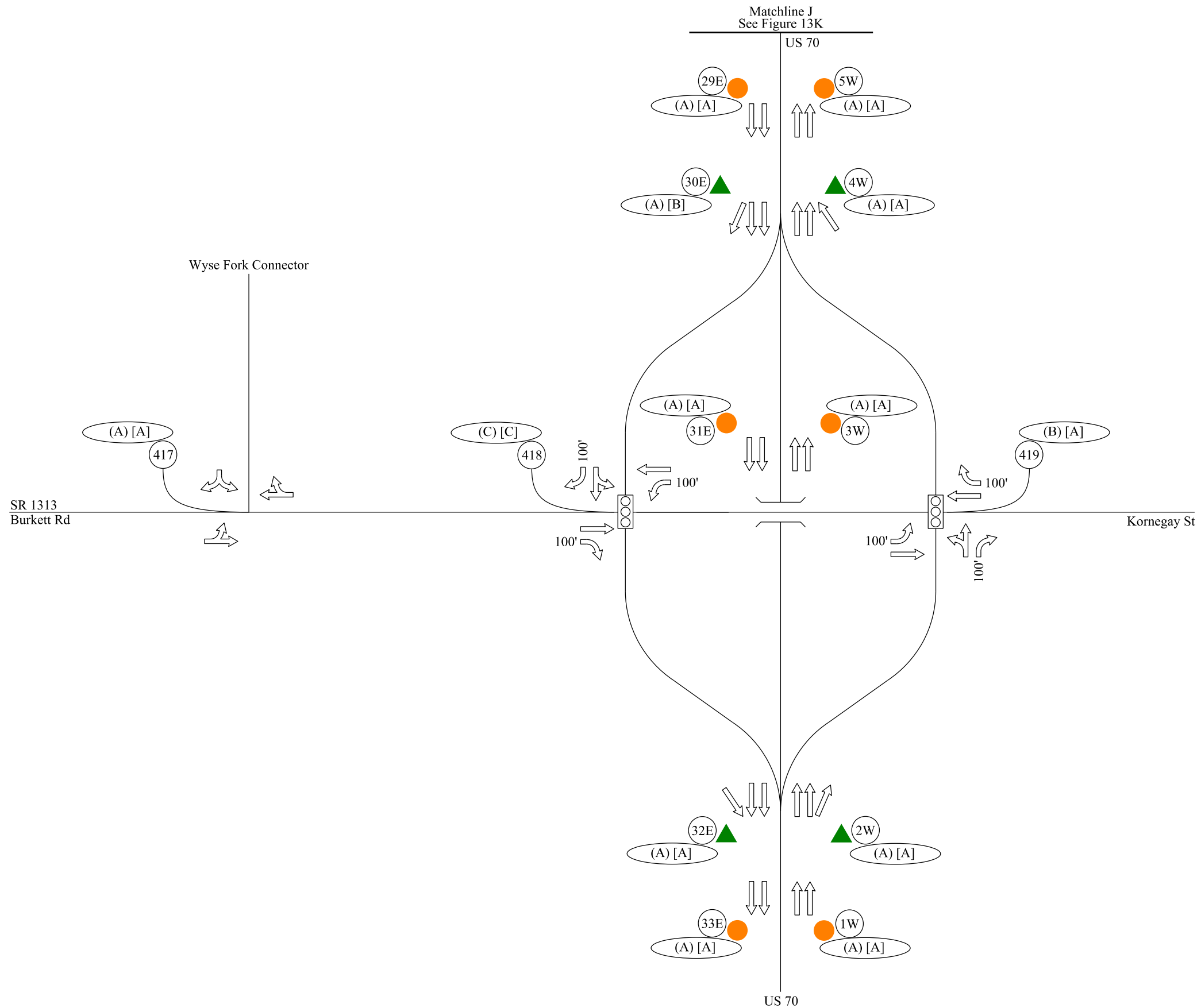
- ← Laneage
- ## Intersection or FREEVAL Number
- (##)(##) AM Peak and PM Peak LOS
- ⊞ Signal
- Basic Freeway Segment
- ▲ Ramp Merge/Diverge
- ### Storage





2040 Build Alternative 35
LOS and Laneage
Figure 13K

- ← Laneage
- ## Intersection or FREEVAL Number
- (##)(##) AM Peak and PM Peak LOS
- ⓧ Signal
- Basic Freeway Segment
- ▲ Ramp Merge/Diverge
- ### Storage



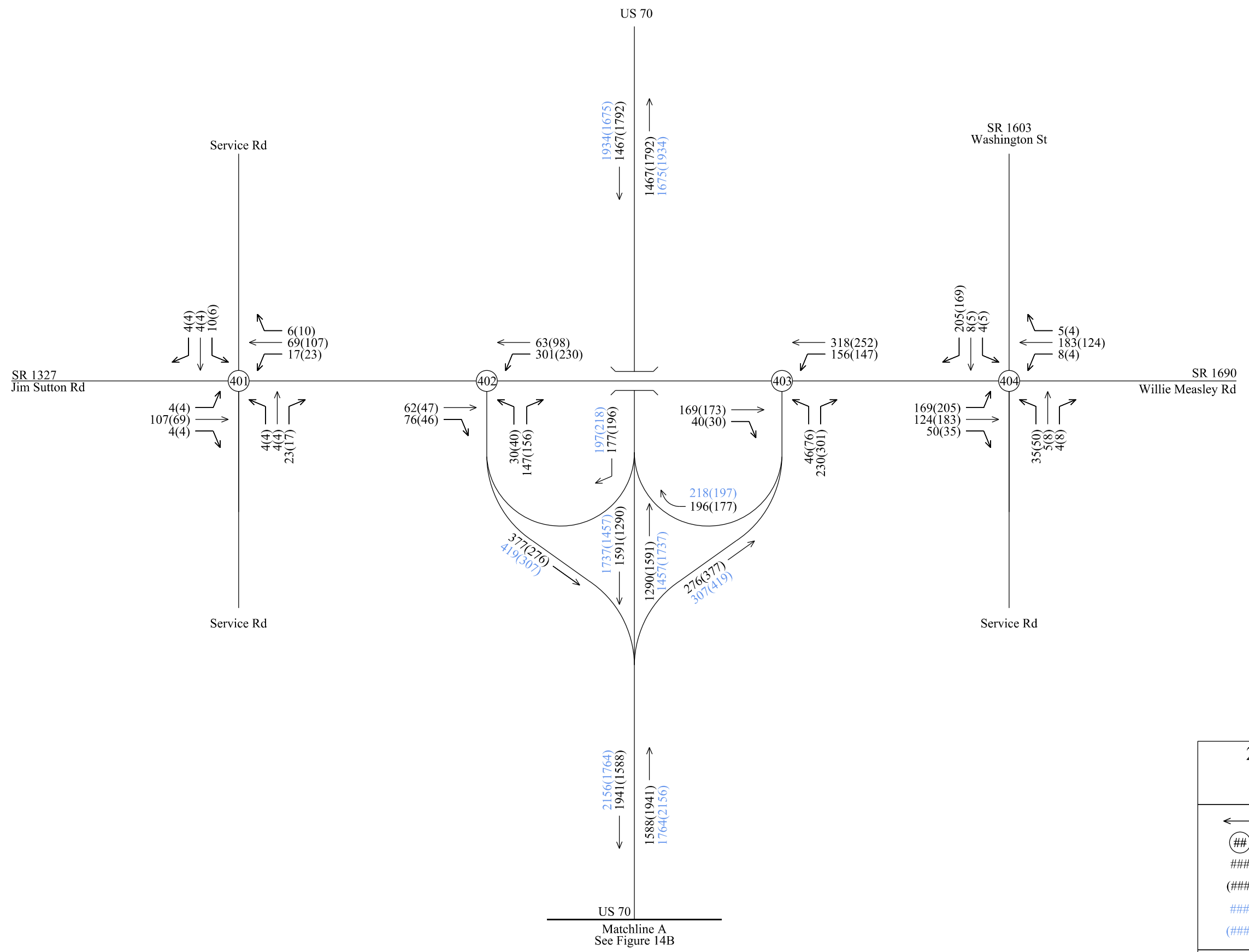
2040 Build Alternative 35
LOS and Laneage
Figure 13L

	Laneage
	Intersection or FREEVAL Number
	AM Peak and PM Peak LOS
	Signal
	Basic Freeway Segment
	Ramp Merge/Diverge
	Storage



**2040 Build Alternative 36
Peak Hour Volume Figures**

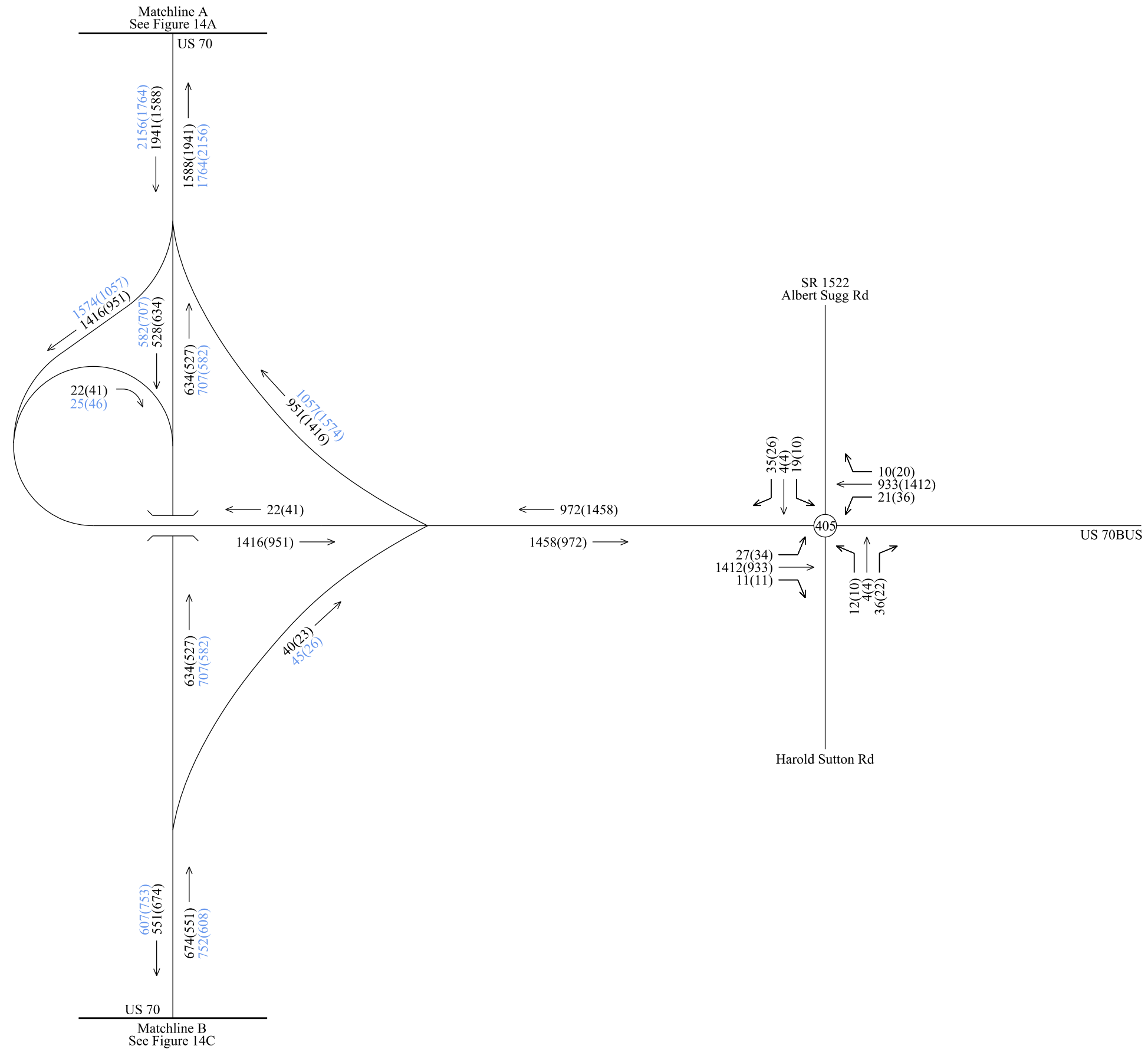
This page left intentionally blank



2040 Build - Alternative 36
Peak Hour Volumes
Figure 14A

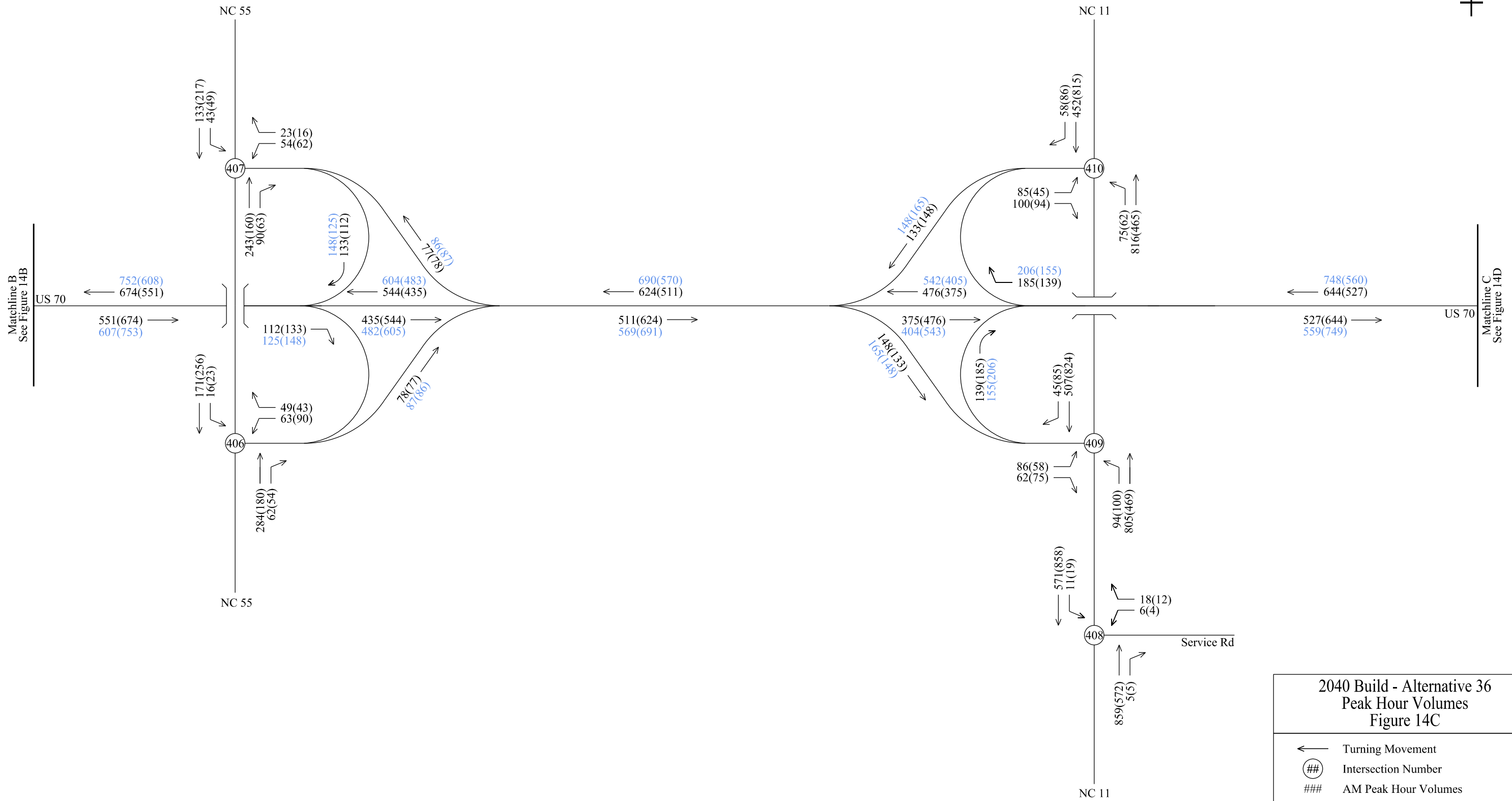
- ← Turning Movement
- ⊙ Intersection Number
- ### AM Peak Hour Volumes
- (###) PM Peak Hour Volumes
- ### AM Balanced and Adjusted Volumes
- (###) PM Balanced and Adjusted Volumes





2040 Build - Alternative 36
Peak Hour Volumes
Figure 14B

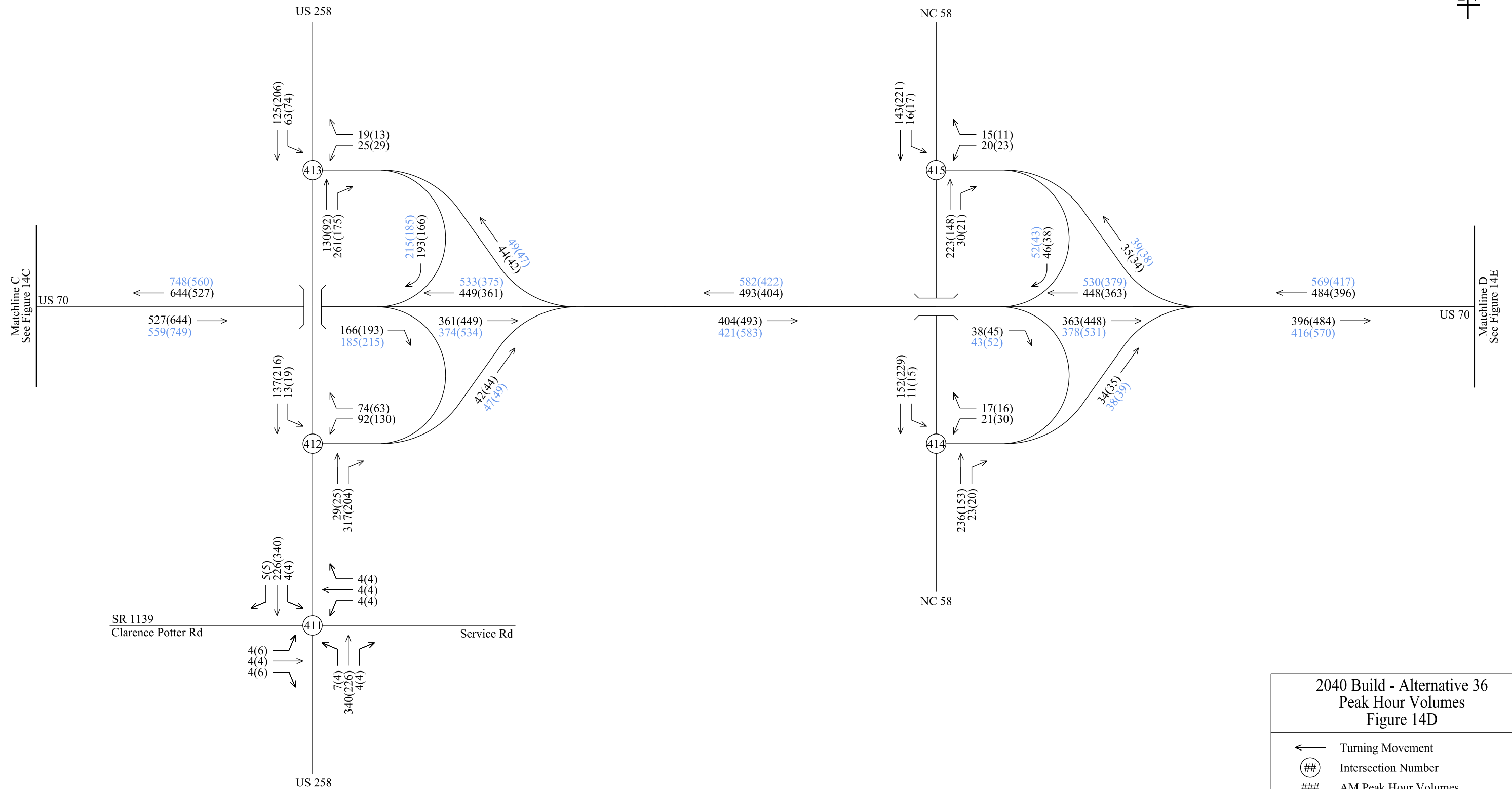
- ← Turning Movement
- ⊙ Intersection Number
- ### AM Peak Hour Volumes
- (###) PM Peak Hour Volumes
- ### AM Balanced and Adjusted Volumes
- (###) PM Balanced and Adjusted Volumes



2040 Build - Alternative 36
Peak Hour Volumes
Figure 14C

- ← Turning Movement
- ⊙ Intersection Number
- ### AM Peak Hour Volumes
- (###) PM Peak Hour Volumes
- ### AM Balanced and Adjusted Volumes
- (###) PM Balanced and Adjusted Volumes

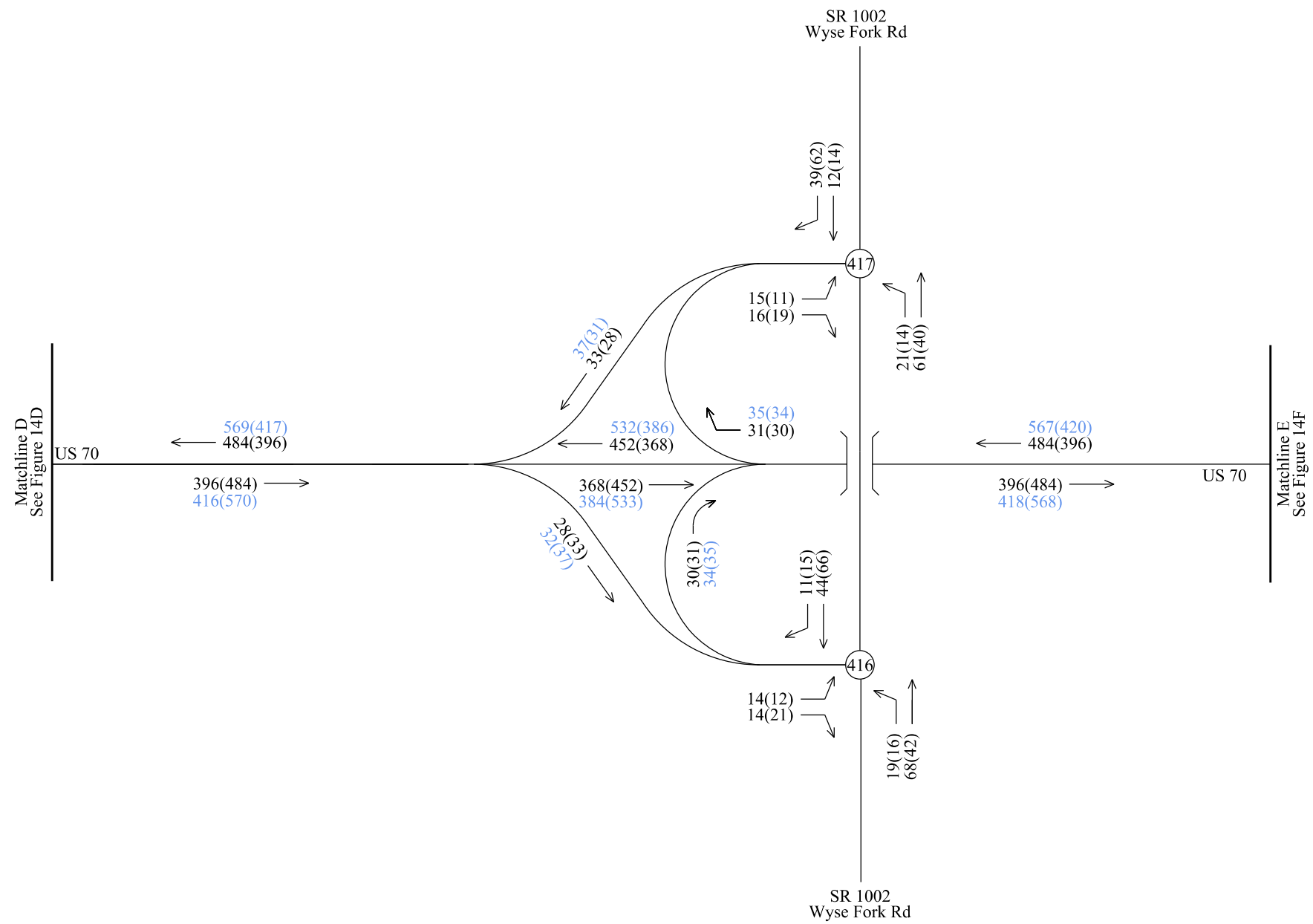




2040 Build - Alternative 36
Peak Hour Volumes
Figure 14D

- ← Turning Movement
- ⊙ Intersection Number
- ### AM Peak Hour Volumes
- (###) PM Peak Hour Volumes
- ### AM Balanced and Adjusted Volumes
- (###) PM Balanced and Adjusted Volumes

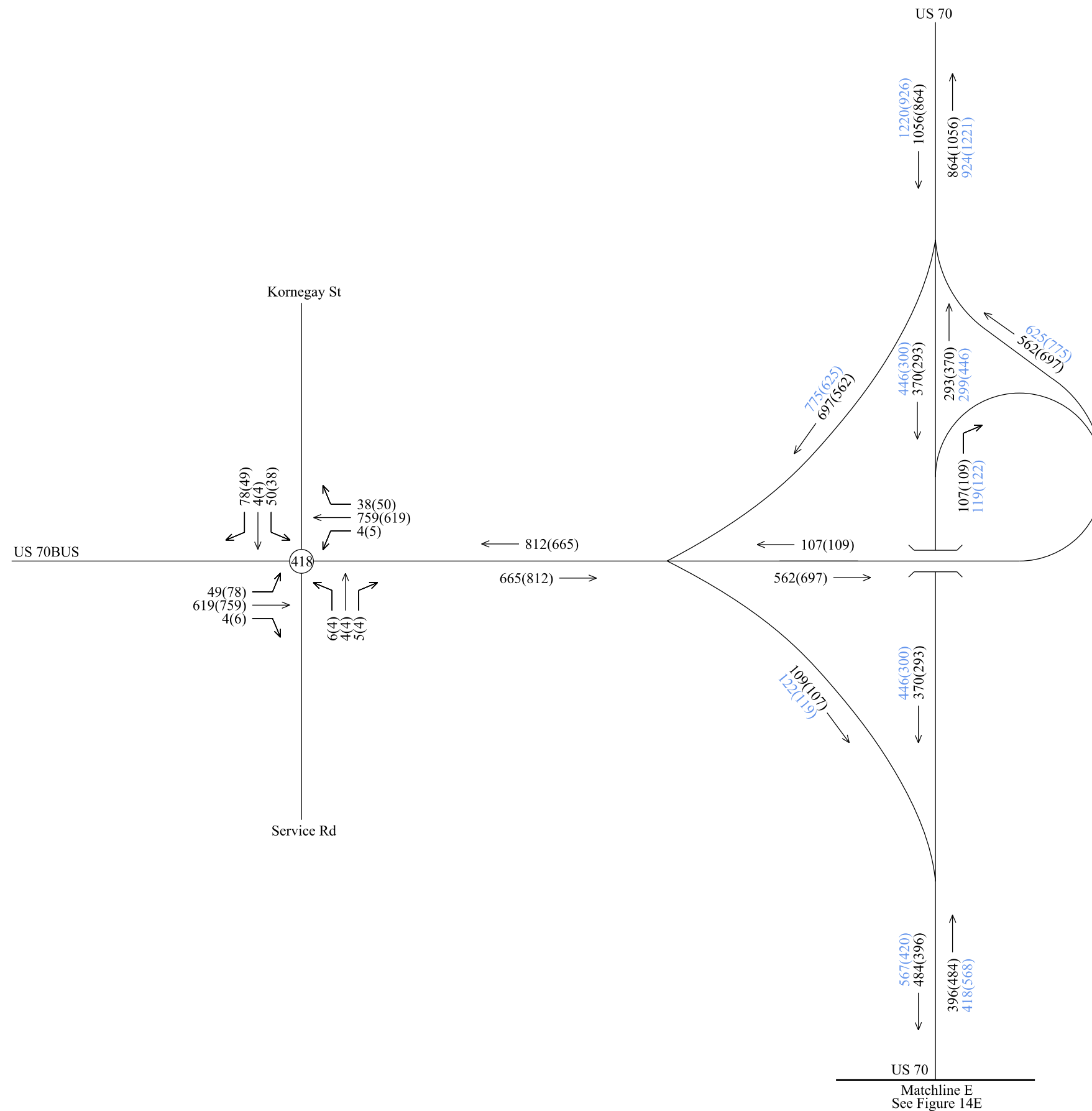




2040 Build - Alternative 36
Peak Hour Volumes
Figure 14E

- ← Turning Movement
- ⊙ Intersection Number
- ### AM Peak Hour Volumes
- (###) PM Peak Hour Volumes
- ### AM Balanced and Adjusted Volumes
- (###) PM Balanced and Adjusted Volumes





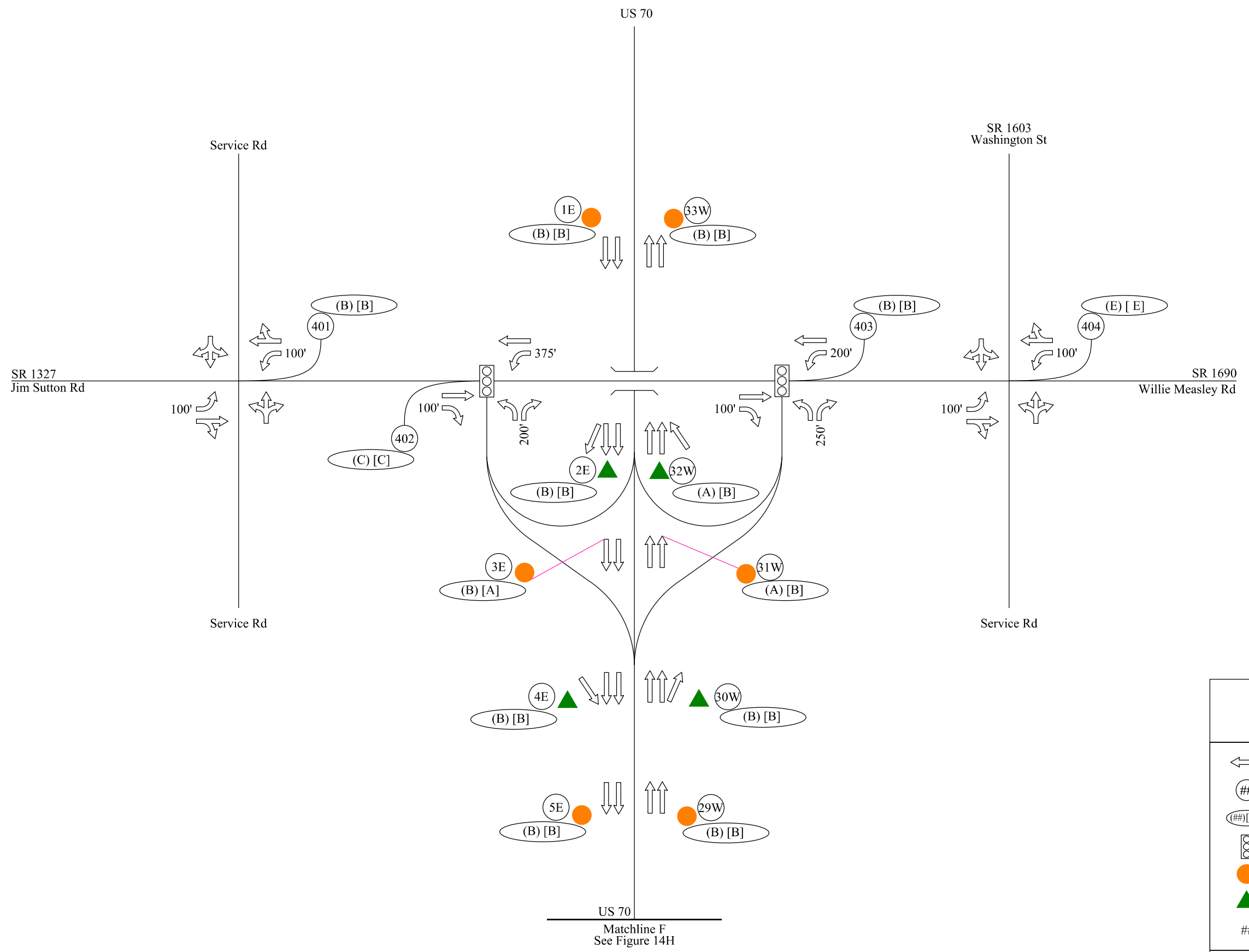
2040 Build - Alternative 36
Peak Hour Volumes
Figure 14F

- ← Turning Movement
- ⊙ Intersection Number
- ### AM Peak Hour Volumes
- (###) PM Peak Hour Volumes
- ### AM Balanced and Adjusted Volumes
- (###) PM Balanced and Adjusted Volumes



**2040 Build Alternative 36
LOS and Laneage Figures**

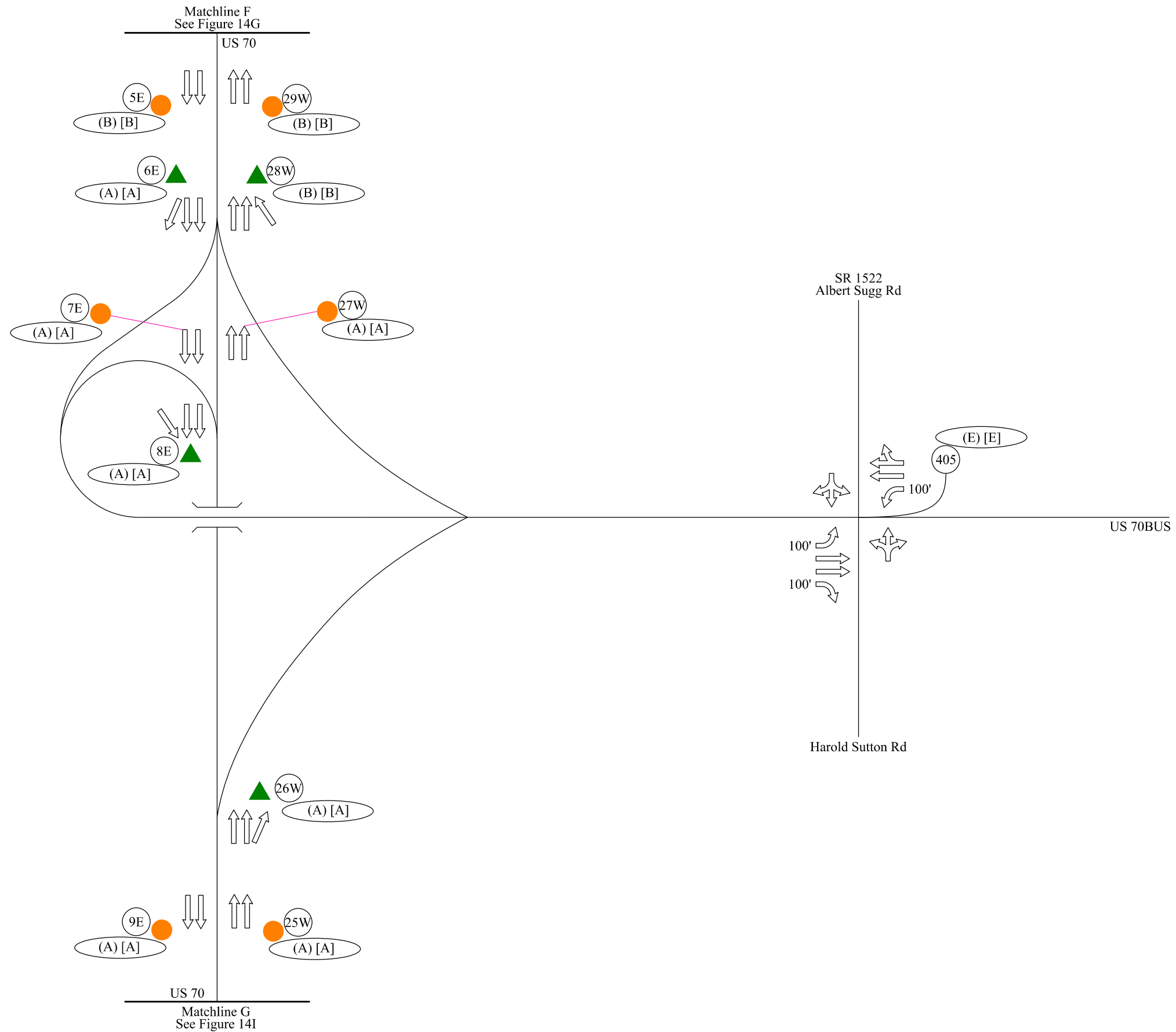
This page left intentionally blank



2040 Build Alternative 36
LOS and Laneage
Figure 14G

	Laneage
	Intersection or FREEVAL Number
	AM Peak and PM Peak LOS
	Signal
	Basic Freeway Segment
	Ramp Merge/Diverge
	Storage

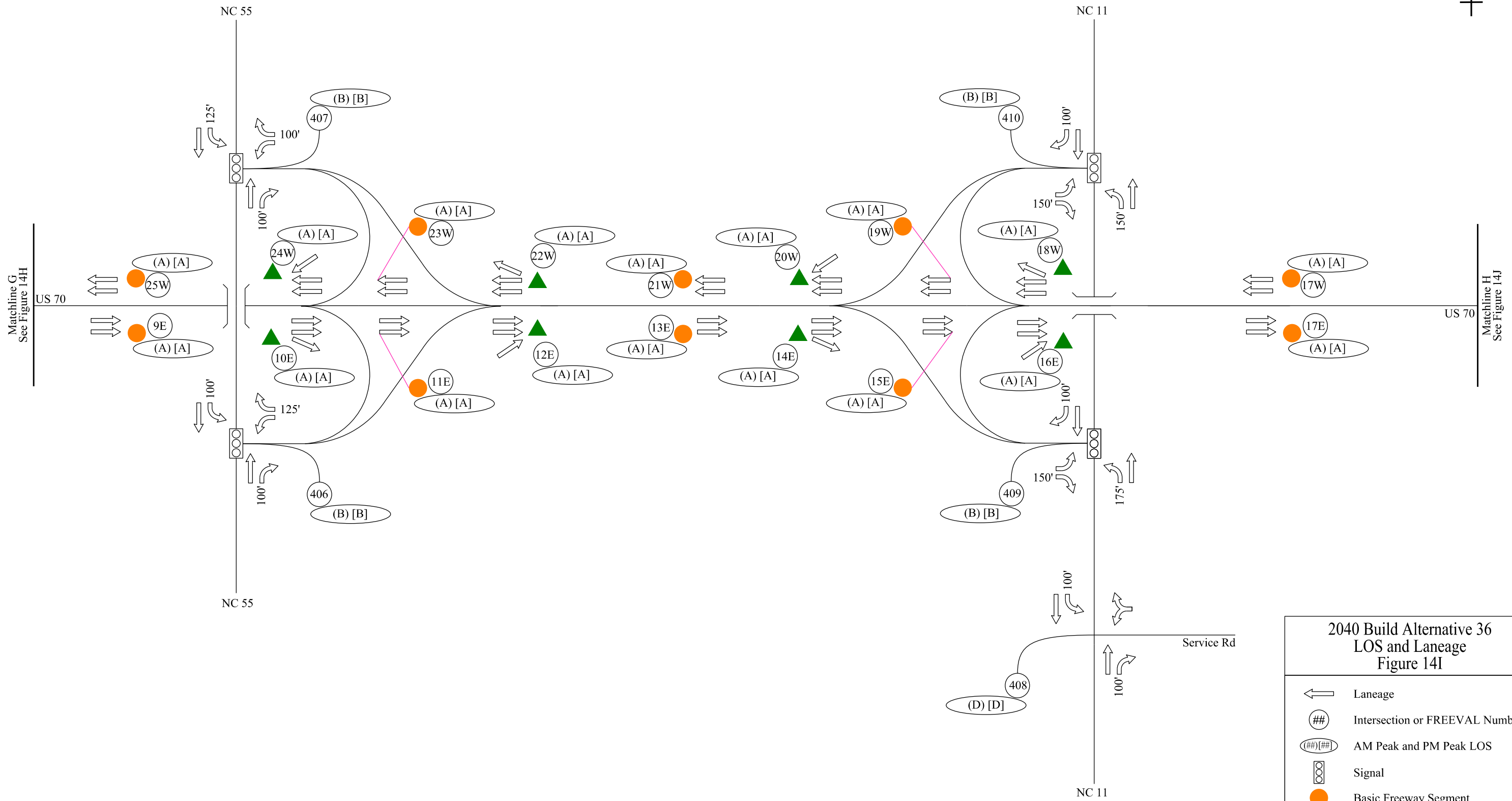




2040 Build Alternative 36
LOS and Laneage
Figure 14H

	Laneage
	Intersection or FREEVAL Number
	AM Peak and PM Peak LOS
	Signal
	Basic Freeway Segment
	Ramp Merge/Diverge
	Storage

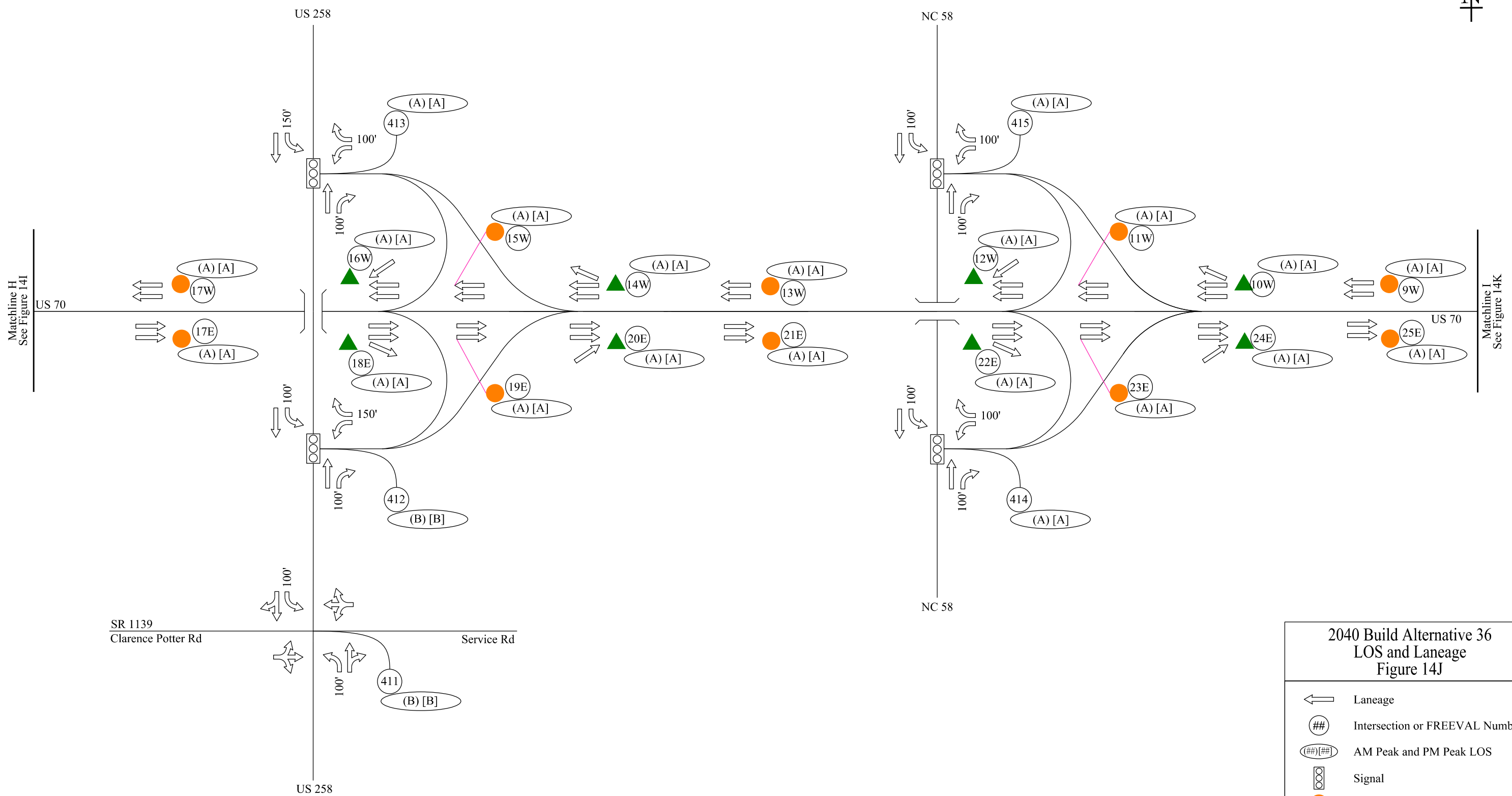




2040 Build Alternative 36
LOS and Laneage
Figure 14I

	Laneage
	Intersection or FREEVAL Number
	AM Peak and PM Peak LOS
	Signal
	Basic Freeway Segment
	Ramp Merge/Diverge
	Storage

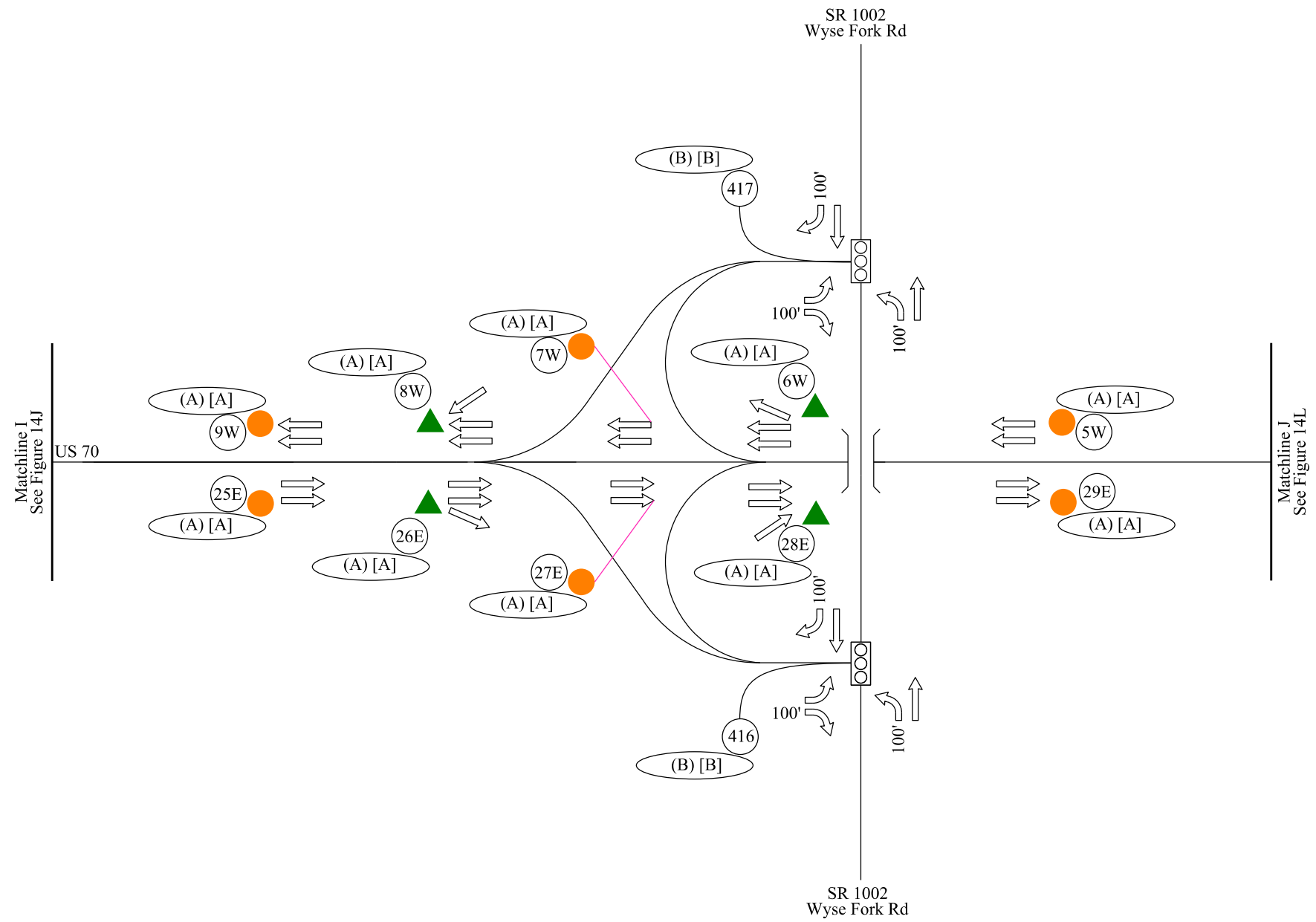




2040 Build Alternative 36
LOS and Laneage
Figure 14J

	Laneage
	Intersection or FREEVAL Number
	AM Peak and PM Peak LOS
	Signal
	Basic Freeway Segment
	Ramp Merge/Diverge
	Storage

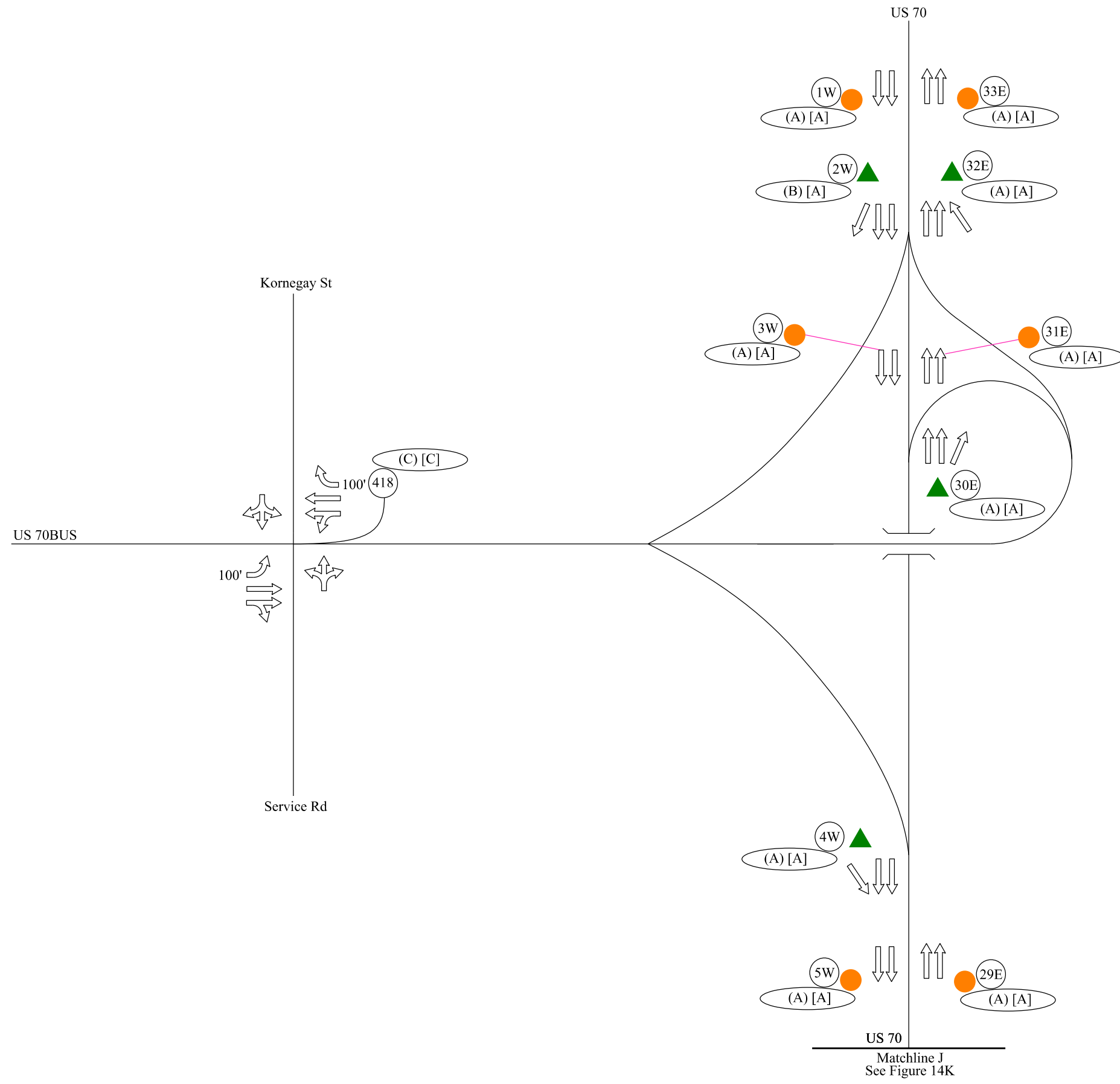




2040 Build Alternative 36
LOS and Laneage
Figure 14K

- Laneage
- Intersection or FREEVAL Number
- AM Peak and PM Peak LOS
- Signal
- Basic Freeway Segment
- Ramp Merge/Diverge
- Storage





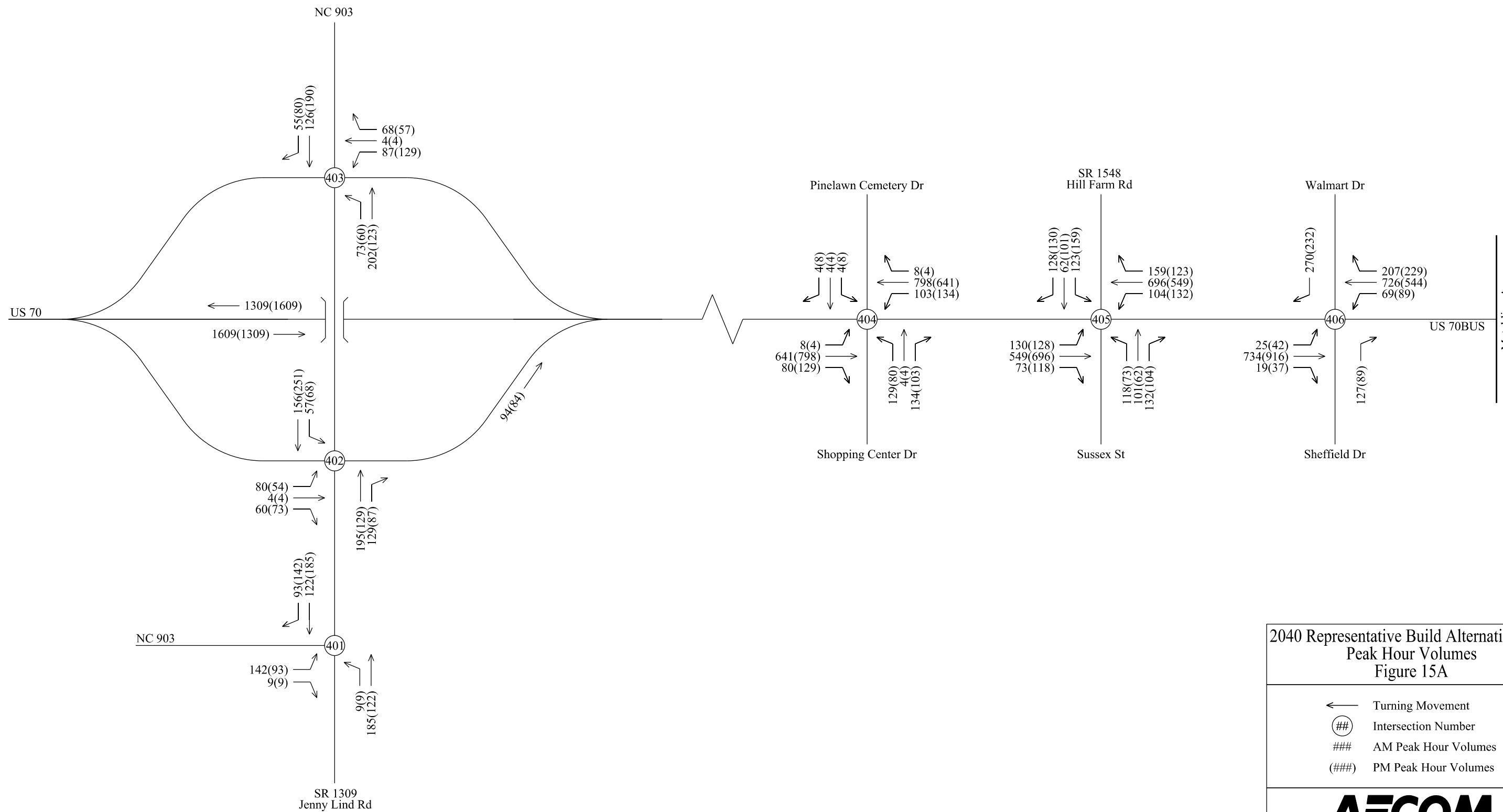
2040 Build Alternative 36
LOS and Laneage
Figure 14L

- Laneage
- Intersection or FREEVAL Number
- AM Peak and PM Peak LOS
- Signal
- Basic Freeway Segment
- Ramp Merge/Diverge
- Storage



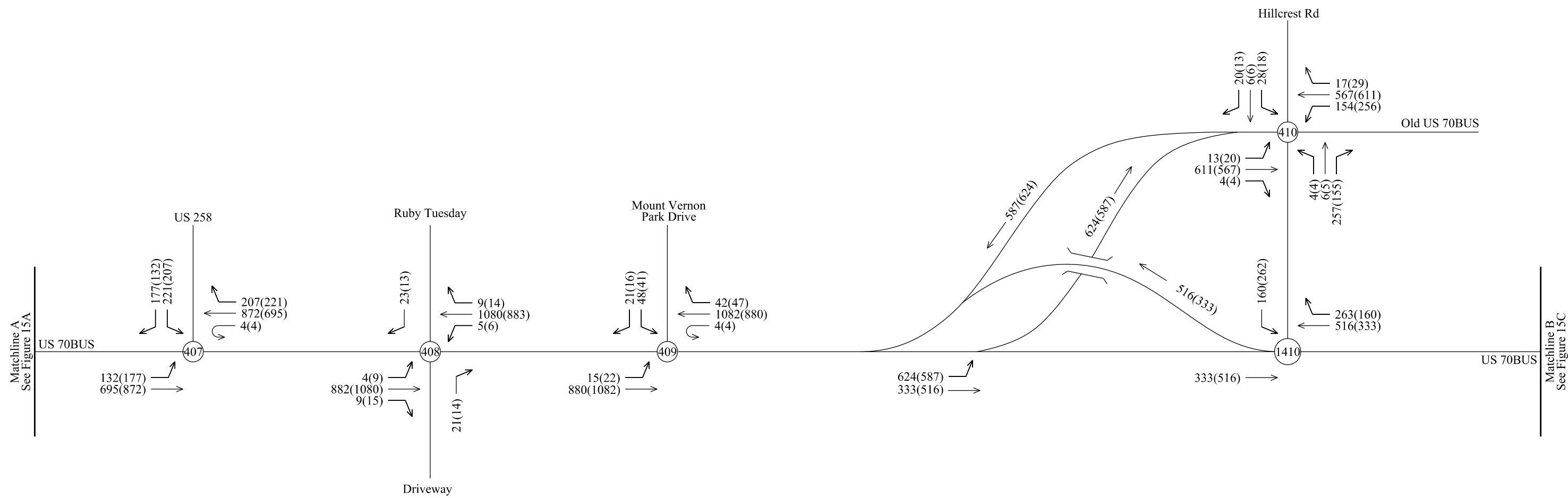
**2040 Representative
Build Alternative 1 SB
Peak Hour Volume Figures**

This page left intentionally blank



Matchline A
See Figure 15B

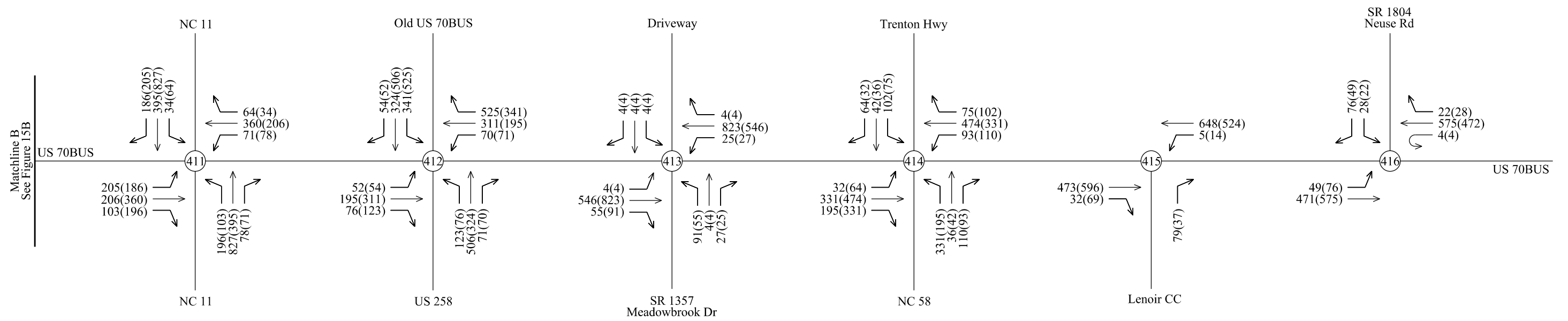




2040 Representative Build Alternative 1 SB
Peak Hour Volumes
Figure 15B

- ← Turning Movement
- ⊙ Intersection Number
- ### AM Peak Hour Volumes
- (###) PM Peak Hour Volumes





2040 Representative Build Alternative 1 SB
Peak Hour Volumes
Figure 15C

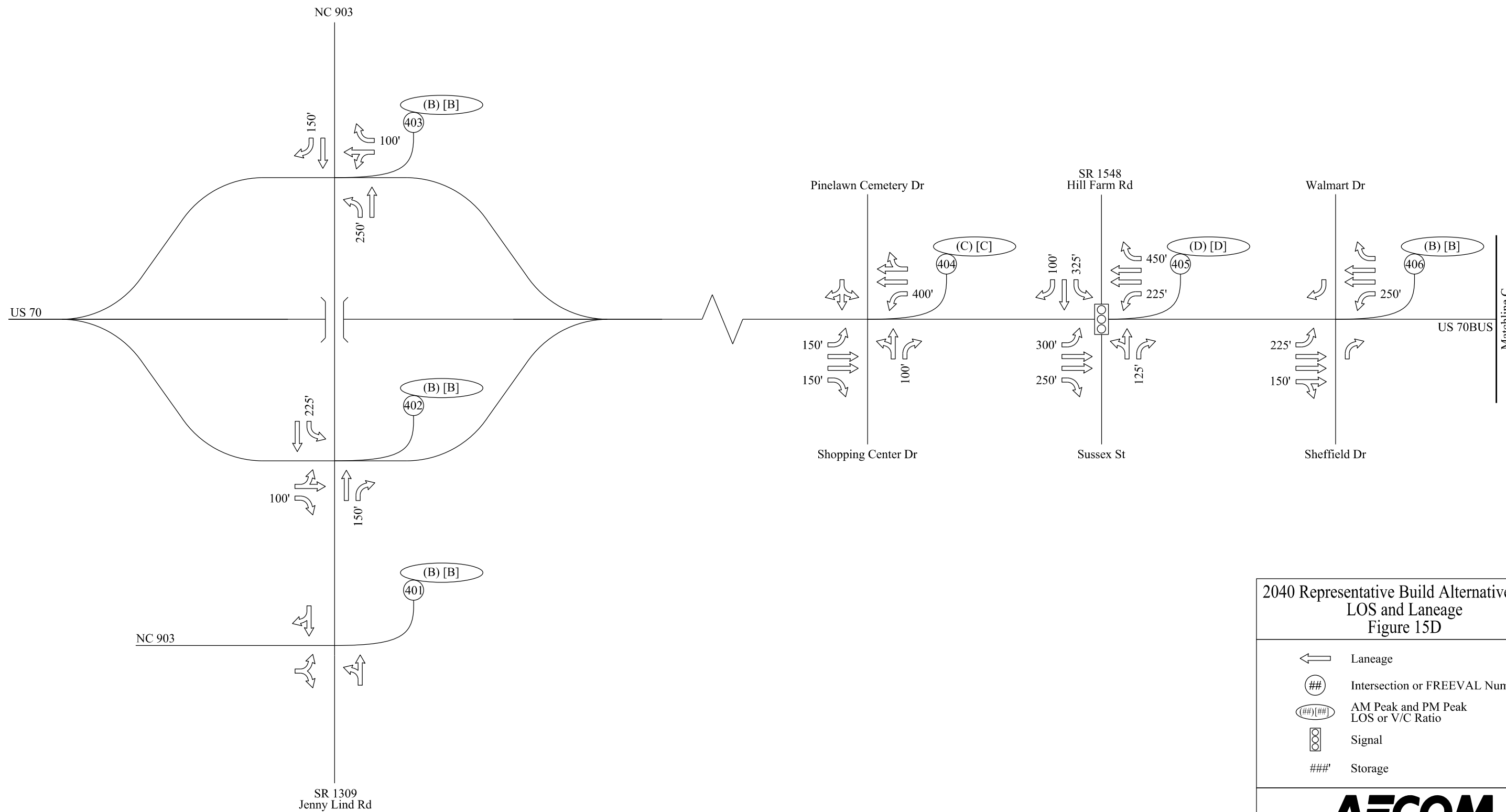
- ← Turning Movement
- ⊙ Intersection Number
- ### AM Peak Hour Volumes
- (###) PM Peak Hour Volumes








This page left intentionally blank

**2040 Representative
Build Alternative 1 SB
LOS and Laneage Figures**

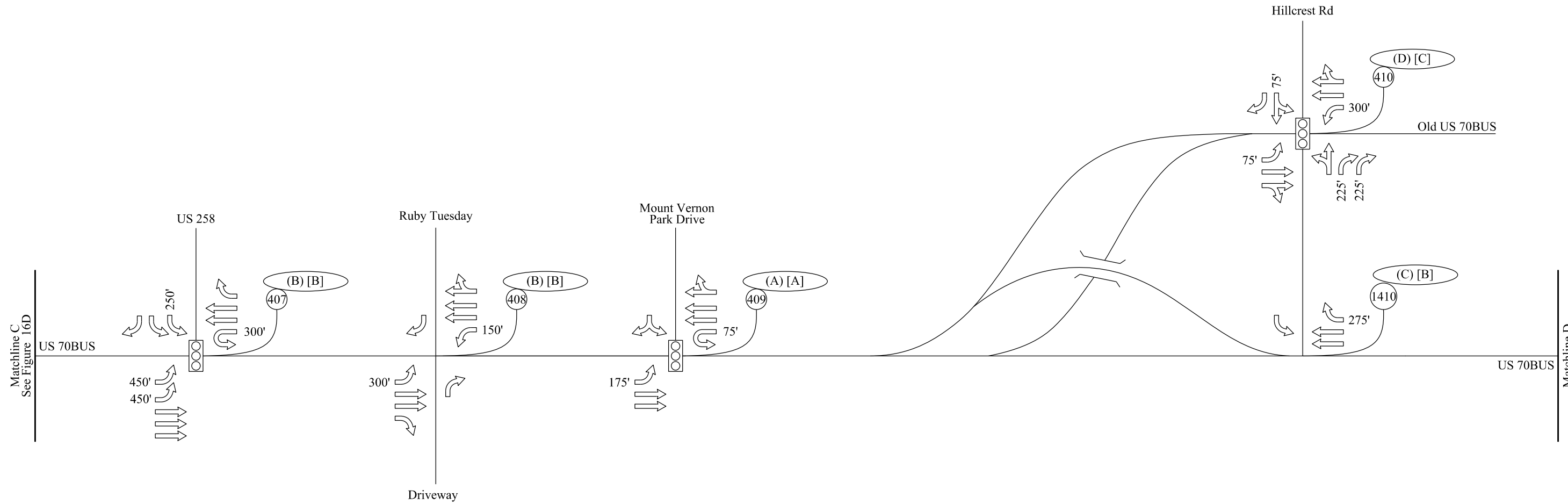
This page left intentionally blank








2040 Representative Build Alternative 1 SB
LOS and Laneage
Figure 15D

-  Laneage
-  Intersection or FREEVAL Number
-  AM Peak and PM Peak LOS or V/C Ratio
-  Signal
-  Storage

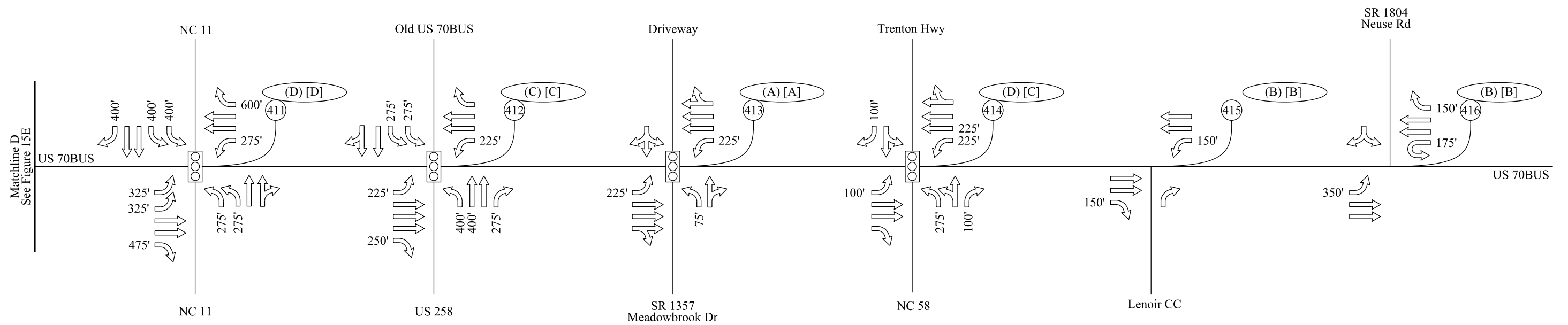









2040 Representative Build Alternative 1 SB
LOS and Laneage
Figure 15E

-  Laneage
-  Intersection or FREEVAL Number
-  AM Peak and PM Peak
LOS or V/C Ratio
-  Signal
-  Storage





2040 Representative Build Alternative 1 SB
LOS and Laneage
Figure 15F

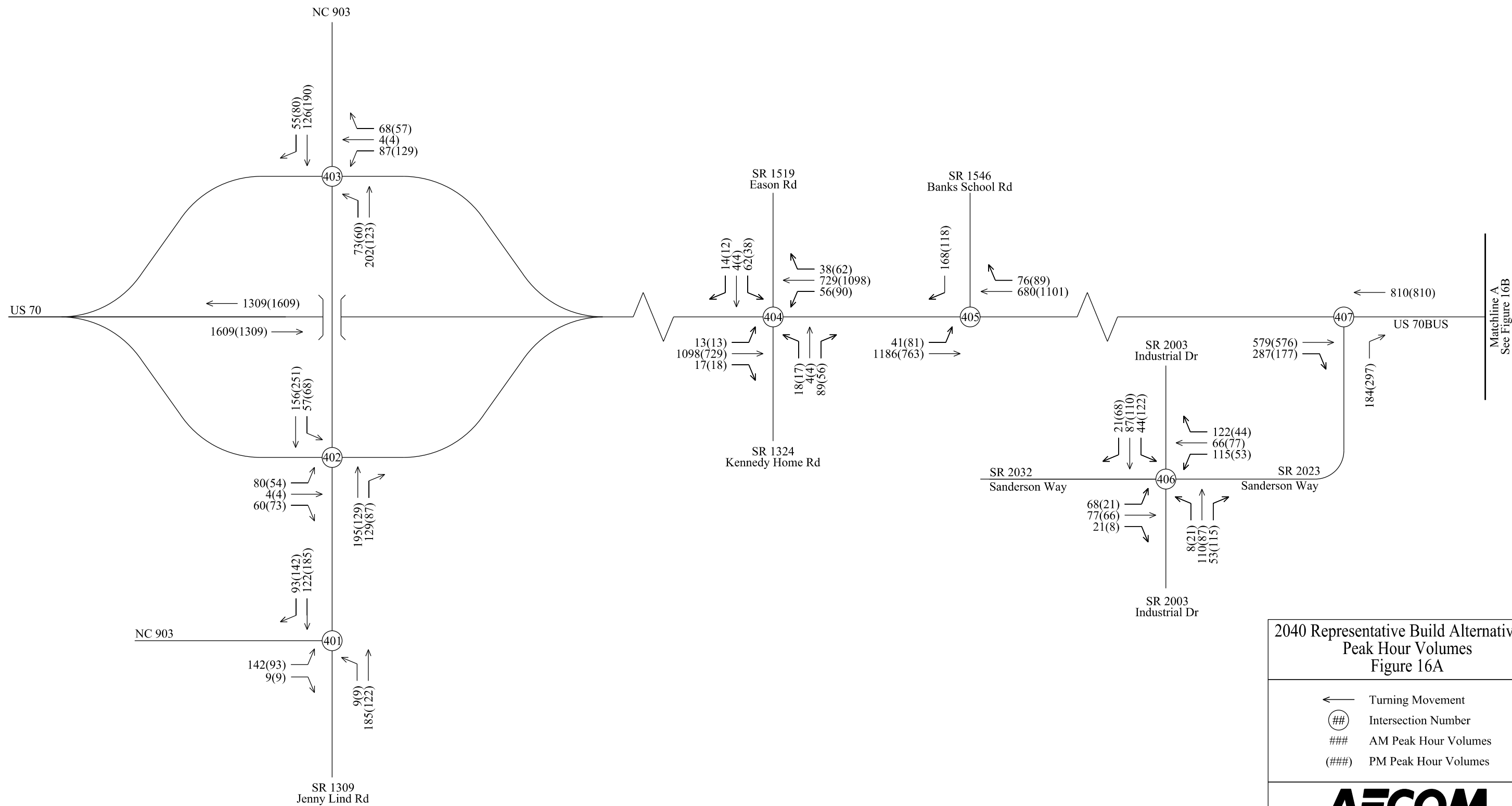
-  Laneage
-  Intersection or FREEVAL Number
-  AM Peak and PM Peak
LOS or V/C Ratio
-  Signal
-  Storage



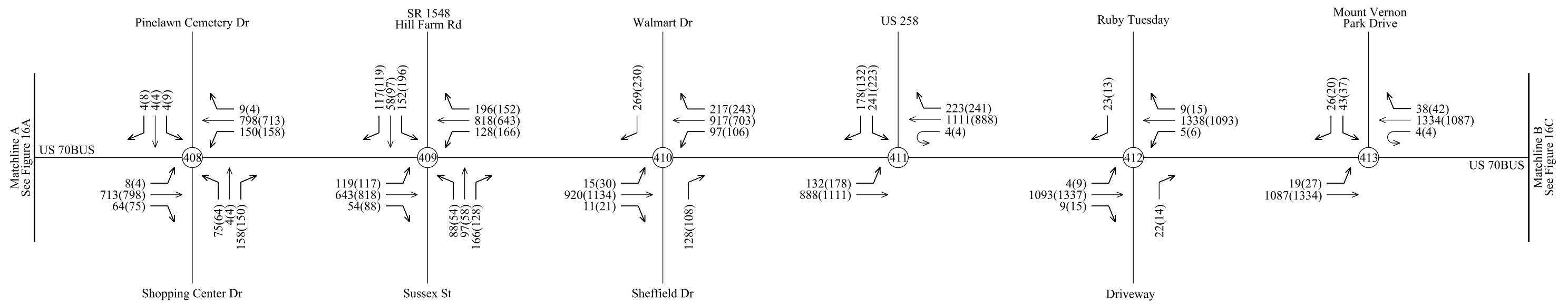
This page left intentionally blank

**2040 Representative
Build Alternative 65
Peak Hour Volume Figures**

This page left intentionally blank



Matchline A
See Figure 16B



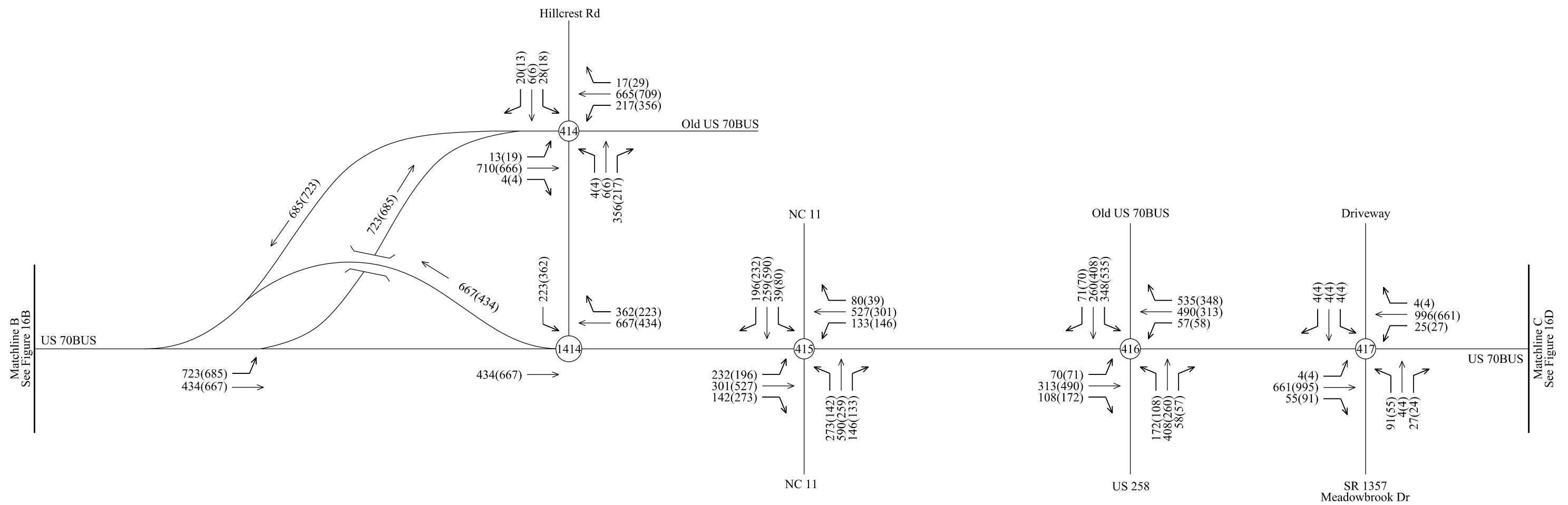
Matchline A
See Figure 16A

Matchline B
See Figure 16C

2040 Representative Build Alternative 65
Peak Hour Volumes
Figure 16B

- ← Turning Movement
- ⊕ Intersection Number
- ### AM Peak Hour Volumes
- (###) PM Peak Hour Volumes

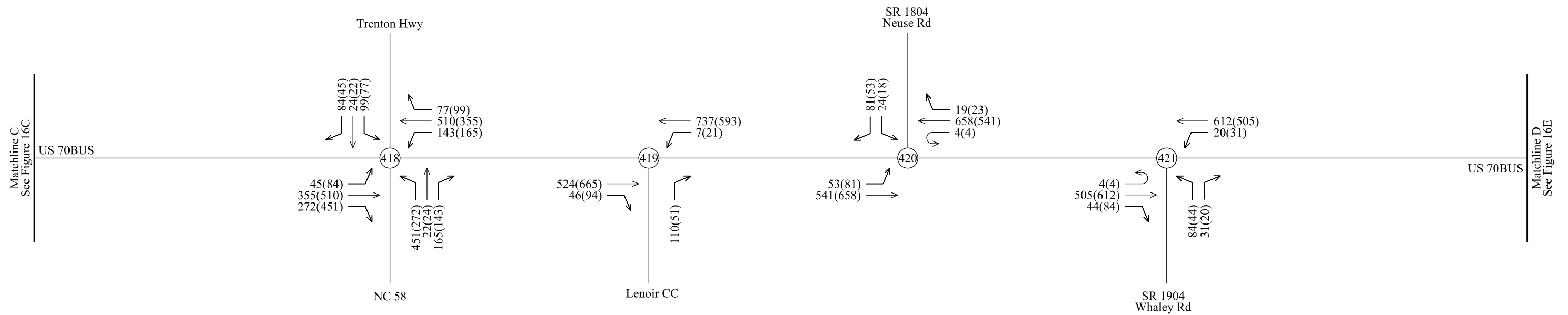




2040 Representative Build Alternative 65
Peak Hour Volumes
Figure 16C

- ← Turning Movement
- ⊕ Intersection Number
- ### AM Peak Hour Volumes
- (###) PM Peak Hour Volumes





2040 Representative Build Alternative 65
Peak Hour Volumes
Figure 16D

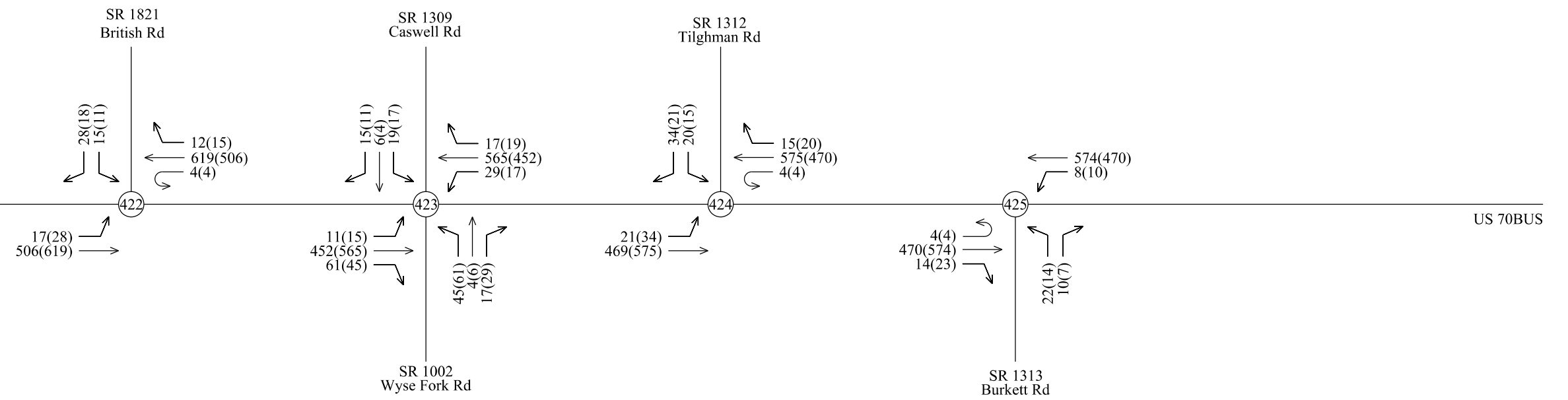
- ← Turning Movement
- ## Intersection Number
- ### AM Peak Hour Volumes
- (###) PM Peak Hour Volumes





Matchline D
See Figure 16D

US 70BUS



US 70BUS

2040 Representative Build Alternative 65
Peak Hour Volumes
Figure 16E

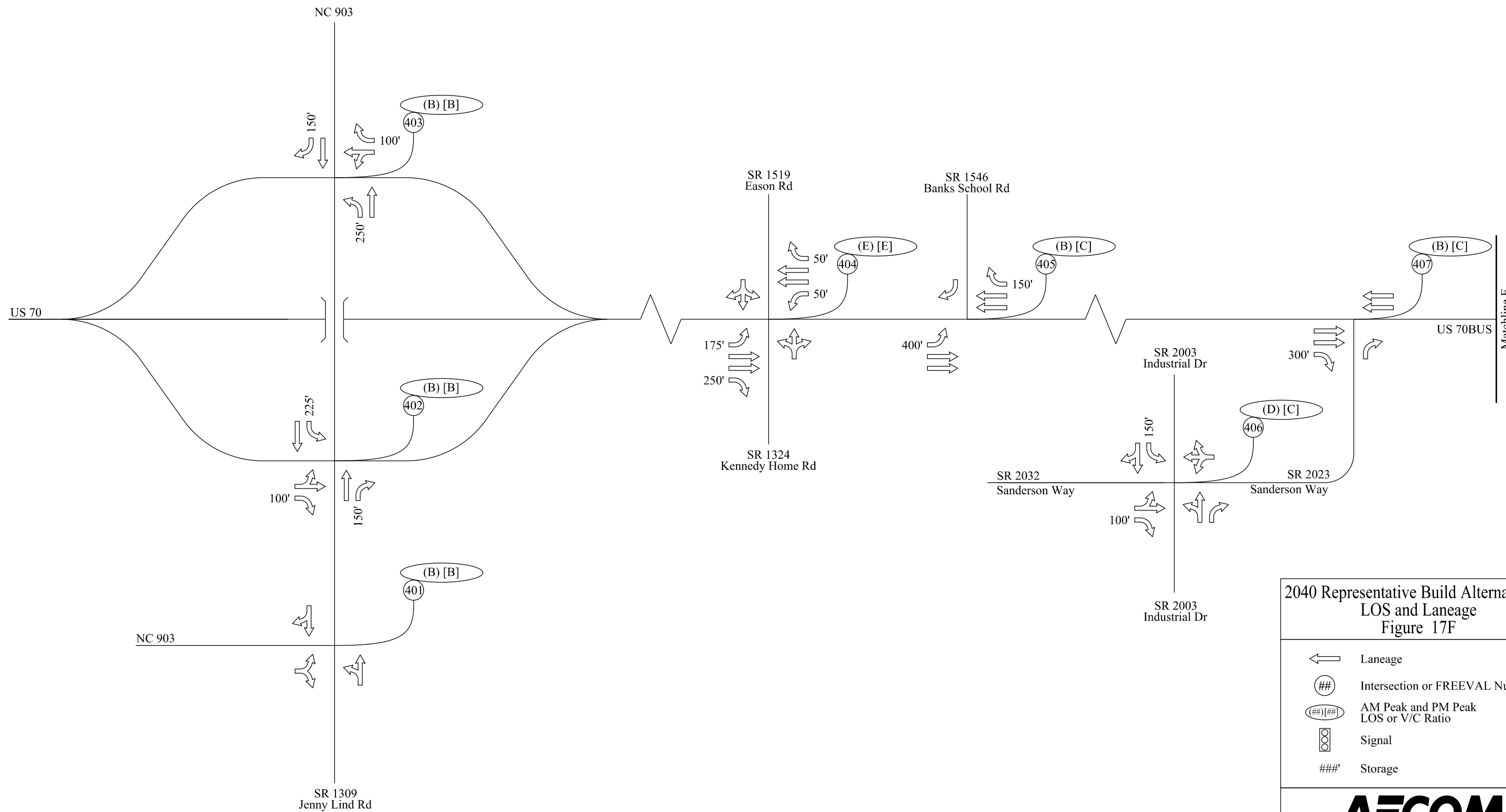
- ← Turning Movement
- ⊕ Intersection Number
- ### AM Peak Hour Volumes
- (###) PM Peak Hour Volumes



This page left intentionally blank






**2040 Representative
Build Alternative 65
LOS and Laneage Figures**

This page left intentionally blank

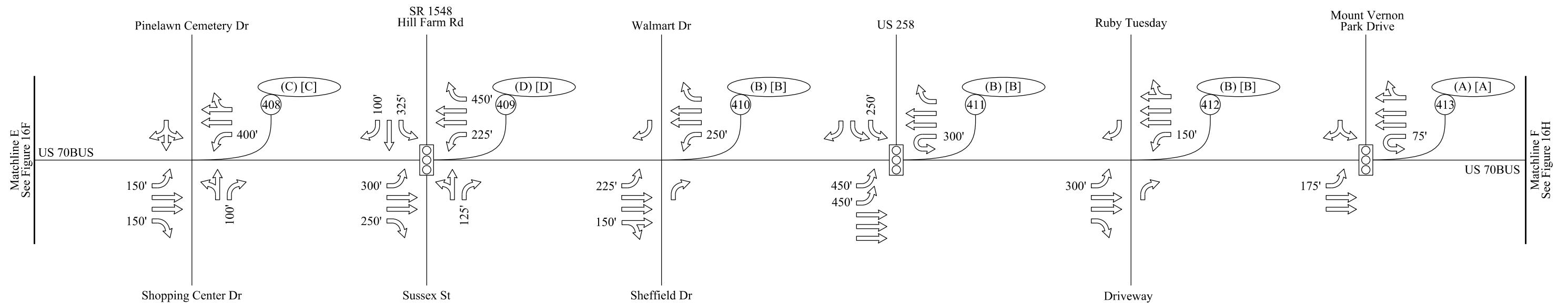


Matchline E
See Figure 16G

2040 Representative Build Alternative 65
LOS and Laneage
Figure 17F

-  Laneage
-  Intersection or FREEVAL Number
-  AM Peak and PM Peak LOS or V/C Ratio
-  Signal
-  Storage

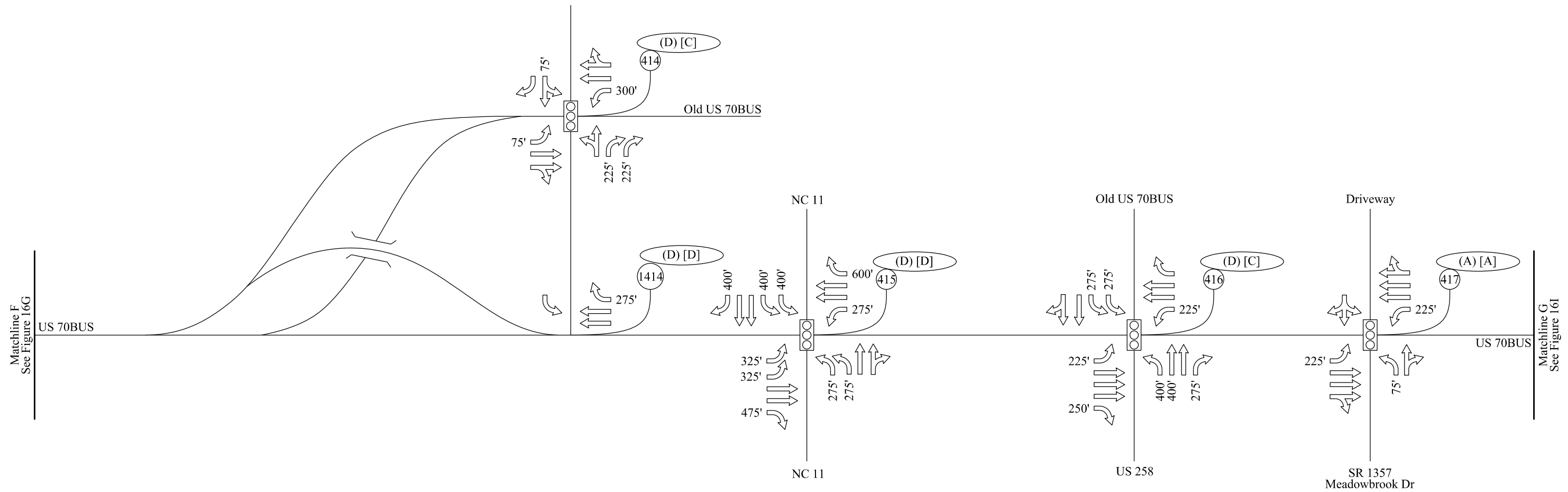




2040 Representative Build Alternative 65
LOS and Laneage
Figure 16G

- Laneage
- Intersection or FREEVAL Number
- AM Peak and PM Peak LOS or V/C Ratio
- Signal
- Storage

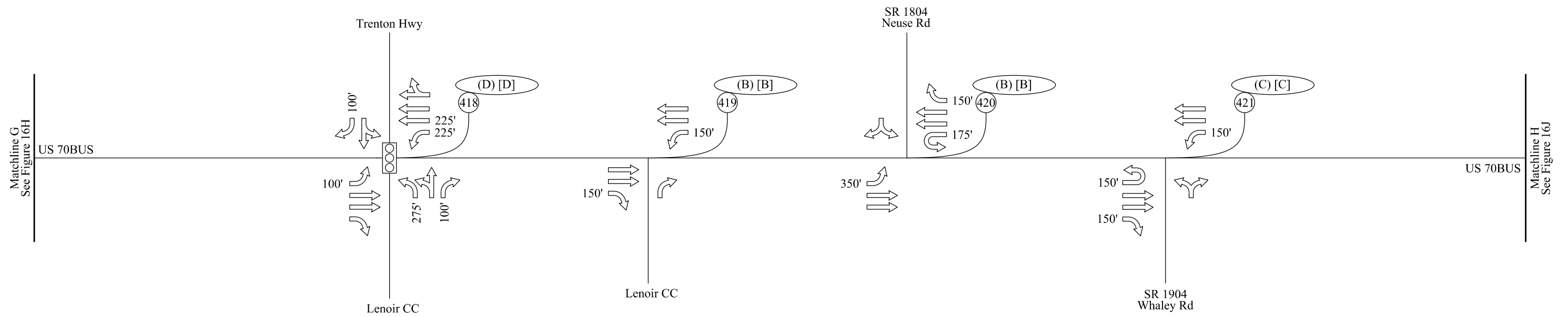









2040 Representative Build Alternative 65
LOS and Laneage
Figure 16H

- ← Laneage
- ## Intersection or FREEVAL Number
- (##)(##) AM Peak and PM Peak LOS or V/C Ratio
- ⊞ Signal
- ###' Storage





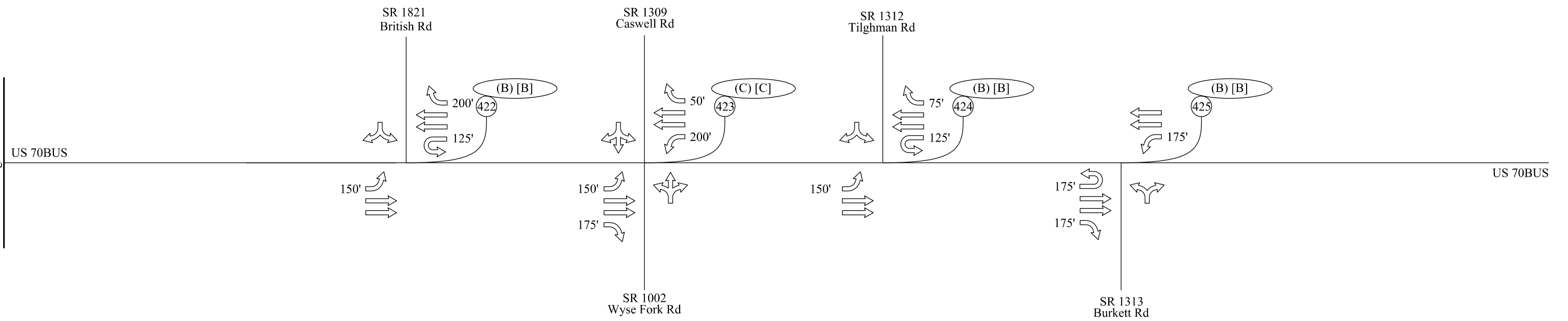
2040 Representative Build Alternative 65
LOS and Laneage
Figure 16I

-  Laneage
-  Intersection or FREEVAL Number
-  AM Peak and PM Peak
LOS or V/C Ratio
-  Signal
-  Storage










Matchline H
See Figure 16I



2040 Representative Build Alternative 65
LOS and Laneage
Figure 16J

-  Laneage
-  Intersection or FREEVAL Number
-  AM Peak and PM Peak
LOS or V/C Ratio
-  Signal
-  Storage



This page left intentionally blank