



STATE OF NORTH CAROLINA  
DEPARTMENT OF TRANSPORTATION

ROY COOPER  
GOVERNOR

JAMES H. TROGDON, III  
SECRETARY

April 12, 2019

MEMORANDUM TO: Mr. Jerry Jennings, P.E.  
Division 1 Engineer

FROM:

*for* Philip S. Harris, III, P.E., Unit Head *Carla Dagnino*  
Environmental Analysis Unit

SUBJECT: Pasquotank County; Improvements to Elizabeth City Computerized  
Traffic Signal System; WBS 45861.1.1; **TIP U-5942**

Attached are the N.C. Division of Coastal Management General Permit and Letter of Refinement, U.S. Army Corps of Engineers Nationwide Permit, and N.C. Division of Water Resources (NCDWR) Water Quality Certification. All environmental permits have been received for the construction of this project.

A copy of this permit package will be posted on the NCDOT website at:

<https://connect.ncdot.gov/resources/Environmental/Pages/Permits-and-Mitigation.aspx>

**Quick Links>Permit Documents> Issued Permits.**

cc: w/o attachment (see website for attachments)

Mr. Ron Davenport, P.E. Contracts Management  
Mr. Paul Williams, Division 1 Environmental Officer  
Dr. Majed Al-Ghandour, P.E., Programming and TIP  
Mr. Carl Barclay, P.E., Utilities  
Mr. Stephen Morgan, P.E., Hydraulics  
Mr. Jason Galloway, P.E. Signal Design  
Mr. Mark Staley, Roadside Environmental  
Mr. Lamar Sylvester, P.E., State Roadway Construction Engineer

# PROJECT COMMITMENTS

T.I.P No. U-5942  
Improvements for Elizabeth City  
Computerized Traffic Signal System  
Pasquotank County  
Federal Aid Project No. STBG-0111(025)  
WBS No. 45861.1.1

## COMMITMENTS FROM PROJECT DEVELOPMENT AND DESIGN

### **Utilities**

At the request of Elizabeth City, Certification of Appropriateness certificates will be placed on the existing cabinets during construction. NCDOT will adhere to all requirements of both the City Administration and the City of Elizabeth City's Public Utilities Department regarding the cabinet installations.

### **Geotech and Division 3 Construction**

A preliminary report identified nine (9), underground storage tanks (USTs) within the project area with a low anticipated risk. If during construction, soil and groundwater contamination is observed or contact is made with the USTs, coordination with the NCDOT GeoEnvironmental Unit will be conducted.

### **Division Construction and Environmental Analysis Unit**

Charles Creek is designated as an anadromous fish spawning area. An in-water work moratorium will be observed from February 15 to June 30.

### **Right-of-Way**

An agreement is in place to exchange two property locations in-kind to NCDOT, requiring no funding for right-of-way acquisition. This includes the intersections of Weeksville Road/Mebane Drive and Water Street/Shepard Street. Weeksville Road/Mebane Drive requires approximately 0.15 acres and the intersection of Water Street/Shepard Street requires 0.005 acres.

## COMMITMENTS FROM PERMITTING

### **Division Construction**

#### **CAMA General Permit Conditions**

- 1) Subaqueous lines must be placed at a minimum depth of two foot below bottom contour.
- 2) All spoils which are permanently removed must be placed on a high ground disposal site and stabilized to prevent return to waters/wetlands.

Any clearing in wetlands must be completed without grubbing.



**CAMA / DREDGE & FILL**  
**GENERAL PERMIT**

New  Modification  Complete Reissue  Partial Reissue

No. 72608

Previous permit # \_\_\_\_\_ A B C D

Date previous permit issued \_\_\_\_\_

As authorized by the State of North Carolina, Department of Environmental Quality and the Coastal Resources Commission in an area of environmental concern pursuant to 15A NCAC \_\_\_\_\_

07H .1600  
 Rules attached.

Applicant Name NC DOT

Project Location: County PASQUOTANK

Address 1000 BIRCH RIDGE DR. / 1596 MAIL SERVICE CENTER

Street Address/ State Road/ Lot #(s) PASQUOTANK BRIDGE

City RALEIGH State NC ZIP 27610

NO. 101, NC 314 (HALSTEAD BLVD. EXTENSION)

Phone # (919) 707-6000 E-Mail crivenbark@ncdot.gov Subdivision \_\_\_\_\_

Authorized Agent Chris Rivenbark

City ELIZABETH CITY ZIP 27909

Affected  CW  EW  PTA  ES  PTS

Phone # (\_\_\_\_) \_\_\_\_\_ River Basin PASQUOTANK

AEC(s):  OEA  HHF  IH  UBA  N/A

Adj. Wtr. Body UT TO KNOXES CREEK (nat)/man/(unkn)

PWS: \_\_\_\_\_

Closest Maj. Wtr. Body PASQUOTANK RIVER

ORW: yes  no  PNA: yes  no

Type of Project/ Activity INSTALLATION OF UNDERGROUND DIRECTIONAL BORE (APPROXIMATELY 760') WITHIN EXISTING RIGHT-OF-WAY FROM UPWARD TO UPWARD, ADJACENT TO PASQUOTANK BOEDIE (Scale: N/A NO. 101)

- Pier (dock) length -
- Fixed Platform(s) -
- Floating Platform(s) -
- Finger pier(s) -
- Groin length -
- number -
- Bulkhead/ Riprap length -
- avg distance offshore -
- max distance offshore -
- Basin, channel -
- cubic yards -
- Boat ramp -
- Boathouse/ Boatlift -
- Beach Bulldozing -
- Other DIRECTIONAL BORE (APPROX. 760'), ASSOCIATED BORE PITS
- Shoreline Length < 500
- SAV: not sure  yes  no
- Moratorium: n/a  yes  no
- Photos:  yes  no
- Waiver Attached:  yes  no

PLANS ATTACHED AND INCORPORATED INTO PERMIT  
 \* SIX (6) DATED 11/27/2018

A building permit may be required by: PASQUOTANK  See note on back regarding River Basin rules.

Notes/ Special Conditions 1) SUBAQUEOUS LINES MUST BE PLACED AT A MINIMUM DEPTH OF 2' BELOW BOTTEM CONTOUR 2) ALL SPOILS WHICH ARE PERMANENTLY REMOVED MUST BE PLACED ON A HIGH GROUND DISPOSAL SITE AND STABILIZED TO PREVENT RETURN TO WATERS/WETLANDS.

for Philip S. Harris, P.E.  
 Agent or Applicant Printed Name  
Carla Druce  
 Signature \*\* Please read compliance statement on back of permit \*\*  
\$ 400.00 Application Fee(s)  
WBS#45861.3.1 Check #

GREG DAISE  
 Permit Officer's Printed Name  
Gy Daise  
 Signature  
4/01/2019 Issuing Date  
4/01/2020 Expiration Date

### Statement of Compliance and Consistency

This permit is subject to compliance with this application, site drawing and attached general and specific conditions. Any violation of these terms may subject the permittee to a fine or criminal or civil action; and may cause the permit to become null and void.

This permit must be on the project site and accessible to the permit officer when the project is inspected for compliance. The applicant certifies by signing this permit that 1) prior to undertaking any activities authorized by this permit, the applicant will confer with appropriate local authorities to confirm that this project is consistent with the local land use plan and all local ordinances, and 2) a written statement or certified mail return receipt has been obtained from the adjacent riparian landowner(s).

The State of North Carolina and the Division of Coastal Management, in issuing this permit under the best available information and belief, certify that this project is consistent with the North Carolina Coastal Management Program.

### River Basin Rules Applicable To Your Project:

Tar - Pamlico River Basin Buffer Rules  
Neuse River Basin Buffer Rules

Other: \_\_\_\_\_

If indicated on front of permit, your project is subject to the Environmental Management Commission's Buffer Rules for the River Basin checked above due to its location within that River Basin. These buffer rules are enforced by the NC Division of Water Resources. Contact the Division of Water Resources at the Washington Regional Office (252-946-6481) or the Wilmington Regional Office (910-796-7215) for more information on how to comply with these buffer rules.

### Division of Coastal Management Offices

#### **Morehead City Headquarters**

400 Commerce Ave  
Morehead City, NC 28557  
252-808-2808/ 1-888-4RCOAST  
Fax: 252-247-3330

(Serves: Carteret, Craven, Onslow -  
North of New River Inlet- and Pamlico  
Counties)

#### **Washington District**

943 Washington Square Mall  
Washington, NC 27889  
252-946-6481  
Fax: 252-948-0478

(Serves: Beaufort, Bertie, Hertford, Hyde,  
Tyrrell and Washington Counties)

#### **Elizabeth City District**

401 S. Griffin St.  
Ste. 300  
Elizabeth City, NC 27909  
252-264-3901  
Fax: 252-264-3723

(Serves: Camden, Chowan, Currituck,  
Dare, Gates, Pasquotank and Perquimans  
Counties)

#### **Wilmington District**

127 Cardinal Drive Ext.  
Wilmington, NC 28405-3845  
910-796-7215  
Fax: 910-395-3964

(Serves: Brunswick, New Hanover,  
Onslow - South of New River Inlet-  
and Pender Counties)

**SECTION .1600 - GENERAL PERMIT FOR THE INSTALLATION OF AERIAL AND SUBAQUEOUS  
UTILITY LINES WITH ATTENDANT STRUCTURES IN COASTAL WETLANDS; ESTUARINE WATERS;  
PUBLIC TRUST WATERS AND ESTUARINE SHORELINES**

**15A NCAC 07H .1601 PURPOSE**

A permit under this Section shall allow for the installation of utility lines both aerially and subaqueously in the coastal wetland, estuarine water, public trust areas and estuarine and public trust shoreline AECs according to the authority provided in Subchapter 7J .1100 and according rules in this Section. This general permit shall not apply to the ocean hazard AECs.

*History Note: Authority G.S. 113-229(c1); 113A-107(a)(b); 113A-113(b); 113A-118.1;  
Eff. March 1, 1985;  
Amended Eff. August 1, 2000; August 1, 1998.*

**15A NCAC 07H .1602 APPROVAL PROCEDURES**

(a) The applicant must contact the Division of Coastal Management and complete an application form requesting approval for development. The applicant shall provide information on site location, dimensions of the project area, and his name and address.

(b) The applicant must provide:

- (1) confirmation that a written statement has been obtained signed by the adjacent riparian property owners indicating that they have no objections to the proposed work; or
- (2) confirmation that the adjacent riparian property owners have been notified by certified mail of the proposed work. Such notice should instruct adjacent property owners to provide any comments on the proposed development in writing for consideration by permitting officials to the Division of Coastal Management within ten days of receipt of the notice, and, indicate that no response will be interpreted as no objection. DCM staff will review all comments and determine, based on their relevance to the potential impacts of the proposed project, if the proposed project can be approved by a General Permit. If DCM staff finds that the comments are worthy of more in-depth review, the applicant will be notified that he must submit an application for a major development permit.

(c) No work shall begin until an on-site meeting is held with the applicant and appropriate Division of Coastal Management representative so that the utility line alignment can be appropriately marked. Written authorization to proceed with the proposed development will be issued during this visit. Construction on the utility line must begin within twelve months of this visit or the general authorization expires.

*History Note: Authority G.S. 113A-107(a)(b); 113A-113(b); 113A-118.1; 113A-229(c1);  
Eff. March 1, 1985;  
Amended Eff. January 1, 1990.*

**15A NCAC 07H .1603 PERMIT FEE**

The applicant shall pay a permit fee of four hundred dollars (\$400.00) by check or money order payable to the Department.

*History Note: Authority G.S. 113-229(c1); 113A-107; 113A-113(b); 113A-118.1; 113A-119; 113A-119.1;  
Eff. March 1, 1985;  
Amended Eff. September 1, 2006; August 1, 2000; March 1, 1991.*

**15A NCAC 07H .1604 GENERAL CONDITIONS**

(a) Utility lines for the purpose of this general permit or any pipes or pipelines for the transportation of potable water, domestic sanitary sewage, natural gas, and any cable, line, or wire for the transmission, for any purpose, of electrical energy, telephone and telegraph messages, and radio and television communication.

(b) There must be no resultant change in preconstruction bottom contours. Authorized fill includes only that necessary to backfill or bed the utility line. Any excess material must be removed to an upland disposal area.

(c) The utility line crossing will not adversely affect a public water supply intake.

- (d) The utility line route or construction method will not disrupt the movement of those species of aquatic life indigenous to the waterbody.
- (e) Individuals shall allow authorized representatives of the Department of Environment, Health, and Natural Resources to make periodic inspections at any time necessary to ensure that the activity being performed under authority of this general permit is in accordance with the terms and conditions prescribed herein.
- (f) This general permit will not be applicable to proposed construction where the Department has determined, based on an initial review of the application, that notice and review pursuant to G.S. 113A-119 is necessary because there are unresolved questions concerning the proposed activity's impact on adjoining properties or on water quality; air quality; coastal wetlands; cultural or historic sites; wildlife; fisheries resources; or public trust rights.
- (g) This permit does not eliminate the need to obtain any other required state, local, or federal authorization, nor, to abide by regulations adopted by any federal or other state agency.
- (h) Development carried out under this permit must be consistent with all local requirements, AEC guidelines, and local Land Use Plans current at the time of authorization.

*History Note: Authority G.S. 113-229(c1); 113A-107(a)(b); 113A-113(b); 113A-118.1;  
Eff. March 1, 1985;  
Amended Eff. May 1, 1990;  
RRC Objection due to ambiguity Eff. May 19, 1994;  
Amended Eff. August 1, 1998; July 1, 1994.*

#### **15A NCAC 07H .1605 SPECIFIC CONDITIONS**

Proposed utility line installations must meet each of the following specific conditions to be eligible for authorization by this general permit:

- (1) All domestic sanitary sewer line requests must be accompanied by a statement of prior approval from the NC Division Water Quality.
- (2) All spoils which are permanently removed must be placed on a high ground disposal site and stabilized so as not to return to waters, marsh or other wetlands.
- (3) Any additional backfill material required must be clean sand or rock free of organic matter.
- (4) Cuts through wetlands must be minimized.
- (5) Finished grades or subaqueous or wetland crossing must be returned to preproject contours.
- (6) There can be no work within any productive shellfish beds.
- (7) No excavation or filling activities will be permitted between April 1 and September 30 of any year within any designated primary nursery area.
- (8) Subaqueous lines must be placed at a depth of six feet below the project depth of federal projects. In other areas they will be installed at a minimum depth of two feet below the bottom contour.
- (9) The minimum clearance for aerial communication lines or any lines not transmitting electricity will be 10' above the clearance required for bridges in the vicinity.
- (10) The minimum clearance for aerial electrical transmission lines shall be consistent with those established by the US Army Corps of Engineers and US Coast Guard.
- (11) The installation of a utility line on pipe bents or otherwise above the elevation of mean high or mean ordinary water must be of sufficient height to allow for traditional navigation in the water body. Additionally the utility line must not interfere with the waterflow of normal or flood waters.
- (12) Natural gas lines must not exceed 11 inches in diameter.

*History Note: Authority G.S. 113-229(c1); 113A-107(a)(b); 113A-113(b); 113A-118.1;  
Eff. March 1, 1985;  
Amended Eff. August 1, 1998.*



STATE OF NORTH CAROLINA  
DEPARTMENT OF TRANSPORTATION

ROY COOPER  
GOVERNOR

JAMES H. TROGDON, III  
SECRETARY

DATE: April 4, 2019

TO: File

FROM: Deanna Riffey, Environmental Program Consultant  
Environmental Analysis Unit

SUBJECT: U-5942 Notice of Use for Section 404 Nationwide Permit 12 and Section 401  
General Water Quality Certification

Per email correspondence with U.S. Army Corps of Engineers (USACE) Regulatory Specialist Kyle Barnes on April 3, 2019, a non-reporting Nationwide Permit 12 is applicable for the jurisdictional impacts associated with the installation of conduit for fiber-optic signal cable. Under the current design, neither written notifications nor written concurrences from the USACE or the N.C. Division of Water Resources (NCDWR) are required. Due to the minimal permanent impacts to Wetland D of < 0.01 acre mitigation is not proposed. NCDOT must comply with all conditions and descriptions in the attached Permit Drawings, 404 General Conditions, and 401 Standard Conditions. A permit modification may be required if any of the above conditions and descriptions cannot be met.

*Mailing Address:*  
NC DEPARTMENT OF TRANSPORTATION  
ENVIRONMENTAL ANALYSIS UNIT  
1598 MAIL SERVICE CENTER  
RALEIGH, NC 27699-1598

*Telephone:* (919) 707-6000  
*Fax:* (919) 212-5785  
*Customer Service:* 1-877-368-4968

*Website:* [www.ncdot.gov](http://www.ncdot.gov)

*Location:*  
1000 BIRCH RIDGE DRIVE  
RALEIGH, NC 27699

**NATIONWIDE PERMIT 12**  
**DEPARTMENT OF THE ARMY**  
**CORPS OF ENGINEERS**  
**FINAL NOTICE OF ISSUANCE AND MODIFICATION OF NATIONWIDE PERMITS**  
**FEDERAL REGISTER**  
**AUTHORIZED MARCH 19, 2017**

**Utility Line Activities.** Activities required for the construction, maintenance, repair, and removal of utility lines and associated facilities in waters of the United States, provided the activity does not result in the loss of greater than 1/2-acre of waters of the United States for each single and complete project.

Utility lines: This NWP authorizes discharges of dredged or fill material into waters of the United States and structures or work in navigable waters for crossings of those waters associated with the construction, maintenance, or repair of utility lines, including outfall and intake structures. There must be no change in pre-construction contours of waters of the United States. A “utility line” is defined as any pipe or pipeline for the transportation of any gaseous, liquid, liquescent, or slurry substance, for any purpose, and any cable, line, or wire for the transmission for any purpose of electrical energy, telephone, and telegraph messages, and internet, radio, and television communication. The term “utility line” does not include activities that drain a water of the United States, such as drainage tile or french drains, but it does apply to pipes conveying drainage from another area.

Material resulting from trench excavation may be temporarily sidecast into waters of the United States for no more than three months, provided the material is not placed in such a manner that it is dispersed by currents or other forces. The district engineer may extend the period of temporary side casting for no more than a total of 180 days, where appropriate. In wetlands, the top 6 to 12 inches of the trench should normally be backfilled with topsoil from the trench. The trench cannot be constructed or backfilled in such a manner as to drain waters of the United States (e.g., backfilling with extensive gravel layers, creating a french drain effect). Any exposed slopes and stream banks must be stabilized immediately upon completion of the utility line crossing of each waterbody.

Utility line substations: This NWP authorizes the construction, maintenance, or expansion of substation facilities associated with a power line or utility line in non-tidal waters of the United States, provided the activity, in combination with all other activities included in one single and complete project, does not result in the loss of greater than 1/2-acre of waters of the United States. This NWP does not authorize discharges into non-tidal wetlands adjacent to tidal waters of the United States to construct, maintain, or expand substation facilities.

Foundations for overhead utility line towers, poles, and anchors: This NWP authorizes the construction or maintenance of foundations for overhead utility line towers, poles, and anchors in all waters of the United States, provided the foundations are the minimum size necessary and separate footings for each tower leg (rather than a larger single pad) are used where feasible.



Access roads: This NWP authorizes the construction of access roads for the construction and maintenance of utility lines, including overhead power lines and utility line substations, in non-tidal waters of the United States, provided the activity, in combination with all other activities included in one single and complete project, does not cause the loss of greater than 1/2-acre of non-tidal waters of the United States. This NWP does not authorize discharges into non-tidal wetlands adjacent to tidal waters for access roads. Access roads must be the minimum width necessary (see Note 2, below). Access roads must be constructed so that the length of the road minimizes any adverse effects on waters of the United States and must be as near as possible to pre-construction contours and elevations (e.g., at grade corduroy roads or geotextile/gravel roads). Access roads constructed above pre-construction contours and elevations in waters of the United States must be properly bridged or culverted to maintain surface flows.

This NWP may authorize utility lines in or affecting navigable waters of the United States even if there is no associated discharge of dredged or fill material (See 33 CFR part 322). Overhead utility lines constructed over section 10 waters and utility lines that are routed in or under section 10 waters without a discharge of dredged or fill material require a section 10 permit.

This NWP authorizes, to the extent that Department of the Army authorization is required, temporary structures, fills, and work necessary for the remediation of inadvertent returns of drilling fluids to waters of the United States through sub-soil fissures or fractures that might occur during horizontal directional drilling activities conducted for the purpose of installing or replacing utility lines. These remediation activities must be done as soon as practicable, to restore the affected waterbody. District engineers may add special conditions to this NWP to require a remediation plan for addressing inadvertent returns of drilling fluids to waters of the United States during horizontal directional drilling activities conducted for the purpose of installing or replacing utility lines.

This NWP also authorizes temporary structures, fills, and work, including the use of temporary mats, necessary to conduct the utility line activity. Appropriate measures must be taken to maintain normal downstream flows and minimize flooding to the maximum extent practicable, when temporary structures, work, and discharges, including cofferdams, are necessary for construction activities, access fills, or dewatering of construction sites. Temporary fills must consist of materials, and be placed in a manner, that will not be eroded by expected high flows. After construction, temporary fills must be removed in their entirety and the affected areas returned to pre-construction elevations. The areas affected by temporary fills must be revegetated, as appropriate.

**Notification:** The permittee must submit a pre-construction notification to the district engineer prior to commencing the activity if any of the following criteria are met: (1) the activity involves mechanized land clearing in a forested wetland for the utility line right-of-way; (2) a section 10 permit is required; (3) the utility line in waters of the United States, excluding overhead lines, exceeds 500 feet; (4) the utility line is placed within a jurisdictional area (i.e., water of the United States), and it runs parallel to or along a stream bed that is within that jurisdictional area; (5) discharges that result in the loss of greater than 1/10-acre of waters of the United States; (6) permanent access roads are constructed above

grade in waters of the United States for a distance of more than 500 feet; or (7) permanent access roads are constructed in waters of the United States with impervious materials. (See general condition 32.) (Authorities: Sections 10 and 404)

**Note 1:** Where the utility line is constructed or installed in navigable waters of the United States (i.e., section 10 waters) within the coastal United States, the Great Lakes, and United States territories, a copy of the NWP verification will be sent by the Corps to the National Oceanic and Atmospheric Administration (NOAA), National Ocean Service (NOS), for charting the utility line to protect navigation.

**Note 2:** For utility line activities crossing a single waterbody more than one time at separate and distant locations, or multiple waterbodies at separate and distant locations, each crossing is considered a single and complete project for purposes of NWP authorization. Utility line activities must comply with 33 CFR 330.6(d).

**Note 3:** Utility lines consisting of aerial electric power transmission lines crossing navigable waters of the United States (which are defined at 33 CFR part 329) must comply with the applicable minimum clearances specified in 33 CFR 322.5(i).

**Note 4:** Access roads used for both construction and maintenance may be authorized, provided they meet the terms and conditions of this NWP. Access roads used solely for construction of the utility line must be removed upon completion of the work, in accordance with the requirements for temporary fills.

**Note 5:** Pipes or pipelines used to transport gaseous, liquid, liquescent, or slurry substances over navigable waters of the United States are considered to be bridges, not utility lines, and may require a permit from the U.S. Coast Guard pursuant to section 9 of the Rivers and Harbors Act of 1899. However, any discharges of dredged or fill material into waters of the United States associated with such pipelines will require a section 404 permit (see NWP 15).

**Note 6:** This NWP authorizes utility line maintenance and repair activities that do not qualify for the Clean Water Act section 404(f) exemption for maintenance of currently serviceable fills or fill structures.

**Note 7:** For overhead utility lines authorized by this NWP, a copy of the PCN and NWP verification will be provided to the Department of Defense Siting Clearinghouse, which will evaluate potential effects on military activities.

**Note 8:** For NWP 12 activities that require pre-construction notification, the PCN must include any other NWP(s), regional general permit(s), or individual permit(s) used or intended to be used to authorize any part of the proposed project or any related activity, including other separate and distant crossings that require Department of the Army authorization but do not require pre-construction notification (see paragraph (b) of general condition 32). The district engineer will evaluate the PCN in accordance with Section D, "District Engineer's Decision." The district engineer may require mitigation to ensure that the authorized activity results in no more than minimal individual and cumulative adverse environmental effects (see general condition 23).

## NATIONWIDE PERMIT GENERAL CONDITIONS

The following General Conditions must be followed in order for any authorization by a NWP to be valid:

1. Navigation. (a) No activity may cause more than a minimal adverse effect on navigation.  
(b) Any safety lights and signals prescribed by the U.S. Coast Guard, through regulations or otherwise, must be installed and maintained at the permittee's expense on authorized facilities in navigable waters of the United States.  
(c) The permittee understands and agrees that, if future operations by the United States require the removal, relocation, or other alteration, of the structure or work herein authorized, or if, in the opinion of the Secretary of the Army or his authorized representative, said structure or work shall cause unreasonable obstruction to the free navigation of the navigable waters, the permittee will be required, upon due notice from the Corps of Engineers, to remove, relocate, or alter the structural work or obstructions caused thereby, without expense to the United States. No claim shall be made against the United States on account of any such removal or alteration.
2. Aquatic Life Movements. No activity may substantially disrupt the necessary life cycle movements of those species of aquatic life indigenous to the waterbody, including those species that normally migrate through the area, unless the activity's primary purpose is to impound water. All permanent and temporary crossings of waterbodies shall be suitably culverted, bridged, or otherwise designed and constructed to maintain low flows to sustain the movement of those aquatic species. If a bottomless culvert cannot be used, then the crossing should be designed and constructed to minimize adverse effects to aquatic life movements.
3. Spawning Areas. Activities in spawning areas during spawning seasons must be avoided to the maximum extent practicable. Activities that result in the physical destruction (e.g., through excavation, fill, or downstream smothering by substantial turbidity) of an important spawning area are not authorized.
4. Migratory Bird Breeding Areas. Activities in waters of the United States that serve as breeding areas for migratory birds must be avoided to the maximum extent practicable.
5. Shellfish Beds. No activity may occur in areas of concentrated shellfish populations, unless the activity is directly related to a shellfish harvesting activity authorized by NWPs 4 and 48, or is a shellfish seeding or habitat restoration activity authorized by NWP 27.
6. Suitable Material. No activity may use unsuitable material (e.g., trash, debris, car bodies, asphalt, etc.). Material used for construction or discharged must be free from toxic pollutants in toxic amounts (see section 307 of the Clean Water Act).

7. Water Supply Intakes. No activity may occur in the proximity of a public water supply intake, except where the activity is for the repair or improvement of public water supply intake structures or adjacent bank stabilization.

8. Adverse Effects From Impoundments. If the activity creates an impoundment of water, adverse effects to the aquatic system due to accelerating the passage of water, and/or restricting its flow must be minimized to the maximum extent practicable.

9. Management of Water Flows. To the maximum extent practicable, the pre-construction course, condition, capacity, and location of open waters must be maintained for each activity, including stream channelization, storm water management activities, and temporary and permanent road crossings, except as provided below. The activity must be constructed to withstand expected high flows. The activity must not restrict or impede the passage of normal or high flows, unless the primary purpose of the activity is to impound water or manage high flows. The activity may alter the pre-construction course, condition, capacity, and location of open waters if it benefits the aquatic environment (e.g., stream restoration or relocation activities).

10. Fills Within 100-Year Floodplains. The activity must comply with applicable FEMA-approved state or local floodplain management requirements.

11. Equipment. Heavy equipment working in wetlands or mudflats must be placed on mats, or other measures must be taken to minimize soil disturbance.

12. Soil Erosion and Sediment Controls. Appropriate soil erosion and sediment controls must be used and maintained in effective operating condition during construction, and all exposed soil and other fills, as well as any work below the ordinary high water mark or high tide line, must be permanently stabilized at the earliest practicable date. Permittees are encouraged to perform work within waters of the United States during periods of low-flow or no-flow, or during low tides.

13. Removal of Temporary Fills. Temporary fills must be removed in their entirety and the affected areas returned to pre-construction elevations. The affected areas must be revegetated, as appropriate.

14. Proper Maintenance. Any authorized structure or fill shall be properly maintained, including maintenance to ensure public safety and compliance with applicable NWP general conditions, as well as any activity-specific conditions added by the district engineer to an NWP authorization.

15. Single and Complete Project. The activity must be a single and complete project. The same NWP cannot be used more than once for the same single and complete project.

16. Wild and Scenic Rivers. (a) No NWP activity may occur in a component of the National Wild and Scenic River System, or in a river officially designated by Congress as a “study river” for possible inclusion in the system while the river is in an official study status,

unless the appropriate Federal agency with direct management responsibility for such river, has determined in writing that the proposed activity will not adversely affect the Wild and Scenic River designation or study status.

(b) If a proposed NWP activity will occur in a component of the National Wild and Scenic River System, or in a river officially designated by Congress as a “study river” for possible inclusion in the system while the river is in an official study status, the permittee must submit a pre-construction notification (see general condition 32). The district engineer will coordinate the PCN with the Federal agency with direct management responsibility for that river. The permittee shall not begin the NWP activity until notified by the district engineer that the Federal agency with direct management responsibility for that river has determined in writing that the proposed NWP activity will not adversely affect the Wild and Scenic River designation or study status.

(c) Information on Wild and Scenic Rivers may be obtained from the appropriate Federal land management agency responsible for the designated Wild and Scenic River or study river (e.g., National Park Service, U.S. Forest Service, Bureau of Land Management, U.S. Fish and Wildlife Service). Information on these rivers is also available at: <http://www.rivers.gov/>.

17. Tribal Rights. No NWP activity may cause more than minimal adverse effects on tribal rights (including treaty rights), protected tribal resources, or tribal lands.

18. Endangered Species. (a) No activity is authorized under any NWP which is likely to directly or indirectly jeopardize the continued existence of a threatened or endangered species or a species proposed for such designation, as identified under the Federal Endangered Species Act (ESA), or which will directly or indirectly destroy or adversely modify the critical habitat of such species. No activity is authorized under any NWP which “may affect” a listed species or critical habitat, unless ESA section 7 consultation addressing the effects of the proposed activity has been completed. Direct effects are the immediate effects on listed species and critical habitat caused by the NWP activity. Indirect effects are those effects on listed species and critical habitat that are caused by the NWP activity and are later in time, but still are reasonably certain to occur.

(b) Federal agencies should follow their own procedures for complying with the requirements of the ESA. If pre-construction notification is required for the proposed activity, the Federal permittee must provide the district engineer with the appropriate documentation to demonstrate compliance with those requirements. The district engineer will verify that the appropriate documentation has been submitted. If the appropriate documentation has not been submitted, additional ESA section 7 consultation may be necessary for the activity and the respective federal agency would be responsible for fulfilling its obligation under section 7 of the ESA.

(c) Non-federal permittees must submit a pre-construction notification to the district engineer if any listed species or designated critical habitat might be affected or is in the vicinity of the activity, or if the activity is located in designated critical habitat, and shall not begin work on the activity until notified by the district engineer that the requirements of the ESA have been satisfied and that the activity is authorized. For activities that might affect Federally-listed endangered or threatened species or designated critical habitat, the pre-construction notification must include the name(s) of the endangered or threatened species that

might be affected by the proposed activity or that utilize the designated critical habitat that might be affected by the proposed activity. The district engineer will determine whether the proposed activity “may affect” or will have “no effect” to listed species and designated critical habitat and will notify the non-Federal applicant of the Corps’ determination within 45 days of receipt of a complete pre-construction notification. In cases where the non-Federal applicant has identified listed species or critical habitat that might be affected or is in the vicinity of the activity, and has so notified the Corps, the applicant shall not begin work until the Corps has provided notification that the proposed activity will have “no effect” on listed species or critical habitat, or until ESA section 7 consultation has been completed. If the non-Federal applicant has not heard back from the Corps within 45 days, the applicant must still wait for notification from the Corps.

(d) As a result of formal or informal consultation with the FWS or NMFS the district engineer may add species-specific permit conditions to the NWP.

(e) Authorization of an activity by an NWP does not authorize the “take” of a threatened or endangered species as defined under the ESA. In the absence of separate authorization (e.g., an ESA Section 10 Permit, a Biological Opinion with “incidental take” provisions, etc.) from the FWS or the NMFS, the Endangered Species Act prohibits any person subject to the jurisdiction of the United States to take a listed species, where “take” means to harass, harm, pursue, hunt, shoot, wound, kill, trap, capture, or collect, or to attempt to engage in any such conduct. The word “harm” in the definition of “take” means an act which actually kills or injures wildlife. Such an act may include significant habitat modification or degradation where it actually kills or injures wildlife by significantly impairing essential behavioral patterns, including breeding, feeding or sheltering.

(f) If the non-federal permittee has a valid ESA section 10(a)(1)(B) incidental take permit with an approved Habitat Conservation Plan for a project or a group of projects that includes the proposed NWP activity, the non-federal applicant should provide a copy of that ESA section 10(a)(1)(B) permit with the PCN required by paragraph (c) of this general condition. The district engineer will coordinate with the agency that issued the ESA section 10(a)(1)(B) permit to determine whether the proposed NWP activity and the associated incidental take were considered in the internal ESA section 7 consultation conducted for the ESA section 10(a)(1)(B) permit. If that coordination results in concurrence from the agency that the proposed NWP activity and the associated incidental take were considered in the internal ESA section 7 consultation for the ESA section 10(a)(1)(B) permit, the district engineer does not need to conduct a separate ESA section 7 consultation for the proposed NWP activity. The district engineer will notify the non-federal applicant within 45 days of receipt of a complete pre-construction notification whether the ESA section 10(a)(1)(B) permit covers the proposed NWP activity or whether additional ESA section 7 consultation is required.

(g) Information on the location of threatened and endangered species and their critical habitat can be obtained directly from the offices of the FWS and NMFS or their world wide web pages at <http://www.fws.gov/> or <http://www.fws.gov/ipac> and <http://www.nmfs.noaa.gov/pr/species/esa/> respectively.

19. Migratory Birds and Bald and Golden Eagles. The permittee is responsible for ensuring their action complies with the Migratory Bird Treaty Act and the Bald and Golden Eagle Protection Act. The permittee is responsible for contacting appropriate local office of the U.S. Fish and Wildlife Service to determine applicable measures to reduce impacts to migratory

birds or eagles, including whether “incidental take” permits are necessary and available under the Migratory Bird Treaty Act or Bald and Golden Eagle Protection Act for a particular activity.

20. Historic Properties. (a) In cases where the district engineer determines that the activity may have the potential to cause effects to properties listed, or eligible for listing, in the National Register of Historic Places, the activity is not authorized, until the requirements of Section 106 of the National Historic Preservation Act (NHPA) have been satisfied.

(b) Federal permittees should follow their own procedures for complying with the requirements of section 106 of the National Historic Preservation Act. If pre-construction notification is required for the proposed NWP activity, the Federal permittee must provide the district engineer with the appropriate documentation to demonstrate compliance with those requirements. The district engineer will verify that the appropriate documentation has been submitted. If the appropriate documentation is not submitted, then additional consultation under section 106 may be necessary. The respective federal agency is responsible for fulfilling its obligation to comply with section 106.

(c) Non-federal permittees must submit a pre-construction notification to the district engineer if the NWP activity might have the potential to cause effects to any historic properties listed on, determined to be eligible for listing on, or potentially eligible for listing on the National Register of Historic Places, including previously unidentified properties. For such activities, the pre-construction notification must state which historic properties might have the potential to be affected by the proposed NWP activity or include a vicinity map indicating the location of the historic properties or the potential for the presence of historic properties. Assistance regarding information on the location of, or potential for, the presence of historic properties can be sought from the State Historic Preservation Officer, Tribal Historic Preservation Officer, or designated tribal representative, as appropriate, and the National Register of Historic Places (see 33 CFR 330.4(g)). When reviewing pre-construction notifications, district engineers will comply with the current procedures for addressing the requirements of section 106 of the National Historic Preservation Act. The district engineer shall make a reasonable and good faith effort to carry out appropriate identification efforts, which may include background research, consultation, oral history interviews, sample field investigation, and field survey. Based on the information submitted in the PCN and these identification efforts, the district engineer shall determine whether the proposed NWP activity has the potential to cause effects on the historic properties. Section 106 consultation is not required when the district engineer determines that the activity does not have the potential to cause effects on historic properties (see 36 CFR 800.3(a)). Section 106 consultation is required when the district engineer determines that the activity has the potential to cause effects on historic properties. The district engineer will conduct consultation with consulting parties identified under 36 CFR 800.2(c) when he or she makes any of the following effect determinations for the purposes of section 106 of the NHPA: no historic properties affected, no adverse effect, or adverse effect. Where the non-Federal applicant has identified historic properties on which the activity might have the potential to cause effects and so notified the Corps, the non-Federal applicant shall not begin the activity until notified by the district engineer either that the activity has no potential to cause effects to historic properties or that NHPA section 106 consultation has been completed.

(d) For non-federal permittees, the district engineer will notify the prospective permittee within 45 days of receipt of a complete pre-construction notification whether NHPA section 106 consultation is required. If NHPA section 106 consultation is required, the district engineer will notify the non-Federal applicant that he or she cannot begin the activity until section 106 consultation is completed. If the non-Federal applicant has not heard back from the Corps within 45 days, the applicant must still wait for notification from the Corps.

(e) Prospective permittees should be aware that section 110k of the NHPA (54 U.S.C. 306113) prevents the Corps from granting a permit or other assistance to an applicant who, with intent to avoid the requirements of section 106 of the NHPA, has intentionally significantly adversely affected a historic property to which the permit would relate, or having legal power to prevent it, allowed such significant adverse effect to occur, unless the Corps, after consultation with the Advisory Council on Historic Preservation (ACHP), determines that circumstances justify granting such assistance despite the adverse effect created or permitted by the applicant. If circumstances justify granting the assistance, the Corps is required to notify the ACHP and provide documentation specifying the circumstances, the degree of damage to the integrity of any historic properties affected, and proposed mitigation. This documentation must include any views obtained from the applicant, SHPO/THPO, appropriate Indian tribes if the undertaking occurs on or affects historic properties on tribal lands or affects properties of interest to those tribes, and other parties known to have a legitimate interest in the impacts to the permitted activity on historic properties.

21. Discovery of Previously Unknown Remains and Artifacts. If you discover any previously unknown historic, cultural or archeological remains and artifacts while accomplishing the activity authorized by this permit, you must immediately notify the district engineer of what you have found, and to the maximum extent practicable, avoid construction activities that may affect the remains and artifacts until the required coordination has been completed. The district engineer will initiate the Federal, Tribal, and state coordination required to determine if the items or remains warrant a recovery effort or if the site is eligible for listing in the National Register of Historic Places.

22. Designated Critical Resource Waters. Critical resource waters include, NOAA-managed marine sanctuaries and marine monuments, and National Estuarine Research Reserves. The district engineer may designate, after notice and opportunity for public comment, additional waters officially designated by a state as having particular environmental or ecological significance, such as outstanding national resource waters or state natural heritage sites. The district engineer may also designate additional critical resource waters after notice and opportunity for public comment.

(a) Discharges of dredged or fill material into waters of the United States are not authorized by NWPs 7, 12, 14, 16, 17, 21, 29, 31, 35, 39, 40, 42, 43, 44, 49, 50, 51, and 52 for any activity within, or directly affecting, critical resource waters, including wetlands adjacent to such waters.

(b) For NWPs 3, 8, 10, 13, 15, 18, 19, 22, 23, 25, 27, 28, 30, 33, 34, 36, 37, 38, and 54, notification is required in accordance with general condition 32, for any activity proposed in the designated critical resource waters including wetlands adjacent to those waters. The district engineer may authorize activities under these NWPs only after it is determined that the impacts to the critical resource waters will be no more than minimal.



23. Mitigation. The district engineer will consider the following factors when determining appropriate and practicable mitigation necessary to ensure that the individual and cumulative adverse environmental effects are no more than minimal:

(a) The activity must be designed and constructed to avoid and minimize adverse effects, both temporary and permanent, to waters of the United States to the maximum extent practicable at the project site (i.e., on site).

(b) Mitigation in all its forms (avoiding, minimizing, rectifying, reducing, or compensating for resource losses) will be required to the extent necessary to ensure that the individual and cumulative adverse environmental effects are no more than minimal.

(c) Compensatory mitigation at a minimum one-for-one ratio will be required for all wetland losses that exceed 1/10-acre and require pre-construction notification, unless the district engineer determines in writing that either some other form of mitigation would be more environmentally appropriate or the adverse environmental effects of the proposed activity are no more than minimal, and provides an activity-specific waiver of this requirement. For wetland losses of 1/10-acre or less that require pre-construction notification, the district engineer may determine on a case-by-case basis that compensatory mitigation is required to ensure that the activity results in only minimal adverse environmental effects.

(d) For losses of streams or other open waters that require pre-construction notification, the district engineer may require compensatory mitigation to ensure that the activity results in no more than minimal adverse environmental effects. Compensatory mitigation for losses of streams should be provided, if practicable, through stream rehabilitation, enhancement, or preservation, since streams are difficult-to-replace resources (see 33 CFR 332.3(e)(3)).

(e) Compensatory mitigation plans for NWP activities in or near streams or other open waters will normally include a requirement for the restoration or enhancement, maintenance, and legal protection (e.g., conservation easements) of riparian areas next to open waters. In some cases, the restoration or maintenance/protection of riparian areas may be the only compensatory mitigation required. Restored riparian areas should consist of native species. The width of the required riparian area will address documented water quality or aquatic habitat loss concerns. Normally, the riparian area will be 25 to 50 feet wide on each side of the stream, but the district engineer may require slightly wider riparian areas to address documented water quality or habitat loss concerns. If it is not possible to restore or maintain/protect a riparian area on both sides of a stream, or if the waterbody is a lake or coastal waters, then restoring or maintaining/protecting a riparian area along a single bank or shoreline may be sufficient. Where both wetlands and open waters exist on the project site, the district engineer will determine the appropriate compensatory mitigation (e.g., riparian areas and/or wetlands compensation) based on what is best for the aquatic environment on a watershed basis. In cases where riparian areas are determined to be the most appropriate form of minimization or compensatory mitigation, the district engineer may waive or reduce the requirement to provide wetland compensatory mitigation for wetland losses.

(f) Compensatory mitigation projects provided to offset losses of aquatic resources must comply with the applicable provisions of 33 CFR part 332.

(1) The prospective permittee is responsible for proposing an appropriate compensatory mitigation option if compensatory mitigation is necessary to ensure that the activity results in no more than minimal adverse environmental effects. For the NWPs, the preferred mechanism for providing compensatory mitigation is mitigation bank credits or in-

lieu fee program credits (see 33 CFR 332.3(b)(2) and (3)). However, if an appropriate number and type of mitigation bank or in-lieu credits are not available at the time the PCN is submitted to the district engineer, the district engineer may approve the use of permittee-responsible mitigation.

(2) The amount of compensatory mitigation required by the district engineer must be sufficient to ensure that the authorized activity results in no more than minimal individual and cumulative adverse environmental effects (see 33 CFR 330.1(e)(3)). (See also 33 CFR 332.3(f)).

(3) Since the likelihood of success is greater and the impacts to potentially valuable uplands are reduced, aquatic resource restoration should be the first compensatory mitigation option considered for permittee-responsible mitigation.

(4) If permittee-responsible mitigation is the proposed option, the prospective permittee is responsible for submitting a mitigation plan. A conceptual or detailed mitigation plan may be used by the district engineer to make the decision on the NWP verification request, but a final mitigation plan that addresses the applicable requirements of 33 CFR 332.4(c)(2) through (14) must be approved by the district engineer before the permittee begins work in waters of the United States, unless the district engineer determines that prior approval of the final mitigation plan is not practicable or not necessary to ensure timely completion of the required compensatory mitigation (see 33 CFR 332.3(k)(3)).

(5) If mitigation bank or in-lieu fee program credits are the proposed option, the mitigation plan only needs to address the baseline conditions at the impact site and the number of credits to be provided.

(6) Compensatory mitigation requirements (e.g., resource type and amount to be provided as compensatory mitigation, site protection, ecological performance standards, monitoring requirements) may be addressed through conditions added to the NWP authorization, instead of components of a compensatory mitigation plan (see 33 CFR 332.4(c)(1)(ii)).

(g) Compensatory mitigation will not be used to increase the acreage losses allowed by the acreage limits of the NWPs. For example, if an NWP has an acreage limit of 1/2-acre, it cannot be used to authorize any NWP activity resulting in the loss of greater than 1/2-acre of waters of the United States, even if compensatory mitigation is provided that replaces or restores some of the lost waters. However, compensatory mitigation can and should be used, as necessary, to ensure that an NWP activity already meeting the established acreage limits also satisfies the no more than minimal impact requirement for the NWPs.

(h) Permittees may propose the use of mitigation banks, in-lieu fee programs, or permittee-responsible mitigation. When developing a compensatory mitigation proposal, the permittee must consider appropriate and practicable options consistent with the framework at 33 CFR 332.3(b). For activities resulting in the loss of marine or estuarine resources, permittee-responsible mitigation may be environmentally preferable if there are no mitigation banks or in-lieu fee programs in the area that have marine or estuarine credits available for sale or transfer to the permittee. For permittee-responsible mitigation, the special conditions of the NWP verification must clearly indicate the party or parties responsible for the implementation and performance of the compensatory mitigation project, and, if required, its long-term management.

(i) Where certain functions and services of waters of the United States are permanently adversely affected by a regulated activity, such as discharges of dredged or fill

material into waters of the United States that will convert a forested or scrub-shrub wetland to a herbaceous wetland in a permanently maintained utility line right-of-way, mitigation may be required to reduce the adverse environmental effects of the activity to the no more than minimal level.

24. Safety of Impoundment Structures. To ensure that all impoundment structures are safely designed, the district engineer may require non-Federal applicants to demonstrate that the structures comply with established state dam safety criteria or have been designed by qualified persons. The district engineer may also require documentation that the design has been independently reviewed by similarly qualified persons, and appropriate modifications made to ensure safety.

25. Water Quality. Where States and authorized Tribes, or EPA where applicable, have not previously certified compliance of an NWP with CWA section 401, individual 401 Water Quality Certification must be obtained or waived (see 33 CFR 330.4(c)). The district engineer or State or Tribe may require additional water quality management measures to ensure that the authorized activity does not result in more than minimal degradation of water quality.

26. Coastal Zone Management. In coastal states where an NWP has not previously received a state coastal zone management consistency concurrence, an individual state coastal zone management consistency concurrence must be obtained, or a presumption of concurrence must occur (see 33 CFR 330.4(d)). The district engineer or a State may require additional measures to ensure that the authorized activity is consistent with state coastal zone management requirements.

27. Regional and Case-By-Case Conditions. The activity must comply with any regional conditions that may have been added by the Division Engineer (see 33 CFR 330.4(e)) and with any case specific conditions added by the Corps or by the state, Indian Tribe, or U.S. EPA in its section 401 Water Quality Certification, or by the state in its Coastal Zone Management Act consistency determination.

28. Use of Multiple Nationwide Permits. The use of more than one NWP for a single and complete project is prohibited, except when the acreage loss of waters of the United States authorized by the NWPs does not exceed the acreage limit of the NWP with the highest specified acreage limit. For example, if a road crossing over tidal waters is constructed under NWP 14, with associated bank stabilization authorized by NWP 13, the maximum acreage loss of waters of the United States for the total project cannot exceed 1/3-acre.

29. Transfer of Nationwide Permit Verifications. If the permittee sells the property associated with a nationwide permit verification, the permittee may transfer the nationwide permit verification to the new owner by submitting a letter to the appropriate Corps district office to validate the transfer. A copy of the nationwide permit verification must be attached to the letter, and the letter must contain the following statement and signature:  
“When the structures or work authorized by this nationwide permit are still in existence at the time the property is transferred, the terms and conditions of this nationwide permit, including any special conditions, will continue to be binding on the new owner(s) of the property. To

validate the transfer of this nationwide permit and the associated liabilities associated with compliance with its terms and conditions, have the transferee sign and date below.”

\_\_\_\_\_  
(Transferee)

\_\_\_\_\_  
(Date)

30. Compliance Certification. Each permittee who receives an NWP verification letter from the Corps must provide a signed certification documenting completion of the authorized activity and implementation of any required compensatory mitigation. The success of any required permittee-responsible mitigation, including the achievement of ecological performance standards, will be addressed separately by the district engineer. The Corps will provide the permittee the certification document with the NWP verification letter. The certification document will include:

(a) A statement that the authorized activity was done in accordance with the NWP authorization, including any general, regional, or activity-specific conditions;

(b) A statement that the implementation of any required compensatory mitigation was completed in accordance with the permit conditions. If credits from a mitigation bank or in-lieu fee program are used to satisfy the compensatory mitigation requirements, the certification must include the documentation required by 33 CFR 332.3(l)(3) to confirm that the permittee secured the appropriate number and resource type of credits; and

(c) The signature of the permittee certifying the completion of the activity and mitigation.

The completed certification document must be submitted to the district engineer within 30 days of completion of the authorized activity or the implementation of any required compensatory mitigation, whichever occurs later.

31. Activities Affecting Structures or Works Built by the United States. If an NWP activity also requires permission from the Corps pursuant to 33 U.S.C. 408 because it will alter or temporarily or permanently occupy or use a U.S. Army Corps of Engineers (USACE) federally authorized Civil Works project (a “USACE project”), the prospective permittee must submit a pre-construction notification. See paragraph (b)(10) of general condition 32. An activity that requires section 408 permission is not authorized by NWP until the appropriate Corps office issues the section 408 permission to alter, occupy, or use the USACE project, and the district engineer issues a written NWP verification.

32. Pre-Construction Notification. (a) Timing. Where required by the terms of the NWP, the prospective permittee must notify the district engineer by submitting a pre-construction notification (PCN) as early as possible. The district engineer must determine if the PCN is complete within 30 calendar days of the date of receipt and, if the PCN is determined to be incomplete, notify the prospective permittee within that 30 day period to request the additional information necessary to make the PCN complete. The request must specify the information needed to make the PCN complete. As a general rule, district engineers will request additional information necessary to make the PCN complete only once. However, if the

prospective permittee does not provide all of the requested information, then the district engineer will notify the prospective permittee that the PCN is still incomplete and the PCN review process will not commence until all of the requested information has been received by the district engineer. The prospective permittee shall not begin the activity until either:

(1) He or she is notified in writing by the district engineer that the activity may proceed under the NWP with any special conditions imposed by the district or division engineer; or

(2) 45 calendar days have passed from the district engineer's receipt of the complete PCN and the prospective permittee has not received written notice from the district or division engineer. However, if the permittee was required to notify the Corps pursuant to general condition 18 that listed species or critical habitat might be affected or are in the vicinity of the activity, or to notify the Corps pursuant to general condition 20 that the activity might have the potential to cause effects to historic properties, the permittee cannot begin the activity until receiving written notification from the Corps that there is "no effect" on listed species or "no potential to cause effects" on historic properties, or that any consultation required under Section 7 of the Endangered Species Act (see 33 CFR 330.4(f)) and/or section 106 of the National Historic Preservation Act (see 33 CFR 330.4(g)) has been completed. Also, work cannot begin under NWPs 21, 49, or 50 until the permittee has received written approval from the Corps. If the proposed activity requires a written waiver to exceed specified limits of an NWP, the permittee may not begin the activity until the district engineer issues the waiver. If the district or division engineer notifies the permittee in writing that an individual permit is required within 45 calendar days of receipt of a complete PCN, the permittee cannot begin the activity until an individual permit has been obtained. Subsequently, the permittee's right to proceed under the NWP may be modified, suspended, or revoked only in accordance with the procedure set forth in 33 CFR 330.5(d)(2).

(b) Contents of Pre-Construction Notification: The PCN must be in writing and include the following information:

(1) Name, address and telephone numbers of the prospective permittee;

(2) Location of the proposed activity;

(3) Identify the specific NWP or NWP(s) the prospective permittee wants to use to authorize the proposed activity;

(4) A description of the proposed activity; the activity's purpose; direct and indirect adverse environmental effects the activity would cause, including the anticipated amount of loss of wetlands, other special aquatic sites, and other waters expected to result from the NWP activity, in acres, linear feet, or other appropriate unit of measure; a description of any proposed mitigation measures intended to reduce the adverse environmental effects caused by the proposed activity; and any other NWP(s), regional general permit(s), or individual permit(s) used or intended to be used to authorize any part of the proposed project or any related activity, including other separate and distant crossings for linear projects that require Department of the Army authorization but do not require pre-construction notification. The description of the proposed activity and any proposed mitigation measures should be sufficiently detailed to allow the district engineer to determine that the adverse environmental effects of the activity will be no more than minimal and to determine the need for compensatory mitigation or other mitigation measures. For single and complete linear projects, the PCN must include the quantity of anticipated losses of wetlands, other special aquatic sites, and other waters for each single and complete crossing of those wetlands, other special aquatic sites, and other waters.

Sketches should be provided when necessary to show that the activity complies with the terms of the NWP. (Sketches usually clarify the activity and when provided results in a quicker decision. Sketches should contain sufficient detail to provide an illustrative description of the proposed activity (e.g., a conceptual plan), but do not need to be detailed engineering plans);

(5) The PCN must include a delineation of wetlands, other special aquatic sites, and other waters, such as lakes and ponds, and perennial, intermittent, and ephemeral streams, on the project site. Wetland delineations must be prepared in accordance with the current method required by the Corps. The permittee may ask the Corps to delineate the special aquatic sites and other waters on the project site, but there may be a delay if the Corps does the delineation, especially if the project site is large or contains many wetlands, other special aquatic sites, and other waters. Furthermore, the 45 day period will not start until the delineation has been submitted to or completed by the Corps, as appropriate;

(6) If the proposed activity will result in the loss of greater than 1/10-acre of wetlands and a PCN is required, the prospective permittee must submit a statement describing how the mitigation requirement will be satisfied, or explaining why the adverse environmental effects are no more than minimal and why compensatory mitigation should not be required. As an alternative, the prospective permittee may submit a conceptual or detailed mitigation plan.

(7) For non-Federal permittees, if any listed species or designated critical habitat might be affected or is in the vicinity of the activity, or if the activity is located in designated critical habitat, the PCN must include the name(s) of those endangered or threatened species that might be affected by the proposed activity or utilize the designated critical habitat that might be affected by the proposed activity. For NWP activities that require pre-construction notification, Federal permittees must provide documentation demonstrating compliance with the Endangered Species Act;

(8) For non-Federal permittees, if the NWP activity might have the potential to cause effects to a historic property listed on, determined to be eligible for listing on, or potentially eligible for listing on, the National Register of Historic Places, the PCN must state which historic property might have the potential to be affected by the proposed activity or include a vicinity map indicating the location of the historic property. For NWP activities that require pre-construction notification, Federal permittees must provide documentation demonstrating compliance with section 106 of the National Historic Preservation Act;

(9) For an activity that will occur in a component of the National Wild and Scenic River System, or in a river officially designated by Congress as a “study river” for possible inclusion in the system while the river is in an official study status, the PCN must identify the Wild and Scenic River or the “study river” (see general condition 16); and

(10) For an activity that requires permission from the Corps pursuant to 33 U.S.C. 408 because it will alter or temporarily or permanently occupy or use a U.S. Army Corps of Engineers federally authorized civil works project, the pre-construction notification must include a statement confirming that the project proponent has submitted a written request for section 408 permission from the Corps office having jurisdiction over that USACE project.

(c) Form of Pre-Construction Notification: The standard individual permit application form (Form ENG 4345) may be used, but the completed application form must clearly indicate that it is an NWP PCN and must include all of the applicable information required in paragraphs (b)(1) through (10) of this general condition. A letter containing the required information may also be used. Applicants may provide electronic files of PCNs and

supporting materials if the district engineer has established tools and procedures for electronic submittals.

(d) Agency Coordination: (1) The district engineer will consider any comments from Federal and state agencies concerning the proposed activity's compliance with the terms and conditions of the NWPs and the need for mitigation to reduce the activity's adverse environmental effects so that they are no more than minimal.

(2) Agency coordination is required for: (i) all NWP activities that require pre-construction notification and result in the loss of greater than 1/2-acre of waters of the United States; (ii) NWP 21, 29, 39, 40, 42, 43, 44, 50, 51, and 52 activities that require pre-construction notification and will result in the loss of greater than 300 linear feet of stream bed; (iii) NWP 13 activities in excess of 500 linear feet, fills greater than one cubic yard per running foot, or involve discharges of dredged or fill material into special aquatic sites; and (iv) NWP 54 activities in excess of 500 linear feet, or that extend into the waterbody more than 30 feet from the mean low water line in tidal waters or the ordinary high water mark in the Great Lakes.

(3) When agency coordination is required, the district engineer will immediately provide (e.g., via e-mail, facsimile transmission, overnight mail, or other expeditious manner) a copy of the complete PCN to the appropriate Federal or state offices (FWS, state natural resource or water quality agency, EPA, and, if appropriate, the NMFS). With the exception of NWP 37, these agencies will have 10 calendar days from the date the material is transmitted to notify the district engineer via telephone, facsimile transmission, or e-mail that they intend to provide substantive, site-specific comments. The comments must explain why the agency believes the adverse environmental effects will be more than minimal. If so contacted by an agency, the district engineer will wait an additional 15 calendar days before making a decision on the pre-construction notification. The district engineer will fully consider agency comments received within the specified time frame concerning the proposed activity's compliance with the terms and conditions of the NWPs, including the need for mitigation to ensure the net adverse environmental effects of the proposed activity are no more than minimal. The district engineer will provide no response to the resource agency, except as provided below. The district engineer will indicate in the administrative record associated with each pre-construction notification that the resource agencies' concerns were considered. For NWP 37, the emergency watershed protection and rehabilitation activity may proceed immediately in cases where there is an unacceptable hazard to life or a significant loss of property or economic hardship will occur. The district engineer will consider any comments received to decide whether the NWP 37 authorization should be modified, suspended, or revoked in accordance with the procedures at 33 CFR 330.5.

(4) In cases of where the prospective permittee is not a Federal agency, the district engineer will provide a response to NMFS within 30 calendar days of receipt of any Essential Fish Habitat conservation recommendations, as required by section 305(b)(4)(B) of the Magnuson-Stevens Fishery Conservation and Management Act.

(5) Applicants are encouraged to provide the Corps with either electronic files or multiple copies of pre-construction notifications to expedite agency coordination.

### **DISTRICT ENGINEER'S DECISION**

1. In reviewing the PCN for the proposed activity, the district engineer will determine whether the activity authorized by the NWP will result in more than minimal

individual or cumulative adverse environmental effects or may be contrary to the public interest. If a project proponent requests authorization by a specific NWP, the district engineer should issue the NWP verification for that activity if it meets the terms and conditions of that NWP, unless he or she determines, after considering mitigation, that the proposed activity will result in more than minimal individual and cumulative adverse effects on the aquatic environment and other aspects of the public interest and exercises discretionary authority to require an individual permit for the proposed activity. For a linear project, this determination will include an evaluation of the individual crossings of waters of the United States to determine whether they individually satisfy the terms and conditions of the NWP(s), as well as the cumulative effects caused by all of the crossings authorized by NWP. If an applicant requests a waiver of the 300 linear foot limit on impacts to streams or of an otherwise applicable limit, as provided for in NWPs 13, 21, 29, 36, 39, 40, 42, 43, 44, 50, 51, 52, or 54, the district engineer will only grant the waiver upon a written determination that the NWP activity will result in only minimal individual and cumulative adverse environmental effects. For those NWPs that have a waivable 300 linear foot limit for losses of intermittent and ephemeral stream bed and a 1/2-acre limit (i.e., NWPs 21, 29, 39, 40, 42, 43, 44, 50, 51, and 52), the loss of intermittent and ephemeral stream bed, plus any other losses of jurisdictional waters and wetlands, cannot exceed 1/2-acre.

2. When making minimal adverse environmental effects determinations the district engineer will consider the direct and indirect effects caused by the NWP activity. He or she will also consider the cumulative adverse environmental effects caused by activities authorized by NWP and whether those cumulative adverse environmental effects are no more than minimal. The district engineer will also consider site specific factors, such as the environmental setting in the vicinity of the NWP activity, the type of resource that will be affected by the NWP activity, the functions provided by the aquatic resources that will be affected by the NWP activity, the degree or magnitude to which the aquatic resources perform those functions, the extent that aquatic resource functions will be lost as a result of the NWP activity (e.g., partial or complete loss), the duration of the adverse effects (temporary or permanent), the importance of the aquatic resource functions to the region (e.g., watershed or ecoregion), and mitigation required by the district engineer. If an appropriate functional or condition assessment method is available and practicable to use, that assessment method may be used by the district engineer to assist in the minimal adverse environmental effects determination. The district engineer may add case-specific special conditions to the NWP authorization to address site-specific environmental concerns.

3. If the proposed activity requires a PCN and will result in a loss of greater than 1/10-acre of wetlands, the prospective permittee should submit a mitigation proposal with the PCN. Applicants may also propose compensatory mitigation for NWP activities with smaller impacts, or for impacts to other types of waters (e.g., streams). The district engineer will consider any proposed compensatory mitigation or other mitigation measures the applicant has included in the proposal in determining whether the net adverse environmental effects of the proposed activity are no more than minimal. The compensatory mitigation proposal may be either conceptual or detailed. If the district engineer determines that the activity complies with the terms and conditions of the NWP and that the adverse environmental effects are no more than minimal, after considering mitigation, the district engineer will notify the permittee and



include any activity-specific conditions in the NWP verification the district engineer deems necessary. Conditions for compensatory mitigation requirements must comply with the appropriate provisions at 33 CFR 332.3(k). The district engineer must approve the final mitigation plan before the permittee commences work in waters of the United States, unless the district engineer determines that prior approval of the final mitigation plan is not practicable or not necessary to ensure timely completion of the required compensatory mitigation. If the prospective permittee elects to submit a compensatory mitigation plan with the PCN, the district engineer will expeditiously review the proposed compensatory mitigation plan. The district engineer must review the proposed compensatory mitigation plan within 45 calendar days of receiving a complete PCN and determine whether the proposed mitigation would ensure the NWP activity results in no more than minimal adverse environmental effects. If the net adverse environmental effects of the NWP activity (after consideration of the mitigation proposal) are determined by the district engineer to be no more than minimal, the district engineer will provide a timely written response to the applicant. The response will state that the NWP activity can proceed under the terms and conditions of the NWP, including any activity-specific conditions added to the NWP authorization by the district engineer.

4. If the district engineer determines that the adverse environmental effects of the proposed activity are more than minimal, then the district engineer will notify the applicant either: (a) that the activity does not qualify for authorization under the NWP and instruct the applicant on the procedures to seek authorization under an individual permit; (b) that the activity is authorized under the NWP subject to the applicant's submission of a mitigation plan that would reduce the adverse environmental effects so that they are no more than minimal; or (c) that the activity is authorized under the NWP with specific modifications or conditions. Where the district engineer determines that mitigation is required to ensure no more than minimal adverse environmental effects, the activity will be authorized within the 45-day PCN period (unless additional time is required to comply with general conditions 18, 20, and/or 31, or to evaluate PCNs for activities authorized by NWPs 21, 49, and 50), with activity-specific conditions that state the mitigation requirements. The authorization will include the necessary conceptual or detailed mitigation plan or a requirement that the applicant submit a mitigation plan that would reduce the adverse environmental effects so that they are no more than minimal. When compensatory mitigation is required, no work in waters of the United States may occur until the district engineer has approved a specific mitigation plan or has determined that prior approval of a final mitigation plan is not practicable or not necessary to ensure timely completion of the required compensatory mitigation.

### **FURTHER INFORMATION**

1. District Engineers have authority to determine if an activity complies with the terms and conditions of an NWP.
2. NWPs do not obviate the need to obtain other federal, state, or local permits, approvals, or authorizations required by law.
3. NWPs do not grant any property rights or exclusive privileges.
4. NWPs do not authorize any injury to the property or rights of others.
5. NWPs do not authorize interference with any existing or proposed Federal project (see general condition 31).

## DEFINITIONS

Best management practices (BMPs): Policies, practices, procedures, or structures implemented to mitigate the adverse environmental effects on surface water quality resulting from development. BMPs are categorized as structural or non-structural.

Compensatory mitigation: The restoration (re-establishment or rehabilitation), establishment (creation), enhancement, and/or in certain circumstances preservation of aquatic resources for the purposes of offsetting unavoidable adverse impacts which remain after all appropriate and practicable avoidance and minimization has been achieved.

Currently serviceable: Useable as is or with some maintenance, but not so degraded as to essentially require reconstruction.

Direct effects: Effects that are caused by the activity and occur at the same time and place.

Discharge: The term “discharge” means any discharge of dredged or fill material into waters of the United States.

Ecological reference: A model used to plan and design an aquatic habitat and riparian area restoration, enhancement, or establishment activity under NWP 27. An ecological reference may be based on the structure, functions, and dynamics of an aquatic habitat type or a riparian area type that currently exists in the region where the proposed NWP 27 activity is located. Alternatively, an ecological reference may be based on a conceptual model for the aquatic habitat type or riparian area type to be restored, enhanced, or established as a result of the proposed NWP 27 activity. An ecological reference takes into account the range of variation of the aquatic habitat type or riparian area type in the region.

Enhancement: The manipulation of the physical, chemical, or biological characteristics of an aquatic resource to heighten, intensify, or improve a specific aquatic resource function(s). Enhancement results in the gain of selected aquatic resource function(s), but may also lead to a decline in other aquatic resource function(s). Enhancement does not result in a gain in aquatic resource area.

Ephemeral stream: An ephemeral stream has flowing water only during, and for a short duration after, precipitation events in a typical year. Ephemeral stream beds are located above the water table year-round. Groundwater is not a source of water for the stream. Runoff from rainfall is the primary source of water for stream flow.

Establishment (creation): The manipulation of the physical, chemical, or biological characteristics present to develop an aquatic resource that did not previously exist at an upland site. Establishment results in a gain in aquatic resource area.

High Tide Line: The line of intersection of the land with the water’s surface at the maximum height reached by a rising tide. The high tide line may be determined, in the absence of actual data, by a line of oil or scum along shore objects, a more or less continuous deposit of fine shell or debris on the foreshore or berm, other physical markings or characteristics, vegetation lines, tidal gages, or other suitable means that delineate the general height reached by a rising tide. The line encompasses spring high tides and other high tides that occur with periodic frequency but does not include storm surges in which there is a departure from the normal or predicted reach of the tide due to the piling up of water against a coast by strong winds such as those accompanying a hurricane or other intense storm.

Historic Property: Any prehistoric or historic district, site (including archaeological site), building, structure, or other object included in, or eligible for inclusion in, the National

Register of Historic Places maintained by the Secretary of the Interior. This term includes artifacts, records, and remains that are related to and located within such properties. The term includes properties of traditional religious and cultural importance to an Indian tribe or Native Hawaiian organization and that meet the National Register criteria (36 CFR part 60).

Independent utility: A test to determine what constitutes a single and complete non-linear project in the Corps Regulatory Program. A project is considered to have independent utility if it would be constructed absent the construction of other projects in the project area. Portions of a multi-phase project that depend upon other phases of the project do not have independent utility. Phases of a project that would be constructed even if the other phases were not built can be considered as separate single and complete projects with independent utility.

Indirect effects: Effects that are caused by the activity and are later in time or farther removed in distance, but are still reasonably foreseeable.

Intermittent stream: An intermittent stream has flowing water during certain times of the year, when groundwater provides water for stream flow. During dry periods, intermittent streams may not have flowing water. Runoff from rainfall is a supplemental source of water for stream flow.

Loss of waters of the United States: Waters of the United States that are permanently adversely affected by filling, flooding, excavation, or drainage because of the regulated activity. Permanent adverse effects include permanent discharges of dredged or fill material that change an aquatic area to dry land, increase the bottom elevation of a waterbody, or change the use of a waterbody. The acreage of loss of waters of the United States is a threshold measurement of the impact to jurisdictional waters for determining whether a project may qualify for an NWP; it is not a net threshold that is calculated after considering compensatory mitigation that may be used to offset losses of aquatic functions and services. The loss of stream bed includes the acres or linear feet of stream bed that are filled or excavated as a result of the regulated activity. Waters of the United States temporarily filled, flooded, excavated, or drained, but restored to pre-construction contours and elevations after construction, are not included in the measurement of loss of waters of the United States. Impacts resulting from activities that do not require Department of the Army authorization, such as activities eligible for exemptions under section 404(f) of the Clean Water Act, are not considered when calculating the loss of waters of the United States.

Navigable waters: Waters subject to section 10 of the Rivers and Harbors Act of 1899. These waters are defined at 33 CFR part 329.

Non-tidal wetland: A non-tidal wetland is a wetland that is not subject to the ebb and flow of tidal waters. Non-tidal wetlands contiguous to tidal waters are located landward of the high tide line (i.e., spring high tide line).

Open water: For purposes of the NWPs, an open water is any area that in a year with normal patterns of precipitation has water flowing or standing above ground to the extent that an ordinary high water mark can be determined. Aquatic vegetation within the area of flowing or standing water is either non-emergent, sparse, or absent. Vegetated shallows are considered to be open waters. Examples of "open waters" include rivers, streams, lakes, and ponds.

Ordinary High Water Mark: An ordinary high water mark is a line on the shore established by the fluctuations of water and indicated by physical characteristics, or by other appropriate means that consider the characteristics of the surrounding areas.

Perennial stream: A perennial stream has flowing water year-round during a typical year. The water table is located above the stream bed for most of the year. Groundwater is the

primary source of water for stream flow. Runoff from rainfall is a supplemental source of water for stream flow.

Practicable: Available and capable of being done after taking into consideration cost, existing technology, and logistics in light of overall project purposes.

Pre-construction notification: A request submitted by the project proponent to the Corps for confirmation that a particular activity is authorized by nationwide permit. The request may be a permit application, letter, or similar document that includes information about the proposed work and its anticipated environmental effects. Pre-construction notification may be required by the terms and conditions of a nationwide permit, or by regional conditions. A pre-construction notification may be voluntarily submitted in cases where pre-construction notification is not required and the project proponent wants confirmation that the activity is authorized by nationwide permit.

Preservation: The removal of a threat to, or preventing the decline of, aquatic resources by an action in or near those aquatic resources. This term includes activities commonly associated with the protection and maintenance of aquatic resources through the implementation of appropriate legal and physical mechanisms. Preservation does not result in a gain of aquatic resource area or functions.

Protected tribal resources: Those natural resources and properties of traditional or customary religious or cultural importance, either on or off Indian lands, retained by, or reserved by or for, Indian tribes through treaties, statutes, judicial decisions, or executive orders, including tribal trust resources.

Re-establishment: The manipulation of the physical, chemical, or biological characteristics of a site with the goal of returning natural/historic functions to a former aquatic resource. Re-establishment results in rebuilding a former aquatic resource and results in a gain in aquatic resource area and functions.

Rehabilitation: The manipulation of the physical, chemical, or biological characteristics of a site with the goal of repairing natural/historic functions to a degraded aquatic resource. Rehabilitation results in a gain in aquatic resource function, but does not result in a gain in aquatic resource area.

Restoration: The manipulation of the physical, chemical, or biological characteristics of a site with the goal of returning natural/historic functions to a former or degraded aquatic resource. For the purpose of tracking net gains in aquatic resource area, restoration is divided into two categories: re-establishment and rehabilitation.

Riffle and pool complex: Riffle and pool complexes are special aquatic sites under the 404(b)(1) Guidelines. Riffle and pool complexes sometimes characterize steep gradient sections of streams. Such stream sections are recognizable by their hydraulic characteristics. The rapid movement of water over a coarse substrate in riffles results in a rough flow, a turbulent surface, and high dissolved oxygen levels in the water. Pools are deeper areas associated with riffles. A slower stream velocity, a streaming flow, a smooth surface, and a finer substrate characterize pools.

Riparian areas: Riparian areas are lands next to streams, lakes, and estuarine- marine shorelines. Riparian areas are transitional between terrestrial and aquatic ecosystems, through which surface and subsurface hydrology connects riverine, lacustrine, estuarine, and marine waters with their adjacent wetlands, non-wetland waters, or uplands. Riparian areas provide a variety of ecological functions and services and help improve or maintain local water quality. (See general condition 23.)

Shellfish seeding: The placement of shellfish seed and/or suitable substrate to increase shellfish production. Shellfish seed consists of immature individual shellfish or individual shellfish attached to shells or shell fragments (i.e., spat on shell). Suitable substrate may consist of shellfish shells, shell fragments, or other appropriate materials placed into waters for shellfish habitat.

Single and complete linear project: A linear project is a project constructed for the purpose of getting people, goods, or services from a point of origin to a terminal point, which often involves multiple crossings of one or more waterbodies at separate and distant locations. The term “single and complete project” is defined as that portion of the total linear project proposed or accomplished by one owner/developer or partnership or other association of owners/developers that includes all crossings of a single water of the United States (i.e., a single waterbody) at a specific location. For linear projects crossing a single or multiple waterbodies several times at separate and distant locations, each crossing is considered a single and complete project for purposes of NWP authorization. However, individual channels in a braided stream or river, or individual arms of a large, irregularly shaped wetland or lake, etc., are not separate waterbodies, and crossings of such features cannot be considered separately.

Single and complete non-linear project: For non-linear projects, the term “single and complete project” is defined at 33 CFR 330.2(i) as the total project proposed or accomplished by one owner/developer or partnership or other association of owners/developers. A single and complete non-linear project must have independent utility (see definition of “independent utility”). Single and complete non-linear projects may not be “piecemealed” to avoid the limits in an NWP authorization.

Stormwater management: Stormwater management is the mechanism for controlling stormwater runoff for the purposes of reducing downstream erosion, water quality degradation, and flooding and mitigating the adverse effects of changes in land use on the aquatic environment.

Stormwater management facilities: Stormwater management facilities are those facilities, including but not limited to, stormwater retention and detention ponds and best management practices, which retain water for a period of time to control runoff and/or improve the quality (i.e., by reducing the concentration of nutrients, sediments, hazardous substances and other pollutants) of stormwater runoff.

Stream bed: The substrate of the stream channel between the ordinary high water marks. The substrate may be bedrock or inorganic particles that range in size from clay to boulders. Wetlands contiguous to the stream bed, but outside of the ordinary high water marks, are not considered part of the stream bed.

Stream channelization: The manipulation of a stream’s course, condition, capacity, or location that causes more than minimal interruption of normal stream processes. A channelized stream remains a water of the United States.

Structure: An object that is arranged in a definite pattern of organization. Examples of structures include, without limitation, any pier, boat dock, boat ramp, wharf, dolphin, weir, boom, breakwater, bulkhead, revetment, riprap, jetty, artificial island, artificial reef, permanent mooring structure, power transmission line, permanently moored floating vessel, piling, aid to navigation, or any other manmade obstacle or obstruction.

Tidal wetland: A tidal wetland is a jurisdictional wetland that is inundated by tidal waters. Tidal waters rise and fall in a predictable and measurable rhythm or cycle due to the gravitational pulls of the moon and sun. Tidal waters end where the rise and fall of the water

surface can no longer be practically measured in a predictable rhythm due to masking by other waters, wind, or other effects. Tidal wetlands are located channelward of the high tide line.

Tribal lands: Any lands title to which is either: 1) held in trust by the United States for the benefit of any Indian tribe or individual; or 2) held by any Indian tribe or individual subject to restrictions by the United States against alienation.

Tribal rights: Those rights legally accruing to a tribe or tribes by virtue of inherent sovereign authority, unextinguished aboriginal title, treaty, statute, judicial decisions, executive order or agreement, and that give rise to legally enforceable remedies.

Vegetated shallows: Vegetated shallows are special aquatic sites under the 404(b)(1) Guidelines. They are areas that are permanently inundated and under normal circumstances have rooted aquatic vegetation, such as seagrasses in marine and estuarine systems and a variety of vascular rooted plants in freshwater systems.

Waterbody: For purposes of the NWPs, a waterbody is a jurisdictional water of the United States. If a wetland is adjacent to a waterbody determined to be a water of the United States, that waterbody and any adjacent wetlands are considered together as a single aquatic unit (see 33 CFR 328.4(c)(2)). Examples of “waterbodies” include streams, rivers, lakes, ponds, and wetlands.

## **FINAL REGIONAL CONDITIONS 2017**

### *NOTICE ABOUT WEB LINKS IN THIS DOCUMENT:*

*The web links (both internal to our Wilmington District and any external links to collaborating agencies) in this document are valid at the time of publication. However, the Wilmington District Regulatory Program web page addresses, as with other agency web sites, may change over the timeframe of the five-year Nationwide Permit renewal cycle, in response to policy mandates or technology advances. While we will make every effort to check on the integrity of our web links and provide re-direct pages whenever possible, we ask that you report any broken links to us so we can keep the page information current and usable. We apologize in advanced for any broken links that you may encounter, and we ask that you navigate from the Regulatory home page (Regulatory Permit Program Wetlands and Streams) of the Wilmington District Corps of Engineers, to the “Permits” section of our web site to find links for pages that cannot be found by clicking directly on the listed web link in this document.*

### **Final 2017 Regional Conditions for Nationwide Permits (NWP) in the Wilmington District**

#### **1.0 Excluded Waters**

The Corps has identified waters that will be excluded from the use of all NWP’s during certain timeframes. These waters are:

##### **1.1 Anadromous Fish Spawning Areas**

Waters of the United States identified by either the North Carolina Division of Marine Fisheries (NCDMF) or the North Carolina Wildlife Resources Commission (NCWRC) as anadromous fish spawning areas are excluded during the period between February 15 and June 30, without prior written approval from the Corps and either NCDMF or NCWRC.

##### **1.2 Trout Waters Moratorium**

Waters of the United States in the designated trout watersheds of North Carolina are excluded during the period between October 15 and April 15 without prior written approval from the NCWRC, or from the Eastern Band of Cherokee Indians (EBCI) Fisheries and Wildlife Management (FWM) office if the project is located on EBCI trust land. (See Section 2.7 for information on the designated trout watersheds).

##### **1.3 Sturgeon Spawning Areas as Designated by the National Marine Fisheries Service (NMFS)**

Waters of the United States designated as sturgeon spawning areas are excluded during the period between February 1 and June 30, without prior written approval from the NMFS.

## **2.0 Waters Requiring Additional Notification**

The Corps has identified waters that will be subject to additional notification requirements for activities authorized by all NWPs. These waters are:

### **2.1 Western NC Counties that Drain to Designated Critical Habitat**

For proposed activities within waters of the United States that require a Pre-Construction Notification (PCN) and are located in the sixteen counties listed below, permittees must provide a copy of the PCN to the U.S. Fish and Wildlife Service (USFWS), 160 Zillicoa Street, Asheville, North Carolina 28801. This PCN must be sent concurrently to the U.S. Fish and Wildlife Service and the Corps Asheville Regulatory Field Office. Please see General Condition 18 for specific notification requirements related to the Endangered Species Act and the below website for information on the location of designated critical habitat.

Counties with tributaries that drain to designated critical habitat that require notification to the Asheville U.S. Fish and Wildlife Service: Avery, Cherokee, Forsyth, Graham, Haywood, Henderson, Jackson, Macon, Mecklenburg, Mitchell, Stokes, Surry, Swain, Transylvania, Union and Yancey.

Website and office addresses for Endangered Species Act Information:

The Wilmington District has developed the following website for permittees which provides guidelines on how to review linked websites and maps in order to fulfill NWP General Condition 18 requirements:

<http://www.saw.usace.army.mil/Missions/RegulatoryPermitProgram/AgencyCoordination/ESA.asp>

Permittees who do not have internet access may contact the appropriate U.S. Fish and Wildlife Service offices listed below or Corps at (910) 251-4633:

Asheville U.S. Fish and Wildlife Service Office counties: All counties west of and including Anson, Stanly, Davidson, Forsythe and Stokes Counties.

U.S. Fish and Wildlife Service  
Asheville Field Office  
160 Zillicoa Street  
Asheville, NC 28801  
Telephone: (828) 258-3939

Raleigh U.S. Fish and Wildlife Service Office counties: all counties east of and including Richmond, Montgomery, Randolph, Guilford, and Rockingham Counties.

U.S. Fish and Wildlife Service  
Raleigh Field Office  
Post Office Box 33726



Raleigh, NC 27636-3726  
Telephone: (919) 856-4520

## **2.2 Special Designation Waters**

Prior to the use of any NWP, except NWP 3, that involves a discharge of dredged or fill material in any of the following identified waters and/or adjacent wetlands in North Carolina, permittees shall submit a PCN to the District Engineer prior to commencing the activity (see General Condition 32). The North Carolina waters and wetlands that require additional notification requirements are:

“Outstanding Resource Waters” (ORW) or “High Quality Waters” (HQW) as designated by the North Carolina Environmental Management Commission; “Primary Nursery Areas” (PNA), including inland PNA, as designated by the North Carolina Marine Fisheries Commission and the NCWRC; or wetlands adjacent to these waters. Definitions of ORW, HQW and PNA waters can be found in the North Carolina State Administrative Code, Title 15A, Subchapters 2B and 10C (15A NCAC 02B, 15A NCAC 10C) and at the following World Wide Web page: <http://reports.oah.state.nc.us/ncac.asp?folderName=\Title%2015A%20-%20Environmental%20Quality&lookupError=15A%20NCAC%20000%20>. Surface water classifications for waters in North Carolina can be viewed at the North Carolina Division of Water Resources website or at the following World Wide Web Page: <https://deq.nc.gov/about/divisions/water-resources/planning/classification-standards/classifications>

Permittees who do not have internet access may contact the Corps at (910) 251- 4633.

## **2.3 Coastal Area Management Act (CAMA) Areas of Environmental Concern**

Non-federal permittees for any NWP in a designated “Area of Environmental Concern” (AEC) in the twenty (20) counties of Eastern North Carolina covered by the North Carolina Coastal Area Management Act (CAMA) must also obtain the required CAMA permit. Development activities for non-federal projects may not commence until a copy of the approved CAMA permit is furnished to the appropriate Wilmington District Regulatory Field Office (Wilmington Field Office – 69 Darlington Avenue, Wilmington, NC 28403, (910) 251-4802 or Washington Field Office – 2407 West 5th Street, Washington, NC 27889, (910) 251-4610).

## **2.4 Barrier Islands**

Prior to the use of any NWP on a barrier island of North Carolina, permittees must submit a PCN to the District Engineer prior to commencing the activity (see General Condition 32).

## **2.5 Mountain or Piedmont Bogs**

Prior to the use of any NWP in a Bog, as classified by the North Carolina Wetland Assessment Methodology (NCWAM), permittees shall submit a PCN to the District Engineer prior to commencing the activity (see General Condition 32). The latest version of NCWAM can be

viewed on the Corps RIBITS (Regulatory In-lieu Fee and Bank Information Tracking System) website or at the following World Wide Web Page:  
[https://ribits.usace.army.mil/ribits\\_apex/f?p=107:27:0::NO::](https://ribits.usace.army.mil/ribits_apex/f?p=107:27:0::NO::)

## 2.6 Animal Waste Facilities

Prior to use of any NWP for construction of animal waste facilities in waters of the United States, including wetlands, permittees shall submit a PCN to the District Engineer prior to commencing the activity (see General Condition 32).

## 2.7 Trout Waters

Prior to any discharge of dredge or fill material into streams, waterbodies or wetlands within the 294 designated trout watersheds of North Carolina, the permittee shall submit a PCN (see General Condition 32) to the District Engineer prior to commencing the activity, unless other thresholds are established in the Regional Conditions in Section 4 (Additional Regional Conditions for Specific Nationwide Permits). The permittee shall also provide a copy of the notification to the appropriate NCWRC office, or to the EBCI FWM Office (if the project is located on EBCI trust land), to facilitate the determination of any potential impacts to designated Trout Waters.

Notification to the Corps will include a statement with the name of the NCWRC or EBCI FWM biologist contacted, the date of the notification, the location of work, a delineation of wetlands and waters, a discussion of alternatives to working in the mountain trout waters, why alternatives were not selected, and, if applicable, a plan to provide compensatory mitigation for all unavoidable adverse impacts to mountain trout waters.

NCWRC and NC Trout Watersheds:

| <b>NCWRC Contact**</b>  | <b>Counties that are entirely within Trout Watersheds*</b>   | <b>Counties that are partially within Trout Watersheds*</b>  |
|---|--|--|
| Mountain Coordinator<br>Balsam Depot<br>20830 Great Smoky<br>Mountain Expressway<br>Waynesville, NC 28786<br>Telephone: (828) 558-6011<br><br>For NCDOT Projects:<br><br>NCDOT Coordinator<br>206 Charter. Street<br>Albemarle, NC 28001<br>Telephone: (704) 982-9181 | Alleghany    Jackson<br>Ashe            Macon<br>Avery            Swain<br>Graham        Transylvania<br>Haywood       Watauga | Burke            McDowell<br>Buncombe      Mitchell<br>Caldwell        Polk<br>Cherokee       Rutherford<br>Clay             Surry<br>Henderson     Wilkes<br>Madison         Yancey |

\*NOTE: To determine notification requirements, contact the Corps Asheville Regulatory Field Office at (828) 271-7980 or view maps for each County at the following World Wide Web page: <http://www.saw.usace.army.mil/Missions/Regulatory-Permit-Program/Agency-Coordination/Trout/>.

\*\*If a project is located on EBCI trust land, submit the PCN in accordance with Section 3.14. Contact the Corps Asheville Regulatory Field Office at (828) 271-7980 with questions.

## **2.8 Western NC Waters and Corridors**

The permittee shall submit a PCN (see General Condition 32) to the District Engineer prior to commencing the activity in waters of the United States if the activity will occur within any of the following identified waters in western North Carolina, within 0.5 mile on either side of these waters, or within 0.75 mile of the Little Tennessee River, as measured from the top of the bank of the respective water (i.e., river, stream, or creek):

Brasstown Creek  
Burningtown Creek  
Cane River  
Caney Fork  
Cartoogechaye Creek  
Chattooga River  
Cheoah River  
Cowee Creek  
Cullasaja River  
Deep Creek  
Ellijay Creek  
French Broad River  
Garden Creek  
Hiwassee River  
Hominy Creek  
Iotla Creek  
Little Tennessee River (within the river or within 0.75 mile on either side of this river)  
Nantahala River  
Nolichucky River  
North Fork French Broad River  
North Toe River  
Nottley River  
Oconaluftee River (portion not located on trust/EBCI land)  
Peachtree Creek  
Shooting Creek  
Snowbird Creek  
South Toe River  
Stecoah Creek  
Swannanoa River  
Sweetwater Creek

Tuckasegee River (also spelled Tuckaseegee or Tuckaseigee)  
Valley River  
Watauga Creek  
Watauga River  
Wayah Creek  
West Fork French Broad River

To determine notification requirements, contact the Corps Asheville Regulatory Field Office at (828) 271-7980 or view maps for all corridors at the following World Wide Web page:  
<http://www.saw.usace.army.mil/Missions/Regulatory-Permit-Program/Agency-Coordination/Designated-Special-Waters.aspx>

### **3.0 List of Corps Regional Conditions for All Nationwide Permits**

The following conditions apply to all Nationwide Permits in the Wilmington District:

#### **3.1 Limitation of Loss of Stream Bed**

NWPs may not be used for activities that may result in the loss or degradation of more than 300 total linear feet of stream bed, unless the District Engineer has waived the 300 linear foot limit for ephemeral and intermittent streams on a case-by-case basis and has determined that the proposed activity will result in minimal individual and cumulative adverse impacts to the aquatic environment. Waivers for the loss of ephemeral and intermittent streams must be in writing and documented by appropriate/accepted stream quality assessments\*. This waiver only applies to the 300 linear feet threshold for NWPs.

This Regional Condition does not apply to NWP 23 (Approved Categorical Exclusions).

\*NOTE: Permittees should utilize the most current methodology prescribed by Wilmington District to assess stream function and quality. Information can be found at:  
[https://ribits.usace.army.mil/ribits\\_apex/f?p=107:27:0::NO::](https://ribits.usace.army.mil/ribits_apex/f?p=107:27:0::NO::)

#### **3.2 Mitigation for Loss of Stream Bed**

For any NWP that results in a loss of more than 150 linear feet of stream, the permittee shall provide a mitigation proposal to compensate for more than minimal individual and cumulative adverse impacts to the aquatic environment. For stream losses of 150 linear feet or less that require a PCN, the District Engineer may determine, on a case-by-case basis, that compensatory mitigation is required to ensure that the activity results in minimal adverse effect on the aquatic environment.

#### **3.3 Pre-construction Notification for Loss of Streambed Exceeding 150 Feet**

Prior to use of any NWP for any activity which impacts more than 150 total linear feet of perennial stream, intermittent or ephemeral stream, the permittee shall submit a PCN to the District Engineer prior to commencing the activity (see General Condition 32). This applies to

NWPs that do not have specific notification requirements. If a NWP has specific notification requirements, the requirements of the NWP should be followed.

### **3.4 Restriction on Use of Live Concrete**

For all NWPs which allow the use of concrete as a building material, live or fresh concrete, including bags of uncured concrete, may not come into contact with the water in or entering into waters of the United States. Water inside coffer dams or casings that has been in contact with wet concrete shall only be returned to waters of the United States after the concrete is set and cured and when it no longer poses a threat to aquatic organisms.

### **3.5 Requirements for Using Riprap for Bank Stabilization**

For all NWPs that allow for the use of riprap material for bank stabilization, the following measures shall be applied:

**3.5.1.** Where bank stabilization is conducted as part of an activity, natural design, bioengineering and/or geoen지니어ing methods that incorporate natural durable materials, native seed mixes, and native plants and shrubs are to be utilized to the maximum extent practicable.

**3.5.2.** Filter cloth must be placed underneath the riprap as an additional requirement of its use in North Carolina waters. The placement of filter fabric is not required if the riprap will be pushed or “keyed” into the bank of the waterbody. A waiver from the specifications in this Regional Condition may be requested in writing. The waiver will only be issued if it can be demonstrated that the impacts of complying with this Regional Condition would result in greater adverse impacts to the aquatic environment.

**3.5.3.** The placement of riprap shall be limited to the areas depicted on submitted work plan drawings.

**3.5.4.** The riprap material shall be clean and free from loose dirt or any pollutant except in trace quantities that would not have an adverse environmental effect.

**3.5.5.** It shall be of a size sufficient to prevent its movement from the authorized alignment by natural forces under normal conditions.

**3.5.6.** The riprap material shall consist of clean rock or masonry material such as, but not limited to, granite, marl, or broken concrete.

### **3.6 Requirements for Culvert Placement**

**3.6.1** For all NWPs that involve the construction/installation of culverts, measures will be included in the construction/installation that will promote the safe passage of fish and other aquatic organisms. The dimension, pattern, and profile of the stream above and below a pipe or culvert should not be modified by altering the width or depth of the stream profile in connection with the construction activity. The width, height, and gradient of a proposed culvert should be

sufficient to pass the average historical low flow and spring flow without adversely altering flow velocity. Spring flow is the seasonal sustained high flow that typically occurs in the spring. Spring flows should be determined from gage data, if available. In the absence of such data, bank-full flow can be used as a comparable indicator.

In Public Trust Areas of Environmental Concern (AEC) and/or the Estuarine Waters AEC as designated by the Coastal Area Management Act (CAMA): All pipes/culverts must be sufficiently sized to allow for the burial of the bottom of the culvert at least one foot below normal bed elevation.

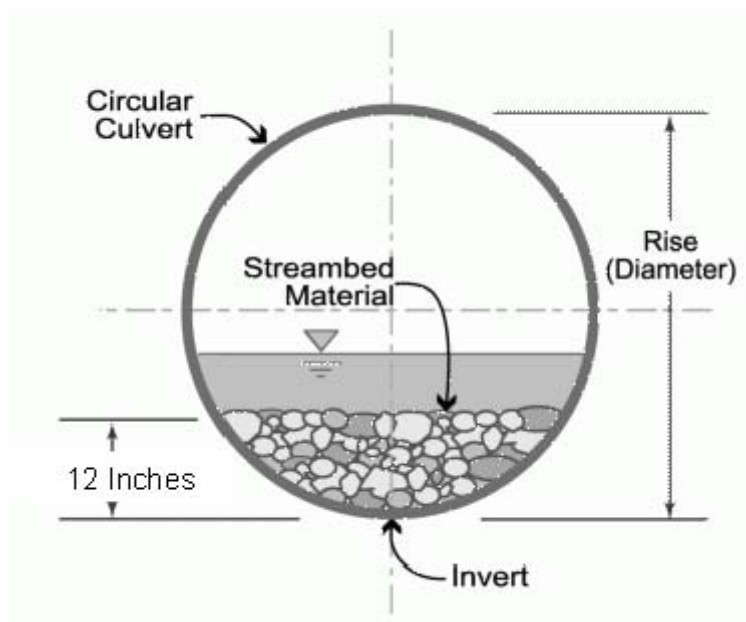

In all other areas: Culverts greater than 48 inches in diameter will be buried at least one foot below the bed of the stream. Culverts 48 inches in diameter or less shall be buried to maintain aquatic passage and to maintain passage during drought or low flow conditions, and every effort shall be made to maintain the existing channel slope.

Culverts must be designed and constructed in a manner that minimizes destabilization and head cutting. Destabilizing the channel and head cutting upstream should be considered and appropriate actions incorporated in the design and placement of the culvert.

A waiver from the depth specifications in this condition may be requested, in writing, by the permittee and issued by the Corp; this request must be specific as to the reasons(s) for the request. The waiver will be issued if it can be demonstrated that the proposed design would result in less impacts to the aquatic environment.

All counties: Culverts placed within riparian and/or riverine wetlands must be installed in a manner that does not restrict the flow and circulation patterns of waters of the United States.

Culverts placed across wetland fills purely for the purposes of equalizing surface water do not have to be buried, but the culverts must be of adequate size and/or number to ensure unrestricted transmission of water.

**3.6.2** Bank-full flows (or less) shall be accommodated through maintenance of the existing bank-full channel cross sectional area. Additional culverts or culvert barrels at such crossings shall be allowed only to receive bank-full flows.

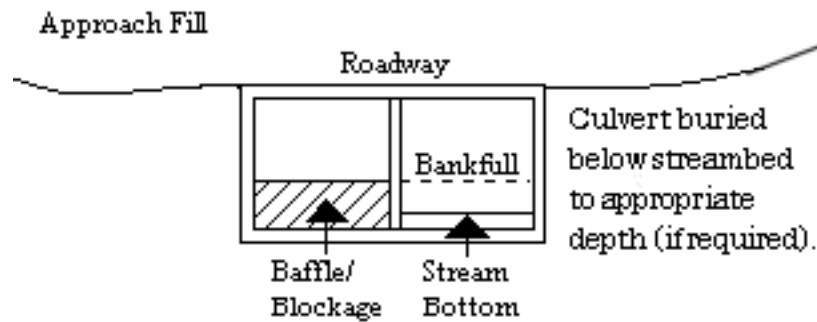

**3.6.3** Where adjacent floodplain is available, flows exceeding bank-full should be accommodated by installing culverts at the floodplain elevation. Additional culverts or culvert barrels at such crossings should not be buried, or if buried, must have sills at the inlets to ensure that they only receive flows exceeding bank-full.

**3.6.4** Excavation of existing stream channels shall be limited to the minimum necessary to construct or install the proposed culvert. The final width of the impacted stream at the culvert inlet and outlet should be no greater than the original stream width. A waiver from this condition may be requested in writing; this request must be specific as to the reason(s) for the request. The waiver will be issued if the proposed design would result in less impacts to the aquatic environment and/or if it can be demonstrated that it is not practicable to restore the final width of the impacted stream at the culvert inlet and outlet to the width of the original stream channel.

**3.6.5** The width of the culvert shall be comparable to the width of the stream channel. If the width of the culvert is wider than the stream channel, the culvert shall include baffles, benches and/or sills to maintain the width of the stream channel. A waiver from this condition may be requested in writing; this request must be specific as to the reason(s) for the request. The waiver will be issued if it can be demonstrated that it is not practicable or necessary to include baffles, benches or sills and the design would result in less impacts to the aquatic environment.

### **3.7 Notification to NCDEQ Shellfish Sanitation Section**

Permittees shall notify the NCDEQ Shellfish Sanitation Section prior to dredging in or removing sediment from an area closed to shell fishing where the effluent may be released to an area open for shell fishing or swimming in order to avoid contamination from the disposal area and cause a temporary shellfish closure to be made. Such notification shall also be provided to the appropriate Corps Regulatory Field Office. Any disposal of sand to the ocean beach should occur between November 1 and April 30 when recreational usage is low. Only clean sand

should be used and no dredged sand from closed shell fishing areas may be used. If beach disposal were to occur at times other than stated above or if sand from a closed shell fishing area is to be used, a swimming advisory shall be posted, and a press release shall be issued by the permittee.

### **3.8 Submerged Aquatic Vegetation**

Impacts to Submerged Aquatic Vegetation (SAV) are not authorized by any NWP, except NWP 48, unless EFH Consultation has been completed pursuant to the Magnuson-Stevens Fisheries Conservation and Management Act (Magnuson-Stevens Act). Permittees shall submit a PCN (See NWP General Condition 32) to the District Engineer prior to commencing the activity if the project would affect SAV. The permittee may not begin work until notified by the Corps that the requirements of the Magnuson-Stevens Act have been satisfied and that the activity is authorized.

### **3.9 Sedimentation and Erosion Control Structures and Measures**

All PCNs will identify and describe sedimentation and erosion control structures and measures proposed for placement in waters of the United States. The structures and measures should be depicted on maps, surveys or drawings showing location and impacts to jurisdictional wetlands and streams.

### **3.10 Restoration of Temporary Impacts to Stream Beds**

Upon completion of work that involves temporary stream impacts, streambeds are to be restored to pre-project elevations and widths using natural streambed material such that the impacted stream reach mimics the adjacent upstream and downstream reach. The impacted area shall be backfilled with natural streambed material to a depth of at least 12 inches or to the bottom depth of the impacted area if shallower than 12 inches. An engineered in-stream structure or material can be used to provide protection of a buried structure if it provides benefits to the aquatic environment and can be accomplished by a natural streambed design. A permittee may request a waiver of this condition if it is determined a buried structure needs significant physical protection beyond those provided in this condition. This condition does not apply to NWP 27 – Aquatic Habitat Restoration, Enhancement, and Establishment Activities.

### **3.11 Restoration of Temporary Impacts to Stream Banks**

Upon completion of work involving temporary stream bank impacts, stream banks are to be restored to pre-project grade and contours or beneficial grade and contours if the original bank slope is steep and unstable. Natural durable materials, native seed mixes, and native plants and shrubs are to be utilized in the restoration. Natural designs which use bioengineered and/or geo-engineered methods are to be applied. An engineered structure or material can be used to provide protection of a buried structure if it provides benefits to the stream bank environment, provided it is not in excess of the minimum amount needed for protection and does not exceed an average of one cubic yard per running foot placed along the bank below the plane of the ordinary high water mark. A permittee may request a waiver of this condition if it is determined a buried structure



needs significant physical protection beyond those provided in this condition. This condition does not apply to NWP 27 – Aquatic Habitat Restoration, Enhancement, and Establishment Activities.

### **3.12 Federal Navigation Channel Setbacks and Corps Easements**

**3.12.1** Authorized structures and fills located in or adjacent to Federally authorized waterways will be constructed in accordance with the latest setback criteria established by the Wilmington District Engineer. You may review the setback policy at <http://www.saw.usace.army.mil/Missions/Navigation/Setbacks.aspx>. This general permit does not authorize the construction of hardened or permanently fixed structures within the Federally Authorized Channel Setback, unless the activity is approved by the Corps. The permittee shall submit a PCN (see General Condition 32) to the District Engineer prior to the construction of any structures or fills within the Federally Authorized Channel Setback.

**3.12.2** The permittee shall obtain a Consent to Cross Government Easement from the Wilmington District’s Land Use Coordinator prior to any crossing of the Corps easement and/or prior to commencing construction of any structures, authorized dredging or other work within the right-of-way of, or in proximity to, a federally designated disposal area. The Land Use Coordinator may be contacted at: CESAW-OP-N, 69 Darlington Avenue, Wilmington, North Carolina 28403-1343, email: [SAWWeb-NAV@usace.army.mil](mailto:SAWWeb-NAV@usace.army.mil)

### **3.13 Northern Long-eared Bat – Endangered Species Act Compliance**

The Wilmington District, U.S. Army Corps of Engineers has consulted with the United States Fish and Wildlife Service (USFWS) in regards to the threatened Northern long-eared bat (NLEB) (*Myotis septentrionalis*) and Standard Local Operating Procedures for Endangered Species (SLOPES) have been approved by the Corps and the USFWS. This condition concerns effects to the NLEB only and does not address effects to other federally listed species and/or federally designated critical habitat.

A. Procedures when the Corps is the lead federal\* agency for a project:

The permittee must comply with (1) and (2) below when:

- the project is located in the western 41 counties of North Carolina, to include non-federal aid North Carolina Department of Transportation (NCDOT) projects, OR;
- the project is located in the 59 eastern counties of North Carolina, and is a non-NCDOT project.

\*Generally, if a project is located on private property or on non-federal land, and the project is not being funded by a federal entity, the Corps will be the lead federal agency due to the requirement to obtain Department of the Army authorization to impact waters of the United States. If the project is located on federal land, contact the Corps to determine the lead federal agency.

(1) A permittee using a NWP must check to see if their project is located in the range of the NLEB by using the following website:

<http://www.fws.gov/midwest/endangered/mammals/nleb/pdf/WNSZone.pdf>. If the project is within the range of the NLEB, or if the project includes percussive activities (e.g., blasting, pile driving, etc.), the permittee is then required to check the appropriate website in the paragraph below to discover if their project:

- is located in a 12-digit Hydrologic Unit Code area (“red HUC” - shown as red areas on the map), AND/OR;
- involves percussive activities within 0.25 mile of a red HUC.

Red HUC maps - for the western 41 counties in NC (covered by the Asheville Ecological Services Field Office), check the project location against the electronic maps found at: [http://www.fws.gov/asheville/htmls/project\\_review/NLEB\\_in\\_WNC.html](http://www.fws.gov/asheville/htmls/project_review/NLEB_in_WNC.html). For the eastern 59 counties in NC (covered by the Raleigh Ecological Services Field Office), check the project location against the electronic maps found at:

[https://www.fws.gov/raleigh/NLEB\\_RFO.html](https://www.fws.gov/raleigh/NLEB_RFO.html).

(2) A permittee must submit a PCN to the District Engineer, and receive written authorization from the District Engineer, prior to commencing the activity, if the activity will involve any of the following:

- tree clearing/removal, construction/installation of wind turbines in a red HUC, AND/OR;
- bridge removal or maintenance, unless the bridge has been inspected and there is no evidence of bat use, (applies anywhere in the range of the NLEB), AND/OR;
- percussive activities in a red HUC, or within 0.25 mile of a red HUC.

The permittee may proceed with the activity without submitting a PCN to either the Corps or the USFWS, provided the activity complies with all applicable NWP terms and general and regional conditions, if the permittee’s review under A.(1) and A.(2) above shows that the project is:

- located outside of a red HUC (and there are no percussive activities), and the activity will NOT include bridge removal or maintenance, unless the bridge has been inspected and there is no evidence of bat use, OR;
- located outside of a red HUC and there are percussive activities, but the percussive activities will not occur within 0.25-mile of a red HUC boundary, and the activity will NOT include bridge removal or maintenance, unless the bridge has been inspected and there is no evidence of bat use, OR;

- located in a red HUC, but the activity will NOT include: tree clearing/removal; construction/installation of wind turbines; bridge removal or maintenance, unless the bridge has been inspected and there is no evidence of bat use, and/or; any percussive activities.

B. Procedures when the USACE is not the lead federal agency:

For projects where another federal agency is the lead federal agency - if that other federal agency has completed project-specific ESA Section 7(a)(2) consultation for the NLEB, and has (1) determined that the project would not cause prohibited incidental take of the NLEB, and (2) completed coordination/consultation that is required by the USFWS (per the directions on the respective USFWS office's website), that project may proceed without notification to either the USACE or the USFWS, provided all General and Regional Permit Conditions are met.

The NLEB SLOPES can be viewed on the USACE website at the following World Wide Web Page: <http://www.saw.usace.army.mil/Missions/Regulatory-Permit-Program/Agency-Coordination/ESA/>. Permittees who do not have internet access may contact the USACE at (910) 251- 4633.

### **3.14 Work on Eastern Band of Cherokee Indians Land**

All PCNs submitted for activities in waters of the United States on Eastern Band of Cherokee Indians (EBCI) trust land (i.e., Qualla Boundary and non-contiguous tracts of trust land), must comply with the requirements of the latest MOU between the Wilmington District and the Eastern Band of Cherokee Indians.

## **4.0 Additional Regional Conditions for Specific Nationwide Permits**

### **4.1 NWP #12 - Utility Line Activities**

**4.1.1** Pipeline/utility line construction through jurisdictional waters and wetlands will be accomplished utilizing directional drilling/boring methods to the maximum extent practicable.

**4.1.2** Temporary discharge of excavated or fill material into wetlands and waters of the United States will be for the absolute minimum period of time necessary to accomplish the work. Temporary discharges will be fully contained with appropriate erosion control or containment methods or otherwise such fills will consist of non-erodible materials.

**4.1.3** The work area authorized by this permit, including temporary and/or permanent fills, will be minimized to the greatest extent practicable. Justification for work corridors exceeding forty (40) feet in width is required and will be based on pipeline diameter and length, size of equipment required to construct the utility line, and other construction information deemed necessary to support the request. The permittee is required to provide this information to the Corps with the initial notification package.

**4.1.4** Excavated materials shall be returned to the excavated areas and any remaining materials shall be disposed of in uplands, unless the Corps authorizes disposal in waters of the United States.

**4.1.5** In areas where a sub-aqueous utility line is to cross a federally-maintained channel, (i.e., the Atlantic Intracoastal Waterway [AIWW]), the line will be buried at least six (6) feet below the allowable overdepth of the authorized channel, including all side slopes. For areas outside federally-maintained channels, sub-aqueous lines must be installed at a minimum depth of two (2) feet below the substrate when such lines might interfere with navigation.

**4.1.6** The minimum clearance\*(see NOTE in 4.1.7) for aerial communication lines, or any lines not transmitting electrical power, will be ten (10) feet above the clearance required for nearby stationary bridges as established by the U.S. Coast Guard. In the event the U.S. Coast Guard has not established a bridge clearance, minimum vertical clearances for power and aerial lines will not be less than required by Section 23, Rule 232, of the latest revision of the National Electrical Safety Code (ANSI C2). Clearances will not be less than shown in Table 232-1, Item 7, ANSI C2.

**4.1.7** The minimum clearance\* for an aerial line, transmitting electrical power, is based on the low point of the line under conditions that produce the greatest sag, taking into consideration temperature, load, wind, length or span and the type of supports. The minimum clearance for an aerial electrical power transmission line crossing navigable waters of the United States, where there is an established bridge clearance established by the U.S. Coast Guard, shall be governed by the system voltage, as indicated below:

| Nominal System    | Minimum Clearance   |
|-------------------|---|
| Voltage, kilovolt | Above Bridge Clearance (As Established by the U.S. Coast Guard) |
| 115 and below     | 20 feet   |
| 138               | 22  |
| 161               | 24  |
| 230               | 26  |
| 350               | 30  |
| 500               | 35  |
| 700               | 42  |
| 750 to 765        | 45  |

\*NOTE: Minimum clearance is the distance measured between the lowest point of a stationary bridge, including *any* infrastructure attached to underside of the bridge, and the Mean High Water (MHW) of the navigable waters of the United States beneath the bridge.

**4.1.8** On navigable waters of the United States, including all federal navigation projects, where there is no bridge for reference for minimum clearance, the proposed project will need to be reviewed by the Corps in order to determine the minimum clearance between the line and MHW necessary to protect navigational interests.

**4.1.9** A plan to restore and re-vegetate wetland areas cleared for construction must be submitted with the required PCN. Cleared wetland areas shall be re-vegetated to the maximum extent practicable with native species of canopy, shrub, and herbaceous species. Fescue grass shall not be used.

**4.1.10** Any permanently maintained corridor along the utility right of way within forested wetlands shall be considered a permanent impact. A compensatory mitigation plan will be required for all such impacts associated with the requested activity if the activity requires PCN and the cumulative total of permanent forested wetland impacts exceeds 1/10-acre, unless the District Engineer determines in writing that either some other form of mitigation would be more environmentally appropriate or the adverse effects of the proposed activity are minimal.

For permanent forested wetland impacts of 1/10-acre or less, the District Engineer may determine, on a case-by-case basis, that compensatory mitigation is required to ensure that the activity results in minimal adverse effects on the aquatic environment.

**4.1.11** Use of rip-rap or any other engineered structures to stabilize a stream bed should be avoided to the maximum extent practicable. If riprap stabilization is needed, it should be placed only on the stream banks, or, if it is necessary to be placed in the stream bed, the finished top elevation of the riprap should not exceed that of the original stream bed.

**4.1.12** When directional boring or horizontal directional drilling (HDD) under waters of the United States, including wetlands, permittees shall closely monitor the project for hydraulic fracturing or “fracking.” Any discharge from hydraulic fracturing or “fracking” into waters of the United States, including wetlands, shall be reported to the appropriate Corps Regulatory Field Office within 48 hours. Restoration and/or compensatory mitigation may be required as a result of any unintended discharges.

**4.1.13** For purposes of this NWP, the term utility line does not include pipes or culverts associated with driveways, roadways, lots, etc.

**4.1.14** The permittee shall submit a PCN to the District Engineer prior to commencing the activity if the activity will involve the discharge of dredged or fill material into more than 1/10-acre of wetlands or 150 linear feet of stream channel for the construction of temporary access fills and/or temporary road crossings. The PCN must include a restoration plan that thoroughly describes how all temporary fills will be removed, describes how pre-project conditions will be restored, and includes a timetable for all restoration activities.

**STATE OF NORTH CAROLINA  
DEPARTMENT OF ENVIRONMENTAL QUALITY  
DIVISION OF WATER RESOURCES**

**WATER QUALITY GENERAL CERTIFICATION NO. 4133**

**GENERAL CERTIFICATION FOR PROJECTS ELIGIBLE FOR US ARMY CORPS OF ENGINEERS**

- **NATIONWIDE PERMIT 12 (UTILITY LINE ACTIVITIES)**

Water Quality Certification Number 4133 is issued in conformity with the requirements of Section 401, Public Laws 92-500 and 95-217 of the United States and subject to the North Carolina Regulations in 15A NCAC 02H .0500 and 15A NCAC 02B .0200 for the discharge of fill material to surface waters and wetland areas as described in 33 CFR 330 Appendix A (B) (12) of the US Army Corps of Engineers regulations.

The State of North Carolina certifies that the specified category of activity will not violate applicable portions of Sections 301, 302, 303, 306 and 307 of the Public Laws 92-500 and 95-217 if conducted in accordance with the conditions hereinafter set forth.

Effective date: December 1, 2017

Signed this day: December 1, 2017

By

A handwritten signature in black ink, appearing to read 'Linda Culpepper', is written over a horizontal line.

*for* Linda Culpepper  
Interim Director

## GC4133

**Activities meeting any one (1) of the following thresholds or circumstances require written approval for a 401 Water Quality Certification from the Division of Water Resources (DWR):**

- a) If any of the Conditions of this Certification (listed below) cannot be met; or
- b) Total permanent impacts to wetlands or open waters equal to or greater than one-tenth (1/10) acre within the entire utility project; or
- c) Any permanent impacts to streams; or
- d) Total temporary impacts to streams greater than 500 feet within the entire utility project; or
- e) Any stream relocation or stream restoration; or
- f) Any high-density utility line and associated facilities project, as defined in 15A NCAC 02H .1003(2)(a) and by the density thresholds specified in 15A NCAC 02H .1017, which:
  - i. Disturbs one acre or more of land (including a project that disturbs less than one acre of land that is part of a larger common plan of development or sale); and
  - ii. Has permanent wetland, stream or open water impacts; and
  - iii. Is proposing new built-upon area; and
  - iv. Does not have a stormwater management plan reviewed and approved under a state stormwater program<sup>1</sup> or a state-approved local government stormwater program<sup>2</sup>.

Projects that have vested rights, exemptions, or grandfathering from state or locally-implemented stormwater programs and projects that satisfy state or locally-implemented stormwater programs through use of community in-lieu programs **require written approval**; or

- g) Any permanent impacts to waters, or to wetlands adjacent to waters, designated as: ORW (including SAV), HQW (including PNA), SA, WS-I, WS-II, Trout, or North Carolina or National Wild and Scenic River; or
- h) Any permanent impacts to coastal wetlands [15A NCAC 07H .0205], or Unique Wetlands (UWL); or
- i) Any impact associated with a Notice of Violation or an enforcement action for violation(s) of NC Wetland Rules (15A NCAC 02H .0500), NC Isolated Wetland Rules (15A NCAC 02H .1300), NC Surface Water or Wetland Standards (15A NCAC 02B .0200), or State Regulated Riparian Buffer Rules (15A NCAC 02B .0200); or
- j) Any impacts to subject water bodies and/or state regulated riparian buffers along subject water bodies in the Neuse, Tar-Pamlico, or Catawba River Basins or in the Randleman Lake, Jordan Lake or Goose Creek Watersheds (or any other basin or watershed with State Regulated Riparian Area Protection Rules [Buffer Rules] in effect at the time of application) *unless*:
  - i. The activities are listed as "EXEMPT" from these rules; or
  - ii. A Buffer Authorization Certificate is issued by the NC Division of Coastal Management (DCM); or

---

<sup>1</sup> e.g. Coastal Counties, HQW, ORW, or state-implemented Phase II NPDES

<sup>2</sup> e.g. Delegated Phase II NPDES, Water Supply Watershed, Nutrient-Sensitive Waters, or Universal Stormwater Management Program

# GC4133

- iii. A Buffer Authorization Certificate or a Minor Variance is issued by a delegated or designated local government implementing a state riparian buffer program pursuant to 143-215.23.

**Activities included in this General Certification that do not meet one of the thresholds listed above do not require written approval.**

## **I. ACTIVITY SPECIFIC CONDITIONS:**

1. All sewer lines shall be designed, constructed and maintained in accordance with Title 15A NCAC Chapter 02T.
2. Any utility construction corridor that is parallel to a stream or open water shall not be closer than 10 feet to the top of bank or ordinary high-water mark. Exceptions to this condition require application to and written approval from DWR. [15A NCAC 02H .0506 (b)(4) and (c)(4)]
3. Where there are temporary or permanent impacts from stream crossings, utility lines shall cross the stream channel at a near-perpendicular direction (i.e., between 75 degrees and 105 degrees to the stream bank). Exceptions to this condition require application to and written approval from DWR. [15A NCAC 02H .0506 (b)(2) and (c)(2)]
4. Construction corridors in wetlands and across stream channels shall be minimized to the maximum extent practicable and shall not exceed 50 feet wide for gas utility lines and 40 feet wide for all other utility lines. Exceptions to this condition require application to and written approval from DWR. [15A NCAC 02H .0506 (b)(2) and (c)(2)]

For construction corridors in wetlands and across stream channels, stumps shall be grubbed only as needed to install the utility and remaining stumps shall be cut off at grade level. The general stripping of topsoil within wetlands along the construction corridor is not permitted.

5. Permanent maintained access corridors in wetlands and across stream channels shall be restricted to the minimum width practicable and shall not exceed 30 feet wide for gas utility lines and 20 feet wide for all other utility lines except at manhole locations. 15-foot by 15-foot perpendicular vehicle turnarounds shall be allowed in access corridors but must be spaced at least 500 feet apart. Exceptions to this condition require application to and written approval from DWR. [15A NCAC 02H .0506 (b)(2) and (c)(2)]
6. For all utility lines constructed within wetlands, an anti-seep collar shall be placed at the downstream (utility line gradient) wetland boundary and every 150 feet up the gradient until the utility exits the wetland. Anti-seep collars may be constructed with class B concrete, compacted clay, PVC pipe, or metal collars. Wetland crossings that are directionally drilled, and perpendicular wetland crossings that are open cut and less than 150 feet long do not require anti-seep collars. The compacted clay shall have a specific



## GC4133

infiltration of  $1 \times 10^{-5}$  cm/sec or less. A section and plan view diagram is attached for the anti-seep collars. [15A NCAC 02H .0506 (b)(4) and (c)(4)]

The following specifications shall apply to class B concrete:

- a. Minimum cement content, sacks per cubic yard with rounded coarse aggregate 5.0
  - b. Minimum cement content, sacks per cubic yard with angular coarse aggregate 5.5
  - c. Maximum water-cement ratio gallons per sack 6.8
  - d. Slump range 2" to 4"
  - e. Minimum strength - 28-day psi 2,500
7. The applicant shall have a specific plan for restoring wetland contours. Any excess material will be removed to a high ground disposal area. [15A NCAC 02H .0506 (b)(2) and (c)(2)]

The mixing of topsoil and subsoils within the wetlands along utility corridors shall be minimized to the greatest extent practical. During excavation, the soils shall be placed on fabric to minimize impacts whenever possible. Topsoil excavated from utility trenches will be piled separately from subsoils and will be backfilled into the trench only after the subsoils have been placed and compacted.

8. For the North Carolina Department of Transportation, compliance with the NCDOT's individual NPDES permit NCS000250 shall serve to satisfy this condition. All other high-density utility line and associated facilities projects that trigger threshold Item (f) above shall comply with one of the following requirements: [15A NCAC 02H .0506(b)(5) and (c)(5)]
- a. Provide a completed Stormwater Management Plan (SMP) for review and approval, including all appropriate stormwater control measure (SCM) supplemental forms and associated items, that complies with the high-density development requirements of 15A NCAC 02H .1003. Stormwater management shall be provided throughout the entire project area in accordance with 15A NCAC 02H .1003. For the purposes of 15A NCAC 02H .1003(2)(a), density thresholds shall be determined in accordance with 15A NCAC 02H .1017.
  - b. Provide documentation (including calculations, photos, etc.) that the project will not cause degradation of downstream surface waters. Documentation shall include a detailed analysis of the hydrological impacts from stormwater runoff when considering the volume and velocity of stormwater runoff from the project built upon area and the size and existing condition of the receiving stream(s).

Exceptions to this condition require application to and written approval from DWR.

### II. GENERAL CONDITIONS:

1. When written authorization is required, the plans and specifications for the project are incorporated into the authorization by reference and are an enforceable part of the Certification. Any modifications to the project require notification to DWR and may require an application submittal to DWR with the appropriate fee. [15A NCAC 02H .0501 and .0502]

## GC4133

2. No waste, spoil, solids, or fill of any kind shall occur in wetlands or waters beyond the footprint of the impacts (including temporary impacts) as authorized in the written approval from DWR; or beyond the thresholds established for use of this Certification without written authorization. [15A NCAC 02H .0501 and .0502]

No removal of vegetation or other impacts of any kind shall occur to state regulated riparian buffers beyond the footprint of impacts approved in a Buffer Authorization or Variance or as listed as an exempt activity in the applicable riparian buffer rules. [15A NCAC 02B .0200]

3. In accordance with 15A NCAC 02H .0506(h) and Session Law 2017-10, compensatory mitigation may be required for losses of greater than 300 linear feet of perennial streams and/or greater than one (1) acre of wetlands. Impacts associated with the removal of a dam shall not require mitigation when the removal complies with the requirements of Part 3 of Article 21 in Chapter 143 of the North Carolina General Statutes. Impacts to isolated and other non-404 jurisdictional wetlands shall not be combined with 404 jurisdictional wetlands for the purpose of determining when impact thresholds trigger a mitigation requirement. For linear publicly owned and maintained transportation projects that are not determined to be part of a larger common plan of development by the US Army Corps of Engineers, compensatory mitigation may be required for losses of greater than 300 linear feet per perennial stream.

Compensatory stream and/or wetland mitigation shall be proposed and completed in compliance with G.S. 143-214.11. For applicants proposing to conduct mitigation within a project site, a complete mitigation proposal developed in accordance with the most recent guidance issued by the US Army Corps of Engineers Wilmington District shall be submitted for review and approval with the application for impacts.

4. All activities shall be in compliance with any applicable State Regulated Riparian Buffer Rules in Chapter 2 of Title 15A.
5. When applicable, all construction activities shall be performed and maintained in full compliance with G.S. Chapter 113A Article 4 (Sediment and Pollution Control Act of 1973). Regardless of applicability of the Sediment and Pollution Control Act, all projects shall incorporate appropriate Best Management Practices for the control of sediment and erosion so that no violations of state water quality standards, statutes, or rules occur. [15A NCAC 02H .0506 (b)(3) and (c)(3) and 15A NCAC 02B .0200]

Design, installation, operation, and maintenance of all sediment and erosion control measures shall be equal to or exceed the requirements specified in the most recent version of the *North Carolina Sediment and Erosion Control Manual*, or for linear transportation projects, the *NCDOT Sediment and Erosion Control Manual*.

All devices shall be maintained on all construction sites, borrow sites, and waste pile (spoil) sites, including contractor-owned or leased borrow pits associated with the project. Sufficient materials required for stabilization and/or repair of erosion control measures and stormwater routing and treatment shall be on site at all times.

## GC4133

For borrow pit sites, the erosion and sediment control measures shall be designed, installed, operated, and maintained in accordance with the most recent version of the *North Carolina Surface Mining Manual*. Reclamation measures and implementation shall comply with the reclamation in accordance with the requirements of the Sedimentation Pollution Control Act and the Mining Act of 1971.

If the project occurs in waters or watersheds classified as Primary Nursery Areas (PNAs), SA, WS-I, WS-II, High Quality Waters (HQW), or Outstanding Resource Waters (ORW), then the sedimentation and erosion control designs shall comply with the requirements set forth in 15A NCAC 04B .0124, *Design Standards in Sensitive Watersheds*.

6. Sediment and erosion control measures shall not be placed in wetlands or waters except within the footprint of temporary or permanent impacts authorized under this Certification. Exceptions to this condition require application to and written approval from DWR. [15A NCAC 02H .0501 and .0502]
7. Erosion control matting that incorporates plastic mesh and/or plastic twine shall not be used along streambanks or within wetlands. Exceptions to this condition require application to and written approval from DWR. [15A NCAC 02B .0201]
8. An NPDES Construction Stormwater Permit (NCG010000) is required for construction projects that disturb one (1) or more acres of land. The NCG010000 Permit allows stormwater to be discharged during land disturbing construction activities as stipulated in the conditions of the permit. If the project is covered by this permit, full compliance with permit conditions including the erosion & sedimentation control plan, inspections and maintenance, self-monitoring, record keeping and reporting requirements is required. [15A NCAC 02H .0506(b)(5) and (c)(5)]

The North Carolina Department of Transportation (NCDOT) shall be required to be in full compliance with the conditions related to construction activities within the most recent version of their individual NPDES (NCS000250) stormwater permit. [15A NCAC 02H .0506(b)(5) and (c)(5)]

9. All work in or adjacent to streams shall be conducted so that the flowing stream does not come in contact with the disturbed area. Approved best management practices from the most current version of the *NC Sediment and Erosion Control Manual*, or the *NC DOT Construction and Maintenance Activities Manual*, such as sandbags, rock berms, cofferdams, and other diversion structures shall be used to minimize excavation in flowing water. Exceptions to this condition require application to and written approval from DWR. [15A NCAC 02H .0506(b)(3) and (c)(3)]
10. If activities must occur during periods of high biological activity (e.g. sea turtle nesting, fish spawning, or bird nesting), then biological monitoring may be required at the request of other state or federal agencies and coordinated with these activities. [15A NCAC 02H .0506 (b)(2) and 15A NCAC 04B .0125]

## GC4133

All moratoriums on construction activities established by the NC Wildlife Resources Commission (WRC), US Fish and Wildlife Service (USFWS), NC Division of Marine Fisheries (DMF), or National Marine Fisheries Service (NMFS) shall be implemented. Exceptions to this condition require written approval by the resource agency responsible for the given moratorium. A copy of the approval from the resource agency shall be forwarded to DWR.

Work within a designated trout watershed of North Carolina (as identified by the Wilmington District of the US Army Corps of Engineers), or identified state or federal endangered or threatened species habitat, shall be coordinated with the appropriate WRC, USFWS, NMFS, and/or DMF personnel.

11. Culverts shall be designed and installed in such a manner that the original stream profiles are not altered and allow for aquatic life movement during low flows. The dimension, pattern, and profile of the stream above and below a pipe or culvert shall not be modified by widening the stream channel or by reducing the depth of the stream in connection with the construction activity. The width, height, and gradient of a proposed culvert shall be such as to pass the average historical low flow and spring flow without adversely altering flow velocity. [15A NCAC 02H .0506(b)(2) and (c)(2)]

Placement of culverts and other structures in streams shall be below the elevation of the streambed by one foot for all culverts with a diameter greater than 48 inches, and 20% of the culvert diameter for culverts having a diameter less than or equal to 48 inches, to allow low flow passage of water and aquatic life.

If multiple pipes or barrels are required, they shall be designed to mimic the existing stream cross section as closely as possible including pipes or barrels at flood plain elevation and/or sills where appropriate. Widening the stream channel shall be avoided.

When topographic constraints indicate culvert slopes of greater than 5%, culvert burial is not required, provided that all alternative options for flattening the slope have been investigated and aquatic life movement/connectivity has been provided when possible (e.g. rock ladders, cross vanes, etc.). Notification, including supporting documentation to include a location map of the culvert, culvert profile drawings, and slope calculations, shall be provided to DWR 60 calendar days prior to the installation of the culvert.

When bedrock is present in culvert locations, culvert burial is not required provided that there is sufficient documentation of the presence of bedrock. Notification, including supporting documentation such as a location map of the culvert, geotechnical reports, photographs, etc. shall be provided to DWR a minimum of 60 calendar days prior to the installation of the culvert. If bedrock is discovered during construction, then DWR shall be notified by phone or email within 24 hours of discovery.

If other site-specific topographic constraints preclude the ability to bury the culverts as described above and/or it can be demonstrated that burying the culvert would result in destabilization of the channel, then exceptions to this condition require application to and written approval from DWR.

## GC4133

Installation of culverts in wetlands shall ensure continuity of water movement and be designed to adequately accommodate high water or flood conditions. When roadways, causeways, or other fill projects are constructed across FEMA-designated floodways or wetlands, openings such as culverts or bridges shall be provided to maintain the natural hydrology of the system as well as prevent constriction of the floodway that may result in destabilization of streams or wetlands.

The establishment of native woody vegetation and other soft stream bank stabilization techniques shall be used where practicable instead of rip-rap or other bank hardening methods.

12. Bridge deck drains shall not discharge directly into the stream. Stormwater shall be directed across the bridge and pre-treated through site-appropriate means to the maximum extent practicable (e.g. grassed swales, pre-formed scour holes, vegetated buffers, etc.) before entering the stream. Exceptions to this condition require application to and written approval from DWR. [15A NCAC 02H .0506(b)(5)]
13. Application of fertilizer to establish planted/seeded vegetation within disturbed riparian areas and/or wetlands shall be conducted at agronomic rates and shall comply with all other Federal, State and Local regulations. Fertilizer application shall be accomplished in a manner that minimizes the risk of contact between the fertilizer and surface waters. [15A NCAC 02B .0200 and 15A NCAC 02B .0231]
14. If concrete is used during construction, then all necessary measures shall be taken to prevent direct contact between uncured or curing concrete and waters of the state. Water that inadvertently contacts uncured concrete shall not be discharged to waters of the state. [15A NCAC 02B .0200]
15. All proposed and approved temporary fill and culverts shall be removed and the impacted area shall be returned to natural conditions within 60 calendar days after the temporary impact is no longer necessary. The impacted areas shall be restored to original grade, including each stream's original cross sectional dimensions, planform pattern, and longitudinal bed profile. For projects that receive written approval, no temporary impacts are allowed beyond those included in the application and authorization. All temporarily impacted sites shall be restored and stabilized with native vegetation. [15A NCAC 02H .0506(b)(2) and (c)(2)]
16. All proposed and approved temporary pipes/culverts/rip-rap pads etc. in streams shall be installed as outlined in the most recent edition of the *North Carolina Sediment and Erosion Control Planning and Design Manual* or the *North Carolina Surface Mining Manual* or the *North Carolina Department of Transportation Best Management Practices for Construction and Maintenance Activities* so as not to restrict stream flow or cause dis-equilibrium during use of this Certification. [15A NCAC 02H .0506(b)(2) and (c)(2)]

## GC4133

17. Any rip-rap required for proper culvert placement, stream stabilization, or restoration of temporarily disturbed areas shall be restricted to the area directly impacted by the approved construction activity. All rip-rap shall be placed such that the original stream elevation and streambank contours are restored and maintained. Placement of rip-rap or other approved materials shall not result in de-stabilization of the stream bed or banks upstream or downstream of the area or in a manner that precludes aquatic life passage. [15A NCAC 02H .0506(b)(2)]
18. Any rip-rap used for stream or shoreline stabilization shall be of a size and density to prevent movement by wave, current action, or stream flows and shall consist of clean rock or masonry material free of debris or toxic pollutants. Rip-rap shall not be installed in the streambed except in specific areas required for velocity control and to ensure structural integrity of bank stabilization measures. [15A NCAC 02H .0506(b)(2)]
19. Applications for rip-rap groins proposed in accordance with 15A NCAC 07H .1401 (NC Division of Coastal Management General Permit for construction of Wooden and Rip-rap Groins in Estuarine and Public Trust Waters) shall meet all the specific conditions for design and construction specified in 15A NCAC 07H .1405.
20. All mechanized equipment operated near surface waters shall be inspected and maintained regularly to prevent contamination of stream waters from fuels, lubricants, hydraulic fluids, or other toxic materials. Construction shall be staged in order to minimize the exposure of equipment to surface waters to the maximum extent practicable. Fueling, lubrication and general equipment maintenance shall be performed in a manner to prevent, to the maximum extent practicable, contamination of surface waters by fuels and oils. [15A NCAC 02H .0506(b)(3) and (c)(3) and 15A NCAC 02B .0211 (12)]
21. Heavy equipment working in wetlands shall be placed on mats or other measures shall be taken to minimize soil disturbance. [15A NCAC 02H .0506(b)(3) and (c)(3)]
22. In accordance with 143-215.85(b), the applicant shall report any petroleum spill of 25 gallons or more; any spill regardless of amount that causes a sheen on surface waters; any petroleum spill regardless of amount occurring within 100 feet of surface waters; and any petroleum spill less than 25 gallons that cannot be cleaned up within 24 hours.
23. If an environmental document is required under the State Environmental Policy Act (SEPA), then this General Certification is not valid until a Finding of No Significant Impact (FONSI) or Record of Decision (ROD) is issued by the State Clearinghouse. If an environmental document is required under the National Environmental Policy Act (NEPA), then this General Certification is not valid until a Categorical Exclusion, the Final Environmental Assessment, or Final Environmental Impact Statement is published by the lead agency. [15A NCAC 01C .0107(a)]

## GC4133

24. This General Certification does not relieve the applicant of the responsibility to obtain all other required Federal, State, or Local approvals before proceeding with the project, including those required by, but not limited to, Sediment and Erosion Control, Non-Discharge, Water Supply Watershed, and Trout Buffer regulations.
25. The applicant and their authorized agents shall conduct all activities in a manner consistent with State water quality standards (including any requirements resulting from compliance with §303(d) of the Clean Water Act), and any other appropriate requirements of State and Federal Law. If DWR determines that such standards or laws are not being met, including failure to sustain a designated or achieved use, or that State or Federal law is being violated, or that further conditions are necessary to assure compliance, then DWR may revoke or modify a written authorization associated with this General Water Quality Certification. [15A NCAC 02H .0507(d)]
26. The permittee shall require its contractors and/or agents to comply with the terms and conditions of this permit in the construction and maintenance of this project, and shall provide each of its contractors and/or agents associated with the construction or maintenance of this project with a copy of this Certification. A copy of this Certification, including all conditions shall be available at the project site during the construction and maintenance of this project. [15A NCAC 02H .0507 (c) and 15A NCAC 02H .0506 (b)(2) and (c)(2)]
27. When written authorization is required for use of this Certification, upon completion of all permitted impacts included within the approval and any subsequent modifications, the applicant shall be required to return a certificate of completion (available on the DWR website: <https://edocs.deq.nc.gov/Forms/Certificate-of-Completion>). [15A NCAC 02H .0502(f)]
28. Additional site-specific conditions, including monitoring and/or modeling requirements, may be added to the written approval letter for projects proposed under this Water Quality Certification in order to ensure compliance with all applicable water quality and effluent standards. [15A NCAC 02H .0507(c)]
29. If the property or project is sold or transferred, the new permittee shall be given a copy of this Certification (and written authorization if applicable) and is responsible for complying with all conditions. [15A NCAC 02H .0501 and .0502]

### III. GENERAL CERTIFICATION ADMINISTRATION:

1. In accordance with North Carolina General Statute 143-215.3D(e), written approval for a 401 Water Quality General Certification must include the appropriate fee. An applicant for a CAMA permit under Article 7 of Chapter 113A of the General Statutes for which a Water Quality Certification is required shall only make one payment to satisfy both agencies; the fee shall be as established by the Secretary in accordance with 143-215.3D(e)(7).

## GC4133

2. This Certification neither grants nor affirms any property right, license, or privilege in any waters, or any right of use in any waters. This Certification does not authorize any person to interfere with the riparian rights, littoral rights, or water use rights of any other person and this Certification does not create any prescriptive right or any right of priority regarding any usage of water. This Certification shall not be interposed as a defense in any action respecting the determination of riparian or littoral rights or other rights to water use. No consumptive user is deemed by virtue of this Certification to possess any prescriptive or other right of priority with respect to any other consumptive user regardless of the quantity of the withdrawal or the date on which the withdrawal was initiated or expanded.
3. This Certification grants permission to the Director, an authorized representative of the Director, or DWR staff, upon the presentation of proper credentials, to enter the property during normal business hours. [15A NCAC 02H .0502(e)]
4. This General Certification shall expire on the same day as the expiration date of the corresponding Nationwide Permit and/or Regional General Permit. The conditions in effect on the date of issuance of Certification for a specific project shall remain in effect for the life of the project, regardless of the expiration date of this Certification. This General Certification is rescinded when the US Army Corps of Engineers reauthorizes any of the corresponding Nationwide Permits and/or Regional General Permits or when deemed appropriate by the Director of the Division of Water Resources.
5. Non-compliance with or violation of the conditions herein set forth by a specific project may result in revocation of this General Certification for the project and may also result in criminal and/or civil penalties.
6. The Director of the North Carolina Division of Water Resources may require submission of a formal application for Individual Certification for any project in this category of activity if it is deemed in the public's best interest or determined that the project is likely to have a significant adverse effect upon water quality, including state or federally listed endangered or threatened aquatic species, or degrade the waters so that existing uses of the water or downstream waters are precluded.

*History Note: Water Quality Certification (WQC) Number 4133 issued December 1, 2017 replaces WQC 4086 issued March 3, 2017; WQC 3884 issued March 19, 2012; WQC Number 3819 issued March 19, 2010; WQC Number 3699 issued November 1, 2007; WQC Number 3625 issued March 19, 2007; WQC Number 3374 issued March 18, 2002; WQC Number 3288 issued June 1, 2000; WQC Number 3101 issued February 11, 1997; WQC Number 3022 issued September 6, 1995, WQC Number 2664 issued January 21, 1992.*



**ANTI -SEEP COLLAR**

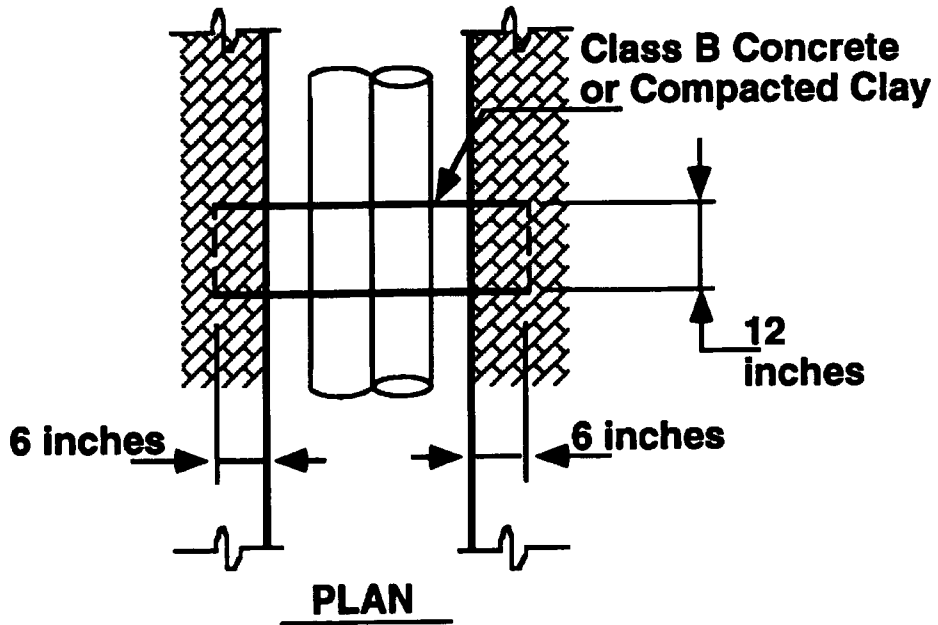
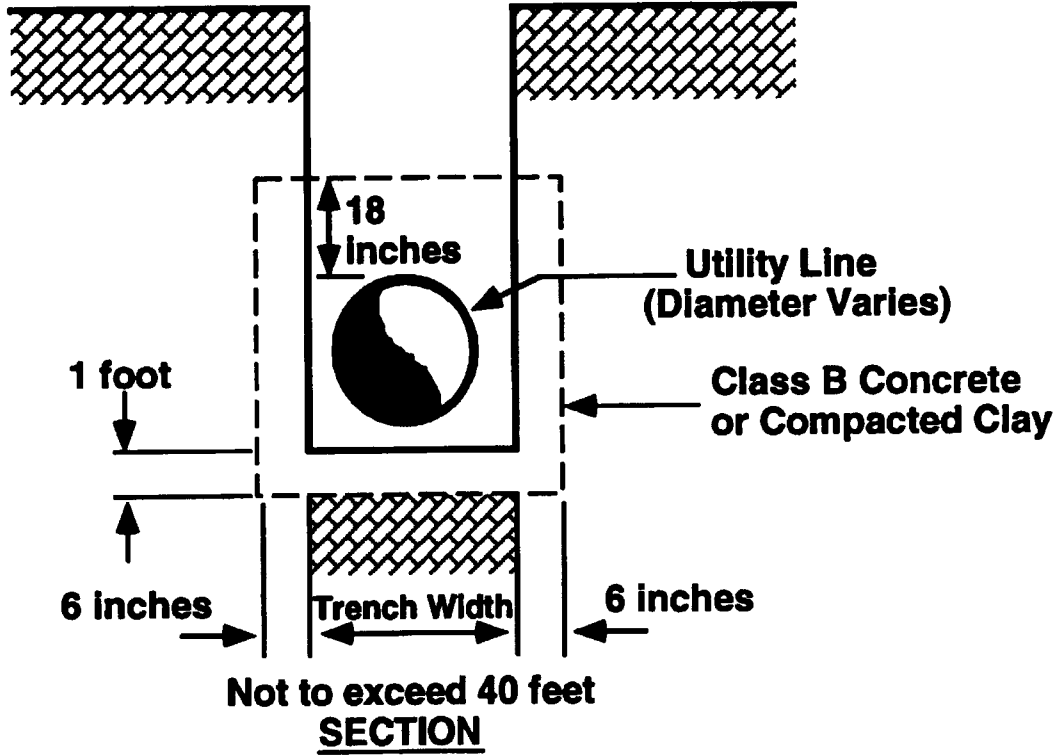

November 27, 2018

09/08/99

**TIP PROJECT: U-5942**

**CONTRACT:**

See Sheet ITS-1.01 For Index of Sheets

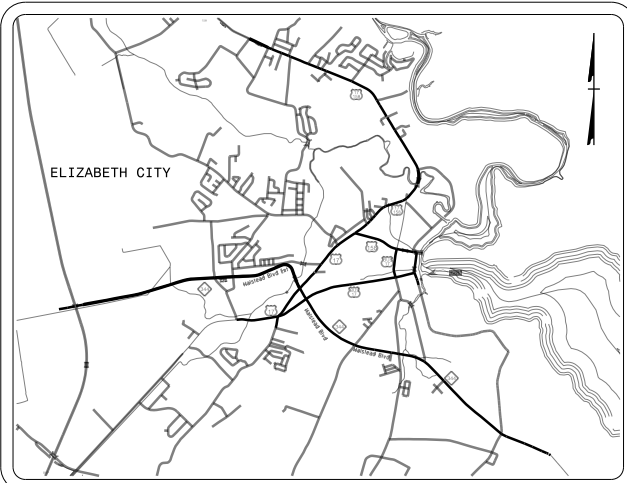

VICINITY MAP

# NORTH CAROLINA DEPARTMENT OF TRANSPORTATION

PLANS FOR PROPOSED IMPROVEMENTS

## ELIZABETH CITY

COMPUTERIZED TRAFFIC SIGNAL SYSTEM

REPLACEMENT OF VARIOUS STANDALONE CLOSED-LOOP TRAFFIC SIGNAL SYSTEMS WITH A NEW COMPUTERIZED TRAFFIC SIGNAL SYSTEM.

RELATED WORK INCLUDES:

UPGRADING LOCAL INTERSECTION CONTROLLERS, CABINETS, AND SYSTEM DETECTORS WITH LIMITED SIGNAL WIRING AND SIGNAL HEAD UPGRADES WHEN NECESSARY; UPGRADE AND EXPANSION OF CCTV MONITORING NETWORK; INSTALLING CENTRAL EQUIPMENT AND CENTRAL SOFTWARE; AND INSTALLATION OF AN ETHERNET COMMUNICATIONS NETWORK COMPRISED OF FIBER-OPTIC CABLE WITH ALL RELATED EQUIPMENT.



| STATE           | STATE PROJECT REFERENCE NO. | SHEET NO.   | TOTAL SHEETS |
|-----------------|-----------------------------|-------------|--------------|
| N.C.            | U-5942                      | ITS-1.00    |              |
| STATE PROJ. NO. | F.A. PROJ. NO.              | DESCRIPTION |              |
| 45861.1.1       |                             | PE          |              |
| 45861.X.X       | STGB-0111(25)               | CONST       |              |
|                 |                             |             |              |
|                 |                             |             |              |
|                 |                             |             |              |
|                 |                             |             |              |

Sheet 1 of 6

2018 STANDARD SPECIFICATION  
LETTING DATE: JANUARY 15, 2019  
PROJECT LENGTH = 20 MILES

Prepared for the Offices of:

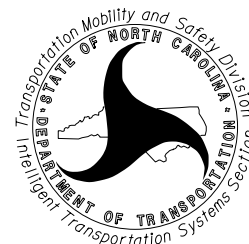

750 N. Greenfield Pkwy., Garner, NC 27529

NCDOT CONTACTS:  
TRANSPORTATION MOBILITY & SAFETY DIVISION  
INTELLIGENT TRANSPORTATION SYSTEMS SECTION

JASON GALLOWAY, P.E. - STATE SIGNALS ENGINEER  
NEIL AVERY - SIGNAL COMMUNICATION  
PROJECT ENGINEER

Plans Prepared By:



DRMP, Inc.  
8000 Regency Parkway, Suite 175  
Cary, NC 27518  
NC License No. C-2213 (919) 650-1038

LM MOON, P.E. - SENIOR PROJECT ENGINEER  
AJ DAVIS, P.E. - PROJECT DESIGN ENGINEER  
RD LAWTON, EIT - PROJECT ENGINEER  
DJ WHITE - PROJECT ENGINEER

INCOMPLETE PLANS  
DO NOT USE FOR R/W ACQUISITION

DOCUMENT NOT CONSIDERED FINAL  
UNLESS ALL SIGNATURES COMPLETED

November 27, 2018



27-Nov-2018 11:10  
 S:\175353\175353\SIGNAL\Signal Design Section\Eastern Region\01\U-5942\Permit\Sheet 2.dgn  
 GDI/lowy

DOCUMENT NOT CONSIDERED FINAL UNLESS ALL SIGNATURES COMPLETED

|               |  |  |  |
|---------------|--|--|--|
|               | <b>SITE 1</b>                          |  | SEAL<br><b>PRELIMINARY PLANS</b><br><small>DO NOT USE FOR CONSTRUCTION</small> |
|               | PLAN DATE: _____<br>PREPARED BY: _____ | REVIEWED BY: _____<br>REVIEWED BY: _____ |  |
| SCALE<br>0 40 | SIGNATURE _____<br>DATE _____          | INIT. _____<br>DATE _____                | SIG. INVENTORY NO. _____   |

November 27, 2018

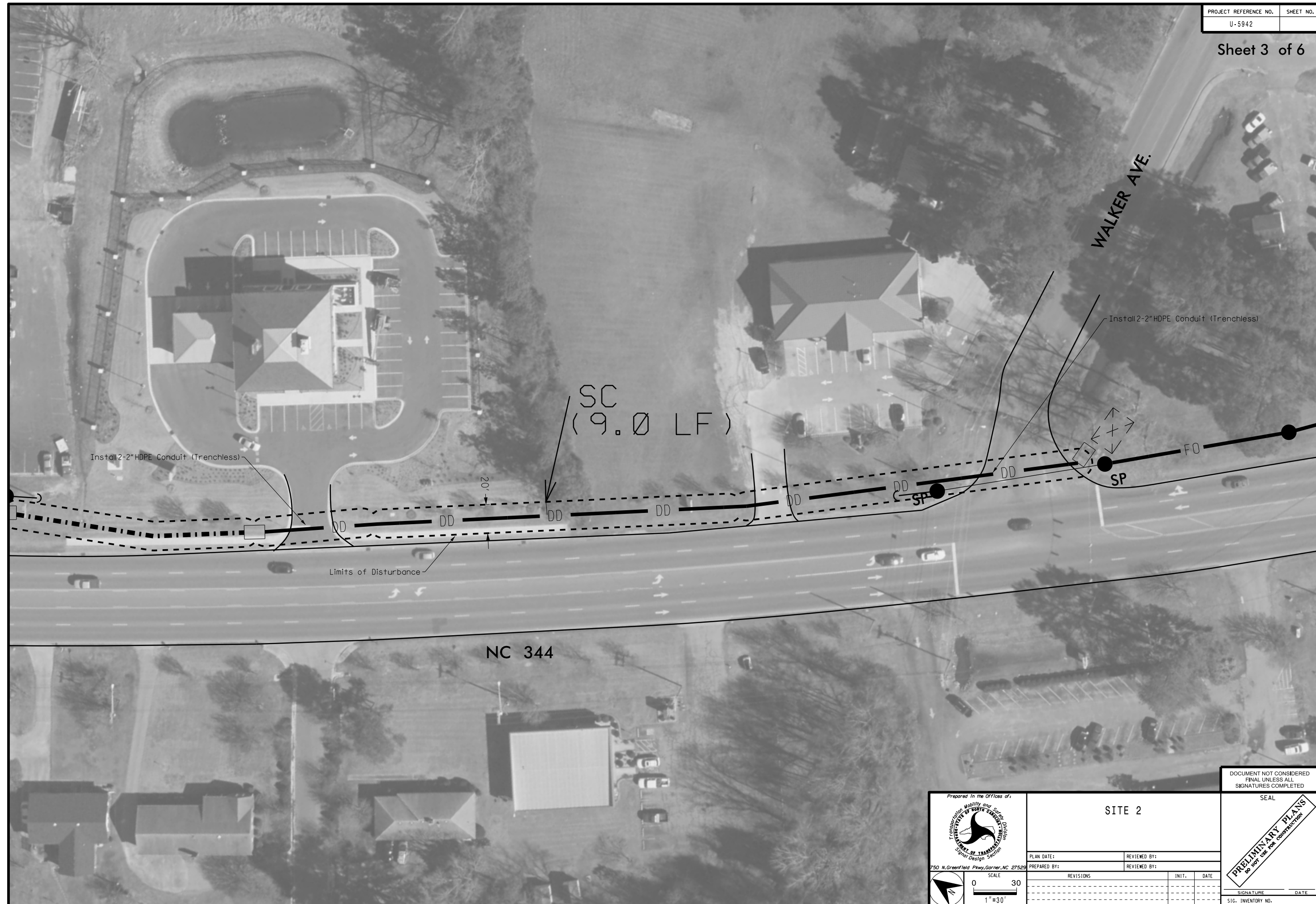

DOCUMENT NOT CONSIDERED FINAL UNLESS ALL SIGNATURES COMPLETED

|                |               |                    |      |
|----------------|---------------|--------------------|------|
|                | <b>SITE 2</b> |                    | SEAL |
|                | PLAN DATE:    | REVIEWED BY:       |      |
| PREPARED BY:   | REVIEWED BY:  |                    |      |
| SCALE          | REVISIONS     | INIT.              | DATE |
| 0 30<br>1"=30' |               |                    |      |
|                |               | SIGNATURE          | DATE |
|                |               | SIG. INVENTORY NO. |      |

November 27, 2018



27-Nov-2018 11:19  
 5:41:58 AM ITS\_Signals\SIGNAL Design Section\Eastern Region\01\U-5942\Permits\Permit Sheet 4.dgn  
 D:\JLowry

DOCUMENT NOT CONSIDERED  
 FINAL UNLESS ALL  
 SIGNATURES COMPLETED

|                         |  |  |  |
|-------------------------|--|--|--|
|                         | <b>SITE 3</b>                          |  | SEAL<br><b>PRELIMINARY PLANS</b><br><small>DO NOT USE FOR CONSTRUCTION</small> |
|                         | PLAN DATE: _____<br>PREPARED BY: _____ | REVIEWED BY: _____<br>REVIEWED BY: _____ |  |
| SCALE<br>0 30<br>1"=30' | INIT. DATE<br>_____                    | SIGNATURE DATE<br>_____                  | SIG. INVENTORY NO.   |

November 27, 2018



DOCUMENT NOT CONSIDERED FINAL UNLESS ALL SIGNATURES COMPLETED

|   |  |  |  |
|---|--|--|--|
| <p>750 N. Greenfield Pkwy, Garner, NC 27529</p> | <b>SITE 4 &amp; SITE 5</b>             |  | SEAL<br><b>PRELIMINARY PLANS</b><br><small>DO NOT USE FOR CONSTRUCTION</small> |
|   | PLAN DATE: _____<br>PREPARED BY: _____ | REVIEWED BY: _____<br>REVIEWED BY: _____ |  |
| SCALE<br>0 40<br>1"=40'                         | INIT. DATE<br>_____                    | SIGNATURE DATE<br>_____                  | SIG. INVENTORY NO.   |

November 27, 2018



(0.0122 ACRE) WC

SB  
(4.41 LF)

DOCUMENT NOT CONSIDERED FINAL UNLESS ALL SIGNATURES COMPLETED



750 N. Greenfield Pkwy, Garner, NC 27529

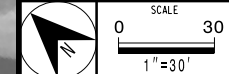

|              |              |
|--------------|--------------|
| SITE 6       |              |
| PLAN DATE:   | REVIEWED BY: |
| PREPARED BY: | REVIEWED BY: |
| REVISIONS    | INIT. DATE   |
|              |              |
|              |              |
|              |              |

|  |
|--|
| SEAL   |
| <b>PRELIMINARY PLANS</b><br><small>DO NOT USE FOR CONSTRUCTION</small> |
| SIGNATURE _____ DATE _____   |
| SIG. INVENTORY NO. _____   |



NORTH CAROLINA  
Environmental Quality

ROY COOPER  
Governor

MICHAEL S. REGAN  
Secretary

BRAXTON C. DAVIS  
Director

February 1, 2019

Phillip Harris III, P.E., C.P.M  
Environmental Analysis Unit  
NC Department of Transportation  
1598 Mail Service Center  
Raleigh, NC 27699-1598

RE: Refinement of CAMA Major Development Permit No. 149-10, Replacement of Bridge No. 19 on eastbound US 158 over the Pasquotank River in Pasquotank and Camden Counties, TIP No. U-4438.

Dear Mr. Harris:

This letter is in response to the request from the N.C. Department of Transportation (NCDOT) dated December 17, 2018, including a cover letter and four (4) drawings dated December 17, 2018. The request is for approval for utility work at the northwest corner of Veteran's Park in Elizabeth City adjacent to Bridge No. 19 over the Pasquotank River in Pasquotank County. NCDOT proposes to install a junction box at the base of an existing utility pole and replace a signal cabinet. The authorized activities would include temporary impacts due to trenching within the Coastal Shoreline Area of Environmental Concern (AEC). No impacts to wetlands or water of the State are proposed.

Please be advised that through this **Letter of Refinement**, the N.C. Division of Coastal Management (DCM) conveys its determination that the activities as described in your request dated December 17, 2018 are consistent with existing State rules and regulations and are in keeping with the original purpose and intent of CAMA Major Permit No. 149-10.

This Letter of Refinement shall be attached to the original of CAMA Major Permit No. 149-10, which was issued on December 22, 2010, as well as the Amendment issued on January 6, 2011, and all subsequent modifications and letters of refinement, and copies of all documents shall be readily available on site when a DCM representative inspects the project for compliance.

All conditions and stipulations of the active permit remain in force unless altered herein. This approval does not eliminate the need to obtain any additional permits, approvals or authorizations that may be required.





Letter of Refinement  
CAMA Major Permit No. 149-10  
U-4438, Pasquotank County  
February 1, 2019  
Page 2 of 2

Please contact Greg Daisey at (252) 264-3901 ext. 249 if you have any questions or concerns.

Sincerely,

A handwritten signature in cursive script that reads "Doug Huggett".

Doug Huggett  
Manager, Major Permits Section

cc: Greg Daisey, NCDCM  
Cathy Brittingham, NCDCM  
Kyle Barnes, USACE  
Garcy Ward, DWR

12/17/18

09/08/99

TIP PROJECT: U-5942

CONTRACT:

See Sheet ITS-1.01 For Index of Sheets

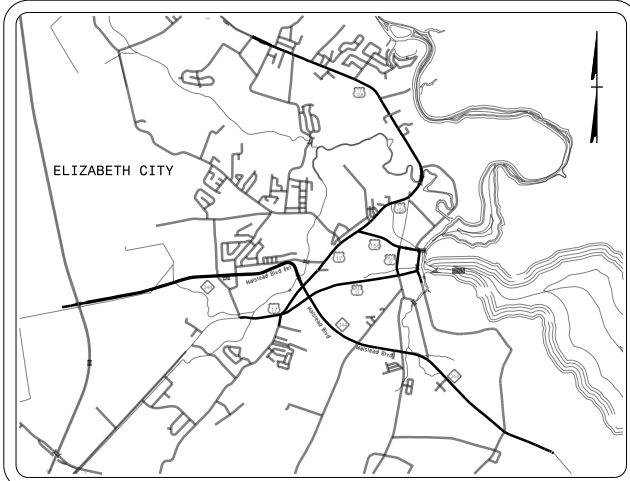

VICINITY MAP

# NORTH CAROLINA DEPARTMENT OF TRANSPORTATION

PLANS FOR PROPOSED IMPROVEMENTS

## ELIZABETH CITY

COMPUTERIZED TRAFFIC SIGNAL SYSTEM

REPLACEMENT OF VARIOUS STANDALONE CLOSED-LOOP TRAFFIC SIGNAL SYSTEMS WITH A NEW COMPUTERIZED TRAFFIC SIGNAL SYSTEM.

RELATED WORK INCLUDES:

UPGRADING LOCAL INTERSECTION CONTROLLERS, CABINETS, AND SYSTEM DETECTORS WITH LIMITED SIGNAL WIRING AND SIGNAL HEAD UPGRADES WHEN NECESSARY; UPGRADE AND EXPANSION OF CCTV MONITORING NETWORK; INSTALLING CENTRAL EQUIPMENT AND CENTRAL SOFTWARE; AND INSTALLATION OF AN ETHERNET COMMUNICATIONS NETWORK COMPRISED OF FIBER-OPTIC CABLE WITH ALL RELATED EQUIPMENT.

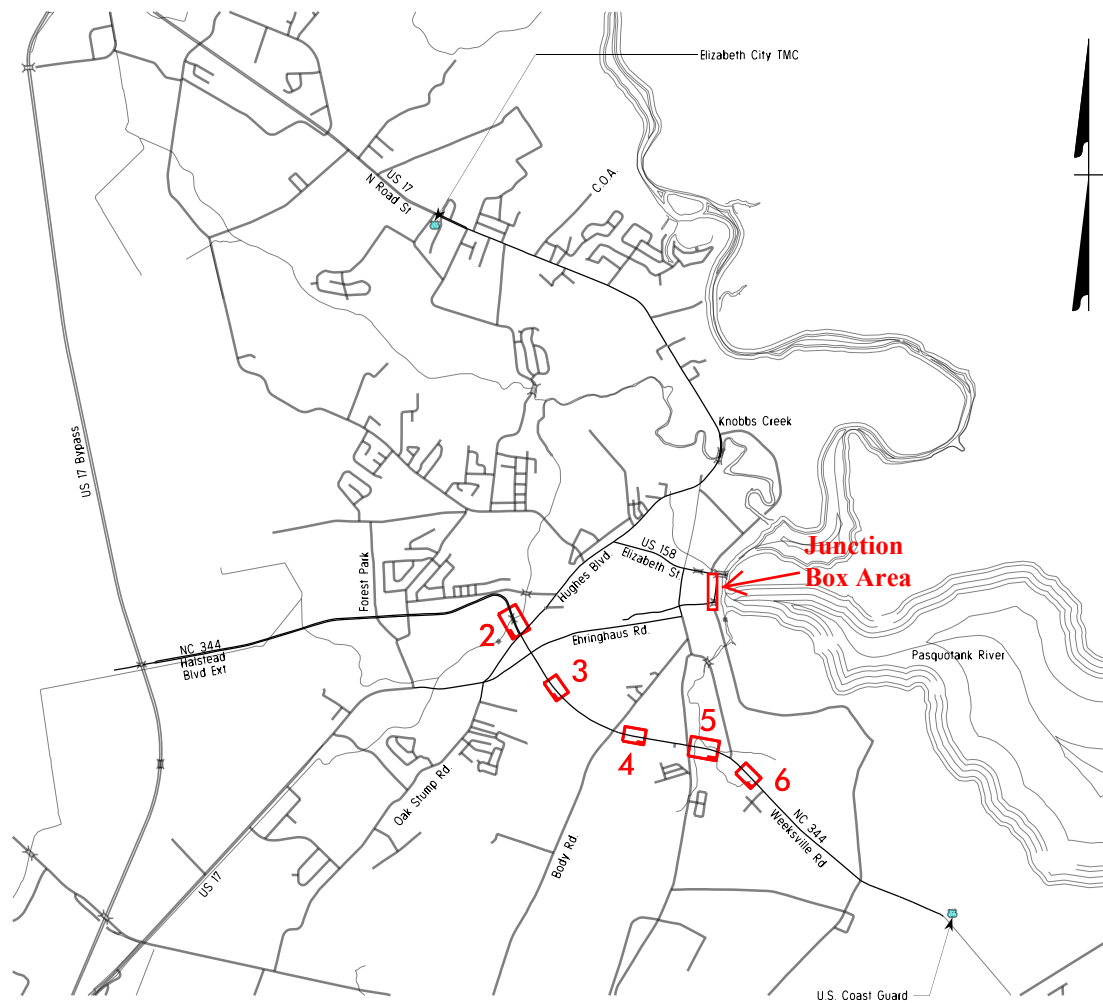

Utility Drawing  
Sheet 1 of 4

| STATE           | STATE PROJECT REFERENCE NO. | SHEET NO.   | TOTAL SHEETS |
|-----------------|-----------------------------|-------------|--------------|
| N.C.            | U-5942                      | ITS-1.00    |              |
| STATE PROJ. NO. | F.A. PROJ. NO.              | DESCRIPTION |              |
| 45861.1.1       |                             | PE          |              |
| 45861.X.X       | STGB-0111(25)               | CONST       |              |
|                 |                             |             |              |
|                 |                             |             |              |
|                 |                             |             |              |
|                 |                             |             |              |

\$\$\$\$\$SYTIME\$\$\$\$\$  
\$\$\$\$\$DDON\$\$\$\$\$  
\$\$\$\$\$USERNAME\$\$\$\$\$

2018 STANDARD SPECIFICATION  
LETTING DATE: JANUARY 15, 2019  
PROJECT LENGTH = 20 MILES

Prepared for the Offices of:



750 N. Greenfield Pkwy., Garner, NC 27529

NCDOT CONTACTS:  
TRANSPORTATION MOBILITY & SAFETY DIVISION  
INTELLIGENT TRANSPORTATION SYSTEMS SECTION

JASON GALLOWAY, P.E. - STATE SIGNALS ENGINEER  
NEIL AVERY - SIGNAL COMMUNICATION  
PROJECT ENGINEER

Plans Prepared By:



DRMP, Inc.  
8000 Regency Parkway, Suite 175  
Cary, NC 27518  
NC License No. C-2213 (919) 650-1038

LM MOON, P.E. - SENIOR PROJECT ENGINEER  
AJ DAVIS, P.E. - PROJECT DESIGN ENGINEER  
RD LAWTON, EIT - PROJECT ENGINEER  
DJ WHITE - PROJECT ENGINEER

INCOMPLETE PLANS  
DO NOT USE FOR R/W ACQUISITION

DOCUMENT NOT CONSIDERED FINAL  
UNLESS ALL SIGNATURES COMPLETED

12/17/18

MATCHLINE - SHEET CRP-036

MATCHLINE - SHEET CRP-038

# Utility Drawing Sheet 2 of 4

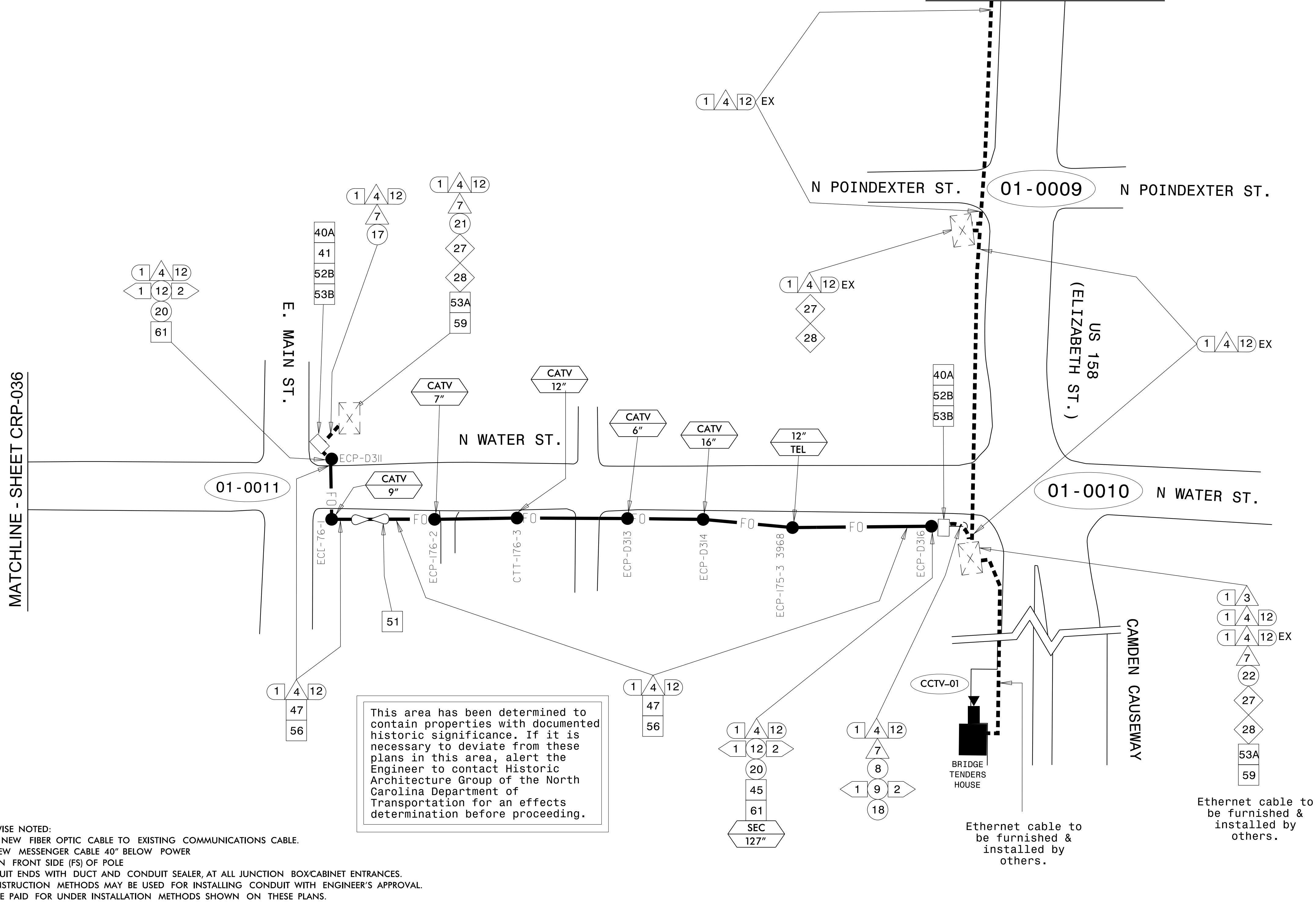

- NOTES:**
- UNLESS OTHERWISE NOTED:
    - OVERLASH NEW FIBER OPTIC CABLE TO EXISTING COMMUNICATIONS CABLE.
    - ATTACH NEW MESSENGER CABLE 40" BELOW POWER
    - ATTACH ON FRONT SIDE (FS) OF POLE
  - SEAL ALL CONDUIT ENDS WITH DUCT AND CONDUIT SEALER, AT ALL JUNCTION BOX/CABINET ENTRANCES.
  - ALTERNATE CONSTRUCTION METHODS MAY BE USED FOR INSTALLING CONDUIT WITH ENGINEER'S APPROVAL. CONDUIT WILL BE PAID FOR UNDER INSTALLATION METHODS SHOWN ON THESE PLANS.

|     |   |     |  |     |  |     |   |    |   |
|-----|---|-----|--|-----|--|-----|---|----|---|
| 1   | NOT USED  | 15  | DIRECTIONAL DRILL CONDUIT  | 29  | INSTALL UNDERGROUND SPLICE ENCLOSURE                     | 43  | NOT USED  | 55 | LASH CABLE(S) TO EXISTING MESSENGER CABLE       |
| 2   | NOT USED  | 16  | NOT USED   | 30  | INSTALL AERIAL SPLICE ENCLOSURE                          | 44  | INSTALL AERIAL GUY ASSEMBLY   | 56 | LASH CABLE(S) TO NEW MESSENGER CABLE            |
| 3   | INSTALL ETHERNET CABLE  | 17  | INSTALL CABLE(S) IN EXISTING CONDUIT   | 31  | NOT USED   | 45  | INSTALL STANDARD GUY ASSEMBLY   | 57 | HANDLASH AND INSTALL AERIAL CABLE PROTECTOR     |
| 4   | INSTALL SMFO CABLE  | 18  | INSTALL CABLE(S) IN NEW CONDUIT  | 32  | NOT USED   | 46  | INSTALL SIDEWALK GUY ASSEMBLY   | 58 | NOT USED  |
| 5   | NOT USED  | 19  | INSTALL CABLE(S) IN EXISTING RISER   | 33  | NOT USED   | 47  | INSTALL MESSENGER CABLE   | 59 | BOND TRACER WIRE TO EQUIPMENT GROUND BUS        |
| 6   | INSTALL FIBER OPTIC DROP CABLE                                    | 20  | INSTALL CABLE(S) IN NEW RISER  | 34  | NOT USED   | 48A | REMOVE EXISTING COMMUNICATIONS CABLE AND MESSENGER CABLE                  | 60 | DO NOT BOND TRACER WIRE TO EQUIPMENT GROUND BUS |
| 7   | INSTALL TRACER WIRE   | 21  | INSTALL CABLE(S) IN EXISTING CONDUIT STUBOUTS  | 35  | NOT USED   | 48B | REMOVE EXISTING COMMUNICATIONS CABLE                                      | 61 | BOND RISER AND MESSENGER CABLE TO POLE GROUND   |
| 8   | TRENCH  | 22  | INSTALL NEW CONDUIT INTO EXISTING CABINET BASE (USE EXISTING CONDUIT STUB-OUTS WHEN AVAILABLE) | 36  | INSTALL CCTV CAMERA ASSEMBLY                             | 49  | NOT USED  | 62 | BOND RISER TO POLE GROUND                       |
| 9   | INSTALL PVC CONDUIT   | 23  | INSTALL NEW RISER INTO EXISTING CABINET BASE (USE EXISTING CONDUIT STUB-OUTS WHEN AVAILABLE)   | 37  | INSTALL CCTV CAMERA 50' WOOD POLE                        | 50  | NOT USED  | 63 | BOND MESSENGER CABLE TO POLE GROUND             |
| 10  | INSTALL RIGID, GALVANIZED STEEL CONDUIT                           | 24  | INSTALL NEW CONDUIT INTO EXISTING POLE MOUNTED CABINET   | 38  | NOT USED   | 51  | INSTALL CABLE STORAGE RACKS (SNOW SHOES) AND STORE 100 FEET OF EACH CABLE | 64 | INSTALL MOLDABLE DUCT SEAL                      |
| 11  | INSTALL RIGID, GALVANIZED STEEL RISER WITH WEATHERHEAD            | 25  | INSTALL NEW RISER INTO EXISTING POLE MOUNTED CABINET   | 39  | INSTALL JUNCTION BOX                                     | 52A | INSTALL DELINEATOR MARKER   | 65 | SLACK SPAN                                      |
| 12  | INSTALL RIGID, GALVANIZED STEEL RISER WITH FIBER OPTIC CABLE SEAL | 26A | MODIFY EXISTING INTERCONNECT CENTER /SPLICE ENCLOSURE  | 40A | INSTALL OVERSIZED JUNCTION BOX                           | 52B | INSTALL JUNCTION BOX MARKER   |    |   |
| 13  | INSTALL HEAT SHRINK TUBING RETROFIT KIT                           | 26B | MODIFY/RELOCATE EXISTING FIBER OPTIC TRANSCEIVER   | 40B | INSTALL SPECIAL OVERSIZED JUNCTION BOX (36" x 24" x 24") | 53A | STORE 30 FEET OF COMMUNICATIONS CABLE                                     |    |   |
| 14A | NOT USED  | 27  | INSTALL NEW ETHERNET EDGE SWITCH IN CABINET  | 41  | REMOVE EXISTING JUNCTION BOX                             | 53B | STORE 50 FEET OF EACH COMMUNICATIONS CABLE                                |    |   |
| 14B | INSTALL POLYETHYLENE CONDUIT                                      | 28  | INSTALL INTERCONNECT CENTER, PATCH PANEL, JUMPERS, AND FUSION SPLICE CABLE IN CABINET          | 42  | INSTALL WOOD POLE  | 54  | LASH CABLE(S) TO EXISTING SIGNAL/COMMUNICATIONS CABLE                     |    |   |

Plans Prepared By:

DRMP, Inc.  
8000 Regency Parkway, Suite 175  
Cary, NC 27513  
NC License No. C-2213 (919) 650-1038

DOCUMENT NOT CONSIDERED FINAL UNLESS ALL SIGNATURES COMPLETED

|                    |                               |                               |                  |                                     |                                     |
|--------------------|-------------------------------|-------------------------------|------------------|-------------------------------------|-------------------------------------|
| NUMBER OF CABLE(S) | NUMBER OF RISER(S)/CONDUIT(S) | NUMBER OF FIBER/TWISTED PAIRS | ATTACHMENT POINT | DISTANCE ABOVE (IN) REFERENCE POINT | DISTANCE BELOW (IN) REFERENCE POINT |
| XX                 | XX                            | XX                            | XX               | XXXX                                | XX                                  |

Prepared for the Offices of:

Elizabeth City Signal System Cable Routing Plans

Division 1 Pasquotank County Elizabeth City

PLAN DATE: April 2018 REVIEWED BY: LM Moon

PREPARED BY: RD Lawton REVIEWED BY:

750 N. Greenfield Pkwy., Garner, NC 27529

SCALE: 0 50  
1" = 50'

SEAL  
LISA M. MOON  
ENGINEER  
9/20/2018

CADD File name: CRP-037.dgn

# INSTALLATION CROSS-SECTION

## JUNCTION BOX OVER-SIZED

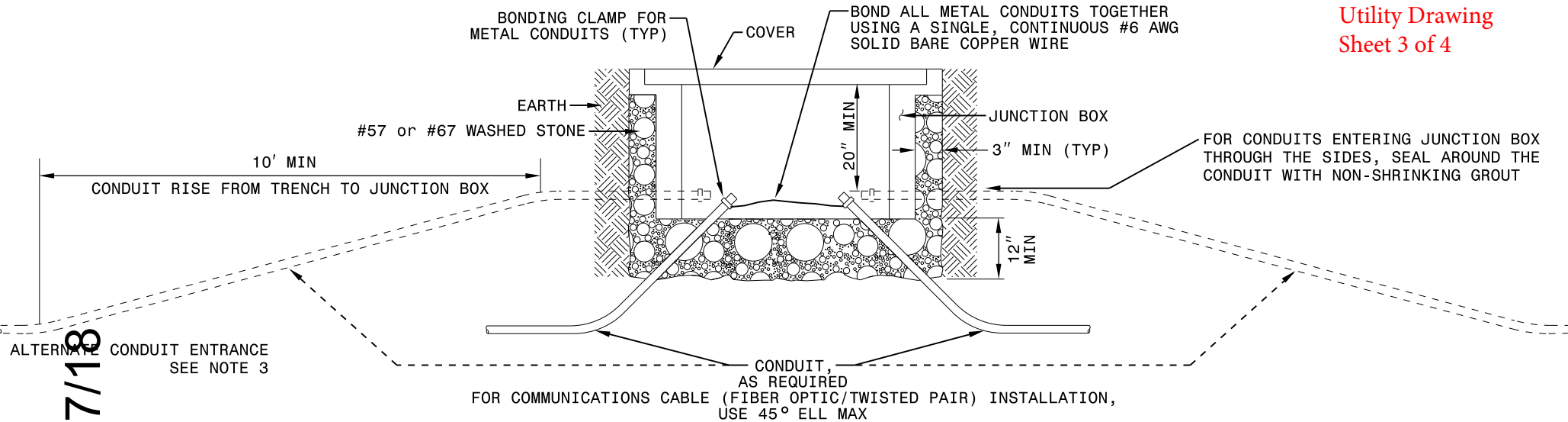

Utility Drawing  
Sheet 3 of 4

12/17/18

### TOP VIEW OF COVER

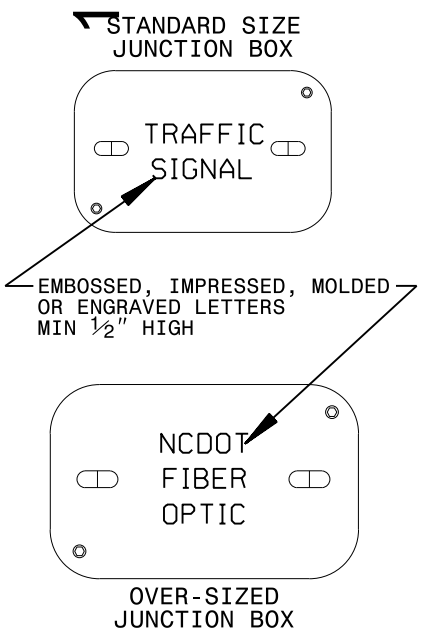

### NOTES

1. OTHER STYLES OF JUNCTION BOXES WILL BE ACCEPTABLE PROVIDED THEY SATISFY REQUIREMENTS OF SECTION 1716 OF THE NCDOT STANDARD SPECIFICATIONS FOR ROADS AND STRUCTURES.
2. SECURE COVER WITH TWO HEX BOLTS.
3. INSTALL CONDUIT THROUGH BOTTOM OF JUNCTION BOX. AS AN ALTERNATIVE, CONDUIT MAY ENTER THROUGH "MOUSE HOLE" INTO SIDE OF JUNCTION BOX.
4. FOR CURB AND GUTTER SECTIONS, LOCATE JUNCTION BOXES A MINIMUM OF 6" BEHIND BACK OF CURB AND FOR PAVEMENT SECTIONS A MINIMUM OF 2' FROM PAVEMENT EDGE OR WITHIN RIGHT OF WAY.
5. COIL AND STORE 10' OF TRACER WIRE IN ALL JUNCTION BOXES WITH FIBER OPTIC CABLE.

## JUNCTION BOX STANDARD SIZE

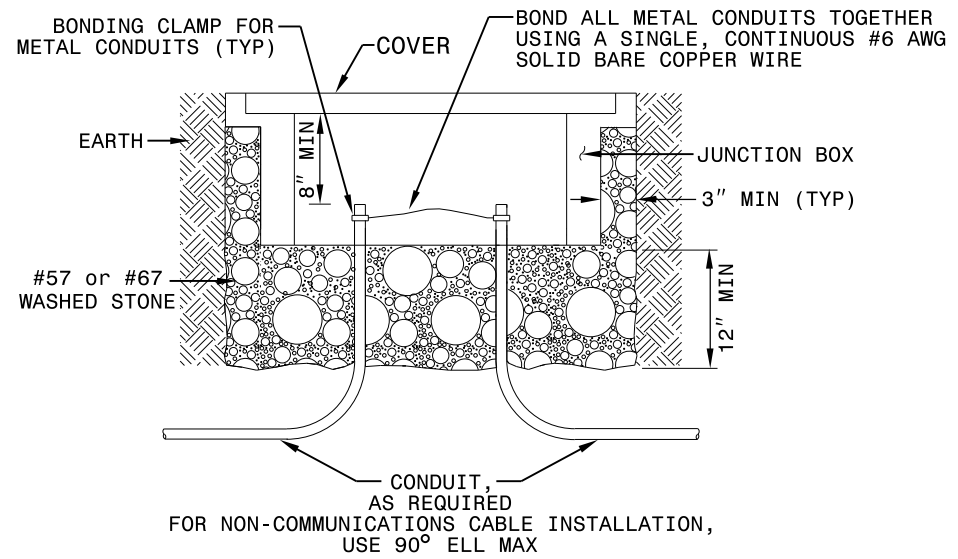

STATE OF  
NORTH CAROLINA  
DEPT. OF TRANSPORTATION  
DIVISION OF HIGHWAYS  
RALEIGH, N.C.

1-18 ROADWAY STANDARD DRAWING FOR  
**JUNCTION BOXES**  
SHEET 1 OF 1  
**1716.01**

12/17/18

**NOTE**

THE CONTRACTOR, WITH APPROVAL FROM THE ENGINEER, MAY ADJUST FINAL BURIAL DEPTH OF CONDUIT(S) IN ORDER TO TRAVERSE NON-MOVABLE OBJECTS.

**CONDUIT TRENCHING**

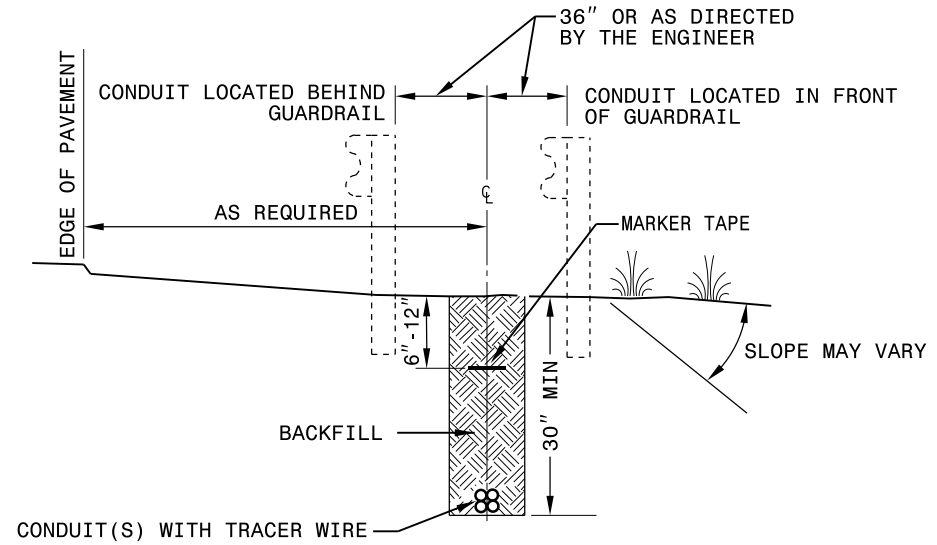

**CONDUIT TRENCHING AROUND NON-MOVABLE OBJECT**

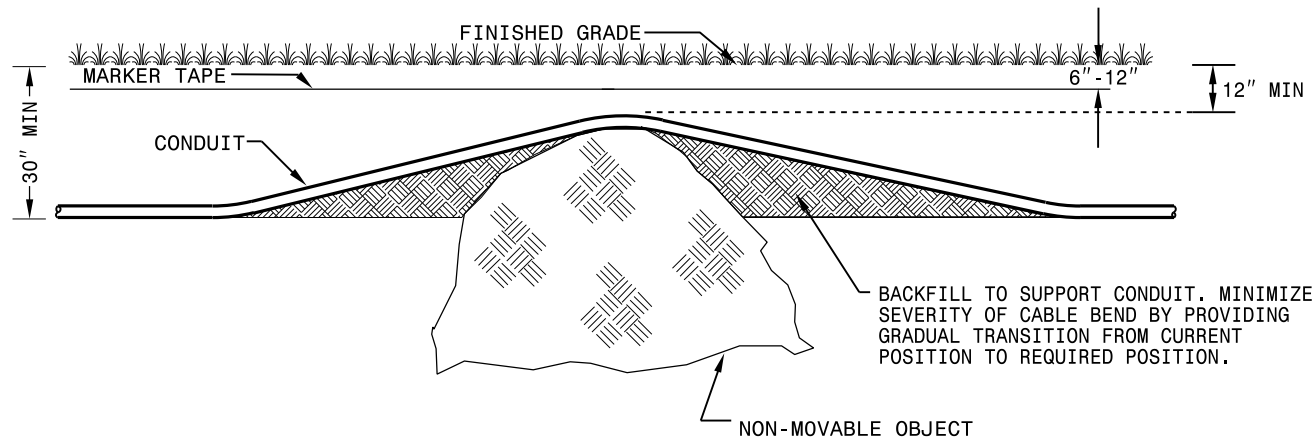

1-18