



STATE OF NORTH CAROLINA  
DEPARTMENT OF TRANSPORTATION

PAT MCCRORY  
GOVERNOR

ANTHONY J. TATA  
SECRETARY

July 7, 2015

MEMORANDUM TO: Mr. Greg Burns, P.E.  
Division 6 Engineer

FROM:  Philip S. Harris, III, P.E., Manager  
Natural Environment Section  
Project Development and Environmental Analysis Unit

SUBJECT: Columbus County, Bridge No. 269 on SR 1849 (Delco-Prosper Road) over Big Branch; Federal Aid Project No. BRZ-1849 (1); WBS No. 46045.1.1; **TIP Project B-5331.**

Attached are the U.S. Army Corps of Engineers (USACE) Section 404 Nationwide Permit and the N.C. Division of Water Resources (DWR) Section 401 Water Quality Certification. All environmental permits have been received for the construction of this project.

A copy of this permit package posted on the NCDOT Website at <https://connect.ncdot.gov/resources/Environmental>, under *Quick Links > Issued Permits*

cc: w/o attachment (see website for attachments):

Mr. Randy Garris, P.E. State Contract Officer  
Mr. James J. Rerko, Division Environmental Officer  
Dr. Majed Alghandour, P.E., Programming and TIP  
Mr. Roger Thomas, P.E., Roadway Design Unit  
Ms. Brenda Moore, P.E., Roadway Design Unit  
Mr. Robert Memory, Utilities Unit  
Mr. Jay Twisdale, P.E., Hydraulics Unit  
Mr. Tom Koch, P.E., Structure Design Unit  
Mr. Mark Staley, Roadside Environmental Unit  
Mr. Ron Hancock, P.E., State Roadway Construction Engineer  
Mr. Kevin Bowen, P.E., State Bridge Construction Engineer  
Mr. Rob Hanson, P.E., PDEA  
Ms. Beth Harmon, NCDMR  
Ms. Linda Fitzpatrick, Natural Environment Section  
Mr. Phillip Ayscue, Office of Inspector general

# PROJECT COMMITMENTS

TIP Project No. B-5331  
Bridge No. 269 on SR 1849  
over Big Branch  
Columbus County  
Federal Aid Project No. BRZ-1849(1)  
W.B.S. No. 46045.1.1

## COMMITMENTS FROM PROJECT DEVELOPMENT AND DESIGN

### **Division Six, Resident Engineer's Office – Offsite Detour**

Contact at least one month prior to road closure, the Schools and Emergency Services for them to make any necessary temporary changes in their routes.

### **Division Six – As Built Construction Plans**

This project involves construction activities on or adjacent to FEMA-regulated stream(s). Therefore, the Division shall submit sealed as built construction plans to the Hydraulics Unit upon completion of project construction, certifying that the drainage structures and roadway embankment that are located within the 100-year floodplain were built as shown in the construction plans, both horizontally and vertically.

### **Hydraulics Unit – FEMA Coordination**

The Hydraulics Unit will coordinate with the NC Floodplain Mapping Program (FMP), to determine status of project with regard to applicability of NCDOT's Memorandum of Agreement, or approval of a Conditional Letter of Map Revision (CLOMR) and subsequent final Letter of Map Revision (LOMR)

## COMMITMENTS FROM PERMITTING

There were no special commitments from permitting.

**U.S. ARMY CORPS OF ENGINEERS  
WILMINGTON DISTRICT**

Action Id. SAW-2011-00063 County: Columbus U.S.G.S. Quad: NC-ACME

**GENERAL PERMIT (REGIONAL AND NATIONWIDE) VERIFICATION**

Permittee: NCDOT  
Mr. Richard Hancock  
Address: 1598 Mail Service Center  
Raleigh, NC, 27699

Size (acres)	<u>n/a</u>	Nearest Town	<u>Acme-Delco</u>
Nearest Waterway	<u>Bay Branch</u>	River Basin	<u>Lower Cape Fear</u>
USGS HUC	<u>03030005</u>	Coordinates	Latitude: <u>34.3000301200049</u> Longitude: <u>-78.2160690257761</u>

Location description: The project site is located at existing bridge number 269 over Big Branch, on SR 1849 (Delco-Prosper Road), in Columbus County, North Carolina.

Description of projects area and activity: This verification authorizes impacts to waters of the U.S. in association with an NC DOT bridge replacement project. Permanent impacts authorized total 0.06 acre wetland for the placement of fill material necessary for the approaches to the new bridge. Additional impacts associated with the bridge replacement authorized total 0.14 acre of wetland excavation, 0.09 acre in wetlands for hand clearing of vegetation and 0.02 acre temporary fill necessary to complete the project. Temporary impacts associated with a utility line activity are also authorized and total 0.17 acre hand clearing in wetlands.

Applicable Law:  Section 404 (Clean Water Act, 33 USC 1344)  
 Section 10 (Rivers and Harbors Act, 33 USC 403)

Authorization: Regional General Permit Number or Nationwide Permit Number: NWP 23/12  
***SEE ATTACHED RGP or NWP GENERAL, REGIONAL AND SPECIAL CONDITIONS***

Your work is authorized by the above referenced permit provided it is accomplished in strict accordance with the attached conditions and your submitted application and attached information dated March 27, 2015. Any violation of the attached conditions or deviation from your submitted plans may subject the permittee to a stop work order, a restoration order, a Class I administrative penalty, and/or appropriate legal action.

This verification will remain valid until the expiration date identified below unless the nationwide authorization is modified, suspended or revoked. If, prior to the expiration date identified below, the nationwide permit authorization is reissued and/or modified, this verification will remain valid until the expiration date identified below, provided it complies with all requirements of the modified nationwide permit. If the nationwide permit authorization expires or is suspended, revoked, or is modified, such that the activity would no longer comply with the terms and conditions of the nationwide permit, activities which have commenced (i.e., are under construction) or are under contract to commence in reliance upon the nationwide permit, will remain authorized provided the activity is completed within twelve months of the date of the nationwide permit's expiration, modification or revocation, unless discretionary authority has been exercised on a case-by-case basis to modify, suspend or revoke the authorization.

Activities subject to Section 404 (as indicated above) may also require an individual Section 401 Water Quality Certification. You should contact the NC Division of Water Quality (telephone 919-807-6300) to determine Section 401 requirements.

For activities occurring within the twenty coastal counties subject to regulation under the Coastal Area Management Act (CAMA), prior to beginning work you must contact the N.C. Division of Coastal Management in Morehead City, NC, at (252) 808-2808.

This Department of the Army verification does not relieve the permittee of the responsibility to obtain any other required Federal, State or local approvals/permits.

If there are any questions regarding this verification, any of the conditions of the Permit, or the Corps of Engineers regulatory program, please contact Sarah Hair at 910-251-4049 or Sarah.E.Hair@usace.army.mil.

Corps Regulatory Official: HAIR.SARAH.E Date: June 12, 2015  
Expiration Date of Verification: A.1054693512  
March 18, 2017

Digitally signed by  
HAIR.SARAH.E.1054693512  
DN: c=US, o=U.S. Government,  
ou=DoD, ou=PKI, ou=USA,  
cn=HAIR.SARAH.E.1054693512  
Date: 2015.06.12 15:48:42 -0400

**Determination of Jurisdiction:**

- A.  Based on preliminary information, there appear to be waters of the US including wetlands within the above described project area. This preliminary determination is not an appealable action under the Regulatory Program Administrative Appeal Process (Reference 33 CFR Part 331).
- B.  There are Navigable Waters of the United States within the above described project area subject to the permit requirements of Section 10 of the Rivers and Harbors Act and Section 404 of the Clean Water Act. Unless there is a change in the law or our published regulations, this determination may be relied upon for a period not to exceed five years from the date of this notification.
- C.  There are waters of the US and/or wetlands within the above described project area subject to the permit requirements of Section 404 of the Clean Water Act (CWA)(33 USC § 1344). Unless there is a change in the law or our published regulations, this determination may be relied upon for a period not to exceed five years from the date of this notification.
- D.  The jurisdictional areas within the above described project area have been identified under a previous action. Please reference jurisdictional determination issued . Action ID: SAW-

**Basis For Determination:**

**Remarks:**

**E. Attention USDA Program Participants**

This delineation/determination has been conducted to identify the limits of Corps' Clean Water Act jurisdiction for the particular site identified in this request. The delineation/determination may not be valid for the wetland conservation provisions of the Food Security Act of 1985. If you or your tenant are USDA Program participants, or anticipate participation in USDA programs, you should request a certified wetland determination from the local office of the Natural Resources Conservation Service, prior to starting work.

**F. Appeals Information (This information applies only to approved jurisdictional determinations as indicated in B and C above).**

This correspondence constitutes an approved jurisdictional determination for the above described site. If you object to this determination, you may request an administrative appeal under Corps regulations at 33 CFR Part 331. Enclosed you will find a Notification of Appeal Process (NAP) fact sheet and request for appeal (RFA) form. If you request to appeal this determination you must submit a completed RFA form to the following address:

US Army Corps of Engineers  
South Atlantic Division  
Attn: Jason Steele, Review Officer  
60 Forsyth Street SW, Room 10M15  
Atlanta, Georgia 30303-8801  
Phone: (404) 562-5137

In order for an RFA to be accepted by the Corps, the Corps must determine that it is complete, that it meets the criteria for appeal under 33 CFR part 331.5, and that it has been received by the Division Office within 60 days of the date of the NAP. Should you decide to submit an RFA form, it must be received at the above address by N/A.

\*\*It is not necessary to submit an RFA form to the Division Office if you do not object to the determination in this correspondence.\*\*

Corps Regulatory Official: \_\_\_\_\_

  
Sarah Hail

Date of JD: **June 12, 2015**  
Expiration Date of JD: N/A



The Wilmington District is committed to providing the highest level of support to the public. To help us ensure we continue to do so, please complete our customer Satisfaction Survey online at <http://regulatory.usacesurvey.com/>.

Copy furnished (e-copy):

Mr. Jim Rerko, NC DOT Division 6, DEO

Mr. Gordon Cashin, NC DOT, PDEA

Mr. Mason Herndon, NC DENR-DWR

## **SPECIAL CONDITIONS**

- 1) All work must be performed in strict compliance with the plans received by this office on 3-27-2015, which are a part of this permit. Any modification to the permit plans must be approved by the USACE prior to implementation
- 2) Failure to institute and carry out the details of these special conditions will result in a directive to cease all ongoing and permitted work within waters and/or wetlands associated with the permitted project, or such other remedies and/or fines as the District Engineer or his authorized representatives may seek.
- 3) The permittee shall require its contractors and/or agents to comply with the terms and conditions of this permit in the construction and maintenance of this project, and shall provide each of its contractors and/or agents associated with the construction or maintenance of this project with a copy of this permit, and any authorized modifications. A copy of this permit, and any authorized modifications, including all conditions, shall be available at the project site during construction and maintenance of this project.
- 4) This permit does not authorize temporary placement or double handling of excavated or fill material within waters or wetlands outside the permitted area.
- 5) The permittee will report any violation of these conditions or violations of Section 404 of the Clean Water Act or Section 10 of the Rivers and Harbors Act in writing to the Wilmington District, U. S Army Corps of Engineers, within 24 hours of the permittee's discovery of the violation.
- 6) In order to compensate for impacts associated with this permit, mitigation shall be provided in accordance with the provisions outlined on the most recent version of the attached Compensatory Mitigation Responsibility Transfer Form. The requirements of this form, including any special conditions listed on this form, are hereby incorporated as special conditions of this permit authorization.

Action ID Number: SAW-2011-00063

County: Columbus

Permittee: NCDOT

Project Name: NCDOT/B-5331/BR 269/SR 184/Div 6

Date Verification Issued: June 12, 2015

Project Manager: Sarah Hair

Upon completion of the activity authorized by this permit and any mitigation required by the permit, sign this certification and return it to the following address:

US ARMY CORPS OF ENGINEERS  
WILMINGTON DISTRICT  
Attn: Sarah Hair  
69 Darlington Avenue  
Wilmington, North Carolina 28403

Please note that your permitted activity is subject to a compliance inspection by a U. S. Army Corps of Engineers representative. Failure to comply with any terms or conditions of this authorization may result in the Corps suspending, modifying or revoking the authorization and/or issuing a Class I administrative penalty, or initiating other appropriate legal action.

I hereby certify that the work authorized by the above referenced permit has been completed in accordance with the terms and condition of the said permit, and required mitigation was completed in accordance with the permit conditions.

\_\_\_\_\_  
Signature of Permittee

\_\_\_\_\_  
Date

**U.S. ARMY CORPS OF ENGINEERS**  
**Wilmington District**  
**Compensatory Mitigation Responsibility Transfer Form**

**Permittee:** NC DOT, Mr. Richard Hancock  
**Project Name:** NC DOT bridge 269/ B-5331

**Action ID:** SAW-2011-00063  
**County:** Columbus

**Instructions to Permittee:** The Permittee must provide a copy of this form to the Mitigation Sponsor, either an approved Mitigation Bank or the North Carolina Ecosystem Enhancement Program (NCEEP), who will then sign the form to verify the transfer of the mitigation responsibility. Once the Sponsor has signed this form, it is the Permittee's responsibility to ensure that to the U.S. Army Corps of Engineers (USACE) Project Manager identified on page two is in receipt of a signed copy of this form before conducting authorized impacts, unless otherwise specified below. If more than one mitigation Sponsor will be used to provide the mitigation associated with the permit, or if the impacts and/or the mitigation will occur in more than one 8-digit Hydrologic Unit Code (HUC), multiple forms will be attached to the permit, and the separate forms for each Sponsor and/or HUC must be provided to the appropriate mitigation Sponsors.

**Instructions to Sponsor:** The Sponsor must verify that the mitigation requirements (credits) shown below are available at the identified site. By signing below, the Sponsor is accepting full responsibility for the identified mitigation, regardless of whether or not they have received payment from the Permittee. Once the form is signed, the Sponsor must update the bank ledger and provide a copy of the signed form and the updated bank ledger to the Permittee, the USACE Project Manager, and the Wilmington District Mitigation Office (see contact information on page 2). The Sponsor must also comply with all reporting requirements established in their authorizing instrument.

**Permitted Impacts and Compensatory Mitigation Requirements:**

Permitted Impacts Requiring Mitigation*			8-digit HUC and Basin: 03030005, Cape Fear River Basin			
Stream Impacts (linear feet)			Wetland Impacts (acres)			
Warm	Cool	Cold	Riparian Riverine	Riparian Non-Riverine	Non-Riparian	Coastal
			0.06			

\*If more than one mitigation sponsor will be used for the permit, only include impacts to be mitigated by this sponsor.

Compensatory Mitigation Requirements:			8-digit HUC and Basin: 03030005, Cape Fear River Basin			
Stream Mitigation (credits)			Wetland Mitigation (credits)			
Warm	Cool	Cold	Riparian Riverine	Riparian Non-Riverine	Non-Riparian	Coastal
			0.12			

**Mitigation Site Debited:** NC EEP (now DMS)  
 (List the name of the bank to be debited. For umbrella banks, also list the specific site. For NCEEP, list NCEEP. If the NCEEP acceptance letter identifies a specific site, also list the specific site to be debited).

<b>Section to be completed by the Mitigation Sponsor</b>	
<p><b>Statement of Mitigation Liability Acceptance:</b> I, the undersigned, verify that I am authorized to approve mitigation transactions for the Mitigation Sponsor shown below, and I certify that the Sponsor agrees to accept full responsibility for providing the mitigation identified in this document (see the table above), associated with the USACE Permittee and Action ID number shown. I also verify that released credits (and/or advance credits for NCEEP), as approved by the USACE, are currently available at the mitigation site identified above. Further, I understand that if the Sponsor fails to provide the required compensatory mitigation, the USACE Wilmington District Engineer may pursue measures against the Sponsor to ensure compliance associated with the mitigation requirements.</p>	
<p><b>Mitigation Sponsor Name:</b> _____</p>	
<p><b>Name of Sponsor's Authorized Representative:</b> _____</p>	
<p>_____  <b>Signature of Sponsor's Authorized Representative</b></p>	<p>_____  <b>Date of Signature</b></p>

**USACE Wilmington District  
Compensatory Mitigation Responsibility Transfer Form, Page 2**

**Conditions for Transfer of Compensatory Mitigation Credit:**

- Once this document has been signed by the Mitigation Sponsor and the USACE is in receipt of the signed form, the Permittee is no longer responsible for providing the mitigation identified in this form, though the Permittee remains responsible for any other mitigation requirements stated in the permit conditions.
- Construction within jurisdictional areas authorized by the permit identified on page one of this form can begin only after the USACE is in receipt of a copy of this document signed by the Sponsor, confirming that the Sponsor has accepted responsibility for providing the mitigation requirements listed herein. For authorized impacts conducted by the North Carolina Department of Transportation (NCDOT), construction within jurisdictional areas may proceed upon permit issuance; however, a copy of this form signed by the Sponsor must be provided to the USACE within 30 days of permit issuance. NCDOT remains fully responsible for the mitigation until the USACE has received this form, confirming that the Sponsor has accepted responsibility for providing the mitigation requirements listed herein.
- Signed copies of this document must be retained by the Permittee, Mitigation Sponsor, and in the USACE administrative records for both the permit and the Bank/ILF Instrument. It is the Permittee's responsibility to ensure that the USACE Project Manager (address below) is provided with a signed copy of this form.
- If changes are proposed to the type, amount, or location of mitigation after this form has been signed and returned to the USACE, the Sponsor must obtain case-by-case approval from the USACE Project Manager and/or North Carolina Interagency Review Team (NCIRT). If approved, higher mitigation ratios may be applied, as per current District guidance and a new version of this form must be completed and included in the USACE administrative records for both the permit and the Bank/ILF Instrument.

**Comments/Additional Conditions:**

Impacts requiring compensatory mitigation at the project site are limited to permanent fill impacts of 0.06 acre wetland at a 2:1 ratio.

This form is not valid unless signed below by the USACE Project Manager and by the Mitigation Sponsor on Page 1. **Once signed, the Sponsor should provide copies of this form along with an updated bank ledger to: 1) the Permittee, 2) the USACE Project Manager at the address below, and 3) the Wilmington District Mitigation Office, Attn: Todd Tugwell, 11405 Falls of Neuse Road, Wake Forest, NC 27587 (email: [todd.tugwell@usace.army.mil](mailto:todd.tugwell@usace.army.mil)).** Questions regarding this form or any of the permit conditions may be directed to the USACE Project Manager below.

**USACE Project Manager:** Liz Hair  
**USACE Field Office:** Wilmington Regulatory Field Office  
US Army Corps of Engineers  
69 Darlington Avenue  
Wilmington, NC 28403

**Email:**

**HAIR.SARAH.E  
A.1054693512**

Digitally signed by  
HAIR.SARAH.EA.1054693512  
DN: c=US, o=U.S. Government,  
ou=DoD, ou=PKI, ou=USA,  
cn=HAIR.SARAH.EA.1054693512  
Date: 2015.06.12 15:56:55 -04'00'

June 12, 2015

**USACE Project Manager Signature**

**Date of Signature**

Current Wilmington District mitigation guidance, including information on mitigation ratios, functional assessments, and mitigation bank location and availability, and credit classifications (including stream temperature and wetland groupings) is available at <http://ribits.usace.army.mil>.

**NATIONWIDE PERMIT 12**  
**DEPARTMENT OF THE ARMY**  
**CORPS OF ENGINEERS**  
**FINAL NOTICE OF ISSUANCE AND MODIFICATION OF NATIONWIDE PERMITS**  
**FEDERAL REGISTER**  
**AUTHORIZED MARCH 19, 2012**

**Utility Line Activities.** Activities required for the construction, maintenance, repair, and removal of utility lines and associated facilities in waters of the United States, provided the activity does not result in the loss of greater than 1/2-acre of waters of the United States for each single and complete project.

**Utility lines:** This NWP authorizes the construction, maintenance, or repair of utility lines, including outfall and intake structures, and the associated excavation, backfill, or bedding for the utility lines, in all waters of the United States, provided there is no change in pre-construction contours. A “utility line” is defined as any pipe or pipeline for the transportation of any gaseous, liquid, liquescent, or slurry substance, for any purpose, and any cable, line, or wire for the transmission for any purpose of electrical energy, telephone, and telegraph messages, and radio and television communication. The term “utility line” does not include activities that drain a water of the United States, such as drainage tile or french drains, but it does apply to pipes conveying drainage from another area.

Material resulting from trench excavation may be temporarily sidecast into waters of the United States for no more than three months, provided the material is not placed in such a manner that it is dispersed by currents or other forces. The district engineer may extend the period of temporary side casting for no more than a total of 180 days, where appropriate. In wetlands, the top 6 to 12 inches of the trench should normally be backfilled with topsoil from the trench. The trench cannot be constructed or backfilled in such a manner as to drain waters of the United States (e.g., backfilling with extensive gravel layers, creating a french drain effect). Any exposed slopes and stream banks must be stabilized immediately upon completion of the utility line crossing of each waterbody.

**Utility line substations:** This NWP authorizes the construction, maintenance, or expansion of substation facilities associated with a power line or utility line in non-tidal waters of the United States, provided the activity, in combination with all other activities included in one single and complete project, does not result in the loss of greater than 1/2-acre of waters of the United States. This NWP does not authorize discharges into non-tidal wetlands adjacent to tidal waters of the United States to construct, maintain, or expand substation facilities.

**Foundations for overhead utility line towers, poles, and anchors:** This NWP authorizes the construction or maintenance of foundations for overhead utility line towers, poles, and anchors in all waters of the United States, provided the foundations are the minimum size necessary and separate footings for each tower leg (rather than a larger single pad) are used where feasible.

**Access roads:** This NWP authorizes the construction of access roads for the construction and maintenance of utility lines, including overhead power lines and utility line substations, in non-tidal waters of the United States, provided the activity, in combination with all other activities included in one single and complete project, does not cause the loss of greater than 1/2-acre of non-tidal waters of the United States. This NWP does not authorize discharges into non-



tidal wetlands adjacent to tidal waters for access roads. Access roads must be the minimum width necessary (see Note 2, below). Access roads must be constructed so that the length of the road minimizes any adverse effects on waters of the United States and must be as near as possible to pre-construction contours and elevations (e.g., at grade corduroy roads or geotextile/gravel roads). Access roads constructed above pre-construction contours and elevations in waters of the United States must be properly bridged or culverted to maintain surface flows.

This NWP may authorize utility lines in or affecting navigable waters of the United States even if there is no associated discharge of dredged or fill material (See 33 CFR Part 322). Overhead utility lines constructed over section 10 waters and utility lines that are routed in or under section 10 waters without a discharge of dredged or fill material require a section 10 permit.

This NWP also authorizes temporary structures, fills, and work necessary to conduct the utility line activity. Appropriate measures must be taken to maintain normal downstream flows and minimize flooding to the maximum extent practicable, when temporary structures, work, and discharges, including cofferdams, are necessary for construction activities, access fills, or dewatering of construction sites. Temporary fills must consist of materials, and be placed in a manner, that will not be eroded by expected high flows. Temporary fills must be removed in their entirety and the affected areas returned to pre-construction elevations. The areas affected by temporary fills must be revegetated, as appropriate.

Notification: The permittee must submit a pre-construction notification to the district engineer prior to commencing the activity if any of the following criteria are met: (1) the activity involves mechanized land clearing in a forested wetland for the utility line right-of-way; (2) a section 10 permit is required; (3) the utility line in waters of the United States, excluding overhead lines, exceeds 500 feet; (4) the utility line is placed within a jurisdictional area (i.e., water of the United States), and it runs parallel to or along a stream bed that is within that jurisdictional area; (5) discharges that result in the loss of greater than 1/10-acre of waters of the United States; (6) permanent access roads are constructed above grade in waters of the United States for a distance of more than 500 feet; or (7) permanent access roads are constructed in waters of the United States with impervious materials. (See general condition 31.) (Sections 10 and 404)

Note 1: Where the proposed utility line is constructed or installed in navigable waters of the United States (i.e., section 10 waters) within the coastal United States, the Great Lakes, and United States territories, copies of the pre-construction notification and NWP verification will be sent by the Corps to the National Oceanic and Atmospheric Administration (NOAA), National Ocean Service (NOS), for charting the utility line to protect navigation.

Note 2: Access roads used for both construction and maintenance may be authorized, provided they meet the terms and conditions of this NWP. Access roads used solely for construction of the utility line must be removed upon completion of the work, in accordance with the requirements for temporary fills.

Note 3: Pipes or pipelines used to transport gaseous, liquid, liquescent, or slurry substances over navigable waters of the United States are considered to be bridges, not utility lines, and may require a permit from the U.S. Coast Guard pursuant to Section 9 of the Rivers and Harbors Act of 1899. However, any discharges of dredged or fill material into waters of the United States associated with such pipelines will require a section 404 permit (see NWP 15).

Note 4: For overhead utility lines authorized by this NWP, a copy of the PCN and NWP verification will be provided to the Department of Defense Siting Clearinghouse, which will evaluate potential effects on military activities.

**NATIONWIDE PERMIT 23  
DEPARTMENT OF THE ARMY  
CORPS OF ENGINEERS  
FINAL NOTICE OF ISSUANCE AND MODIFICATION OF NATIONWIDE PERMITS  
FEDERAL REGISTER  
AUTHORIZED MARCH 19, 2012**

**Approved Categorical Exclusions.** Activities undertaken, assisted, authorized, regulated, funded, or financed, in whole or in part, by another Federal agency or department where:

(a) That agency or department has determined, pursuant to the Council on Environmental Quality's implementing regulations for the National Environmental Policy Act (40 CFR part 1500 et seq.), that the activity is categorically excluded from environmental documentation, because it is included within a category of actions which neither individually nor cumulatively have a significant effect on the human environment; and

(b) The Office of the Chief of Engineers (Attn: CECW-CO) has concurred with that agency's or department's determination that the activity is categorically excluded and approved the activity for authorization under NWP 23.

The Office of the Chief of Engineers may require additional conditions, including pre-construction notification, for authorization of an agency's categorical exclusions under this NWP.

**Notification:** Certain categorical exclusions approved for authorization under this NWP require the permittee to submit a pre-construction notification to the district engineer prior to commencing the activity (see general condition 31). The activities that require pre-construction notification are listed in the appropriate Regulatory Guidance Letters. (Sections 10 and 404)

**Note:** The agency or department may submit an application for an activity believed to be categorically excluded to the Office of the Chief of Engineers (Attn: CECW-CO). Prior to approval for authorization under this NWP of any agency's activity, the Office of the Chief of Engineers will solicit public comment. As of the date of issuance of this NWP, agencies with approved categorical exclusions are the: Bureau of Reclamation, Federal Highway Administration, and U.S. Coast Guard. Activities approved for authorization under this NWP as of the date of this notice are found in Corps Regulatory Guidance Letter 05-07, which is available at:

<http://www.usace.army.mil/Missions/CivilWorks/RegulatoryProgramandPermits/GuidanceLetters.aspx> . Any future approved categorical exclusions will be announced in Regulatory Guidance Letters and posted on this same web site.

## NATIONWIDE PERMIT CONDITIONS

The following General Conditions must be followed in order for any authorization by a NWP to be valid:

1. Navigation. (a) No activity may cause more than a minimal adverse effect on navigation.

(b) Any safety lights and signals prescribed by the U.S. Coast Guard, through regulations or otherwise, must be installed and maintained at the permittee's expense on authorized facilities in navigable waters of the United States.

(c) The permittee understands and agrees that, if future operations by the United States require the removal, relocation, or other alteration, of the structure or work herein authorized, or if, in the opinion of the Secretary of the Army or his authorized representative, said structure or work shall cause unreasonable obstruction to the free navigation of the navigable waters, the permittee will be required, upon due notice from the Corps of Engineers, to remove, relocate, or alter the structural work or obstructions caused thereby, without expense to the United States. No claim shall be made against the United States on account of any such removal or alteration.

2. Aquatic Life Movements. No activity may substantially disrupt the necessary life cycle movements of those species of aquatic life indigenous to the waterbody, including those species that normally migrate through the area, unless the activity's primary purpose is to impound water. All permanent and temporary crossings of waterbodies shall be suitably culverted, bridged, or otherwise designed and constructed to maintain low flows to sustain the movement of those aquatic species.

3. Spawning Areas. Activities in spawning areas during spawning seasons must be avoided to the maximum extent practicable. Activities that result in the physical destruction (e.g., through excavation, fill, or downstream smothering by substantial turbidity) of an important spawning area are not authorized.

4. Migratory Bird Breeding Areas. Activities in waters of the United States that serve as breeding areas for migratory birds must be avoided to the maximum extent practicable.

5. Shellfish Beds. No activity may occur in areas of concentrated shellfish populations, unless the activity is directly related to a shellfish harvesting activity authorized by NWPs 4 and 48, or is a shellfish seeding or habitat restoration activity authorized by NWP 27.

6. Suitable Material. No activity may use unsuitable material (e.g., trash, debris, car bodies, asphalt, etc.). Material used for construction or discharged must be free from toxic pollutants in toxic amounts (see Section 307 of the Clean Water Act).

7. Water Supply Intakes. No activity may occur in the proximity of a public water supply intake, except where the activity is for the repair or improvement of public water supply intake structures or adjacent bank stabilization.

8. Adverse Effects From Impoundments. If the activity creates an impoundment of water, adverse effects to the aquatic system due to accelerating the passage of water, and/or restricting its flow must be minimized to the maximum extent practicable.

9. Management of Water Flows. To the maximum extent practicable, the pre-construction course, condition, capacity, and location of open waters must be maintained for each activity, including stream channelization and storm water management activities, except as provided below. The activity must be constructed to withstand expected high flows. The activity must not restrict or impede the passage of normal or high flows, unless the primary purpose of the activity is to impound water or manage high flows. The activity may alter the pre-construction course, condition, capacity, and location of open waters if it benefits the aquatic environment (e.g., stream restoration or relocation activities).

10. Fills Within 100-Year Floodplains. The activity must comply with applicable FEMA-approved state or local floodplain management requirements.

11. Equipment. Heavy equipment working in wetlands or mudflats must be placed on mats, or other measures must be taken to minimize soil disturbance.

12. Soil Erosion and Sediment Controls. Appropriate soil erosion and sediment controls must be used and maintained in effective operating condition during construction, and all exposed soil and other fills, as well as any work below the ordinary high water mark or high tide line, must be permanently stabilized at the earliest practicable date. Permittees are encouraged to perform work within waters of the United States during periods of low-flow or no-flow.

13. Removal of Temporary Fills. Temporary fills must be removed in their entirety and the affected areas returned to pre-construction elevations. The affected areas must be revegetated, as appropriate.

14. Proper Maintenance. Any authorized structure or fill shall be properly maintained, including maintenance to ensure public safety and compliance with applicable NWP general conditions, as well as any activity-specific conditions added by the district engineer to an NWP authorization.

15. Single and Complete Project. The activity must be a single and complete project. The same NWP cannot be used more than once for the same single and complete project.

16. Wild and Scenic Rivers. No activity may occur in a component of the National Wild and Scenic River System, or in a river officially designated by Congress as a “study river” for possible inclusion in the system while the river is in an official study status, unless the appropriate Federal agency with direct management responsibility for such river, has determined in writing that the proposed activity will not adversely affect the Wild and Scenic River designation or study status. Information on Wild and Scenic Rivers may be obtained from the appropriate Federal land management agency responsible for the designated Wild and Scenic River or study river (e.g., National Park Service, U.S. Forest Service, Bureau of Land Management, U.S. Fish and Wildlife Service).

17. Tribal Rights. No activity or its operation may impair reserved tribal rights, including, but not limited to, reserved water rights and treaty fishing and hunting rights.

18. Endangered Species. (a) No activity is authorized under any NWP which is likely to directly or indirectly jeopardize the continued existence of a threatened or endangered species or a species proposed for such designation, as identified under the Federal Endangered Species Act (ESA), or which will directly or indirectly destroy or adversely modify the critical habitat of such species. No activity is authorized under any NWP which “may affect” a listed species or critical habitat, unless Section 7 consultation addressing the effects of the proposed activity has been completed.

(b) Federal agencies should follow their own procedures for complying with the requirements of the ESA. Federal permittees must provide the district engineer with the appropriate documentation to demonstrate compliance with those requirements. The district engineer will review the documentation and determine whether it is sufficient to address ESA compliance for the NWP activity, or whether additional ESA consultation is necessary.

(c) Non-federal permittees must submit a pre-construction notification to the district engineer if any listed species or designated critical habitat might be affected or is in the vicinity of the project, or if the project is located in designated critical habitat, and shall not begin work on the activity until notified by the district engineer that the requirements of the ESA have been satisfied and that the activity is authorized. For activities that might affect Federally-listed endangered or threatened species or designated critical habitat, the pre-construction notification must include the name(s) of the endangered or threatened species that might be affected by the proposed work or that utilize the designated critical habitat that might be affected by the proposed work. The district engineer will determine whether the proposed activity “may affect” or will have “no effect” to listed species and designated critical habitat and will notify the non-Federal applicant of the Corps’ determination within 45 days of receipt of a complete pre-construction notification. In cases where the non-Federal applicant has identified listed species or critical habitat that might be affected or is in the vicinity of the project, and has so notified the Corps, the applicant shall not begin work until the Corps has provided notification the proposed activities will have “no effect” on listed species or critical habitat, or until Section 7 consultation has been completed. If the non-Federal applicant has not heard back from the Corps within 45 days, the applicant must still wait for notification from the Corps.

(d) As a result of formal or informal consultation with the FWS or NMFS the district engineer may add species-specific regional endangered species conditions to the NWPs.

(e) Authorization of an activity by a NWP does not authorize the “take” of a threatened or endangered species as defined under the ESA. In the absence of separate authorization (e.g., an ESA Section 10 Permit, a Biological Opinion with “incidental take” provisions, etc.) from the U.S. FWS or the NMFS, The Endangered Species Act prohibits any person subject to the jurisdiction of the United States to take a listed species, where "take" means to harass, harm, pursue, hunt, shoot, wound, kill, trap, capture, or collect, or to attempt to engage in any such conduct. The word “harm” in the definition of “take” means an act which actually kills or injures wildlife. Such an act may include significant habitat modification or degradation where it actually kills or injures wildlife by significantly impairing essential behavioral patterns, including breeding, feeding or sheltering.



(f) Information on the location of threatened and endangered species and their critical habitat can be obtained directly from the offices of the U.S. FWS and NMFS or their world wide web pages at <http://www.fws.gov/> or <http://www.fws.gov/ipac> and <http://www.noaa.gov/fisheries.html> respectively.

19. Migratory Birds and Bald and Golden Eagles. The permittee is responsible for obtaining any “take” permits required under the U.S. Fish and Wildlife Service’s regulations governing compliance with the Migratory Bird Treaty Act or the Bald and Golden Eagle Protection Act. The permittee should contact the appropriate local office of the U.S. Fish and Wildlife Service to determine if such “take” permits are required for a particular activity.

20. Historic Properties. (a) In cases where the district engineer determines that the activity may affect properties listed, or eligible for listing, in the National Register of Historic Places, the activity is not authorized, until the requirements of Section 106 of the National Historic Preservation Act (NHPA) have been satisfied.

(b) Federal permittees should follow their own procedures for complying with the requirements of Section 106 of the National Historic Preservation Act. Federal permittees must provide the district engineer with the appropriate documentation to demonstrate compliance with those requirements. The district engineer will review the documentation and determine whether it is sufficient to address section 106 compliance for the NWP activity, or whether additional section 106 consultation is necessary.

(c) Non-federal permittees must submit a pre-construction notification to the district engineer if the authorized activity may have the potential to cause effects to any historic properties listed on, determined to be eligible for listing on, or potentially eligible for listing on the National Register of Historic Places, including previously unidentified properties. For such activities, the pre-construction notification must state which historic properties may be affected by the proposed work or include a vicinity map indicating the location of the historic properties or the potential for the presence of historic properties. Assistance regarding information on the location of or potential for the presence of historic resources can be sought from the State Historic Preservation Officer or Tribal Historic Preservation Officer, as appropriate, and the National Register of Historic Places (see 33 CFR 330.4(g)). When reviewing pre-construction notifications, district engineers will comply with the current procedures for addressing the requirements of Section 106 of the National Historic Preservation Act. The district engineer shall make a reasonable and good faith effort to carry out appropriate identification efforts, which may include background research, consultation, oral history interviews, sample field investigation, and field survey. Based on the information submitted and these efforts, the district engineer shall determine whether the proposed activity has the potential to cause an effect on the historic properties. Where the non-Federal applicant has identified historic properties on which the activity may have the potential to cause effects and so notified the Corps, the non-Federal applicant shall not begin the activity until notified by the district engineer either that the activity has no potential to cause effects or that consultation under Section 106 of the NHPA has been completed.

(d) The district engineer will notify the prospective permittee within 45 days of receipt of a complete pre-construction notification whether NHPA Section 106 consultation is required. Section 106 consultation is not required when the Corps determines that the activity does not have the potential to cause effects on historic properties (see 36 CFR §800.3(a)). If NHPA

section 106 consultation is required and will occur, the district engineer will notify the non-Federal applicant that he or she cannot begin work until Section 106 consultation is completed. If the non-Federal applicant has not heard back from the Corps within 45 days, the applicant must still wait for notification from the Corps.

(e) Prospective permittees should be aware that section 110k of the NHPA (16 U.S.C. 470h-2(k)) prevents the Corps from granting a permit or other assistance to an applicant who, with intent to avoid the requirements of Section 106 of the NHPA, has intentionally significantly adversely affected a historic property to which the permit would relate, or having legal power to prevent it, allowed such significant adverse effect to occur, unless the Corps, after consultation with the Advisory Council on Historic Preservation (ACHP), determines that circumstances justify granting such assistance despite the adverse effect created or permitted by the applicant. If circumstances justify granting the assistance, the Corps is required to notify the ACHP and provide documentation specifying the circumstances, the degree of damage to the integrity of any historic properties affected, and proposed mitigation. This documentation must include any views obtained from the applicant, SHPO/THPO, appropriate Indian tribes if the undertaking occurs on or affects historic properties on tribal lands or affects properties of interest to those tribes, and other parties known to have a legitimate interest in the impacts to the permitted activity on historic properties.

21. Discovery of Previously Unknown Remains and Artifacts. If you discover any previously unknown historic, cultural or archeological remains and artifacts while accomplishing the activity authorized by this permit, you must immediately notify the district engineer of what you have found, and to the maximum extent practicable, avoid construction activities that may affect the remains and artifacts until the required coordination has been completed. The district engineer will initiate the Federal, Tribal and state coordination required to determine if the items or remains warrant a recovery effort or if the site is eligible for listing in the National Register of Historic Places.

22. Designated Critical Resource Waters. Critical resource waters include, NOAA-managed marine sanctuaries and marine monuments, and National Estuarine Research Reserves. The district engineer may designate, after notice and opportunity for public comment, additional waters officially designated by a state as having particular environmental or ecological significance, such as outstanding national resource waters or state natural heritage sites. The district engineer may also designate additional critical resource waters after notice and opportunity for public comment.

(a) Discharges of dredged or fill material into waters of the United States are not authorized by NWP 7, 12, 14, 16, 17, 21, 29, 31, 35, 39, 40, 42, 43, 44, 49, 50, 51, and 52 for any activity within, or directly affecting, critical resource waters, including wetlands adjacent to such waters.

(b) For NWP 3, 8, 10, 13, 15, 18, 19, 22, 23, 25, 27, 28, 30, 33, 34, 36, 37, and 38, notification is required in accordance with general condition 31, for any activity proposed in the designated critical resource waters including wetlands adjacent to those waters. The district engineer may authorize activities under these NWPs only after it is determined that the impacts to the critical resource waters will be no more than minimal.

23. Mitigation. The district engineer will consider the following factors when determining appropriate and practicable mitigation necessary to ensure that adverse effects on the aquatic environment are minimal:

(a) The activity must be designed and constructed to avoid and minimize adverse effects, both temporary and permanent, to waters of the United States to the maximum extent practicable at the project site (i.e., on site).

(b) Mitigation in all its forms (avoiding, minimizing, rectifying, reducing, or compensating for resource losses) will be required to the extent necessary to ensure that the adverse effects to the aquatic environment are minimal.

(c) Compensatory mitigation at a minimum one-for-one ratio will be required for all wetland losses that exceed 1/10-acre and require pre-construction notification, unless the district engineer determines in writing that either some other form of mitigation would be more environmentally appropriate or the adverse effects of the proposed activity are minimal, and provides a project-specific waiver of this requirement. For wetland losses of 1/10-acre or less that require pre-construction notification, the district engineer may determine on a case-by-case basis that compensatory mitigation is required to ensure that the activity results in minimal adverse effects on the aquatic environment. Compensatory mitigation projects provided to offset losses of aquatic resources must comply with the applicable provisions of 33 CFR part 332.

(1) The prospective permittee is responsible for proposing an appropriate compensatory mitigation option if compensatory mitigation is necessary to ensure that the activity results in minimal adverse effects on the aquatic environment.

(2) Since the likelihood of success is greater and the impacts to potentially valuable uplands are reduced, wetland restoration should be the first compensatory mitigation option considered.

(3) If permittee-responsible mitigation is the proposed option, the prospective permittee is responsible for submitting a mitigation plan. A conceptual or detailed mitigation plan may be used by the district engineer to make the decision on the NWP verification request, but a final mitigation plan that addresses the applicable requirements of 33 CFR 332.4(c)(2) – (14) must be approved by the district engineer before the permittee begins work in waters of the United States, unless the district engineer determines that prior approval of the final mitigation plan is not practicable or not necessary to ensure timely completion of the required compensatory mitigation (see 33 CFR 332.3(k)(3)).

(4) If mitigation bank or in-lieu fee program credits are the proposed option, the mitigation plan only needs to address the baseline conditions at the impact site and the number of credits to be provided.

(5) Compensatory mitigation requirements (e.g., resource type and amount to be provided as compensatory mitigation, site protection, ecological performance standards, monitoring requirements) may be addressed through conditions added to the NWP authorization, instead of components of a compensatory mitigation plan.

(d) For losses of streams or other open waters that require pre-construction notification, the district engineer may require compensatory mitigation, such as stream rehabilitation, enhancement, or preservation, to ensure that the activity results in minimal adverse effects on the aquatic environment.

(e) Compensatory mitigation will not be used to increase the acreage losses allowed by the acreage limits of the NWPs. For example, if an NWP has an acreage limit of 1/2-acre, it cannot be used to authorize any project resulting in the loss of greater than 1/2-acre of waters of

the United States, even if compensatory mitigation is provided that replaces or restores some of the lost waters. However, compensatory mitigation can and should be used, as necessary, to ensure that a project already meeting the established acreage limits also satisfies the minimal impact requirement associated with the NWPs.

(f) Compensatory mitigation plans for projects in or near streams or other open waters will normally include a requirement for the restoration or establishment, maintenance, and legal protection (e.g., conservation easements) of riparian areas next to open waters. In some cases, riparian areas may be the only compensatory mitigation required. Riparian areas should consist of native species. The width of the required riparian area will address documented water quality or aquatic habitat loss concerns. Normally, the riparian area will be 25 to 50 feet wide on each side of the stream, but the district engineer may require slightly wider riparian areas to address documented water quality or habitat loss concerns. If it is not possible to establish a riparian area on both sides of a stream, or if the waterbody is a lake or coastal waters, then restoring or establishing a riparian area along a single bank or shoreline may be sufficient. Where both wetlands and open waters exist on the project site, the district engineer will determine the appropriate compensatory mitigation (e.g., riparian areas and/or wetlands compensation) based on what is best for the aquatic environment on a watershed basis. In cases where riparian areas are determined to be the most appropriate form of compensatory mitigation, the district engineer may waive or reduce the requirement to provide wetland compensatory mitigation for wetland losses.

(g) Permittees may propose the use of mitigation banks, in-lieu fee programs, or separate permittee-responsible mitigation. For activities resulting in the loss of marine or estuarine resources, permittee-responsible compensatory mitigation may be environmentally preferable if there are no mitigation banks or in-lieu fee programs in the area that have marine or estuarine credits available for sale or transfer to the permittee. For permittee-responsible mitigation, the special conditions of the NWP verification must clearly indicate the party or parties responsible for the implementation and performance of the compensatory mitigation project, and, if required, its long-term management.

(h) Where certain functions and services of waters of the United States are permanently adversely affected, such as the conversion of a forested or scrub-shrub wetland to a herbaceous wetland in a permanently maintained utility line right-of-way, mitigation may be required to reduce the adverse effects of the project to the minimal level.

24. Safety of Impoundment Structures. To ensure that all impoundment structures are safely designed, the district engineer may require non-Federal applicants to demonstrate that the structures comply with established state dam safety criteria or have been designed by qualified persons. The district engineer may also require documentation that the design has been independently reviewed by similarly qualified persons, and appropriate modifications made to ensure safety.

25. Water Quality. Where States and authorized Tribes, or EPA where applicable, have not previously certified compliance of an NWP with CWA Section 401, individual 401 Water Quality Certification must be obtained or waived (see 33 CFR 330.4(c)). The district engineer or State or Tribe may require additional water quality management measures to ensure that the authorized activity does not result in more than minimal degradation of water quality.

26. Coastal Zone Management. In coastal states where an NWP has not previously received a state coastal zone management consistency concurrence, an individual state coastal zone management consistency concurrence must be obtained, or a presumption of concurrence must occur (see 33 CFR 330.4(d)). The district engineer or a State may require additional measures to ensure that the authorized activity is consistent with state coastal zone management requirements.

27. Regional and Case-By-Case Conditions. The activity must comply with any regional conditions that may have been added by the Division Engineer (see 33 CFR 330.4(e)) and with any case specific conditions added by the Corps or by the state, Indian Tribe, or U.S. EPA in its section 401 Water Quality Certification, or by the state in its Coastal Zone Management Act consistency determination.

28. Use of Multiple Nationwide Permits. The use of more than one NWP for a single and complete project is prohibited, except when the acreage loss of waters of the United States authorized by the NWPs does not exceed the acreage limit of the NWP with the highest specified acreage limit. For example, if a road crossing over tidal waters is constructed under NWP 14, with associated bank stabilization authorized by NWP 13, the maximum acreage loss of waters of the United States for the total project cannot exceed 1/3-acre.

29. Transfer of Nationwide Permit Verifications. If the permittee sells the property associated with a nationwide permit verification, the permittee may transfer the nationwide permit verification to the new owner by submitting a letter to the appropriate Corps district office to validate the transfer. A copy of the nationwide permit verification must be attached to the letter, and the letter must contain the following statement and signature:

“When the structures or work authorized by this nationwide permit are still in existence at the time the property is transferred, the terms and conditions of this nationwide permit, including any special conditions, will continue to be binding on the new owner(s) of the property. To validate the transfer of this nationwide permit and the associated liabilities associated with compliance with its terms and conditions, have the transferee sign and date below.”

---

(Transferee)

---

(Date)

30. Compliance Certification. Each permittee who receives an NWP verification letter from the Corps must provide a signed certification documenting completion of the authorized activity and any required compensatory mitigation. The success of any required permittee-responsible mitigation, including the achievement of ecological performance standards, will be addressed separately by the district engineer. The Corps will provide the permittee the certification document with the NWP verification letter. The certification document will include:

(a) A statement that the authorized work was done in accordance with the NWP authorization, including any general, regional, or activity-specific conditions;

(b) A statement that the implementation of any required compensatory mitigation was completed in accordance with the permit conditions. If credits from a mitigation bank or in-lieu fee program are used to satisfy the compensatory mitigation requirements, the certification must include the documentation required by 33 CFR 332.3(1)(3) to confirm that the permittee secured the appropriate number and resource type of credits; and

(c) The signature of the permittee certifying the completion of the work and mitigation.

31. Pre-Construction Notification. (a) Timing. Where required by the terms of the NWP, the prospective permittee must notify the district engineer by submitting a pre-construction notification (PCN) as early as possible. The district engineer must determine if the PCN is complete within 30 calendar days of the date of receipt and, if the PCN is determined to be incomplete, notify the prospective permittee within that 30 day period to request the additional information necessary to make the PCN complete. The request must specify the information needed to make the PCN complete. As a general rule, district engineers will request additional information necessary to make the PCN complete only once. However, if the prospective permittee does not provide all of the requested information, then the district engineer will notify the prospective permittee that the PCN is still incomplete and the PCN review process will not commence until all of the requested information has been received by the district engineer. The prospective permittee shall not begin the activity until either:

(1) He or she is notified in writing by the district engineer that the activity may proceed under the NWP with any special conditions imposed by the district or division engineer; or

(2) 45 calendar days have passed from the district engineer's receipt of the complete PCN and the prospective permittee has not received written notice from the district or division engineer. However, if the permittee was required to notify the Corps pursuant to general condition 18 that listed species or critical habitat might be affected or in the vicinity of the project, or to notify the Corps pursuant to general condition 20 that the activity may have the potential to cause effects to historic properties, the permittee cannot begin the activity until receiving written notification from the Corps that there is "no effect" on listed species or "no potential to cause effects" on historic properties, or that any consultation required under Section 7 of the Endangered Species Act (see 33 CFR 330.4(f)) and/or Section 106 of the National Historic Preservation (see 33 CFR 330.4(g)) has been completed. Also, work cannot begin under NWPs 21, 49, or 50 until the permittee has received written approval from the Corps. If the proposed activity requires a written waiver to exceed specified limits of an NWP, the permittee may not begin the activity until the district engineer issues the waiver. If the district or division engineer notifies the permittee in writing that an individual permit is required within 45 calendar days of receipt of a complete PCN, the permittee cannot begin the activity until an individual permit has been obtained. Subsequently, the permittee's right to proceed under the NWP may be modified, suspended, or revoked only in accordance with the procedure set forth in 33 CFR 330.5(d)(2).

(b) Contents of Pre-Construction Notification: The PCN must be in writing and include the following information:

(1) Name, address and telephone numbers of the prospective permittee;

(2) Location of the proposed project;



(3) A description of the proposed project; the project's purpose; direct and indirect adverse environmental effects the project would cause, including the anticipated amount of loss of water of the United States expected to result from the NWP activity, in acres, linear feet, or other appropriate unit of measure; any other NWP(s), regional general permit(s), or individual permit(s) used or intended to be used to authorize any part of the proposed project or any related activity. The description should be sufficiently detailed to allow the district engineer to determine that the adverse effects of the project will be minimal and to determine the need for compensatory mitigation. Sketches should be provided when necessary to show that the activity complies with the terms of the NWP. (Sketches usually clarify the project and when provided results in a quicker decision. Sketches should contain sufficient detail to provide an illustrative description of the proposed activity (e.g., a conceptual plan), but do not need to be detailed engineering plans);

(4) The PCN must include a delineation of wetlands, other special aquatic sites, and other waters, such as lakes and ponds, and perennial, intermittent, and ephemeral streams, on the project site. Wetland delineations must be prepared in accordance with the current method required by the Corps. The permittee may ask the Corps to delineate the special aquatic sites and other waters on the project site, but there may be a delay if the Corps does the delineation, especially if the project site is large or contains many waters of the United States. Furthermore, the 45 day period will not start until the delineation has been submitted to or completed by the Corps, as appropriate;

(5) If the proposed activity will result in the loss of greater than 1/10-acre of wetlands and a PCN is required, the prospective permittee must submit a statement describing how the mitigation requirement will be satisfied, or explaining why the adverse effects are minimal and why compensatory mitigation should not be required. As an alternative, the prospective permittee may submit a conceptual or detailed mitigation plan.

(6) If any listed species or designated critical habitat might be affected or is in the vicinity of the project, or if the project is located in designated critical habitat, for non-Federal applicants the PCN must include the name(s) of those endangered or threatened species that might be affected by the proposed work or utilize the designated critical habitat that may be affected by the proposed work. Federal applicants must provide documentation demonstrating compliance with the Endangered Species Act; and

(7) For an activity that may affect a historic property listed on, determined to be eligible for listing on, or potentially eligible for listing on, the National Register of Historic Places, for non-Federal applicants the PCN must state which historic property may be affected by the proposed work or include a vicinity map indicating the location of the historic property. Federal applicants must provide documentation demonstrating compliance with Section 106 of the National Historic Preservation Act.

(c) Form of Pre-Construction Notification: The standard individual permit application form (Form ENG 4345) may be used, but the completed application form must clearly indicate that it is a PCN and must include all of the information required in paragraphs (b)(1) through (7) of this general condition. A letter containing the required information may also be used.

(d) Agency Coordination: (1) The district engineer will consider any comments from Federal and state agencies concerning the proposed activity's compliance with the terms and conditions of the NWPs and the need for mitigation to reduce the project's adverse environmental effects to a minimal level.

(2) For all NWP activities that require pre-construction notification and result in the loss of greater than 1/2-acre of waters of the United States, for NWP 21, 29, 39, 40, 42, 43, 44, 50, 51, and 52 activities that require pre-construction notification and will result in the loss of greater than 300 linear feet of intermittent and ephemeral stream bed, and for all NWP 48 activities that require pre-construction notification, the district engineer will immediately provide (e.g., via e-mail, facsimile transmission, overnight mail, or other expeditious manner) a copy of the complete PCN to the appropriate Federal or state offices (U.S. FWS, state natural resource or water quality agency, EPA, State Historic Preservation Officer (SHPO) or Tribal Historic Preservation Office (THPO), and, if appropriate, the NMFS). With the exception of NWP 37, these agencies will have 10 calendar days from the date the material is transmitted to telephone or fax the district engineer notice that they intend to provide substantive, site-specific comments. The comments must explain why the agency believes the adverse effects will be more than minimal. If so contacted by an agency, the district engineer will wait an additional 15 calendar days before making a decision on the pre-construction notification. The district engineer will fully consider agency comments received within the specified time frame concerning the proposed activity's compliance with the terms and conditions of the NWPs, including the need for mitigation to ensure the net adverse environmental effects to the aquatic environment of the proposed activity are minimal. The district engineer will provide no response to the resource agency, except as provided below. The district engineer will indicate in the administrative record associated with each pre-construction notification that the resource agencies' concerns were considered. For NWP 37, the emergency watershed protection and rehabilitation activity may proceed immediately in cases where there is an unacceptable hazard to life or a significant loss of property or economic hardship will occur. The district engineer will consider any comments received to decide whether the NWP 37 authorization should be modified, suspended, or revoked in accordance with the procedures at 33 CFR 330.5.

(3) In cases of where the prospective permittee is not a Federal agency, the district engineer will provide a response to NMFS within 30 calendar days of receipt of any Essential Fish Habitat conservation recommendations, as required by Section 305(b)(4)(B) of the Magnuson-Stevens Fishery Conservation and Management Act.

(4) Applicants are encouraged to provide the Corps with either electronic files or multiple copies of pre-construction notifications to expedite agency coordination.

#### D. District Engineer's Decision

1. In reviewing the PCN for the proposed activity, the district engineer will determine whether the activity authorized by the NWP will result in more than minimal individual or cumulative adverse environmental effects or may be contrary to the public interest. For a linear project, this determination will include an evaluation of the individual crossings to determine whether they individually satisfy the terms and conditions of the NWP(s), as well as the cumulative effects caused by all of the crossings authorized by NWP. If an applicant requests a waiver of the 300 linear foot limit on impacts to intermittent or ephemeral streams or of an otherwise applicable limit, as provided for in NWPs 13, 21, 29, 36, 39, 40, 42, 43, 44, 50, 51 or 52, the district engineer will only grant the waiver upon a written determination that the NWP activity will result in minimal adverse effects. When making minimal effects determinations the district engineer will consider the direct and indirect effects caused by the NWP activity. The district engineer will also consider site specific factors, such as the environmental setting in the

vicinity of the NWP activity, the type of resource that will be affected by the NWP activity, the functions provided by the aquatic resources that will be affected by the NWP activity, the degree or magnitude to which the aquatic resources perform those functions, the extent that aquatic resource functions will be lost as a result of the NWP activity (e.g., partial or complete loss), the duration of the adverse effects (temporary or permanent), the importance of the aquatic resource functions to the region (e.g., watershed or ecoregion), and mitigation required by the district engineer. If an appropriate functional assessment method is available and practicable to use, that assessment method may be used by the district engineer to assist in the minimal adverse effects determination. The district engineer may add case-specific special conditions to the NWP authorization to address site-specific environmental concerns.

2. If the proposed activity requires a PCN and will result in a loss of greater than 1/10-acre of wetlands, the prospective permittee should submit a mitigation proposal with the PCN. Applicants may also propose compensatory mitigation for projects with smaller impacts. The district engineer will consider any proposed compensatory mitigation the applicant has included in the proposal in determining whether the net adverse environmental effects to the aquatic environment of the proposed activity are minimal. The compensatory mitigation proposal may be either conceptual or detailed. If the district engineer determines that the activity complies with the terms and conditions of the NWP and that the adverse effects on the aquatic environment are minimal, after considering mitigation, the district engineer will notify the permittee and include any activity-specific conditions in the NWP verification the district engineer deems necessary. Conditions for compensatory mitigation requirements must comply with the appropriate provisions at 33 CFR 332.3(k). The district engineer must approve the final mitigation plan before the permittee commences work in waters of the United States, unless the district engineer determines that prior approval of the final mitigation plan is not practicable or not necessary to ensure timely completion of the required compensatory mitigation. If the prospective permittee elects to submit a compensatory mitigation plan with the PCN, the district engineer will expeditiously review the proposed compensatory mitigation plan. The district engineer must review the proposed compensatory mitigation plan within 45 calendar days of receiving a complete PCN and determine whether the proposed mitigation would ensure no more than minimal adverse effects on the aquatic environment. If the net adverse effects of the project on the aquatic environment (after consideration of the compensatory mitigation proposal) are determined by the district engineer to be minimal, the district engineer will provide a timely written response to the applicant. The response will state that the project can proceed under the terms and conditions of the NWP, including any activity-specific conditions added to the NWP authorization by the district engineer.

3. If the district engineer determines that the adverse effects of the proposed work are more than minimal, then the district engineer will notify the applicant either: (a) That the project does not qualify for authorization under the NWP and instruct the applicant on the procedures to seek authorization under an individual permit; (b) that the project is authorized under the NWP subject to the applicant's submission of a mitigation plan that would reduce the adverse effects on the aquatic environment to the minimal level; or (c) that the project is authorized under the NWP with specific modifications or conditions. Where the district engineer determines that mitigation is required to ensure no more than minimal adverse effects occur to the aquatic environment, the activity will be authorized within the 45-day PCN period, with activity-specific

conditions that state the mitigation requirements. The authorization will include the necessary conceptual or detailed mitigation or a requirement that the applicant submit a mitigation plan that would reduce the adverse effects on the aquatic environment to the minimal level. When mitigation is required, no work in waters of the United States may occur until the district engineer has approved a specific mitigation plan or has determined that prior approval of a final mitigation plan is not practicable or not necessary to ensure timely completion of the required compensatory mitigation.

### **FURTHER INFORMATION**

1. District Engineers have authority to determine if an activity complies with the terms and conditions of an NWP.
2. NWPs do not obviate the need to obtain other federal, state, or local permits, approvals, or authorizations required by law.
3. NWPs do not grant any property rights or exclusive privileges.
4. NWPs do not authorize any injury to the property or rights of others.
5. NWPs do not authorize interference with any existing or proposed Federal project.

### **DEFINITIONS**

Best management practices (BMPs): Policies, practices, procedures, or structures implemented to mitigate the adverse environmental effects on surface water quality resulting from development. BMPs are categorized as structural or non-structural.

Compensatory mitigation: The restoration (re-establishment or rehabilitation), establishment (creation), enhancement, and/or in certain circumstances preservation of aquatic resources for the purposes of offsetting unavoidable adverse impacts which remain after all appropriate and practicable avoidance and minimization has been achieved.

Currently serviceable: Useable as is or with some maintenance, but not so degraded as to essentially require reconstruction.

Direct effects: Effects that are caused by the activity and occur at the same time and place.

Discharge: The term “discharge” means any discharge of dredged or fill material.

Enhancement: The manipulation of the physical, chemical, or biological characteristics of an aquatic resource to heighten, intensify, or improve a specific aquatic resource function(s). Enhancement results in the gain of selected aquatic resource function(s), but may also lead to a decline in other aquatic resource function(s). Enhancement does not result in a gain in aquatic resource area.

Ephemeral stream: An ephemeral stream has flowing water only during, and for a short duration after, precipitation events in a typical year. Ephemeral stream beds are located above the water table year-round. Groundwater is not a source of water for the stream. Runoff from rainfall is the primary source of water for stream flow.

Establishment (creation): The manipulation of the physical, chemical, or biological characteristics present to develop an aquatic resource that did not previously exist at an upland site. Establishment results in a gain in aquatic resource area.

High Tide Line: The line of intersection of the land with the water’s surface at the maximum height reached by a rising tide. The high tide line may be determined, in the absence

of actual data, by a line of oil or scum along shore objects, a more or less continuous deposit of fine shell or debris on the foreshore or berm, other physical markings or characteristics, vegetation lines, tidal gages, or other suitable means that delineate the general height reached by a rising tide. The line encompasses spring high tides and other high tides that occur with periodic frequency but does not include storm surges in which there is a departure from the normal or predicted reach of the tide due to the piling up of water against a coast by strong winds such as those accompanying a hurricane or other intense storm.

Historic Property: Any prehistoric or historic district, site (including archaeological site), building, structure, or other object included in, or eligible for inclusion in, the National Register of Historic Places maintained by the Secretary of the Interior. This term includes artifacts, records, and remains that are related to and located within such properties. The term includes properties of traditional religious and cultural importance to an Indian tribe or Native Hawaiian organization and that meet the National Register criteria (36 CFR part 60).

Independent utility: A test to determine what constitutes a single and complete non-linear project in the Corps regulatory program. A project is considered to have independent utility if it would be constructed absent the construction of other projects in the project area. Portions of a multi-phase project that depend upon other phases of the project do not have independent utility. Phases of a project that would be constructed even if the other phases were not built can be considered as separate single and complete projects with independent utility.

Indirect effects: Effects that are caused by the activity and are later in time or farther removed in distance, but are still reasonably foreseeable.

Intermittent stream: An intermittent stream has flowing water during certain times of the year, when groundwater provides water for stream flow. During dry periods, intermittent streams may not have flowing water. Runoff from rainfall is a supplemental source of water for stream flow.

Loss of waters of the United States: Waters of the United States that are permanently adversely affected by filling, flooding, excavation, or drainage because of the regulated activity. Permanent adverse effects include permanent discharges of dredged or fill material that change an aquatic area to dry land, increase the bottom elevation of a waterbody, or change the use of a waterbody. The acreage of loss of waters of the United States is a threshold measurement of the impact to jurisdictional waters for determining whether a project may qualify for an NWP; it is not a net threshold that is calculated after considering compensatory mitigation that may be used to offset losses of aquatic functions and services. The loss of stream bed includes the linear feet of stream bed that is filled or excavated. Waters of the United States temporarily filled, flooded, excavated, or drained, but restored to pre-construction contours and elevations after construction, are not included in the measurement of loss of waters of the United States. Impacts resulting from activities eligible for exemptions under Section 404(f) of the Clean Water Act are not considered when calculating the loss of waters of the United States.

Non-tidal wetland: A non-tidal wetland is a wetland that is not subject to the ebb and flow of tidal waters. The definition of a wetland can be found at 33 CFR 328.3(b). Non-tidal wetlands contiguous to tidal waters are located landward of the high tide line (i.e., spring high tide line).

Open water: For purposes of the NWPs, an open water is any area that in a year with normal patterns of precipitation has water flowing or standing above ground to the extent that an ordinary high water mark can be determined. Aquatic vegetation within the area of standing or

flowing water is either non-emergent, sparse, or absent. Vegetated shallows are considered to be open waters. Examples of “open waters” include rivers, streams, lakes, and ponds.

Ordinary High Water Mark: An ordinary high water mark is a line on the shore established by the fluctuations of water and indicated by physical characteristics, or by other appropriate means that consider the characteristics of the surrounding areas (see 33 CFR 328.3(e)).

Perennial stream: A perennial stream has flowing water year-round during a typical year. The water table is located above the stream bed for most of the year. Groundwater is the primary source of water for stream flow. Runoff from rainfall is a supplemental source of water for stream flow.

Practicable: Available and capable of being done after taking into consideration cost, existing technology, and logistics in light of overall project purposes.

Pre-construction notification: A request submitted by the project proponent to the Corps for confirmation that a particular activity is authorized by nationwide permit. The request may be a permit application, letter, or similar document that includes information about the proposed work and its anticipated environmental effects. Pre-construction notification may be required by the terms and conditions of a nationwide permit, or by regional conditions. A pre-construction notification may be voluntarily submitted in cases where pre-construction notification is not required and the project proponent wants confirmation that the activity is authorized by nationwide permit.

Preservation: The removal of a threat to, or preventing the decline of, aquatic resources by an action in or near those aquatic resources. This term includes activities commonly associated with the protection and maintenance of aquatic resources through the implementation of appropriate legal and physical mechanisms. Preservation does not result in a gain of aquatic resource area or functions.

Re-establishment: The manipulation of the physical, chemical, or biological characteristics of a site with the goal of returning natural/historic functions to a former aquatic resource. Re-establishment results in rebuilding a former aquatic resource and results in a gain in aquatic resource area and functions.

Rehabilitation: The manipulation of the physical, chemical, or biological characteristics of a site with the goal of repairing natural/historic functions to a degraded aquatic resource. Rehabilitation results in a gain in aquatic resource function, but does not result in a gain in aquatic resource area.

Restoration: The manipulation of the physical, chemical, or biological characteristics of a site with the goal of returning natural/historic functions to a former or degraded aquatic resource. For the purpose of tracking net gains in aquatic resource area, restoration is divided into two categories: re-establishment and rehabilitation.

Riffle and pool complex: Riffle and pool complexes are special aquatic sites under the 404(b)(1) Guidelines. Riffle and pool complexes sometimes characterize steep gradient sections of streams. Such stream sections are recognizable by their hydraulic characteristics. The rapid movement of water over a coarse substrate in riffles results in a rough flow, a turbulent surface, and high dissolved oxygen levels in the water. Pools are deeper areas associated with riffles. A slower stream velocity, a streaming flow, a smooth surface, and a finer substrate characterize pools.

Riparian areas: Riparian areas are lands adjacent to streams, lakes, and estuarine-marine shorelines. Riparian areas are transitional between terrestrial and aquatic ecosystems, through



which surface and subsurface hydrology connects riverine, lacustrine, estuarine, and marine waters with their adjacent wetlands, non-wetland waters, or uplands. Riparian areas provide a variety of ecological functions and services and help improve or maintain local water quality. (See general condition 23.)

Shellfish seeding: The placement of shellfish seed and/or suitable substrate to increase shellfish production. Shellfish seed consists of immature individual shellfish or individual shellfish attached to shells or shell fragments (i.e., spat on shell). Suitable substrate may consist of shellfish shells, shell fragments, or other appropriate materials placed into waters for shellfish habitat.

Single and complete linear project: A linear project is a project constructed for the purpose of getting people, goods, or services from a point of origin to a terminal point, which often involves multiple crossings of one or more waterbodies at separate and distant locations. The term “single and complete project” is defined as that portion of the total linear project proposed or accomplished by one owner/developer or partnership or other association of owners/developers that includes all crossings of a single water of the United States (i.e., a single waterbody) at a specific location. For linear projects crossing a single or multiple waterbodies several times at separate and distant locations, each crossing is considered a single and complete project for purposes of NWP authorization. However, individual channels in a braided stream or river, or individual arms of a large, irregularly shaped wetland or lake, etc., are not separate waterbodies, and crossings of such features cannot be considered separately.

Single and complete non-linear project: For non-linear projects, the term “single and complete project” is defined at 33 CFR 330.2(i) as the total project proposed or accomplished by one owner/developer or partnership or other association of owners/developers. A single and complete non-linear project must have independent utility (see definition of “independent utility”). Single and complete non-linear projects may not be “piecemealed” to avoid the limits in an NWP authorization.

Stormwater management: Stormwater management is the mechanism for controlling stormwater runoff for the purposes of reducing downstream erosion, water quality degradation, and flooding and mitigating the adverse effects of changes in land use on the aquatic environment.

Stormwater management facilities: Stormwater management facilities are those facilities, including but not limited to, stormwater retention and detention ponds and best management practices, which retain water for a period of time to control runoff and/or improve the quality (i.e., by reducing the concentration of nutrients, sediments, hazardous substances and other pollutants) of stormwater runoff.

Stream bed: The substrate of the stream channel between the ordinary high water marks. The substrate may be bedrock or inorganic particles that range in size from clay to boulders. Wetlands contiguous to the stream bed, but outside of the ordinary high water marks, are not considered part of the stream bed.

Stream channelization: The manipulation of a stream’s course, condition, capacity, or location that causes more than minimal interruption of normal stream processes. A channelized stream remains a water of the United States.

Structure: An object that is arranged in a definite pattern of organization. Examples of structures include, without limitation, any pier, boat dock, boat ramp, wharf, dolphin, weir, boom, breakwater, bulkhead, revetment, riprap, jetty, artificial island, artificial reef, permanent

mooring structure, power transmission line, permanently moored floating vessel, piling, aid to navigation, or any other manmade obstacle or obstruction.

Tidal wetland: A tidal wetland is a wetland (i.e., water of the United States) that is inundated by tidal waters. The definitions of a wetland and tidal waters can be found at 33 CFR 328.3(b) and 33 CFR 328.3(f), respectively. Tidal waters rise and fall in a predictable and measurable rhythm or cycle due to the gravitational pulls of the moon and sun. Tidal waters end where the rise and fall of the water surface can no longer be practically measured in a predictable rhythm due to masking by other waters, wind, or other effects. Tidal wetlands are located channelward of the high tide line, which is defined at 33 CFR 328.3(d).

Vegetated shallows: Vegetated shallows are special aquatic sites under the 404(b)(1) Guidelines. They are areas that are permanently inundated and under normal circumstances have rooted aquatic vegetation, such as seagrasses in marine and estuarine systems and a variety of vascular rooted plants in freshwater systems.

Waterbody: For purposes of the NWP, a waterbody is a jurisdictional water of the United States. If a jurisdictional wetland is adjacent – meaning bordering, contiguous, or neighboring – to a waterbody determined to be a water of the United States under 33 CFR 328.3(a)(1)-(6), that waterbody and its adjacent wetlands are considered together as a single aquatic unit (see 33 CFR 328.4(c)(2)). Examples of “waterbodies” include streams, rivers, lakes, ponds, and wetlands.

## **Final Regional Conditions 2012**

### ***NOTICE ABOUT WEB LINKS IN THIS DOCUMENT:***

*The web links (both internal to our District and any external links to collaborating agencies) in this document are valid at the time of publication. However, the Wilmington District Regulatory Program web page addresses, as with other agency web sites, may change over the timeframe of the five-year Nationwide Permit renewal cycle, in response to policy mandates or technology advances. While we will make every effort to check on the integrity of our web links and provide re-direct pages whenever possible, we ask that you report any broken links to us so we can keep the page information current and usable. We apologize in advanced for any broken links that you may encounter, and we ask that you navigate from the regulatory home page (wetlands and stream permits) of the Wilmington District Corps of Engineers, to the “Permits” section of our web site to find links for pages that cannot be found by clicking directly on the listed web link in this document.*

## **Final 2012 Regional Conditions for Nationwide Permits (NWP) in the Wilmington District**

### **1.0 Excluded Waters**

The Corps has identified waters that will be excluded from the use of all NWP’s during certain timeframes. These waters are:

#### **1.1 Anadromous Fish Spawning Areas**

Waters of the United States identified by either the North Carolina Division of Marine Fisheries (NCDMF) or the North Carolina Wildlife Resources Commission (NCWRC) as anadromous fish spawning areas are excluded during the period between February 15 and June 30, without prior written approval from NCDMF or NCWRC and the Corps.

#### **1.2 Trout Waters Moratorium**

Waters of the United States in the twenty-five designated trout counties of North Carolina are excluded during the period between October 15 and April 15 without prior written approval from the NCWRC. (See Section 2.7 for a list of the twenty-five trout counties).

#### **1.3 Sturgeon Spawning Areas as Designated by the National Marine Fisheries Service (NMFS)**

Waters of the United States designated as sturgeon spawning areas are excluded during the period between February 1 and June 30, without prior written approval from the NMFS.

## **2.0 Waters Requiring Additional Notification**

The Corps has identified waters that will be subject to additional notification requirements for activities authorized by all NWP's. These waters are:

### **2.1 Western NC Counties that Drain to Designated Critical Habitat**

For proposed activities within Waters of the U.S. that require a Pre-Construction Notification pursuant to General Condition 31 (PCN) and are located in the sixteen counties listed below, applicants must provide a copy of the PCN to the US Fish and Wildlife Service, 160 Zillicoa Street, Asheville, North Carolina 28801. This PCN must be sent concurrently to the US Fish and Wildlife Service and the Corps Asheville Regulatory Field Office. Please see General Condition 18 for specific notification requirements related to Federally Endangered Species and the following website for information on the location of designated critical habitat.

Counties with tributaries that drain to designated critical habitat that require notification to the Asheville US Fish and Wildlife Service: Avery, Cherokee, Forsyth, Graham, Haywood, Henderson, Jackson, Macon Mecklenburg, Mitchell, Stokes, Surry, Swain, Transylvania, Union and Yancey.

Website and office addresses for Endangered Species Act Information:

The Wilmington District has developed the following website for applicants which provides guidelines on how to review linked websites and maps in order to fulfill NWP general condition 18 requirements: <http://www.saw.usace.army.mil/wetlands/ESA>

Applicants who do not have internet access may contact the appropriate US Fish and Wildlife Service offices listed below or the US Army Corps of Engineers at (910) 251- 4633:

US Fish and Wildlife Service  
Asheville Field Office  
160 Zillicoa Street  
Asheville, NC 28801  
Telephone: (828) 258-3939

Asheville US Fish and Wildlife Service Office counties: All counties west of and including Anson, Stanly, Davidson, Forsyth and Stokes Counties

US Fish and Wildlife Service  
Raleigh Field Office  
Post Office Box 33726  
Raleigh, NC 27636-3726  
Telephone: (919) 856-4520

Raleigh US Fish and Wildlife Service Office counties: all counties east of and including Richmond, Montgomery, Randolph, Guilford, and Rockingham Counties.

## **2.2 Special Designation Waters**

Prior to the use of any NWP in any of the following identified waters and contiguous wetlands in North Carolina, applicants must comply with Nationwide Permit General Condition 31 (PCN). The North Carolina waters and contiguous wetlands that require additional notification requirements are:

“Outstanding Resource Waters” (ORW) or “High Quality Waters” (HQW) as designated by the North Carolina Environmental Management Commission; “Inland Primary Nursery Areas” (IPNA) as designated by the NCWRC; “Contiguous Wetlands” as defined by the North Carolina Environmental Management Commission; or “Primary Nursery Areas” (PNA) as designated by the North Carolina Marine Fisheries Commission.

## **2.3 Coastal Area Management Act (CAMA) Areas of Environmental Concern**

Non-federal applicants for any NWP in a designated “Area of Environmental Concern” (AEC) in the twenty (20) counties of Eastern North Carolina covered by the North Carolina Coastal Area Management Act (CAMA) must also obtain the required CAMA permit. Development activities for non-federal projects may not commence until a copy of the approved CAMA permit is furnished to the appropriate Wilmington District Regulatory Field Office (Wilmington Field Office – 69 Darlington Avenue, Wilmington, NC 28403 or Washington Field Office – 2407 West 5th Street, Washington, NC 27889).

## **2.4 Barrier Islands**

Prior to the use of any NWP on a barrier island of North Carolina, applicants must comply with Nationwide Permit General Condition 31 (PCN).

## **2.5 Mountain or Piedmont Bogs**

Prior to the use of any NWP in a Bog classified by the North Carolina Wetland Assessment Methodology (NCWAM), applicants shall comply with Nationwide Permit General Condition 31 (PCN). The latest version of NCWAM is located on the NC DWQ web site at: <http://portal.ncdenr.org/web/wq/swp/ws/pdu/ncwam> .

## **2.6 Animal Waste Facilities**

Prior to use of any NWP for construction of animal waste facilities in waters of the US, including wetlands, applicants shall comply with Nationwide Permit General Condition 31 (PCN).

## **2.7 Trout Waters**

Prior to any discharge of dredge or fill material into streams or waterbodies within the twenty-five (25) designated trout counties of North Carolina, the applicant shall comply with Nationwide Permit General Condition 31 (PCN). The applicant shall also provide a copy of the notification to the appropriate NCWRC office to facilitate the determination of any potential

impacts to designated Trout Waters. Notification to the Corps of Engineers will include a statement with the name of the NCWRC biologist contacted, the date of the notification, the location of work, a delineation of wetlands, a discussion of alternatives to working in the mountain trout waters, why alternatives were not selected, and a plan to provide compensatory mitigation for all unavoidable adverse impacts to mountain trout waters.

#### NCWRC and NC Trout Counties

Western Piedmont Region Coordinator	Alleghany	Caldwell	Watauga
20830 Great Smoky Mtn. Expressway	Ashe	Mitchell	Wilkes
Waynesville, NC 28786	Avery	Stokes	
Telephone: (828) 452-2546	Burke	Surry	

Mountain Region Coordinator	Buncombe	Henderson	Polk
20830 Great Smoky Mtn. Expressway	Cherokee	Jackson	Rutherford
Waynesville, NC 28786	Clay	Macon	Swain
Telephone: (828) 452-2546	Graham	Madison	Transylvania
Fax: (828) 452-7772	Haywood	McDowell	Yancey

### 3.0 List of Corps Regional Conditions for All Nationwide Permits

The following conditions apply to all Nationwide Permits in the Wilmington District:

#### 3.1 Limitation of Loss of Perennial Stream Bed

NWPs may not be used for activities that may result in the loss or degradation of greater than 300 total linear feet of perennial, intermittent or ephemeral stream, unless the District Commander has waived the 300 linear foot limit for ephemeral and intermittent streams on a case-by-case basis and he determines that the proposed activity will result in minimal individual and cumulative adverse impacts to the aquatic environment. Loss of stream includes the linear feet of stream bed that is filled, excavated, or flooded by the proposed activity. Waivers for the loss of ephemeral and intermittent streams must be in writing and documented by appropriate/accepted stream quality assessments\*. This waiver only applies to the 300 linear feet threshold for NWPs.

\*NOTE: Applicants should utilize the most current methodology prescribed by Wilmington District to assess stream function and quality. Information can be found at:

<http://www.saw.usace.army.mil/wetlands/permits/nwp/nwp2012> (see “Quick Links”)

### **3.2 Mitigation for Loss of Stream Bed**

For any NWP that results in a loss of more than 150 linear feet of perennial and/or ephemeral/intermittent stream, the applicant shall provide a mitigation proposal to compensate for more than minimal individual and cumulative adverse impacts to the aquatic environment. For stream losses less than 150 linear feet, that require a PCN, the District Commander may determine, on a case-by-case basis that compensatory mitigation is required to ensure that the activity results in minimal adverse effect on the aquatic environment.

### **3.3 Pre-construction Notification for Loss of Streambed Exceeding 150 Feet.**

Prior to use of any NWP for any activity which impacts more than 150 total linear feet of perennial stream or ephemeral/ intermittent stream, the applicant must comply with Nationwide Permit General Condition 31 (PCN). This applies to NWPs that do not have specific notification requirements. If a NWP has specific notification requirements, the requirements of the NWP should be followed.

### **3.4 Restriction on Use of Live Concrete**

For all NWPs which allow the use of concrete as a building material, live or fresh concrete, including bags of uncured concrete, may not come into contact with the water in or entering into waters of the US. Water inside coffer dams or casings that has been in contact with wet concrete shall only be returned to waters of the US when it is no longer poses a threat to aquatic organisms.

### **3.5 Requirements for Using Riprap for Bank Stabilization**

For all NWPs that allow for the use of riprap material for bank stabilization, the following measures shall be applied:

**3.5.1.** Filter cloth must be placed underneath the riprap as an additional requirement of its use in North Carolina waters.

**3.5.2.** The placement of riprap shall be limited to the areas depicted on submitted work plan drawings.

**3.5.3.** The riprap material shall be clean and free from loose dirt or any pollutant except in trace quantities that would not have an adverse environmental effect.

**3.5.4.** It shall be of a size sufficient to prevent its movement from the authorized alignment by natural forces under normal conditions.

**3.5.5.** The riprap material shall consist of clean rock or masonry material such as, but not limited to, granite, marl, or broken concrete.

**3.5.6.** A waiver from the specifications in this Regional Condition may be requested in writing. The waiver will only be issued if it can be demonstrated that the impacts of complying with this Regional condition would result in greater adverse impacts to the aquatic environment.

### **3.6 Safe Passage Requirements for Culvert Placement**

For all NWP's that involve the construction/installation of culverts, measures will be included in the construction/installation that will promote the safe passage of fish and other aquatic organisms. The dimension, pattern, and profile of the stream above and below a pipe or culvert should not be modified by widening the stream channel or by reducing the depth of the stream in connection with the construction activity. The width, height, and gradient of a proposed culvert should be such as to pass the average historical low flow and spring flow without adversely altering flow velocity. Spring flow should be determined from gage data, if available. In the absence of such data, bankfull flow can be used as a comparable level.

In the twenty (20) counties of North Carolina designated as coastal counties by the Coastal Area Management Act (CAMA): All pipes/culverts must be sufficiently sized to allow for the burial of the bottom of the pipe/culvert at least one foot below normal bed elevation when they are placed within the Public Trust Area of Environmental Concern (AEC) and/or the Estuarine Waters AEC as designated by CAMA, and/or all streams appearing as blue lines on United States Geological Survey (USGS) 7.5-minute quadrangle maps.

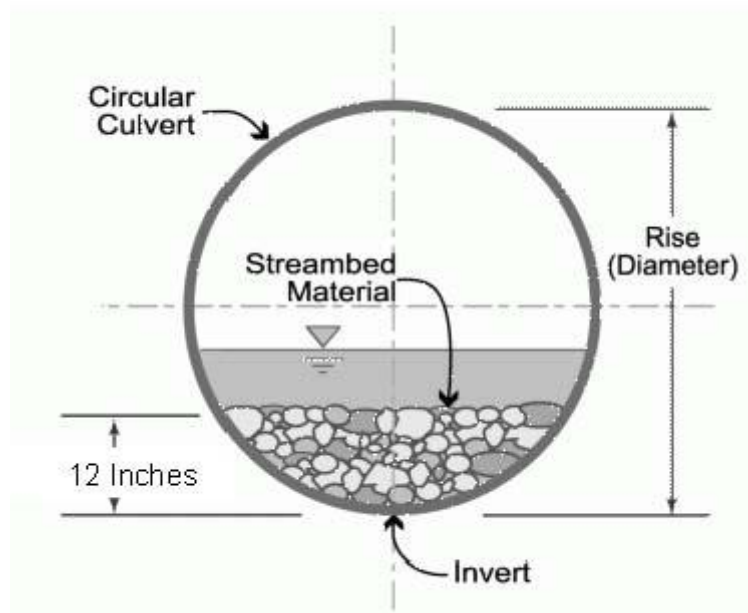

In all other counties: Culverts greater than 48 inches in diameter will be buried at least one foot below the bed of the stream. Culverts 48 inches in diameter or less shall be buried or placed on the stream bed as practicable and appropriate to maintain aquatic passage, and every effort shall be made to maintain the existing channel slope. The bottom of the culvert must be placed at a



depth below the natural stream bottom to provide for passage during drought or low flow conditions.

Culverts are to be designed and constructed in a manner that minimizes destabilization and head cutting. Destabilizing the channel and head cutting upstream should be considered and appropriate actions incorporated in the design and placement of the culvert.

A waiver from the depth specifications in this condition may be requested in writing. The waiver will be issued if it can be demonstrated that the proposal would result in the least impacts to the aquatic environment.

All counties: Culverts placed within riparian and/or riverine wetlands must be installed in a manner that does not restrict the flow and circulation patterns of waters of the United States. Culverts placed across wetland fills purely for the purposes of equalizing surface water do not have to be buried.

### **3.7 Notification to NCDENR Shellfish Sanitation Section**

Applicants shall notify the NCDENR Shellfish Sanitation Section prior to dredging in or removing sediment from an area closed to shell fishing where the effluent may be released to an area open for shell fishing or swimming in order to avoid contamination from the disposal area and cause a temporary shellfish closure to be made. Such notification shall also be provided to the appropriate Corps of Engineers Regulatory Field Office. Any disposal of sand to the ocean beach should occur between November 1 and April 30 when recreational usage is low. Only clean sand should be used and no dredged sand from closed shell fishing areas may be used. If beach disposal were to occur at times other than stated above or if sand from a closed shell fishing area is to be used, a swimming advisory shall be posted, and a press release shall be issued by the permittee.

### **3.8 Preservation of Submerged Aquatic Vegetation**

Adverse impacts to Submerged Aquatic Vegetation (SAV) are not authorized by any NWP within any of the twenty coastal counties defined by North Carolina's Coastal Area Management Act of 1974 (CAMA).

### **3.9 Sedimentation and Erosion Control Structures and Measures**

**3.9.1.** All PCNs will identify and describe sedimentation and erosion control structures and measures proposed for placement in waters of the US. The structures and measures should be depicted on maps, surveys or drawings showing location and impacts to jurisdictional wetlands and streams.

## **4.0 Additional Regional Conditions for Specific Nationwide Permits**

### **4.1 NWP #12 - Utility Line Activities**

**4.1.1.** Pipeline/utility line construction through jurisdictional waters and wetlands will be accomplished utilizing directional drilling/boring methods to the maximum extent practicable.

**4.1.2.** Temporary discharge of excavated or fill material into wetlands and waters of the United States will be for the absolute minimum period of time necessary to accomplish the work. Temporary discharges will be fully contained with appropriate erosion control or containment methods or otherwise such fills will consist of non-erodible materials.

**4.1.3.** The work area authorized by this permit, including temporary and/or permanent fills, will be minimized to the greatest extent practicable. Justification for work corridors exceeding forty (40) feet in width is required and will be based on pipeline diameter and length, size of equipment required to construct the utility line, and other construction information deemed necessary to support the request. The applicant is required to provide this information to the Corps with the initial notification package.

**4.1.4.** In areas where a sub-aqueous utility line is to cross a federally-maintained channel, (i.e., the Atlantic Intracoastal Waterway [AIWW]), the line will be buried at least six (6) feet below the allowable overdepth of the authorized channel, including all side slopes. For areas outside federally-maintained channels, sub-aqueous lines must be installed at a minimum depth of two (2) feet below the substrate when such lines might interfere with navigation.

**4.1.5.** The minimum clearance\*(see NOTE in 4.3.6.) for aerial communication lines, or any lines not transmitting electrical power, will be ten (10) feet above the clearance required for nearby stationary bridges as established by the U.S. Coast Guard. In the event the U.S. Coast Guard has not established a bridge clearance, minimum vertical clearances for power and aerial lines will not be less than required by Section 23, Rule 232, of the latest revision of the National Electrical Safety Code (ANSI C2). Clearances will not be less than shown in Table 232-1, Item 7, ANSI C2.

**4.1.6.** The minimum clearance\* for an aerial line, transmitting electrical power, is based on the low point of the line under conditions that produce the greatest sag, taking into consideration temperature, load, wind, length or span and the type of supports. The minimum clearance for an aerial electrical power transmission line crossing navigable waters of the US shall be governed by the system voltage, as indicated below:

Nominal System Voltage, kilovolt	Minimum Clearance
	Above Bridge Clearance (As Established by the U.S. Coast Guard)
115 and below	20 feet
138	22
161	24
230	26
350	30
500	35
700	42
750 to 765	45

\*NOTE: Minimum clearance is the distance measured between the lowest point of a stationary bridge, including *any* infrastructure attached to underside of the bridge, and the Mean High Water (MHW) of the navigable waters of the US beneath the bridge.

**4.1.7.** On navigable waters of the US, including all federal navigation projects, where there is no bridge for reference for minimum clearance, the proposed project will need to be reviewed by the US Army Corps of Engineers in order to determine the minimum clearance between the line and MHW necessary to protect navigational interests.

**4.1.8.** A plan to restore and re-vegetate wetland areas cleared for construction must be submitted with the required PCN. Cleared wetland areas shall be re-vegetated to the maximum extent practicable with native species of canopy, shrub, and herbaceous species. Fescue grass shall not be used.

**4.1.9.** For the purposes of this NWP, any permanently maintained corridor along the utility ROW within forested wetlands shall be considered a permanent impact and a compensatory mitigation plan will be required for all such impacts associated with the requested activity.

**4.1.10.** Use of rip-rap or any other engineered structures to stabilize a stream bed should be avoided to the maximum extent practicable. If riprap stabilization is needed, it should be placed only on the stream banks, or, if it is necessary to be placed in the stream bed, the finished top elevation of the riprap should not exceed that of the original stream bed.

**4.1.11.** When directional boring or horizontal directional drilling (HDD) under waters of the U.S., including wetlands, permittees shall closely monitor the project for hydraulic fracturing or “fracking.” Any discharge from hydraulic fracturing or “fracking” into waters of the U.S., including wetlands, shall be reported to the appropriate Corps Regulatory Field Office within 48 hours. Restoration and/or mitigation may be required as a result from any unintended discharges.

## **4.0 Additional Regional Conditions for Specific Nationwide Permits**

### **4.1 NWP #23 – Approved Categorical Exclusions**

**4.1.1.** No development activities authorized by this NWP may begin until the permittee obtains a consistency concurrence or a CAMA permit from the North Carolina Division of Coastal Management, if either is required.



North Carolina Department of Environment and Natural Resources

Pat McCrory  
Governor

Donald R. van der Vaart  
Secretary

April 7, 2015  
Columbus County  
NCDWR Project No. 15-0317  
Bridge 269 on SR 1849  
TIP No. B-5331

**APPROVAL of 401 WATER QUALITY CERTIFICATION, with ADDITIONAL CONDITIONS**

Mr. Richard W. Hancock, P.E., Manager  
Project Development and Environmental Analysis  
North Carolina Department of Transportation  
1598 Mail Service Center  
Raleigh, North Carolina, 27699-1598

Dear Mr. Hancock:

You have our approval, in accordance with the conditions listed below, for the following impacts for the purpose of replacing Bridge No. 269 over Big Branch on SR 1849 (Delco Prosper Road) in Columbus County:

**Wetland Impacts in the Cape Fear River Basin (riparian)**

Site	Station	Fill (ac)	Fill (temporary) (ac)	Excavation (ac)	Mechanized Clearing (ac)	Hand Clearing (ac)	Total Wetland Impact (ac)
1	-L- 13+03 to 17+83	0.06	0	0.14	0	0.09	0.29
1	EC Measures in HC areas	0	0.02	0	0	0	0.02
UTILITIES							
1	-L- 13+63 to 15+13	0	0	0	0	0.08	0.08
2	-L- 15+37 to 16+93	0	0	0	0	0.09	0.09
<b>Total</b>		<b>0.06</b>	<b>0.02</b>	<b>0.14</b>	<b>0</b>	<b>0.26</b>	<b>0.48</b>

**Total Wetland Impact for Project: 0.48 acres.**

The project shall be constructed in accordance with your application dated received March 30, 2015. After reviewing your application, we have decided that these impacts are covered by General Water Quality Certification Number 3891 and 3884. This certification corresponds to the Nationwide Permit 23 and Nationwide Permit 12 issued by the Corps of Engineers. In addition, you should acquire any other federal, state or local permits before you proceed with your project including (but not limited to) Sediment and Erosion Control, Non-Discharge and Water Supply Watershed regulations. This approval will expire with the accompanying 404 permit.

This approval is valid solely for the purpose and design described in your application (unless modified below). Should your project change, you must notify the NCDWR and submit a new application. If the property is sold, the new owner must be given a copy of this Certification and approval letter, and is thereby responsible for complying with all the conditions. If total wetland fills for this project (now or in the future) exceed one acre, or of total

1617 Mail Service Center, Raleigh, North Carolina 27699-1617  
Phone: 919-807-6300 \ Internet: www.ncdenr.gov

impacts to streams (now or in the future) exceed 150 linear feet, compensatory mitigation may be required as described in 15A NCAC 2H .0506 (h) (6) and (7). For this approval to remain valid, you must adhere to the conditions listed in the attached certification(s) and any additional conditions listed below.

#### Condition(s) of Certification:

##### Project Specific Conditions

1. As a condition of this 401 Water Quality Certification, the bridge demolition and construction must be accomplished in strict compliance with the most recent version of NCDOT's Best Management Practices for Construction and Maintenance Activities. [15A NCAC 02H .0507(d)(2) and 15A NCAC 02H .0506(b)(5)].
2. Erosion control matting placed in riparian areas shall not contain a nylon mesh grid, which can impinge and entrap small animals. Matting should be secured in place with staples, stakes, or wherever possible, live stakes of native trees. Riparian areas are defined as a distance 25 feet landward from top of stream bank. [15A NCAC 02H.0506(b)(3) and (c)(3)]
3. Bridge piles and bents shall be constructed using driven piles (hammer or vibratory) or drilled shaft construction methods. More specifically, jetting or other methods of pile driving are prohibited without prior written approval from the NCDWR first. [15A NCAC 02H.0506(b)(2)]
4. No drill slurry or water that has been in contact with uncured concrete shall be allowed to enter surface waters. This water shall be captured, treated, and disposed of properly. [15A NCAC 02H .0506(b)(3)]
5. Bridge deck drains shall not discharge directly into the stream. Stormwater shall be directed across the bridge and pre-treated through site-appropriate means (grassed swales, pre-formed scour holes, vegetated buffers, etc.) before entering the stream. Please refer to the most current version of *Stormwater Best Management Practices*. [15A NCAC 02H .0507(d)(2) and 15A NCAC 02H .0506(b)(5)]
6. The project shall be constructed in accordance with the provisions of the NCDOT's National Pollutant Discharge Elimination (NPDES) Stormwater Permit NCS000250, including the applicable requirements of the NCG01000. [15A NCAC 02B.0211].

##### General Conditions

7. Unless otherwise approved in this certification, placement of culverts and other structures in open waters and streams shall be placed below the elevation of the streambed by one foot for all culverts with a diameter greater than 48 inches, and 20 percent of the culvert diameter for culverts having a diameter less than 48 inches, to allow low flow passage of water and aquatic life. Design and placement of culverts and other structures including temporary erosion control measures shall not be conducted in a manner that may result in dis-equilibrium of wetlands or streambeds or banks, adjacent to or upstream and downstream of the above structures. The applicant is required to provide evidence that the equilibrium is being maintained if requested in writing by NCDWR. If this condition is unable to be met due to bedrock or other limiting features encountered during construction, please contact NCDWR for guidance on how to proceed and to determine whether or not a permit modification will be required. [15A NCAC 02H.0506(b)(2)]
8. If concrete is used during construction, a dry work area shall be maintained to prevent direct contact between curing concrete and stream water. Water that inadvertently contacts uncured concrete shall not be discharged to surface waters due to the potential for elevated pH and possible aquatic life and fish kills. [15A NCAC 02B.0200]
9. During the construction of the project, no staging of equipment of any kind is permitted in waters of the U.S., or protected riparian buffers. [15A NCAC 02H.0506(b)(2)]

10. The dimension, pattern and profile of the stream above and below the crossing shall not be modified. Disturbed floodplains and streams shall be restored to natural geomorphic conditions. [15A NCAC 02H.0506(b)(2)]
11. The use of rip-rap above the Normal High Water Mark shall be minimized. Any rip-rap placed for stream stabilization shall be placed in stream channels in such a manner that it does not impede aquatic life passage. [15A NCAC 02H.0506(b)(2)]
12. The Permittee shall ensure that the final design drawings adhere to the permit and to the permit drawings submitted for approval. [15A NCAC 02H .0507(c) and 15A NCAC 02H .0506 (b)(2) and (c)(2)]
13. All work in or adjacent to stream waters shall be conducted in a dry work area. Approved BMP measures from the most current version of NCDOT Construction and Maintenance Activities manual such as sandbags, rock berms, cofferdams and other diversion structures shall be used to prevent excavation in flowing water. [15A NCAC 02H.0506(b)(3) and (c)(3)]
14. Heavy equipment shall be operated from the banks rather than in the stream channel in order to minimize sedimentation and reduce the introduction of other pollutants into the stream. [15A NCAC 02H.0506(b)(3)]
15. All mechanized equipment operated near surface waters must be regularly inspected and maintained to prevent contamination of stream waters from fuels, lubricants, hydraulic fluids, or other toxic materials. [15A NCAC 02H.0506(b)(3)]
16. No rock, sand or other materials shall be dredged from the stream channel except where authorized by this certification. [15A NCAC 02H.0506(b)(3)]
17. Discharging hydroseed mixtures and washing out hydroseeders and other equipment in or adjacent to surface waters is prohibited. [15A NCAC 02H.0506(b)(3)]
18. The permittee and its authorized agents shall conduct its activities in a manner consistent with State water quality standards (including any requirements resulting from compliance with §303(d) of the Clean Water Act) and any other appropriate requirements of State and Federal law. If the NCDWR determines that such standards or laws are not being met (including the failure to sustain a designated or achieved use) or that State or federal law is being violated, or that further conditions are necessary to assure compliance, the NCDWR may reevaluate and modify this certification. [15A NCAC 02B.0200]
19. All fill slopes located in jurisdictional wetlands shall be placed at slopes no flatter than 3:1, unless otherwise authorized by this certification. [15A NCAC 02H.0506(b)(2)]
20. A copy of this Water Quality Certification shall be maintained on the construction site at all times. In addition, the Water Quality Certification and all subsequent modifications, if any, shall be maintained with the Division Engineer and the on-site project manager. [15A NCAC 02H .0507(c) and 15A NCAC 02H .0506 (b)(2) and (c)(2)]
21. The outside buffer, wetland or water boundary located within the construction corridor approved by this authorization shall be clearly marked by highly visible fencing prior to any land disturbing activities. Impacts to areas within the fencing are prohibited unless otherwise authorized by this certification. [15A NCAC 02H.0501 and .0502]
22. The issuance of this certification does not exempt the Permittee from complying with any and all statutes, rules, regulations, or ordinances that may be imposed by other government agencies (i.e. local, state, and federal) having jurisdiction, including but not limited to applicable buffer rules, stormwater management rules, soil erosion and sedimentation control requirements, etc.
23. The Permittee shall report any violations of this certification to the Division of Water Resources within 24 hours of discovery. [15A NCAC 02B.0506(b)(2)]



24. Upon completion of the project (including any impacts at associated borrow or waste sites), the NCDOT Division Engineer shall complete and return the enclosed "Certification of Completion Form" to notify the NCDWR when all work included in the 401 Certification has been completed. [15A NCAC 02H.0502(f)]
25. Native riparian vegetation must be reestablished in the riparian areas within the construction limits of the project by the end of the growing season following completion of construction.[15A NCAC 02B.0506(b)(2)]
26. There shall be no excavation from, or waste disposal into, jurisdictional wetlands or waters associated with this permit without appropriate modification. Should waste or borrow sites, or access roads to waste or borrow sites, be located in wetlands or streams, compensatory mitigation will be required since that is a direct impact from road construction activities.[15A NCAC 02H.0506(b)(3) and (c)(3)]
27. Erosion and sediment control practices must be in full compliance with all specifications governing the proper design, installation and operation and maintenance of such Best Management Practices in order to protect surface waters standards [15A NCAC 02H.0506(b)(3) and (c)(3)]:
  - a. The erosion and sediment control measures for the project must be designed, installed, operated, and maintained in accordance with the most recent version of the *North Carolina Sediment and Erosion Control Planning and Design Manual*.
  - b. The design, installation, operation, and maintenance of the sediment and erosion control measures must be such that they equal, or exceed, the requirements specified in the most recent version of the *North Carolina Sediment and Erosion Control Manual*. The devices shall be maintained on all construction sites, borrow sites, and waste pile (spoil) projects, including contractor-owned or leased borrow pits associated with the project.
  - c. For borrow pit sites, the erosion and sediment control measures must be designed, installed, operated, and maintained in accordance with the most recent version of the *North Carolina Surface Mining Manual*.
  - d. The reclamation measures and implementation must comply with the reclamation in accordance with the requirements of the Sedimentation Pollution Control Act.
28. Where placement of sediment and erosion control devices in wetlands and/or waters is unavoidable, they shall be removed and the natural grade restored upon completion of the project. [15A NCAC 02H.0506(b)(3) and (c)(3)]

If you wish to contest any statement in the attached Certification you must file a petition for an administrative hearing. You may obtain the petition form from the office of Administrative hearings. You must file the petition with the office of Administrative Hearings within sixty (60) days of receipt of this notice. A petition is considered filed when it is received in the office of Administrative Hearings during normal office hours. The Office of Administrative Hearings accepts filings Monday through Friday between the hours of 8:00am and 5:00pm, except for official state holidays. The original and one (1) copy of the petition must be filed with the Office of Administrative Hearings.

The petition may be faxed-provided the original and one copy of the document is received by the Office of Administrative Hearings within five (5) business days following the faxed transmission.  
The mailing address for the Office of Administrative Hearings is:

Office of Administrative Hearings  
6714 Mail Service Center  
Raleigh, NC 27699-6714  
Telephone: (919)-431-3000, Facsimile: (919)-431-3100

A copy of the petition must also be served on DENR as follows:

Mr. Sam M. Hayes, General Counsel  
Department of Environment and Natural Resources  
1601 Mail Service Center

This letter completes the review of the Division of Water Resources under Section 401 of the Clean Water Act. If you have any questions, please contact Mason Herndon at (910) 308-4021 or [mason.herndon@ncdenr.gov](mailto:mason.herndon@ncdenr.gov).

Sincerely,

  
S. Jay Zimmerman, Director  
Division of Water Resources

Electronic copy only distribution:

Liz Hair, US Army Corps of Engineers, Wilmington Field Office  
Jim Rerko, Division 6 Environmental Officer  
Colin Mellor, NC Department of Transportation  
Chris Rivenbark, NC Department of Transportation  
Gary Jordan, US Fish and Wildlife Service  
Travis Wilson, NC Wildlife Resources Commission  
NC Division of Water Resources Raleigh Central Office  
File Copy



North Carolina Department of Environment and Natural Resources

Pat McCrory  
Governor

Donald R. van der Vaart  
Secretary

NCDWR Project No.: \_\_\_\_\_ County: \_\_\_\_\_

Applicant: \_\_\_\_\_

Project Name: \_\_\_\_\_

Date of Issuance of 401 Water Quality Certification: \_\_\_\_\_

**Certificate of Completion**

Upon completion of all work approved within the 401 Water Quality Certification or applicable Buffer Rules, and any subsequent modifications, the applicant is required to return this certificate to the 401 Transportation Permitting Unit, North Carolina Division of Water Resources, 1617 Mail Service Center, Raleigh, NC, 27699-1617. This form may be returned to NCDWR by the applicant, the applicant's authorized agent, or the project engineer. It is not necessary to send certificates from all of these.

***Applicant's Certification***

I, \_\_\_\_\_, hereby state that, to the best of my abilities, due care and diligence was used in the observation of the construction such that the construction was observed to be built within substantial compliance and intent of the 401 Water Quality Certification and Buffer Rules, the approved plans and specifications, and other supporting materials.

Signature: \_\_\_\_\_ Date: \_\_\_\_\_

***Agent's Certification***

I, \_\_\_\_\_, hereby state that, to the best of my abilities, due care and diligence was used in the observation of the construction such that the construction was observed to be built within substantial compliance and intent of the 401 Water Quality Certification and Buffer Rules, the approved plans and specifications, and other supporting materials.

Signature: \_\_\_\_\_ Date: \_\_\_\_\_

***Engineer's Certification***

\_\_\_\_\_ Partial \_\_\_\_\_ Final

I, \_\_\_\_\_, as a duly registered Professional Engineer in the State of North Carolina, having been authorized to observe (periodically, weekly, full time) the construction of the project for the Permittee hereby state that, to the best of my abilities, due care and diligence was used in the observation of the construction such that the construction was observed to be built within substantial compliance and intent of the 401 Water Quality Certification and Buffer Rules, the approved plans and specifications, and other supporting materials.

Signature \_\_\_\_\_ Registration No. \_\_\_\_\_

Date \_\_\_\_\_

# Water Quality Certification No. 3884

**GENERAL CERTIFICATION FOR PROJECTS ELIGIBLE  
FOR U.S. ARMY CORPS OF ENGINEERS NATIONWIDE PERMIT  
NUMBERS 12 (UTILITY LINE ACTIVITIES) AND 47 (PIPELINE SAFETY PROGRAM  
DESIGNATED TIME SENSITIVE INSPECTIONS AND REPAIRS),  
AND RIPARIAN AREA PROTECTION RULES (BUFFER RULES)**

Water Quality Certification Number 3884 is issued in conformity with the requirements of Section 401, Public Laws 92-500 and 95-217 of the United States and subject to the North Carolina Division of Water Quality (DWQ) Regulations in 15A NCAC 02H .0500 and 15A NCAC 02B .0200 for the discharge of fill material to waters and wetland areas as described in 33 CFR 330 Appendix A (B) (12 and 47) of the Corps of Engineers regulations including any fill activity for utility line backfill and bedding, and for the Riparian Area Protection Rules (Buffer Rules) in 15A NCAC 02B .0200.

The State of North Carolina certifies that the specified category of activity will not violate applicable portions of Sections 301, 302, 303, 306 and 307 of the Public Laws 92-500 and 95-217 if conducted in accordance with the conditions hereinafter set forth.

**Activities meeting any one (1) of the following thresholds or circumstances require *written approval* for a 401 Water Quality Certification from the Division of Water Quality (the "Division"):**

- a) Permanent impacts to any wetlands and/or waters, including streams; or
- b) Any stream relocation; or
- c) Impacts to any wetlands and/or waters if the maintenance corridor in a wetland or at a stream crossing is greater than 15 feet wide (except activities located in areas with Riparian Area Protection Rules when the maintenance corridor at stream crossing must be 10 feet wide or less). Gas pipelines may have a maintenance corridor wider than fifteen feet if mitigation is provided for these additional wetland fills.
- d) Any impact associated with a Notice of Violation or an enforcement action for violation(s) of DWQ Wetland Rules (15A NCAC 02H .0500), Isolated Wetland Rules (15A NCAC 02H .1300), DWQ Surface Water or Wetland Standards, or Riparian Buffer Rules (15A NCAC 02B .0200); or
- e) Any impacts to streams and/or buffers in the Neuse, Tar-Pamlico, or Catawba River Basins or in the Randleman, Jordan or Goose Creek Watersheds (or any other basin or watershed with Riparian Area Protection Rules [Buffer Rules] in effect at the time of application) *unless* the activities are listed as "EXEMPT" from these rules or a Buffer Authorization Certificate is issued through N.C. Division of Coastal Management (DCM) delegation for "ALLOWABLE" activities.

In accordance with North Carolina General Statute 143-215.3D(e), written approval for a 401 Water Quality General Certification must include the appropriate fee. If a project also requires a CAMA Permit, then one payment to both agencies shall be submitted and will be the higher of the two fees.

**Activities included in this General Certification that do not meet one of the thresholds listed above do not require written approval from the Division as long as they comply with the Conditions of Certification listed below. If any of these Conditions cannot be met, then written approval from the Division is required.**



# Water Quality Certification No. 3884

## Conditions of Certification:

1. No Impacts Beyond those Authorized in the Written Approval or Beyond the Threshold of Use of this Certification

No waste, spoil, solids, or fill of any kind shall occur in wetlands, waters, or riparian areas beyond the footprint of the impacts depicted in the Pre-Construction Notification, as authorized in the written approval from the Division or beyond the thresholds established for use of this Certification without written authorization, including incidental impacts. All construction activities, including the design, installation, operation, and maintenance of sediment and erosion control Best Management Practices shall be performed so that no violations of state water quality standards, statutes, or rules occur. Approved plans and specifications for this project are incorporated by reference and are enforceable parts of this permit.

2. Standard Erosion and Sediment Control Practices

Erosion and sediment control practices must be in full compliance with all specifications governing the proper design, installation and operation and maintenance of such Best Management Practices and if applicable, comply with the specific conditions and requirements of the NPDES Construction Stormwater Permit issued to the site:

- a. Design, installation, operation, and maintenance of the sediment and erosion control measures must be such that they equal or exceed the requirements specified in the most recent version of the *North Carolina Sediment and Erosion Control Manual*. The devices shall be maintained on all construction sites, borrow sites, and waste pile (spoil) projects, including contractor-owned or leased borrow pits associated with the project.
  - b. For borrow pit sites, the erosion and sediment control measures must be designed, installed, operated, and maintained in accordance with the most recent version of the *North Carolina Surface Mining Manual*.
  - c. Reclamation measures and implementation must comply with the reclamation in accordance with the requirements of the Sedimentation Pollution Control Act and the Mining Act of 1971.
  - d. Sufficient materials required for stabilization and/or repair of erosion control measures and stormwater routing and treatment shall be on site at all times.
  - e. If the project occurs in waters or watersheds classified as Primary Nursery Areas (PNAs), SA, WS-I, WS-II, High Quality (HQW), or Outstanding Resource (ORW) waters, then the sedimentation and erosion control designs must comply with the requirements set forth in 15A NCAC 04B .0124, *Design Standards in Sensitive Watersheds*.
3. No Sediment and Erosion Control Measures in Wetlands or Waters

Sediment and erosion control measures shall not be placed in wetlands or waters. Exceptions to this condition require application submittal to and written approval by the Division. If placement of sediment and erosion control devices in wetlands and waters is unavoidable, then design and placement of temporary erosion control measures shall not be conducted in a manner that may result in dis-equilibrium of wetlands, stream beds, or banks, adjacent to or upstream and downstream of the above structures. All sediment and erosion control devices shall be removed and the natural grade restored within two (2) months of the date that the Division of Land Resources (DLR) or locally delegated program has released the specific area within the project.

# Water Quality Certification No. 3884

## 4. Construction Stormwater Permit NCG010000

An NPDES Construction Stormwater Permit is required for construction projects that disturb one (1) or more acres of land. This Permit allows stormwater to be discharged during land disturbing construction activities as stipulated in the conditions of the permit. If your project is covered by this permit, full compliance with permit conditions including the erosion & sedimentation control plan, inspections and maintenance, self-monitoring, record keeping and reporting requirements is required. A copy of the general permit (NCG010000), inspection log sheets, and other information may be found at <http://portal.ncdenr.org/web/wq/ws/su/npdessw#tab-w>.

The North Carolina Department of Transportation (NCDOT) shall be required to be in full compliance with the conditions related to construction activities within the most recent version of their individual NPDES (NCS000250) stormwater permit.

## 5. Construction Moratoriums and Coordination

If activities must occur during periods of high biological activity (i.e. sea turtle nesting, fish spawning, or bird nesting), then biological monitoring may be required at the request of other state or federal agencies and coordinated with these activities.

All moratoriums on construction activities established by the NC Wildlife Resources Commission (WRC), US Fish and Wildlife Service (USFWS), NC Division of Marine Fisheries (DMF), or National Marine Fisheries Service (NMFS) to lessen impacts on trout, anadromous fish, larval/post-larval fishes and crustaceans, or other aquatic species of concern shall be implemented. Exceptions to this condition require written approval by the resource agency responsible for the given moratorium.

Work within the twenty-five (25) designated trout counties or identified state or federal endangered or threatened species habitat shall be coordinated with the appropriate WRC, USFWS, NMFS, and/or DMF personnel.

## 6. Work in the Dry

All work in or adjacent to stream waters shall be conducted so that the flowing stream does not come in contact with the disturbed area. Approved best management practices from the most current version of the NC Sediment and Erosion Control Manual, or the NC DOT Construction and Maintenance Activities Manual, such as sandbags, rock berms, cofferdams, and other diversion structures shall be used to minimize excavation in flowing water. Exceptions to this condition require application submittal to and written approval by the Division.

## 7. Riparian Area Protection (Buffer) Rule

Activities located in the protected riparian areas (whether jurisdictional wetlands or not), within the Neuse, Tar-Pamlico, or Catawba River Basins or in the Randleman, Jordan, or Goose Creek Watersheds (or any other basin or watershed with buffer rules) shall be limited to "uses" identified within and constructed in accordance with 15A NCAC 02B .0233, .0259, .0243, .0250, .0267 and .0605, and shall be located, designed, constructed, and maintained to have minimal disturbance to protect water quality to the maximum extent practicable through the use of best management practices. All buffer rule requirements, including diffuse flow requirements, must be met.



# Water Quality Certification No. 3884

## 8. Compensatory Mitigation

In accordance with 15A NCAC 02H .0506 (h), compensatory mitigation may be required for losses of equal to or greater than 150 linear feet of streams (intermittent and perennial) and/or equal to or greater than one (1) acre of wetlands. For linear public transportation projects, impacts equal to or exceeding 150 linear feet per stream shall require mitigation.

Buffer mitigation may be required for any project with Buffer Rules in effect at the time of application for activities classified as "Allowable with Mitigation" or "Prohibited" within the Table of Uses.

A determination of buffer, wetland, and stream mitigation requirements shall be made for any General Water Quality Certification for this Nationwide and/or Regional General Permit. Design and monitoring protocols shall follow the US Army Corps of Engineers Wilmington District *Stream Mitigation Guidelines* (April 2003) or its subsequent updates. Compensatory mitigation plans shall be submitted to the Division for written approval as required in those protocols. The mitigation plan must be implemented and/or constructed before any impacts occur on site. Alternatively, the Division will accept payment into an in-lieu fee program or a mitigation bank. In these cases, proof of payment shall be provided to the Division before any impacts occur on site.

9. Relocated stream designs should include the same dimensions, patterns, and profiles as the existing channel (or a stable reference reach if the existing channel is unstable), to the maximum extent practical. The new channel should be constructed in the dry and water shall not be turned into the new channel until the banks are stabilized. Vegetation used for bank stabilization shall be limited to native woody species, and should include establishment of a 30-foot wide wooded and an adjacent 20-foot wide vegetated buffer on both sides of the relocated channel to the maximum extent practical. A transitional phase incorporating appropriate erosion control matting materials and seedling establishment is allowable, however matting that incorporates plastic mesh and/or plastic twine shall not be used in wetlands, riparian buffers or floodplains as recommended by the North Carolina Sediment and Erosion Control Manual. Rip-rap, A-Jacks, concrete, gabions or other hard structures may be allowed if it is necessary to maintain the physical integrity of the stream; however, the applicant must provide written justification and any calculations used to determine the extent of rip-rap coverage. Please note that if the stream relocation is conducted as a stream restoration as defined in the US Army Corps of Engineers Wilmington District, April 2003 *Stream Mitigation Guidelines* (or its subsequent updates), the restored length may be used as compensatory mitigation for the impacts resulting from the relocation.

10. For sewer lines, when the construction corridor is parallel to a stream, then the edge of the construction corridor shall not be closer than 10 feet from top of bank. For streams classified as WS (except WS-IV or WS-V), B, SA, ORW, HQW, or SB from normal high water (or tide elevation) and wetlands, the edge of the construction corridor shall not be closer than 50 feet to a stream; or 100 feet to private or public water supply sources or waters classified as WS-I waters or Class I or Class II impounded reservoirs used as a source of drinking water in accordance with 15A NCAC 02T .0305(f).

Utility lines within the Riparian Buffers shall be installed in accordance with the Table of uses in the most recent version of the appropriate buffer rules.

Utility lines shall not cross a stream channel at other than a near-perpendicular direction (i.e., stream channel crossings shall not be at an angle of less than 75 degrees or more than 105 degrees to the stream bank).

11. Any wastewater line that crosses any stream shall be installed in accordance with the most recent version of the Gravity Sewer minimum Design Criteria or the most recent version of



## Water Quality Certification No. 3884

the Minimum Design Criteria for the Fast-Track Permitting of Pump Stations and Force Main published on the Division of Water Quality's website. Exceptions to this condition require application submittal to, and written approval by, the Division.

12. If concrete is used during the construction, then all necessary measures shall be taken to prevent direct contact between uncured or curing concrete and waters of the state. Water that inadvertently contacts uncured concrete shall not be discharged to waters of the state due to the potential for elevated pH and possible aquatic life/ fish kills.
13. Any rip-rap required for proper culvert placement, stream stabilization, or restoration of temporarily disturbed areas shall be restricted to the the area directly impacted by approved construction activity. All rip-rap shall be buried and/or "keyed in" such that the original stream elevation and streambank contours are restored and maintained. Placement of rip-rap or other approved materials shall not result in de-stabilization of the stream bed or banks upstream or downstream of the area
14. Annual native species suitable for wet locations shall be planted and established within jurisdictional wetlands for soil and erosion control. Non-native perennials such as fescue are prohibited.
15. A one-time application of fertilizer to re-establish vegetation is allowed in disturbed areas including riparian buffers, but is restricted to no closer than 10 feet from top of bank of streams. Any fertilizer application must comply with all other Federal, State and Local regulations.
16. The construction corridor (including access roads, sediment and erosion control measures and stockpiling of materials) is limited to 40 feet (12.2 meters) in width in wetlands and across stream channels and must be minimized to the maximum extent practicable.
17. Permanent, maintained access corridors shall be restricted to the minimum width practicable and shall not exceed 15 feet in width except at manhole locations. A 15-foot by 15-foot perpendicular vehicle turnaround must be spaced at least 500 feet (152.4 meters) apart.
18. An anti-seep collar shall be placed at the downstream (utility line gradient) wetland boundary and every 150 feet (45.7 meters) up the gradient until the utility exits the wetland for buried utility lines. Anti-seep collars may be constructed with class B concrete, compacted clay, PVC pipe, or metal collars. Wetland crossings that are directionally drilled, and perpendicular wetland crossings that are open cut and less than 150 feet (45.7 meters) long do not require anti-seep collars. The compacted clay shall have a specific infiltration of 1 X 10<sup>-5</sup> cm/sec or less. A section and plan view diagram is attached for the anti-seep collars.

The following specifications shall apply to class B concrete:

- a) Minimum cement content, sacks per cubic yard with rounded course aggregate 5.0
  - b) Minimum cement content, sacks per cubic yard with angular course aggregate 5.5
  - c) Maximum water-cement ratio gallons per sack 6.8
  - d) Slump range 2" to 4"
  - e) Minimum strength - 28 day psi 2,500
19. The applicant shall have a specific plan for restoring wetland contours. Any excess material will be removed to a high ground disposal area.

The mixing of topsoil and subsoils within the wetlands along utility corridors shall be minimized to the greatest extent practical. During excavation, the soils shall be placed on fabric to minimize impacts whenever possible. Topsoil excavated from utility trenches will be



## Water Quality Certification No. 3884

piled separately from subsoils and will be backfilled into the trench only after the subsoils have been placed and compacted.

Along utility corridors within wetlands, grub stumps only as needed to install the utility and cut remaining stumps off at grade level. The general stripping of topsoil within wetlands along the utility corridor is not permitted.

20. If an environmental document is required under the National or State Environmental Policy Act (NEPA or SEPA), then this General Certification is not valid until a Finding of No Significant Impact (FONSI) or Record of Decision (ROD) is issued by the State Clearinghouse.
21. In the twenty (20) coastal counties, the appropriate DWQ Regional Office must be contacted to determine if Coastal Stormwater Regulations will be required.
22. This General Certification does not relieve the applicant of the responsibility to obtain all other required Federal, State, or Local approvals.
23. The applicant/permittee and their authorized agents shall conduct all activities in a manner consistent with State water quality standards (including any requirements resulting from compliance with §303(d) of the Clean Water Act), and any other appropriate requirements of State and Federal Law. If the Division determines that such standards or laws are not being met, including failure to sustain a designated or achieved use, or that State or Federal law is being violated, or that further conditions are necessary to assure compliance, then the Division may reevaluate and modify this General Water Quality Certification.
24. When written authorization is required for use of this certification, upon completion of all permitted impacts included within the approval and any subsequent modifications, the applicant shall be required to return the certificate of completion attached to the approval. One copy of the certificate shall be sent to the DWQ Central Office in Raleigh at 1650 Mail Service Center, Raleigh, NC, 27699-1650.
25. Additional site-specific conditions, including monitoring and/or modeling requirements, may be added to the written approval letter for projects proposed under this Water Quality Certification in order to ensure compliance with all applicable water quality and effluent standards.
26. This certification grants permission to the director, an authorized representative of the Director, or DENR staff, upon the presentation of proper credentials, to enter the property during normal business hours.

This General Certification shall expire on the same day as the expiration date of the corresponding Nationwide and/or Regional General Permit. The conditions in effect on the date of issuance of Certification for a specific project shall remain in effect for the life of the project, regardless of the expiration date of this Certification.

Non-compliance with or violation of the conditions herein set forth by a specific project may result in revocation of this General Certification for the project and may also result in criminal and/or civil penalties.

The Director of the North Carolina Division of Water Quality may require submission of a formal application for Individual Certification for any project in this category of activity if it is determined that the project is likely to have a significant adverse effect upon water quality, including state or federally listed endangered or threatened aquatic species, or degrade the waters so that existing uses of the wetland or downstream waters are precluded.

# Water Quality Certification No. 3884

Public hearings may be held for specific applications or group of applications prior to a Certification decision if deemed in the public's best interest by the Director of the North Carolina Division of Water Quality.

Effective date: March 19, 2012

DIVISION OF WATER QUALITY

By

A handwritten signature in blue ink, appearing to read "Charles Wakild" with a stylized flourish at the end.

Charles Wakild, P.E.

Director

*History Note: Water Quality Certification (WQC) Number 3884 issued March 19, 2012 replaces WQC Number 3819 issued March 19, 2010; WQC Number 3699 issued November 1, 2007; WQC Number 3625 issued March 19, 2007; WQC Number 3374 issued March 18, 2002; WQC Number 3288 issued June 1, 2000; WQC Number 3101 issued February 11, 1997; WQC Number 3022 issued September 6, 1995, WQC Number 2664 issued January 21, 1992. This General Certification is rescinded when the Corps of Engineers reauthorizes any of the corresponding Nationwide and/or Regional General Permits or when deemed appropriate by the Director of the Division of Water Quality.*

### ANTI-SEEP COLLAR

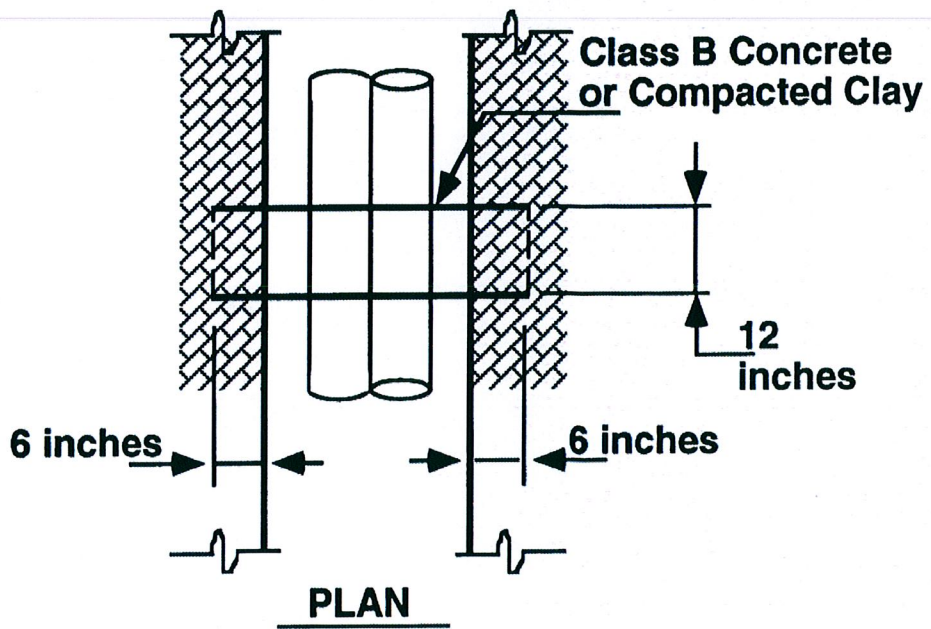
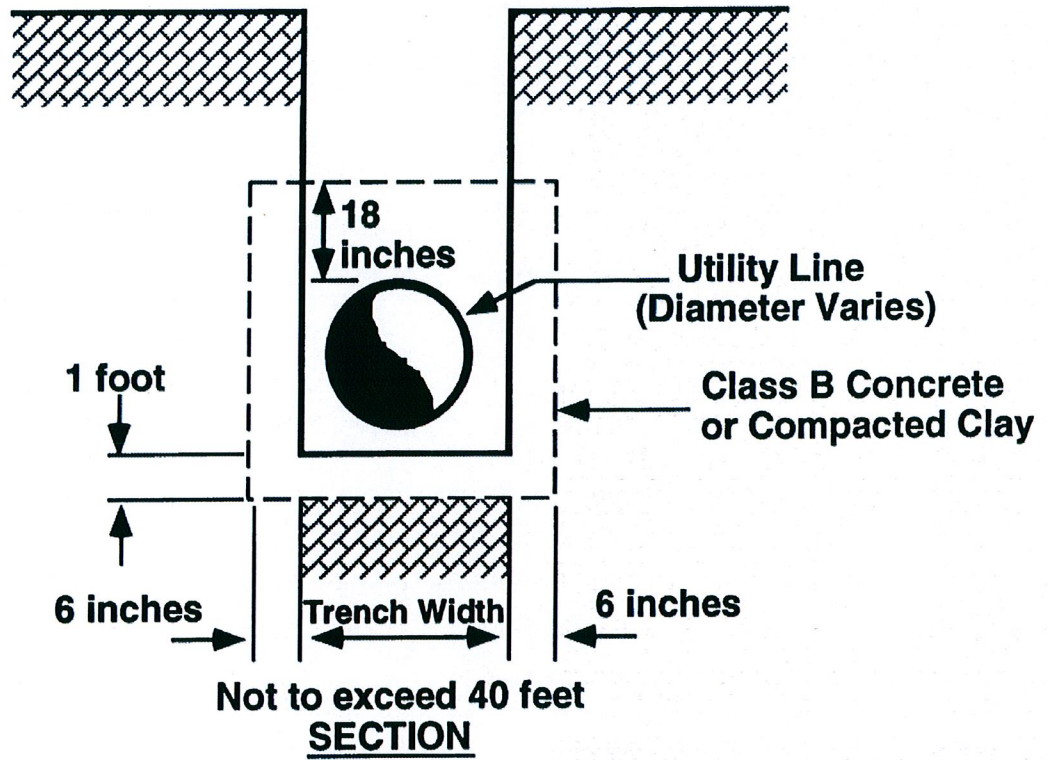



# Water Quality Certification No. 3891

## **GENERAL CERTIFICATION FOR PROJECTS ELIGIBLE FOR U.S. ARMY CORPS OF ENGINEERS NATIONWIDE PERMIT NUMBER 23 (APPROVED CATEGORICAL EXCLUSIONS) AND RIPARIAN AREA PROTECTION RULES (BUFFER RULES)**

Water Quality Certification Number 3891 is issued in conformity with the requirements of Section 401, Public Laws 92-500 and 95-217 of the United States and subject to the North Carolina Division of Water Quality Regulations in 15A NCAC 02H .0500 and 15A NCAC 02B .0200 for the discharge of fill material to waters and wetland areas as described in 33 CFR 330 Appendix A (B) (23) and for the Riparian Area Protection Rules (Buffer Rules) in 15A NCAC 02B .0200.

The category of activities shall include only Federally-approved Categorical Exclusion projects.

The State of North Carolina certifies that the specified category of activity will not violate applicable portions of Sections 301, 302, 303, 306 and 307 of the Public Laws 92-500 and 95-217 if conducted in accordance with the conditions hereinafter set forth.

**Activities meeting any one (1) of the following thresholds or circumstances require *written approval* for a 401 Water Quality Certification from the Division of Water Quality (the "Division"):**

- a) Stream impacts (temporary or permanent) equal or greater than 40 linear feet; or
- b) Any stream relocation; or
- c) Impacts equal to or greater than one-tenth (1/10) acre of wetlands or open waters; or
- d) Any impacts to wetlands adjacent to waters designated as: ORW, SA, WS-I, WS-II, or Trout, or wetlands contiguous to waters designated as a North Carolina or National Wild and Scenic River.
- e) Any impacts to coastal wetlands [15A NCAC 7H .0205)], or Unique Wetlands (UWL) [15A NCAC 2H .0506].
- f) Any impact associated with a Notice of Violation or an enforcement action for violation(s) of DWQ Wetland Rules (15A NCAC 02H .0500), Isolated Wetland Rules (15A NCAC 02H .1300), DWQ Surface Water or Wetland Standards, or Riparian Buffer Rules (15A NCAC 02B .0200); or
- g) Any impacts to streams and/or buffers in the Neuse, Tar-Pamlico, or Catawba River Basins or in the Randleman, Jordan or Goose Creek Watersheds (or any other basin or watershed with Riparian Area Protection Rules [Buffer Rules] in effect at the time of application) *unless* the activities are listed as "EXEMPT" from these rules or a Buffer Authorization Certificate is issued through N.C. Division of Coastal Management (DCM) delegation for "ALLOWABLE" activities.

In accordance with North Carolina General Statute 143-215.3D(e), written approval for a 401 Water Quality General Certification must include the appropriate fee. If a project also requires a CAMA Permit, then one payment to both agencies shall be submitted and will be the higher of the two fees.

**Activities included in this General Certification that do not meet one of the thresholds listed above do not require written approval from the Division as long as they comply with the Conditions of Certification listed below. If any of these Conditions cannot be met, then written approval from the Division is required.**

Conditions of Certification:

1. No Impacts Beyond those Authorized in the Written Approval or Beyond the Threshold of Use of this Certification

No waste, spoil, solids, or fill of any kind shall occur in wetlands, waters, or riparian areas beyond the footprint of the impacts depicted in the Pre-Construction Notification, as

# Water Quality Certification No. 3891

authorized in the written approval from the Division or beyond the thresholds established for use of this Certification without written authorization, including incidental impacts. All construction activities, including the design, installation, operation, and maintenance of sediment and erosion control Best Management Practices shall be performed so that no violations of state water quality standards, statutes, or rules occur. Approved plans and specifications for this project are incorporated by reference and are enforceable parts of this permit.

## 2. Standard Erosion and Sediment Control Practices

Erosion and sediment control practices must be in full compliance with all specifications governing the proper design, installation and operation and maintenance of such Best Management Practices and if applicable, comply with the specific conditions and requirements of the NPDES Construction Stormwater Permit issued to the site:

- a. Design, installation, operation, and maintenance of the sediment and erosion control measures must be such that they equal or exceed the requirements specified in the most recent version of the *North Carolina Sediment and Erosion Control Manual*. The devices shall be maintained on all construction sites, borrow sites, and waste pile (spoil) projects, including contractor-owned or leased borrow pits associated with the project.
- b. For borrow pit sites, the erosion and sediment control measures must be designed, installed, operated, and maintained in accordance with the most recent version of the *North Carolina Surface Mining Manual*.
- c. Reclamation measures and implementation must comply with the reclamation in accordance with the requirements of the Sedimentation Pollution Control Act and the Mining Act of 1971.
- d. Sufficient materials required for stabilization and/or repair of erosion control measures and stormwater routing and treatment shall be on site at all times.
- e. If the project occurs in waters or watersheds classified as Primary Nursery Areas (PNAs), SA, WS-I, WS-II, High Quality (HQW), or Outstanding Resource (ORW) waters, then the sedimentation and erosion control designs must comply with the requirements set forth in 15A NCAC 04B .0124, *Design Standards in Sensitive Watersheds*.

## 3. No Sediment and Erosion Control Measures in Wetlands or Waters

Sediment and erosion control measures shall not be placed in wetlands or waters. Exceptions to this condition require application submittal to and written approval by the Division. If placement of sediment and erosion control devices in wetlands and waters is unavoidable, then design and placement of temporary erosion control measures shall not be conducted in a manner that may result in dis-equilibrium of wetlands, stream beds, or banks, adjacent to or upstream and downstream of the above structures. All sediment and erosion control devices shall be removed and the natural grade restored within two (2) months of the date that the Division of Land Resources (DLR) or locally delegated program has released the specific area within the project.

## 4. Construction Stormwater Permit NCG010000



# Water Quality Certification No. 3891

An NPDES Construction Stormwater Permit is required for construction projects that disturb one (1) or more acres of land. This Permit allows stormwater to be discharged during land disturbing construction activities as stipulated in the conditions of the permit. If your project is covered by this permit, full compliance with permit conditions including the erosion & sedimentation control plan, inspections and maintenance, self-monitoring, record keeping and reporting requirements is required. A copy of the general permit (NCG010000), inspection log sheets, and other information may be found at <http://portal.ncdenr.org/web/wq/ws/su/npdessw#tab-w>.

The North Carolina Department of Transportation (NCDOT) shall be required to be in full compliance with the conditions related to construction activities within the most recent version of their individual NPDES (NCS000250) stormwater permit.

## 5. Construction Moratoriums and Coordination

If activities must occur during periods of high biological activity (i.e. sea turtle nesting, fish spawning, or bird nesting), then biological monitoring may be required at the request of other state or federal agencies and coordinated with these activities.

All moratoriums on construction activities established by the NC Wildlife Resources Commission (WRC), US Fish and Wildlife Service (USFWS), NC Division of Marine Fisheries (DMF), or National Marine Fisheries Service (NMFS) to lessen impacts on trout, anadromous fish, larval/post-larval fishes and crustaceans, or other aquatic species of concern shall be implemented. Exceptions to this condition require written approval by the resource agency responsible for the given moratorium.

Work within the twenty-five (25) designated trout counties or identified state or federal endangered or threatened species habitat shall be coordinated with the appropriate WRC, USFWS, NMFS, and/or DMF personnel.

## 6. Work in the Dry

All work in or adjacent to stream waters shall be conducted so that the flowing stream does not come in contact with the disturbed area. Approved best management practices from the most current version of the NC Sediment and Erosion Control Manual, or the NC DOT Construction and Maintenance Activities Manual, such as sandbags, rock berms, cofferdams, and other diversion structures shall be used to minimize excavation in flowing water. Exceptions to this condition require application submittal to and written approval by the Division.

## 7. Riparian Area Protection (Buffer) Rules

Activities located in the protected riparian areas (whether jurisdictional wetlands or not), within the Neuse, Tar-Pamlico, or Catawba River Basins or in the Randleman, Jordan, or Goose Creek Watersheds (or any other basin or watershed with buffer rules) shall be limited to "uses" identified within and constructed in accordance with 15A NCAC 02B .0233, .0259, .0243, .0250, .0267 and .0605, and shall be located, designed, constructed, and maintained to have minimal disturbance to protect water quality to the maximum extent practicable through the use of best management practices. All buffer rule requirements, including diffuse flow requirements, must be met.

8. If concrete is used during the construction, then all necessary measures shall be taken to prevent direct contact between uncured or curing concrete and waters of the state. Water that inadvertently contacts uncured concrete shall not be discharged to waters of the state due to the potential for elevated pH and possible aquatic life/ fish kills.



# Water Quality Certification No. 3891

9. Bridge deck drains shall not discharge directly into the stream. Stormwater shall be directed across the bridge and pre-treated through site-appropriate means (grassed swales, pre-formed scour holes, vegetated buffers, etc.) before entering the stream. Please refer to the most current version of *Stormwater Best Management Practices*. Exceptions to this condition require written approval by the Division.
10. Relocated stream designs should include the same dimensions, patterns, and profiles as the existing channel (or a stable reference reach if the existing channel is unstable), to the maximum extent practical. The new channel should be constructed in the dry and water shall not be turned into the new channel until the banks are stabilized. Vegetation used for bank stabilization shall be limited to native woody species, and should include establishment of a 30-foot wide wooded and an adjacent 20-foot wide vegetated buffer on both sides of the relocated channel to the maximum extent practical. A transitional phase incorporating appropriate erosion control matting materials and seedling establishment is allowable, however matting that incorporates plastic mesh and/or plastic twine shall not be used in wetlands, riparian buffers or floodplains as recommended by the North Carolina Sediment and Erosion Control Manual. Rip-rap, A-Jacks, concrete, gabions or other hard structures may be allowed if it is necessary to maintain the physical integrity of the stream; however, the applicant must provide written justification and any calculations used to determine the extent of rip-rap coverage. Please note that if the stream relocation is conducted as a stream restoration as defined in the US Army Corps of Engineers Wilmington District, April 2003 *Stream Mitigation Guidelines* (or its subsequent updates), the restored length may be used as compensatory mitigation for the impacts resulting from the relocation.
11. Placement of Culverts and Other Structures in Waters and Wetlands

Culverts required for this project shall be designed and installed in such a manner that the original stream profiles are not altered and allow for aquatic life movement during low flows. Existing stream dimensions (including the cross section dimensions, pattern, and longitudinal profile) must be maintained above and below locations of each culvert.

Placement of culverts and other structures in waters and streams must be below the elevation of the streambed by one foot for all culverts with a diameter greater than 48 inches, and 20 percent of the culvert diameter for culverts having a diameter less than or equal to 48 inches, to allow low flow passage of water and aquatic life.

When topographic constraints indicate culvert slopes of greater than 5%, culvert burial is not required, provided that all alternative options for flattening the slope have been investigated and aquatic life movement/ connectivity has been provided when possible (rock ladders, crossvanes, etc). Notification to the Division including supporting documentation to include a location map of the culvert, culvert profile drawings, and slope calculations shall be provided to the Division 60 days prior to the installation of the culvert.

When bedrock is present in culvert locations, culvert burial is not required provided that there is sufficient documentation of the presence of bedrock. Notification to the Division including supporting documentation such as, but not limited to, a location map of the culvert, geotechnical reports, photographs, etc shall be provided to the Division a minimum of 60 days prior to the installation of the culvert. If bedrock is discovered during construction, then the Division shall be notified by phone or email within 24 hours of discovery.

If other site-specific topographic constraints preclude the ability to bury the culverts as described above and/or it can be demonstrated that burying the culvert would result in destabilization of the channel, then exceptions to this condition require application submittal to, and written approval by, the Division of Water Quality, regardless of the total impacts to streams or wetlands from the project.



# Water Quality Certification No. 3891

Installation of culverts in wetlands must ensure continuity of water movement and be designed to adequately accommodate high water or flood conditions. Additionally, when roadways, causeways, or other fill projects are constructed across FEMA-designated floodways or wetlands, openings such as culverts or bridges must be provided to maintain the natural hydrology of the system as well as prevent constriction of the floodway that may result in destabilization of streams or wetlands.

The establishment of native, woody vegetation and other soft stream bank stabilization techniques must be used where practicable instead of riprap or other bank hardening methods.

## 12. Compensatory Mitigation

In accordance with 15A NCAC 02H .0506 (h), compensatory mitigation may be required for losses of equal to or greater than 150 linear feet of streams (intermittent and perennial) and/or equal to or greater than one (1) acre of wetlands. For linear public transportation projects, impacts equal to or exceeding 150 linear feet per stream shall require mitigation.

Buffer mitigation may be required for any project with Buffer Rules in effect at the time of application for activities classified as "Allowable with Mitigation" or "Prohibited" within the Table of Uses.

A determination of buffer, wetland, and stream mitigation requirements shall be made for any General Water Quality Certification for this Nationwide and/or Regional General Permit. Design and monitoring protocols shall follow the US Army Corps of Engineers Wilmington District *Stream Mitigation Guidelines* (April 2003) or its subsequent updates. Compensatory mitigation plans shall be submitted to the Division for written approval as required in those protocols. The mitigation plan must be implemented and/or constructed before any impacts occur on site. Alternatively, the Division will accept payment into an in-lieu fee program or a mitigation bank. In these cases, proof of payment shall be provided to the Division before any impacts occur on site.

13. If an environmental document is required under the National or State Environmental Policy Act (NEPA or SEPA), then this General Certification is not valid until a Finding of No Significant Impact (FONSI) or Record of Decision (ROD) is issued by the State Clearinghouse.
14. In the twenty (20) coastal counties, the appropriate DWQ Regional Office must be contacted to determine if Coastal Stormwater Regulations will be required.
15. This General Certification does not relieve the applicant of the responsibility to obtain all other required Federal, State, or Local approvals.
16. The applicant/permittee and their authorized agents shall conduct all activities in a manner consistent with State water quality standards (including any requirements resulting from compliance with §303(d) of the Clean Water Act), and any other appropriate requirements of State and Federal Law. If the Division determines that such standards or laws are not being met, including failure to sustain a designated or achieved use, or that State or Federal law is being violated, or that further conditions are necessary to assure compliance, then the Division may reevaluate and modify this General Water Quality Certification.



# Water Quality Certification No. 3891

17. When written authorization is required for use of this certification, upon completion of all permitted impacts included within the approval and any subsequent modifications, the applicant shall be required to return the certificate of completion attached to the approval. One copy of the certificate shall be sent to the DWQ Central Office in Raleigh at 1650 Mail Service Center, Raleigh, NC, 27699-1650.
18. Additional site-specific conditions, including monitoring and/or modeling requirements, may be added to the written approval letter for projects proposed under this Water Quality Certification in order to ensure compliance with all applicable water quality and effluent standards.
19. This certification grants permission to the director, an authorized representative of the Director, or DENR staff, upon the presentation of proper credentials, to enter the property during normal business hours.

This General Certification shall expire on the same day as the expiration date of the corresponding Nationwide and/or Regional General Permit. The conditions in effect on the date of issuance of Certification for a specific project shall remain in effect for the life of the project, regardless of the expiration date of this Certification.

Non-compliance with or violation of the conditions herein set forth by a specific project may result in revocation of this General Certification for the project and may also result in criminal and/or civil penalties.

The Director of the North Carolina Division of Water Quality may require submission of a formal application for Individual Certification for any project in this category of activity if it is determined that the project is likely to have a significant adverse effect upon water quality, including state or federally listed endangered or threatened aquatic species, or degrade the waters so that existing uses of the wetland or downstream waters are precluded.

Public hearings may be held for specific applications or group of applications prior to a Certification decision if deemed in the public's best interest by the Director of the North Carolina Division of Water Quality.

Effective date: March 19, 2012

DIVISION OF WATER QUALITY

By



Charles Wakild, P.E.

Director

*History Note: Water Quality Certification (WQC) Number 3891 issued March 19, 2012 replaces WQC 3701 issued November 1, 2007; WQC Number 3632 issued March 2007; WQC Number 3403 issued March 2003; WQC Number 3361 issued March 18, 2002; WQC Number 3107 issued February 11, 1997; WQC Number 2734 issued May 1 1993; and WQC Number 2670 issued on January 21, 1992. This General Certification is rescinded when the Corps of Engineers reauthorizes any of the corresponding Nationwide and/or Regional General Permits or when deemed appropriate by the Director of the Division of Water Quality.*



**TIP PROJECT: B-5331**

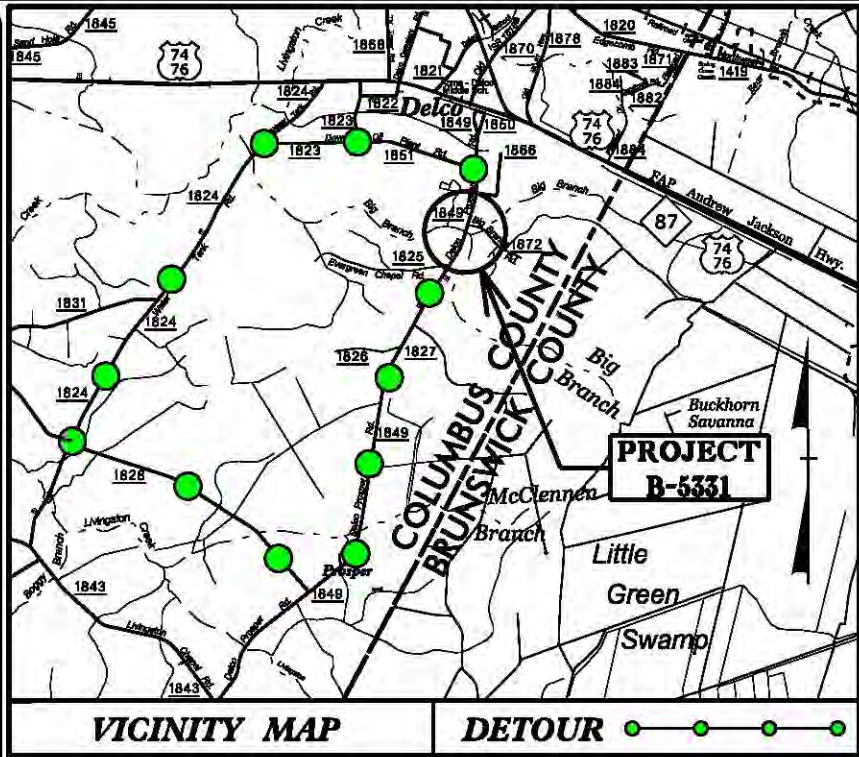

VICINITY MAP

DETOUR

See Sheet 1A For Index of Sheets  
See Sheet 1B For Conventional Symbols

STATE OF NORTH CAROLINA  
DIVISION OF HIGHWAYS

**COLUMBUS COUNTY**

LOCATION: BRIDGE NO. 269 OVER BIG BRANCH  
ON SR 1849 (DELCO PROSPER ROAD)

TYPE OF WORK: GRADING, PAVING, DRAINAGE & STRUCTURE

**WETLAND AND STREAM IMPACTS**

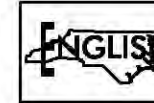

STATE	STATE PROJECT REFERENCE NO.	SHEET NO.	TOTAL SHEETS
N.C.	B-5331	1	
STATE FUNDING	F.A.P.FUNDING	DESCRIPTION	
46045.1.1	BRZ-1849(1)	PE	
46045.2.1	BRZ-1849(1)	RW, UTIL.	

PERMIT DRAWING  
SHEET 1 OF 8

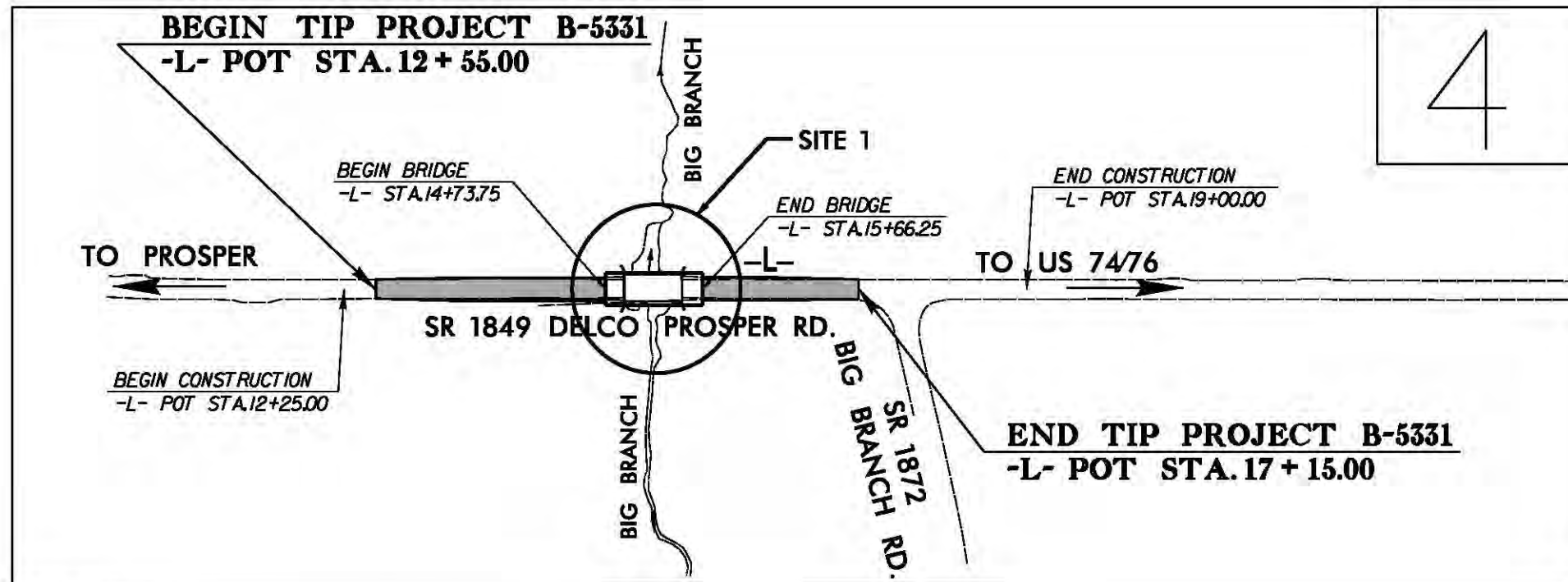
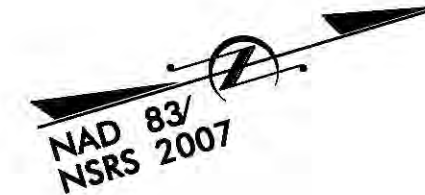

THERE IS NO CONTROL OF ACCESS ON THIS PROJECT.  
THIS PROJECT IS NOT WITHIN ANY MUNICIPAL BOUNDARIES.  
CLEARING ON THIS PROJECT SHALL BE PERFORMED TO THE LIMITS ESTABLISHED BY METHOD II.

**PRELIMINARY PLANS**  
DO NOT USE FOR CONSTRUCTION

**CONTRACT:**

**GRAPHIC SCALES**

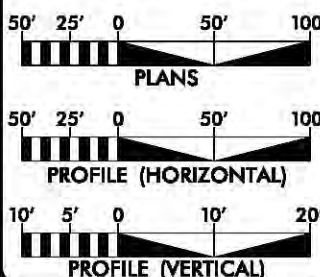

**DESIGN DATA**

ADT 2015 = 1,433  
ADT 2035 = 2,100  
K = 9 %  
D = 60 %  
T = 5 % \*  
V = 60 MPH  
\* TTST = 2% DUAL = 3%  
FUNC CLASS = RURAL LOCAL  
SUBREGIONAL TIER

**PROJECT LENGTH**

LENGTH ROADWAY TIP PROJECT B-5331 = 0.069 MI.  
LENGTH STRUCTURE TIP PROJECT B-5331 = 0.018 MI.  
TOTAL LENGTH OF TIP PROJECT B-5331 = 0.087 MI.

Prepared in the Office of:  
**DIVISION OF HIGHWAYS**  
1000 Birch Ridge Dr., Raleigh NC, 27610

2012 STANDARD SPECIFICATIONS

RIGHT OF WAY DATE:  
NOVEMBER 21, 2014

LETTING DATE:  
NOVEMBER 17, 2015

REKHA PATEL, P.E.  
PROJECT ENGINEER

BRIAN ROBINSON  
PROJECT DESIGN ENGINEER

HYDRAULICS ENGINEER

SIGNATURE: \_\_\_\_\_ P.E.

ROADWAY DESIGN ENGINEER

SIGNATURE: \_\_\_\_\_ P.E.









12/16/2014  
 mshaikh  
 R:\Hydraulics\PERMITS\_Environmental\Drawings\B-5118\_Hyd\_perm\_wet\_enlargement.dgn

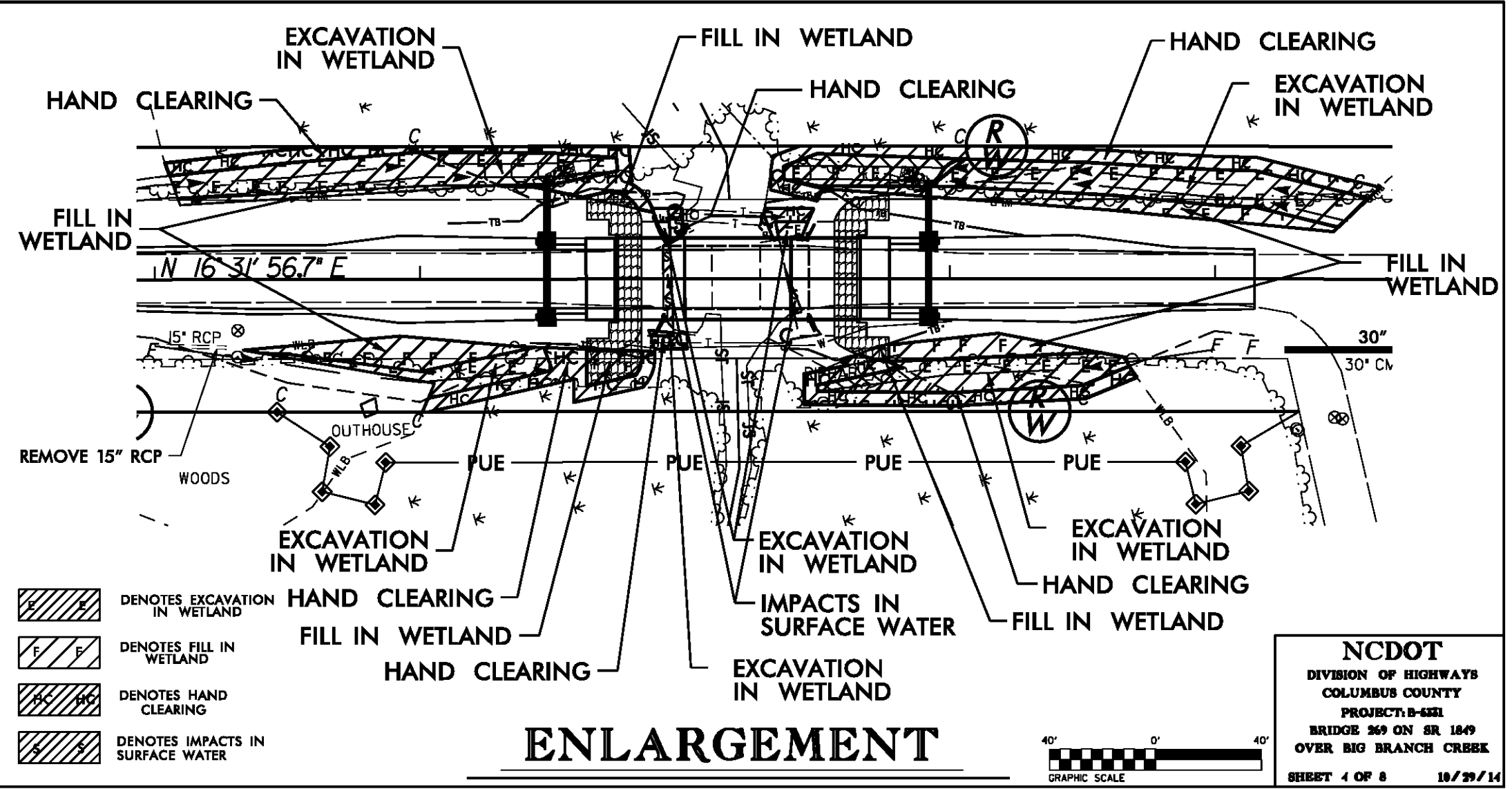

# ENLARGEMENT

5/14/99



STRUCTURE HYDRAULIC DATA	
DESIGN DISCHARGE	= 950 CFS
DESIGN FREQUENCY	= 25 YRS
DESIGN HW ELEVATION	= 340 FT
BASE DISCHARGE	= 1,300 CFS
BASE FREQUENCY	= 100 YRS
BASE HW ELEVATION	= 350 FT
OVERTOPPING DISCHARGE	= 1,800+ CFS
OVERTOPPING FREQUENCY	= 500+ YRS
OVERTOPPING ELEVATION	= 365 FT

PI = 14+75.00  
 EL = 37.32  
 VC = 200'  
 K = 291

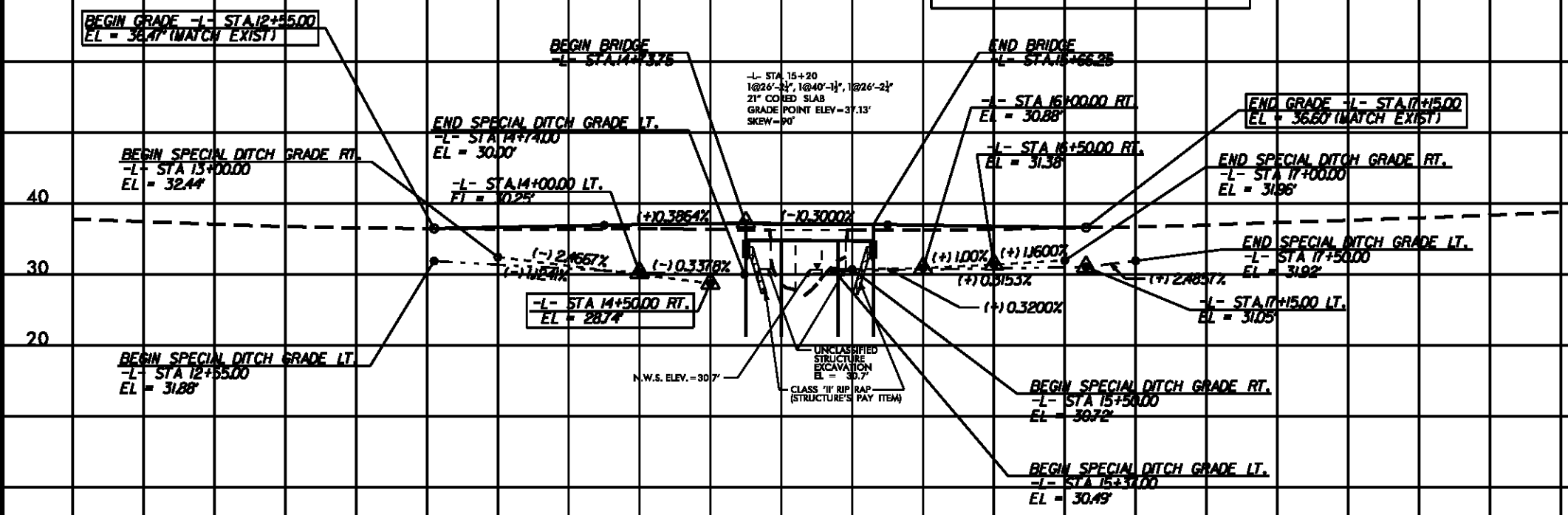

RIGHT DITCH - - - - -

LEFT DITCH - - - - -

FOR -L- PLAN VIEW  
SEE SHEET 4

12/18/2014  
 beanderson  
 R:\Hydraulics\PERMITS\_Environmental\Drawings\B5331\_Hyd\_prm\_pfi.dgn  
 \*\*\*\*\*SYTIME\*\*\*\*\*  
 \*\*\*\*\*DGN\*\*\*\*\*

10 11 12 13 14 15 16 17 18 19 20

8/23/99

PERMIT DRAWING  
SHEET 6 OF 8

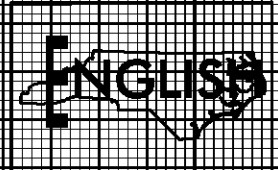

END BRIDGE -L- STA 15+66.25

0.020 0.020

36.26

15+50.00

0.020 0.020

36.26

15+00.00

BEGIN BRIDGE -L- STA 14+73.75

36.27

14+73.74

0.020 0.020

36.34

14+50.00

CLEARING  
LIMIT

WLB

WLB

CLEARING  
LIMIT

12/16/2014  
mahalkh  
R:\Hydraulics\PERMITS\_Environmental\Drawings\5331\_Hyd\_perm\_xpl.dgn  
\$\$\$\$\$SYSTEMTIME\$\$\$\$\$  
\$\$\$\$\$USERPROFILE\$\$\$\$\$

8/23/99

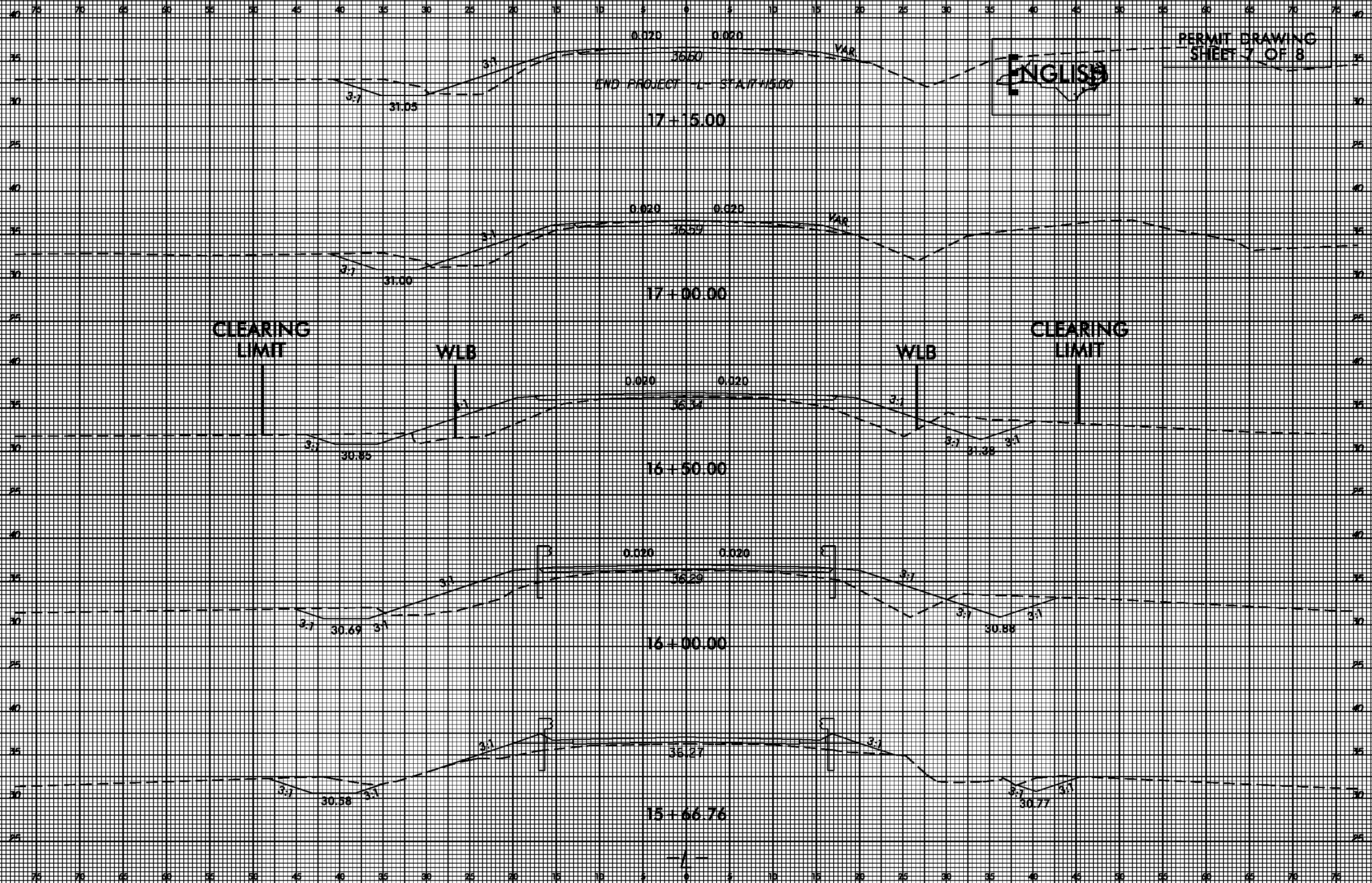

PERMIT DRAWING  
SHEET 7 OF 8

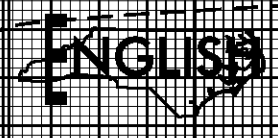

CLEARING  
LIMIT

WLB

WLB

CLEARING  
LIMIT

12/6/2014  
mahalich  
R:\Hydraulics\PERMITS\_Environmental\Drawings\b5331\_Hyd\_prm\_xpl.dgn  
SYSTEMTIME:#####  
#####  
#####  
#####



**WETLAND PERMIT IMPACT SUMMARY**

Site No.	Station (From/To)	Structure Size / Type	WETLAND IMPACTS					SURFACE WATER IMPACTS				
			Permanent Fill In Wetlands (ac)	Temp. Fill In Wetlands (ac)	Excavation in Wetlands (ac)	Mechanized Clearing in Wetlands (ac)	Hand Clearing in Wetlands (ac)	Permanent SW impacts (ac)	Temp. SW impacts (ac)	Existing Channel Impacts Permanent (ft)	Existing Channel Impacts Temp. (ft)	Natural Stream Design (ft)
1	-L- STA 13+03 TO -L- STA 17+63	BRIDGE	0.06		0.14			0.09	< 0.01			
<b>TOTALS:</b>			0.06		0.14			0.09	< 0.01			

NOTES:  
 Permanent impacts due to bent in water or wetlands: 11.0 sq. ft.  
 0.02 acres of Temporary Fill in Wetlands in the Hand Clearing areas for erosion control measures.

NC DEPARTMENT OF TRANSPORTATION  
 DIVISION OF HIGHWAYS  
 B-5331  
 COLUMBUS COUNTY  
 BRIDGE 0269 ON SR 1849  
 OVER BIG BRANCH CREEK  
 SHEET 8 OF 8 3/24/2015

**TIP PROJECT: B-5331**

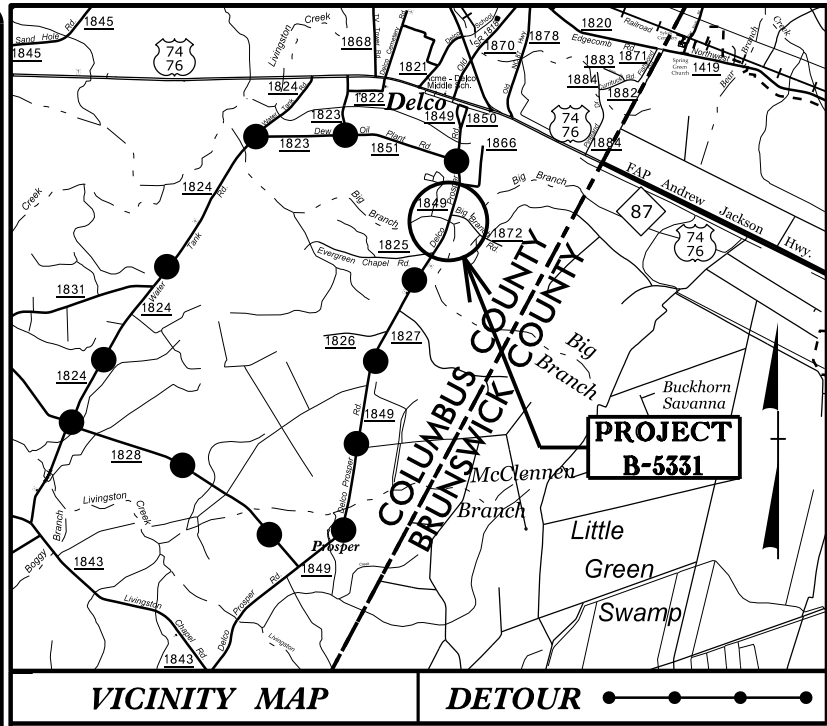

**VICINITY MAP**

**DETOUR**

See Sheet 1A For Index of Sheets  
See Sheet 1B For Conventional Symbols

STATE OF NORTH CAROLINA  
DIVISION OF HIGHWAYS

---

## COLUMBUS COUNTY

---

### NEU PERMIT DRAWING PLANS

**LOCATION: BRIDGE NO. 269 OVER BIG BRANCH  
ON SR 1849 (DELCO PROSPER ROAD)**

**TYPE OF WORK: RELOCATING UTILITY LINES**

STATE	STATE PROJECT REFERENCE NO.	SHEET NO.	TOTAL SHEETS
N.C.	B-5331	UE-01	
STATE PROJ. NO.	F.A. PROJ. NO.	DESCRIPTION	
46045.1.1	BRZ-1849(1)	PE	
46045.2.1	BRZ-1849(1)	RW, UTIL.	

Utility Permit Drawings  
Sheet 1 of 3

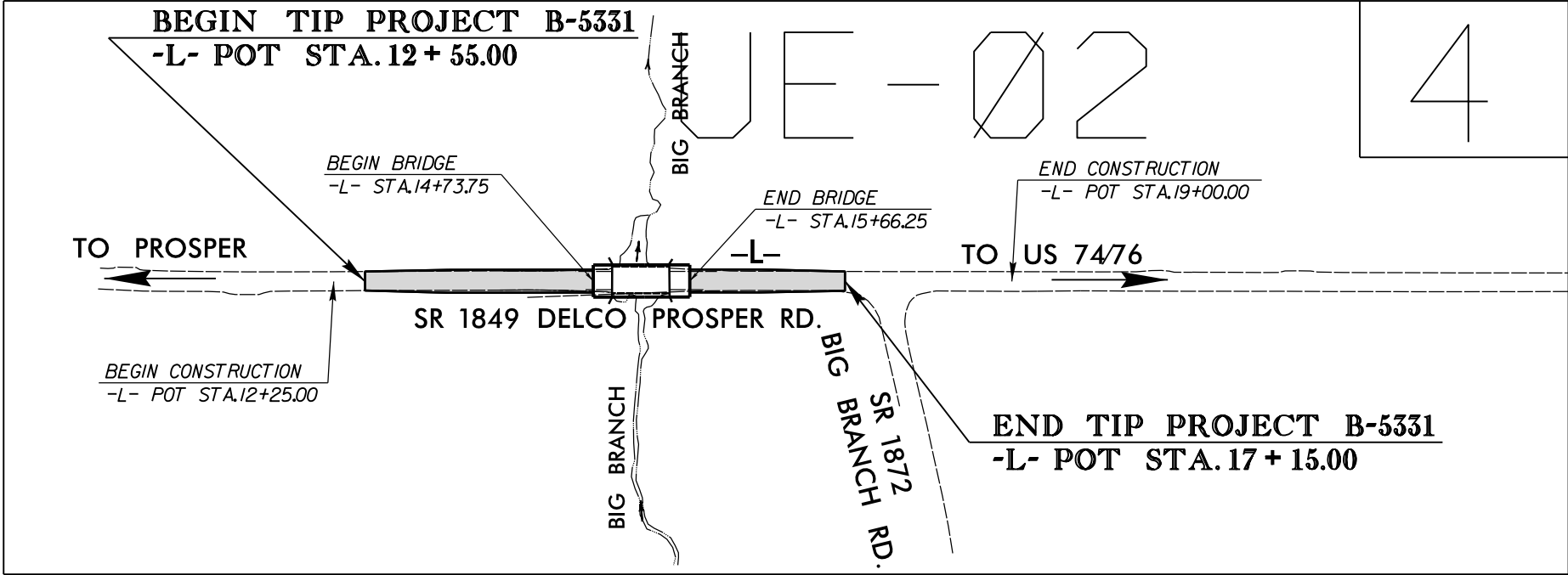
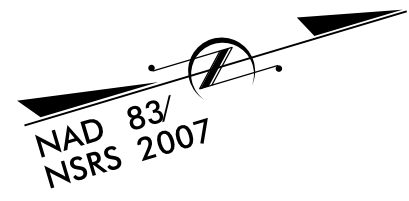

THERE IS NO CONTROL OF ACCESS ON THIS PROJECT.  
THIS PROJECT IS NOT WITHIN ANY MUNICIPAL BOUNDARIES.  
CLEARING ON THIS PROJECT SHALL BE PERFORMED TO THE LIMITS ESTABLISHED BY METHOD II.

**PRELIMINARY PLANS**  
DO NOT USE FOR CONSTRUCTION

**CONTRACT:**

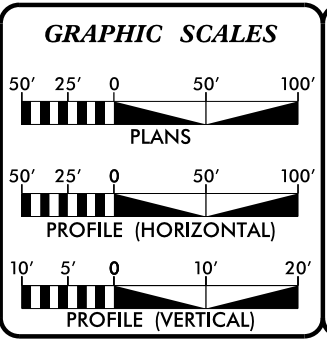

**DESIGN DATA**

ADT 2015 =	1,433
ADT 2035 =	2,100
K =	9 %
D =	60 %
T =	5 % *
V =	60 MPH
* TTST = 2% DUAL = 3%	
FUNC CLASS =	RURAL LOCAL
SUBREGIONAL TIER	

**PROJECT LENGTH**

LENGTH ROADWAY TIP PROJECT B-5331 =	0.069 MI.
LENGTH STRUCTURE TIP PROJECT B-5331 =	0.018 MI.
TOTAL LENGTH OF TIP PROJECT B-5331 =	0.087 MI.

Prepared in the Office of:  
**DIVISION OF HIGHWAYS**  
1000 Birch Ridge Dr., Raleigh NC, 27610

<p>2012 STANDARD SPECIFICATIONS</p> <p><b>RIGHT OF WAY DATE:</b> NOVEMBER 21, 2014</p> <p><b>LETTING DATE:</b> NOVEMBER 17, 2015</p>	<p><b>REKHA PATEL, P.E.</b> PROJECT ENGINEER</p> <hr/> <p><b>BRIAN ROBINSON</b> PROJECT DESIGN ENGINEER</p>
--	---

**HYDRAULICS ENGINEER**

SIGNATURE: \_\_\_\_\_ P.E.

---

**ROADWAY DESIGN ENGINEER**

SIGNATURE: \_\_\_\_\_ P.E.

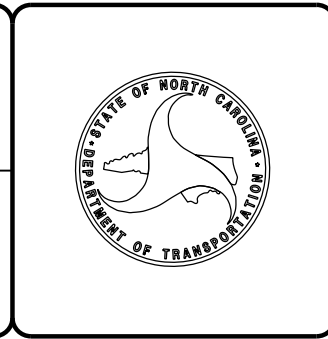

02-JAN-2015 07:44 R:\Utilities\Engineering\NEU\Permit Plans and Narrative\b5331\_ut\_tsh\_UE01\_psh.dgn \$\$\$USERNAME\$\$\$

PROJECT REFERENCE NO. B-5331	SHEET NO. UE-02
RW SHEET NO.	
ROADWAY DESIGN ENGINEER	HYDRAULICS ENGINEER
<b>PRELIMINARY PLANS</b> DO NOT USE FOR CONSTRUCTION	

-L- CURVE DATA

PI Sta. 11+08.34	PI Sta. 16+24.12
$\Delta = 1^{\circ}42'34.6"$ (LT)	$\Delta = 0^{\circ}13'33.6"$ (RT)
$D = 1^{\circ}49'18.5"$	$D = 0^{\circ}06'41"$
$L = 93.84'$	$L = 202.82'$
$T = 46.92'$	$T = 101.4'$
$R = 3,145.00'$	$R = 51,420.00'$

NAD 83/NSRS 2007

Utility Permit Drawings  
Sheet 2 of 3

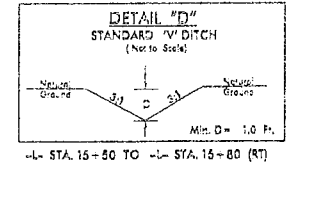
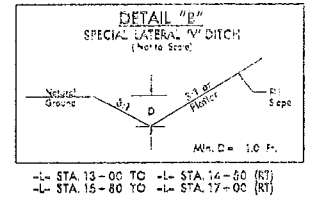
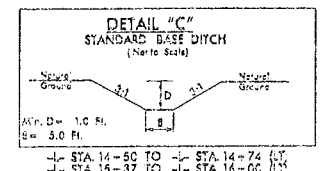
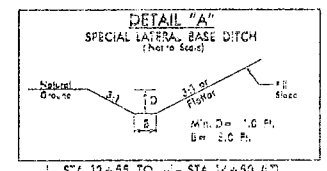
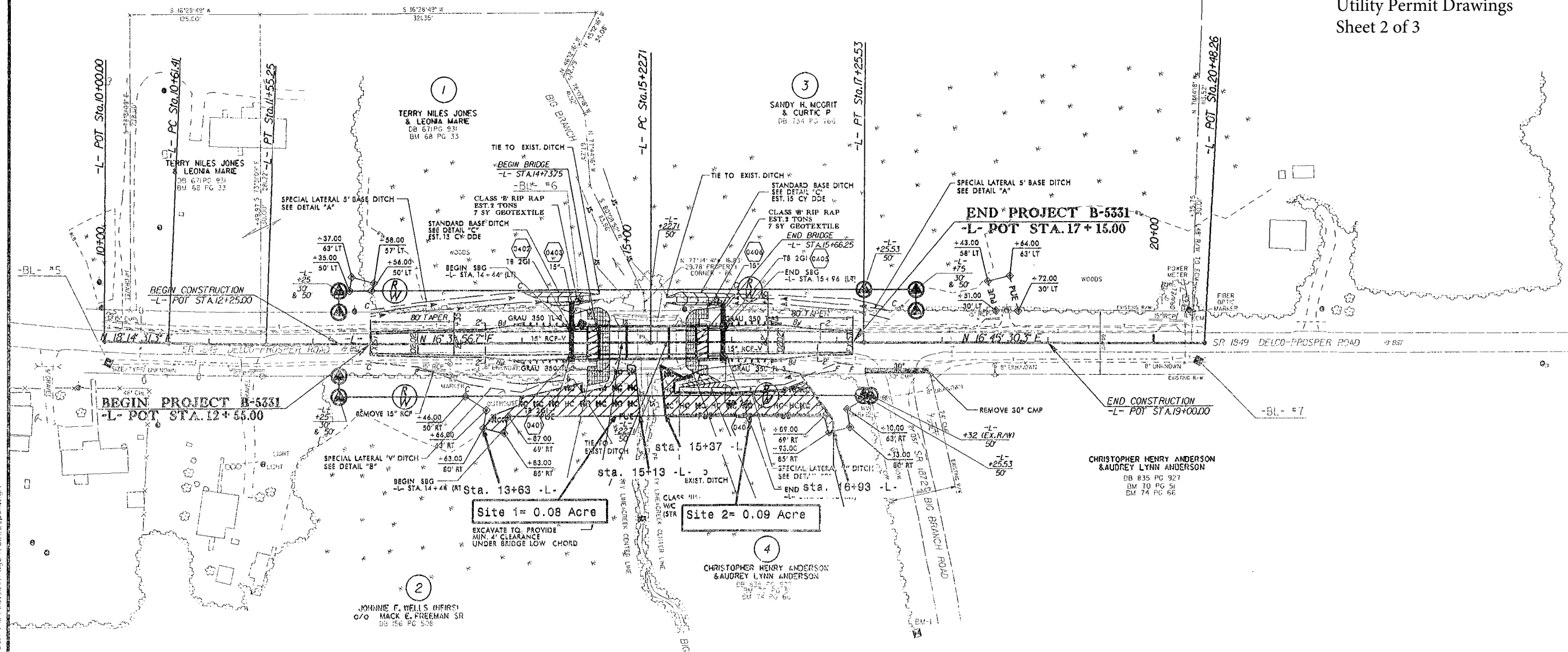

HC HC DENOTES HAND CLEARING

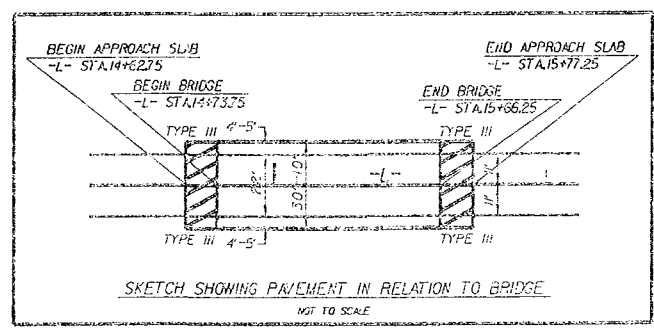

NOTES: (1) SEE SHEET 5 FOR -L- PROFILE  
(2) SEE SHEETS S- TO S- FOR STRUCTURE DETAILS

REVISIONS

Revision: B-331, ut-ed, 04, UE02, psh/dgn

**WETLAND PERMIT IMPACT SUMMARY**

Site No.	Station (From/To)	Structure Size / Type	WETLAND IMPACTS					SURFACE WATER IMPACTS				
			Permanent Fill In Wetlands (ac)	Temp. Fill In Wetlands (ac)	Excavation in Wetlands (ac)	Mechanized Clearing in Wetlands (ac)	Hand Clearing in Wetlands (ac)	Permanent SW impacts (ac)	Temp. SW impacts (ac)	Existing Channel Impacts Permanent (ft)	Existing Channel Impacts Temp. (ft)	Natural Stream Design (ft)
1	-L-13+63 TO 15+13 (SHEET 4)	Aerial Power line					0.08					
2	-L-15+37 TO 16+93 (SHEET 4)	Aerial power lines					0.09					
<b>TOTALS:</b>			0.00	0.00	0.00	0.00	0.17	0.00	0.00	0.00	0.00	0.00

Utility Permit Drawings  
Sheet 3 of 3

NC DEPARTMENT OF TRANSPORTATION  
DIVISION OF HIGHWAYS  
COLUMBUS COUNTY  
TIP PROJECT (B-5331)

**TIP PROJECT: B-5331**

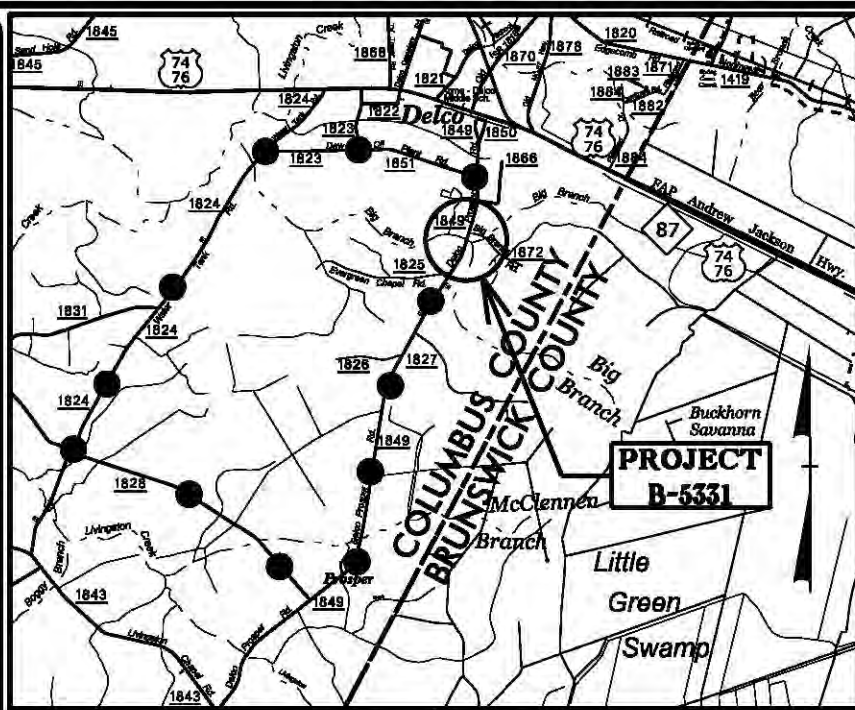

**VICINITY MAP**

**DETOUR**

See Sheet 1A For Index of Sheets  
See Sheet 1B For Conventional Symbols

STATE OF NORTH CAROLINA  
DIVISION OF HIGHWAYS

**COLUMBUS COUNTY**

**LOCATION: BRIDGE NO. 269 OVER BIG BRANCH  
ON SR 1849 (DELCO PROSPER ROAD)**

**TYPE OF WORK: GRADING, PAVING, DRAINAGE & STRUCTURE**

STATE	STATE PROJECT REFERENCE NO.	SHEET NO.	TOTAL SHEETS
N.C.	B-5331	1	
STATE PROJ. NO.	F.A. PROJ. NO.	DESCRIPTION	
46045.1.1	BRZ-1849(1)	PE	
46045.2.1	BRZ-1849(1)	RW, UTIL.	

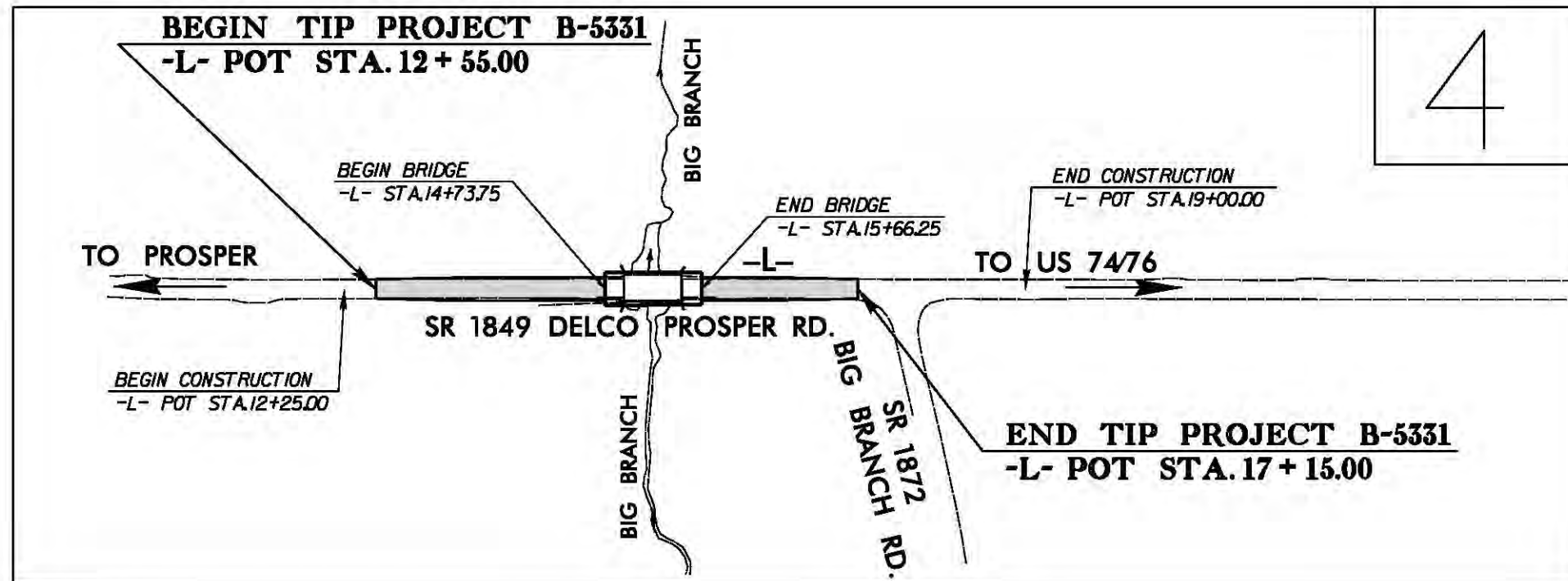
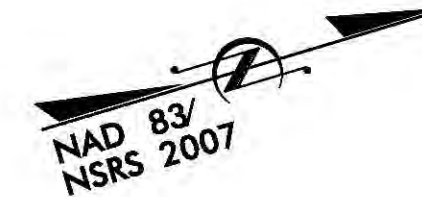

THERE IS NO CONTROL OF ACCESS ON THIS PROJECT.  
THIS PROJECT IS NOT WITHIN ANY MUNICIPAL BOUNDARIES.  
CLEARING ON THIS PROJECT SHALL BE PERFORMED TO THE LIMITS ESTABLISHED BY METHOD II.

**PRELIMINARY PLANS**  
DO NOT USE FOR CONSTRUCTION

**CONTRACT:**

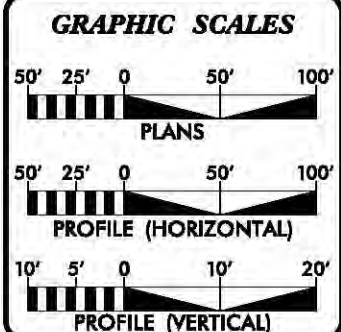

**DESIGN DATA**

ADT 2015 =	1,433
ADT 2035 =	2,100
K =	9 %
D =	60 %
T =	5 % *
V =	60 MPH
* TTST =	2% DUAL = 3%
FUNC CLASS =	RURAL LOCAL
SUBREGIONAL TIER	

**PROJECT LENGTH**

LENGTH ROADWAY TIP PROJECT B-5331 =	0.069 MI.
LENGTH STRUCTURE TIP PROJECT B-5331 =	0.018 MI.
TOTAL LENGTH OF TIP PROJECT B-5331 =	0.087 MI.

Prepared In the Office of:  
**DIVISION OF HIGHWAYS**  
1000 Birch Ridge Dr., Raleigh NC, 27610

2012 STANDARD SPECIFICATIONS

**RIGHT OF WAY DATE:**  
NOVEMBER 26, 2014

**LETTING DATE:**  
NOVEMBER 17, 2015

**REKHA PATEL, P.E.**  
PROJECT ENGINEER

**BRIAN ROBINSON**  
PROJECT DESIGN ENGINEER

**HYDRAULICS ENGINEER**

SIGNATURE: \_\_\_\_\_ P.E.

**ROADWAY DESIGN ENGINEER**

SIGNATURE: \_\_\_\_\_ P.E.

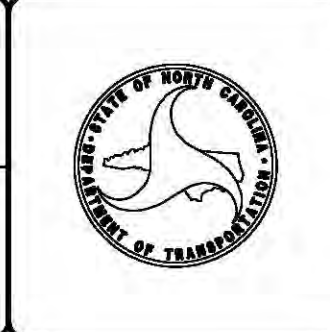

25-NOV-2014 13:25  
RAYRODWAY\PROJ\N5331\_Rdy\_+sh.dgn  
\$\$\$\$\$SERVNAME\$\$\$\$\$

12/05/11

Note: Not to Scale

\*S.U.E. = Subsurface Utility Engineering

STATE OF NORTH CAROLINA  
DIVISION OF HIGHWAYS

# CONVENTIONAL PLAN SHEET SYMBOLS

### BOUNDARIES AND PROPERTY:

State Line	-----
County Line	-----
Township Line	-----
City Line	-----
Reservation Line	-----
Property Line	-----
Existing Iron Pin	○
Property Corner	✕
Property Monument	□
Parcel/Sequence Number	②③
Existing Fence Line	-x-x-x-
Proposed Woven Wire Fence	○
Proposed Chain Link Fence	□
Proposed Barbed Wire Fence	◇
Existing Wetland Boundary	-----
Proposed Wetland Boundary	-----
Existing Endangered Animal Boundary	-----
Existing Endangered Plant Boundary	-----
Known Soil Contamination: Area or Site	☠ ☠
Potential Soil Contamination: Area or Site	☠ ☠

### BUILDINGS AND OTHER CULTURE:

Gas Pump Vent or U/G Tank Cap	○
Sign	○
Well	♀
Small Mine	✕
Foundation	□
Area Outline	□
Cemetery	⊕
Building	□
School	⊕
Church	⊕
Dam	▬

### HYDROLOGY:

Stream or Body of Water	-----
Hydro, Pool or Reservoir	□
Jurisdictional Stream	----- JS
Buffer Zone 1	----- BZ 1
Buffer Zone 2	----- BZ 2
Flow Arrow	→
Disappearing Stream	→
Spring	○
Wetland	✕
Proposed Lateral, Tail, Head Ditch	-----
False Sump	▽

### RAILROADS:

Standard Gauge	-----
RR Signal Milepost	○
Switch	□
RR Abandoned	-----
RR Dismantled	-----

### RIGHT OF WAY:

Baseline Control Point	◆
Existing Right of Way Marker	△
Existing Right of Way Line	-----
Proposed Right of Way Line	-----
Proposed Right of Way Line with Iron Pin and Cap Marker	○
Proposed Right of Way Line with Concrete or Granite R/W Marker	○
Proposed Control of Access Line with Concrete C/A Marker	○
Existing Control of Access	○
Proposed Control of Access	○
Existing Easement Line	----- E
Proposed Temporary Construction Easement	----- E
Proposed Temporary Drainage Easement	----- TDE
Proposed Permanent Drainage Easement	----- PDE
Proposed Permanent Drainage / Utility Easement	----- DUE
Proposed Permanent Utility Easement	----- PUE
Proposed Temporary Utility Easement	----- TUE
Proposed Aerial Utility Easement	----- AUE
Proposed Permanent Easement with Iron Pin and Cap Marker	◆

### ROADS AND RELATED FEATURES:

Existing Edge of Pavement	-----
Existing Curb	-----
Proposed Slope Stakes Cut	----- C
Proposed Slope Stakes Fill	----- F
Proposed Curb Ramp	----- CR
Existing Metal Guardrail	-----
Proposed Guardrail	-----
Existing Cable Guiderail	-----
Proposed Cable Guiderail	-----
Equality Symbol	⊕
Pavement Removal	XXXX
VEGETATION:	
Single Tree	✿
Single Shrub	✿
Hedge	-----
Woods Line	-----

Orchard	-----
Vineyard	-----

### EXISTING STRUCTURES:

MAJOR:	
Bridge, Tunnel or Box Culvert	----- CONC
Bridge Wing Wall, Head Wall and End Wall	----- CONC WW
MINOR:	
Head and End Wall	----- CONC HW
Pipe Culvert	-----
Footbridge	-----
Drainage Box: Catch Basin, DI or JB	□ CB
Paved Ditch Gutter	-----
Storm Sewer Manhole	⊕
Storm Sewer	-----

### UTILITIES:

POWER:	
Existing Power Pole	●
Proposed Power Pole	○
Existing Joint Use Pole	●
Proposed Joint Use Pole	○
Power Manhole	⊕
Power Line Tower	⊗
Power Transformer	⊗
U/G Power Cable Hand Hole	□
H-Frame Pole	●
Recorded U/G Power Line	-----
Designated U/G Power Line (S.U.E.*)	-----

### TELEPHONE:

Existing Telephone Pole	●
Proposed Telephone Pole	○
Telephone Manhole	⊕
Telephone Booth	⊕
Telephone Pedestal	⊕
Telephone Cell Tower	⊕
U/G Telephone Cable Hand Hole	□
Recorded U/G Telephone Cable	-----
Designated U/G Telephone Cable (S.U.E.*)	-----
Recorded U/G Telephone Conduit	-----
Designated U/G Telephone Conduit (S.U.E.*)	-----
Recorded U/G Fiber Optics Cable	-----
Designated U/G Fiber Optics Cable (S.U.E.*)	-----

### WATER:

Water Manhole	⊕
Water Meter	○
Water Valve	⊕
Water Hydrant	⊕
Recorded U/G Water Line	-----
Designated U/G Water Line (S.U.E.*)	-----
Above Ground Water Line	----- A/G Water

### TV:

TV Satellite Dish	☾
TV Pedestal	⊕
TV Tower	⊗
U/G TV Cable Hand Hole	□
Recorded U/G TV Cable	----- TV
Designated U/G TV Cable (S.U.E.*)	----- TV
Recorded U/G Fiber Optic Cable	----- TV FO
Designated U/G Fiber Optic Cable (S.U.E.*)	----- TV FO

### GAS:

Gas Valve	◇
Gas Meter	⊕
Recorded U/G Gas Line	-----
Designated U/G Gas Line (S.U.E.*)	-----
Above Ground Gas Line	----- A/G Gas

### SANITARY SEWER:

Sanitary Sewer Manhole	⊕
Sanitary Sewer Cleanout	⊕
U/G Sanitary Sewer Line	----- SS
Above Ground Sanitary Sewer	----- A/G Sanitary Sewer
Recorded SS Forced Main Line	----- FMS
Designated SS Forced Main Line (S.U.E.*)	----- FMS

### MISCELLANEOUS:

Utility Pole	●
Utility Pole with Base	□
Utility Located Object	○
Utility Traffic Signal Box	⊕
Utility Unknown U/G Line	-----
U/G Tank; Water, Gas, Oil	□
Underground Storage Tank, Approx. Loc.	⊕
A/G Tank; Water, Gas, Oil	□
Geoenvironmental Boring	⊕
U/G Test Hole (S.U.E.*)	⊕
Abandoned According to Utility Records	AATUR
End of Information	E.O.I.

PAVEMENT SCHEDULE (FINAL PAVEMENT DESIGN)	
C1	PROP. APPROX. 2½" ASPHALT CONCRETE SURFACE COURSE, TYPE SF9.5A, AT AN AVERAGE RATE OF 137.5 LBS. PER SQ. YD. IN EACH OF TWO LAYERS
C2	PROP. VAR. DEPTH ASPHALT CONCRETE SURFACE COURSE, TYPE SF9.6A, AT AN AVERAGE RATE OF 110 LBS. PER SQ. YD. PER 1" DEPTH TO BE PLACED IN LAYERS NOT LESS THAN 1" IN DEPTH OR GREATER THAN 1½" IN DEPTH.
E1	PROP. APPROX. 4" ASPHALT CONCRETE BASE COURSE, TYPE B25.0B, AT AN AVERAGE RATE OF 455 LBS. PER SQ. YD.
R1	CONCRETE SHOULDER BERM GUTTER
T	EARTH MATERIAL

NOTE: PAVEMENT EDGE SLOPES ARE 1:1 UNLESS SHOWN OTHERWISE

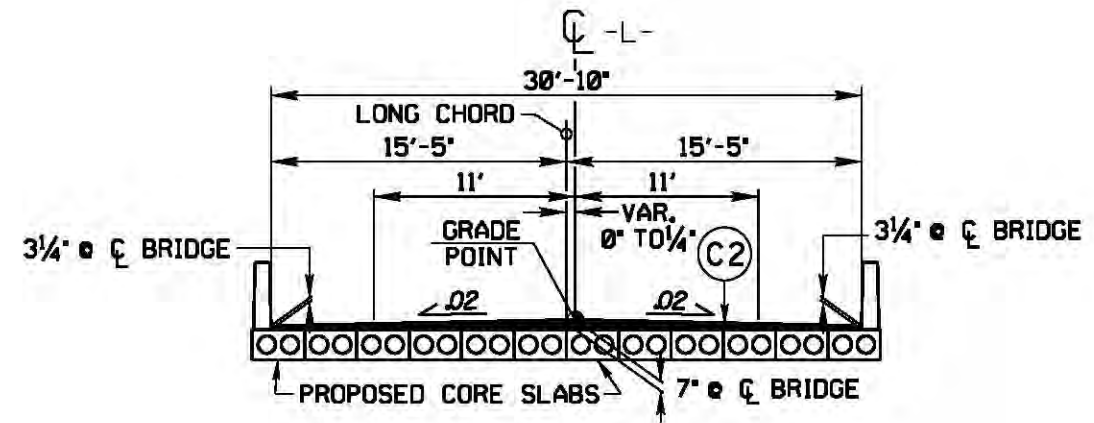

TYPICAL SECTION ON STRUCTURE  
(SEE STRUCTURE PLANS)  
-L- STA. 14+73.75 TO -L- STA. 15+66.25

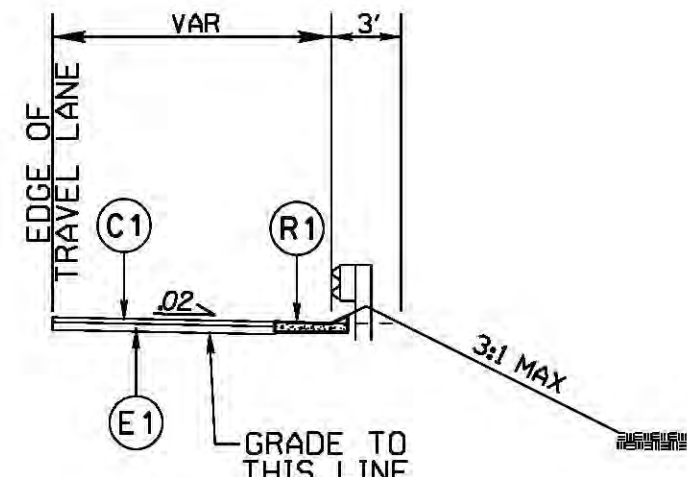

INSET NO. 1

INSET NO. 1

Use with Typical Section No. 1  
 -L- STA. 14+44.00 TO -L- STA. 14+62.75 (RT.)  
 -L- STA. 14+44.00 TO -L- STA. 14+62.75 (LT.) REVERSE  
 -L- STA. 15+77.25 TO -L- STA. 15+96.00 (RT.)  
 -L- STA. 15+77.25 TO -L- STA. 15+96.00 (LT.) REVERSE

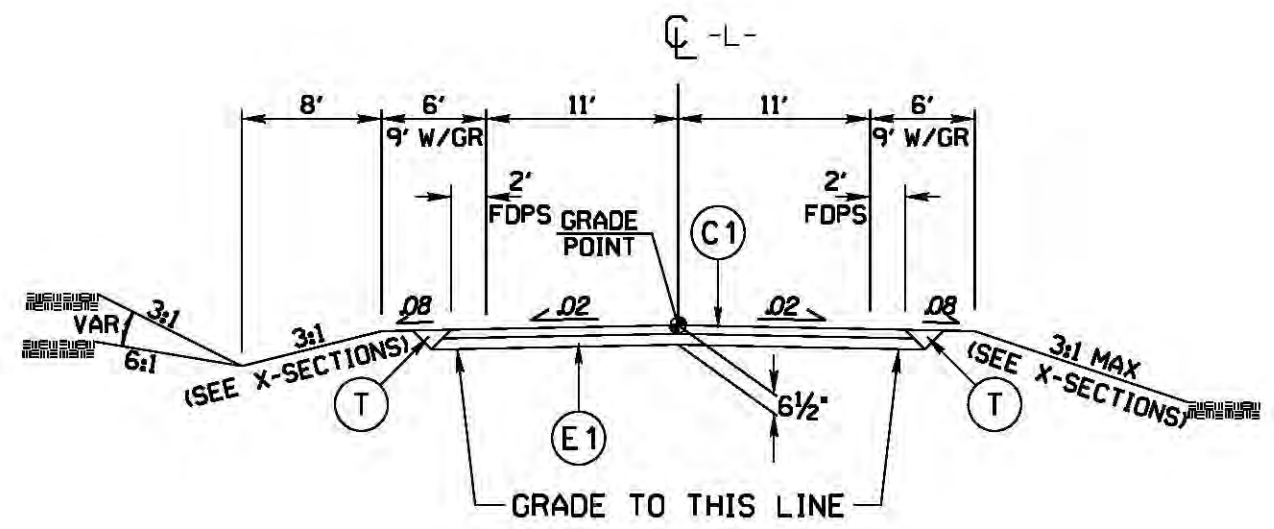

TYPICAL SECTION NO. 1

USE TYPICAL SECTION NO. 1

-L- STA. 13+35.00 TO -L- STA. 14+73.75 (BEGIN BRIDGE)  
 -L- STA. 15+66.25 (END BRIDGE) TO -L- STA. 16+35.00

NOTES:  
 (1) TRANSITION FROM EXISTING TO T.S. NO. 1  
 -L- STA. 12+55.00 TO -L- STA. 13+35.00  
 (2) TRANSITION FROM T.S. NO. 1 TO EXISTING  
 -L- STA. 16+35.00 TO -L- STA. 17+15.00

6/27/99  
 25-NOV-2014 13:25  
 R:\Roadway\Projects\B5331\dj\_typ.dgn  
 155331.dwg



**-L- CURVE DATA**

PI Sta 11+08.34	PI Sta 16+24.12
$\Delta = 142^\circ 34' 5" (LT)$	$\Delta = 013^\circ 33' 6" (RT)$
$D = 149' 18.5"$	$D = 0' 06' 4.1"$
$L = 93.84'$	$L = 202.82'$
$T = 46.92'$	$T = 101.4'$
$R = 3,145.00'$	$R = 51,420.00'$

NAD 83/NSRS 2007

REVISIONS

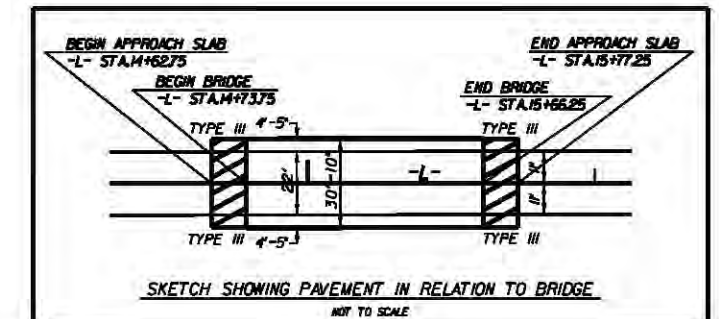
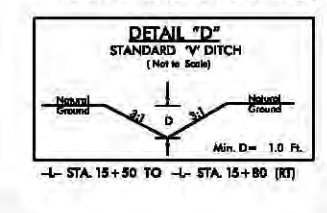
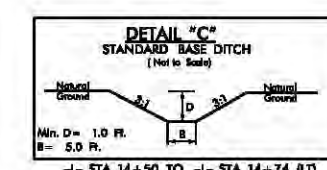
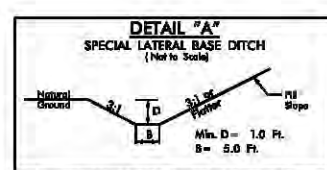
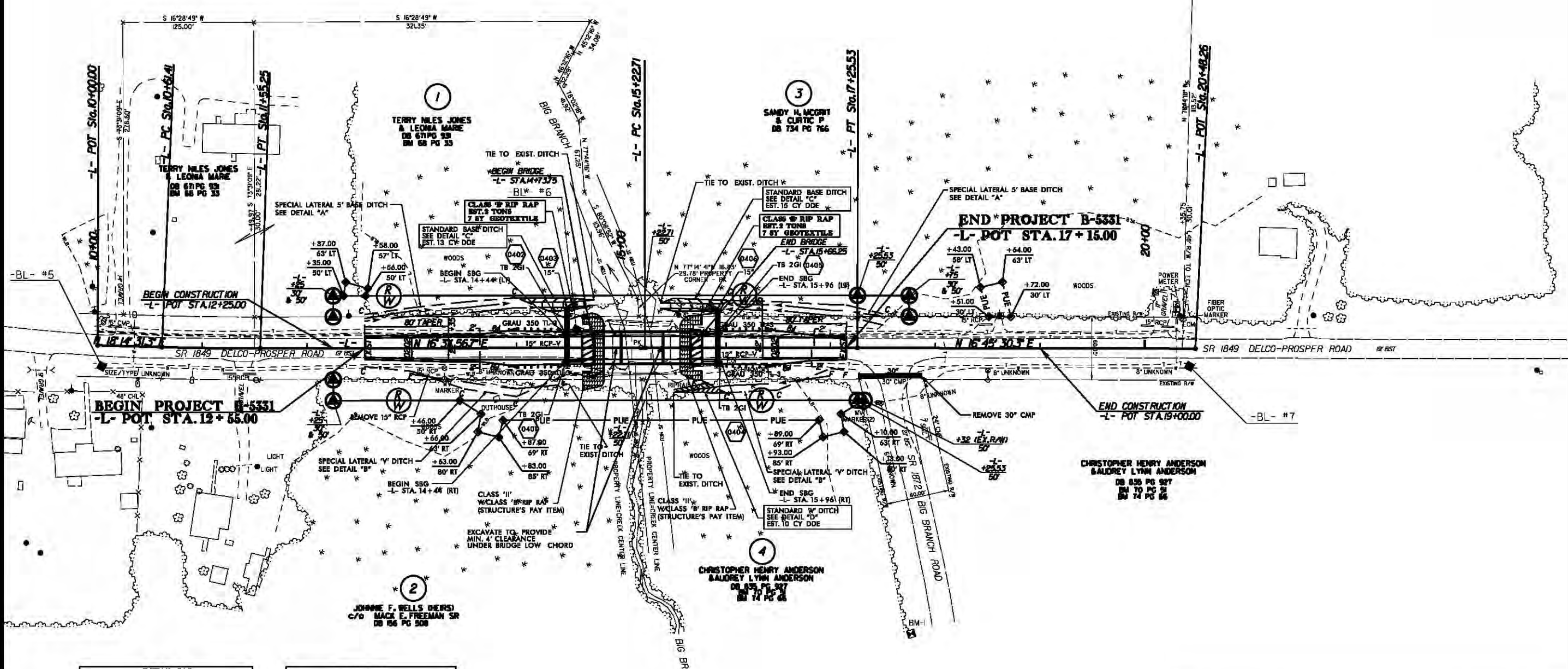

NOTES: (1) SEE SHEET 5 FOR -L- PROFILE  
(2) SEE SHEETS S- TO S- FOR STRUCTURE DETAILS

26-NOV-2014 12:56  
R:\Roadway\Proj\B5331\_Rd\psn.dgn  
B5331.dwg