



STATE OF NORTH CAROLINA  
DEPARTMENT OF TRANSPORTATION

PAT L. MCCRORY  
GOVERNOR

ANTHONY J. TATA  
SECRETARY

August 27, 2013

MEMORANDUM TO: Mr. Mike Holder, PE  
Division 12 Engineer

FROM: Philip S. Harris, III, P.E., Head  
Natural Environment Section  
Project Development and Environmental Analysis Unit

SUBJECT: Catawba County; Replace Bridge No. 83 over Clark Creek on SR  
1149; Federal Project No. BRZ-1149(5); WBS Element  
42223.1.2; **TIP B-5101.**

*E. J. Lusk*

Attached are the U.S. Army Corps of Engineers Section 404 Nationwide permit and the N.C. Division of Water Quality Section 401 Water Quality Certification for the above referenced project. All environmental permits have been received for the construction of this project.

A copy of this permit package will be posted on the NCDOT website at:  
<http://www.ncdot.gov/doh/preconstruct/pe/neu/permit.html>

Cc: w/o attachment (see website for attachments):

Mr. Randy Garris, P.E. State Contract Officer  
Ms. Trish Beam, Division Environmental Officer  
Mr. Majed Alghandour, P. E., Programming and TIP  
Mr. Jay Bennett, P.E., Roadway Design Unit  
Mr. Dewayne Sykes, P.E. Utilities Unit  
Mr. Art McMillan, P.E., Hydraulics Unit  
Mr. Tom Koch, P.E., Structure Design Unit  
Mr. Mark Staley, Roadside Environmental Unit  
Mr. Ron Hancock, P.E., State Roadway Construction Engineer  
Mr. Mike Robinson, P.E., State Bridge Construction Engineer  
Mr. Bill Goodwin, P.E., PDEA Bridge Unit Head

**MAILING ADDRESS:**  
NC DEPARTMENT OF TRANSPORTATION  
PROJECT DEVELOPMENT AND ENVIRONMENTAL ANALYSIS  
1598 MAIL SERVICE CENTER  
RALEIGH NC 27699-1598

TELEPHONE: 919-707-6100  
FAX: 919-212-5785  
WEBSITE: [WWW.NCDOT.ORG](http://WWW.NCDOT.ORG)

**LOCATION:**  
1020 BIRCH RIDGE DRIVE  
RALEIGH NC 27610-4328

# PROJECT COMMITMENTS

T.I.P. No. B-5101  
Replacement of Bridge No. 83 over Clark Creek  
on SR 1149  
Catawba County  
Federal Aid Project No. BRZ-1149 (5)  
W.B.S. No. 42223.1.1

## COMMITMENTS FROM PROJECT DEVELOPMENT AND DESIGN

### **Division Twelve Construction, Resident Engineer's Office – Offsite Detour**

Catawba County Emergency Medical Services will be contacted at (828) 465-8234 sixty days prior to road closure to make the necessary temporary reassignments to primary response units.

In order to have time to adequately reroute school busses, the Catawba County School Director of Transportation will be contacted at (828) 465-0470 at least one month prior to road closure.

### **Contracts Unit - Duration of Construction**

In order to address specific requests from the School Transportation Director for Catawba County, NCDOT will set the minimum reasonable contract time to reduce the period of road closure.

### **Roadway Design/Program Development Branch – Bicycle Accommodations**

Bridge No. 83 is not located along a designated bicycle route. In response to the Division of Bicycle and Pedestrian's recommendation, designers will provide a minimum of 4-foot wide bicycle lanes on the bridge as well as 54-inch bicycle-safe railings. The approach roadway will provide adequate width to accommodate bicycle lanes as well.

### **Hydraulic Unit – FEMA Coordination**

The Hydraulics Unit will coordinate with the NC Floodplain Mapping Program (FMP), to determine status of project with regard to applicability of NCDOT'S Memorandum of Agreement, or approval of a Conditional Letter of Map Revision (CLOMR) and subsequent final Letter of Map Revision (LOMR).

### **Division Construction-FEMA**

This project involves construction activities on or adjacent to FEMA-regulated stream(s). Therefore, the Division shall submit sealed as-built construction plans to the Hydraulics Unit upon completion of project construction, certifying that the drainage structure(s) and roadway embankment that are located within the 100-year floodplain were built as shown in the construction plans, both horizontally and vertically.

## COMMITMENTS FROM PERMITTING

No additional commitments were developed during project permitting.

**U.S. ARMY CORPS OF ENGINEERS  
WILMINGTON DISTRICT**

Action ID: **2013-01141 TIP No. B-5101**

County: **Catawba**

**GENERAL PERMIT (REGIONAL AND NATIONWIDE) VERIFICATION**

Property Owner / Authorized Agent: **North Carolina Department of Transportation**  
**Attn: Dr. Gregory Thorpe**

Address: **1598 Mail Service Center**  
**Raleigh, North Carolina 27699-1598**

Telephone No.: **919-707-6103**

Size and location of property (water body, road name/number, town, etc.): **The project is located at Bridge No. 83 over Clark Creek on SR 1149 near Newton, Catawba County, North Carolina.**

Description of projects area and activity: **In order to replace the bridge, the permittee is authorized to impact waters of the U.S. as follows:**

**Summary of Authorized Impacts and Required Mitigation**

Impact ID #	NWP / GP #	Open Water (ac)		Wetland (ac)		Stream (lf)	
		Temporary	Permanent	Temporary	Permanent	Temporary	Permanent
Site 1 (Clark Creek)	<b><u>33</u></b>					<b><u>15</u></b>	
<b>Impact Totals</b>						<b><u>15</u></b>	
Total Loss of Waters of the U.S. (ac)				Total Loss of Waters of the U.S. (lf)			<b><u>0</u></b>
Required Wetland Mitigation (ac)				Required Stream Mitigation (lf)			<b><u>0</u></b>

Applicable Law:  Section 404 (Clean Water Act, 33 USC 1344)  
 Section 10 (Rivers and Harbors Act, 33 USC 403)

Authorization: Regional General Permit Number:  
Nationwide Permit Number: **33**

Your work is authorized by the above referenced permit provided it is accomplished in strict accordance with the attached conditions, your submitted plans, and the following special conditions:

**Special Conditions**

1. All work must be performed in strict compliance with the description of work and plans in the application dated May 28, 2013. Any modification to the description of work and/or the permit plans must be approved by the USACE prior to implementation.
2. The permittee shall require its contractors and/or agents to comply with the terms and conditions of this authorization letter in the construction and maintenance of this project, and shall provide each of its contractors and/or agents associated with the construction or maintenance of this project with a copy of this authorization letter, all conditions, and any authorized modifications. A copy of this authorization letter, all conditions, and any authorized modifications, shall be available at the project site during construction and maintenance of this project.
3. This permit does not authorize temporary placement or double handling of excavated or fill material within waters or wetlands outside the permitted area.
4. The permittee will report any violation of these conditions or violations of Section 404 of the Clean Water Act or Section 10 of the Rivers and Harbors Act in writing to the Wilmington District, U. S Army Corps of Engineers, within 24 hours of the permittee's discovery of the violation.

Any violation of the noted conditions or deviation from your submitted plans may subject the permittee to a stop work order, a restoration order and/or appropriate legal action.

This verification will remain valid until the expiration date identified below unless the nationwide authorization is modified, suspended or revoked. If, prior to the expiration date identified below, the nationwide permit authorization is reissued and/or modified, this verification will remain valid until the expiration date identified below, provided it complies with all requirements of the modified nationwide permit. If the nationwide permit authorization expires or is suspended, revoked, or is modified, such that the activity would no longer comply with the terms and conditions of the nationwide permit, activities which have commenced (i.e., are under construction) or are under contract to commence in reliance upon the nationwide permit, will remain authorized provided the activity is completed within twelve months of the date of the nationwide permit's expiration, modification or revocation, unless discretionary authority has been exercised on a case-by-case basis to modify, suspend or revoke the authorization.

Activities subject to Section 404 (as indicated above) may also require an individual Section 401 Water Quality Certification. You should contact the NC Division of Water Quality (telephone 919-807-6300) to determine Section 401 requirements.

For activities occurring within the twenty coastal counties subject to regulation under the Coastal Area Management Act (CAMA), prior to beginning work you must contact the N.C. Division of Coastal Management.

This Department of the Army verification does not relieve the permittee of the responsibility to obtain any other required Federal, State or local approvals/permits.

If there are any questions regarding this verification, any of the conditions of the Permit, or the Corps of Engineers regulatory program, please contact Lori Beckwith at 828-271-7980.

Corps Regulatory Official: Lori Beckwith

Date: **July 8, 2013**

Expiration Date of Verification: **March 18, 2017**



### Determination of Jurisdiction:

- A.  Based on preliminary information, there appear to be waters of the US including wetlands within the above described project area. This preliminary determination is not an appealable action under the Regulatory Program Administrative Appeal Process ( Reference 33 CFR Part 331).
- B.  There are Navigable Waters of the United States within the above described project area subject to the permit requirements of Section 10 of the Rivers and Harbors Act and Section 404 of the Clean Water Act. Unless there is a change in the law or our published regulations, this determination may be relied upon for a period not to exceed five years from the date of this notification.
- C.  There are waters of the US and/or wetlands within the above described project area subject to the permit requirements of Section 404 of the Clean Water Act (CWA)(33 USC § 1344). Unless there is a change in the law or our published regulations, this determination may be relied upon for a period not to exceed five years from the date of this notification.
- D.  The jurisdictional areas within the above described project area have been identified under a previous action. Please reference jurisdictional determination issued \_\_\_\_. Action ID

**E. Basis of Jurisdictional Determination:** The stream channel in the project area is Clark Creek and it exhibits indicators of an ordinary high water mark and has perennial flow (RPW). Clark Creek flows into South Fork Catawba River, then into the Catawba River. The Catawba River becomes a water of the U.S. regulated pursuant to Section 10 of the Rivers and Harbors Act of 1899 downstream of the Mountain Island Lake dam on the Mecklenburg/Gaston County line. This jurisdictional determination is valid for the impact area only.

#### Attention USDA Program Participants

This delineation/determination has been conducted to identify the limits of Corps' Clean Water Act jurisdiction for the particular site identified in this request. The delineation/determination may not be valid for the wetland conservation provisions of the Food Security Act of 1985. If you or your tenant are USDA Program participants, or anticipate participation in USDA programs, you should request a certified wetland determination from the local office of the Natural Resources Conservation Service, prior to starting work.

#### F. Appeals Information (This information applies only to approved jurisdictional determinations as indicated in B and C above).

(This information applies only to approved jurisdictional determinations as indicated in B and C above).

This correspondence constitutes an approved jurisdictional determination for the above described site. If you object to this determination, you may request an administrative appeal under Corps regulations at 33 CFR Part 331. Enclosed you will find a request for appeal (RFA) form. If you request to appeal this determination you must submit a completed RFA form to the following address:

US Army Corps of Engineers  
South Atlantic Division  
Attn: Jason Steele, Review Officer  
60 Forsyth Street SW, Room 10M15  
Atlanta, Georgia 30303-8801  
Phone: (404) 562-5137

In order for an RFA to be accepted by the Corps, the Corps must determine that it is complete, that it meets the criteria for appeal under 33 CFR part 331.5, and that it has been received by the Division Office within 60 days of the date of the NAP. Should you decide to submit an RFA form, it must be received at the above address by September 5, 2013.

\*\*It is not necessary to submit an RFA form to the Division Office if you do not object to the determination in this correspondence.\*\*

Corps Regulatory Official: Lori Beckwith

Issue Date: **July 8, 2013**

Expiration Date: Five years from *Issue Date*

SURVEY PLATS, FIELD SKETCH, WETLAND DELINEATION FORMS, PROJECT PLANS, ETC.,  
MUST BE ATTACHED TO THE FILE COPY OF THIS FORM, IF REQUIRED OR AVAILABLE.

Copy Furnished: By e-mail - NCDOT - Mr. Michael Turchy

Permit Number: 2013-01141 TIP No. B-5101  
Permit Type: NW33  
Name of County: Catawba  
Name of Permittee: North Carolina Department of Transportation  
Attn: Dr. Gregory Thorpe  
Date of Issuance: July 8, 2013  
Project Manager: Lori Beckwith

Upon completion of the activity authorized by this permit and any mitigation required by the permit, sign this certification and return it to the following address:

U.S. Army Corps of Engineers  
Attention: CESA-W-RG-A  
151 Patton Avenue, Room 208  
Asheville, North Carolina 28801-5006

Please note that your permitted activity is subject to a compliance inspection by an U.S. Army Corps of Engineers representative. If you fail to comply with this permit you are subject to permit suspension, modification, or revocation.

I hereby certify that the work authorized by the above referenced permit has been completed in accordance with the terms and conditions of the said permit, and required mitigation was completed in accordance with the permit conditions.

---

Signature of Permittee

---

Date

**NOTIFICATION OF ADMINISTRATIVE APPEAL OPTIONS AND PROCESS AND REQUEST FOR APPEAL**

Applicant: North Carolina Department of Transportation, Attn: Dr. Gregory Thorpe		File Number: 2013-01141 TIP No. B-5101	Date: July 8, 2013
Attached is:			See Section below
	INITIAL PROFFERED PERMIT (Standard Permit or Letter of permission)		A
	PROFFERED PERMIT (Standard Permit or Letter of permission)		B
	PERMIT DENIAL		C
X	APPROVED JURISDICTIONAL DETERMINATION		D
	PRELIMINARY JURISDICTIONAL DETERMINATION		E

**SECTION I - The following identifies your rights and options regarding an administrative appeal of the above decision. Additional information may be found at [http://www.usace.army.mil/CECW/Pages/reg\\_materials.aspx](http://www.usace.army.mil/CECW/Pages/reg_materials.aspx) or Corps regulations at 33 CFR Part 331.**

**A: INITIAL PROFFERED PERMIT: You may accept or object to the permit.**

- **ACCEPT:** If you received a Standard Permit, you may sign the permit document and return it to the district engineer for final authorization. If you received a Letter of Permission (LOP), you may accept the LOP and your work is authorized. Your signature on the Standard Permit or acceptance of the LOP means that you accept the permit in its entirety, and waive all rights to appeal the permit, including its terms and conditions, and approved jurisdictional determinations associated with the permit.
- **OBJECT:** If you object to the permit (Standard or LOP) because of certain terms and conditions therein, you may request that the permit be modified accordingly. You must complete Section II of this form and return the form to the district engineer. Your objections must be received by the district engineer within 60 days of the date of this notice, or you will forfeit your right to appeal the permit in the future. Upon receipt of your letter, the district engineer will evaluate your objections and may: (a) modify the permit to address all of your concerns, (b) modify the permit to address some of your objections, or (c) not modify the permit having determined that the permit should be issued as previously written. After evaluating your objections, the district engineer will send you a proffered permit for your reconsideration, as indicated in Section B below.

**B: PROFFERED PERMIT: You may accept or appeal the permit**

- **ACCEPT:** If you received a Standard Permit, you may sign the permit document and return it to the district engineer for final authorization. If you received a Letter of Permission (LOP), you may accept the LOP and your work is authorized. Your signature on the Standard Permit or acceptance of the LOP means that you accept the permit in its entirety, and waive all rights to appeal the permit, including its terms and conditions, and approved jurisdictional determinations associated with the permit.
- **APPEAL:** If you choose to decline the proffered permit (Standard or LOP) because of certain terms and conditions therein, you may appeal the declined permit under the Corps of Engineers Administrative Appeal Process by completing Section II of this form and sending the form to the division engineer. This form must be received by the division engineer within 60 days of the date of this notice.

**C: PERMIT DENIAL: You may appeal the denial of a permit under the Corps of Engineers Administrative Appeal Process by completing Section II of this form and sending the form to the division engineer. This form must be received by the division engineer within 60 days of the date of this notice.**

**D: APPROVED JURISDICTIONAL DETERMINATION: You may accept or appeal the approved JD or provide new information.**

- **ACCEPT:** You do not need to notify the Corps to accept an approved JD. Failure to notify the Corps within 60 days of the date of this notice, means that you accept the approved JD in its entirety, and waive all rights to appeal the approved JD.
- **APPEAL:** If you disagree with the approved JD, you may appeal the approved JD under the Corps of Engineers Administrative Appeal Process by completing Section II of this form and sending the form to the division engineer. This form must be received by the division engineer within 60 days of the date of this notice.

E: PRELIMINARY JURISDICTIONAL DETERMINATION: You do not need to respond to the Corps regarding the preliminary JD. The Preliminary JD is not appealable. If you wish, you may request an approved JD (which may be appealed), by contacting the Corps district for further instruction. Also you may provide new information for further consideration by the Corps to reevaluate the JD.

**SECTION II - REQUEST FOR APPEAL or OBJECTIONS TO AN INITIAL PROFFERED PERMIT**

REASONS FOR APPEAL OR OBJECTIONS: (Describe your reasons for appealing the decision or your objections to an initial proffered permit in clear concise statements. You may attach additional information to this form to clarify where your reasons or objections are addressed in the administrative record.)

ADDITIONAL INFORMATION: The appeal is limited to a review of the administrative record, the Corps memorandum for the record of the appeal conference or meeting, and any supplemental information that the review officer has determined is needed to clarify the administrative record. Neither the appellant nor the Corps may add new information or analyses to the record. However, you may provide additional information to clarify the location of information that is already in the administrative record.

**POINT OF CONTACT FOR QUESTIONS OR INFORMATION:**

If you have questions regarding this decision and/or the appeal process you may contact:  
Lori Beckwith, Project Manager  
USACE, Asheville Regulatory Field Office  
151 Patton Ave  
RM 208  
Asheville, NC 28801  
828-271-7980

If you only have questions regarding the appeal process you may also contact:  
Mr. Jason Steele, Administrative Appeal Review Officer  
CESAD-PDO  
U.S. Army Corps of Engineers, South Atlantic Division  
60 Forsyth Street, Room 10M15  
Atlanta, Georgia 30303-8801  
Phone: (404) 562-5137

RIGHT OF ENTRY: Your signature below grants the right of entry to Corps of Engineers personnel, and any government consultants, to conduct investigations of the project site during the course of the appeal process. You will be provided a 15 day notice of any site investigation, and will have the opportunity to participate in all site investigations.

_____	Date:	Telephone number:
Signature of appellant or agent.		

**For appeals on Initial Proffered Permits and approved Jurisdictional Determinations send this form to:**

**District Engineer, Wilmington Regulatory Division, Attn: Lori Beckwith, Project Manager, 69 Darlington Avenue, Wilmington, NC 28403.**

**For Permit denials and Proffered Permits send this form to:**

**Division Engineer, Commander, U.S. Army Engineer Division, South Atlantic, Attn: Mr. Jason Steele, Administrative Appeal Officer, CESAD-PDO, 60 Forsyth Street, Room 10M15, Atlanta, Georgia 30303-8801  
Phone: (404) 562-5137**

**NATIONWIDE PERMIT 33  
DEPARTMENT OF THE ARMY  
CORPS OF ENGINEERS  
FINAL NOTICE OF ISSUANCE AND MODIFICATION OF NATIONWIDE PERMITS  
FEDERAL REGISTER  
AUTHORIZED MARCH 19, 2012**

**Temporary Construction, Access, and Dewatering.** Temporary structures, work, and discharges, including cofferdams, necessary for construction activities or access fills or dewatering of construction sites, provided that the associated primary activity is authorized by the Corps of Engineers or the U.S. Coast Guard. This NWP also authorizes temporary structures, work, and discharges, including cofferdams, necessary for construction activities not otherwise subject to the Corps or U.S. Coast Guard permit requirements. Appropriate measures must be taken to maintain near normal downstream flows and to minimize flooding. Fill must consist of materials, and be placed in a manner, that will not be eroded by expected high flows. The use of dredged material may be allowed if the district engineer determines that it will not cause more than minimal adverse effects on aquatic resources. Following completion of construction, temporary fill must be entirely removed to an area that has no waters of the United States, dredged material must be returned to its original location, and the affected areas must be restored to pre-construction elevations. The affected areas must also be revegetated, as appropriate. This permit does not authorize the use of cofferdams to dewater wetlands or other aquatic areas to change their use. Structures left in place after construction is completed require a separate section 10 permit if located in navigable waters of the United States. (See 33 CFR part 322.)

**Notification:** The permittee must submit a pre-construction notification to the district engineer prior to commencing the activity (see general condition 31). The pre-construction notification must include a restoration plan showing how all temporary fills and structures will be removed and the area restored to pre-project conditions. (Sections 10 and 404)

**NATIONWIDE PERMIT 13  
DEPARTMENT OF THE ARMY  
CORPS OF ENGINEERS  
FINAL NOTICE OF ISSUANCE AND MODIFICATION OF NATIONWIDE PERMITS  
FEDERAL REGISTER  
AUTHORIZED MARCH 19, 2012**

**Bank Stabilization.** Bank stabilization activities necessary for erosion prevention, provided the activity meets all of the following criteria:

- (a) No material is placed in excess of the minimum needed for erosion protection;
- (b) The activity is no more than 500 feet in length along the bank, unless the district engineer waives this criterion by making a written determination concluding that the discharge will result in minimal adverse effects;
- (c) The activity will not exceed an average of one cubic yard per running foot placed along the bank below the plane of the ordinary high water mark or the high tide line, unless the district engineer waives this criterion by making a written determination concluding that the discharge will result in minimal adverse effects;
- (d) The activity does not involve discharges of dredged or fill material into special aquatic sites, unless the district engineer waives this criterion by making a written determination concluding that the discharge will result in minimal adverse effects;
- (e) No material is of a type, or is placed in any location, or in any manner, that will impair surface water flow into or out of any waters of the United States;
- (f) No material is placed in a manner that will be eroded by normal or expected high flows (properly anchored trees and treetops may be used in low energy areas); and,
- (g) The activity is not a stream channelization activity.

This NWP also authorizes temporary structures, fills, and work necessary to construct the bank stabilization activity. Appropriate measures must be taken to maintain normal downstream flows and minimize flooding to the maximum extent practicable, when temporary structures, work, and discharges, including cofferdams, are necessary for construction activities, access fills, or dewatering of construction sites. Temporary fills must consist of materials, and be placed in a manner, that will not be eroded by expected high flows. Temporary fills must be removed in their entirety and the affected areas returned to pre-construction elevations. The areas affected by temporary fills must be revegetated, as appropriate.

Invasive plant species shall not be used for bioengineering or vegetative bank stabilization.

**Notification:** The permittee must submit a pre-construction notification to the district engineer prior to commencing the activity if the bank stabilization activity: (1) involves discharges into special aquatic sites; or (2) is in excess of 500 feet in length; or (3) will involve the discharge of greater than an average of one cubic yard per running foot along the bank below the plane of the ordinary high water mark or the high tide line. (See general condition 31.) (Sections 10 and 404)



## NATIONWIDE PERMIT CONDITIONS

The following General Conditions must be followed in order for any authorization by a NWP to be valid:

1. Navigation. (a) No activity may cause more than a minimal adverse effect on navigation.

(b) Any safety lights and signals prescribed by the U.S. Coast Guard, through regulations or otherwise, must be installed and maintained at the permittee's expense on authorized facilities in navigable waters of the United States.

(c) The permittee understands and agrees that, if future operations by the United States require the removal, relocation, or other alteration, of the structure or work herein authorized, or if, in the opinion of the Secretary of the Army or his authorized representative, said structure or work shall cause unreasonable obstruction to the free navigation of the navigable waters, the permittee will be required, upon due notice from the Corps of Engineers, to remove, relocate, or alter the structural work or obstructions caused thereby, without expense to the United States. No claim shall be made against the United States on account of any such removal or alteration.

2. Aquatic Life Movements. No activity may substantially disrupt the necessary life cycle movements of those species of aquatic life indigenous to the waterbody, including those species that normally migrate through the area, unless the activity's primary purpose is to impound water. All permanent and temporary crossings of waterbodies shall be suitably culverted, bridged, or otherwise designed and constructed to maintain low flows to sustain the movement of those aquatic species.

3. Spawning Areas. Activities in spawning areas during spawning seasons must be avoided to the maximum extent practicable. Activities that result in the physical destruction (e.g., through excavation, fill, or downstream smothering by substantial turbidity) of an important spawning area are not authorized.

4. Migratory Bird Breeding Areas. Activities in waters of the United States that serve as breeding areas for migratory birds must be avoided to the maximum extent practicable.

5. Shellfish Beds. No activity may occur in areas of concentrated shellfish populations, unless the activity is directly related to a shellfish harvesting activity authorized by NWPs 4 and 48, or is a shellfish seeding or habitat restoration activity authorized by NWP 27.

6. Suitable Material. No activity may use unsuitable material (e.g., trash, debris, car bodies, asphalt, etc.). Material used for construction or discharged must be free from toxic pollutants in toxic amounts (see Section 307 of the Clean Water Act).

7. Water Supply Intakes. No activity may occur in the proximity of a public water supply intake, except where the activity is for the repair or improvement of public water supply intake structures or adjacent bank stabilization.

8. Adverse Effects From Impoundments. If the activity creates an impoundment of water, adverse effects to the aquatic system due to accelerating the passage of water, and/or restricting its flow must be minimized to the maximum extent practicable.

9. Management of Water Flows. To the maximum extent practicable, the pre-construction course, condition, capacity, and location of open waters must be maintained for each activity, including stream channelization and storm water management activities, except as provided below. The activity must be constructed to withstand expected high flows. The activity must not restrict or impede the passage of normal or high flows, unless the primary purpose of the activity is to impound water or manage high flows. The activity may alter the pre-construction course, condition, capacity, and location of open waters if it benefits the aquatic environment (e.g., stream restoration or relocation activities).

10. Fills Within 100-Year Floodplains. The activity must comply with applicable FEMA-approved state or local floodplain management requirements.

11. Equipment. Heavy equipment working in wetlands or mudflats must be placed on mats, or other measures must be taken to minimize soil disturbance.

12. Soil Erosion and Sediment Controls. Appropriate soil erosion and sediment controls must be used and maintained in effective operating condition during construction, and all exposed soil and other fills, as well as any work below the ordinary high water mark or high tide line, must be permanently stabilized at the earliest practicable date. Permittees are encouraged to perform work within waters of the United States during periods of low-flow or no-flow.

13. Removal of Temporary Fills. Temporary fills must be removed in their entirety and the affected areas returned to pre-construction elevations. The affected areas must be revegetated, as appropriate.

14. Proper Maintenance. Any authorized structure or fill shall be properly maintained, including maintenance to ensure public safety and compliance with applicable NWP general conditions, as well as any activity-specific conditions added by the district engineer to an NWP authorization.

15. Single and Complete Project. The activity must be a single and complete project. The same NWP cannot be used more than once for the same single and complete project.

16. Wild and Scenic Rivers. No activity may occur in a component of the National Wild and Scenic River System, or in a river officially designated by Congress as a “study river” for possible inclusion in the system while the river is in an official study status, unless the appropriate Federal agency with direct management responsibility for such river, has determined in writing that the proposed activity will not adversely affect the Wild and Scenic River designation or study status. Information on Wild and Scenic Rivers may be obtained from the appropriate Federal land management agency responsible for the designated Wild and Scenic River or study river (e.g., National Park Service, U.S. Forest Service, Bureau of Land Management, U.S. Fish and Wildlife Service).

17. Tribal Rights. No activity or its operation may impair reserved tribal rights, including, but not limited to, reserved water rights and treaty fishing and hunting rights.

18. Endangered Species. (a) No activity is authorized under any NWP which is likely to directly or indirectly jeopardize the continued existence of a threatened or endangered species or a species proposed for such designation, as identified under the Federal Endangered Species Act (ESA), or which will directly or indirectly destroy or adversely modify the critical habitat of such species. No activity is authorized under any NWP which “may affect” a listed species or critical habitat, unless Section 7 consultation addressing the effects of the proposed activity has been completed.

(b) Federal agencies should follow their own procedures for complying with the requirements of the ESA. Federal permittees must provide the district engineer with the appropriate documentation to demonstrate compliance with those requirements. The district engineer will review the documentation and determine whether it is sufficient to address ESA compliance for the NWP activity, or whether additional ESA consultation is necessary.

(c) Non-federal permittees must submit a pre-construction notification to the district engineer if any listed species or designated critical habitat might be affected or is in the vicinity of the project, or if the project is located in designated critical habitat, and shall not begin work on the activity until notified by the district engineer that the requirements of the ESA have been satisfied and that the activity is authorized. For activities that might affect Federally-listed endangered or threatened species or designated critical habitat, the pre-construction notification must include the name(s) of the endangered or threatened species that might be affected by the proposed work or that utilize the designated critical habitat that might be affected by the proposed work. The district engineer will determine whether the proposed activity “may affect” or will have “no effect” to listed species and designated critical habitat and will notify the non-Federal applicant of the Corps’ determination within 45 days of receipt of a complete pre-construction notification. In cases where the non-Federal applicant has identified listed species or critical habitat that might be affected or is in the vicinity of the project, and has so notified the Corps, the applicant shall not begin work until the Corps has provided notification the proposed activities will have “no effect” on listed species or critical habitat, or until Section 7 consultation has been completed. If the non-Federal applicant has not heard back from the Corps within 45 days, the applicant must still wait for notification from the Corps.

(d) As a result of formal or informal consultation with the FWS or NMFS the district engineer may add species-specific regional endangered species conditions to the NWPs.

(e) Authorization of an activity by a NWP does not authorize the “take” of a threatened or endangered species as defined under the ESA. In the absence of separate authorization (e.g., an ESA Section 10 Permit, a Biological Opinion with “incidental take” provisions, etc.) from the U.S. FWS or the NMFS, The Endangered Species Act prohibits any person subject to the jurisdiction of the United States to take a listed species, where "take" means to harass, harm, pursue, hunt, shoot, wound, kill, trap, capture, or collect, or to attempt to engage in any such conduct. The word “harm” in the definition of “take” means an act which actually kills or injures wildlife. Such an act may include significant habitat modification or degradation where it actually kills or injures wildlife by significantly impairing essential behavioral patterns, including breeding, feeding or sheltering.

(f) Information on the location of threatened and endangered species and their critical habitat can be obtained directly from the offices of the U.S. FWS and NMFS or their world wide web pages at <http://www.fws.gov/> or <http://www.fws.gov/ipac> and <http://www.noaa.gov/fisheries.html> respectively.

19. Migratory Birds and Bald and Golden Eagles. The permittee is responsible for obtaining any “take” permits required under the U.S. Fish and Wildlife Service’s regulations governing compliance with the Migratory Bird Treaty Act or the Bald and Golden Eagle Protection Act. The permittee should contact the appropriate local office of the U.S. Fish and Wildlife Service to determine if such “take” permits are required for a particular activity.

20. Historic Properties. (a) In cases where the district engineer determines that the activity may affect properties listed, or eligible for listing, in the National Register of Historic Places, the activity is not authorized, until the requirements of Section 106 of the National Historic Preservation Act (NHPA) have been satisfied.

(b) Federal permittees should follow their own procedures for complying with the requirements of Section 106 of the National Historic Preservation Act. Federal permittees must provide the district engineer with the appropriate documentation to demonstrate compliance with those requirements. The district engineer will review the documentation and determine whether it is sufficient to address section 106 compliance for the NWP activity, or whether additional section 106 consultation is necessary.

(c) Non-federal permittees must submit a pre-construction notification to the district engineer if the authorized activity may have the potential to cause effects to any historic properties listed on, determined to be eligible for listing on, or potentially eligible for listing on the National Register of Historic Places, including previously unidentified properties. For such activities, the pre-construction notification must state which historic properties may be affected by the proposed work or include a vicinity map indicating the location of the historic properties or the potential for the presence of historic properties. Assistance regarding information on the location of or potential for the presence of historic resources can be sought from the State Historic Preservation Officer or Tribal Historic Preservation Officer, as appropriate, and the National Register of Historic Places (see 33 CFR 330.4(g)). When reviewing pre-construction notifications, district engineers will comply with the current procedures for addressing the requirements of Section 106 of the National Historic Preservation Act. The district engineer shall make a reasonable and good faith effort to carry out appropriate identification efforts, which may include background research, consultation, oral history interviews, sample field investigation, and field survey. Based on the information submitted and these efforts, the district engineer shall determine whether the proposed activity has the potential to cause an effect on the historic properties. Where the non-Federal applicant has identified historic properties on which the activity may have the potential to cause effects and so notified the Corps, the non-Federal applicant shall not begin the activity until notified by the district engineer either that the activity has no potential to cause effects or that consultation under Section 106 of the NHPA has been completed.

(d) The district engineer will notify the prospective permittee within 45 days of receipt of a complete pre-construction notification whether NHPA Section 106 consultation is required. Section 106 consultation is not required when the Corps determines that the activity does not have the potential to cause effects on historic properties (see 36 CFR §800.3(a)). If NHPA

section 106 consultation is required and will occur, the district engineer will notify the non-Federal applicant that he or she cannot begin work until Section 106 consultation is completed. If the non-Federal applicant has not heard back from the Corps within 45 days, the applicant must still wait for notification from the Corps.

(e) Prospective permittees should be aware that section 110k of the NHPA (16 U.S.C. 470h-2(k)) prevents the Corps from granting a permit or other assistance to an applicant who, with intent to avoid the requirements of Section 106 of the NHPA, has intentionally significantly adversely affected a historic property to which the permit would relate, or having legal power to prevent it, allowed such significant adverse effect to occur, unless the Corps, after consultation with the Advisory Council on Historic Preservation (ACHP), determines that circumstances justify granting such assistance despite the adverse effect created or permitted by the applicant. If circumstances justify granting the assistance, the Corps is required to notify the ACHP and provide documentation specifying the circumstances, the degree of damage to the integrity of any historic properties affected, and proposed mitigation. This documentation must include any views obtained from the applicant, SHPO/THPO, appropriate Indian tribes if the undertaking occurs on or affects historic properties on tribal lands or affects properties of interest to those tribes, and other parties known to have a legitimate interest in the impacts to the permitted activity on historic properties.

21. Discovery of Previously Unknown Remains and Artifacts. If you discover any previously unknown historic, cultural or archeological remains and artifacts while accomplishing the activity authorized by this permit, you must immediately notify the district engineer of what you have found, and to the maximum extent practicable, avoid construction activities that may affect the remains and artifacts until the required coordination has been completed. The district engineer will initiate the Federal, Tribal and state coordination required to determine if the items or remains warrant a recovery effort or if the site is eligible for listing in the National Register of Historic Places.

22. Designated Critical Resource Waters. Critical resource waters include, NOAA-managed marine sanctuaries and marine monuments, and National Estuarine Research Reserves. The district engineer may designate, after notice and opportunity for public comment, additional waters officially designated by a state as having particular environmental or ecological significance, such as outstanding national resource waters or state natural heritage sites. The district engineer may also designate additional critical resource waters after notice and opportunity for public comment.

(a) Discharges of dredged or fill material into waters of the United States are not authorized by NWP 7, 12, 14, 16, 17, 21, 29, 31, 35, 39, 40, 42, 43, 44, 49, 50, 51, and 52 for any activity within, or directly affecting, critical resource waters, including wetlands adjacent to such waters.

(b) For NWPs 3, 8, 10, 13, 15, 18, 19, 22, 23, 25, 27, 28, 30, 33, 34, 36, 37, and 38, notification is required in accordance with general condition 31, for any activity proposed in the designated critical resource waters including wetlands adjacent to those waters. The district engineer may authorize activities under these NWPs only after it is determined that the impacts to the critical resource waters will be no more than minimal.

23. Mitigation. The district engineer will consider the following factors when determining appropriate and practicable mitigation necessary to ensure that adverse effects on the aquatic environment are minimal:

(a) The activity must be designed and constructed to avoid and minimize adverse effects, both temporary and permanent, to waters of the United States to the maximum extent practicable at the project site (i.e., on site).

(b) Mitigation in all its forms (avoiding, minimizing, rectifying, reducing, or compensating for resource losses) will be required to the extent necessary to ensure that the adverse effects to the aquatic environment are minimal.

(c) Compensatory mitigation at a minimum one-for-one ratio will be required for all wetland losses that exceed 1/10-acre and require pre-construction notification, unless the district engineer determines in writing that either some other form of mitigation would be more environmentally appropriate or the adverse effects of the proposed activity are minimal, and provides a project-specific waiver of this requirement. For wetland losses of 1/10-acre or less that require pre-construction notification, the district engineer may determine on a case-by-case basis that compensatory mitigation is required to ensure that the activity results in minimal adverse effects on the aquatic environment. Compensatory mitigation projects provided to offset losses of aquatic resources must comply with the applicable provisions of 33 CFR part 332.

(1) The prospective permittee is responsible for proposing an appropriate compensatory mitigation option if compensatory mitigation is necessary to ensure that the activity results in minimal adverse effects on the aquatic environment.

(2) Since the likelihood of success is greater and the impacts to potentially valuable uplands are reduced, wetland restoration should be the first compensatory mitigation option considered.

(3) If permittee-responsible mitigation is the proposed option, the prospective permittee is responsible for submitting a mitigation plan. A conceptual or detailed mitigation plan may be used by the district engineer to make the decision on the NWP verification request, but a final mitigation plan that addresses the applicable requirements of 33 CFR 332.4(c)(2) – (14) must be approved by the district engineer before the permittee begins work in waters of the United States, unless the district engineer determines that prior approval of the final mitigation plan is not practicable or not necessary to ensure timely completion of the required compensatory mitigation (see 33 CFR 332.3(k)(3)).

(4) If mitigation bank or in-lieu fee program credits are the proposed option, the mitigation plan only needs to address the baseline conditions at the impact site and the number of credits to be provided.

(5) Compensatory mitigation requirements (e.g., resource type and amount to be provided as compensatory mitigation, site protection, ecological performance standards, monitoring requirements) may be addressed through conditions added to the NWP authorization, instead of components of a compensatory mitigation plan.

(d) For losses of streams or other open waters that require pre-construction notification, the district engineer may require compensatory mitigation, such as stream rehabilitation, enhancement, or preservation, to ensure that the activity results in minimal adverse effects on the aquatic environment.

(e) Compensatory mitigation will not be used to increase the acreage losses allowed by the acreage limits of the NWPs. For example, if an NWP has an acreage limit of 1/2-acre, it cannot be used to authorize any project resulting in the loss of greater than 1/2-acre of waters of

the United States, even if compensatory mitigation is provided that replaces or restores some of the lost waters. However, compensatory mitigation can and should be used, as necessary, to ensure that a project already meeting the established acreage limits also satisfies the minimal impact requirement associated with the NWP.

(f) Compensatory mitigation plans for projects in or near streams or other open waters will normally include a requirement for the restoration or establishment, maintenance, and legal protection (e.g., conservation easements) of riparian areas next to open waters. In some cases, riparian areas may be the only compensatory mitigation required. Riparian areas should consist of native species. The width of the required riparian area will address documented water quality or aquatic habitat loss concerns. Normally, the riparian area will be 25 to 50 feet wide on each side of the stream, but the district engineer may require slightly wider riparian areas to address documented water quality or habitat loss concerns. If it is not possible to establish a riparian area on both sides of a stream, or if the waterbody is a lake or coastal waters, then restoring or establishing a riparian area along a single bank or shoreline may be sufficient. Where both wetlands and open waters exist on the project site, the district engineer will determine the appropriate compensatory mitigation (e.g., riparian areas and/or wetlands compensation) based on what is best for the aquatic environment on a watershed basis. In cases where riparian areas are determined to be the most appropriate form of compensatory mitigation, the district engineer may waive or reduce the requirement to provide wetland compensatory mitigation for wetland losses.

(g) Permittees may propose the use of mitigation banks, in-lieu fee programs, or separate permittee-responsible mitigation. For activities resulting in the loss of marine or estuarine resources, permittee-responsible compensatory mitigation may be environmentally preferable if there are no mitigation banks or in-lieu fee programs in the area that have marine or estuarine credits available for sale or transfer to the permittee. For permittee-responsible mitigation, the special conditions of the NWP verification must clearly indicate the party or parties responsible for the implementation and performance of the compensatory mitigation project, and, if required, its long-term management.

(h) Where certain functions and services of waters of the United States are permanently adversely affected, such as the conversion of a forested or scrub-shrub wetland to a herbaceous wetland in a permanently maintained utility line right-of-way, mitigation may be required to reduce the adverse effects of the project to the minimal level.

24. Safety of Impoundment Structures. To ensure that all impoundment structures are safely designed, the district engineer may require non-Federal applicants to demonstrate that the structures comply with established state dam safety criteria or have been designed by qualified persons. The district engineer may also require documentation that the design has been independently reviewed by similarly qualified persons, and appropriate modifications made to ensure safety.

25. Water Quality. Where States and authorized Tribes, or EPA where applicable, have not previously certified compliance of an NWP with CWA Section 401, individual 401 Water Quality Certification must be obtained or waived (see 33 CFR 330.4(c)). The district engineer or State or Tribe may require additional water quality management measures to ensure that the authorized activity does not result in more than minimal degradation of water quality.



26. Coastal Zone Management. In coastal states where an NWP has not previously received a state coastal zone management consistency concurrence, an individual state coastal zone management consistency concurrence must be obtained, or a presumption of concurrence must occur (see 33 CFR 330.4(d)). The district engineer or a State may require additional measures to ensure that the authorized activity is consistent with state coastal zone management requirements.

27. Regional and Case-By-Case Conditions. The activity must comply with any regional conditions that may have been added by the Division Engineer (see 33 CFR 330.4(e)) and with any case specific conditions added by the Corps or by the state, Indian Tribe, or U.S. EPA in its section 401 Water Quality Certification, or by the state in its Coastal Zone Management Act consistency determination.

28. Use of Multiple Nationwide Permits. The use of more than one NWP for a single and complete project is prohibited, except when the acreage loss of waters of the United States authorized by the NWPs does not exceed the acreage limit of the NWP with the highest specified acreage limit. For example, if a road crossing over tidal waters is constructed under NWP 14, with associated bank stabilization authorized by NWP 13, the maximum acreage loss of waters of the United States for the total project cannot exceed 1/3-acre.

29. Transfer of Nationwide Permit Verifications. If the permittee sells the property associated with a nationwide permit verification, the permittee may transfer the nationwide permit verification to the new owner by submitting a letter to the appropriate Corps district office to validate the transfer. A copy of the nationwide permit verification must be attached to the letter, and the letter must contain the following statement and signature:

“When the structures or work authorized by this nationwide permit are still in existence at the time the property is transferred, the terms and conditions of this nationwide permit, including any special conditions, will continue to be binding on the new owner(s) of the property. To validate the transfer of this nationwide permit and the associated liabilities associated with compliance with its terms and conditions, have the transferee sign and date below.”

---

(Transferee)

---

(Date)

30. Compliance Certification. Each permittee who receives an NWP verification letter from the Corps must provide a signed certification documenting completion of the authorized activity and any required compensatory mitigation. The success of any required permittee-responsible mitigation, including the achievement of ecological performance standards, will be addressed separately by the district engineer. The Corps will provide the permittee the certification document with the NWP verification letter. The certification document will include:

(a) A statement that the authorized work was done in accordance with the NWP authorization, including any general, regional, or activity-specific conditions;

(b) A statement that the implementation of any required compensatory mitigation was completed in accordance with the permit conditions. If credits from a mitigation bank or in-lieu fee program are used to satisfy the compensatory mitigation requirements, the certification must include the documentation required by 33 CFR 332.3(1)(3) to confirm that the permittee secured the appropriate number and resource type of credits; and

(c) The signature of the permittee certifying the completion of the work and mitigation.

31. Pre-Construction Notification. (a) Timing. Where required by the terms of the NWP, the prospective permittee must notify the district engineer by submitting a pre-construction notification (PCN) as early as possible. The district engineer must determine if the PCN is complete within 30 calendar days of the date of receipt and, if the PCN is determined to be incomplete, notify the prospective permittee within that 30 day period to request the additional information necessary to make the PCN complete. The request must specify the information needed to make the PCN complete. As a general rule, district engineers will request additional information necessary to make the PCN complete only once. However, if the prospective permittee does not provide all of the requested information, then the district engineer will notify the prospective permittee that the PCN is still incomplete and the PCN review process will not commence until all of the requested information has been received by the district engineer. The prospective permittee shall not begin the activity until either:

(1) He or she is notified in writing by the district engineer that the activity may proceed under the NWP with any special conditions imposed by the district or division engineer; or

(2) 45 calendar days have passed from the district engineer's receipt of the complete PCN and the prospective permittee has not received written notice from the district or division engineer. However, if the permittee was required to notify the Corps pursuant to general condition 18 that listed species or critical habitat might be affected or in the vicinity of the project, or to notify the Corps pursuant to general condition 20 that the activity may have the potential to cause effects to historic properties, the permittee cannot begin the activity until receiving written notification from the Corps that there is "no effect" on listed species or "no potential to cause effects" on historic properties, or that any consultation required under Section 7 of the Endangered Species Act (see 33 CFR 330.4(f)) and/or Section 106 of the National Historic Preservation (see 33 CFR 330.4(g)) has been completed. Also, work cannot begin under NWPs 21, 49, or 50 until the permittee has received written approval from the Corps. If the proposed activity requires a written waiver to exceed specified limits of an NWP, the permittee may not begin the activity until the district engineer issues the waiver. If the district or division engineer notifies the permittee in writing that an individual permit is required within 45 calendar days of receipt of a complete PCN, the permittee cannot begin the activity until an individual permit has been obtained. Subsequently, the permittee's right to proceed under the NWP may be modified, suspended, or revoked only in accordance with the procedure set forth in 33 CFR 330.5(d)(2).

(b) Contents of Pre-Construction Notification: The PCN must be in writing and include the following information:

(1) Name, address and telephone numbers of the prospective permittee;

(2) Location of the proposed project;

(3) A description of the proposed project; the project's purpose; direct and indirect adverse environmental effects the project would cause, including the anticipated amount of loss of water of the United States expected to result from the NWP activity, in acres, linear feet, or other appropriate unit of measure; any other NWP(s), regional general permit(s), or individual permit(s) used or intended to be used to authorize any part of the proposed project or any related activity. The description should be sufficiently detailed to allow the district engineer to determine that the adverse effects of the project will be minimal and to determine the need for compensatory mitigation. Sketches should be provided when necessary to show that the activity complies with the terms of the NWP. (Sketches usually clarify the project and when provided results in a quicker decision. Sketches should contain sufficient detail to provide an illustrative description of the proposed activity (e.g., a conceptual plan), but do not need to be detailed engineering plans);

(4) The PCN must include a delineation of wetlands, other special aquatic sites, and other waters, such as lakes and ponds, and perennial, intermittent, and ephemeral streams, on the project site. Wetland delineations must be prepared in accordance with the current method required by the Corps. The permittee may ask the Corps to delineate the special aquatic sites and other waters on the project site, but there may be a delay if the Corps does the delineation, especially if the project site is large or contains many waters of the United States. Furthermore, the 45 day period will not start until the delineation has been submitted to or completed by the Corps, as appropriate;

(5) If the proposed activity will result in the loss of greater than 1/10-acre of wetlands and a PCN is required, the prospective permittee must submit a statement describing how the mitigation requirement will be satisfied, or explaining why the adverse effects are minimal and why compensatory mitigation should not be required. As an alternative, the prospective permittee may submit a conceptual or detailed mitigation plan.

(6) If any listed species or designated critical habitat might be affected or is in the vicinity of the project, or if the project is located in designated critical habitat, for non-Federal applicants the PCN must include the name(s) of those endangered or threatened species that might be affected by the proposed work or utilize the designated critical habitat that may be affected by the proposed work. Federal applicants must provide documentation demonstrating compliance with the Endangered Species Act; and

(7) For an activity that may affect a historic property listed on, determined to be eligible for listing on, or potentially eligible for listing on, the National Register of Historic Places, for non-Federal applicants the PCN must state which historic property may be affected by the proposed work or include a vicinity map indicating the location of the historic property. Federal applicants must provide documentation demonstrating compliance with Section 106 of the National Historic Preservation Act.

(c) Form of Pre-Construction Notification: The standard individual permit application form (Form ENG 4345) may be used, but the completed application form must clearly indicate that it is a PCN and must include all of the information required in paragraphs (b)(1) through (7) of this general condition. A letter containing the required information may also be used.

(d) Agency Coordination: (1) The district engineer will consider any comments from Federal and state agencies concerning the proposed activity's compliance with the terms and conditions of the NWPs and the need for mitigation to reduce the project's adverse environmental effects to a minimal level.

(2) For all NWP activities that require pre-construction notification and result in the loss of greater than 1/2-acre of waters of the United States, for NWP 21, 29, 39, 40, 42, 43, 44, 50, 51, and 52 activities that require pre-construction notification and will result in the loss of greater than 300 linear feet of intermittent and ephemeral stream bed, and for all NWP 48 activities that require pre-construction notification, the district engineer will immediately provide (e.g., via e-mail, facsimile transmission, overnight mail, or other expeditious manner) a copy of the complete PCN to the appropriate Federal or state offices (U.S. FWS, state natural resource or water quality agency, EPA, State Historic Preservation Officer (SHPO) or Tribal Historic Preservation Office (THPO), and, if appropriate, the NMFS). With the exception of NWP 37, these agencies will have 10 calendar days from the date the material is transmitted to telephone or fax the district engineer notice that they intend to provide substantive, site-specific comments. The comments must explain why the agency believes the adverse effects will be more than minimal. If so contacted by an agency, the district engineer will wait an additional 15 calendar days before making a decision on the pre-construction notification. The district engineer will fully consider agency comments received within the specified time frame concerning the proposed activity's compliance with the terms and conditions of the NWPs, including the need for mitigation to ensure the net adverse environmental effects to the aquatic environment of the proposed activity are minimal. The district engineer will provide no response to the resource agency, except as provided below. The district engineer will indicate in the administrative record associated with each pre-construction notification that the resource agencies' concerns were considered. For NWP 37, the emergency watershed protection and rehabilitation activity may proceed immediately in cases where there is an unacceptable hazard to life or a significant loss of property or economic hardship will occur. The district engineer will consider any comments received to decide whether the NWP 37 authorization should be modified, suspended, or revoked in accordance with the procedures at 33 CFR 330.5.

(3) In cases of where the prospective permittee is not a Federal agency, the district engineer will provide a response to NMFS within 30 calendar days of receipt of any Essential Fish Habitat conservation recommendations, as required by Section 305(b)(4)(B) of the Magnuson-Stevens Fishery Conservation and Management Act.

(4) Applicants are encouraged to provide the Corps with either electronic files or multiple copies of pre-construction notifications to expedite agency coordination.

#### D. District Engineer's Decision

1. In reviewing the PCN for the proposed activity, the district engineer will determine whether the activity authorized by the NWP will result in more than minimal individual or cumulative adverse environmental effects or may be contrary to the public interest. For a linear project, this determination will include an evaluation of the individual crossings to determine whether they individually satisfy the terms and conditions of the NWP(s), as well as the cumulative effects caused by all of the crossings authorized by NWP. If an applicant requests a waiver of the 300 linear foot limit on impacts to intermittent or ephemeral streams or of an otherwise applicable limit, as provided for in NWPs 13, 21, 29, 36, 39, 40, 42, 43, 44, 50, 51 or 52, the district engineer will only grant the waiver upon a written determination that the NWP activity will result in minimal adverse effects. When making minimal effects determinations the district engineer will consider the direct and indirect effects caused by the NWP activity. The district engineer will also consider site specific factors, such as the environmental setting in the

vicinity of the NWP activity, the type of resource that will be affected by the NWP activity, the functions provided by the aquatic resources that will be affected by the NWP activity, the degree or magnitude to which the aquatic resources perform those functions, the extent that aquatic resource functions will be lost as a result of the NWP activity (e.g., partial or complete loss), the duration of the adverse effects (temporary or permanent), the importance of the aquatic resource functions to the region (e.g., watershed or ecoregion), and mitigation required by the district engineer. If an appropriate functional assessment method is available and practicable to use, that assessment method may be used by the district engineer to assist in the minimal adverse effects determination. The district engineer may add case-specific special conditions to the NWP authorization to address site-specific environmental concerns.

2. If the proposed activity requires a PCN and will result in a loss of greater than 1/10-acre of wetlands, the prospective permittee should submit a mitigation proposal with the PCN. Applicants may also propose compensatory mitigation for projects with smaller impacts. The district engineer will consider any proposed compensatory mitigation the applicant has included in the proposal in determining whether the net adverse environmental effects to the aquatic environment of the proposed activity are minimal. The compensatory mitigation proposal may be either conceptual or detailed. If the district engineer determines that the activity complies with the terms and conditions of the NWP and that the adverse effects on the aquatic environment are minimal, after considering mitigation, the district engineer will notify the permittee and include any activity-specific conditions in the NWP verification the district engineer deems necessary. Conditions for compensatory mitigation requirements must comply with the appropriate provisions at 33 CFR 332.3(k). The district engineer must approve the final mitigation plan before the permittee commences work in waters of the United States, unless the district engineer determines that prior approval of the final mitigation plan is not practicable or not necessary to ensure timely completion of the required compensatory mitigation. If the prospective permittee elects to submit a compensatory mitigation plan with the PCN, the district engineer will expeditiously review the proposed compensatory mitigation plan. The district engineer must review the proposed compensatory mitigation plan within 45 calendar days of receiving a complete PCN and determine whether the proposed mitigation would ensure no more than minimal adverse effects on the aquatic environment. If the net adverse effects of the project on the aquatic environment (after consideration of the compensatory mitigation proposal) are determined by the district engineer to be minimal, the district engineer will provide a timely written response to the applicant. The response will state that the project can proceed under the terms and conditions of the NWP, including any activity-specific conditions added to the NWP authorization by the district engineer.

3. If the district engineer determines that the adverse effects of the proposed work are more than minimal, then the district engineer will notify the applicant either: (a) That the project does not qualify for authorization under the NWP and instruct the applicant on the procedures to seek authorization under an individual permit; (b) that the project is authorized under the NWP subject to the applicant's submission of a mitigation plan that would reduce the adverse effects on the aquatic environment to the minimal level; or (c) that the project is authorized under the NWP with specific modifications or conditions. Where the district engineer determines that mitigation is required to ensure no more than minimal adverse effects occur to the aquatic environment, the activity will be authorized within the 45-day PCN period, with activity-specific

conditions that state the mitigation requirements. The authorization will include the necessary conceptual or detailed mitigation or a requirement that the applicant submit a mitigation plan that would reduce the adverse effects on the aquatic environment to the minimal level. When mitigation is required, no work in waters of the United States may occur until the district engineer has approved a specific mitigation plan or has determined that prior approval of a final mitigation plan is not practicable or not necessary to ensure timely completion of the required compensatory mitigation.

### **FURTHER INFORMATION**

1. District Engineers have authority to determine if an activity complies with the terms and conditions of an NWP.
2. NWPs do not obviate the need to obtain other federal, state, or local permits, approvals, or authorizations required by law.
3. NWPs do not grant any property rights or exclusive privileges.
4. NWPs do not authorize any injury to the property or rights of others.
5. NWPs do not authorize interference with any existing or proposed Federal project.

### **DEFINITIONS**

Best management practices (BMPs): Policies, practices, procedures, or structures implemented to mitigate the adverse environmental effects on surface water quality resulting from development. BMPs are categorized as structural or non-structural.

Compensatory mitigation: The restoration (re-establishment or rehabilitation), establishment (creation), enhancement, and/or in certain circumstances preservation of aquatic resources for the purposes of offsetting unavoidable adverse impacts which remain after all appropriate and practicable avoidance and minimization has been achieved.

Currently serviceable: Useable as is or with some maintenance, but not so degraded as to essentially require reconstruction.

Direct effects: Effects that are caused by the activity and occur at the same time and place.

Discharge: The term “discharge” means any discharge of dredged or fill material.

Enhancement: The manipulation of the physical, chemical, or biological characteristics of an aquatic resource to heighten, intensify, or improve a specific aquatic resource function(s). Enhancement results in the gain of selected aquatic resource function(s), but may also lead to a decline in other aquatic resource function(s). Enhancement does not result in a gain in aquatic resource area.

Ephemeral stream: An ephemeral stream has flowing water only during, and for a short duration after, precipitation events in a typical year. Ephemeral stream beds are located above the water table year-round. Groundwater is not a source of water for the stream. Runoff from rainfall is the primary source of water for stream flow.

Establishment (creation): The manipulation of the physical, chemical, or biological characteristics present to develop an aquatic resource that did not previously exist at an upland site. Establishment results in a gain in aquatic resource area.

High Tide Line: The line of intersection of the land with the water’s surface at the maximum height reached by a rising tide. The high tide line may be determined, in the absence

of actual data, by a line of oil or scum along shore objects, a more or less continuous deposit of fine shell or debris on the foreshore or berm, other physical markings or characteristics, vegetation lines, tidal gages, or other suitable means that delineate the general height reached by a rising tide. The line encompasses spring high tides and other high tides that occur with periodic frequency but does not include storm surges in which there is a departure from the normal or predicted reach of the tide due to the piling up of water against a coast by strong winds such as those accompanying a hurricane or other intense storm.

Historic Property: Any prehistoric or historic district, site (including archaeological site), building, structure, or other object included in, or eligible for inclusion in, the National Register of Historic Places maintained by the Secretary of the Interior. This term includes artifacts, records, and remains that are related to and located within such properties. The term includes properties of traditional religious and cultural importance to an Indian tribe or Native Hawaiian organization and that meet the National Register criteria (36 CFR part 60).

Independent utility: A test to determine what constitutes a single and complete non-linear project in the Corps regulatory program. A project is considered to have independent utility if it would be constructed absent the construction of other projects in the project area. Portions of a multi-phase project that depend upon other phases of the project do not have independent utility. Phases of a project that would be constructed even if the other phases were not built can be considered as separate single and complete projects with independent utility.

Indirect effects: Effects that are caused by the activity and are later in time or farther removed in distance, but are still reasonably foreseeable.

Intermittent stream: An intermittent stream has flowing water during certain times of the year, when groundwater provides water for stream flow. During dry periods, intermittent streams may not have flowing water. Runoff from rainfall is a supplemental source of water for stream flow.

Loss of waters of the United States: Waters of the United States that are permanently adversely affected by filling, flooding, excavation, or drainage because of the regulated activity. Permanent adverse effects include permanent discharges of dredged or fill material that change an aquatic area to dry land, increase the bottom elevation of a waterbody, or change the use of a waterbody. The acreage of loss of waters of the United States is a threshold measurement of the impact to jurisdictional waters for determining whether a project may qualify for an NWP; it is not a net threshold that is calculated after considering compensatory mitigation that may be used to offset losses of aquatic functions and services. The loss of stream bed includes the linear feet of stream bed that is filled or excavated. Waters of the United States temporarily filled, flooded, excavated, or drained, but restored to pre-construction contours and elevations after construction, are not included in the measurement of loss of waters of the United States. Impacts resulting from activities eligible for exemptions under Section 404(f) of the Clean Water Act are not considered when calculating the loss of waters of the United States.

Non-tidal wetland: A non-tidal wetland is a wetland that is not subject to the ebb and flow of tidal waters. The definition of a wetland can be found at 33 CFR 328.3(b). Non-tidal wetlands contiguous to tidal waters are located landward of the high tide line (i.e., spring high tide line).

Open water: For purposes of the NWPs, an open water is any area that in a year with normal patterns of precipitation has water flowing or standing above ground to the extent that an ordinary high water mark can be determined. Aquatic vegetation within the area of standing or



flowing water is either non-emergent, sparse, or absent. Vegetated shallows are considered to be open waters. Examples of “open waters” include rivers, streams, lakes, and ponds.

Ordinary High Water Mark: An ordinary high water mark is a line on the shore established by the fluctuations of water and indicated by physical characteristics, or by other appropriate means that consider the characteristics of the surrounding areas (see 33 CFR 328.3(e)).

Perennial stream: A perennial stream has flowing water year-round during a typical year. The water table is located above the stream bed for most of the year. Groundwater is the primary source of water for stream flow. Runoff from rainfall is a supplemental source of water for stream flow.

Practicable: Available and capable of being done after taking into consideration cost, existing technology, and logistics in light of overall project purposes.

Pre-construction notification: A request submitted by the project proponent to the Corps for confirmation that a particular activity is authorized by nationwide permit. The request may be a permit application, letter, or similar document that includes information about the proposed work and its anticipated environmental effects. Pre-construction notification may be required by the terms and conditions of a nationwide permit, or by regional conditions. A pre-construction notification may be voluntarily submitted in cases where pre-construction notification is not required and the project proponent wants confirmation that the activity is authorized by nationwide permit.

Preservation: The removal of a threat to, or preventing the decline of, aquatic resources by an action in or near those aquatic resources. This term includes activities commonly associated with the protection and maintenance of aquatic resources through the implementation of appropriate legal and physical mechanisms. Preservation does not result in a gain of aquatic resource area or functions.

Re-establishment: The manipulation of the physical, chemical, or biological characteristics of a site with the goal of returning natural/historic functions to a former aquatic resource. Re-establishment results in rebuilding a former aquatic resource and results in a gain in aquatic resource area and functions.

Rehabilitation: The manipulation of the physical, chemical, or biological characteristics of a site with the goal of repairing natural/historic functions to a degraded aquatic resource. Rehabilitation results in a gain in aquatic resource function, but does not result in a gain in aquatic resource area.

Restoration: The manipulation of the physical, chemical, or biological characteristics of a site with the goal of returning natural/historic functions to a former or degraded aquatic resource. For the purpose of tracking net gains in aquatic resource area, restoration is divided into two categories: re-establishment and rehabilitation.

Riffle and pool complex: Riffle and pool complexes are special aquatic sites under the 404(b)(1) Guidelines. Riffle and pool complexes sometimes characterize steep gradient sections of streams. Such stream sections are recognizable by their hydraulic characteristics. The rapid movement of water over a coarse substrate in riffles results in a rough flow, a turbulent surface, and high dissolved oxygen levels in the water. Pools are deeper areas associated with riffles. A slower stream velocity, a streaming flow, a smooth surface, and a finer substrate characterize pools.

Riparian areas: Riparian areas are lands adjacent to streams, lakes, and estuarine-marine shorelines. Riparian areas are transitional between terrestrial and aquatic ecosystems, through

which surface and subsurface hydrology connects riverine, lacustrine, estuarine, and marine waters with their adjacent wetlands, non-wetland waters, or uplands. Riparian areas provide a variety of ecological functions and services and help improve or maintain local water quality. (See general condition 23.)

Shellfish seeding: The placement of shellfish seed and/or suitable substrate to increase shellfish production. Shellfish seed consists of immature individual shellfish or individual shellfish attached to shells or shell fragments (i.e., spat on shell). Suitable substrate may consist of shellfish shells, shell fragments, or other appropriate materials placed into waters for shellfish habitat.

Single and complete linear project: A linear project is a project constructed for the purpose of getting people, goods, or services from a point of origin to a terminal point, which often involves multiple crossings of one or more waterbodies at separate and distant locations. The term “single and complete project” is defined as that portion of the total linear project proposed or accomplished by one owner/developer or partnership or other association of owners/developers that includes all crossings of a single water of the United States (i.e., a single waterbody) at a specific location. For linear projects crossing a single or multiple waterbodies several times at separate and distant locations, each crossing is considered a single and complete project for purposes of NWP authorization. However, individual channels in a braided stream or river, or individual arms of a large, irregularly shaped wetland or lake, etc., are not separate waterbodies, and crossings of such features cannot be considered separately.

Single and complete non-linear project: For non-linear projects, the term “single and complete project” is defined at 33 CFR 330.2(i) as the total project proposed or accomplished by one owner/developer or partnership or other association of owners/developers. A single and complete non-linear project must have independent utility (see definition of “independent utility”). Single and complete non-linear projects may not be “piecemealed” to avoid the limits in an NWP authorization.

Stormwater management: Stormwater management is the mechanism for controlling stormwater runoff for the purposes of reducing downstream erosion, water quality degradation, and flooding and mitigating the adverse effects of changes in land use on the aquatic environment.

Stormwater management facilities: Stormwater management facilities are those facilities, including but not limited to, stormwater retention and detention ponds and best management practices, which retain water for a period of time to control runoff and/or improve the quality (i.e., by reducing the concentration of nutrients, sediments, hazardous substances and other pollutants) of stormwater runoff.

Stream bed: The substrate of the stream channel between the ordinary high water marks. The substrate may be bedrock or inorganic particles that range in size from clay to boulders. Wetlands contiguous to the stream bed, but outside of the ordinary high water marks, are not considered part of the stream bed.

Stream channelization: The manipulation of a stream’s course, condition, capacity, or location that causes more than minimal interruption of normal stream processes. A channelized stream remains a water of the United States.

Structure: An object that is arranged in a definite pattern of organization. Examples of structures include, without limitation, any pier, boat dock, boat ramp, wharf, dolphin, weir, boom, breakwater, bulkhead, revetment, riprap, jetty, artificial island, artificial reef, permanent

mooring structure, power transmission line, permanently moored floating vessel, piling, aid to navigation, or any other manmade obstacle or obstruction.

Tidal wetland: A tidal wetland is a wetland (i.e., water of the United States) that is inundated by tidal waters. The definitions of a wetland and tidal waters can be found at 33 CFR 328.3(b) and 33 CFR 328.3(f), respectively. Tidal waters rise and fall in a predictable and measurable rhythm or cycle due to the gravitational pulls of the moon and sun. Tidal waters end where the rise and fall of the water surface can no longer be practically measured in a predictable rhythm due to masking by other waters, wind, or other effects. Tidal wetlands are located channelward of the high tide line, which is defined at 33 CFR 328.3(d).

Vegetated shallows: Vegetated shallows are special aquatic sites under the 404(b)(1) Guidelines. They are areas that are permanently inundated and under normal circumstances have rooted aquatic vegetation, such as seagrasses in marine and estuarine systems and a variety of vascular rooted plants in freshwater systems.

Waterbody: For purposes of the NWP, a waterbody is a jurisdictional water of the United States. If a jurisdictional wetland is adjacent – meaning bordering, contiguous, or neighboring – to a waterbody determined to be a water of the United States under 33 CFR 328.3(a)(1)-(6), that waterbody and its adjacent wetlands are considered together as a single aquatic unit (see 33 CFR 328.4(c)(2)). Examples of “waterbodies” include streams, rivers, lakes, ponds, and wetlands.

## **Final Regional Conditions 2012**

### ***NOTICE ABOUT WEB LINKS IN THIS DOCUMENT:***

*The web links (both internal to our District and any external links to collaborating agencies) in this document are valid at the time of publication. However, the Wilmington District Regulatory Program web page addresses, as with other agency web sites, may change over the timeframe of the five-year Nationwide Permit renewal cycle, in response to policy mandates or technology advances. While we will make every effort to check on the integrity of our web links and provide re-direct pages whenever possible, we ask that you report any broken links to us so we can keep the page information current and usable. We apologize in advanced for any broken links that you may encounter, and we ask that you navigate from the regulatory home page (wetlands and stream permits) of the Wilmington District Corps of Engineers, to the “Permits” section of our web site to find links for pages that cannot be found by clicking directly on the listed web link in this document.*

## **Final 2012 Regional Conditions for Nationwide Permits (NWP) in the Wilmington District**

### **1.0 Excluded Waters**

The Corps has identified waters that will be excluded from the use of all NWP’s during certain timeframes. These waters are:

#### **1.1 Anadromous Fish Spawning Areas**

Waters of the United States identified by either the North Carolina Division of Marine Fisheries (NCDMF) or the North Carolina Wildlife Resources Commission (NCWRC) as anadromous fish spawning areas are excluded during the period between February 15 and June 30, without prior written approval from NCDMF or NCWRC and the Corps.

#### **1.2 Trout Waters Moratorium**

Waters of the United States in the twenty-five designated trout counties of North Carolina are excluded during the period between October 15 and April 15 without prior written approval from the NCWRC. (See Section 2.7 for a list of the twenty-five trout counties).

#### **1.3 Sturgeon Spawning Areas as Designated by the National Marine Fisheries Service (NMFS)**

Waters of the United States designated as sturgeon spawning areas are excluded during the period between February 1 and June 30, without prior written approval from the NMFS.

## **2.0 Waters Requiring Additional Notification**

The Corps has identified waters that will be subject to additional notification requirements for activities authorized by all NWP's. These waters are:

### **2.1 Western NC Counties that Drain to Designated Critical Habitat**

For proposed activities within Waters of the U.S. that require a Pre-Construction Notification pursuant to General Condition 31 (PCN) and are located in the sixteen counties listed below, applicants must provide a copy of the PCN to the US Fish and Wildlife Service, 160 Zillicoa Street, Asheville, North Carolina 28801. This PCN must be sent concurrently to the US Fish and Wildlife Service and the Corps Asheville Regulatory Field Office. Please see General Condition 18 for specific notification requirements related to Federally Endangered Species and the following website for information on the location of designated critical habitat.

Counties with tributaries that drain to designated critical habitat that require notification to the Asheville US Fish and Wildlife Service: Avery, Cherokee, Forsyth, Graham, Haywood, Henderson, Jackson, Macon Mecklenburg, Mitchell, Stokes, Surry, Swain, Transylvania, Union and Yancey.

Website and office addresses for Endangered Species Act Information:

The Wilmington District has developed the following website for applicants which provides guidelines on how to review linked websites and maps in order to fulfill NWP general condition 18 requirements: <http://www.saw.usace.army.mil/wetlands/ESA>

Applicants who do not have internet access may contact the appropriate US Fish and Wildlife Service offices listed below or the US Army Corps of Engineers at (910) 251- 4633:

US Fish and Wildlife Service  
Asheville Field Office  
160 Zillicoa Street  
Asheville, NC 28801  
Telephone: (828) 258-3939

Asheville US Fish and Wildlife Service Office counties: All counties west of and including Anson, Stanly, Davidson, Forsyth and Stokes Counties

US Fish and Wildlife Service  
Raleigh Field Office  
Post Office Box 33726  
Raleigh, NC 27636-3726  
Telephone: (919) 856-4520

Raleigh US Fish and Wildlife Service Office counties: all counties east of and including Richmond, Montgomery, Randolph, Guilford, and Rockingham Counties.

## **2.2 Special Designation Waters**

Prior to the use of any NWP in any of the following identified waters and contiguous wetlands in North Carolina, applicants must comply with Nationwide Permit General Condition 31 (PCN). The North Carolina waters and contiguous wetlands that require additional notification requirements are:

“Outstanding Resource Waters” (ORW) or “High Quality Waters” (HQW) as designated by the North Carolina Environmental Management Commission; “Inland Primary Nursery Areas” (IPNA) as designated by the NCWRC; “Contiguous Wetlands” as defined by the North Carolina Environmental Management Commission; or “Primary Nursery Areas” (PNA) as designated by the North Carolina Marine Fisheries Commission.

## **2.3 Coastal Area Management Act (CAMA) Areas of Environmental Concern**

Non-federal applicants for any NWP in a designated “Area of Environmental Concern” (AEC) in the twenty (20) counties of Eastern North Carolina covered by the North Carolina Coastal Area Management Act (CAMA) must also obtain the required CAMA permit. Development activities for non-federal projects may not commence until a copy of the approved CAMA permit is furnished to the appropriate Wilmington District Regulatory Field Office (Wilmington Field Office – 69 Darlington Avenue, Wilmington, NC 28403 or Washington Field Office – 2407 West 5th Street, Washington, NC 27889).

## **2.4 Barrier Islands**

Prior to the use of any NWP on a barrier island of North Carolina, applicants must comply with Nationwide Permit General Condition 31 (PCN).

## **2.5 Mountain or Piedmont Bogs**

Prior to the use of any NWP in a Bog classified by the North Carolina Wetland Assessment Methodology (NCWAM), applicants shall comply with Nationwide Permit General Condition 31 (PCN). The latest version of NCWAM is located on the NC DWQ web site at: <http://portal.ncdenr.org/web/wq/swp/ws/pdu/ncwam> .

## **2.6 Animal Waste Facilities**

Prior to use of any NWP for construction of animal waste facilities in waters of the US, including wetlands, applicants shall comply with Nationwide Permit General Condition 31 (PCN).

## **2.7 Trout Waters**

Prior to any discharge of dredge or fill material into streams or waterbodies within the twenty-five (25) designated trout counties of North Carolina, the applicant shall comply with Nationwide Permit General Condition 31 (PCN). The applicant shall also provide a copy of the notification to the appropriate NCWRC office to facilitate the determination of any potential

impacts to designated Trout Waters. Notification to the Corps of Engineers will include a statement with the name of the NCWRC biologist contacted, the date of the notification, the location of work, a delineation of wetlands, a discussion of alternatives to working in the mountain trout waters, why alternatives were not selected, and a plan to provide compensatory mitigation for all unavoidable adverse impacts to mountain trout waters.

NCWRC and NC Trout Counties

Western Piedmont Region Coordinator	Alleghany	Caldwell	Watauga
20830 Great Smoky Mtn. Expressway	Ashe	Mitchell	Wilkes
Waynesville, NC 28786	Avery	Stokes	
Telephone: (828) 452-2546	Burke	Surry	

Mountain Region Coordinator	Buncombe	Henderson	Polk
20830 Great Smoky Mtn. Expressway	Cherokee	Jackson	Rutherford
Waynesville, NC 28786	Clay	Macon	Swain
Telephone: (828) 452-2546	Graham	Madison	Transylvania
Fax: (828) 452-7772	Haywood	McDowell	Yancey

**3.0 List of Corps Regional Conditions for All Nationwide Permits**

The following conditions apply to all Nationwide Permits in the Wilmington District:

**3.1 Limitation of Loss of Perennial Stream Bed**

NWPs may not be used for activities that may result in the loss or degradation of greater than 300 total linear feet of perennial, intermittent or ephemeral stream, unless the District Commander has waived the 300 linear foot limit for ephemeral and intermittent streams on a case-by-case basis and he determines that the proposed activity will result in minimal individual and cumulative adverse impacts to the aquatic environment. Loss of stream includes the linear feet of stream bed that is filled, excavated, or flooded by the proposed activity. Waivers for the loss of ephemeral and intermittent streams must be in writing and documented by appropriate/accepted stream quality assessments\*. This waiver only applies to the 300 linear feet threshold for NWPs.

\*NOTE: Applicants should utilize the most current methodology prescribed by Wilmington District to assess stream function and quality. Information can be found at:

<http://www.saw.usace.army.mil/wetlands/permits/nwp/nwp2012> (see “Quick Links”)



### **3.2 Mitigation for Loss of Stream Bed**

For any NWP that results in a loss of more than 150 linear feet of perennial and/or ephemeral/intermittent stream, the applicant shall provide a mitigation proposal to compensate for more than minimal individual and cumulative adverse impacts to the aquatic environment. For stream losses less than 150 linear feet, that require a PCN, the District Commander may determine, on a case-by-case basis that compensatory mitigation is required to ensure that the activity results in minimal adverse effect on the aquatic environment.

### **3.3 Pre-construction Notification for Loss of Streambed Exceeding 150 Feet.**

Prior to use of any NWP for any activity which impacts more than 150 total linear feet of perennial stream or ephemeral/ intermittent stream, the applicant must comply with Nationwide Permit General Condition 31 (PCN). This applies to NWPs that do not have specific notification requirements. If a NWP has specific notification requirements, the requirements of the NWP should be followed.

### **3.4 Restriction on Use of Live Concrete**

For all NWPs which allow the use of concrete as a building material, live or fresh concrete, including bags of uncured concrete, may not come into contact with the water in or entering into waters of the US. Water inside coffer dams or casings that has been in contact with wet concrete shall only be returned to waters of the US when it is no longer poses a threat to aquatic organisms.

### **3.5 Requirements for Using Riprap for Bank Stabilization**

For all NWPs that allow for the use of riprap material for bank stabilization, the following measures shall be applied:

**3.5.1.** Filter cloth must be placed underneath the riprap as an additional requirement of its use in North Carolina waters.

**3.5.2.** The placement of riprap shall be limited to the areas depicted on submitted work plan drawings.

**3.5.3.** The riprap material shall be clean and free from loose dirt or any pollutant except in trace quantities that would not have an adverse environmental effect.

**3.5.4.** It shall be of a size sufficient to prevent its movement from the authorized alignment by natural forces under normal conditions.

**3.5.5.** The riprap material shall consist of clean rock or masonry material such as, but not limited to, granite, marl, or broken concrete.

**3.5.6.** A waiver from the specifications in this Regional Condition may be requested in writing. The waiver will only be issued if it can be demonstrated that the impacts of complying with this Regional condition would result in greater adverse impacts to the aquatic environment.

### **3.6 Safe Passage Requirements for Culvert Placement**

For all NWP's that involve the construction/installation of culverts, measures will be included in the construction/installation that will promote the safe passage of fish and other aquatic organisms. The dimension, pattern, and profile of the stream above and below a pipe or culvert should not be modified by widening the stream channel or by reducing the depth of the stream in connection with the construction activity. The width, height, and gradient of a proposed culvert should be such as to pass the average historical low flow and spring flow without adversely altering flow velocity. Spring flow should be determined from gage data, if available. In the absence of such data, bankfull flow can be used as a comparable level.

In the twenty (20) counties of North Carolina designated as coastal counties by the Coastal Area Management Act (CAMA): All pipes/culverts must be sufficiently sized to allow for the burial of the bottom of the pipe/culvert at least one foot below normal bed elevation when they are placed within the Public Trust Area of Environmental Concern (AEC) and/or the Estuarine Waters AEC as designated by CAMA, and/or all streams appearing as blue lines on United States Geological Survey (USGS) 7.5-minute quadrangle maps.

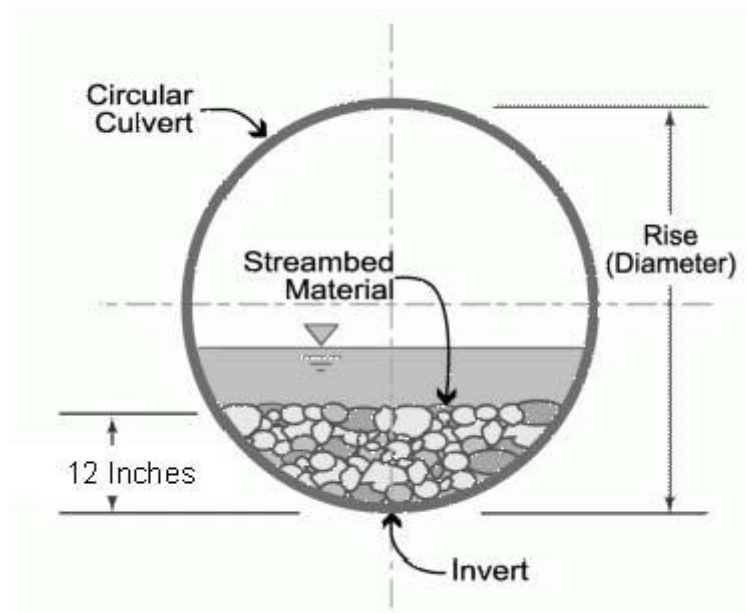

In all other counties: Culverts greater than 48 inches in diameter will be buried at least one foot below the bed of the stream. Culverts 48 inches in diameter or less shall be buried or placed on the stream bed as practicable and appropriate to maintain aquatic passage, and every effort shall be made to maintain the existing channel slope. The bottom of the culvert must be placed at a

depth below the natural stream bottom to provide for passage during drought or low flow conditions.

Culverts are to be designed and constructed in a manner that minimizes destabilization and head cutting. Destabilizing the channel and head cutting upstream should be considered and appropriate actions incorporated in the design and placement of the culvert.

A waiver from the depth specifications in this condition may be requested in writing. The waiver will be issued if it can be demonstrated that the proposal would result in the least impacts to the aquatic environment.

All counties: Culverts placed within riparian and/or riverine wetlands must be installed in a manner that does not restrict the flow and circulation patterns of waters of the United States. Culverts placed across wetland fills purely for the purposes of equalizing surface water do not have to be buried.

### **3.7 Notification to NCDENR Shellfish Sanitation Section**

Applicants shall notify the NCDENR Shellfish Sanitation Section prior to dredging in or removing sediment from an area closed to shell fishing where the effluent may be released to an area open for shell fishing or swimming in order to avoid contamination from the disposal area and cause a temporary shellfish closure to be made. Such notification shall also be provided to the appropriate Corps of Engineers Regulatory Field Office. Any disposal of sand to the ocean beach should occur between November 1 and April 30 when recreational usage is low. Only clean sand should be used and no dredged sand from closed shell fishing areas may be used. If beach disposal were to occur at times other than stated above or if sand from a closed shell fishing area is to be used, a swimming advisory shall be posted, and a press release shall be issued by the permittee.

### **3.8 Preservation of Submerged Aquatic Vegetation**

Adverse impacts to Submerged Aquatic Vegetation (SAV) are not authorized by any NWP within any of the twenty coastal counties defined by North Carolina's Coastal Area Management Act of 1974 (CAMA).

### **3.9 Sedimentation and Erosion Control Structures and Measures**

**3.9.1.** All PCNs will identify and describe sedimentation and erosion control structures and measures proposed for placement in waters of the US. The structures and measures should be depicted on maps, surveys or drawings showing location and impacts to jurisdictional wetlands and streams.

#### **4.0 Additional Regional Conditions for Specific Nationwide Permits**

##### **4.1 NWP #33 – Temporary Construction, Access and Dewatering**

**4.1.1.** The required restoration plan must include a timetable for restoration activities.

# Water Quality Certification No. 3893

**GENERAL CERTIFICATION FOR PROJECTS ELIGIBLE  
FOR U.S. ARMY CORPS OF ENGINEERS NATIONWIDE PERMIT NUMBER 33  
(TEMPORARY CONSTRUCTION, ACCESS AND DEWATERING)  
AND RIPARIAN AREA PROTECTION RULES (BUFFER RULES)**

Water Quality Certification Number 3893 is issued in conformity with the requirements of Section 401, Public Laws 92-500 and 95-217 of the United States and subject to the North Carolina Division of Water Quality Regulations in 15A NCAC 02H .0500 and 15A NCAC 02B .0200 for the discharge of fill material to waters and wetland areas as described in 33 CFR 330 Appendix A (B) (33) and for the Riparian Area Protection Rules (Buffer Rules) in 15A NCAC 02B .0200.

The State of North Carolina certifies that the specified category of activity will not violate applicable portions of Sections 301, 302, 303, 306 and 307 of the Public Laws 92-500 and 95-217 if conducted in accordance with the conditions hereinafter set forth.

**Activities meeting any one (1) of the following thresholds or circumstances require *written approval* for a 401 Water Quality Certification from the Division of Water Quality (the "Division"):**

- a. Any stream relocation; or
- b. Any impact associated with a Notice of Violation or an enforcement action for violation(s) of DWQ Wetland Rules (15A NCAC 02H .0500), Isolated Wetland Rules (15A NCAC 02H .1300), DWQ Surface Water or Wetland Standards, or Riparian Buffer Rules (15A NCAC 02B .0200); or
- c. Any impacts to streams and/or buffers in the Neuse, Tar-Pamlico, or Catawba River Basins or in the Randleman, Jordan or Goose Creek Watersheds (or any other basin or watershed with Riparian Area Protection Rules [Buffer Rules] in effect at the time of application) *unless* the activities are listed as "EXEMPT" from these rules or a Buffer Authorization Certificate is issued through N.C. Division of Coastal Management (DCM) delegation for "ALLOWABLE" activities.

In accordance with North Carolina General Statute 143-215.3D(e), written approval for a 401 Water Quality General Certification must include the appropriate fee. If a project also requires a CAMA Permit, then one payment to both agencies shall be submitted and will be the higher of the two fees.

**Activities included in this General Certification that do not meet one of the thresholds listed above do not require written approval from the Division as long as they comply with the Conditions of Certification listed below. If any of these Conditions cannot be met, then written approval from the Division is required.**

Conditions of Certification:

1. No Impacts Beyond those Authorized in the Written Approval or Beyond the Threshold of Use of this Certification

No waste, spoil, solids, or fill of any kind shall occur in wetlands, waters, or riparian areas beyond the footprint of the impacts depicted in the Pre-Construction Notification, as authorized in the written approval from the Division or beyond the thresholds established for use of this Certification without written authorization, including incidental impacts. All construction activities, including the design, installation, operation, and maintenance of sediment and erosion control Best Management Practices shall be performed so that no violations of state water quality standards, statutes, or rules occur. Approved plans and specifications for this project are incorporated by reference and are enforceable parts of this permit.



# Water Quality Certification No. 3893

## 2. Standard Erosion and Sediment Control Practices

Erosion and sediment control practices must be in full compliance with all specifications governing the proper design, installation and operation and maintenance of such Best Management Practices and if applicable, comply with the specific conditions and requirements of the NPDES Construction Stormwater Permit issued to the site:

- a. Design, installation, operation, and maintenance of the sediment and erosion control measures must be such that they equal or exceed the requirements specified in the most recent version of the *North Carolina Sediment and Erosion Control Manual*. The devices shall be maintained on all construction sites, borrow sites, and waste pile (spoil) projects, including contractor-owned or leased borrow pits associated with the project.
- b. For borrow pit sites, the erosion and sediment control measures must be designed, installed, operated, and maintained in accordance with the most recent version of the *North Carolina Surface Mining Manual*.
- c. Reclamation measures and implementation must comply with the reclamation in accordance with the requirements of the Sedimentation Pollution Control Act and the Mining Act of 1971.
- d. Sufficient materials required for stabilization and/or repair of erosion control measures and stormwater routing and treatment shall be on site at all times.
- e. If the project occurs in waters or watersheds classified as Primary Nursery Areas (PNAs), SA, WS-I, WS-II, High Quality (HQW), or Outstanding Resource (ORW) waters, then the sedimentation and erosion control designs must comply with the requirements set forth in 15A NCAC 04B .0124, *Design Standards in Sensitive Watersheds*.

## 3. No Sediment and Erosion Control Measures in Wetlands or Waters

Sediment and erosion control measures shall not be placed in wetlands or waters. Exceptions to this condition require application submittal to and written approval by the Division. If placement of sediment and erosion control devices in wetlands and waters is unavoidable, then design and placement of temporary erosion control measures shall not be conducted in a manner that may result in dis-equilibrium of wetlands, stream beds, or banks, adjacent to or upstream and downstream of the above structures. All sediment and erosion control devices shall be removed and the natural grade restored within two (2) months of the date that the Division of Land Resources (DLR) or locally delegated program has released the specific area within the project.

## 4. Construction Stormwater Permit NCG010000

An NPDES Construction Stormwater Permit is required for construction projects that disturb one (1) or more acres of land. This Permit allows stormwater to be discharged during land disturbing construction activities as stipulated in the conditions of the permit. If your project is covered by this permit, full compliance with permit conditions including the erosion & sedimentation control plan, inspections and maintenance, self-monitoring, record keeping and reporting requirements is required. A copy of the general permit (NCG010000), inspection log sheets, and other information may be found at <http://portal.ncdenr.org/web/wq/ws/su/npdcssw#tab-w>.

The North Carolina Department of Transportation (NCDOT) shall be required to be in full compliance with the conditions related to construction activities within the most recent version of their individual NPDES (NCS000250) stormwater permit.



# Water Quality Certification No. 3893

## 5. Construction Moratoriums and Coordination

If activities must occur during periods of high biological activity (i.e. sea turtle nesting, fish spawning, or bird nesting), then biological monitoring may be required at the request of other state or federal agencies and coordinated with these activities.

All moratoriums on construction activities established by the NC Wildlife Resources Commission (WRC), US Fish and Wildlife Service (USFWS), NC Division of Marine Fisheries (DMF), or National Marine Fisheries Service (NMFS) to lessen impacts on trout, anadromous fish, larval/post-larval fishes and crustaceans, or other aquatic species of concern shall be implemented. Exceptions to this condition require written approval by the resource agency responsible for the given moratorium.

Work within the twenty-five (25) designated trout counties or identified state or federal endangered or threatened species habitat shall be coordinated with the appropriate WRC, USFWS, NMFS, and/or DMF personnel.

## 6. Work in the Dry

All work in or adjacent to stream waters shall be conducted so that the flowing stream does not come in contact with the disturbed area. Approved best management practices from the most current version of the NC Sediment and Erosion Control Manual, or the NC DOT Construction and Maintenance Activities Manual, such as sandbags, rock berms, cofferdams, and other diversion structures shall be used to minimize excavation in flowing water. Exceptions to this condition require application submittal to and written approval by the Division.

## 7. Riparian Area Protection (Buffer) Rules

Activities located in the protected riparian areas (whether jurisdictional wetlands or not), within the Neuse, Tar-Pamlico, or Catawba River Basins or in the Randleman, Jordan, or Goose Creek Watersheds (or any other basin or watershed with buffer rules) shall be limited to "uses" identified within and constructed in accordance with 15A NCAC 02B .0233, .0259, .0243, .0250, .0267 and .0605, and shall be located, designed, constructed, and maintained to have minimal disturbance to protect water quality to the maximum extent practicable through the use of best management practices. All buffer rule requirements, including diffuse flow requirements, must be met.

8. If concrete is used during the construction, then all necessary measures shall be taken to prevent direct contact between uncured or curing concrete and waters of the state. Water that inadvertently contacts uncured concrete shall not be discharged to waters of the state due to the potential for elevated pH and possible aquatic life/ fish kills.

9. Bridge deck drains shall not discharge directly into the stream. Stormwater shall be directed across the bridge and pre-treated through site-appropriate means (grassed swales, pre-formed scour holes, vegetated buffers, etc.) before entering the stream. Please refer to the most current version of *Stormwater Best Management Practices*. Exceptions to this condition require written approval by the Division.

## 10. Placement of culverts and other structures in Waters and Wetlands

Culverts required for this project shall be designed and installed in such a manner that the original stream profiles are not altered and allow for aquatic life movement during low flows. Existing stream dimensions (including the cross section dimensions, pattern, and longitudinal profile) must be maintained above and below locations of each culvert.



# Water Quality Certification No. 3893

Placement of culverts and other structures in waters and streams must be below the elevation of the streambed by one foot for all culverts with a diameter greater than 48 inches, and 20 percent of the culvert diameter for culverts having a diameter less than or equal to 48 inches, to allow low flow passage of water and aquatic life.

When topographic constraints indicate culvert slopes of greater than 5%, culvert burial is not required, provided that all alternative options for flattening the slope have been investigated and aquatic life movement/ connectivity has been provided when possible (rock ladders, crossvanes, etc). Notification to the Division including supporting documentation to include a location map of the culvert, culvert profile drawings, and slope calculations shall be provided to the Division 60 days prior to the installation of the culvert.

When bedrock is present in culvert locations, culvert burial is not required provided that there is sufficient documentation of the presence of bedrock. Notification to the Division including supporting documentation such as, but not limited to, a location map of the culvert, geotechnical reports, photographs, etc shall be provided to the Division a minimum of 60 days prior to the installation of the culvert. If bedrock is discovered during construction, then the Division shall be notified by phone or email within 24 hours of discovery.

If other site-specific topographic constraints preclude the ability to bury the culverts as described above and/or it can be demonstrated that burying the culvert would result in destabilization of the channel, then exceptions to this condition require application submittal to, and written approval by, the Division of Water Quality, regardless of the total impacts to streams or wetlands from the project.

Installation of culverts in wetlands must ensure continuity of water movement and be designed to adequately accommodate high water or flood conditions. Additionally, when roadways, causeways, or other fill projects are constructed across FEMA-designated floodways or wetlands, openings such as culverts or bridges must be provided to maintain the natural hydrology of the system as well as prevent constriction of the floodway that may result in destabilization of streams or wetlands.

The establishment of native, woody vegetation and other soft stream bank stabilization techniques must be used where practicable instead of riprap or other bank hardening methods.

## 11. Compensatory Mitigation

In accordance with 15A NCAC 02H .0506 (h), compensatory mitigation may be required for losses of equal to or greater than 150 linear feet of streams (intermittent and perennial) and/or equal to or greater than one (1) acre of wetlands. For linear public transportation projects, impacts equal to or exceeding 150 linear feet per stream shall require mitigation.

Buffer mitigation may be required for any project with Buffer Rules in effect at the time of application for activities classified as "Allowable with Mitigation" or "Prohibited" within the Table of Uses.

A determination of buffer, wetland, and stream mitigation requirements shall be made for any General Water Quality Certification for this Nationwide and/or Regional General Permit. Design and monitoring protocols shall follow the US Army Corps of Engineers Wilmington District *Stream Mitigation Guidelines* (April 2003) or its subsequent updates. Compensatory mitigation plans shall be submitted to the Division for written approval as required in those protocols. The mitigation plan must be implemented and/or constructed before any impacts occur on site. Alternatively, the Division will accept payment into an in-lieu fee program or a mitigation bank. In these cases, proof of payment shall be provided to the Division before any impacts occur on site.



## Water Quality Certification No. 3893

12. Relocated stream designs should include the same dimensions, patterns, and profiles as the existing channel (or a stable reference reach if the existing channel is unstable), to the maximum extent practical. The new channel should be constructed in the dry and water shall not be turned into the new channel until the banks are stabilized. Vegetation used for bank stabilization shall be limited to native woody species, and should include establishment of a 30-foot wide wooded and an adjacent 20-foot wide vegetated buffer on both sides of the relocated channel to the maximum extent practical. A transitional phase incorporating appropriate erosion control matting materials and seedling establishment is allowable, however matting that incorporates plastic mesh and/or plastic twine shall not be used in wetlands, riparian buffers or floodplains as recommended by the North Carolina Sediment and Erosion Control Manual. Rip-rap, A-Jacks, concrete, gabions or other hard structures may be allowed if it is necessary to maintain the physical integrity of the stream; however, the applicant must provide written justification and any calculations used to determine the extent of rip-rap coverage. Please note that if the stream relocation is conducted as a stream restoration as defined in the US Army Corps of Engineers Wilmington District, April 2003 *Stream Mitigation Guidelines* (or its subsequent updates), the restored length may be used as compensatory mitigation for the impacts resulting from the relocation.
13. All temporary fill and culverts shall be removed and the impacted area returned to natural conditions within 60 days of the determination that the temporary impact is no longer necessary. The impacted areas shall be restored to original grade, including each stream's original cross sectional dimensions, plan form pattern, and longitudinal bed and bed profile, and the various sites shall be stabilized with natural woody vegetation (except for the approved maintenance areas) and restored to prevent erosion.
14. Pipes shall be installed under the road or causeway in all streams to carry at least the 25-year storm event as outlined in the most recent edition of the *North Carolina Sediment and Erosion Control Planning and Design Manual* or the *North Carolina Surface Mining Manual* so as not to restrict stream flow during use of this General Certification.
15. If an environmental document is required under the National or State Environmental Policy Act (NEPA or SEPA), then this General Certification is not valid until a Finding of No Significant Impact (FONSI) or Record of Decision (ROD) is issued by the State Clearinghouse.
16. In the twenty (20) coastal counties, the appropriate DWQ Regional Office must be contacted to determine if Coastal Stormwater Regulations will be required.
17. This General Certification does not relieve the applicant of the responsibility to obtain all other required Federal, State, or Local approvals.
18. The applicant/permittee and their authorized agents shall conduct all activities in a manner consistent with State water quality standards (including any requirements resulting from compliance with §303(d) of the Clean Water Act), and any other appropriate requirements of State and Federal Law. If the Division determines that such standards or laws are not being met, including failure to sustain a designated or achieved use, or that State or Federal law is being violated, or that further conditions are necessary to assure compliance, then the Division may reevaluate and modify this General Water Quality Certification.
19. When written authorization is required for use of this certification, upon completion of all permitted impacts included within the approval and any subsequent modifications, the applicant shall be required to return the certificate of completion attached to the approval. One copy of the certificate shall be sent to the DWQ Central Office in Raleigh at 1650 Mail Service Center, Raleigh, NC, 27699-1650.

## Water Quality Certification No. 3893

20. Additional site-specific conditions, including monitoring and/or modeling requirements, may be added to the written approval letter for projects proposed under this Water Quality Certification in order to ensure compliance with all applicable water quality and effluent standards.
21. This certification grants permission to the director, an authorized representative of the Director, or DENR staff, upon the presentation of proper credentials, to enter the property during normal business hours.

This General Certification shall expire on the same day as the expiration date of the corresponding Nationwide and/or Regional General Permit. The conditions in effect on the date of issuance of Certification for a specific project shall remain in effect for the life of the project, regardless of the expiration date of this Certification.

Non-compliance with or violation of the conditions herein set forth by a specific project may result in revocation of this General Certification for the project and may also result in criminal and/or civil penalties.

The Director of the North Carolina Division of Water Quality may require submission of a formal application for Individual Certification for any project in this category of activity if it is determined that the project is likely to have a significant adverse effect upon water quality, including state or federally listed endangered or threatened aquatic species, or degrade the waters so that existing uses of the wetland or downstream waters are precluded.

Public hearings may be held for specific applications or group of applications prior to a Certification decision if deemed in the public's best interest by the Director of the North Carolina Division of Water Quality.

Effective date: March 19, 2012

DIVISION OF WATER QUALITY

By



Charles Wakild, P.E.

Director

*History Note: Water Quality Certification (WQC) Number 3893 issued March 19, 2012 replaces WQC Number 3688 issued November 1, 2007; WQC Number 3634 issued March 19, 2007; WQC Number 3366 issued March 18, 2002; WQC Number 3114 issued February 11, 1997; and WQC Number 2727 issued May 1, 1992. This General Certification is rescinded when the Corps of Engineers reauthorizes any of the corresponding Nationwide and/or Regional General Permits or when deemed appropriate by the Director of the Division of Water Quality.*



## Water Quality Certification No. 3885

**GENERAL CERTIFICATION FOR STREAM RESTORATION, ENHANCEMENT AND STABILIZATION PROJECTS AND WETLAND AND RIPARIAN RESTORATION AND CREATION ACTIVITIES INCLUDING THOSE ELIGIBLE FOR U.S. ARMY CORPS OF ENGINEERS NATIONWIDE PERMIT NUMBERS 13 (BANK STABILIZATION) AND 27 (WETLAND AND RIPARIAN RESTORATION AND CREATION), AND REGIONAL PERMIT 197800080 (BULKHEADS AND RIPRAP) AND RIPARIAN AREA PROTECTION RULES (BUFFER RULES)**

Water Quality Certification Number 3885 is issued in conformity with the requirements of Section 401, Public Laws 92-500 and 95-217 of the United States and subject to the North Carolina Division of Water Quality Regulations in 15A NCAC 02H .0500 and 15A NCAC 02B .0200 for the discharge of fill material to waters as described in 33 CFR 330 Appendix A (B) (13 and 27) and Regional Permit 197800080 and for the Riparian Area Protection Rules (Buffer Rules) in 15A NCAC 02B .0200.

**The State of North Carolina certifies that the specified category of activity will not violate applicable portions of Sections 301, 302, 303, 306 and 307 of the Public Laws 92-500 and 95-217 if conducted in accordance with the conditions hereinafter set forth.**

**Activities meeting any one (1) of the following thresholds or circumstances require *written approval* for a 401 Water Quality Certification from the Division of Water Quality (the "Division"):**

- a) All proposed fill or modification of wetlands and/or waters, including streams and streambanks, regardless of the purpose of the restoration, enhancement, stabilization, or creation activity, except for single and independent projects involving in-stream structures for the sole purpose of streambank stabilization, which are designed based on current natural channel techniques, and do not exceed a total of three structures within 100 feet or less of streambank; or
- b) Any stream relocation; or
- c) Bank Stabilization projects qualifying for Nationwide Permit 13 for erosion protection which utilize non-natural armoring such as riprap, gabion baskets, deflection walls etc of greater than 150 feet in streambank length; or
- d) Bank Stabilization projects qualifying for Nationwide Permit 13 for erosion protection which utilize natural streambank sloping, vegetation, and other natural channel protection techniques of greater than 500 feet of streambank length; or
- e) Any impact associated with a Notice of Violation or an enforcement action for violation(s) of DWQ Wetland Rules (15A NCAC 02H .0500), Isolated Wetland Rules (15A NCAC 02H .1300), DWQ Surface Water or Wetland Standards, or Riparian Buffer Rules (15A NCAC 02B .0200); or
- f) Any impacts to streams and/or buffers in the Neuse, Tar-Pamlico, or Catawba River Basins or in the Randleman, Jordan or Goose Creek Watersheds (or any other basin or watershed with Riparian Area Protection Rules [Buffer Rules] in effect at the time of application) *unless* the activities are listed as "EXEMPT" from these rules or a Buffer Authorization Certificate is issued through N.C. Division of Coastal Management (DCM) delegation for "ALLOWABLE" activities.

In accordance with North Carolina General Statute 143-215.3D(e), written approval for a 401 Water Quality General Certification must include the appropriate fee. If a project also requires a CAMA Permit, then one payment to both agencies shall be submitted and will be the higher of the two fees.

## Water Quality Certification No. 3885

**Activities included in this General Certification that do not meet one of the thresholds listed above do not require written approval from the Division as long as they comply with the Conditions of Certification listed below. If any of these Conditions cannot be met, then written approval from the Division is required.**

Conditions of Certification:

1. Activities shall meet the definitions, design, and monitoring protocols specified within the US Army Corps of Engineers Wilmington District *Regulatory Guidance Letter* (RGL02-02) and the *Stream Mitigation Guidelines* (April 2003) or any subsequent updates to these documents.
2. No Impacts Beyond those Authorized in the Written Approval or Beyond the Threshold of Use of this Certification

No waste, spoil, solids, or fill of any kind shall occur in wetlands, waters, or riparian areas beyond the footprint of the impacts depicted in the Pre-Construction Notification, as authorized in the written approval from the Division or beyond the thresholds established for use of this Certification without written authorization, including incidental impacts. All construction activities, including the design, installation, operation, and maintenance of sediment and erosion control Best Management Practices shall be performed so that no violations of state water quality standards, statutes, or rules occur. Approved plans and specifications for this project are incorporated by reference and are enforceable parts of this permit.

3. Standard Erosion and Sediment Control Practices

Erosion and sediment control practices must be in full compliance with all specifications governing the proper design, installation and operation and maintenance of such Best Management Practices and if applicable, comply with the specific conditions and requirements of the NPDES Construction Stormwater Permit issued to the site:

- a. Design, installation, operation, and maintenance of the sediment and erosion control measures must be such that they equal or exceed the requirements specified in the most recent version of the *North Carolina Sediment and Erosion Control Manual*. The devices shall be maintained on all construction sites, borrow sites, and waste pile (spoil) projects, including contractor-owned or leased borrow pits associated with the project.
- b. For borrow pit sites, the erosion and sediment control measures must be designed, installed, operated, and maintained in accordance with the most recent version of the *North Carolina Surface Mining Manual*.
- c. Reclamation measures and implementation must comply with the reclamation in accordance with the requirements of the Sedimentation Pollution Control Act and the Mining Act of 1971.
- d. Sufficient materials required for stabilization and/or repair of erosion control measures and stormwater routing and treatment shall be on site at all times.
- e. If the project occurs in waters or watersheds classified as Primary Nursery Areas (PNAs), SA, WS-I, WS-II, High Quality (HQW), or Outstanding Resource (ORW) waters, then the sedimentation and erosion control designs must comply with the requirements set forth in 15A NCAC 04B .0124, *Design Standards in Sensitive Watersheds*.



## Water Quality Certification No. 3885

### 4. No Sediment and Erosion Control Measures in Wetlands or Waters

Sediment and erosion control measures shall not be placed in wetlands or waters. Exceptions to this condition require application submittal to and written approval by the Division. If placement of sediment and erosion control devices in wetlands and waters is unavoidable, then design and placement of temporary erosion control measures shall not be conducted in a manner that may result in dis-equilibrium of wetlands, stream beds, or banks, adjacent to or upstream and downstream of the above structures. All sediment and erosion control devices shall be removed and the natural grade restored within two (2) months of the date that the Division of Land Resources (DLR) or locally delegated program has released the specific area within the project.

### 5. Construction Stormwater Permit NCG010000

An NPDES Construction Stormwater Permit is required for construction projects that disturb one (1) or more acres of land. This Permit allows stormwater to be discharged during land disturbing construction activities as stipulated in the conditions of the permit. If your project is covered by this permit, full compliance with permit conditions including the erosion & sedimentation control plan, inspections and maintenance, self-monitoring, record keeping and reporting requirements is required. A copy of the general permit (NCG010000), inspection log sheets, and other information may be found at <http://portal.ncdenr.org/web/wq/ws/su/npdessw#tab-w>.

The North Carolina Department of Transportation (NCDOT) shall be required to be in full compliance with the conditions related to construction activities within the most recent version of their individual NPDES (NCS000250) stormwater permit.

### 6. Construction Moratoriums and Coordination

If activities must occur during periods of high biological activity (i.e. sea turtle nesting, fish spawning, or bird nesting), then biological monitoring may be required at the request of other state or federal agencies and coordinated with these activities.

All moratoriums on construction activities established by the NC Wildlife Resources Commission (WRC), US Fish and Wildlife Service (USFWS), NC Division of Marine Fisheries (DMF), or National Marine Fisheries Service (NMFS) to lessen impacts on trout, anadromous fish, larval/post-larval fishes and crustaceans, or other aquatic species of concern shall be implemented. Exceptions to this condition require written approval by the resource agency responsible for the given moratorium.

Work within the twenty-five (25) designated trout counties or identified state or federal endangered or threatened species habitat shall be coordinated with the appropriate WRC, USFWS, NMFS, and/or DMF personnel.

### 7. Work in the Dry

All work in or adjacent to stream waters shall be conducted so that the flowing stream does not come in contact with the disturbed area. Approved best management practices from the most current version of the NC Sediment and Erosion Control Manual, or the NC DOT Construction and Maintenance Activities Manual, such as sandbags, rock berms, cofferdams, and other diversion structures shall be used to minimize excavation in flowing water. Exceptions to this condition require application submittal to and written approval by the Division.

## Water Quality Certification No. 3885

### 8. Riparian Area Protection (Buffer) Rules

Activities located in the protected riparian areas (whether jurisdictional wetlands or not), within the Neuse, Tar-Pamlico, or Catawba River Basins or in the Randleman, Jordan, or Goose Creek Watersheds (or any other basin or watershed with buffer rules) shall be limited to "uses" identified within and constructed in accordance with 15A NCAC 02B .0233, .0259, .0243, .0250, .0267 and .0605, and shall be located, designed, constructed, and maintained to have minimal disturbance to protect water quality to the maximum extent practicable through the use of best management practices. All buffer rule requirements, including diffuse flow requirements, must be met.

9. If concrete is used during the construction, then all necessary measures shall be taken to prevent direct contact between uncured or curing concrete and waters of the state. Water that inadvertently contacts uncured concrete shall not be discharged to waters of the state due to the potential for elevated pH and possible aquatic life/ fish kills.
10. All temporary fill and culverts shall be removed and the impacted area returned to natural conditions within 60 days of the determination that the temporary impact is no longer necessary. The impacted areas shall be restored to original grade, including each stream's original cross sectional dimensions, plan form pattern, and longitudinal bed and bed profile, and the various sites shall be stabilized with natural woody vegetation (except for the approved maintenance areas) and restored to prevent erosion.
11. All temporary pipes/ culverts/ riprap pads etc, shall be installed in all streams as outlined in the most recent edition of the *North Carolina Sediment and Erosion Control Planning and Design Manual* or the *North Carolina Surface Mining Manual* so as not to restrict stream flow or cause dis-equilibrium during use of this General Certification.
12. Any riprap required for proper culvert placement, stream stabilization, or restoration of temporarily disturbed areas shall be restricted to the area directly impacted by the approved construction activity. All rip-rap shall be buried and/or "keyed in" such that the original stream elevation and streambank contours are restored and maintained. Placement of rip-rap or other approved materials shall not result in de-stabilization of the stream bed or banks upstream or downstream of the area.
13. Any rip-rap used for stream stabilization shall be of a size and density so as not to be able to be carried off by wave, current action, or stream flows and consist of clean rock or masonry material free of debris or toxic pollutants. Rip-rap shall not be installed in the streambed except in specific areas required for velocity control and to ensure structural integrity of bank stabilization measures.
14. A one-time application of fertilizer to re-establish vegetation is allowed in disturbed areas including riparian buffers, but is restricted to no closer than 10 feet from top of bank of streams. Any fertilizer application must comply with all other Federal, State and Local regulations.
15. Applications for riprap groins proposed in accordance with 15A NCAC 07H .1401 (NC Division of Coastal Management General Permit for construction of Wooden and Riprap Groins in Estuarine and Public Trust Waters) must meet all the specific conditions for design and construction specified in 15A NCAC 07H .1405.



## Water Quality Certification No. 3885

### 16. Compensatory Mitigation

In accordance with 15A NCAC 02H .0506 (h), compensatory mitigation may be required for losses of equal to or greater than 150 linear feet of streams (intermittent and perennial) and/or equal to or greater than one (1) acre of wetlands. For linear public transportation projects, impacts equal to or exceeding 150 linear feet per stream shall require mitigation.

Buffer mitigation may be required for any project with Buffer Rules in effect at the time of application for activities classified as "Allowable with Mitigation" or "Prohibited" within the Table of Uses.

A determination of buffer, wetland, and stream mitigation requirements shall be made for any General Water Quality Certification for this Nationwide and/or Regional General Permit. Design and monitoring protocols shall follow the US Army Corps of Engineers Wilmington District *Stream Mitigation Guidelines* (April 2003) or its subsequent updates. Compensatory mitigation plans shall be submitted to the Division for written approval as required in those protocols. The mitigation plan must be implemented and/or constructed before any impacts occur on site. Alternatively, the Division will accept payment into an in-lieu fee program or a mitigation bank. In these cases, proof of payment shall be provided to the Division before any impacts occur on site.

17. If an environmental document is required under the National or State Environmental Policy Act (NEPA or SEPA), then this General Certification is not valid until a Finding of No Significant Impact (FONSI) or Record of Decision (ROD) is issued by the State Clearinghouse.
18. In the twenty (20) coastal counties, the appropriate DWQ Regional Office must be contacted to determine if Coastal Stormwater Regulations will be required.
19. This General Certification does not relieve the applicant of the responsibility to obtain all other required Federal, State, or Local approvals.
20. The applicant/permittee and their authorized agents shall conduct all activities in a manner consistent with State water quality standards (including any requirements resulting from compliance with §303(d) of the Clean Water Act), and any other appropriate requirements of State and Federal Law. If the Division determines that such standards or laws are not being met, including failure to sustain a designated or achieved use, or that State or Federal law is being violated, or that further conditions are necessary to assure compliance, then the Division may reevaluate and modify this General Water Quality Certification.
21. When written authorization is required for use of this certification, upon completion of all permitted impacts included within the approval and any subsequent modifications, the applicant shall be required to return the certificate of completion attached to the approval. One copy of the certificate shall be sent to the DWQ Central Office in Raleigh at 1650 Mail Service Center, Raleigh, NC, 27699-1650.
22. Additional site-specific conditions, including monitoring and/or modeling requirements, may be added to the written approval letter for projects proposed under this Water Quality Certification in order to ensure compliance with all applicable water quality and effluent standards.
23. This certification grants permission to the director, an authorized representative of the Director, or DENR staff, upon the presentation of proper credentials, to enter the property during normal business hours.

## Water Quality Certification No. 3885

This General Certification shall expire on the same day as the expiration date of the corresponding Nationwide and/or Regional General Permit. The conditions in effect on the date of issuance of Certification for a specific project shall remain in effect for the life of the project, regardless of the expiration date of this Certification.

Non-compliance with or violation of the conditions herein set forth by a specific project may result in revocation of this General Certification for the project and may also result in criminal and/or civil penalties.

The Director of the North Carolina Division of Water Quality may require submission of a formal application for Individual Certification for any project in this category of activity if it is determined that the project is likely to have a significant adverse effect upon water quality, including state or federally listed endangered or threatened aquatic species, or degrade the waters so that existing uses of the wetland or downstream waters are precluded.

Public hearings may be held for specific applications or group of applications prior to a Certification decision if deemed in the public's best interest by the Director of the North Carolina Division of Water Quality.

Effective date: March 19, 2012

DIVISION OF WATER QUALITY

By

A handwritten signature in blue ink that reads "Matt Mauter for".

Charles Wakild, P.E.

Director

*History Note: Water Quality Certification (WQC) Number 3885 issued March 19, 2012 replaces WQC Number 3689 issued November 1, 2007; WQC Number 3626 issued March, 2007; WQC Number 3495 issued December 31, 2004; and WQC Number 3399 issued March 2003. This General Certification is rescinded when the Corps of Engineers reauthorizes any of the corresponding Nationwide and/or Regional General Permits and/or when deemed appropriate by the Director of the Division of Water Quality.*



TIP PROJECT: B-5101

CONTRACT: C203299

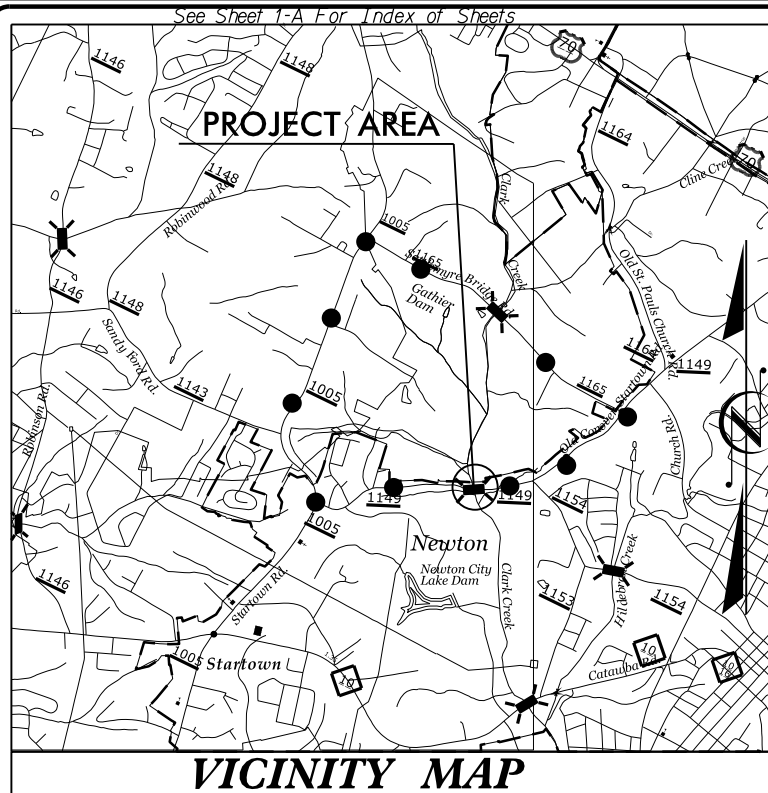

**VICINITY MAP**  
**DETOUR**

STATE OF NORTH CAROLINA  
DIVISION OF HIGHWAYS

**CATAWBA COUNTY**

**LOCATION: BRIDGE NO. 83 ON SR 1149  
OVER CLARK CREEK**

**TYPE OF WORK: GRADING, PAVING, DRAINAGE,  
AND STRUCTURE**

**SURFACE WATER IMPACTS PERMIT**

STATE	STATE PROJECT REFERENCE NO.	SHEET NO.	TOTAL SHEETS
N.C.	B-5101	1	
STATE PROJ. NO.	F.A. PROJ. NO.	DESCRIPTION	
42223.1.1	BRZ-1149(5)	PE	
42223.2.1	BRZ-1149(5)	RW, UTL.	
42223.3.1	BRZ-1149(5)	CONST.	

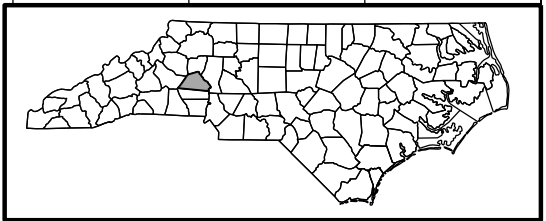

Permit Sheet 1 of 7

NAD 83/NSRS 2007

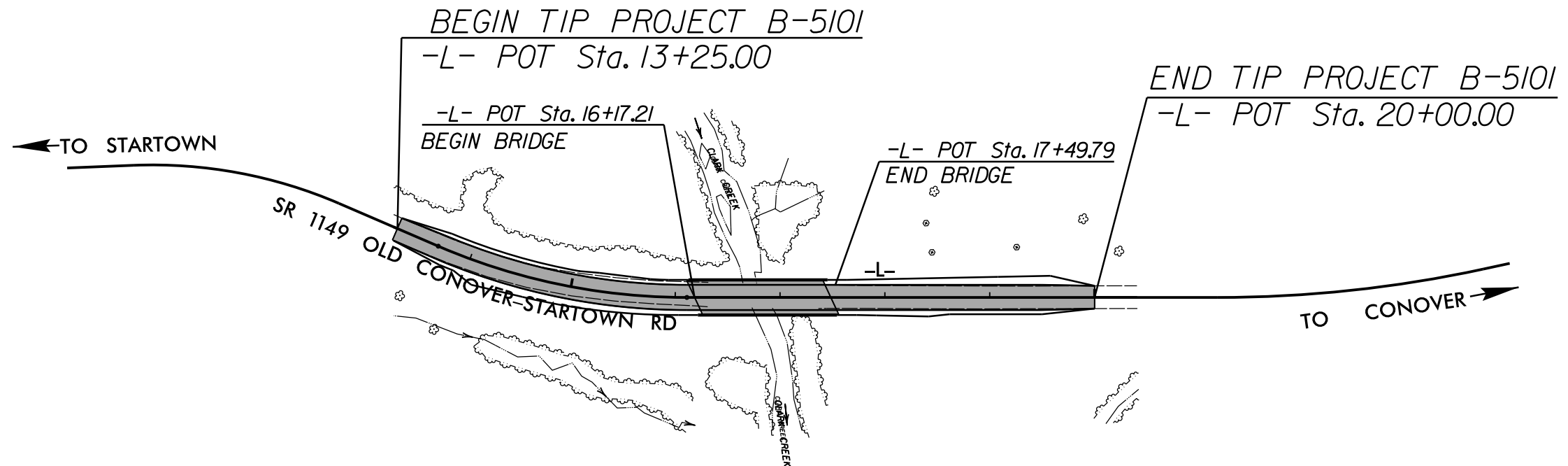

THIS PROJECT IS WITHIN THE MUNICIPAL BOUNDARIES OF NEWTON.  
CLEARING ON THIS PROJECT SHALL BE PERFORMED  
BY THE LIMITS ESTABLISHED BY METHOD III.

**PRELIMINARY PLANS**  
DO NOT USE FOR CONSTRUCTION

**GRAPHIC SCALES**

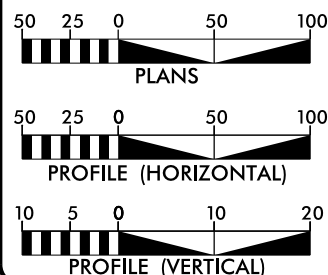

**DESIGN DATA**

ADT 2012 = 6390  
ADT 2035 = 9400  
DHV = 11%  
D = 65%  
T = 4% \*  
V = 50 MPH  
Func Class:  
URBAN MINOR ARTERIAL  
SUBREGIONAL TIER  
\* TTST 1% DUAL 3%

**PROJECT LENGTH**

Length Roadway TIP Project B-5101 = 0.103 mi  
Length Structure TIP Project B-5101 = 0.025 mi  
Total Length TIP Project B-5101 = 0.128 mi

Prepared in the Office of:  
**DIVISION OF HIGHWAYS**

1000 Birch Ridge Dr., Raleigh NC, 27610

2012 STANDARD SPECIFICATIONS

RIGHT OF WAY DATE:  
JULY 20, 2012

LETTING DATE:  
OCTOBER 15, 2013

JASON MOORE, P.E.  
PROJECT ENGINEER

JEANIE TYSON  
PROJECT DESIGN ENGINEER

**HYDRAULICS ENGINEER**

SIGNATURE: \_\_\_\_\_ P.E.  
**ROADWAY DESIGN  
ENGINEER**

SIGNATURE: \_\_\_\_\_ P.E.  
STATE HIGHWAY DESIGN ENGINEER

**DIVISION OF HIGHWAYS  
STATE OF NORTH CAROLINA**

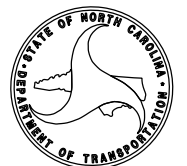

STATE HIGHWAY DESIGN ENGINEER

\$\$\$\$ SYSTEM TIME \$\$\$  
\$\$\$ DONOR \$\$\$  
\$\$\$ USERNAME \$\$\$

# SURFACE WATER IMPACTS PERMIT

NAD 83/NSRS 2007

PROJECT REFERENCE NO. B-5101	SHEET NO. 4
RW SHEET NO.	
ROADWAY DESIGN ENGINEER	HYDRAULICS ENGINEER
<b>PRELIMINARY PLANS</b> DO NOT USE FOR CONSTRUCTION	

Permit Sheet  
2 of 7

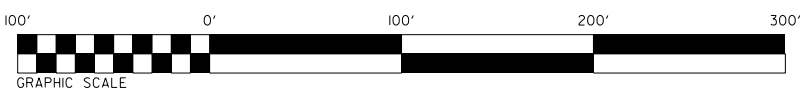
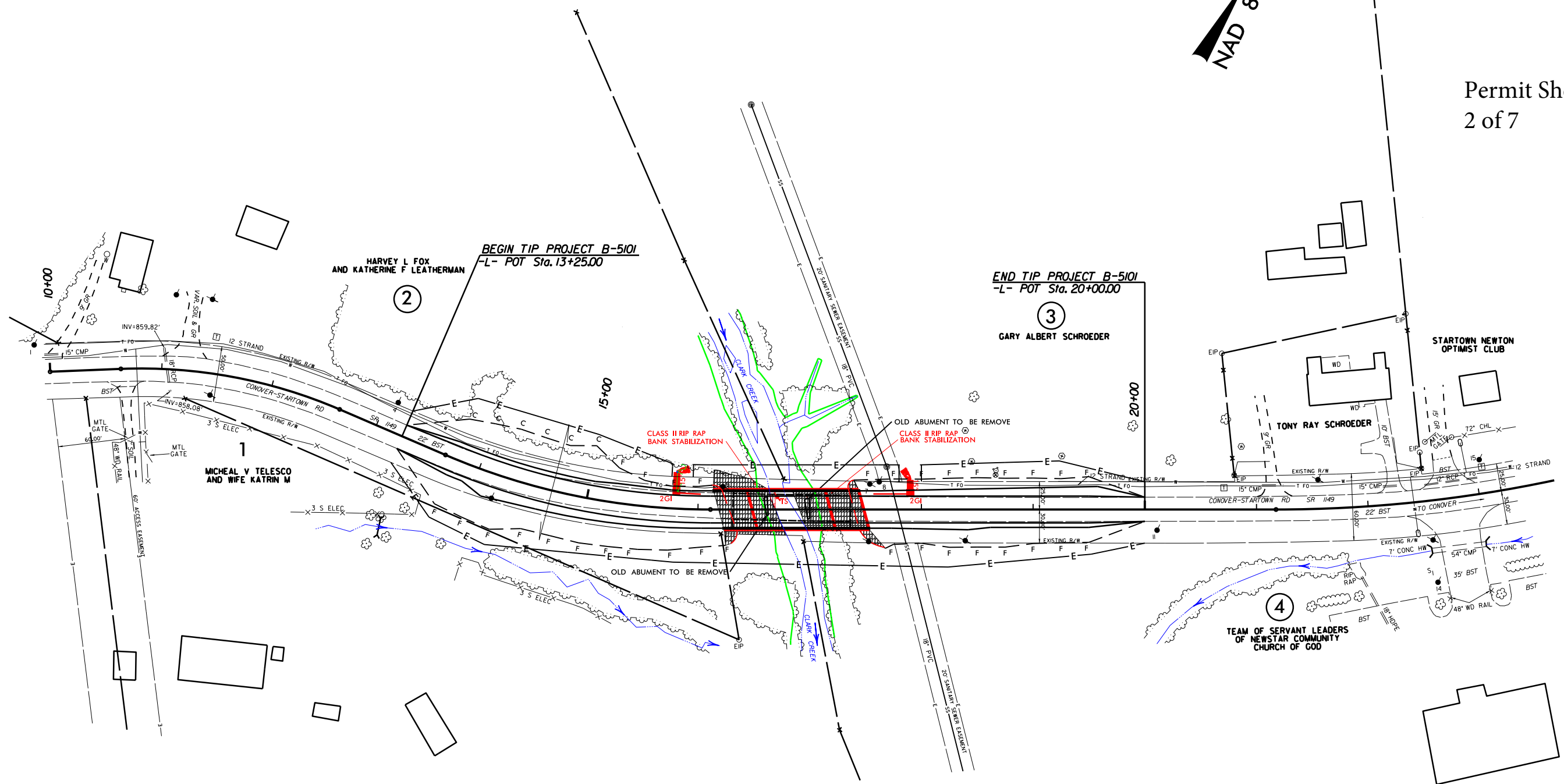

DENOTES TEMPORARY IMPACTS IN SURFACE WATER

66  
65  
64  
63  
62  
61  
60  
59  
58  
57  
56  
55  
54  
53  
52  
51  
50  
49  
48  
47  
46  
45  
44  
43  
42  
41  
40  
39  
38  
37  
36  
35  
34  
33  
32  
31  
30  
29  
28  
27  
26  
25  
24  
23  
22  
21  
20  
19  
18  
17  
16  
15  
14  
13  
12  
11  
10  
9  
8  
7  
6  
5  
4  
3  
2  
1

8/17/99

# SURFACE WATER IMPACTS PERMIT

NAD 83/NSRS 2007

PROJECT REFERENCE NO. B-5101	SHEET NO. 4				
RW SHEET NO. ROADWAY DESIGN ENGINEER	HYDRAULICS ENGINEER				
<table border="1" style="width: 100%; border-collapse: collapse;"> <tr> <td colspan="2" style="text-align: center;">PRELIMINARY PLANS</td> </tr> <tr> <td colspan="2" style="text-align: center;">DO NOT USE FOR CONSTRUCTION</td> </tr> </table>		PRELIMINARY PLANS		DO NOT USE FOR CONSTRUCTION	
PRELIMINARY PLANS					
DO NOT USE FOR CONSTRUCTION					

Permit Sheet  
3 of 7

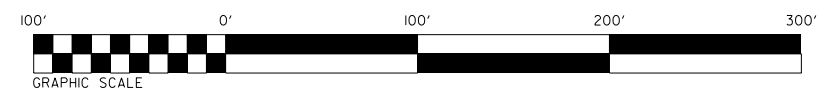
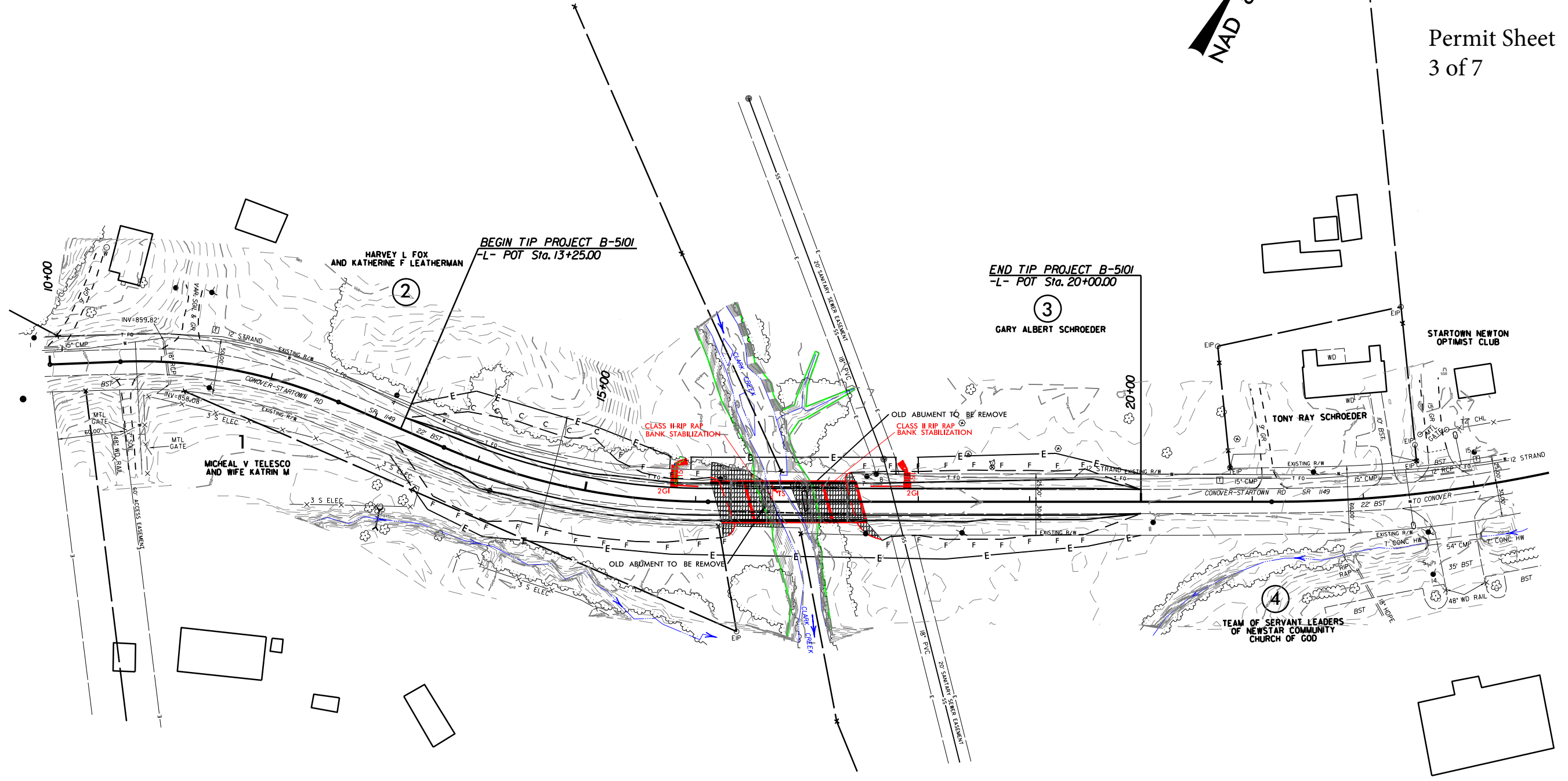

DENOTES TEMPORARY IMPACTS IN SURFACE WATER

1 2 3 4 5 6 7 8 9 10 11 12 13 14 15 16 17 18 19 20 21 22 23 24 25 26 27 28 29 30 31 32 33 34 35 36 37 38 39 40 41 42 43 44 45 46 47 48 49 50 51 52 53 54 55 56 57 58 59 60 61 62 63 64 65 66 67 68 69 70 71 72 73 74 75 76 77 78 79 80 81 82 83 84 85 86 87 88 89 90 91 92 93 94 95 96 97 98 99 100

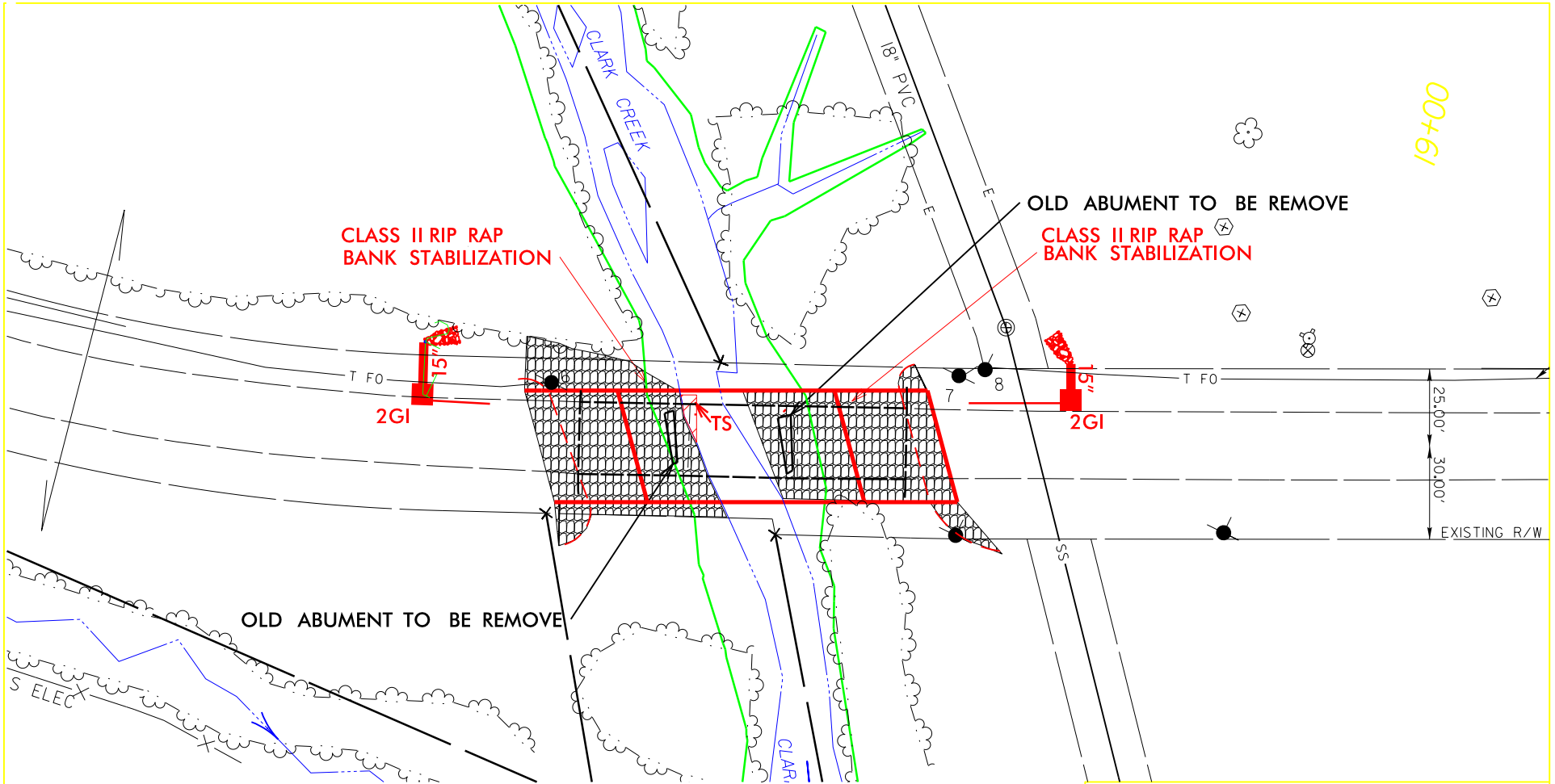

19+00

**SURFACE WATER IMPACTS PERMIT**



DENOTES TEMPORARY IMPACTS IN SURFACE WATER

50' 0' 50'



GRAPHIC SCALE

**NCDOT**  
 DIVISION OF HIGHWAYS  
 CATAWBA COUNTY  
 PROJECT: 42223.1.1 (B-5101)  
 BRIDGE NO. 83 OVER  
 CLARK CREEK ON  
 SR 1149 (CONOVER-STARTOWN RD)

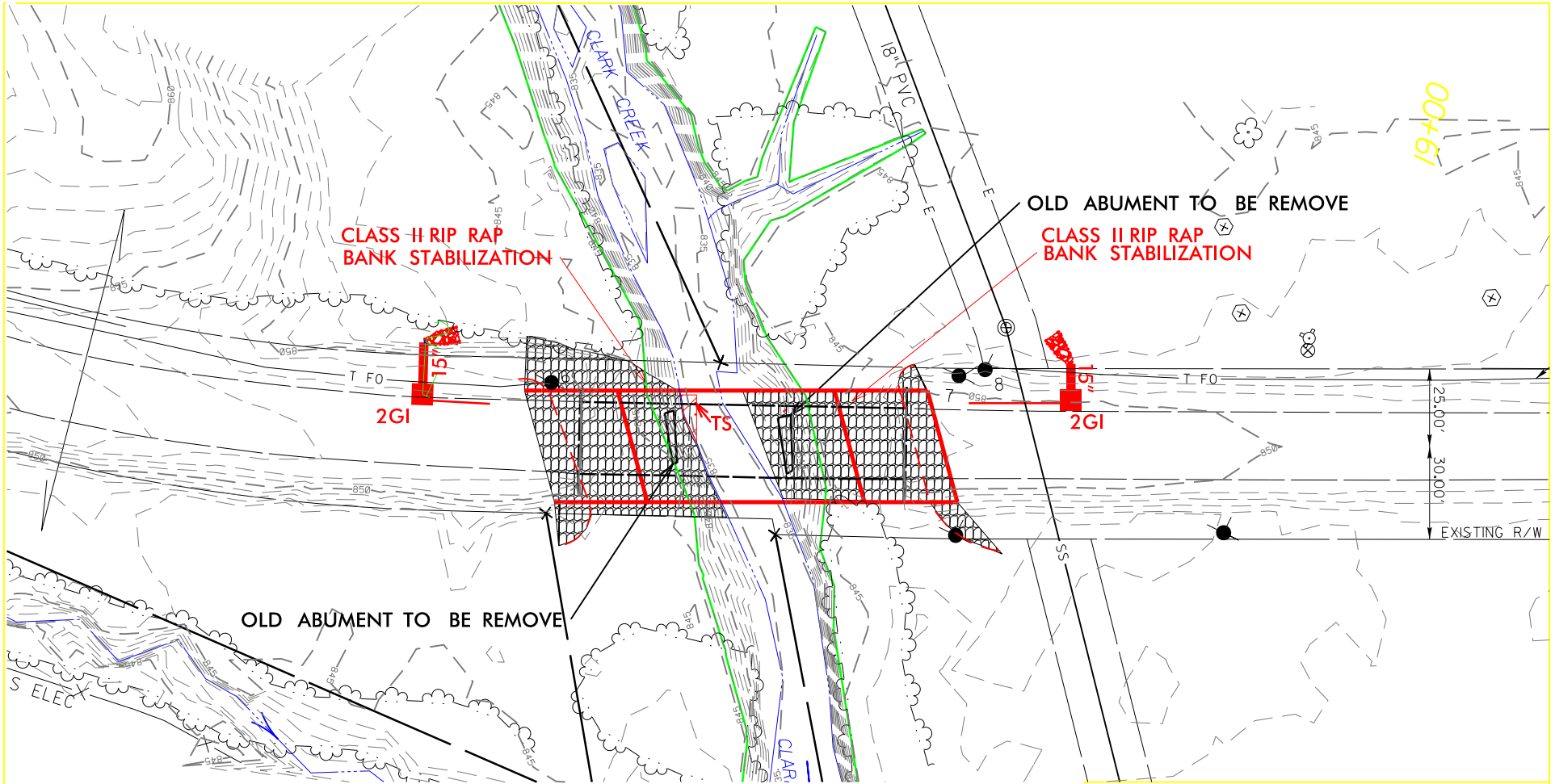

19+00

**SURFACE WATER IMPACTS PERMIT**



DENOTES TEMPORARY IMPACTS IN SURFACE WATER

50' 0' 50'



GRAPHIC SCALE

**NCDOT**

**DIVISION OF HIGHWAYS  
CATAWBA COUNTY**

**PROJECT: 42223.1.1 (B-5101)**

**BRIDGE NO. 83 OVER  
CLARK CREEK ON**

**SR 1149 (CONOVER-STARTOWN RD)**

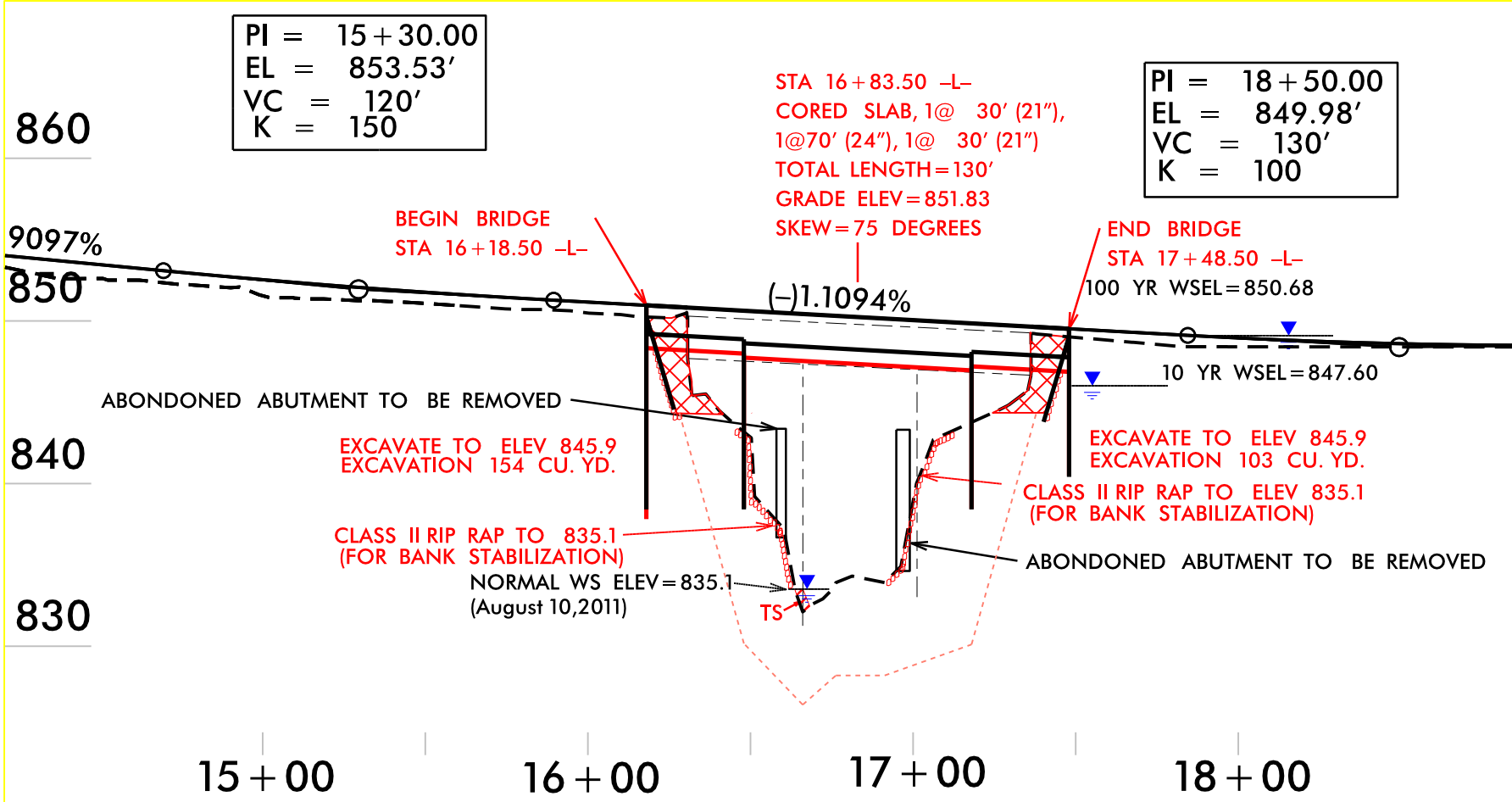

PI = 15+30.00  
 EL = 853.53'  
 VC = 120'  
 K = 150

PI = 18+50.00  
 EL = 849.98'  
 VC = 130'  
 K = 100

STA 16+83.50 -L-  
 CORED SLAB, 1@ 30' (21"),  
 1@70' (24"), 1@ 30' (21")  
 TOTAL LENGTH=130'  
 GRADE ELEV=851.83  
 SKEW=75 DEGREES

BEGIN BRIDGE  
 STA 16+18.50 -L-

END BRIDGE  
 STA 17+48.50 -L-  
 100 YR WSEL=850.68

(-)1.1094%

ABONDONED ABUTMENT TO BE REMOVED

EXCAVATE TO ELEV 845.9  
EXCAVATION 154 CU. YD.

EXCAVATE TO ELEV 845.9  
EXCAVATION 103 CU. YD.

CLASS II RIP RAP TO 835.1  
(FOR BANK STABILIZATION)

CLASS II RIP RAP TO ELEV 835.1  
(FOR BANK STABILIZATION)

NORMAL WS ELEV=835.1  
(August 10,2011)

ABONDONED ABUTMENT TO BE REMOVED

TS

15+00

16+00

17+00

18+00

PROFILE



DENOTES TEMPORARY IMPACTS IN SURFACE WATER

**NCDOT**  
 DIVISION OF HIGHWAYS  
 CATAWBA COUNTY  
 PROJECT: 42223.1.1 (B-5101)  
 BRIDGE NO. 83 OVER  
 CLARK CREEK ON  
 SR 1149 (CONOVER-STARTOWN RD)

**WETLAND PERMIT IMPACT SUMMARY**

Site No.	Station (From/To)	Structure Size / Type	WETLAND IMPACTS					SURFACE WATER IMPACTS				
			Permanent Fill In Wetlands (ac)	Temp. Fill In Wetlands (ac)	Excavation in Wetlands (ac)	Mechanized Clearing in Wetlands (ac)	Hand Clearing in Wetlands (ac)	Permanent SW impacts (ac)	Temp. SW impacts (ac)	Existing Channel Impacts Permanent (ft)	Existing Channel Impacts Temp. (ft)	Natural Stream Design (ft)
1	16+66	Pier Removal						<0.01			15	
<b>TOTALS:</b>								<0.01	0	15		

NC DEPARTMENT OF TRANSPORTATION  
 DIVISION OF HIGHWAYS  
  
 CATAWBA COUNTY  
 WBS - 42223.1.1 (B-5101)  
  
**7 of 7**  
 SHEET 5/21/2013