



STATE OF NORTH CAROLINA  
DEPARTMENT OF TRANSPORTATION

MICHAEL F. EASLEY  
GOVERNOR

LYNDO TIPPETT  
SECRETARY

July 16, 2008

MEMORANDUM TO: Mr. Richard E. Greene, Jr., PE  
Division Four Engineer

FROM: Philip S. Harris, III, P.E., Unit Head *E. L. Fuchs*  
Natural Environment Unit  
Project Development and Environmental Analysis Branch

SUBJECT: Wayne County, Replace Bridge No.35 on SR 1532 over  
Nahunta Swamp; T.I.P. Number B-4671; Federal Aid  
Project No. BRZ-1532(3); State Project No. 8.2331701

Attached are the U.S. Army Corps of Engineers Section 404 Nationwide Permit Numbers 23 and 33, the N.C. Division of Water Quality Section 401 General Water Quality Certification and the Riparian Buffer Authorization for the above referenced project. All environmental permits have been received for the construction of this project.

PSH/gyb

Attachment

Cc:

Mr. Majed Alghandour, P. E., Programming and TIP  
Mr. Jay Bennett, P.E., Roadway Design  
Dr. David Chang, P.E., Hydraulics  
Mr. Randy Garris, P.E. State Contract Officer  
Mr. Art McMillan, P.E., Highway Design  
Mr. Greg Perfetti, P.E., Structure Design  
Mr. Mark Staley, Roadside Environmental  
Mr. John F. Sullivan, FHWA  
Ms. Beth Harmon, EEP  
Mr. Rob Hanson, P.E., PDEA Eastern Region Unit Head  
Mr. Jamie Guerrero, Division Environmental Officer

## **PROJECT COMMITMENTS**

**Wayne County  
Bridge No. 35 on SR 1532  
Over Nahunta Swamp  
Federal Aid Project No. BRZ-1532(3)  
State Project No. 8.2331701  
W.B.S. No. 33826.1.1  
T.I.P. No. B-4671**

### **COMMITMENTS DEVELOPED THROUGH PROJECT DEVELOPMENT**

**Division 4 Construction Engineer, Structure Design Unit, Roadway Design Unit,  
Roadside Environmental-Anadromous fish moratorium**

Anadromous fish species are found in this portion of Nahunta Swamp. NCDOT will follow all stream crossing guidelines for anadromous fish passage, including an in-water work moratorium from February 15 to June 15.

#### **Bridge Demolition**

There is no anticipated temporary fill associated with the demolition of Bridge No. 35.

### **COMMITMENTS DEVELOPED THROUGH PERMITTING**

No special conditions were developed during the permitting process.



STATE OF NORTH CAROLINA  
DEPARTMENT OF TRANSPORTATION

MICHAEL F. EASLEY  
GOVERNOR

LYNDO TIPPETT  
SECRETARY

July 14, 2008

To: File

From: Amy James, Environmental Senior Specialist

Subject: B-4671 Section 404 Permit by Default

The Section 404 permit for this project has been issued by default, as the U.S. Army Corps of Engineers review time period has exceeded 45 days (per Nationwide Permit General Condition number 27). Therefore, NCDOT must comply with all conditions and descriptions in the attached permit application dated March 28, 2008, Pre-Construction Notification Form, Permit Drawings, and 404 General Conditions. A permit modification will be required if any of the above conditions and descriptions cannot be met.



STATE OF NORTH CAROLINA  
DEPARTMENT OF TRANSPORTATION

MICHAEL F. EASLEY  
GOVERNOR

LYNDO TIPPETT  
SECRETARY

March 28, 2008

U.S. Army Corps of Engineers  
Regulatory Field Office  
Post Office Box 1000  
Washington, NC 27889-1000

ATTENTION: Mr. William Wescott  
NCDOT Coordinator

Dear Sir,

Subject: **Application for Section 404 Nationwide Permits 23 and 33, Section 401 Water Quality Certification, and Neuse Riparian Buffer Authorization** for the replacement of Bridge No. 35 over Nahunta Swamp on SR 1532 (Lanetown Rd.); Wayne County; TIP Project B-4671; Federal Aid Project No. BRZ-1532(3); State Project No. 8.2331701; Debit \$240.00 from WBS 33826.1.1.

Please find enclosed a site map, permit drawings, and half size plan sheets for the above mentioned project. A Programmatic Categorical Exclusion (PCE) was completed for this project on May 19, 2006, and distributed shortly thereafter. Additional copies are available upon request. The North Carolina Department of Transportation (NCDOT) proposes to replace Bridge No. 35 over Nahunta Swamp on existing alignment, while using an off-site detour to maintain traffic during construction. Bridge No. 35 is currently 151-feet long. The proposed structure will be a 165-foot, 3-span 21 inch deep cored slab bridge with 29 feet 10 inches of clear deck width. The structure will provide two 11-foot travel lanes with 3.5-foot offsets. The roadway approaches will consist of two 11-foot travel lanes with 4-foot grassed shoulders (shoulders will be 7-feet where guardrail is included). Proposed permanent impacts include 0.03 acre to riverine wetlands.

### Impacts to Waters of the United States

General Description: This project is located in the Neuse River Basin (Hydrologic Cataloging Unit 03020203) on Nahunta Swamp [DWQ Index # 27-86-14], which is a Division of Water Quality Class "C Sw NSW" Water of the State. Two jurisdictional wetlands adjacent to Nahunta Swam will be impacted in the project area.

MAILING ADDRESS:  
NC DEPARTMENT OF TRANSPORTATION  
PROJECT DEVELOPMENT AND ENVIRONMENTAL ANALYSIS  
1598 MAIL SERVICE CENTER  
RALEIGH NC 27699-1598

TELEPHONE: 919-715-1334  
FAX: 919-715-5501

WEBSITE: [WWW.NCDOT.ORG](http://WWW.NCDOT.ORG)

LOCATION:  
2728 CAPITAL BLVD  
SUITE 240  
RALEIGH NC 27604

Nahunta Swamp is not designated as a North Carolina Natural or Scenic River, or as a national Wild and Scenic River. No designated Outstanding Resource Waters (ORW), High Quality Waters (HQW), Water Supply I (WS-I), or Water Supply II (WS-II) waters occur within 1.0 mile of the project study area. Additionally, Nahunta Swamp is not listed on the Final 2006 303(d) list of impaired waters due to sedimentation for the Neuse River Basin, nor does it drain into any Section 303(d) waters within 1.0 mile of the project study area.

Permanent Impacts: There is 0.03 acre of proposed impacts to riverine wetlands due to roadway fill on this project.

Temporary Impacts: NCDOT anticipates 0.03 acre of temporary impacts to wetlands within hand-clearing areas. These impacts involve the placement of temporary wetland fill for the installation of erosion control measures. These include some or all of the following: Temporary Silt Fence, Special Sediment Control Fence, and Temporary Rock Silt Checks.

Hand-Clearing: There will be 0.12 acre of hand clearing in jurisdictional areas on this project.

Utility Impacts: No impacts to jurisdictional resources will occur due to relocation of utilities in the project area.

Bridge Demolition: The superstructure for Bridge No. 35 is comprised of 8 pre-stressed concrete channels, with a substructure composed of concrete end bents and interior bent caps on timber piles. Best Management Practices for Bridge Demolition and Removal will be followed to prevent any temporary fill from entering Waters of the United States.

### **Neuse River Buffer Rules**

This project is located in the Neuse River Basin; therefore, the regulations pertaining to the Neuse River Buffer Rules apply. There will be a total of 3,806 square feet (sqft) of impacts to riparian buffers. This includes 1,779 sqft in Zone 1 and 2,027 in Zone 2 due to the bridge crossing. According to the buffer rules, bridges are allowable. Uses designated as allowable may proceed within the riparian buffer provided that there are no practical alternatives to the requested use pursuant to Item (8) of this rule. There are no practicable alternatives to bridge replacement over Nahunta Swamp.

### **In-Stream Work Moratorium**

According to the NC Wildlife Resources Commission, anadromous fish species are found in this portion of Nahunta Swamp; therefore, NCDOT will strictly adhere to all stream-crossing guidelines for anadromous fish passage, including an in-water work moratorium between February 15 and June 15.

### **Avoidance and Minimization**

Avoidance examines all appropriate and practicable possibilities of averting impacts to "Waters of the United States". Due to the presence of surface waters and wetlands within

the project area, avoidance of all impacts is not possible. The NCDOT is committed to incorporating all reasonable and practicable design features to avoid and minimize jurisdictional impacts. Minimization measures were incorporated as part of the project design. These include:

- NCDOT is replacing Bridge No. 17 in place, with a spanning structure and utilizing an off-site detour.
- The roadway grade was kept as close as possible to the existing, minimizing fill height.
- Hand clearing will be utilized to reduce permanent wetland impacts.
- NCDOT will observe an in-stream construction moratorium from February 15 to June 15 and utilize Stream Crossing Guidelines for Anadromous Fish Passage.
- Design Standards in Sensitive Watersheds will be utilized during demolition of the existing bridge and construction of the new bridge.

### **Mitigation**

Due to the minimal permanent wetland impacts proposed for this project, no compensatory mitigation is proposed.

### **Federally Protected Species**

As of January 31, 2008, the US Fish and Wildlife Service (USFWS) lists one federally protected species for Wayne County: red-cockaded woodpecker (*Picoides borealis*). The red-cockaded woodpecker is listed as endangered. There is no potential habitat in the project area; therefore the biological conclusion is 'No Effect'.

### **Bald and Golden Eagle Protection Act**

Included on the January 2008 list is the bald eagle, which was de-listed on August 8, 2007 and no longer requires a biological conclusion. However, the bald eagle is still protected under the Bald and Golden Eagle Protection Act. Suitable habitat in the form of large, open water bodies that provide nesting and foraging habitat for the bald eagle is not found within 660 feet of the project area. In addition, a search of the NC Natural Heritage Program database (updated February 2008) did not reveal any records of the bald eagle within one mile of the project area.

### **Project Schedule**

The project has a scheduled let of October 21, 2008 with a review date of September 2, 2008.

### **Regulatory Approvals**

Section 404 Permit: All aspects of this project are being processed by the Federal Highway Administration as a "Categorical Exclusion" in accordance with 23 CFR 771.115(b). The NCDOT requests that these activities be authorized by a Nationwide Permit 23 (72 CFR; 11092-11198, March 12, 2007). We are also requesting the issuance

of a Nationwide Permit 33 for temporary fill due to the installation of erosion control measures (72 CFR; 11092-11198, March 12, 2007).

Section 401 Permit: We anticipate 401 General Certification numbers 3701 and 3688 will apply to this project. All general conditions of the Water Quality Certification will be met. NCDOT is providing five copies of this application to the NCDWQ for their review and approval. Authorization to debit the \$240 Permit Application Fee from WBS Element 33826.1.1 is hereby given.

Neuse River Riparian Buffer Authorization: NCDOT requests that the NC Division of Water Quality review this application and issue a written approval for a Neuse Riparian Buffer Authorization.

A copy of this permit application will be posted on the NCDOT website at: <http://www.ncdot.org/doh/preconstruct/pe/neu/permit.html>.

If you have any questions or need additional information, please contact Amy James at (919) 715-7216.

Sincerely,



for

Gregory J. Thorpe, Ph.D., Environmental Management Director  
Project Development and Environmental Analysis

W/attachment

Mr. Brian Wrenn, NCDWQ (5 copies)  
Mr. Travis Wilson, NCWRC  
Mr. Gary Jordan, USFWS  
Mr. Ron Sechler, NMFS  
Ms. Jeanne Hardy, NCDMF

W/o attachment (see website for attachments)

Dr. David Chang, P.E., Hydraulics  
Mr. Greg Perfetti, P.E., Structure Design  
Mr. Victor Barbour, P.E., Project Services Unit  
Mr. Mark Staley, Roadside Environmental  
Mr. Scott McLendon, USACE, Wilmington  
Mr. Jay Bennett, P.E., Roadway Design  
Mr. Majed Alghandour, P. E., Programming and TIP  
Mr. Art McMillan, P.E., Highway Design  
Ms. Natalie Lockhart, Project Planning Engineer  
Mr. Richard E. Greene, P.E. Div. 4 Engineer  
Mr. Chad Coggins, Div. 4 Environmental Officer

USACE Action ID No. \_\_\_\_\_ DWQ No. \_\_\_\_\_

(If any particular item is not applicable to this project, please enter "Not Applicable" or "N/A".)

**I. Processing**

- 1. Check all of the approval(s) requested for this project:
 

<input checked="" type="checkbox"/> Section 404 Permit	<input checked="" type="checkbox"/> Riparian or Watershed Buffer Rules
<input type="checkbox"/> Section 10 Permit	<input type="checkbox"/> Isolated Wetland Permit from DWQ
<input checked="" type="checkbox"/> 401 Water Quality Certification	<input type="checkbox"/> Express 401 Water Quality Certification
- 2. Nationwide, Regional or General Permit Number(s) Requested: NWP 23 and 33
- 3. If this notification is solely a courtesy copy because written approval for the 401 Certification is not required, check here:
- 4. If payment into the North Carolina Ecosystem Enhancement Program (NCEEP) is proposed for mitigation of impacts, attach the acceptance letter from NCEEP, complete section VIII, and check here:
- 5. If your project is located in any of North Carolina's twenty coastal counties (listed on page 4), and the project is within a North Carolina Division of Coastal Management Area of Environmental Concern (see the top of page 2 for further details), check here:

**II. Applicant Information**

- 1. Owner/Applicant Information
 

Name: Gregory J. Thorpe, Ph.D., Environmental Management Director

Mailing Address: 1598 Mail Service Center  
Raleigh, NC 27699-1548

---

Telephone Number: (919) 733-3141 Fax Number: (919) 733-9794

E-mail Address: \_\_\_\_\_
- 2. Agent/Consultant Information (A signed and dated copy of the Agent Authorization letter must be attached if the Agent has signatory authority for the owner/applicant.)
 

Name: N/A

Company Affiliation: \_\_\_\_\_

Mailing Address: \_\_\_\_\_

---

Telephone Number: \_\_\_\_\_ Fax Number: \_\_\_\_\_

E-mail Address: \_\_\_\_\_



### III. Project Information

Attach a **vicinity map** clearly showing the location of the property with respect to local landmarks such as towns, rivers, and roads. Also provide a detailed **site plan** showing property boundaries and development plans in relation to surrounding properties. Both the vicinity map and site plan must include a scale and north arrow. The specific footprints of all buildings, impervious surfaces, or other facilities must be included. If possible, the maps and plans should include the appropriate USGS Topographic Quad Map and NRCS Soil Survey with the property boundaries outlined. Plan drawings, or other maps may be included at the applicant's discretion, so long as the property is clearly defined. For administrative and distribution purposes, the USACE requires information to be submitted on sheets no larger than 11 by 17-inch format; however, DWQ may accept paperwork of any size. DWQ prefers full-size construction drawings rather than a sequential sheet version of the full-size plans. If full-size plans are reduced to a small scale such that the final version is illegible, the applicant will be informed that the project has been placed on hold until decipherable maps are provided.

1. Name of project: Replacement of Bridge no. 35 over Nahunta Swamp on SR 1532
2. T.I.P. Project Number or State Project Number (NCDOT Only): B-4671
3. Property Identification Number (Tax PIN): N/A
4. Location  
County: Wayne Nearest Town: Goldsboro  
Subdivision name (include phase/lot number): \_\_\_\_\_  
Directions to site (include road numbers/names, landmarks, etc.): see vicinity map
5. Site coordinates (For linear projects, such as a road or utility line, attach a sheet that separately lists the coordinates for each crossing of a distinct waterbody.)  
Decimal Degrees (6 digits minimum): -77.829765 °N 35.475447 °W
6. Property size (acres): N/A
7. Name of nearest receiving body of water: Nahunta Swamp
8. River Basin: Neuse  
(Note – this must be one of North Carolina's seventeen designated major river basins. The River Basin map is available at <http://h2o.enr.state.nc.us/admin/maps/>.)
9. Describe the existing conditions on the site and general land use in the vicinity of the project at the time of this application: The project is located in a rural area consisting of low density residential and forested areas as well as agricultural land.
10. Describe the overall project in detail, including the type of equipment to be used: \_\_\_\_\_

Bridge No. 35 will be replaced on the existing alignment with an offsite detour. Heavy duty excavation equipment will be used such as trucks, dozers, cranes and other various equipment necessary for roadway construction.

---

11. Explain the purpose of the proposed work: To replace a deteriorating bridge

#### **IV. Prior Project History**

If jurisdictional determinations and/or permits have been requested and/or obtained for this project (including all prior phases of the same subdivision) in the past, please explain. Include the USACE Action ID Number, DWQ Project Number, application date, and date permits and certifications were issued or withdrawn. Provide photocopies of previously issued permits, certifications or other useful information. Describe previously approved wetland, stream and buffer impacts, along with associated mitigation (where applicable). If this is a NCDOT project, list and describe permits issued for prior segments of the same T.I.P. project, along with construction schedules. This site was visited by USACE representative William Wescott on June 21, 2007 for a jurisdictional determination. All wetlands were verified at this visit. After the Rapanos decision, JD forms were filled out for all wetlands and sent electronically to Mr. Wescott on October 22, 2007. No isolated wetlands or wetlands without a significant nexus were identified. A tear sheet has not been received.

---

#### **V. Future Project Plans**

Are any future permit requests anticipated for this project? If so, describe the anticipated work, and provide justification for the exclusion of this work from the current application.  
No future permit requests are anticipated for this project.

---

#### **VI. Proposed Impacts to Waters of the United States/Waters of the State**

It is the applicant's (or agent's) responsibility to determine, delineate and map all impacts to wetlands, open water, and stream channels associated with the project. Each impact must be listed separately in the tables below (e.g., culvert installation should be listed separately from riprap dissipater pads). Be sure to indicate if an impact is temporary. All proposed impacts, permanent and temporary, must be listed, and must be labeled and clearly identifiable on an accompanying site plan. All wetlands and waters, and all streams (intermittent and perennial) should be shown on a delineation map, whether or not impacts are proposed to these systems. Wetland and stream evaluation and delineation forms should be included as appropriate. Photographs may be included at the applicant's discretion. If this proposed impact is strictly for wetland or stream mitigation, list and describe the impact in Section VIII below. If additional space is needed for listing or description, please attach a separate sheet.

1. Provide a written description of the proposed impacts: 0.03 acre of permanent wetland and 0.03 acre of temporary wetland impacts resulting from fill are proposed for this project.
2. Individually list wetland impacts. Types of impacts include, but are not limited to mechanized clearing, grading, fill, excavation, flooding, ditching/drainage, etc. For dams, separately list impacts due to both structure and flooding.

Wetland Impact Site Number (indicate on map)	Type of Impact	Type of Wetland (e.g., forested, marsh, herbaceous, bog, etc.)	Located within 100-year Floodplain (yes/no)	Distance to Nearest Stream (linear feet)	Area of Impact (acres)
Site 1	Permanent Fill	Forested	Yes	80	0.03
Site 2	Permanent Fill	Forested	Yes	80	<0.01
Site 1 & 2	Temporary Fill	Forested	Yes	80	0.03
Total Wetland Impact (acres)					0.06

3. List the total acreage (estimated) of all existing wetlands on the property: 16 acres
4. Individually list all intermittent and perennial stream impacts. Be sure to identify temporary impacts. Stream impacts include, but are not limited to placement of fill or culverts, dam construction, flooding, relocation, stabilization activities (e.g., cement walls, rip-rap, crib walls, gabions, etc.), excavation, ditching/straightening, etc. If stream relocation is proposed, plans and profiles showing the linear footprint for both the original and relocated streams must be included. To calculate acreage, multiply length X width, then divide by 43,560.

Stream Impact Number (indicate on map)	Stream Name	Type of Impact	Perennial or Intermittent?	Average Stream Width Before Impact	Impact Length (linear feet)	Area of Impact (acres)
N/A						
Total Stream Impact (by length and acreage)						0.0

5. Individually list all open water impacts (including lakes, ponds, estuaries, sounds, Atlantic Ocean and any other water of the U.S.). Open water impacts include, but are not limited to fill, excavation, dredging, flooding, drainage, bulkheads, etc.

Open Water Impact Site Number (indicate on map)	Name of Waterbody (if applicable)	Type of Impact	Type of Waterbody (lake, pond, estuary, sound, bay, ocean, etc.)	Area of Impact (acres)
N/A				
Total Open Water Impact (acres)				0.0

6. List the cumulative impact to all Waters of the U.S. resulting from the project:

Stream Impact (acres):	0
Wetland Impact (acres):	0.06
Open Water Impact (acres):	0
Total Impact to Waters of the U.S. (acres)	0.06
Total Stream Impact (linear feet):	0

7. Isolated Waters

Do any isolated waters exist on the property?  Yes  No

Describe all impacts to isolated waters, and include the type of water (wetland or stream) and the size of the proposed impact (acres or linear feet). Please note that this section only applies to waters that have specifically been determined to be isolated by the USACE.

---

8. Pond Creation

If construction of a pond is proposed, associated wetland and stream impacts should be included above in the wetland and stream impact sections. Also, the proposed pond should be described here and illustrated on any maps included with this application.

Pond to be created in (check all that apply):  uplands  stream  wetlands

Describe the method of construction (e.g., dam/embankment, excavation, installation of draw-down valve or spillway, etc.): N/A

Proposed use or purpose of pond (e.g., livestock watering, irrigation, aesthetic, trout pond, local stormwater requirement, etc.): N/A

Current land use in the vicinity of the pond: N/A

Size of watershed draining to pond: \_\_\_\_\_ Expected pond surface area: \_\_\_\_\_

## **VII. Impact Justification (Avoidance and Minimization)**

Specifically describe measures taken to avoid the proposed impacts. It may be useful to provide information related to site constraints such as topography, building ordinances, accessibility, and financial viability of the project. The applicant may attach drawings of alternative, lower-impact site layouts, and explain why these design options were not feasible. Also discuss how impacts were minimized once the desired site plan was developed. If applicable, discuss construction techniques to be followed during construction to reduce impacts.

- NCDOT is replacing Bridge No. 17 in place and utilizing an off-site detour.
- The roadway grade was kept as close as possible to the existing, minimizing fill height.
- Hand clearing will be utilized to reduce permanent wetland impacts.
- NCDOT will observe an in-stream construction moratorium from February 15 to June 15 and utilize Stream Crossing Guidelines for Anadromous Fish Passage.

## **VIII. Mitigation**

DWQ - In accordance with 15A NCAC 2H .0500, mitigation may be required by the NC Division of Water Quality for projects involving greater than or equal to one acre of impacts to freshwater wetlands or greater than or equal to 150 linear feet of total impacts to perennial streams.

USACE – In accordance with the Final Notice of Issuance and Modification of Nationwide Permits, published in the Federal Register on January 15, 2002, mitigation will be required when necessary to ensure that adverse effects to the aquatic environment are minimal. Factors including size and type of proposed impact and function and relative value of the impacted aquatic resource will be considered in determining acceptability of appropriate and practicable mitigation as proposed. Examples of mitigation that may be appropriate and practicable include, but are not limited to: reducing the size of the project; establishing and maintaining wetland and/or upland vegetated buffers to protect open waters such as streams; and replacing losses of aquatic resource functions and values by creating, restoring, enhancing, or preserving similar functions and values, preferable in the same watershed.

If mitigation is required for this project, a copy of the mitigation plan must be attached in order for USACE or DWQ to consider the application complete for processing. Any application lacking a required mitigation plan or NCEEP concurrence shall be placed on hold as incomplete. An applicant may also choose to review the current guidelines for stream restoration in DWQ's Draft Technical Guide for Stream Work in North Carolina, available at <http://h2o.enr.state.nc.us/ncwetlands/strmgide.html>.

1. Provide a brief description of the proposed mitigation plan. The description should provide as much information as possible, including, but not limited to: site location (attach directions and/or map, if offsite), affected stream and river basin, type and amount (acreage/linear feet) of mitigation proposed (restoration, enhancement, creation, or preservation), a plan view, preservation mechanism (e.g., deed restrictions, conservation easement, etc.), and a description of the current site conditions and proposed method of construction. Please attach a separate sheet if more space is needed.

Due to minimal permanent impacts, no mitigation is proposed.

---

---

---

---

2. Mitigation may also be made by payment into the North Carolina Ecosystem Enhancement Program (NCEEP). Please note it is the applicant's responsibility to contact the NCEEP at (919) 715-0476 to determine availability, and written approval from the NCEEP indicating that they are will to accept payment for the mitigation must be attached to this form. For additional information regarding the application process for the NCEEP, check the NCEEP website at <http://h2o.enr.state.nc.us/wrp/index.htm>. If use of the NCEEP is proposed, please check the appropriate box on page five and provide the following information:

Amount of stream mitigation requested (linear feet): 0

Amount of buffer mitigation requested (square feet): 0

Amount of Riparian wetland mitigation requested (acres): 0

Amount of Non-riparian wetland mitigation requested (acres): 0

Amount of Coastal wetland mitigation requested (acres): 0

## IX. Environmental Documentation (required by DWQ)

1. Does the project involve an expenditure of public (federal/state/local) funds or the use of public (federal/state) land? Yes  No
2. If yes, does the project require preparation of an environmental document pursuant to the requirements of the National or North Carolina Environmental Policy Act (NEPA/SEPA)?  
Note: If you are not sure whether a NEPA/SEPA document is required, call the SEPA coordinator at (919) 733-5083 to review current thresholds for environmental documentation.  
Yes  No
3. If yes, has the document review been finalized by the State Clearinghouse? If so, please attach a copy of the NEPA or SEPA final approval letter. Yes  No

**X. Proposed Impacts on Riparian and Watershed Buffers (required by DWQ)**

It is the applicant's (or agent's) responsibility to determine, delineate and map all impacts to required state and local buffers associated with the project. The applicant must also provide justification for these impacts in Section VII above. All proposed impacts must be listed herein, and must be clearly identifiable on the accompanying site plan. All buffers must be shown on a map, whether or not impacts are proposed to the buffers. Correspondence from the DWQ Regional Office may be included as appropriate. Photographs may also be included at the applicant's discretion.

1. Will the project impact protected riparian buffers identified within 15A NCAC 2B .0233 (Neuse), 15A NCAC 2B .0259 (Tar-Pamlico), 15A NCAC 02B .0243 (Catawba) 15A NCAC 2B .0250 (Randleman Rules and Water Supply Buffer Requirements), or other (please identify \_\_\_\_\_)? Yes  No
2. If "yes", identify the square feet and acreage of impact to each zone of the riparian buffers. If buffer mitigation is required calculate the required amount of mitigation by applying the buffer multipliers.

Zone*	Impact (square feet)	Multiplier	Required Mitigation
1	1,779	3 (2 for Catawba)	0.0
2	2,027	1.5	0.0
Total	3,806		0.0

\* Zone 1 extends out 30 feet perpendicular from the top of the near bank of channel; Zone 2 extends an additional 20 feet from the edge of Zone 1.

- XI. 3. If buffer mitigation is required, please discuss what type of mitigation is proposed (i.e., Donation of Property, Riparian Buffer Restoration / Enhancement, or Payment into the Riparian Buffer Restoration Fund). Please attach all appropriate information as identified within 15A NCAC 2B .0242 or .0244, or .0260. All buffer impacts are considered allowable.

**XII. Stormwater (required by DWQ)**

Describe impervious acreage (existing and proposed) versus total acreage on the site. Discuss stormwater controls proposed in order to protect surface waters and wetlands downstream from the property. If percent impervious surface exceeds 20%, please provide calculations demonstrating total proposed impervious level. N/A

---



---

**XIII. Sewage Disposal (required by DWQ)**

Clearly detail the ultimate treatment methods and disposition (non-discharge or discharge) of wastewater generated from the proposed project, or available capacity of the subject facility. N/A

---

**XIV. Violations (required by DWQ)**

Is this site in violation of DWQ Wetland Rules (15A NCAC 2H .0500) or any Buffer Rules?

Yes  No

Is this an after-the-fact permit application? Yes  No

**XV. Cumulative Impacts (required by DWQ)**

Will this project (based on past and reasonably anticipated future impacts) result in additional development, which could impact nearby downstream water quality? Yes  No

If yes, please submit a qualitative or quantitative cumulative impact analysis in accordance with the most recent North Carolina Division of Water Quality policy posted on our website at <http://h2o.enr.state.nc.us/ncwetlands>. If no, please provide a short narrative description: \_\_\_\_\_

\_\_\_\_\_  
\_\_\_\_\_

**XVI. Other Circumstances (Optional):**

It is the applicant's responsibility to submit the application sufficiently in advance of desired construction dates to allow processing time for these permits. However, an applicant may choose to list constraints associated with construction or sequencing that may impose limits on work schedules (e.g., draw-down schedules for lakes, dates associated with Endangered and Threatened Species, accessibility problems, or other issues outside of the applicant's control).

None

\_\_\_\_\_  
\_\_\_\_\_

*E. P. Fuest*

3. 27. 08

**Applicant/Agent's Signature**

**Date**

(Agent's signature is valid only if an authorization letter from the applicant is provided.)



**NATIONWIDE PERMIT 33  
DEPARTMENT OF THE ARMY  
CORPS OF ENGINEERS  
FINAL NOTICE OF ISSUANCE AND MODIFICATION OF NATIONWIDE PERMITS  
FEDERAL REGISTER  
AUTHORIZED MARCH 19, 2007**

**Temporary Construction, Access, and Dewatering.** Temporary structures, work, and discharges, including cofferdams, necessary for construction activities or access fills or dewatering of construction sites, provided that the associated primary activity is authorized by the Corps of Engineers or the U.S. Coast Guard. This NWP also authorizes temporary structures, work, and discharges, including cofferdams, necessary for construction activities not otherwise subject to the Corps or U.S. Coast Guard permit requirements. Appropriate measures must be taken to maintain near normal downstream flows and to minimize flooding. Fill must consist of materials, and be placed in a manner, that will not be eroded by expected high flows. The use of dredged material may be allowed if the district engineer determines that it will not cause more than minimal adverse effects on aquatic resources. Following completion of construction, temporary fill must be entirely removed to upland areas, dredged material must be returned to its original location, and the affected areas must be restored to pre-construction elevations. The affected areas must also be revegetated, as appropriate. This permit does not authorize the use of cofferdams to dewater wetlands or other aquatic areas to change their use. Structures left in place after construction is completed require a section 10 permit if located in navigable waters of the United States. (See 33 CFR part 322.)

Notification: The permittee must submit a pre-construction notification to the district engineer prior to commencing the activity (see general condition 27). The pre-construction notification must include a restoration plan showing how all temporary fills and structures will be removed and the area restored to pre-project conditions. (Sections 10 and 404)

**NATIONWIDE PERMIT 23  
DEPARTMENT OF THE ARMY  
CORPS OF ENGINEERS  
FINAL NOTICE OF ISSUANCE AND MODIFICATION OF NATIONWIDE PERMITS  
FEDERAL REGISTER  
AUTHORIZED MARCH 19, 2007**

**Approved Categorical Exclusions.** Activities undertaken, assisted, authorized, regulated, funded, or financed, in whole or in part, by another Federal agency or department where:

(a) That agency or department has determined, pursuant to the Council on Environmental Quality's implementing regulations for the National Environmental Policy Act (40 CFR part 1500 et seq.), that the activity is categorically excluded from environmental documentation, because it is included within a category of actions which neither individually nor cumulatively have a significant effect on the human environment; and

(b) The Office of the Chief of Engineers (Attn: CECW-CO) has concurred with that agency's or department's determination that the activity is categorically excluded and approved the activity for authorization under NWP 23.

The Office of the Chief of Engineers may require additional conditions, including pre-construction notification, for authorization of an agency's categorical exclusions under this NWP.

Notification: Certain categorical exclusions approved for authorization under this NWP require the permittee to submit a pre-construction notification to the district engineer prior to commencing the activity (see general condition 27). The activities that require pre-construction notification are listed in the appropriate Regulatory Guidance Letters. (Sections 10 and 404)

Note: The agency or department may submit an application for an activity believed to be categorically excluded to the Office of the Chief of Engineers (Attn: CECW-CO). Prior to approval for authorization under this NWP of any agency's activity, the Office of the Chief of Engineers will solicit public comment. As of the date of issuance of this NWP, agencies with approved categorical exclusions are the: Bureau of Reclamation, Federal Highway Administration, and U.S. Coast Guard. Activities approved for authorization under this NWP as of the date of this notice are found in Corps Regulatory Guidance Letter 05-07, which is available at:

<http://www.usace.army.mil/inet/functions/cw/cecwo/reg/rglsindx.htm> . Any future approved categorical exclusions will be announced in Regulatory Guidance Letters and posted on this same web site.

## NATIONWIDE PERMIT CONDITIONS

The following General Conditions must be followed in order for any authorization by a NWP to be valid:

1. Navigation. (a) No activity may cause more than a minimal adverse effect on navigation.  
(b) Any safety lights and signals prescribed by the U.S. Coast Guard, through regulations or otherwise, must be installed and maintained at the permittee's expense on authorized facilities in navigable waters of the United States.  
(c) The permittee understands and agrees that, if future operations by the United States require the removal, relocation, or other alteration, of the structure or work herein authorized, or if, in the opinion of the Secretary of the Army or his authorized representative, said structure or work shall cause unreasonable obstruction to the free navigation of the navigable waters, the permittee will be required, upon due notice from the Corps of Engineers, to remove, relocate, or alter the structural work or obstructions caused thereby, without expense to the United States. No claim shall be made against the United States on account of any such removal or alteration.
2. Aquatic Life Movements. No activity may substantially disrupt the necessary life cycle movements of those species of aquatic life indigenous to the waterbody, including those species that normally migrate through the area, unless the activity's primary purpose is to impound water. Culverts placed in streams must be installed to maintain low flow conditions.
3. Spawning Areas. Activities in spawning areas during spawning seasons must be avoided to the maximum extent practicable. Activities that result in the physical destruction (e.g., through excavation, fill, or downstream smothering by substantial turbidity) of an important spawning area are not authorized.
4. Migratory Bird Breeding Areas. Activities in waters of the United States that serve as breeding areas for migratory birds must be avoided to the maximum extent practicable.
5. Shellfish Beds. No activity may occur in areas of concentrated shellfish populations, unless the activity is directly related to a shellfish harvesting activity authorized by NWPs 4 and 48.
6. Suitable Material. No activity may use unsuitable material (e.g., trash, debris, car bodies, asphalt, etc.). Material used for construction or discharged must be free from toxic pollutants in toxic amounts (see Section 307 of the Clean Water Act).
7. Water Supply Intakes. No activity may occur in the proximity of a public water supply intake, except where the activity is for the repair or improvement of public water supply intake structures or adjacent bank stabilization.
8. Adverse Effects From Impoundments. If the activity creates an impoundment of water, adverse effects to the aquatic system due to accelerating the passage of water, and/or restricting its flow must be minimized to the maximum extent practicable.

9. Management of Water Flows. To the maximum extent practicable, the pre-construction course, condition, capacity, and location of open waters must be maintained for each activity, including stream channelization and storm water management activities, except as provided below. The activity must be constructed to withstand expected high flows. The activity must not restrict or impede the passage of normal or high flows, unless the primary purpose of the activity is to impound water or manage high flows. The activity may alter the pre-construction course, condition, capacity, and location of open waters if it benefits the aquatic environment (e.g., stream restoration or relocation activities).

10. Fills Within 100-Year Floodplains. The activity must comply with applicable FEMA-approved state or local floodplain management requirements.

11. Equipment. Heavy equipment working in wetlands or mudflats must be placed on mats, or other measures must be taken to minimize soil disturbance.

12. Soil Erosion and Sediment Controls. Appropriate soil erosion and sediment controls must be used and maintained in effective operating condition during construction, and all exposed soil and other fills, as well as any work below the ordinary high water mark or high tide line, must be permanently stabilized at the earliest practicable date. Permittees are encouraged to perform work within waters of the United States during periods of low-flow or no-flow.

13. Removal of Temporary Fills. Temporary fills must be removed in their entirety and the affected areas returned to pre-construction elevations. The affected areas must be revegetated, as appropriate.

14. Proper Maintenance. Any authorized structure or fill shall be properly maintained, including maintenance to ensure public safety.

15. Wild and Scenic Rivers. No activity may occur in a component of the National Wild and Scenic River System, or in a river officially designated by Congress as a "study river" for possible inclusion in the system while the river is in an official study status, unless the appropriate Federal agency with direct management responsibility for such river, has determined in writing that the proposed activity will not adversely affect the Wild and Scenic River designation or study status. Information on Wild and Scenic Rivers may be obtained from the appropriate Federal land management agency in the area (e.g., National Park Service, U.S. Forest Service, Bureau of Land Management, U.S. Fish and Wildlife Service).

16. Tribal Rights. No activity or its operation may impair reserved tribal rights, including, but not limited to, reserved water rights and treaty fishing and hunting rights.

17. Endangered Species. (a) No activity is authorized under any NWP which is likely to jeopardize the continued existence of a threatened or endangered species or a species proposed for such designation, as identified under the Federal Endangered Species Act (ESA), or which will destroy or adversely modify the critical habitat of such species. No activity is authorized

under any NWP which “may affect” a listed species or critical habitat, unless Section 7 consultation addressing the effects of the proposed activity has been completed.

(b) Federal agencies should follow their own procedures for complying with the requirements of the ESA. Federal permittees must provide the district engineer with the appropriate documentation to demonstrate compliance with those requirements.

(c) Non-federal permittees shall notify the district engineer if any listed species or designated critical habitat might be affected or is in the vicinity of the project, or if the project is located in designated critical habitat, and shall not begin work on the activity until notified by the district engineer that the requirements of the ESA have been satisfied and that the activity is authorized. For activities that might affect Federally-listed endangered or threatened species or designated critical habitat, the pre-construction notification must include the name(s) of the endangered or threatened species that may be affected by the proposed work or that utilize the designated critical habitat that may be affected by the proposed work. The district engineer will determine whether the proposed activity “may affect” or will have “no effect” to listed species and designated critical habitat and will notify the non-Federal applicant of the Corps’ determination within 45 days of receipt of a complete pre-construction notification. In cases where the non-Federal applicant has identified listed species or critical habitat that might be affected or is in the vicinity of the project, and has so notified the Corps, the applicant shall not begin work until the Corps has provided notification the proposed activities will have “no effect” on listed species or critical habitat, or until Section 7 consultation has been completed.

(d) As a result of formal or informal consultation with the FWS or NMFS the district engineer may add species-specific regional endangered species conditions to the NWPs.

(e) Authorization of an activity by a NWP does not authorize the “take” of a threatened or endangered species as defined under the ESA. In the absence of separate authorization (e.g., an ESA Section 10 Permit, a Biological Opinion with “incidental take” provisions, etc.) from the U.S. FWS or the NMFS, both lethal and non-lethal “takes” of protected species are in violation of the ESA. Information on the location of threatened and endangered species and their critical habitat can be obtained directly from the offices of the U.S. FWS and NMFS or their world wide Web pages at <http://www.fws.gov/> and <http://www.noaa.gov/fisheries.html> respectively.

18. Historic Properties. (a) In cases where the district engineer determines that the activity may affect properties listed, or eligible for listing, in the National Register of Historic Places, the activity is not authorized, until the requirements of Section 106 of the National Historic Preservation Act (NHPA) have been satisfied.

(b) Federal permittees should follow their own procedures for complying with the requirements of Section 106 of the National Historic Preservation Act. Federal permittees must provide the district engineer with the appropriate documentation to demonstrate compliance with those requirements.

(c) Non-federal permittees must submit a pre-construction notification to the district engineer if the authorized activity may have the potential to cause effects to any historic properties listed, determined to be eligible for listing on, or potentially eligible for listing on the National Register of Historic Places, including previously unidentified properties. For such activities, the pre-construction notification must state which historic properties may be affected by the proposed work or include a vicinity map indicating the location of the historic properties or the potential for the presence of historic properties. Assistance regarding information on the location of or potential for the presence of historic resources can be sought from the State

Historic Preservation Officer or Tribal Historic Preservation Officer, as appropriate, and the National Register of Historic Places (see 33 CFR 330.4(g)). The district engineer shall make a reasonable and good faith effort to carry out appropriate identification efforts, which may include background research, consultation, oral history interviews, sample field investigation, and field survey. Based on the information submitted and these efforts, the district engineer shall determine whether the proposed activity has the potential to cause an effect on the historic properties. Where the non-Federal applicant has identified historic properties which the activity may have the potential to cause effects and so notified the Corps, the non-Federal applicant shall not begin the activity until notified by the district engineer either that the activity has no potential to cause effects or that consultation under Section 106 of the NHPA has been completed.

(d) The district engineer will notify the prospective permittee within 45 days of receipt of a complete pre-construction notification whether NHPA Section 106 consultation is required. Section 106 consultation is not required when the Corps determines that the activity does not have the potential to cause effects on historic properties (see 36 CFR 800.3(a)). If NHPA section 106 consultation is required and will occur, the district engineer will notify the non-Federal applicant that he or she cannot begin work until Section 106 consultation is completed.

(e) Prospective permittees should be aware that section 110k of the NHPA (16 U.S.C. 470h-2(k)) prevents the Corps from granting a permit or other assistance to an applicant who, with intent to avoid the requirements of Section 106 of the NHPA, has intentionally significantly adversely affected a historic property to which the permit would relate, or having legal power to prevent it, allowed such significant adverse effect to occur, unless the Corps, after consultation with the Advisory Council on Historic Preservation (ACHP), determines that circumstances justify granting such assistance despite the adverse effect created or permitted by the applicant. If circumstances justify granting the assistance, the Corps is required to notify the ACHP and provide documentation specifying the circumstances, explaining the degree of damage to the integrity of any historic properties affected, and proposed mitigation. This documentation must include any views obtained from the applicant, SHPO/THPO, appropriate Indian tribes if the undertaking occurs on or affects historic properties on tribal lands or affects properties of interest to those tribes, and other parties known to have a legitimate interest in the impacts to the permitted activity on historic properties.

19. Designated Critical Resource Waters. Critical resource waters include, NOAA-designated marine sanctuaries, National Estuarine Research Reserves, state natural heritage sites, and outstanding national resource waters or other waters officially designated by a state as having particular environmental or ecological significance and identified by the district engineer after notice and opportunity for public comment. The district engineer may also designate additional critical resource waters after notice and opportunity for comment.

(a) Discharges of dredged or fill material into waters of the United States are not authorized by NWPs 7, 12, 14, 16, 17, 21, 29, 31, 35, 39, 40, 42, 43, 44, 49, and 50 for any activity within, or directly affecting, critical resource waters, including wetlands adjacent to such waters.

(b) For NWPs 3, 8, 10, 13, 15, 18, 19, 22, 23, 25, 27, 28, 30, 33, 34, 36, 37, and 38, notification is required in accordance with general condition 27, for any activity proposed in the designated critical resource waters including wetlands adjacent to those waters. The district engineer may authorize activities under these NWPs only after it is determined that the impacts to the critical resource waters will be no more than minimal.

20. Mitigation. The district engineer will consider the following factors when determining appropriate and practicable mitigation necessary to ensure that adverse effects on the aquatic environment are minimal:

(a) The activity must be designed and constructed to avoid and minimize adverse effects, both temporary and permanent, to waters of the United States to the maximum extent practicable at the project site (i.e., on site).

(b) Mitigation in all its forms (avoiding, minimizing, rectifying, reducing, or compensating) will be required to the extent necessary to ensure that the adverse effects to the aquatic environment are minimal.

(c) Compensatory mitigation at a minimum one-for-one ratio will be required for all wetland losses that exceed 1/10 acre and require pre-construction notification, unless the district engineer determines in writing that some other form of mitigation would be more environmentally appropriate and provides a project-specific waiver of this requirement. For wetland losses of 1/10 acre or less that require pre-construction notification, the district engineer may determine on a case-by-case basis that compensatory mitigation is required to ensure that the activity results in minimal adverse effects on the aquatic environment. Since the likelihood of success is greater and the impacts to potentially valuable uplands are reduced, wetland restoration should be the first compensatory mitigation option considered.

(d) For losses of streams or other open waters that require pre-construction notification, the district engineer may require compensatory mitigation, such as stream restoration, to ensure that the activity results in minimal adverse effects on the aquatic environment.

(e) Compensatory mitigation will not be used to increase the acreage losses allowed by the acreage limits of the NWP. For example, if an NWP has an acreage limit of 1/2 acre, it cannot be used to authorize any project resulting in the loss of greater than 1/2 acre of waters of the United States, even if compensatory mitigation is provided that replaces or restores some of the lost waters. However, compensatory mitigation can and should be used, as necessary, to ensure that a project already meeting the established acreage limits also satisfies the minimal impact requirement associated with the NWP.

(f) Compensatory mitigation plans for projects in or near streams or other open waters will normally include a requirement for the establishment, maintenance, and legal protection (e.g., conservation easements) of riparian areas next to open waters. In some cases, riparian areas may be the only compensatory mitigation required. Riparian areas should consist of native species. The width of the required riparian area will address documented water quality or aquatic habitat loss concerns. Normally, the riparian area will be 25 to 50 feet wide on each side of the stream, but the district engineer may require slightly wider riparian areas to address documented water quality or habitat loss concerns. Where both wetlands and open waters exist on the project site, the district engineer will determine the appropriate compensatory mitigation (e.g., riparian areas and/or wetlands compensation) based on what is best for the aquatic environment on a watershed basis. In cases where riparian areas are determined to be the most appropriate form of compensatory mitigation, the district engineer may waive or reduce the requirement to provide wetland compensatory mitigation for wetland losses.

(g) Permittees may propose the use of mitigation banks, in-lieu fee arrangements or separate activity-specific compensatory mitigation. In all cases, the mitigation provisions will specify the party responsible for accomplishing and/or complying with the mitigation plan.

(h) Where certain functions and services of waters of the United States are permanently adversely affected, such as the conversion of a forested or scrub-shrub wetland to a herbaceous wetland in a permanently maintained utility line right-of-way, mitigation may be required to reduce the adverse effects of the project to the minimal level.

21. Water Quality. Where States and authorized Tribes, or EPA where applicable, have not previously certified compliance of an NWP with CWA Section 401, individual 401 Water Quality Certification must be obtained or waived (see 33 CFR 330.4(c)). The district engineer or State or Tribe may require additional water quality management measures to ensure that the authorized activity does not result in more than minimal degradation of water quality.

22. Coastal Zone Management. In coastal states where an NWP has not previously received a state coastal zone management consistency concurrence, an individual state coastal zone management consistency concurrence must be obtained, or a presumption of concurrence must occur (see 33 CFR 330.4(d)). The district engineer or a State may require additional measures to ensure that the authorized activity is consistent with state coastal zone management requirements.

23. Regional and Case-By-Case Conditions. The activity must comply with any regional conditions that may have been added by the Division Engineer (see 33 CFR 330.4(e)) and with any case specific conditions added by the Corps or by the state, Indian Tribe, or U.S. EPA in its section 401 Water Quality Certification, or by the state in its Coastal Zone Management Act consistency determination.

24. Use of Multiple Nationwide Permits. The use of more than one NWP for a single and complete project is prohibited, except when the acreage loss of waters of the United States authorized by the NWPs does not exceed the acreage limit of the NWP with the highest specified acreage limit. For example, if a road crossing over tidal waters is constructed under NWP 14, with associated bank stabilization authorized by NWP 13, the maximum acreage loss of waters of the United States for the total project cannot exceed 1/3-acre.

25. Transfer of Nationwide Permit Verifications. If the permittee sells the property associated with a nationwide permit verification, the permittee may transfer the nationwide permit verification to the new owner by submitting a letter to the appropriate Corps district office to validate the transfer. A copy of the nationwide permit verification must be attached to the letter, and the letter must contain the following statement and signature:  
“When the structures or work authorized by this nationwide permit are still in existence at the time the property is transferred, the terms and conditions of this nationwide permit, including any special conditions, will continue to be binding on the new owner(s) of the property. To validate



the transfer of this nationwide permit and the associated liabilities associated with compliance with its terms and conditions, have the transferee sign and date below.”

---

(Transferee)

---

(Date)

26. Compliance Certification. Each permittee who received an NWP verification from the Corps must submit a signed certification regarding the completed work and any required mitigation. The certification form must be forwarded by the Corps with the NWP verification letter and will include:

- (a) A statement that the authorized work was done in accordance with the NWP authorization, including any general or specific conditions;
- (b) A statement that any required mitigation was completed in accordance with the permit conditions; and
- (c) The signature of the permittee certifying the completion of the work and mitigation.

27. Pre-Construction Notification. (a) Timing. Where required by the terms of the NWP, the prospective permittee must notify the district engineer by submitting a pre-construction notification (PCN) as early as possible. The district engineer must determine if the PCN is complete within 30 calendar days of the date of receipt and, as a general rule, will request additional information necessary to make the PCN complete only once. However, if the prospective permittee does not provide all of the requested information, then the district engineer will notify the prospective permittee that the PCN is still incomplete and the PCN review process will not commence until all of the requested information has been received by the district engineer. The prospective permittee shall not begin the activity until either:

- (1) He or she is notified in writing by the district engineer that the activity may proceed under the NWP with any special conditions imposed by the district or division engineer; or
- (2) Forty-five calendar days have passed from the district engineer’s receipt of the complete PCN and the prospective permittee has not received written notice from the district or division engineer. However, if the permittee was required to notify the Corps pursuant to general condition 17 that listed species or critical habitat might be affected or in the vicinity of the project, or to notify the Corps pursuant to general condition 18 that the activity may have the potential to cause effects to historic properties, the permittee cannot begin the activity until receiving written notification from the Corps that is “no effect” on listed species or “no potential to cause effects” on historic properties, or that any consultation required under Section 7 of the Endangered Species Act (see 33 CFR 330.4(f)) and/or Section 106 of the National Historic Preservation Act (see 33 CFR 330.4(g)) is completed. Also, work cannot begin under NWPs 21, 49, or 50 until the permittee has received written approval from the Corps. If the proposed activity requires a written waiver to exceed specified limits of an NWP, the permittee cannot begin the activity until the district engineer issues the waiver. If the district or division engineer notifies the permittee in writing that an individual permit is required within 45 calendar days of receipt of a complete PCN, the permittee cannot begin the activity until an individual permit has been obtained.

Subsequently, the permittee's right to proceed under the NWP may be modified, suspended, or revoked only in accordance with the procedure set forth in 33 CFR 330.5(d)(2).

(b) Contents of Pre-Construction Notification: The PCN must be in writing and include the following information:

(1) Name, address and telephone numbers of the prospective permittee;

(2) Location of the proposed project;

(3) A description of the proposed project; the project's purpose; direct and indirect adverse environmental effects the project would cause; any other NWP(s), regional general permit(s), or individual permit(s) used or intended to be used to authorize any part of the proposed project or any related activity. The description should be sufficiently detailed to allow the district engineer to determine that the adverse effects of the project will be minimal and to determine the need for compensatory mitigation. Sketches should be provided when necessary to show that the activity complies with the terms of the NWP. (Sketches usually clarify the project and when provided result in a quicker decision.);

(4) The PCN must include a delineation of special aquatic sites and other waters of the United States on the project site. Wetland delineations must be prepared in accordance with the current method required by the Corps. The permittee may ask the Corps to delineate the special aquatic sites and other waters of the United States, but there may be a delay if the Corps does the delineation, especially if the project site is large or contains many waters of the United States. Furthermore, the 45 day period will not start until the delineation has been submitted to or completed by the Corps, where appropriate;

(5) If the proposed activity will result in the loss of greater than 1/10 acre of wetlands and a PCN is required, the prospective permittee must submit a statement describing how the mitigation requirement will be satisfied. As an alternative, the prospective permittee may submit a conceptual or detailed mitigation plan.

(6) If any listed species or designated critical habitat might be affected or is in the vicinity of the project, or if the project is located in designated critical habitat, for non-Federal applicants the PCN must include the name(s) of those endangered or threatened species that might be affected by the proposed work or utilize the designated critical habitat that may be affected by the proposed work. Federal applicants must provide documentation demonstrating compliance with the Endangered Species Act; and

(7) For an activity that may affect a historic property listed on, determined to be eligible for listing on, or potentially eligible for listing on, the National Register of Historic Places, for non-Federal applicants the PCN must state which historic property may be affected by the proposed work or include a vicinity map indicating the location of the historic property. Federal applicants must provide documentation demonstrating compliance with Section 106 of the National Historic Preservation Act.

(c) Form of Pre-Construction Notification: The standard individual permit application form (Form ENG 4345) may be used, but the completed application form must clearly indicate that it is a PCN and must include all of the information required in paragraphs (b)(1) through (7) of this general condition. A letter containing the required information may also be used.

(d) Agency Coordination: (1) The district engineer will consider any comments from Federal and state agencies concerning the proposed activity's compliance with the terms and conditions of the NWPs and the need for mitigation to reduce the project's adverse environmental effects to a minimal level.

(2) For all NWP 48 activities requiring pre-construction notification and for other NWP activities requiring pre-construction notification to the district engineer that result in the loss of greater than 1/2-acre of waters of the United States, the district engineer will immediately provide (e.g., via facsimile transmission, overnight mail, or other expeditious manner) a copy of the PCN to the appropriate Federal or state offices (U.S. FWS, state natural resource or water quality agency, EPA, State Historic Preservation Officer (SHPO) or Tribal Historic Preservation Office (THPO), and, if appropriate, the NMFS). With the exception of NWP 37, these agencies will then have 10 calendar days from the date the material is transmitted to telephone or fax the district engineer notice that they intend to provide substantive, site-specific comments. If so contacted by an agency, the district engineer will wait an additional 15 calendar days before making a decision on the pre-construction notification. The district engineer will fully consider agency comments received within the specified time frame, but will provide no response to the resource agency, except as provided below. The district engineer will indicate in the administrative record associated with each pre-construction notification that the resource agencies' concerns were considered. For NWP 37, the emergency watershed protection and rehabilitation activity may proceed immediately in cases where there is an unacceptable hazard to life or a significant loss of property or economic hardship will occur. The district engineer will consider any comments received to decide whether the NWP 37 authorization should be modified, suspended, or revoked in accordance with the procedures at 33 CFR 330.5.

(3) In cases of where the prospective permittee is not a Federal agency, the district engineer will provide a response to NMFS within 30 calendar days of receipt of any Essential Fish Habitat conservation recommendations, as required by Section 305(b)(4)(B) of the Magnuson-Stevens Fishery Conservation and Management Act.

(4) Applicants are encouraged to provide the Corps multiple copies of pre-construction notifications to expedite agency coordination.

(5) For NWP 48 activities that require reporting, the district engineer will provide a copy of each report within 10 calendar days of receipt to the appropriate regional office of the NMFS.

(e) District Engineer's Decision: In reviewing the PCN for the proposed activity, the district engineer will determine whether the activity authorized by the NWP will result in more than minimal individual or cumulative adverse environmental effects or may be contrary to the public interest. If the proposed activity requires a PCN and will result in a loss of greater than 1/10 acre of wetlands, the prospective permittee should submit a mitigation proposal with the PCN. Applicants may also propose compensatory mitigation for projects with smaller impacts. The district engineer will consider any proposed compensatory mitigation the applicant has included in the proposal in determining whether the net adverse environmental effects to the aquatic environment of the proposed work are minimal. The compensatory mitigation proposal may be either conceptual or detailed. If the district engineer determines that the activity complies with the terms and conditions of the NWP and that the adverse effects on the aquatic environment are minimal, after considering mitigation, the district engineer will notify the permittee and include any conditions the district engineer deems necessary. The district engineer must approve any compensatory mitigation proposal before the permittee commences work. If the prospective permittee elects to submit a compensatory mitigation plan with the PCN, the district engineer will expeditiously review the proposed compensatory mitigation plan. The district engineer must review the plan within 45 calendar days of receiving a complete PCN and determine whether the proposed mitigation would ensure no more than minimal adverse effects on the aquatic environment. If the net adverse effects of the project on the aquatic environment

(after consideration of the compensatory mitigation proposal) are determined by the district engineer to be minimal, the district engineer will provide a timely written response to the applicant. The response will state that the project can proceed under the terms and conditions of the NWP.

If the district engineer determines that the adverse effects of the proposed work are more than minimal, then the district engineer will notify the applicant either: (1) That the project does not qualify for authorization under the NWP and instruct the applicant on the procedures to seek authorization under an individual permit; (2) that the project is authorized under the NWP subject to the applicant's submission of a mitigation plan that would reduce the adverse effects on the aquatic environment to the minimal level; or (3) that the project is authorized under the NWP with specific modifications or conditions. Where the district engineer determines that mitigation is required to ensure no more than minimal adverse effects occur to the aquatic environment, the activity will be authorized within the 45-day PCN period. The authorization will include the necessary conceptual or specific mitigation or a requirement that the applicant submit a mitigation plan that would reduce the adverse effects on the aquatic environment to the minimal level. When mitigation is required, no work in waters of the United States may occur until the district engineer has approved a specific mitigation plan.

28. Single and Complete Project. The activity must be a single and complete project. The same NWP cannot be used more than once for the same single and complete project.

### **FURTHER INFORMATION**

1. District Engineers have authority to determine if an activity complies with the terms and conditions of an NWP.
2. NWPs do not obviate the need to obtain other federal, state, or local permits, approvals, or authorizations required by law.
3. NWPs do not grant any property rights or exclusive privileges.
4. NWPs do not authorize any injury to the property or rights of others.
5. NWPs do not authorize interference with any existing or proposed Federal project.

### **DEFINITIONS**

Best management practices (BMPs): Policies, practices, procedures, or structures implemented to mitigate the adverse environmental effects on surface water quality resulting from development. BMPs are categorized as structural or non-structural.

Compensatory mitigation: The restoration, establishment (creation), enhancement, or preservation of aquatic resources for the purpose of compensating for unavoidable adverse impacts which remain after all appropriate and practicable avoidance and minimization has been achieved.

Currently serviceable: Useable as is or with some maintenance, but not so degraded as to essentially require reconstruction.

Discharge: The term "discharge" means any discharge of dredged or fill material.

Enhancement: The manipulation of the physical, chemical, or biological characteristics of an aquatic resource to heighten, intensify, or improve a specific aquatic resource function(s). Enhancement results in the gain of selected aquatic resource function(s), but may also lead to a

decline in other aquatic resource function(s). Enhancement does not result in a gain in aquatic resource area.

*Ephemeral stream*: An ephemeral stream has flowing water only during, and for a short duration after, precipitation events in a typical year. Ephemeral stream beds are located above the water table year-round. Groundwater is not a source of water for the stream. Runoff from rainfall is the primary source of water for stream flow.

*Establishment (creation)*: The manipulation of the physical, chemical, or biological characteristics present to develop an aquatic resource that did not previously exist at an upland site. Establishment results in a gain in aquatic resource area.

*Historic Property*: Any prehistoric or historic district, site (including archaeological site), building, structure, or other object included in, or eligible for inclusion in, the National Register of Historic Places maintained by the Secretary of the Interior. This term includes artifacts, records, and remains that are related to and located within such properties. The term includes properties of traditional religious and cultural importance to an Indian tribe or Native Hawaiian organization and that meet the National Register criteria (36 CFR part 60).

*Independent utility*: A test to determine what constitutes a single and complete project in the Corps regulatory program. A project is considered to have independent utility if it would be constructed absent the construction of other projects in the project area. Portions of a multi-phase project that depend upon other phases of the project do not have independent utility. Phases of a project that would be constructed even if the other phases were not built can be considered as separate single and complete projects with independent utility.

*Intermittent stream*: An intermittent stream has flowing water during certain times of the year, when groundwater provides water for stream flow. During dry periods, intermittent streams may not have flowing water. Runoff from rainfall is a supplemental source of water for stream flow.

*Loss of waters of the United States*: Waters of the United States that are permanently adversely affected by filling, flooding, excavation, or drainage because of the regulated activity. Permanent adverse effects include permanent discharges of dredged or fill material that change an aquatic area to dry land, increase the bottom elevation of a waterbody, or change the use of a waterbody. The acreage of loss of waters of the United States is a threshold measurement of the impact to jurisdictional waters for determining whether a project may qualify for an NWP; it is not a net threshold that is calculated after considering compensatory mitigation that may be used to offset losses of aquatic functions and services. The loss of stream bed includes the linear feet of stream bed that is filled or excavated. Waters of the United States temporarily filled, flooded, excavated, or drained, but restored to pre-construction contours and elevations after construction, are not included in the measurement of loss of waters of the United States. Impacts resulting from activities eligible for exemptions under Section 404(f) of the Clean Water Act are not considered when calculating the loss of waters of the United States.

*Non-tidal wetland*: A non-tidal wetland is a wetland that is not subject to the ebb and flow of tidal waters. The definition of a wetland can be found at 33 CFR 328.3(b). Non-tidal wetlands contiguous to tidal waters are located landward of the high tide line (i.e., spring high tide line).

*Open water*: For purposes of the NWPs, an open water is any area that in a year with normal patterns of precipitation has water flowing or standing above ground to the extent that an ordinary high water mark can be determined. Aquatic vegetation within the area of standing or

flowing water is either non-emergent, sparse, or absent. Vegetated shallows are considered to be open waters. Examples of “open waters” include rivers, streams, lakes, and ponds.

Ordinary High Water Mark: An ordinary high water mark is a line on the shore established by the fluctuations of water and indicated by physical characteristics, or by other appropriate means that consider the characteristics of the surrounding areas (see 33 CFR 328.3(e)).

Perennial stream: A perennial stream has flowing water year-round during a typical year. The water table is located above the stream bed for most of the year. Groundwater is the primary source of water for stream flow. Runoff from rainfall is a supplemental source of water for stream flow.

Practicable: Available and capable of being done after taking into consideration cost, existing technology, and logistics in light of overall project purposes.

Pre-construction notification: A request submitted by the project proponent to the Corps for confirmation that a particular activity is authorized by nationwide permit. The request may be a permit application, letter, or similar document that includes information about the proposed work and its anticipated environmental effects. Pre-construction notification may be required by the terms and conditions of a nationwide permit, or by regional conditions. A pre-construction notification may be voluntarily submitted in cases where pre-construction notification is not required and the project proponent wants confirmation that the activity is authorized by nationwide permit.

Preservation: The removal of a threat to, or preventing the decline of, aquatic resources by an action in or near those aquatic resources. This term includes activities commonly associated with the protection and maintenance of aquatic resources through the implementation of appropriate legal and physical mechanisms. Preservation does not result in a gain of aquatic resource area or functions.

Re-establishment: The manipulation of the physical, chemical, or biological characteristics of a site with the goal of returning natural/historic functions to a former aquatic resource. Re-establishment results in rebuilding a former aquatic resource and results in a gain in aquatic resource area.

Rehabilitation: The manipulation of the physical, chemical, or biological characteristics of a site with the goal of repairing natural/historic functions to a degraded aquatic resource. Rehabilitation results in a gain in aquatic resource function, but does not result in a gain in aquatic resource area.

Restoration: The manipulation of the physical, chemical, or biological characteristics of a site with the goal of returning natural/historic functions to a former or degraded aquatic resource. For the purpose of tracking net gains in aquatic resource area, restoration is divided into two categories: re-establishment and rehabilitation.

Riffle and pool complex: Riffle and pool complexes are special aquatic sites under the 404(b)(1) Guidelines. Riffle and pool complexes sometimes characterize steep gradient sections of streams. Such stream sections are recognizable by their hydraulic characteristics. The rapid movement of water over a coarse substrate in riffles results in a rough flow, a turbulent surface, and high dissolved oxygen levels in the water. Pools are deeper areas associated with riffles. A slower stream velocity, a streaming flow, a smooth surface, and a finer substrate characterize pools.

Riparian areas: Riparian areas are lands adjacent to streams, lakes, and estuarine-marine shorelines. Riparian areas are transitional between terrestrial and aquatic ecosystems, through

which surface and subsurface hydrology connects waterbodies with their adjacent uplands. Riparian areas provide a variety of ecological functions and services and help improve or maintain local water quality. (See general condition 20.)

*Shellfish seeding:* The placement of shellfish seed and/or suitable substrate to increase shellfish production. Shellfish seed consists of immature individual shellfish or individual shellfish attached to shells or shell fragments (i.e., spat on shell). Suitable substrate may consist of shellfish shells, shell fragments, or other appropriate materials placed into waters for shellfish habitat.

*Single and complete project:* The term “single and complete project” is defined at 33 CFR 330.2(i) as the total project proposed or accomplished by one owner/developer or partnership or other association of owners/developers. A single and complete project must have independent utility (see definition). For linear projects, a “single and complete project” is all crossings of a single water of the United States (i.e., a single waterbody) at a specific location. For linear projects crossing a single waterbody several times at separate and distant locations, each crossing is considered a single and complete project. However, individual channels in a braided stream or river, or individual arms of a large, irregularly shaped wetland or lake, etc., are not separate waterbodies, and crossings of such features cannot be considered separately.

*Stormwater management:* Stormwater management is the mechanism for controlling stormwater runoff for the purposes of reducing downstream erosion, water quality degradation, and flooding and mitigating the adverse effects of changes in land use on the aquatic environment.

*Stormwater management facilities:* Stormwater management facilities are those facilities, including but not limited to, stormwater retention and detention ponds and best management practices, which retain water for a period of time to control runoff and/or improve the quality (i.e., by reducing the concentration of nutrients, sediments, hazardous substances and other pollutants) of stormwater runoff.

*Stream bed:* The substrate of the stream channel between the ordinary high water marks. The substrate may be bedrock or inorganic particles that range in size from clay to boulders. Wetlands contiguous to the stream bed, but outside of the ordinary high water marks, are not considered part of the stream bed.

*Stream channelization:* The manipulation of a stream’s course, condition, capacity, or location that causes more than minimal interruption of normal stream processes. A channelized stream remains a water of the United States.

*Structure:* An object that is arranged in a definite pattern of organization. Examples of structures include, without limitation, any pier, boat dock, boat ramp, wharf, dolphin, weir, boom, breakwater, bulkhead, revetment, riprap, jetty, artificial island, artificial reef, permanent mooring structure, power transmission line, permanently moored floating vessel, piling, aid to navigation, or any other manmade obstacle or obstruction.

*Tidal wetland:* A tidal wetland is a wetland (i.e., water of the United States) that is inundated by tidal waters. The definitions of a wetland and tidal waters can be found at 33 CFR 328.3(b) and 33 CFR 328.3(f), respectively. Tidal waters rise and fall in a predictable and measurable rhythm or cycle due to the gravitational pulls of the moon and sun. Tidal waters end where the rise and fall of the water surface can no longer be practically measured in a predictable rhythm due to masking by other waters, wind, or other effects. Tidal wetlands are located channelward of the high tide line, which is defined at 33 CFR 328.3(d).

Vegetated shallows: Vegetated shallows are special aquatic sites under the 404(b)(1) Guidelines. They are areas that are permanently inundated and under normal circumstances have rooted aquatic vegetation, such as seagrasses in marine and estuarine systems and a variety of vascular rooted plants in freshwater systems.

Waterbody: For purposes of the NWP, a waterbody is a jurisdictional water of the United States that, during a year with normal patterns of precipitation, has water flowing or standing above ground to the extent that an ordinary high water mark (OHWM) or other indicators of jurisdiction can be determined, as well as any wetland area (see 33 CFR 328.3(b)). If a jurisdictional wetland is adjacent--meaning bordering, contiguous, or neighboring--to a jurisdictional waterbody displaying an OHWM or other indicators of jurisdiction, that waterbody and its adjacent wetlands are considered together as a single aquatic unit (see 33 CFR 328.4(c)(2)). Examples of "waterbodies" include streams, rivers, lakes, ponds, and wetlands.



## **REGIONAL CONDITIONS FOR NATIONWIDE PERMITS IN THE WILMINGTON DISTRICT**

### **1.0 Excluded Waters**

The Corps has identified waters that will be excluded from the use of all NWP's during certain timeframes. These waters are:

#### **1.1. Anadromous Fish Spawning Areas**

Waters of the United States identified by either the North Carolina Division of Marine Fisheries (NCDMF) or the North Carolina Wildlife Resources Commission (NCWRC) as anadromous fish spawning areas are excluded during the period between February 15 and June 30, without prior written approval from NCDMF or NCWRC and the Corps.

#### **1.2. Trout Waters Moratorium**

Waters of the United States in the twenty-five designated trout counties of North Carolina are excluded during the period between October 15 and April 15 without prior written approval from the NCWRC. (see Section I. b. 7. for a list of the twenty-five trout counties).

#### **1.3. Sturgeon Spawning Areas**

Waters of the United States designated as sturgeon spawning areas are excluded during the period between February 1 and June 30, without prior written approval from the National Marine Fisheries Service (NMFS).

### **2.0 Waters Requiring Additional Notification**

The Corps has identified waters that will be subject to additional notification requirements for activities authorized by all NWP's. These waters are:

#### **2.1. Western NC Counties that Drain to Designated Critical Habitat**

Waters of the U.S. that requires a Pre-Construction Notification pursuant to General Condition 27 (PCN) and located in the sixteen counties listed below, applicants must provide a copy of the PCN to the US Fish and Wildlife Service, 160 Zillicoa Street, Asheville, North Carolina 28805. This PCN must be sent concurrently to the US Fish and Wildlife Service and the Corps Asheville Regulatory Field Office. Please see General Condition 17 for specific notification requirements related to Federally Endangered Species and the following website for information on the location of designated critical habitat.

Counties with tributaries that drain to designated critical habitat that require notification to the Asheville US Fish and Wildlife Service: Avery, Cherokee, Forsyth, Graham, Haywood,

Henderson, Jackson, Macon Mecklenburg, Mitchell, Stokes, Surry, Swain, Transylvania, Union and Yancey.

Website and office addresses for Endangered Species Act Information:

The Wilmington District has developed the following website for applicants which provide guidelines on how to review linked websites and maps in order to fulfill NWP general condition 17 requirements.

<http://www.saw.usace.army.mil/wetlands/ESA>

Applicants who do not have internet access may contact the appropriate US Fish and Wildlife Service offices or the US Army Corps of Engineers office listed below.

US Fish and Wildlife Service  
Asheville Field Office  
160 Zillicoa Street  
Asheville, NC 28801  
Telephone: (828) 258-3939

Asheville US Fish and Wildlife Service Office counties: All counties west of and including Anson, Stanly, Davidson, Forsyth and Stokes Counties

US Fish and Wildlife Service  
Raleigh Field Office  
Post Office Box 33726  
Raleigh, NC 27636-3726  
Telephone: (919) 856-4520

Raleigh US Fish and Wildlife Service Office counties: all counties east of and including Richmond, Montgomery, Randolph, Guilford, and Rockingham Counties.

## **2.2. Special Designation Waters**

Prior to the use of any NWP in any of the following North Carolina identified waters and contiguous wetlands, applicants must comply with Nationwide Permit General Condition 27 (PCN). The North Carolina waters and contiguous wetlands that require additional notification requirements are:

“Outstanding Resource Waters” (ORW) and “High Quality Waters” (HQW) (as designated by the North Carolina Environmental Management Commission), or  
“Inland Primary Nursery Areas” (IPNA) (as designated by the North Carolina Wildlife Resources Commission), or “Contiguous Wetlands” (as defined by the North Carolina Environmental Management Commission), or “Primary Nursery Areas” (PNA) (as designated by the North Carolina Marine Fisheries Commission).

### 2.3. Coastal Area Management Act (CAMA) Areas of Environmental Concern

Non-Federal applicants for any NWP in a designated “Area of Environmental Concern” (AEC) in the twenty (20) counties of Eastern North Carolina covered by the North Carolina Coastal Area Management Act (CAMA), must also obtain the required CAMA permit. Construction activities for non-Federal projects may not commence until a copy of the approved CAMA permit is furnished to the appropriate Wilmington District Regulatory Field Office (Wilmington Field Office – P.O. Box 1890, Wilmington, NC 28402 or Washington Field Office – P.O. Box 1000, Washington, NC 27889).

### 2.4. Barrier Islands

Prior to the use of any NWP on a barrier island of North Carolina, applicants must comply with Nationwide Permit General Condition 27 (PCN).

### 2.5. Mountain or Piedmont Bogs

Prior to the use of any NWP in a “Mountain or Piedmont Bog” of North Carolina, applicants shall comply with Nationwide Permit General Condition 27 (PCN).

Note: The following wetland community types identified in the N.C. Natural Heritage Program document, “Classification of Natural communities of North Carolina (Michael P. Schafale and Alan S. Weakley, 1990), are subject to this regional condition.

Mountain Bogs	Piedmont Bogs
Swamp Forest-Bog Complex	Upland depression Swamp Forest
Swamp Forest-Bog Complex (Spruce Subtype)	
Southern Appalachian Bog (Northern Subtype)	
Southern Appalachian Bog (Southern Subtype)	
Southern Appalachian Fen	

### 2.6. Animal Waste Facilities

Prior to use of any NWP for construction of animal waste facilities in waters of the US, including wetlands, applicants shall comply with Nationwide Permit General Condition 27 (PCN).

### 2.7. Trout Waters

Prior to any discharge of dredge or fill material into streams or waterbodies within the twenty-five (25) designated trout counties of North Carolina, the applicant shall comply with

Nationwide Permit General Condition 27 (PCN). The applicant shall also provide a copy of the notification to the appropriate NCWRC office to facilitate the determination of any potential impacts to designated Trout Waters. Notification to the Corps of Engineers will include a statement with the name of the NCWRC biologist contacted, the date of the notification, the location of work, a delineation of wetlands, a discussion of alternatives to working in the mountain trout waters, why alternatives were not selected, and a plan to provide compensatory mitigation for all unavoidable adverse impacts to mountain trout waters.

#### NCWRC and NC Trout Counties

Mr. Ron Linville			
Western Piedmont Region Coordinator	Alleghany	Caldwell	Watauga
3855 Idlewild Road	Ashe	Mitchell	Wilkes
Kernersville, NC 27284-9180	Avery	Stokes	
Telephone: (336) 769-9453	Burke	Surry	

Mr. Dave McHenry			
Mountain Region Coordinator	Buncombe	Henderson	Polk
20830 Great Smoky Mtn. Expressway	Cherokee	Jackson	Rutherford
Waynesville, NC 28786	Clay	Macon	Swain
Telephone: (828) 452-2546	Graham	Madison	Transylvania
Fax: (828) 452-7772	Haywood	McDowell	Yancey

### 3.0 List of Corps Regional Conditions for All Nationwide Permits

The following conditions apply to all Nationwide Permits in the Wilmington District:

#### 3.1. Limitation of Loss of Perennial Stream Bed

NWPs may not be used for activities that may result in the loss or degradation of greater than 300 total linear feet of perennial streams. The NWPs may not be used for activities that may result in the loss or degradation of greater than 300 total linear feet of ephemeral and intermittent streams that exhibit important aquatic function(s)\* Loss of stream includes the linear feet of stream bed that is filled, excavated, or flooded by the proposed activity. The District Commander can waive the 300 linear foot limit for ephemeral and intermittent streams on a case-by-case basis if he determines that the proposed activity will result in minimal individual and cumulative adverse impacts to the aquatic environment. Waivers for the loss of ephemeral and intermittent streams must be in writing. This waiver only applies to the 300 linear feet threshold for NWPs. Mitigation may still be required for impacts to ephemeral and intermittent streams, on a case-by-case basis, depending on the impacts to the aquatic environment of the proposed project. [\*Note: The Corps uses the Stream Quality Assessment Worksheet, located with Permit Information on the Regulatory Program Web Site, to aid in the determination of aquatic function within the intermittent stream channel.]

### **3.2. Mitigation for Loss of Stream Bed Exceeding 150 Feet.**

For any NWP that results in a loss of more than 150 linear feet of perennial and/or ephemeral/intermittent stream, the applicant shall provide a mitigation proposal to compensate for the loss of aquatic function associated with the proposed activity. For stream losses less than 150 linear feet, that require a PCN, the District Commander may determine, on a case-by-case basis that compensatory mitigation is required to ensure that the activity results in minimal adverse effect on the aquatic environment.

### **3.3. Pre-construction Notification for Loss of Streambed Exceeding 150 Feet.**

Prior to use of any NWP for any activity which impacts more than 150 total linear feet of perennial stream or ephemeral/ intermittent stream, the applicant must comply with Nationwide Permit General Condition 27 (PCN). This applies to NWPs that do not have specific notification requirements. If a NWP has specific notification requirements, the requirements of the NWP should be followed.

### **3.4. Restriction on Use of Live Concrete**

For all NWPs which allow the use of concrete as a building material, measures will be taken to prevent live or fresh concrete, including bags of uncured concrete, from coming into contact with waters of the state until the concrete has hardened.

### **3.5. Requirements for Using Riprap for Bank Stabilization**

For all NWPs that allow for the use of riprap material for bank stabilization, the following measures shall be applied:

**3.5.1.** Filter cloth must be placed underneath the riprap as an additional requirement of its use in North Carolina waters.

**3.5.2.** The placement of riprap shall be limited to the areas depicted on submitted work plan drawings.

**3.5.3.** The riprap material shall be clean and free from loose dirt or any pollutant except in trace quantities that would not have an adverse environmental effect.

**3.5.4.** It shall be of a size sufficient to prevent its movement from the authorized alignment by natural forces under normal conditions.

**3.5.5.** The riprap material shall consist of clean rock or masonry material such as, but not limited to, granite, marl, or broken concrete.

**3.5.6.** A waiver from the specifications in this Regional Condition may be requested in writing. The waiver will only be issued if it can be demonstrated that the impacts of complying with this Regional condition would result in greater adverse impacts to the aquatic environment.

### **3.6. Safe Passage Requirements for Culvert Placement**

For all NWP's that involve the construction/installation of culverts, measures will be included in the construction/installation that will promote the safe passage of fish and other aquatic organisms. The dimension, pattern, and profile of the stream above and below a pipe or culvert should not be modified by widening the stream channel or by reducing the depth of the stream in connection with the construction activity. The width, height, and gradient of a proposed opening should be such as to pass the average historical low flow and spring flow without adversely altering flow velocity. Spring flow should be determined from gage data, if available. In the absence of such data, bankfull flow can be used as a comparable level.

In the twenty (20) counties of North Carolina designated as coastal counties by the Coastal Area Management Act (CAMA): All pipe and culvert bottoms shall be buried at least one foot below normal bed elevation when they are placed within the Public Trust Area of Environmental Concern (AEC) and/or the Estuarine Waters AEC as designated by CAMA, and/or all streams appearing as blue lines on United States Geological Survey (USGS) quad sheets.

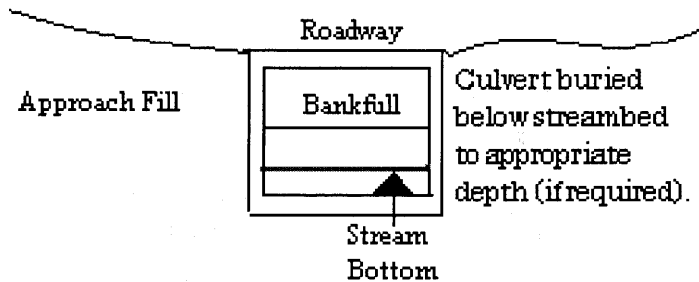

In all other counties: Culverts greater than 48 inches in diameter will be buried at least one foot below the bed of the stream. Culverts 48 inches in diameter or less shall be buried or placed on the stream bed as practicable and appropriate to maintain aquatic passage, and every effort shall be made to maintain the existing channel slope. The bottom of the culvert must be placed at a depth below the natural stream bottom to provide for passage during drought or low flow conditions.

Destabilizing the channel and head cutting upstream should be considered in the placement of the culvert.

A waiver from the depth specifications in this condition may be requested in writing. The waiver will be issued if it can be demonstrated that the proposal would result in the least impacts to the aquatic environment.

All counties: Culverts placed in wetlands do not have to be buried.

### **3.7. Notification to NCDENR Shellfish Sanitation Section**

Applicants shall notify the NCDENR Shellfish Sanitation Section prior to dredging in or removing sediment from an area closed to shell fishing where the effluent may be released to an area open for shell fishing or swimming in order to avoid contamination from the disposal area and cause a temporary shellfish closure to be made. Such notification shall also be provided to the appropriate Corps of Engineers Regulatory Field Office. Any disposal of sand to the ocean beach should occur between November 1 and April 30 when recreational usage is low. Only clean sand should be used and no dredged sand from closed shell fishing areas may be used. If beach disposal were to occur at times other than stated above or if sand from a closed shell fishing area is to be used, a swimming advisory shall be posted, and a press release shall be issued.

### **3.8. Preservation of Submerged Aquatic Vegetation**

Adverse impacts to Submerged Aquatic Vegetation (SAV) are not authorized by any NWP within any of the twenty coastal counties defined by North Carolina's Coastal Area Management Act of 1974 (CAMA).

### **4.0 Additional Regional Conditions for Specific Nationwide Permits**

#### **4.1 The following regional condition is required for NWP #23 – Approved Categorical Exclusions**

No development activities authorized by this NWP may begin until the permittee obtains a consistency determination or a CAMA permit from the North Carolina Division of Coastal Management, if either required.

## **NC DIVISION OF WATER QUALITY - GENERAL CERTIFICATION CONDITIONS**

For the most recent General Certification conditions, call the NC Division of Water Quality, Wetlands/401 Certification Unit at (919) 733-1786 or access the following website:  
<http://h2o.enr.state.nc.us/ncwetlands/certs.html>

## **NC DIVISION OF COASTAL MANAGEMENT - STATE CONSISTENCY**

In a letter dated May 7, 2007, the North Carolina Division of Coastal Management found this NWP consistent with the North Carolina Coastal Zone Management Program. Updates on CAMA Consistency for NC can be found on the NC DCM web site at:  
<http://dcm2.enr.state.nc.us/Permits/consist.htm>

## **EASTERN BAND OF THE CHEROKEE INDIANS TRIBAL WATER QUALITY CERTIFICATIONS**

In a letter dated May 8, 2007, US EPA, on behalf of the Eastern Band of Cherokee Indians, provided Tribal General Conditions for Nationwide Permits on Cherokee Indian Reservation. These Tribal General Conditions are located on the Corps website at:  
<http://www.saw.usace.army.mil/WETLANDS/NWP2007/EBCI-certs.html>

### **Citations:**

2007 Nationwide Permits Public Notice for Final Issue Date: March 15, 2007

Correction Notice for Nationwide Permits, Federal Register / Vol. 72, No. 88 / Tuesday, May 8, 2007 / Notices p.26082

2007 SAW Regional Conditions – Authorized June 1, 2007

This and other information can be found on the Corps web site at:  
<http://www.saw.usace.army.mil/WETLANDS/NWP2007/nationwide-permits.html>



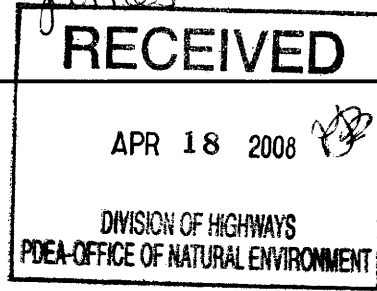
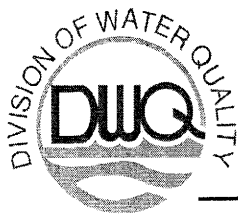

April 16, 2008  
 Wayne County  
 DWQ Project No. 20080669  
 Bridge 35 on SR 1532  
 TIP No. B-4671

**APPROVAL of 401 WATER QUALITY CERTIFICATION and NEUSE BUFFER AUTHORIZATION, with ADDITIONAL CONDITIONS**

Dr. Gregory J. Thorpe, Ph.D., Environmental Management Director  
 NCDOT, PDEA  
 1598 Mail Service Center  
 Raleigh, NC 27699-1598

Dear Dr. Thorpe:

You have our approval, in accordance with the conditions listed below, for the following impacts for the purpose of replacing Bridge 35 in Wayne County:

**Wetland Impacts in the Neuse River Basin**

Site	Permanent Fill (ac)	Fill (temporary) (ac)	Hand Clearing (ac)	Total Wetland Impact (ac)
1	0.03	0.03	0.07	0.13
2	0.01	0.03	0.05	0.09
<b>Total</b>	<b>0.04</b>	<b>0.06</b>	<b>0.12</b>	<b>0.22</b>

**Total Wetland Impact for Project: 0.22 acres.**

**Neuse Riparian Buffer Impacts**

Site	Zone 1 Impact (sq ft)	minus Wetlands in Zone 1 (sq ft)	= Zone 1 Buffers (not wetlands) (sq ft)	Zone 1 Buffer Mitigation Required (using 3:1 ratio)	Zone 2 Impact (sq ft)	minus Wetlands in Zone 2 (sq ft)	= Zone 2 Buffers (not wetlands) (sq ft)	Zone 2 Buffer Mitigation Required (using 1.5:1 ratio)
1	1779	0	1779	N/A	2027	0	2027	N/A
<b>Totals</b>	<b>1779</b>	<b>0</b>	<b>1779</b>	<b>0</b>	<b>2027</b>	<b>0</b>	<b>2027</b>	<b>0</b>

\* n/a = Total for Site is less than 1/3 acre and 150 linear feet of impact, no mitigation required

**Total Buffer Impact for Project: 3,806 square feet.**

The project shall be constructed in accordance with your application dated received April 10, 2008. After reviewing your application, we have decided that these impacts are covered by General Water Quality Certification Number 3701 and 3688. This certification corresponds to the Nationwide Permit 23 and Nationwide Permit 33 issued by the Corps of Engineers. This approval is also valid for the Neuse Riparian Buffer Rules (15A NCAC 2B.0233). In addition, you should acquire any other federal, state or local permits before you proceed with your project including (but not limited to) Sediment and Erosion Control, Non-Discharge and Water Supply Watershed regulations. This approval will expire with the accompanying 404 permit.



This approval is valid solely for the purpose and design described in your application (unless modified below). Should your project change, you must notify the DWQ and submit a new application. If the property is sold, the new owner must be given a copy of this Certification and approval letter, and is thereby responsible for complying with all the conditions. If total wetland fills for this project (now or in the future) exceed one acre, or of total impacts to streams (now or in the future) exceed 150 linear feet, compensatory mitigation may be required as described in 15A NCAC 2H .0506 (h) (6) and (7). For this approval to remain valid, you must adhere to the conditions listed in the attached certification as well as those listed below:

**Conditions of Certification:**

1. Strict adherence to the most recent version of NCDOT's Best Management Practices For Bridge Demolition and Removal approved by the US Army Corps of Engineers is a condition of the 401 Water Quality Certification.
2. Bridge deck drains shall not discharge directly into the stream. Stormwater shall be directed across the bridge and pre-treated through site-appropriate means (grassed swales, pre-formed scour holes, vegetated buffers, etc.) before entering the stream. Please refer to the most current version of *Stormwater Best Management Practices*.
3. All riparian buffers impacted by the placement of temporary fill or clearing activities shall be restored to the preconstruction contours and revegetated. Maintained buffers shall be permanently revegetated with non-woody species by the end of the growing season following completion of construction. For the purpose of this condition, maintained buffer areas are defined as areas within the transportation corridor that will be subject to regular DOT maintenance activities including mowing. The area with non-maintained buffers shall be permanently revegetated, with native woody species before the next growing season following completion of construction.
4. Pursuant to NCAC15A 2B.0233(6), sediment and erosion control devices shall not be placed in Zone 1 of any Neuse Buffer without prior approval by the NCDWQ. At this time, the NCDWQ has approved no sediment and erosion control devices in Zone 1, outside of the approved project impacts, anywhere on this project. Moreover, sediment and erosion control devices shall be allowed in Zone 2 of the buffers provided that Zone 1 is not compromised and that discharge is released as diffuse flow.
5. All stormwater runoff shall be directed as sheetflow through stream buffers at nonerosive velocities, unless otherwise approved by this certification.
6. If concrete is used during construction, a dry work area shall be maintained to prevent direct contact between curing concrete and stream water. Water that inadvertently contacts uncured concrete shall not be discharged to surface waters due to the potential for elevated pH and possible aquatic life and fish kills.
7. During the construction of the project, no staging of equipment of any kind is permitted in waters of the U.S., or protected riparian buffers.
8. The dimension, pattern and profile of the stream above and below the crossing shall not be modified. Disturbed floodplains and streams shall be restored to natural geomorphic conditions.
9. The use of rip-rap above the Normal High Water Mark shall be minimized. Any rip-rap placed for stream stabilization shall be placed in stream channels in such a manner that it does not impede aquatic life passage.
10. The Permittee shall ensure that the final design drawings adhere to the permit and to the permit drawings submitted for approval.
11. Heavy equipment shall be operated from the banks rather than in the stream channel in order to minimize sedimentation and reduce the introduction of other pollutants into the stream.



12. All work in or adjacent to stream waters shall be conducted in a dry work area. Approved BMP measures from the most current version of NCDOT Construction and Maintenance Activities manual such as sandbags, rock berms, cofferdams and other diversion structures shall be used to prevent excavation in flowing water.
13. All mechanized equipment operated near surface waters must be regularly inspected and maintained to prevent contamination of stream waters from fuels, lubricants, hydraulic fluids, or other toxic materials.
14. No rock, sand or other materials shall be dredged from the stream channel except where authorized by this certification.
15. Discharging hydroseed mixtures and washing out hydroseeders and other equipment in or adjacent to surface waters is prohibited.
16. The permittee and its authorized agents shall conduct its activities in a manner consistent with State water quality standards (including any requirements resulting from compliance with §303(d) of the Clean Water Act) and any other appropriate requirements of State and Federal law. If DWQ determines that such standards or laws are not being met (including the failure to sustain a designated or achieved use) or that State or federal law is being violated, or that further conditions are necessary to assure compliance, DWQ may reevaluate and modify this certification.
17. All fill slopes located in jurisdictional wetlands shall be placed at slopes no flatter than 3:1, unless otherwise authorized by this certification.
18. A copy of this Water Quality Certification shall be maintained on site at the construction site at all times. In addition, the Water Quality Certification and all subsequent modifications, if any, shall be maintained with the Division Engineer and the on-site project manager.
19. The outside buffer, wetland or water boundary located within the construction corridor approved by this authorization shall be clearly marked by highly visible fencing prior to any land disturbing activities. Impacts to areas within the fencing are prohibited unless otherwise authorized by this certification.
20. The issuance of this certification does not exempt the Permittee from complying with any and all statutes, rules, regulations, or ordinances that may be imposed by other government agencies (i.e. local, state, and federal) having jurisdiction, including but not limited to applicable buffer rules, stormwater management rules, soil erosion and sedimentation control requirements, etc.
21. The Permittee shall report any violations of this certification to the Division of Water Quality within 24 hours of discovery.
22. Upon completion of the project (including any impacts at associated borrow or waste site), the NCDOT Division Engineer shall complete and return the enclosed "Certification of Completion Form" to notify DWQ when all work included in the 401 Certification has been completed.
23. Native woody riparian vegetation (i.e., trees and shrubs native to your geographic region) must be reestablished within the construction limits of the project by the end of the growing season following completion of construction.
24. There shall be no excavation from, or waste disposal into, jurisdictional wetlands or waters associated with this permit without appropriate modification. Should waste or borrow sites, or access roads to waste or borrow sites, be located in wetlands or streams, compensatory mitigation will be required since that is a direct impact from road construction activities.



25. Erosion and sediment control practices must be in full compliance with all specifications governing the proper design, installation and operation and maintenance of such Best Management Practices in order to protect surface waters standards:

- a. The erosion and sediment control measures for the project must be designed, installed, operated, and maintained in accordance with the most recent version of the *North Carolina Sediment and Erosion Control Planning and Design Manual*.
- b. The design, installation, operation, and maintenance of the sediment and erosion control measures must be such that they equal, or exceed, the requirements specified in the most recent version of the *North Carolina Sediment and Erosion Control Manual*. The devices shall be maintained on all construction sites, borrow sites, and waste pile (spoil) projects, including contractor-owned or leased borrow pits associated with the project.
- c. For borrow pit sites, the erosion and sediment control measures must be designed, installed, operated, and maintained in accordance with the most recent version of the *North Carolina Surface Mining Manual*.
- d. The reclamation measures and implementation must comply with the reclamation in accordance with the requirements of the Sedimentation Pollution Control Act.

26. Where placement of sediment and erosion control devices in wetlands and/or waters is unavoidable, they shall be removed and the natural grade restored upon completion of the project.

If you do not accept any of the conditions of this certification, you may ask for an adjudicatory hearing. You must act within 60 days of the date that you receive this letter. To ask for a hearing, send a written petition that conforms to Chapter 150B of the North Carolina General Statutes to the Office of Administrative Hearings, 6714 Mail Service Center, Raleigh, N.C. 27699. This certification and its conditions are final and binding unless you ask for a hearing. This letter completes the review of the Division of Water Quality under Section 401 of the Clean Water Act. If you have any questions, please contact Rob Ridings at (919) 733-9817.

Sincerely,

Coleen Sullins,  
Director

Attachments (General Certification and Certificate of Completion form)

cc: Chad Coggins, Division 4 Environmental Officer  
William Wescott, US Army Corps of Engineers, Washington Field Office  
Travis Wilson, NC Wildlife Resources Commission  
Amy James, NCDOT NEU  
File Copy

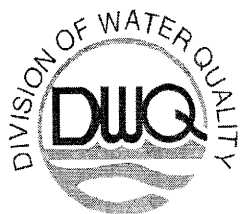

DWQ Project No.: \_\_\_\_\_ County: \_\_\_\_\_

Applicant: \_\_\_\_\_

Project Name: \_\_\_\_\_

Date of Issuance of 401 Water Quality Certification: \_\_\_\_\_

**Certificate of Completion**

Upon completion of all work approved within the 401 Water Quality Certification or applicable Buffer Rules, and any subsequent modifications, the applicant is required to return this certificate to the 401 Transportation Permitting Unit, North Carolina Division of Water Quality, 1650 Mail Service Center, Raleigh, NC, 27699-1650. This form may be returned to DWQ by the applicant, the applicant's authorized agent, or the project engineer. It is not necessary to send certificates from all of these.

**Applicant's Certification**

I, \_\_\_\_\_, hereby state that, to the best of my abilities, due care and diligence was used in the observation of the construction such that the construction was observed to be built within substantial compliance and intent of the 401 Water Quality Certification and Buffer Rules, the approved plans and specifications, and other supporting materials.

Signature: \_\_\_\_\_ Date: \_\_\_\_\_

**Agent's Certification**

I, \_\_\_\_\_, hereby state that, to the best of my abilities, due care and diligence was used in the observation of the construction such that the construction was observed to be built within substantial compliance and intent of the 401 Water Quality Certification and Buffer Rules, the approved plans and specifications, and other supporting materials.

Signature: \_\_\_\_\_ Date: \_\_\_\_\_

**Engineer's Certification**

\_\_\_\_\_ Partial \_\_\_\_\_ Final

I, \_\_\_\_\_, as a duly registered Professional Engineer in the State of North Carolina, having been authorized to observe (periodically, weekly, full time) the construction of the project, for the Permittee hereby state that, to the best of my abilities, due care and diligence was used in the observation of the construction such that the construction was observed to be built within substantial compliance and intent of the 401 Water Quality Certification and Buffer Rules, the approved plans and specifications, and other supporting materials.

Signature \_\_\_\_\_ Registration No. \_\_\_\_\_

Date \_\_\_\_\_

# Water Quality Certification N°. 3701

## **GENERAL CERTIFICATION FOR PROJECTS ELIGIBLE FOR U.S. ARMY CORPS OF ENGINEERS NATIONWIDE PERMIT NUMBER 23 (APPROVED CATEGORICAL EXCLUSIONS) AND RIPARIAN AREA PROTECTION RULES (BUFFER RULES)**

Water Quality Certification Number 3701 is issued in conformity with the requirements of Section 401, Public Laws 92-500 and 95-217 of the United States and subject to the North Carolina Division of Water Quality Regulations in 15A NCAC 2H, Section .0500 and 15A NCAC 2B .0200 for the discharge of fill material to waters and wetland areas as described in 33 CFR 330 Appendix A (B) (23) and for the Riparian Area Protection Rules (Buffer Rules) in 15A NCAC 2B .0200. The category of activities shall include only Federally-approved Categorical Exclusion projects.

The State of North Carolina certifies that the specified category of activity will not violate applicable portions of Sections 301, 302, 303, 306 and 307 of the Public Laws 92-500 and 95-217 if conducted in accordance with the conditions hereinafter set forth.

Any proposed fill or substantial modification of wetlands or waters (including streams) under this General Certification requires notification to the Division of Water Quality (the "Division"). Two (2) copies shall be submitted to the Division at the time of notification in accordance with 15A NCAC 2H .0501(a).

If any one (1) of the Conditions of Certification cannot be met, or, if the activities meet any one (1) of the following thresholds, then require *written approval* from the Division of Water Quality (the "Division") is required:

- I. Stream and/or buffer impacts:
  - a. Stream impacts equal or greater than 40 linear feet.
  - b. Any impacts to streams and/or buffers in the Neuse, Tar-Pamlico, Randleman and Catawba River Basins (or any other basins with Riparian Area Protection Rules [Buffer Rules] in effect at the time of application [in accordance with 15A NCAC 2B .0200]), *unless* the activities are listed as "EXEMPT" from these Rules.
- II. Impacts to waters of equal to or greater than one-third (1/3) of an acre.
- III. Wetland impacts:
  - a. Equal to or greater than one-third (1/3) acre East of Interstate-95.
  - b. Equal to or greater than one-tenth (1/10) acre West of Interstate-95.
  - c. Any impacts to wetlands adjacent to waters designated as: ORW, SA, WS-I, WS-II, or Trout, or wetlands contiguous to waters designated as a North Carolina or National Wild and Scenic River.
  - d. Any impacts to coastal wetlands [15A NCAC 7H .0205]], or Unique Wetlands (UWL) [15A NCAC 2H .0506].
- IV. If the activity is associated with or in response to a Notice of Violation or an enforcement action initiated by the Division and/or the Division of Land Resources.
- V. Projects with any impacts to streams, wetlands, and/or waters that have received a Notice of Violation from the Division and/or Division of Land Resources.

In accordance with North Carolina General Statute Section 143-215.3D(e), any requirement for written approval for a 401 Water Quality Certification must include the appropriate fee. If a project also requires a CAMA Permit, then one payment to both agencies shall be submitted and will be the higher of the two fees.

# Water Quality Certification N<sup>o</sup>. 3701

## Conditions of Certification:

1. No Impacts Beyond those Authorized in the Written Approval or Beyond the Thresholds for use of This Certification

No waste, spoil, solids, or fill of any kind shall occur in wetlands, waters, or riparian areas beyond the footprint of the impacts authorized in the written approval or beyond the thresholds allowed for use of this General Certification, including incidental impacts. All construction activities, including the design, installation, operation, and maintenance of sediment and erosion control Best Management Practices, shall be performed so that no violations of state water quality standards, statutes, or rules occur.

2. Standard Erosion and Sediment Control Practices

Erosion and sediment control practices must be in full compliance with all specifications governing the proper design, installation and operation and maintenance of such Best Management Practices:

- a. Design, installation, operation, and maintenance of the sediment and erosion control measures must be such that they equal, or exceed, the requirements specified in the most recent version of the *North Carolina Sediment and Erosion Control Manual*. The devices shall be maintained on all construction sites, borrow sites, and waste pile (spoil) projects, including contractor-owned or leased borrow pits associated with the project.
- b. For borrow pit sites, the erosion and sediment control measures must be designed, installed, operated, and maintained in accordance with the most recent version of the *North Carolina Surface Mining Manual*.
- c. Reclamation measures and implementation must comply with the reclamation in accordance with the requirements of the Sedimentation Pollution Control Act and the Mining Act of 1971.
- d. Sufficient materials required for stabilization and/or repair of erosion control measures and stormwater routing and treatment shall be on site at all times, except for publicly funded linear transportation projects when materials can be accessed offsite in a timely manner.
- e. If the project occurs in waters or watersheds classified as Primary Nursery Areas (PNA's), Trout (Tr), SA, WS-I, WS-II, High Quality (HQW), or Outstanding Resource (ORW) waters, then the sediment and erosion control requirements contained within *Design Standards in Sensitive Watersheds* (15A NCAC 04B .0124) supercede all other sediment and erosion control requirements.

3. No Sediment and Erosion Control Measures in Wetlands or Waters

Sediment and erosion control measures should not be placed in wetlands or waters outside of the permitted impact areas without prior written approval by the Division. If placement of sediment and erosion control devices in wetlands and waters is unavoidable, design and placement of temporary erosion control measures shall not be conducted in a manner that may result in dis-equilibrium of wetlands or stream beds or banks, adjacent to or upstream and down stream of the above structures. All sediment and erosion control devices shall be removed and the natural grade restored within two (2) months of the date that the Division of Land Resources or locally delegated program has released the project.

# Water Quality Certification N<sup>o</sup>. 3701

## 4. Construction Stormwater Permit NCG010000

Upon the approval of an Erosion and Sedimentation Control Plan issued by the Division of Land Resources (DLR) or a DLR delegated local erosion and sedimentation control program, an NPDES General stormwater permit (NCG010000) administered by the Division is automatically issued to the project. This General Permit allows stormwater to be discharged during land disturbing construction activities as stipulated by conditions in the permit. If your project is covered by this permit [applicable to construction projects that disturb one (1) or more acres], full compliance with permit conditions including the sedimentation control plan, self-monitoring, record keeping and reporting requirements are required. A copy of this permit and monitoring report forms may be found at [http://h2o.enr.state.nc.us/su/Forms\\_Documents.htm](http://h2o.enr.state.nc.us/su/Forms_Documents.htm).

NCDOT shall be required to be in full compliance with the conditions related to construction activities within the most recent version of their individual NPDES (NCS000250) stormwater permit.

## 5. Construction Moratoriums and Coordination

If activities must occur during periods of high biological activity (i.e. sea turtle or bird nesting), then biological monitoring may be required at the request of other state or federal agencies and coordinated with these activities. This condition can be waived through written concurrence on a case-by-case basis upon reasonable justification.

All moratoriums on construction activities established by the NC Wildlife Resources Commission (WRC), US Fish and Wildlife Service (USFWS), NC Division of Marine Fisheries (DMF), or National Marine Fisheries Service (NMFS) to lessen impacts on trout, anadromous fish, larval/post-larval fishes and crustaceans, or other aquatic species of concern must be obeyed. This condition can be waived through written concurrence on a case-by-case basis upon reasonable justification.

Work within the twenty-five (25) designated trout counties or identified state or federal endangered or threatened species habitat shall be coordinated with the appropriate WRC, USFWS, NMFS, and/or DMF personnel.

## 6. If concrete is used during the construction, then a dry work area should be maintained to prevent direct contact between curing concrete and stream water. Water that inadvertently contacts uncured concrete should not be discharged to surface waters due to the potential for elevated pH and possible aquatic life/fish kills.

## 7. Riparian Area Protection (Buffer) Rules

Activities located in the protected 50-foot wide riparian areas (whether jurisdictional wetlands or not) within the Neuse, Tar-Pamlico, Randleman, or Catawba River Basins (or any other basin with buffer rules), shall be limited to "uses" identified within and constructed in accordance with 15A NCAC 2B .0233, .0259, .0250, and .0243, and shall be located, designed, constructed, and maintained to have minimal disturbance to protect water quality to the maximum extent practicable through the use of best management practices. All riparian area protection rule requirements, including diffuse flow requirements, must be met.



# Water Quality Certification N<sup>o</sup>. 3701

## 8. Water Supply Watershed Buffers

The 100-foot wide (high-density development) or the 30-foot wide vegetative buffer (all other development) shall be maintained adjacent to all perennial waters except for allowances as provided in the Water Supply Watershed Protection Rules [15A NCAC 2B .0212 through .0215].

## 9. Work in the Dry

All work in or adjacent to stream waters shall be conducted in a dry work area. Approved best management practices from the most current version of the NC Sediment and Erosion Control Manual, or the NC DOT Construction and Maintenance Activities Manual, such as sandbags, rock berms, cofferdams, and other diversion structures shall be used to minimize excavation in flowing water. Channel realignments shall be constructed by excavating the new channel from downstream to upstream before connecting it to the existing channel. Exceptions to this condition require submittal to, and approval by, the Division of Water Quality.

10. For all activities requiring re-alignment of streams, a stream relocation plan must be included for written Division approval. Relocated stream designs should include the same dimensions, patterns and profiles as the existing channel (or a stable reference reach if the existing channel is unstable), to the maximum extent practical. The new channel should be constructed in the dry and water shall not be turned into the new channel until the banks are stabilized. Vegetation used for permanent bank stabilization shall be limited to native woody species, and should include establishment of a 30-foot wide wooded and an adjacent 20-foot wide vegetated buffer on both sides of the relocated channel to the maximum extent practical. A transitional phase incorporating appropriate erosion control matting materials and seedling establishment is allowable. Rip-rap, A-Jacks, concrete, gabions or other hard structures may be allowed if it is necessary to maintain the physical integrity of the stream, but the applicant must provide written justification and any calculations used to determine the extent of rip-rap coverage. Please note that if the stream relocation is conducted as a stream restoration as defined in the US Army Corps of Engineers Wilmington District, April 2003 *Stream Mitigation Guidelines* (or its subsequent updates), the restored length can be used as compensatory mitigation for the impacts resulting from the relocation.

## 11. Placement of Culverts and Other Structures in Waters and Wetlands

The application must include construction plans with cross-sectional details in order to indicate that the current stability of the stream will be maintained or enhanced (i.e., not result in head cuts).

Culverts required for this project shall be designed and installed in such a manner that the original stream profiles are not altered and allow for aquatic life movement during low flows. Existing stream dimensions (including the cross section dimensions, pattern, and longitudinal profile) must be maintained above and below locations of each culvert. Placement of culverts and other structures in waters, streams, and wetlands must be placed below the elevation of the streambed by one foot for all culverts with a diameter greater than 48 inches, and 20 percent of the culvert diameter for culverts having a diameter less than 48 inches, to allow low flow passage of water and aquatic life unless otherwise justified and approved by the Division.

Installation of culverts in wetlands must ensure continuity of water movement and be designed to adequately accommodate high water or flood conditions. Additionally, when roadways, causeways or other fill projects are constructed across FEMA-designated floodways or wetlands, openings such as culverts or bridges must be provided to maintain

# Water Quality Certification N°. 3701

the natural hydrology of the system as well as prevent constriction of the floodway that may result in destabilization of streams or wetlands.

Any rip rap required for normal pipe burial and stabilization shall be buried such that the original stream elevation is restored and maintained.

The establishment of native, woody vegetation and other soft stream bank stabilization techniques must be used where practicable instead of rip-rap or other bank hardening methods.

## 12. Compensatory Mitigation

In accordance with 15A NCAC 2H .0506 (h), compensatory mitigation maybe required for losses of 150 linear feet or more of streams and/or one (1) acre or more of wetlands. For linear, public transportation projects, impacts equal to or exceeding 150 lines feet per stream may require mitigation.

In watersheds classified as: ORW, HQW, Tr, WS-I, and WS-II, compensatory stream mitigation may be required at a 1:1 ratio for not only perennial but also intermittent stream impacts equal to or exceeding 150 feet and that require application and written approval from the Division, unless the project is a linear, publicly-funded transportation project, which has a 150-foot per-stream impact allowance.

Buffer mitigation may be required for any project with Buffer Rules in effect at the time of application for buffer impacts resulting from activities classified as "allowable with mitigation" within the Buffer Rules or require a variance under the Buffer Rules.

A determination of buffer, wetland and stream mitigation requirements shall be made for any General Certification for this Nationwide Permit.

When compensatory mitigation is required for a project, the mitigation plans must be approved by the Division, in writing, before the impacts approved by this Certification occur. The most current design and monitoring protocols from the Division shall be followed and written plans submitted for the Division approval as required in those protocols. Alternately, the Division will accept payment into an in-lieu fee program or mitigation bank. Before any permanent building or structure on site is occupied, the mitigation plan must be implemented and/or constructed or proof of payment to a mitigation bank or in-lieu fee program must be provided to the Division. In the case of public road projects, the mitigation plan must be implemented, before the road is opened to the traveling public whenever practical or at the earliest reasonable time during the construction of the project

13. If an environmental document is required under NEPA or SEPA, then this General Certification is not valid until a Finding of No Significant Impact (FONSI) or Record of Decision (ROD) is issued by the State Clearinghouse.
14. For activities requiring written approval, additional site-specific conditions may be added to the cover letter projects in order to ensure compliance with all applicable water quality and effluent standards.
15. Certificate of Completion

When written authorization is required for use of this certification, upon completion of all permitted impacts included within the approval and any subsequent modifications, the applicant shall be required to return the certificate of completion attached to the approval. One copy of the certificate shall be sent to the DWQ Central Office in Raleigh at 1650 Mail Service Center, Raleigh, NC, 27699-1650.

## Water Quality Certification N<sup>o</sup>. 3701

16. This General Certification shall expire three (3) years from the date of issuance of the written approval or on the same day as the expiration date of the corresponding Nationwide and Regional General Permits. In accordance with General Statute 136-44.7B, certifications issued to the NCDOT shall expire only upon expiration of the federal 404 Permit. The conditions in effect on the date of issuance of Certification for a specific project shall remain in effect for the life of the project, regardless of the expiration date of this Certification. If the construction process for approved activities will overlap the expiration and renewal date of the corresponding 404 Permit and the Corps allows for continued use of the 404 Permit, then the General Certification shall also remain in effect without requiring re-application and re-approval to use this Certification for the specific impacts already approved.
17. The applicant/permittee and their authorized agents shall conduct all activities in a manner consistent with State water quality standards (including any requirements resulting from compliance with §303(d) of the Clean Water Act), and any other appropriate requirements of State and Federal Law. If the Division determines that such standards or laws are not being met, including failure to sustain a designated or achieved use, or that State or Federal law is being violated, or that further conditions are necessary to assure compliance, then the Division may reevaluate and modify this General Water Quality Certification.

Non-compliance with or violation of the conditions herein set forth by a specific fill project shall result in revocation of this General Certification for the project and may result in criminal and/or civil penalties.

The Director of the North Carolina Division of Water Quality may require submission of a formal application for individual certification for any project in this category of activity, if it is determined that the project is likely to have a significant adverse effect upon water quality including state or federally listed endangered or threatened aquatic species or degrade the waters so that existing uses of the wetland, stream or downstream waters are precluded.

Public hearings may be held for specific applications or group of applications prior to a Certification decision if deemed in the public's best interest by the Director of the North Carolina Division of Water Quality.

Effective date: November 1, 2007

DIVISION OF WATER QUALITY

By

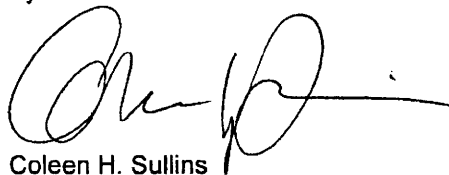

Coleen H. Sullins

Director

*History Note: Water Quality Certification (WQC) Number 3701 replaces Water Quality Certification Number 2670 issued on January 21, 1992, WQC Number 2734 issued on May 1 1993, WQC Number 3107 issued on February 11, 1997, WQC Certification Number 3361 issued March 18, 2002, WQC Certification Number 3403 issued March 2003, and WQC Number 3632 issued March 2007. This General Certification is rescinded when the Corps of Engineers re-authorizes Nationwide Permit 23 or when deemed appropriate by the Director of the DWQ.*

# Water Quality Certification N<sup>o</sup>. 3688

**GENERAL CERTIFICATION FOR PROJECTS ELIGIBLE  
FOR U.S. ARMY CORPS OF ENGINEERS NATIONWIDE PERMIT NUMBER 33  
(TEMPORARY CONSTRUCTION, ACCESS AND DEWATERING)  
AND RIPARIAN AREA PROTECTION RULES (BUFFER RULES)**

Water Quality Certification Number 3688 is issued in conformity with the requirements of Section 401, Public Laws 92-500 and 95-217 of the United States and subject to the North Carolina Division of Water Quality Regulations in 15A NCAC 2H, Section .0500 and 15A NCAC 2B .0200 for the discharge of fill material to waters and wetland areas as described in 33 CFR 330 Appendix A (B) (33) and for the Riparian Area Protection Rules (Buffer Rules) in 15A NCAC 2B .0200. The category of activities shall include any fill activity for temporary construction, access and de-watering.

The State of North Carolina certifies that the specified category of activity will not violate appropriate portions of Sections 301, 302, 303, 306 and 307 of the Public Laws 92-500 and 95-217 if conducted in accordance with the conditions hereinafter set forth.

Activities covered by this General Certification *do not* require written approval from the Division of Water Quality (the "Division") as long as they comply with the Conditions listed below. **If any of these Conditions cannot be met, or if the activity is associated with or in response to a Notice of Violation from the Division of Water Quality or the NC Division of Land Resources, then written approval from the Division is required. Activities that are located within river basins with Riparian Area Protection Rules (Buffer Rules) require written approval unless listed in the as "Exempt" within the riparian rules.**

In accordance with North Carolina General Statute Section 143-215.3D(e), any requirement for written approval for a 401 Water Quality Certification must include the appropriate fee. If a project also requires a CAMA Permit, then one payment to both agencies shall be submitted and will be the higher of the two fees.

#### Conditions of Certification:

1. No Impacts Beyond those authorized by this Certification

No waste, spoil, solids, or fill of any kind shall occur in wetlands, waters, or riparian areas beyond the thresholds authorized by this Certification, including incidental impacts. All construction activities, including the design, installation, operation, and maintenance of sediment and erosion control Best Management Practices, shall be performed so that no violations of state water quality standards, statutes, or rules occur.

2. Standard Erosion and Sediment Control Practices

Erosion and sediment control practices shall be in full compliance with all specifications governing the proper design, installation and operation and maintenance of such Best Management Practices:

- a. Design, installation, operation, and maintenance of the sediment and erosion control measures must be such that they equal, or exceed, the requirements specified in the most recent version of the *North Carolina Sediment and Erosion Control Manual*. The devices shall be maintained on all construction sites, borrow sites, and waste pile (spoil) projects, including contractor-owned or leased borrow pits associated with the project.
- b. For borrow pit sites, the erosion and sediment control measures must be designed, installed, operated, and maintained in accordance with the most recent version of the *North Carolina Surface Mining Manual*.

## Water Quality Certification N<sup>o</sup>. 3688

- c. Reclamation measures and implementation must comply with the reclamation in accordance with the requirements of the Sedimentation Pollution Control Act and the Mining Act of 1971.
- d. Sufficient materials required for stabilization and/or repair of erosion control measures and stormwater routing and treatment shall be on site at all times, except for publicly funded linear transportation projects when materials can be accessed offsite in a timely manner.
- e. If the project occurs in waters or watersheds classified as Primary Nursery Areas (PNAs), Trout (Tr), SA, WS-I, WS-II, High Quality (HQW), or Outstanding Resource (ORW) waters, then the sediment and erosion control requirements contained within *Design Standards in Sensitive Watersheds* (15A NCAC 04B .0124) supercede all other sediment and erosion control requirements.

### 3. No Sediment and Erosion Control Measures in Wetlands or Waters

Sediment and erosion control measures should not be placed in wetlands or waters outside of the permitted impact areas without prior written approval from the Division. If placement of sediment and erosion control devices in wetlands and waters is unavoidable, then the design and placement of temporary erosion control measures shall not be conducted in a manner that may result in dis-equilibrium of wetlands or stream beds or banks, adjacent to or upstream and down stream of the above structures. All sediment and erosion control devices shall be removed and the natural grade restored within two (2) months of the date that the Division of Land Resources or locally delegated program has released the project.

### 4. Construction Stormwater Permit NCG010000

Upon the approval of an Erosion and Sedimentation Control Plan issued by the Division of Land Resources (DLR) or a DLR delegated local erosion and sedimentation control program, an NPDES General stormwater permit (NCG010000) administered by the Division is automatically issued to the project. This General Permit allows stormwater to be discharged during land disturbing construction activities as stipulated by conditions in the permit. If your project is covered by this permit [applicable to construction projects that disturb one (1) or more acres], full compliance with permit conditions including the sedimentation control plan, self-monitoring, record keeping and reporting requirements are required. A copy of this permit and monitoring report forms may be found at [http://h2o.enr.state.nc.us/su/Forms\\_Documents.htm](http://h2o.enr.state.nc.us/su/Forms_Documents.htm).

NCDOT shall be required to be in full compliance with the conditions related to construction activities within the most recent version of their individual NPDES (NCS000250) stormwater permit.

### 5. Construction Moratoriums and Coordination

All moratoriums on construction activities established by the NC Wildlife Resources Commission (WRC), US Fish and Wildlife Service (USFWS), NC Division of Marine Fisheries (DMF), or National Marine Fisheries Service (NMFS) to lessen impacts on trout, anadromous fish, larval/post-larval fishes and crustaceans, or other aquatic species of concern must be obeyed. This condition can be waived through written concurrence on a case by case basis upon reasonable justification.

Work within the twenty-five (25) designated trout counties or identified state or federal endangered or threatened species habitat shall be coordinated with the appropriate WRC, USFWS, NMFS, and/or DMF personnel.

# Water Quality Certification N<sup>o</sup>. 3688

## 6. Riparian Area Protection (Buffer) Rules

Activities located in the protected 50-foot wide riparian areas (whether jurisdictional wetlands or not) within the Neuse, Tar-Pamlico, Randleman and Catawba River Basins (or any other basin with buffer rules), shall be limited to "uses" identified within and constructed in accordance with 15A NCAC 2B .0233, .0259, .0250, and .0243, and shall be located, designed, constructed, and maintained to have minimal disturbance to protect water quality to the maximum extent practicable through the use of best management practices. All buffer rule requirements, including diffuse flow requirements, shall be met.

## 7. Water Supply Watershed Buffers

The 100-foot wide (high-density development) or the 30-foot wide vegetative buffer (all other development) shall be maintained adjacent to all perennial waters except for allowances as provided in the Water Supply Watershed Protection Rules [15A NCAC 2B .0212 through .0215].

8. If an environmental document is required under NEPA or SEPA, then this General Certification is not valid until a Finding of No Significant Impact (FONSI) or Record of Decision (ROD) is issued by the State Clearinghouse.

## 9. Placement of culverts and other structures in waters, streams, and wetlands

The application must include construction plans with cross-sectional details in order to indicate that the current stability of the stream will be maintained or enhanced (i.e., not result in head cuts).

Culverts required for this project shall be designed and installed in such a manner that the original stream profiles are not altered and allow for aquatic life movement during low flows. Existing stream dimensions (including the cross section dimensions, pattern, and longitudinal profile) must be maintained above and below locations of each culvert. Placement of culverts and other structures in waters, streams, and wetlands must be placed below the elevation of the streambed by one foot for all culverts with a diameter greater than 48 inches, and 20 percent of the culvert diameter for culverts having a diameter less than 48 inches, to allow low flow passage of water and aquatic life, unless otherwise justified and approved by the Division

Installation of culverts in wetlands must ensure continuity of water movement and be designed to adequately accommodate high water or flood conditions. Additionally, when roadways, causeways or other fill projects are constructed across FEMA-designated floodways or wetlands, openings such as culverts or bridges must be provided to maintain the natural hydrology of the system as well as prevent constriction of the floodway that may result in destabilization of streams or wetlands.

Any rip rap required for normal pipe burial and stabilization shall be buried such that the original stream elevation is restored and maintained.

The establishment of native, woody vegetation and other soft stream bank stabilization techniques must be used where practicable instead of rip-rap or other bank hardening methods.

# Water Quality Certification N<sup>o</sup>. 3688

## 10. Work in the Dry

All work in or adjacent to stream waters shall be conducted in a dry work area. Approved best management practices from the most current version of the NC Sediment and Erosion Control Manual, or the NC DOT Construction and Maintenance Activities Manual, such as sandbags, rock berms, cofferdams, and other diversion structures shall be used to minimize excavation in flowing water. Channel realignments shall be constructed by excavating the new channel from downstream to upstream before connecting it to the existing channel. Exceptions to this condition require submittal to, and approval by, the Division of Water Quality.

11. If concrete is used during the construction, then a dry work area should be maintained to prevent direct contact between curing concrete and stream water. Water that inadvertently contacts uncured concrete should not be discharged to surface waters due to the potential for elevated pH and possible aquatic life/fish kills.

## 12. Temporary Fills

All temporary fill and culverts shall be removed and the impacted area returned to the original grade, including each stream's original cross sectional dimensions, planform pattern, and longitudinal bed and bed profile after construction is complete or within two (2) months of the establishment of the crossing, whichever is sooner, and the various sites shall be stabilized with natural woody vegetation (except for the maintenance areas of permanent utility crossings) and restored to prevent erosion. If the crossings are not completely removed and restored as described above within the specified time above, then written approval from the Division must be obtained to modify this condition.

13. Pipes shall be installed under the road or causeway in all streams to carry at least the 25-year storm event as outlined in the most recent edition of the *North Carolina Sediment and Erosion Control Planning and Design Manual* or the *North Carolina Surface Mining Manual* so as not to restrict stream flow during use of this General Certification.

14. For projects requiring written approval, additional site-specific conditions may be added to the cover letter in order to ensure compliance with all applicable water quality and effluent standards.

## 15. Certificate of Completion

When written authorization is required for use of this certification, upon completion of all permitted impacts included within the approval and any subsequent modifications, the applicant shall be required to return the certificate of completion attached to the approval. One copy of the certificate shall be sent to the DWQ Central Office in Raleigh at 1650 Mail Service Center, Raleigh, NC, 27699-1650.

16. This General Certification shall expire three (3) years from the date of issuance of the written approval or on the same day as the expiration date of these corresponding Nationwide and Regional General Permits. In accordance with General Statute 136-44.7B, certifications issued to the NCDOT shall expire only upon expiration of the federal 404 Permit. The conditions in effect on the date of issuance of Certification for a specific project shall remain in effect for the life of the project, regardless of the expiration date of this Certification. If the construction process for approved activities will overlap the expiration and renewal date of the corresponding 404 Permit and the Corps allows for continued use of the 404 Permit, then the General Certification shall also remain in effect without requiring re-application and re-approval to use this Certification for the specific impacts already approved.

## Water Quality Certification N<sup>o</sup>. 3688

17. The applicant/permittee and their authorized agents shall conduct all activities in a manner consistent with State water quality standards (including any requirements resulting from compliance with §303(d) of the Clean Water Act), and any other appropriate requirements of State and Federal Law. If the Division determines that such standards or laws are not being met, including failure to sustain a designated or achieved use, or that State or Federal law is being violated, or that further conditions are necessary to assure compliance, then the Division may reevaluate and modify this General Water Quality Certification.

Non-compliance with or violation of the conditions herein set forth by a specific fill project shall result in revocation of this General Certification for the project and may result in criminal and/or civil penalties.

The Director of the North Carolina Division of Water Quality may require submission of a formal application for individual certification for any project in this category of activity if it is determined that the project is likely to have a significant adverse effect upon water quality, including state or federally listed endangered or threatened aquatic species, or degrade the waters so that existing uses of the wetland, stream or downstream waters are precluded.

Public hearings may be held for specific applications or group of applications prior to a Certification decision if deemed in the public's best interest by the Director of the North Carolina Division of Water Quality.

Effective date: November 1, 2007

DIVISION OF WATER QUALITY

By



Coleen H. Sullins

Director

*History Note: Water Quality Certification Number 3388 replaces Water Quality Certification Number 2727 issued on May 1, 1992, Certification Number 3114 issued on February 11, 1997, Certification Number 3366 issued March 18, 2002, and Certification Number 3634 issued March, 2007. This General Certification is rescinded when the Corps of Engineers reauthorize Nationwide Permit 33 or when deemed appropriate by the Director of the Division of Water Quality.*



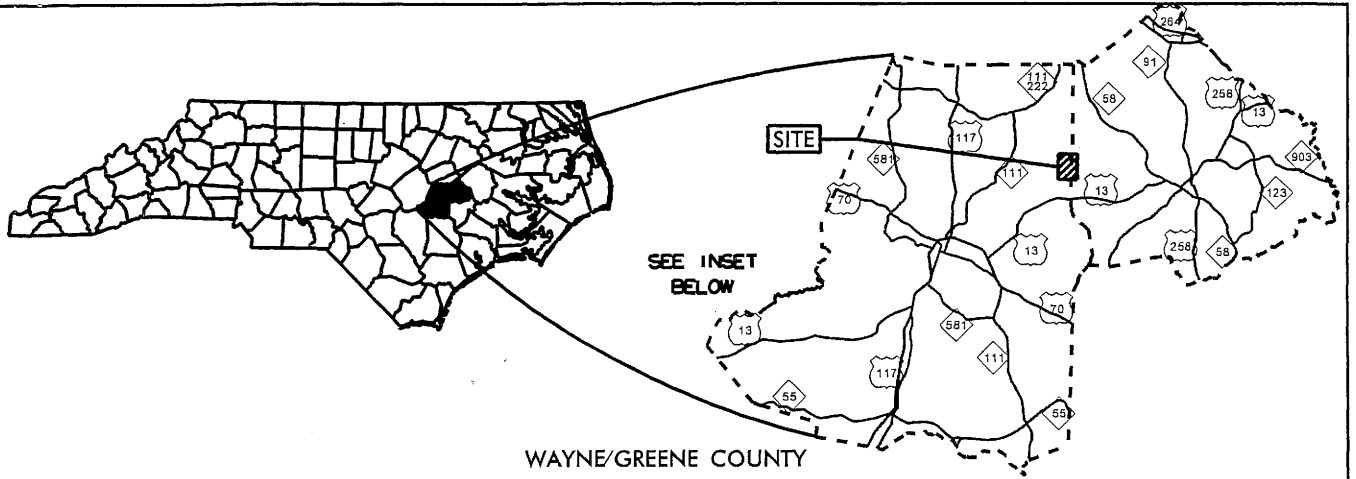

WAYNE/GREENE COUNTY

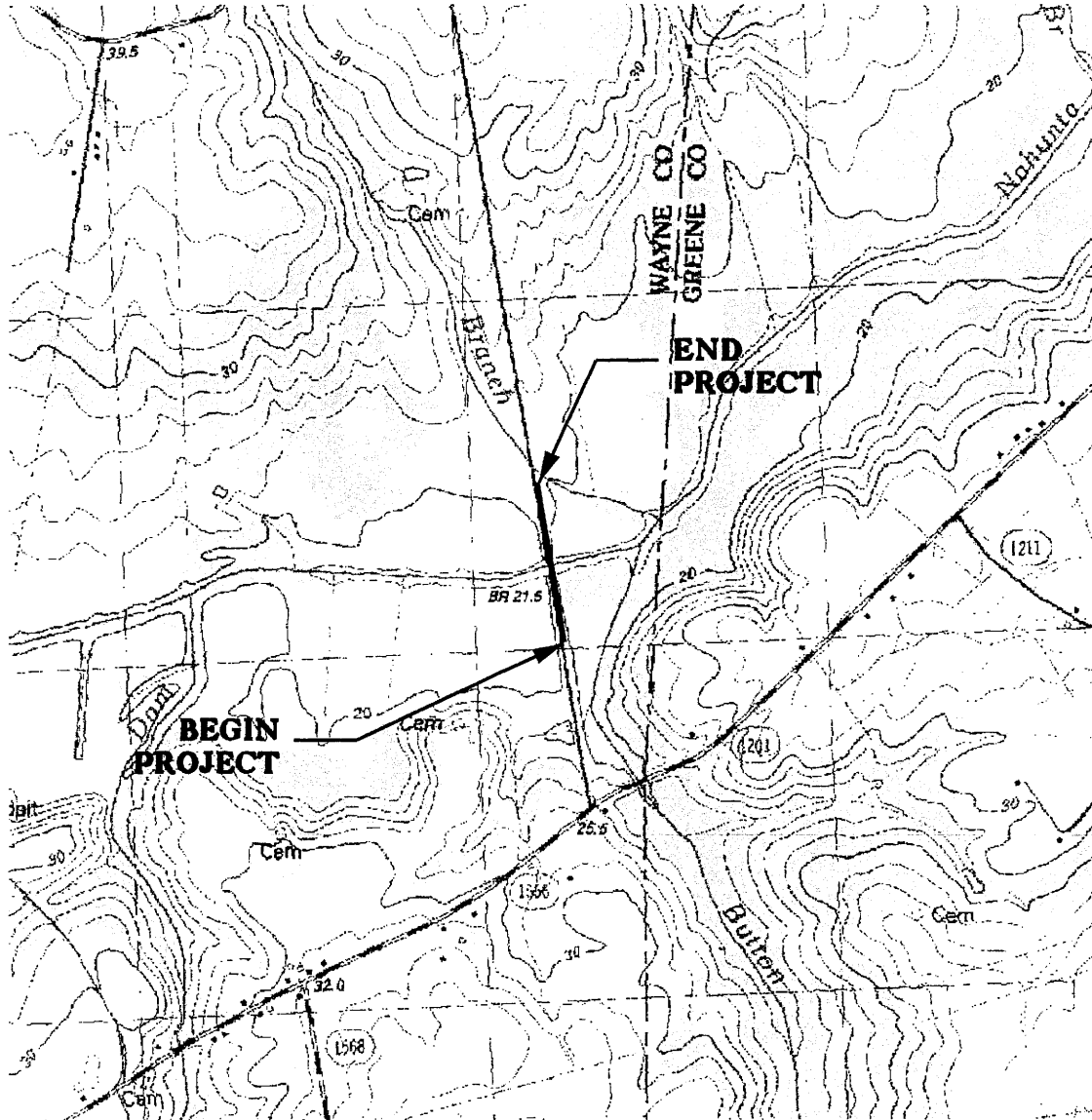

BUFFER IMPACTS  
VICINITY MAP

N.C. DEPT. OF TRANSPORTATION  
DIVISION OF HIGHWAYS  
WAYNE COUNTY

PROJECT: 33826.1.1 (B-4671)  
BRIDGE NO. 35 OVER  
NAHUNTA SWAMP  
ON SR 1532

SHEET \_\_\_ OF \_\_\_

2/4/08

Buffer Drawing  
Sheet 1 of 8

## BUFFER IMPACTS SUMMARY

SITE NO.	STRUCTURE SIZE / TYPE	STATION (FROM/TO)	IMPACT						BUFFER REPLACEMENT				
			TYPE		ALLOWABLE		MITIGABLE		ZONE 1 (ft <sup>2</sup> )	ZONE 2 (ft <sup>2</sup> )			
			ROAD CROSSING	BRIDGE	PARALLEL IMPACT	ZONE 1 (ft <sup>2</sup> )	ZONE 2 (ft <sup>2</sup> )	TOTAL (ft <sup>2</sup> )			ZONE 1 (ft <sup>2</sup> )	ZONE 2 (ft <sup>2</sup> )	
1	3 Span Bridge	16+72-17+37 -L- LT & RT		X		1779	2027	3806					
<b>TOTAL:</b>						1779	2027	3806	0.0	0.0	0.0		

N.C. DEPT. OF TRANSPORTATION  
DIVISION OF HIGHWAYS

WAYNE COUNTY  
PROJECT: 33826.1.1 (B-4671)

2/4/2008  
SHEET OF

# WORKPAD DETAIL (NOT TO SCALE)

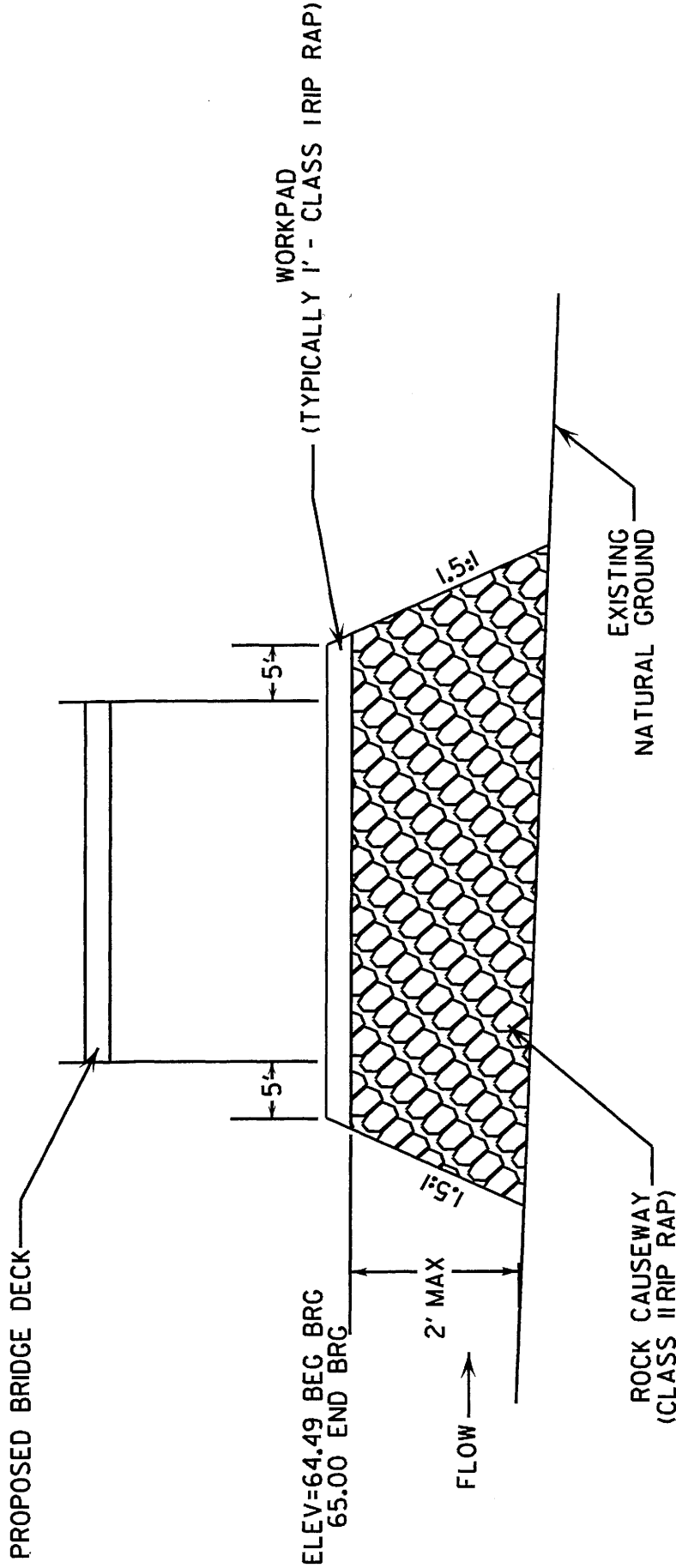

N.C. DEPT. OF TRANSPORTATION  
DIVISION OF HIGHWAYS

WAYNE COUNTY  
PROJECT: 33836.11 (B-4671)  
BRIDGE NO. 35 OVER  
NAHUNTA SWAMP ON SR 1532

SHEET \_\_\_ OF \_\_\_ 2/4/08

## QUANTITIES OF ESTIMATES

VOLUME OF CLASS II RIP RAP = 253 yds<sup>3</sup>  
AREA OF CLASS II RIP RAP = 0.08 ac  
Estimate 360 Tons Class II Rip Rap

**PROPERTY OWNERS**  
**NAMES AND ADDRESSES**

<b>PARCEL NO.</b>	<b>NAMES</b>	<b>ADDRESSES</b>
<b>1</b>	<b>CITY OF WILSON</b>	<b>P.O. BOX 10 WILSON, NC 27894</b>

**NCDOT**  
**DIVISION OF HIGHWAYS**

**WAYNE COUNTY**

**PROJECT: 33826.L1 (B-4671)**  
**BRIDGE NO. 35 OVER**  
**NAHUNTA SWAMP ON SR 1532**

**SHEET OF 2 / 4 / 08**

Buffer Drawing  
Sheet 4 of 8

CONTRACT: TIP PROJECT: B-4671  
 SYSTEM TIME: 08/19/09 09:08:09  
 USER: DGN  
 USER NAME:

**TIP PROJECT: B-4671**

**CONTRACT:**

See Sheet 1-A For Index of Sheets

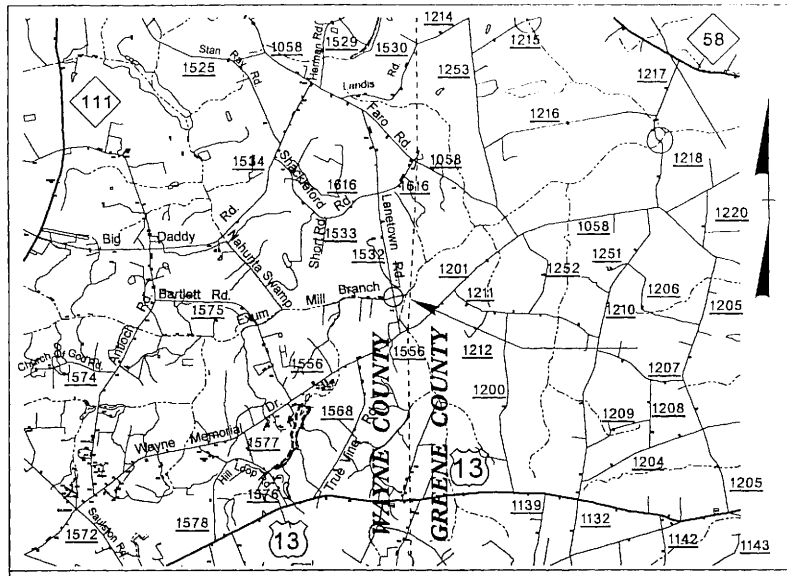

Detour Route

VICINITY MAP

THIS PROJECT IS NOT WITHIN ANY MUNICIPAL BOUDARIES.

STATE OF NORTH CAROLINA  
 DIVISION OF HIGHWAYS

**WAYNE COUNTY**

LOCATION: BRIDGE 35 ON SR 1532 OVER  
 NAHUNTA SWAMP

TYPE OF WORK: GRADING, DRAINAGE, PAVING  
 AND STRUCTURE



STATE	STATE PROJECT REFERENCE NO.	SHEET NO.	TOTAL SHEETS
N.C.	B-4671	1	
STATE PROJ. NO.	F.A. PROJ. NO.	DESCRIPTION	
33826.1.1	BRZ-1532(3)	PE	
33826.2.1	BRZ-1532(3)	R/W & UTIL	

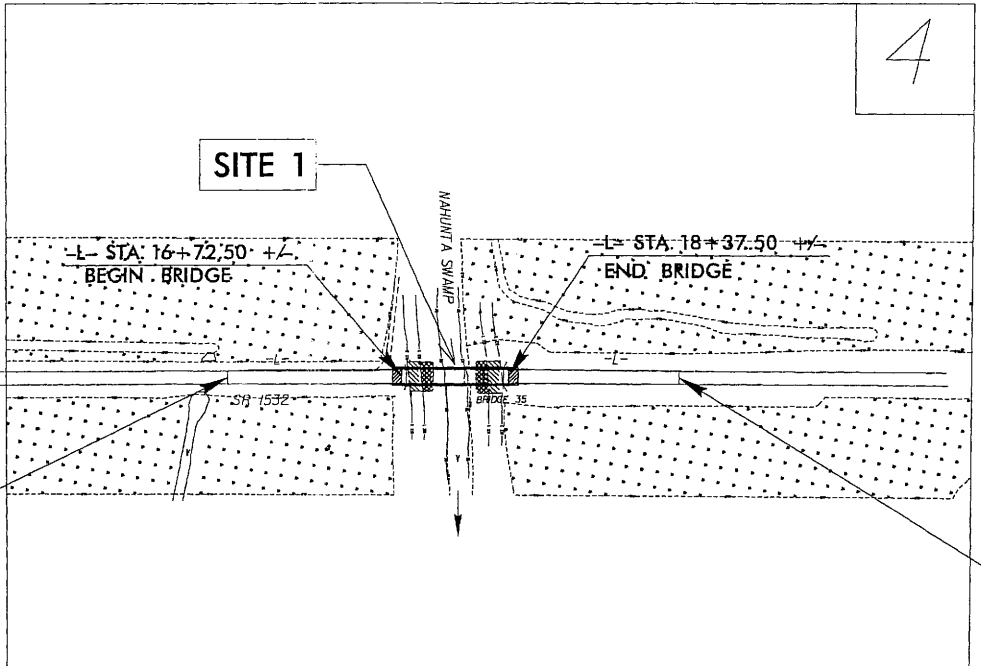

**BUFFER IMPACTS**

PRELIMINARY PLANS  
 DO NOT USE FOR CONSTRUCTION

CLEARING ON THIS PROJECT SHALL BE PERFORMED TO THE LIMITS ESTABLISHED BY METHOD III

<p><b>GRAPHIC SCALES</b></p> <p>50 25 0 50 100   PLANS</p> <p>50 25 0 50 100   PROFILE (HORIZONTAL)</p> <p>10 5 0 10 20   PROFILE (VERTICAL)</p>	<p><b>DESIGN DATA</b></p> <p>ADT 2006 = 225          ADT 2030 = 500          DHV = 60 %          D = 10 %          T = 3 % *          V = 55 MPH          * TTST 1% DUAL 2%          FUNCTIONAL CLASSIFICATION          RURAL LOCAL</p>	<p><b>PROJECT LENGTH</b></p> <p>LENGTH ROADWAY TIP PROJECT B-4671 = 0.102 MILES</p> <p>LENGTH STRUCTURE TIP PROJECT B-4671 = 0.031 MILES</p> <p>TOTAL LENGTH TIP PROJECT B-4671 = 0.133 MILES</p>	<p>Prepared in the Office of:  <b>DIVISION OF HIGHWAYS</b>          1000 Birch Ridge Dr., Raleigh NC, 27610</p> <p>2006 STANDARD SPECIFICATIONS</p> <p>RIGHT OF WAY DATE:          DECEMBER 18, 2007</p> <p>LETTING DATE:          DECEMBER 16, 2008</p> <p>G.E. BREW, PE          PROJECT ENGINEER</p> <p>I.T. YOUNIS          PROJECT DESIGN ENGINEER</p>	<p>HYDRAULICS ENGINEER</p> <p>SIGNATURE: _____ P.E.</p> <p>ROADWAY DESIGN ENGINEER</p> <p>SIGNATURE: _____ F.E.</p>	<p>DIVISION OF HIGHWAYS          STATE OF NORTH CAROLINA</p> <p>STATE HIGHWAY DESIGN ENGINEER</p>
--	---	---	---	---	---

B/17/99



PROJECT REFERENCE NO. B-4671	SHEET NO. 4
R/W SHEET NO.	
ROADWAY DESIGN ENGINEER	HYDRAULICS ENGINEER
<b>PRELIMINARY PLANS</b> DO NOT USE FOR CONSTRUCTION	



FOR PROFILE OF LINE -L- SEE SHEET 5

REVISIONS

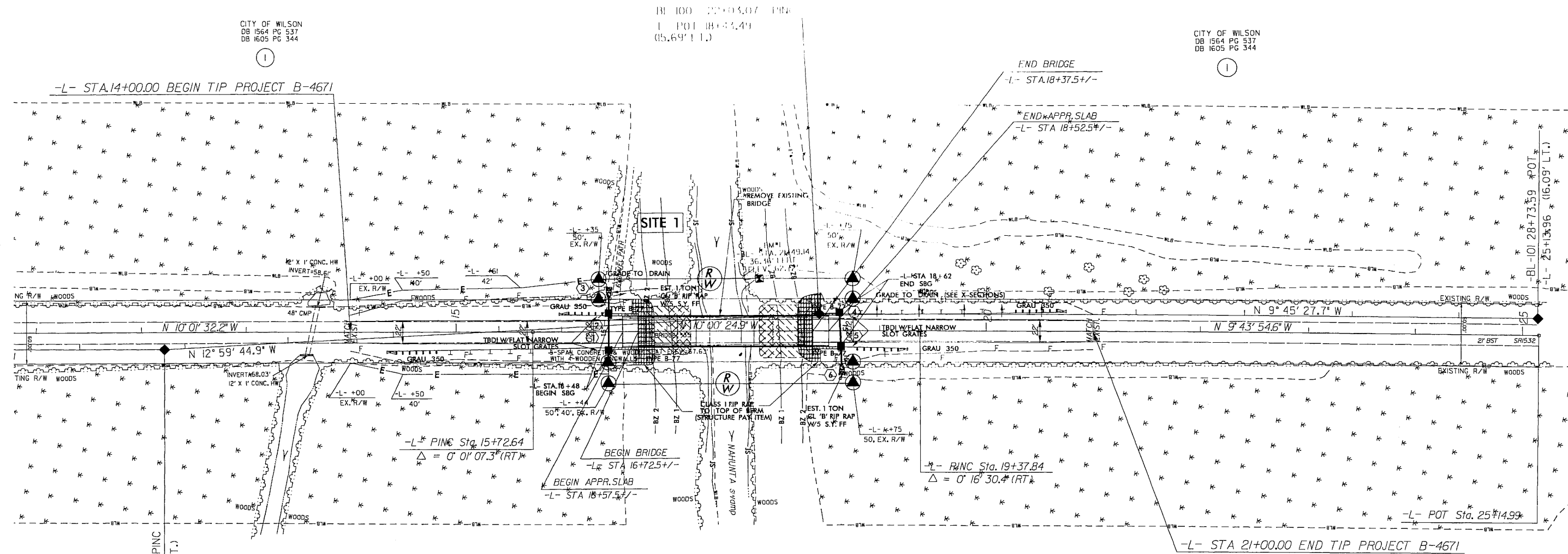

CITY OF WILSON  
DB 1564 PG 537  
DB 1605 PG 344

CITY OF WILSON  
DB 1564 PG 537  
DB 1605 PG 344

CITY OF WILSON  
DB 1564 PG 537  
DB 1605 PG 344

GPS B4671-2 15+80.23 PINC  
-L- STA 12+21.53 (16.91' RT.)

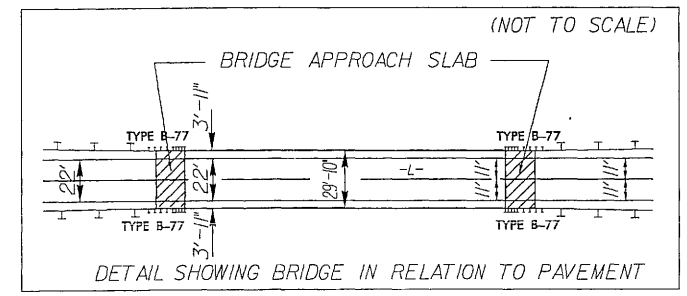

8/17/99

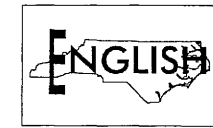

PROJECT REFERENCE NO. B-4671	SHEET NO. 4
RW SHEET NO.	
ROADWAY DESIGN ENGINEER	HYDRAULICS ENGINEER
PRELIMINARY PLANS DO NOT USE FOR CONSTRUCTION	

FOR PROFILE OF LINE -L- SEE SHEET 5



CITY OF WILSON  
DB 1564 PG 537  
DB 1605 PG 344

BL-100 22+03.07 PIV  
L POT 18+13.49  
(15.69' LT.)

CITY OF WILSON  
DB 1564 PG 537  
DB 1605 PG 344

-L- STA.14+00.00 BEGIN TIP PROJECT B-4671

END BRIDGE  
-L- STA.18+37.5+/-

END APPR. SLAB  
-L- STA 18+52.5+/-

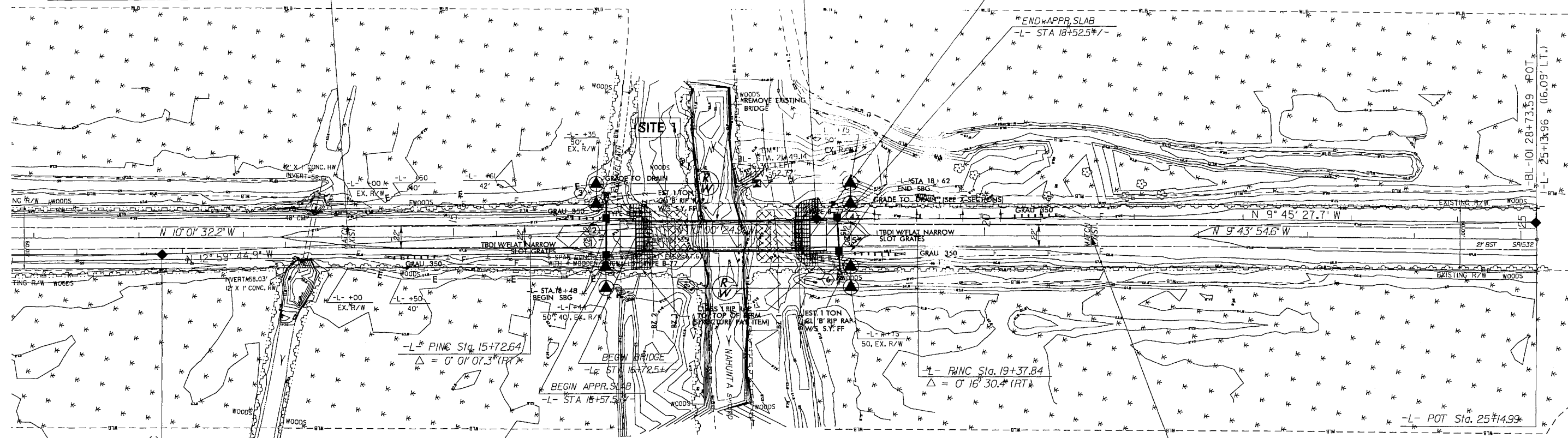

CITY OF WILSON  
DB 1564 PG 537  
DB 1605 PG 344

CITY OF WILSON  
DB 1564 PG 537  
DB 1605 PG 344

GPS B4671-2 15+80.23 PINC  
-L- STA 12+21.53 (16.91' RT.)

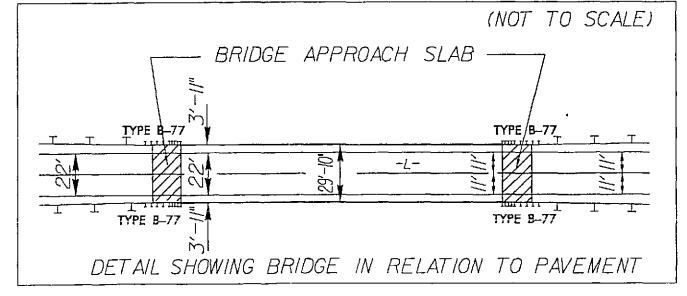

FOR PLANS OF LINE -L- SEE SHEET 4

**BRIDGE HYDRAULIC DATA**

DESIGN DISCHARGE	= 3550	CFS
DESIGN FREQUENCY	= 25	YRS
DESIGN HW ELEVATION	= 67.4	FT
BASE DISCHARGE	= 5680	CFS
BASE FREQUENCY	= 100	YRS
BASE HW ELEVATION	= 68.6	FT
OVERTOPPING DISCHARGE	= 3550	CFS
OVERTOPPING FREQUENCY	= 25	YRS
OVERTOPPING ELEVATION	= 66.8	FT
	=	FT
DATE OF SURVEY	= 4/13/07	
W.S. ELEVATION AT DATE OF SURVEY	= 58.0	FT

BEGIN GRADE  
-L- STA 14+00.00  
ELEV. 67.35

PI = 15+20.00  
EL = 67.71'  
VC = 180'  
K = 212

CI STA 17+55.1  
30x55" CORED SLAB (21") (OAL 165")  
CRG# 7020  
90° SKYW

PI = 17+40.00  
EL = 70.24'  
VC = 260'  
K = 147

PI = 20+00.00  
EL = 68.63'  
VC = 150'  
K = 152

HW \*11.11V 67.71'  
TL - STA 21+43.4 36.36' LEFT  
N 63°06'32" W L 2348.5617860  
RR SPIKE IN BASE OF 14" TWIN RIVERBIRCH

END GRADE  
-L- STA 21+00.00  
ELEV. 69.00

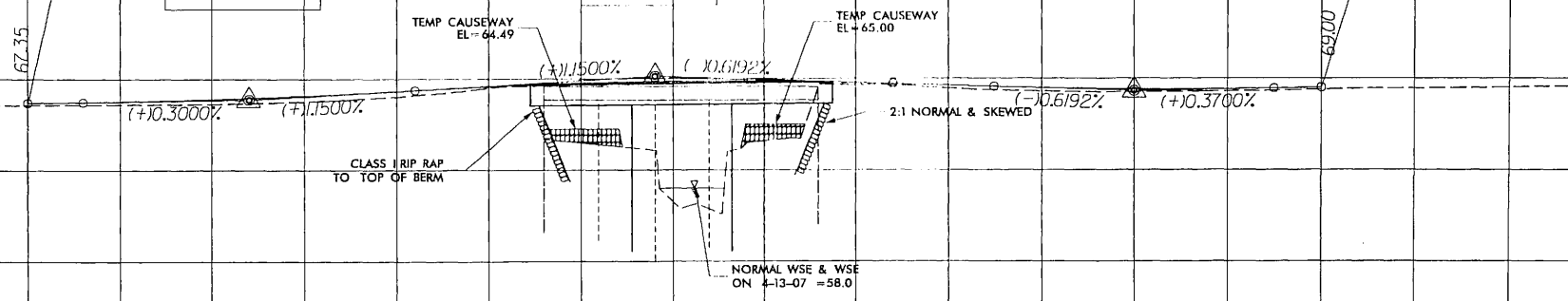



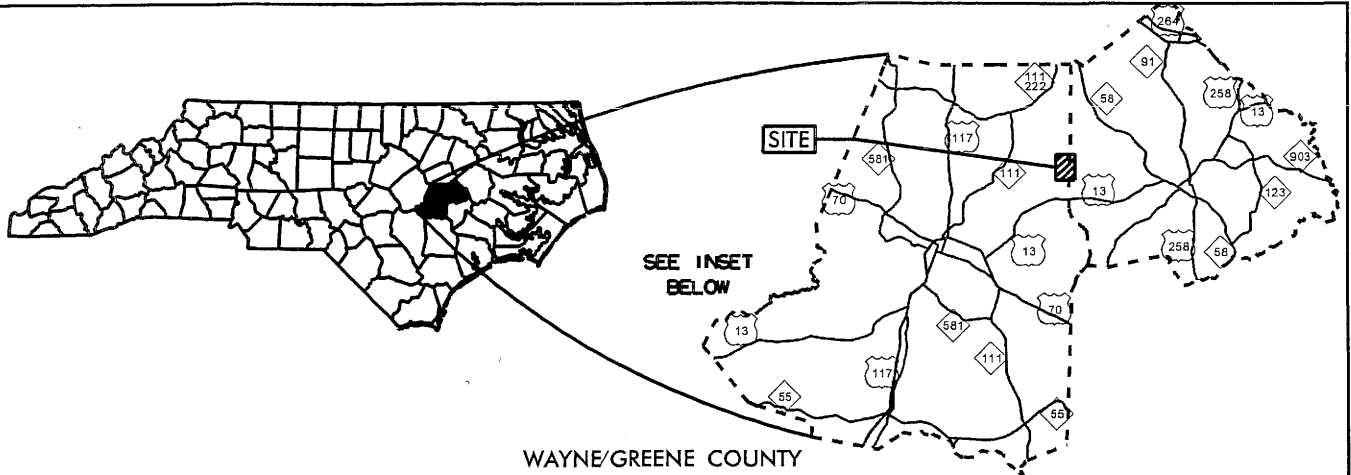

WAYNE/GREENE COUNTY

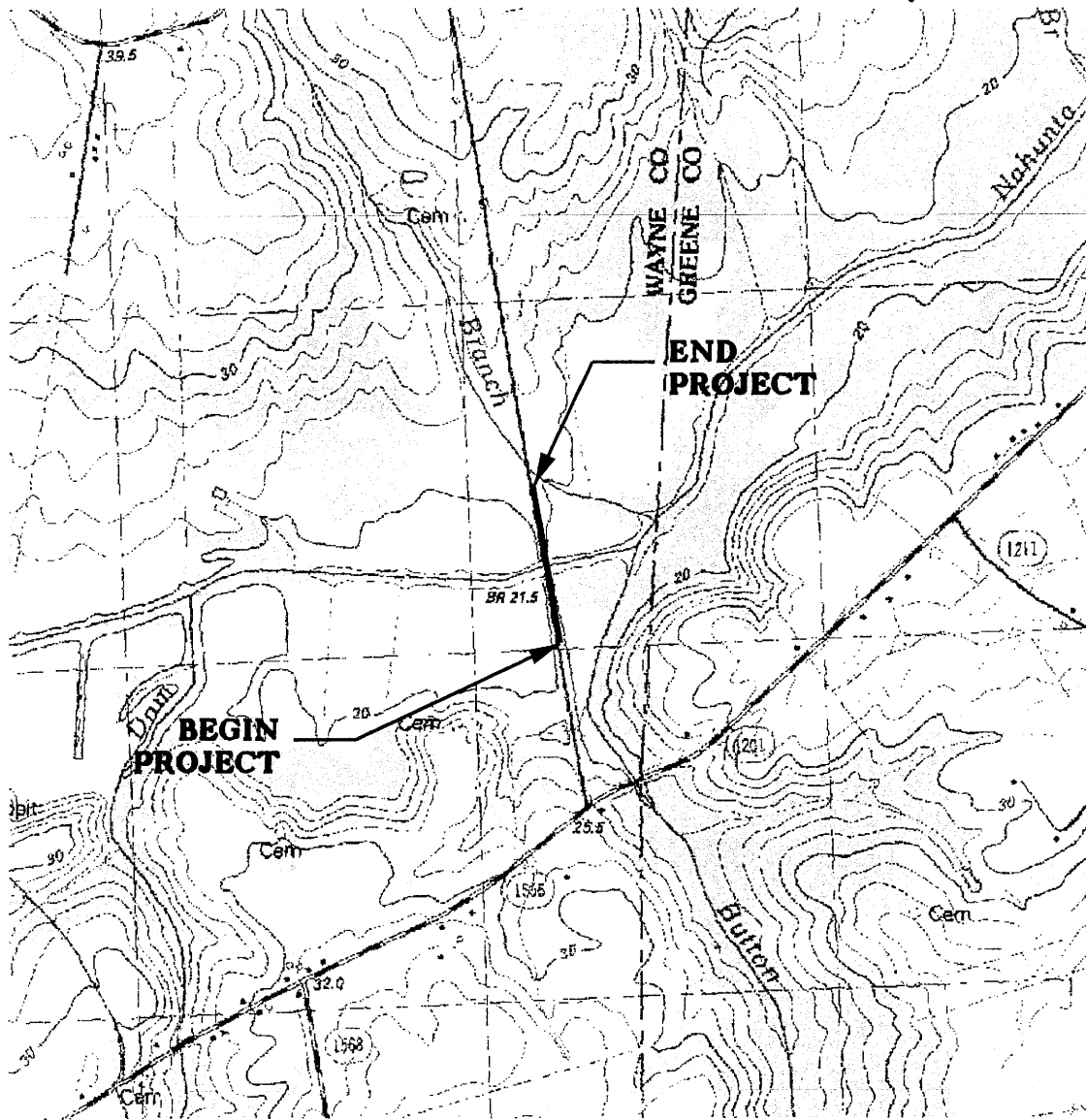

WETLAND/STREAM IMPACTS  
VICINITY MAP

N.C. DEPT. OF TRANSPORTATION  
DIVISION OF HIGHWAYS  
WAYNE COUNTY

PROJECT: 33826.1.1 (B-4671)  
BRIDGE NO. 35 OVER  
NAHUNTA SWAMP  
ON SR 1532

SHEET \_\_\_ OF \_\_\_

2 / 4 / 08

Permit Drawing

Sheet 1 of 8

### WETLAND PERMIT IMPACT SUMMARY

Site No.	Station (From/To)	Structure Size / Type	WETLAND IMPACTS				SURFACE WATER IMPACTS								
			Permanent Fill In Wetlands (ac)	Temp. Fill In Wetlands (ac)	Excavation in Wetlands (ac)	Mechanized Clearing in Wetlands (ac)	Hand Clearing in Wetlands (ac)	Permanent SW impacts (ac)	Temp. SW impacts (ac)	Existing Channel Impacts Permanent (ft)	Existing Channel Impacts Temp. (ft)	Natural Stream Design (ft)			
1	14+00/16+48 -L- LT	BRIDGE	0.03					0.07							
2	14+00/16+48 -L- RT	BRIDGE	<0.01					0.05							
<b>TOTALS:</b>			0.03					0.12							

0.03 acres of Temporary Fill in Wetlands in the Hand Clearing areas for erosion control measures.

NC DEPARTMENT OF TRANSPORTATION  
DIVISION OF HIGHWAYS  
  
WAYNE COUNTY  
PROJECT: 33826.1.1 (B-4671)

SHEET

ATN/Revised 9/31/05

March-08

**Permit Drawing**  
**Sheet 2 of 8**

**PROPERTY OWNERS**  
**NAMES AND ADDRESSES**

<b>PARCEL NO.</b>	<b>NAMES</b>	<b>ADDRESSES</b>
<b>1</b>	<b>CITY OF WILSON</b>	<b>P.O. BOX 10 WILSON, NC 27894</b>

**NCDOT**  
**DIVISION OF HIGHWAYS**  
  
**WAYNE COUNTY**  
  
**PROJECT: 33826.1.1 (B-4671)**  
**BRIDGE NO. 35 OVER**  
**NAHUNTA SWAMP ON SR 1532**  
  
**SHEET OF 2 / 4 / 08**

09/20/05/99

**TIP PROJECT: B-4671**

**CONTRACT:**

\$\$\$\$\$ SYSTEMS TIME\$\$\$\$\$  
\$\$\$\$\$ DGN\$\$\$\$\$  
\$\$\$\$\$ CURNAME\$\$\$\$\$

See Sheet 1-A For Index of Sheets

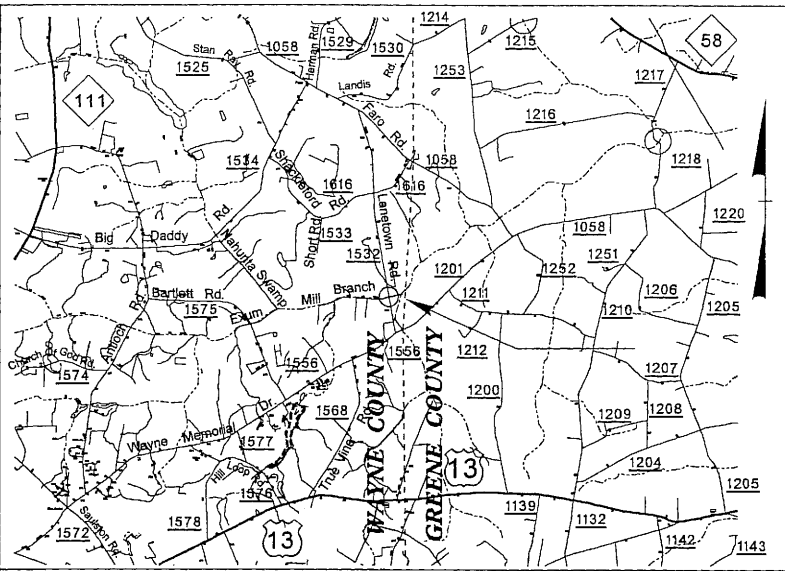

Detour Route  
VICINITY MAP

THIS PROJECT IS NOT WITHIN ANY MUNICIPAL BOUNDARIES.

STATE OF NORTH CAROLINA  
DIVISION OF HIGHWAYS

**WAYNE COUNTY**

LOCATION: BRIDGE 35 ON SR 1532 OVER  
NAHUNTA SWAMP

TYPE OF WORK: GRADING, DRAINAGE, PAVING  
AND STRUCTURE



STATE	STATE PROJECT REFERENCE NO.	SHEET NO.	TOTAL SHEETS
N.C.	B-4671	1	
STATE PROJ. NO.	F.A. PROJ. NO.	DESCRIPTION	
33826.1.1	BRZ-1532(3)	PE	
33826.2.1	BRZ-1532(3)	RW & UTIL	

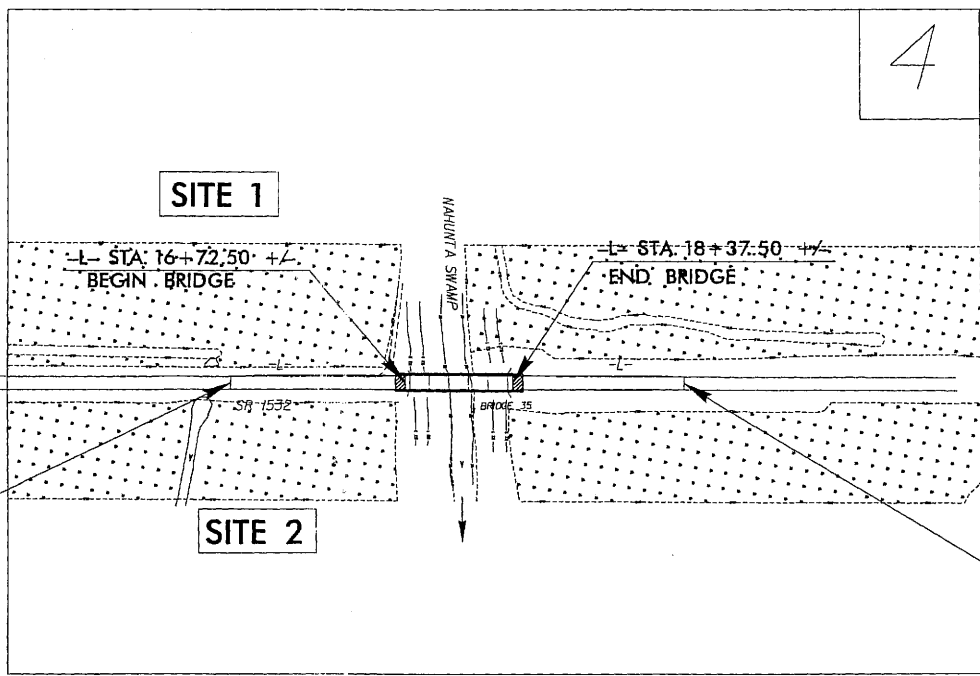
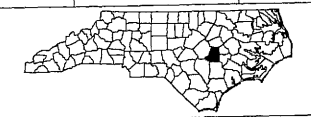

**WETLAND/STREAM IMPACTS**

PRELIMINARY PLANS  
DO NOT USE FOR CONSTRUCTION

CLEARING ON THIS PROJECT SHALL BE PERFORMED TO THE LIMITS ESTABLISHED BY METHOD III

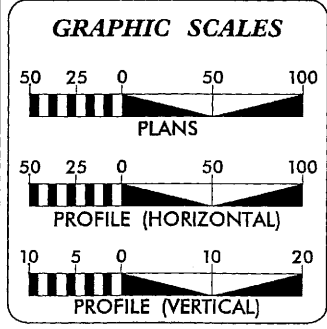

**DESIGN DATA**

ADT 2006 = 225  
ADT 2030 = 500  
DHV = 60 %  
D = 10 %  
T = 3 % \*  
V = 55 MPH  
\* TTST 1% DUAL 2%

FUNCTIONAL CLASSIFICATION  
RURAL LOCAL

**PROJECT LENGTH**

LENGTH ROADWAY TIP PROJECT B-4671 = 0.102 MILES  
LENGTH STRUCTURE TIP PROJECT B-4671 = 0.031 MILES  
TOTAL LENGTH TIP PROJECT B-4671 = 0.133 MILES

Prepared in the Office of:  
**DIVISION OF HIGHWAYS**  
1000 Birch Ridge Dr., Raleigh NC, 27610

2006 STANDARD SPECIFICATIONS

RIGHT OF WAY DATE:  
DECEMBER 18, 2007

LETTING DATE:  
DECEMBER 16, 2008

G.E. BREW, PE  
PROJECT ENGINEER

I.T. YOUNIS  
PROJECT DESIGN ENGINEER

HYDRAULICS ENGINEER

SIGNATURE: \_\_\_\_\_ P.E.

ROADWAY DESIGN ENGINEER

SIGNATURE: \_\_\_\_\_ P.E.

DIVISION OF HIGHWAYS  
STATE OF NORTH CAROLINA

STATE HIGHWAY DESIGN ENGINEER P.E.

B/17/99

PROJECT REFERENCE NO. B-4671	SHEET NO. 4
RAW SHEET NO.	
ROADWAY DESIGN ENGINEER	HYDRAULICS ENGINEER
<b>PRELIMINARY PLANS</b> DO NOT USE FOR CONSTRUCTION	
FOR PROFILE OF LINE -L- SEE SHEET 5	



DENOTES FILL IN WETLAND

DENOTES HAND CLEARING



CITY OF WILSON  
DB 1564 PG 537  
DB 1605 PG 344

CITY OF WILSON  
DB 1564 PG 537  
DB 1605 PG 344

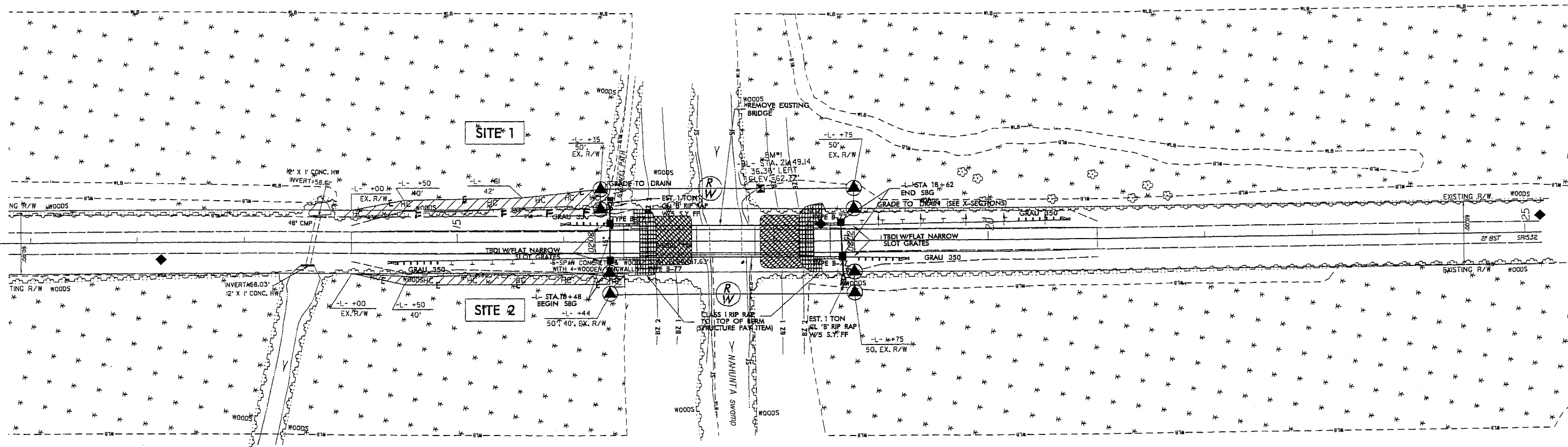

CITY OF WILSON  
DB 1564 PG 537  
DB 1605 PG 344

CITY OF WILSON  
DB 1564 PG 537  
DB 1605 PG 344

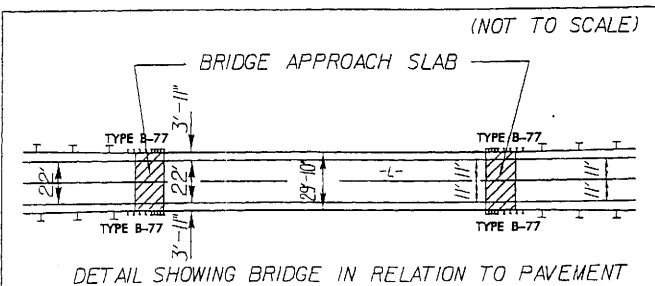

REVISIONS

\*\*\*\*\*  
 1  
 2  
 3  
 4  
 5  
 6  
 7  
 8  
 9  
 10  
 11  
 12  
 13  
 14  
 15  
 16  
 17  
 18  
 19  
 20  
 21  
 22  
 23  
 24  
 25  
 26  
 27  
 28  
 29  
 30  
 31  
 32  
 33  
 34  
 35  
 36  
 37  
 38  
 39  
 40  
 41  
 42  
 43  
 44  
 45  
 46  
 47  
 48  
 49  
 50  
 51  
 52  
 53  
 54  
 55  
 56  
 57  
 58  
 59  
 60  
 61  
 62  
 63  
 64  
 65  
 66  
 67  
 68  
 69  
 70  
 71  
 72  
 73  
 74  
 75  
 76  
 77  
 78  
 79  
 80  
 81  
 82  
 83  
 84  
 85  
 86  
 87  
 88  
 89  
 90  
 91  
 92  
 93  
 94  
 95  
 96  
 97  
 98  
 99  
 100  
 \*\*\*\*\*

8/17/94



PROJECT REFERENCE NO. B-4671	SHEET NO. 4
RW SHEET NO.	
ROADWAY DESIGN ENGINEER	HYDRAULICS ENGINEER
<b>PRELIMINARY PLANS</b> DO NOT USE FOR CONSTRUCTION	

F F DENOTES FILL IN WETLAND

HC HC DENOTES HAND CLEARING

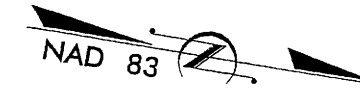

FOR PROFILE OF LINE -L- SEE SHEET 5

CITY OF WILSON  
DB 1564 PG 537  
DB 1605 PG 344

CITY OF WILSON  
DB 1564 PG 537  
DB 1605 PG 344

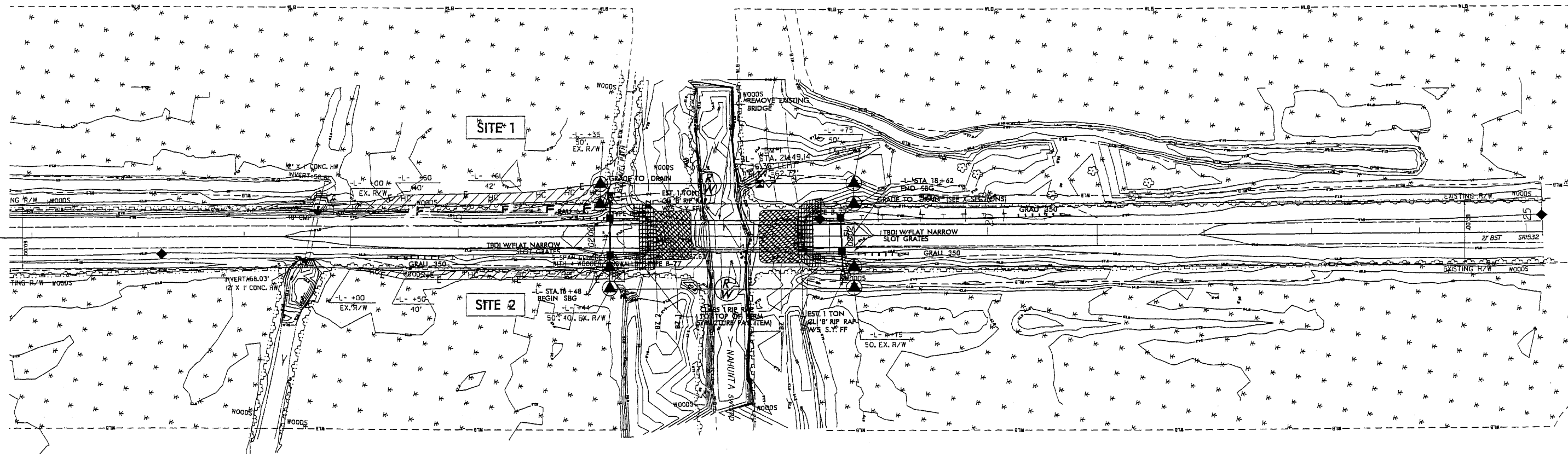

CITY OF WILSON  
DB 1564 PG 537  
DB 1605 PG 344

CITY OF WILSON  
DB 1564 PG 537  
DB 1605 PG 344

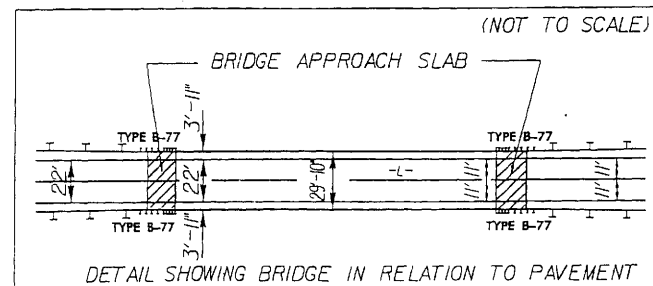

5/28/99

PROJECT REFERENCE NO. B-4671	SHEET NO. 5
ROADWAY DESIGN ENGINEER	HYDRAULICS ENGINEER
<b>PRELIMINARY PLANS</b> DO NOT USE FOR CONSTRUCTION	
FOR PLANS OF LINE -L- SEE SHEET 4	

BRIDGE HYDRAULIC DATA		
DESIGN DISCHARGE	= 3550	CFS
DESIGN FREQUENCY	= 25	YRS
DESIGN HW ELEVATION	= 67.4	FT
BASE DISCHARGE	= 5680	CFS
BASE FREQUENCY	= 100	YRS
BASE HW ELEVATION	= 68.6	FT
OVERTOPPING DISCHARGE	= -3550	CFS
OVERTOPPING FREQUENCY	= 25	YRS
OVERTOPPING ELEVATION	= 66.8	FT
	=	FT
DATE OF SURVEY	= 4/13/07	
W.S. ELEVATION AT DATE OF SURVEY	= 58.0	FT

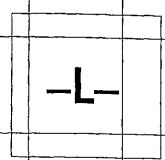

BM \*1 ELEV 62.72'  
 -BL- STA 21+49.14 36.38' LEFT  
 N 63°06.3'25" E 2348.3617860'  
 RR SPIKE IN BASE OF 14" TWIN RIVER BIRCH

CL STA 17+55 -L-  
 3@55' CORED SLAB (21") (CAL=165')  
 CRG# 70.20  
 90° SKEW

BEGIN GRADE  
 -L- STA 14+00.00  
 ELEV. 67.35

END GRADE  
 -L- STA 21+00.00  
 ELEV. 69.00

PI = 15+20.00  
 EL = 67.71'  
 VC = 180'  
 K = 212

PI = 17+40.00  
 EL = 70.24'  
 VC = 260'  
 K = 147

PI = 20+00.00  
 EL = 68.63'  
 VC = 150'  
 K = 152

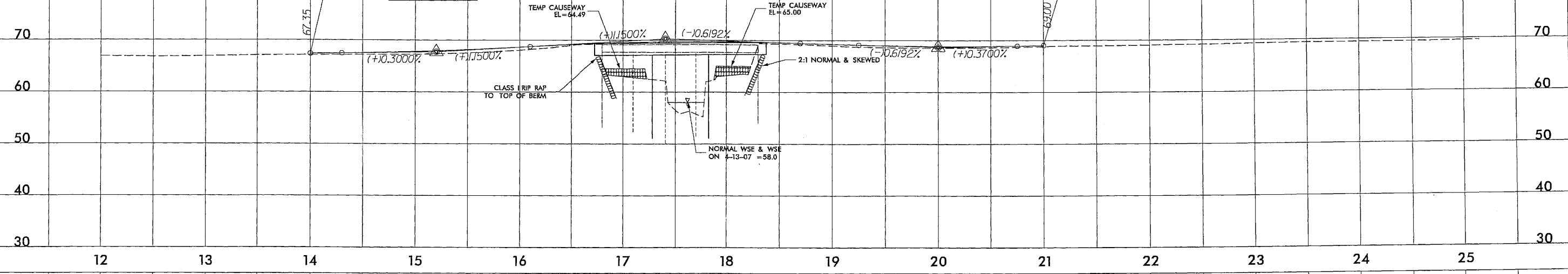

SYSTEMS INC. 5055 W. 12TH AVE. SUITE 100 DENVER, CO 80202  
 TEL: 303.751.1100 FAX: 303.751.1101  
 WWW.SYSTEMSINC.COM

8/23/99

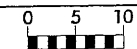

PROJ. REFERENCE NO.  
B-4671

SHEET NO.  
X-1

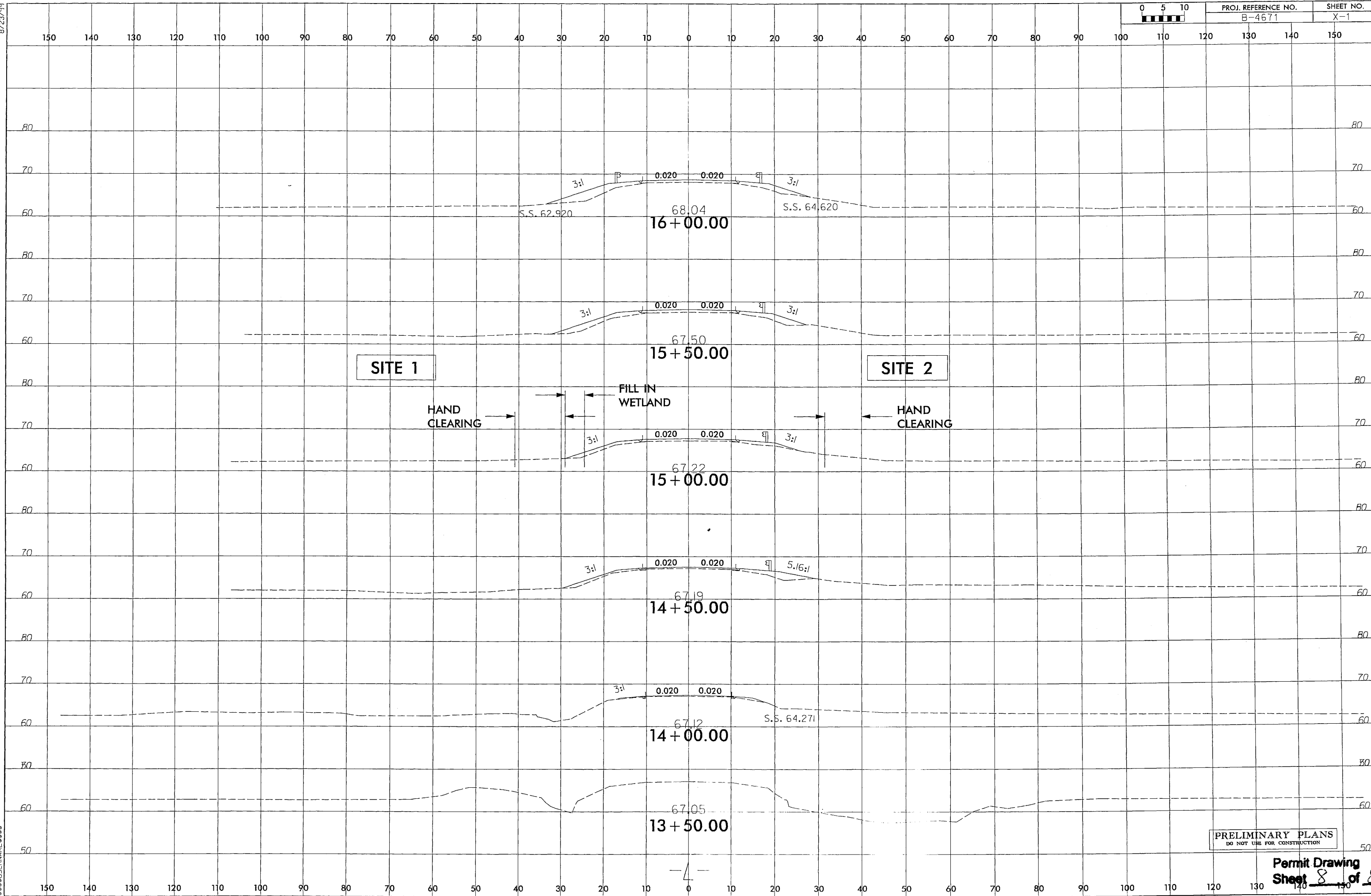

\*\*\*\*\*  
CONSTRUCTION  
\*\*\*\*\*

PRELIMINARY PLANS  
DO NOT USE FOR CONSTRUCTION

Permit Drawing  
Sheet 8 of 8

-4-