



STATE OF NORTH CAROLINA
DEPARTMENT OF TRANSPORTATION

BEVERLY PERDUE
GOVERNOR

EUGENE CONTI
SECRETARY

July 18, 2011

MEMORANDUM TO: Mr. Bobby Lewis, PE
Division 4 Engineer

FROM: Philip S. Harris, III, P.E., Unit Head 
Natural Environment Unit
Project Development and Environmental Analysis Branch

SUBJECT: Nash County, Replacement of Bridge No. 1 on SR 1670 over
Stoney Creek,; Federal Aid Project No. BRZ-1670(1); State Project
No. 8.2323001; Debit \$240.00 from WBS 33788.1.1. ;
TIP No. B-4588

Attached are the U.S. Army Corps of Engineers Section 404 Regional General Permit 31, N.C. Division of Water Quality Section 401 Water Quality Certification, and NC DWQ Riparian Buffer Authorization for the above referenced project. All environmental permits have been received for the construction of this project.

A copy of this permit package will be posted on the NCDOT website at:
<http://www.ncdot.gov/doh/preconstruct/pe/neu/permit.html>

cc:
Mr. Randy Garris, P.E. State Contract Officer
Mr. Chad Coggins, Division Environ. Officer
Mr. Majed Alghandour, P. E., Program. and TIP
Mr. Jay Bennett, P.E., Roadway Design
Dr. David Chang, P.E., Hydraulics
Mr. Art McMillan, P.E., Highway Design
Mr. Tom Koch, P.E., Structure Design
Mr. Mark Staley, Roadside Environmental
Mr. Ron Hancock, P.E., State Roadway Construction Engineer
Mr. Mike Robinson, P.E., State Bridge Construction Engineer
Mr. Bill Goodwin, P.E., PDEA Bridge Unit Head

PROJECT COMMITMENTS:

T.I.P. No. B-4588
Bridge No. 1 on SR 1670 over Stoney Creek
Nash County
Federal Aid Project No. BRZ-1670(1)
State Project No. 8.2323001
W.B.S. No. 33788.1.1

COMMITMENTS FROM PROJECT DEVELOPMENT AND DESIGN

Division Four Construction, Resident Engineer's Office – Offsite Detour

In order to have time to adequately reroute school buses, Nash-Rocky Mount Public Schools should be contacted at (252) 462-2480 at least one month prior to road closure.

Nash County Emergency Services needs to be contacted at (252) 459-9805 at least one month prior to road closure to make the necessary temporary reassignments to primary response units.

Division Engineer's Office, Hydraulics Unit

The Hydraulics Unit will coordinate with the Federal Emergency Management Agency (FEMA) to determine if a Conditional Letter of Map Revision (CLOMR) and a subsequent final Letter of Map Revision (LOMR) are required for the project. If required, the Division will submit sealed as-built construction plans to the Hydraulics Unit upon project completion certifying the project was built as shown on construction plans.

GeoEnvironmental Section

An active gas station presently or formerly containing petroleum USTs was identified within the project limits. NCDOT will provide soil and groundwater assessments on site before right-of-way acquisition.

Hydraulic Unit, Natural Environment Unit – Tar-Pamlico River Buffer Rules

The Tar-Pamlico River Riparian Buffer Rules apply to this project.

Roadway Design/ Structure Design

Bicycle and pedestrian accommodations will be provided. The bridge will include one 11-foot lane and 4-foot offset on the west side and one 13-foot lane, a 2-foot offset and a 5.5-foot sidewalk on the east side. Standard AASHTO bicycle safe rails will be provided on the west side of the bridge. The approach roadway will also include bicycle and pedestrian accommodations.

Roadway Design/ Future Greenway

Roadway design and PDEA will coordinate with the Town of Nashville on the future greenway plans and paddle trail in the vicinity of this bridge.

COMMITMENTS FROM PERMITTING

No additional special conditions were developed through the permitting process.

**U.S. ARMY CORPS OF ENGINEERS
WILMINGTON DISTRICT**

Action ID: **201101286**

County: **Nash**

USGS Quad: **NC-Nashville**

GENERAL PERMIT (REGIONAL AND NATIONWIDE) VERIFICATION

Property Owner / Authorized Agent: **NCDOT / Gregory Thorpe**

Address: **PDEA**

1598 Mail Service Center

aleigh, North Carolina 27699-1598

Telephone No.: **919-707-6118**

Size and location of property (water body, road name/number, town, etc.): **B-4588: Bridge 1 on SR 1670 over Stoney Creek, near Nashville, Nash County, North Carolina..**

Description of projects area and activity: **Replace functionally obsolete and structurally deficient 144' bridge with a 150' bridge on existing ;location. Activity includes 0.09 ac of permanent wetland impacts..**

Applicable Law: Section 404 (Clean Water Act, 33 USC 1344)
 Section 10 (Rivers and Harbors Act, 33 USC 403)

Authorization: Regional General Permit Number: **RGP 31**
Nationwide Permit Number: _____

Your work is authorized by the above referenced permit provided it is accomplished in strict accordance with the attached conditions and your submitted plans. Any violation of the attached conditions or deviation from your submitted plans may subject the permittee to a stop work order, a restoration order and/or appropriate legal action.

This verification is valid until the NWP is modified, reissued, or revoked. All of the existing NWPs are scheduled to be modified, reissued, or revoked prior to March 18, 2012. It is incumbent upon you to remain informed of changes to the NWPs. We will issue a public notice when the NWPs are reissued. Furthermore, if you commence or are under contract to commence this activity before the date that the relevant nationwide permit is modified or revoked, you will have twelve (12) months from the date of the modification or revocation of the NWP to complete the activity under the present terms and conditions of this nationwide permit.

Activities subject to Section 404 (as indicated above) may also require an individual Section 401 Water Quality Certification. You should contact the NC Division of Water Quality (telephone (919) 733-1786) to determine Section 401 requirements.

For activities occurring within the twenty coastal counties subject to regulation under the Coastal Area Management Act (CAMA), prior to beginning work you must contact the N.C. Division of Coastal Management .

This Department of the Army verification does not relieve the permittee of the responsibility to obtain any other required Federal, State or local approvals/permits.

If there are any questions regarding this verification, any of the conditions of the Permit, or the Corps of Engineers regulatory program, please contact Tom Steffens at (910)-251-4615 .

Corps Regulatory Official  T. STEFFENS Date: **07/13/2011**

Expiration Date of Verification: **10/31/2013**

The Wilmington District is committed to providing the highest level of support to the public. To help us ensure we continue to do so, please complete the Customer Satisfaction Survey located at our website at <http://regulatory.usacesurvey.com/> to complete the survey online.

Determination of Jurisdiction:

- Based on preliminary information, there appear to be waters of the US including wetlands within the above described project area. This preliminary determination is not an appealable action under the Regulatory Program Administrative Appeal Process (Reference 33 CFR Part 331).
- There are Navigable Waters of the United States within the above described project area subject to the permit requirements of Section 10 of the Rivers and Harbors Act and Section 404 of the Clean Water Act. Unless there is a change in the law or our published regulations, this determination may be relied upon for a period not to exceed five years from the date of this notification.
- There are waters of the US and/or wetlands within the above described project area subject to the permit requirements of Section 404 of the Clean Water Act (CWA)(33 USC § 1344). Unless there is a change in the law or our published regulations, this determination may be relied upon for a period not to exceed five years from the date of this notification.
- The jurisdictional areas within the above described project area have been identified under a previous action. Please reference jurisdictional determination issued _____. Action ID _____

Basis of Jurisdictional Determination: **This site exhibits wetland criteria as described in the 1987 Corps Wetland Delineation Manual and is part of a broad continuum of wetlands abutting Stoney Creek and direct tributary of the Tar River, a TNW.**

Appeals Information (This information applies only to approved jurisdictional determinations.)

Attached to this verification is an approved jurisdictional determination. If you are not in agreement with that approved jurisdictional determination, you can make an administrative appeal under 33 CFR 331. Enclosed you will find a Notification of Appeal Process (NAP) fact sheet and request for appeal (RFA) form. If you request to appeal this determination you must submit a completed RFA form to the following address:

District Engineer, Wilmington Regulatory Division
Attn: Tom Steffens, Project Manager,
Washington Regulatory Field Office
Post Office Box 1000
Washington, North Carolina 27889

In order for an RFA to be accepted by the Corps, the Corps must determine that it is complete, that it meets the criteria for appeal under 33 CFR part 331.5, and that it has been received by the District Office within 60 days of the date of the NAP. Should you decide to submit an RFA form, it must be received at the above address by _____.

****It is not necessary to submit an RFA form to the District Office if you do not object to the determination in this correspondence.****

Corps Regulatory Official:  T STEFFENS

Date 07/13/2011 Expiration Date 07/13/2016

SURVEY PLATS, FIELD SKETCH, WETLAND DELINEATION FORMS, PROJECT PLANS, ETC., MUST BE ATTACHED TO THE FILE COPY OF THIS FORM, IF REQUIRED OR AVAILABLE.

Copy Furnished:
RG-W

Action ID Number: SAW-2011-01286

County: Nash

Permittee: NCDOT:

Date Verification Issued: 07/13/2011

Project Manager: Tom Steffens

Upon completion of the activity authorized by this permit and any mitigation required by the permit, sign this certification and return it to the following address:

US ARMY CORPS OF ENGINEERS
WILMINGTON DISTRICT
WILMINGTON REGULATORY FIELD OFFICE
POST OFFICE BOX 1890
WILMINGTON, NORTH CAROLINA 28402-1890

Please note that your permitted activity is subject to a compliance inspection by a U. S. Army Corps of Engineers representative. If you fail to comply with this permit you are subject to permit suspension, modification, or revocation.

I hereby certify that the work authorized by the above referenced permit has been completed in accordance with the terms and condition of the said permit, and required mitigation was completed in accordance with the permit conditions.

Signature of Permittee

Date

DEPARTMENT OF THE ARMY
Wilmington District, Corps of Engineers
Post Office Box 1890
Wilmington, North Carolina 28402-1890

Regional General Permit No. 198200031
Name of Permittee: General Public
Effective Date: November 1, 2008
Expiration Date: October 31, 2013

**DEPARTMENT OF THE ARMY
REGIONAL GENERAL PERMIT**

A regional general permit (RGP) to perform work in or affecting navigable waters of the United States and waters of the United States, upon recommendation of the Chief of Engineers, pursuant to Section 10 of the Rivers and Harbors Act of March 3, 1899 (33 U.S.C. 403), and Section 404 of the Clean Water Act (33 U.S.C. 1344), is hereby modified and re-issued by authority of the Secretary of the Army by the

District Engineer
U.S. Army Engineer District, Wilmington
Corps of Engineers
Post Office Box 1890
Wilmington, North Carolina 28402-1890

TO AUTHORIZE THE DISCHARGE OF DREDGED OR FILL MATERIAL IN WATERS OF THE UNITED STATES, INCLUDING WETLANDS, ASSOCIATED WITH THE CONSTRUCTION, MAINTENANCE AND REPAIR OF BRIDGES, INCLUDING COFFERDAMS, ABUTMENTS, FOUNDATION SEALS, PIERS, APPROACH FILLS, DETOUR FILLS, BOX CULVERT INSTALLATION AND TEMPORARY CONSTRUCTION AND ACCESS FILLS, IN WATERS OF THE UNITED STATES AS PART OF WORK CONDUCTED BY THE NORTH CAROLINA DEPARTMENT OF TRANSPORTATION (NCDOT) OR OTHER STATE, FEDERAL OR LOCAL GOVERNMENTAL ENTITY, IN THE STATE OF NORTH CAROLINA.

1. Special Conditions.

a. Written confirmation that the proposed work complies with this RGP must be received from the Wilmington District Engineer prior to the commencement of any work. To enable this determination to be made, the permittee must furnish the Wilmington District Engineer a pre-construction notification with the following information:

(1) A map indicating the location of the work.

(2) Plans of the proposed work showing all pertinent structures, elevations, dimensions and quantities of materials and locations of all structures and/or fill in wetlands or waterward of the normal/high water elevation contours.

(3) A brief discussion of the affected aquatic resources, including streams and wetlands. The discussion shall include the identification and types of vegetation present.

(4) Approximate commencement and completion dates.

(5) A description of methods to be employed to avoid and/or minimize permanent and temporary impacts to aquatic resources caused by the proposed work.

(6) Plans, including timetables and techniques, for construction, stabilization and removal of all unavoidable temporary fills.

(7) Names and addresses of adjoining property owners.

b. In the case of fills of one acre or less, including permanent approach fills, detour fills and fills associated with culvert installation, the Corps of Engineers' Project Manager will determine, after appropriate onsite visits and review of plans, if the impacts on aquatic resources, including streams and wetlands, are likely to be such as to require review by Federal and State agencies. If it is determined that impacts are minimal or can be made minimal by changes agreed to by the applicant, a letter of authorization to proceed will be provided. If it is determined that review by Federal and State agencies is necessary to fully evaluate impacts, copies of all plans and materials will be forwarded to the U.S. Fish and Wildlife Service (USFWS), the National Marine Fisheries Service (NMFS), the U.S. Environmental Protection Agency (EPA) and the North Carolina Department of Environment and Natural Resources (NCDENR). These agencies will furnish comments to the Wilmington District Engineer within thirty (30) days.

c. In cases of fills greater than one acre, copies of all plans and materials will be forwarded to the USFWS, the NMFS, the EPA and the NCDENR. These agencies will furnish comments to the Wilmington District Engineer in thirty (30) days. In cases of land disturbing activities comprising more than one acre, a Sedimentation/Erosion Control Plan will be filed with the North Carolina Division of Land Resources, Land Quality Section, thirty (30) days prior to commencing work.

d. Where work is proposed within the twenty (20) coastal counties, as defined by the North Carolina Division of Coastal Management, the applicant shall forward a copy of the pre-construction notification to:

**National Marine Fisheries Service
101 Pivers Island Road**

Beaufort, North Carolina 28516

The counties in which this condition applies are:

Bertie	Carteret	Dare	Hyde	Pender
Beaufort	Chowan	Gates	Onslow	Perquimans
Brunswick	Craven	New Hanover	Pamlico	Tyrrell
Camden	Currituck	Hertford	Pasquotank	Washington

e. In the event that any Federal agency maintains an objection or any required State authorization is outstanding, no notice to proceed will be given until objections are resolved and State authorizations are issued.

f. No work will proceed until after the applicant has received written notice to proceed from the Wilmington District Engineer. This notice may include additional conditions and/or restrictions. Copies of the notice to proceed will be furnished to the USFWS, the NMFS, the EPA and the NCDENR with a brief description of the work, including the area of wetlands affected and the quantity of fill material.

g. Upon completion of any work authorized by this RGP, all temporary fills will be completely removed and the area reestablished as a wetland by restoring natural hydrology and native vegetation. Stream contours and riparian vegetation will be reestablished upon the removal of temporary culverts. In such instances, a restoration plan will be submitted to the Wilmington District Engineer for approval. Information in the restoration plan will be in accordance with special condition j. below.

h. Appropriate soil and erosion control measures must be established and maintained during construction. All fills, temporary and permanent, must be adequately stabilized at the earliest practicable date to prevent erosion of fill material into adjacent waters or wetlands.

i. In cases where new alignment approaches are to be constructed and the existing wetland approach fill is to be abandoned and no longer to be maintained as a roadway, the abandoned fill shall be removed and the area reestablished as a wetland. In such instances, a restoration plan will be submitted to the Wilmington District Engineer for approval. Information in the restoration plan will be in accordance with special condition j. below.

j. Discharges of dredged or fill material into waters of the United States, including wetlands, must be minimized or avoided to the maximum extent practicable. In reviewing an activity, the Wilmington District Engineer will first determine whether the activity will result in more than minimal adverse environmental affects. For activities that are determined to have more than minimal impacts, compensatory mitigation will be required. To expedite the process, the applicant will provide a mitigation plan with the request for authorization. Site specific mitigation proposals will include, but are not necessarily limited to, a description of work, a schedule of work and a monitoring plan, and they will be in accordance with currently approved

Wilmington District and/or Corps-wide mitigation guidelines. The applicant may propose other forms of mitigation, such as mitigation bank credits or in-lieu fee mitigation with the notification, which in some situations and at the discretion of the Wilmington District, may be considered acceptable mitigation.

k. Activities in any North Carolina designated "Mountain Trout Waters" must comply with all pH, temperature and turbidity criteria established for such waters by the North Carolina Wildlife Resources Commission (NCWRC) and/or the North Carolina Division of Water Quality (NCDWQ). Work that may result in the sedimentation of trout waters will generally be prohibited from October 15 to April 15, of any year, to avoid impacts on trout spawning.

l. Before discharging dredged or fill material into waters of the United States, including wetlands, in the twenty-five (25) mountain counties of North Carolina that contain trout waters, the applicant will obtain and provide a letter of comments and recommendations from the NCWRC on the proposed activities. A discussion of alternatives to working in the mountain trout waters and why alternatives were not selected, and a plan to provide compensatory mitigation for all unavoidable adverse impacts to the mountain trout waters shall also be submitted with the letter from NCWRC. To facilitate coordination with the NCWRC, the proponent may provide a copy of the notification to the NCWRC concurrent with the notification to the District Engineer. The NCWRC will respond both to the proponent and directly to the Corps of Engineers.

The applicant should contact NCWRC in the following NC Trout Counties at:

Mr. Ron Linville Western Piedmont Region Coordinator 3855 Idlewild Road Kernersville, NC 27284-9180 Telephone: (336) 769-9453	Counties		
	Alleghany	Caldwell	Watauga
	Ashe	Mitchell	Wilkes
	Avery	Stokes	
	Burke	Surry	

Mr. Dave McHenry Mountain Region Coordinator 20830 Great Smoky Mtn. Expressway Waynesville, NC 28786 Telephone: (828) 452-2546 Fax: (828) 452-7772	Counties		
	Buncombe	Henderson	Polk
	Cherokee	Jackson	Rutherford
	Clay	Macon	Swain
	Graham	Madison	Transylvania
	Haywood	McDowell	Yancey

m. This permit does not authorize the use of culverts in areas designated as anadromous fish spawning areas by the North Carolina Division of Marine Fisheries (NCDMF) or the North Carolina Wildlife Resources Commission (NCWRC).

n. Discharges into Waters of the United States designated by either the North Carolina Division of Marine Fisheries (NCDMF) or the NCWRC as anadromous fish spawning area are prohibited during the period between February 15 and June 30, without prior written approval from NCDMF or NCWRC and the Corps. Discharges into waters of the United States designated by NCDMF as primary nursery areas and discharges into waters of the United States designated by NCWRC as inland nursery areas shall be coordinated with NCDMF and NCWRC prior to being authorized by this RGP. Coordination with NCDMF and NCWRC may result in a required construction moratorium during periods of significant biological productivity or critical life stages.

The Applicant should contact:

**NC Division of Marine Fisheries
3441 Arendell Street
Morehead City, NC 28557
Telephone 252-726-7021
or 800-682-2632**

**North Carolina Wildlife Resources Commission
Habitat Conservation Program Manager
1721 Mail Service Center
Raleigh, NC 27699-1721
Telephone (919) 733-7638**

o. No activity may result in substantial permanent disruption of the movement of those species of aquatic life indigenous to the waterbody, including those species that normally migrate through the area. The dimension, pattern, and profile of the stream above and below a pipe or culvert should not be modified by widening the stream channel or by reducing the depth of the stream in connection with the construction activity. The width, height, and gradient of a proposed opening should be such as to pass the average historical low flow and spring flow without adversely altering flow velocity. Spring flow should be determined from gage data, if available. In the absence of such data, bankfull flow can be used as a comparable level.

p. This permit generally allows the permanent installation of culverts to 100 feet in length. For culverts longer than 100 feet, the proposed application will be closely evaluated to determine if unacceptable impacts on movement of aquatic organisms would result. In such cases, approval may not be provided.

q. If the project is located within the twenty (20) counties of North Carolina designated as coastal counties by the Coastal Area Management Act (CAMA), then all pipe and culvert inverts will be buried at least one foot below normal bed elevation when they are placed within the Public Trust Area of Environmental Concern (AEC) and/or the Estuarine Waters AEC as designated by CAMA, and/or all streams appearing as blue lines on United States Geological Survey (USGS) quad sheets. If the project is not located within the twenty (20) counties of North Carolina designated as coastal counties by CAMA, then culvert inverts will be buried at least one foot below the bed of the stream for culverts greater than 48 inches in diameter. Culverts 48 inches in diameter or less shall be buried or placed on the stream bed as practicable and appropriate to maintain aquatic passage, and every effort shall be made to maintain the existing channel slope. The potential for destabilization of the channel and head cutting upstream should

be considered in the placement of the culvert. A waiver from the depth specifications in this condition may be requested in writing. The waiver will only be issued if it can be demonstrated that the impacts of complying with this condition would result in more adverse impacts to the aquatic environment. Culverts placed in wetlands do not have to be buried.

r. All activities authorized by this RGP shall, to the extent practicable, be conducted "in the dry", with barriers installed between work areas and aquatic habitat to protect that habitat from cement or other pollutants. Where concrete is utilized, measures will be taken to prevent live or fresh concrete, including bags of uncured concrete, from coming into contact with waters of the state until the concrete has hardened. Water in the work area will be pumped to holding and settling ponds as practicable, and water will not be allowed to re-enter the water column until decanted.

s. If the project authorized by this RGP is proposed by a Federal or State agency, and is located within the twenty (20) counties of North Carolina designated as coastal counties by the CAMA, then prior to project initiation the proponent must obtain a consistency concurrence that the proposed project would be consistent with the state's coastal management program from the N.C. Division of Coastal Management (DCM). A copy of the state's consistency approval must be provided to the appropriate Wilmington District Regulatory Office at the following address:

Wilmington Regulatory Field Office
P.O. Box 1890
Wilmington, NC 28402

Washington Regulatory Field Office
P.O. Box 1000
Washington, NC 27889

The state's consistency approval will be conveyed in the form of a CAMA permit if the project is located within a designated CAMA Area of Environmental Concern (AEC), and will be conveyed in the form of a Consistency concurrence letter from DCM if the project is not located within a designated CAMA AEC.

t. No work shall be authorized by the RGP within the twenty coastal counties, as defined by the North Carolina Division of Coastal Management, without prior consultation with NOAA Fisheries. For each activity reviewed by the Corps of Engineers where it is determined that the activity may affect Essential Fish Habitat (EFH) for Federally managed species, an EFH Assessment shall be prepared by the applicant and forwarded to the Corps of Engineers and NOAA Fisheries for review and comment prior to authorization of work.

u. All work will comply with Water Quality Certification No. 3404, issued by the NCDWQ on 30 September 2008.

v. The activity must be designed to maintain preconstruction downstream flow conditions (e.g., location, capacity, and flow rates). Furthermore, the activity must not permanently restrict or impede the passage of normal or expected high flows and the structure or discharge of dredged or fill material must withstand expected high flows

2. General Conditions.

a. All activities authorized by this RGP that involve the discharge of dredged or fill material in waters of the United States will be consistent with applicable water quality standards, effluent limitations and standards of performance, prohibitions, pre-treatment standards and management practices established pursuant to the Clean Water Act (33 U.S.C. 1344) and applicable State and local law. If the proposed activity involves the discharge of dredged or fill material in waters of the United States, prior to the commencement of any work, the applicant will satisfy the NCDWQ regarding the need for a Water Quality Certification pursuant to Section 401 of the Clean Water Act.

b. All activities authorized by this RGP that involve the use of concrete as a building material, measures will be taken to prevent live or fresh concrete, including bags of uncured concrete, from coming into contact with waters of the state until the concrete has hardened.

c. To the maximum extent practicable, the pre-construction course, condition, capacity, and location of open waters must be maintained for each activity, including stream channelization and storm water management activities, except as provided below. The activity must be constructed to withstand expected high flows. The activity must not restrict or impede the passage of normal or high flows. The activity may alter the pre-construction course, condition, capacity, and location of open waters if it benefits the aquatic environment (e.g., stream restoration or relocation activities).

d. All activities authorized by this RGP that involve the use of riprap material for bank stabilization, the following measures shall be applied:

(1) Filter cloth must be placed underneath the riprap as an additional requirement of its use in North Carolina waters.

(2) The placement of riprap shall be limited to the areas depicted on submitted work plan drawings.

(3) The riprap material shall be clean and free from loose dirt or any pollutant except in trace quantities that would not have an adverse environmental effect.

(4) It shall be of a size sufficient to prevent its movement from the authorized alignment by natural forces under normal conditions.

(5) The riprap material shall consist of clean rock or masonry material such as, but not limited to, granite, marl, or broken concrete.

(6) A waiver from the specifications in this general condition may be requested in writing. The waiver will only be issued if it can be demonstrated that the impacts of complying with this Regional condition would result in greater adverse impacts to the aquatic environment.

- e. There will be no unreasonable interference with navigation or the right of the public to riparian access by the existence or use of activities authorized by this RGP.
- f. The activity must comply with applicable FEMA approved state or local floodplain management requirements.
- g. Heavy equipment working in wetlands or mudflats must be placed on mats, or other measures must be taken to minimize soil disturbance.
- h. A permittee, upon receipt of written notice from the Wilmington District Engineer of failure to comply with the terms or conditions of this RGP, will, within 60 days, without expense to the U.S. Government, and in such manner as the Wilmington District Engineer may direct, affect compliance with the terms and conditions or return the worksite to a pre-work condition.
- i. The permittee must make every reasonable effort to perform the work authorized herein in a manner so as to minimize any adverse impact on fish, wildlife and natural environmental values.
- j. The permittee must perform the work authorized herein in a manner so as to minimize any degradation of water quality. The activity will be conducted in such a manner as to prevent a significant increase in turbidity outside the area of construction or construction-related discharge. Increases such that the turbidity in the water body is 50 NTU's or less in all rivers not designated as trout waters by the North Carolina Division of Environmental Management (NCDEM), 25 NTU's or less in all saltwater classes and in all lakes and reservoirs, and 10 NTU's or less in trout waters, are not considered significant.
- k. The permittee will permit the Wilmington District Engineer or his representative to make periodic inspections at any time deemed necessary in order to assure that the activity is being performed or maintained in strict accordance with the Special and General Conditions of this permit.
- l. This RGP **does not** convey any rights, either in real estate or material, or any exclusive privileges; and it does not authorize any injury to property or invasion of rights or any infringement of Federal, State or local laws or regulations, nor does it obviate the requirement to obtain State or local assent required by law for the activity authorized herein. These may include, but are not necessarily limited to, a Dredge and/or Fill Permit (N.C.G.S. 113-229), a CAMA Permit (N.C.G.S. 113A-118), an Easement to Fill (N.C.G.S. 146-12) and a Water Quality Certification pursuant to Section 401 of the Clean Water Act.
- m. Authorization provided by this RGP may be modified, suspended or revoked in whole or in part if the Wilmington District Engineer, acting on behalf of the Secretary of the Army, determines that such action would be in the best public interest. Unless subject to modification, suspension or revocation, the term of this RGP shall be five years. Any modification, suspension or revocation of this authorization will not be the basis for any claim for damages against the U.S. Government.

n. This RGP does not authorize the interference with any existing or proposed Federal project and the permittee will not be entitled to compensation for damages or injury to the structures or work authorized herein which may be caused by or results from existing or future operations undertaken by the United States in the public interest.

o. This RGP will not be applicable to proposed construction when the Wilmington District Engineer determines that the proposed activity would significantly affect the quality of the human environment and determines that an Environmental Impact Statement (EIS) must be prepared.

p. This RGP will not be applicable to proposed construction when the Wilmington District Engineer determines, after any necessary investigations, that the proposed activity would adversely affect areas that possess historic, cultural, scenic, conservation or recreational values. Application of this exemption applies to:

(1) Rivers named in Section 3 of the Wild and Scenic Rivers Act (15 U.S.C. 1273), those proposed for inclusion as provided by Sections 4 and 5 of the Act and wild, scenic and recreational rivers established by State and local entities.

(2) Historic, cultural or archeological sites listed in or eligible for inclusion in the National Register of Historic Places as defined in the National Historic Preservation Act of 1966 as amended, the Abandoned Shipwreck Act of 1987 and the Native American Graves Protection and Repatriation Act.

(3) Sites included in or determined eligible for listing in the National Registry of Natural Landmarks.

(4) Endangered or threatened species or habitat of such species as determined by the Secretaries of Interior or Commerce and concerned in accordance with the Endangered Species Act (16 U.S.C. 1531).

(5) NOAA designated marine sanctuaries, National Estuarine Research Reserves, and coral reefs.

q. Permittees are advised that activities in or near a floodway may be subject to the National Flood Insurance Program, which prohibits any activities, including fill within a floodway that results in any increase in base flood elevations.

r. At his discretion, the Wilmington District Engineer may determine that this RGP will not be applicable to a specific construction proposal. In such case, the procedure for processing an individual permit in accordance with 33 CFR 325 will be available.

s. Any authorized structure or fill shall be properly maintained, including maintenance to ensure public safety.

t. The discharge of dredged or fill material shall consist of suitable material free from toxic pollutants in toxic amounts.

BY AUTHORITY OF THE SECRETARY OF THE ARMY:

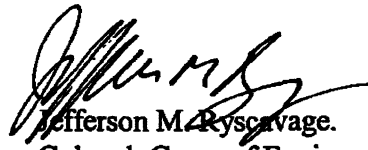

Jefferson M. Ryscavage.
Colonel, Corps of Engineers
District Commander



North Carolina Department of Environment and Natural Resources
 Division of Water Quality
 Coleen H. Sullins
 Director

Beverly Eaves Perdue
 Governor

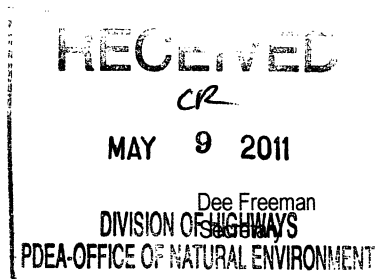

May 5, 2011
 Nash County
 NCDWQ Project No. 20110389
 Bridge 1 on SR 1670
 TIP No. B-4588

APPROVAL of 401 WATER QUALITY CERTIFICATION and TAR-PAMLICO BUFFER AUTHORIZATION, with ADDITIONAL CONDITIONS

Dr. Gregory J. Thorpe, Environmental Management Director
 NCDOT PDEA
 1598 Mail Service Center
 Raleigh, NC 27699-1598

Dear Dr. Thorpe:

You have our approval, in accordance with the conditions listed below, for the following impacts for the purpose of replacing Bridge 1 in Nash County:

Stream Impacts in the Tar-Pamlico River Basin

Site	Temporary Fill in Perennial Stream (linear ft)	Total Stream Impact (linear ft)
1	95	95
Total	95	95

Total Stream Impact for Project: 95 linear feet.

Wetland Impacts in the Tar-Pamlico River Basin

Site	Permanent Fill (ac)	Temporary Fill (ac)	Mechanized Clearing (ac)	Hand Clearing (ac)	Total Wetland Impact (ac)
1	0.03	0.01	0.06	0.07	0.17
Total	0.03	0.01	0.06	0.07	0.17

Total Wetland Impact for Project: 0.17 acres.

Tar-Pamlico Riparian Buffer Impacts

Site	Zone 1 Impact (sq ft)	minus Wetlands in Zone 1 (sq ft)	= Zone 1 Buffers (not wetlands) (sq ft)	Zone 1 Buffer Mitigation Required (using 3:1 ratio)	Zone 2 Impact (sq ft)	minus Wetlands in Zone 2 (sq ft)	= Zone 2 Buffers (not wetlands) (sq ft)	Zone 2 Buffer Mitigation Required (using 1.5:1 ratio)
1	7282	2785	4497	N/A	2099	706	1393	N/A
Totals	7282	2785	4497	0	2099	706	1393	0

* n/a = Total for Site is less than 1/3 acre and 150 linear feet of impact, no mitigation required

Total Buffer Impact for Project: 9,381 square feet.

Transportation Permitting Unit
 Wetlands & Stormwater Branch
 1650 Mail Service Center, Raleigh, North Carolina 27699-1650
 Phone: 919-807-6399 \ FAX: 919-807-6494
 Internet: <http://h2o.enr.state.nc.us/ncwetlands/>



The project shall be constructed in accordance with your application dated received April 26, 2011. After reviewing your application, we have decided that these impacts are covered by General Water Quality Certification Number 3820. This certification corresponds to the General Permit 31 issued by the Corps of Engineers. This approval is also valid for the Tar-Pamlico Riparian Buffer Rules (15A NCAC 2B.0259). In addition, you should acquire any other federal, state or local permits before you proceed with your project including (but not limited to) Sediment and Erosion Control, Non-Discharge and Water Supply Watershed regulations. This approval will expire with the accompanying 404 permit.

This approval is valid solely for the purpose and design described in your application (unless modified below). Should your project change, you must notify the NCDWQ and submit a new application. If the property is sold, the new owner must be given a copy of this Certification and approval letter, and is thereby responsible for complying with all the conditions. If total wetland fills for this project (now or in the future) exceed one acre, or of total impacts to streams (now or in the future) exceed 150 linear feet, compensatory mitigation may be required as described in 15A NCAC 2H .0506 (h) (6) and (7). Additional buffer impacts may require compensatory mitigation as described in 15A NCAC.02602(9). For this approval to remain valid, you must adhere to the conditions listed in the attached certification(s) and any additional conditions listed below.

Conditions of Certification:

1. The post-construction removal of any temporary bridge structures must return the project site to its preconstruction contours and elevations. The impacted areas shall be revegetated with appropriate native species.
2. Strict adherence to the most recent version of NCDOT's Best Management Practices For Bridge Demolition and Removal approved by the US Army Corps of Engineers is a condition of the 401 Water Quality Certification.
3. Bridge deck drains shall not discharge into the stream. Stormwater shall be directed across the bridge and pre-treated through site-appropriate means (grassed swales, pre-formed scour holes, vegetated buffers, etc.) before entering the stream. Please refer to the most current version of *Stormwater Best Management Practices*.
4. Bridge piles and bents shall be constructed using driven piles (hammer or vibratory) or drilled shaft construction methods. More specifically, jetting or other methods of pile driving are prohibited without prior written approval from NCDWQ first.
5. No drill slurry or water that has been in contact with uncured concrete shall be allowed to enter surface waters. This water shall be captured, treated, and disposed of properly.
6. All pile driving or drilling activities in surface waters shall be enclosed in turbidity curtains unless otherwise approved by NCDWQ in this certification.
7. Riprap shall not be placed in the active thalweg channel or placed in the streambed in a manner that precludes aquatic life passage. Bioengineering boulders or structures should be properly designed, sized and installed.
8. For any streams being impacted due to site dewatering activities, the site shall be graded to its preconstruction contours and revegetated with appropriate native species.
9. All stormwater runoff shall be directed as sheetflow through stream buffers at nonerosive velocities, unless otherwise approved by this certification.
10. All riparian buffers impacted by the placement of temporary fill or clearing activities shall be restored to the preconstruction contours and revegetated. Maintained buffers shall be permanently revegetated with non-woody species by the end of the growing season following completion of construction. For the purpose of this condition, maintained buffer areas are defined as areas within the transportation corridor that will be subject to regular NCDOT maintenance activities including mowing. The area with non-maintained buffers shall be permanently revegetated with native woody species before the next growing season following completion of construction.
11. If concrete is used during construction, a dry work area shall be maintained to prevent direct contact between curing concrete and stream water. Water that inadvertently contacts uncured concrete shall not be discharged to surface waters due to the potential for elevated pH and possible aquatic life and fish kills.

12. Pursuant to NCAC15A 2B.0259(6), sediment and erosion control devices shall not be placed in Zone 1 of any Tar-Pamlico Buffer without prior approval by NCDWQ. At this time, NCDWQ has approved no sediment and erosion control devices in Zone 1, outside of the approved project impacts, anywhere on this project. Moreover, sediment and erosion control devices shall be allowed in Zone 2 of the buffers provided that Zone 1 is not compromised and that discharge is released as diffuse flow.
13. During the construction of the project, no staging of equipment of any kind is permitted in waters of the U.S., or protected riparian buffers.
14. The dimension, pattern and profile of the stream above and below the crossing shall not be modified. Disturbed floodplains and streams shall be restored to natural geomorphic conditions.
15. The use of rip-rap above the Normal High Water Mark shall be minimized. Any rip-rap placed for stream stabilization shall be placed in stream channels in such a manner that it does not impede aquatic life passage.
16. The Permittee shall ensure that the final design drawings adhere to the permit and to the permit drawings submitted for approval.
17. All work in or adjacent to stream waters shall be conducted in a dry work area. Approved BMP measures from the most current version of NCDOT Construction and Maintenance Activities manual such as sandbags, rock berms, cofferdams and other diversion structures shall be used to prevent excavation in flowing water.
18. Heavy equipment shall be operated from the banks rather than in the stream channel in order to minimize sedimentation and reduce the introduction of other pollutants into the stream.
19. All mechanized equipment operated near surface waters must be regularly inspected and maintained to prevent contamination of stream waters from fuels, lubricants, hydraulic fluids, or other toxic materials.
20. No rock, sand or other materials shall be dredged from the stream channel except where authorized by this certification.
21. Discharging hydroseed mixtures and washing out hydroseeders and other equipment in or adjacent to surface waters is prohibited.
22. The permittee and its authorized agents shall conduct its activities in a manner consistent with State water quality standards (including any requirements resulting from compliance with §303(d) of the Clean Water Act) and any other appropriate requirements of State and Federal law. If NCDWQ determines that such standards or laws are not being met (including the failure to sustain a designated or achieved use) or that State or federal law is being violated, or that further conditions are necessary to assure compliance, NCDWQ may reevaluate and modify this certification.
23. All fill slopes located in jurisdictional wetlands shall be placed at slopes no flatter than 3:1, unless otherwise authorized by this certification..
24. A copy of this Water Quality Certification shall be maintained on the construction site at all times. In addition, the Water Quality Certification and all subsequent modifications, if any, shall be maintained with the Division Engineer and the on-site project manager.
25. The outside buffer, wetland or water boundary located within the construction corridor approved by this authorization shall be clearly marked by highly visible fencing prior to any land disturbing activities. Impacts to areas within the fencing are prohibited unless otherwise authorized by this certification.
26. The issuance of this certification does not exempt the Permittee from complying with any and all statutes, rules, regulations, or ordinances that may be imposed by other government agencies (i.e. local, state, and federal) having jurisdiction, including but not limited to applicable buffer rules, stormwater management rules, soil erosion and sedimentation control requirements, etc.
27. The Permittee shall report any violations of this certification to the Division of Water Quality within 24 hours of discovery.

28. Upon completion of the project (including any impacts at associated borrow or waste sites), the NCDOT Division Engineer shall complete and return the enclosed "Certification of Completion Form" to notify NCDWQ when all work included in the 401 Certification has been completed.

29. Native riparian vegetation (i.e., trees and shrubs native to your geographic region) must be reestablished within the construction limits of the project by the end of the growing season following completion of construction.

30. There shall be no excavation from, or waste disposal into, jurisdictional wetlands or waters associated with this permit without appropriate modification. Should waste or borrow sites, or access roads to waste or borrow sites, be located in wetlands or streams, compensatory mitigation will be required since that is a direct impact from road construction activities.

31. Erosion and sediment control practices must be in full compliance with all specifications governing the proper design, installation and operation and maintenance of such Best Management Practices in order to protect surface waters standards:

- a. The erosion and sediment control measures for the project must be designed, installed, operated, and maintained in accordance with the most recent version of the *North Carolina Sediment and Erosion Control Planning and Design Manual*.
- b. The design, installation, operation, and maintenance of the sediment and erosion control measures must be such that they equal, or exceed, the requirements specified in the most recent version of the *North Carolina Sediment and Erosion Control Manual*. The devices shall be maintained on all construction sites, borrow sites, and waste pile (spoil) projects, including contractor-owned or leased borrow pits associated with the project.
- c. For borrow pit sites, the erosion and sediment control measures must be designed, installed, operated, and maintained in accordance with the most recent version of the *North Carolina Surface Mining Manual*.
- d. The reclamation measures and implementation must comply with the reclamation in accordance with the requirements of the Sedimentation Pollution Control Act.

32. Sediment and erosion control measures shall not be placed in wetlands or waters unless otherwise approved by this Certification.

If you wish to contest any statement in the attached Certification you must file a petition for an administrative hearing. You may obtain the petition form from the office of Administrative hearings. You must file the petition with the office of Administrative Hearings within sixty (60) days of receipt of this notice. A petition is considered filed when it is received in the office of Administrative Hearings during normal office hours. The Office of Administrative Hearings accepts filings Monday through Friday between the hours of 8:00am and 5:00pm, except for official state holidays. The original and one (1) copy of the petition must be filed with the Office of Administrative Hearings.

The petition may be faxed-provided the original and one copy of the document is received by the Office of Administrative Hearings within five (5) business days following the faxed transmission.

The mailing address for the Office of Administrative Hearings is:

Office of Administrative Hearings
6714 Mail Service Center
Raleigh, NC 27699-6714
Telephone: (919)-733-2698, Facsimile: (919)-733-3478

A copy of the petition must also be served on DENR as follows:

Ms. Mary Penny Thompson, General Counsel
Department of Environment and Natural Resources
1601 Mail Service Center
Raleigh, NC 27699-1601

This letter completes the review of the Division of Water Quality under Section 401 of the Clean Water Act. If you have any questions, please contact Rob Ridings at 919-807-6403.

Sincerely,



Coleen H. Sullins
Director

Cc: Chad Coggins, Division 4 Environmental Officer
Tom Steffens, US Army Corps of Engineers, Washington Field Office
Travis Wilson, NC Wildlife Resources Commission
Amy James, NCDOT NEU
File Copy

NCDWQ Project No.: _____

County: _____

Applicant: _____

Project Name: _____

Date of Issuance of 401 Water Quality Certification: _____

Certificate of Completion

Upon completion of all work approved within the 401 Water Quality Certification or applicable Buffer Rules, and any subsequent modifications, the applicant is required to return this certificate to the 401 Transportation Permitting Unit, North Carolina Division of Water Quality, 1650 Mail Service Center, Raleigh, NC, 27699-1650. This form may be returned to NCDWQ by the applicant, the applicant's authorized agent, or the project engineer. It is not necessary to send certificates from all of these.

Applicant's Certification

I, _____, hereby state that, to the best of my abilities, due care and diligence was used in the observation of the construction such that the construction was observed to be built within substantial compliance and intent of the 401 Water Quality Certification and Buffer Rules, the approved plans and specifications, and other supporting materials.

Signature: _____ Date: _____

Agent's Certification

I, _____, hereby state that, to the best of my abilities, due care and diligence was used in the observation of the construction such that the construction was observed to be built within substantial compliance and intent of the 401 Water Quality Certification and Buffer Rules, the approved plans and specifications, and other supporting materials.

Signature: _____ Date: _____

Engineer's Certification

_____ Partial _____ Final

I, _____, as a duly registered Professional Engineer in the State of North Carolina, having been authorized to observe (periodically, weekly, full time) the construction of the project, for the Permittee hereby state that, to the best of my abilities, due care and diligence was used in the observation of the construction such that the construction was observed to be built within substantial compliance and intent of the 401 Water Quality Certification and Buffer Rules, the approved plans and specifications, and other supporting materials.

Signature _____ Registration No. _____

Date _____

Water Quality Certification N^o. 3820

GENERAL CERTIFICATION FOR PROJECTS ELIGIBLE FOR U.S. ARMY CORPS OF ENGINEERS NATIONWIDE PERMIT NUMBER 14 (LINEAR TRANSPORTATION PROJECTS) AND REGIONAL GENERAL PERMIT 198200031 (WORK ASSOCIATED WITH BRIDGE CONSTRUCTION, MAINTENANCE OR REPAIR CONDUCTED BY NCDOT OR OTHER GOVERNMENT AGENCIES) AND RIPARIAN AREA PROTECTION RULES (BUFFER RULES)

Water Quality Certification Number 3820 is issued in conformity with the requirements of Section 401, Public Laws 92-500 and 95-217 of the United States and subject to the North Carolina Division of Water Quality (DWQ) Regulations in 15A NCAC 2H, Section .0500 and 15A NCAC 2B .0200 for the discharge of fill material to waters and adjacent wetland areas or to wetland areas that are not a part of the surface tributary system to interstate waters or navigable waters of the United States (as described in 33 CFR 330 Appendix A (B) (14) of the Corps of Engineers regulations (Nationwide Permit No. 14 and Regional General Permit 198200031) and for the Riparian Area Protection Rules (Buffer Rules) in 15A NCAC 2B .0200.

The State of North Carolina certifies that the specified category of activity will not violate applicable portions of Sections 301, 302, 303, 306 and 307 of the Public Laws 92-500 and 95-217 if conducted in accordance with the conditions hereinafter set forth.

Any proposed fill or modification of wetlands and/or waters, including streams, under this General Certification requires application to, and written approval from the Division of Water Quality (the "Division") except for the single family lot exemption described below.

Application and written approval is *not required* for construction of a driveway to a single family lot as long as the driveway involves *less than 25 feet* of temporary and/or permanent stream channel impacts, including any in-stream stabilization needed for the crossing. This activity must meet all of the Conditions of Certification listed below. If any of these Conditions cannot be met, **or if the activity is associated with or in response to a Notice of Violation from the Division of Water Quality or the NC Division of Land Resources, then written approval from the Division is required.**

In accordance with North Carolina General Statute Section 143-215.3D(e), written approval for a 401 Water Quality General Certification must include the appropriate fee. If a project also requires a CAMA Permit, one payment to both agencies shall be submitted and will be the higher of the two fees.

Conditions of Certification:

1. No Impacts Beyond those Authorized in the Written Approval or Beyond the Threshold for Use of this Certification

No waste, spoil, solids, or fill of any kind shall occur in wetlands, waters, or riparian areas beyond the footprint of the impacts authorized in the written approval or beyond the thresholds for use of this Certification, including incidental impacts. All construction activities, including the design, installation, operation, and maintenance of sediment and erosion control Best Management Practices, shall be performed so that no violations of state water quality standards, statutes, or rules occur.

2. Standard Erosion and Sediment Control Practices

Erosion and sediment control practices must be in full compliance with all specifications governing the proper design, installation and operation and maintenance of such Best Management Practices:

Water Quality Certification N^o. 3820

- a. Design, installation, operation, and maintenance of the sediment and erosion control measures must be such that they equal, or exceed, the requirements specified in the most recent version of the *North Carolina Sediment and Erosion Control Manual*. The devices shall be maintained on all construction sites, borrow sites, and waste pile (spoil) projects, including contractor-owned or leased borrow pits associated with the project.
 - b. For borrow pit sites, the erosion and sediment control measures must be designed, installed, operated, and maintained in accordance with the most recent version of the *North Carolina Surface Mining Manual*.
 - c. Reclamation measures and implementation must comply with the reclamation in accordance with the requirements of the Sedimentation Pollution Control Act and the Mining Act of 1971.
 - d. Sufficient materials required for stabilization and/or repair of erosion control measures and stormwater routing and treatment shall be on site at all times, except for publicly funded linear transportation projects when materials can be accessed offsite in a timely manner.
 - e. If the project occurs in waters or watersheds classified as Primary Nursery Areas (PNA's), Trout (Tr), SA, WS-I, WS-II, High Quality (HQW), or Outstanding Resource (ORW) waters, then the sediment and erosion control requirements contained within *Design Standards in Sensitive Watersheds* (15A NCAC 04B .0124) supercede all other sediment and erosion control requirements.
3. No Sediment and Erosion Control Measures in Wetlands or Waters

Sediment and erosion control measures should not be placed in wetlands or waters outside of the permitted impact areas without prior approval by the Division. If placement of sediment and erosion control devices in wetlands and waters is unavoidable, design and placement of temporary erosion control measures shall not be conducted in a manner that may result in dis-equilibrium of wetlands or stream beds or banks, adjacent to or upstream and down stream of the above structures. All sediment and erosion control devices shall be removed and the natural grade restored within two (2) months of the date that the Division of Land Resources or locally delegated program has released the project.

4. Construction Stormwater Permit NCG010000

Upon the approval of an Erosion and Sedimentation Control Plan issued by the Division of Land Resources (DLR) or a DLR delegated local erosion and sedimentation control program, an NPDES General stormwater permit (NCG010000) administered by the Division is automatically issued to the project. This General Permit allows stormwater to be discharged during land disturbing construction activities as stipulated by conditions in the permit. If your project is covered by this permit [applicable to construction projects that disturb one (1) or more acres], full compliance with permit conditions including the sedimentation control plan, self-monitoring, record keeping and reporting requirements are required. A copy of this permit and monitoring report forms may be found at http://h2o.enr.state.nc.us/su/Forms_Documents.htm.

The North Carolina Department of Transportation (NCDOT) shall be required to be in full compliance with the conditions related to construction activities within the most recent version of their individual NPDES (NCS000250) stormwater permit.

Water Quality Certification N°. 3820

5. Work in the Dry

All work in or adjacent to stream waters shall be conducted in a dry work area. Approved best management practices from the most current version of the NC Sediment and Erosion Control Manual, or the NC DOT Construction and Maintenance Activities Manual, such as sandbags, rock berms, cofferdams, and other diversion structures shall be used to minimize excavation in flowing water. Exceptions to this condition require submittal to, and approval by, the Division of Water Quality.

6. Construction Moratoriums and Coordination

If activities must occur during periods of high biological activity (i.e. sea turtle or bird nesting), then biological monitoring may be required at the request of other state or federal agencies and coordinated with these activities. This condition can be waived through written concurrence on a case-by-case basis upon reasonable justification.

All moratoriums on construction activities established by the NC Wildlife Resources Commission (WRC), US Fish and Wildlife Service (USFWS), NC Division of Marine Fisheries (DMF), or National Marine Fisheries Service (NMFS) to lessen impacts on trout, anadromous fish, larval/post-larval fishes and crustaceans, or other aquatic species of concern shall be implemented. This condition can be waived through written concurrence on a case-by-case basis upon reasonable justification.

Work within the twenty-five (25) designated trout counties or identified state or federal endangered or threatened species habitat shall be coordinated with the appropriate WRC, USFWS, NMFS, and/or DMF personnel.

7. Riparian Area Protection (Buffer) Rules

Activities located in the protected 50-foot wide riparian areas (whether jurisdictional wetlands or not), within the Neuse, Tar-Pamlico, Catawba, Randleman, and Jordan (or any other basin with buffer rules), shall be limited to "uses" identified within and constructed in accordance with 15A NCAC 2B .0233, .0259, .0250, .0243, and .0267, and shall be located, designed, constructed, and maintained to have minimal disturbance to protect water quality to the maximum extent practicable through the use of best management practices. All buffer rule requirements, including diffuse flow requirements, must be met.

8. Water Supply Watershed Buffers

The 100-foot wide vegetative buffer (high-density development) or the 30-foot wide vegetative buffer (low density development) shall be maintained adjacent to all perennial waters except for allowances as provided in the Water Supply Watershed Protection Rules [15A NCAC 2B .0212 through .0215].

9. If concrete is used during the construction, then a dry work area should be maintained to prevent direct contact between curing concrete and stream water. Water that inadvertently contacts uncured concrete should not be discharged to surface waters due to the potential for elevated pH and possible aquatic life/fish kills.

10. Compensatory Mitigation

In accordance with 15A NCAC 2H .0506 (h), compensatory mitigation may be required for losses of 150 linear feet or more of streams (intermittent and perennial) and/or one (1) acre or more of wetlands. For linear, public transportation projects, impacts equal to or exceeding 150 linear feet per stream may require mitigation.

Water Quality Certification N^o. 3820

Buffer mitigation may be required for any project with Buffer Rules in effect at the time of application for buffer impacts resulting from activities classified as "Allowable with Mitigation" within the Buffer Rules or require a variance under the Buffer Rules.

A determination of buffer, wetland and stream mitigation requirements shall be made by the Division for any application to use this Certification. Design and monitoring protocols shall follow the US Army Corps of Engineers Wilmington District *Stream Mitigation Guidelines* (April 2003), or its subsequent updates. Compensatory mitigation plans shall be submitted for written Division approval as required in those protocols. Alternatively, the Division will accept payment into an in-lieu fee program or credit purchase from a mitigation bank.

Finally, the mitigation plan must be implemented and/or constructed before any permanent building or structure on site is occupied. In the case of public road projects, the mitigation plan must be implemented before the road is opened to the public whenever practical or at the earliest reasonable time during the construction of the project. Proof of payment to an in-lieu fee program or mitigation bank must be provided to the Division to satisfy this requirement.

11. For all activities requiring re-alignment of streams, a stream relocation plan must be included for written Division approval. Relocated stream designs should include the same dimensions, patterns and profiles as the existing channel (or a stable reference reach if the existing channel is unstable), to the maximum extent practical. The new channel should be constructed in the dry and water shall not be turned into the new channel until the banks are stabilized. Vegetation used for permanent bank stabilization shall be limited to native woody species, and should include establishment of a 30-foot wide wooded and an adjacent 20-foot wide vegetated buffer on both sides of the relocated channel to the maximum extent practical. A transitional phase incorporating appropriate erosion control matting materials and seedling establishment is allowable. Rip-rap, A-Jacks, concrete, gabions or other hard structures may be allowed if it is necessary to maintain the physical integrity of the stream, however, the applicant must provide written justification and any calculations used to determine the extent of rip-rap coverage. Please note that if the stream relocation is conducted as a stream restoration as defined in the US Army Corps of Engineers Wilmington District, April 2003 *Stream Mitigation Guidelines*, the restored length can be used as compensatory mitigation for the impacts resulting from the relocation.
12. Stormwater Management Plan Requirements
 - A. Linear public transportation projects will be required to treat stormwater runoff to the Maximum Extent Practicable in accordance with the practices described in the NCDOT Best Management Practices (BMP) Manual.
 - B. All other projects shall comply with the requirements set forth below. In addition, the applicants shall follow the procedures explained in the version of *Protocol for Stormwater Management Plan (SMP) Approval and Implementation* that is in place on the date of the submittal of the SMP.
 - i. **Project Density:** Projects with SMPs that require 401 Oversight/ Express Unit approval shall be classified as either Low or High Density according to the criteria described below.
 - a. **Low Density:** A development shall be considered Low Density if ALL of the following criteria are shown to have been met.
 1. The overall site plan, excluding ponds, lakes, rivers (as specified in North Carolina's Schedule of Classifications) and saltwater wetlands

Water Quality Certification N°. 3820

(SWL), must contain less than 24% impervious surface area considering both current and future development.

2. All stormwater from the entire site must be transported primarily via vegetated conveyances designed in accordance with the most recent version of the NC DWQ Stormwater BMP Manual.
 3. The project must not include a stormwater collection system (such as piped conveyances) as defined in 15A NCAC 2B .0202(60).
 4. If a portion of project has a density equal to or greater than 24%, then the higher density area must be located in an upland area and away from surface waters and drainageways to the maximum extent practicable.
- b. **High Density:** Projects that do not meet all of the Low Density criteria described above are considered to be High Density, requiring the installation of appropriate BMPs as described below.
1. All stormwater runoff from the site must be treated by BMPs that are designed, at a *minimum*, to remove 85 percent of Total Suspended Solids (TSS).
 2. Projects located in watersheds that drain directly to waters containing the following supplemental classifications shall meet these additional requirements:

<i>Water Quality Supplemental Classification</i>	<i>Stormwater BMP Requirement</i>
§303(d)	Project-specific conditions may be added by the Division to target the cause of the water quality impairment.
NSW	A minimum of 30 percent total phosphorus and 30 percent total nitrogen removal, or other applicable nutrient reduction goal for the watershed as codified in the 15A NCAC 2B .0200 rules.
Trout (Tr)	A minimum of 30 percent total phosphorus and 30 percent total nitrogen removal; BMPs should also be designed to minimize thermal pollution.

3. All BMPs must be designed in accordance with the version of the *NC Division of Water Quality Stormwater Best Management Practices Manual* that is in place on the date of the submittal of the SMP. Use of stormwater BMPs other than those listed in the *Manual* may be approved on a case-by-case basis if the applicant can demonstrate that these BMPs provide equivalent or higher pollutant removal and water quality protection.
- ii. **Vegetated Setback:** In areas that are not subject to a state Riparian Area Protection Rule, a 30-foot wide vegetated setback must be maintained adjacent to streams, rivers and tidal waters as specified below.
- a. The width of the setback shall be measured horizontally from:

Water Quality Certification N^o. 3820

1. The normal pool elevation of impounded structures,
 2. The streambank of streams and rivers, and
 3. The mean high waterline of tidal waters, perpendicular to shoreline.
- b. The vegetated setback may be cleared or graded, but must be planted with and maintained in grass or other appropriate plant cover.
 - c. The DWQ may, on a case-by-case basis, grant a minor variance from the vegetated setback requirements pursuant to the procedures set forth in 15A NCAC 02B .0233(9)(b).
 - d. Vegetated setbacks and filters required by state rules or local governments may be met concurrently with this requirement and may contain coastal, isolated or 404 jurisdictional wetlands.
- iii. **Stormwater Flowing to Streams and Wetlands:** Stormwater conveyances that discharge to streams and wetlands must discharge at a non-erosive velocity prior to entering the stream or wetland during the peak flow from the ten-year storm.
 - iv. **Projects Below Written Authorization Thresholds:** Projects that are below written authorization thresholds must comply with the version of *Protocol for Stormwater Management Plan (SMP) Review and Approval* that is in place on the date of the certification for the project.
 - v. **Phased Projects:** The DWQ will allow SMPs to be phased on a case-by-case basis, with a final SMP required for the current phase and a conceptual SMP for the future phase(s). If the current phase meets the Low Density criteria, but future phase(s) do not meet the Low Density criteria, then the entire project shall be considered to be High Density.
13. If this Water Quality Certification is used to access building sites, all lots owned by the applicant must be buildable without additional fill. For road construction purposes, this General Water Quality Certification shall only be utilized from natural high ground to natural high ground.
14. Placement of Culverts and Other Structures in Waters and Wetlands

The application must include construction plans with cross-sectional details in order to indicate that the current stability of the stream will be maintained or enhanced (i.e., not result in head cuts).

Culverts required for this project shall be designed and installed in such a manner that the original stream profiles are not altered and allow for aquatic life movement during low flows. Existing stream dimensions (including the cross section dimensions, pattern, and longitudinal profile) must be maintained above and below locations of each culvert. Placement of culverts and other structures in waters, streams, and wetlands must be placed below the elevation of the streambed by one foot for all culverts with a diameter greater than 48 inches, and 20 percent of the culvert diameter for culverts having a diameter less than or equal to 48 inches, to allow low flow passage of water and aquatic life unless otherwise justified and approved by the Division

Water Quality Certification N°. 3820

Installation of culverts in wetlands must ensure continuity of water movement and be designed to adequately accommodate high water or flood conditions. Additionally, when roadways, causeways or other fill projects are constructed across FEMA-designated floodways or wetlands, openings such as culverts or bridges must be provided to maintain the natural hydrology of the system as well as prevent constriction of the floodway that may result in destabilization of streams or wetlands.

Any rip rap required for normal pipe burial and stabilization shall be buried such that the original stream elevation is restored and maintained.

The establishment of native, woody vegetation and other soft stream bank stabilization techniques must be used where practicable instead of rip-rap or other bank hardening methods.

15. Additional site-specific conditions may be added to the written approval in order to ensure compliance with all applicable water quality and effluent standards.
16. If an environmental document is required under the National or State Environmental Policy Act (NEPA or SEPA), then this General Certification is not valid until a Finding of No Significant Impact (FONSI) or Record of Decision (ROD) is issued by the State Clearinghouse.
17. Deed notifications or similar mechanisms shall be placed on all retained jurisdictional wetlands, waters and protective buffers in order to assure compliance for future wetland, water and buffer impact. These mechanisms shall be put in place at the time of recording of the property, or of individual lots, whichever is appropriate. A sample deed notification can be downloaded from the 401/Wetlands Unit web site at <http://portal.ncdenr.org/web/wq/swp/ws/401/certsandpermits/apply/forms>
The text of the sample deed notification may be modified as appropriate to suit to a specific project.
18. Certificate of Completion

When written authorization is required for use of this certification, upon completion of all permitted impacts included within the approval and any subsequent modifications, the applicant shall be required to return the certificate of completion attached to the approval. One copy of the certificate shall be sent to the DWQ Central Office in Raleigh at 1650 Mail Service Center, Raleigh, NC, 27699-1650.
19. This General Certification shall expire three (3) years from the date of issuance of the written approval from the Division or on the same day as the expiration date of the corresponding Nationwide Permit 14 or Regional General Permit 198200031. In accordance with General Statute 136-44.7B, certifications issued to the NCDOT shall expire only upon expiration of the federal 404 Permit. The conditions in effect on the date of issuance of Certification for a specific project shall remain in effect for the life of the project, regardless of the expiration date of this Certification. If the construction process for approved activities will overlap the expiration and renewal date of the corresponding 404 Permit and the Corps allows for continued use of the 404 Permit, then the General Certification shall also remain in effect without requiring re-application and re-approval to use this Certification for the specific impacts already approved.
20. The applicant/permittee and their authorized agents shall conduct all activities in a manner consistent with State water quality standards (including any requirements resulting from compliance with §303(d) of the Clean Water Act), and any other appropriate requirements of State and Federal Law. If the Division determines that such standards or laws are not being met, including failure to sustain a designated or achieved use, or that State or Federal law is

Water Quality Certification N^o. 3820

being violated, or that further conditions are necessary to assure compliance, then the Division may reevaluate and modify this General Water Quality Certification.

Non-compliance with or violation of the conditions herein set forth by a specific fill project may result in revocation of this Certification for the project and may also result in criminal and/or civil penalties.

The Director of the North Carolina Division of Water Quality may require submission of a formal application for Individual Certification for any project in this category of activity, if it is determined that the project is likely to have a significant adverse effect upon water quality including state or federally listed endangered or threatened aquatic species or degrade the waters so that existing uses of the wetland or downstream waters are precluded.

Public hearings may be held for specific applications or group of applications prior to a Certification decision if deemed in the public's best interest by the Director of the North Carolina Division of Water Quality.

Effective date: April 6, 2010

DIVISION OF WATER QUALITY

By

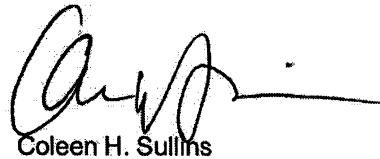

Coleen H. Sullins

Director

History Note: Water Quality Certification (WQC) Number 3820 issued April 6, 2010 replaces WQC Number 3704 issued November 1, 2007, WQC Number 3627 issued March 2007, WQC Number 3404 issued March 2003, WQC Number 3375 issued March 18, 2002, WQC Number 3289 issued June 1, 2000, WQC Number 3103 issued on February 11, 1997, WQC Number 2732 issued May 1, 1992, WQC Number 2666 issued January 21, 1992, and WQC Number 2177 issued November 5, 1987. This WQC is rescinded when the Corps of Engineers re-authorizes Nationwide Permit 14 or Regional General Permit 198200031 or when deemed appropriate by the Director of the Division of Water Quality.

TIP PROJECT: B-4588

CONTRACT: C202749

See Sheet 1-A For Index of Sheets
See Sheet 1-B For Conventional Symbols

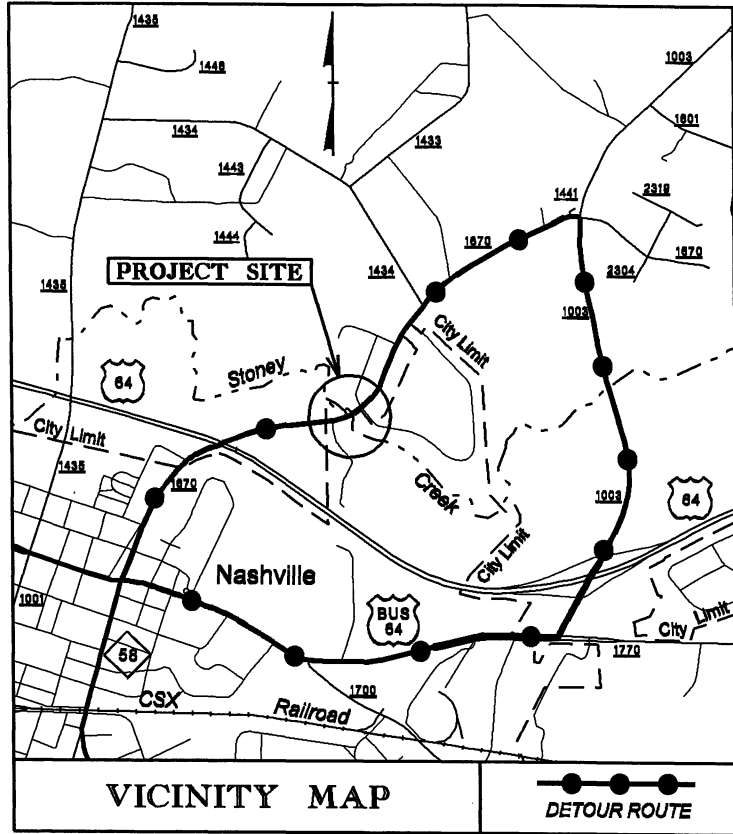

STATE OF NORTH CAROLINA
DIVISION OF HIGHWAYS
NASH COUNTY

LOCATION: BRIDGE NO.1 OVER STONEY CREEK ON SR 1670

TYPE OF WORK: GRADING, DRAINAGE, PAVING, & STRUCTURE

STATE	STATE PROJECT REFERENCE NO.	SHEET NO.	TOTAL SHEETS
N.C.	B-4588	1	
STATE PROJ. NO.	F.A. PROJ. NO.	DESCRIPTION	
33788.1.1	BRZ-1670(1)	PE	
33788.2.1	BRZ-1670(1)	RW & UTIL.	

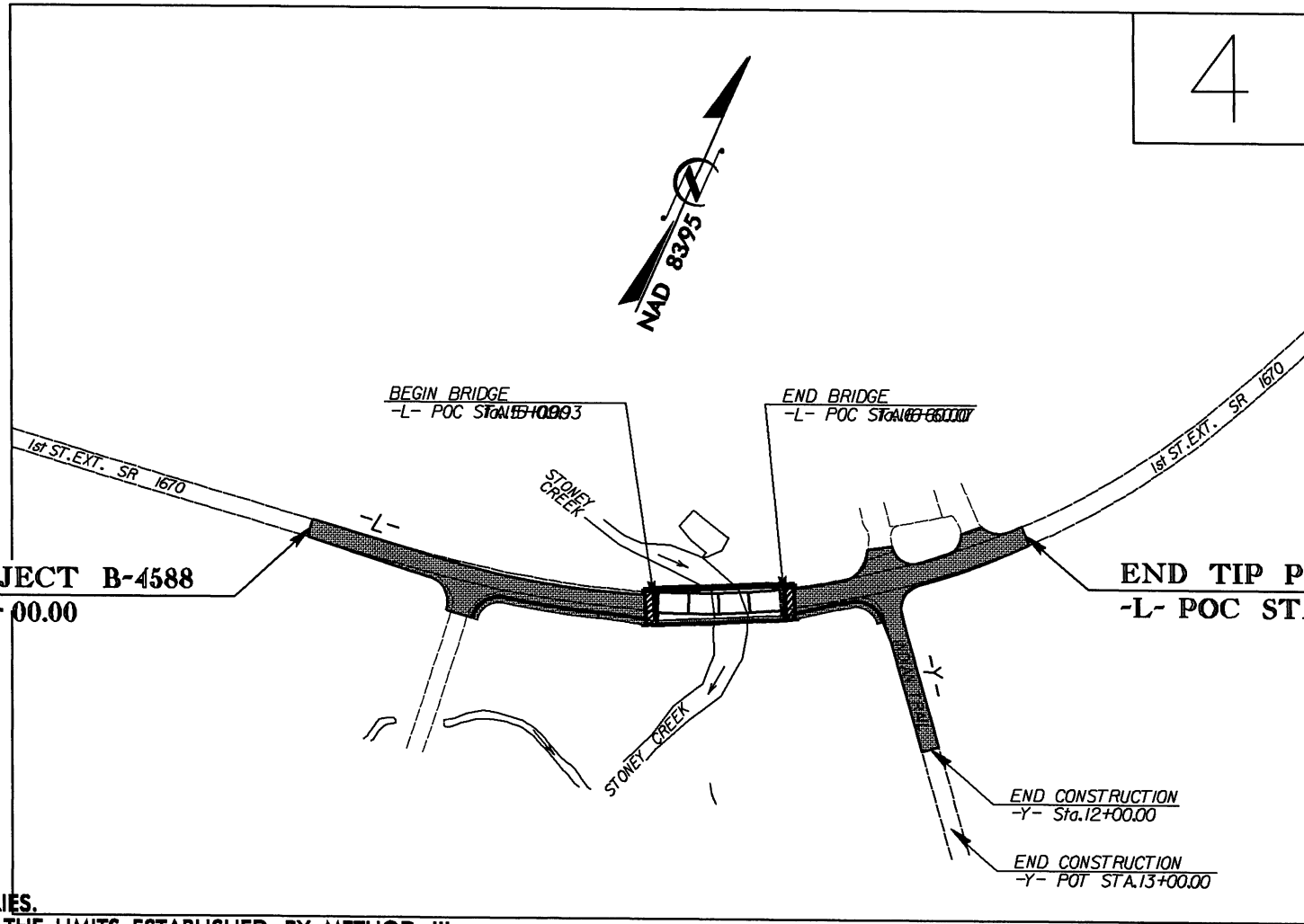

WETLAND/STREAM IMPACTS

Permit Drawing
Sheet 1 of 8

- NOTES:
 (1) THIS PROJECT IS NOT WITHIN ANY MUNICIPAL BOUNDARIES.
 (2) CLEARING ON THIS PROJECT SHALL BE PERFORMED TO THE LIMITS ESTABLISHED BY METHOD III.

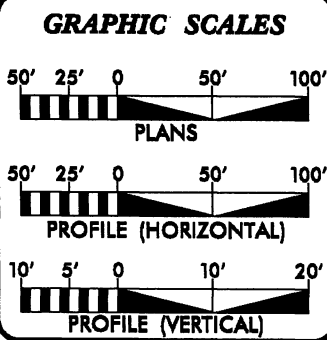

DESIGN DATA

ADT 2012 =	4,400
ADT 2032 =	6845
DHV =	10 %
D =	60 %
T =	3 % *
V =	50 MPH
FUNC. CLASS. =	LOCAL
* TTST 1 %	DUAL 2 %

PROJECT LENGTH

LENGTH ROADWAY	TIP PROJECT B-4588 =	0.133 MI.
LENGTH STRUCTURE	TIP PROJECT B-4588 =	0.028 MI.
TOTAL LENGTH OF	TIP PROJECT B-4588 =	0.161 MI.

Prepared in the Office of:
DIVISION OF HIGHWAYS
 1000 Birch Ridge Dr.
 Raleigh, NC 27610

2006 STANDARD SPECIFICATIONS

RIGHT OF WAY DATE:
JANUARY 4, 2011

LETTING DATE:
JANUARY 17, 2012

REKHA PATEL, P.E.
PROJECT ENGINEER

MICHAEL W. LITTLE, P.E.
PROJECT DESIGN ENGINEER

HYDRAULICS ENGINEER

ROADWAY DESIGN ENGINEER

PRELIMINARY PLANS
DO NOT USE FOR CONSTRUCTION

INCOMPLETE PLANS
DO NOT USE FOR R/W ACQUISITION

DIVISION OF HIGHWAYS
STATE OF NORTH CAROLINA

STATE HIGHWAY DESIGN ENGINEER

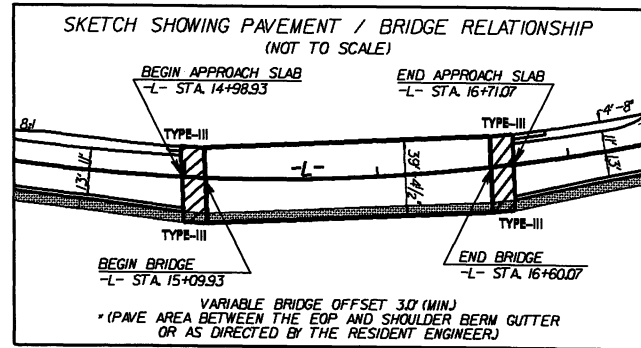

- DENOTES FILL IN WETLAND
- DENOTES MECHANIZED CLEARING
- DENOTES TEMPORARY IMPACTS IN SURFACE WATER
- DENOTES TEMPORARY FILL IN WETLAND
- DENOTES HAND CLEARING

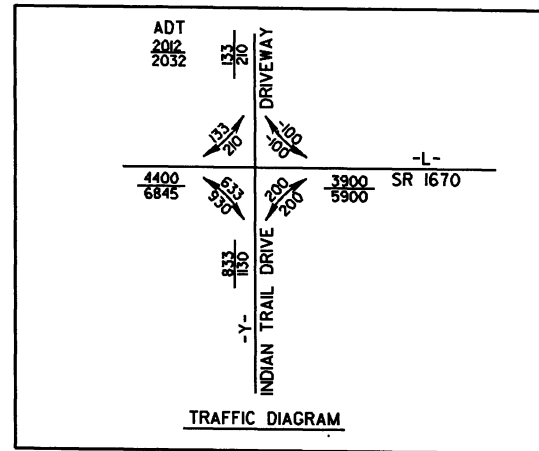

PROJECT REFERENCE NO. B-4588		SHEET NO. 4
ROADWAY DESIGN ENGINEER		HYDRAULICS ENGINEER
INCOMPLETE PLANS DO NOT USE FOR A/W ACQUISITION PRELIMINARY PLANS DO NOT USE FOR CONSTRUCTION		

REVISIONS

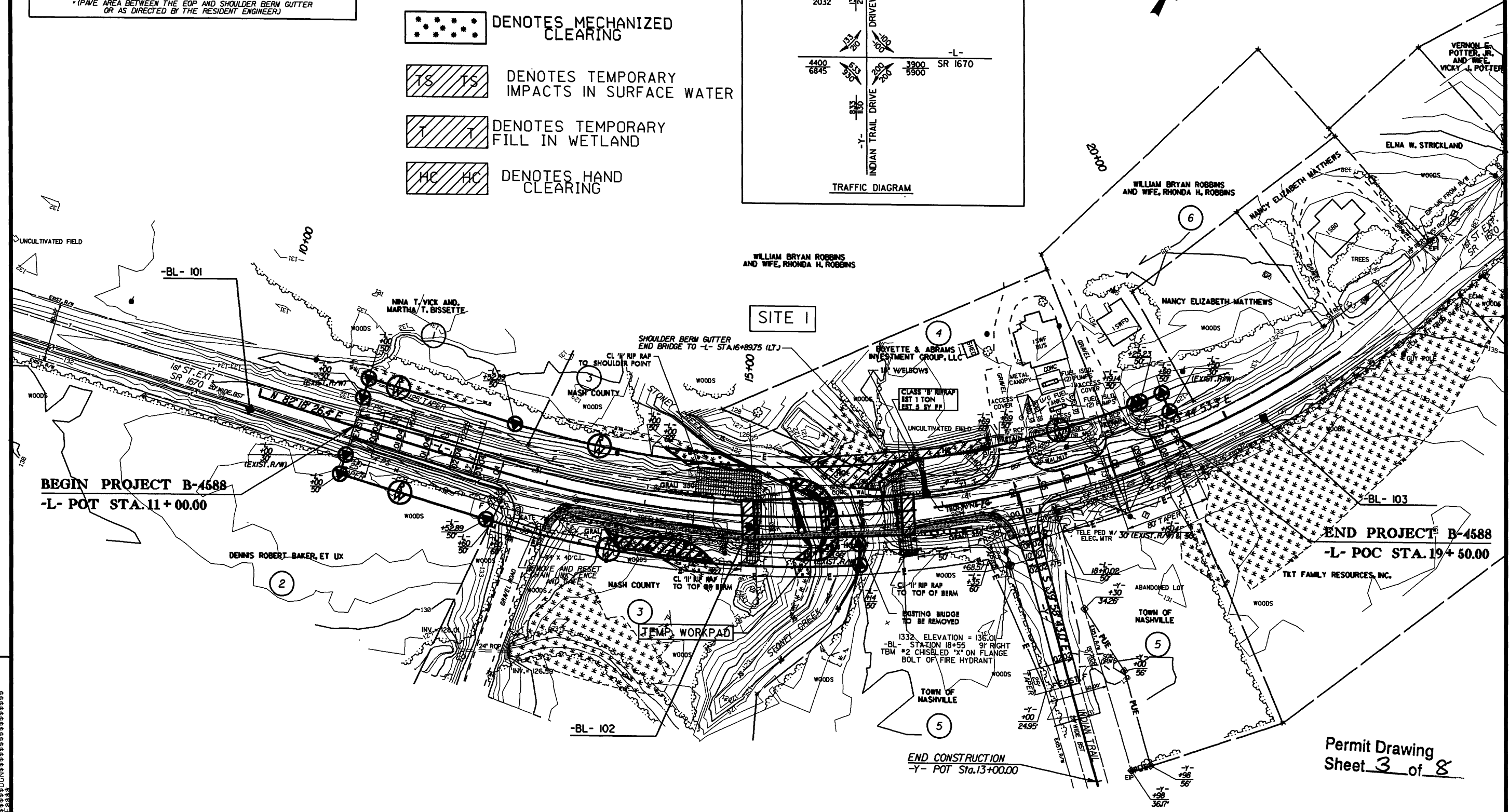

BEGIN PROJECT B-4588
-L- POT STA. 11+00.00

END PROJECT B-4588
-L- POC STA. 19+50.00

END CONSTRUCTION
-Y- POT Sta. 13+00.00

Permit Drawing
Sheet 3 of 8

NOTES: (1) SEE SHEET 5 FOR -L- & -Y- PROFILES
(2) SEE SHEETS S-1 TO S- FOR STRUCTURE DETAILS

 SYSTEMS TIME *****

 USER NAME *****

STRUCTURE HYDRAULIC DATA	
DESIGN DISCHARGE	= 6500 CFS
DESIGN FREQUENCY	= 25 YRS
DESIGN HW ELEVATION	= 136.0 FT
BASE DISCHARGE	= 9300 CFS
BASE FREQUENCY	= 100 YRS
BASE HW ELEVATION	= 136.8 FT
OVERTOPPING DISCHARGE	= <4900 CFS
OVERTOPPING FREQUENCY	= <10 YRS
OVERTOPPING ELEVATION	= 133.0 FT

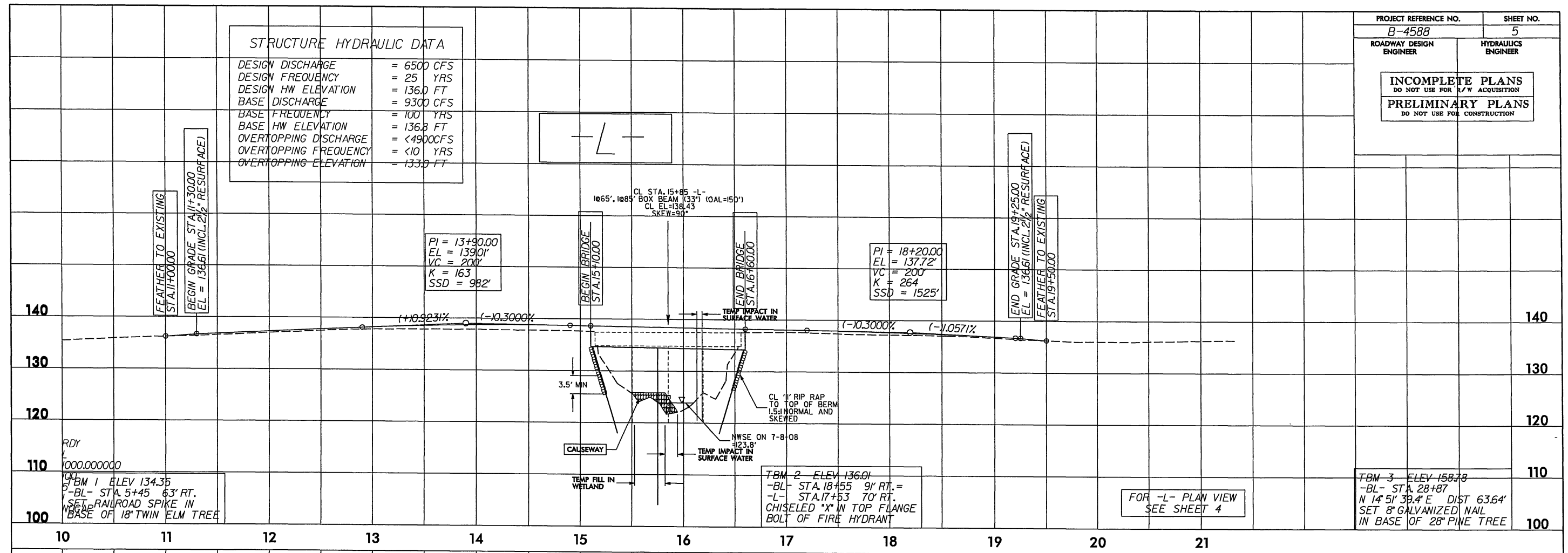

-Y-

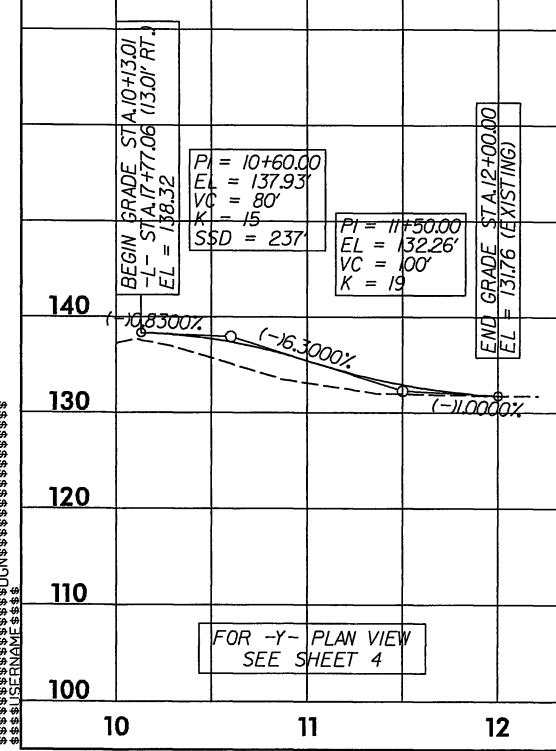

WORKPAD DETAIL (NOT TO SCALE)

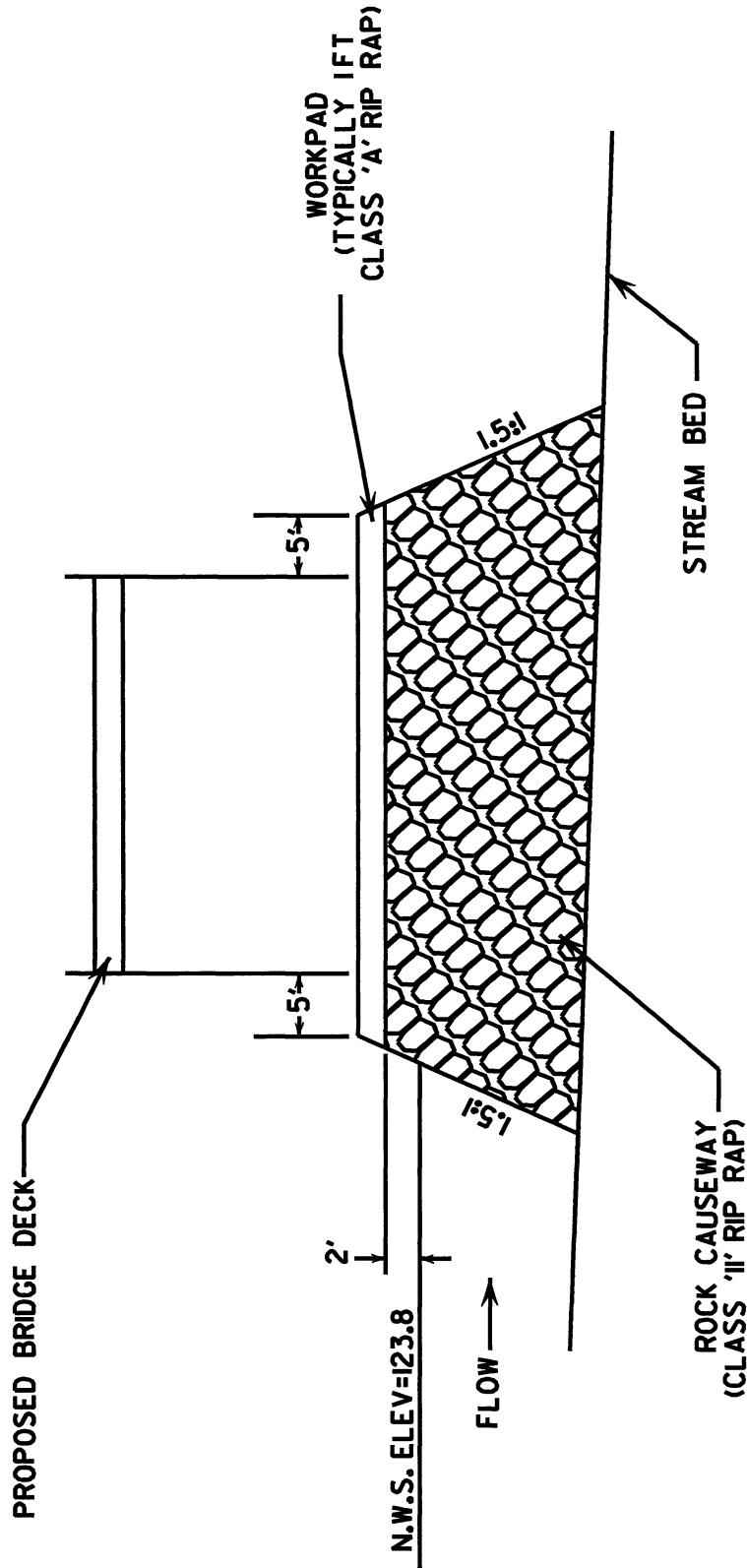

QUANTITIES OF ESTIMATES

VOLUME OF CLASS II RIP RAP= 110 yds³
 AREA OF CLASS II RIP RAP= 0.134 ac
 Estimate 160 Tons Class 'II' Rip Rap
 Estimate 100 Tons Class 'A' Rip Rap

N.C. DEPT. OF TRANSPORTATION
 DIVISION OF HIGHWAYS

NASH COUNTY

PROJECT: 33788.1.1 (B-4588)
 BRIDGE NO. 1
 OVER STONEY CREEK
 ON SR 1670

SHEET 6 OF 8

1/12/10

PROPERTY OWNERS
NAMES AND ADDRESSES

PARCEL NO.	NAMES	ADDRESSES
3	NASH COUNTY	120 WASHINGTON ST NASHVILLE, NC 27856
4	BOYETTE AND ABRAMS INVESTMENT GROUP, LLC	4633 DEWFIELD DR WILSON, NC 27893

**WETLAND/STREAM
IMPACTS**

NCDOT
DIVISION OF HIGHWAYS
NASH COUNTY
PROJECT: 33788.1.1 (B-4588)
BRIDGE #1 OVER STONEY
CREEK ON SR 1670

See Sheet 1-A For Index of Sheets
See Sheet 1-B For Conventional Symbols

STATE OF NORTH CAROLINA
DIVISION OF HIGHWAYS

NASH COUNTY

LOCATION: BRIDGE NO.1 OVER STONEY CREEK ON SR 1670

TYPE OF WORK: GRADING, DRAINAGE, PAVING, & STRUCTURE

STATE	STATE PROJECT REFERENCE NO.	SHEET NO.	TOTAL SHEETS
N.C.	B-4588	1	
STATE PROJ. NO.	F.A. PROJ. NO.	DESCRIPTION	
33788.1.1	BRZ-1670(1)	PE	
33788.2.1	BRZ-1670(1)	RW & UTIL.	



TIP PROJECT: B-4588

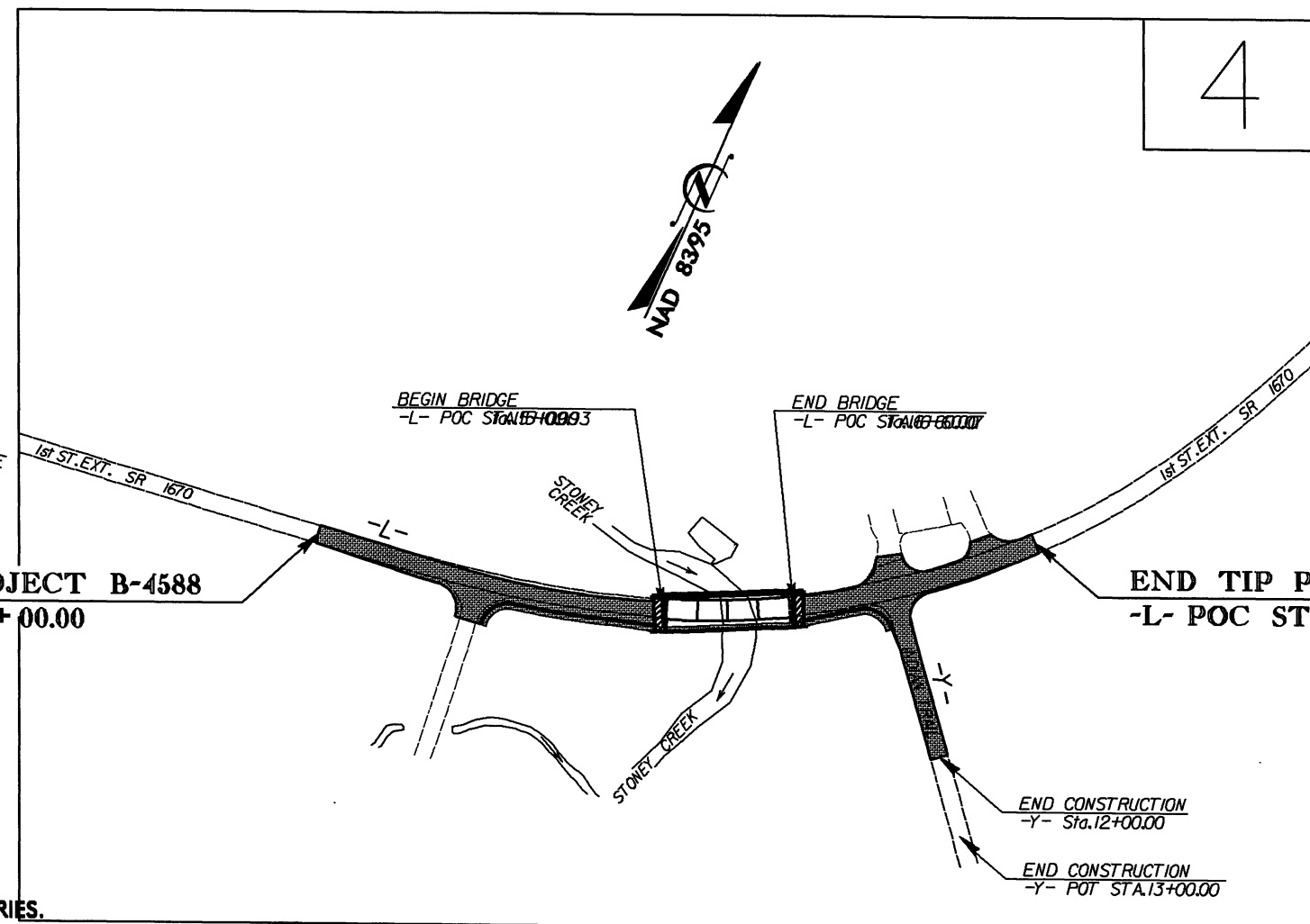
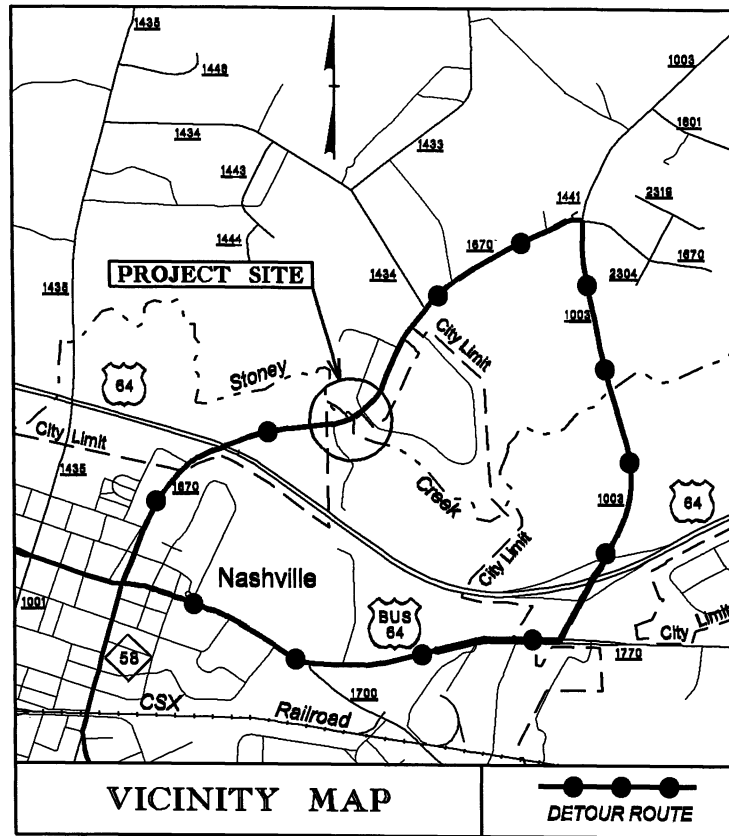

4
BUFFER IMPACTS

- NOTES:
(1) THIS PROJECT IS NOT WITHIN ANY MUNICIPAL BOUNDARIES.
(2) CLEARING ON THIS PROJECT SHALL BE PERFORMED TO THE LIMITS ESTABLISHED BY METHOD III.

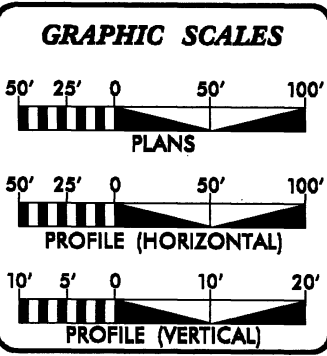

DESIGN DATA

ADT 2012 = 4,400
ADT 2032 = 6845
DHV = 10 %
D = 60 %
T = 3 % *
V = 50 MPH
FUNC. CLASS. = LOCAL
* TTST 1 % DUAL 2 %

PROJECT LENGTH

LENGTH ROADWAY TIP PROJECT B-4588 = 0.133 MI.
LENGTH STRUCTURE TIP PROJECT B-4588 = 0.028 MI.
TOTAL LENGTH OF TIP PROJECT B-4588 = 0.161 MI.

Prepared in the Office of:
DIVISION OF HIGHWAYS
1000 Birch Ridge Dr.
Raleigh, NC 27610

2006 STANDARD SPECIFICATIONS

RIGHT OF WAY DATE:
JANUARY 4, 2011

LETTING DATE:
JANUARY 17, 2012

REKHA PATEL, P.E.
PROJECT ENGINEER

MICHAEL W. LITTLE, P.E.
PROJECT DESIGN ENGINEER

HYDRAULICS ENGINEER

SIGNATURE: _____ P.E.

ROADWAY DESIGN ENGINEER

SIGNATURE: _____ P.E.

PRELIMINARY PLANS
DO NOT USE FOR CONSTRUCTION

INCOMPLETE PLANS
DO NOT USE FOR R/W ACQUISITION

DIVISION OF HIGHWAYS
STATE OF NORTH CAROLINA

STATE HIGHWAY DESIGN ENGINEER

Buffer Drawing
Sheet 1 of 5

CONTRACT: C202749

WETLANDS IN BUFFER IMPACTS SUMMARY

SITE NO.	STATION (FROM/TO)	WETLANDS IN BUFFERS	
		ZONE 1 (ft ²)	ZONE 2 (ft ²)
	14+12 to 15+08 -L- LT	750	0
	15+34 to 15+96 -L-	475	0
	15+56 to 16+60 -L- LT	1560	706
TOTAL:		2785	706

N.C. DEPT. OF TRANSPORTATION
 DIVISION OF HIGHWAYS
 NASH COUNTY
 PROJECT: 33788.1.1 (B-4588)

PROPERTY OWNERS
NAMES AND ADDRESSES

PARCEL NO.	NAMES	ADDRESSES
3	NASH COUNTY	120 WASHINGTON ST NASHVILLE, NC 27856
4	BOYETTE AND ABRAMS INVESTMENT GROUP, LLC	4633 DEWFIELD DR WILSON, NC 27893
5	TOWN OF NASHVILLE	P.O. BOX 987 NASHVILLE, NC 27856

**BUFFER
IMPACTS**

NCDOT
DIVISION OF HIGHWAYS
NASH COUNTY
PROJECT: 33788.1.1 (B-4588)
**BRIDGE #1 OVER STONEY
CREEK ON SR 1670**

SHEET 5 OF 5 **1/12/10**