



STATE OF NORTH CAROLINA
DEPARTMENT OF TRANSPORTATION

MICHAEL F. EASLEY
GOVERNOR

LYNDO TIPPETT
SECRETARY

March 15, 2006

MEMORANDUM TO: Mr. D. R. Conner, P.E.
Division One Engineer

FROM: Philip S. Harris, III, P.E. *PHS*
Natural Environment Unit Head
Project Development and
Environmental Analysis Branch

SUBJECT: Bertie County, Replace Bridge No.11 on SR 1219 (Francis Mill
Road) over the Cashie River; T.I.P. Number B-4027; Federal
Aid Project BRZ-1219 (1); State Project 8.2010501

Attached is the U. S. Army Corps of Engineers Nationwide Permit No. 23, the general conditions for the DWQ 401 Water Quality Certification and the CAMA Major Development Permit conditions for the above referenced project. All environmental permits have been received for the construction of this project.

PSH/gyb

Attachment

cc: Mr. Art McMillan, P.E.
Mr. Jay Bennett, P.E.
Mr. David Chang, P.E.
Mr. Randy Garris, P.E.
Mr. Greg Perfetti, P.E.
Mr. Mark Staley
Mr. Omar Sultan
Mr. John F. Sullivan, FHWA
Mr. Clay Willis, Division 1 DEO

PROJECT COMMITMENTS

Bertie County
Bridge No. 11 on SR 1219 over the Cashie River
Federal Project No. BRZ-1219[1]
State Project No. 8.2010501
TIP No. B-4027.

In addition to the Nationwide Permit 23 Conditions, the General Nationwide Permit Conditions, Section 404 Only Conditions, Regional Conditions, State Consistency Conditions, CAMA Major Development Permit Conditions, NCDOT's Guidelines for Best Management Practices for Bridge Demolition and Removal, NCDOT's Best Management Practices for Protection of Surface Waters, General Certification Conditions, and Section 401 Conditions of Certification, the following special commitments have been agreed to by NCDOT:

Division 1 Construction Engineer, Structure Design Unit

The proposed structure should be designed to facilitate top-down construction. If it is determined that top-down construction cannot be used, then additional coordination with the United States Army Corps of Engineers and Bertie County Emergency Management Services will be required.

Action: Bridge was designed to facilitate top-down construction.

No deck drains will be allowed to discharge directly into the Cashie River.

Action: Deck drains were eliminated from bridge.

Division 1 Construction Engineer, Roadway Design Unit

The total time of **road closure** for this project should be held to a minimum due to the length of delay on the proposed detour route for the local citizens. The contractor should be given incentives to minimize the road closures for the project. The **total project construction time** can be longer, as long as work can be done under traffic. Bertie County Emergency Management Services will be notified a minimum of thirty (30) days in advance of the beginning of the road closures.

This reach of the Cashie River has potential as a travel corridor for anadromous fish. Therefore, and in-stream moratorium will be in effect from **February 15 to June 30**. The Stream Crossing Guidelines for Anadromous Fish Passage will be implemented, as applicable.

Project Development and Environmental Analysis Branch

The North Carolina Ecosystem Enhancement Program will provide compensatory mitigation for the unavoidable wetland losses of 0.275 acre.



IN REPLY REFER TO

**DEPARTMENT OF THE ARMY
WILMINGTON DISTRICT, CORPS OF ENGINEERS**

Washington Regulatory Field Office
P.O. Box 1000
Washington, North Carolina 27889-1000

February 14, 2006

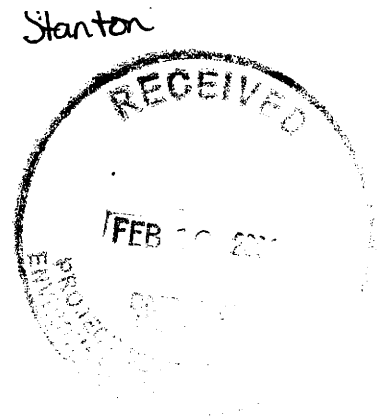

Regulatory Division

Action ID No. 200310719

Mr. Gregory J. Thorpe, Ph.D.
Environmental Management Director, PDEA
1548 Mail Service Center
Raleigh, North Carolina 27699-1548

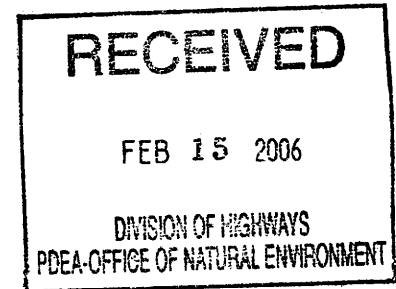

Dear Mr. Thorpe:

Reference the Department of the Army (DA) Nationwide Permit 23, Categorical Exclusion, issued to you on December 6, 2005, associated with the replacement of Bridge No. 11 on NCSR 1219 over the Cashie River, Federal Aid Project No. BRZ-1219 (1), State Project No. 8.2010501, T.I.P. B-4027, Bertie County, North Carolina. Also reference your subsequent written request dated December 19, 2005, for a permit modification to impact additional jurisdictional wetlands associated with utility line relocations.

The proposed modification will require additional mechanized land clearing which will permanently impact 0.039 acres of jurisdictional wetlands. The additional impacts are needed to join the new waterline to the existing waterline with an elbow connection.

This modification request was coordinated with the appropriate State and Federal agencies and the coordination revealed no objections to this modification request. Therefore, the permit is hereby modified in accordance with the specific work activities described above and in the enclosed plans. It is understood that all conditions of the original permit remain applicable and that the expiration date is unchanged. In addition, based on the revised wetland impacts for the project and an error in identifying the correct Hydrologic Cataloging Unit for the project, Special Condition (a) of the original permit is hereby modified as follows:

- a. Compensatory mitigation for the unavoidable impacts to 0.275 acres of riverine wetlands associated with the proposed project shall be provided by the Ecosystem Enhancement Program (EEP), as outlined in the revision letter dated February 7, 2006, from William D. Gilmore, EEP Director. Pursuant to the EEP Memorandum of Agreement (MOA) between the State of North Carolina and the US Army Corps of Engineers signed on July 22, 2003, the EEP will provide 0.55 acres of restoration equivalent riverine wetlands in the Roanoke River basin (Hydrologic Cataloging Unit 03010107) by one year of the date of this permit. For wetlands, a minimum of 1:1 (impact to mitigation) must be in the form of wetland restoration.

The NCDOT shall, within 30 days of the issue date of this permit, certify that sufficient funds have been provided to EEP to complete the required mitigation, pursuant to Paragraph V. of the MOA.

Any questions regarding this correspondence may be directed to Mr. Bill Biddlecome, NCDOT Coordinator/Regulatory Project Manager at the Washington Regulatory Field Office, telephone (252) 975-1616, extension 26.

Sincerely,

William J. Biddlecome
Project Manager

Attachments

Copies Furnished:

Mr. John Hennessy
Water Quality Section
Division of Environmental Management
North Carolina Department of Environment
and Natural Resources
1650 Mail Service Center
Raleigh, North Carolina 27699-1650

Mr. Travis Wilson
Eastern Region Highway Project Coordinator
Habitat Conservation Program
1142 I-85 Service Road
Creedmoor, North Carolina 27522

Mr. Gary Jordan
U.S. Fish and Wildlife Service
Fish and Wildlife Enhancement
Post Office Box 33726
Raleigh, North Carolina 27636-3726

Mr. Ron Sechler
National Marine Fisheries Service
101 Pivers Island
Beaufort, North Carolina 28516

Mr. Chris Militscher
U.S. Environmental Protection Agency
C/O FHWA, Raleigh Office
310 New Bern Avenue, Room 206
Raleigh, North Carolina 27601

Mr. William D. Gilmore, P.E.
EEP Director
North Carolina Ecosystem Enhancement Program
1652 Mail Service Center
Raleigh, North Carolina 27699-1652

Ms. Wanda Gooden
Division of Coastal Management
1367 U.S. Hwy 17 South
Elizabeth City, North Carolina 27909

Ms. Cathy Brittingham
Division of Coastal Management
1638 Mail Service Center
Raleigh, North Carolina 27699-1638

Ms. Kathy Matthews
3112 Avondale Court
Raleigh, North Carolina 27613

Ms. Sara Winslow
NC Division of Marine Fisheries
1367 U.S. Hwy 17 South
Elizabeth City, North Carolina 27909

TOTAL PERMANENT IMPACTS ON WETLAND
DUE TO WATER LINE RELOCATION USING
MECHANIZED CLEARING METHOD

Impact Area(A5+A6)= 0.012+ 0.027=0.039 Acres

Excavation in wetlands= 0.002 Acres

Temporary Fill in wetlands= 0.002 Acres

TOTAL TEMPORARY IMPACTS ON WETLAND
DUE TO UTILITIES RELOCATION OF POWER
LINES AND TELE. LINES USING HAND
CLEARING METHOD

Impact Area (A1+A2+A3+A4)= 0.011+ 0.015+0.022+0.017= 0.065 Acres

TOTAL TEMPORARY IMPACTS = 0.065 Acres
TOTAL PERMANENT IMPACTS = 0.039 Acres

TOTAL WETLANDS IMPACT
0.065+0.039= 0.104 Acres

N. C. DEPT. OF TRANSPORTATION
DIVISION OF HIGHWAYS
BERTIE COUNTY

PROJECT: 8.2010501, (B-4027)
BRIDGE 11 OVER CASHIE RIVER
ON SR 1219



IN REPLY REFER TO

DEPARTMENT OF THE ARMY
WILMINGTON DISTRICT, CORPS OF ENGINEERS
Washington Regulatory Field Office
P.O. Box 1000
Washington, North Carolina 27889-1000

December 6, 2005

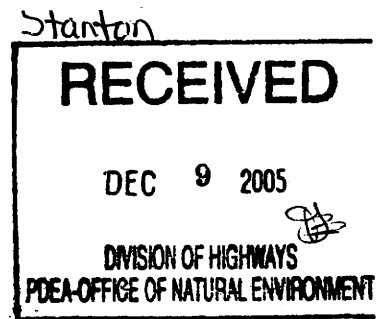

Regulatory Division

Subject: Action ID No. 200310719 and Nationwide Permit No. 23 (Approved Categorical Exclusions)

Dr. Gregory J. Thorpe, Ph.D.
Environmental Management Director, PDEA
N.C. Department of Transportation
1548 Mail Service Center
Raleigh, North Carolina 27699-1548

Dear Dr. Thorpe:

Reference your Categorical Exclusion Document, approved on February 27, 2004, and your subsequent correspondence dated October 31, 2005, for the replacement of Bridge No. 11 on NCSR 1219 over the Cashie River, Federal Aid Project No. BRZ-1219 (1), State Project No. 8.2010501, T.I.P. No. B-4027, Bertie County, North Carolina. The preferred alternative involves an off site detour and will replace the existing structure with a 160-foot cored slab bridge at approximately the same location adversely impacting 0.54 acres of wetlands adjacent to the Cashie River.

For the purposes of the Corps of Engineers Regulatory Program, Title 33, Code of Federal Regulations (CFR), Part 330.6, published in the Federal Register on November 22, 1991, lists nationwide permits. Authorization pursuant to Section 10 of the Rivers and Harbors Act of 1899 and Section 404 of the Clean Water Act, was provided for activities undertaken, assisted, authorized, regulated, funded or financed, in whole or part, by another Federal agency or department where that agency or department has determined, pursuant to the CEQ Regulation for the Implementing the Procedural Provisions of the National Environmental Policy Act, that the activity, work or discharge is categorically excluded from environmental documentation because it is included within a category of actions which neither individually nor cumulatively have a significant effect on the human environment, and the Office of the Chief of Engineers has been furnished notice of the agency's or department's application for the categorical exclusion and concurs with that determination.

Review of this project indicates that the construction of the new bridge will adversely impact 0.54 acres of riverine wetlands consisting of 0.24 acres of permanent fill for the bridge replacement and 0.30 acres of temporary impacts from hand clearing for the installation of

erosion control devices and the relocation of utility lines. The permanent wetland impacts are for the widening of the roadway shoulders at the approach fills for the replacement bridge.

Your work is authorized under Nationwide Permit 23, Categorical Exclusion, provided it is accomplished in strict accordance with the enclosed Nationwide Permit Conditions and the following special conditions:

a. Compensatory mitigation for the unavoidable impacts to 0.236 acres of riverine wetlands associated with the proposed project shall be provided by the Ecosystem Enhancement Program (EEP), as outlined in the letter dated September 20, 2005, from William D. Gilmore, EEP Director. Pursuant to the EEP Memorandum of Agreement (MOA) between the State of North Carolina and the US Army Corps of Engineers signed on July 22, 2003, the EEP will provide 0.47 acres of restoration equivalent riverine wetlands in the Pasquotank River basin (Hydrologic Cataloging Unit 03010205) by one year of the date of this permit. For wetlands, a minimum of 1:1 (impact to mitigation) must be in the form of wetland restoration. The NCDOT shall, within 30 days of the issue date of this permit, certify that sufficient funds have been provided to EEP to complete the required mitigation, pursuant to Paragraph V. of the MOA.

b. To avoid adverse impacts to spawning populations of fish, anadromous and resident species at the project site, NCDOT will follow the "Stream Crossing Guidelines for Anadromous Fish Passage."

c. To avoid adverse impacts to anadromous fish species at this project site, no in-water work will be conducted between February 15 and June 15. For the purpose of this moratorium, in water is defined as those areas that are inundated at mean high water.

d. All measures will be taken to avoid any temporary fill from entering into the Cashie River from bridge demolition. Bridge demolition shall follow NCDOT best management practices for construction and maintenance activities dated August 2003 and incorporate NCDOT policy entitled "Bridge Demolition and Removal in Waters of the United States" dated September 20, 1999.

e. No bridge demolition debris or excavated or fill material will be placed at any time, in any wetlands or surrounding waters, outside of the alignment of the fill area indicated on the work plans.

f. All excavated materials will be confined above normal high water and landward of regularly or irregularly flooded wetlands behind adequate dikes or retaining structures to prevent spillover of solids into any wetlands or surrounding waters.

g. Except as authorized by this permit or any USACE approved modification to this permit, no excavation, fill, or mechanized land-clearing activities shall take place at any time in the construction or maintenance of this project, within waters or wetlands, or any activities that

cause the degradation of waters or wetlands, except as authorized by this permit, or any modification to this permit. This permit does not authorize temporary placement or double handling of excavated or fill material within waters or wetlands outside the permitted area. There shall be no excavation from, waste disposal into, or degradation of, jurisdictional waters or wetlands associated with this permit without appropriate modification of this permit, including appropriate compensatory mitigation. This prohibition applies to all borrow and fill activities connected with this project.

h. To ensure that all borrow and waste activities occur on high ground and do not result in the degradation of adjacent wetlands and streams, except as authorized by this permit, the permittee shall require its contractors and/or agents to identify all areas to be used to borrow material, or to dispose of dredged, fill, or waste material. The permittee shall provide the USACE with appropriate maps indicating the locations of proposed borrow or waste sites as soon as the permittee has that information. The permittee will coordinate with the USACE before approving any borrow or waste sites that are within 400 feet of any streams or wetlands. The permittee shall ensure that all such areas comply with condition (k) of this permit, and shall require and maintain documentation of the location and characteristics of all borrow and disposal sites associated with this project. This information will include data regarding soils, vegetation and hydrology sufficient to clearly demonstrate compliance with the preceding condition (k). All information will be available to the USACE upon request. NCDOT shall require its contractors to complete and execute reclamation plans for each waste and borrow site and provide written documentation that the reclamation plans have been implemented and all work is completed. This documentation will be provided to the Corps of Engineers within 30 days of the completion of the reclamation work.

i. The permittee shall require its contractors and/or agents to comply with the terms and conditions of this permit in the construction and maintenance of this project, and shall provide each of its contractors and/or agents associated with the construction or maintenance of this project with a copy of this permit. A copy of this permit, including all conditions and any Corps approved modifications shall be available at the project site during construction and maintenance of this project.

j. Any violation of these conditions or violations of Section 404 of the Clean Water Act or Section 10 of the Rivers and Harbors Act must be reported in writing to the Wilmington District, U.S. Army Corps of Engineers, within 24 hours of the violation.

k. Failure to institute and carry out the details of special conditions a. - j., above, may result in a directive to cease all ongoing and permitted work within waters and/or wetlands associated with TIP No. B-4027, or such other remedy as the District Engineer or his authorized representatives may seek.

This nationwide permit does not relieve you of the responsibility to obtain any required State or local approval. This permit is valid until the NWP is modified, reissued, or revoked. All

of the existing NWP's are scheduled to be modified, reissued, or revoked prior to March 18, 2007. It is incumbent upon you to remain informed of changes to the NWP's. We will issue a public notice when the NWP's are reissued. Furthermore, if you commence or are under contract to commence this activity before the date that the relevant nationwide permit is modified or revoked, you will have twelve (12) months from the date of the modification or revocation of the NWP to complete the activity under the present terms and conditions of this nationwide permit. If, prior to the expiration date of March 18, 2007, the nationwide permit authorization is reissued and/or modified, this verification will remain valid until March 18, 2007, provided it complies with all new and/or modified terms and conditions. The District Engineer may, at any time, exercise his discretionary authority to modify, suspend, or revoke a case specific activity's authorization under any NWP.

Thank you for your time and cooperation. If you have any questions, you may contact me at the Washington Regulatory Field Office, Post Office Box 1000, Washington, North Carolina, 27889, or telephone 252-975-1616, extension 26.

Sincerely,

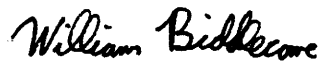

William Biddlecome
Project Manager

Copies Furnished:

Ms. Christina Breen
Water Quality Section
North Carolina Division of Environment
and Natural Resources
1650 Mail Service Center
Raleigh, North Carolina 27699-1650

Mr. Travis Wilson
Eastern Region Highway Project Coordinator
Habitat Conservation Program
1142 I-85 Service Road
Creedmoor, North Carolina 27522

Mr. Gary Jordan
U.S. Fish and Wildlife Service
Fish and Wildlife Enhancement
Post Office Box 33726
Raleigh, North Carolina 27636-3726

Mr. Ron Sechler
National Marine Fisheries Service
101 Pivers Island
Beaufort, North Carolina 28516

Mr. Chris Militscher
U.S. Environmental Protection Agency
C/O FHWA, Raleigh Office
310 New Bern Avenue, Room 206
Raleigh, North Carolina 27601

Mr. William D. Gilmore, P.E.
EEP Director
North Carolina Ecosystem Enhancement Program
1652 Mail Service Center
Raleigh, North Carolina 27699-1652

NATIONWIDE PERMIT 23
DEPARTMENT OF THE ARMY
CORPS OF ENGINEERS
FINAL NOTICE OF ISSUANCE AND MODIFICATION OF NATIONWIDE PERMITS
FEDERAL REGISTER
AUTHORIZED MARCH 18, 2002

Approved Categorical Exclusions: Activities undertaken, assisted, authorized, regulated, funded, or financed, in whole or in part, by another Federal agency or department where that agency or department has determined, pursuant to the Council on Environmental Quality Regulation for Implementing the Procedural Provisions of the National Environmental Policy Act (NEPA) (40 CFR part 1500 et seq.), that the activity, work, or discharge is categorically excluded from environmental documentation because it is included within a category of actions which neither individually nor cumulatively have a significant effect on the human environment, and the Office of the Chief of Engineers (ATTN: CECW-OR) has been furnished notice of the agency's or department's application for the categorical exclusion and concurs with that determination. Before to approval for purposes of this nationwide permit of any agency's categorical exclusions, the Chief of Engineers will solicit public comment. In addressing these comments, the Chief of Engineers may require certain conditions for authorization of an agency's categorical exclusions under this nationwide permit. (Sections 10 and 404)

NATIONWIDE PERMIT GENERAL CONDITIONS

The following General Conditions must be followed in order for any authorization by a NWP to be valid:

1. Navigation. No activity may cause more than a minimal adverse effect on navigation.
2. Proper Maintenance. Any structure or fill authorized shall be properly maintained, including maintenance to ensure public safety.
3. Soil Erosion and Sediment Controls. Appropriate soil erosion and sediment controls must be used and maintained in effective operating condition during construction, and all exposed soil and other fills, as well as any work below the ordinary high water mark or high tide line, must be permanently stabilized at the earliest practicable date. Permittees are encouraged to perform work within waters of the United States during periods of low-flow or no-flow.
4. Aquatic Life Movements. No activity may substantially disrupt the necessary life-cycle movements of those species of aquatic life indigenous to the waterbody, including those species that normally migrate through the area, unless the activity's primary purpose is to impound water. Culverts placed in streams must be installed to maintain low flow conditions.
5. Equipment. Heavy equipment working in wetlands must be placed on mats, or other measures must be taken to minimize soil disturbance.
6. Regional and Case-By-Case Conditions. The activity must comply with any regional conditions that may have been added by the Division Engineer (see 33 CFR 330.4(e)) and with any case specific conditions added by the Corps or by the state or tribe in its Section 401 Water Quality Certification and Coastal Zone Management Act consistency determination.
7. Wild and Scenic Rivers. No activity may occur in a component of the National Wild and Scenic River System; or in a river officially designated by Congress as a 'study river' for possible inclusion in the system, while the river is in an official study status; unless the appropriate Federal agency, with direct management responsibility for such river, has determined in writing that the proposed activity will not adversely affect the Wild and Scenic River designation, or study status. Information on Wild and Scenic Rivers may be obtained from the appropriate Federal land management agency in the area (e.g., National Park Service, U.S. Forest Service, Bureau of Land Management, U.S. Fish and Wildlife Service).
8. Tribal Rights. No activity or its operation may impair reserved tribal rights, including, but not limited to, reserved water rights and treaty fishing and hunting rights.
9. Water Quality.

a. In certain states and tribal lands an individual 401 Water Quality Certification must be obtained or waived (See 33 CFR 330.4(c)).

b. For NWP's 12, 14, 17, 18, 32, 39, 40, 42, 43, and 44, where the state or tribal 401 certification (either generically or individually) does not require or approve water quality management measures, the permittee must provide water quality management measures that will ensure that the authorized work does not result in more than minimal degradation of water quality (or the Corps determines that compliance with state or local standards, where applicable, will ensure no more than minimal adverse effect on water quality). An important component of water quality management includes stormwater management that minimizes degradation of the downstream aquatic system, including water quality (refer to General Condition 21 for stormwater management requirements). Another important component of water quality management is the establishment and maintenance of vegetated buffers next to open waters, including streams (refer to General Condition 19 for vegetated buffer requirements for the NWP's).

This condition is only applicable to projects that have the potential to affect water quality. While appropriate measures must be taken, in most cases it is not necessary to conduct detailed studies to identify such measures or to require monitoring.

10. Coastal Zone Management. In certain states, an individual state coastal zone management consistency concurrence must be obtained or waived (see 33 CFR 330.4(d)).

11. Endangered Species.

a. No activity is authorized under any NWP which is likely to jeopardize the continued existence of a threatened or endangered species or a species proposed for such designation, as identified under the Federal Endangered Species Act (ESA), or which will destroy or adversely modify the critical habitat of such species. Non-federal permittees shall notify the District Engineer if any listed species or designated critical habitat might be affected or is in the vicinity of the project, or is located in the designated critical habitat and shall not begin work on the activity until notified by the District Engineer that the requirements of the ESA have been satisfied and that the activity is authorized. For activities that may affect Federally-listed endangered or threatened species or designated critical habitat, the notification must include the name(s) of the endangered or threatened species that may be affected by the proposed work or that utilize the designated critical habitat that may be affected by the proposed work. As a result of formal or informal consultation with the FWS or NMFS the District Engineer may add species-specific regional endangered species conditions to the NWP's.

b. Authorization of an activity by a NWP does not authorize the "take" of a threatened or endangered species as defined under the ESA. In the absence of separate authorization (e.g., an ESA Section 10 Permit, a Biological Opinion with "incidental take" provisions, etc.) from the

USFWS or the NMFS, both lethal and non-lethal "takes" of protected species are in violation of the ESA. Information on the location of threatened and endangered species and their critical habitat can be obtained directly from the offices of the USFWS and NMFS or their World Wide Web pages at <http://www.fws.gov/r9endspp/endspp.html> and <http://www.nfms.noaa.gov/protres/overview/es.html> respectively.

12. Historic Properties. No activity that may affect historic properties listed, or eligible for listing, in the National Register of Historic Places is authorized, until the District Engineer has complied with the provisions of 33 CFR part 325, Appendix C. The prospective permittee must notify the District Engineer if the authorized activity may affect any historic properties listed, determined to be eligible, or which the prospective permittee has reason to believe may be eligible for listing on the National Register of Historic Places, and shall not begin the activity until notified by the District Engineer that the requirements of the National Historic Preservation Act have been satisfied and that the activity is authorized. Information on the location and existence of historic resources can be obtained from the State Historic Preservation Office and the National Register of Historic Places (see 33 CFR 330.4(g)). For activities that may affect historic properties listed in, or eligible for listing in, the National Register of Historic Places, the notification must state which historic property may be affected by the proposed work or include a vicinity map indicating the location of the historic property.

13. Notification.

a. Timing; where required by the terms of the NWP, the prospective permittee must notify the District Engineer with a preconstruction notification (PCN) as early as possible. The District Engineer must determine if the notification is complete within 30 days of the date of receipt and can request additional information necessary to make the PCN complete only once. However, if the prospective permittee does not provide all of the requested information, then the District Engineer will notify the prospective permittee that the notification is still incomplete and the PCN review process will not commence until all of the requested information has been received by the District Engineer. The prospective permittee shall not begin the activity:

1. Until notified in writing by the District Engineer that the activity may proceed under the NWP with any special conditions imposed by the District or Division Engineer; or

2. If notified in writing by the District or Division Engineer that an Individual Permit is required; or

3. Unless 45 days have passed from the District Engineer's receipt of the complete notification and the prospective permittee has not received written notice from the District or Division Engineer. Subsequently, the permittee's right to proceed under the NWP may be modified, suspended, or revoked only in accordance with the procedure set forth in 33 CFR 330.5(d)(2).

b. Contents of Notification: The notification must be in writing and include the

following information:

1. Name, address and telephone numbers of the prospective permittee;
2. Location of the proposed project;
3. Brief description of the proposed project; the project's purpose; direct and indirect adverse environmental effects the project would cause; any other NWP(s), Regional General Permit(s), or Individual Permit(s) used or intended to be used to authorize any part of the proposed project or any related activity. Sketches should be provided when necessary to show that the activity complies with the terms of the NWP (Sketches usually clarify the project and when provided result in a quicker decision.);
4. For NWPs 7, 12, 14, 18, 21, 34, 38, 39, 40, 41, 42, and 43, the PCN must also include a delineation of affected special aquatic sites, including wetlands, vegetated shallows (e.g., submerged aquatic vegetation, seagrass beds), and riffle and pool complexes (see paragraph 13(f));
5. For NWP 7 (Cutfall Structures and Maintenance), the PCN must include information regarding the original design capacities and configurations of those areas of the facility where maintenance dredging or excavation is proposed;
6. For NWP 14 (Linear Transportation Projects), the PCN must include a compensatory mitigation proposal to offset permanent losses of waters of the US and a statement describing how temporary losses of waters of the US will be minimized to the maximum extent practicable;
7. For NWP 21 (Surface Coal Mining Activities), the PCN must include an Office of Surface Mining (OSM) or state-approved mitigation plan, if applicable. To be authorized by this NWP, the District Engineer must determine that the activity complies with the terms and conditions of the NWP and that the adverse environmental effects are minimal both individually and cumulatively and must notify the project sponsor of this determination in writing;
8. For NWP 27 (Stream and Wetland Restoration Activities), the PCN must include documentation of the prior condition of the site that will be reverted by the permittee;
9. For NWP 29 (Single-Family Housing), the PCN must also include:
 - i. Any past use of this NWP by the Individual Permittee and/or the permittee's spouse;
 - ii. A statement that the single-family housing activity is for a personal residence of the permittee;

iii. A description of the entire parcel, including its size, and a delineation of wetlands. For the purpose of this NWP, parcels of land measuring $\frac{1}{4}$ -acre or less will not require a formal on-site delineation. However, the applicant shall provide an indication of where the wetlands are and the amount of wetlands that exists on the property. For parcels greater than $\frac{1}{4}$ -acre in size, formal wetland delineation must be prepared in accordance with the current method required by the Corps. (See paragraph 13(f));

iv. A written description of all land (including, if available, legal descriptions) owned by the prospective permittee and/or the prospective permittee's spouse, within a one mile radius of the parcel, in any form of ownership (including any land owned as a partner, corporation, joint tenant, co-tenant, or as a tenant-by-the-entirety) and any land on which a purchase and sale agreement or other contract for sale or purchase has been executed;

10. For NWP 31 (Maintenance of Existing Flood Control Facilities), the prospective permittee must either notify the District Engineer with a PCN prior to each maintenance activity or submit a five-year (or less) maintenance plan. In addition, the PCN must include all of the following:

i. Sufficient baseline information identifying the approved channel depths and configurations and existing facilities. Minor deviations are authorized, provided the approved flood control protection or drainage is not increased;

ii. A delineation of any affected special aquatic sites, including wetlands; and,

iii. Location of the dredged material disposal site;

11. For NWP 33 (Temporary Construction, Access, and Dewatering), the PCN must also include a restoration plan of reasonable measures to avoid and minimize adverse effects to aquatic resources;

12. For NWPs 39, 43 and 44, the PCN must also include a written statement to the District Engineer explaining how avoidance and minimization for losses of waters of the US were achieved on the project site;

13. For NWP 39 and NWP 42, the PCN must include a compensatory mitigation proposal to offset losses of waters of the US or justification explaining why compensatory mitigation should not be required. For discharges that cause the loss of greater than 300 linear feet of an intermittent stream bed, to be authorized, the District Engineer must determine that the activity complies with the other terms and conditions of the NWP, determine adverse environmental effects are minimal both individually and cumulatively, and waive the limitation on stream impacts in writing before the permittee may proceed;

14. For NWP 40 (Agricultural Activities), the PCN must include a compensatory mitigation proposal to offset losses of waters of the US. This NWP does not authorize the

relocation of greater than 300 linear feet of existing serviceable drainage ditches constructed in non-tidal streams unless, for drainage ditches constructed in intermittent nontidal streams, the District Engineer waives this criterion in writing, and the District Engineer has determined that the project complies with all terms and conditions of this NWP, and that any adverse impacts of the project on the aquatic environment are minimal, both individually and cumulatively;

15. For NWP 43 (Stormwater Management Facilities), the PCN must include, for the construction of new stormwater management facilities, a maintenance plan (in accordance with state and local requirements, if applicable) and a compensatory mitigation proposal to offset losses of waters of the US. For discharges that cause the loss of greater than 300 linear feet of an intermittent stream bed, to be authorized, the District Engineer must determine that the activity complies with the other terms and conditions of the NWP, determine adverse environmental effects are minimal both individually and cumulatively, and waive the limitation on stream impacts in writing before the permittee may proceed;

16. For NWP 44 (Mining Activities), the PCN must include a description of all waters of the US adversely affected by the project, a description of measures taken to minimize adverse effects to waters of the US, a description of measures taken to comply with the criteria of the NWP, and a reclamation plan (for all aggregate mining activities in isolated waters and non-tidal wetlands adjacent to headwaters and any hard rock/mineral mining activities);

17. For activities that may adversely affect Federally-listed endangered or threatened species, the PCN must include the name(s) of those endangered or threatened species that may be affected by the proposed work or utilize the designated critical habitat that may be affected by the proposed work; and

18. For activities that may affect historic properties listed in, or eligible for listing in, the National Register of Historic Places, the PCN must state which historic property may be affected by the proposed work or include a vicinity map indicating the location of the historic property.

c. Form of Notification: The standard Individual Permit application form (Form ENG 4345) may be used as the notification but must clearly indicate that it is a PCN and must include all of the information required in (b) (1)-(18) of General Condition 13. A letter containing the requisite information may also be used.

d. District Engineer's Decision: In reviewing the PCN for the proposed activity, the District Engineer will determine whether the activity authorized by the NWP will result in more than minimal individual or cumulative adverse environmental effects or may be contrary to the public interest. The prospective permittee may submit a proposed mitigation plan with the PCN to expedite the process. The District Engineer will consider any proposed compensatory mitigation the applicant has included in the proposal in determining whether the net adverse environmental effects to the aquatic environment of the proposed work are minimal. If the District Engineer determines that the activity complies with the terms and conditions of the NWP

and that the adverse effects on the aquatic environment are minimal, after considering mitigation, the District Engineer will notify the permittee and include any conditions the District Engineer deems necessary. The District Engineer must approve any compensatory mitigation proposal before the permittee commences work. If the prospective permittee is required to submit a compensatory mitigation proposal with the PCN, the proposal may be either conceptual or detailed. If the prospective permittee elects to submit a compensatory mitigation plan with the PCN, the District Engineer will expeditiously review the proposed compensatory mitigation plan. The District Engineer must review the plan within 45 days of receiving a complete PCN and determine whether the conceptual or specific proposed mitigation would ensure no more than minimal adverse effects on the aquatic environment. If the net adverse effects of the project on the aquatic environment (after consideration of the compensatory mitigation proposal) are determined by the District Engineer to be minimal, the District Engineer will provide a timely written response to the applicant. The response will state that the project can proceed under the terms and conditions of the NWP.

If the District Engineer determines that the adverse effects of the proposed work are more than minimal, then the District Engineer will notify the applicant either:

1. That the project does not qualify for authorization under the NWP and instruct the applicant on the procedures to seek authorization under an Individual Permit;
2. that the project is authorized under the NWP subject to the applicant's submission of a mitigation proposal that would reduce the adverse effects on the aquatic environment to the minimal level; or
3. that the project is authorized under the NWP with specific modifications or conditions. Where the District Engineer determines that mitigation is required to ensure no more than minimal adverse effects occur to the aquatic environment, the activity will be authorized within the 45-day PCN period. The authorization will include the necessary conceptual or specific mitigation or a requirement that the applicant submit a mitigation proposal that would reduce the adverse effects on the aquatic environment to the minimal level. When conceptual mitigation is included, or a mitigation plan is required under item (2) above, no work in waters of the US will occur until the District Engineer has approved a specific mitigation plan.

e. Agency Coordination: The District Engineer will consider any comments from Federal and state agencies concerning the proposed activity's compliance with the terms and conditions of the NWPs and the need for mitigation to reduce the project's adverse environmental effects to a minimal level.

For activities requiring notification to the District Engineer that result in the loss of greater than $\frac{1}{2}$ -acre of waters of the US, the District Engineer will provide immediately (e.g., via facsimile transmission, overnight mail, or other expeditious manner) a copy to the appropriate Federal or state offices (USFWS, state natural resource or water quality agency, EPA, State Historic Preservation Officer (SHPO), and, if appropriate, the NMFS). With the exception of

NWP 37, these agencies will then have 10 calendar days from the date the material is transmitted to telephone or fax the District Engineer notice that they intend to provide substantive, site-specific comments. If so contacted by an agency, the District Engineer will wait an additional 15 calendar days before making a decision on the notification. The District Engineer will fully consider agency comments received within the specified time frame, but will provide no response to the resource agency, except as provided below. The District Engineer will indicate in the administrative record associated with each notification that the resource agencies' concerns were considered. As required by section 305(b)(4)(B) of the Magnuson-Stevens Fishery Conservation and Management Act, the District Engineer will provide a response to NMFS within 30 days of receipt of any Essential Fish Habitat conservation recommendations. Applicants are encouraged to provide the Corps multiple copies of notifications to expedite agency notification.

f. Wetland Delineations: Wetland delineations must be prepared in accordance with the current method required by the Corps (For NWP 29 see paragraph (b)(9)(iii) for parcels less than $\frac{1}{4}$ -acre in size). The permittee may ask the Corps to delineate the special aquatic site. There may be some delay if the Corps does the delineation. Furthermore, the 45-day period will not start until the wetland delineation has been completed and submitted to the Corps, where appropriate.

14. Compliance Certification. Every permittee who has received NWP verification from the Corps will submit a signed certification regarding the completed work and any required mitigation. The certification will be forwarded by the Corps with the authorization letter and will include:

a. A statement that the authorized work was done in accordance with the Corps authorization, including any general or specific conditions;

b. A statement that any required mitigation was completed in accordance with the permit conditions; and

c. The signature of the permittee certifying the completion of the work and mitigation.

15. Use of Multiple Nationwide Permits. The use of more than one NWP for a single and complete project is prohibited, except when the acreage loss of waters of the US authorized by the NWPs does not exceed the acreage limit of the NWP with the highest specified acreage limit (e.g. if a road crossing over tidal waters is constructed under NWP 14, with associated bank stabilization authorized by NWP 13, the maximum acreage loss of waters of the US for the total project cannot exceed $\frac{1}{3}$ -acre).

16. Water Supply Intakes. No activity, including structures and work in navigable waters of the US or discharges of dredged or fill material, may occur in the proximity of a public water supply intake except where the activity is for repair of the public water supply intake structures or adjacent bank stabilization.

17. Shellfish Beds. No activity, including structures and work in navigable waters of the US or discharges of dredged or fill material, may occur in areas of concentrated shellfish populations, unless the activity is directly related to a shellfish harvesting activity authorized by NWP 4.

18. Suitable Material. No activity, including structures and work in navigable waters of the US or discharges of dredged or fill material, may consist of unsuitable material (e.g., trash, debris, car bodies, asphalt, etc.) and material used for construction or discharged must be free from toxic pollutants in toxic amounts (see section 307 of the CWA).

19. Mitigation. The District Engineer will consider the factors discussed below when determining the acceptability of appropriate and practicable mitigation necessary to offset adverse effects on the aquatic environment that are more than minimal.

a. The project must be designed and constructed to avoid and minimize adverse effects to waters of the US to the maximum extent practicable at the project site (i.e., on site).

b. Mitigation in all its forms (avoiding, minimizing, rectifying, reducing or compensating) will be required to the extent necessary to ensure that the adverse effects to the aquatic environment are minimal.

c. Compensatory mitigation at a minimum one-for-one ratio will be required for all wetland impacts requiring a PCN, unless the District Engineer determines in writing that some other form of mitigation would be more environmentally appropriate and provides a project-specific waiver of this requirement. Consistent with National policy, the District Engineer will establish a preference for restoration of wetlands as compensatory mitigation, with preservation used only in exceptional circumstances.

d. Compensatory mitigation (i.e., replacement or substitution of aquatic resources for those impacted) will not be used to increase the acreage losses allowed by the acreage limits of some of the NWPs. For example, $\frac{1}{4}$ -acre of wetlands cannot be created to change a $\frac{3}{4}$ -acre loss of wetlands to a $\frac{1}{2}$ -acre loss associated with NWP 39 verification. However, $\frac{1}{2}$ -acre of created wetlands can be used to reduce the impacts of a $\frac{1}{2}$ -acre loss of wetlands to the minimum impact level in order to meet the minimal impact requirement associated with NWPs.

e. To be practicable, the mitigation must be available and capable of being done considering costs, existing technology, and logistics in light of the overall project purposes. Examples of mitigation that may be appropriate and practicable include, but are not limited to: reducing the size of the project; establishing and maintaining wetland or upland vegetated buffers to protect open waters such as streams; and replacing losses of aquatic resource functions and values by creating, restoring, enhancing, or preserving similar functions and values, preferably in the same watershed.

f. Compensatory mitigation plans for projects in or near streams or other open waters will normally include a requirement for the establishment, maintenance, and legal protection (e.g., easements, deed restrictions) of vegetated buffers to open waters. In many cases, vegetated buffers will be the only compensatory mitigation required. Vegetated buffers should consist of native species. The width of the vegetated buffers required will address documented water quality or aquatic habitat loss concerns. Normally, the vegetated buffer will be 25 to 50 feet wide on each side of the stream, but the District Engineers may require slightly wider vegetated buffers to address documented water quality or habitat loss concerns. Where both wetlands and open waters exist on the project site, the Corps will determine the appropriate compensatory mitigation (e.g., stream buffers or wetlands compensation) based on what is best for the aquatic environment or, a watershed basis. In cases where vegetated buffers are determined to be the most appropriate form of compensatory mitigation, the District Engineer may waive or reduce the requirement to provide wetland compensatory mitigation for wetland impacts.

g. Compensatory mitigation proposals submitted with the " notification" may be either conceptual or detailed. If conceptual plans are approved under the verification, then the Corps will condition the verification to require detailed plans be submitted and approved by the Corps prior to construction of the authorized activity in waters of the US.

h. Permittees may propose the use of mitigation banks, in-lieu fee arrangements or separate activity-specific compensatory mitigation. In all cases that require compensatory mitigation, the mitigation provisions will specify the party responsible for accomplishing and/or complying with the mitigation plan.

20. Spawning Areas. Activities, including structures and work in navigable waters of the US or discharges of dredged or fill material, in spawning areas during spawning seasons must be avoided to the maximum extent practicable. Activities that result in the physical destruction (e.g., excavate, fill, or smother downstream by substantial turbidity) of an important spawning area are not authorized.

21. Management of Water Flows. To the maximum extent practicable, the activity must be designed to maintain preconstruction downstream flow conditions (e.g., location, capacity, and flow rates). Furthermore, the activity must not permanently restrict or impede the passage of normal or expected high flows (unless the primary purpose of the fill is to impound waters) and the structure or discharge of dredged or fill material must withstand expected high flows. The activity must, to the maximum extent practicable, provide for retaining excess flows from the site, provide for maintaining surface flow rates from the site similar to preconstruction conditions, and provide for not increasing water flows from the project site, relocating water, or redirecting water flow beyond preconstruction conditions. Stream channelizing will be reduced to the minimal amount necessary, and the activity must, to the maximum extent practicable, reduce adverse effects such as flooding or erosion downstream and upstream of the project site, unless the activity is part of a larger system designed to manage water flows. In most cases, it will not be a requirement to conduct detailed studies and monitoring of water flow.

This condition is only applicable to projects that have the potential to affect waterflows. While appropriate measures must be taken, it is not necessary to conduct detailed studies to identify such measures or require monitoring to ensure their effectiveness. Normally, the Corps will defer to state and local authorities regarding management of water flow.

22. Adverse Effects From Impoundments. If the activity creates an impoundment of water, adverse effects to the aquatic system due to the acceleration of the passage of water, and/or the restricting its flow shall be minimized to the maximum extent practicable. This includes structures and work in navigable waters of the US, or discharges of dredged or fill material.

23. Waterfowl Breeding Areas. Activities, including structures and work in navigable waters of the US or discharges of dredged or fill material, into breeding areas for migratory waterfowl must be avoided to the maximum extent practicable.

24. Removal of Temporary Fills. Any temporary fills must be removed in their entirety and the affected areas returned to their preexisting elevation.

25. Designated Critical Resource Waters. Critical resource waters include, NOAA-designated marine sanctuaries, National Estuarine Research Reserves, National Wild and Scenic Rivers, critical habitat for Federally listed threatened and endangered species, coral reefs, state natural heritage sites, and outstanding national resource waters or other waters officially designated by a state as having particular environmental or ecological significance and identified by the District Engineer after notice and opportunity for public comment. The District Engineer may also designate additional critical resource waters after notice and opportunity for comment.

a. Except as noted below, discharges of dredged or fill material into waters of the US are not authorized by NWPs 7, 12, 14, 16, 17, 21, 29, 31, 35, 39, 40, 42, 43, and 44 for any activity within, or directly affecting, critical resource waters, including wetlands adjacent to such waters. Discharges of dredged or fill materials into waters of the US may be authorized by the above NWPs in National Wild and Scenic Rivers if the activity complies with General Condition 7. Further, such discharges may be authorized in designated critical habitat for Federally listed threatened or endangered species if the activity complies with General Condition 11 and the USFWS or the NMFS has concurred in a determination of compliance with this condition.

b. For NWPs 3, 8, 10, 13, 15, 18, 19, 22, 23, 25, 27, 28, 30, 33, 34, 36, 37, and 38, notification is required in accordance with General Condition 13, for any activity proposed in the designated critical resource waters including wetlands adjacent to those waters. The District Engineer may authorize activities under these NWPs only after it is determined that the impacts to the critical resource waters will be no more than minimal.

26. Fills Within 100-Year Floodplains. For purposes of this General Condition, 100-year floodplains will be identified through the existing Federal Emergency Management Agency's (FEMA) Flood Insurance Rate Maps or FEMA-approved local floodplain maps.

a. Discharges in Floodplain; Below Headwaters. Discharges of dredged or fill material into waters of the US within the mapped 100year floodplain, below headwaters (i.e. five cfs), resulting in permanent above-grade fills, are not authorized by NWP's 39, 40, 42, 43, and 44.

b. Discharges in Floodway; Above Headwaters. Discharges of dredged or fill material into waters of the US within the FEMA or locally mapped floodway, resulting in permanent above-grade fills, are not authorized by NWP's 39, 40, 42, and 44.

c. The permittee must comply with any applicable FEMA-approved state or local floodplain management requirements.

27. Construction Period. For activities that have not been verified by the Corps and the project was commenced or under contract to commence by the expiration date of the NWP (or modification or revocation date), the work must be completed within 12-months after such date (including any modification that affects the project).

For activities that have been verified and the project was commenced or under contract to commence within the verification period, the work must be completed by the date determined by the Corps.

For projects that have been verified by the Corps, an extension of a Corps approved completion date maybe requested. This request must be submitted at least one month before the previously approved completion date.

FURTHER INFORMATION

1. District Engineers have authority to determine if an activity complies with the terms and conditions of a NWP.
2. NWP's do not obviate the need to obtain other Federal, State, or local permits, approvals, or authorizations required by law.
3. NWP's do not grant any property rights or exclusive privileges.
4. NWP's do not authorize any injury to the property or rights of others.
5. NWP's do not authorize interference with any existing or proposed Federal project.

DEFINITIONS

Best Management Practices (BMPs): BMPs are policies, practices, procedures, or structures implemented to mitigate the adverse environmental effects on surface water quality resulting

from development. BMPs are categorized as structural or nonstructural. A BMP policy may affect the limits on a development.

Compensatory Mitigation: For purposes of Section 10/404, compensatory mitigation is the restoration, creation, enhancement, or in exceptional circumstances, preservation of wetlands and/or other aquatic resources for the purpose of compensating for unavoidable adverse impacts, which remain, after all appropriate and practicable avoidance and minimization has been achieved.

Creation: The establishment of a wetland or other aquatic resource where one did not formerly exist.

Enhancement: Activities conducted in existing wetlands or other aquatic resources that increase one or more aquatic functions.

Ephemeral Stream: An ephemeral stream has *flowing* water only during and for a short duration after, precipitation events in a typical year. Ephemeral stream beds are located above the water table year-round. Groundwater is not a source of water for the stream. Runoff from rainfall is the primary source of water for stream flow.

Farm Tract: A unit of contiguous land under one ownership that is operated as a farm or part of a farm.

Flood Fringe: That portion of the 100-year floodplain outside of the floodway (often referred to as “floodway fringe”).

Floodway: The area regulated by Federal, state, or local requirements to provide for the discharge of the base flood so the cumulative increase in water surface elevation is no more than a designated amount (not to exceed one foot as set by the National Flood Insurance Program) within the 100-year floodplain.

Independent Utility: A test to determine what constitutes a single and complete project in the Corps regulatory program. A project is considered to have independent utility if it would be constructed absent the construction of other projects in the project area. Portions of a multi-phase project that depend upon other phases of the project do not have independent utility. Phases of a project that would be constructed even if the other phases were not built can be considered as separate single and complete projects with independent utility.

Intermittent Stream: An intermittent stream has flowing water during certain times of the year, when groundwater provides water for stream flow. During dry periods, intermittent streams may not have flowing water. Runoff from rainfall is a supplemental source of water for stream flow.

Loss of waters of the US: Waters of the US that include the filled area and other waters that are permanently adversely affected by flooding, excavation, or drainage because of the regulated activity. Permanent adverse effects include permanent above-grade, at-grade, or below-grade fills that change an aquatic area to dry land, increase the bottom elevation of a waterbody, or change the use of a waterbody. The acreage of loss of waters of the US is the threshold measurement of the impact to existing waters for determining whether a project may qualify for a NWP; it is not a net threshold that is calculated after considering compensatory mitigation that may be used to offset losses of aquatic functions and values. The loss of stream bed includes the linear feet of stream bed that is filled or excavated. Waters of the US temporarily filled, flooded, excavated, or drained, but restored to preconstruction contours and elevations after construction, are not included in the measurement of loss of waters of the US. Impacts to ephemeral waters are only not included in the acreage or linear foot measurements of loss of waters of the US or loss of stream bed, for the purpose of determining compliance with the threshold limits of the NWPs.

Non-tidal Wetland: An area that, during a year with normal patterns of precipitation has standing or flowing water for sufficient duration to establish an ordinary high water mark. Aquatic vegetation within the area of standing or flowing water is either non-emergent, sparse, or absent. Vegetated shallows are considered to be open waters. The term “open water” includes rivers, streams, lakes, and ponds. For the purposes of the NWPs, this term does not include ephemeral waters.

Perennial Stream: A perennial stream has flowing water year-round during a typical year. The water table is located above the stream bed for the most of the year. Groundwater is the primary source of water for stream flow. Runoff from rainfall is a supplemental source of water for stream flow.

Permanent Above-grade Fill: A discharge of dredged or fill material into waters of the US, including wetlands, that results in a substantial increase in ground elevation and permanently converts part or all of the waterbody to dry land. Structural fills authorized by NWPs 3, 25, 36, etc. are not included.

Preservation: The protection of ecologically important wetlands or other aquatic resources in perpetuity through the implementation of appropriate legal and physical mechanisms. Preservation may include protection of upland areas adjacent to wetlands as necessary to ensure protection and/or enhancement of the overall aquatic ecosystem.

Restoration: Re-establishment of wetland and/or other aquatic resource characteristics and function(s) at a site where they have ceased to exist, or exist in a substantially degraded state.

Riffle and Pool Complex: Riffle and pool complexes are special aquatic sites under the 404(b)(1) Guidelines. Riffle and pool complexes sometimes characterize steep gradient sections of streams. Such stream sections are recognizable by their hydraulic characteristics. The rapid movement of water over a coarse substrate in riffles results in a rough flow, a turbulent surface and high dissolved oxygen levels in the water. Pools are deeper areas associated with riffles. A slower stream velocity, a streaming flow, a smooth surface, and a finer substrate characterize pools.

Single and Complete Project: The term “single and complete project” is defined at 33 CFR 330.2(i) as the total project proposed or accomplished by one owner/developer or partnership or other association of owners/developers (see definition of independent utility). For linear projects, the “single and complete project” (i.e., a single and complete crossing) will apply to each crossing of a separate water of the US (i.e., a single waterbody) at that location. An exception is for linear projects crossing a single waterbody several times at separate and distant locations; each crossing is considered a single and complete project. However, individual channels in a braided stream or river, or individual arms of a large, irregularly shaped wetland or lake, etc., are not separate waterbodies.

Stormwater Management: Stormwater management is the mechanism for controlling stormwater runoff for the purposes of reducing downstream erosion, water quality degradation, and flooding and mitigating the adverse effects of changes in land use on the aquatic environment.

Stormwater Management Facilities: Stormwater management facilities are those facilities, including but not limited to, stormwater retention and detention ponds and BMPs, which retain water for a period of time to control runoff and/or improve the quality (i.e., by reducing the concentration of nutrients, sediments, hazardous substances and other pollutants) of stormwater runoff.

Stream Channelization: The manipulation of a stream channel to increase the rate of water flow through the stream channel. Manipulation may include deepening, widening, straightening, armoring, or other activities that change the stream cross-section or other aspects of stream channel geometry to increase the rate of water flow through the stream channel. A channelized stream remains a water of the US, despite the modifications to increase the rate of water flow.

Tidal Wetland: A tidal wetland is a wetland (i.e., water of the US) that is inundated by tidal waters. The definitions of a wetland and tidal waters can be found at 33 CFR 328.3(b) and 33 CFR 328.3(f), respectively. Tidal waters rise and fall in a predictable and measurable rhythm or cycle due to the gravitational pulls of the moon and sun. Tidal waters end where the rise and fall of the water surface can no longer be practically measured in a predictable rhythm due to masking by other waters, wind, or other effects. Tidal wetlands are located channelward of the high tide line (i.e., spring high tide line) and are inundated by tidal waters two times per lunar month, during spring high tides.

Vegetated Buffer: A vegetated upland or wetland area next to rivers, streams, lakes, or other

open waters, which separates the open water from developed areas, including agricultural land. Vegetated buffers provide a variety of aquatic habitat functions and values (e.g., aquatic habitat for fish and other aquatic organisms, moderation of water temperature changes, and detritus for aquatic food webs) and help improve or maintain local water quality. A vegetated buffer can be established by maintaining an existing vegetated area or planting native trees, shrubs, and herbaceous plants on land next to openwaters. Mowed lawns are not considered vegetated buffers because they provide little or no aquatic habitat functions and values. The establishment and maintenance of vegetated buffers is a method of compensatory mitigation that can be used in conjunction with the restoration, creation, enhancement or preservation of aquatic habitats to ensure that activities authorized by NWP's result in minimal adverse effects to the aquatic environment. (See General Condition 19.)

Vegetated Shallows: Vegetated shallows are special aquatic sites under the 404(b)(1) Guidelines. They are areas that are permanently inundated and under normal circumstances have rooted aquatic vegetation, such as seagrasses in marine and estuarine systems and a variety of vascular rooted plants in freshwater systems.

Waterbody: A waterbody is any area that in a normal year has water flowing or standing above ground to the extent that evidence of an ordinary high water mark is established. Wetlands contiguous to the waterbody are considered part of the waterbody.

FINAL REGIONAL CONDITIONS FOR NATIONWIDE PERMITS IN THE WILMINGTON DISTRICT

1. Waters Excluded from NWP or Subject to Additional Notification Requirements:

a. The Corps identified waters that will be excluded from use of this NWP. These waters are:

1. Discharges into Waters of the United States designated by either the North Carolina Division of Marine Fisheries (NCDMF) or the North Carolina Wildlife Resources Commission (NCWRC) as anadromous fish spawning area are prohibited during the period between February 15 and June 30, without prior written approval from NCDMF or NCWRC and the Corps.

2. Discharges into Waters of the United States designated as sturgeon spawning areas are prohibited during the period between February 1 and June 30, without prior written approval from the National Marine Fisheries Service (NMFS).

b. The Corps identified waters that will be subject to additional notification requirements for activities authorized by this NWP. These waters are:

1. Prior to the use of any NWP in any of the following North Carolina *designated waters*, applicants must comply with Nationwide Permit General Condition 13. In addition, the applicant must furnish a written statement of compliance with all of the conditions of the applicable

Nationwide Permit. The North Carolina *designated waters* that require additional notification requirements are “Outstanding Resource Waters” (ORW) and “High Quality Waters” (HQW) (as defined by the North Carolina Division of Water Quality), or “Inland Primary Nursery Areas” (IPNA) (as defined by the North Carolina Wildlife Resources Commission), or contiguous wetlands (as defined by the North Carolina Division of Water Quality), or “Primary Nursery Areas” (PNA) (as defined by the North Carolina Division of Marine Fisheries).

2. Applicants for any NWP in a designated “Area of Environmental Concern” (AEC) in the twenty (20) coastal counties of Eastern North Carolina covered by the North Carolina Coastal Area Management Act (CAMA), must also obtain the required CAMA permit. Construction activities may not commence until a copy of the approved CAMA permit is furnished to the appropriate Wilmington District Regulatory Field Office (Wilmington Field Office – P.O. Box 1890, Wilmington, NC 28402 or Washington Field Office – P.O. Box 1000, Washington, NC 27889) for authorization to begin work.

3. Prior to the use of any NWP on a Barrier Island of North Carolina, applicants must comply with Nationwide Permit General Condition 13. In addition, the applicant shall furnish a written statement of compliance with all of the conditions listed of the applicable Nationwide Permit.

4. Prior to the use of any NWP in a “Mountain or Piedmont Bog” of North Carolina, applicants shall comply with Nationwide Permit General Condition 13. In addition, the applicant shall furnish a written statement of compliance with all of the conditions listed of the applicable NWP.

Note: The following wetland community types identified in the N.C. Natural Heritage Program document, “Classification of Natural communities of North Carolina (Michael P. Schafale and Alan S. Weakley, 1990), are subject to this regional condition.

Mountain Bogs

Swamp Forest-Bog Complex
Swamp Forest-Bog Complex (Spruce Subtype)
Southern Appalachian Bog (Northern Subtype)
Southern Appalachian Bog (Southern Subtype)
Southern Appalachian Fen

Piedmont Bogs

Upland Depression Swamp Forest

5. Prior to the use of any NWP in Mountain Trout Waters within twenty-five (25) designated counties of North Carolina, applicants shall comply with Nationwide General Condition 13. In addition, the applicant shall furnish a written statement of compliance with all of the conditions listed of the applicable NWP. Notification will include a letter of comments and recommendations from the North Carolina Wildlife Resources Commission (NCWRC), the

location of work, a delineation of wetlands, a discussion of alternatives to working in the Mountain Trout Waters, why other alternatives were not selected, and a plan to provide compensatory mitigation for all unavoidable adverse impacts to the Mountain Trout Waters. To facilitate coordination with the NCWRC, the proponent may provide a copy of the notification to the NCWRC concurrent with the notification to the District Engineer. The NCWRC will respond both to the proponent and directly to the Corps of Engineers.

The twenty-five (25) designated counties are:

Alleghany	Ashe	Avery	Yancey
Buncombe	Burke	Caldwell	Wilkes
Cherokee	Clay	Graham	Swain
Haywood	Henderson	Jackson	Surry
Macon	Madison	McDowell	Stokes
Mitchell	Polk	Rutherford	
Transylvania	Watauga		

6. Applicants shall notify the NCDENR Shellfish Sanitation Section prior to dredging in or removing sediment from an area closed to shell fishing where the effluent may be released to an area open for shell fishing or swimming in order to avoid contamination of the disposal area and allow a temporary shellfish closure to be made. Any disposal of sand to the beach should occur between November 1 and April 30 when recreational usage is low. Only clean sand should be used and no dredged sand from closed shell fishing areas. If beach disposal was to occur at times other than stated above or if sand from a closed shell fishing area is to be used, a swim advisory shall be posted and a press release shall be made. NCDENR Shellfish Sanitation Section must be notified before commencing this activity.

2. List of Final Corps Regional Modifications and Conditions for All Nationwide Permits

a. Individual or multiple NWP may not be used for activities that result in the cumulative loss or degradation of greater than 300 total linear feet of perennial streambed or intermittent streambed that exhibits important aquatic function(s).

b. Prior to the use of any NWP (except 13, 27, and 39) for any activity that has more than a total of 150 total linear feet of perennial streambed impacts or intermittent streambed impacts (if the intermittent stream has important aquatic function), the applicant must comply with Nationwide Permit General Condition 13. In addition, the applicant shall furnish a written statement of compliance with all of the conditions listed of the applicable NWP. Compensatory mitigation is typically required for any impact that requires such notification. [Note: The Corps uses the Intermittent Channel Evaluation Form, located with Permit Information on the Regulatory Program Web Site, to aid in the determination of the intermittent channel stream status. Also, NWP 13, 27 and 39 have specific reporting requirements.]

c. For all Nationwide Permits which allow the use of concrete as a building material, measures will be taken to prevent live or fresh concrete, including bags of uncured concrete, from coming into contact with waters of the state until the concrete has hardened.

d. For all Nationwide Permits that allow for the use of riprap material for bank stabilization, filter cloth must be placed underneath the riprap as an additional requirement of its use in North Carolina waters.

e. For all NWP's that involve the construction of culverts, measures will be included in the construction that will promote the safe passage of fish and other aquatic organisms. All culverts in the 20 CAMA coastal counties must be buried to a depth of one foot below the

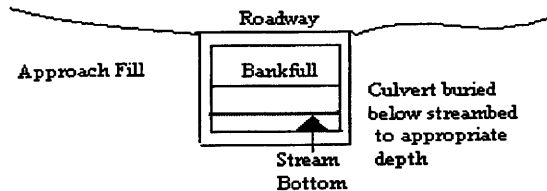

bed of the stream or wetland. For all culvert construction activities, the dimension, pattern, and profile of the stream, (above and below a pipe or culvert), should not be modified by widening the stream channel or by reducing the depth of the stream. Culvert inverts will be buried at least one foot below the bed of the stream for culverts greater than 48 inches in diameter. For culverts 48 inches in diameter or smaller, culverts must be buried below the bed of the stream to a depth equal to or greater than 20 percent of the diameter of the culvert. Bottomless arch culverts will satisfy this condition. A waiver from the depth specifications in this Regional Condition may be requested in writing. The waiver will only be issued if it can be demonstrated that the impacts of complying with this Regional Condition would result in more adverse impacts to the aquatic environment.

NORTH CAROLINA DIVISION OF WATER QUALITY
GENERAL CERTIFICATION CONDITIONS
GC3361

1. Proposed fill or substantial modification of wetlands or waters (including streams) under this General Certification requires notification to the Division of Water Quality. Two copies shall be submitted to DWQ at the time of notification in accordance with 15A NCAC 2H .0501(a). Written concurrence from DWQ is not required unless any standard conditions of this Certification cannot be met;

2. Appropriate sediment and erosion control practices which equal or exceed those outlined in the most recent version of the "North Carolina Sediment and Erosion Control Planning and Design Manual" or the "North Carolina Surface Mining Manual" whichever is more appropriate (available from the Division of Land Resources (DLR) in the DENR Regional or Central Offices) shall be in full compliance with all specifications governing the proper design, installation and operation and maintenance of such Best Management Practices in order to assure compliance

with the appropriate turbidity water quality standard;

3. In accordance with 15A NCAC 2H .0506 (h) compensatory mitigation may be required for impacts to 150 linear feet or more of streams and/or one acre or more of wetlands. In addition, buffer mitigation may be required for any project with Buffer Rules in effect at the time of application for buffer impacts resulting from activities classified as "allowable with mitigation" within the "Table of Uses" section of the Buffer Rules or require a variance under the Buffer Rules. A determination of buffer, wetland and stream mitigation requirements shall be made for any Certification for this Nationwide Permit. The most current design and monitoring protocols from DWQ shall be followed and written plans submitted for DWQ approval as required in those protocols. When compensatory mitigation is required for a project, the mitigation plans must be approved by DWQ in writing before the impacts approved by the Certification occur. The mitigation plan must be implemented and/or constructed before any permanent building or structure on site is occupied. In the case of public road projects, the mitigation plan must be implemented before the road is opened to the traveling public;

4. Compensatory stream mitigation shall be required at a 1:1 ratio for all perennial and intermittent stream impacts equal to or exceeding 150 feet and that require application to DWQ in watersheds classified as ORW, HQW, Tr, WS-I and WS-II;

5. All sediment and erosion control measures placed in wetlands or waters shall be removed and the original grade restored within two months after the Division of Land Resources has released the project;

6. Measures shall be taken to prevent live or fresh concrete from coming into contact with waters of the state until the concrete has hardened;

7. In accordance with North Carolina General Statute Section 143-215.3D(e), any request for written concurrence for a 401 Water Quality Certification must include the appropriate fee. If a project also requires a CAMA Permit, one payment to both agencies shall be submitted and will be the higher of the two fees;

8. Impacts to any stream length in the Neuse, Tar-Pamlico, Randleman and Catawba River Basins (or any other river basins with Riparian Area Protection Rules [Buffer Rules] in effect at the time of application) requires written concurrence from DWQ in accordance with 15A NCAC 2B.0200. Activities listed as "exempt" from these rules do not need to apply for written concurrence under this Certification. New development activities located in the protected 50-foot wide riparian areas (whether jurisdictional wetlands or not) within the Neuse, Tar-Pamlico, Randleman and Catawba River Basins shall be limited to "uses" identified within and constructed in accordance with 15A NCAC 2B .0200. All new development shall be located, designed, constructed, and maintained to have minimal disturbance to protect water quality to the maximum extent practicable through the use of best management practices;

9. Additional site-specific conditions may be added to projects for which written concurrence is

required or requested under this Certification in order to ensure compliance with all applicable water quality and effluent standards;

10. Concurrence from DWQ that this Certification applies to an individual project shall expire three years from the date of the cover letter from DWQ or on the same day as the expiration date of the corresponding Nationwide and Regional General Permits, whichever is sooner;

11. When written concurrence is required, the applicant is required to use the most recent version of the Certification of Completion form to notify DWQ when all work included in the 401 Certification has been completed.

NORTH CAROLINA DIVISION OF COASTAL MANAGEMENT
STATE CONSISTENCY

Consistent.

Citations:

2002 Nationwide Permits - Federal Register Notice 15 Jan 2002

2002 Nationwide Permits Corrections - Federal Register Notice 13 Feb 2002

2002 Regional Conditions – Authorized 17 May 2002

Permit Class
NEW

Permit Number
42-06

STATE OF NORTH CAROLINA
Department of Environment and Natural Resources
and
Coastal Resources Commission

Permit

for

Major Development in an Area of Environmental Concern
pursuant to NCGS 113A-118

Excavation and/or filling pursuant to NCGS 113-229

Issued to N.C. Department of Transportation, 1548 Mail Service Center, Raleigh, NC 27699-1548

Authorizing development in Bertie County at Cashie River, Bridge No. 11 on SR 1219
(Francis Mill Road), as requested in the permittee's application dated 12/20/05, including the
attached workplan drawings (12): 3 dated 9/12/05, 1 dated 4/22/05, 7 dated 5/25/05, and 1 dated 11/28/05.

This permit, issued on 3/10/06, is subject to compliance with the application (where consistent with the permit), all applicable regulations, special conditions and notes set forth below. Any violation of these terms may be subject to fines, imprisonment or civil action; or may cause the permit to be null and void.

TIP No. B-4027, Bridge Replacement

- 1) In order to protect spawning adult and juvenile anadromous fisheries resources and other finfish populations in the Cashie River, no in-water work shall be conducted between February 15th and June 30th of any year without prior approval of the N.C. Division of Coastal Management (DCM), in consultation with the N.C. Wildlife Resources Commission and the N.C. Division of Marine Fisheries. For the purposes of this moratorium, in-water is defined as those areas that are inundated at normal water level, including the waters or contiguous inundated wetlands of the Cashie River.
- 2) The permittee shall implement the N.C. Department of Transportation's (NCDOT's) Stream Crossing Guidelines for Anadromous Fish Passage, except as modified by Condition No. 1 of this permit.

(See attached sheets for Additional Conditions)

This permit action may be appealed by the permittee or other qualified persons within twenty (20) days of the issuing date. An appeal requires resolution prior to work initiation or continuance as the case may be.

This permit must be accessible on-site to Department personnel when the project is inspected for compliance.

Any maintenance work or project modification not covered hereunder requires further Division approval.

All work must cease when the permit expires on

No expiration date, pursuant to GS 136-44.7B

In issuing this permit, the State of North Carolina agrees that your project is consistent with the North Carolina Coastal Management Program.

Signed by the authority of the Secretary of DENR and the Chairman of the Coastal Resources Commission.

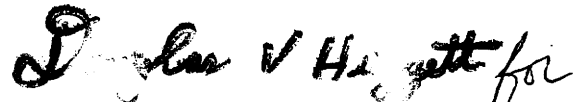

Charles S. Jones, Director
Division of Coastal Management

This permit and its conditions are hereby accepted.

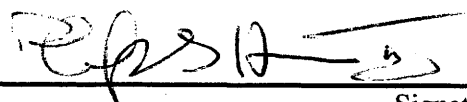

Signature of Permittee

ADDITIONAL CONDITIONS

- 3) All excavated materials shall be confined above normal water level and landward of regularly or irregularly flooded wetlands behind adequate dikes or other retaining structures to prevent spillover of solids into any wetlands or surrounding waters.
- 4) The temporary placement and double handling of any excavated or fill material within waters or vegetated wetlands is not authorized. This condition also applies to removal of the existing bridge, roadway asphalt and/or associated materials.
- 5) No excavation shall take place at any time in any vegetated wetlands or surrounding waters outside of the alignment of the areas indicated on the attached workplan drawings, without permit modification.
- 6) No excavated or fill material shall be placed at any time in any vegetated wetlands or surrounding waters outside of the alignment of the fill area(s) as indicated on the attached workplan drawings, without permit modification.
- 7) All fill material shall be obtained from an upland source and shall be clean and free of any pollutants except in trace quantities. High ground material excavated during this project may be used in fill areas associated with the project or shall be removed from the site and taken to an approved high ground location.
- 8) Live concrete shall not be allowed to contact the water in or entering into the Cashie River or adjacent wetlands.
- 9) The bridge shall be constructed using top down construction methodologies. Any other construction method may require additional authorization.
- 10) All construction access shall be through the use of the existing bridge, except for the use of temporary work mats for utility relocations as described in the attached permit application.
- 11) Unless specifically altered herein, NCDOT's document "Best Management Practices for Bridge Demolition and Removal" (final 9/20/99) shall be followed during both demolition and construction activities.
- 12) Pilings from the existing bridge, as well as any remnant pilings from previous bridges, shall be removed in their entirety. In the event that a piling breaks during removal and cannot be removed in its entirety, the piling may be cut off flush with the bed of the water body only if prior approval is received from DCM.
- 13) If the permittee determines that it is necessary to remove the existing bulkhead at the north end of the bridge, they shall first contact a Division Representative to determine if any additional authorization is required from DCM.
- 14) The pile installation for the bridge shall be accomplished using pile driving. Should the permittee determine that another type of pile installation, such as jetting or drilled shaft construction, is preferred, additional authorization from DCM shall be required.

ADDITIONAL CONDITIONS

- 15) Debris resulting from the removal of the existing bridge, including deck components, roadway asphalt and associated materials, shall not enter wetlands or waters of the State, even temporarily.
- 16) All materials and debris associated with the removal and/or construction of the existing and/or new bridge, roadway and associated materials shall be disposed of at an approved upland site or shall be recycled in an environmentally appropriate manner provided appropriate authorizations from any relevant state, federal, or local authorities are obtained.
- 17) The placement of riprap shall be limited to the areas as depicted on the attached workplan drawing(s). The riprap material shall be clean and free from loose dirt or any pollutant except in trace quantities. The riprap material shall consist of clean rock or masonry materials such as, but not limited to, granite, marl or broken concrete.
- 18) The permittee plans to use construction mats to support equipment within wetland areas to minimize temporary wetland impacts during utility relocations. These mats shall be removed immediately after completion of the authorized utility relocations.

Sedimentation and Erosion Control

- 19) Turbidity curtains and silt fences shall be used to isolate all work areas from the Cashie River, including pile installation, placement of riprap, excavation or filling. The turbidity curtains shall be installed parallel to the banks on each side of the river. The turbidity curtains shall extend past the construction limits and be attached to the silt fences containing the work site. The turbidity curtains shall not fully encircle the work area or extend across the Cashie River. The turbidity curtains shall be properly maintained and retained in the water until construction is complete and all of the work area contained by the turbidity curtains has been stabilized by vegetation or other means. The turbidity curtains shall be removed when turbidity within the curtains reaches ambient levels.
- 20) Appropriate sedimentation and erosion control devices, measures or structures shall be implemented to ensure that eroded materials do not enter adjacent wetlands, watercourses and properties (e.g. silt fence, diversion swales or berms, etc.).
- 21) This project shall conform to all requirements of the N.C. Sedimentation Pollution Control Act and NCDOT's Memorandum of Agreement with the Division of Land Resources.
- 22) The permittee shall follow "Best Management Practices for the Protection of Surface Waters".
- 23) In order to protect water quality, runoff from construction shall not visibly increase the amount of suspended sediments in adjacent waters.

Mitigation

NOTE:

This project will permanently impact approximately 0.275 acres of riverine wetlands (0.236 acres due to fill for the bridge replacement and 0.039 acres due to mechanized clearing and excavation for the utility relocations). This project will temporarily impact approximately 0.259 acres of riverine wetlands (0.194 acres of riverine wetlands due to hand clearing for the bridge replacement and 0.065 acres due to hand clearing for the utility relocations).

ADDITIONAL CONDITIONS

- 24) Compensatory mitigation for 0.275 acres of riverine wetland impacts associated with the proposed project shall be provided in accordance with the letter dated 2/7/06 from the Ecosystem Enhancement Program (EEP), and in accordance with the "Tri-Party" Memorandum of Agreement (MOA) entered into on 7/22/03 by the NC Department of Environment and Natural Resources (NCDENR), NCDOT, and the United States Army Corps of Engineers (USACE), Wilmington District, and in accordance with the "Two-Party" MOA entered into on 4/12/04 by NCDENR and NCDOT.

Stormwater Management

- 25) The N.C. Division of Water Quality (DWQ) approved this project under stormwater management rules of the Environmental Management Commission under Stormwater Permit No. SW7050811 on 9/7/05. Any violation of the permit approved by DWQ shall be considered a violation of this CAMA permit.

General

- 26) Any relocation of utility lines that is not specifically depicted on the attached workplan drawing(s), and/or described within the attached permit application, shall require approval from DCM, either under the authority of this permit, or by the utility company obtaining separate authorization.
- 27) Unless specifically altered herein, any mitigative measures or environmental commitments specifically made by the permittee in the CAMA permit application and the Categorical Exclusion document dated 2/27/04 shall be implemented, regardless of whether or not such commitments are addressed by individual conditions of this permit.
- 28) No attempt shall be made by the permittee to prevent the full and free use by the public of all navigable waters at or adjacent to the authorized work.

NOTE: The permittee is encouraged to implement all practical measures to ensure that the project does not result in undue interference with the public's right of access to the Cashie River within the project area.

- 29) If it is determined that additional permanent and/or temporary impacts (such as but not limited to temporary access roads, detours, or matting to transport equipment across wetlands) are necessary that are not shown on the attached workplan drawing(s), a permit modification and/or additional authorization from DCM shall be required. In addition, any changes in the approved plan may also require a permit modification and/or additional authorization from DCM. The permittee shall contact a Division representative prior to commencement of any such activity for this determination and any permit modification.
- 30) Development authorized by this permit shall only be conducted within NCDOT Right-of-Ways and/or easements.
- 31) The N.C. Division of Water Quality (DWQ) authorized the proposed project on 11/2/05 (DWQ Project No. 05-2001) under General Water Quality Certification Nos. 3403 and 3374. Any violation of the Certifications approved by DWQ shall be considered a violation of this CAMA permit.

ADDITIONAL CONDITIONS

- NOTE:** The U.S. Army Corps of Engineers (USACE) authorized the proposed project under Nationwide Permit Number 23 (COE Action ID No. 200310719), which was issued on 12/6/05. A modification of this Nationwide Permit was issued by USACE on 2/14/06.
- NOTE:** This permit does not eliminate the need to obtain any additional permits, approvals or authorizations that may be required.
- NOTE:** The Bertie County Water Department may have water service in the project area, and should be contacted to determine precise locations and coordinate that construction does not affect utility piping or services to customers. The permittee should contact the Utilities Superintendent at (252) 794-4427.
- NOTE:** If any modifications occur to the water service distribution systems, plans and specifications should be submitted to the N.C. Division of Environmental Health Public Water Supply Plan Review Section for review and approval prior to construction.

WQC #3403

GENERAL CERTIFICATION FOR PROJECTS ELIGIBLE FOR CORPS OF ENGINEERS NATIONWIDE PERMIT NUMBER 23 (APPROVED CATEGORICAL EXCLUSIONS) AND RIPARIAN AREA PROTECTION RULES (BUFFER RULES)

This General Certification is issued in conformity with the requirements of Section 401, Public Laws 92-500 and 95-217 of the United States and subject to the North Carolina Division of Water Quality Regulations in 15A NCAC 2H, Section .0500 and 15A NCAC 2B .0200 for the discharge of fill material to waters and wetland areas as described in 33 CFR 330 Appendix A (B) (23) and for the Riparian Area Protection Rules (Buffer Rules) in 15A NCAC 2B .0200. This Certification replaces Water Quality Certification Number 2670 issued on January 21, 1992, Certification Number 2734 issued on May 1 1993, Certification Number 3107 issued on February 11, 1997 and Water Quality Certification Number 3361 issued March 18, 2002. This WQC is rescinded when the Corps of Engineers re-authorizes Nationwide Permit 23 or when deemed appropriate by the Director of the DWQ.

The State of North Carolina certifies that the specified category of activity will not violate applicable portions of Sections 301, 302, 303, 306 and 307 of the Public Laws 92-500 and 95-217 if conducted in accordance with the conditions hereinafter set forth.

Conditions of Certification:

1. Proposed fill or substantial modification of wetlands or waters (including streams) under this General Certification requires notification to the Division of Water Quality. Two copies shall be submitted to DWQ at the time of notification in accordance with 15A NCAC 2H .0501(a). Written concurrence from DWQ is not required unless any standard conditions of this Certification cannot be met;
2. Appropriate sediment and erosion control practices which equal or exceed those outlined in the most recent version of the "North Carolina Sediment and Erosion Control Planning and Design Manual" or the "North Carolina Surface Mining Manual" whichever is more appropriate (available from the Division of Land Resources (DLR) in the DENR Regional or Central Offices) shall be in full compliance with all specifications governing the proper design, installation and operation and maintenance of such Best Management Practices in order to assure compliance with the appropriate turbidity water quality standard;
3. In accordance with 15A NCAC 2H .0506 (h) compensatory mitigation may be required for impacts to 150 linear feet or more of streams and/or one acre or more of wetlands. In addition, buffer mitigation may be required for any project with Buffer Rules in effect at the time of application for buffer impacts resulting from activities classified as "allowable with mitigation" within the "Table of Uses" section of the Buffer Rules or require a variance under the Buffer Rules. A determination of buffer, wetland and stream mitigation requirements shall be made for any Certification for this Nationwide Permit. The most current design and monitoring protocols from DWQ shall be followed and written plans submitted for DWQ approval as required in those protocols. When compensatory mitigation is required for a project, the mitigation plans must be approved by DWQ in writing before the impacts approved by the Certification occur. The mitigation plan must be implemented and/or constructed before any permanent building or structure on

WQC #3403

site is occupied. In the case of public road projects, the mitigation plan must be implemented before the road is opened to the travelling public;

4. Compensatory stream mitigation shall be required at a 1:1 ratio for not only perennial but also intermittent stream impacts equal to or exceeding 150 feet and that require application to DWQ in watersheds classified as ORW, HQW, Tr, WS-I and WS-II unless the project is a linear, publicly-funded transportation project, which has a 150-foot per-stream impact allowance;
5. All sediment and erosion control measures placed in wetlands or waters shall be removed and the original grade restored within two months after the Division of Land Resources has released the project;
6. Measures shall be taken to prevent live or fresh concrete from coming into contact with freshwaters of the state until the concrete has hardened;
7. In accordance with North Carolina General Statute Section 143-215.3D(e), any request for written concurrence for a 401 Water Quality Certification must include the appropriate fee. If a project also requires a CAMA Permit, one payment to both agencies shall be submitted and will be the higher of the two fees;
8. Impacts to any stream length in the Neuse, Tar-Pamlico, Randleman and Catawba River Basins (or any other river basins with Riparian Area Protection Rules [Buffer Rules] in effect at the time of application) requires written concurrence from DWQ in accordance with 15A NCAC 2B.0200. Activities listed as "exempt" from these rules do not need to apply for written concurrence under this Certification. New development activities located in the protected 50-foot wide riparian areas (whether jurisdictional wetlands or not) within the Neuse, Tar-Pamlico, Randleman and Catawba River Basins shall be limited to "uses" identified within and constructed in accordance with 15A NCAC 2B .0200. All new development shall be located, designed, constructed, and maintained to have minimal disturbance to protect water quality to the maximum extent practicable through the use of best management practices;
9. Additional site-specific conditions may be added to projects for which written concurrence is required or requested under this Certification in order to ensure compliance with all applicable water quality and effluent standards;
10. Concurrence from DWQ that this Certification applies to an individual project shall expire three years from the date of the cover letter from DWQ or on the same day as the expiration date of the corresponding Nationwide and Regional General Permits, whichever is sooner;
11. When written concurrence is required, the applicant is required to use the most recent version of the Certification of Completion form to notify DWQ when all work included in the 401 Certification has been completed.

Non-compliance with or violation of the conditions herein set forth by a specific fill project shall result in revocation of this Certification for the project and may result in criminal and/or civil penalties.

WQC #3403

The Director of the North Carolina Division of Water Quality may require submission of a formal application for individual certification for any project in this category of activity that requires written concurrence under this certification, if it is determined that the project is likely to have a significant adverse effect upon water quality or degrade the waters so that existing uses of the wetland, stream or downstream waters are precluded.

Public hearings may be held for specific applications or group of applications prior to a Certification decision if deemed in the public's best interest by the Director of the North Carolina Division of Water Quality.

Effective date: March 2003

DIVISION OF WATER QUALITY

By

Alan W. Klimek, P.E.

Director

WQC # 3403

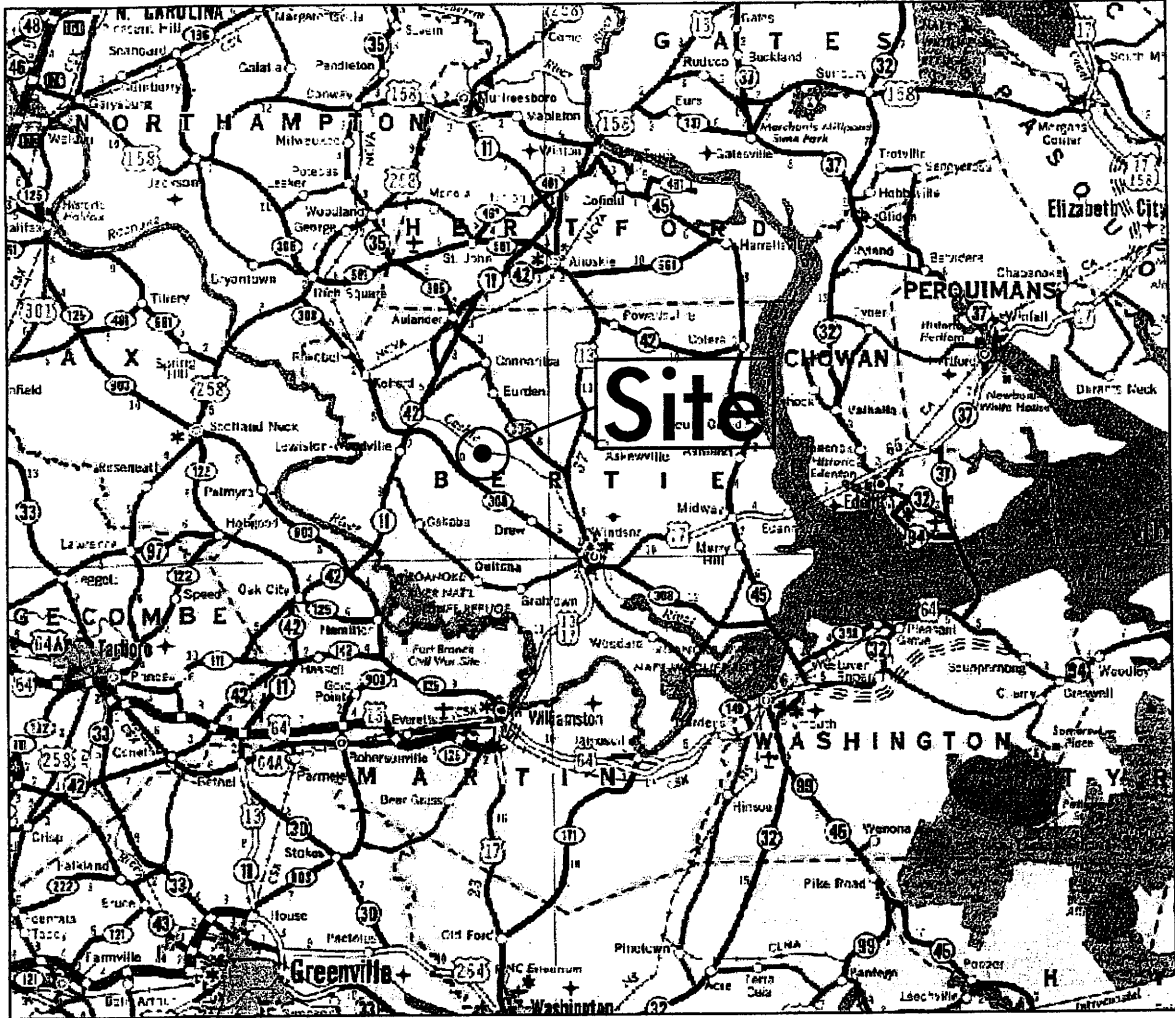

VICINITY MAP



NORTH CAROLINA

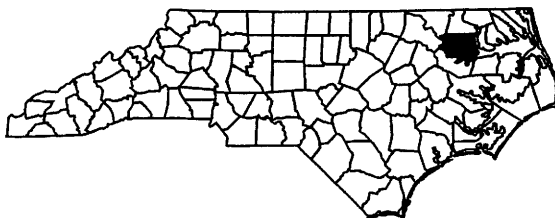

NCDOT
 DIVISION OF HIGHWAYS
 BERTIE COUNTY
 PROJECT: 33394.1F (B-4027)
 BRIDGE REPLACEMENT
 BRIDGE #11 ON SR1219
 OVER CASHIE RIVER
 PERMIT DRAWINGS

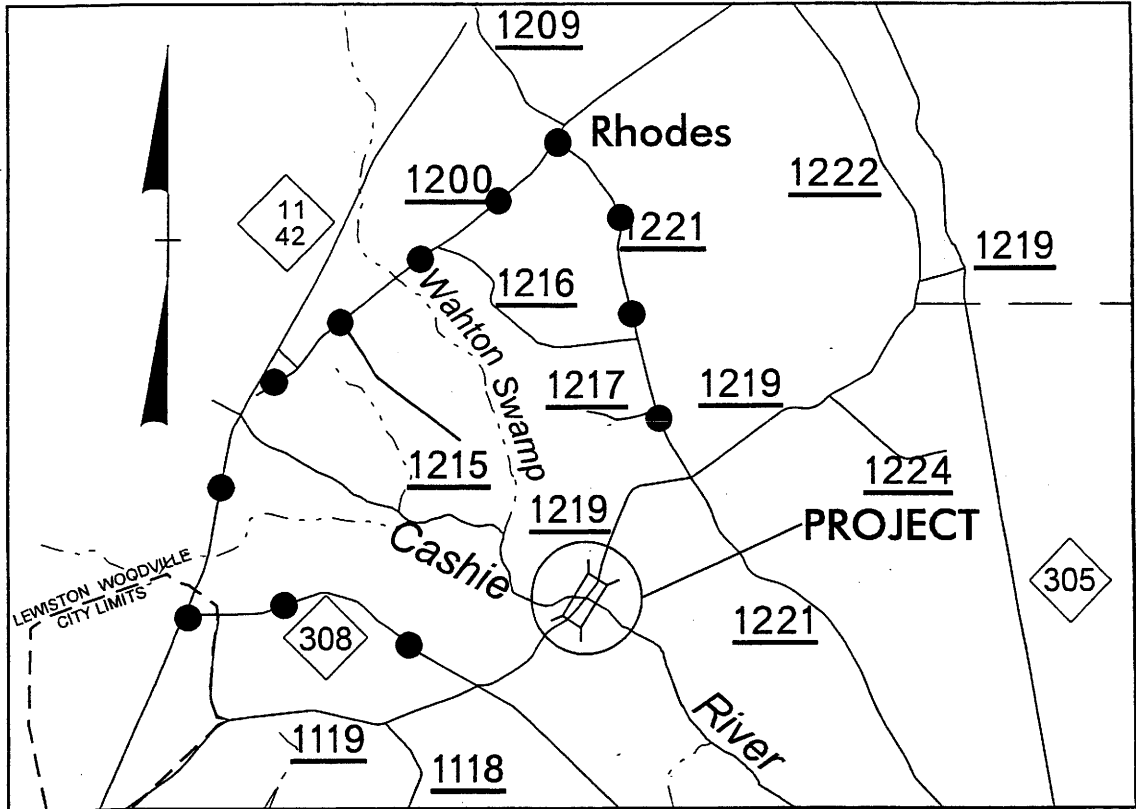

Detour —●—●—●—●—●—

VICINITY MAP

NCDOT
 DIVISION OF HIGHWAYS
 BERTIE COUNTY
 PROJECT: 33394.11 (B-4027)
 BRIDGE REPLACEMENT
 BRIDGE #11 ON SR1219
 OVER CASHIE RIVER

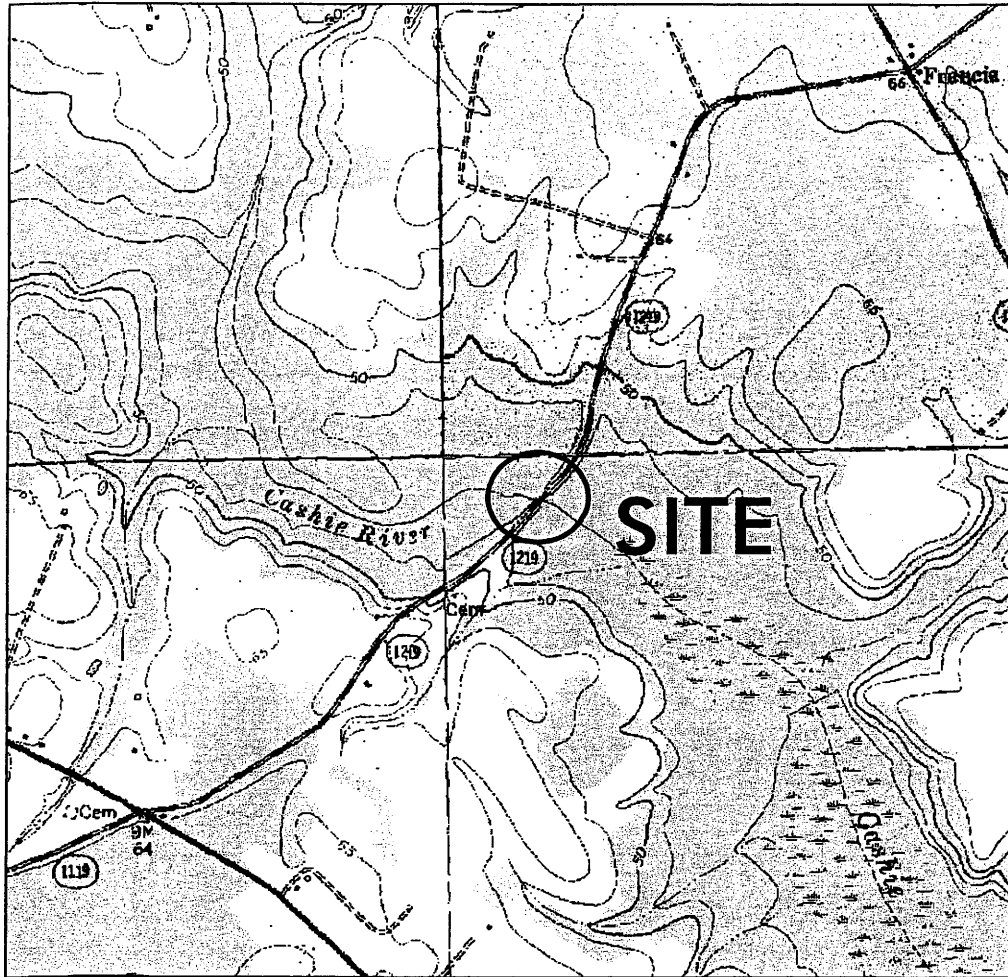

Kelford	Aulander
Woodville	* Republican

Quad Map Layout
*Site

DATUM DESCRIPTION
 THE LOCALIZED COORDINATE SYSTEM DEVELOPED FOR THIS PROJECT
 IS BASED ON THE STATE PLANE COORDINATES ESTABLISHED BY
 NCDOT FOR MONUMENT "B4027-1"
 WITH NAD 1983/95 STATE PLANE GRID COORDINATES OF
 NORTHING: 8685387651(1) EASTING: 2554185997(1)
 VERTICAL DATUM USED IS NAVD 88



SITE MAP

NCDOT
 DIVISION OF HIGHWAYS
 BERTIE COUNTY
 PROJECT: 33394.1.1 (B-4027)
 BRIDGE REPLACEMENT
 BRIDGE #11 ON SR1219
 OVER CASHIE RIVER

PROPERTY OWNERS

NAMES AND ADDRESSES

PARCEL NO.	NAME	ADDRESS
①	Katherine O. Jernigan	414 N. Curtis Street Ahoskie NC 27910
②	James C. Doughtie, Jr	329 Francis Mill Road Aulander NC 27805
③	Plum Creek Timberlands, L.P.	987 Griswoldville Road Macon GA

NCDOT

DIVISION OF HIGHWAYS

BERTIE COUNTY

PROJECT: 33394.1.1 (B-4027)

BRIDGE REPLACEMENT

BRIDGE #11 ON SR1219

OVER CASHIE RIVER

09/08/99

TIP PROJECT: B-4027

CONTRACT: C201441

See Sheet 1-A For Index of Sheets
See Sheet 1-B For Symbology Sheet

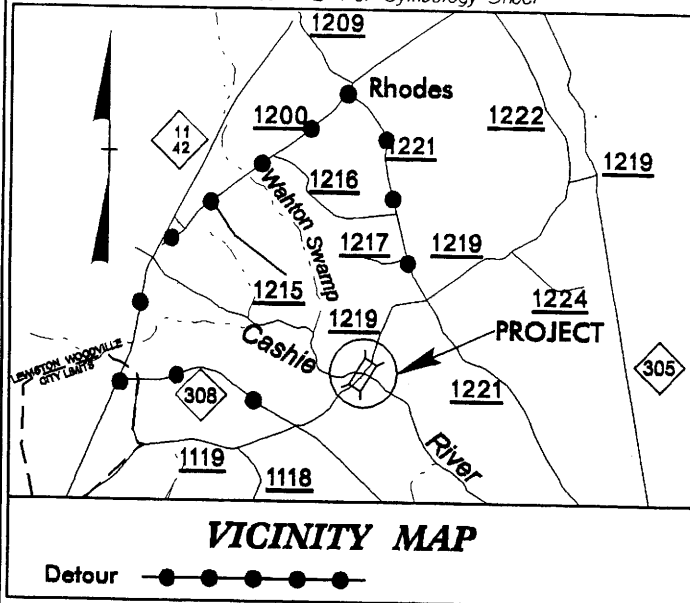

STATE OF NORTH CAROLINA
DIVISION OF HIGHWAYS

BERTIE COUNTY

LOCATION: BRIDGE NO. 11 OVER CASHIE RIVER ON
SR 1219

TYPE OF WORK: GRADING, DRAINAGE, PAVING AND STRUCTURE

STATE	STATE PROJECT REFERENCE NO.	SHEET NO.	TOTAL SHEETS
N.C.	B-4027	1	
STATE PROJ. NO.	F.A. PROJ. NO.	DESCRIPTION	
33394.1.1	BRZ-1219(1)	PE	
33394.2.1	BRZ-1219(1)	RAW, UTILI	
33394.3.1	BRZ-1219(1)	CONST.	

ROADWAY PLANS

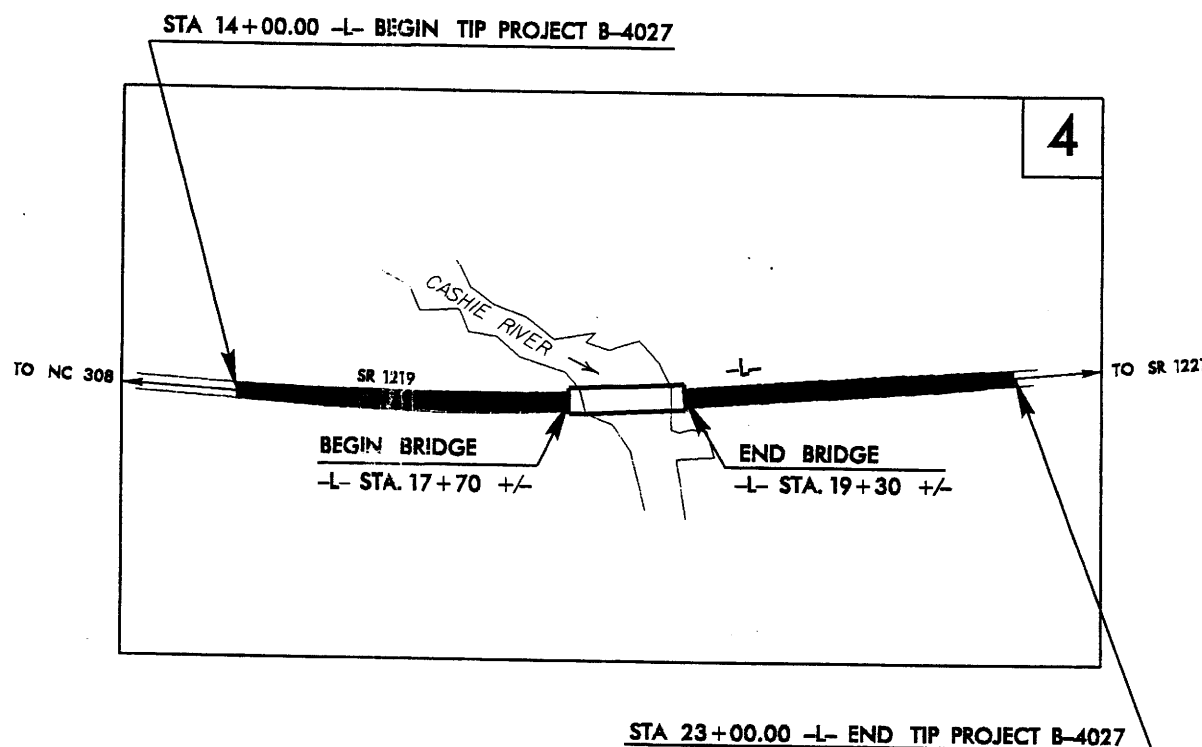

THIS PROJECT IS NOT WITHIN ANY MUNICIPAL BOUNDARIES.
CLEARING ON THIS PROJECT SHALL BE PERFORMED TO THE LIMITS ESTABLISHED BY METHOD II.

PRELIMINARY PLANS
DO NOT USE FOR CONSTRUCTION

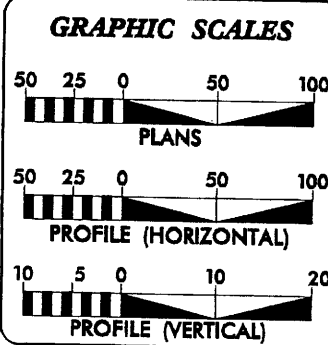

DESIGN DATA

ADT 2006 = 687
ADT 2026 = 1122
DHV = 10 %
D = 60 %
T = 3 % *
V = 60 MPH
* TTST 1% DUAL 2%
FUNC CLASS = Rural Local

PROJECT LENGTH

LENGTH ROADWAY TIP PROJECT B-4027	=	0.140
LENGTH STRUCTURE TIP PROJECT B-4027	=	0.030
TOTAL LENGTH TIP PROJECT B-4027	=	0.170

Prepared In the Office of:
DIVISION OF HIGHWAYS
1000 Birch Ridge Dr., Raleigh NC, 27610

2002 STANDARD SPECIFICATIONS

RIGHT OF WAY DATE:
FEBRUARY 24, 2005

LETTING DATE:
FEBRUARY 21, 2006

BRENDA MOORE, PE
PROJECT ENGINEER

REKHA PATEL, PE
PROJECT DESIGN ENGINEER

HYDRAULICS ENGINEER

ROADWAY DESIGN ENGINEER

SIGNATURE: _____ P.E.

SIGNATURE: _____ P.E.

DIVISION OF HIGHWAYS
STATE OF NORTH CAROLINA

STATE DESIGN ENGINEER

DEPARTMENT OF TRANSPORTATION
FEDERAL HIGHWAY ADMINISTRATION

APPROVED

DIVISION ADMINISTRATOR

DATE

25-MAY-2005 11:34 AM
C:\WORK\B-4027.rdy.tsh.dgn
USER:RAME

Note: Not to Scale

*S.U.E. = Subsurface Utility Engineering

STATE OF NORTH CAROLINA
DIVISION OF HIGHWAYS

CONVENTIONAL PLAN SHEET SYMBOLS

BOUNDARIES AND PROPERTY:

State Line	-----
County Line	-----
Township Line	-----
City Line	-----
Reservation Line	-----
Property Line	-----
Existing Iron Pin	○
Property Corner	-----
Property Monument	□
Parcel/Sequence Number	②③
Existing Fence Line	-----
Proposed Woven Wire Fence	-----
Proposed Chain Link Fence	-----
Proposed Barbed Wire Fence	-----
Existing Wetland Boundary	-----
Proposed Wetland Boundary	-----
Existing High Quality Wetland Boundary	-----
Existing Endangered Animal Boundary	-----
Existing Endangered Plant Boundary	-----

BUILDINGS AND OTHER CULTURE:

Gas Pump Vent or UG Tank Cap	○
Sign	○
Well	○
Small Mine	⊗
Foundation	□
Area Outline	□
Cemetery	⊕
Building	□
School	□
Church	□
Dam	-----

HYDROLOGY:

Stream or Body of Water	-----
Hydro, Pool or Reservoir	-----
River Basin Buffer	-----
Flow Arrow	-----
Disappearing Stream	-----
Spring	-----
Swamp Marsh	-----
Proposed Lateral, Tail, Head Ditch	-----
False Sump	-----

RAILROADS:

Standard Gauge	-----
RR Signal Milepost	○
Switch	□
RR Abandoned	-----
RR Dismantled	-----

RIGHT OF WAY:

Baseline Control Point	◆
Existing Right of Way Marker	△
Existing Right of Way Line	-----
Proposed Right of Way Line	-----
Proposed Right of Way Line with Iron Pin and Cap Marker	-----
Proposed Right of Way Line with Concrete or Granite Marker	-----
Existing Control of Access	-----
Proposed Control of Access	-----
Existing Easement Line	-----
Proposed Temporary Construction Easement	-----
Proposed Temporary Drainage Easement	-----
Proposed Permanent Drainage Easement	-----
Proposed Permanent Utility Easement	-----

ROADS AND RELATED FEATURES:

Existing Edge of Pavement	-----
Existing Curb	-----
Proposed Slope Stakes Cut	-----
Proposed Slope Stakes Fill	-----
Proposed Wheel Chair Ramp	-----
Curb Cut for Future Wheel Chair Ramp	-----
Existing Metal Guardrail	-----
Proposed Guardrail	-----
Existing Cable Guiderail	-----
Proposed Cable Guiderail	-----
Equallity Symbol	-----
Pavement Removal	-----

VEGETATION:

Single Tree	○
Single Shrub	○
Hedge	-----
Woods Line	-----
Orchard	-----
Vineyard	-----

EXISTING STRUCTURES:

MAJOR:	
Bridge, Tunnel or Box Culvert	-----
Bridge Wing Wall, Head Wall and End Wall	-----
MINOR:	
Head and End Wall	-----
Pipe Culvert	-----
Footbridge	-----
Drainage Box: Catch Basin, DI or JB	-----
Paved Ditch Gutter	-----
Storm Sewer Manhole	-----
Storm Sewer	-----

UTILITIES:

POWER:	
Existing Power Pole	-----
Proposed Power Pole	-----
Existing Joint Use Pole	-----
Proposed Joint Use Pole	-----
Power Manhole	-----
Power Line Tower	-----
Power Transformer	-----
UG Power Cable Hand Hole	-----
H-Frame Pole	-----
Recorded UG Power Line	-----
Designated UG Power Line (S.U.E.*)	-----

TELEPHONE:

Existing Telephone Pole	-----
Proposed Telephone Pole	-----
Telephone Manhole	-----
Telephone Booth	-----
Telephone Pedestal	-----
Telephone Cell Tower	-----
UG Telephone Cable Hand Hole	-----
Recorded UG Telephone Cable	-----
Designated UG Telephone Cable (S.U.E.*)	-----
Recorded UG Telephone Conduit	-----
Designated UG Telephone Conduit (S.U.E.*)	-----
Recorded UG Fiber Optics Cable	-----
Designated UG Fiber Optics Cable (S.U.E.*)	-----

WATER:

Water Manhole	-----
Water Meter	-----
Water Valve	-----
Water Hydrant	-----
Recorded UG Water Line	-----
Designated UG Water Line (S.U.E.*)	-----
Above Ground Water Line	-----

TV:

TV Satellite Dish	-----
TV Pedestal	-----
TV Tower	-----
UG TV Cable Hand Hole	-----
Recorded UG TV Cable	-----
Designated UG TV Cable (S.U.E.*)	-----
Recorded UG Fiber Optic Cable	-----
Designated UG Fiber Optic Cable (S.U.E.*)	-----

GAS:

Gas Valve	-----
Gas Meter	-----
Recorded UG Gas Line	-----
Designated UG Gas Line (S.U.E.*)	-----
Above Ground Gas Line	-----

SANITARY SEWER:

Sanitary Sewer Manhole	-----
Sanitary Sewer Cleanout	-----
UG Sanitary Sewer Line	-----
Above Ground Sanitary Sewer	-----
Recorded SS Forced Main Line	-----
Designated SS Forced Main Line (S.U.E.*)	-----

MISCELLANEOUS:

Utility Pole	-----
Utility Pole with Base	-----
Utility Located Object	-----
Utility Traffic Signal Box	-----
Utility Unknown UG Line	-----
UG Tank; Water, Gas, Oil	-----
AG Tank; Water, Gas, Oil	-----
UG Test Hole (S.U.E.*)	-----
Abandoned According to Utility Records	-----
End of Information	-----

PROJECT REFERENCE NO. B-4027	SHEET NO. 4
HW SHEET NO.	
ROADWAY DESIGN ENGINEER	HYDRAULICS ENGINEER
PRELIMINARY PLANS DO NOT USE FOR CONSTRUCTION	

FOR -L- PROFILE SEE SHEET 5



DB 89E PG 12
DB 624 PG 352
DB 637 PG 467
DB 624 PG 354 (PLAT)

DB 697 PG 873
DB 649 PG 40 (PLAT)

DB 788 PG 23
DB 692 PG 117
PC-A PG 983

STA 14+00.00 -L- BEGIN STATE PROJECT B-4027

STA 23+00.00 -L- END STATE PROJECT B-4027

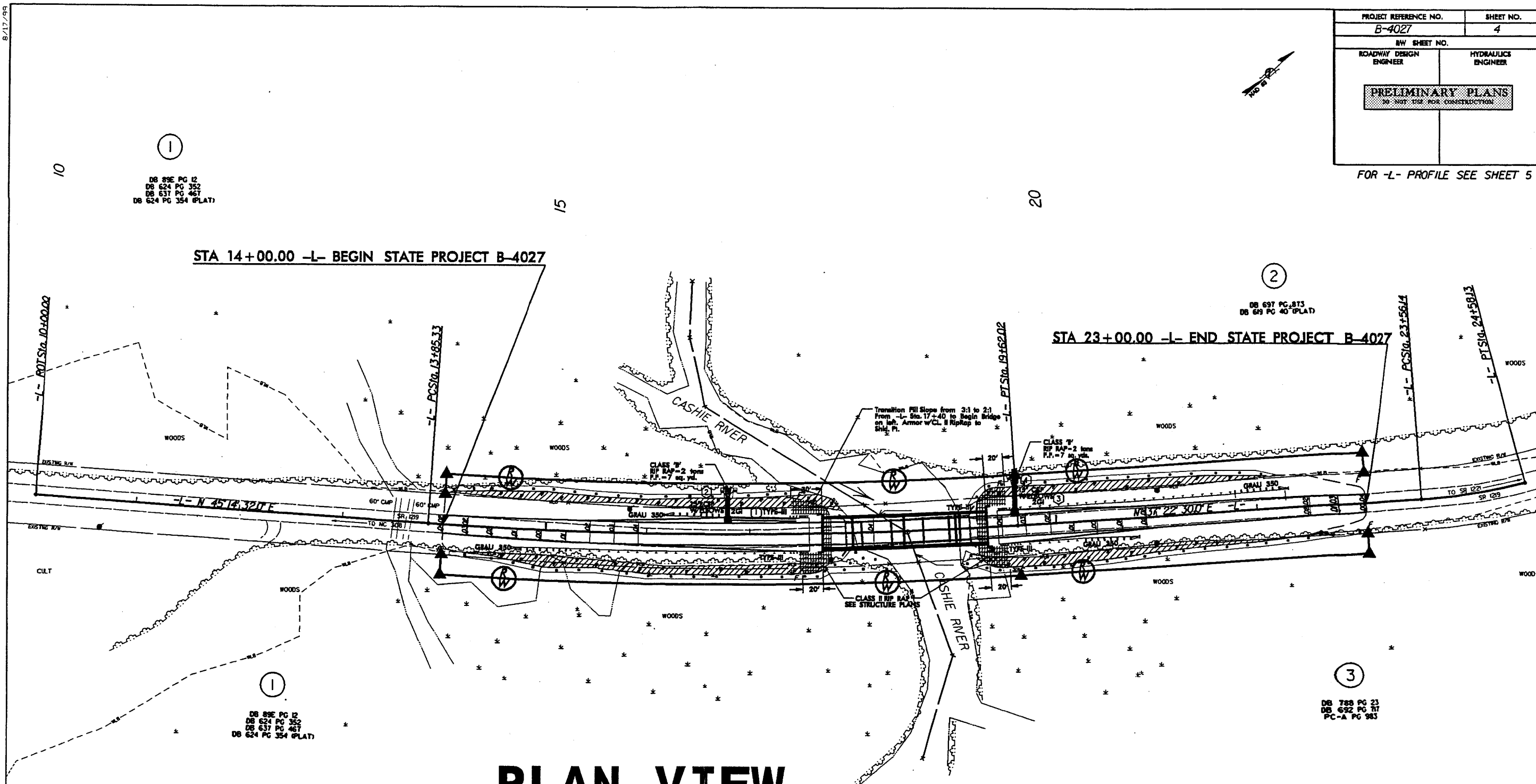

PLAN VIEW

DB 89E PG 12
DB 624 PG 352
DB 637 PG 467
DB 624 PG 354 (PLAT)

-L-
PI Sta 16+74.13
 $\Delta = 7' 52'' 02.0'' (LT)$
 $D = 1' 21'' 51''$
 $L = 576.70'$
 $T = 288.80'$
 $R = 4200.00'$
 $SE = .04$
RUNOFF = SEE PLANS

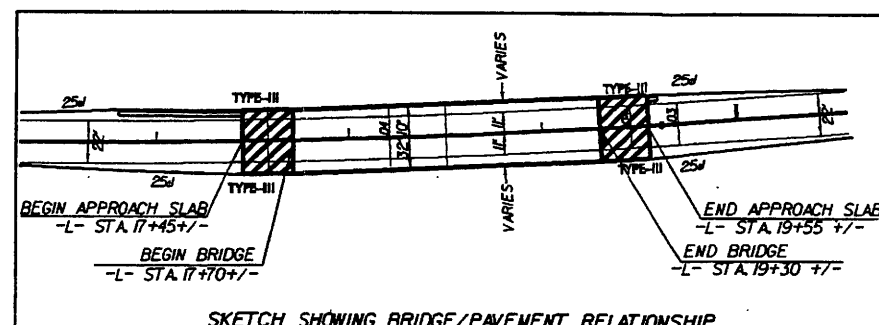

SKETCH SHOWING BRIDGE/PAVEMENT RELATIONSHIP

- DENOTES FILL IN WETLANDS
- DENOTES HAND CLEARING IN WETLANDS

SHEET 5 OF 10 9/12/05

BRIDGE APPROACH SLAB

12-SEP-2005 11:16
r:\hydr\autlog_b-0927_hyd-pmt-psn04.dgn
smcgon

PROJECT REFERENCE NO. B-4027	SHEET NO. 4
HW SHEET NO.	
ROADWAY DESIGN ENGINEER	HYDRAULICS ENGINEER
PRELIMINARY PLANS <small>NO. NOT FOR CONSTRUCTION</small>	

FOR -L- PROFILE SEE SHEET 5

DB 89E PG 12
DB 624 PG 352
DB 637 PG 467
DB 624 PG 354 (PLAT)

DB 697 PG 873
DB 619 PG 40 (PLAT)

DB 788 PG 23
DB 692 PG 717
PC-A PG 983

STA 14+00.00 -L- BEGIN STATE PROJECT B-4027

STA 23+00.00 -L- END STATE PROJECT B-4027

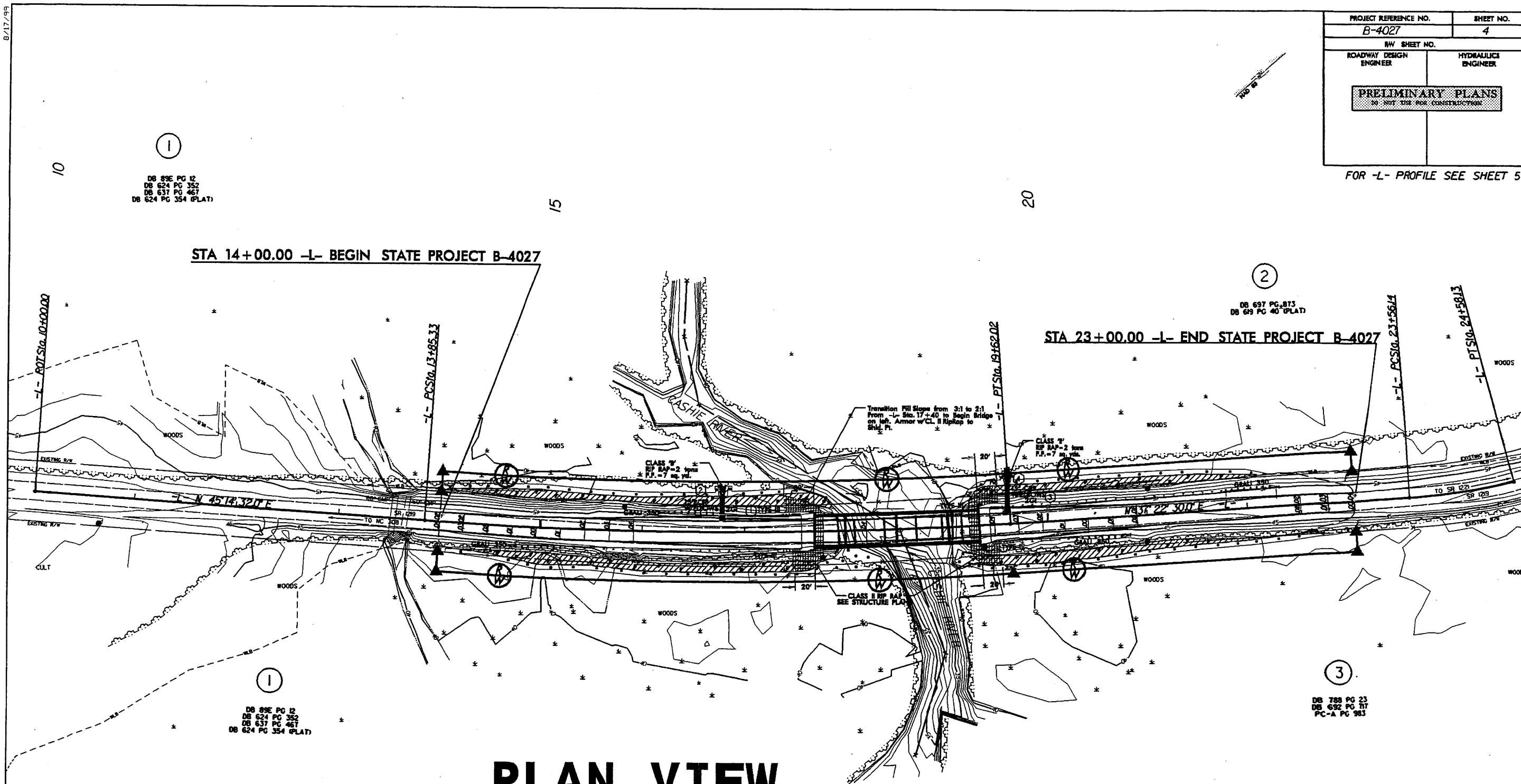

PLAN VIEW

DB 89E PG 12
DB 624 PG 352
DB 637 PG 467
DB 624 PG 354 (PLAT)

-L-
PI Sta 16+74.13
 $\Delta = 7^{\circ} 52' 02''$ (LT)
D = 121.51'
L = 576.70'
T = 288.80'
R = 4200.00'
SE = 104
RUNOFF = SEE PLANS

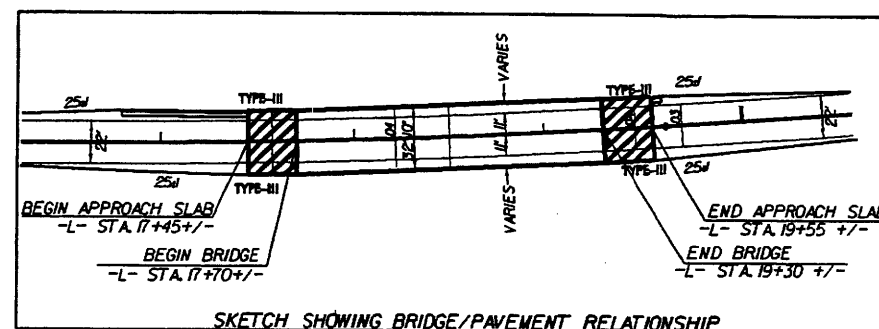

- DENOTES FILL IN WETLANDS
- DENOTES HAND CLEARING IN WETLANDS

SHEET 6 OF 10 9/12/05

BRIDGE APPROACH SLAB

12-SEP-2005 10:46
r:\hydrolite\B4027\hyd-pmt-psn04.dgn
magnon

N 868618 E 2554182
 STATION 10+00
 S 57° 06' 14.3" W DIST 137.40
 R/R SPIKE IN BASE OF 16" GUM

BM7 ELEVATION = 44.31
 N 869866 E 2555206
 STATION 24+58
 N 29° 14' 13.7" W Dist 133.69
 R/R SPIKE IN BASE OF 16" OAK

PROJECT REFERENCE NO. B-4027 SHEET NO. 5

ROADWAY DESIGN ENGINEER HYDRAULICS ENGINEER

PRELIMINARY PLANS
 DO NOT USE FOR CONSTRUCTION

STRUCTURE HYDRAULIC DATA

DESIGN DISCHARGE	= 2400 CFS
DESIGN FREQUENCY	= 25 YRS
DESIGN HW ELEVATION	= 45.0 FT
BASE DISCHARGE	= 3600 CFS
BASE FREQUENCY	= 100 YRS
BASE HW ELEVATION	= 46.6 FT
OVERTOPPING DISCHARGE	= 5300 CFS
OVERTOPPING FREQUENCY	= 500 YRS
OVERTOPPING ELEVATION	= 47.7 FT

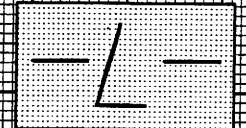

PROFILE VIEW

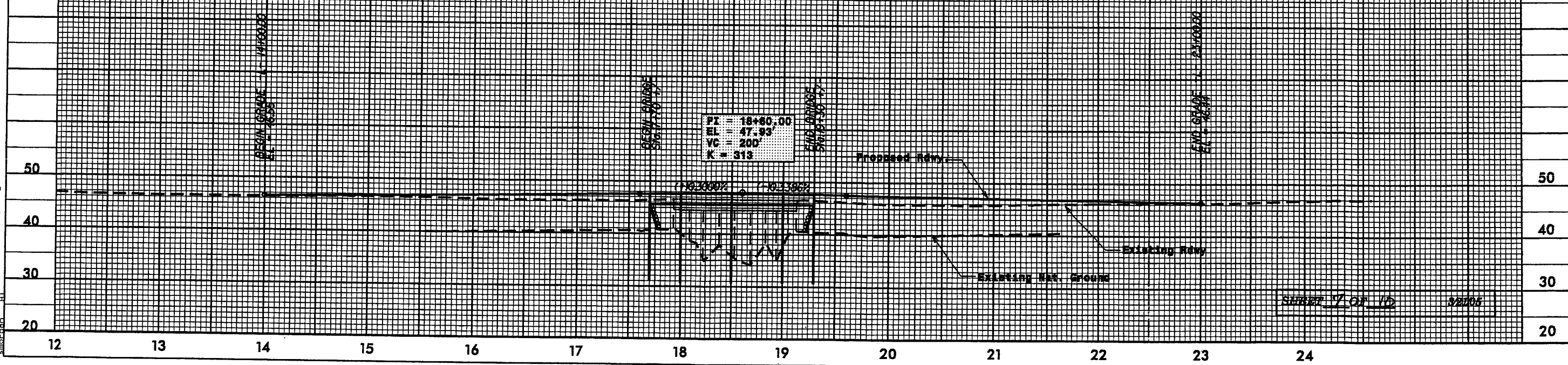

22-APR-2006 08:28
 F:\hyd\ed\lcs\8-2827_hyd_pmt_pf1.dgn
 amonon

8/23/99
12-SEP-2005 11:24
r:\hydro\lic\B4027\Fig-L-xpl-permit.dgn
smorgan AT HY221528

CROSS SECTION VIEW

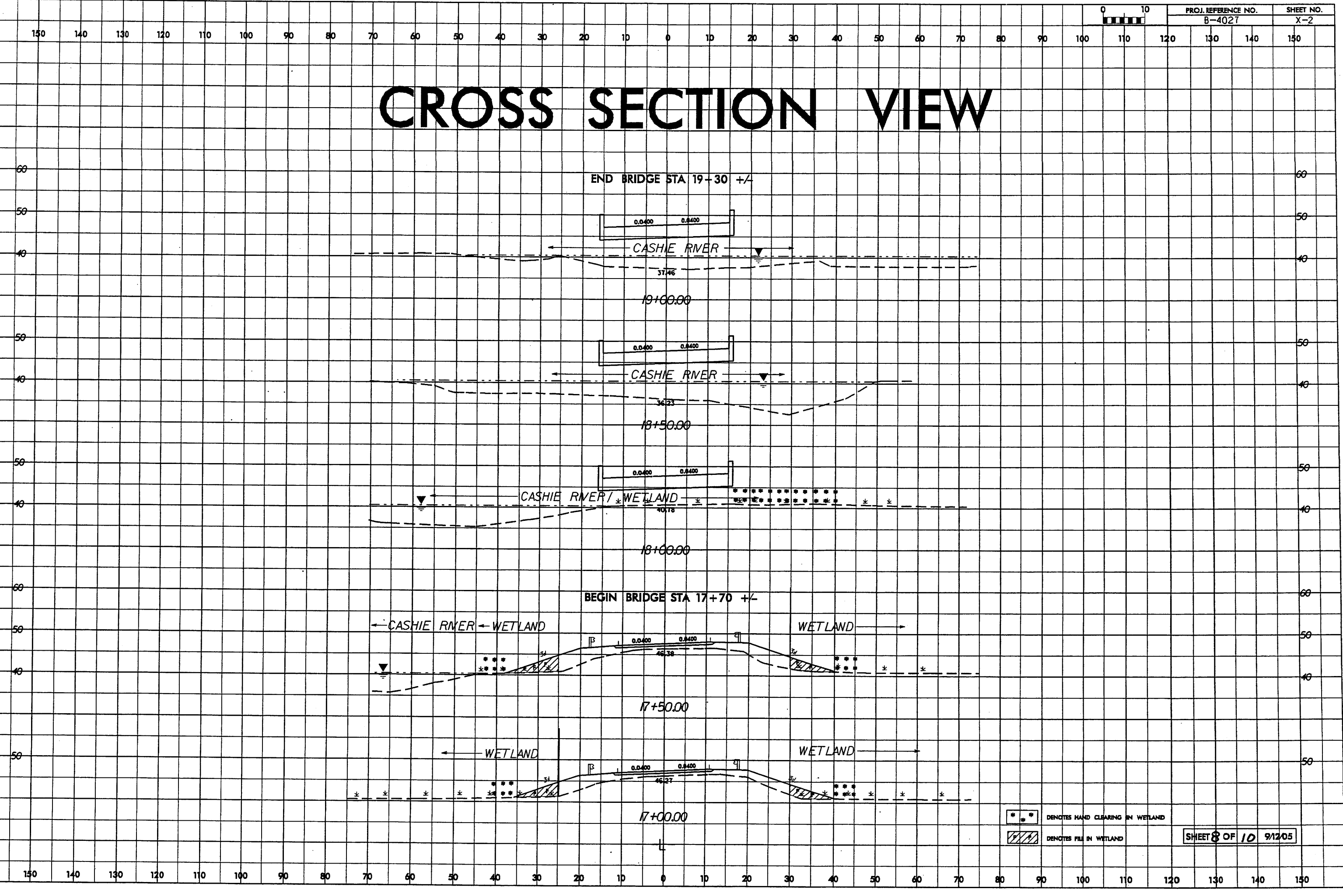

* * * DENOTES HAND CLEARING IN WETLAND
[Hatched Box] DENOTES FILL IN WETLAND

Note: Not to Scale

*S.U.E. = Subsurface Utility Engineering

STATE OF NORTH CAROLINA
DIVISION OF HIGHWAYS

CONVENTIONAL PLAN SHEET SYMBOLS

BOUNDARIES AND PROPERTY:

State Line	-----
County Line	-----
Township Line	-----
City Line	-----
Reservation Line	-----
Property Line	-----
Existing Iron Pin	○
Property Corner	-----
Property Monument	□
Parcel/Sequence Number	①23
Existing Fence Line	-----
Proposed Woven Wire Fence	-----
Proposed Chain Link Fence	-----
Proposed Barbed Wire Fence	-----
Existing Wetland Boundary	-----
Proposed Wetland Boundary	-----
Existing High Quality Wetland Boundary	-----
Existing Endangered Animal Boundary	-----
Existing Endangered Plant Boundary	-----

BUILDINGS AND OTHER CULTURE:

Gas Pump Vent or UG Tank Cap	○
Sign	○
Well	○
Small Mine	⊗
Foundation	□
Area Outline	□
Cemetery	↑
Building	□
School	□
Church	□
Dam	-----

HYDROLOGY:

Stream or Body of Water	-----
Hydro, Pool or Reservoir	□
River Basin Buffer	-----
Flow Arrow	-----
Disappearing Stream	-----
Spring	○
Swamp Marsh	-----
Proposed Lateral, Tail, Head Ditch	-----
False Sump	-----

RAILROADS:

Standard Gauge	-----
RR Signal Milepost	○
Switch	□
RR Abandoned	-----
RR Dismantled	-----

RIGHT OF WAY:

Baseline Control Point	◆
Existing Right of Way Marker	△
Existing Right of Way Line	-----
Proposed Right of Way Line	-----
Proposed Right of Way Line with Iron Pin and Cap Marker	-----
Proposed Right of Way Line with Concrete or Granite Marker	-----
Existing Control of Access	○
Proposed Control of Access	○
Existing Easement Line	-----
Proposed Temporary Construction Easement	-----
Proposed Temporary Drainage Easement	-----
Proposed Permanent Drainage Easement	-----
Proposed Permanent Utility Easement	-----

ROADS AND RELATED FEATURES:

Existing Edge of Pavement	-----
Existing Curb	-----
Proposed Slope Stakes Cut	C
Proposed Slope Stakes Fill	F
Proposed Wheel Chair Ramp	WCR
Curb Cut for Future Wheel Chair Ramp	CCR
Existing Metal Guardrail	-----
Proposed Guardrail	-----
Existing Cable Guiderail	-----
Proposed Cable Guiderail	-----
Equality Symbol	⊕
Pavement Removal	-----

VEGETATION:

Single Tree	⊕
Single Shrub	⊙
Hedge	-----
Woods Line	-----
Orchard	-----
Vineyard	-----

EXISTING STRUCTURES:

MAJOR:	
Bridge, Tunnel or Box Culvert	-----
Bridge Wing Wall, Head Wall and End Wall	-----
MINOR:	
Head and End Wall	-----
Pipe Culvert	-----
Footbridge	-----
Drainage Box: Catch Basin, DI or JB	□
Paved Ditch Gutter	-----
Storm Sewer Manhole	○
Storm Sewer	-----

UTILITIES:

POWER:	
Existing Power Pole	○
Proposed Power Pole	○
Existing Joint Use Pole	○
Proposed Joint Use Pole	○
Power Manhole	○
Power Line Tower	⊗
Power Transformer	⊗
UG Power Cable Hand Hole	□
H-Frame Pole	-----
Recorded UG Power Line	-----
Designated UG Power Line (S.U.E.*)	-----

TELEPHONE:

Existing Telephone Pole	○
Proposed Telephone Pole	○
Telephone Manhole	○
Telephone Booth	□
Telephone Pedestal	□
Telephone Cell Tower	⊕
UG Telephone Cable Hand Hole	□
Recorded UG Telephone Cable	-----
Designated UG Telephone Cable (S.U.E.*)	-----
Recorded UG Telephone Conduit	-----
Designated UG Telephone Conduit (S.U.E.*)	-----
Recorded UG Fiber Optics Cable	-----
Designated UG Fiber Optics Cable (S.U.E.*)	-----

WATER:

Water Manhole	○
Water Meter	○
Water Valve	⊗
Water Hydrant	⊕
Recorded UG Water Line	-----
Designated UG Water Line (S.U.E.*)	-----
Above Ground Water Line	-----

TV:

TV Satellite Dish	⊕
TV Pedestal	□
TV Tower	⊗
UG TV Cable Hand Hole	□
Recorded UG TV Cable	-----
Designated UG TV Cable (S.U.E.*)	-----
Recorded UG Fiber Optic Cable	-----
Designated UG Fiber Optic Cable (S.U.E.*)	-----

GAS:

Gas Valve	⊕
Gas Meter	⊕
Recorded UG Gas Line	-----
Designated UG Gas Line (S.U.E.*)	-----
Above Ground Gas Line	-----

SANITARY SEWER:

Sanitary Sewer Manhole	⊕
Sanitary Sewer Cleanout	⊕
UG Sanitary Sewer Line	-----
Above Ground Sanitary Sewer	-----
Recorded SS Forced Main Line	-----
Designated SS Forced Main Line (S.U.E.*)	-----

MISCELLANEOUS:

Utility Pole	○
Utility Pole with Base	□
Utility Located Object	○
Utility Traffic Signal Box	□
Utility Unknown UG Line	-----
UG Tank; Water, Gas, Oil	□
AG Tank; Water, Gas, Oil	□
UG Test Hole (S.U.E.*)	⊕
Abandoned According to Utility Records	AATUR
End of Information	E.O.I.

SURVEY CONTROL SHEET B-4027

CONTROL DATA

BL	POINT	DESC.	NORTH	EAST	ELEVATION	L STATION	OFFSET
BL1	GPS B4027-1		868538.7650	2554185.9970	48.60	OUTSIDE PROJECT LIMITS	
BL3	BL-3		869255.1770	2554821.9690	45.28	17+70.27	12.30 LT
BL2	GPS B4027-2		869733.0080	2555221.9200	46.07	23+92.61	12.35 RT

BENCHMARK DATA

.....
 BM6 ELEVATION - 47.51
 N 868618 E 2554182
 L STATION 10+00
 S 57° 06' 14.3" W DIST 137.40
 R/R SPIKE IN BASE OF 16" GUM

 BM7 ELEVATION - 44.31
 N 869866 E 2555206
 L STATION 24+58
 N 29° 14' 13.7" W DIST 79.38
 R/R SPIKE IN BASE OF 16" OAK

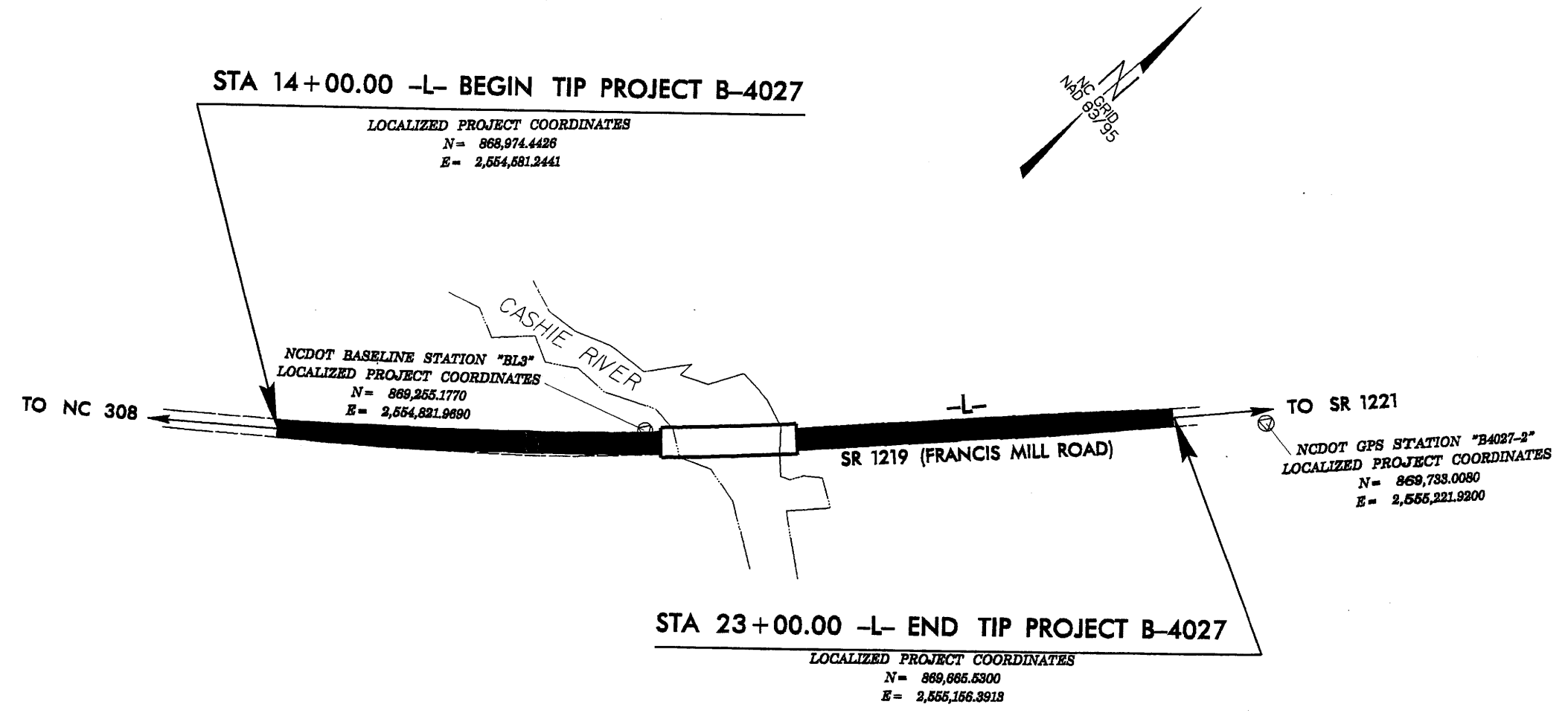

DATUM DESCRIPTION

THE LOCALIZED COORDINATE SYSTEM DEVELOPED FOR THIS PROJECT IS BASED ON THE STATE PLANE COORDINATES ESTABLISHED BY NCDOT FOR MONUMENT "B4027-1" WITH NAD 1983/95 STATE PLANE GRID COORDINATES OF NORTHING: 868538.765(F1) EASTING: 2554185.997(F1) THE AVERAGE COMBINED GRID FACTOR USED ON THIS PROJECT (GROUND TO GRID) IS: 0.99999200 THE N.C. LAMBERT GRID BEARING AND LOCALIZED HORIZONTAL GROUND DISTANCE FROM "B4027-1" TO L- STATION 14+00.00 IS N 42° 12' 51.6" E 588.2476 ft ALL LINEAR DIMENSIONS ARE LOCALIZED HORIZONTAL DISTANCES VERTICAL DATUM USED IS NAVD 88

NOTES:

- THE CONTROL DATA FOR THIS PROJECT CAN BE FOUND ELECTRONICALLY BY SELECTING [HTTP://WWW.DOH.DOT.STATE.NC.US/PRECONSTRUCT/HIGHWAY/LOCATION/PROJECT](http://www.doh.dot.state.nc.us/preconstruct/highway/location/project)
- FILE: b4027_ls_control_040822.txt
- SITE CALIBRATION PARAMETERS HAVE NOT BEEN DETERMINED FOR THIS PROJECT. IF FURTHER INFORMATION IS NEEDED, PLEASE CONTACT THE LOCATION AND SURVEYS UNIT.
- ⊙ INDICATES GEODETIC CONTROL MONUMENTS USED OR SET FOR HORIZONTAL PROJECT CONTROL BY THE NCDOT LOCATION AND SURVEYS UNIT.
- PROJECT CONTROL ESTABLISHED UTILIZING GLOBAL POSITIONING SYSTEM.
- NETWORK FOR GPS "B4027-1" ESTABLISHED FROM NGS ONLINE POSITIONING USER SERVICE (OPUS)

NOTE: DRAWING NOT TO SCALE

6-2-99

FINAL PAVEMENT SCHEDULE	
C1	PROP. APPROX. 1 1/4" ASPHALT CONCRETE SURFACE COURSE, TYPE SF9.5A, AT AN AVERAGE RATE OF 137.5 LBS. PER SQ. YD.
C2	PROP. APPROX. 2 1/2" ASPHALT CONCRETE SURFACE COURSE, TYPE SF9.5A, AT AN AVERAGE RATE OF 137.5 LBS. PER SQ. YD. IN EACH OF TWO LAYERS.
C3	PROP. VAR. DEPTH ASPHALT CONCRETE SURFACE COURSE, TYPE SF9.5A, AT AN AVERAGE RATE OF 110 LBS. PER SQ. YD. PER 1" DEPTH. TO BE PLACED IN LAYERS NOT TO EXCEED 1 1/2" IN DEPTH.
E1	PROP. APPROX. 4" ASPHALT CONCRETE BASE COURSE, TYPE B25.0B, AT AN AVERAGE RATE OF 450 LBS. PER SQ. YD.
E2	PROP. VAR. DEPTH ASPHALT CONCRETE BASE COURSE, TYPE B25.0B, AT AN AVERAGE RATE OF 114 LBS. PER SQ. YD. PER 1" DEPTH. TO BE PLACED IN LAYERS NOT LESS THAN 3" IN DEPTH OR GREATER THAN 5 1/2" IN DEPTH.
R	SHOULDER BERM GUTTER.
T	EARTH MATERIAL.
U	EXISTING PAVEMENT.
W	VARIABLE DEPTH ASPHALT PAVEMENT (SEE STANDARD WEDGING DETAIL).

NOTE: PAVEMENT EDGE SLOPES ARE 1:1 UNLESS SHOWN OTHERWISE.

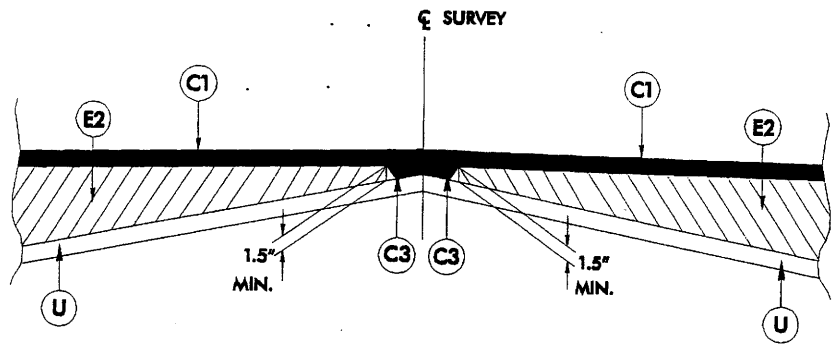

Wedging Detail

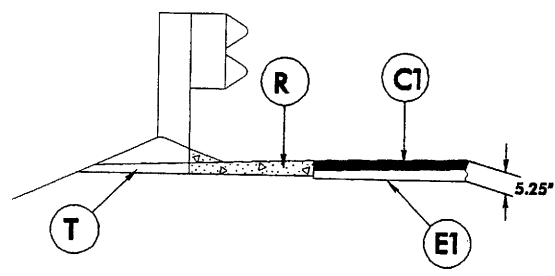

SHOULDER BERM GUTTER DETAIL

USE SHOULDER BERM GUTTER
 -L- STA. 16+80.00 TO -L- STA. 17+45.00 (LT.)
 -L- STA. 19+55.00 TO -L- STA. 19+60.67 (LT.)

PROJECT REFERENCE NO. B-4027	SHEET NO. 2
ROADWAY DESIGN ENGINEER	PAVEMENT DESIGN ENGINEER
PRELIMINARY PLANS <small>DO NOT USE FOR CONSTRUCTION</small>	

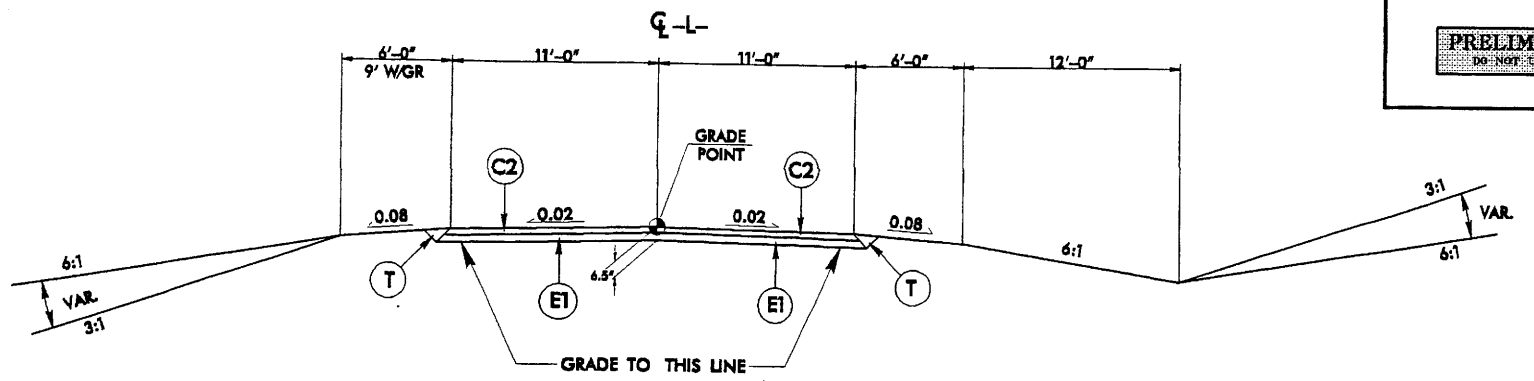

TYPICAL SECTION NO. 1

USE TYPICAL SECTION NO. 1
 -L- STA 16+50.00 TO 17+70 +/- (BEGIN BRIDGE)
 -L- STA 19+30 +/- (END BRIDGE) TO 21+00.00

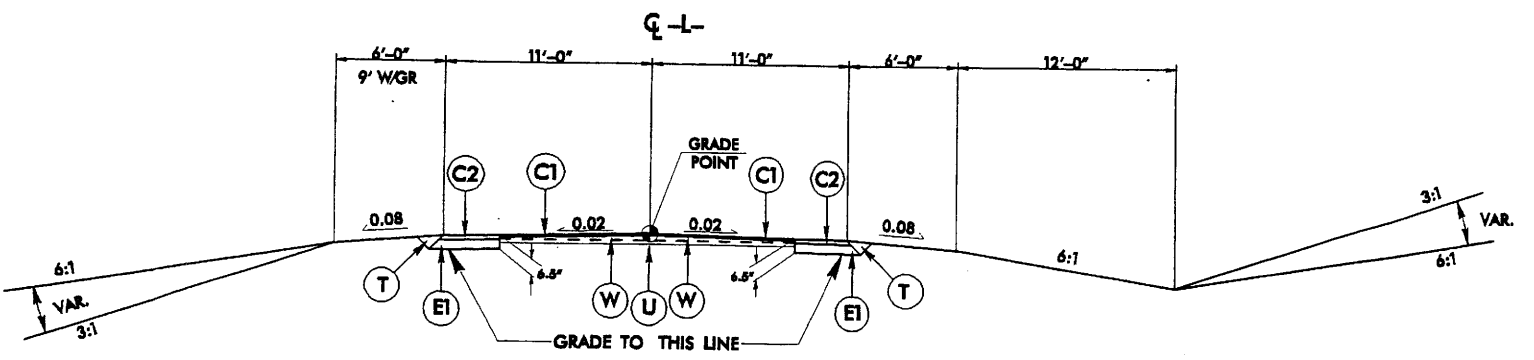

TYPICAL SECTION NO. 2

USE TYPICAL SECTION NO. 2
 -L- STA 14+00.00 TO 16+50.00
 -L- STA 21+00.00 TO 23+00.00

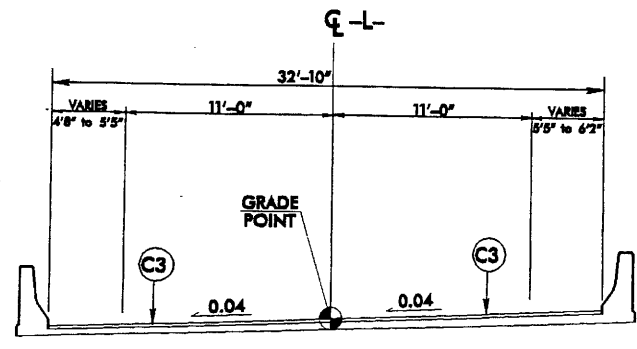

TYPICAL SECTION NO. 3

USE TYPICAL SECTION NO. 3
 -L- STA 17+70 +/- TO 19+30 +/-

25-MAY-2005 11:34
 C:\PROJ\B-4027\rdy_tsp.dgn

PROJECT REFERENCE NO. B-4027	SHEET NO. 4
R/W SHEET NO. ROADWAY DESIGN ENGINEER	HYDRAULICS ENGINEER
PRELIMINARY PLANS DO NOT USE FOR CONSTRUCTION	

FOR -L- PROFILE SEE SHEET 5

8/17/94

10

①
KATHERINE ODOM JERNIGAN
DB 89E PG 12
DB 624 PG 352
DB 631 PG 461
DB 624 PG 354 (PLAT)

15

20

STA 14+00.00 -L- BEGIN STATE PROJECT B-4027

②
JAMES C. DOUGHTIE, JR.
DB 69T PG 873
DB 619 PG 40 (PLAT)

STA 23+00.00 -L- END STATE PROJECT B-4027

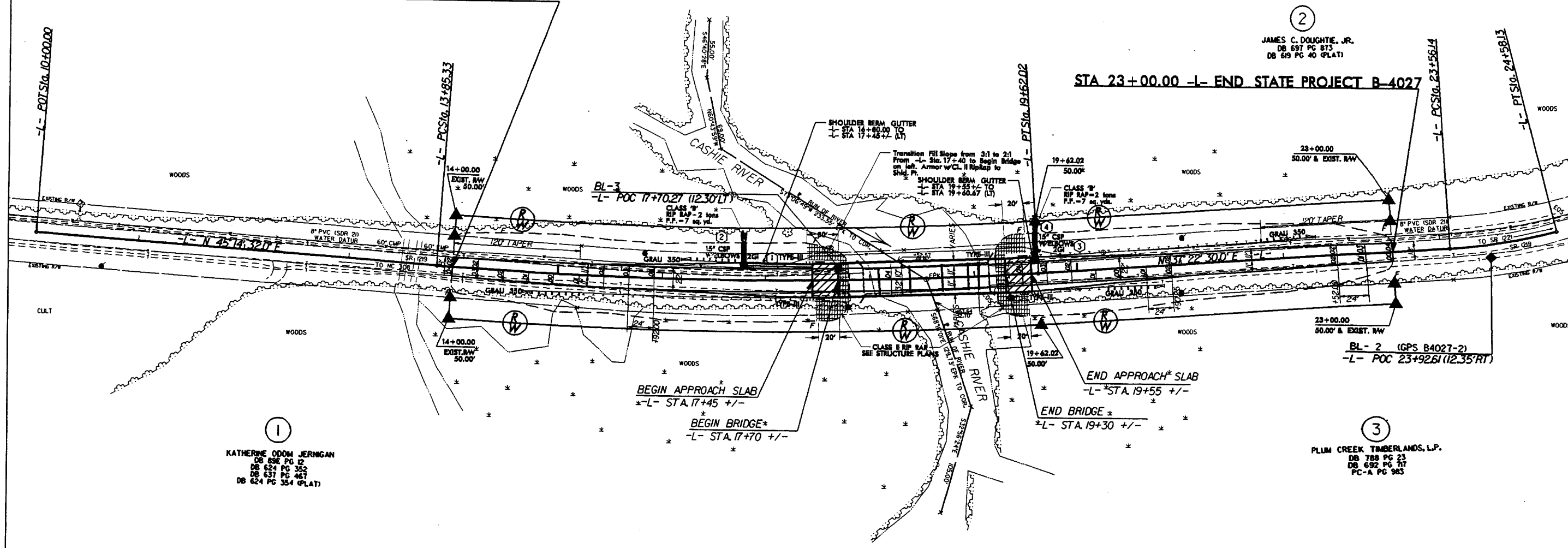

①
KATHERINE ODOM JERNIGAN
DB 89E PG 12
DB 624 PG 352
DB 631 PG 461
DB 624 PG 354 (PLAT)

③
PLUM CREEK TIMBERLANDS, L.P.
DB 788 PG 23
DB 692 PG 71
PC-A PG 983

-L-
PI Sta 16+74.13
Δ = 7' 52" 02.0' (LT)
D = 1' 21" 51.1'
L = 576.70'
T = 288.80'
R = 4,200.00'
SE = D4
RUNOFF = SEE PLANS

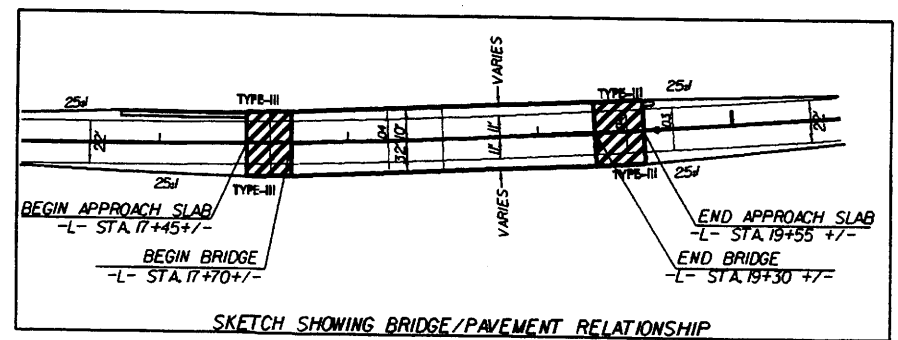

SKETCH SHOWING BRIDGE/PAVEMENT RELATIONSHIP

BRIDGE APPROACH SLAB

25-MAY-2005 11:34
C:\p04\B04027-rdy-pah04.dgn
KATHERINE ODOM JERNIGAN

5/14/99

BM6 ELEVATION = 47.51
N 868618 E 2554182
STATION 10+00
R/C 57' 06" 14.3' W DIST 137.40
R/R SPIKE IN BASE OF 16" GUM

BM7 ELEVATION = 44.31
N 869866 E 2555206
STATION 24+58
R/C 29' 14" 13.7' W DIST 133.69
R/R SPIKE IN BASE OF 16" OAK

PROJECT REFERENCE NO. SHEET NO.
B-4027 5

ROADWAY DESIGN ENGINEER HYDRAULICS ENGINEER

PRELIMINARY PLANS
DO NOT USE FOR CONSTRUCTION

STRUCTURE HYDRAULIC DATA

DESIGN DISCHARGE = 2400 CFS
DESIGN FREQUENCY = 25 YRS
DESIGN HW ELEVATION = 45.0 FT
BASE DISCHARGE = 3600 CFS
BASE FREQUENCY = 100 YRS
BASE HW ELEVATION = 46.6 FT
OVERTOPPING DISCHARGE = 5300 CFS
OVERTOPPING FREQUENCY = 500 YRS
OVERTOPPING ELEVATION = 47.7 FT

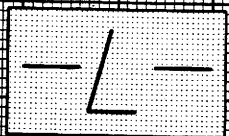

BEGIN GRADE 11+00.00

DESIGN BRIDGE 18+60.00

END BRIDGE 20+00.00

END GRADE 23+00.00

PI = 18+80.00
EL = 47.93'
VC = 200'
K = 313

+R0.3000% +R0.3500%



25-MAY-2005 11:34
R:\Roadway\Proj\B-4027_r.dwg.plt.dgn
\$\$\$\$USERNAME\$\$\$\$

12 13 14 15 16 17 18 19 20 21 22 23 24

50
40
30
20

50
40
30
20

B:23-79



PROJ. REFERENCE NO.	SHEET NO.
B-4027	X-1

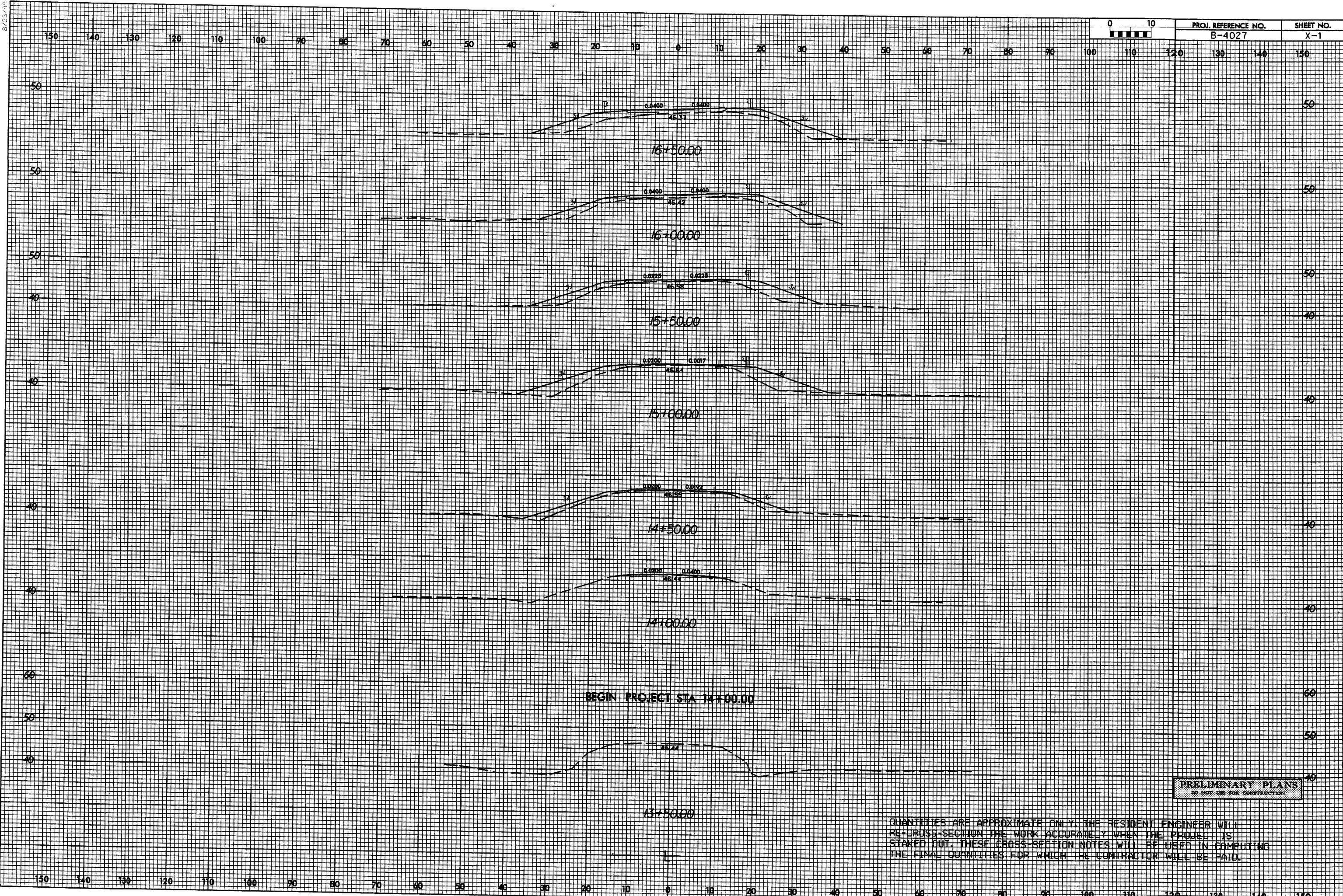

BEGIN PROJECT STA 14+00.00

PRELIMINARY PLANS
NOT TO BE USED FOR CONSTRUCTION

QUANTITIES ARE APPROXIMATE ONLY. THE RESIDENT ENGINEER WILL RE-CROSS-SECTION THE WORK ACCURATELY WHEN THE PROJECT IS STAKED OUT. THESE CROSS-SECTION NOTES WILL BE USED IN COMPUTING THE FINAL QUANTITIES FOR WHICH THE CONTRACTOR WILL BE PAID.

25-MAR-2005 10:34
F:\PROJECTS\B-4027.rdy.L_xpl.dgn

8/23/99

0	10	PROJ. REFERENCE NO.	SHEET NO.
[Scale bar: 0 to 10 units]		B-4027	X-2

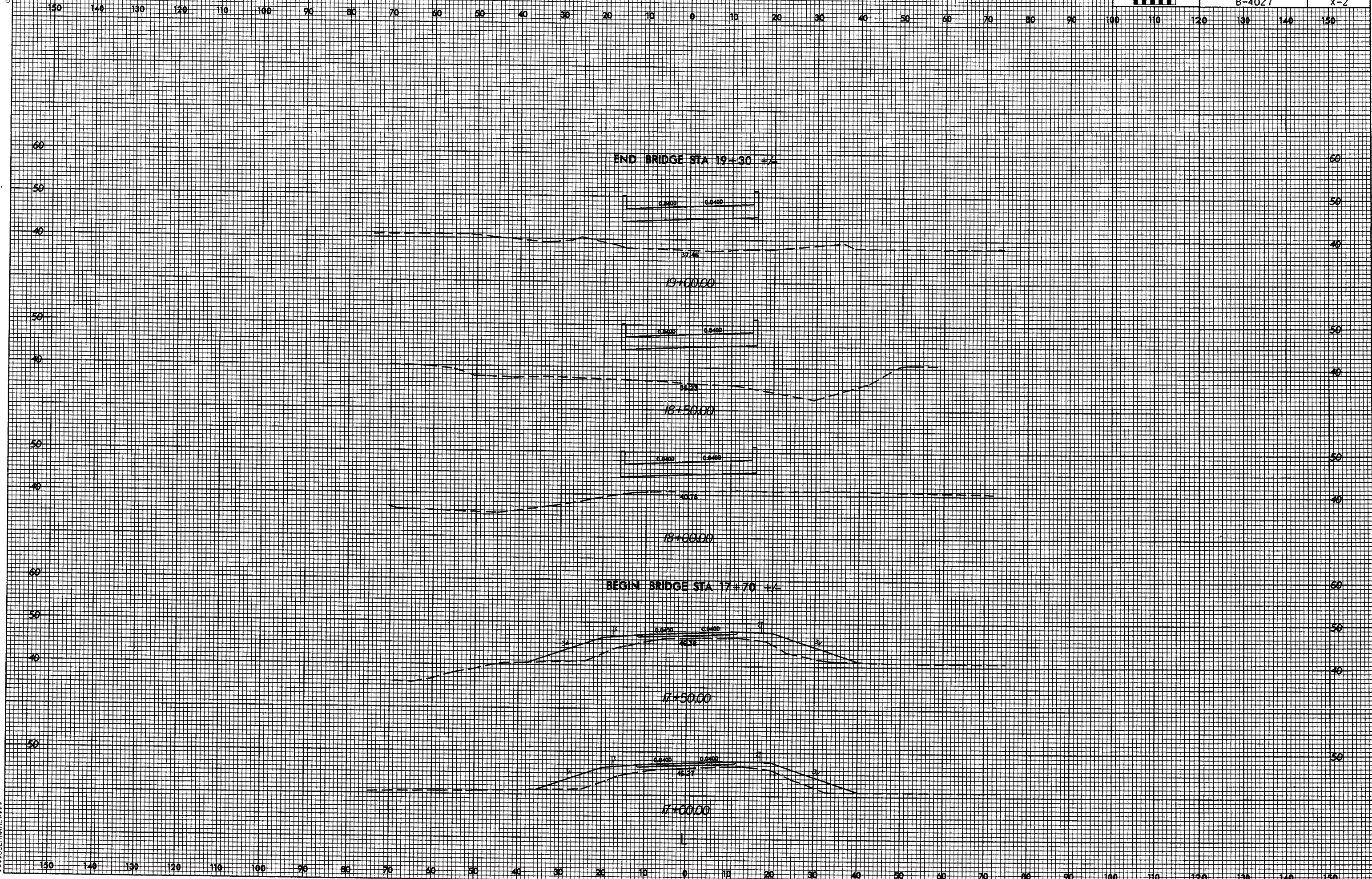

15-MAY-2005 11:31
C:\PERS\BRANES\B-4027_rdy.L.sp1.dgn

8/23/99

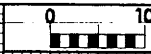

PROJ. REFERENCE NO.
B-4027

SHEET NO.
X-3

150 140 130 120 110 100 90 80 70 60 50 40 30 20 10 0 10 20 30 40 50 60 70 80 90 100 110 120 130 140 150

END PROJECT STA 23+00.00

50 50

23+00.00

22+50.00

22+00.00

21+50.00

21+00.00

20+50.00

20+00.00

19+50.00

50 50

40 40

50 50

40 40

50 50

40 40

150 140 130 120 110 100 90 80 70 60 50 40 30 20 10 0 10 20 30 40 50 60 70 80 90 100 110 120 130 140 150

25-MAY-2005 11:34
I:\PROJECTS\B4027\rdy.Lxp.l.dgn
I:\USER\RDY\B4027

8/23/99

150	140	130	120	110	100	90	80	70	60	50	40	30	20	10	0	10	20	30	40	50	60	70	80	90	100	110	120	130	140	150
-----	-----	-----	-----	-----	-----	----	----	----	----	----	----	----	----	----	---	----	----	----	----	----	----	----	----	----	-----	-----	-----	-----	-----	-----

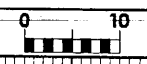

PROJ. REFERENCE NO.	SHEET NO.
B-4027	X-4



25-MAY-2006 11:34
 USERNAME
 C:\GOSERR\B4027.rdl.L.sp1.dgn

150	140	130	120	110	100	90	80	70	60	50	40	30	20	10	0	10	20	30	40	50	60	70	80	90	100	110	120	130	140	150
-----	-----	-----	-----	-----	-----	----	----	----	----	----	----	----	----	----	---	----	----	----	----	----	----	----	----	----	-----	-----	-----	-----	-----	-----

See Sheet 1-A For Index of Sheets
See Sheet 1-B For Symbology Sheet

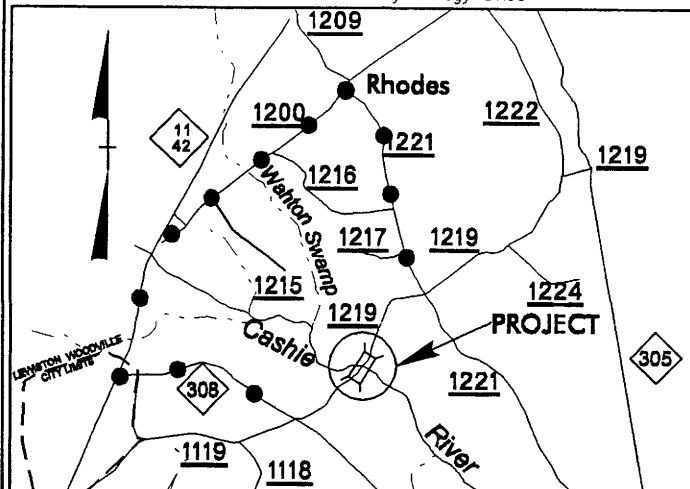

VICINITY MAP

Detour —●—●—●—●—●—

STATE OF NORTH CAROLINA
DIVISION OF HIGHWAYS

BERTIE COUNTY

LOCATION: BRIDGE NO. 11 OVER CASHIE RIVER ON SR 1219

TYPE OF WORK: GRADING, DRAINAGE, PAVING AND STRUCTURE

STATE	STATE PROJECT REFERENCE NO.	SHEET NO.	TOTAL SHEETS
N.C.	B-4027	1	
STATE PROJ. NO.	F.A. PROJ. NO.	DESCRIPTION	
33394.1.1	BRZ-1219(1)	PE	
33394.2.1	BRZ-1219(1)	RAW, UTILI	
33394.3.1	BRZ-1219(1)	CONST.	

UTILITY PLANS



TIP PROJECT: B-4027

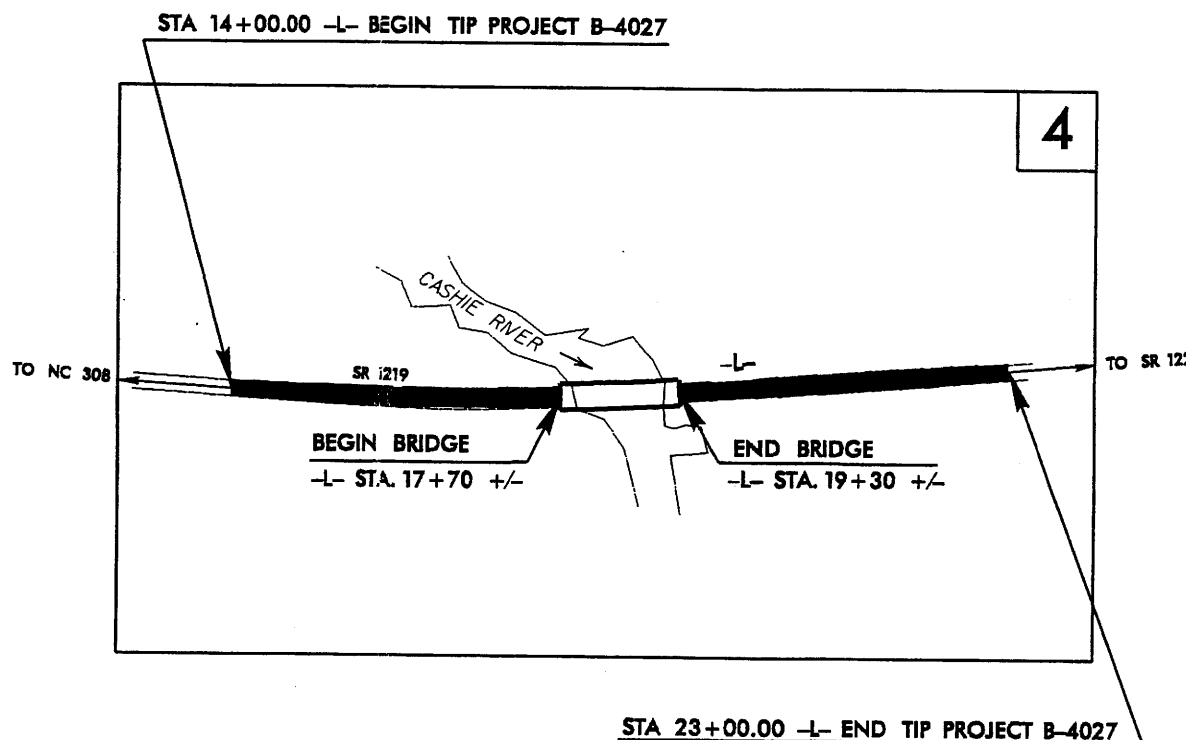

THIS PROJECT IS NOT WITHIN ANY MUNICIPAL BOUNDARIES.

CLEARING ON THIS PROJECT SHALL BE PERFORMED TO THE LIMITS ESTABLISHED BY METHOD II.

PRELIMINARY PLANS
DO NOT USE FOR CONSTRUCTION

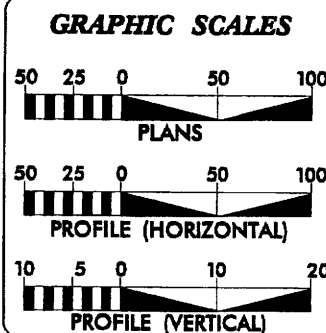

DESIGN DATA

ADT 2006 =	687
ADT 2026 =	1122
DHV =	10 %
D =	60 %
T =	3 % *
V =	60 MPH
* TTST 1% DUAL 2%	
FUNC CLASS =	Rural Local

PROJECT LENGTH

LENGTH ROADWAY TIP PROJECT B-4027	=	0.140
LENGTH STRUCTURE TIP PROJECT B-4027	=	0.030
TOTAL LENGTH TIP PROJECT B-4027	=	0.170

Prepared in the Office of:
DIVISION OF HIGHWAYS
1000 Birch Ridge Dr., Raleigh NC, 27610

2002 STANDARD SPECIFICATIONS

RIGHT OF WAY DATE:
FEBRUARY 24, 2005

LETTING DATE:
FEBRUARY 21, 2006

BRENDA MOORE, PE
PROJECT ENGINEER

REKHA PATEL, PE
PROJECT DESIGN ENGINEER

HYDRAULICS ENGINEER

ROADWAY DESIGN ENGINEER

STATE DESIGN ENGINEER

DEPARTMENT OF TRANSPORTATION
FEDERAL HIGHWAY ADMINISTRATION

APPROVED
DIVISION ADMINISTRATOR

DATE

DIVISION OF HIGHWAYS
STATE OF NORTH CAROLINA

STATE DESIGN ENGINEER

DEPARTMENT OF TRANSPORTATION
FEDERAL HIGHWAY ADMINISTRATION

APPROVED
DIVISION ADMINISTRATOR

DATE

16-SEP-2005 11:10
C:\Utilities\EGY\proj\B-4027.rdy-tsh.dgn
kkamil AT P-21454

PROJECT REFERENCE NO. B-4027	SHEET NO. 4
RW SHEET NO.	
ROADWAY DESIGN ENGINEER	HYDRAULICS ENGINEER
PRELIMINARY PLANS NO. 407 USE FOR CONSTRUCTION	

FOR -L- PROFILE SEE SHEET 5

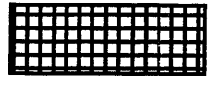

DENOTES IMPACT AREA ON WETLAND DUE TO WATER LINE RELOCATION (HAND CLEARING)

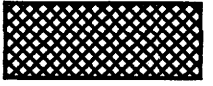

DENOTES IMPACT AREA ON WETLAND DUE TO UTILITIES RELOCATION OF POWER LINES & TELE. LINES (HAND CLEARING)

①
KATHERINE ODOM JERNIGAN
DB 89E PG 12
DB 624 PG 352
DB 637 PG 467
DB 624 PG 354 (PLAT)

②
JAMES C. DOUGHTIE, JR.
DB 69T PG 873
DB 699 PG 40 (PLAT)

③
PLUM CREEK TIMBERLANDS, L.P.
DB 788 PG 23
DB 652 PG 117
PC-A PG 983

STA 14+00.00 -L- BEGIN STATE PROJECT B-4027

STA 23+00.00 -L- END STATE PROJECT B-4027

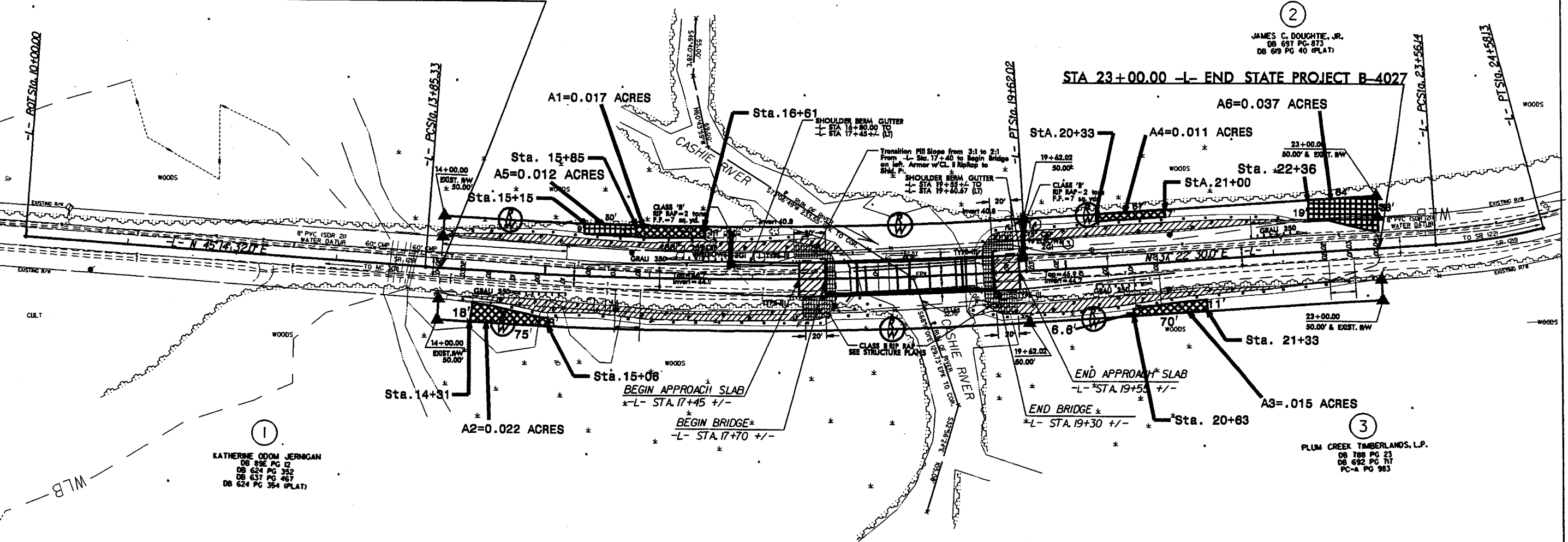

①
KATHERINE ODOM JERNIGAN
DB 89E PG 12
DB 624 PG 352
DB 637 PG 467
DB 624 PG 354 (PLAT)

-L-
PI Sta 16+74.13
 $\Delta = 7' 52' 02.0''$ (LT)
D = 1' 21' 51.1"
L = 576.70'
T = 288.80'
R = 4,200.00'
SE = .04
RUNOFF = SEE PLANS

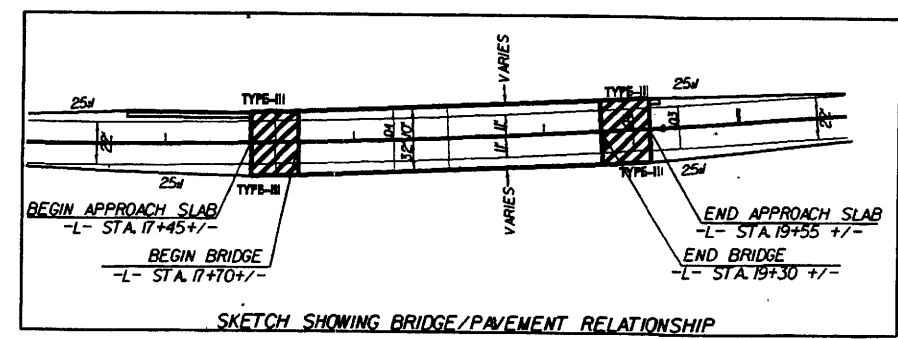

SKETCH SHOWING BRIDGE/PAVEMENT RELATIONSHIP

BRIDGE APPROACH SLAB

16-SEP-2005 10:30
C:\Users\jgibson\Documents\proj\B-4027-wetland\rev2.oreo_pah04.dgn
11/11/05 11:58:54 AM
11/11/05 11:58:54 AM

TOTAL TEMPORARY IMPACTS ON WETLAND
DUE TO WATER LINE RELOCATION

Area=0.049 Acres

TOTAL TEMPORARY IMPACTS ON WETLAND
DUE TO UTILITIES RELOCATION OF POWER
LINES AND TELE. LINES

Area=0.065 Acres

TOTAL WETLANDS IMPACT

Area=0.114 Acres

N. C. DEPT. OF TRANSPORTATION
DIVISION OF HIGHWAYS
BERTIE COUNTY

PROJECT: 8.2010501, (B-4027)
BRIDGE 11 OVER CASHIE RIVER
ON SR 1219