



STATE OF NORTH CAROLINA
DEPARTMENT OF TRANSPORTATION

MICHAEL F. EASLEY
GOVERNOR

LYNDO TIPPETT
SECRETARY

July 12, 2004

MEMORANDUM TO: Mr. Jon G. Nance, P.E.
Division 5 Engineer

FROM: Philip S. Harris, III, P.E., Manager *Maleyander*
John Office of the Natural Environment
Project Development and
Environmental Analysis Branch

SUBJECT: Durham County; Division 5; Replace Bridge No. 111 over SR 1107 over
New Hope Creek; Federal Aid No. BRSTP-1107(4), State Project No.
8.2352201; TIP Project No. B-2963

Attached are the U. S. Army Corps of Engineers Nationwide Permit Number 23 and the Division of Water Quality 404 Certification for the above referenced project. All environmental permits have been received for the construction of this project.

PSH/mka

Attachment

cc: Mr. Art McMillan, P.E.
Mr. Omar Sultan
Mr. Jay Bennett, P.E.
Mr. David Chang, P.E.
Mr. Randy Garris, P.E.
Mr. Greg Perfetti, P.E.
Mr. Mark Staley
Mr. John F. Sullivan, III, FHWA
Mr. Chris Murray, Division 5 DEO

PROJECT COMMITMENTS

Durham County
Bridge No. 111 on SR 1107
Over New Hope Creek
Federal Project BRSTP-1107 (4)
State Project 8.2352201
TIP No. B-2963

Commitments Developed Through Project Development and Design

Roadside Environmental Unit, Division 5 Construction, Structure Design Unit

Bridge Demolition: Best Management Practices for Bridge Demolition & Removal will be implemented. The existing bridge is composed entirely of timber. Therefore, no components of the structure will be dropped into Waters of the United States during construction.

Hydraulics Unit

During final hydraulic design, efforts will be made to design the deck drainage so that there are no weepholes over the stream, and if possible, no weepholes on the bridge at all.

Division 5 Construction

The bridge replacement will impact land on both sides of the roadway for the length of the project. This land is part of a waterfowl impoundment managed by the North Carolina Wildlife Resource Commission (NCWRC). The following commitments are made to protect the Section 4(f) Gamelands and waterfowl impoundment:

1. The hunter access to the waterfowl impoundment located on the west side of the existing bridge must remain open from September 1 to January 31.
2. NCWRC personnel must have access to the impoundment at all times.
3. The parking lot at the impoundment will not be available for use as a construction staging area by the contractor.
4. Disturbance of the area during the waterfowl season (September 1-January 31) must be kept to a minimum.
5. NCWRC has requested that mitigation take one of two forms; either purchase an appropriate amount of land adjacent to the property, or add 6 inches of gravel to the parking lot at the impoundment and stabilize all newly graded slopes with weeping lovegrass.
6. David Cox of the NCWRC (919/528-9886) will be invited by the NCDOT Resident Engineer to attend the preconstruction meeting for this project.
7. If the gate to the NCWRC access road east of the bridge is to be moved, NCDOT will contact NCWRC to coordinate the relocation.
8. If the grade of SR 1107 (Stagecoach Road) is raised at the entrances to the NCWRC's access roads, the slopes on the access roads will be reworked to allow for vehicular access.
9. The entrances to both access roads will be regaveled following construction.

PROJECT COMMITMENTS

**Durham County
Bridge No. 111 on SR 1107
Over New Hope Creek
Federal Project BRSTP-1107 (4)
State Project 8.2352201
TIP No. B-2963**

Commitments Developed Through Project Development and Design

Division 5 Construction

In order to allow Emergency Management Services (EMS) time to prepare for road closure, the NCDOT Resident Engineer will notify Jeff Batten with Durham County EMS at (919) 560-4517 of the bridge removal 30 days prior to road closure.

Division 5 Construction

The US Geological Survey (USGS) Gaging Station attached to the south side of the existing bridge is currently in use. In order to allow USGS time to remove all gaging equipment from the bridge, the NCDOT Resident Engineer will notify Doug Smith with USGS at (919) 571-4000 of the bridge removal 30 days prior to construction.

Division 5 Construction

A gravel parking lot will be constructed on the north side of SR 1107 approximately 900 feet (275 meters) east of the bridge. No parking signs will be posted along the shoulders of the road in the vicinity of the bridge. The parking lot will remain property of USACE Operations. The parking lot will be maintained and managed by WRC and USACE Operations Branch.

RECEIVED

JUL 6 2004

DIVISION OF HIGHWAYS
PDEA-OFFICE OF NATURAL ENVIRONMENT

Feulner

U.S. ARMY CORPS OF ENGINEERS

WILMINGTON DISTRICT

(Web page - <http://www.saw.usace.army.mil/wetlands/index.html>)

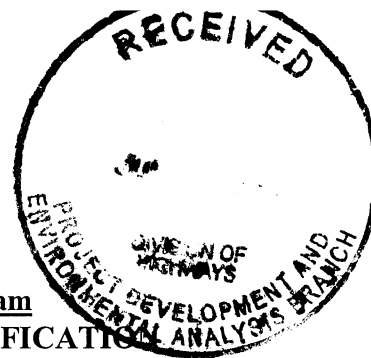

Action ID. 200220853 TIP No. B-2963 County: Durham USGS Quad: Southwest Durham

GENERAL PERMIT (REGIONAL AND NATIONWIDE) VERIFICATION

Property Owner: Gregory J. Thorpe, Ph.D.
Address: Environmental Management Director, PDEA
N.C. Department of Transportation
1548 Mail Service Center
Raleigh, NC 27699-1548
Telephone No.: (919) 715-1488 (Brett Feulner)

Location of project (waterway, road name/number, town, etc.): On SR 1107; Stagecoach Road; over New Hope Creek, southwest of Durham, North Carolina.

Description of Activity: Discharge of fill material impacting a total of 0.27 acre of wetlands and 0.06 acre of stream, for construction of the replacement of Bridge No. 111 with a new bridge on the existing location, including minor road re-alignment and temporary construction access, as shown in the attached drawings (TIP No. B-2963), and subject to the following special condition: The permittee shall implement the compensatory wetland mitigation plan entitled "B-2963 Flood Storage and Wetland Mitigation Plan", dated December, 2003, to provide the following mitigation: The permittee shall mitigate for 0.27 acre of unavoidable impacts to riverine alluvial forest wetlands associated with this project with 0.54 acre of riverine bottomland hardwood wetland restoration at the B-2963 Wetland Mitigation Site. This nationwide permit verification replaces the previous verification dated June 14, 1999 (AID 199708086) Note: This verification does not include fill impacts to waters of the United States from any on-site detours, borrow sites, spoil disposal, stream diversion, site dewatering, or bridge demolition. These impacts would have to be permitted separately if they become necessary.

Applicable Law: Section 404 (Clean Water Act, 33 USC 1344)
 Section 10 (Rivers and Harbors Act, 33 USC 403)

Authorization: Regional General Permit Number: _____
Nationwide Permit Number(s): 23

Your work is authorized by the above referenced permit provided it is accomplished in strict accordance with the attached conditions and your submitted plans. Any violation of the attached conditions or deviation from your submitted plans may subject the permittee to a stop work order, a restoration order and/or appropriate legal action.

This verification will remain valid until the expiration date identified below unless the nationwide authorization is modified, reissued or revoked. If, prior to the expiration date identified below, the nationwide permit authorization is reissued and/or modified, this verification will remain valid until the expiration date identified below, provided it complies with all modifications. If during the two years, the nationwide permit authorization expires or is suspended, revoked, or is modified, such that the activity would no longer comply with the terms and conditions of the nationwide permit, activities which have commenced (i.e., are under construction) or are under contract to commence in reliance upon the nationwide permit, will remain authorized provided the activity is completed within twelve months of the date of the nationwide permit's expiration, modification or revocation, unless discretionary authority has been exercised on a case-by-case basis to modify, suspend or revoke the authorization.

Activities subject to Section 404 (as indicated above) may also require an individual Section 401 Water Quality Certification. You should contact the NC Division of Water Quality (telephone (919) 733-1786) to determine Section 401 requirements. This Department of the Army verification does not relieve the permittee of the responsibility to obtain any other required Federal, State or local approvals/permits.

If there are any questions regarding this verification, any of the conditions of the Permit, or the Corps of Engineers regulatory program, please contact Eric Alsmeyer at telephone no. (919) 876-8441, ext. 23. Please contact Mr. Alsmeyer when work in stream or wetlands begins.

Corps Regulatory Official [Signature] Date June 30, 2004

Expiration Date of Verification: June 30, 2006

SURVEY PLATS, FIELD SKETCH, WETLAND DELINEATION FORM, ETC., MUST BE ATTACHED TO THE FILE COPY OF THIS FORM, IF REQUIRED OR AVAILABLE.

Copy Furnished: FHWA
USACE, Jordan Lake

Permit Number: **200220853**

Name of Permittee: **NCDOT /TIP No. B-2963/SR 1107/BR 111/Wake County**

Issuance: **June 30, 2004**

Upon completion of the activity authorized by this permit and any mitigation required by the permit, sign this certification and return it to the following address:

**US ARMY CORPS OF ENGINEERS
RALEIGH REGULATORY FIELD OFFICE
ATTN: Eric Alsmeyer
6508 FALLS OF NEUSE ROAD, SUITE 120
RALEIGH, NORTH CAROLINA 27615**

Please note that your permitted activity is subject to a compliance inspection by a U.S. Army Corps of Engineers representative. If you fail to comply with this permit you are subject to permit suspension, modification, or revocation.

I hereby certify that the work authorized by the above referenced permit has been completed in accordance with the terms and condition of the said permit, and required mitigation was completed in accordance with the permit conditions.

**Signature of Division
Environmental Officer**

Signature of Division Engineer

NORTH CAROLINA

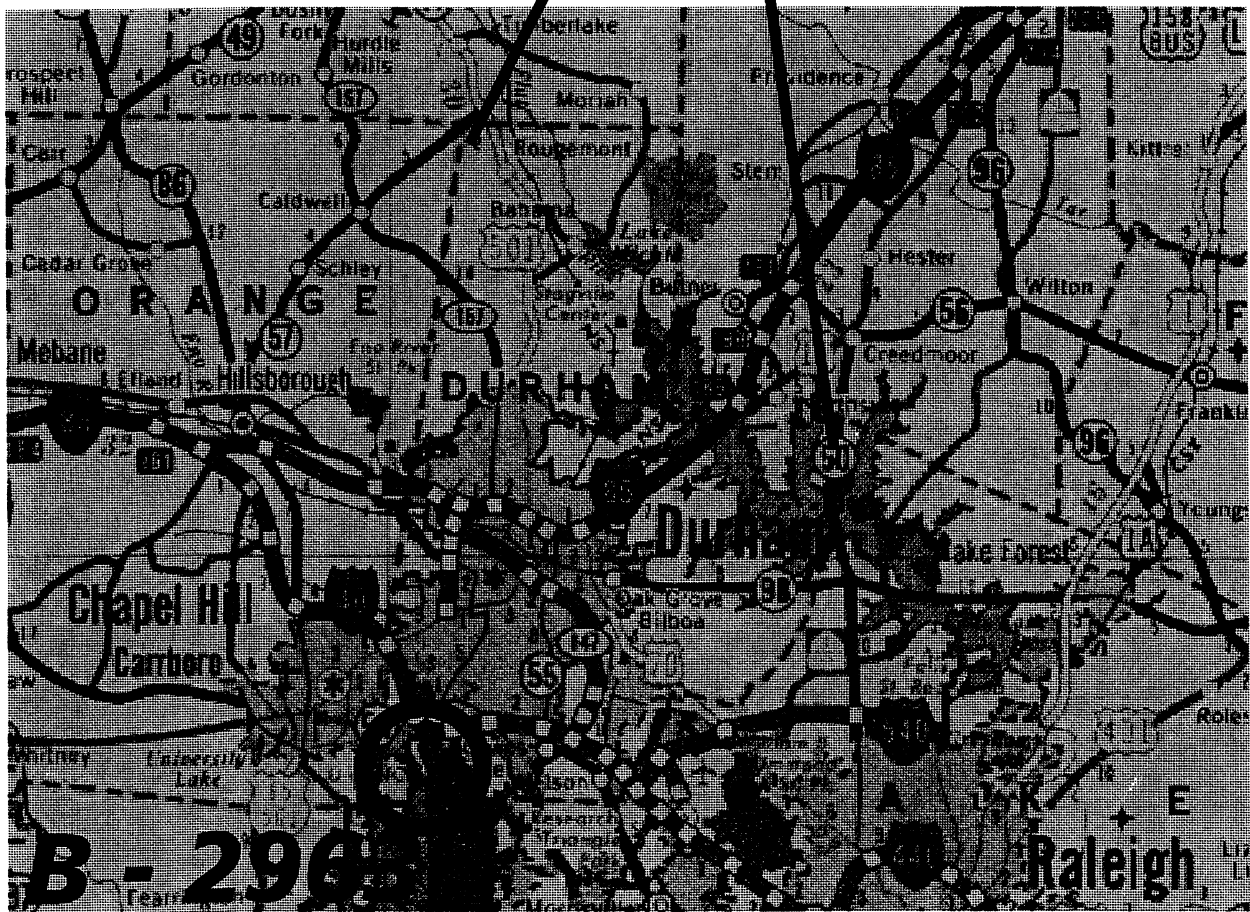
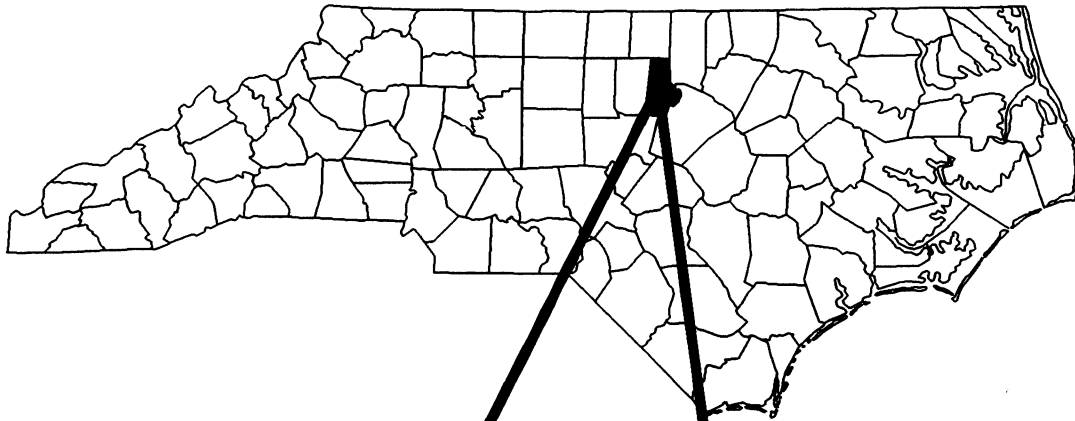

VICINITY MAP

(NOT TO SCALE)

N. C. DEPT. OF TRANSPORTATION

DIVISION OF HIGHWAYS

DURHAM COUNTY

PROJECT: 8.2352201 (B-2963)

BRIDGE NO. 111 OVER
NEW HOPE CREEK
ON SR 1107

SHEET 1 OF 9

DATE: 4/25/02

WETLAND LEGEND

— WLB — WETLAND BOUNDARY

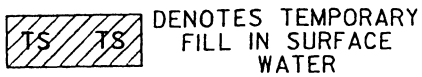
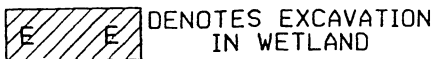
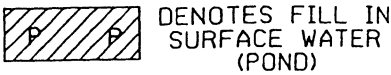
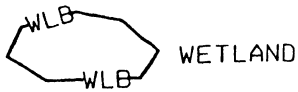

— — FLOW DIRECTION

— TB — TOP OF BANK

— WE — EDGE OF WATER

— C — PROP. LIMIT OF CUT

— F — PROP. LIMIT OF FILL

▲ PROP. RIGHT OF WAY

— NG — NATURAL GROUND

— PL — PROPERTY LINE

— TDE — TEMP. DRAINAGE EASEMENT

— PDE — PERMANENT DRAINAGE EASEMENT

— EAB — EXIST. ENDANGERED ANIMAL BOUNDARY

— EPB — EXIST. ENDANGERED PLANT BOUNDARY

— ∇ — WATER SURFACE

x x x x
x x x x
LIVE STAKES

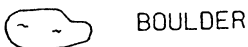

— — CORE FIBER ROLLS

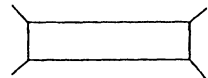
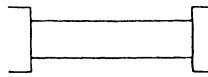

— — PROPOSED PIPE CULVERT
12"-48"
PIPES
54" PIPES
& ABOVE

(DASHED LINES DENOTE EXISTING STRUCTURES)

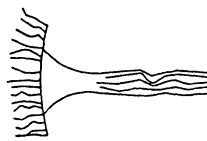
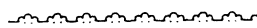

ROOTWAD

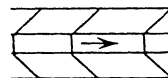
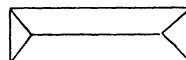

N. C. DEPT. OF TRANSPORTATION

DIVISION OF HIGHWAYS

DURHAM COUNTY

PROJECT: 8.2352201 (B-2965)

BRIDGE NO. 111 OVER

NEW HOPE CREEK

ON SR 1107

SHEET 3 OF 9

DATE: 4 / 25 / 02

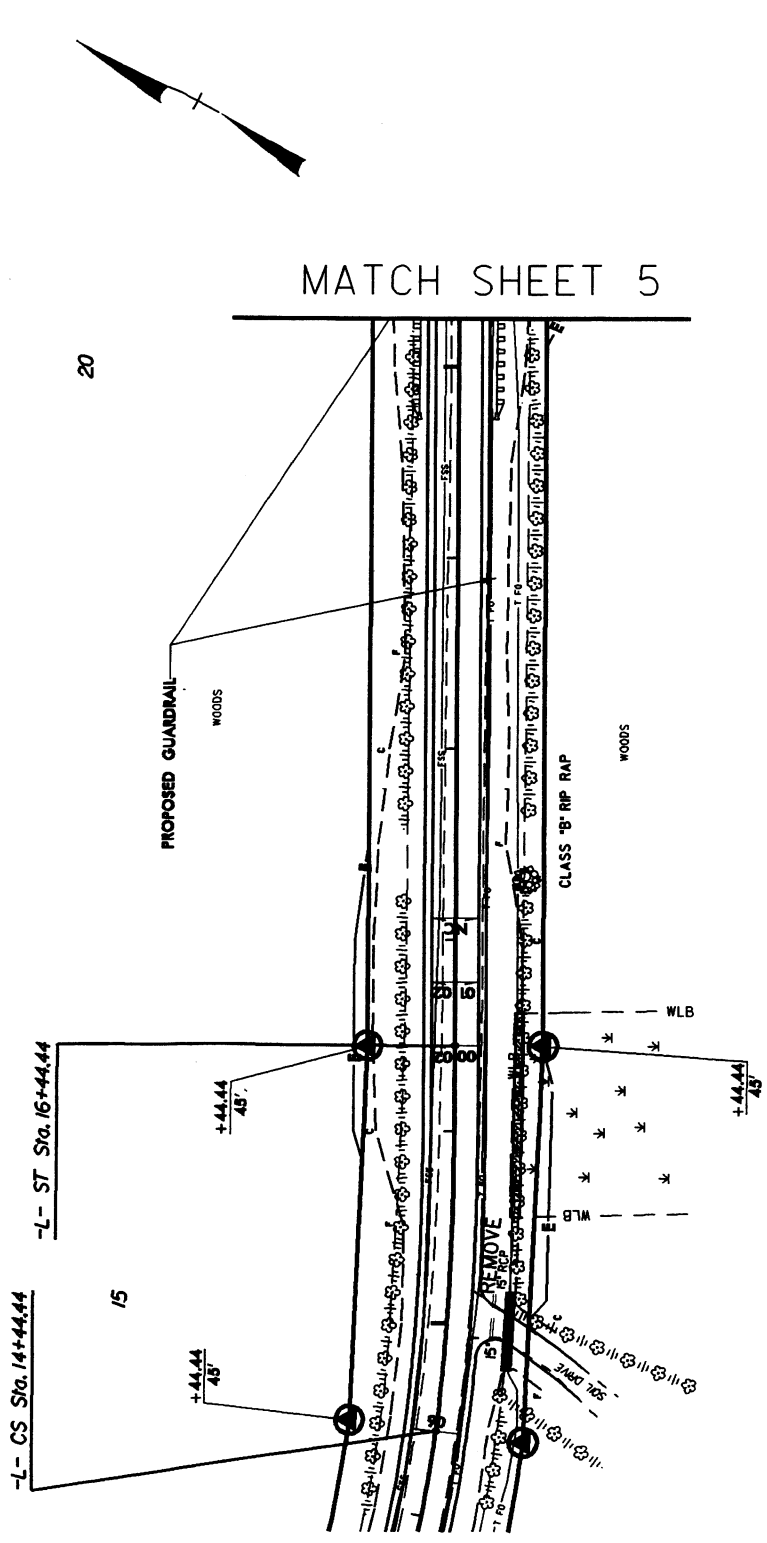

MATCH SHEET 5

SITE I

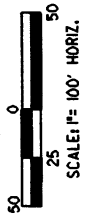

PLAN VIEW

N. C. DEPT. OF TRANSPORTATION
 DIVISION OF HIGHWAYS
 DURHAM COUNTY
 PROJECT: 8.2352201 (B-2963)
 BRIDGE NO. 111 OVER
 NEW HOPE CREEK
 ON SR 1107
 SHEET 4 OF 9 DATE: 10 / 08 / 02

US ARMY CORPS OF ENGINEERS
DB 428-PG 259

1

SITE 4
(SEE SHEET 6 ALSO)

MATCH SHEET 6

SITE 3
25

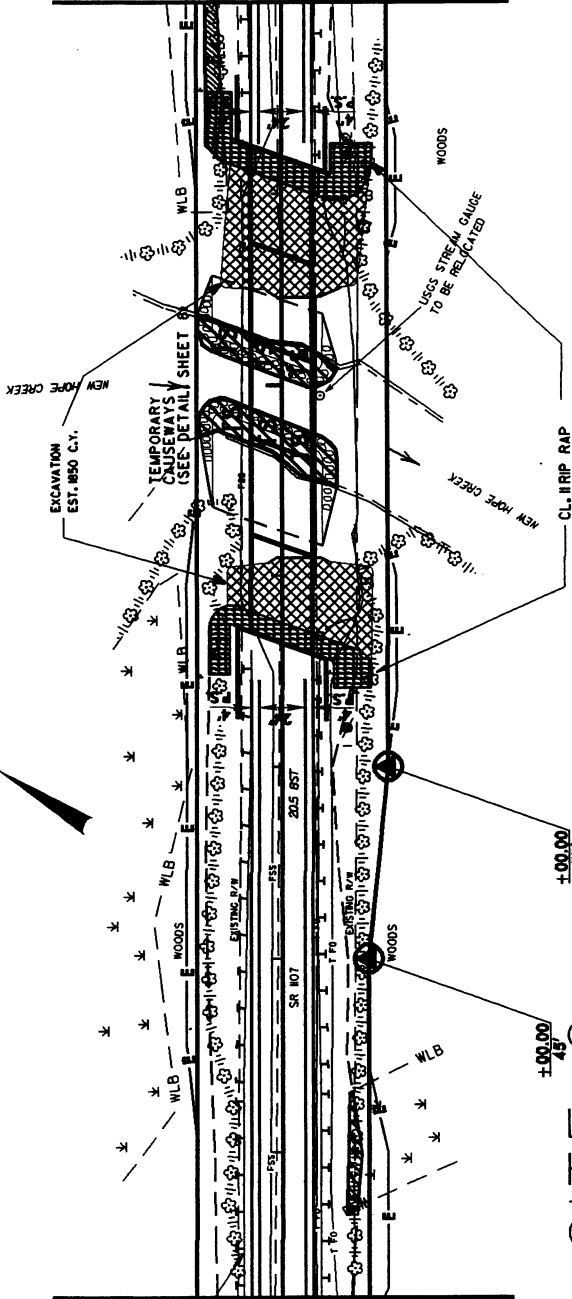

SITE 2

US ARMY CORPS OF ENGINEERS
DB 428-PG 259

1

PLAN VIEW

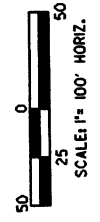

20

MATCH SHEET 4

N. C. DEPT. OF TRANSPORTATION
 DIVISION OF HIGHWAYS
 DURHAM COUNTY
 PROJECT: 8.2352201 (B-2963)
 BRIDGE NO. 111 OVER
 NEW HOPE CREEK
 ON SR 1107
 SHEET 5 OF 9 DATE: 10 / 08 / 02

US ARMY CORPS OF ENGINEERS
DB 428 PG 259

①

SITE 4
(SEE SHEET 5 ALSO)

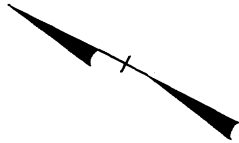

-L- TS Sta. 31+82.06

-L- SC Sta. 33+82.06

-L- CS Sta. 36+05.79

US ARMY CORPS OF ENGINEERS
DB 428 PG 259

①

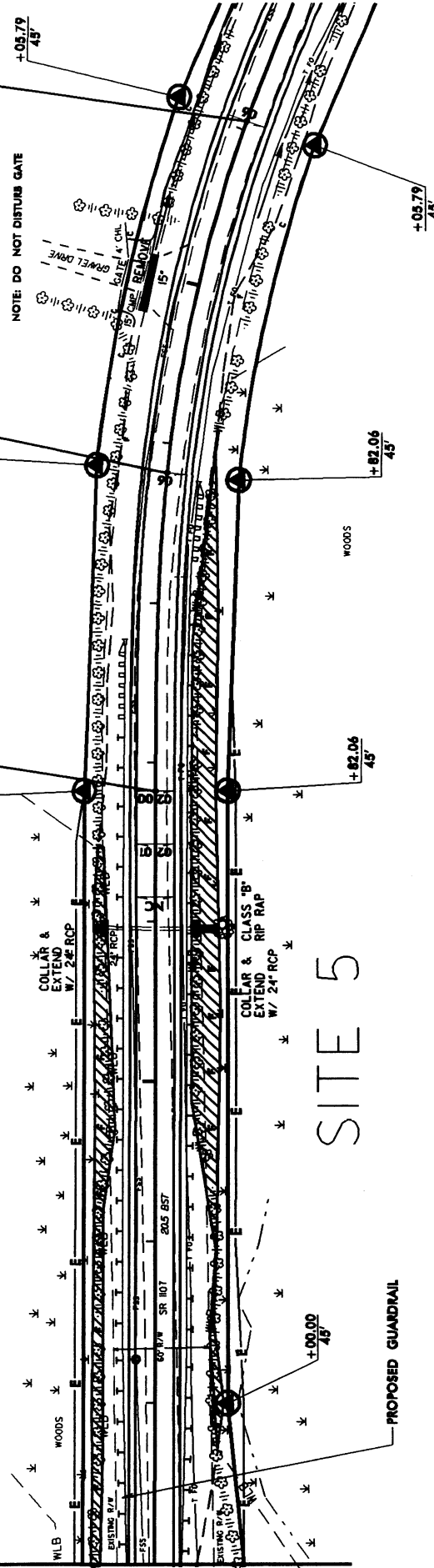

MATCH SHEET 5

US ARMY CORPS OF ENGINEERS
DB 428 PG 259

①



N. C. DEPT. OF TRANSPORTATION
 DIVISION OF HIGHWAYS
 DURHAM COUNTY
 PROJECT: 8.2352201 (B-2963)

PLAN VIEW

BRIDGE NO. 111 OVER
 NEW HOPE CREEK
 ON SR 1107

SHEET 6 OF 9 DATE: 10 / 08 / 02

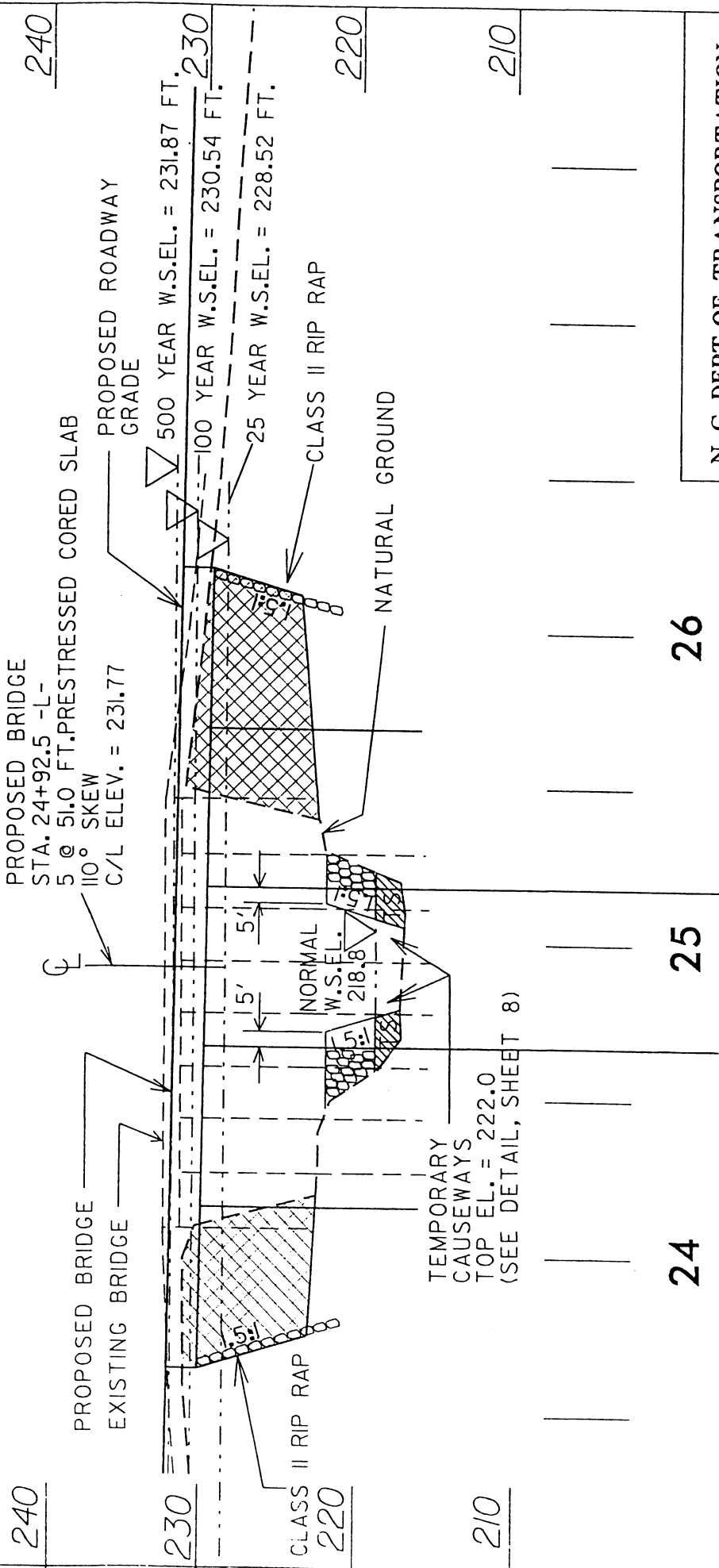

 DENOTES TEMPORARY FILL IN SURFACE WATER

 DENOTES FILL TO BE REMOVED

EXCAVATION ESTIMATE: 1850 CU. YD.

PROFILE

N. C. DEPT. OF TRANSPORTATION
 DIVISION OF HIGHWAYS
 DURHAM COUNTY
 PROJECT: 8.2352201 (B-2963)
 BRIDGE NO. 111 OVER
 NEW HOPE CREEK
 ON SR 1107

SHEET 7 OF 9 DATE: 4/25/02

SITE 3 CAUSEWAY DETAIL

(NOT TO SCALE)

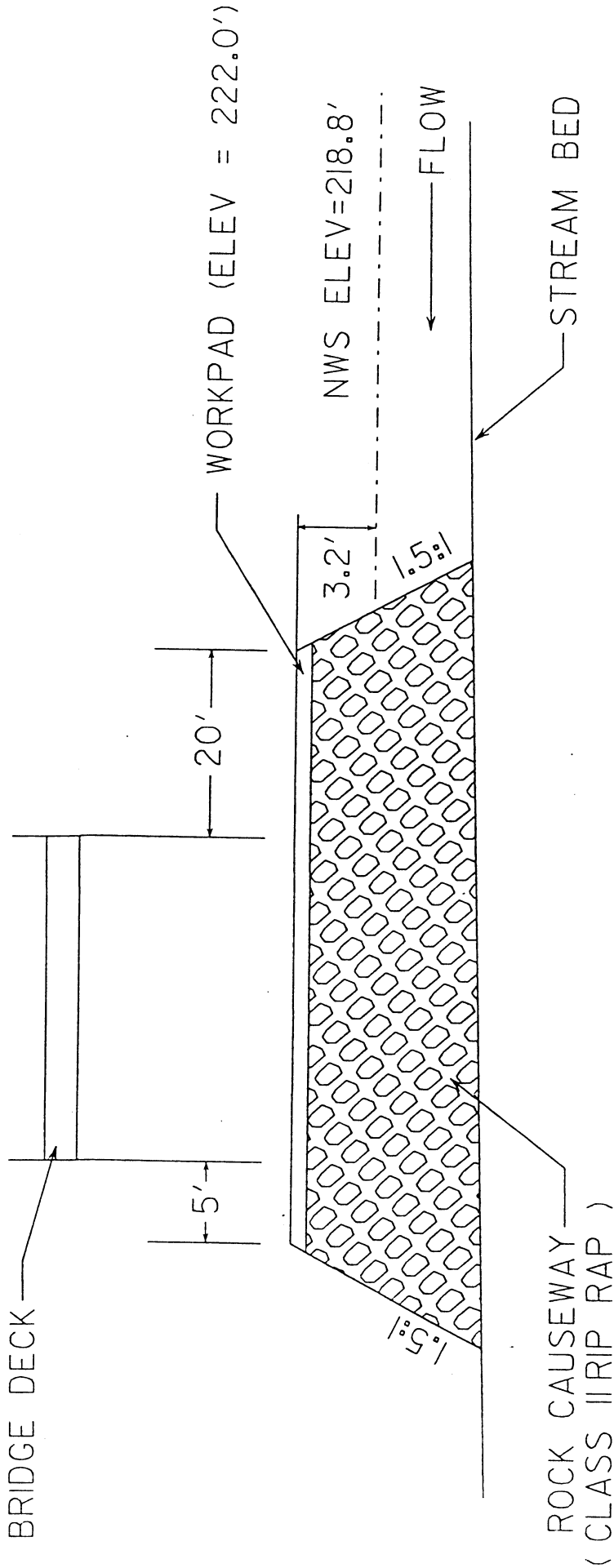

ESTIMATED QUANTITY CLASS II RIP RAP

1425 TONS (TOTAL)
755 TONS (WEST)
670 TONS (EAST)

DIVISION OF HIGHWAYS

DURHAM COUNTY

PROJECT: 8.2352201 (B-2963)

BRIDGE NO. 111 OVER

NEW HOPE CREEK

ON SR 1107

SHEET 8 OF 9 DATE: 4/25/02

WETLAND PERMIT IMPACT SUMMARY

Site No.	Station (From/To)	Structure Size / Type	Fill In Wetlands (ac)	Temp. Fill In Wetlands (ac)	Excavation In Wetlands (ac)	Mechanized Clearing (Method II) (ac)	Fill In SW (Natural) (ac)	Fill In SW (Pond) (ac)	Temp. Fill In SW (ac)	Existing Channel Impacted (ft)	Natural Stream Design (ft)
1	15+50 TO 16+50 RT		0.011			NOTE: METHOD II CLEARING TO SLOPE STAKE LIMITS					
2	20+50 TO 21+50 RT		0.007			WILL NOT RESULT IN ADDITIONAL WETLAND IMPACTS.			0.059		
3	24+92.5	255' BRIDGE									
4	26+00 TO 31+50 LT		0.092								
5	27+50 TO 34+50 RT		0.157								
TOTALS:			0.267	0	0	0	0	0	0.059	0	0

NCDOT

DIVISION OF HIGHWAYS
DURHAM COUNTY
PROJECT 8.2352201 (B-2963)
BRIDGE NO. 111 OVER
NEW HOPE CREEK
ON SR 1107

NATIONWIDE PERMIT 23
DEPARTMENT OF THE ARMY
CORPS OF ENGINEERS
FINAL NOTICE OF ISSUANCE AND MODIFICATION OF NATIONWIDE PERMITS
FEDERAL REGISTER
AUTHORIZED MARCH 18, 2002

Approved Categorical Exclusions: Activities undertaken, assisted, authorized, regulated, funded, or financed, in whole or in part, by another Federal agency or department where that agency or department has determined, pursuant to the Council on Environmental Quality Regulation for Implementing the Procedural Provisions of the National Environmental Policy Act (NEPA) (40 CFR part 1500 et seq.), that the activity, work, or discharge is categorically excluded from environmental documentation because it is included within a category of actions which neither individually nor cumulatively have a significant effect on the human environment, and the Office of the Chief of Engineers (ATTN: CECW-OR) has been furnished notice of the agency's or department's application for the categorical exclusion and concurs with that determination. Before to approval for purposes of this nationwide permit of any agency's categorical exclusions, the Chief of Engineers will solicit public comment. In addressing these comments, the Chief of Engineers may require certain conditions for authorization of an agency's categorical exclusions under this nationwide permit. (Sections 10 and 404)

NATIONWIDE PERMIT GENERAL CONDITIONS

The following General Conditions must be followed in order for any authorization by a NWP to be valid:

1. Navigation. No activity may cause more than a minimal adverse effect on navigation.
2. Proper Maintenance. Any structure or fill authorized shall be properly maintained, including maintenance to ensure public safety.
3. Soil Erosion and Sediment Controls. Appropriate soil erosion and sediment controls must be used and maintained in effective operating condition during construction, and all exposed soil and other fills, as well as any work below the ordinary high water mark or high tide line, must be permanently stabilized at the earliest practicable date. Permittees are encouraged to perform work within waters of the United States during periods of low-flow or no-flow.
4. Aquatic Life Movements. No activity may substantially disrupt the necessary life-cycle movements of those species of aquatic life indigenous to the waterbody, including those species that normally migrate through the area, unless the activity's primary purpose is to impound water. Culverts placed in streams must be installed to maintain low flow conditions.
5. Equipment. Heavy equipment working in wetlands must be placed on mats, or other measures must be taken to minimize soil disturbance.
6. Regional and Case-By-Case Conditions. The activity must comply with any regional conditions that may have been added by the Division Engineer (see 33 CFR 330.4(e)) and with any case specific conditions added by the Corps or by the state or tribe in its Section 401 Water Quality Certification and Coastal Zone Management Act consistency determination.
7. Wild and Scenic Rivers. No activity may occur in a component of the National Wild and Scenic River System; or in a river officially designated by Congress as a 'study river" for possible inclusion in the system, while the river is in an official study status; unless the appropriate Federal agency, with direct management responsibility for such river, has determined in writing that the proposed activity will not adversely affect the Wild and Scenic River designation, or study status. Information on Wild and Scenic Rivers may be obtained from the appropriate Federal land management agency in the area (e.g., National Park Service, U.S. Forest Service, Bureau of Land Management, U.S. Fish and Wildlife Service).
8. Tribal Rights. No activity or its operation may impair reserved tribal rights, including, but not limited to, reserved water rights and treaty fishing and hunting rights.
9. Water Quality.

a. In certain states and tribal lands an individual 401 Water Quality Certification must be obtained or waived (See 33 CFR 330.4(c)).

b. For NWPs 12, 14, 17, 18, 32, 39, 40, 42, 43, and 44, where the state or tribal 401 certification (either generically or individually) does not require or approve water quality management measures, the permittee must provide water quality management measures that will ensure that the authorized work does not result in more than minimal degradation of water quality (or the Corps determines that compliance with state or local standards, where applicable, will ensure no more than minimal adverse effect on water quality). An important component of water quality management includes stormwater management that minimizes degradation of the downstream aquatic system, including water quality (refer to General Condition 21 for stormwater management requirements). Another important component of water quality management is the establishment and maintenance of vegetated buffers next to open waters, including streams (refer to General Condition 19 for vegetated buffer requirements for the NWPs).

This condition is only applicable to projects that have the potential to affect water quality. While appropriate measures must be taken, in most cases it is not necessary to conduct detailed studies to identify such measures or to require monitoring.

10. Coastal Zone Management. In certain states, an individual state coastal zone management consistency concurrence must be obtained or waived (see 33 CFR 330.4(d)).

11. Endangered Species.

a. No activity is authorized under any NWP which is likely to jeopardize the continued existence of a threatened or endangered species or a species proposed for such designation, as identified under the Federal Endangered Species Act (ESA), or which will destroy or adversely modify the critical habitat of such species. Non-federal permittees shall notify the District Engineer if any listed species or designated critical habitat might be affected or is in the vicinity of the project, or is located in the designated critical habitat and shall not begin work on the activity until notified by the District Engineer that the requirements of the ESA have been satisfied and that the activity is authorized. For activities that may affect Federally-listed endangered or threatened species or designated critical habitat, the notification must include the name(s) of the endangered or threatened species that may be affected by the proposed work or that utilize the designated critical habitat that may be affected by the proposed work. As a result of formal or informal consultation with the FWS or NMFS the District Engineer may add species-specific regional endangered species conditions to the NWPs.

b. Authorization of an activity by a NWP does not authorize the "take" of a threatened or endangered species as defined under the ESA. In the absence of separate authorization (e.g., an ESA Section 10 Permit, a Biological Opinion with "incidental take" provisions, etc.) from the

USFWS or the NMFS, both lethal and non-lethal "takes" of protected species are in violation of the ESA. Information on the location of threatened and endangered species and their critical habitat can be obtained directly from the offices of the USFWS and NMFS or their World Wide Web pages at <http://www.fws.gov/r9endspp/endspp.html> and <http://www.nfms.noaa.gov/protres/overview/es.html> respectively.

12. Historic Properties. No activity that may affect historic properties listed, or eligible for listing, in the National Register of Historic Places is authorized, until the District Engineer has complied with the provisions of 33 CFR part 325, Appendix C. The prospective permittee must notify the District Engineer if the authorized activity may affect any historic properties listed, determined to be eligible, or which the prospective permittee has reason to believe may be eligible for listing on the National Register of Historic Places, and shall not begin the activity until notified by the District Engineer that the requirements of the National Historic Preservation Act have been satisfied and that the activity is authorized. Information on the location and existence of historic resources can be obtained from the State Historic Preservation Office and the National Register of Historic Places (see 33 CFR 330.4(g)). For activities that may affect historic properties listed in, or eligible for listing in, the National Register of Historic Places, the notification must state which historic property may be affected by the proposed work or include a vicinity map indicating the location of the historic property.

13. Notification.

a. Timing; where required by the terms of the NWP, the prospective permittee must notify the District Engineer with a preconstruction notification (PCN) as early as possible. The District Engineer must determine if the notification is complete within 30 days of the date of receipt and can request additional information necessary to make the PCN complete only once. However, if the prospective permittee does not provide all of the requested information, then the District Engineer will notify the prospective permittee that the notification is still incomplete and the PCN review process will not commence until all of the requested information has been received by the District Engineer. The prospective permittee shall not begin the activity:

1. Until notified in writing by the District Engineer that the activity may proceed under the NWP with any special conditions imposed by the District or Division Engineer; or

2. If notified in writing by the District or Division Engineer that an Individual Permit is required; or

3. Unless 45 days have passed from the District Engineer's receipt of the complete notification and the prospective permittee has not received written notice from the District or Division Engineer. Subsequently, the permittee's right to proceed under the NWP may be modified, suspended, or revoked only in accordance with the procedure set forth in 33 CFR 330.5(d)(2).

b. Contents of Notification: The notification must be in writing and include the

following information:

1. Name, address and telephone numbers of the prospective permittee;
2. Location of the proposed project;
3. Brief description of the proposed project; the project's purpose; direct and indirect adverse environmental effects the project would cause; any other NWP(s), Regional General Permit(s), or Individual Permit(s) used or intended to be used to authorize any part of the proposed project or any related activity. Sketches should be provided when necessary to show that the activity complies with the terms of the NWP (Sketches usually clarify the project and when provided result in a quicker decision.);
4. For NWPs 7, 12, 14, 18, 21, 34, 38, 39, 40, 41, 42, and 43, the PCN must also include a delineation of affected special aquatic sites, including wetlands, vegetated shallows (e.g., submerged aquatic vegetation, seagrass beds), and riffle and pool complexes (see paragraph 13(f));
5. For NWP 7 (Cutfall Structures and Maintenance), the PCN must include information regarding the original design capacities and configurations of those areas of the facility where maintenance dredging or excavation is proposed;
6. For NWP 14 (Linear Transportation Projects), the PCN must include a compensatory mitigation proposal to offset permanent losses of waters of the US and a statement describing how temporary losses of waters of the US will be minimized to the maximum extent practicable;
7. For NWP 21 (Surface Coal Mining Activities), the PCN must include an Office of Surface Mining (OSM) or state-approved mitigation plan, if applicable. To be authorized by this NWP, the District Engineer must determine that the activity complies with the terms and conditions of the NWP and that the adverse environmental effects are minimal both individually and cumulatively and must notify the project sponsor of this determination in writing;
8. For NWP 27 (Stream and Wetland Restoration Activities), the PCN must include documentation of the prior condition of the site that will be reverted by the permittee;
9. For NWP 29 (Single-Family Housing), the PCN must also include:
 - i. Any past use of this NWP by the Individual Permittee and/or the permittee's spouse;
 - ii. A statement that the single-family housing activity is for a personal residence of the permittee;

iii. A description of the entire parcel, including its size, and a delineation of wetlands. For the purpose of this NWP, parcels of land measuring $\frac{1}{4}$ -acre or less will not require a formal on-site delineation. However, the applicant shall provide an indication of where the wetlands are and the amount of wetlands that exists on the property. For parcels greater than $\frac{1}{4}$ -acre in size, formal wetland delineation must be prepared in accordance with the current method required by the Corps. (See paragraph 13(f));

iv. A written description of all land (including, if available, legal descriptions) owned by the prospective permittee and/or the prospective permittee's spouse, within a one mile radius of the parcel, in any form of ownership (including any land owned as a partner, corporation, joint tenant, co-tenant, or as a tenant-by-the-entirety) and any land on which a purchase and sale agreement or other contract for sale or purchase has been executed;

10. For NWP 31 (Maintenance of Existing Flood Control Facilities), the prospective permittee must either notify the District Engineer with a PCN prior to each maintenance activity or submit a five-year (or less) maintenance plan. In addition, the PCN must include all of the following:

i. Sufficient baseline information identifying the approved channel depths and configurations and existing facilities. Minor deviations are authorized, provided the approved flood control protection or drainage is not increased;

ii. A delineation of any affected special aquatic sites, including wetlands; and,

iii. Location of the dredged material disposal site;

11. For NWP 33 (Temporary Construction, Access, and Dewatering), the PCN must also include a restoration plan of reasonable measures to avoid and minimize adverse effects to aquatic resources;

12. For NWPs 39, 43 and 44, the PCN must also include a written statement to the District Engineer explaining how avoidance and minimization for losses of waters of the US were achieved on the project site;

13. For NWP 39 and NWP 42, the PCN must include a compensatory mitigation proposal to offset losses of waters of the US or justification explaining why compensatory mitigation should not be required. For discharges that cause the loss of greater than 300 linear feet of an intermittent stream bed, to be authorized, the District Engineer must determine that the activity complies with the other terms and conditions of the NWP, determine adverse environmental effects are minimal both individually and cumulatively, and waive the limitation on stream impacts in writing before the permittee may proceed;

14. For NWP 40 (Agricultural Activities), the PCN must include a compensatory mitigation proposal to offset losses of waters of the US. This NWP does not authorize the

relocation of greater than 300 linear feet of existing serviceable drainage ditches constructed in non-tidal streams unless, for drainage ditches constructed in intermittent nontidal streams, the District Engineer waives this criterion in writing, and the District Engineer has determined that the project complies with all terms and conditions of this NWP, and that any adverse impacts of the project on the aquatic environment are minimal, both individually and cumulatively;

15. For NWP 43 (Stormwater Management Facilities), the PCN must include, for the construction of new stormwater management facilities, a maintenance plan (in accordance with state and local requirements, if applicable) and a compensatory mitigation proposal to offset losses of waters of the US. For discharges that cause the loss of greater than 300 linear feet of an intermittent stream bed, to be authorized, the District Engineer must determine that the activity complies with the other terms and conditions of the NWP, determine adverse environmental effects are minimal both individually and cumulatively, and waive the limitation on stream impacts in writing before the permittee may proceed;

16. For NWP 44 (Mining Activities), the PCN must include a description of all waters of the US adversely affected by the project, a description of measures taken to minimize adverse effects to waters of the US, a description of measures taken to comply with the criteria of the NWP, and a reclamation plan (for all aggregate mining activities in isolated waters and non-tidal wetlands adjacent to headwaters and any hard rock/mineral mining activities);

17. For activities that may adversely affect Federally-listed endangered or threatened species, the PCN must include the name(s) of those endangered or threatened species that may be affected by the proposed work or utilize the designated critical habitat that may be affected by the proposed work; and

18. For activities that may affect historic properties listed in, or eligible for listing in, the National Register of Historic Places, the PCN must state which historic property may be affected by the proposed work or include a vicinity map indicating the location of the historic property.

c. Form of Notification: The standard Individual Permit application form (Form ENG 4345) may be used as the notification but must clearly indicate that it is a PCN and must include all of the information required in (b) (1)-(18) of General Condition 13. A letter containing the requisite information may also be used.

d. District Engineer's Decision: In reviewing the PCN for the proposed activity, the District Engineer will determine whether the activity authorized by the NWP will result in more than minimal individual or cumulative adverse environmental effects or may be contrary to the public interest. The prospective permittee may submit a proposed mitigation plan with the PCN to expedite the process. The District Engineer will consider any proposed compensatory mitigation the applicant has included in the proposal in determining whether the net adverse environmental effects to the aquatic environment of the proposed work are minimal. If the District Engineer determines that the activity complies with the terms and conditions of the NWP

and that the adverse effects on the aquatic environment are minimal, after considering mitigation, the District Engineer will notify the permittee and include any conditions the District Engineer deems necessary. The District Engineer must approve any compensatory mitigation proposal before the permittee commences work. If the prospective permittee is required to submit a compensatory mitigation proposal with the PCN, the proposal may be either conceptual or detailed. If the prospective permittee elects to submit a compensatory mitigation plan with the PCN, the District Engineer will expeditiously review the proposed compensatory mitigation plan. The District Engineer must review the plan within 45 days of receiving a complete PCN and determine whether the conceptual or specific proposed mitigation would ensure no more than minimal adverse effects on the aquatic environment. If the net adverse effects of the project on the aquatic environment (after consideration of the compensatory mitigation proposal) are determined by the District Engineer to be minimal, the District Engineer will provide a timely written response to the applicant. The response will state that the project can proceed under the terms and conditions of the NWP.

If the District Engineer determines that the adverse effects of the proposed work are more than minimal, then the District Engineer will notify the applicant either:

1. That the project does not qualify for authorization under the NWP and instruct the applicant on the procedures to seek authorization under an Individual Permit;
2. that the project is authorized under the NWP subject to the applicant's submission of a mitigation proposal that would reduce the adverse effects on the aquatic environment to the minimal level; or
3. that the project is authorized under the NWP with specific modifications or conditions. Where the District Engineer determines that mitigation is required to ensure no more than minimal adverse effects occur to the aquatic environment, the activity will be authorized within the 45-day PCN period. The authorization will include the necessary conceptual or specific mitigation or a requirement that the applicant submit a mitigation proposal that would reduce the adverse effects on the aquatic environment to the minimal level. When conceptual mitigation is included, or a mitigation plan is required under item (2) above, no work in waters of the US will occur until the District Engineer has approved a specific mitigation plan.

e. Agency Coordination: The District Engineer will consider any comments from Federal and state agencies concerning the proposed activity's compliance with the terms and conditions of the NWPs and the need for mitigation to reduce the project's adverse environmental effects to a minimal level.

For activities requiring notification to the District Engineer that result in the loss of greater than $\frac{1}{2}$ -acre of waters of the US, the District Engineer will provide immediately (e.g., via facsimile transmission, overnight mail, or other expeditious manner) a copy to the appropriate Federal or state offices (USFWS, state natural resource or water quality agency, EPA, State Historic Preservation Officer (SHPO), and, if appropriate, the NMFS). With the exception of

NWP 37, these agencies will then have 10 calendar days from the date the material is transmitted to telephone or fax the District Engineer notice that they intend to provide substantive, site-specific comments. If so contacted by an agency, the District Engineer will wait an additional 15 calendar days before making a decision on the notification. The District Engineer will fully consider agency comments received within the specified time frame, but will provide no response to the resource agency, except as provided below. The District Engineer will indicate in the administrative record associated with each notification that the resource agencies' concerns were considered. As required by section 305(b)(4)(B) of the Magnuson-Stevens Fishery Conservation and Management Act, the District Engineer will provide a response to NMFS within 30 days of receipt of any Essential Fish Habitat conservation recommendations. Applicants are encouraged to provide the Corps multiple copies of notifications to expedite agency notification.

f. Wetland Delineations: Wetland delineations must be prepared in accordance with the current method required by the Corps (For NWP 29 see paragraph (b)(9)(iii) for parcels less than $\frac{1}{4}$ -acre in size). The permittee may ask the Corps to delineate the special aquatic site. There may be some delay if the Corps does the delineation. Furthermore, the 45-day period will not start until the wetland delineation has been completed and submitted to the Corps, where appropriate.

14. Compliance Certification. Every permittee who has received NWP verification from the Corps will submit a signed certification regarding the completed work and any required mitigation. The certification will be forwarded by the Corps with the authorization letter and will include:

a. A statement that the authorized work was done in accordance with the Corps authorization, including any general or specific conditions;

b. A statement that any required mitigation was completed in accordance with the permit conditions; and

c. The signature of the permittee certifying the completion of the work and mitigation.

15. Use of Multiple Nationwide Permits. The use of more than one NWP for a single and complete project is prohibited, except when the acreage loss of waters of the US authorized by the NWPs does not exceed the acreage limit of the NWP with the highest specified acreage limit (e.g. if a road crossing over tidal waters is constructed under NWP 14, with associated bank stabilization authorized by NWP 13, the maximum acreage loss of waters of the US for the total project cannot exceed $\frac{1}{3}$ -acre).

16. Water Supply Intakes. No activity, including structures and work in navigable waters of the US or discharges of dredged or fill material, may occur in the proximity of a public water supply intake except where the activity is for repair of the public water supply intake structures or adjacent bank stabilization.

17. Shellfish Beds. No activity, including structures and work in navigable waters of the US or discharges of dredged or fill material, may occur in areas of concentrated shellfish populations, unless the activity is directly related to a shellfish harvesting activity authorized by NWP 4.

18. Suitable Material. No activity, including structures and work in navigable waters of the US or discharges of dredged or fill material, may consist of unsuitable material (e.g., trash, debris, car bodies, asphalt, etc.) and material used for construction or discharged must be free from toxic pollutants in toxic amounts (see section 307 of the CWA).

19. Mitigation. The District Engineer will consider the factors discussed below when determining the acceptability of appropriate and practicable mitigation necessary to offset adverse effects on the aquatic environment that are more than minimal.

a. The project must be designed and constructed to avoid and minimize adverse effects to waters of the US to the maximum extent practicable at the project site (i.e., on site).

b. Mitigation in all its forms (avoiding, minimizing, rectifying, reducing or compensating) will be required to the extent necessary to ensure that the adverse effects to the aquatic environment are minimal.

c. Compensatory mitigation at a minimum one-for-one ratio will be required for all wetland impacts requiring a PCN, unless the District Engineer determines in writing that some other form of mitigation would be more environmentally appropriate and provides a project-specific waiver of this requirement. Consistent with National policy, the District Engineer will establish a preference for restoration of wetlands as compensatory mitigation, with preservation used only in exceptional circumstances.

d. Compensatory mitigation (i.e., replacement or substitution of aquatic resources for those impacted) will not be used to increase the acreage losses allowed by the acreage limits of some of the NWPs. For example, $\frac{1}{4}$ -acre of wetlands cannot be created to change a $\frac{3}{4}$ -acre loss of wetlands to a $\frac{1}{2}$ -acre loss associated with NWP 39 verification. However, $\frac{1}{2}$ -acre of created wetlands can be used to reduce the impacts of a $\frac{1}{2}$ -acre loss of wetlands to the minimum impact level in order to meet the minimal impact requirement associated with NWPs.

e. To be practicable, the mitigation must be available and capable of being done considering costs, existing technology, and logistics in light of the overall project purposes. Examples of mitigation that may be appropriate and practicable include, but are not limited to: reducing the size of the project; establishing and maintaining wetland or upland vegetated buffers to protect open waters such as streams; and replacing losses of aquatic resource functions and values by creating, restoring, enhancing, or preserving similar functions and values, preferably in the same watershed.

f. Compensatory mitigation plans for projects in or near streams or other open waters will normally include a requirement for the establishment, maintenance, and legal protection (e.g., easements, deed restrictions) of vegetated buffers to open waters. In many cases, vegetated buffers will be the only compensatory mitigation required. Vegetated buffers should consist of native species. The width of the vegetated buffers required will address documented water quality or aquatic habitat loss concerns. Normally, the vegetated buffer will be 25 to 50 feet wide on each side of the stream, but the District Engineers may require slightly wider vegetated buffers to address documented water quality or habitat loss concerns. Where both wetlands and open waters exist on the project site, the Corps will determine the appropriate compensatory mitigation (e.g., stream buffers or wetlands compensation) based on what is best for the aquatic environment or, a watershed basis. In cases where vegetated buffers are determined to be the most appropriate form of compensatory mitigation, the District Engineer may waive or reduce the requirement to provide wetland compensatory mitigation for wetland impacts.

g. Compensatory mitigation proposals submitted with the " notification" may be either conceptual or detailed. If conceptual plans are approved under the verification, then the Corps will condition the verification to require detailed plans be submitted and approved by the Corps prior to construction of the authorized activity in waters of the US.

h. Permittees may propose the use of mitigation banks, in-lieu fee arrangements or separate activity-specific compensatory mitigation. In all cases that require compensatory mitigation, the mitigation provisions will specify the party responsible for accomplishing and/or complying with the mitigation plan.

20. Spawning Areas. Activities, including structures and work in navigable waters of the US or discharges of dredged or fill material, in spawning areas during spawning seasons must be avoided to the maximum extent practicable. Activities that result in the physical destruction (e.g., excavate, fill, or smother downstream by substantial turbidity) of an important spawning area are not authorized.

21. Management of Water Flows. To the maximum extent practicable, the activity must be designed to maintain preconstruction downstream flow conditions (e.g., location, capacity, and flow rates). Furthermore, the activity must not permanently restrict or impede the passage of normal or expected high flows (unless the primary purpose of the fill is to impound waters) and the structure or discharge of dredged or fill material must withstand expected high flows. The activity must, to the maximum extent practicable, provide for retaining excess flows from the site, provide for maintaining surface flow rates from the site similar to preconstruction conditions, and provide for not increasing water flows from the project site, relocating water, or redirecting water flow beyond preconstruction conditions. Stream channelizing will be reduced to the minimal amount necessary, and the activity must, to the maximum extent practicable, reduce adverse effects such as flooding or erosion downstream and upstream of the project site, unless the activity is part of a larger system designed to manage water flows. In most cases, it will not be a requirement to conduct detailed studies and monitoring of water flow.

This condition is only applicable to projects that have the potential to affect waterflows. While appropriate measures must be taken, it is not necessary to conduct detailed studies to identify such measures or require monitoring to ensure their effectiveness. Normally, the Corps will defer to state and local authorities regarding management of water flow.

22. Adverse Effects From Impoundments. If the activity creates an impoundment of water, adverse effects to the aquatic system due to the acceleration of the passage of water, and/or the restricting its flow shall be minimized to the maximum extent practicable. This includes structures and work in navigable waters of the US, or discharges of dredged or fill material.

23. Waterfowl Breeding Areas. Activities, including structures and work in navigable waters of the US or discharges of dredged or fill material, into breeding areas for migratory waterfowl must be avoided to the maximum extent practicable.

24. Removal of Temporary Fills. Any temporary fills must be removed in their entirety and the affected areas returned to their preexisting elevation.

25. Designated Critical Resource Waters. Critical resource waters include, NOAA-designated marine sanctuaries, National Estuarine Research Reserves, National Wild and Scenic Rivers, critical habitat for Federally listed threatened and endangered species, coral reefs, state natural heritage sites, and outstanding national resource waters or other waters officially designated by a state as having particular environmental or ecological significance and identified by the District Engineer after notice and opportunity for public comment. The District Engineer may also designate additional critical resource waters after notice and opportunity for comment.

a. Except as noted below, discharges of dredged or fill material into waters of the US are not authorized by NWPs 7, 12, 14, 16, 17, 21, 29, 31, 35, 39, 40, 42, 43, and 44 for any activity within, or directly affecting, critical resource waters, including wetlands adjacent to such waters. Discharges of dredged or fill materials into waters of the US may be authorized by the above NWPs in National Wild and Scenic Rivers if the activity complies with General Condition 7. Further, such discharges may be authorized in designated critical habitat for Federally listed threatened or endangered species if the activity complies with General Condition 11 and the USFWS or the NMFS has concurred in a determination of compliance with this condition.

b. For NWPs 3, 8, 10, 13, 15, 18, 19, 22, 23, 25, 27, 28, 30, 33, 34, 36, 37, and 38, notification is required in accordance with General Condition 13, for any activity proposed in the designated critical resource waters including wetlands adjacent to those waters. The District Engineer may authorize activities under these NWPs only after it is determined that the impacts to the critical resource waters will be no more than minimal.

26. Fills Within 100-Year Floodplains. For purposes of this General Condition, 100-year floodplains will be identified through the existing Federal Emergency Management Agency's (FEMA) Flood Insurance Rate Maps or FEMA-approved local floodplain maps.

a. Discharges in Floodplain; Below Headwaters. Discharges of dredged or fill material into waters of the US within the mapped 100year floodplain, below headwaters (i.e. five cfs), resulting in permanent above-grade fills, are not authorized by NWPs 39, 40, 42, 43, and 44.

b. Discharges in Floodway; Above Headwaters. Discharges of dredged or fill material into waters of the US within the FEMA or locally mapped floodway, resulting in permanent above-grade fills, are not authorized by NWPs 39, 40, 42, and 44.

c. The permittee must comply with any applicable FEMA-approved state or local floodplain management requirements.

27. Construction Period. For activities that have not been verified by the Corps and the project was commenced or under contract to commence by the expiration date of the NWP (or modification or revocation date), the work must be completed within 12-months after such date (including any modification that affects the project).

For activities that have been verified and the project was commenced or under contract to commence within the verification period, the work must be completed by the date determined by the Corps.

For projects that have been verified by the Corps, an extension of a Corps approved completion date maybe requested. This request must be submitted at least one month before the previously approved completion date.

FURTHER INFORMATION

1. District Engineers have authority to determine if an activity complies with the terms and conditions of a NWP.
2. NWPs do not obviate the need to obtain other Federal, State, or local permits, approvals, or authorizations required by law.
3. NWPs do not grant any property rights or exclusive privileges.
4. NWPs do not authorize any injury to the property or rights of others.
5. NWPs do not authorize interference with any existing or proposed Federal project.

DEFINITIONS

Best Management Practices (BMPs): BMPs are policies, practices, procedures, or structures

implemented to mitigate the adverse environmental effects on surface water quality resulting from development. BMPs are categorized as structural or nonstructural. A BMP policy may affect the limits on a development.

Compensatory Mitigation: For purposes of Section 10/404, compensatory mitigation is the restoration, creation, enhancement, or in exceptional circumstances, preservation of wetlands and/or other aquatic resources for the purpose of compensating for unavoidable adverse impacts, which remain, after all appropriate and practicable avoidance and minimization has been achieved.

Creation: The establishment of a wetland or other aquatic resource where one did not formerly exist.

Enhancement: Activities conducted in existing wetlands or other aquatic resources that increase one or more aquatic functions.

Ephemeral Stream: An ephemeral stream has *flowing* water only during and for a short duration after precipitation events in a typical year. Ephemeral stream beds are located above the water table year-round. Groundwater is not a source of water for the stream. Runoff from rainfall is the primary source of water for stream flow.

Farm Tract: A unit of contiguous land under one ownership that is operated as a farm or part of a farm.

Flood Fringe: That portion of the 100-year floodplain outside of the floodway (often referred to as “floodway fringe”).

Floodway: The area regulated by Federal, state, or local requirements to provide for the discharge of the base flood so the cumulative increase in water surface elevation is no more than a designated amount (not to exceed one foot as set by the National Flood Insurance Program) within the 100-year floodplain.

Independent Utility: A test to determine what constitutes a single and complete project in the Corps regulatory program. A project is considered to have independent utility if it would be constructed absent the construction of other projects in the project area. Portions of a multi-phase project that depend upon other phases of the project do not have independent utility. Phases of a project that would be constructed even if the other phases were not built can be considered as separate single and complete projects with independent utility.

Intermittent Stream: An intermittent stream has flowing water during certain times of the year, when groundwater provides water for stream flow. During dry periods, intermittent streams may not have flowing water. Runoff from rainfall is a supplemental source of water for stream flow.

Loss of waters of the US: Waters of the US that include the filled area and other waters that are permanently adversely affected by flooding, excavation, or drainage because of the regulated activity. Permanent adverse effects include permanent above-grade, at-grade, or below-grade fills that change an aquatic area to dry land, increase the bottom elevation of a waterbody, or change the use of a waterbody. The acreage of loss of waters of the US is the threshold measurement of the impact to existing waters for determining whether a project may qualify for a NWP; it is not a net threshold that is calculated after considering compensatory mitigation that may be used to offset losses of aquatic functions and values. The loss of stream bed includes the linear feet of stream bed that is filled or excavated. Waters of the US temporarily filled, flooded, excavated, or drained, but restored to preconstruction contours and elevations after construction, are not included in the measurement of loss of waters of the US. Impacts to ephemeral waters are only not included in the acreage or linear foot measurements of loss of waters of the US or loss of stream bed, for the purpose of determining compliance with the threshold limits of the NWPs.

Non-tidal Wetland: An area that, during a year with normal patterns of precipitation has standing or flowing water for sufficient duration to establish an ordinary high water mark. Aquatic vegetation within the area of standing or flowing water is either non-emergent, sparse, or absent. Vegetated shallows are considered to be open waters. The term “open water” includes rivers, streams, lakes, and ponds. For the purposes of the NWPs, this term does not include ephemeral waters.

Perennial Stream: A perennial stream has flowing water year-round during a typical year. The water table is located above the stream bed for the most of the year. Groundwater is the primary source of water for stream flow. Runoff from rainfall is a supplemental source of water for stream flow.

Permanent Above-grade Fill: A discharge of dredged or fill material into waters of the US, including wetlands, that results in a substantial increase in ground elevation and permanently converts part or all of the waterbody to dry land. Structural fills authorized by NWPs 3, 25, 36, etc. are not included.

Preservation: The protection of ecologically important wetlands or other aquatic resources in perpetuity through the implementation of appropriate legal and physical mechanisms. Preservation may include protection of upland areas adjacent to wetlands as necessary to ensure protection and/or enhancement of the overall aquatic ecosystem.

Restoration: Re-establishment of wetland and/or other aquatic resource characteristics and function(s) at a site where they have ceased to exist, or exist in a substantially degraded state.

Riffle and Pool Complex: Riffle and pool complexes are special aquatic sites under the 404(b)(1) Guidelines. Riffle and pool complexes sometimes characterize steep gradient sections of streams. Such stream sections are recognizable by their hydraulic characteristics. The rapid movement of water over a coarse substrate in riffles results in a rough flow, a turbulent surface and high dissolved oxygen levels in the water. Pools are deeper areas associated with riffles. A slower stream velocity, a streaming flow, a smooth surface, and a finer substrate characterize pools.

Single and Complete Project: The term “single and complete project” is defined at 33 CFR 330.2(i) as the total project proposed or accomplished by one owner/developer or partnership or other association of owners/developers (see definition of independent utility). For linear projects, the “single and complete project” (i.e., a single and complete crossing) will apply to each crossing of a separate water of the US (i.e., a single waterbody) at that location. An exception is for linear projects crossing a single waterbody several times at separate and distant locations; each crossing is considered a single and complete project. However, individual channels in a braided stream or river, or individual arms of a large, irregularly shaped wetland or lake, etc., are not separate waterbodies.

Stormwater Management: Stormwater management is the mechanism for controlling stormwater runoff for the purposes of reducing downstream erosion, water quality degradation, and flooding and mitigating the adverse effects of changes in land use on the aquatic environment.

Stormwater Management Facilities: Stormwater management facilities are those facilities, including but not limited to, stormwater retention and detention ponds and BMPs, which retain water for a period of time to control runoff and/or improve the quality (i.e., by reducing the concentration of nutrients, sediments, hazardous substances and other pollutants) of stormwater runoff.

Stream Channelization: The manipulation of a stream channel to increase the rate of water flow through the stream channel. Manipulation may include deepening, widening, straightening, armoring, or other activities that change the stream cross-section or other aspects of stream channel geometry to increase the rate of water flow through the stream channel. A channelized stream remains a water of the US, despite the modifications to increase the rate of water flow.

Tidal Wetland: A tidal wetland is a wetland (i.e., water of the US) that is inundated by tidal waters. The definitions of a wetland and tidal waters can be found at 33 CFR 328.3(b) and 33 CFR 328.3(f), respectively. Tidal waters rise and fall in a predictable and measurable rhythm or cycle due to the gravitational pulls of the moon and sun. Tidal waters end where the rise and fall of the water surface can no longer be practically measured in a predictable rhythm due to masking by other waters, wind, or other effects. Tidal wetlands are located channelward of the high tide line (i.e., spring high tide line) and are inundated by tidal waters two times per lunar month, during spring high tides.

Vegetated Buffer: A vegetated upland or wetland area next to rivers, streams, lakes, or other

open waters, which separates the open water from developed areas, including agricultural land. Vegetated buffers provide a variety of aquatic habitat functions and values (e.g., aquatic habitat for fish and other aquatic organisms, moderation of water temperature changes, and detritus for aquatic food webs) and help improve or maintain local water quality. A vegetated buffer can be established by maintaining an existing vegetated area or planting native trees, shrubs, and herbaceous plants on land next to openwaters. Mowed lawns are not considered vegetated buffers because they provide little or no aquatic habitat functions and values. The establishment and maintenance of vegetated buffers I a method of compensatory mitigation that can be used in conjunction with the restoration, creation, enhancement or preservation of aquatic habitats to ensure that activities authorized by NWP result in minimal adverse effects to the aquatic environment. (See General Condition 19.)

Vegetated Shallows: Vegetated shallows are special aquatic sites under the 404(b)(1) Guidelines. They are areas that are permanently inundated and under normal circumstances have rooted aquatic vegetation, such as seagrasses in marine and estuarine systems and a variety of vascular rooted plants in freshwater systems.

Waterbody: A waterbody is any area that in a normal year has water flowing or standing above ground to the extent that evidence of an ordinary high water mark is established. Wetlands contiguous to the waterbody are considered part of the waterbody.

FINAL REGIONAL CONDITIONS FOR NATIONWIDE PERMITS IN THE WILMINGTON DISTRICT

1. Waters Excluded from NWP or Subject to Additional Notification Requirements:
 - a. The Corps identified waters that will be excluded from use of this NWP. These waters are:
 1. Discharges into Waters of the United States designated by either the North Carolina Division of Marine Fisheries (NCDMF) or the North Carolina Wildlife Resources Commission (NCWRC) as anadromous fish spawning area are prohibited during the period between February 15 and June 30, without prior written approval from NCDMF or NCWRC and the Corps.
 2. Discharges into Waters of the United States designated as sturgeon spawning areas are prohibited during the period between February 1 and June 30, without prior written approval from the National Marine Fisheries Service (NMFS).
 - b. The Corps identified waters that will be subject to additional notification requirements for activities authorized by this NWP. These waters are:
 1. Prior to the use of any NWP in any of the following North Carolina *designated waters*, applicants must comply with Nationwide Permit General Condition 13. In addition, the

applicant must furnish a written statement of compliance with all of the conditions of the applicable Nationwide Permit. The North Carolina *designated waters* that require additional notification requirements are “Outstanding Resource Waters” (ORW) and “High Quality Waters” (HQW) (as defined by the North Carolina Division of Water Quality), or “Inland Primary Nursery Areas” (IPNA) (as defined by the North Carolina Wildlife Resources Commission), or contiguous wetlands (as defined by the North Carolina Division of Water Quality), or “Primary Nursery Areas” (PNA) (as defined by the North Carolina Division of Marine Fisheries).

2. Applicants for any NWP in a designated “Area of Environmental Concern” (AEC) in the twenty (20) coastal counties of Eastern North Carolina covered by the North Carolina Coastal Area Management Act (CAMA), must also obtain the required CAMA permit. Construction activities may not commence until a copy of the approved CAMA permit is furnished to the appropriate Wilmington District Regulatory Field Office (Wilmington Field Office – P.O. Box 1890, Wilmington, NC 28402 or Washington Field Office – P.O. Box 1000, Washington, NC 27889) for authorization to begin work.

3. Prior to the use of any NWP on a Barrier Island of North Carolina, applicants must comply with Nationwide Permit General Condition 13. In addition, the applicant shall furnish a written statement of compliance with all of the conditions listed of the applicable Nationwide Permit.

4. Prior to the use of any NWP in a “Mountain or Piedmont Bog” of North Carolina, applicants shall comply with Nationwide Permit General Condition 13. In addition, the applicant shall furnish a written statement of compliance with all of the conditions listed of the applicable NWP.

Note: The following wetland community types identified in the N.C. Natural Heritage Program document, “Classification of Natural communities of North Carolina (Michael P. Schafale and Alan S. Weakley, 1990), are subject to this regional condition.

Mountain Bogs

Swamp Forest-Bog Complex
Swamp Forest-Bog Complex (Spruce Subtype)
Southern Appalachian Bog (Northern Subtype)
Southern Appalachian Bog (Southern Subtype)
Southern Appalachian Fen

Piedmont Bogs

Upland Depression Swamp Forest

5. Prior to the use of any NWP in Mountain Trout Waters within twenty-five (25) designated counties of North Carolina, applicants shall comply with Nationwide General Condition 13. In addition, the applicant shall furnish a written statement of compliance with all of the conditions listed of the applicable NWP. Notification will include a letter of comments and recommendations from the North Carolina Wildlife Resources Commission (NCWRC), the

location of work, a delineation of wetlands, a discussion of alternatives to working in the Mountain Trout Waters, why other alternatives were not selected, and a plan to provide compensatory mitigation for all unavoidable adverse impacts to the Mountain Trout Waters. To facilitate coordination with the NCWRC, the proponent may provide a copy of the notification to the NCWRC concurrent with the notification to the District Engineer. The NCWRC will respond both to the proponent and directly to the Corps of Engineers.

The twenty-five (25) designated counties are:

Alleghany	Ashe	Avery	Yancey
Buncombe	Burke	Caldwell	Wilkes
Cherokee	Clay	Graham	Swain
Haywood	Henderson	Jackson	Surry
Macon	Madison	McDowell	Stokes
Mitchell	Polk	Rutherford	
Transylvania	Watauga		

6. Applicants shall notify the NCDENR Shellfish Sanitation Section prior to dredging in or removing sediment from an area closed to shell fishing where the effluent may be released to an area open for shell fishing or swimming in order to avoid contamination of the disposal area and allow a temporary shellfish closure to be made. Any disposal of sand to the beach should occur between November 1 and April 30 when recreational usage is low. Only clean sand should be used and no dredged sand from closed shell fishing areas. If beach disposal was to occur at times other than stated above or if sand from a closed shell fishing area is to be used, a swim advisory shall be posted and a press release shall be made. NCDENR Shellfish Sanitation Section must be notified before commencing this activity.

2. List of Final Corps Regional Modifications and Conditions for All Nationwide Permits

a. Individual or multiple NWPs may not be used for activities that result in the cumulative loss or degradation of greater than 300 total linear feet of perennial streambed or intermittent streambed that exhibits important aquatic function(s).

b. Prior to the use of any NWP (except 13, 27, and 39) for any activity that has more than a total of 150 total linear feet of perennial streambed impacts or intermittent streambed impacts (if the intermittent stream has important aquatic function), the applicant must comply with Nationwide Permit General Condition 13. In addition, the applicant shall furnish a written statement of compliance with all of the conditions listed of the applicable NWP. Compensatory mitigation is typically required for any impact that requires such notification. [Note: The Corps uses the Intermittent Channel Evaluation Form, located with Permit Information on the Regulatory Program Web Site, to aid in the determination of the intermittent channel stream status. Also, NWPs 13, 27 and 39 have specific reporting requirements.]

c. For all Nationwide Permits which allow the use of concrete as a building material, measures will be taken to prevent live or fresh concrete, including bags of uncured concrete, from coming into contact with waters of the state until the concrete has hardened.

d. For all Nationwide Permits that allow for the use of riprap material for bank stabilization, filter cloth must be placed underneath the riprap as an additional requirement of its use in North Carolina waters.

e. For all NWP's that involve the construction of culverts, measures will be included in the construction that will promote the safe passage of fish and other aquatic organisms. All culverts in the 20 CAMA coastal counties must be buried to a depth of one foot below the

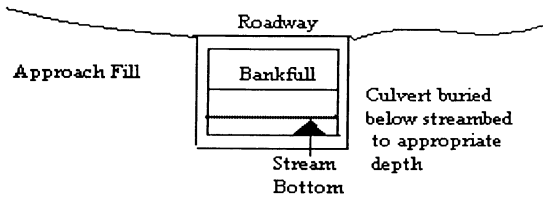

bed of the stream or wetland. For all culvert construction activities, the dimension, pattern, and profile of the stream, (above and below a pipe or culvert), should not be modified by widening the stream channel or by reducing the depth of the stream. Culvert inverts will be buried at least one foot below the bed of the stream for culverts greater than 48 inches in diameter. For culverts 48 inches in diameter or smaller, culverts must be buried below the bed of the stream to a depth equal to or greater than 20 percent of the diameter of the culvert. Bottomless arch culverts will satisfy this condition. A waiver from the depth specifications in this Regional Condition may be requested in writing. The waiver will only be issued if it can be demonstrated that the impacts of complying with this Regional Condition would result in more adverse impacts to the aquatic environment.

NORTH CAROLINA DIVISION OF WATER QUALITY
GENERAL CERTIFICATION CONDITIONS
GC3361

1. Proposed fill or substantial modification of wetlands or waters (including streams) under this General Certification requires notification to the Division of Water Quality. Two copies shall be submitted to DWQ at the time of notification in accordance with 15A NCAC 2H .0501(a). Written concurrence from DWQ is not required unless any standard conditions of this Certification cannot be met;

2. Appropriate sediment and erosion control practices which equal or exceed those outlined in the most recent version of the "North Carolina Sediment and Erosion Control Planning and Design Manual" or the "North Carolina Surface Mining Manual" whichever is more appropriate (available from the Division of Land Resources (DLR) in the DENR Regional or Central Offices) shall be in full compliance with all specifications governing the proper design,

installation and operation and maintenance of such Best Management Practices in order to assure compliance with the appropriate turbidity water quality standard;

3. In accordance with 15A NCAC 2H .0506 (h) compensatory mitigation may be required for impacts to 150 linear feet or more of streams and/or one acre or more of wetlands. In addition, buffer mitigation may be required for any project with Buffer Rules in effect at the time of application for buffer impacts resulting from activities classified as "allowable with mitigation" within the "Table of Uses" section of the Buffer Rules or require a variance under the Buffer Rules. A determination of buffer, wetland and stream mitigation requirements shall be made for any Certification for this Nationwide Permit. The most current design and monitoring protocols from DWQ shall be followed and written plans submitted for DWQ approval as required in those protocols. When compensatory mitigation is required for a project, the mitigation plans must be approved by DWQ in writing before the impacts approved by the Certification occur. The mitigation plan must be implemented and/or constructed before any permanent building or structure on site is occupied. In the case of public road projects, the mitigation plan must be implemented before the road is opened to the traveling public;

4. Compensatory stream mitigation shall be required at a 1:1 ratio for all perennial and intermittent stream impacts equal to or exceeding 150 feet and that require application to DWQ in watersheds classified as ORW, HQW, Tr, WS-I and WS-II;

5. All sediment and erosion control measures placed in wetlands or waters shall be removed and the original grade restored within two months after the Division of Land Resources has released the project;

6. Measures shall be taken to prevent live or fresh concrete from coming into contact with waters of the state until the concrete has hardened;

7. In accordance with North Carolina General Statute Section 143-215.3D(e), any request for written concurrence for a 401 Water Quality Certification must include the appropriate fee. If a project also requires a CAMA Permit, one payment to both agencies shall be submitted and will be the higher of the two fees;

8. Impacts to any stream length in the Neuse, Tar-Pamlico, Randleman and Catawba River Basins (or any other river basins with Riparian Area Protection Rules [Buffer Rules] in effect at the time of application) requires written concurrence from DWQ in accordance with 15A NCAC 2B.0200. Activities listed as "exempt" from these rules do not need to apply for written concurrence under this Certification. New development activities located in the protected 50-foot wide riparian areas (whether jurisdictional wetlands or not) within the Neuse, Tar-Pamlico, Randleman and Catawba River Basins shall be limited to "uses" identified within and constructed in accordance with 15A NCAC 2B .0200. All new development shall be located, designed, constructed, and maintained to have minimal disturbance to protect water quality to the maximum extent practicable through the use of best management practices;

9. Additional site-specific conditions may be added to projects for which written concurrence is required or requested under this Certification in order to ensure compliance with all applicable water quality and effluent standards;

10. Concurrence from DWQ that this Certification applies to an individual project shall expire three years from the date of the cover letter from DWQ or on the same day as the expiration date of the corresponding Nationwide and Regional General Permits, whichever is sooner;

11. When written concurrence is required, the applicant is required to use the most recent version of the Certification of Completion form to notify DWQ when all work included in the 401 Certification has been completed.

NORTH CAROLINA DIVISION OF COASTAL MANAGEMENT
STATE CONSISTENCY

Consistent.

Citations:

2002 Nationwide Permits - Federal Register Notice 15 Jan 2002

2002 Nationwide Permits Corrections - Federal Register Notice 13 Feb 2002

2002 Regional Conditions – Authorized 17 May 2002



STATE OF NORTH CAROLINA
DEPARTMENT OF TRANSPORTATION

MICHAEL F. EASLEY
GOVERNOR

LYNDO TIPPETT
SECRETARY

July 12, 2004

To: File

From: Brett Feulner, Permit Specialist

Subject: B-2963 Water Quality (401) Certification

Written concurrence with the 401 certification is not required for this project, per Division of Water Quality Certification #3403. Written concurrence from DWQ is not required unless any standard condition of the General Certification(s), and additional commitments developed through permitting (Greensheet) cannot be met.