



STATE OF NORTH CAROLINA  
DEPARTMENT OF TRANSPORTATION

PAT MCCRORY  
GOVERNOR

NICHOLAS J. TENNYSON  
SECRETARY

September 1, 2015

U. S. Army Corps of Engineers  
Regulatory Field Office  
151 Patton Avenue, Room 208  
Asheville, NC 28801-5006

ATTN: Ms. Loretta Beckwith  
NCDOT Coordinator

Subject: **Application for Section 404 Nationwide Permits 13 and 23 and Section 401 Water Quality Certification** for the proposed replacement of Bridge No. 363 over Robinson Creek on SR 3197 (Lower Christ School Rd.) in Buncombe County, Federal Aid Project No. BRZ-3197(1), Division 13, TIP No. B-5244, Debit \$240 from WBS 42846.1.1.

Dear Ms. Beckwith:

The North Carolina Department of Transportation (NCDOT) proposes to replace Bridge No. 363 over Robinson Creek on SR 3197 (a 34-foot bridge) with a 45-foot cored slab bridge on the existing alignment that will span Robinson Creek. The project will utilize an off-site detour.

There will be a total of 119 linear feet (lf) of permanent stream impacts:

Site 1. 90 lf of bank stabilization along Robinson Creek:

- 47 lf associated with the new bridge
- 13 lf associated with the tying in of a new ditch to Robinson Creek (southwest quadrant)
- 30 lf associated with the tying in of a new ditch to Robinson Creek (northeast quadrant)

Site 2. 29 lf of impact from the filling of the UT to Robinson Creek.

A new ditch will be constructed outside/beyond the fill slope of the UT to Robinson Creek that is to be filled, replacing the lost function of the stream.

With this submittal, the NCDOT is also requesting a Preliminary Jurisdictional Determination (PJD).

**MAILING ADDRESS:**  
NC DEPARTMENT OF TRANSPORTATION  
PROJECT DEVELOPMENT AND ENVIRONMENTAL ANALYSIS  
1548 MAIL SERVICE CENTER  
RALEIGH NC 27699-1548

TELEPHONE: 919-707-6000  
FAX: 919-250-4224

WEBSITE:  
[HTTPS://CONNECT.NCDOT.GOV/RESOURCES/ENVIRONMENTAL/PAGES/DEFAULT.ASPX](https://connect.ncdot.gov/resources/environmental/pages/default.aspx)

**LOCATION:**  
CENTURY CENTER, BUILDING A  
1000 BIRCH RIDGE DRIVE  
RALEIGH NC 27610

Please see enclosed copies of the Pre-Construction Notification (PCN), USFWS Concurrence Letter, PJD Packet, stormwater management plan, permit drawings and design plans for the above-referenced project. The Programmatic Categorical Exclusion (PCE) was completed in June 2014 and distributed shortly thereafter. Additional copies are available upon request.

This project calls for a letting date of February 16, 2016 and a review date of December 29, 2015; however, the let date may advance as additional funding becomes available.

A copy of this permit application and its distribution list will be posted on the NCDOT Website at: <http://connect.ncdot.gov/resources/Environmental>. If you have any questions or need additional information, please call Bill Barrett at (919) 707-6103.

Sincerely,



Richard W. Hancock, P.E., Manager  
Project Development and Environmental Analysis Unit

cc:  
NCDOT Permit Application Standard Distribution List



Office Use Only:  
 Corps action ID no. \_\_\_\_\_  
 DWQ project no. \_\_\_\_\_  
 Form Version 1.4 January 2009

## Pre-Construction Notification (PCN) Form

### A. Applicant Information

#### 1. Processing

1a. Type(s) of approval sought from the Corps:	<input checked="" type="checkbox"/> Section 404 Permit	<input type="checkbox"/> Section 10 Permit
1b. Specify Nationwide Permit (NWP) number: 13 23 or General Permit (GP) number:		
1c. Has the NWP or GP number been verified by the Corps?	<input type="checkbox"/> Yes	<input checked="" type="checkbox"/> No
1d. Type(s) of approval sought from the DWQ (check all that apply):		
<input type="checkbox"/> 401 Water Quality Certification – Regular <span style="margin-left: 150px;"><input type="checkbox"/> Non-404 Jurisdictional General Permit</span> <input checked="" type="checkbox"/> 401 Water Quality Certification – Express <span style="margin-left: 150px;"><input type="checkbox"/> Riparian Buffer Authorization</span>		
1e. Is this notification solely for the record because written approval is not required?	For the record only for DWQ 401 Certification: <input checked="" type="checkbox"/> Yes <input type="checkbox"/> No	For the record only for Corps Permit: <input type="checkbox"/> Yes <input checked="" type="checkbox"/> No
1f. Is payment into a mitigation bank or in-lieu fee program proposed for mitigation of impacts? If so, attach the acceptance letter from mitigation bank or in-lieu fee program.	<input type="checkbox"/> Yes	<input type="checkbox"/> No
1g. Is the project located in any of NC's twenty coastal counties. If yes, answer 1h below.	<input type="checkbox"/> Yes	<input checked="" type="checkbox"/> No
1h. Is the project located within a NC DCM Area of Environmental Concern (AEC)?	<input type="checkbox"/> Yes	<input checked="" type="checkbox"/> No

#### 2. Project Information

2a. Name of project:	Replacement of Bridge 363 over Robinson Creek on SR 3197
2b. County:	Buncombe
2c. Nearest municipality / town:	Arden, NC
2d. Subdivision name:	<i>not applicable</i>
2e. NCDOT only, T.I.P. or state project no:	B-5244

#### 3. Owner Information

3a. Name(s) on Recorded Deed:	North Carolina Department of Transportation
3b. Deed Book and Page No.	<i>not applicable</i>
3c. Responsible Party (for LLC if applicable):	<i>not applicable</i>
3d. Street address:	1598 Mail Service Center
3e. City, state, zip:	Raleigh, NC 27699-1598
3f. Telephone no.:	(919) 707-6103
3g. Fax no.:	(919) 212-5785
3h. Email address:	wabarrett@ncdot.gov

<b>4. Applicant Information (if different from owner)</b>	
4a. Applicant is:	<input type="checkbox"/> Agent <input type="checkbox"/> Other, specify:
4b. Name:	<i>not applicable</i>
4c. Business name (if applicable):	
4d. Street address:	
4e. City, state, zip:	
4f. Telephone no.:	
4g. Fax no.:	
4h. Email address:	
<b>5. Agent/Consultant Information (if applicable)</b>	
5a. Name:	<i>not applicable</i>
5b. Business name (if applicable):	
5c. Street address:	
5d. City, state, zip:	
5e. Telephone no.:	
5f. Fax no.:	
5g. Email address:	



<b>B. Project Information and Prior Project History</b>	
<b>1. Property Identification</b>	
1a. Property identification no. (tax PIN or parcel ID):	<i>not applicable</i>
1b. Site coordinates (in decimal degrees):	Latitude: 35.459989 (DD.DDDDDD) Longitude: - 82.480958 (-DD.DDDDDD)
1c. Property size:	0.20 acres
<b>2. Surface Waters</b>	
2a. Name of nearest body of water (stream, river, etc.) to proposed project:	Robinson Creek
2b. Water Quality Classification of nearest receiving water:	C;Tr
2c. River basin:	French Broad
<b>3. Project Description</b>	
3a. Describe the existing conditions on the site and the general land use in the vicinity of the project at the time of this application: predominately residential	
3b. List the total estimated acreage of all existing wetlands on the property: 0	
3c. List the total estimated linear feet of all existing streams (intermittent and perennial) on the property: 150	
3d. Explain the purpose of the proposed project: To replace a structurally deficient (and/ or) functionally obsolete bridge.	
3e. Describe the overall project in detail, including the type of equipment to be used: The project involves replacing a 36-foot bridge with a 45-foot, single-span bridge on the existing alignment with an off-site detour. Standard road building equipment, such as trucks, dozers, and cranes will be used.	
<b>4. Jurisdictional Determinations</b>	
4a. Have jurisdictional wetland or stream determinations by the Corps or State been requested or obtained for this property / project (including all prior phases) in the past? Comments: PJD request being submitted with this permit application.	<input type="checkbox"/> Yes <input checked="" type="checkbox"/> No <input type="checkbox"/> Unknown
4b. If the Corps made the jurisdictional determination, what type of determination was made?	<input type="checkbox"/> Preliminary <input type="checkbox"/> Final
4c. If yes, who delineated the jurisdictional areas? Name (if known):	Agency/Consultant Company: Other:
4d. If yes, list the dates of the Corps jurisdictional determinations or State determinations and attach documentation.	
<b>5. Project History</b>	
5a. Have permits or certifications been requested or obtained for this project (including all prior phases) in the past?	<input type="checkbox"/> Yes <input checked="" type="checkbox"/> No <input type="checkbox"/> Unknown
5b. If yes, explain in detail according to "help file" instructions.	
<b>6. Future Project Plans</b>	
6a. Is this a phased project?	<input type="checkbox"/> Yes <input checked="" type="checkbox"/> No
6b. If yes, explain.	

<b>C. Proposed Impacts Inventory</b>						
<b>1. Impacts Summary</b>						
1a. Which sections were completed below for your project (check all that apply):						
<input type="checkbox"/> Wetlands		<input checked="" type="checkbox"/> Streams - tributaries		<input type="checkbox"/> Buffers		
<input type="checkbox"/> Open Waters		<input type="checkbox"/> Pond Construction				
<b>2. Wetland Impacts</b>						
If there are wetland impacts proposed on the site, then complete this question for each wetland area impacted.						
2a. Wetland impact number – Permanent (P) or Temporary (T)	2b. Type of impact	2c. Type of wetland (if known)	2d. Forested	2e. Type of jurisdiction	2f. Area of impact (acres)	
Site 1 <input type="checkbox"/> P <input type="checkbox"/> T		Choose One	<input type="checkbox"/> Yes <input type="checkbox"/> No	<input type="checkbox"/> Corps <input type="checkbox"/> DWQ		
Site 2 <input type="checkbox"/> P <input type="checkbox"/> T		Choose One	<input type="checkbox"/> Yes <input type="checkbox"/> No	<input type="checkbox"/> Corps <input type="checkbox"/> DWQ		
Site 3 <input type="checkbox"/> P <input type="checkbox"/> T		Choose One	<input type="checkbox"/> Yes <input type="checkbox"/> No	<input type="checkbox"/> Corps <input type="checkbox"/> DWQ		
Site 4 <input type="checkbox"/> P <input type="checkbox"/> T		Choose One	<input type="checkbox"/> Yes <input type="checkbox"/> No	<input type="checkbox"/> Corps <input type="checkbox"/> DWQ		
Site 5 <input type="checkbox"/> P <input type="checkbox"/> T		Choose One	<input type="checkbox"/> Yes <input type="checkbox"/> No	<input type="checkbox"/> Corps <input type="checkbox"/> DWQ		
Site 6 <input type="checkbox"/> P <input type="checkbox"/> T		Choose One	<input type="checkbox"/> Yes <input type="checkbox"/> No	<input type="checkbox"/> Corps <input type="checkbox"/> DWQ		
<b>2g. Total wetland impacts</b>					X Permanent X Temporary	
2h. Comments:						
<b>3. Stream Impacts</b>						
If there are perennial or intermittent stream impacts (including temporary impacts) proposed on the site, then complete this question for all stream sites impacted.						
3a. Stream impact number - Permanent (P) or Temporary (T)	3b. Type of impact	3c. Stream name	3d. Perennial (PER) or intermittent (INT)?	3e. Type of jurisdiction (Corps - 404, 10 DWQ – non-404, other)	3f. Average stream width (feet)	3g. Impact length (linear feet)
Site 1 <input checked="" type="checkbox"/> P <input type="checkbox"/> T	bank stabilization (bridge)	Robinson Creek	<input checked="" type="checkbox"/> PER <input type="checkbox"/> INT	<input checked="" type="checkbox"/> Corps <input type="checkbox"/> DWQ	15	47
Site 1 <input checked="" type="checkbox"/> P <input type="checkbox"/> T	bank stabilization (ditch confluence)	Robinson Creekk	<input checked="" type="checkbox"/> PER <input type="checkbox"/> INT	<input checked="" type="checkbox"/> Corps <input type="checkbox"/> DWQ	15	13
Site 1 <input checked="" type="checkbox"/> P <input type="checkbox"/> T	bank stabilization (ditch confluence)	Robinson Creek	<input checked="" type="checkbox"/> PER <input type="checkbox"/> INT	<input checked="" type="checkbox"/> Corps <input type="checkbox"/> DWQ	15	30
Site 2 <input checked="" type="checkbox"/> P <input type="checkbox"/> T	fill	UT to Robinson Creek	<input checked="" type="checkbox"/> PER <input type="checkbox"/> INT	<input checked="" type="checkbox"/> Corps <input type="checkbox"/> DWQ	3	29
Site 5 <input type="checkbox"/> P <input type="checkbox"/> T			<input type="checkbox"/> PER <input type="checkbox"/> INT	<input type="checkbox"/> Corps <input type="checkbox"/> DWQ		

Site 6 <input type="checkbox"/> P <input type="checkbox"/> T			<input type="checkbox"/> PER <input type="checkbox"/> INT	<input type="checkbox"/> Corps <input type="checkbox"/> DWQ				
<b>3h. Total stream and tributary impacts</b>						119 Perm 0 Temp		
3i. Comments:								
<b>4. Open Water Impacts</b>								
If there are proposed impacts to lakes, ponds, estuaries, tributaries, sounds, the Atlantic Ocean, or any other open water of the U.S. then individually list all open water impacts below.								
4a. Open water impact number – Permanent (P) or Temporary (T)	4b. Name of waterbody (if applicable)	4c. Type of impact			4d. Waterbody type	4e. Area of impact (acres)		
O1 <input type="checkbox"/> P <input type="checkbox"/> T								
O2 <input type="checkbox"/> P <input type="checkbox"/> T								
O3 <input type="checkbox"/> P <input type="checkbox"/> T								
O4 <input type="checkbox"/> P <input type="checkbox"/> T								
<b>4f. Total open water impacts</b>						X Permanent X Temporary		
4g. Comments:								
<b>5. Pond or Lake Construction</b>								
If pond or lake construction proposed, then complete the chart below.								
5a. Pond ID number	5b. Proposed use or purpose of pond	5c. Wetland Impacts (acres)			5d. Stream Impacts (feet)			5e. Upland (acres)
		Flooded	Filled	Excavated	Flooded	Filled	Excavated	Flooded
P1								
P2								
<b>5f. Total</b>								
5g. Comments:								
5h. Is a dam high hazard permit required?			<input type="checkbox"/> Yes <input type="checkbox"/> No      If yes, permit ID no:					
5i. Expected pond surface area (acres):								
5j. Size of pond watershed (acres):								
5k. Method of construction:								

**6. Buffer Impacts (for DWQ)**

If project will impact a protected riparian buffer, then complete the chart below. If yes, then individually list all buffer impacts below. If any impacts require mitigation, then you **MUST** fill out Section D of this form.

6a. Project is in which protected basin?		<input type="checkbox"/> Neuse <input type="checkbox"/> Tar-Pamlico <input type="checkbox"/> Other: <input type="checkbox"/> Catawba <input type="checkbox"/> Randleman			
6b. Buffer impact number – Permanent (P) or Temporary (T)	6c. Reason for impact	6d. Stream name	6e. Buffer mitigation required?	6f. Zone 1 impact (square feet)	6g. Zone 2 impact (square feet)
B1 <input type="checkbox"/> P <input type="checkbox"/> T			<input type="checkbox"/> Yes <input type="checkbox"/> No		
B2 <input type="checkbox"/> P <input type="checkbox"/> T			<input type="checkbox"/> Yes <input type="checkbox"/> No		
B3 <input type="checkbox"/> P <input type="checkbox"/> T			<input type="checkbox"/> Yes <input type="checkbox"/> No		
<b>6h. Total buffer impacts</b>					
6i. Comments:					

<b>D. Impact Justification and Mitigation</b>		
<b>1. Avoidance and Minimization</b>		
1a. Specifically describe measures taken to avoid or minimize the proposed impacts in designing project. The proposed bridge is 9 feet longer than the existing bridge; the proposed bridge will span Robinson Creek; the proposed bridge will be at approximately the same grade as the existing structure; an off site detour will be used, 3:1 fill slopes where practicable.		
1b. Specifically describe measures taken to avoid or minimize the proposed impacts through construction techniques.		
<b>2. Compensatory Mitigation for Impacts to Waters of the U.S. or Waters of the State</b>		
2a. Does the project require Compensatory Mitigation for impacts to Waters of the U.S. or Waters of the State?	<input checked="" type="checkbox"/> Yes <input checked="" type="checkbox"/> No If no, explain: Pursuant to contact with Lori Beckwith of the USACE (see attached e.mail dated 6/24/2015, mitigation will not be required for the filling of the UT to Robinson Creek (29 lf), as the proposed ditch will provide the lost function.  NCDOT does not propose mitigation for the 90 lf of bank stabilization impact at Site 1, as it does not require fill in the stream bed and therefore, under Section 404 of the Clean Water Act, does not constitute Loss of Waters of the U.S. and is not subject to compensatory mitigation. Furthermore, the proposed bank stabilization is necessary to prevent erosion and sedimentation by preventing bank destabilization and thereby minimizing impacts to the environment.	
2b. If yes, mitigation is required by (check all that apply):	<input type="checkbox"/> DWQ <input checked="" type="checkbox"/> Corps	
2c. If yes, which mitigation option will be used for this project?	<input type="checkbox"/> Mitigation bank <input checked="" type="checkbox"/> Payment to in-lieu fee program <input type="checkbox"/> Permittee Responsible Mitigation	
<b>3. Complete if Using a Mitigation Bank</b>		
3a. Name of Mitigation Bank: not applicable		
3b. Credits Purchased (attach receipt and letter)	Type	Quantity
3c. Comments:		
<b>4. Complete if Making a Payment to In-lieu Fee Program</b>		
4a. Approval letter from in-lieu fee program is attached.	<input checked="" type="checkbox"/> Yes	
4b. Stream mitigation requested:	29 linear feet	
4c. If using stream mitigation, stream temperature:	<input type="checkbox"/> warm <input checked="" type="checkbox"/> cool <input type="checkbox"/> cold	
4d. Buffer mitigation requested (DWQ only):	square feet	
4e. Riparian wetland mitigation requested:	acres	
4f. Non-riparian wetland mitigation requested:	acres	
4g. Coastal (tidal) wetland mitigation requested:	acres	
4h. Comments:		
<b>5. Complete if Using a Permittee Responsible Mitigation Plan</b>		

5a. If using a permittee responsible mitigation plan, provide a description of the proposed mitigation plan.

**6. Buffer Mitigation (State Regulated Riparian Buffer Rules) – required by DWQ**

6a. Will the project result in an impact within a protected riparian buffer that requires buffer mitigation?  Yes  No

6b. If yes, then identify the square feet of impact to each zone of the riparian buffer that requires mitigation. Calculate the amount of mitigation required.

Zone	6c. Reason for impact	6d. Total impact (square feet)	Multiplier	6e. Required mitigation (square feet)
Zone 1			3 (2 for Catawba)	
Zone 2			1.5	
<b>6f. Total buffer mitigation required:</b>				

6g. If buffer mitigation is required, discuss what type of mitigation is proposed (e.g., payment to private mitigation bank, permittee responsible riparian buffer restoration, payment into an approved in-lieu fee fund).

6h. Comments:



<b>E. Stormwater Management and Diffuse Flow Plan (required by DWQ)</b>	
<b>1. Diffuse Flow Plan</b>	
1a. Does the project include or is it adjacent to protected riparian buffers identified within one of the NC Riparian Buffer Protection Rules?	<input type="checkbox"/> Yes <input checked="" type="checkbox"/> No
1b. If yes, then is a diffuse flow plan included? If not, explain why. Comments: If required from 1a, see attached buffer permit drawings.	<input type="checkbox"/> Yes <input type="checkbox"/> No
<b>2. Stormwater Management Plan</b>	
2a. What is the overall percent imperviousness of this project?	N/A
2b. Does this project require a Stormwater Management Plan?	<input checked="" type="checkbox"/> Yes <input type="checkbox"/> No
2c. If this project DOES NOT require a Stormwater Management Plan, explain why:	
2d. If this project DOES require a Stormwater Management Plan, then provide a brief, narrative description of the plan: See attached permit drawings.	
2e. Who will be responsible for the review of the Stormwater Management Plan?	<input type="checkbox"/> Certified Local Government <input type="checkbox"/> DWQ Stormwater Program <input checked="" type="checkbox"/> DWQ 401 Unit
<b>3. Certified Local Government Stormwater Review</b>	
3a. In which local government's jurisdiction is this project?	not applicable
3b. Which of the following locally-implemented stormwater management programs apply (check all that apply):	<input type="checkbox"/> Phase II <input type="checkbox"/> NSW <input type="checkbox"/> USMP <input type="checkbox"/> Water Supply Watershed <input type="checkbox"/> Other:
3c. Has the approved Stormwater Management Plan with proof of approval been attached?	<input type="checkbox"/> Yes <input type="checkbox"/> No
<b>4. DWQ Stormwater Program Review</b>	
4a. Which of the following state-implemented stormwater management programs apply (check all that apply):	<input type="checkbox"/> Coastal counties <input type="checkbox"/> HQW <input type="checkbox"/> ORW <input type="checkbox"/> Session Law 2006-246 <input type="checkbox"/> Other:
4b. Has the approved Stormwater Management Plan with proof of approval been attached?	<input type="checkbox"/> Yes <input type="checkbox"/> No n/a
<b>5. DWQ 401 Unit Stormwater Review</b>	
5a. Does the Stormwater Management Plan meet the appropriate requirements?	<input type="checkbox"/> Yes <input type="checkbox"/> No n/a
5b. Have all of the 401 Unit submittal requirements been met?	<input type="checkbox"/> Yes <input type="checkbox"/> No n/a

<b>F. Supplementary Information</b>	
<b>1. Environmental Documentation (DWQ Requirement)</b>	
1a. Does the project involve an expenditure of public (federal/state/local) funds or the use of public (federal/state) land?	<input checked="" type="checkbox"/> Yes <input type="checkbox"/> No
1b. If you answered "yes" to the above, does the project require preparation of an environmental document pursuant to the requirements of the National or State (North Carolina) Environmental Policy Act (NEPA/SEPA)?	<input checked="" type="checkbox"/> Yes <input type="checkbox"/> No
1c. If you answered "yes" to the above, has the document review been finalized by the State Clearing House? (If so, attach a copy of the NEPA or SEPA final approval letter.)  Comments:	<input checked="" type="checkbox"/> Yes <input type="checkbox"/> No
<b>2. Violations (DWQ Requirement)</b>	
2a. Is the site in violation of DWQ Wetland Rules (15A NCAC 2H .0500), Isolated Wetland Rules (15A NCAC 2H .1300), DWQ Surface Water or Wetland Standards, or Riparian Buffer Rules (15A NCAC 2B .0200)?	<input type="checkbox"/> Yes <input checked="" type="checkbox"/> No
2b. Is this an after-the-fact permit application?	<input type="checkbox"/> Yes <input checked="" type="checkbox"/> No
2c. If you answered "yes" to one or both of the above questions, provide an explanation of the violation(s):	
<b>3. Cumulative Impacts (DWQ Requirement)</b>	
3a. Will this project (based on past and reasonably anticipated future impacts) result in additional development, which could impact nearby downstream water quality?	<input type="checkbox"/> Yes <input checked="" type="checkbox"/> No
3b. If you answered "yes" to the above, submit a qualitative or quantitative cumulative impact analysis in accordance with the most recent DWQ policy. If you answered "no," provide a short narrative description.  Due to the minimal transportation impact resulting from this bridge replacement, this project will neither influence nearby land uses nor stimulate growth. Therefore, a detailed indirect or cumulative effects study will not be necessary.	
<b>4. Sewage Disposal (DWQ Requirement)</b>	
4a. Clearly detail the ultimate treatment methods and disposition (non-discharge or discharge) of wastewater generated from the proposed project, or available capacity of the subject facility.  not applicable	

<b>5. Endangered Species and Designated Critical Habitat (Corps Requirement)</b>		
5a. Will this project occur in or near an area with federally protected species or habitat?	<input checked="" type="checkbox"/> Yes	<input type="checkbox"/> No
5b. Have you checked with the USFWS concerning Endangered Species Act impacts?	<input checked="" type="checkbox"/> Yes	<input type="checkbox"/> No
5c. If yes, indicate the USFWS Field Office you have contacted.	<input type="checkbox"/> Raleigh <input checked="" type="checkbox"/> Asheville	
5d. What data sources did you use to determine whether your site would impact Endangered Species or Designated Critical Habitat?  <i>USFWS and NHP websites, and on-site surveys. Of the species listed for Buncombe County, only three have habitat present: Bunched arrowhead, Virginia spiraea, and the recent inclusion of the Northern long-eared bat (NLEB). Bunched arrowhead was surveyed for on May 23, 2011, and no individuals of this species were found and there is no NHP listing of this species within 1 mile of the project. The portion of the study area that provided habitat for bunched arrowhead, is not within the boundary of the project, as currently designed.</i>  <i>Virginia spiraea was most recently surveyed on June 27, 2013. No individuals of this species were identified, and there is no NHP listing of this species within 1 mile of the project.</i>  <i>With the recent listing of the NLEB, this project was assessed for habitat. As noted in the July 24, 2015 Memorandum, this proposed project has a biological conclusion of May Affect - Not Likely to Adversely Affect. A letter requesting concurrence with this biological conclusion, dated August 10, 2015, has been submitted to the USFWS. Construction activities will not take place until ESA compliance is satisfied for the NLEB.</i>		
<b>6. Essential Fish Habitat (Corps Requirement)</b>		
6a. Will this project occur in or near an area designated as essential fish habitat?	<input type="checkbox"/> Yes	<input checked="" type="checkbox"/> No
6b. What data sources did you use to determine whether your site would impact Essential Fish Habitat? NMFS County Index		
<b>7. Historic or Prehistoric Cultural Resources (Corps Requirement)</b>		
7a. Will this project occur in or near an area that the state, federal or tribal governments have designated as having historic or cultural preservation status (e.g., National Historic Trust designation or properties significant in North Carolina history and archaeology)?	<input type="checkbox"/> Yes	<input checked="" type="checkbox"/> No
7b. What data sources did you use to determine whether your site would impact historic or archeological resources? NEPA Documentation		
<b>8. Flood Zone Designation (Corps Requirement)</b>		
8a. Will this project occur in a FEMA-designated 100-year floodplain?	<input checked="" type="checkbox"/> Yes	<input type="checkbox"/> No
8b. If yes, explain how project meets FEMA requirements: NCDOT Hydraulics Unit coordination with FEMA		
8c. What source(s) did you use to make the floodplain determination? FEMA Maps		
for Richard W. Hancock, P.E. Applicant/Agent's Printed Name	 Applicant/Agent's Signature <small>(Agent's signature is valid only if an authorization letter from the applicant is provided.)</small>	9-1-2015 Date



# United States Department of the Interior

## FISH AND WILDLIFE SERVICE

Asheville Field Office  
160 Zillicoa Street  
Asheville, North Carolina 28801

August 20, 2015

Mr. Richard Hancock, P.E.  
North Carolina Department of Transportation  
1598 Mail Service Center  
Raleigh, North Carolina 27669

Dear Mr. Hancock:

Subject: Endangered Species Concurrence for proposed replacement of Bridge Number 363 (B-5244) on SR 3197 over Robinson Creek in Buncombe County, North Carolina.

On August 10, 2015 we received your letter (via email) requesting section 7 concurrence on effects the subject bridge replacement projects may have on the federally threatened northern long-eared bat (*Myotis septentrionalis*, NLEB). The following comments are provided in accordance with section 7 of the Endangered Species Act of 1973, as amended (16 U.S.C. 1531-1543) (Act).

We have reviewed the information provided in your concurrence request letter. The action area for these proposed projects is within the known range of the NLEB. We agree with your assessment that tree clearing associated with these projects is minimal and is within close proximity to existing maintained right of way, and that your agreement to cut trees outside of the bat maternity roosting season April 15-August 15, will reduce the probability of take for NLEB to a discountable level; and accordingly, we concur with your biological conclusion that the proposed construction may affect, but is not likely to adversely affect the NLEB or IB. Therefore, we believe the requirements under section 7(c) of the Act are fulfilled. However, obligations under section 7 of the Act must be reconsidered if: (1) new information reveals impacts of this identified action that may affect listed species or critical habitat in a manner not previously considered, (2) this action is subsequently modified in a manner that was not considered in this review, or (3) a new species is listed or critical habitat is determined that may be affected by the identified action.

If we can be of assistance or if you have any questions about these comments, please contact Mr. Jason Mays of our staff at 828/258-3939, Ext. 226. In any future correspondence concerning this project, please reference our Log Numbers 4-2-11-082.

Sincerely,

A handwritten signature in blue ink, appearing to read "Janet Mizzi". The signature is fluid and cursive, with the first name "Janet" being more prominent than the last name "Mizzi".

Janet Mizzi  
Field Supervisor



## Barrett, William A

---

**From:** Beckwith, Loretta A SAW <Loretta.A.Beckwith@usace.army.mil>  
**Sent:** Wednesday, July 01, 2015 11:28 AM  
**To:** Barrett, William A  
**Subject:** RE: B-5244 (UNCLASSIFIED)

Classification: UNCLASSIFIED  
Caveats: NONE

Hi Bill,

Thanks for the information. I'm comfortable with the relocation counting as mitigation for the impact to this particular stream, as long as no length is lost. It wouldn't hurt to put that we discussed this in the PCN or the cover letter for this project.

And as discussed below, for future projects, please submit the NC SAM forms.

Thanks and have a great 4th!

Lori

-----Original Message-----

From: Barrett, William A [<mailto:wabarrett@ncdot.gov>]  
Sent: Wednesday, July 01, 2015 10:39 AM  
To: Beckwith, Loretta A SAW  
Subject: [EXTERNAL] RE: B-5244 (UNCLASSIFIED)

Hi Lori,

THANKS for your response and the additional information you provided.

This is a project that I have taken over, and I had tried to find stream forms for this particular feature, but could not; which is why I provided the site photos (and agree with you pics are inefficient for determining stream quality, but went with what I had available). I was out at the site during some of the field reconnaissance; and can verify that it is a fair quality stream. There were other features within the original study area (that are now outside the construction area) that required much more attention and evaluation while out at the site. I do understand the need to provide the stream forms so that USACE has proper documentation, and will make sure that we have these in the future.

I have requested mitigation from EEP for the 29 lf of impact to the UT, while awaiting your response so as not to delay the application submittal. I have received EEP's confirmation of mitigation. I know that you concurred with the submitted rationale for not requiring mitigation for the impacts to the UT, and just want to make sure that you are comfortable with that call in absence of stream quality forms. I have mitigation confirmation in hand, if that is the preferable route to go.

Let me know.

THANKS



Bill

p.s. by the way, the application submittal is being delayed a little bit, as the NLEB discussions continue.

-----Original Message-----

From: Beckwith, Loretta A SAW [<mailto:Loretta.A.Beckwith@usace.army.mil>]

Sent: Wednesday, June 24, 2015 4:03 PM

To: Barrett, William A

Subject: RE: B-5244 (UNCLASSIFIED)

Classification: UNCLASSIFIED

Caveats: NONE

Hi Bill,

What you have in mind for this project sounds fine.

It's always good to have an NCSAM sheet (or a SQAW for older projects) as mitigation may be an issue with stream relocation projects. Mitigation isn't an issue for this project based on the length and apparent fair quality, but it's a good idea to collect this information during field visits and include it in the PCN/application. If we don't have a form showing that the stream in question is fair quality (vs. good) we may default to a 2:1 mitigation ratio, in which case we may require more mitigation than the stream relocation yields. The form helps, too, because you often can't determine stream quality from photos.

Thanks,

Lori

-----Original Message-----

From: Barrett, William A [<mailto:wabarrett@ncdot.gov>]

Sent: Wednesday, June 17, 2015 2:21 PM

To: Beckwith, Loretta A SAW

Subject: [EXTERNAL] B-5244

Hi Lori,

I am working on the permit application for B-5244, the replacement of Bridge No. 363 on SR 3197 (Lower Christ School Rd.) over Robinson Creek, in Buncombe County.

This project has a similar scenario as B-5403, where the function of a stream (that is located parallel to the road and is to be filled due to the new bridge) will be replaced by the creation of a ditch located outside the fill slope. Unlike B-5403, this stream (a UT to Robinson Creek that originates in a roadside ditch and has eroded down to become jurisdictional for the last 29 feet) runs straight, rather than meandering).

Using the thought process that was done for B-5403, the loss of function of the stream should be replaced by the new ditch. I have attached one of the permit pages to represent what I have attempted to describe. The 29 linear foot JD stream section is highlighted in yellow and labeled in a red box.

I have also attached three pictures, with their approximate location and orientation, shown on the attached the plan sheet.

Please let me know your thoughts, and feel free to call if you would like to discuss.

THANKS!

Bill

William A. Barrett

PDEA-Natural Environment Section

Environmental Coordination and Permitting

919-707-6103

[wabarrett@ncdot.gov](mailto:wabarrett@ncdot.gov)

---

Email correspondence to and from this sender is subject to the N.C. Public Records Law and may be disclosed to third parties.

Classification: UNCLASSIFIED

Caveats: NONE

---

Email correspondence to and from this sender is subject to the N.C. Public Records Law and may be disclosed to third parties.

**PRELIMINARY JURISDICTIONAL DETERMINATION FORM**

**BACKGROUND INFORMATION**

**A. REPORT COMPLETION DATE FOR PRELIMINARY JURISDICTIONAL DETERMINATION (JD):**

**B. NAME AND ADDRESS OF PERSON REQUESTING PRELIMINARY JD:**  
Bill Barrett, NCDOT, 1598 Mail Service Center, Raleigh, NC 27699-1598

**C. DISTRICT OFFICE, FILE NAME, AND NUMBER: CESAW-RG-**

**D. PROJECT LOCATION(S) AND BACKGROUND INFORMATION:**

TIP: B-5244 Description: replacement of Bridge No. 363 on SR 3197  
(Lower Christ School Rd.) over Robinson Creek.

**(USE THE ATTACHED TABLE TO DOCUMENT MULTIPLE WATERBODIES AT DIFFERENT SITES)**

State: NC County/parish/borough: Buncombe City: Arden  
Center coordinates of site (lat/long in degree decimal format):  
Lat. 35.45999971°**N**, Long. -82.480985° **W**  
Universal Transverse Mercator:  
Name of nearest waterbody:

Identify (estimate) amount of waters in the review area:

Non-wetland waters: 150 linear feet: 15 width (ft) and/or            acres.  
Cowardin Class: Riverine  
Stream Flow: Perennial  
Wetlands: 0 acres.  
Cowardin Class:

Name of any water bodies on the site that have been identified as Section 10 waters:

Tidal: N/A  
Non-Tidal: N/A

**E. REVIEW PERFORMED FOR SITE EVALUATION (CHECK ALL THAT APPLY):**

- Office (Desk) Determination Date:
- Field Determination Date(s):

1. The Corps of Engineers believes that there may be jurisdictional waters of the United States on the subject site, and the permit applicant or other affected party who requested this preliminary JD is hereby advised of his or her option to request and obtain an approved jurisdictional determination (JD) for that site. Nevertheless, the permit applicant or other person who requested this

preliminary JD has declined to exercise the option to obtain an approved JD in this instance and at this time.

2. In any circumstance where a permit applicant obtains an individual permit, or a Nationwide General Permit (NWP) or other general permit verification requiring “pre-construction notification” (PCN), or requests verification for a non-reporting NWP or other general permit, and the permit applicant has not requested an approved JD for the activity, the permit applicant is hereby made aware of the following: (1) the permit applicant has elected to seek a permit authorization based on a preliminary JD, which does not make an official determination of jurisdictional waters; (2) that the applicant has the option to request an approved JD before accepting the terms and conditions of the permit authorization, and that basing a permit authorization on an approved JD could possibly result in less compensatory mitigation being required or different special conditions; (3) that the applicant has the right to request an individual permit rather than accepting the terms and conditions of the NWP or other general permit authorization; (4) that the applicant can accept a permit authorization and thereby agree to comply with all the terms and conditions of that permit, including whatever mitigation requirements the Corps has determined to be necessary; (5) that undertaking any activity in reliance upon the subject permit authorization without requesting an approved JD constitutes the applicant’s acceptance of the use of the preliminary JD, but that either form of JD will be processed as soon as is practicable; (6) accepting a permit authorization (e.g., signing a proffered individual permit) or undertaking any activity in reliance on any form of Corps permit authorization based on a preliminary JD constitutes agreement that all wetlands and other water bodies on the site affected in any way by that activity are jurisdictional waters of the United States, and precludes any challenge to such jurisdiction in any administrative or judicial compliance or enforcement action, or in any administrative appeal or in any Federal court; and (7) whether the applicant elects to use either an approved JD or a preliminary JD, that JD will be processed as soon as is practicable. Further, an approved JD, a proffered individual permit (and all terms and conditions contained therein), or individual permit denial can be administratively appealed pursuant to 33 C.F.R. Part 331, and that in any administrative appeal, jurisdictional issues can be raised (see 33 C.F.R. 331.5(a)(2)). If, during that administrative appeal, it becomes necessary to make an official determination whether CWA jurisdiction exists over a site, or to provide an official delineation of jurisdictional waters on the site, the Corps will provide an approved JD to accomplish that result, as soon as is practicable. This preliminary JD finds that there “*may be*” waters of the United States on the subject project site, and identifies all aquatic features on the site that could be affected by the proposed activity, based on the following information:

**SUPPORTING DATA: Data reviewed for preliminary JD (check all that apply)**

- checked items should be included in case file and, where checked and requested, appropriately reference sources below):

- Maps, plans, plots or plat submitted by or on behalf of the applicant/consultant
- Data sheets prepared/submitted by or on behalf of the applicant/consultant
  - Office concurs with data sheets/delineation report.
  - Office does not concur with data sheets/delineation report.
- Data sheets prepared by the Corps:
- Corps navigable waters' study:
- U.S. Geological Survey Hydrologic Atlas:
  - USGS NHD data.
  - USGS 8 and 12 digit HUC maps
- U.S. Geological Survey map(s). Cite scale & quad name: 1:24000;
- USDA Natural Resources Conservation Service Soil Survey  
Citation:
- National wetlands inventory map(s). Cite name:
- State/Local wetland inventory map(s):
- FEMA/FIRM maps:
- 100-year Floodplain Elevation is: (National Geodectic Vertical Datum of 1929)
- Photographs:  Aerial (Name & Date): or  Other (Name & Date):
- Previous determination(s). File no. and date of response letter:
- Other information (please specify):

**IMPORTANT NOTE: The information recorded on this form has not necessarily been verified by the Corps and should not be relied upon for later jurisdictional determinations.**

\_\_\_\_\_  
Signature and date of  
Regulatory Project Manager  
(REQUIRED)

*WASA B # / 6-24-15*  
\_\_\_\_\_  
Signature and date of  
person requesting preliminary JD  
(REQUIRED, unless obtaining  
the signature is impracticable)

<b>Site Name</b>	<b>Latitude</b>	<b>Longitude</b>	<b>Cowardin Class</b>	<b>Estimated amount of aquatic resource in review area</b>	<b>Class of aquatic resource</b>
1	35.459°N	-82.480°W	R3UB	131 linear feet	non-section 10 – non-wetland
2	35.499°N	-82.480°W	R2UB	29 linear feet	non-section 10 – non-wetland
	°N	- °W		acre(s)	section 10 – tidal
	°N	- °W		acre(s)	section 10 – tidal
	°N	- °W		acre(s)	section 10 – tidal
	°N	- °W		acre(s)	section 10 – tidal
	°N	- °W		acre(s)	section 10 – tidal
	°N	- °W		acre(s)	section 10 – tidal
	°N	- °W		acre(s)	section 10 – tidal
	°N	- °W		acre(s)	section 10 – tidal
	°N	- °W		acre(s)	section 10 – tidal
	°N	- °W		acre(s)	section 10 – tidal
	°N	- °W		acre(s)	section 10 – tidal
	°N	- °W		acre(s)	section 10 – tidal
	°N	- °W		acre(s)	section 10 – tidal
	°N	- °W		acre(s)	section 10 – tidal
	°N	- °W		acre(s)	section 10 – tidal
	°N	- °W		acre(s)	section 10 – tidal
	°N	- °W		acre(s)	section 10 – tidal
	°N	- °W		acre(s)	section 10 – tidal
	°N	- °W		acre(s)	section 10 – tidal
	°N	- °W		acre(s)	section 10 – tidal
	°N	- °W		acre(s)	section 10 – tidal
	°N	- °W		acre(s)	section 10 – tidal
	°N	- °W		acre(s)	section 10 – tidal
	°N	- °W		acre(s)	section 10 – tidal
	°N	- °W		acre(s)	section 10 – tidal
	°N	- °W		acre(s)	section 10 – tidal



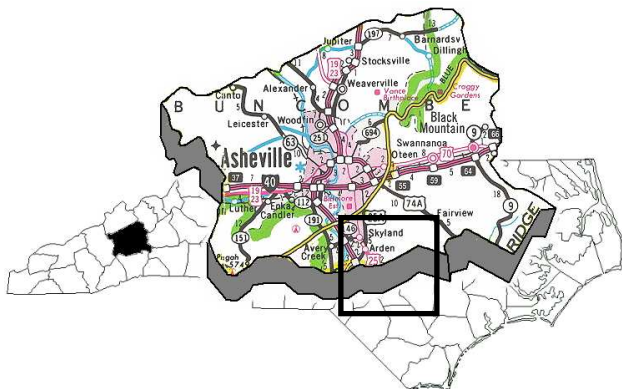
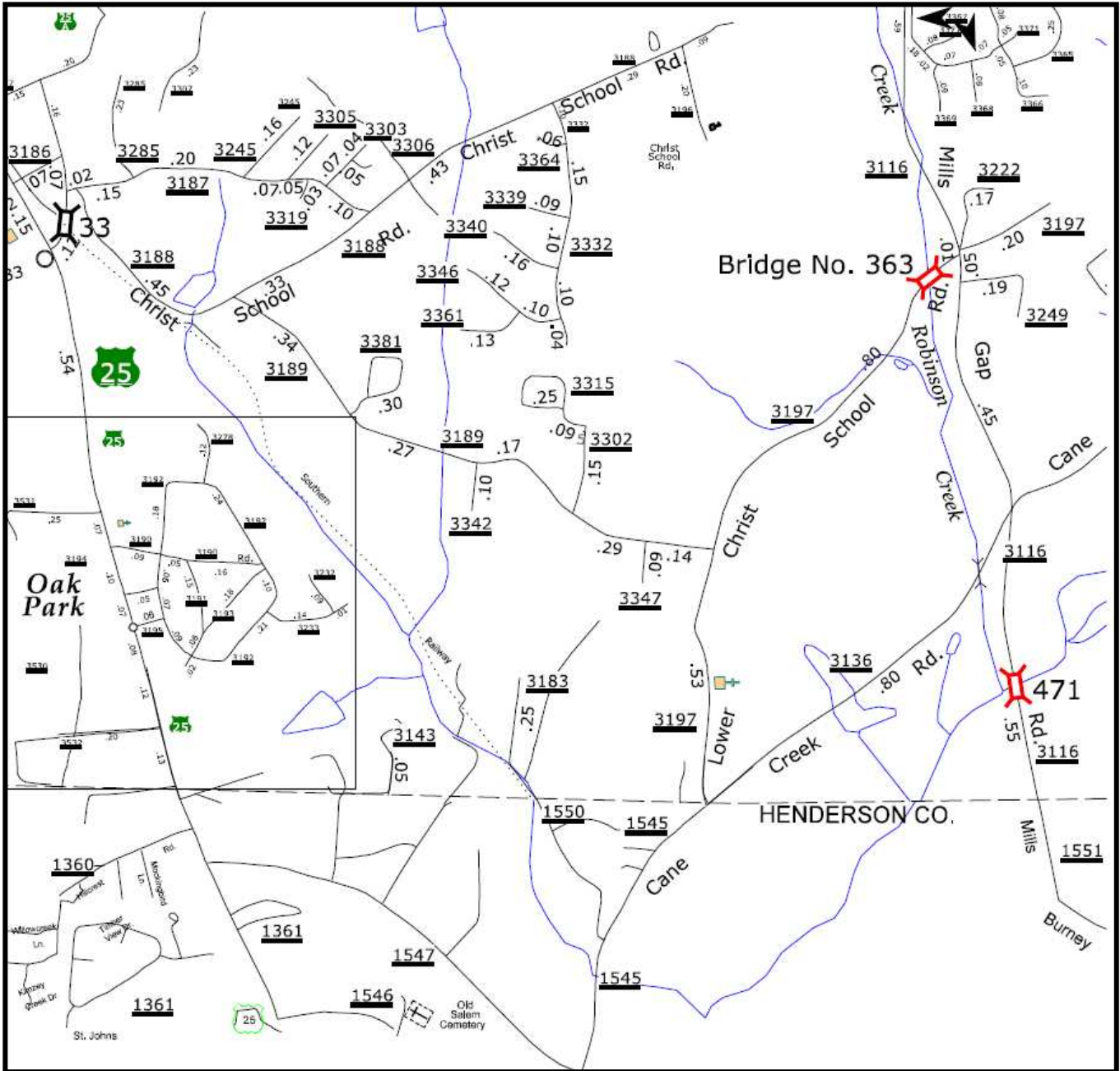

NORTH CAROLINA DEPARTMENT OF  
TRANSPORTATION  
DIVISION OF HIGHWAYS  
PROJECT DEVELOPMENT &  
ENVIRONMENTAL ANALYSIS BRANCH

**BUNCOMBE COUNTY  
REPLACE BRIDGE NO. 363 ON SR 3197  
OVER ROBINSON CREEK  
B-5244**

Figure 1

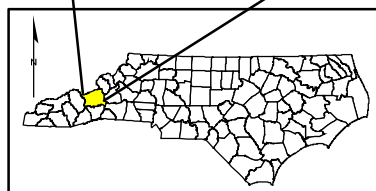
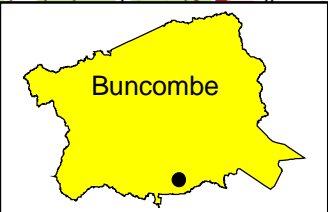
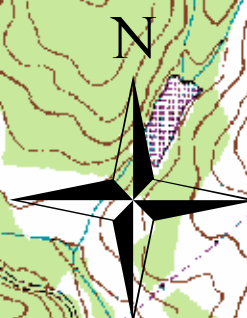
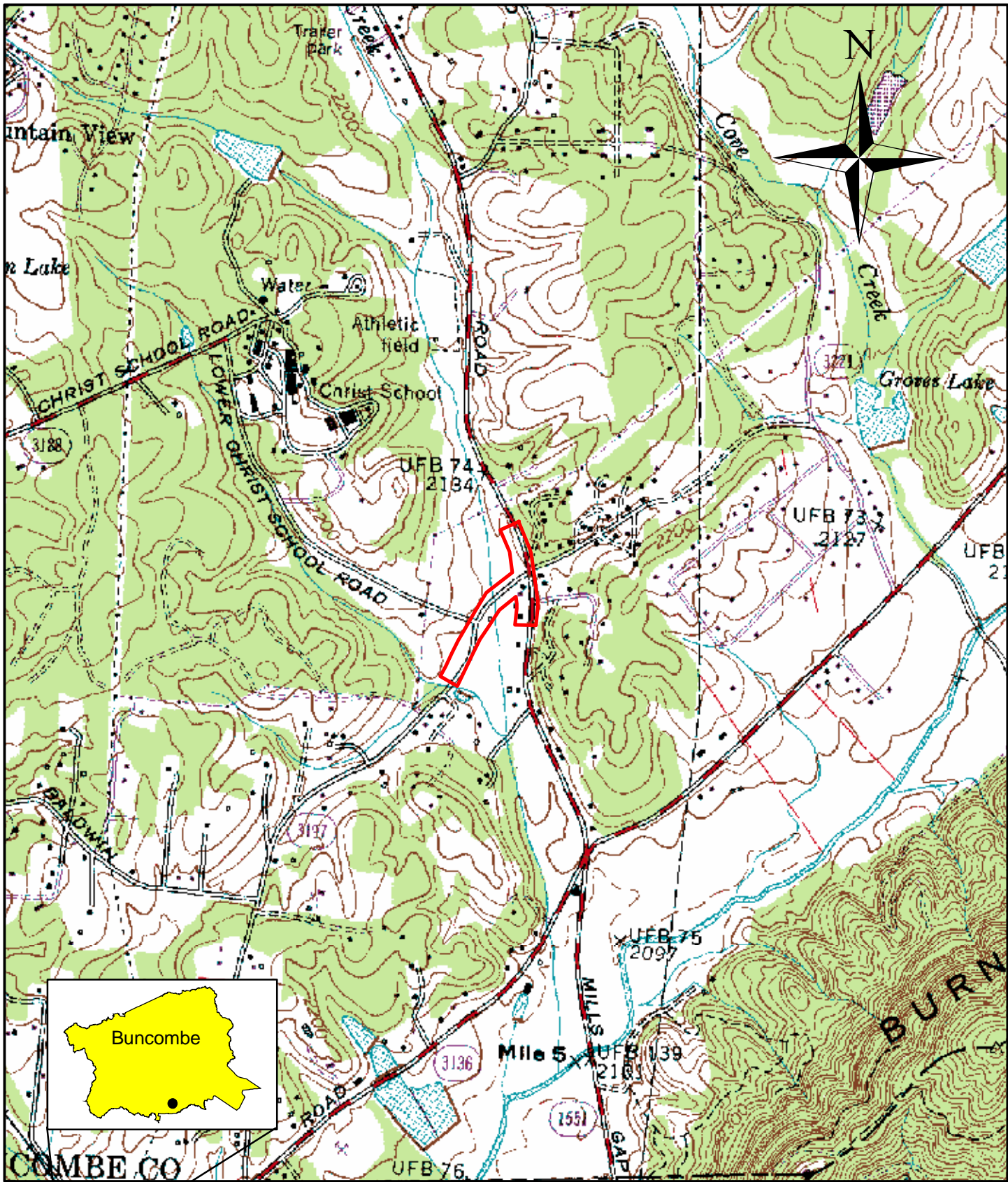

# B-5244

Buncombe County  
Project Study Area Map

Figure 2



Prepared by NCDOT

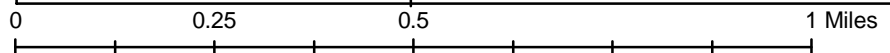



# Jurisdictional Features and Natural Communities Map

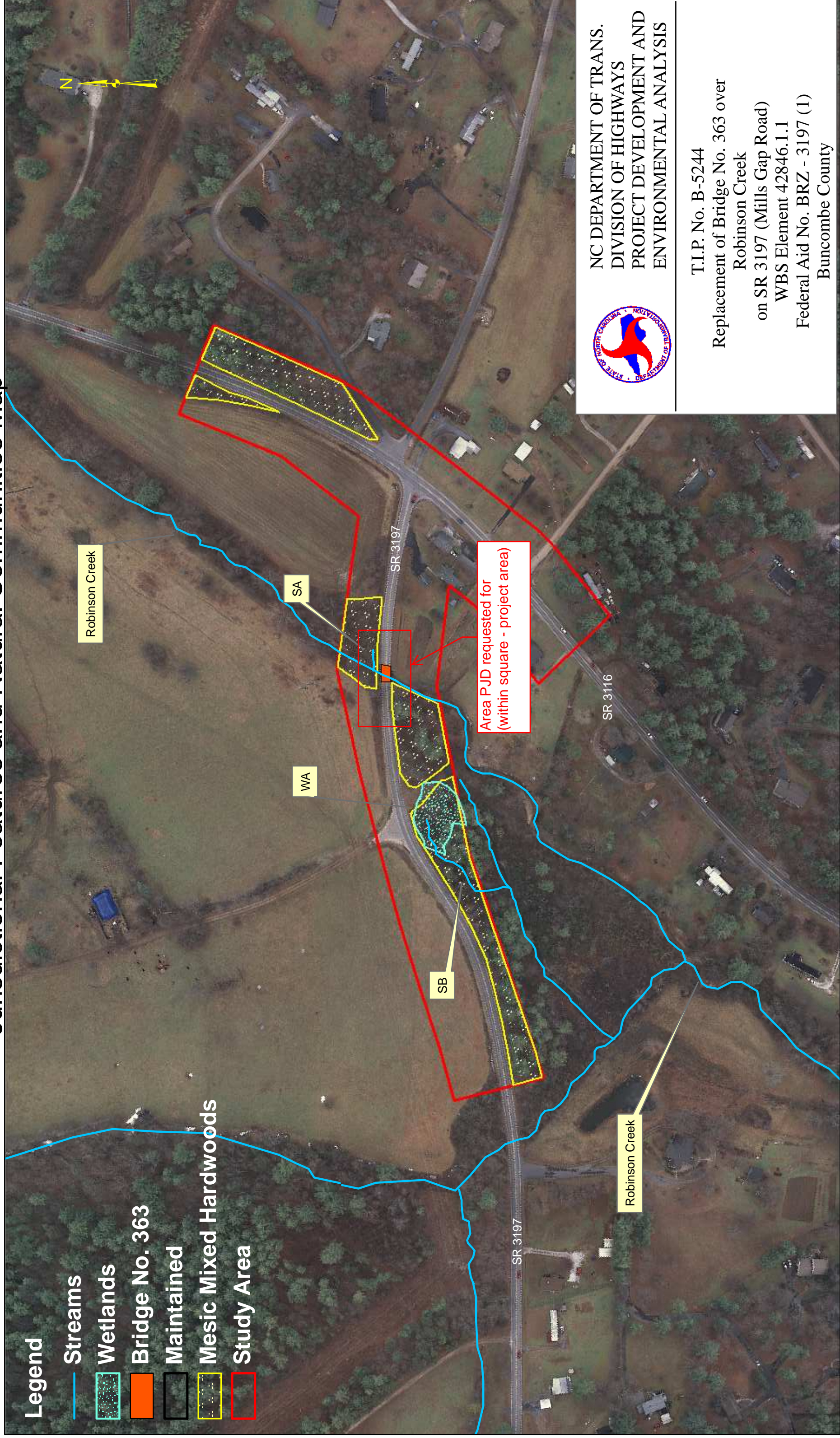

**Figure 3**





**North Carolina Department of Transportation**  
**Highway Stormwater Program**  
**STORMWATER MANAGEMENT PLAN**  
**FOR LINEAR ROADWAY PROJECTS**



(Version 1.2; Released September 2011)

**Project/TIP No.:** B-5244      **County(ies):** Buncombe      **Page** 1 **of** 2

**General Project Information**

<b>Project No.:</b>	B-5244	<b>Project Type:</b>	Bridge Replacement	<b>Date:</b>	6/10/2015
<b>NCDOT Contact:</b>	William (Bill) Zerman Jr., PE	<b>Contractor / Designer:</b>	HDR Engineering		
<b>Address:</b>	1020 Birch Ridge Road Raleigh, NC 27610	<b>Address:</b>	3733 National Drive, Suite 207 Raleigh, NC 27612		
<b>Phone:</b>	(919) 707-6755	<b>Phone:</b>	(919) 232-6600		
<b>Email:</b>	bzerman@ncdot.gov	<b>Email:</b>	wyatt.yelverton@hdrinc.com		
<b>City/Town:</b>	Arden, NC	<b>County(ies):</b>	Buncombe		
<b>River Basin(s):</b>	French Broad	<b>CAMA County?</b>	No		
<b>Primary Receiving Water:</b>	Robinson Creek	<b>NCDWQ Stream Index No.:</b>	6-57-17		
<b>NCDWQ Surface Water Classification for Primary Receiving Water</b>		<b>Primary:</b>	Class C		
		<b>Supplemental:</b>	Trout Waters (Tr)		
<b>Other Stream Classification:</b>	None				
<b>303(d) Impairments:</b>	None				
<b>Buffer Rules in Effect</b>	N/A				

**Project Description**

<b>Project Length (lin. Miles or feet):</b>	300 Ft.	<b>Surrounding Land Use:</b>	Agricultural-Low Residential (Rural)		
	<b>Proposed Project</b>		<b>Existing Site</b>		
<b>Project Built-Upon Area (ac.)</b>	0.20 ac.		0.13 ac.		
<b>Typical Cross Section Description:</b>	Roadway - (2) 11' travel lanes with 4' shoulders. Bridge - (2) 11' travel lanes, 33' out to out (cored slab)		Roadway - (2) 10' lanes with 2' shoulders. Bridge - (2) 10' lanes, 20.17' out to out.		
<b>Average Daily Traffic (veh/hr/day):</b>	<b>Design/Future:</b> 4000 (2035)	<b>Existing:</b>	2200 (2011)		

**General Project Narrative:** Replace bridge #363 on SR 3197 (Lower Christ School Rd.) over Robinson Creek with a 45' cored slab bridge.

**References**



Highway Stormwater Program  
**STORMWATER MANAGEMENT PLAN**  
 FOR LINEAR ROADWAY PROJECTS

(Version 1.2; Released September 2011)

**Project Environmental Summary**

**Surface Water Impacts**

Sheet No.	Station (From / To)	Feature Impacted	Water / Wetland / Buffer Type	Receiving Surface Water Name	NRTR Map ID	NCDWQ Stream Index	NCDWQ Surface Water Classification	303(d) Impairments	Type of Impact	Existing SCM	Proposed SCM
4	13+79.5 14+24.5	Stream	Perennial	Robinson Creek		6-57-17	C;Tr	None	Stabilization	N/A	N/A
4	14+23 14+52	Stream	Perennial	Unnamed Tributary to Robinson Creek		N/A	C;Tr	None	Stabilization	N/A	N/A

\* List all stream and surface water impact locations regardless of jurisdiction or size.  
 Equalizer Pipes to be noted as a minimization of impacts.  
 All proposed SCMs listed must also be listed under Swales, Preformed Sour Holes and other Energy Dissipators, or Other Stormwater Control Measures.

**Description of Minimization of Impacts or Mitigation**

**References**

STATE	STATE PROJECT REFERENCE NO.	SHEET NO.	TOTAL SHEETS
N.C.	B-5244	1	
STATE PROJ. NO.	F.A. PROJ. NO.	DESCRIPTION	
42846.1.1	BRZ-3197 (1)	PE	
42846.2.FD1	BRZ-3197 (1)	RW & UTL.	

PERMIT DRAWING  
SHEET 1 OF 5

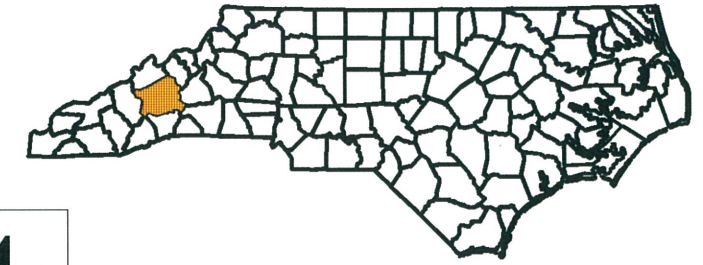

STATE OF NORTH CAROLINA  
DIVISION OF HIGHWAYS

**BUNCOMBE COUNTY**

LOCATION: BRIDGE NO. 363 OVER ROBINSON CREEK  
ON SR 3197

TYPE OF WORK: GRADING, PAVING, DRAINAGE, AND STRUCTURE

WETLAND & STREAM IMPACTS

See Sheet 1-A For Index of Sheets

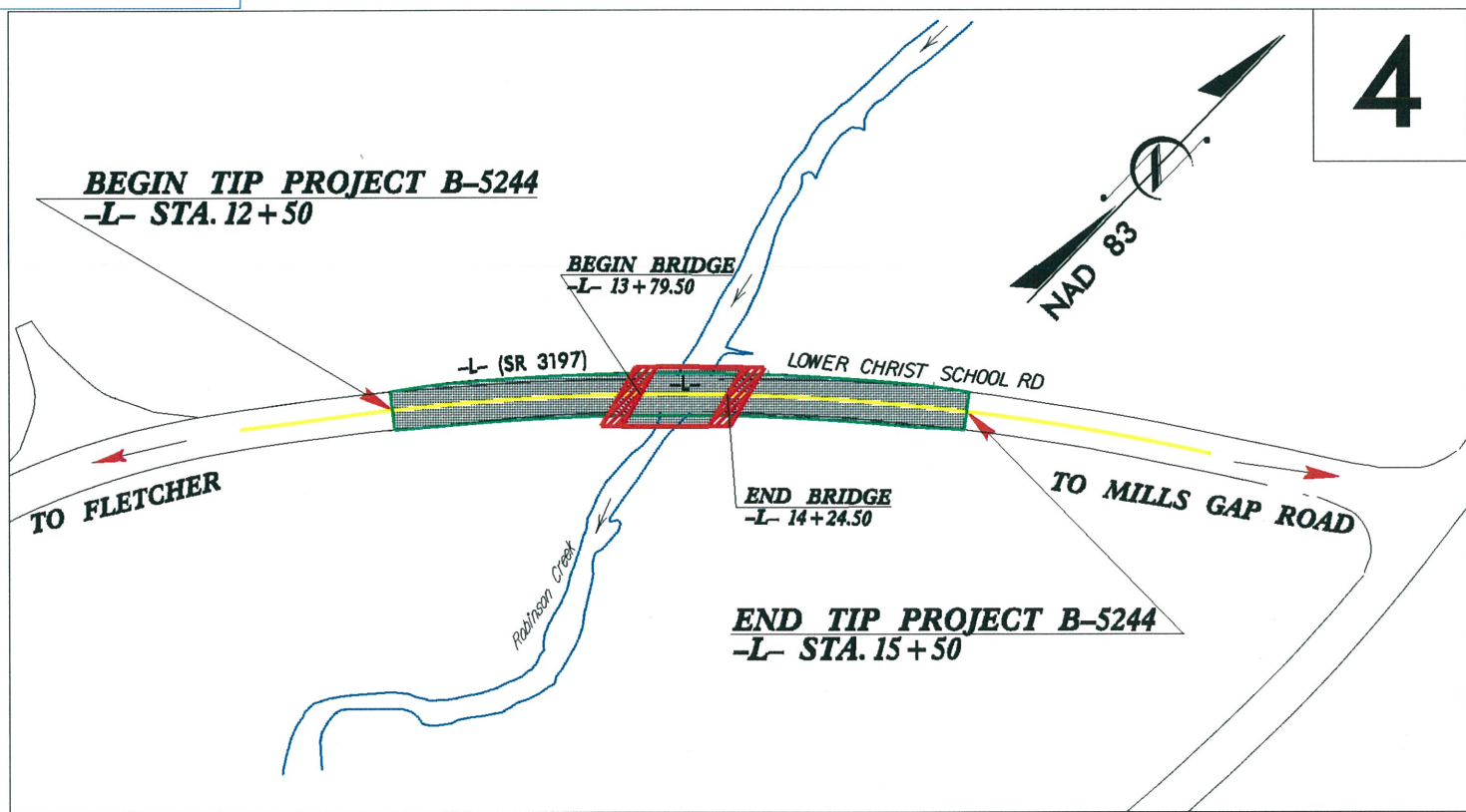
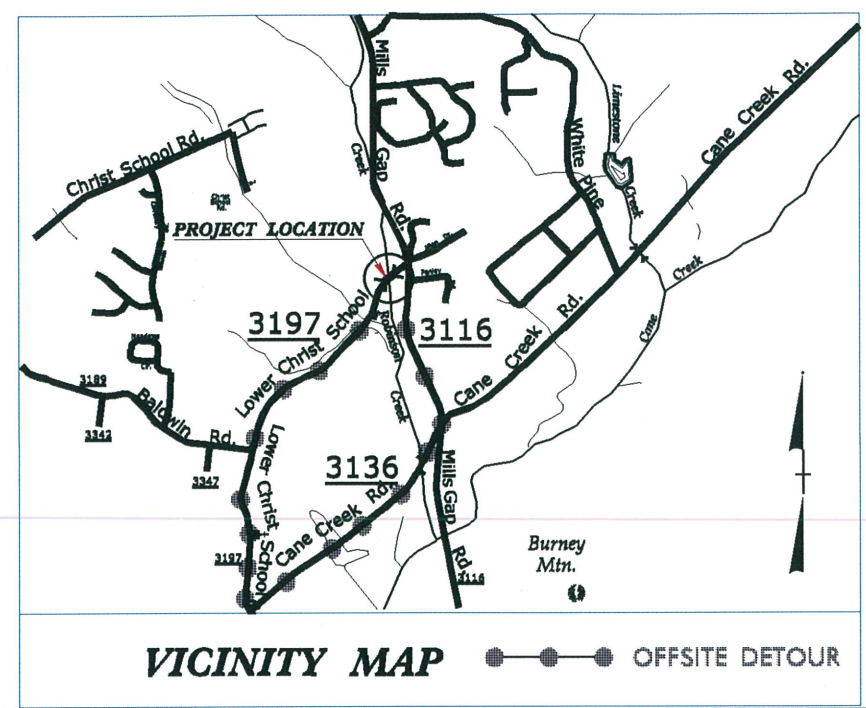

4

PRELIMINARY PLANS  
DO NOT USE FOR CONSTRUCTION

CLEARING ON THIS PROJECT SHALL BE PERFORMED TO THE LIMITS ESTABLISHED BY METHOD II  
THIS PROJECT IS NOT WITHIN THE LIMITS OF MUNICIPAL BOUNDARIES.  
THIS IS NOT A CONTROL OF ACCESS PROJECT.

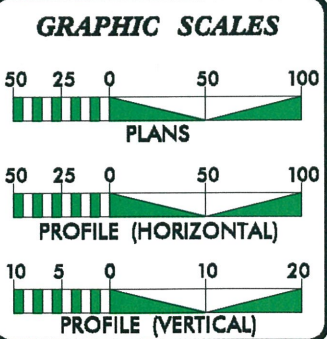

**DESIGN DATA**

ADT 2011 =	2200
ADT 2035 =	4000
K =	9 %
D =	70 %
T =	3 % *
V =	40 MPH
* TTST =	1% DUAL 2%
FUNC CLASS =	LOCAL
SUB-REGIONAL TIER	

**PROJECT LENGTH**

LENGTH ROADWAY TIP PROJECT B-5244 =	0.048 MILE
LENGTH OF STRUCTURE TIP PROJECT B-5244 =	0.009 MILE
TOTAL LENGTH TIP PROJECT B-5244 =	0.057 MILE

Prepared in the Office of:  
**DIVISION OF HIGHWAYS**  
1000 Birch Ridge Dr., Raleigh NC, 27610

2012 STANDARD SPECIFICATIONS

RIGHT OF WAY DATE:  
FEBRUARY 20, 2015

LETTING DATE:  
FEBRUARY 16, 2016

KEVIN E. MOORE, PE  
PROJECT ENGINEER

NATHAN N. ADIMA, PE  
PROJECT DESIGN ENGINEER

HYDRAULICS ENGINEER

SIGNATURE: \_\_\_\_\_ P.E.

ROADWAY DESIGN ENGINEER

SIGNATURE: \_\_\_\_\_ P.E.

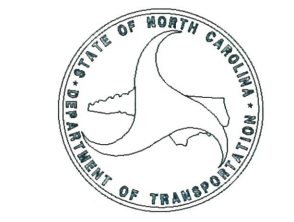

TIP PROJECT: B-5244

CONTRACT: C203669

\$\$\$\$\$SYTIME\$\$\$\$\$  
\$\$\$\$\$DCN\$\$\$\$\$  
\$\$\$\$\$USERNAME\$\$\$\$\$



PROJECT REFERENCE NO. B-5244	SHEET NO. 4
RW SHEET NO.	
ROADWAY DESIGN ENGINEER	HYDRAULICS ENGINEER

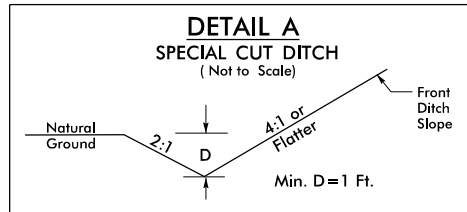

FROM STA. 14+10 RT TO STA. 14+75 RT

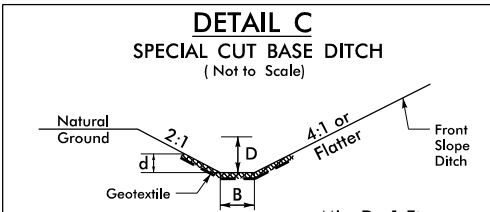

Type of Liner = Class B Rip-Rap  
FROM STA. 12+75 LT TO STA. 13+50 LT

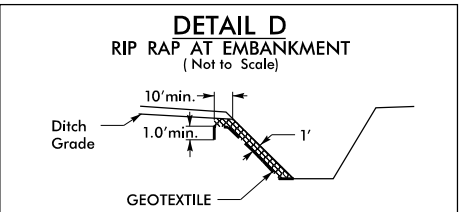

STA. 13+70 RT  
STA. 14+00 RT  
STA. 14+35 LT

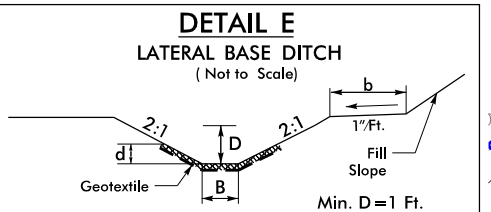

FROM STA. 14+40 LT TO STA. 15+25 LT

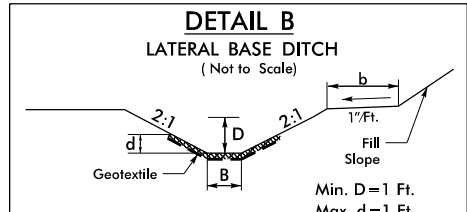

FROM STA. 13+50 RT TO STA. 13+60 RT

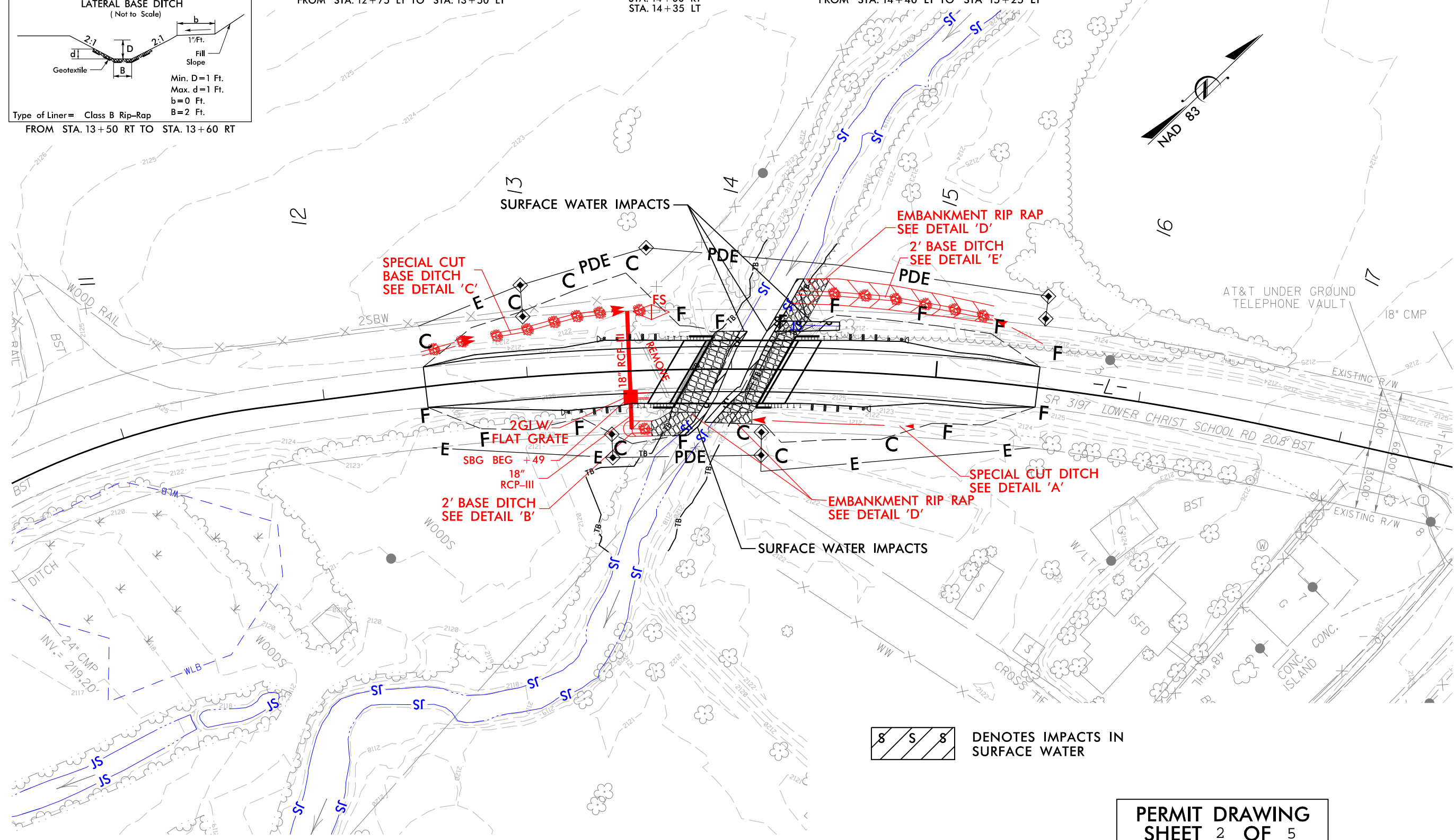

DENOTES IMPACTS IN SURFACE WATER

PERMIT DRAWING  
SHEET 2 OF 5

REVISIONS

6/10/2015 6:00 PM C:\Users\jrgs\Documents\B5244\_Hyd.prm\_wet.dgn

PROJECT REFERENCE NO. B-5244	SHEET NO. 4
RW SHEET NO.	
ROADWAY DESIGN ENGINEER	HYDRAULICS ENGINEER

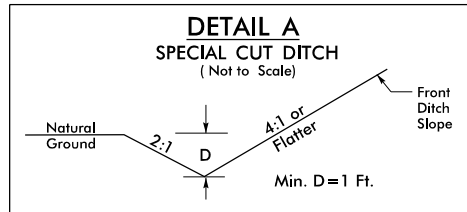

FROM STA. 14+10 RT TO STA. 14+75 RT

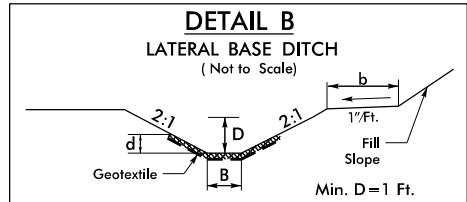

FROM STA. 13+50 RT TO STA. 13+60 RT

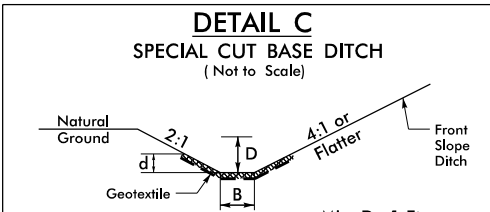

Type of Liner = Class B Rip-Rap  
FROM STA. 12+75 LT TO STA. 13+50 LT

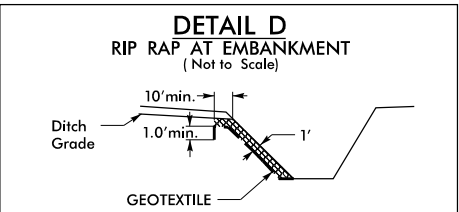

STA. 13+70 RT  
STA. 14+00 RT  
STA. 14+35 LT

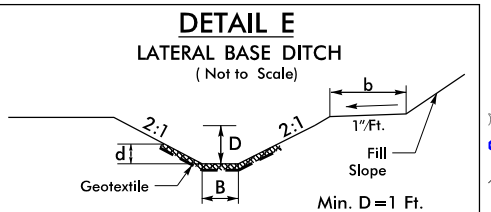

Type of Liner = Class B Rip-Rap  
FROM STA. 14+40 LT TO STA. 15+25 LT

8/17/99  
  
 REVISIONS  
  
 6/10/2015  
 C:\Drawings\B5244\_Hyd.prm\_wet.dgn  
 J:\SUSAN\B5244

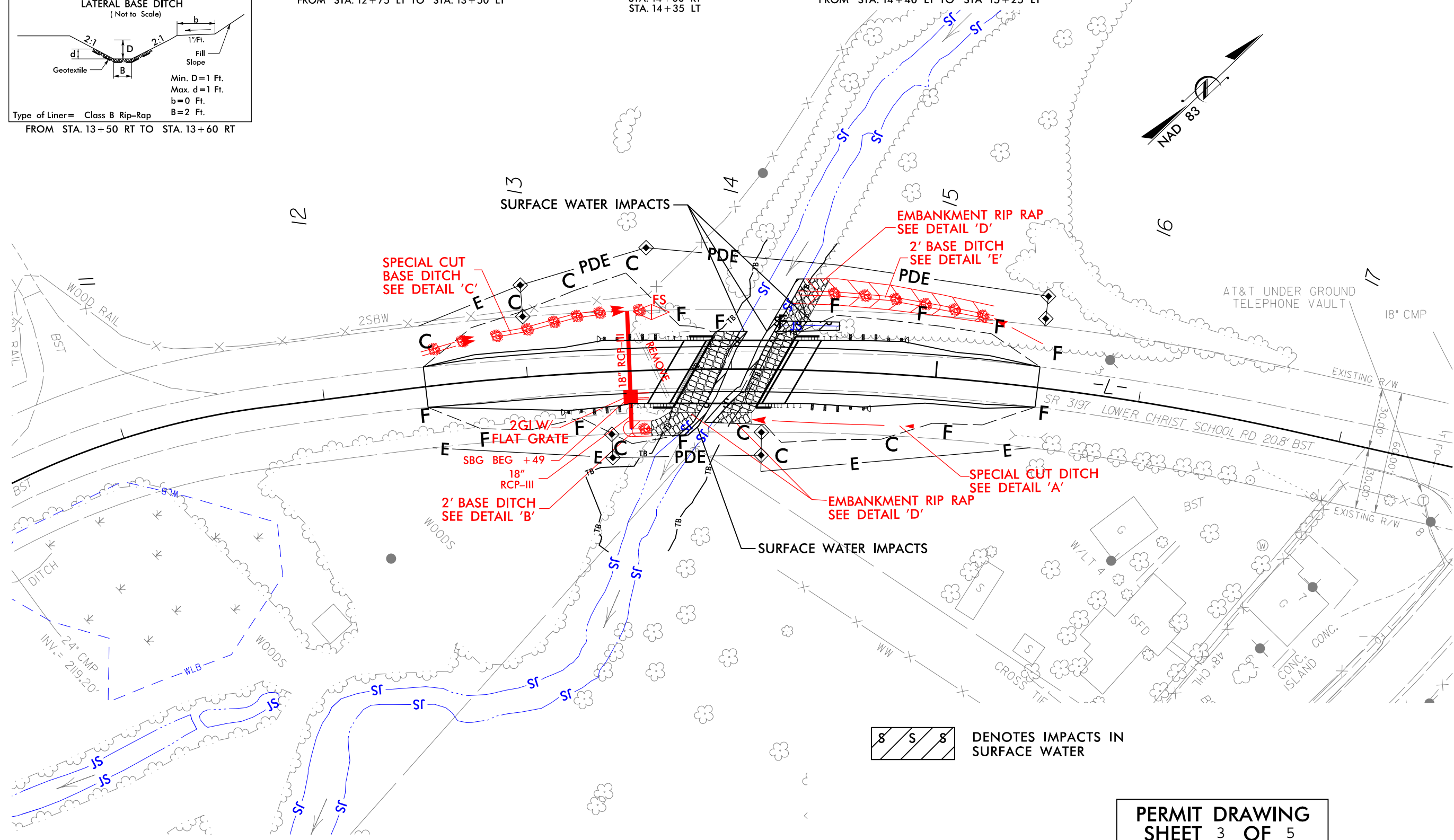

DENOTES IMPACTS IN SURFACE WATER

PERMIT DRAWING  
SHEET 3 OF 5

PROJECT REFERENCE NO.	SHEET NO.
B-5244	
ROADWAY DESIGN ENGINEER	HYDRAULICS ENGINEER

5/14/99

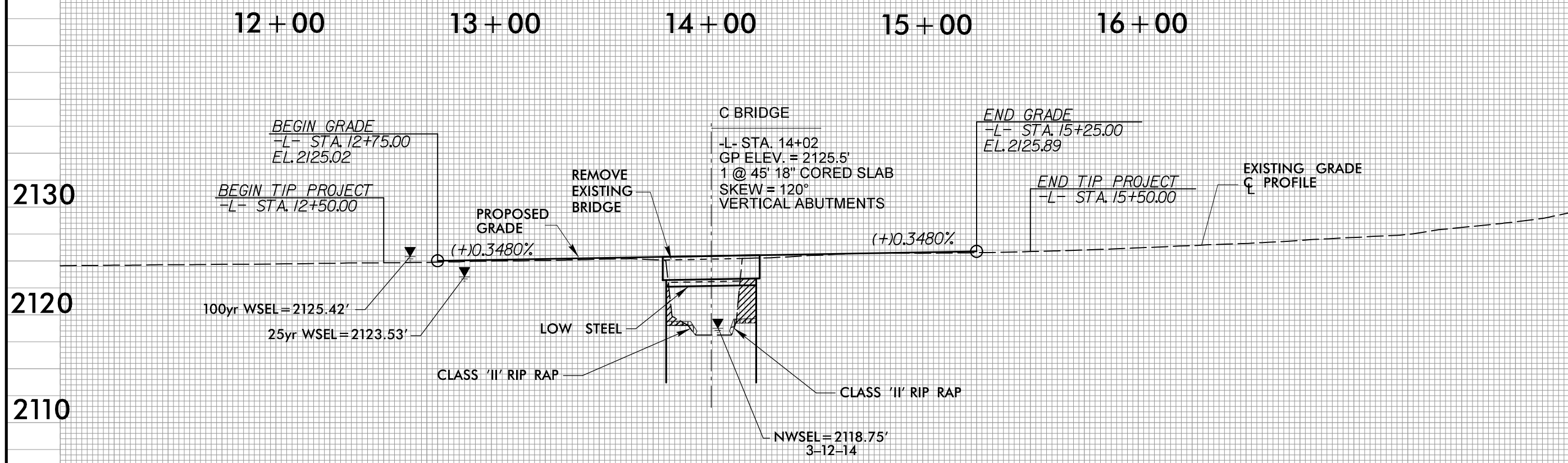

**CL PROFILE - PROPOSED BRIDGE**

PERMIT DRAWING  
SHEET 4 OF 5

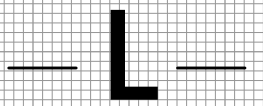

3/2/2015 10:36:20 AM C:\Users\B5244\pdm\wet-pfl.dgn

12 + 00      13 + 00      14 + 00      15 + 00      16 + 00

**WETLAND PERMIT IMPACT SUMMARY**

Site No.	Station (From/To)	Structure Size / Type	WETLAND IMPACTS					SURFACE WATER IMPACTS					
			Permanent Fill In Wetlands (ac)	Temp. Fill In Wetlands (ac)	Excavation in Wetlands (ac)	Mechanized Clearing in Wetlands (ac)	Hand Clearing in Wetlands (ac)	Permanent SW impacts (ac)	Temp. SW impacts (ac)	Existing Channel Impacts Permanent (ft)	Existing Channel Impacts Temp. (ft)	Natural Stream Design (ft)	
	13+79.5 -L- / 14+24.5 -L-	Bank Stabilization (bridge)							< 0.01		47		
	13+60 -L- / 14+10 -L- (RT)	Bank Stabilization (ditch)							< 0.01		13		
	14+23 -L- / 14+52 -L- (LT)	Stabilization (reconstruct ditch)							< 0.01		29		
	14+31 -L- / 14+44 -L- (LT)	Bank Stabilization (ditch)							< 0.01		30		
<b>TOTALS*:</b>									0.01		119	0	0

\*Rounded totals are sum of actual impacts

NOTES:

NC DEPARTMENT OF TRANSPORTATION  
 DIVISION OF HIGHWAYS  
 06.10.15  
 BUNCOMBE COUNTY  
 BRIDGE 0363 ON SR 3197  
 OVER ROBINSON CREEK  
 SHEET 5 OF 5

09/08/09

See Sheet 1-A For Index of Sheets

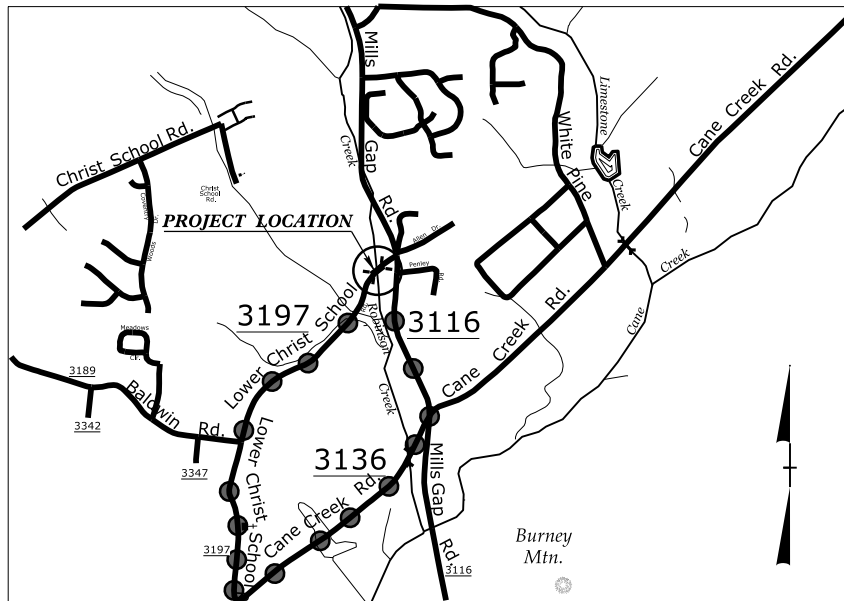

VICINITY MAP ●—● OFFSITE DETOUR

STATE OF NORTH CAROLINA  
DIVISION OF HIGHWAYS

**BUNCOMBE COUNTY**

LOCATION: BRIDGE NO. 363 OVER ROBINSON CREEK  
ON SR 3197

TYPE OF WORK: GRADING, PAVING, DRAINAGE, AND STRUCTURE

STATE	STATE PROJECT REFERENCE NO.	SHEET NO.	TOTAL SHEETS
N.C.	B-5244	1	
STATE PROJ. NO.	F.A. PROJ. NO.	DESCRIPTION	
42846.1.1	BRZ-3197 (1)	PE	
42846.2.FD1	BRZ-3197 (1)	RW & UTL.	

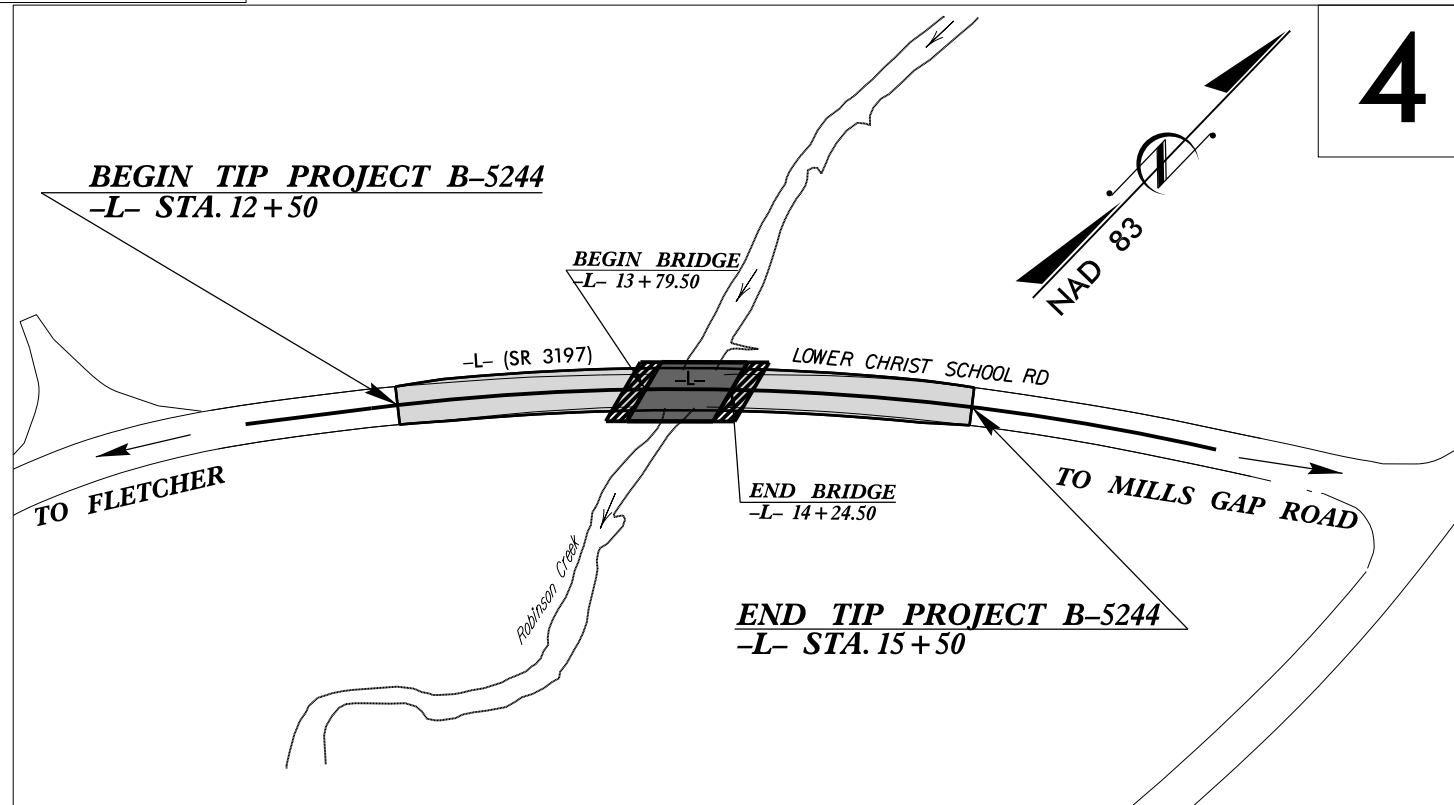
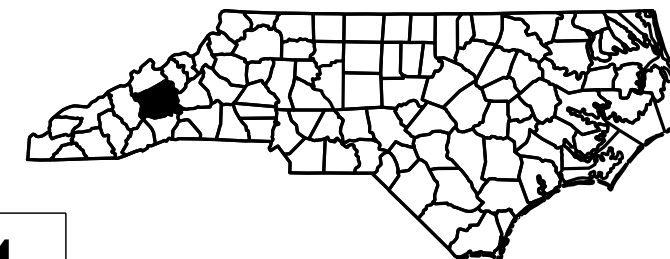

PRELIMINARY PLANS  
DO NOT USE FOR CONSTRUCTION

CLEARING ON THIS PROJECT SHALL BE PERFORMED TO THE LIMITS ESTABLISHED BY METHOD II  
THIS PROJECT IS NOT WITHIN THE LIMITS OF MUNICIPAL BOUNDARIES.  
THIS IS NOT A CONTROL OF ACCESS PROJECT.

GRAPHIC SCALES

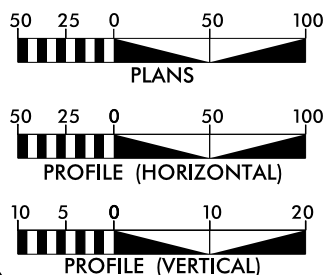

DESIGN DATA

ADT 2011 = 2200  
ADT 2035 = 4000  
K = 9 %  
D = 70 %  
T = 3 % \*  
V = 40 MPH  
\* TTST = 1% DUAL 2%  
FUNC CLASS =  
LOCAL  
SUB-REGIONAL TIER

PROJECT LENGTH

LENGTH ROADWAY TIP PROJECT B-5244 = 0.048 MILE  
LENGTH OF STRUCTURE TIP PROJECT B-5244 = 0.009 MILE  
TOTAL LENGTH TIP PROJECT B-5244 = 0.057 MILE

Prepared in the Office of:  
**DIVISION OF HIGHWAYS**

1000 Birch Ridge Dr., Raleigh NC, 27610

2012 STANDARD SPECIFICATIONS

RIGHT OF WAY DATE:  
FEBRUARY 20, 2015

LETTING DATE:  
FEBRUARY 16, 2016

KEVIN E. MOORE, PE  
PROJECT ENGINEER

NATHAN N. ADIMA, PE  
PROJECT DESIGN ENGINEER

HYDRAULICS ENGINEER

SIGNATURE: \_\_\_\_\_ P.E.

ROADWAY DESIGN  
ENGINEER

SIGNATURE: \_\_\_\_\_ P.E.

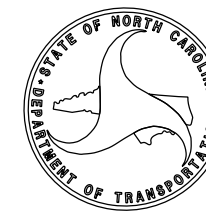

TIP PROJECT: B-5244

CONTRACT: C203669

IO-MAR-2015 11:17  
R:\Roadway\Proj\B5244\_Rdy\_tsh\_L.dgn  
\$\$\$\$\$USERNAME\$\$\$\$\$

Note: Not to Scale

\*S.U.E. = Subsurface Utility Engineering

# CONVENTIONAL PLAN SHEET SYMBOLS

## BOUNDARIES AND PROPERTY:

State Line	-----
County Line	-----
Township Line	-----
City Line	-----
Reservation Line	-----
Property Line	-----
Existing Iron Pin	○ EP
Property Corner	-----
Property Monument	□ ECM
Parcel/Sequence Number	②③
Existing Fence Line	-x-x-x-
Proposed Woven Wire Fence	○
Proposed Chain Link Fence	□
Proposed Barbed Wire Fence	◇
Existing Wetland Boundary	----- MLB
Proposed Wetland Boundary	----- MLB
Existing Endangered Animal Boundary	----- EAB
Existing Endangered Plant Boundary	----- EPB
Known Soil Contamination: Area or Site	☠ ☠
Potential Soil Contamination: Area or Site	☠ ☠

## BUILDINGS AND OTHER CULTURE:

Gas Pump Vent or U/G Tank Cap	○
Sign	○
Well	♀
Small Mine	✕
Foundation	□
Area Outline	□
Cemetery	⊕
Building	□
School	□
Church	⊕
Dam	-----

## HYDROLOGY:

Stream or Body of Water	-----
Hydro, Pool or Reservoir	-----
Jurisdictional Stream	----- JS
Buffer Zone 1	----- BZ 1
Buffer Zone 2	----- BZ 2
Flow Arrow	←
Disappearing Stream	-----
Spring	○
Wetland	-----
Proposed Lateral, Tail, Head Ditch	-----
False Sump	-----

## RAILROADS:

Standard Gauge	-----
RR Signal Milepost	○
Switch	□
RR Abandoned	-----
RR Dismantled	-----

## RIGHT OF WAY:

Baseline Control Point	◆
Existing Right of Way Marker	△
Existing Right of Way Line	-----
Proposed Right of Way Line	-----
Proposed Right of Way Line with Iron Pin and Cap Marker	-----
Proposed Right of Way Line with Concrete or Granite Marker	-----
Existing Control of Access	○
Proposed Control of Access	○
Existing Easement Line	----- E
Proposed Temporary Construction Easement	----- E
Proposed Temporary Drainage Easement	----- TDE
Proposed Permanent Drainage Easement	----- PDE
Proposed Permanent Drainage / Utility Easement	----- DUE
Proposed Permanent Utility Easement	----- PUE
Proposed Temporary Utility Easement	----- TUE
Proposed Aerial Utility Easement	----- AUE
Proposed Permanent Easement with Iron Pin and Cap Marker	◆

## ROADS AND RELATED FEATURES:

Existing Edge of Pavement	-----
Existing Curb	-----
Proposed Slope Stakes Cut	----- C
Proposed Slope Stakes Fill	----- F
Proposed Curb Ramp	----- CR
Existing Metal Guardrail	-----
Proposed Guardrail	-----
Existing Cable Guiderail	-----
Proposed Cable Guiderail	-----
Equality Symbol	⊕
Pavement Removal	-----

## VEGETATION:

Single Tree	○
Single Shrub	○
Hedge	-----
Woods Line	-----

Orchard	-----
Vineyard	-----

## EXISTING STRUCTURES:

MAJOR:	
Bridge, Tunnel or Box Culvert	----- CONC
Bridge Wing Wall, Head Wall and End Wall	----- CONC WW
MINOR:	
Head and End Wall	----- CONC HW
Pipe Culvert	-----
Footbridge	-----
Drainage Box: Catch Basin, DI or JB	□ CB
Paved Ditch Gutter	-----
Storm Sewer Manhole	⊕
Storm Sewer	----- S

## UTILITIES:

POWER:	
Existing Power Pole	●
Proposed Power Pole	○
Existing Joint Use Pole	●
Proposed Joint Use Pole	○
Power Manhole	⊕
Power Line Tower	⊗
Power Transformer	⊗
U/G Power Cable Hand Hole	□
H-Frame Pole	-----
Recorded U/G Power Line	----- P
Designated U/G Power Line (S.U.E.*)	----- P

## TELEPHONE:

Existing Telephone Pole	●
Proposed Telephone Pole	○
Telephone Manhole	⊕
Telephone Booth	□
Telephone Pedestal	⊕
Telephone Cell Tower	⊗
U/G Telephone Cable Hand Hole	□
Recorded U/G Telephone Cable	----- T
Designated U/G Telephone Cable (S.U.E.*)	----- T
Recorded U/G Telephone Conduit	----- TC
Designated U/G Telephone Conduit (S.U.E.*)	----- TC
Recorded U/G Fiber Optics Cable	----- T FO
Designated U/G Fiber Optics Cable (S.U.E.*)	----- T FO

## WATER:

Water Manhole	⊕
Water Meter	○
Water Valve	⊗
Water Hydrant	⊕
Recorded U/G Water Line	-----
Designated U/G Water Line (S.U.E.*)	-----
Above Ground Water Line	----- A/G Water

## TV:

TV Satellite Dish	⊕
TV Pedestal	⊕
TV Tower	⊗
U/G TV Cable Hand Hole	□
Recorded U/G TV Cable	----- TV
Designated U/G TV Cable (S.U.E.*)	----- TV
Recorded U/G Fiber Optic Cable	----- TV FO
Designated U/G Fiber Optic Cable (S.U.E.*)	----- TV FO

## GAS:

Gas Valve	◇
Gas Meter	⊕
Recorded U/G Gas Line	----- G
Designated U/G Gas Line (S.U.E.*)	----- G
Above Ground Gas Line	----- A/G Gas

## SANITARY SEWER:

Sanitary Sewer Manhole	⊕
Sanitary Sewer Cleanout	⊕
U/G Sanitary Sewer Line	----- SS
Above Ground Sanitary Sewer	----- A/G Sanitary Sewer
Recorded SS Forced Main Line	----- FSS
Designated SS Forced Main Line (S.U.E.*)	----- FSS

## MISCELLANEOUS:

Utility Pole	●
Utility Pole with Base	□
Utility Located Object	○
Utility Traffic Signal Box	⊕
Utility Unknown U/G Line	----- TUL
U/G Tank; Water, Gas, Oil	□
Underground Storage Tank, Approx. Loc.	⊕
A/G Tank; Water, Gas, Oil	□
Geoenvironmental Boring	⊕
U/G Test Hole (S.U.E.*)	○
Abandoned According to Utility Records	AATUR
End of Information	E.O.I.



# SURVEY CONTROL SHEET B-5244

PROJECT REFERENCE NO.	SHEET NO.
42846.1.1	1C
Location and Surveys	

BL POINT	DESC.	NORTH	EAST	ELEVATION	L STATION	OFFSET
2	BL-2	640300.3422	963469.6980	2124.60	11+41.42	15.54 LT
1	BL-1	640487.4932	963622.1611	2125.07	13+80.45	11.45 LT
GPS2	B5244-2	640770.6660	963975.4760	2129.70	OUTSIDE PROJECT LIMITS	

.....  
 BM1 ELEVATION = 2123.63  
 N 640432 E 963641  
 L STATION 13+52.09 39.80' RIGHT  
 RR SPIKE SET IN BASE OF A 18"  
 CHERRY TREE ACROSS FROM BL-2  
 .....

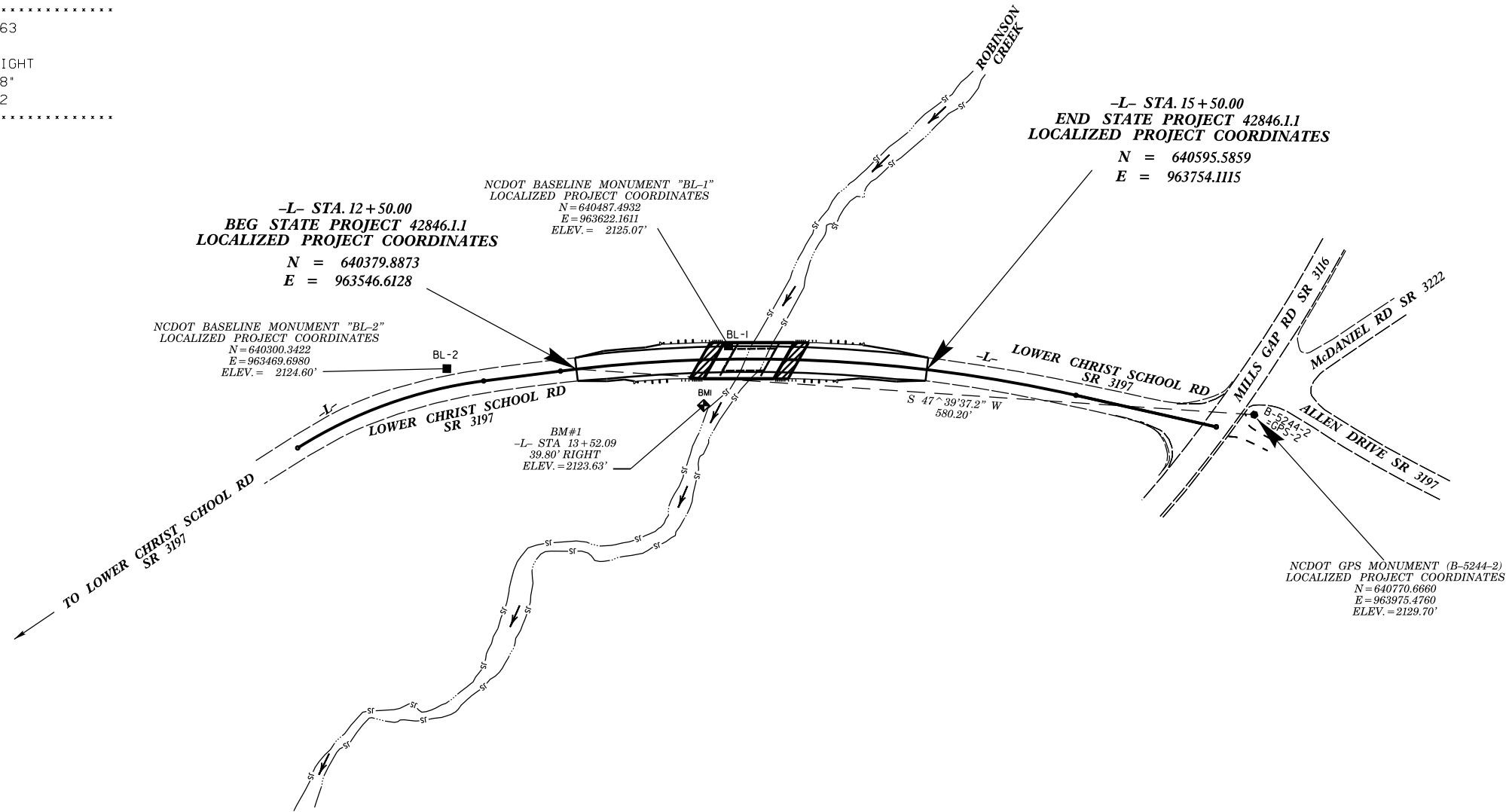
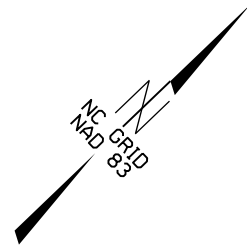

**NOTES:**

- THE CONTROL DATA FOR THIS PROJECT CAN BE FOUND ELECTRONICALLY BY SELECTING PROJECT CONTROL DATA AT:  
[HTTP://WWW.DOH.DOT.STATE.NC.US/PRECONSTRUCT/HIGHWAY/LOCATION/PROJECT/](http://www.doh.dot.state.nc.us/preconstruct/highway/location/project/)  
 THE FILES TO BE FOUND ARE AS FOLLOWS:  
 B5422\_LS\_CONTROL.TXT  
 SITE CALIBRATION INFORMATION HAS NOT BEEN PROVIDED FOR THIS PROJECT. IF FURTHER INFORMATION IS NEEDED, PLEASE CONTACT THE LOCATION AND SURVEYS UNIT.
- INDICATES GEODETIC CONTROL MONUMENTS USED OR SET FOR HORIZONTAL PROJECT CONTROL BY THE NCDOT LOCATION AND SURVEYS UNIT.  
 PROJECT CONTROL ESTABLISHED USING GLOBAL POSITIONING SYSTEM.  
 NETWORK ESTABLISHED FROM NGS ONLINE POSITIONING SERVICE (OPUS)

**DATUM DESCRIPTION**  
 THE LOCALIZED COORDINATE SYSTEM DEVELOPED FOR THIS PROJECT IS BASED ON THE STATE PLANE COORDINATES ESTABLISHED BY NCGS FOR MONUMENT "B-5244-2 = GPS-2" WITH NAD 83 STATE PLANE GRID COORDINATES OF  
 NORTHING: 640770.6660(±) EASTING: 963975.4760(±)  
 ELEVATION: 2129.70(±)  
 THE AVERAGE COMBINED GRID FACTOR USED ON THIS PROJECT (GROUND TO GRID) IS: 0.99963296  
 THE N.C. LAMBERT GRID BEARING AND LOCALIZED HORIZONTAL GROUND DISTANCE FROM "B-5244-2 = GPS-2" TO -L- STATION 12+50.00 IS  
 S 47° 39' 37.2" W 580.20'  
 ALL LINEAR DIMENSIONS ARE LOCALIZED HORIZONTAL DISTANCES  
 VERTICAL DATUM USED IS NAVD 88

NOTE: DRAWING NOT TO SCALE

REVISIONS

8/17/99

PAVEMENT SCHEDULE	
C1	PROP. APPROX. 1.5" ASPHALT CONCRETE SURFACE COURSE, TYPE SF9.5A, AT AN AVERAGE RATE OF 165 LBS. PER SQ. YD.
C2	PROP. APPROX. 3" ASPHALT CONCRETE SURFACE COURSE, TYPE SF9.5A, AT AN AVERAGE RATE OF 165 LBS. PER SQ. YD. IN EACH OF TWO LAYERS.
C3	PROP. VAR. DEPTH ASPHALT CONCRETE SURFACE COURSE, TYPE SF9.5A, AT AN AVERAGE RATE OF 110 LBS. PER SQ. YD. PER 1" DEPTH. TO BE PLACED IN LAYERS NOT TO EXCEED 1.5" IN DEPTH.
D1	PROP. APPROX. 2.5" ASPHALT CONCRETE INTERMEDIATE COURSE, TYPE I19.0B, AT AN AVERAGE RATE OF 285 LBS. PER SQ. YD.
D2	PROP. VAR. DEPTH ASPHALT CONCRETE INTERMEDIATE COURSE, TYPE I19.0B, AT AN AVERAGE RATE OF 114 LBS. PER SQ. YD. PER 1" DEPTH, TO BE PLACED IN LAYERS NOT LESS THAN 2.5" IN DEPTH OR GREATER THAN 4" IN DEPTH.
E1	PROP. APPROX. 4" ASPHALT CONCRETE BASE COURSE, TYPE B25.0B, AT AN AVERAGE RATE OF 456 LBS. PER SQ. YD.
E2	PROP. VAR. DEPTH ASPHALT CONCRETE BASE COURSE, TYPE B25.0B, AT AN AVERAGE RATE OF 114 LBS. PER SQ. YD. PER 1" DEPTH, TO BE PLACED IN LAYERS NOT LESS THAN 4" IN DEPTH OR GREATER THAN 5 1/2" IN DEPTH.
R1	SHOULDER BERM GUTTER
T_	EARTH MATERIAL
U_	EXISTING PAVEMENT
W	WEDGING

NOTE: PAVEMENT EDGE SLOPES ARE 1:1 UNLESS SHOWN OTHERWISE.

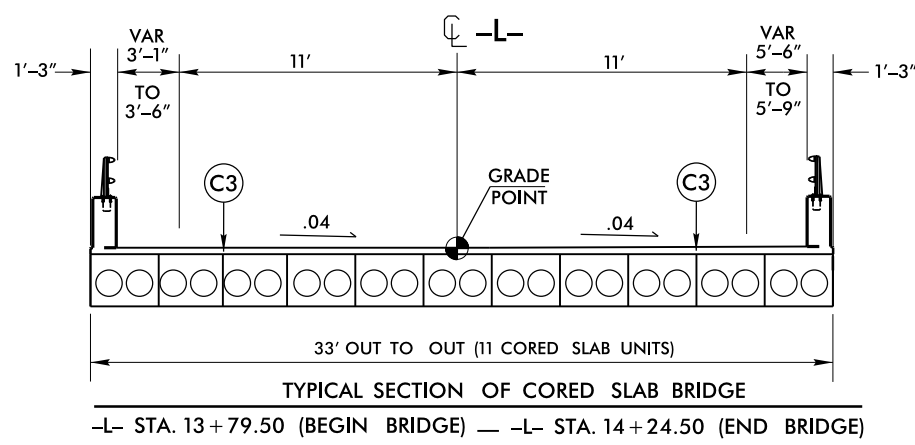
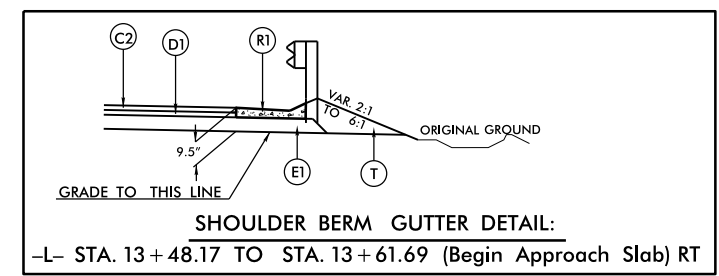
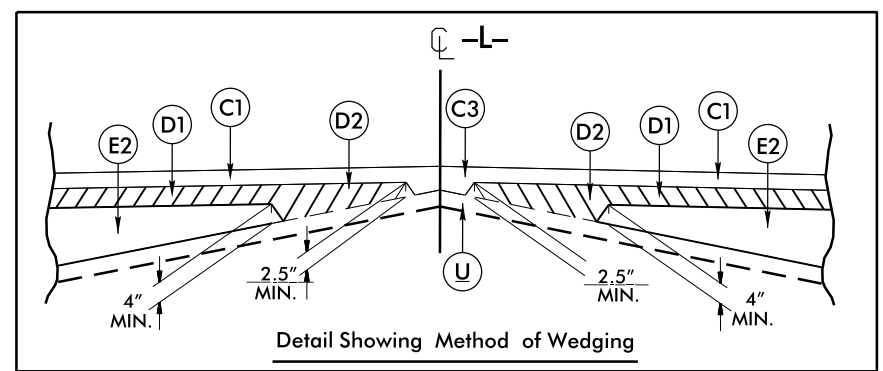

PROJECT REFERENCE NO. <b>B-5244</b>	SHEET NO. <b>2A-1</b>
ROADWAY DESIGN ENGINEER	PAVEMENT DESIGN ENGINEER
<b>PRELIMINARY PLANS</b> DO NOT USE FOR CONSTRUCTION	

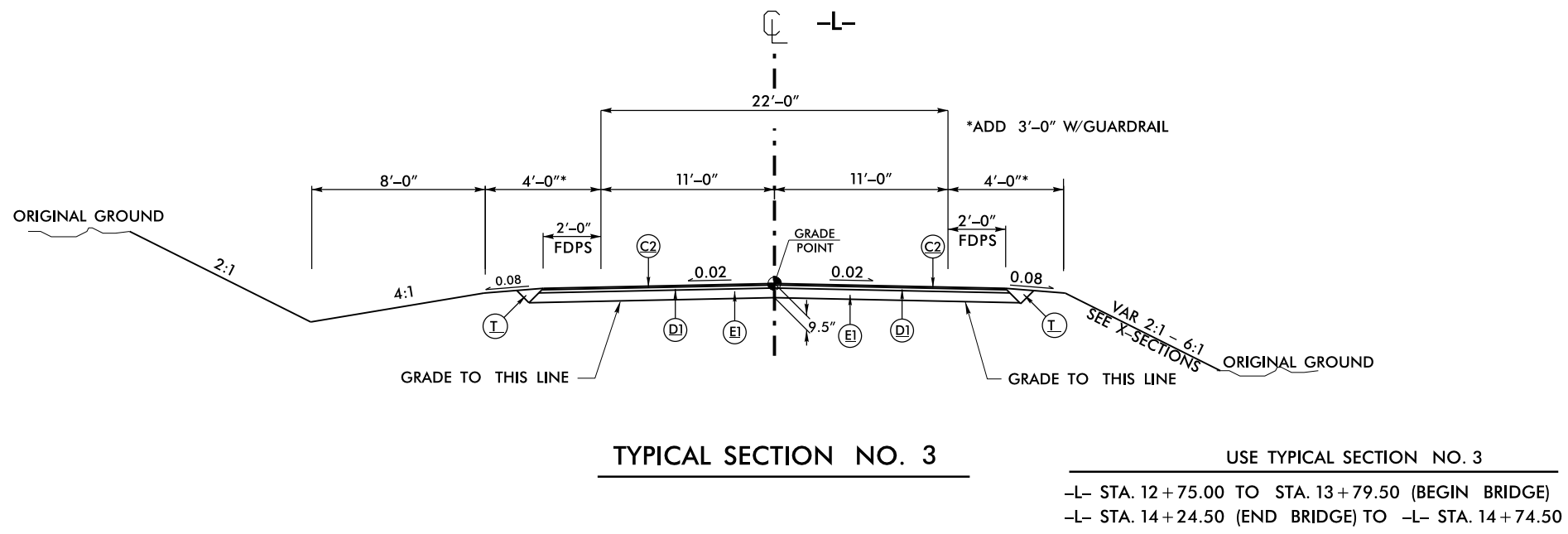
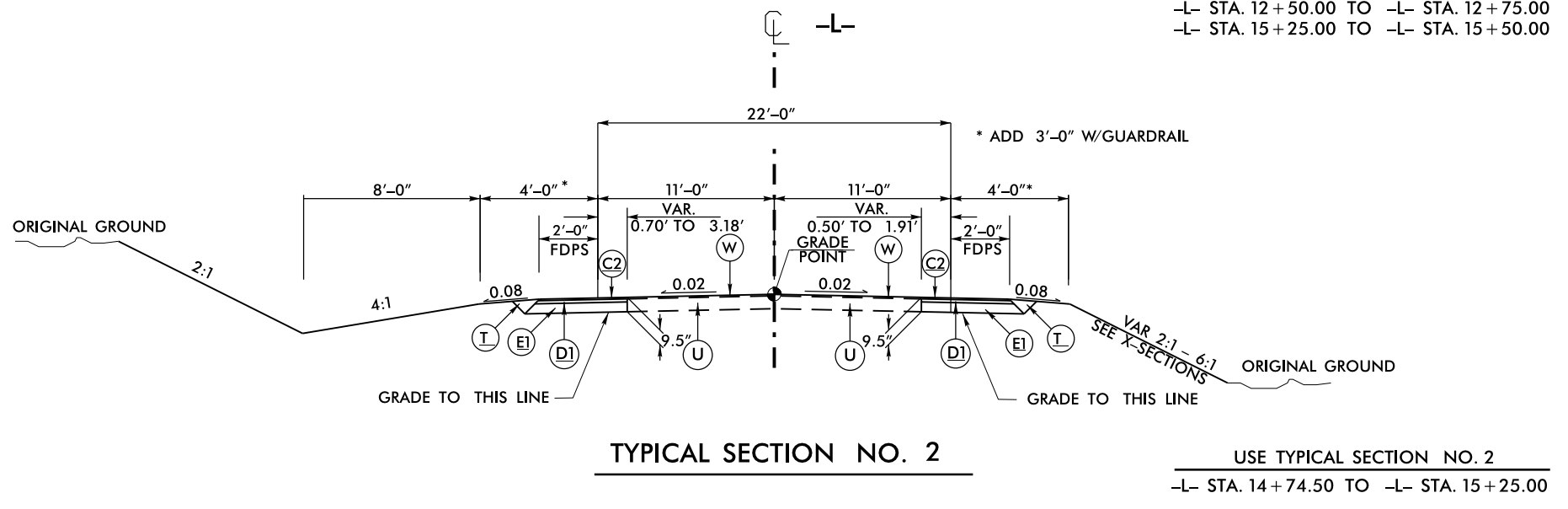
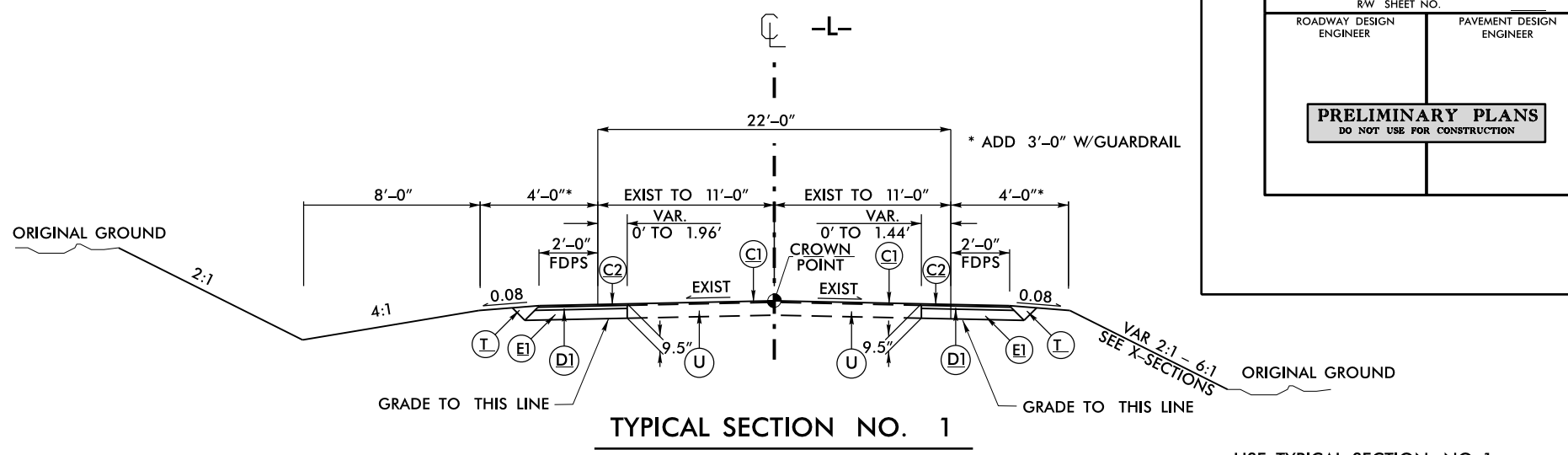

REVISIONS

10-MAR-2015 10:48 AM  
R:\PROJECTS\105244\B5244\_Rdy\_typ\_L.dgn  
8/17/99



PROJECT REFERENCE NO. <b>B-5244</b>	SHEET NO. <b>4</b>
R/W SHEET NO.	
ROADWAY DESIGN ENGINEER	HYDRAULICS ENGINEER
<b>PRELIMINARY PLANS</b> DO NOT USE FOR CONSTRUCTION	

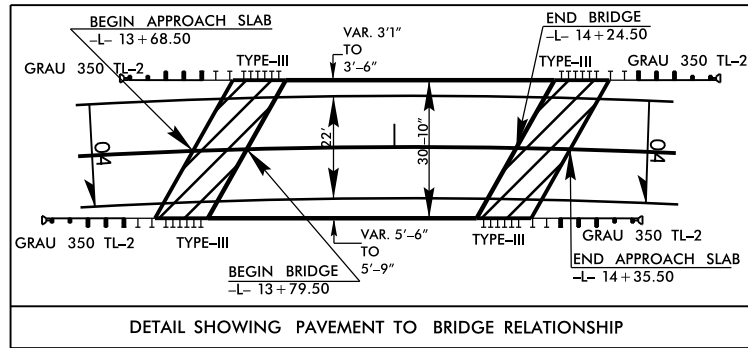

10

PROP. APPROACH SLAB

15

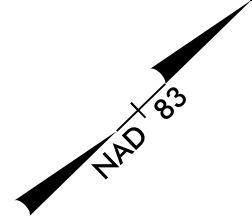

CHRIST SCHOOL, INC.  
D.B. 65, PG. 459, FIRST TRACT  
PORTION OF P.B. 2, PG. 23

1

**END TIP PROJECT B-5244**  
-L- STA. 15+50

**BEGIN TIP PROJECT B-5244**  
-L- STA. 12+50

CHRIST SCHOOL, INC.  
D.B. 65, PG. 459, FIRST TRACT  
PORTION OF P.B. 2, PG. 23

1

-L- PC Sta. 10+00.00

-L- PT Sta. 11+70.17

-L- PC Sta. 12+36.33

CHRIST SCHOOL, INC.  
D.B. 723, PG. 259  
PORTION OF P.B. 2, PG. 23

3

DONALD EUGENE CRAIG  
D.B. 2269, PG. 787

4

-L- PT Sta. 16+79.29

R.C. SOUTHER & LORRAINE C. SOUTHER  
D.B. 173, PG. 347

5

R.C. SOUTHER & RUBY EDEY DEES  
D.B. 4095, PG. 38

-L- POT Sta. 18+02.10

GLEN WILLIAMS SILVERS & ETHEL JANE SILVERS  
REF. D.B. 660, PG. 624

SEE SHEET 5 FOR PROFILE  
SEE SHEET 5 FOR STRUCTURE PLANS

-L-		
PI Sta 10+86.46	PI Sta 14+60.08	
$\Delta = 25^{\circ} 00' 00.0''$ (RT)	$\Delta = 20^{\circ} 00' 00.0''$ (RT)	
D = 14' 41" 28.4"	D = 4' 30' 54"	
L = 170.17'	L = 442.96'	
T = 86.46'	T = 223.76'	
R = 390.00'	R = 1,269.00'	
SE = SEE PLAN	SE = SEE PLAN	

SHOULDER BERM GUTTER  
SEE SHEET 2A-1 FOR DETAIL  
-L- STA. 13+48.17 TO 13+61.69 (BEGIN APPROACH SLAB) RT

REVISIONS  
 Row Revision 6-10-15 EAD: -L- 13+60 To 15+50 LT - Adjusted PDE and removed TCE and removed PDE and removed TCE  
 Design Revision 6-10-15 EAD: -L- 14+25 To 15+50 LT - Added a lateral base ditch.

8/17/99

10-JUN-2015 12:13  
 R:\Roadway\proj\5244\_rdu\_psh4.dgn  
 \$\$\$\$SYSTRAN\$\$\$\$

5/14/99

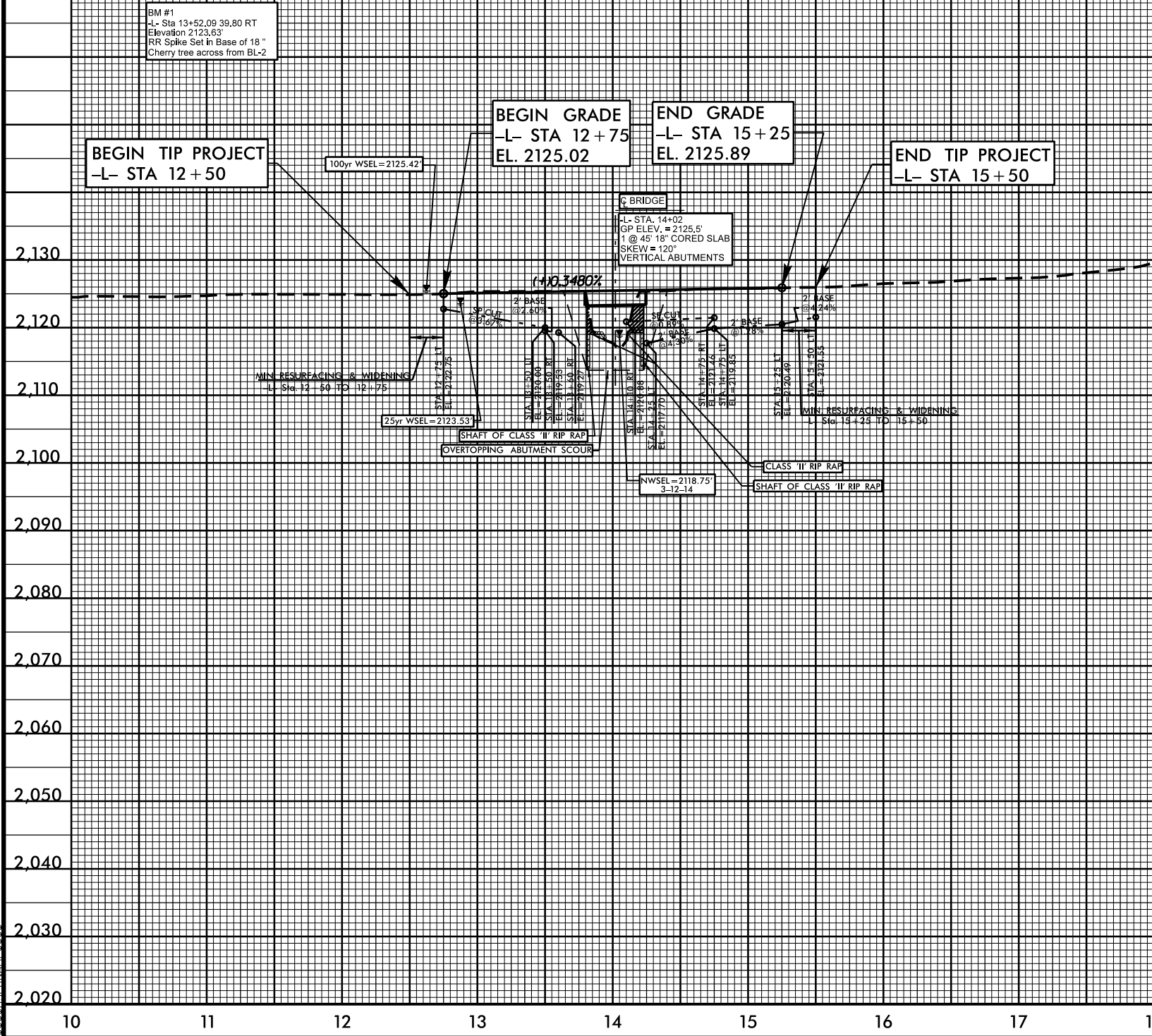
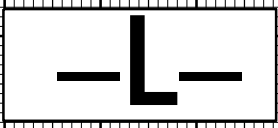

SEE SHEET 4 FOR -L- PLAN

10-JUN-2015 12:13  
 R:\Roadway\pco\B5244\_rdy\_pfl\_pst5.dgn  
 5/14/99

10-MAR-2015 11:09 R:\Roadwork\Corridor\Modeling\B5244\_Rdu\_XPL\_emo.dgn \$\$\$USERNAME\$\$\$

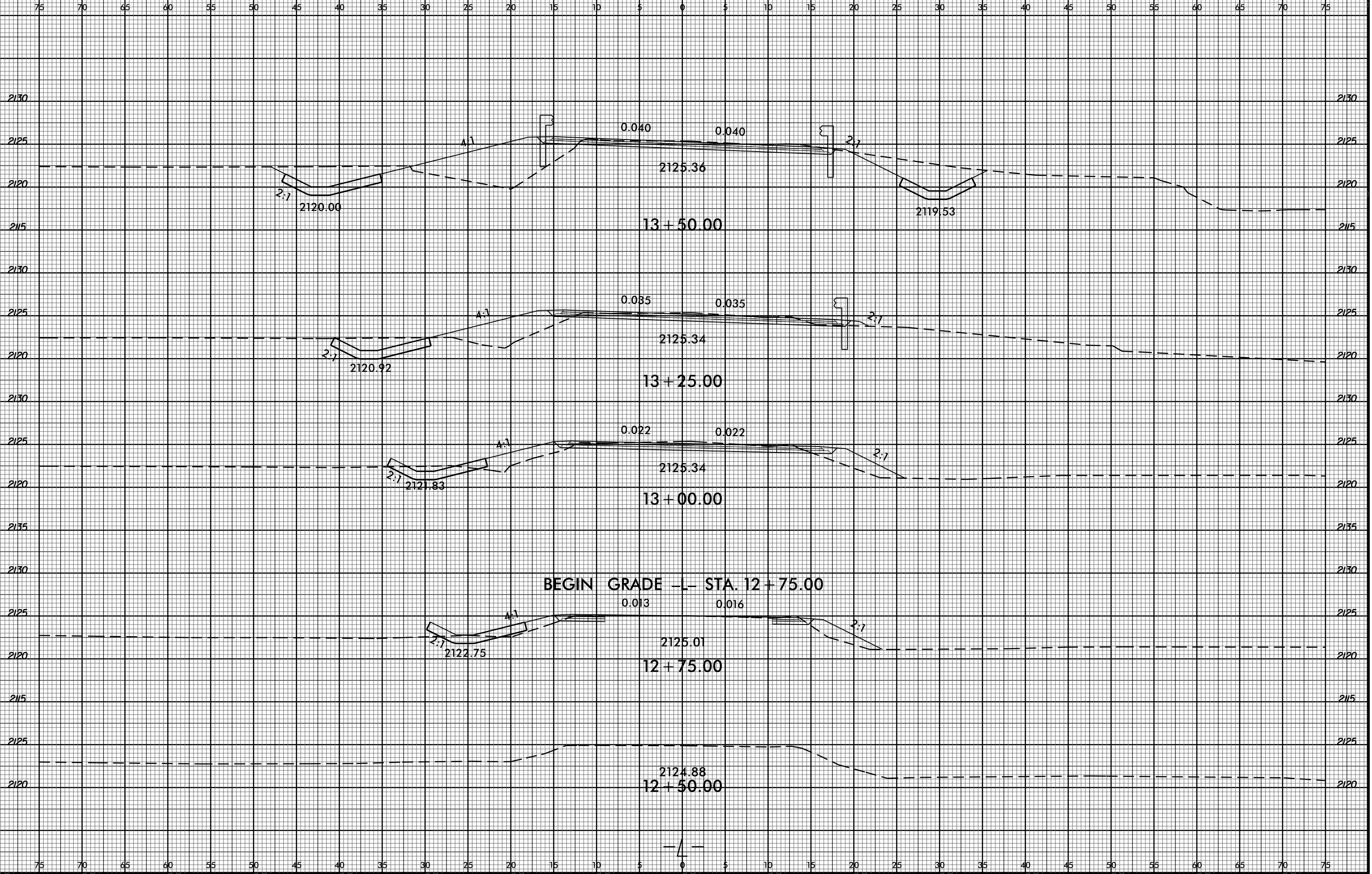

10-JUN-2015 12:16  
R:\Roadway\CorridorModeling\B5244\_Rdu\_XPL\_cmd.dgn  
\$\$\$\$\$USERNAME\$\$\$\$\$

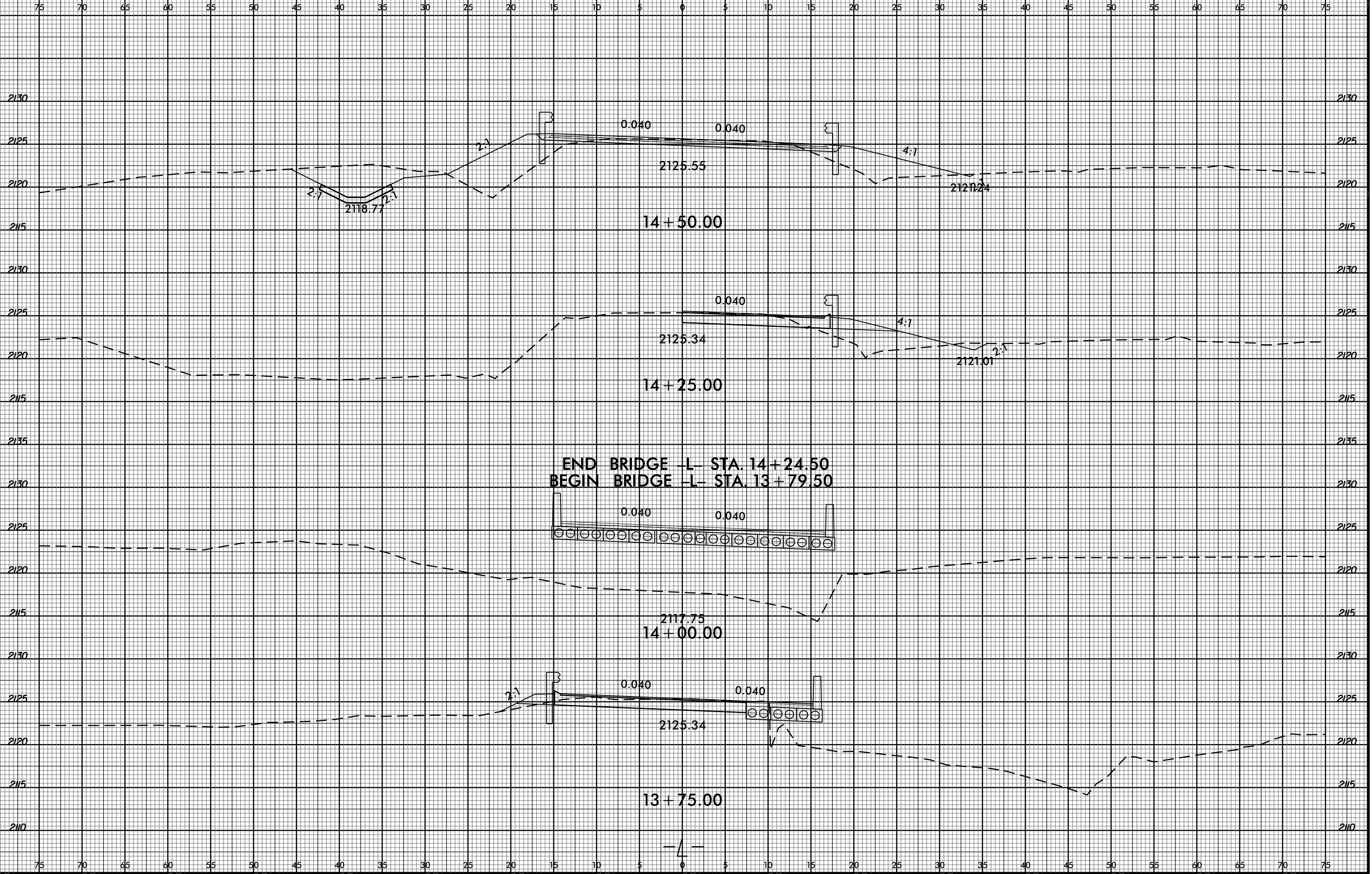

B:\223\99  
10-JUN-2015 12:17  
R:\Roadway\Corridor\Modeling\B5244\_Rdu\_XPL\_cmd.dgn  
\$\$\$\$\$USERNAME\$\$\$\$

