

NOTE: Map includes only state maintained roads. County and state boundaries provided by state and federal agencies, and are shown in their approximate location on this map as of September, 2016.

COPIES OF THIS MAP ARE AVAILABLE AT THE FOLLOWING ADDRESS:
 N.C. DEPARTMENT OF TRANSPORTATION
 MSAU - MAPPING SECTION
 8001 LITTLE ROCK ROAD
 RALEIGH, NC 27606

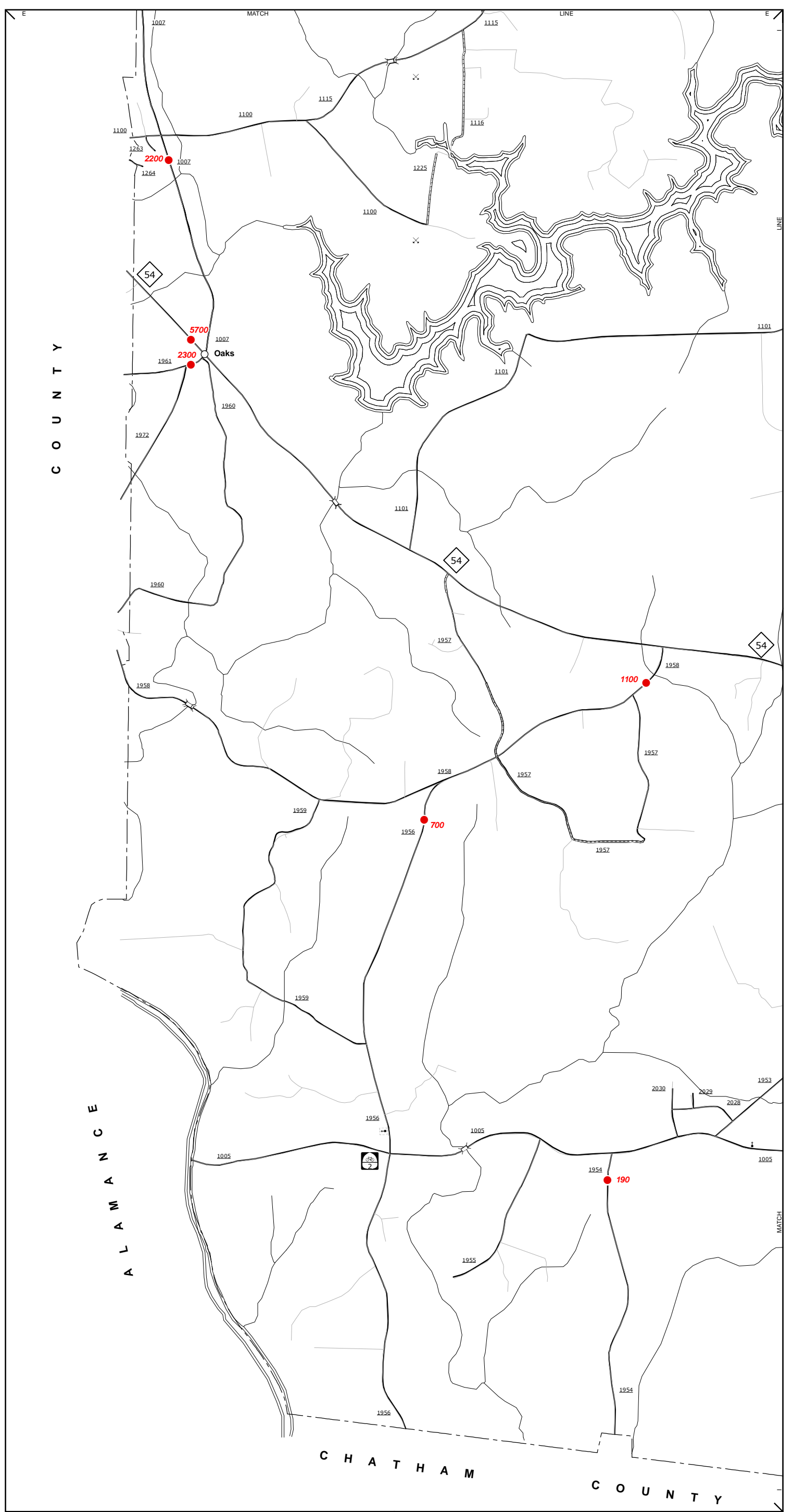

Oak and Vicinity

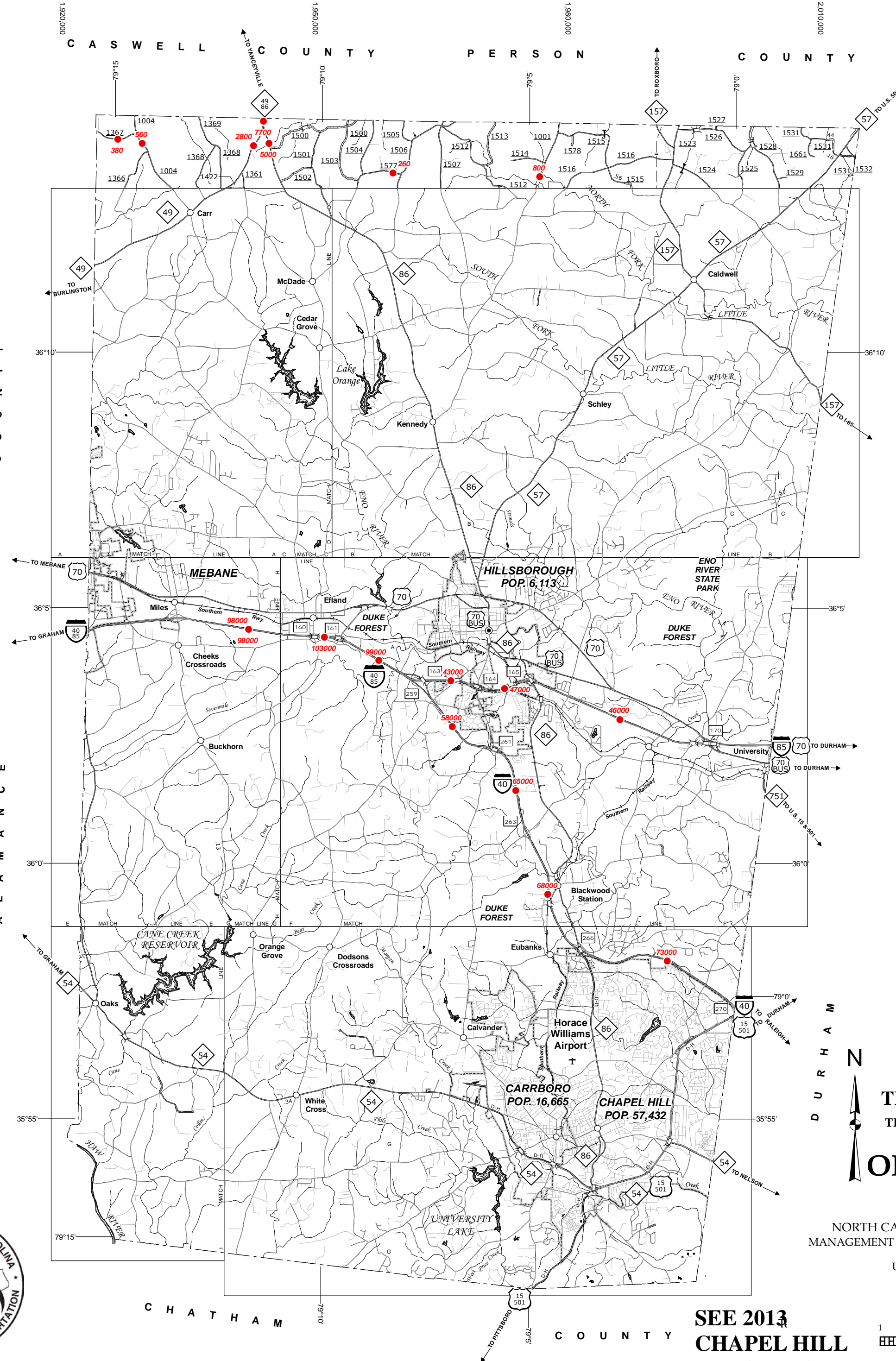
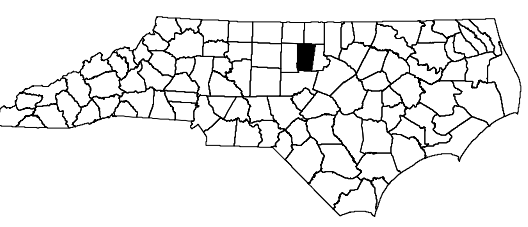
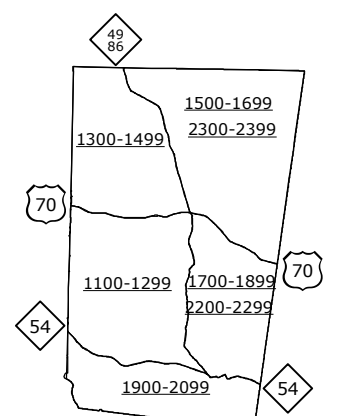
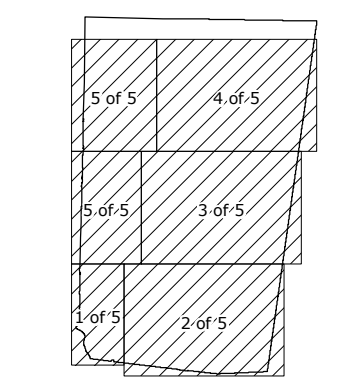

- LEGEND**
- UNPAVED SURFACED ROAD
 - HARD SURFACED ROAD
 - 4 LANE UNDIVIDED HIGHWAY
 - DIVIDED HIGHWAY INSET
 - FULL CONTROL ACCESS
 - NON-SYSTEM ROADS
 - PROJECTED LOCATION
 - NATIONAL PARK ROAD
 - BLUE RIDGE PARKWAY
 - INTERSECTION DISTANCE
 - TRAFFIC CIRCLE
 - DETAILED HIGHWAY INTERCHANGE
 - ROAD THROUGH MOUNTAIN PASS
 - HIGHWAY BRIDGE
 - UNDERPASS
 - OVERPASS
 - DRAW SPAN ON BRIDGE
 - HIGHWAY TUNNEL
 - FORD
 - INTERSTATE HIGHWAY
 - U.S. NUMBERED HIGHWAY
 - N.C. NUMBERED HIGHWAY
 - U.S. NUMBERED BICYCLE ROUTE
 - N.C. NUMBERED BICYCLE ROUTE
 - INTERSTATE INTERCHANGE NUMBER
 - SECONDARY ROAD NUMBER
 - UTILITY LINES
 - RAILROAD
 - RAILROAD STATION
 - GRADE CROSSING
 - INSET AREA
 - URBAN EXTENSION LINE
 - NATIONAL FOREST BOUNDARY
 - RESERVATION OR PARK BOUNDARY
 - STATE FOREST BOUNDARY
 - STATE GAMEDLAND BOUNDARY
 - FEDERAL GAMEDLAND BOUNDARY
 - MILITARY RESERVATION BOUNDARY
 - STATE LINE
 - COUNTY LINE
 - CITY LIMIT
 - FERRY ROUTE
 - CANAL
 - NARROW CREEK OR STREAM
 - WIDE RIVER OR CREEK
 - RESERVOIR, POND OR LAKE W/ ISLAND
 - DAM OR DAM WITH LOCK
 - WATERFALL
 - SWAMP
 - COMMUNITY, TOWN OR CITY CENTER
 - COUNTY SEAT
 - STATE CAPITAL
 - SCHOOL
 - COLLEGE OR UNIVERSITY
 - HOSPITAL
 - COAST GUARD STATION
 - CHURCH
 - CHURCH WITH CEMETERY
 - CEMETERY
 - PATROL STATION
 - CORRECTION OR PENAL INSTITUTION
 - QUARRY
 - MINE OR PIT
 - HIGHWAY GARAGE OR MAINT. YARD
 - HIGHWAY DIV. OR DIST. OFFICE
 - POST OFFICE
 - MILITARY POST
 - WILDLIFE REFUGE
 - WEIGH STATION
 - FAIRGROUNDS
 - HISTORICAL SITE
 - POINTS OF INTEREST
 - STATE FOREST
 - LIGHTHOUSE
 - MOUNTAIN GAP
 - MOUNTAIN SUMMIT
 - OVERLOOK
 - GEODEIC MARKER
 - REST AREA
 - VISITOR CTR/REST AREA
 - WELCOME CTR/REST AREA
 - MAJOR AIRPORT
 - AIRPORT
 - MILITARY AIRPORT
 - HELIPORT

2015 AADT
 ANNUAL AVERAGE DAILY TRAFFIC
 GENERATED BY THE
TRAFFIC SURVEY GROUP
 TRANSPORTATION PLANNING BRANCH

ORANGE COUNTY
 NORTH CAROLINA

PREPARED BY THE
 NORTH CAROLINA DEPARTMENT OF TRANSPORTATION
 MANAGEMENT SYSTEMS AND ASSESSMENTS UNIT - MAPPING SECTION
 IN COOPERATION WITH THE
 U.S. DEPARTMENT OF TRANSPORTATION
 FEDERAL HIGHWAY ADMINISTRATION

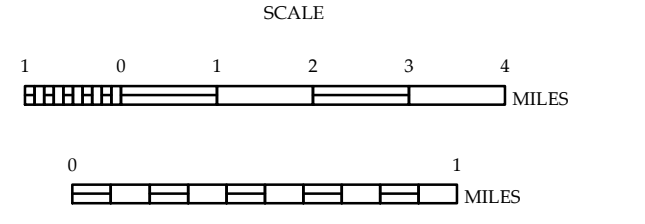

10,000 FOOT GRID BASED ON NORTH CAROLINA PLANE COORDINATE SYSTEM
 LAMBERT CONFORMAL CONIC PROJECTION

SEE 2013
CHAPEL HILL
URBAN MAP



NOTE: Map includes only state maintained roads. County and state boundaries provided by state and federal agencies, and are shown in their approximate information on this map is current up to September, 2016.

COPIES OF THIS MAP ARE AVAILABLE AT A FEE. PUBLIC AT NOMINAL COST. ADDRESS: N.C. DEPARTMENT OF TRANSPORTATION, MSAU - MAPPING SECTION, ROUTE 158, NC 27606

Chapel Hill and Vicinity

**SEE 2015
CHAPEL HILL
URBAN MAP**

2015 AADT
ANNUAL AVERAGE DAILY TRAFFIC
GENERATED BY THE
TRAFFIC SURVEY GROUP
TRANSPORTATION PLANNING BRANCH

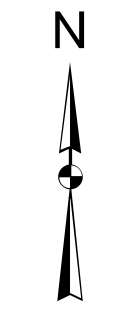

ENLARGED MUNICIPAL AND SUBURBAN AREAS

**ORANGE COUNTY
NORTH CAROLINA**

PREPARED BY THE
NORTH CAROLINA DEPARTMENT OF TRANSPORTATION
MANAGEMENT SYSTEMS AND ASSESSMENTS UNIT - MAPPING SECTION
IN COOPERATION WITH THE
U.S. DEPARTMENT OF TRANSPORTATION
FEDERAL HIGHWAY ADMINISTRATION

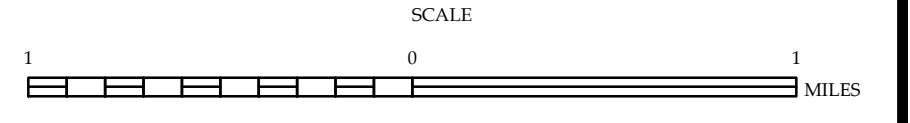

10,000 FOOT GRID BASED ON NORTH CAROLINA PLANE COORDINATE SYSTEM LAMBERT CONFORMAL CONIC PROJECTION

NOTE: Map includes only state-maintained roads. County and state boundaries provided by state and federal agencies, and are shown in their approximate information on this map is current up to September, 2016.

COPIES OF THIS MAP ARE AVAILABLE AT A FEE. CONTACT: N.C. DEPARTMENT OF TRANSPORTATION, MS4U - MAPPING SECTION, 800 WEST WASHINGTON STREET, RALEIGH, NC 27603



Hillsborough and Vicinity

2015 AADT
ANNUAL AVERAGE DAILY TRAFFIC
GENERATED BY THE
TRAFFIC SURVEY GROUP
TRANSPORTATION PLANNING BRANCH

ENLARGED MUNICIPAL AND SUBURBAN AREAS
ORANGE COUNTY
NORTH CAROLINA

PREPARED BY THE
NORTH CAROLINA DEPARTMENT OF TRANSPORTATION
MANAGEMENT SYSTEMS AND ASSESSMENTS UNIT - MAPPING SECTION
IN COOPERATION WITH THE
U.S. DEPARTMENT OF TRANSPORTATION
FEDERAL HIGHWAY ADMINISTRATION

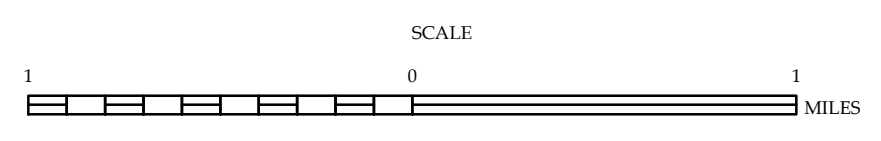

10,000 FOOT GRID BASED ON NORTH CAROLINA PLANE COORDINATE SYSTEM
LAMBERT CONFORMAL CONIC PROJECTION

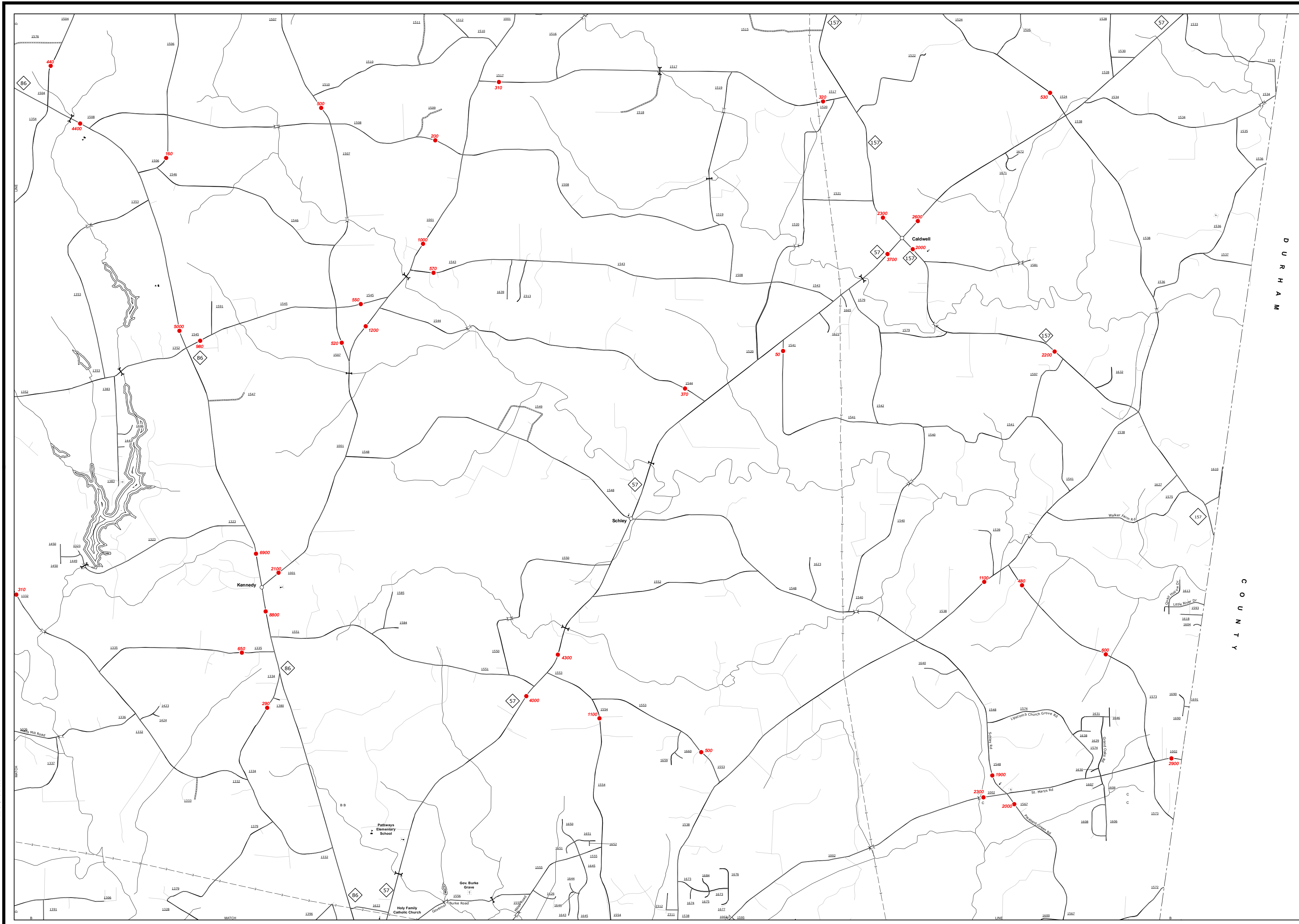

D U R H A M
C O U N T Y

Caldwell, Kennedy, Schley and Vicinity

2015 AADT
ANNUAL AVERAGE DAILY TRAFFIC
GENERATED BY THE
TRAFFIC SURVEY GROUP
TRANSPORTATION PLANNING BRANCH

ENLARGED MUNICIPAL AND SUBURBAN AREAS

ORANGE COUNTY
NORTH CAROLINA

PREPARED BY THE
NORTH CAROLINA DEPARTMENT OF TRANSPORTATION
MANAGEMENT SYSTEMS AND ASSESSMENTS UNIT - MAPPING SECTION
IN COOPERATION WITH THE
U.S. DEPARTMENT OF TRANSPORTATION
FEDERAL HIGHWAY ADMINISTRATION

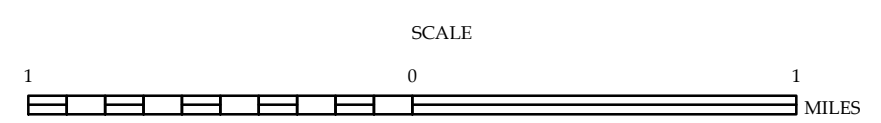

10,000 FOOT GRID BASED ON NORTH CAROLINA PLANE COORDINATE SYSTEM
LAMBERT CONFORMAL CONIC PROJECTION

SHEET 4 OF 5

NOTE: Map includes only state-maintained roads
and is not intended to be used for legal
county and state boundaries provided by state and
federal agencies, and are shown in their approximate
locations. Information on this map is current up to September, 2016.

COPIES OF THIS MAP ARE AVAILABLE
FOR PURCHASE AT NOMINAL COST.
ADDRESS:
N.C. DEPARTMENT OF TRANSPORTATION
MSAU - MAPPING SECTION
RAULIEN LN., #20906
Raleigh, NC 27606

COPIES OF THIS MAP ARE AVAILABLE
 PUBLIC AT NOMINAL COST.
 ADDRESS:
 N.C. DEPARTMENT OF TRANSPORTATION
 MS&U - MAPPING SECTION
 ROUTE 1248, BOX 24096
 RALEIGH, NC 27624

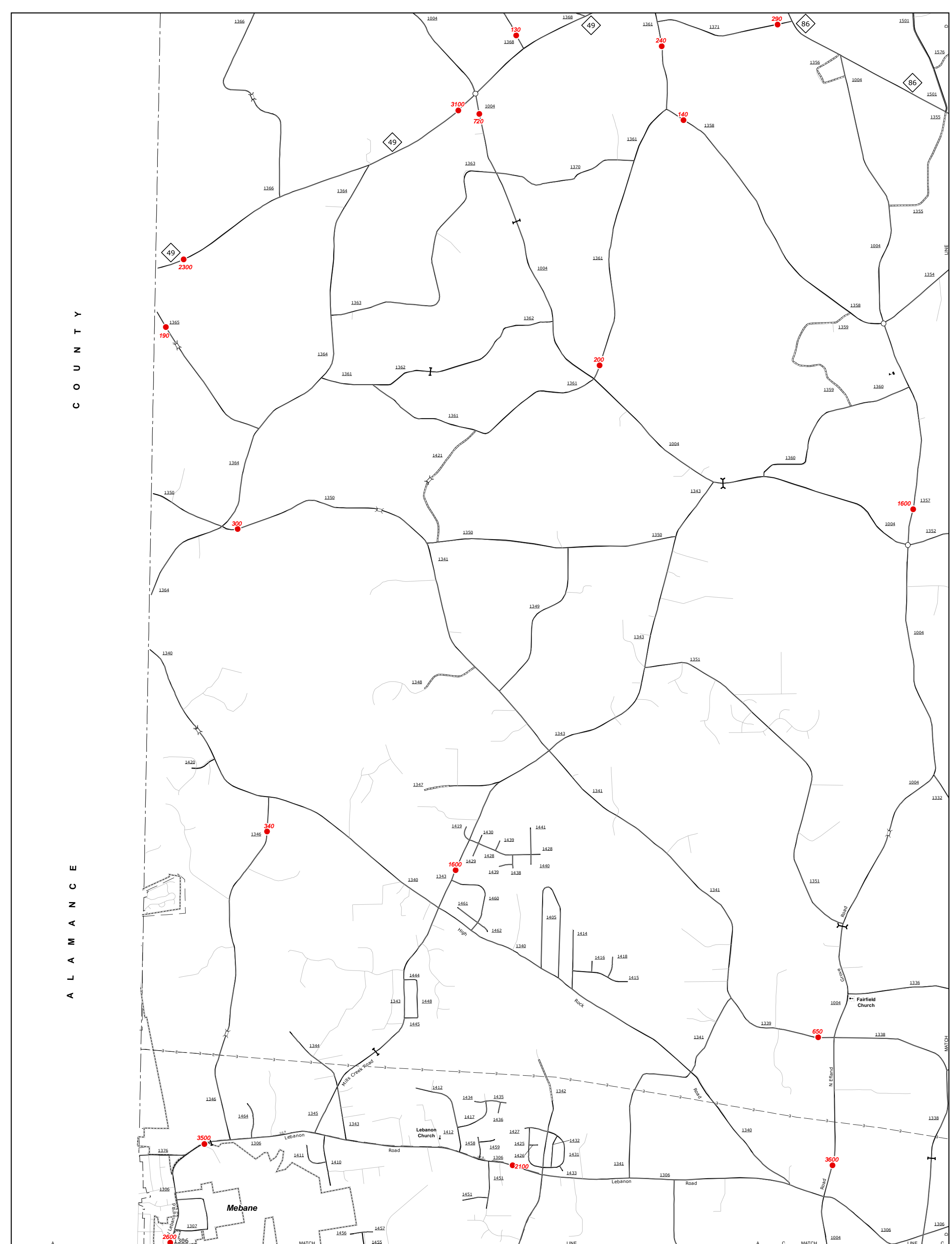

Mebane North

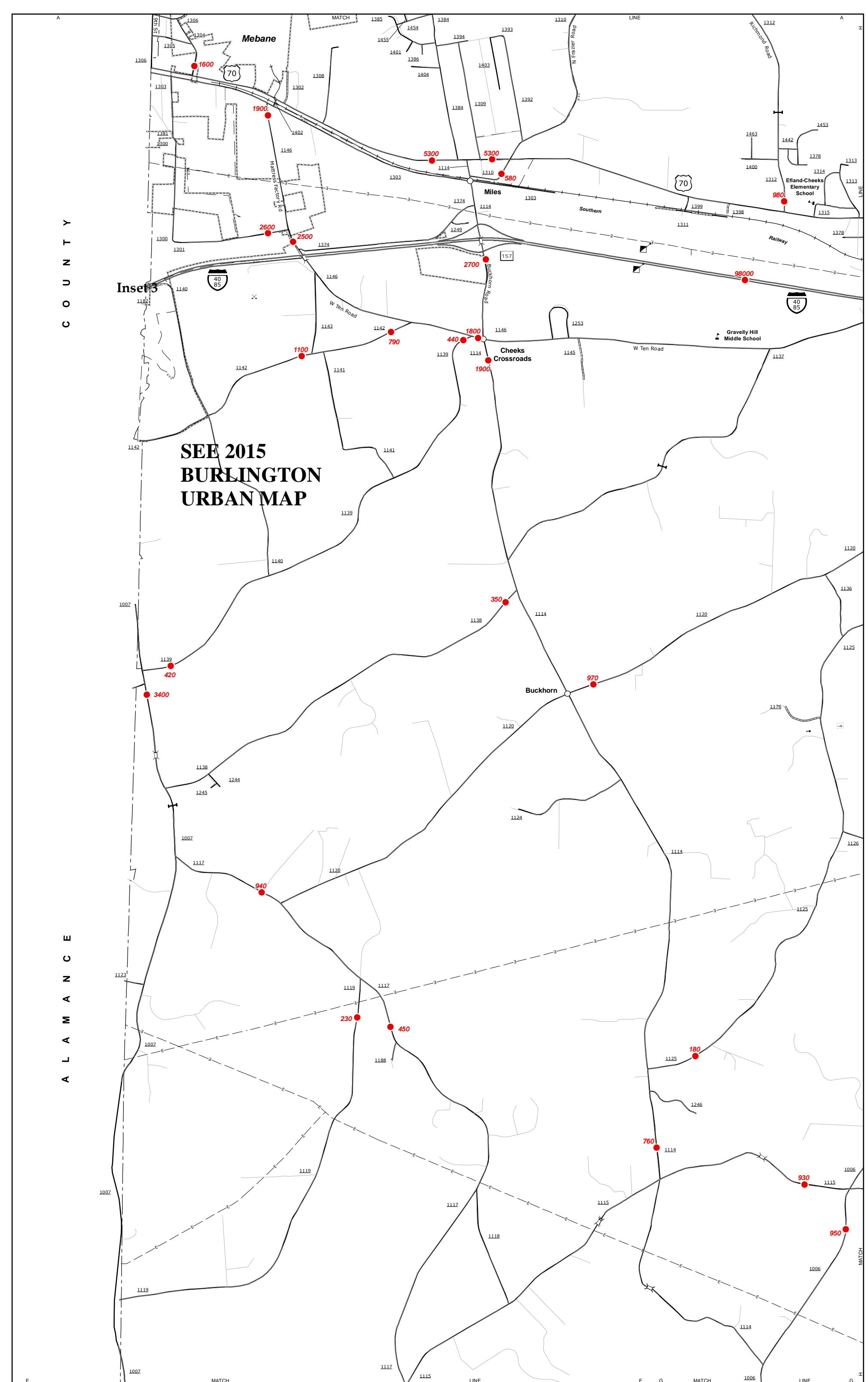

Mebane South

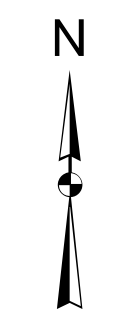

2015 AADT
 ANNUAL AVERAGE DAILY TRAFFIC
 GENERATED BY THE
TRAFFIC SURVEY GROUP
 TRANSPORTATION PLANNING BRANCH
 ENLARGED MUNICIPAL AND SUBURBAN AREAS
ORANGE COUNTY
 NORTH CAROLINA
 PREPARED BY THE
 NORTH CAROLINA DEPARTMENT OF TRANSPORTATION
 MANAGEMENT SYSTEMS AND ASSESSMENTS UNIT - MAPPING SECTION
 IN COOPERATION WITH THE
 U.S. DEPARTMENT OF TRANSPORTATION
 FEDERAL HIGHWAY ADMINISTRATION

