

NEWPORT

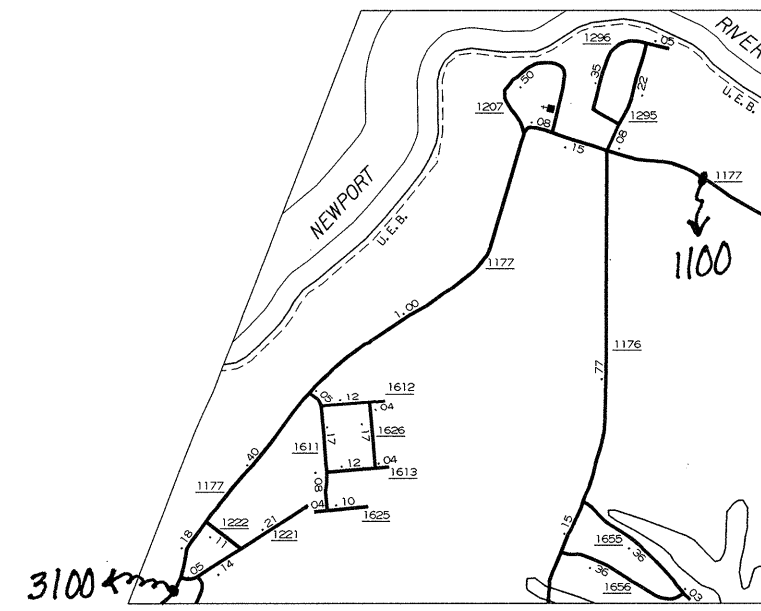

INSET 2

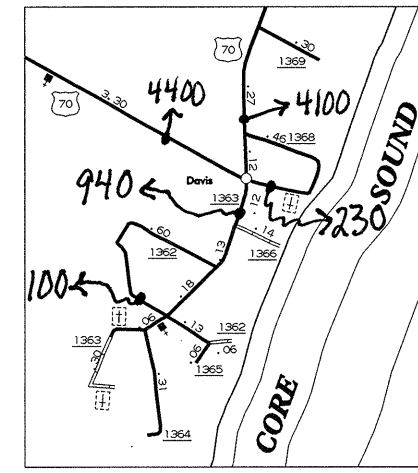

DAVIS

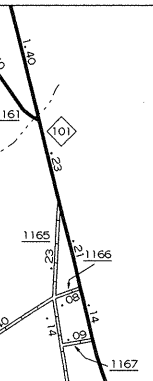
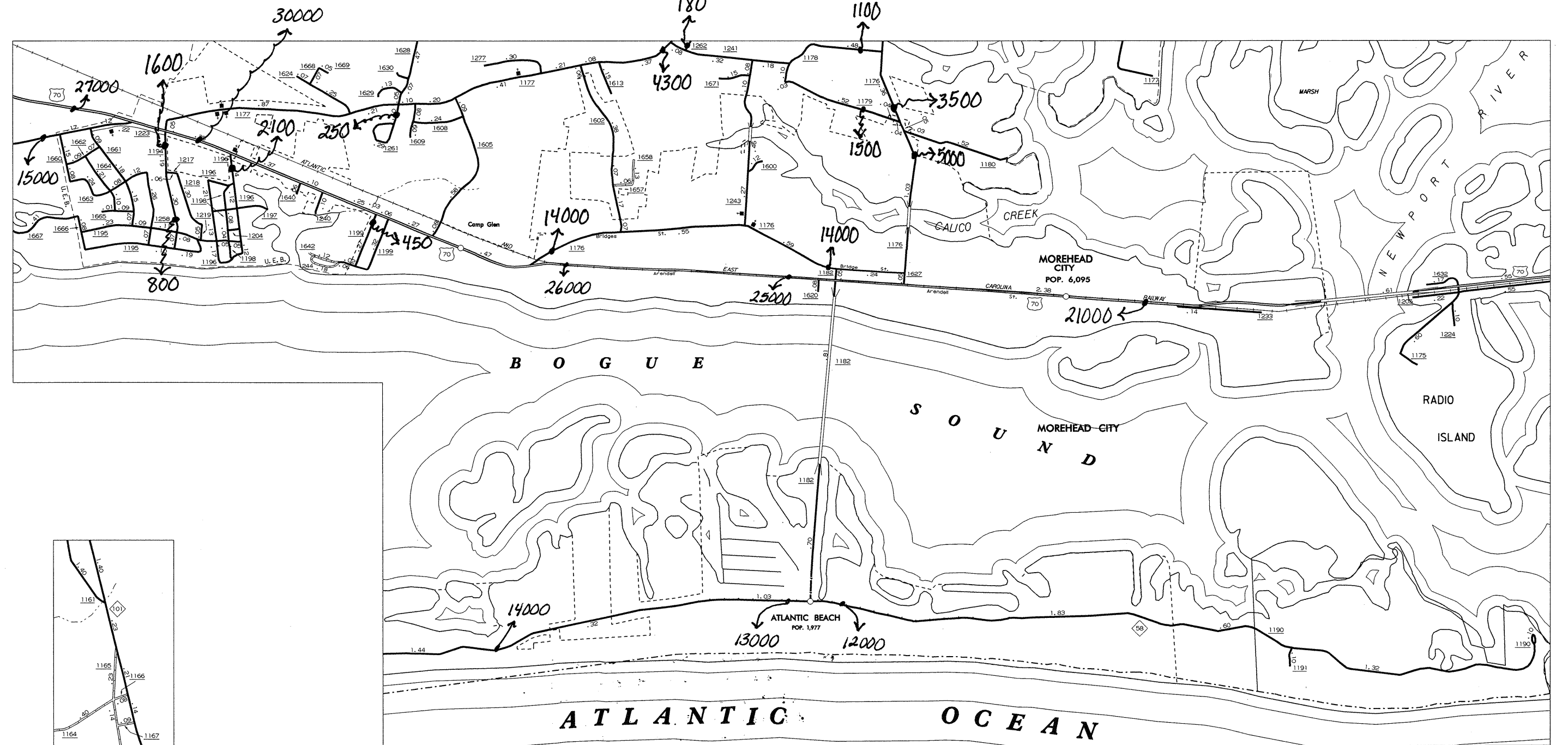

INSET 1

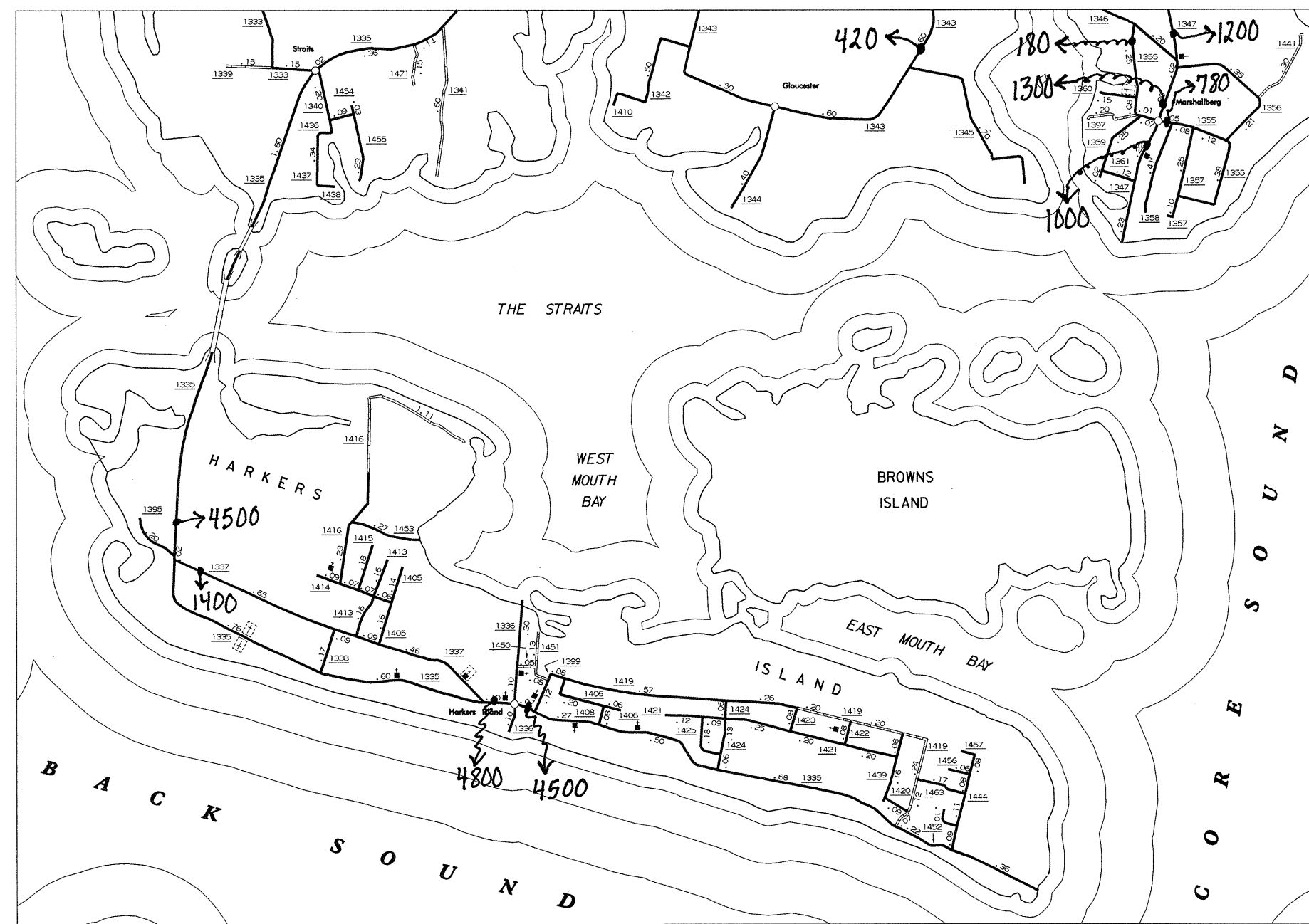

HARKERS ISLAND

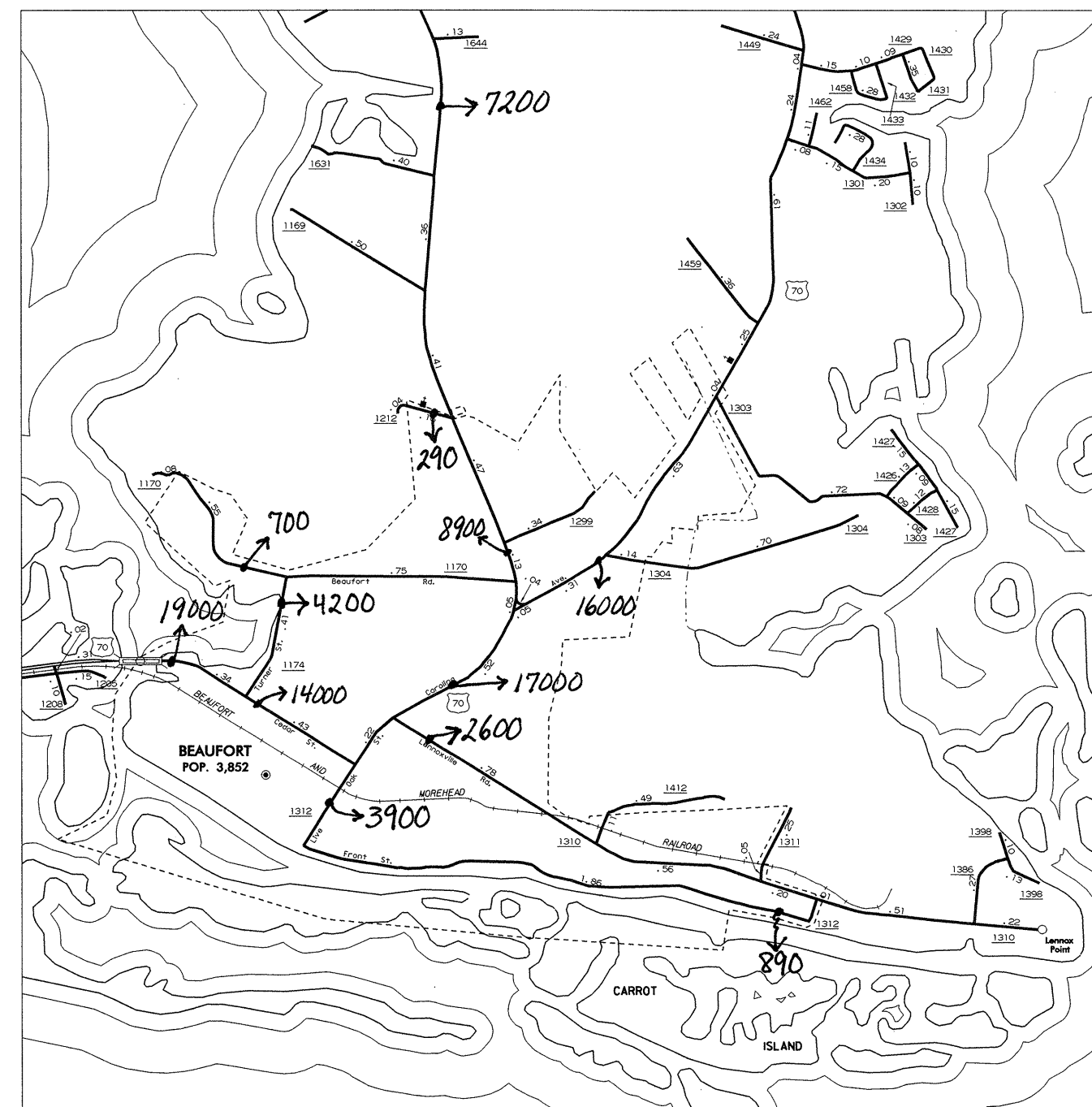

BEAUFORT

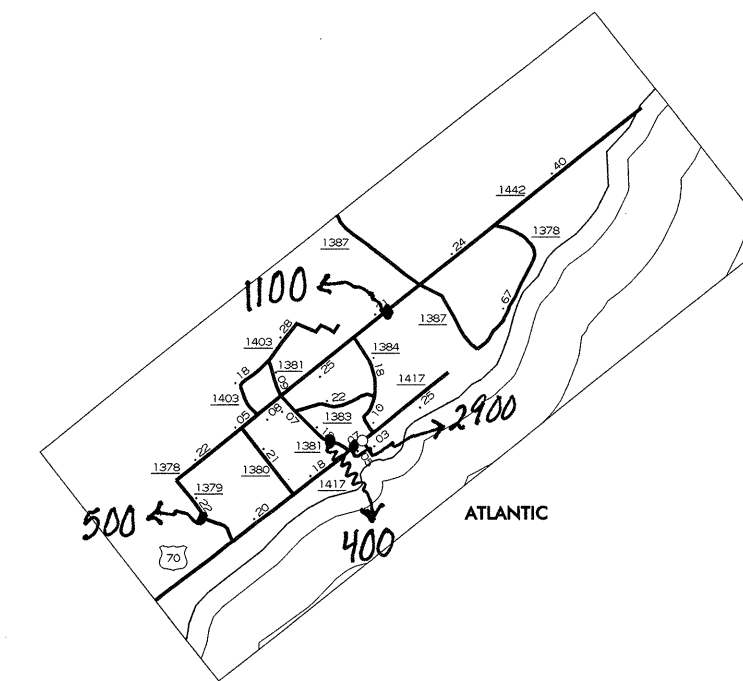

ATLANTIC

Some of the traffic estimates in this county were based on data collected after hurricane events in 1999. Contact the Traffic Survey Unit at (919) 733-8770 for information about a particular location or area.

N.C. Department of Transportation
Statewide Planning Branch
Traffic Survey Unit
1554 Mail Service Center
Raleigh, NC 27699-1554

1999
ANNUAL AVERAGE
DAILY TRAFFIC

ENLARGED MUNICIPAL AND SUBURBAN AREAS

CARTERET COUNTY

NORTH CAROLINA

PREPARED BY THE
NORTH CAROLINA DEPARTMENT OF TRANSPORTATION
DIVISION OF HIGHWAYS - GIS UNIT

IN COOPERATION WITH THE
U.S. DEPARTMENT OF TRANSPORTATION
FEDERAL HIGHWAY ADMINISTRATION

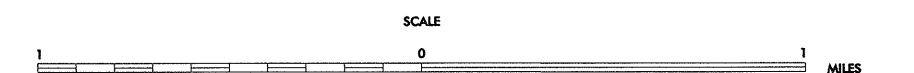
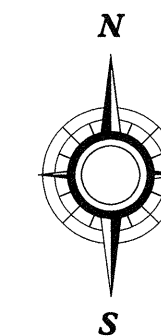

10,000 FOOT GRID BASED ON NORTH CAROLINA PLANE COORDINATE SYSTEM
NATIONAL GRID PROJECTION

COPIES OF THIS MAP ARE AVAILABLE TO THE PUBLIC AT A MINIMAL COST. ADDRESS: N.C. DEPARTMENT OF TRANSPORTATION, DIVISION OF HIGHWAYS, RATION, NORTH CAROLINA, 27611

REVISED 1-1-95 RLN