

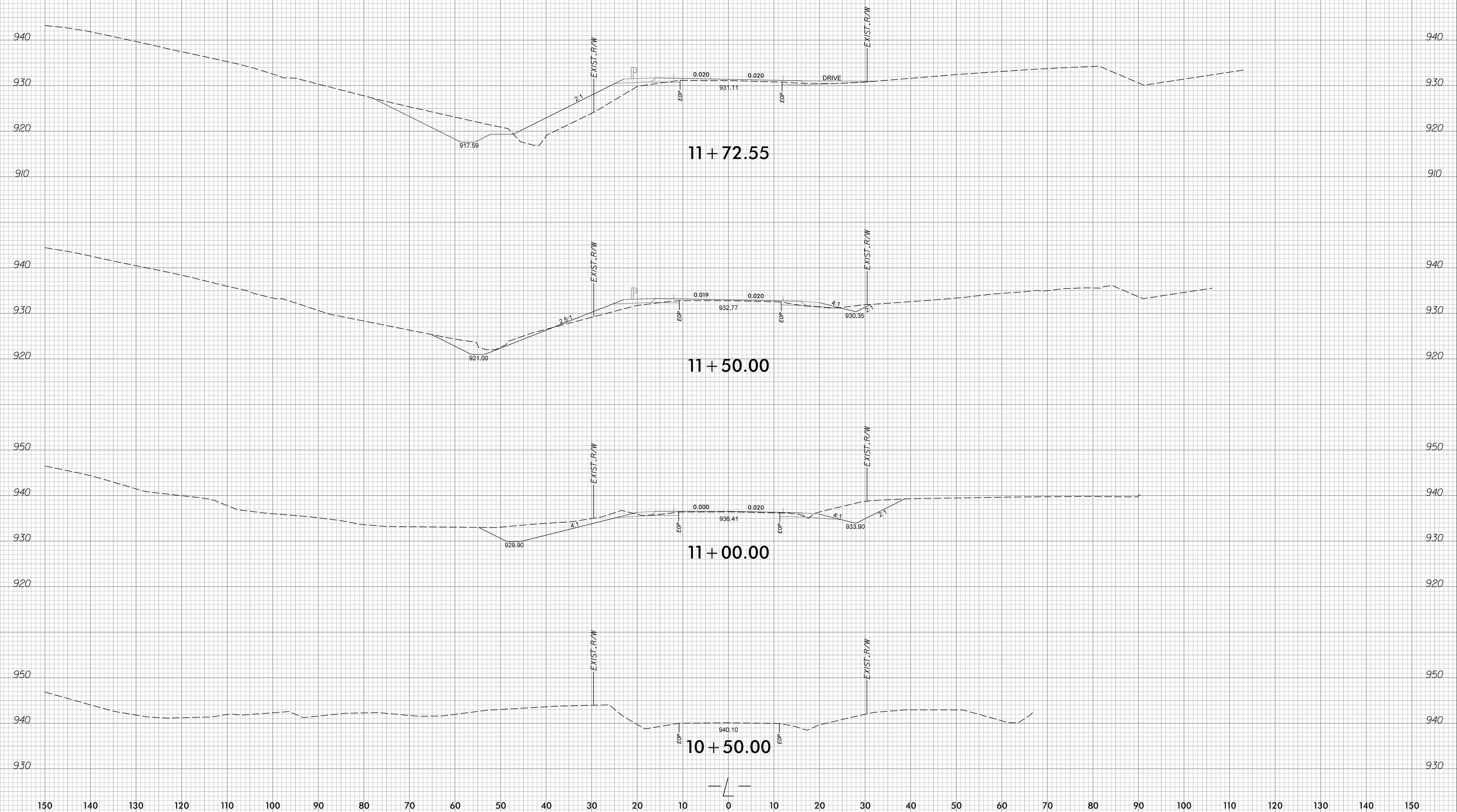



150 140 130 120 110 100 90 80 70 60 50 40 30 20 10 0 10 20 30 40 50 60 70 80 90 100 110 120 130 140 150



1/6/2025 9:17:13 AM  
 c:\pwworking\hmm\raji-transit\cor66165\00176849\840286.rdy\_xpl.l.dgn  
 150 E:\01.dgn

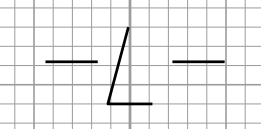

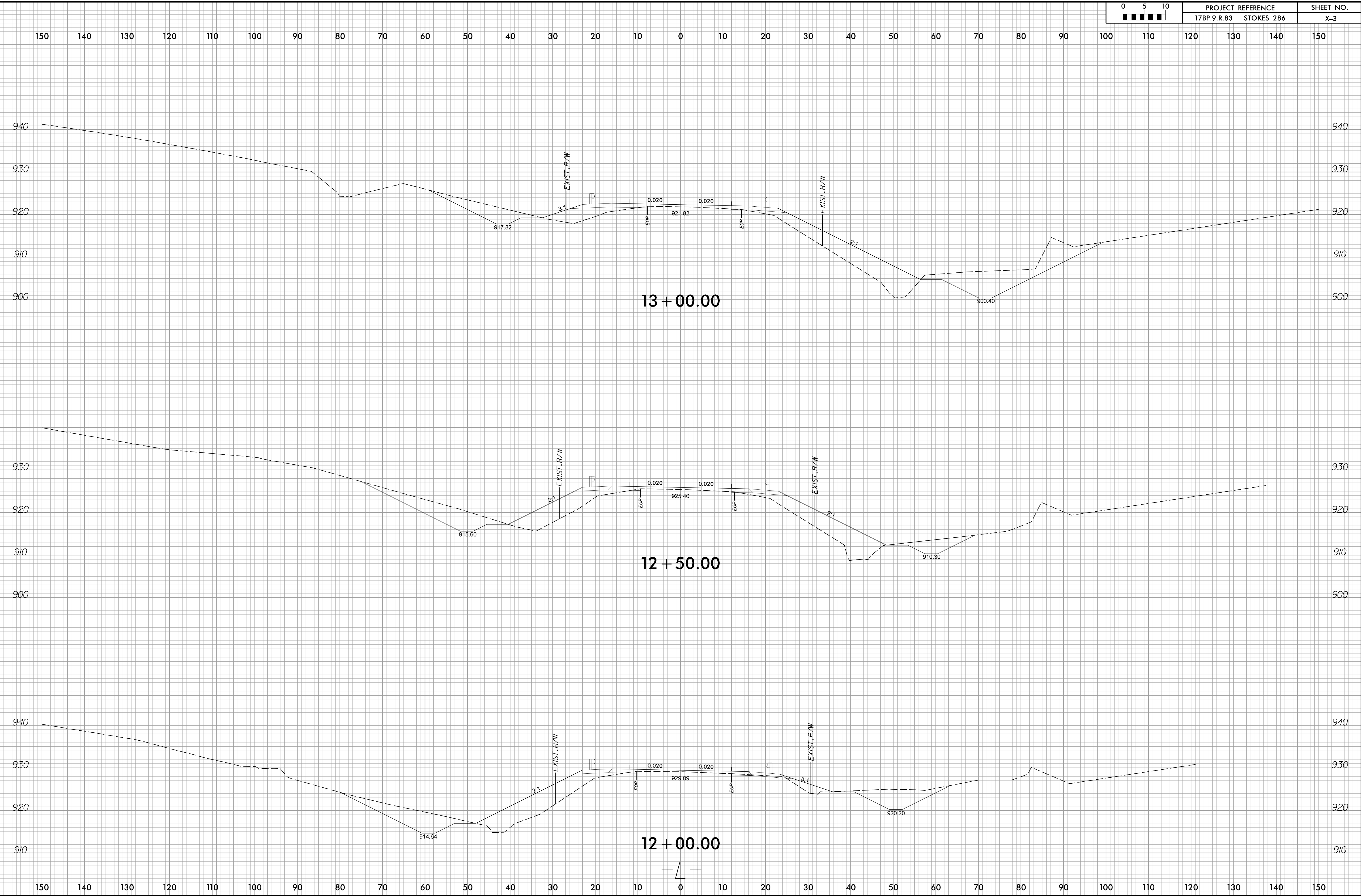

1/6/2025 9:17:21 AM  
 c:\pwworking\hmm\raji\transit\cor66165\0176849\840286.rdy.xpl.i.dgn  
 150 E:\01.dgn

150 140 130 120 110 100 90 80 70 60 50 40 30 20 10 0 10 20 30 40 50 60 70 80 90 100 110 120 130 140 150

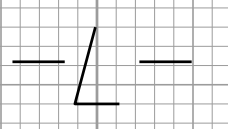
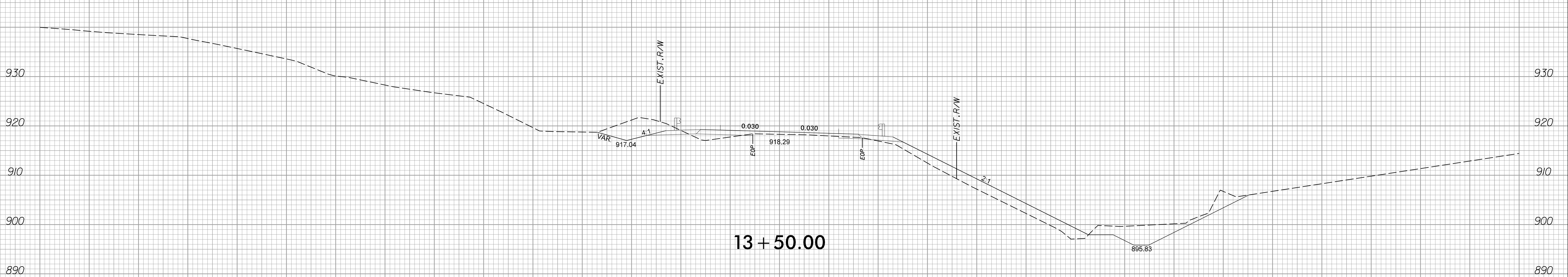
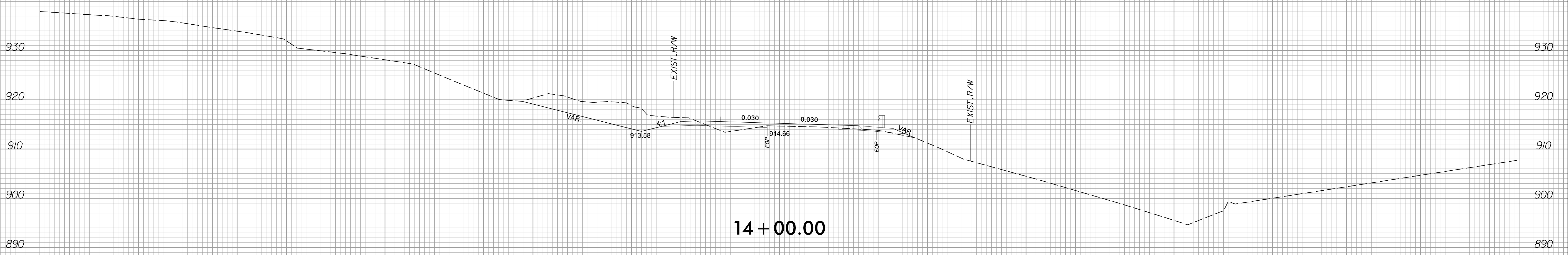

1/6/2025 9:17:30 AM  
 c:\pwworking\hmm\raji\transit\cor66165\0176849\840286\_rdy\_xpl\_1.dgn  
 130 PLOT.DGN

150 140 130 120 110 100 90 80 70 60 50 40 30 20 10 0 10 20 30 40 50 60 70 80 90 100 110 120 130 140 150

150 140 130 120 110 100 90 80 70 60 50 40 30 20 10 0 10 20 30 40 50 60 70 80 90 100 110 120 130 140 150

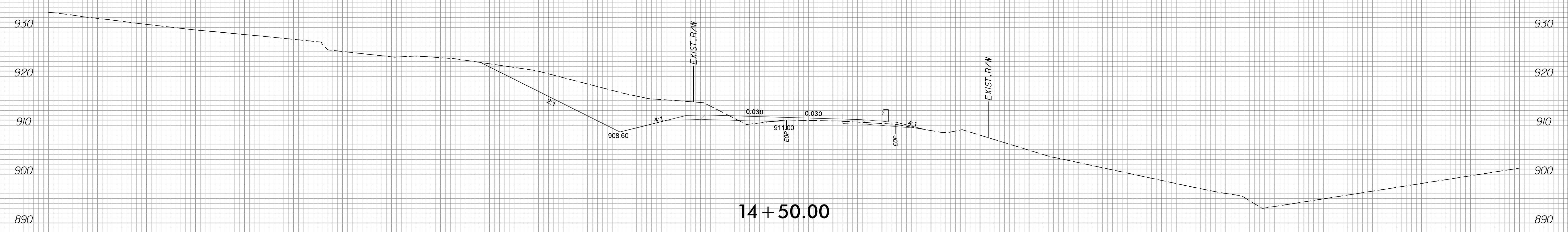
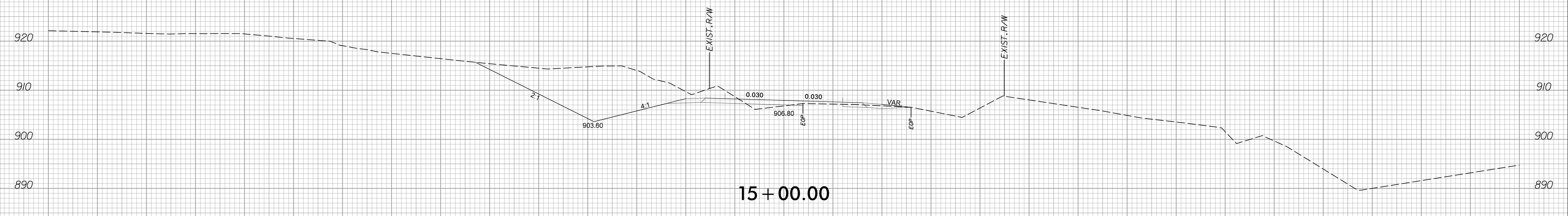
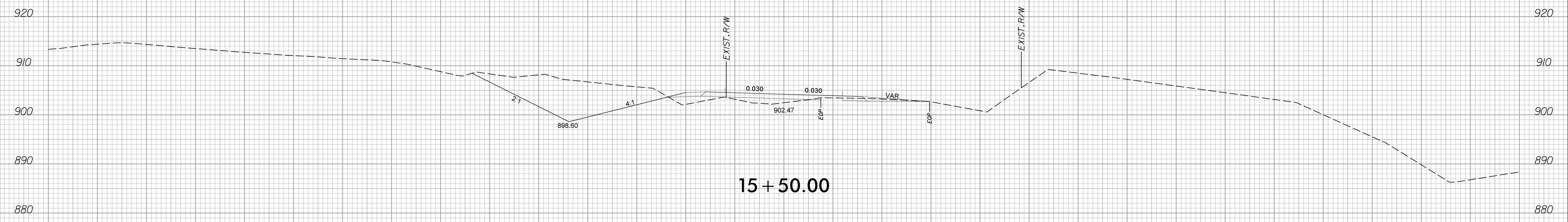

150 140 130 120 110 100 90 80 70 60 50 40 30 20 10 0 10 20 30 40 50 60 70 80 90 100 110 120 130 140 150

1/6/2025 9:17:39 AM  
 c:\pwworking\hmm\raii\transit\cor66165\0176849\840286.rdy.xpl.i.dgn  
 150 E:\01.dgn

150 140 130 120 110 100 90 80 70 60 50 40 30 20 10 0 10 20 30 40 50 60 70 80 90 100 110 120 130 140 150

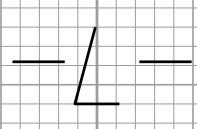
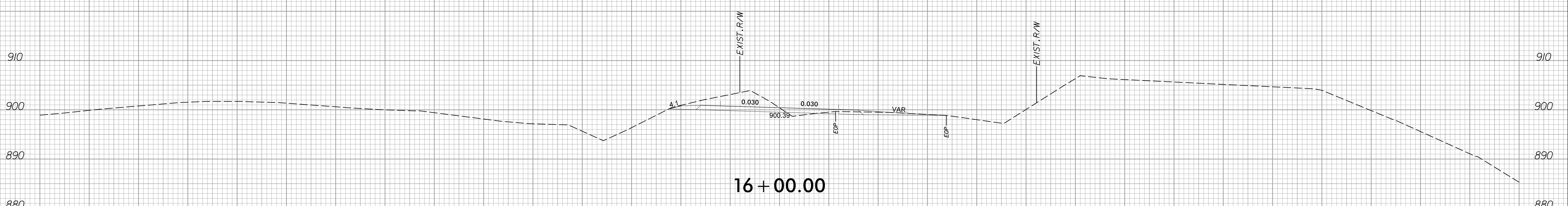
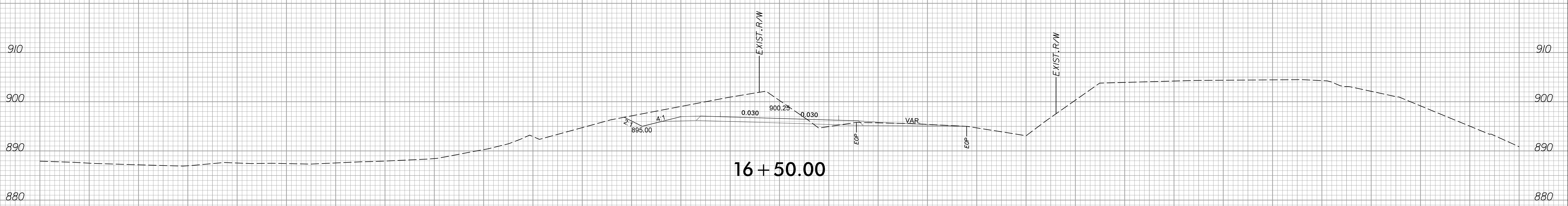
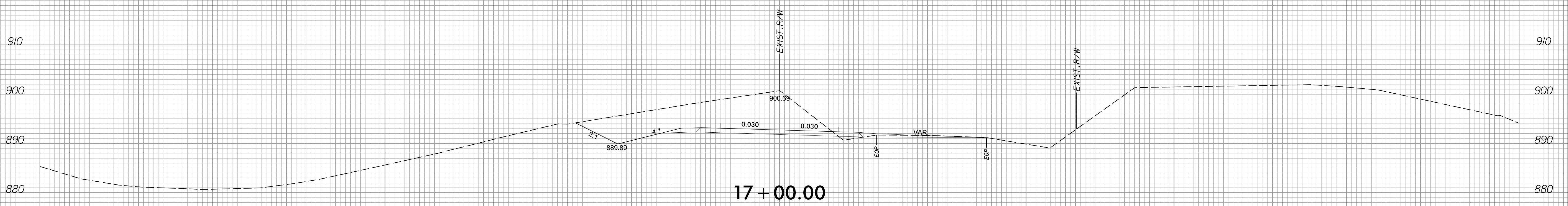

1/6/2025 9:17:48 AM  
 c:\pwworking\hmm\raji\transit\17BP.9.R.83\17BP.9.R.83.dwg  
 17BP.9.R.83.dwg

150 140 130 120 110 100 90 80 70 60 50 40 30 20 10 0 10 20 30 40 50 60 70 80 90 100 110 120 130 140 150

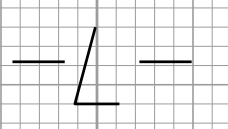
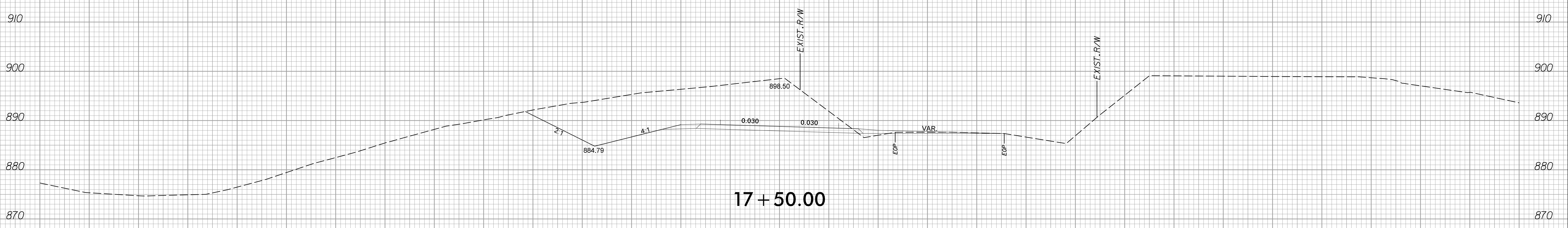
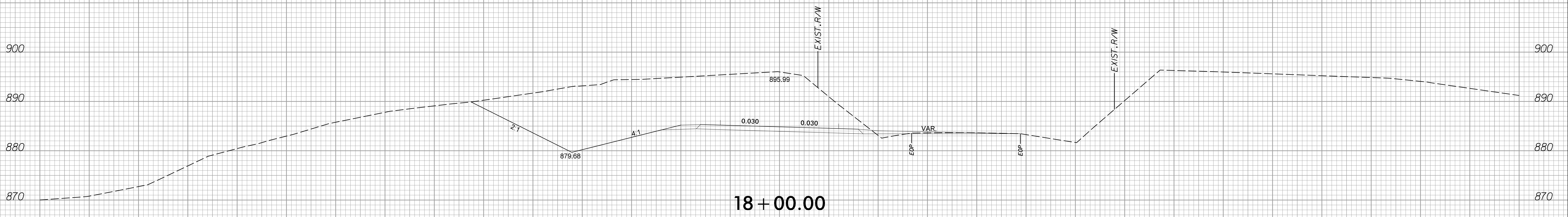
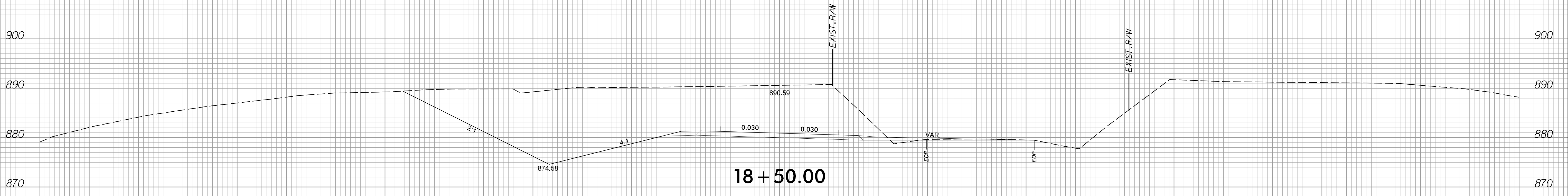

1/6/2025 9:17:56 AM  
 c:\pwworking\hmm\ra\l\transit\cor66165\00176849\840286.rdy.xpl.i.dgn  
 150 E:\01.dgn



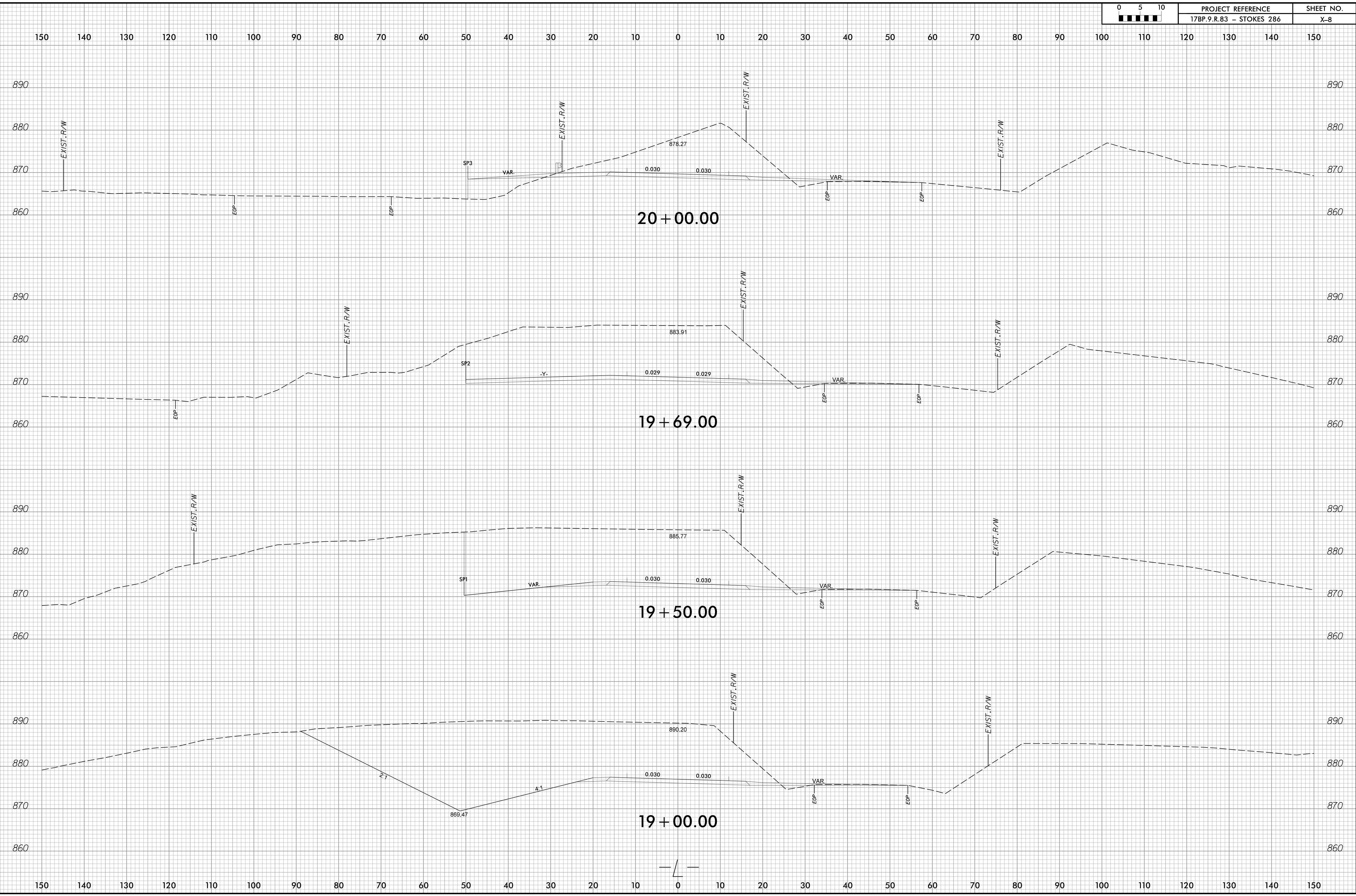

1/6/2025 9:18:05 AM  
 c:\pwworking\hmm\raii-transit\cor66165\00176849\840286.rdy.xpl.i.dgn  
 150 E:\01.dgn

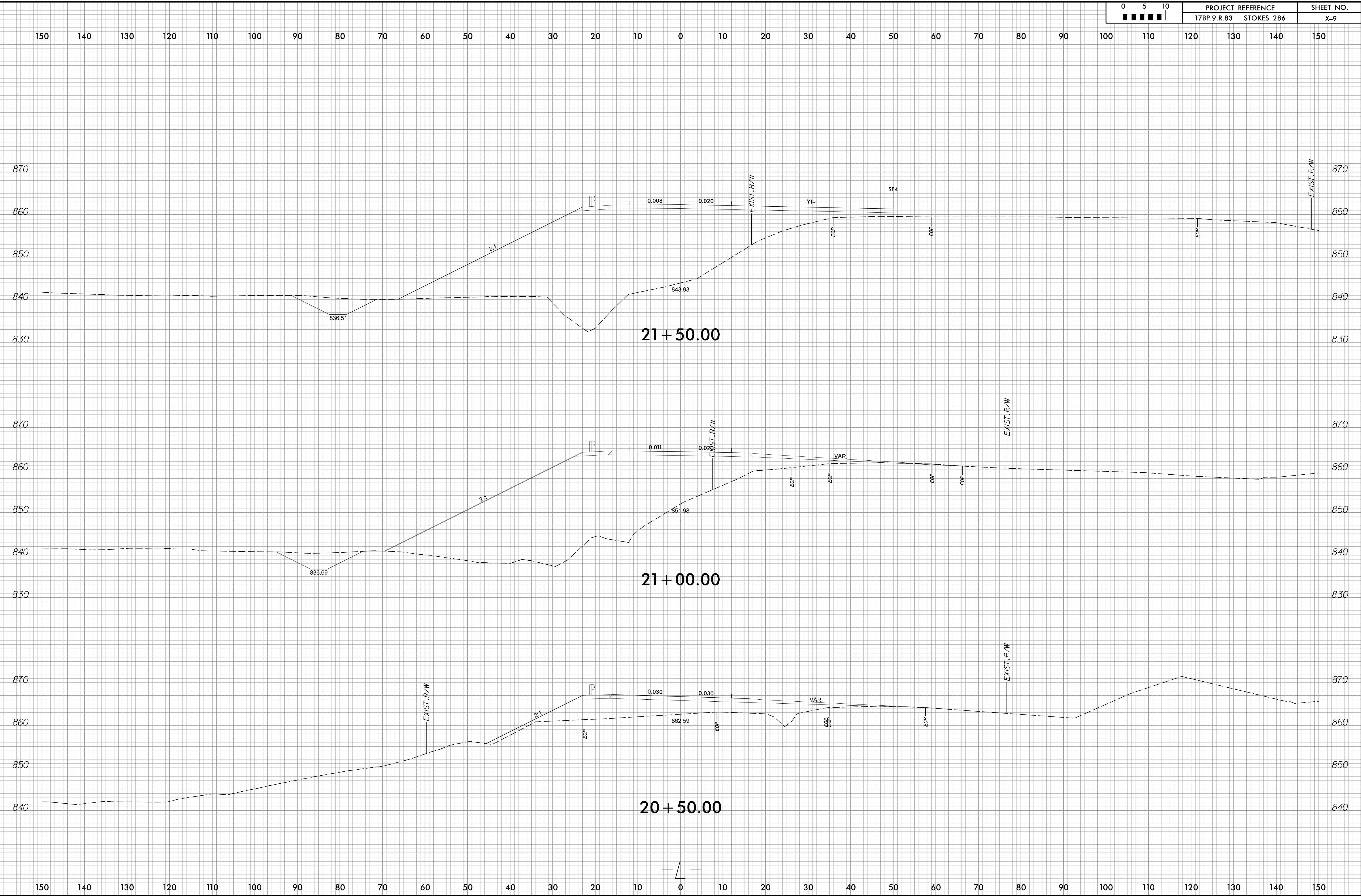

1/6/2025 9:18:14 AM  
 c:\pwworking\hmm\raii-transit\cor66165\0176849\840286.rdy.xpl.i.dgn  
 150 EOP.dgn

150 140 130 120 110 100 90 80 70 60 50 40 30 20 10 0 10 20 30 40 50 60 70 80 90 100 110 120 130 140 150

**BEGIN BRIDGE 23+03.21**

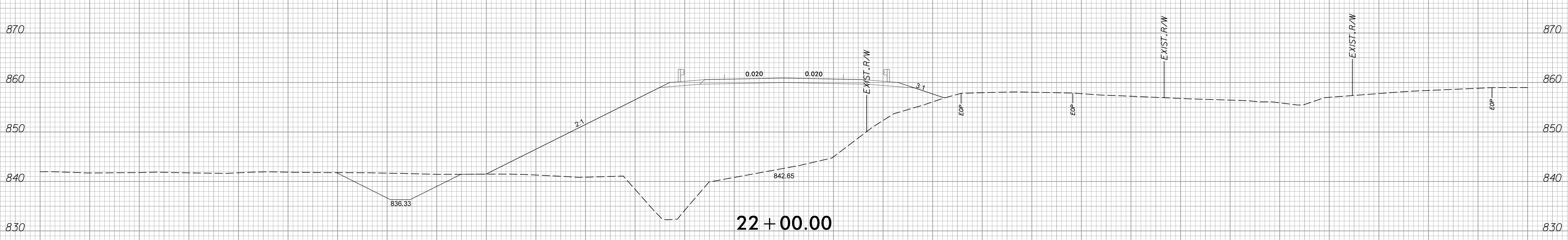
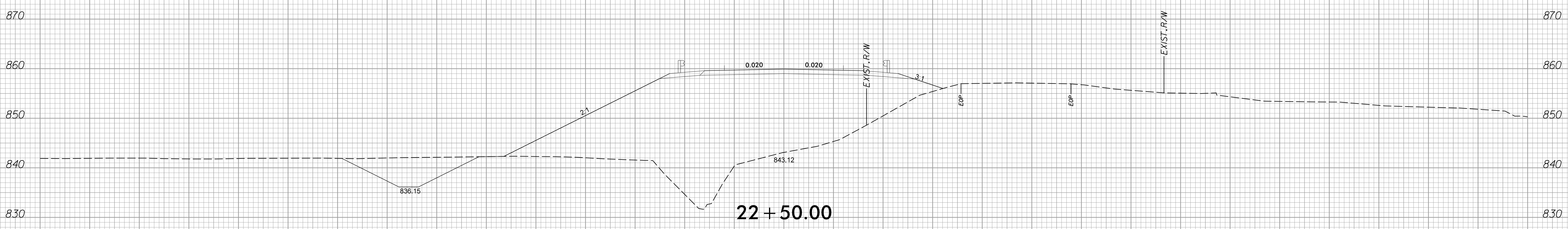
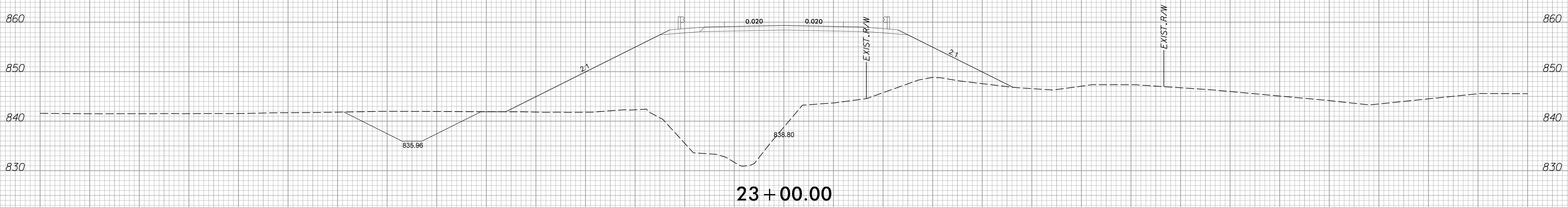

150 140 130 120 110 100 90 80 70 60 50 40 30 20 10 0 10 20 30 40 50 60 70 80 90 100 110 120 130 140 150

1/6/2025 9:18:22 AM  
 c:\pwworking\hmm\raii-transit\cor66165\0176849\840286\_rdy\_xpl.i.dgn  
 150 E:\01.dgn

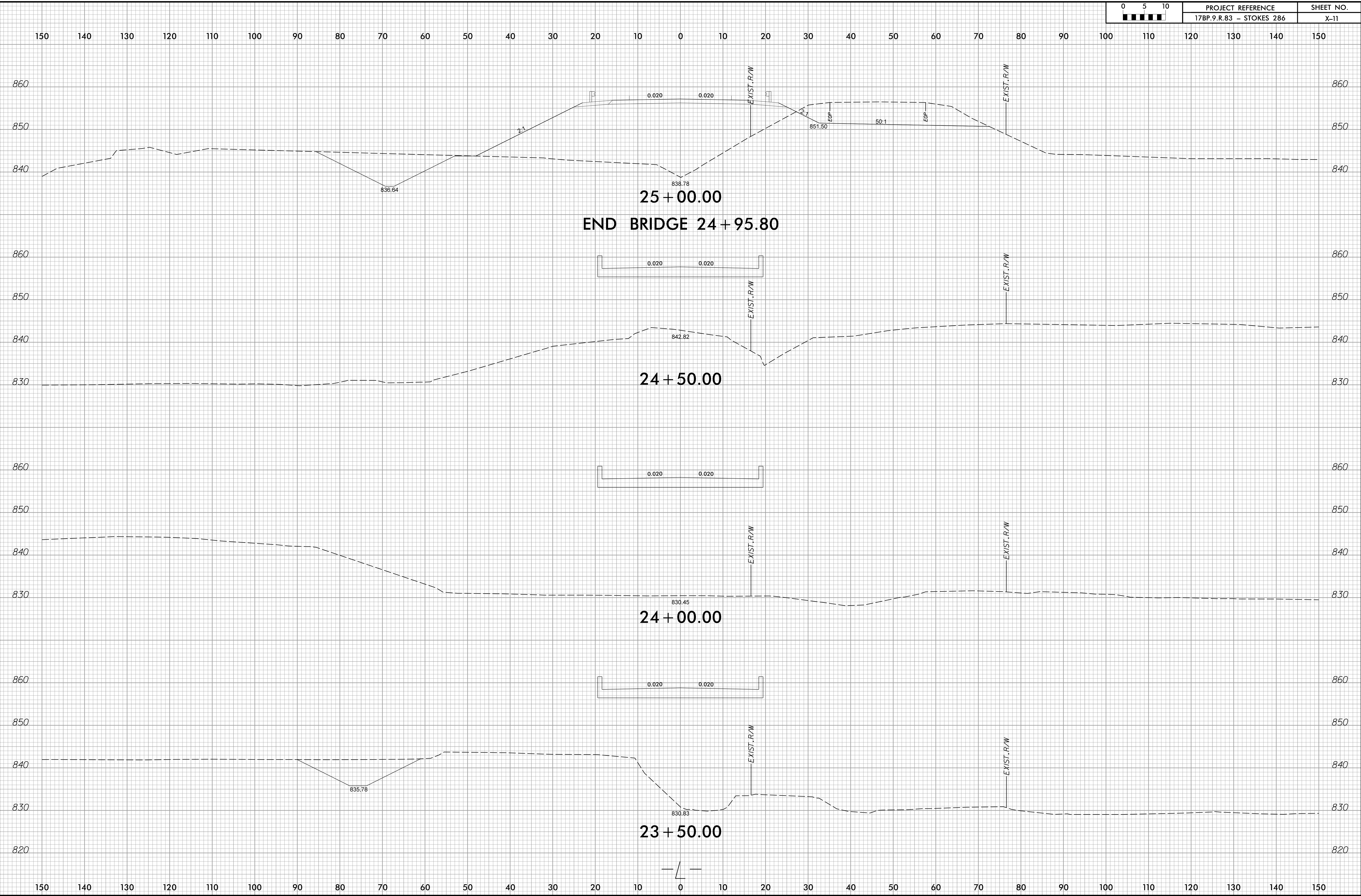

1/6/2025 9:18:32 AM  
 c:\pwworking\hmm\raii\transit\cor66165\00176849\840286\_rdy\_xpl.l.dgn  
 150 2101.dgn

150 140 130 120 110 100 90 80 70 60 50 40 30 20 10 0 10 20 30 40 50 60 70 80 90 100 110 120 130 140 150

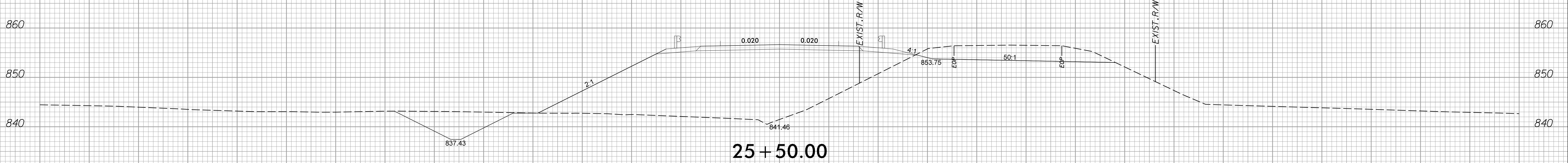
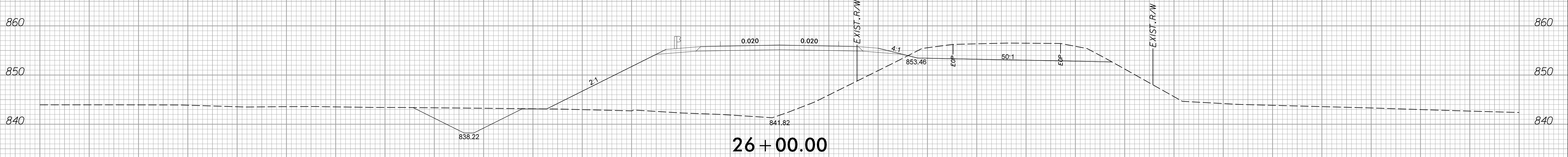
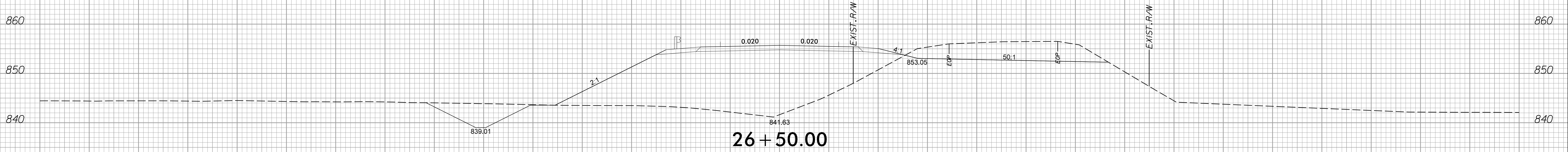
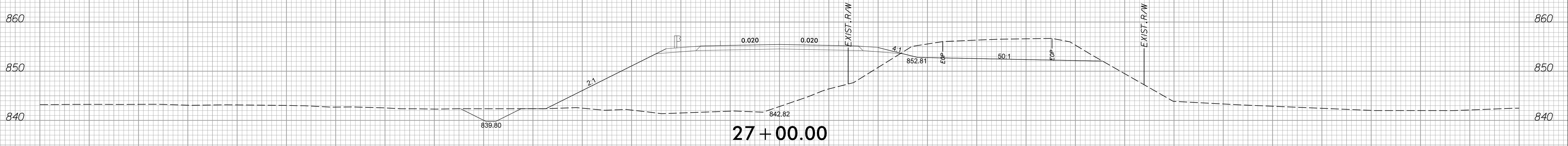

150 140 130 120 110 100 90 80 70 60 50 40 30 20 10 0 10 20 30 40 50 60 70 80 90 100 110 120 130 140 150

1/6/2025 9:18:41 AM  
 c:\pwworking\hmm\raii-transit\cor66165\00176849\840286.rdy\_xpl.i.dgn  
 150 PLOT.DGN

150 140 130 120 110 100 90 80 70 60 50 40 30 20 10 0 10 20 30 40 50 60 70 80 90 100 110 120 130 140 150

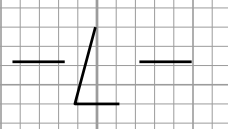
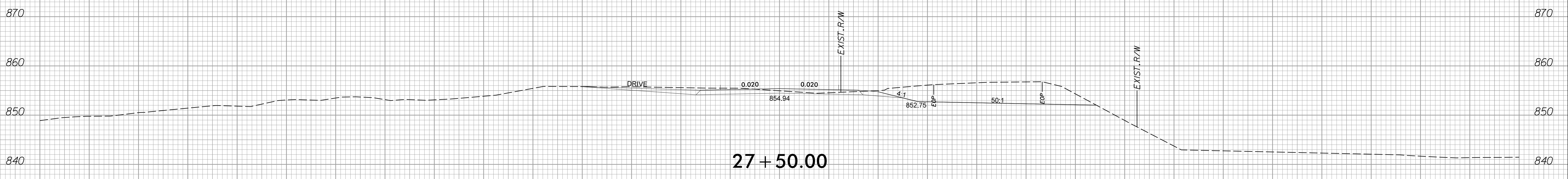
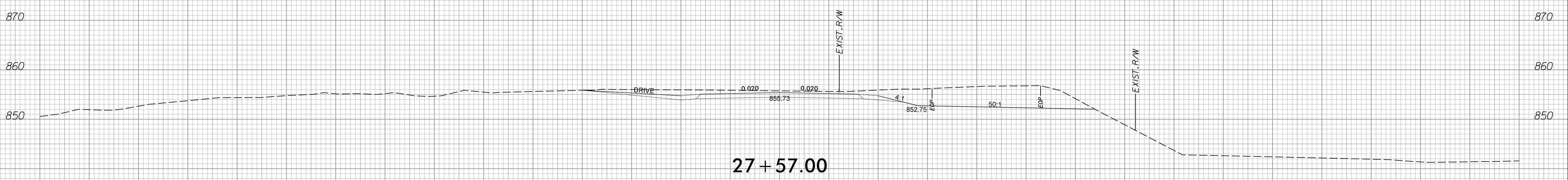
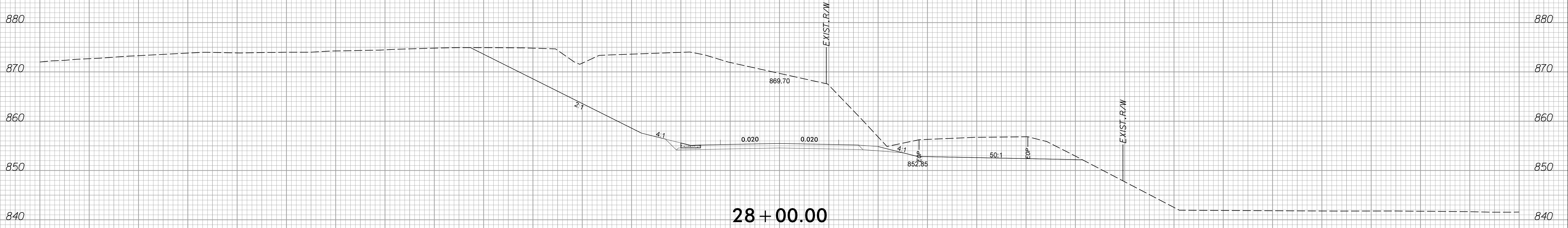

150 140 130 120 110 100 90 80 70 60 50 40 30 20 10 0 10 20 30 40 50 60 70 80 90 100 110 120 130 140 150

150 140 130 120 110 100 90 80 70 60 50 40 30 20 10 0 10 20 30 40 50 60 70 80 90 100 110 120 130 140 150

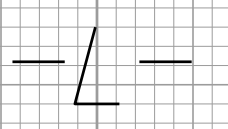
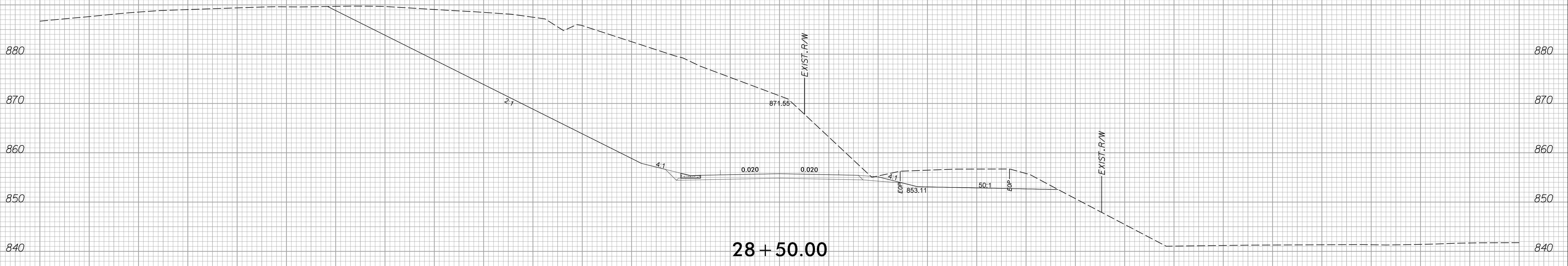
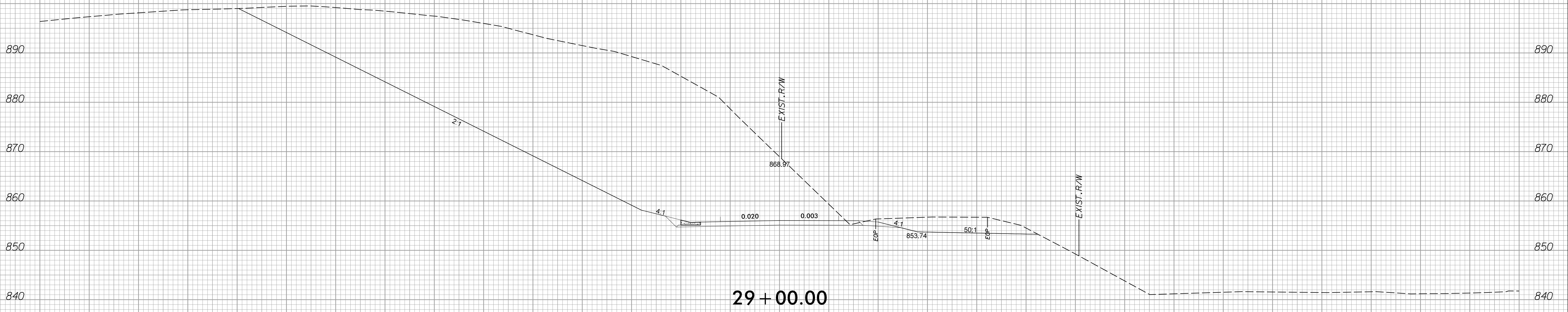

150 140 130 120 110 100 90 80 70 60 50 40 30 20 10 0 10 20 30 40 50 60 70 80 90 100 110 120 130 140 150

1/6/2025 9:18:58 AM  
 c:\pwworking\hmm\raii\transit\cor66165\0176849\840286\_rdy\_xpl.i.dgn  
 150 E:\01.dgn

150 140 130 120 110 100 90 80 70 60 50 40 30 20 10 0 10 20 30 40 50 60 70 80 90 100 110 120 130 140 150

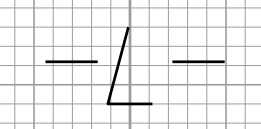
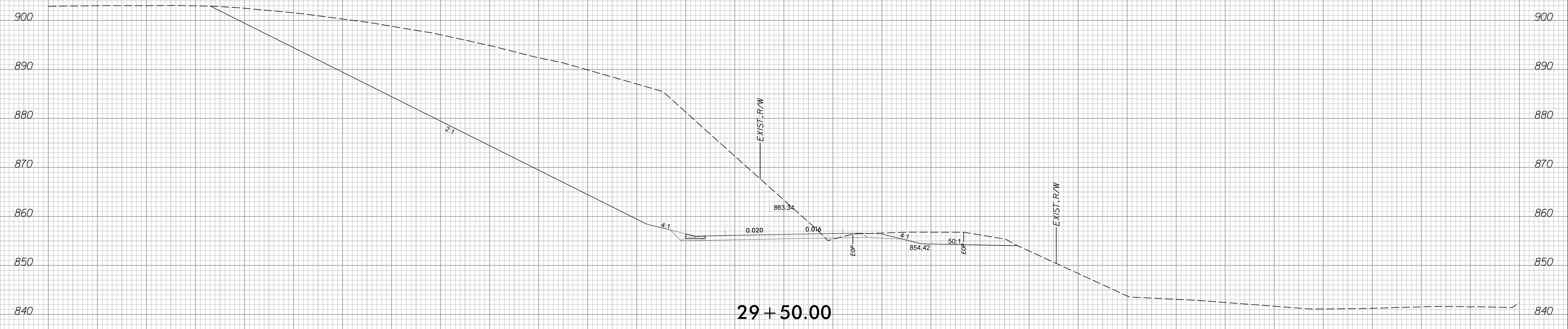
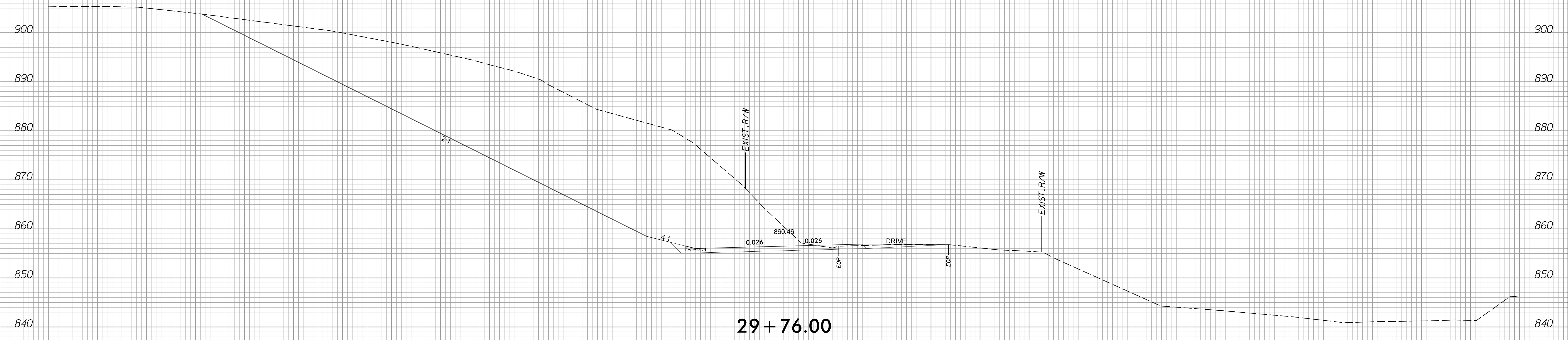

150 140 130 120 110 100 90 80 70 60 50 40 30 20 10 0 10 20 30 40 50 60 70 80 90 100 110 120 130 140 150

1/6/2025 9:19:07 AM  
 c:\pwworking\hmm\raii\transit\cor66165\0176849\840286.rdy.xpl.i.dgn  
 150 E:\01.dgn



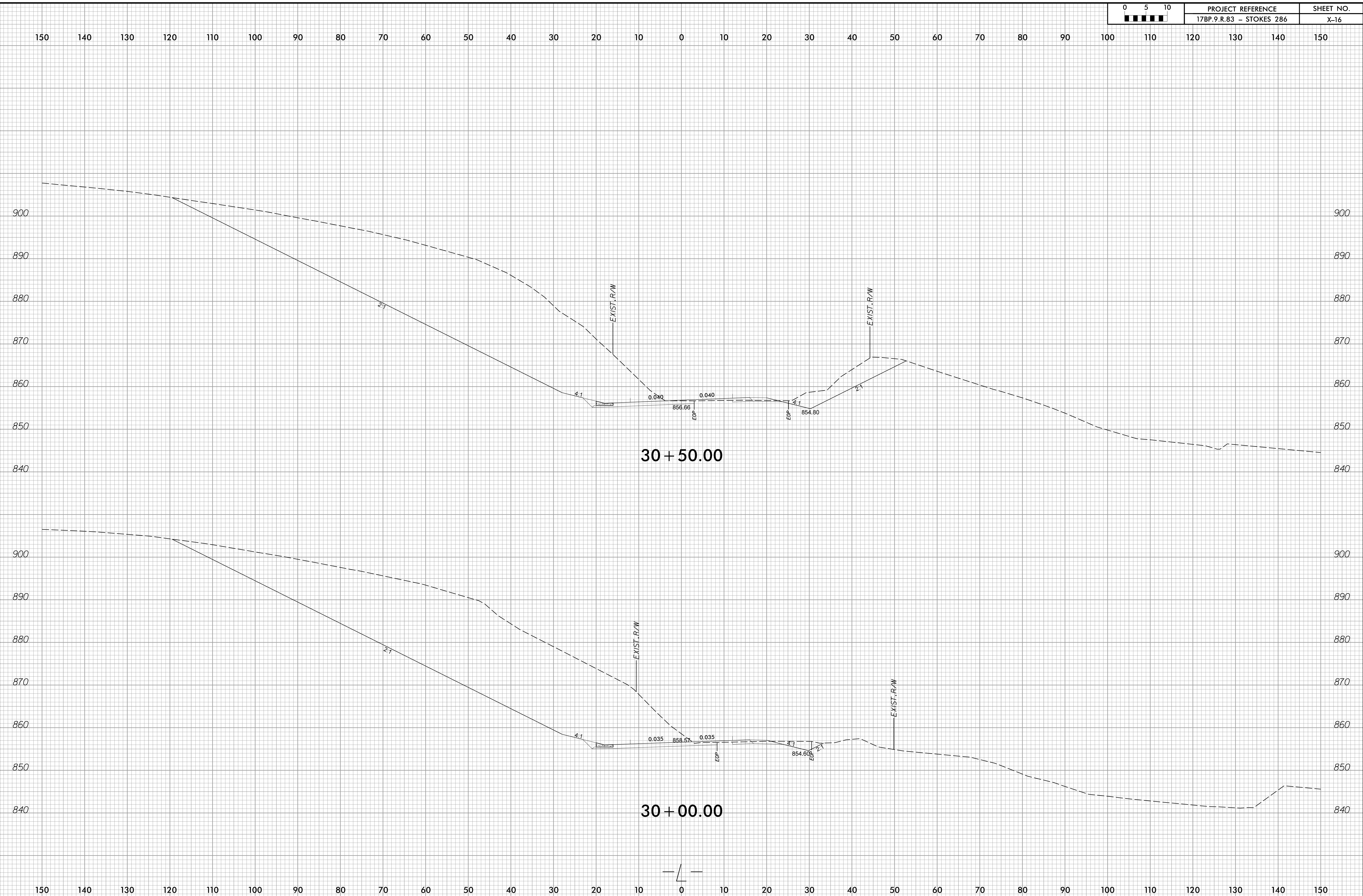

1/6/2025 9:19:15 AM  
 c:\pwworking\hmm\raii-transit\cor66165\00176849\840286.rdy\_xpl.i.dgn  
 150 E:\cor66165

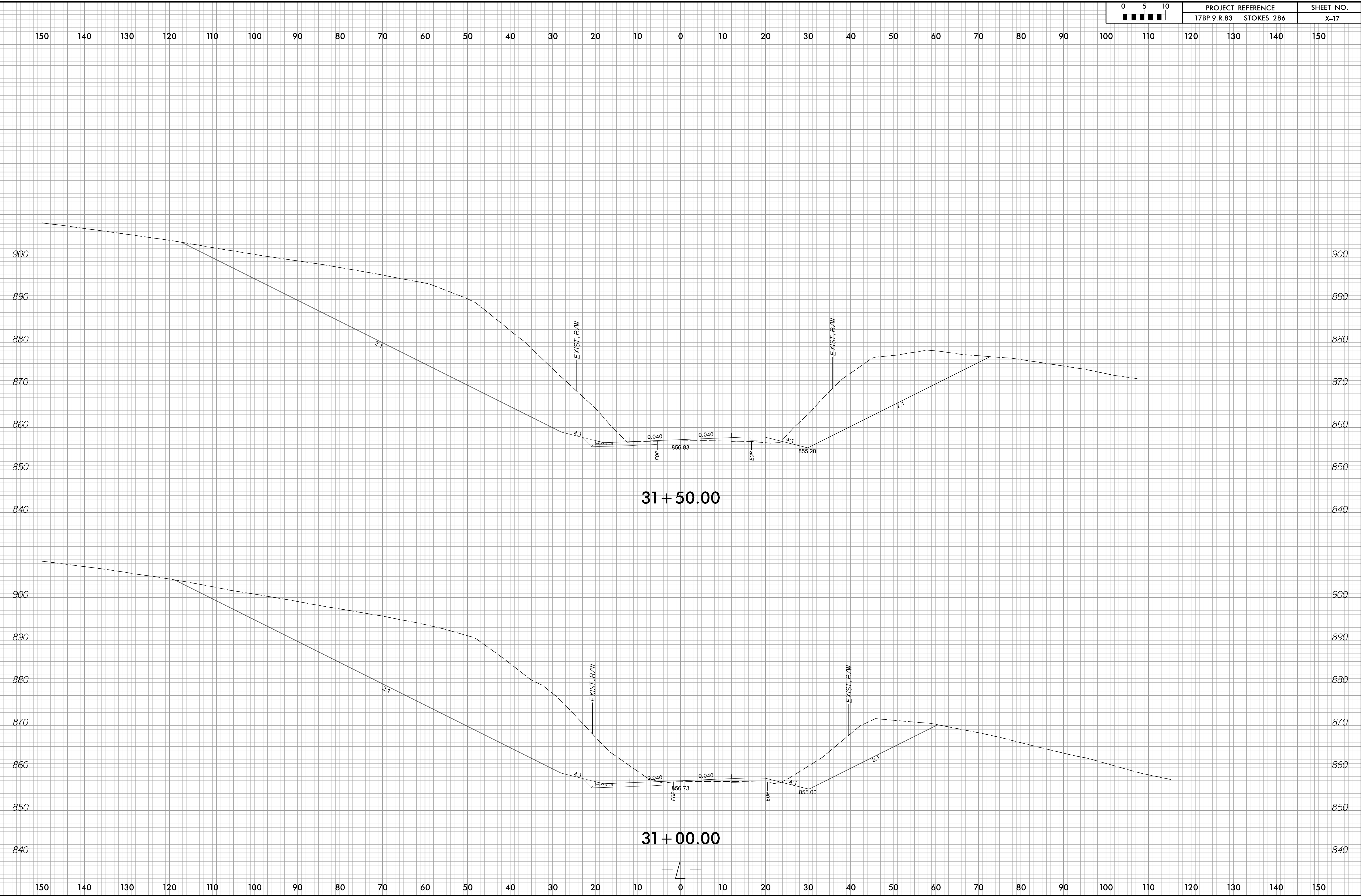

1/6/2025 9:19:24 AM  
 c:\pwworking\hmm\raii\transit\cor66165\0176849\840286.rdy\_xpl.i.dgn  
 150 E:\01.dgn

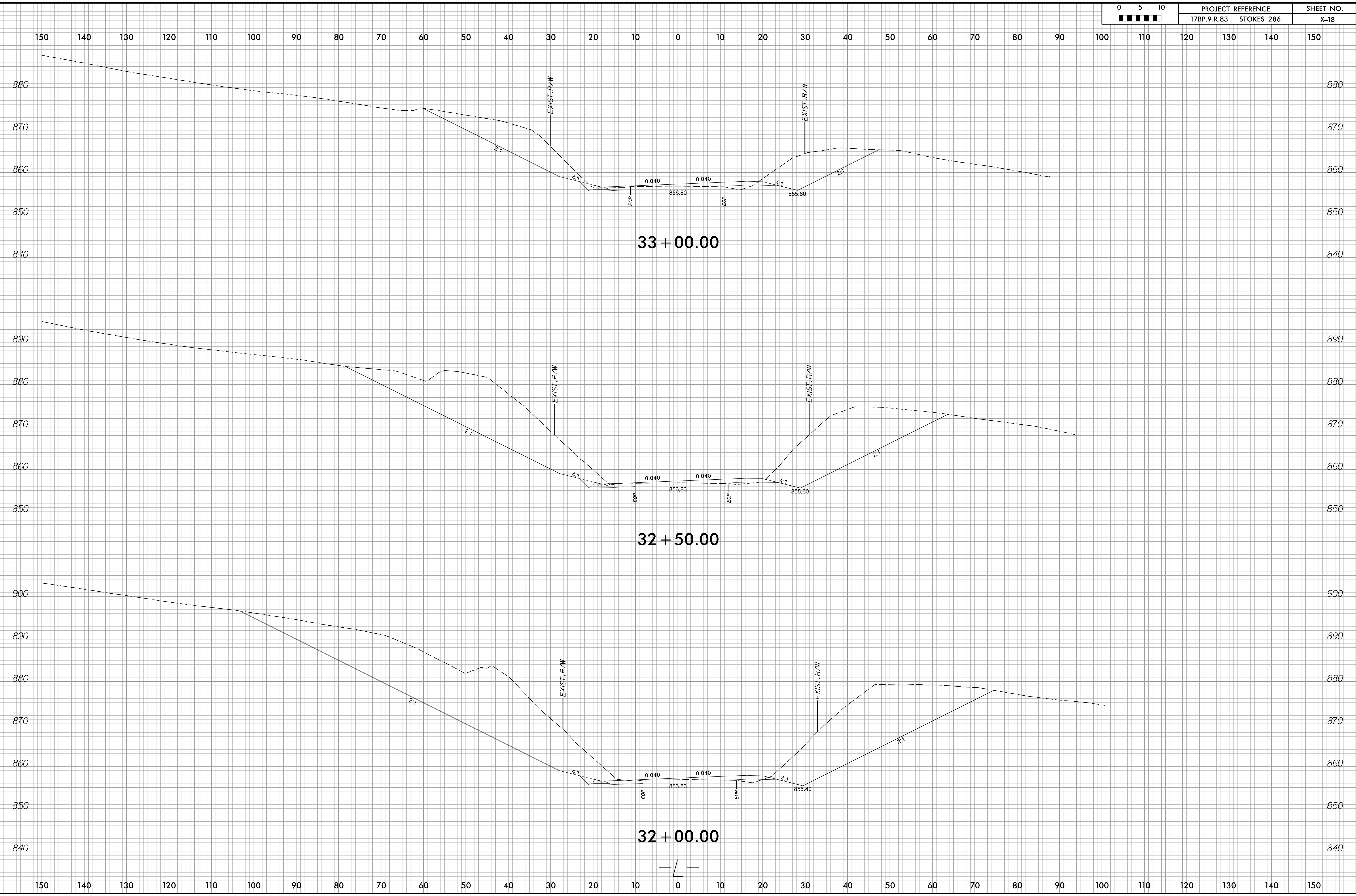

1/6/2025 9:19:33 AM  
 c:\pwworking\hmm\raii\transist\jor66165\0176849\840286.rdy.xpl.i.dgn  
 150 E:\Jor66165

150 140 130 120 110 100 90 80 70 60 50 40 30 20 10 0 10 20 30 40 50 60 70 80 90 100 110 120 130 140 150

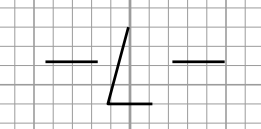
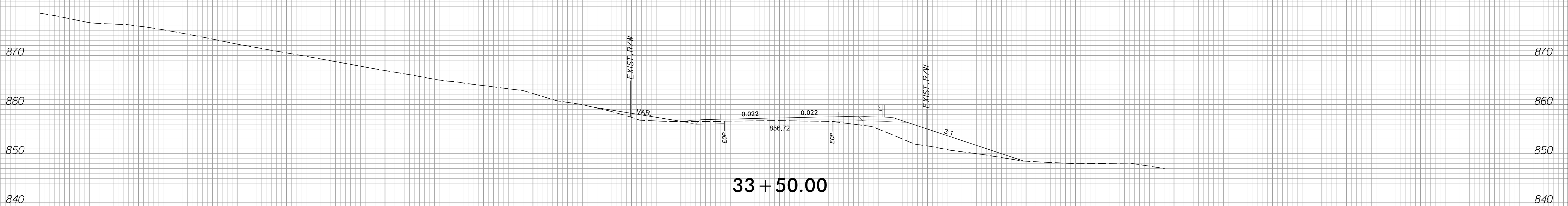
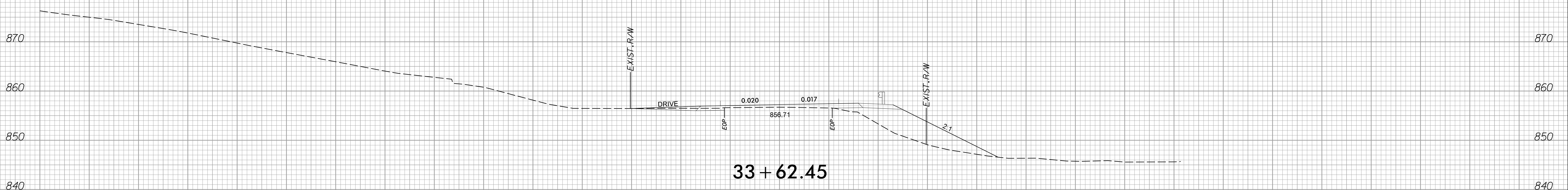
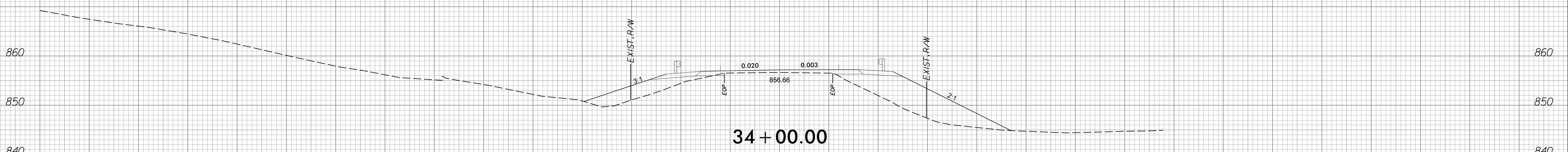
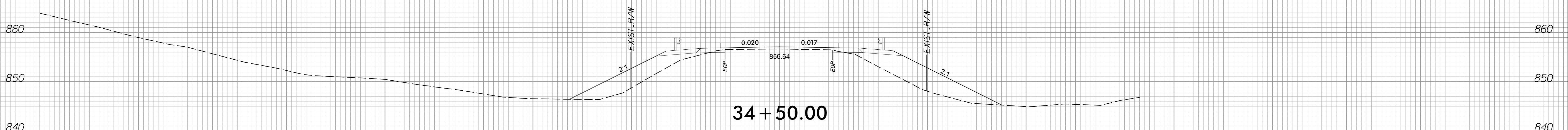

1/6/2025 9:19:41 AM  
 c:\pwworking\hmm\raii-transit\cor66165\0176849\840286.rdy.xpl.i.dgn  
 150 E:\01.dgn

150 140 130 120 110 100 90 80 70 60 50 40 30 20 10 0 10 20 30 40 50 60 70 80 90 100 110 120 130 140 150

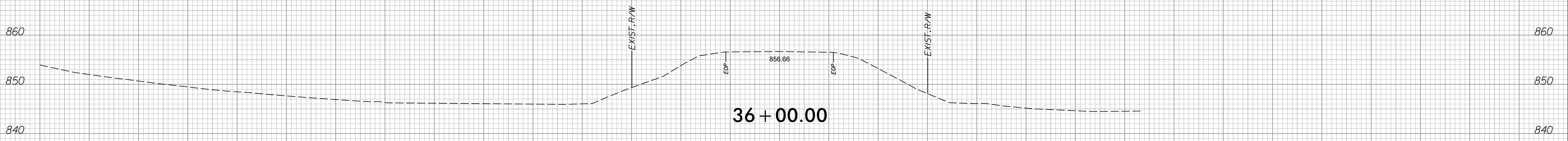

36 + 00.00

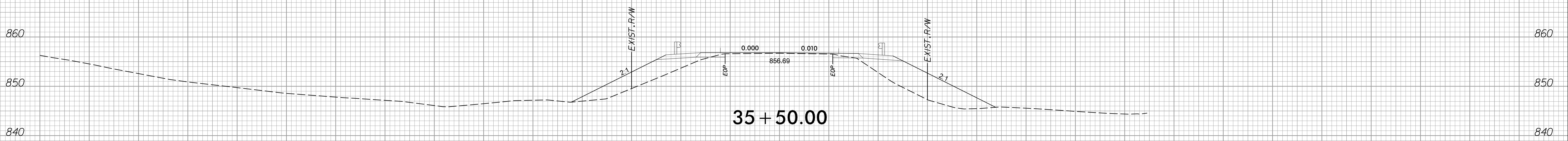

35 + 50.00

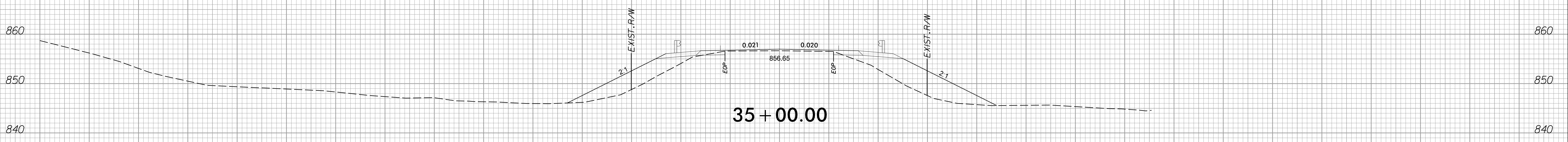

35 + 00.00

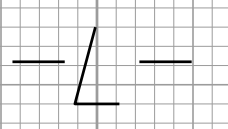

1/6/2025 9:19:50 AM  
 c:\pwworking\hmm\raii\transit\cor66165\00176849\840286.rdy.xpl.i.dgn  
 150 E:\01.dgn

150 140 130 120 110 100 90 80 70 60 50 40 30 20 10 0 10 20 30 40 50 60 70 80 90 100 110 120 130 140 150

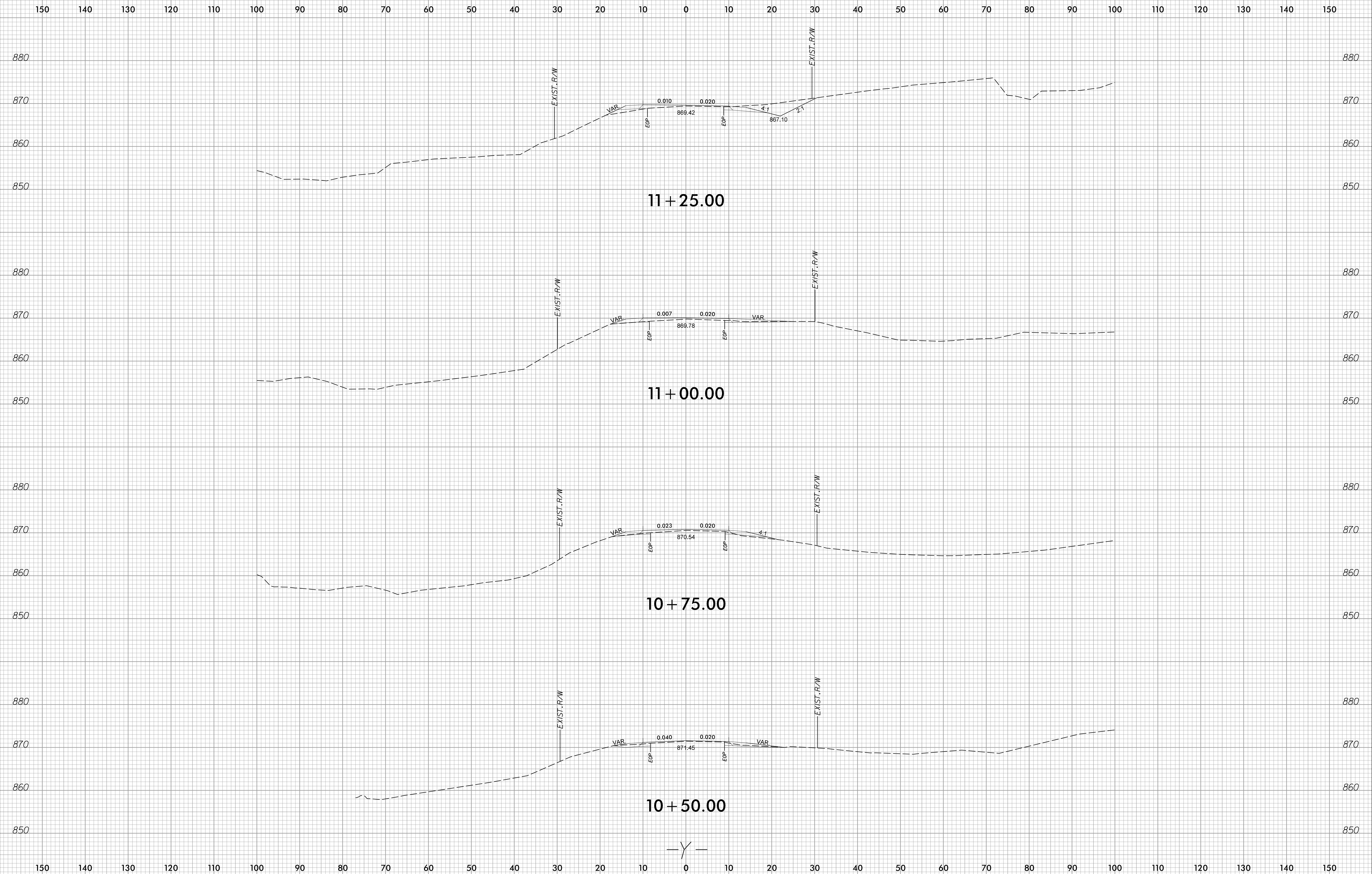

1/6/2025 9:20:01 AM  
 c:\pwworking\hmm\raii-transit\cor66165\00176849\840286.rdy\_xpl.X.dgn  
 150 2101.dgn

150 140 130 120 110 100 90 80 70 60 50 40 30 20 10 0 10 20 30 40 50 60 70 80 90 100 110 120 130 140 150

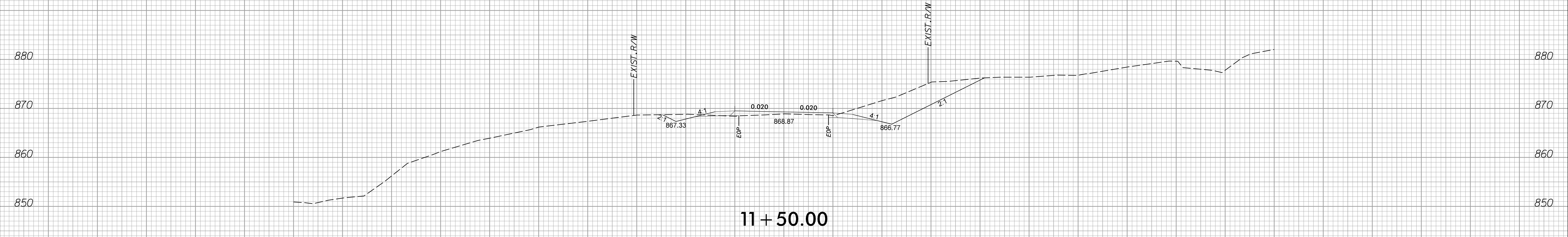
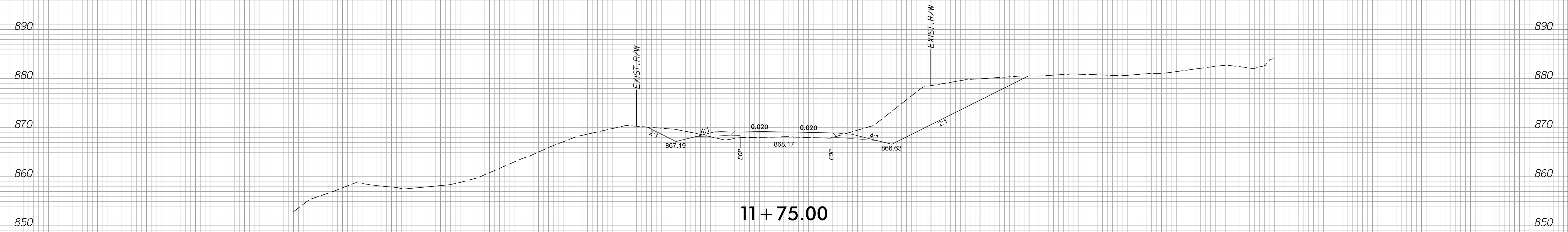
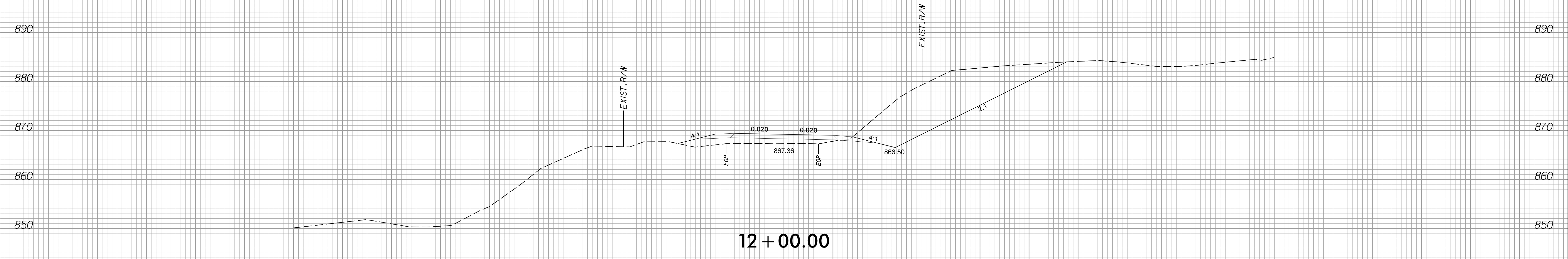

— Y —

150 140 130 120 110 100 90 80 70 60 50 40 30 20 10 0 10 20 30 40 50 60 70 80 90 100 110 120 130 140 150

150 140 130 120 110 100 90 80 70 60 50 40 30 20 10 0 10 20 30 40 50 60 70 80 90 100 110 120 130 140 150

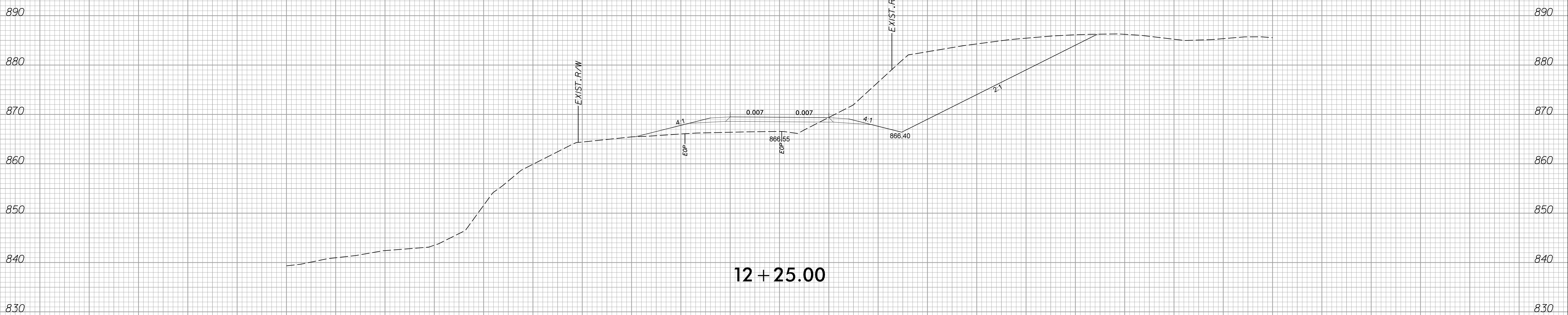
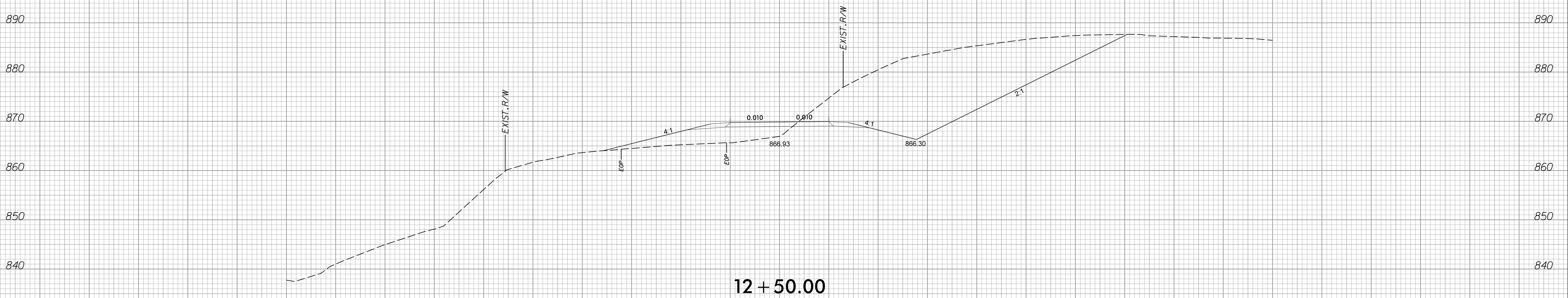

— Y —

150 140 130 120 110 100 90 80 70 60 50 40 30 20 10 0 10 20 30 40 50 60 70 80 90 100 110 120 130 140 150



150 140 130 120 110 100 90 80 70 60 50 40 30 20 10 0 10 20 30 40 50 60 70 80 90 100 110 120 130 140 150

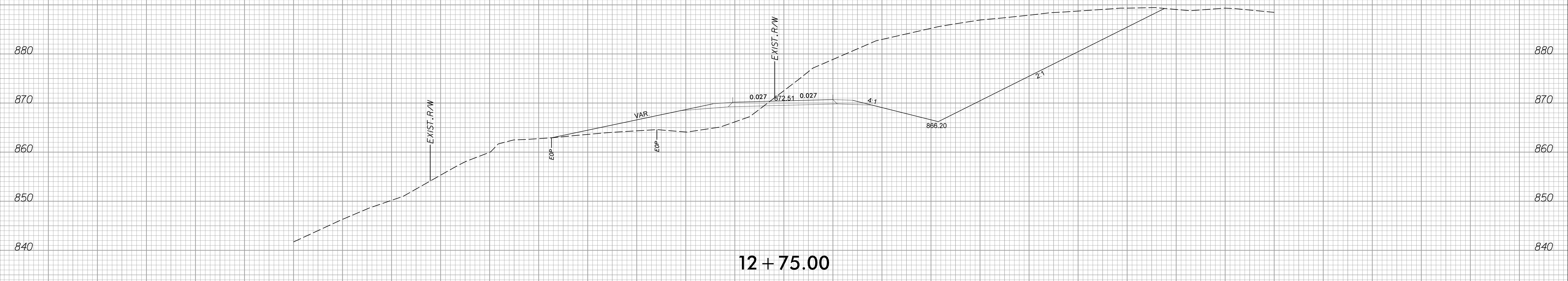
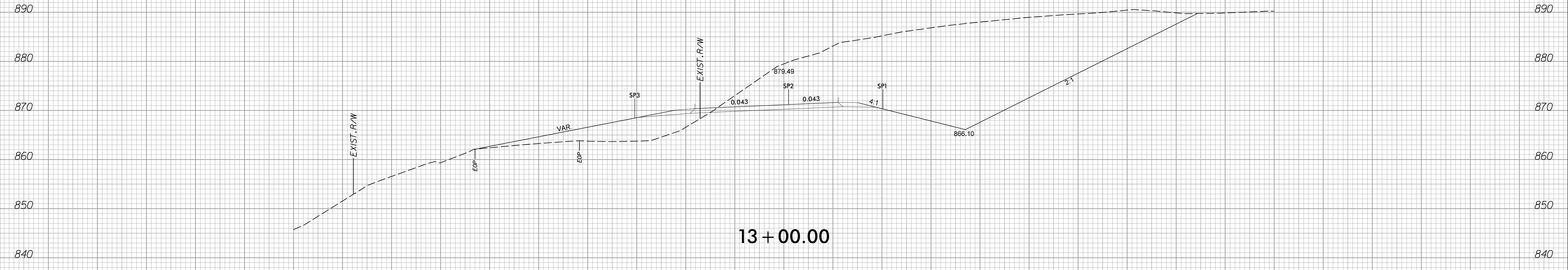

— Y —

150 140 130 120 110 100 90 80 70 60 50 40 30 20 10 0 10 20 30 40 50 60 70 80 90 100 110 120 130 140 150

150 140 130 120 110 100 90 80 70 60 50 40 30 20 10 0 10 20 30 40 50 60 70 80 90 100 110 120 130 140 150

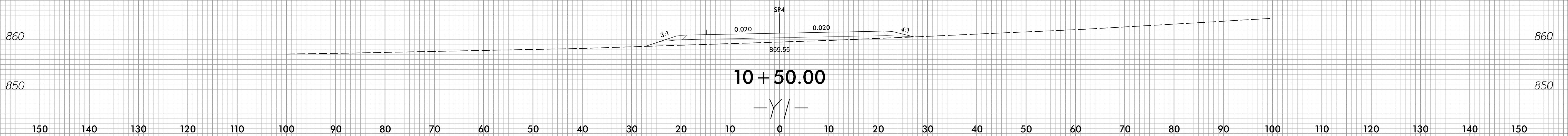
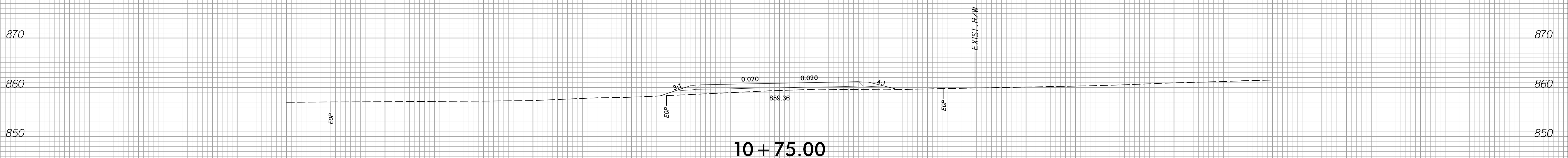
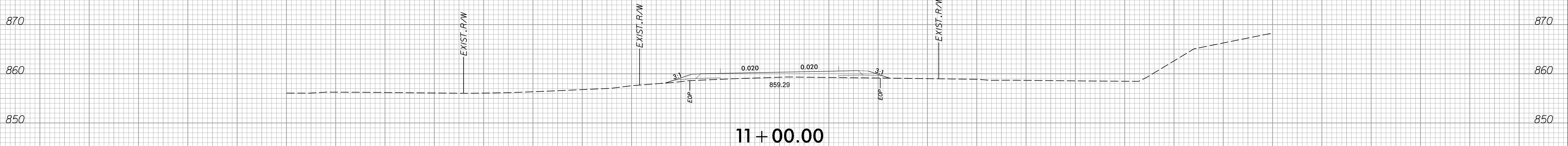
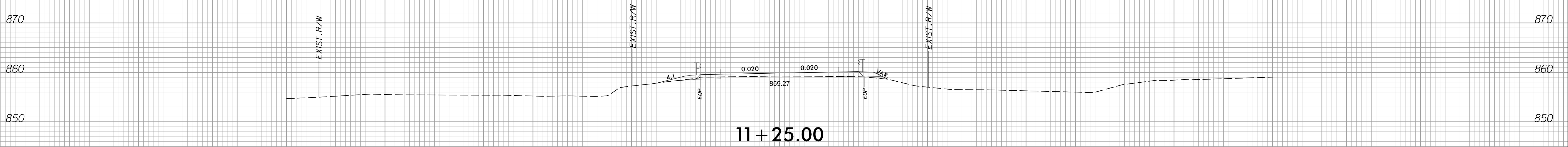
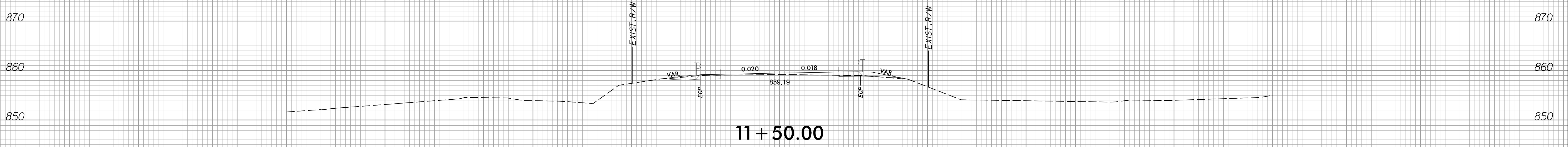

150 140 130 120 110 100 90 80 70 60 50 40 30 20 10 0 10 20 30 40 50 60 70 80 90 100 110 120 130 140 150

1/6/2025 9:20:36 AM  
 c:\pwworking\hmm\raii-transit\cor66165\00176849\840286.rdy.xpl.11.dgn  
 150 2101.dgn

150 140 130 120 110 100 90 80 70 60 50 40 30 20 10 0 10 20 30 40 50 60 70 80 90 100 110 120 130 140 150

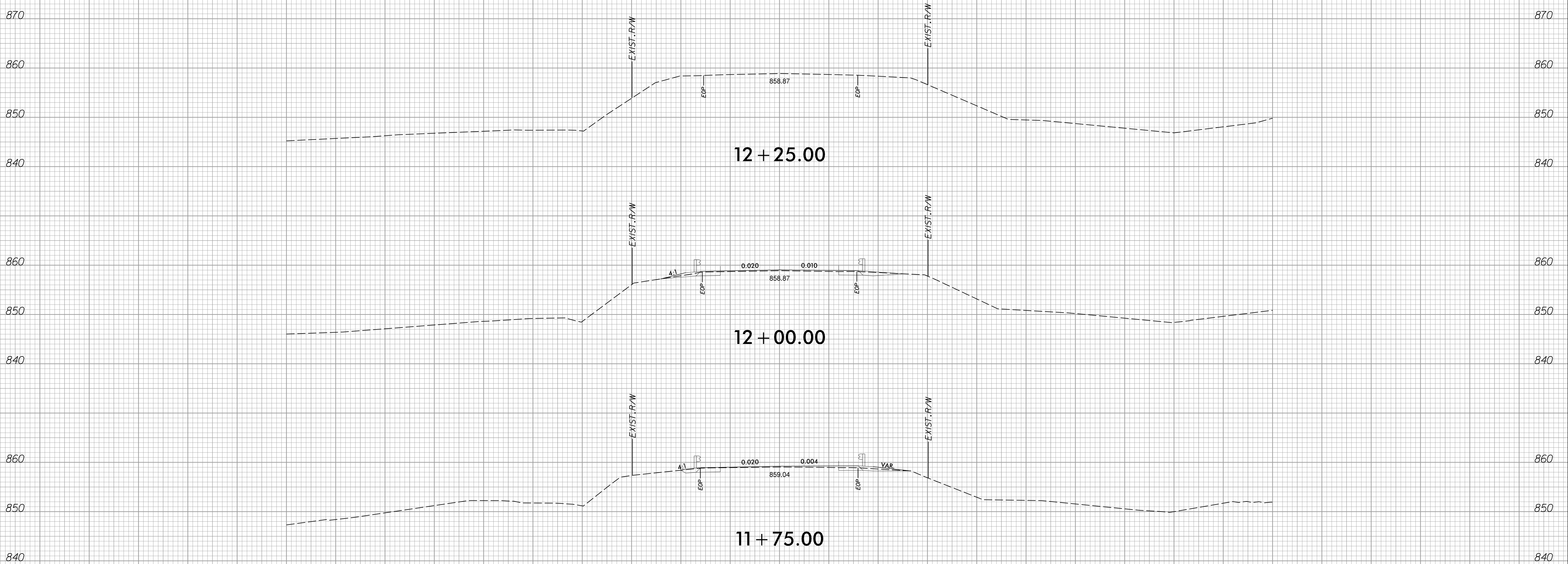

12 + 25.00

12 + 00.00

11 + 75.00

-Y/-

1/6/2025 9:20:43 AM c:\pwworking\hmm\raii-transit\cor66165\00176849\840286.rdy.xpl.Y1.dgn

150 140 130 120 110 100 90 80 70 60 50 40 30 20 10 0 10 20 30 40 50 60 70 80 90 100 110 120 130 140 150