

PLOT DRIVER: NCDOT_color_eng_50.ppt
PENTABLE: NCDOT_PMP.tbl
USER: CHARNDEN
DATE: 1/21/2025
TIME: 11:19:14 AM
FILE: p:\p\h\p\users\charnd\US_East_01\Documents\17BP_9.R.83\Work_In_Progress\17BP_9.R.83\Traffic\Pavement_Markings\840286_PMP_PMF01.dgn

PROJECT: 17BP.9.R.83

STATE OF NORTH CAROLINA DEPARTMENT OF TRANSPORTATION

PAVEMENT MARKING PLAN

STOKES COUNTY

LOCATION: BRIDGE NO. 286 OVER LITTLE YADKIN RIVER
ON SR 1236 (NORTH OLD 52)

PROJECT NO. 17BP.9.R.83	SHEET NO. PMP-1
APPROVED: <i>Michael T. Rzepka</i>	
DATE: 1/21/2025	
SEAL	
	
DOCUMENT NOT CONSIDERED FINAL UNLESS ALL SIGNATURES COMPLETED	

INDEX

SHEET NO.	DESCRIPTION
PMP-1	PAVEMENT MARKING PLAN TITLE, GENERAL NOTES, ROADWAY STANDARD DRAWINGS, INDEX, AND PAVEMENT MARKING SCHEDULE
PMP-2 AND PMP-3	PAVEMENT MARKING PLAN

ROADWAY STANDARD DRAWING

THE FOLLOWING ROADWAY STANDARDS AS APPEAR IN "ROADWAY STANDARD DRAWINGS" - N.C. DEPARTMENT OF TRANSPORTATION - RALEIGH, N.C., DATED JANUARY 2024 ARE APPLICABLE TO THIS PROJECT AND BY REFERENCE HEREBY ARE CONSIDERED A PART OF THESE PLANS:

STD. NO.	TITLE
1205.01	PAVEMENT MARKINGS - LINE TYPES AND OFFSETS
1205.02	PAVEMENT MARKINGS - TWO-LANE AND MULTI-LANE ROADWAYS
1205.04	PAVEMENT MARKINGS - INTERSECTIONS
1205.12	PAVEMENT MARKINGS - BRIDGES
1250.01	RAISED PAVEMENT MARKERS - INSTALLATION SPACING
1251.01	RAISED PAVEMENT MARKERS - PERMANENT AND TEMPORARY
1261.01	GUARDRAIL AND BARRIER DELINEATORS - INSTALLATION SPACING
1261.02	GUARDRAIL AND BARRIER DELINEATORS - TYPES AND MOUNTING
1262.01	GUARDRAIL END DELINEATION
1264.01	OBJECT MARKERS - TYPES
1264.02	OBJECT MARKERS - INSTALLATION

GENERAL NOTES

THE FOLLOWING GENERAL NOTES APPLY AT ALL TIMES FOR THE DURATION OF THE CONSTRUCTION PROJECT, EXCEPT WHEN OTHERWISE NOTED IN THE PLAN, OR DIRECTED BY THE ENGINEER.

A) INSTALL PAVEMENT MARKINGS AND PAVEMENT MARKERS ON THE FINAL SURFACE AS FOLLOWS:

ROAD NAME	MARKING	MARKER
-L- N. OLD US 52	INTEGRATED MULTIPOLYMER	POLYCARBONATE H-SHAPED SNOWPLOWABLE (RAISED ON BRIDGE DECK)
-Y- DALTON LOOP -Y1- W. DALTON RD.	INTEGRATED MULTIPOLYMER	NONE

B) TIE PROPOSED PAVEMENT MARKING LINES TO EXISTING PAVEMENT MARKING LINES.

C) REMOVE/REPLACE ANY CONFLICTING/DAMAGED PAVEMENT MARKINGS AND MARKERS.

D) REMOVE ALL RESIDUE AND SURFACE LAITANCE BY ACCEPTABLE METHODS ON CONCRETE BRIDGE DECKS PRIOR TO PLACING INTEGRATED POLYMER PAVEMENT MARKING MATERIAL.

PAVEMENT MARKING SCHEDULE

IM1	INTEGRATED MULTIPOLYMER WHITE EDGE LINE (4", 90 MIL)
IM5	INTEGRATED MULTIPOLYMER 2'-6'/SP. WHITE MINI-SKIP (4", 90 MIL)
IM13	INTEGRATED MULTIPOLYMER YELLOW DOUBLE CENTER (4", 90 MIL)
MA	PERMANENT RAISED MARKER YELLOW & YELLOW
ME	POLYCARBONATE H-SHAPED SNOWPLOWABLE MARKER YELLOW & YELLOW

PLAN REVIEWED BY: N.C.D.O.T. SIGNING AND DELINEATION UNIT

J. P. COUCH, P.E. ASST. DIVISION MAINTENANCE ENGINEER

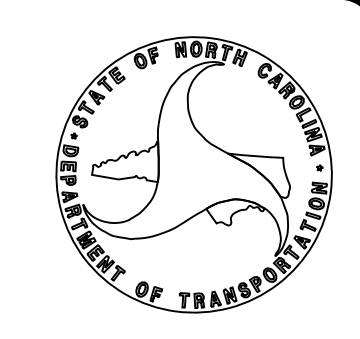

PLAN PREPARED BY: HDR ENGINEERING, INC. OF THE CAROLINAS

MIKE RZEPKA, P.E. SIGNING & DELINEATION PROJECT DESIGN ENGINEER
CHRIS HARNDEN SIGNING & DELINEATION PROJECT DESIGN TECHNICIAN



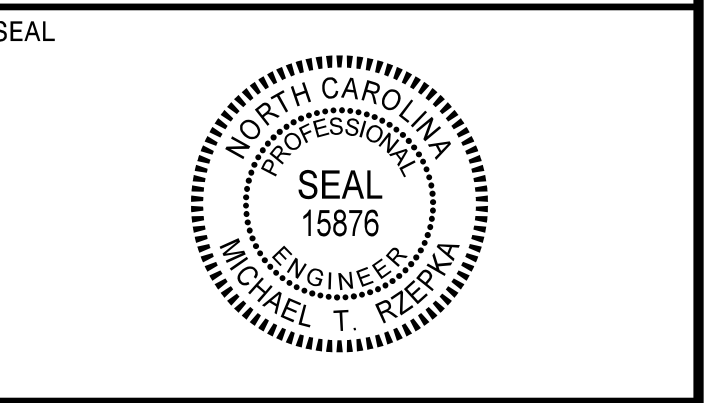

**DOCUMENT NOT CONSIDERED FINAL
UNLESS ALL SIGNATURES COMPLETED**

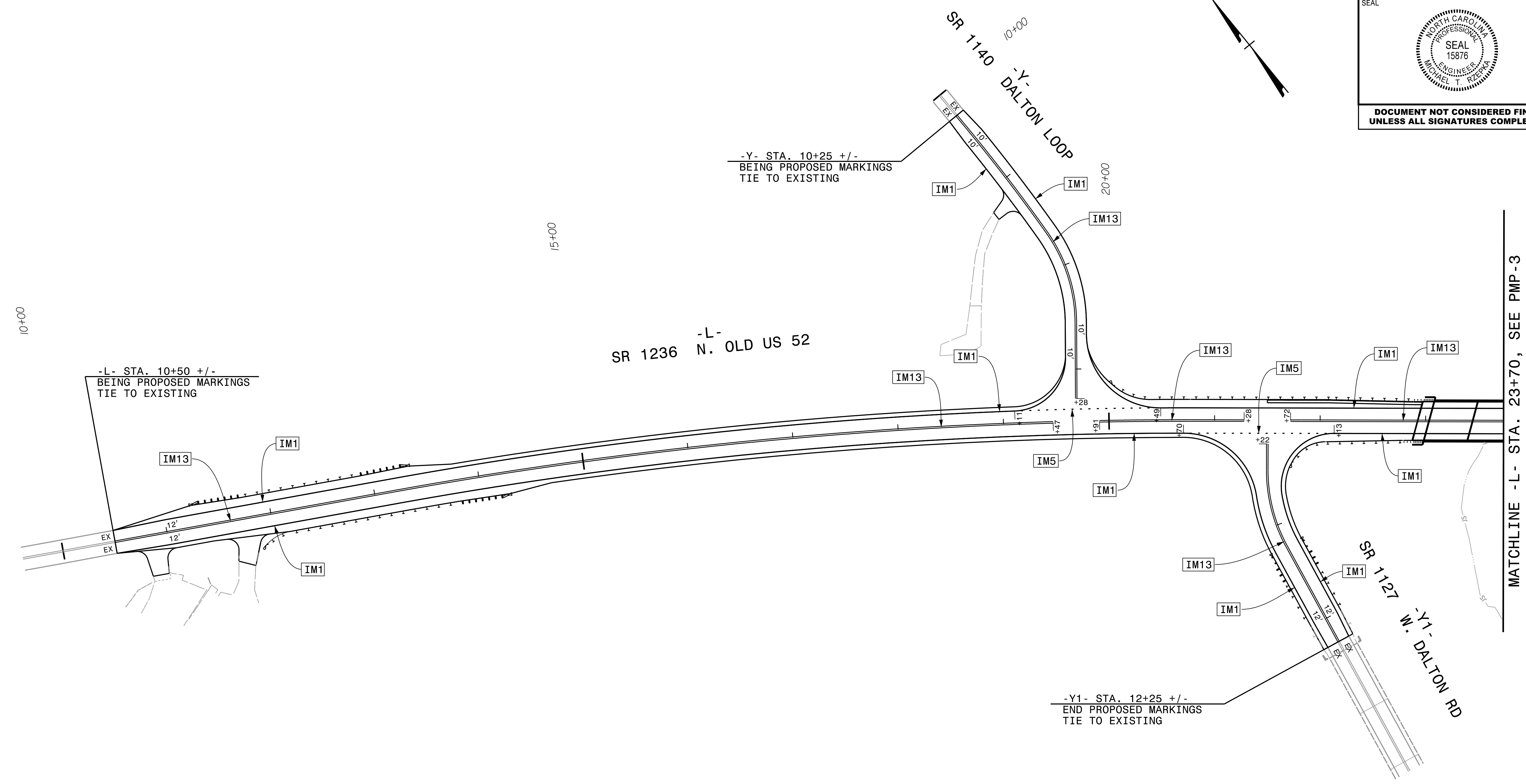
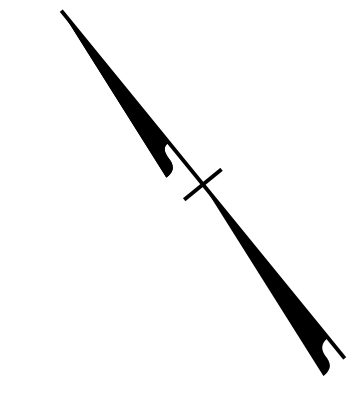

PAVEMENT MARKING SCHEDULE

- IM1** INTEGRATED MULTIPOLYMER WHITE EDGE LINE (4", 90 MIL)
- IM5** INTEGRATED MULTIPOLYMER 2'-6"/SP. WHITE MINI-SKIP (4", 90 MIL)
- IM13** INTEGRATED MULTIPOLYMER YELLOW DOUBLE CENTER (4", 90 MIL)
- MA** PERMANENT RAISED MARKER YELLOW & YELLOW
- ME** POLYCARBONATE H-SHAPED SNOWPLOWABLE MARKER YELLOW & YELLOW

LANE WIDTHS ARE 12', UNLESS NOTED

PAVEMENT MARKING PLAN

PLOT DRIVER: NCDOT_pdf_color_eng_50.pit
USER: CHARNDEN
FILE: p:\dwg\hdr\users\01\HDR_US_Eost.01\Documents\17BP.9.R.83\Traffic\ Pavement\ Markings\840286.PM_PMP02.dgn
PENTABLE: NCDOT_PMP.tbl
DATE: 1/21/2025
TIME: 10:17:42 AM

MATCHLINE -L- STA. 23+70, SEE PMP-3

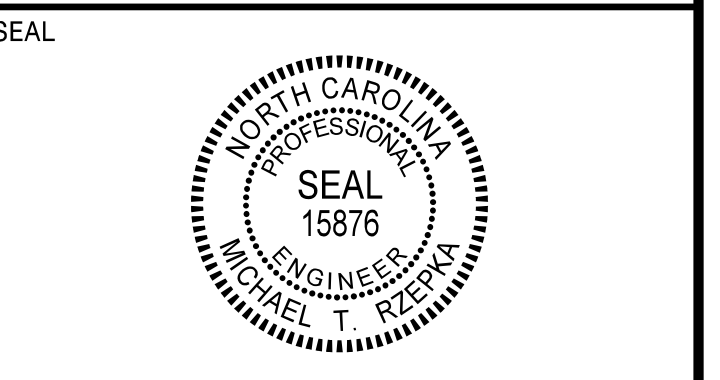

**DOCUMENT NOT CONSIDERED FINAL
UNLESS ALL SIGNATURES COMPLETED**

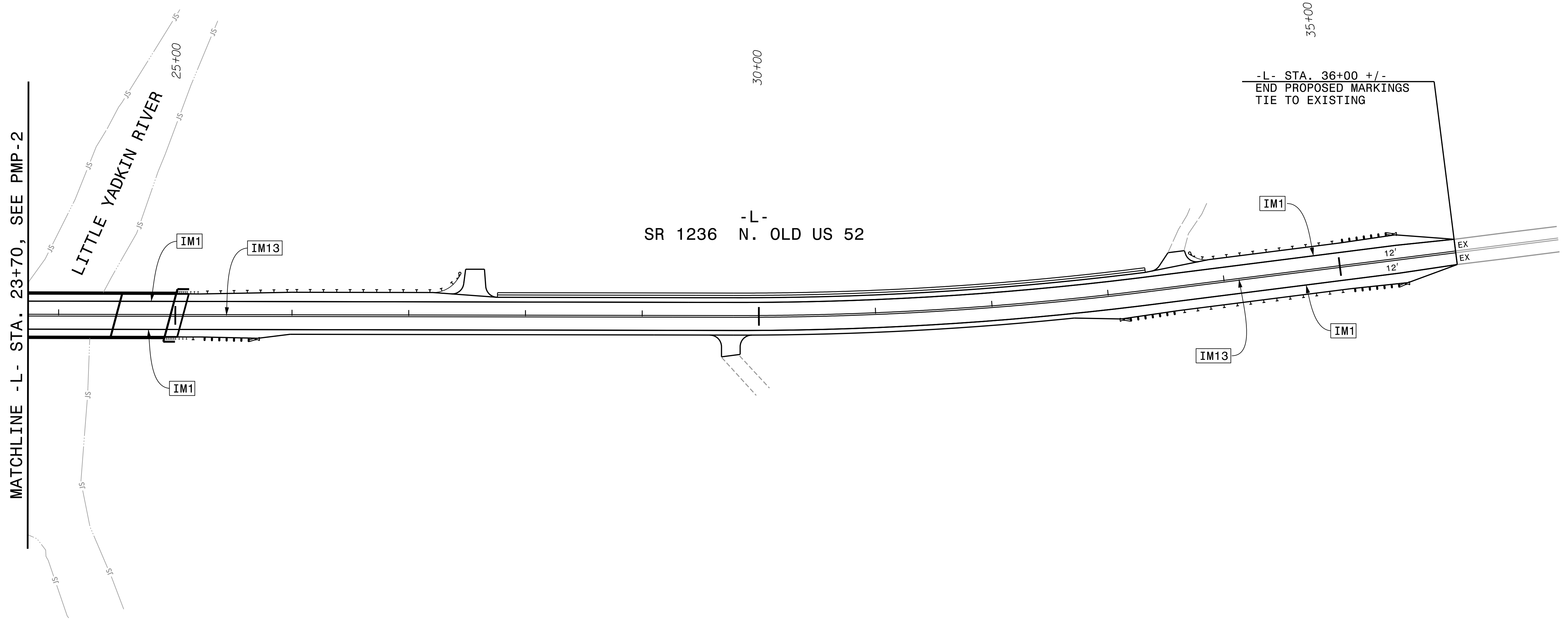
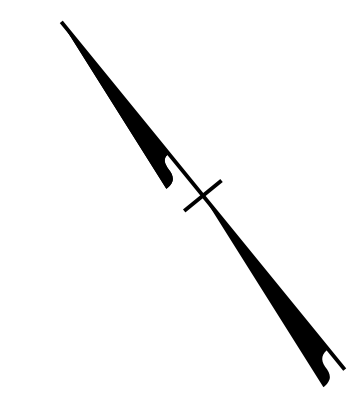

MATCHLINE -L- STA. 23+70, SEE PMP-2

LITTLE YADKIN RIVER

-L-
SR 1236 N. OLD US 52

-L- STA. 36+00 +/-
END PROPOSED MARKINGS
TIE TO EXISTING

PAVEMENT MARKING SCHEDULE

- IM1** INTEGRATED MULTIPOLYMER WHITE EDGE LINE (4", 90 MIL)
- IM5** INTEGRATED MULTIPOLYMER 2'-6"/SP. WHITE MINI-SKIP (4", 90 MIL)
- IM13** INTEGRATED MULTIPOLYMER YELLOW DOUBLE CENTER (4", 90 MIL)
- MA** PERMANENT RAISED MARKER YELLOW & YELLOW
- ME** POLYCARBONATE H-SHAPED SNOWPLOWABLE MARKER YELLOW & YELLOW

LANE WIDTHS ARE 12', UNLESS NOTED

PAVEMENT MARKING PLAN

PLOT DRIVER: NCDOT_pdf_color_eng_50.pht
PENTABLE: NCDOT_PMP.tbl
USER: CHARNDEN
DATE: 1/21/2025
TIME: 10:17:47 AM
FILE: p:\dwg\hdr\users\01\HDR_US_Eost_01\Documents\5705\10082711\6.0_CAD_BIM\6.2_Work_In_Progress\17BP.9.R.83_Traffic\ Pavement\ Markings\840286_PMP_PMP03.dgn