

STATE OF NORTH CAROLINA
DIVISION OF HIGHWAYS

U-4709
CROSS SECTION INDEX OF SHEETS

ALIGNMENT AND STATIONING

SHEET NUMBERS

-L-	STA. 10+00.00 TO STA. 50+00.00	X-2 TO X-19
-RND-	STA. 10+00.00 TO STA. 13+75.00	X-20 TO X-25
-RNDI-	STA. 10+00.00 TO STA. 13+00.00	X-26 TO X-30
-Y-	STA. 6+00.00 TO STA. 41+00.00	X-31 TO X-47
-Y1-	STA. 10+00.00 TO STA. 25+25.00	X-48 TO X-58
-Y2-	STA. 10+00.00 TO STA. 13+00.00	X-59 TO X-61
-Y2A-	STA. 10+00.00 TO STA. 12+75.00	X-62 TO X-64
-Y3-	STA. 10+00.00 TO STA. 12+50.00	X-65 TO X-66
-Y3A-	STA. 10+50.00 TO STA. 12+50.00	X-67 TO X-68
-Y4-	STA. 10+00.00 TO STA. 12+00.00	X-69 TO X-70
-Y5-	STA. 10+00.00 TO STA. 12+25.00	X-71 TO X-73
-Y6-	STA. 10+00.00 TO STA. 12+25.00	X-74 TO X-75
-Y7-	STA. 10+00.00 TO STA. 13+75.00	X-76 TO X-79
-Y8-	STA. 10+00.00 TO STA. 14+00.00	X-80 TO X-83
-Y10-	STA. 10+00.00 TO STA. 11+75.00	X-84 TO X-85
-Y11-	STA. 10+00.00 TO STA. 11+75.00	X-86 TO X-87
-Y12-	STA. 10+25.00 TO STA. 15+00.00	X-88 TO X-92
-Y13-	STA. 10+25.00 TO STA. 12+25.00	X-93 TO X-94
-OUTLET-	STA. 10+00.00 TO STA. 29+50.00	X-95 TO X-108

STATE OF NORTH CAROLINA DIVISION OF HIGHWAYS

PROJ. REFERENCE NO.	SHEET NO.
U-4709	X-1A

Approximate quantities only. Unclassified excavation, borrow excavation, fine grading, clearing and grubbing and removal of existing pavement will be paid for at the lump sum price for "Grading".

NOTE: EMBANKMENT COLUMN DOES NOT INCLUDE BACKFILL FOR UNDERCUT

CROSS-SECTION SUMMARY

Station	Uncl. Exc.	Embt	UnderCut	Station	Uncl. Exc.	Embt	UnderCut	Station	Uncl. Exc.	Embt	UnderCut	Station	Uncl. Exc.	Embt		
L	(cu. yd.)	(cu. yd.)	(cu. yd.)	L	(cu. yd.)	(cu. yd.)	(cu. yd.)	L	(cu. yd.)	(cu. yd.)	(cu. yd.)	Y3A	(cu. yd.)	(cu. yd.)		
10+45.00	0	0	0	26+50.00	0	68	0	41+00.00	25	12	0	12+00.00	6	7		
10+50.00	2	0	0	27+00.00	1	73	0	41+50.00	30	10	0	12+31.75	8	6		
11+00.00	42	0	0	27+50.00	2	70	0	42+00.00	59	6	0					
11+50.00	37	0	0	28+00.00	4	63	0	42+50.00	101	2	0	Station	Uncl. Exc.	Embt		
12+00.00	42	0	0	28+50.00	17	56	0	43+00.00	79	0	0	Y6	(cu. yd.)	(cu. yd.)		
12+50.00	51	0	0	28+62.22	7	13	0	43+50.00	26	6	0					
13+00.00	60	0	0					44+00.00	6	28	0	10+25.00	0	0		
13+50.00	60	0	0	Station	Uncl. Exc.	Embt		44+50.00	1	42	0	10+50.00	6	0		
14+00.00	51	0	0	Rnd	(cu. yd.)	(cu. yd.)		45+00.00	5	20	0	10+75.00	22	0		
14+50.00	60	0	0					45+50.00	9	0	0	11+00.00	37	0		
15+00.00	56	0	0	10+00.00	0	0		46+00.00	46	0	0	11+25.00	46	0		
15+50.00	119	0	0	10+25.00	0	167		46+50.00	55	4	0	11+50.00	52	0		
16+00.00	205	0	0	10+50.00	0	208		47+00.00	19	7	0	11+75.00	65	1		
16+49.51	213	0	0	10+75.00	0	175		47+50.00	9	6	0	11+99.65	77	1		
				11+00.00	0	133		48+00.00	3	20	0					
Station	Uncl. Exc.	Embt		11+25.00	0	175		48+50.00	2	22	0	Station	Uncl. Exc.	Embt		
Rnd1	(cu. yd.)	(cu. yd.)		11+50.00	0	208		49+00.00	6	7	0	Y7	(cu. yd.)	(cu. yd.)		
				11+75.00	0	190		49+50.00	6	14	0					
10+00.00	0	0		12+00.00	0	184		49+92.36	2	17	0	10+53.70	0	0		
10+25.00	42	54		12+25.00	1	164						10+75.00	15	0		
10+50.00	83	41		12+50.00	1	131		Station	Uncl. Exc.	Embt		11+00.00	25	0		
10+75.00	104	31		12+75.00	2	82		Y2	(cu. yd.)	(cu. yd.)		11+25.00	22	3		
11+00.00	88	30		13+00.00	2	62						11+50.00	40	5		
11+25.00	45	25		13+25.00	0	86		10+00.00	0	0		11+75.00	21	17		
11+50.00	22	16		13+50.00	0	97		10+25.00	6	2		11+92.77	5	20		
11+75.00	12	20		13+75.00	0	112		10+50.00	10	6						
12+00.00	50	27		13+76.99	0	10		10+75.00	8	7		Station	Uncl. Exc.	Embt		
12+25.00	85	33						11+00.00	10	5		Y8	(cu. yd.)	(cu. yd.)		
12+50.00	94	49		Station	Uncl. Exc.	Embt	UnderCut	11+25.00	17	2						
12+75.00	80	64		Summary No. 3 (LT.)				11+50.00	23	3		10+25.00	0	0		
13+00.00	29	69		(cu. yd.)	(cu. yd.)	(cu. yd.)		11+75.00	23	5		10+50.00	7	0		
13+14.16	2	38		L				12+00.00	19	10		10+75.00	22	0		
				30+42.24	0	0		12+25.00	12	19		11+00.00	31	0		
Station	Uncl. Exc.	Embt	UnderCut	30+50.00	0	8						11+25.00	38	1		
L	(cu. yd.)	(cu. yd.)	(cu. yd.)	31+00.00	2	43		Station	Uncl. Exc.	Embt		11+50.00	48	13		
				31+50.00	4	31		Y3	(cu. yd.)	(cu. yd.)		11+75.00	54	23		
18+09.43	0	0	0	32+00.00	7	26						11+92.77	2	1		
18+50.00	8	11	0	32+50.00	20	24		Station	Uncl. Exc.	Embt						
19+00.00	10	20	0	33+00.00	17	32		Y3	(cu. yd.)	(cu. yd.)		Station	Uncl. Exc.	Embt	UnderCut	
19+50.00	8	31	0	33+50.00	9	33						Summary No. 4 (RT.)				
20+00.00	4	49	0	34+00.00	10	29		11+00.00	0	0		(cu. yd.)	(cu. yd.)	(cu. yd.)	(cu. yd.)	
20+50.00	0	64	0	34+50.00	5	27		11+25.00	4	5						
21+00.00	0	57	0	35+00.00	7	25		11+50.00	20	6		10+45.00	0	0	0	
21+50.00	2	39	0	35+50.00	10	21		11+75.00	49	0		10+50.00	0	0	0	
22+00.00	10	15	0	36+00.00	11	23		12+00.00	47	0		11+00.00	9	0	0	
22+50.00	20	4	0	36+50.00	11	19		12+14.95	17	0		11+50.00	6	0	0	
23+00.00	21	3	0	37+00.00	10	16						12+00.00	1	9	0	
23+50.00	22	4	0	37+50.00	9	19		Station	Uncl. Exc.	Embt		12+50.00	0	26	0	
24+00.00	22	6	0	38+00.00	7	15		Y3A	(cu. yd.)	(cu. yd.)		13+00.00	0	42	0	
24+50.00	13	13	0	38+50.00	6	15						13+50.00	0	52	0	
25+00.00	6	26	0	39+00.00	6	8		11+00.00	0	0		14+00.00	0	46	0	
25+50.00	3	40	0	39+50.00	11	3		11+25.00	9	1		14+50.00	0	68	0	
26+00.00	1	56	0	40+00.00	19	6		11+50.00	16	3		15+00.00	6	59	0	
				40+50.00	23	8		11+75.00	9	7						

STATE OF NORTH CAROLINA DIVISION OF HIGHWAYS

PROJ. REFERENCE NO.	SHEET NO.
U-4709	X-1B

Approximate quantities only. Unclassified excavation, borrow excavation, fine grading, clearing and grubbing and removal of existing pavement will be paid for at the lump sum price for "Grading".

NOTE: EMBANKMENT COLUMN DOES NOT INCLUDE BACKFILL FOR UNDERCUT

CROSS-SECTION SUMMARY

Station	Uncl. Exc. Summary No. 4 (RT.) Cont. (cu. yd.)	Embt (cu. yd.)	UnderCut (cu. yd.)	Station	Uncl. Exc. Summary No. 6 (RT.) (cu. yd.)	Embt (cu. yd.)	UnderCut (cu. yd.)	Station	Uncl. Exc. (cu. yd.)	Embt (cu. yd.)	Station	Uncl. Exc. (cu. yd.)	Embt (cu. yd.)	
L				L				Y2A			Y8			
15+50.00	17	14	0	30+42.25	0	0	0	10+60.00	0	0	12+33.44	0	0	
16+00.00	39	3	0	30+50.00	7	2	0	10+75.00	0	83	12+50.00	2	74	
16+49.51	56	3	0	31+00.00	31	30	0	11+00.00	0	102	12+75.00	4	66	
				31+50.00	39	27	0	11+25.00	2	55	13+00.00	2	10	
				32+00.00	69	7	0	11+50.00	13	32				
Station	Uncl. Exc. Summary No. 5 (RT.) (cu. yd.)	Embt (cu. yd.)	UnderCut (cu. yd.)	Station	Uncl. Exc. Summary No. 6 (RT.) (cu. yd.)	Embt (cu. yd.)	UnderCut (cu. yd.)	Station	Uncl. Exc. (cu. yd.)	Embt (cu. yd.)	Station	Uncl. Exc. (cu. yd.)	Embt (cu. yd.)	UnderCut (cu. yd.)
L				L				Y			Y			
18+09.43	0	0	0	32+50.00	53	14	0	11+75.00	25	14	7+35.00	0	0	0
18+50.00	57	0	0	33+00.00	16	56	0	12+00.00	18	4	7+50.00	0	0	0
19+00.00	52	2	0	33+50.00	0	128	0	12+25.00	3	1	8+00.00	4	0	0
19+50.00	18	21	0	34+00.00	0	186	0				8+50.00	10	0	0
20+00.00	6	37	0	34+50.00	0	268	0	10+34.75	0	0	9+00.00	16	0	0
20+50.00	6	40	0	35+00.00	0	381	0	10+50.00	0	241	9+50.00	19	0	0
21+00.00	5	39	0	35+50.00	0	349	0	10+75.00	0	318	10+00.00	26	0	0
21+50.00	7	17	0	36+00.00	0	476	0	11+00.00	0	176	10+50.00	36	0	0
22+00.00	12	2	0	36+50.00	0	696	0	11+25.00	3	76	11+00.00	37	0	0
22+50.00	19	5	0	37+00.00	0	674	0	11+50.00	3	22	11+50.00	30	4	0
23+00.00	21	6	0	37+50.00	0	652	0	11+75.00	5	1	12+00.00	22	11	0
23+50.00	18	8	0	38+00.00	0	606	0	12+00.00	5	0	12+50.00	21	13	0
24+00.00	8	16	0	38+50.00	0	511	0				13+00.00	19	19	0
24+50.00	3	25	0	39+00.00	2	395	0	Station	Uncl. Exc. (cu. yd.)	Embt (cu. yd.)	13+50.00	26	23	0
25+00.00	1	17	0	39+50.00	4	305	0	Y5			14+00.00	73	11	0
25+50.00	0	37	0	40+00.00	6	264	0	Y4			14+50.00	217	1	0
26+00.00	0	69	0	40+50.00	6	229	0				14+51.65	11	0	0
26+50.00	0	68	0	41+00.00	2	128	0	10+30.88	0	0				
27+00.00	1	65	0	41+50.00	2	107	0	10+50.00	0	173	Station	Uncl. Exc. (cu. yd.)	Embt (cu. yd.)	UnderCut (cu. yd.)
27+50.00	4	55	0	42+00.00	14	131	0	10+75.00	0	154	Y			
28+00.00	11	38	0	42+50.00	33	54	0	11+00.00	0	60	Summary No. 8 (LT.) (cu. yd.)			
28+50.00	36	21	0	43+00.00	44	14	0	11+25.00	0	22	16+11.42	0	0	0
28+62.22	14	1	0	43+50.00	28	12	0	11+50.00	1	3	16+50.00	241	0	0
				44+00.00	6	59	0	11+75.00	5	0	17+00.00	232	0	0
				44+50.00	2	79	0	12+00.00	3	0	17+50.00	105	5	0
				45+00.00	4	28	0				18+00.00	49	13	0
				45+50.00	9	0	0	Station	Uncl. Exc. (cu. yd.)	Embt (cu. yd.)	18+50.00	28	32	0
				46+00.00	18	14	0	Y7			19+00.00	7	63	0
				46+50.00	12	28	0							
				47+00.00	2	59	0	12+50.27	0	0				
				47+50.00	1	46	0	12+75.00	3	27				
10+32.50	0	0	0	48+00.00	0	40	0	13+00.00	8	15				
10+50.00	8	7	0	48+50.00	0	71	0	13+25.00	5	2				
10+75.00	9	5	0	49+00.00	7	43	0	13+50.00	6	1				
11+00.00	4	0	0	49+50.00	22	18	0	13+75.00	7	1				
				49+92.36	25	13	0	13+85.00	6	0				

STATE OF NORTH CAROLINA DIVISION OF HIGHWAYS

PROJ. REFERENCE NO.	SHEET NO.
U-4709	X-1C

Approximate quantities only. Unclassified excavation, borrow excavation, fine grading, clearing and grubbing and removal of existing pavement will be paid for at the lump sum price for "Grading".

NOTE: EMBANKMENT COLUMN DOES NOT INCLUDE BACKFILL FOR UNDERCUT

CROSS-SECTION SUMMARY

Station	Uncl. Exc.	Embt	UnderCut	Station	Uncl. Exc.	Embt	UnderCut	Station	Uncl. Exc.	Embt	UnderCut	Station	Uncl. Exc.	Embt	UnderCut
Y	(cu. yd.)	(cu. yd.)	(cu. yd.)	Y11	(cu. yd.)	(cu. yd.)	(cu. yd.)	Y	(cu. yd.)	(cu. yd.)	(cu. yd.)	Y	(cu. yd.)	(cu. yd.)	(cu. yd.)
19+50.00	0	88	0	10+20.00	0	0	0	14+00.00	123	7	0	38+87.56	74	1	0
20+00.00	0	104	0	10+25.00	1	1	0	14+50.00	276	0	0				
20+50.00	1	95	0	10+50.00	8	6	0	14+51.65	15	0	0	Station	Uncl. Exc.	Embt	UnderCut
21+00.00	4	82	0	10+75.00	5	12	0					Y	(cu. yd.)	(cu. yd.)	(cu. yd.)
21+50.00	5	94	0	11+00.00	2	22	0	Station	Uncl. Exc.	Embt	UnderCut				
22+00.00	6	90	0	11+25.00	0	36	0	Summary No. 10 (RT.)				39+44.74	0	0	0
22+50.00	7	59	0	11+47.37	0	39	0	(cu. yd.)	(cu. yd.)	(cu. yd.)	(cu. yd.)	40+00.00	27	0	0
23+00.00	7	25	0					16+11.42	0	0	0	40+50.00	30	2	0
23+50.00	15	18	0	Station	Uncl. Exc.	Embt		16+50.00	1	29	0	40+96.65	16	2	0
24+00.00	25	32	0					17+00.00	1	38	0				
24+50.00	37	33	0	Y13	(cu. yd.)	(cu. yd.)		17+50.00	0	19	0	Station	Uncl. Exc.	Embt	
25+00.00	57	25	0	10+85.00	0	0		18+00.00	1	7	0	Y12	(cu. yd.)	(cu. yd.)	
25+50.00	69	17	0	11+00.00	6	2		18+50.00	1	58	0				
26+00.00	55	12	0	11+25.00	5	11		19+00.00	0	105	0	13+00.00	0	0	
26+50.00	28	17	0	11+50.00	0	45		19+50.00	0	88	0	13+25.00	0	0	
27+00.00	17	25	0	11+75.00	0	104		20+00.00	1	45	0	13+50.00	12	0	
27+50.00	31	25	0	12+00.00	0	153		20+50.00	3	43	0	13+75.00	20	6	
28+00.00	51	24	0	12+12.69	0	87		21+00.00	7	32	0	14+00.00	16	4	
28+50.00	54	24	0					21+50.00	10	19	0	14+25.00	14	1	
29+00.00	53	19	0	Station	Uncl. Exc.	Embt		22+00.00	7	37	0	14+50.00	9	0	
29+50.00	54	15	0					22+50.00	4	39	0	14+75.00	7	0	
30+00.00	52	15	0	Y12	(cu. yd.)	(cu. yd.)		23+00.00	2	57	0	15+00.00	6	0	
30+50.00	46	15	0	10+05.00	0	0		23+50.00	1	81	0	15+25.00	6	0	
31+00.00	29	25	0	10+25.00	4	0		24+00.00	0	92	0	15+50.00	6	0	
31+50.00	7	46	0	10+50.00	5	1		24+50.00	0	100	0	15+53.00	1	0	
32+00.00	0	81	0	10+75.00	7	6		25+00.00	0	105	0				
32+50.00	0	98	0	11+00.00	12	11		25+50.00	1	62	0				
33+00.00	0	90	0	11+25.00	14	13		26+00.00	2	66	0				
33+50.00	0	99	0	11+50.00	15	12		26+50.00	2	131	0				
34+00.00	0	156	0	11+75.00	12	9		27+00.00	1	162	0				
34+50.00	0	181	0	12+00.00	9	8		27+50.00	0	177	0				
35+00.00	0	147	0	12+25.00	7	12		28+00.00	0	100	0				
35+50.00	0	119	0	12+50.00	4	7		28+50.00	1	89	0				
36+00.00	0	102	0	12+75.00	0	0		29+00.00	5	137	0				
36+50.00	0	102	0	13+00.00	0	0		29+50.00	8	102	0				
37+00.00	0	100	0					30+00.00	9	78	0				
37+50.00	0	94	0	Station	Uncl. Exc.	Embt	UnderCut	30+50.00	10	63	0				
38+00.00	3	84	0					31+00.00	13	49	0				
38+50.00	10	37	0	Y	(cu. yd.)	(cu. yd.)	(cu. yd.)	31+50.00	13	40	0				
38+87.56	11	0	0	7+35.00	0	0	0	32+00.00	10	40	0				
				7+50.00	0	0	0	32+50.00	9	38	0				
Station	Uncl. Exc.	Embt		8+00.00	5	0	0	33+00.00	8	33	0				
Y10	(cu. yd.)	(cu. yd.)		8+50.00	9	0	0	33+50.00	7	32	0				
				9+00.00	7	1	0	34+00.00	7	30	0				
10+50.00	0	0		9+50.00	5	1	0	34+50.00	5	26	0				
10+75.00	8	6		10+00.00	3	0	0	35+00.00	8	19	0				
11+00.00	5	12		10+50.00	7	22	0	35+50.00	21	6	0				
11+25.00	2	26		11+00.00	8	57	0	36+00.00	45	0	0				
11+50.00	0	56		11+50.00	2	67	0	36+50.00	57	0	0				
11+60.09	0	30		12+00.00	0	92	0	37+00.00	71	0	0				
				12+50.00	0	143	0	37+50.00	84	0	0				
				13+00.00	0	123	0	38+00.00	67	0	0				
				13+50.00	36	44	0	38+50.00	75	1	0				

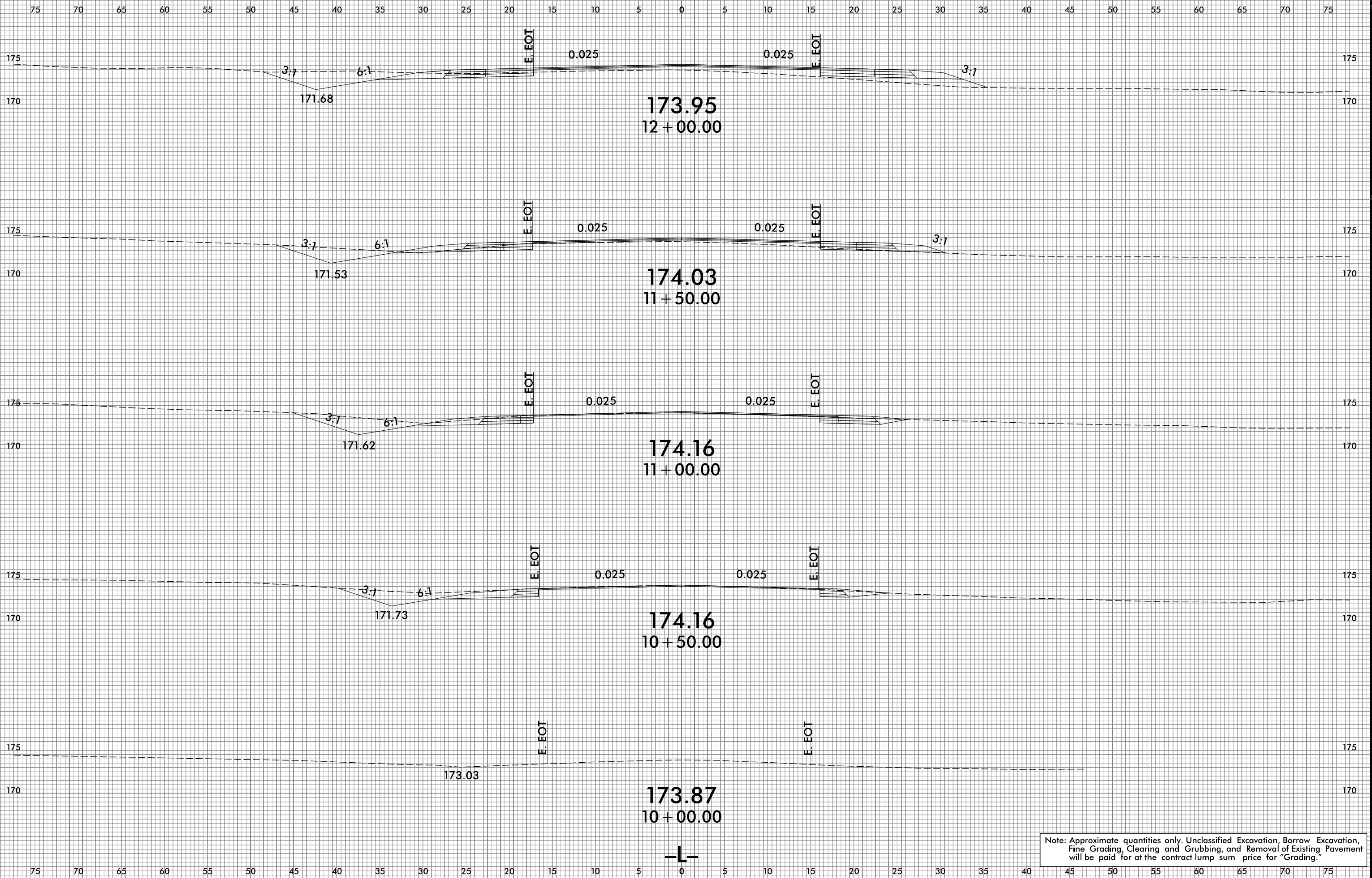

Note: Approximate quantities only. Unclassified Excavation, Borrow Excavation, Fine Grading, Clearing and Grubbing, and Removal of Existing Pavement will be paid for at the contract lump sum price for "Grading."

75 70 65 60 55 50 45 40 35 30 25 20 15 10 5 0 5 10 15 20 25 30 35 40 45 50 55 60 65 70 75

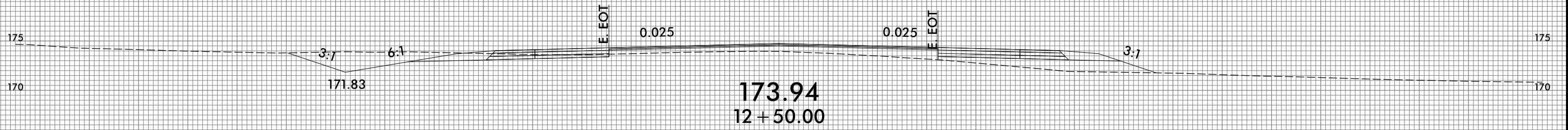
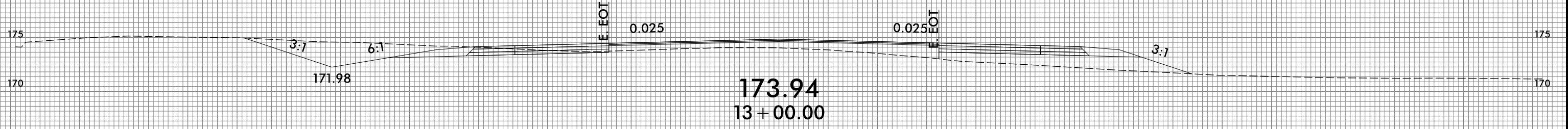
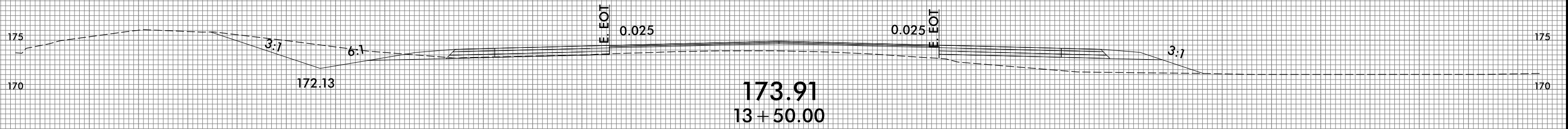
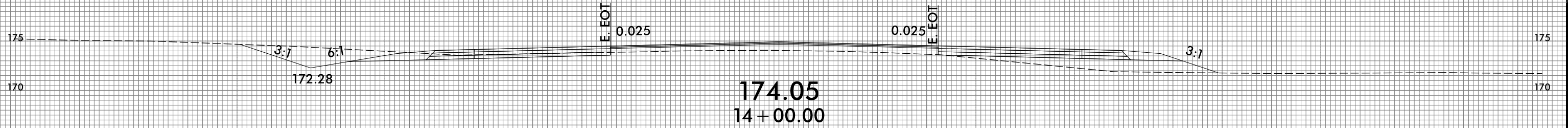

-L-

75 70 65 60 55 50 45 40 35 30 25 20 15 10 5 0 5 10 15 20 25 30 35 40 45 50 55 60 65 70 75

75 70 65 60 55 50 45 40 35 30 25 20 15 10 5 0 5 10 15 20 25 30 35 40 45 50 55 60 65 70 75

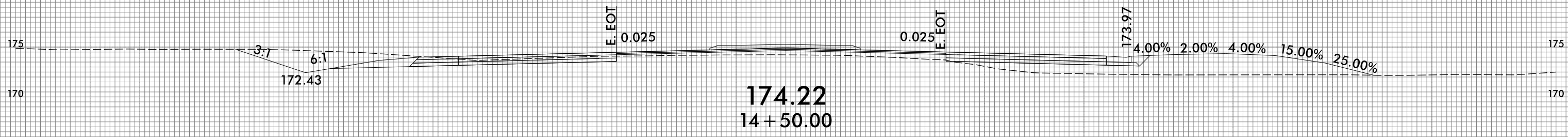
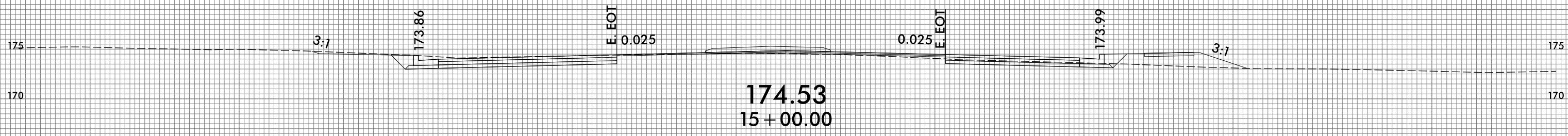
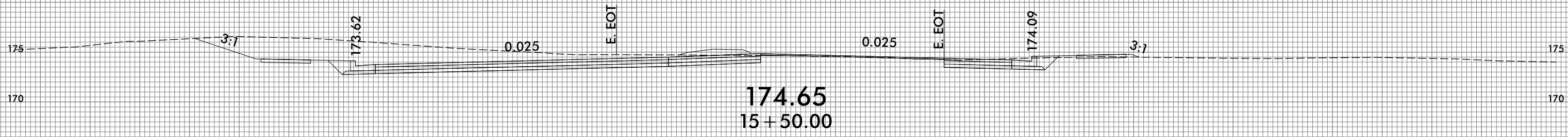
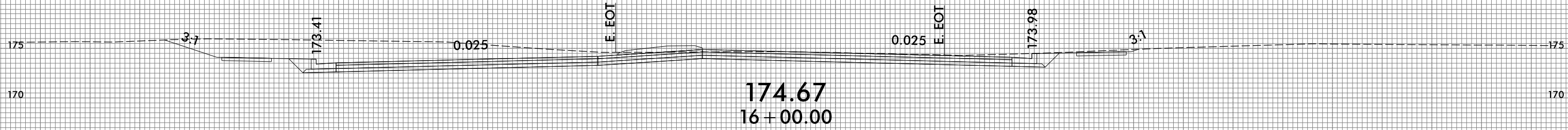

75 70 65 60 55 50 45 40 35 30 25 20 15 10 5 0 5 10 15 20 25 30 35 40 45 50 55 60 65 70 75

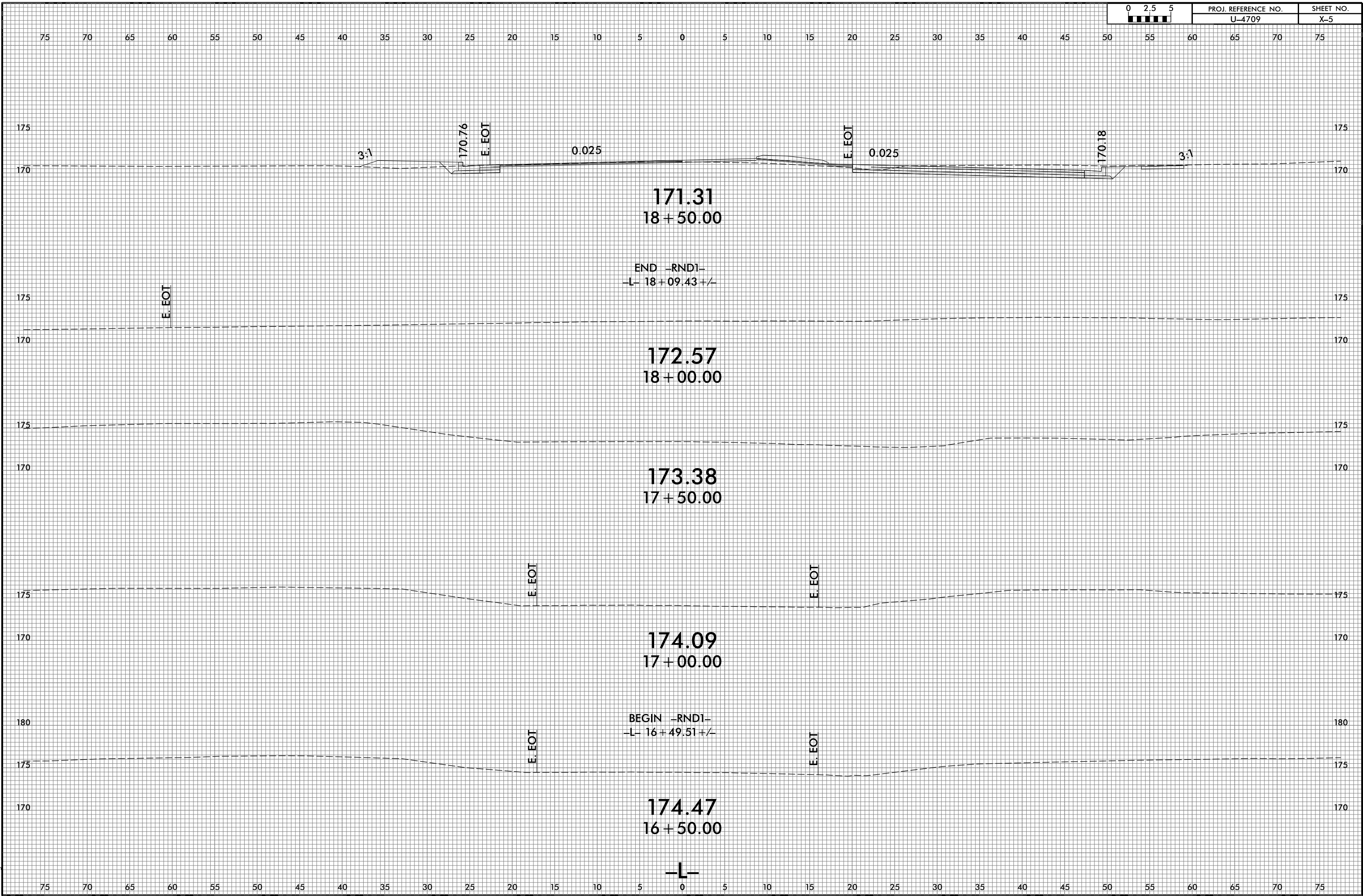

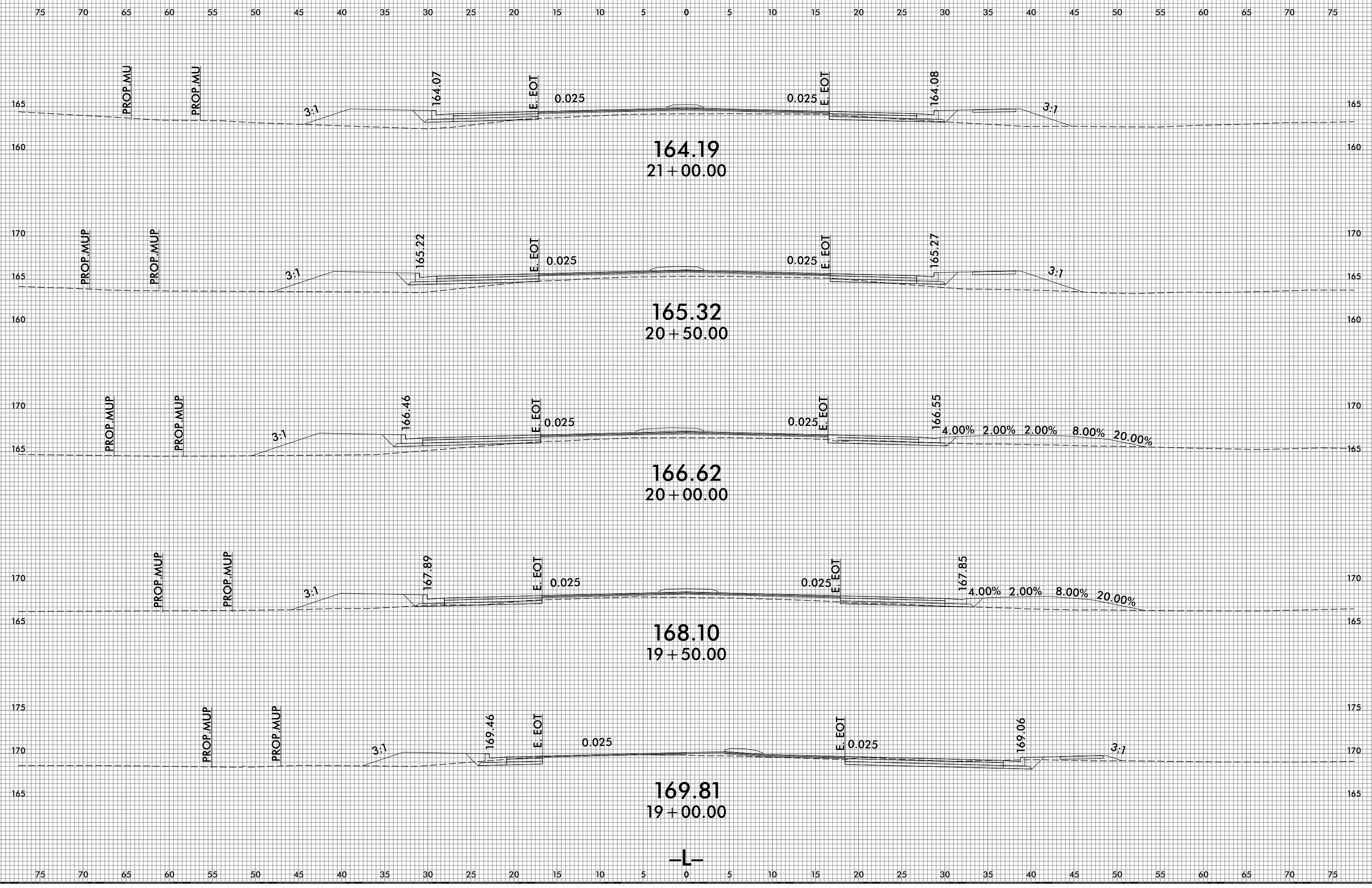

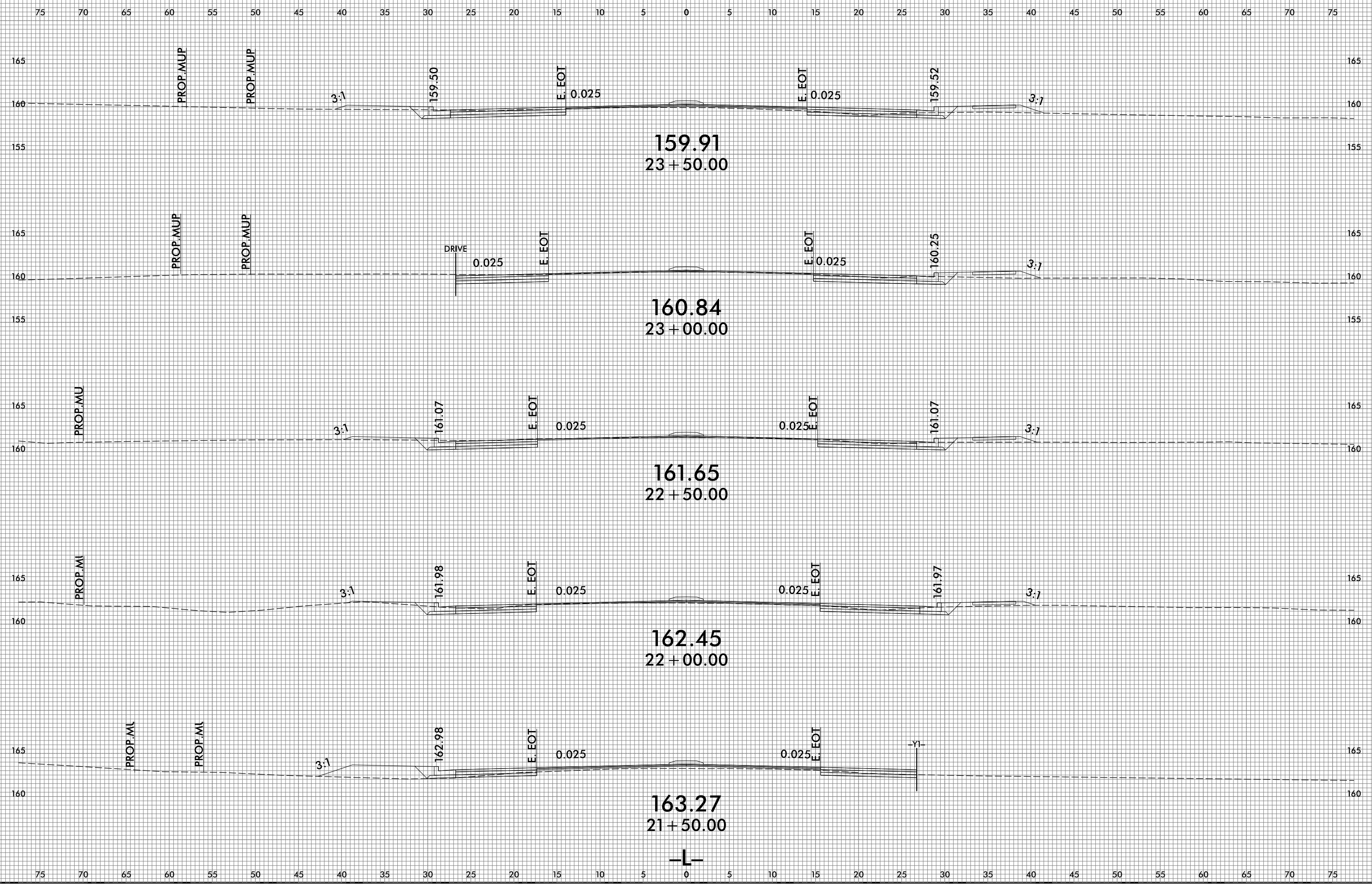

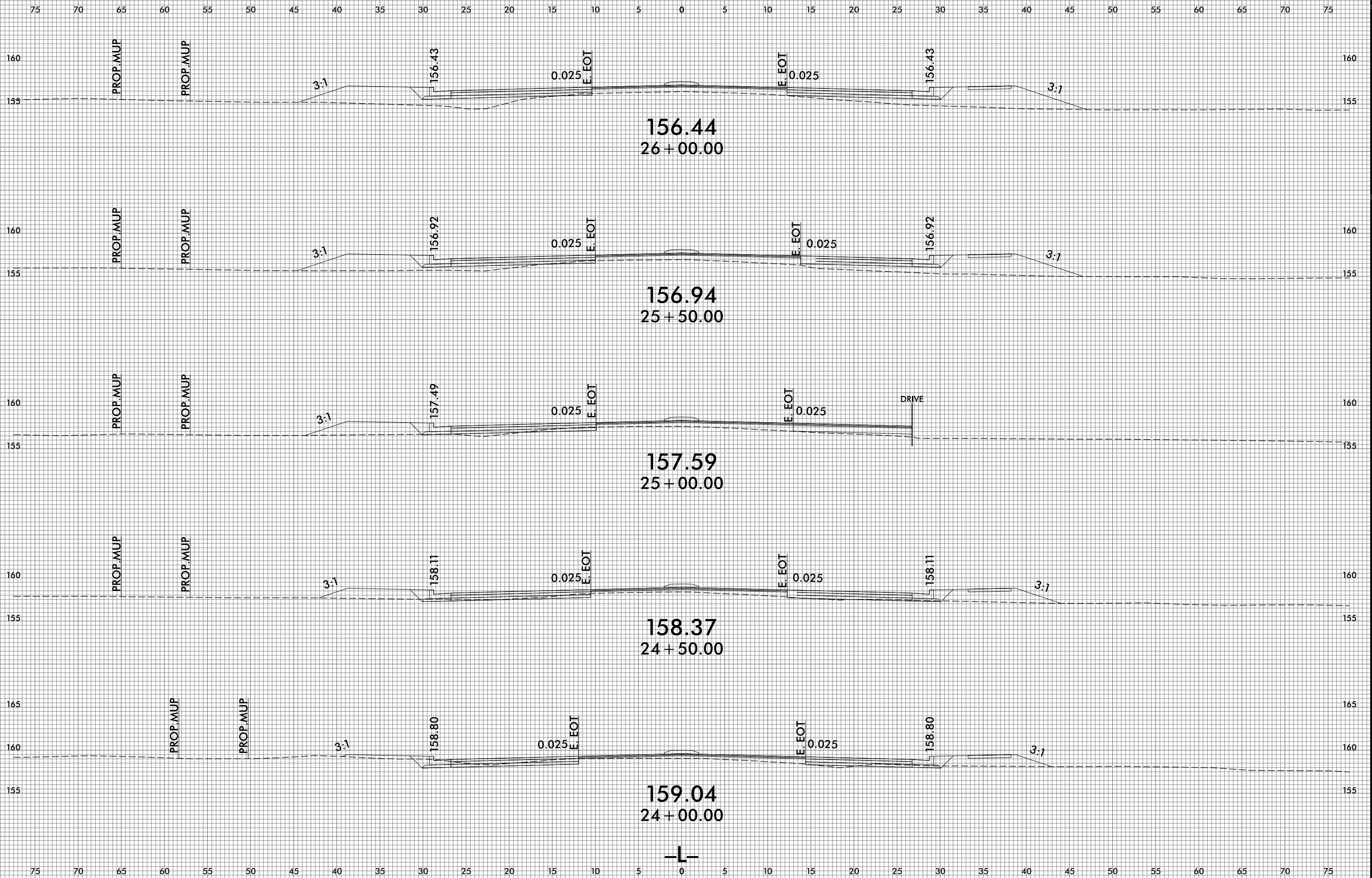

75 70 65 60 55 50 45 40 35 30 25 20 15 10 5 0 5 10 15 20 25 30 35 40 45 50 55 60 65 70 75

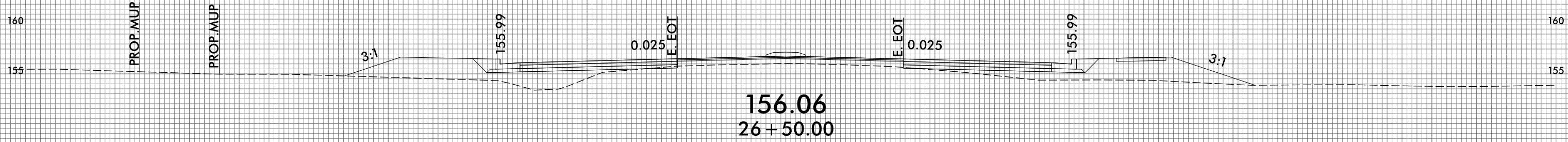
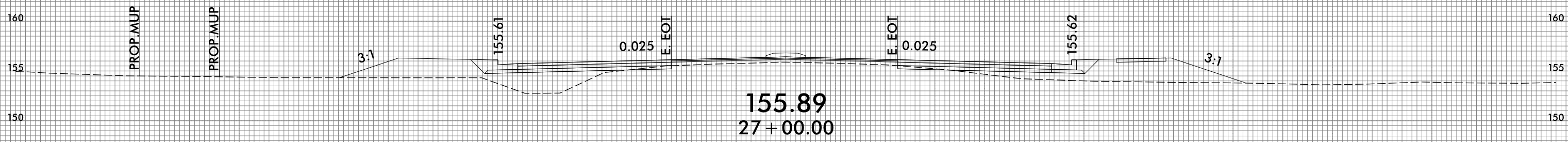
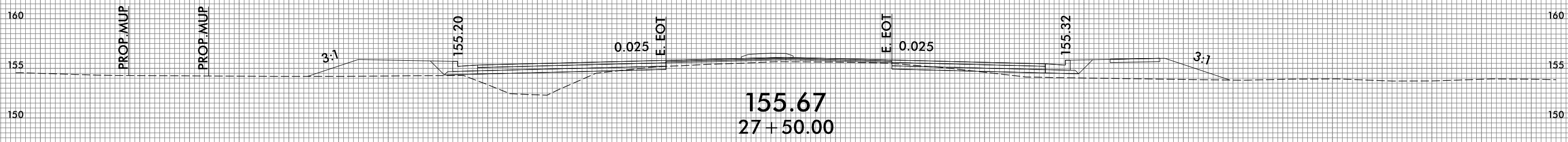
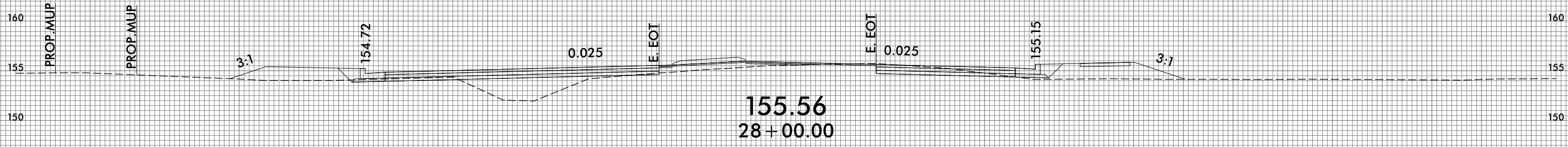

75 70 65 60 55 50 45 40 35 30 25 20 15 10 5 0 5 10 15 20 25 30 35 40 45 50 55 60 65 70 75



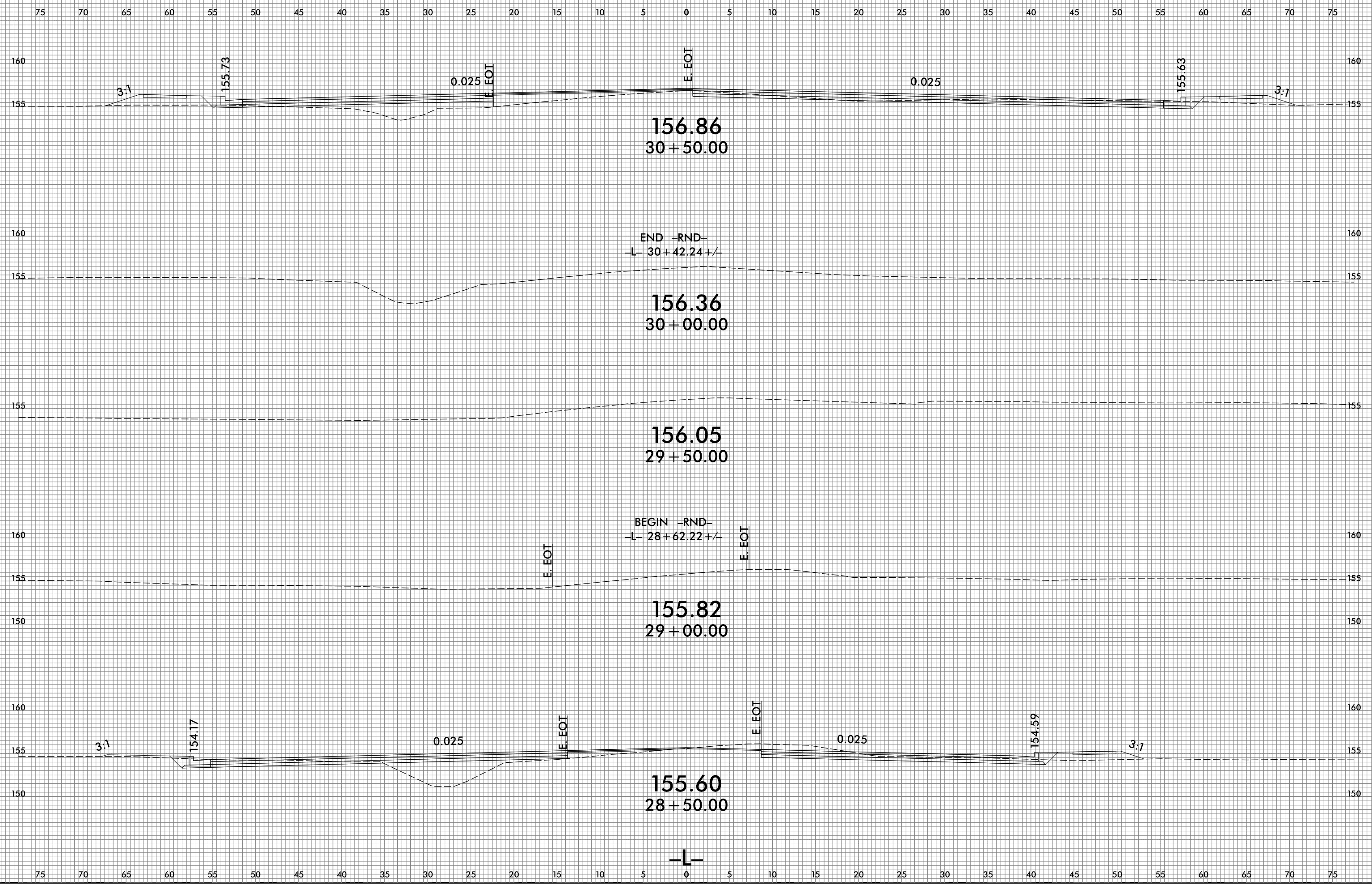

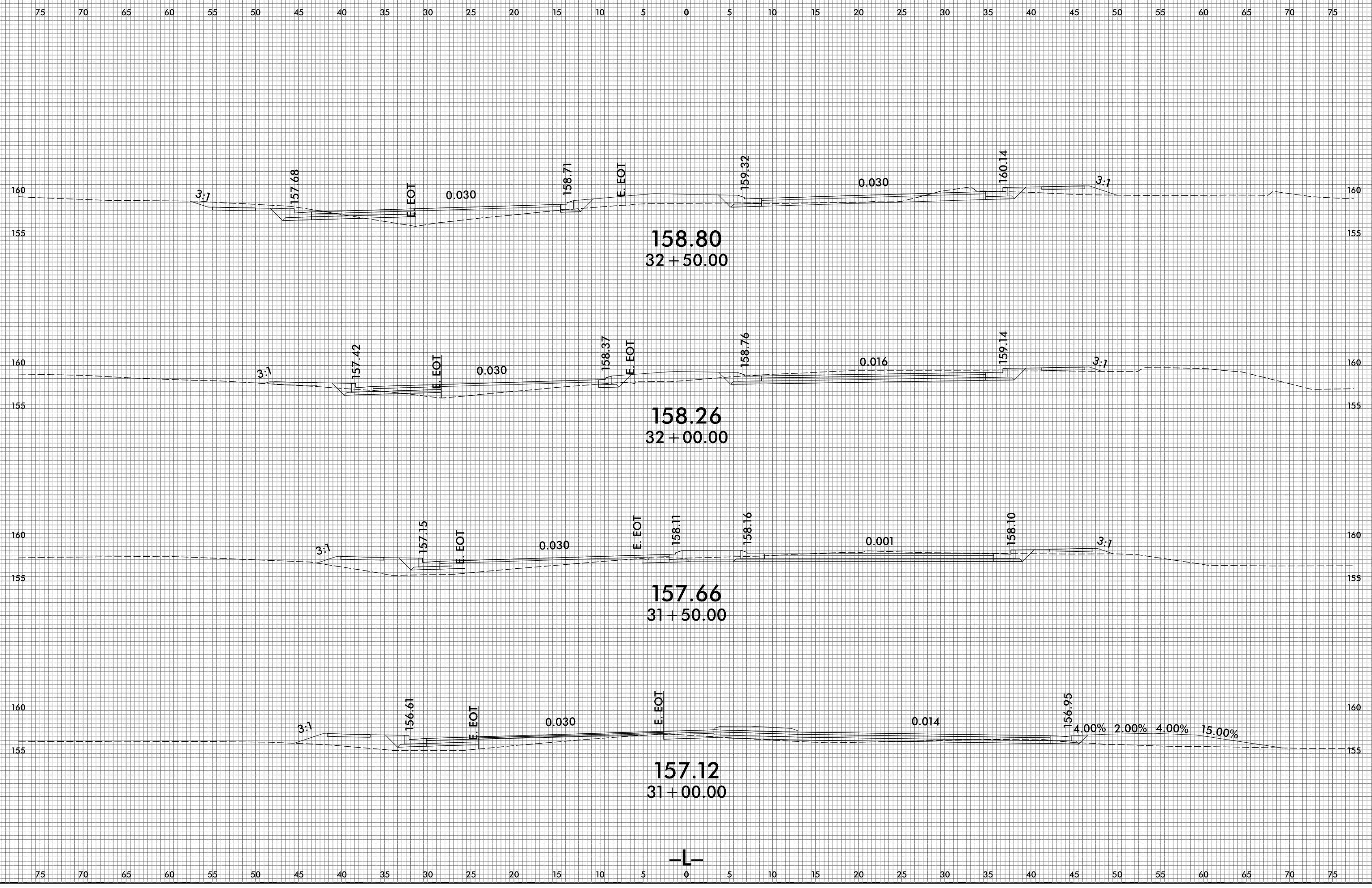

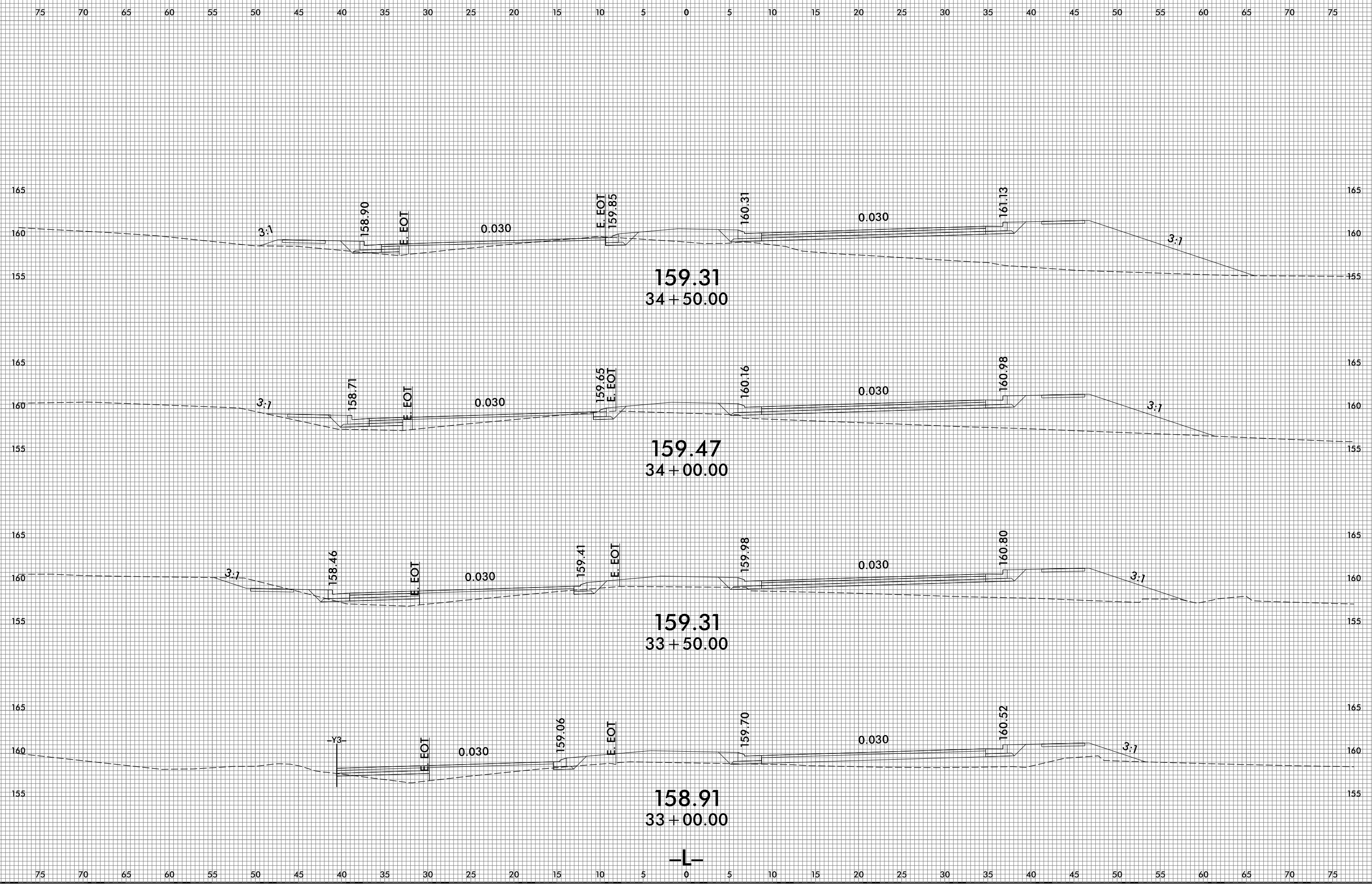

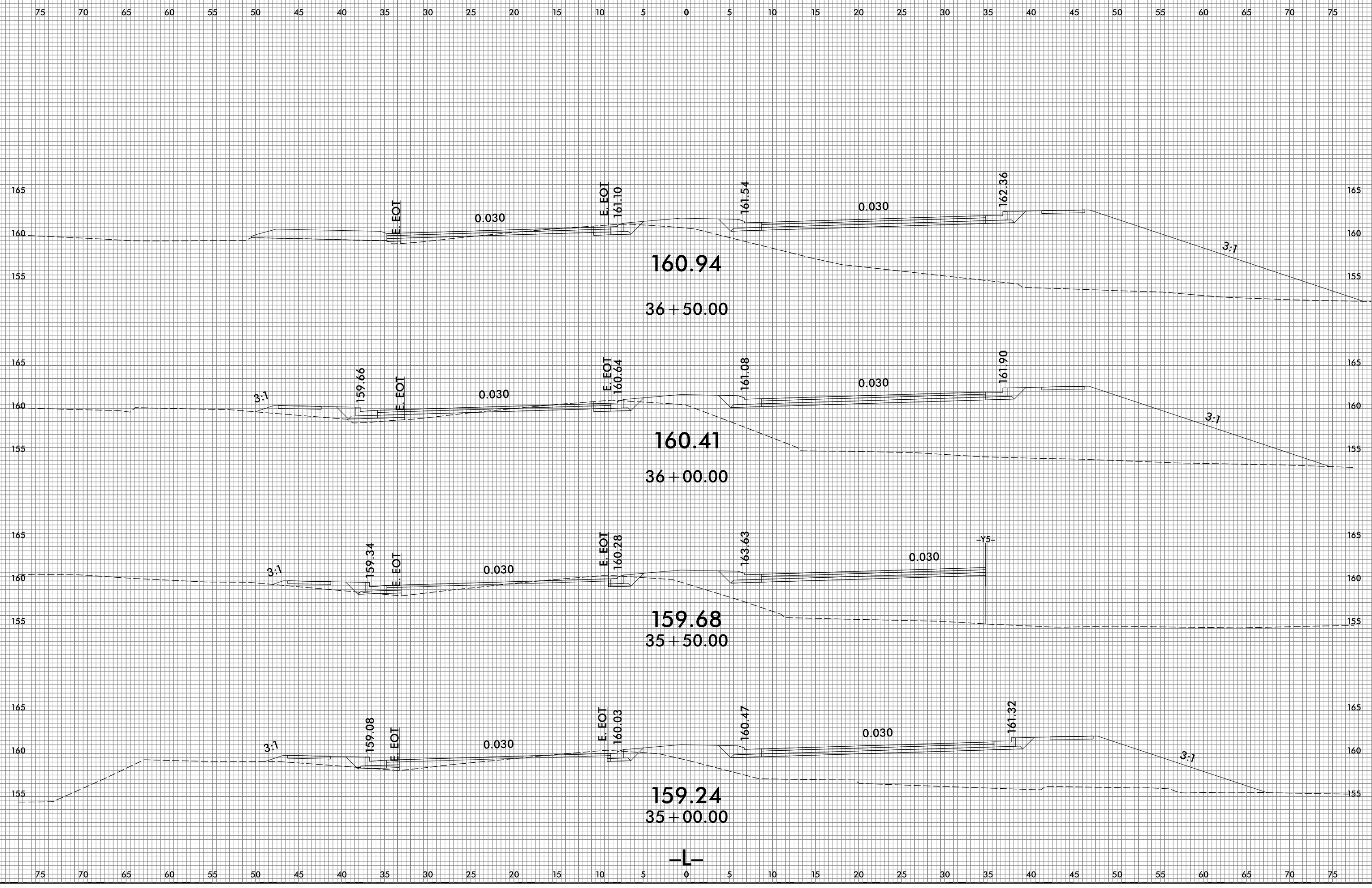

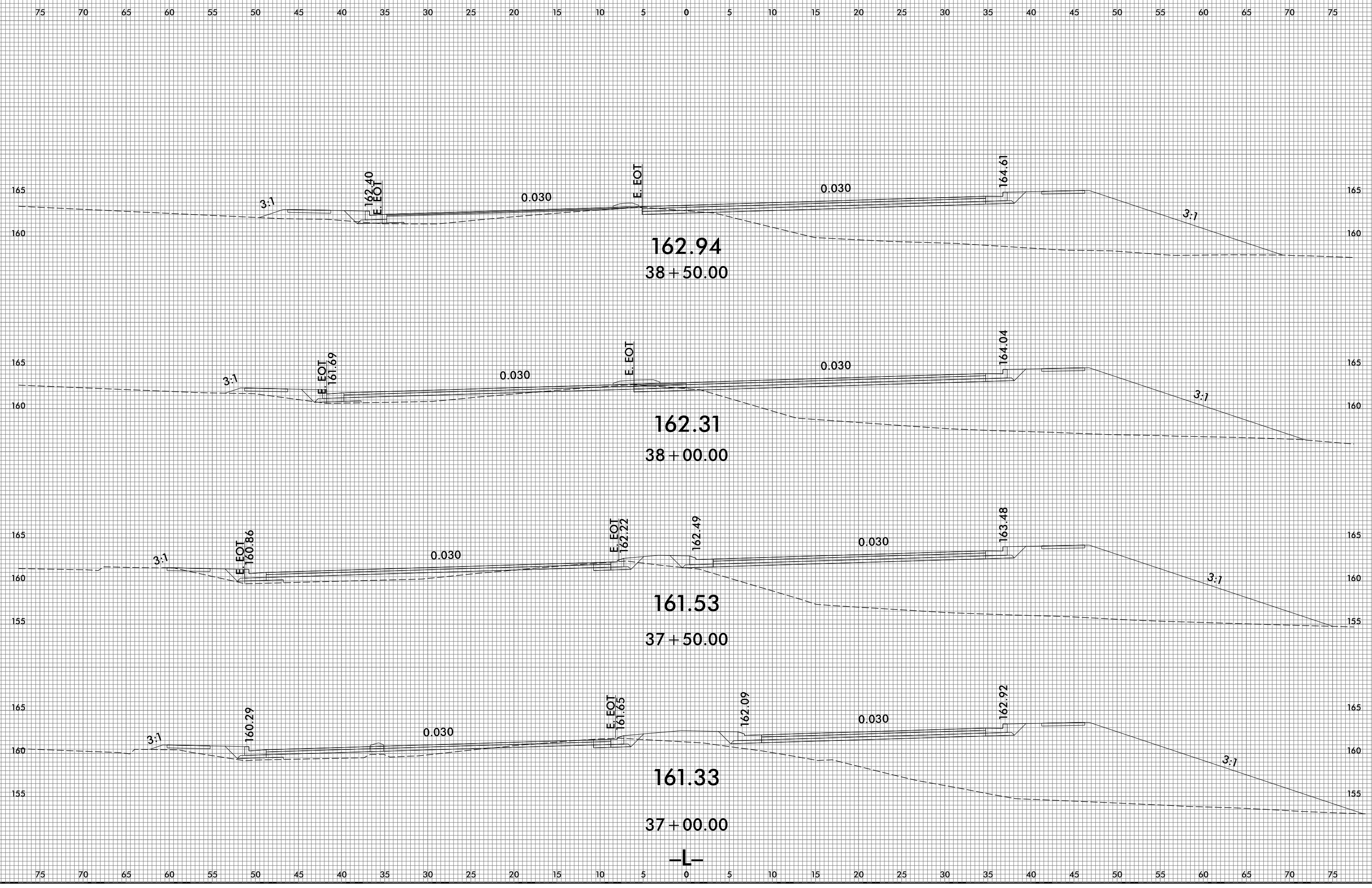

75 70 65 60 55 50 45 40 35 30 25 20 15 10 5 0 5 10 15 20 25 30 35 40 45 50 55 60 65 70 75

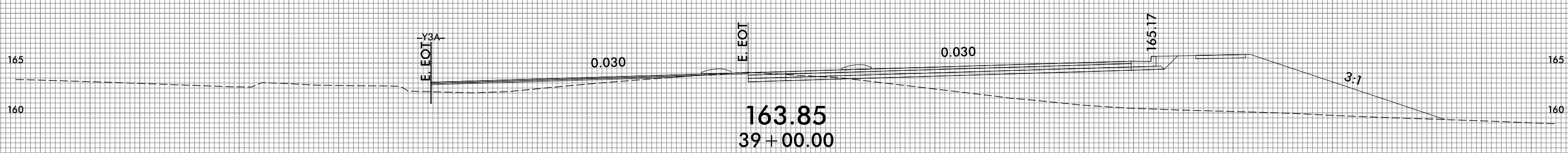
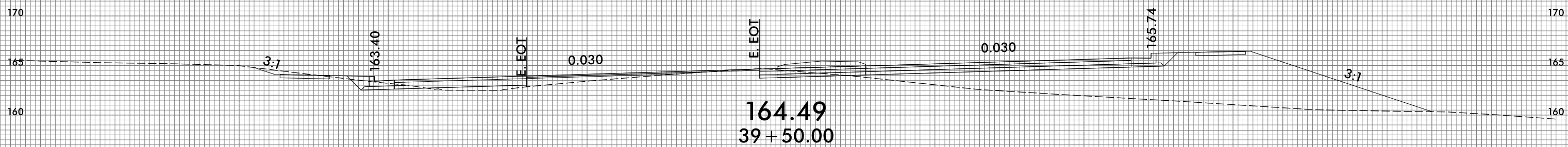
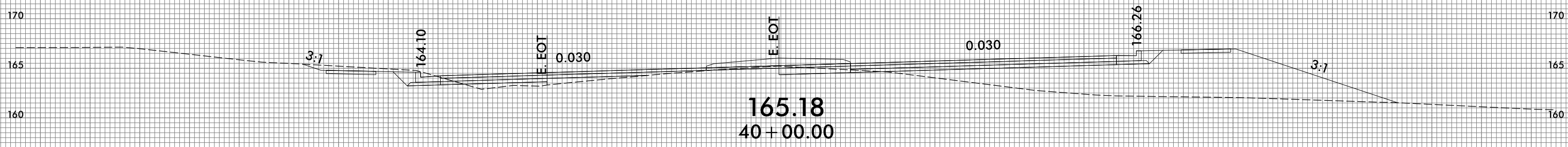
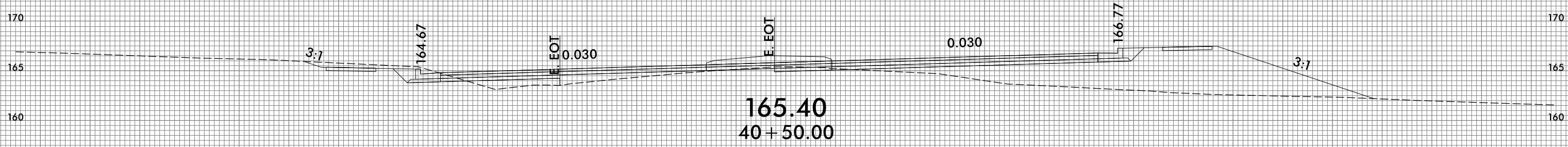

75 70 65 60 55 50 45 40 35 30 25 20 15 10 5 0 5 10 15 20 25 30 35 40 45 50 55 60 65 70 75

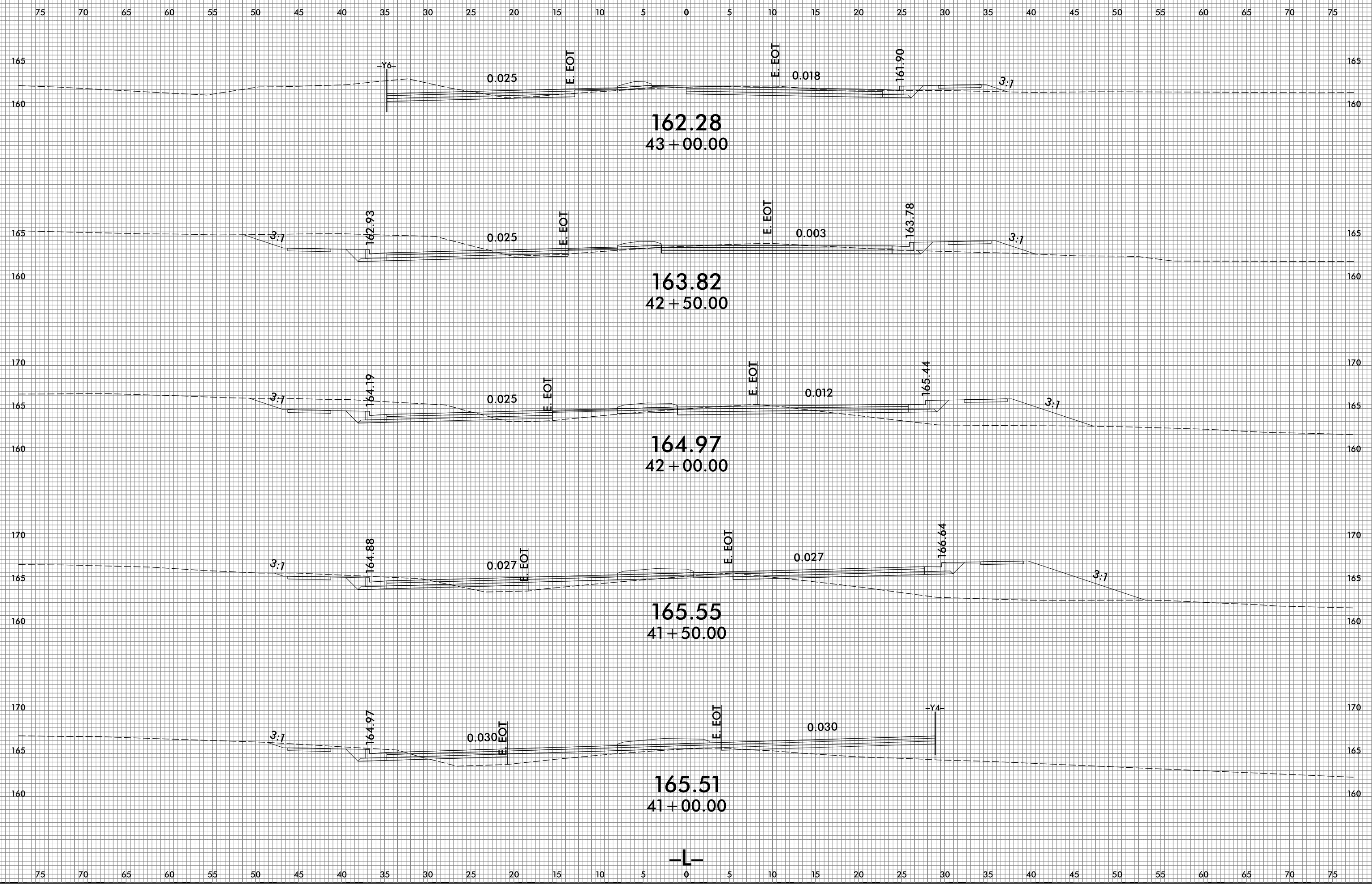

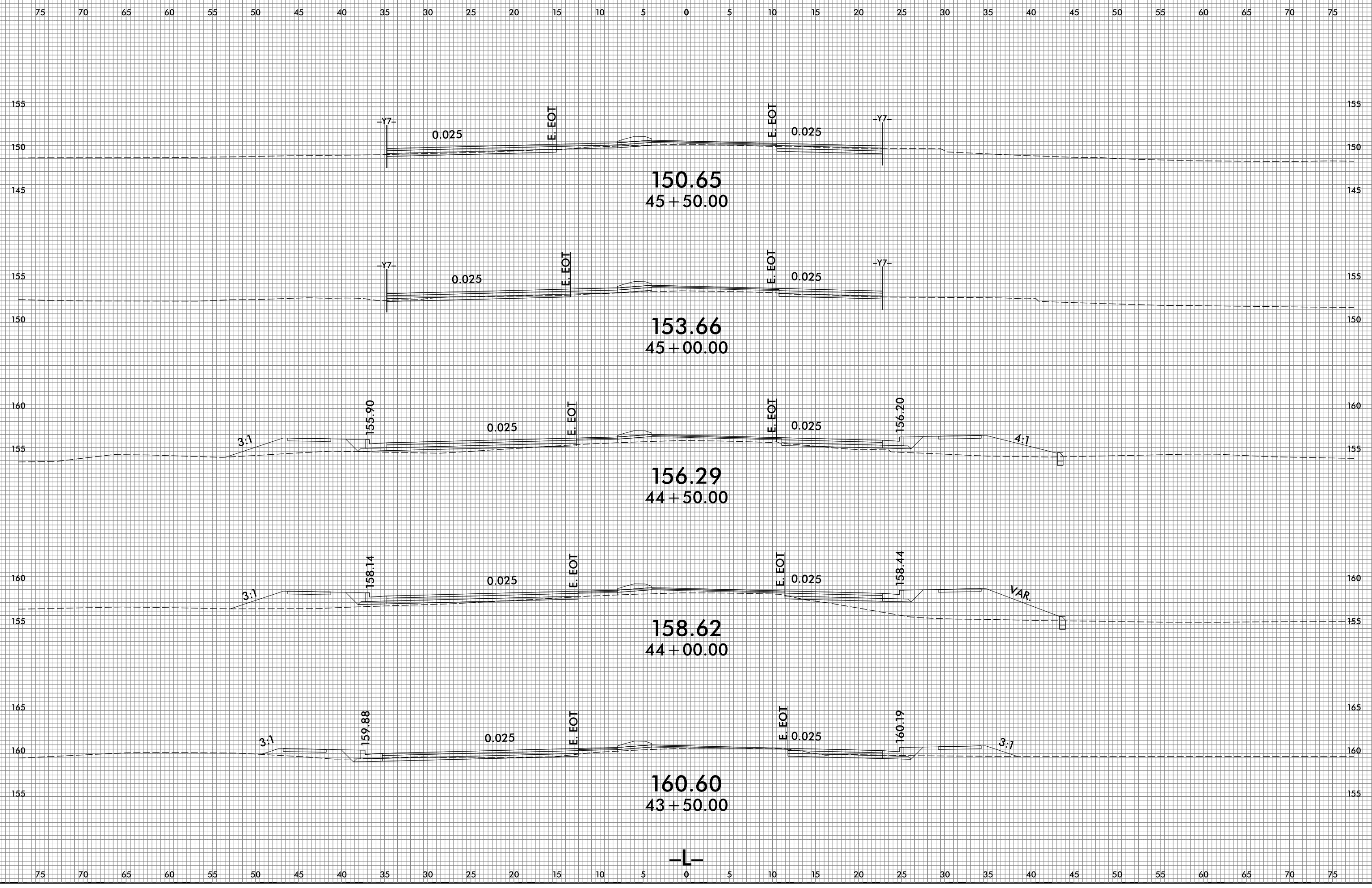

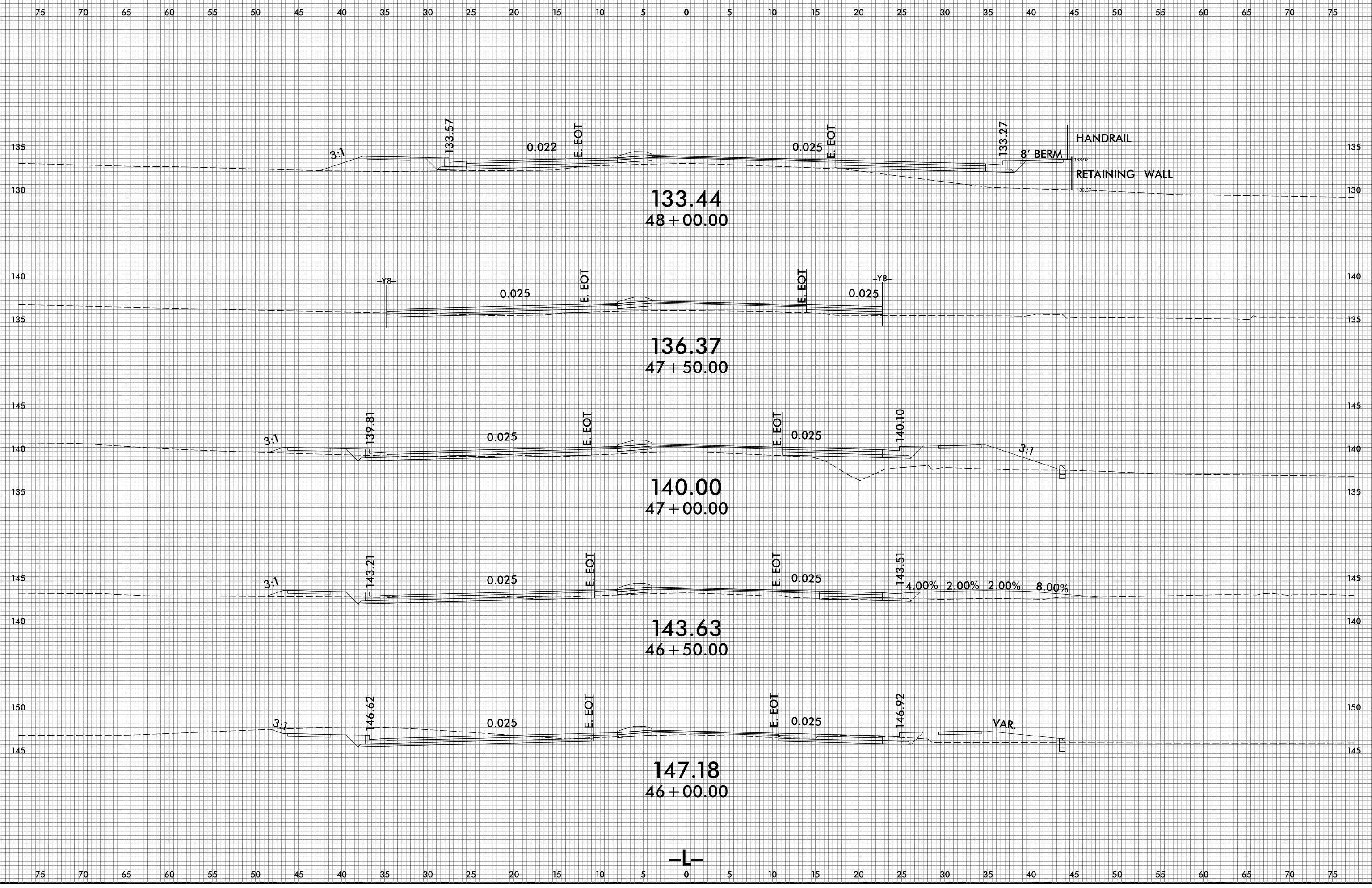

75 70 65 60 55 50 45 40 35 30 25 20 15 10 5 0 5 10 15 20 25 30 35 40 45 50 55 60 65 70 75

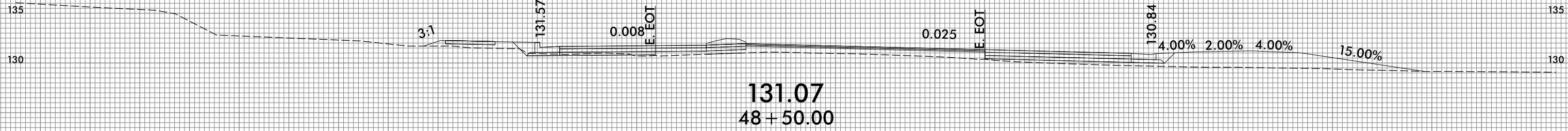
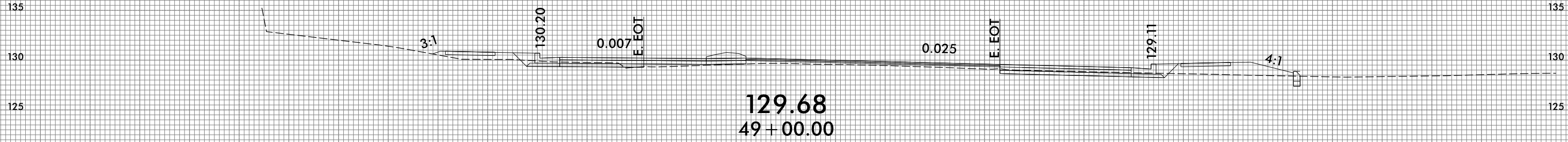
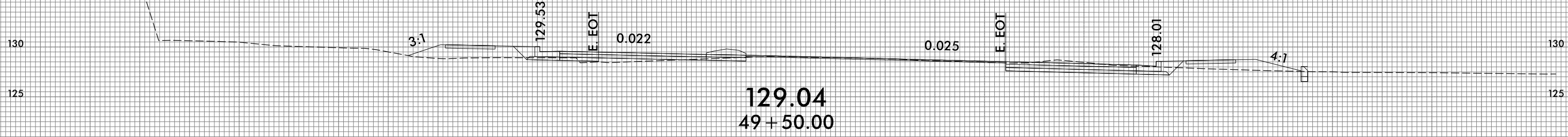
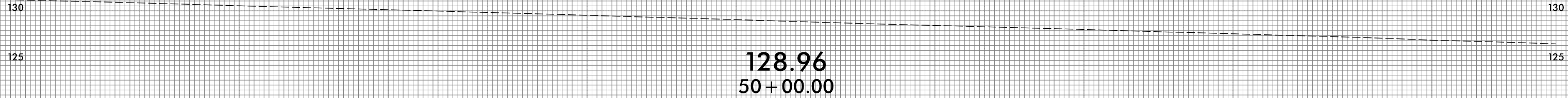

75 70 65 60 55 50 45 40 35 30 25 20 15 10 5 0 5 10 15 20 25 30 35 40 45 50 55 60 65 70 75



75 70 65 60 55 50 45 40 35 30 25 20 15 10 5 0 5 10 15 20 25 30 35 40 45 50 55 60 65 70 75

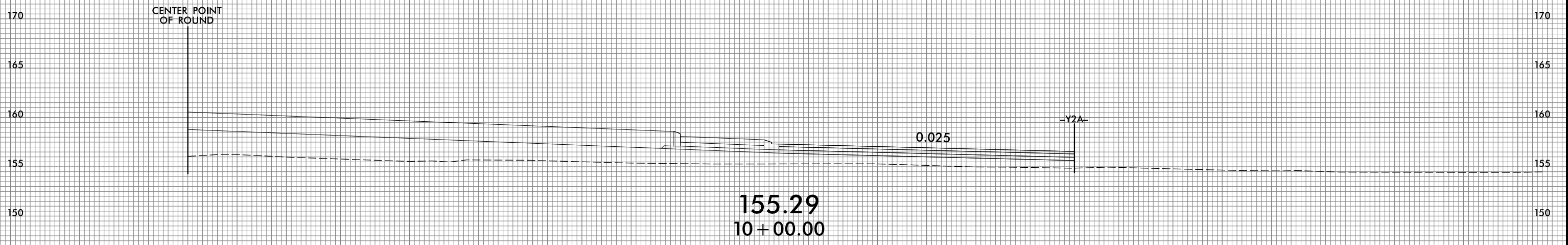
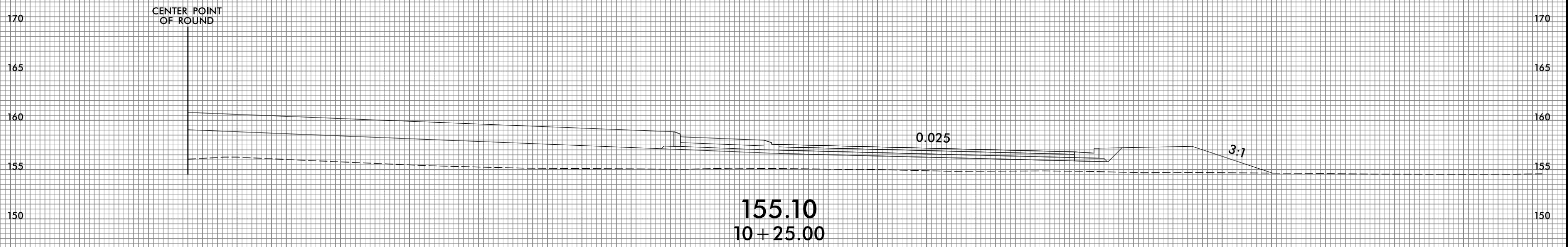
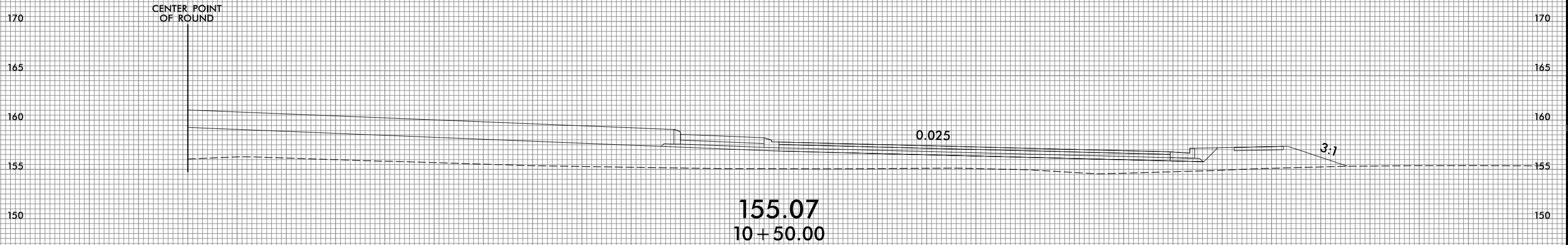

75 70 65 60 55 50 45 40 35 30 25 20 15 10 5 0 5 10 15 20 25 30 35 40 45 50 55 60 65 70 75

-RND-

75 70 65 60 55 50 45 40 35 30 25 20 15 10 5 0 5 10 15 20 25 30 35 40 45 50 55 60 65 70 75

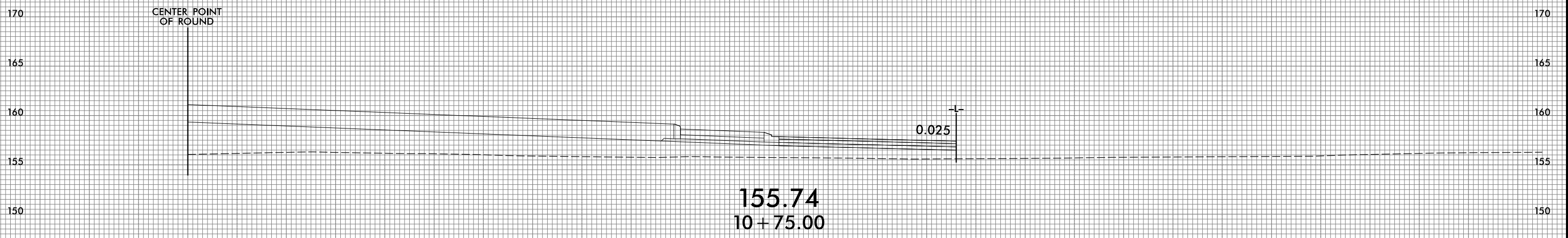
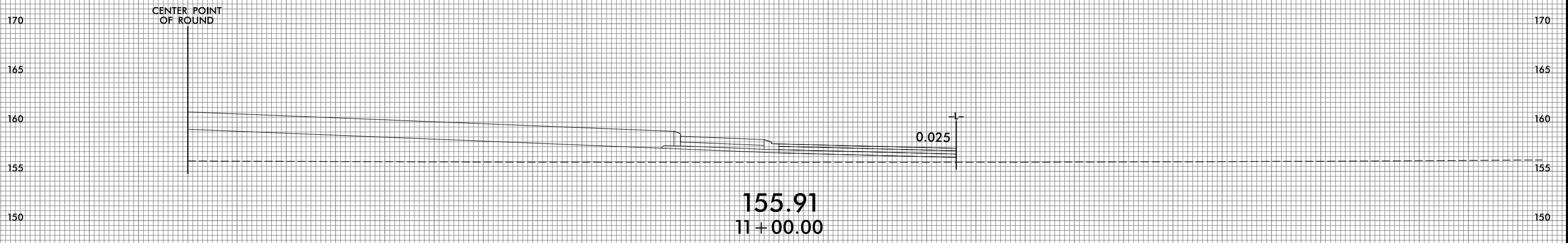
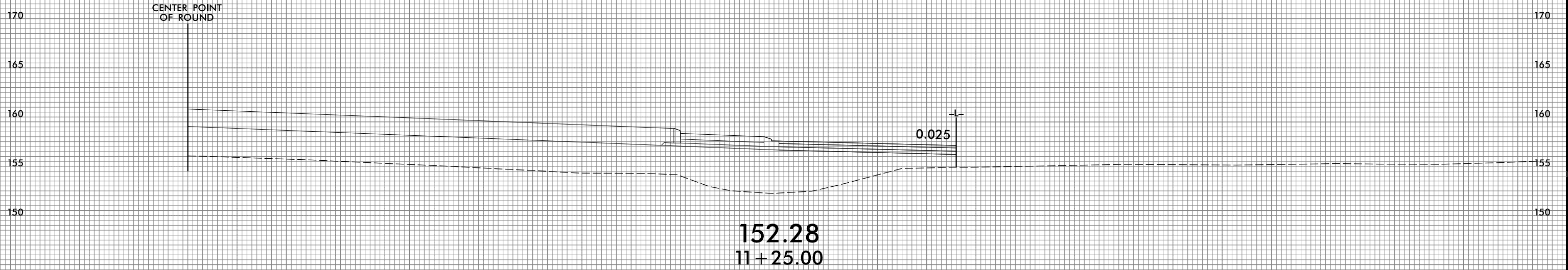

75 70 65 60 55 50 45 40 35 30 25 20 15 10 5 0 5 10 15 20 25 30 35 40 45 50 55 60 65 70 75

-RND-

75 70 65 60 55 50 45 40 35 30 25 20 15 10 5 0 5 10 15 20 25 30 35 40 45 50 55 60 65 70 75

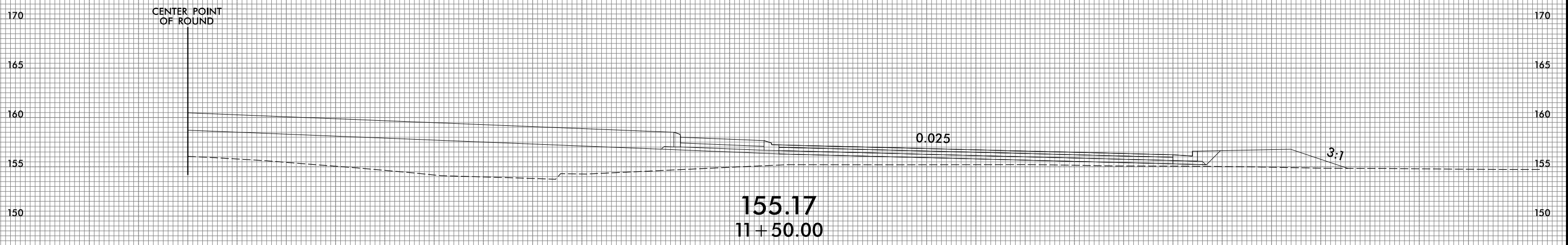
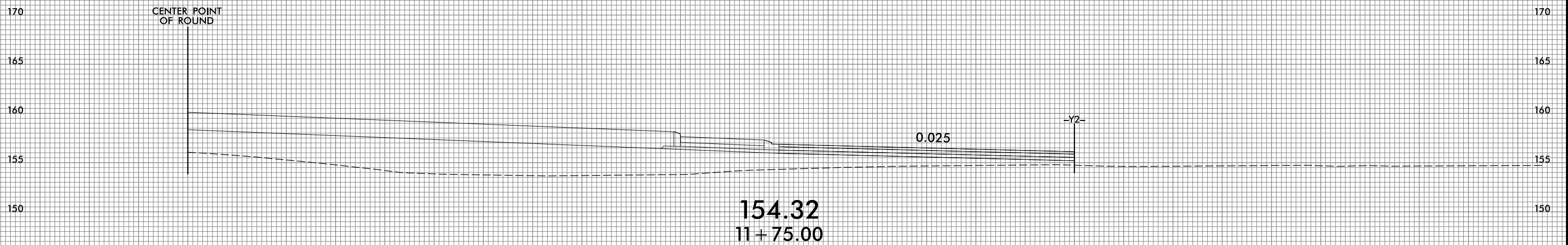
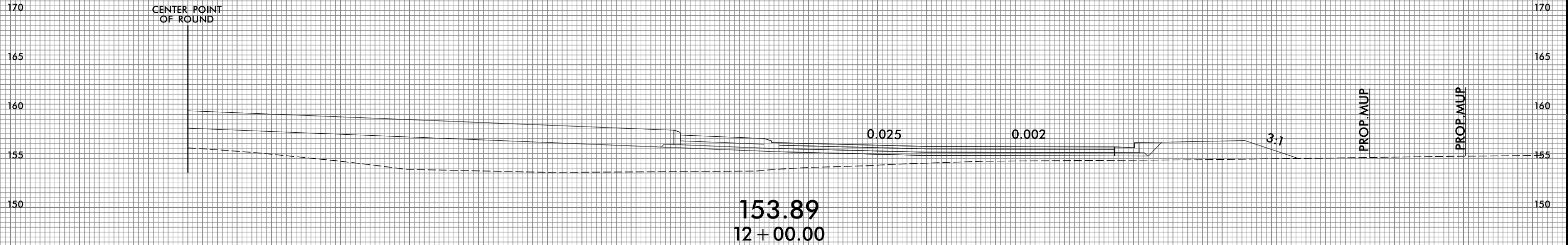

-RND-

75 70 65 60 55 50 45 40 35 30 25 20 15 10 5 0 5 10 15 20 25 30 35 40 45 50 55 60 65 70 75

75 70 65 60 55 50 45 40 35 30 25 20 15 10 5 0 5 10 15 20 25 30 35 40 45 50 55 60 65 70 75

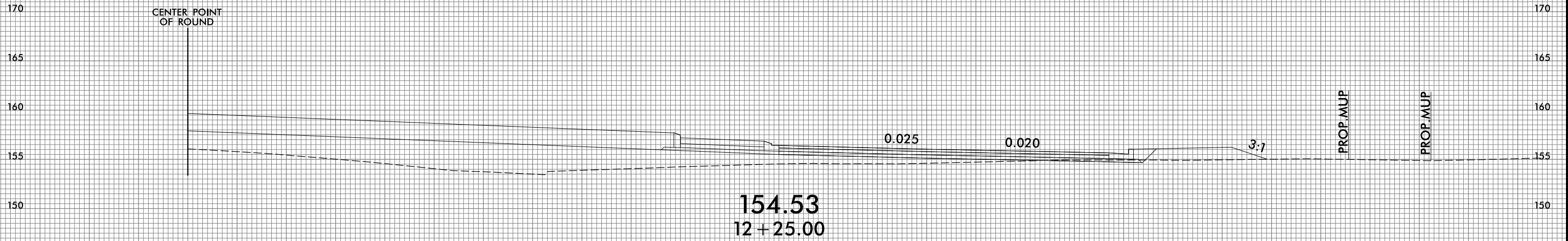
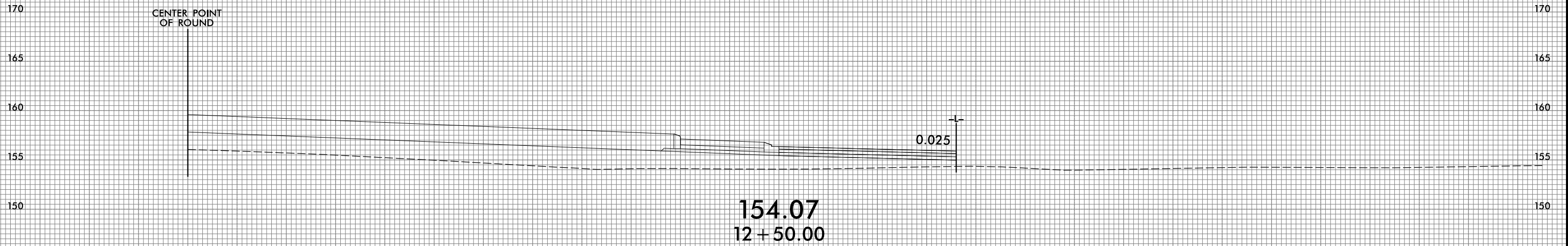
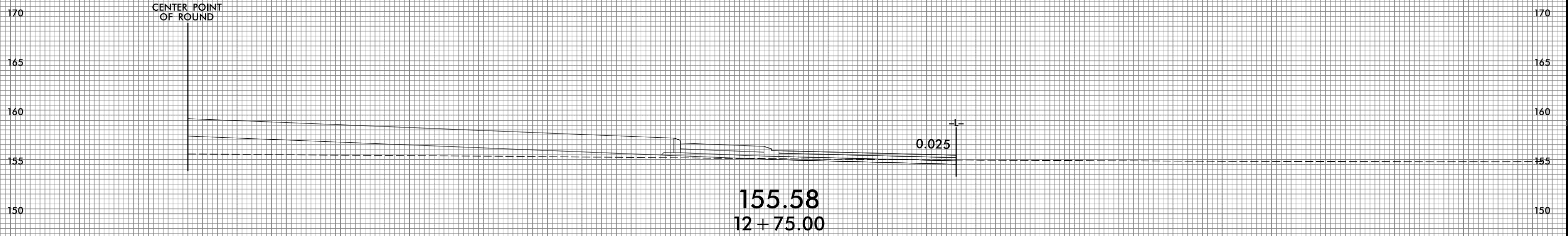

75 70 65 60 55 50 45 40 35 30 25 20 15 10 5 0 5 10 15 20 25 30 35 40 45 50 55 60 65 70 75

-RND-

75 70 65 60 55 50 45 40 35 30 25 20 15 10 5 0 5 10 15 20 25 30 35 40 45 50 55 60 65 70 75

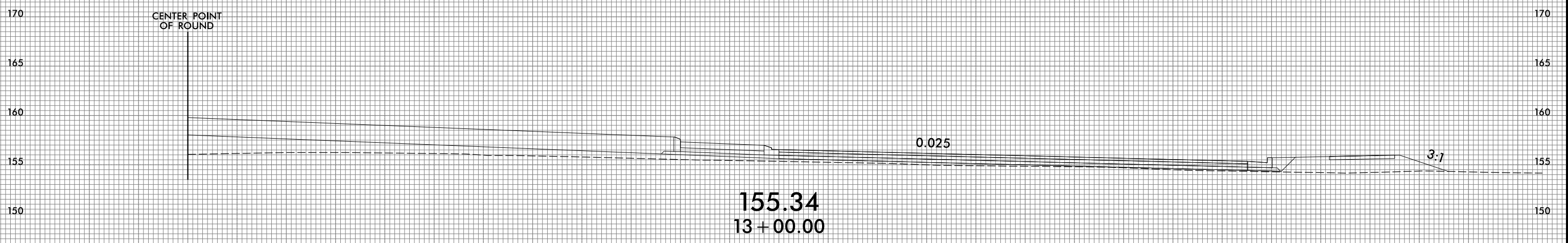
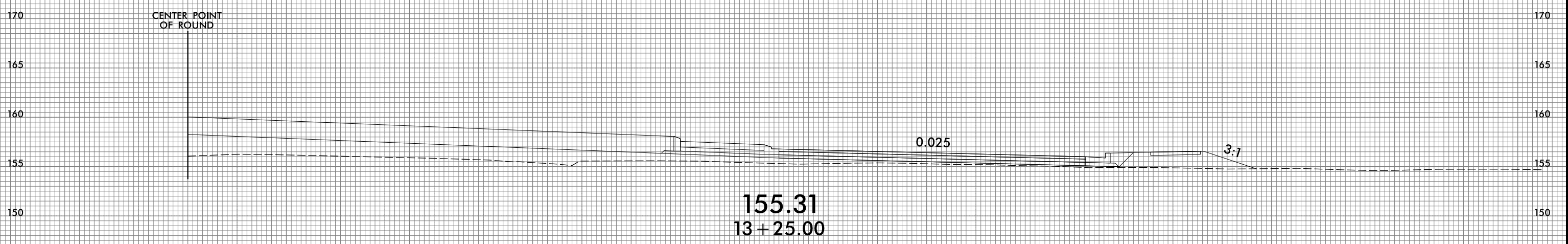
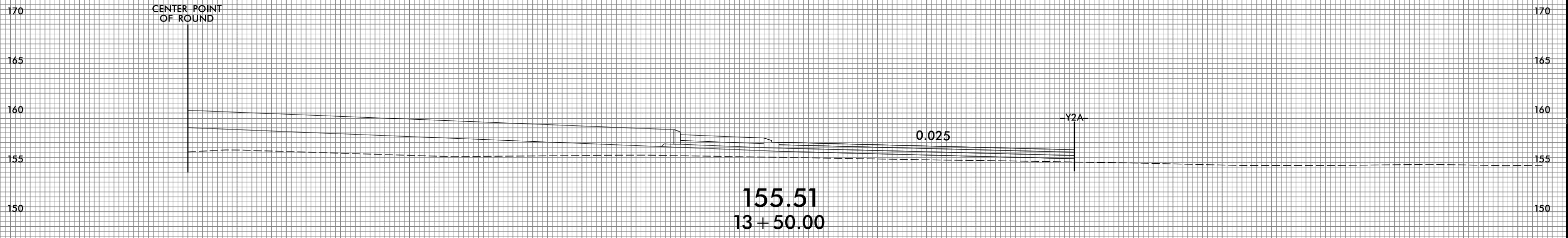

-RND-

75 70 65 60 55 50 45 40 35 30 25 20 15 10 5 0 5 10 15 20 25 30 35 40 45 50 55 60 65 70 75

75 70 65 60 55 50 45 40 35 30 25 20 15 10 5 0 5 10 15 20 25 30 35 40 45 50 55 60 65 70 75

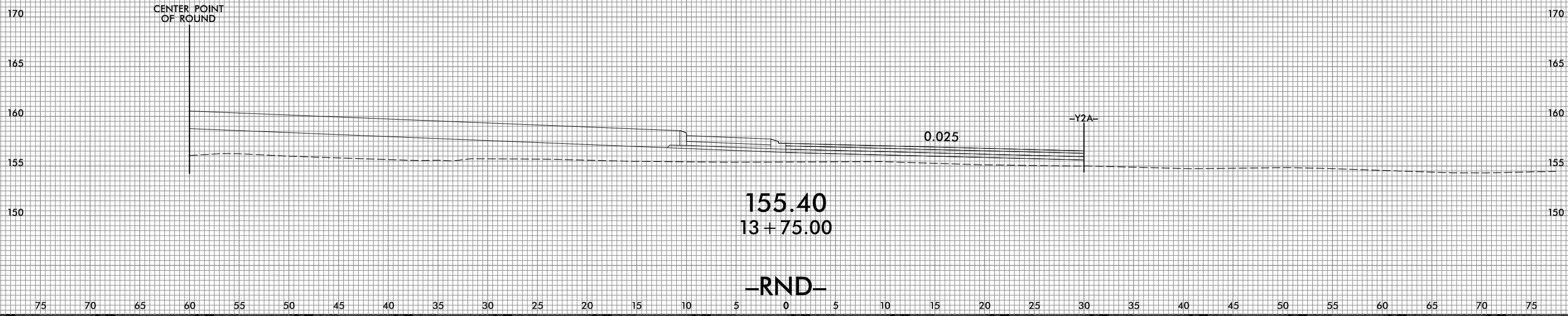

75 70 65 60 55 50 45 40 35 30 25 20 15 10 5 0 5 10 15 20 25 30 35 40 45 50 55 60 65 70 75

75 70 65 60 55 50 45 40 35 30 25 20 15 10 5 0 5 10 15 20 25 30 35 40 45 50 55 60 65 70 75

CENTER POINT OF ROUND

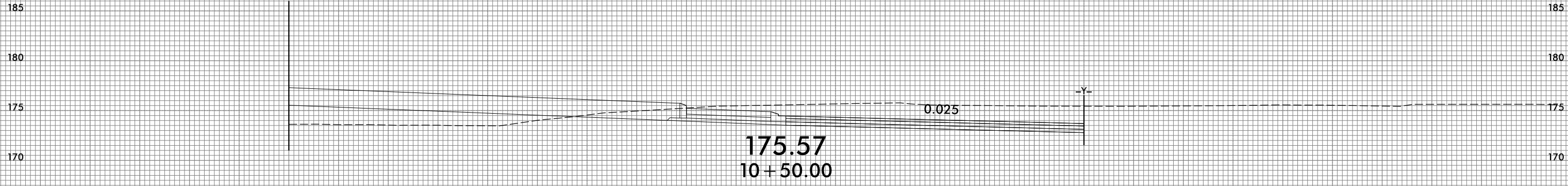

CENTER POINT OF ROUND

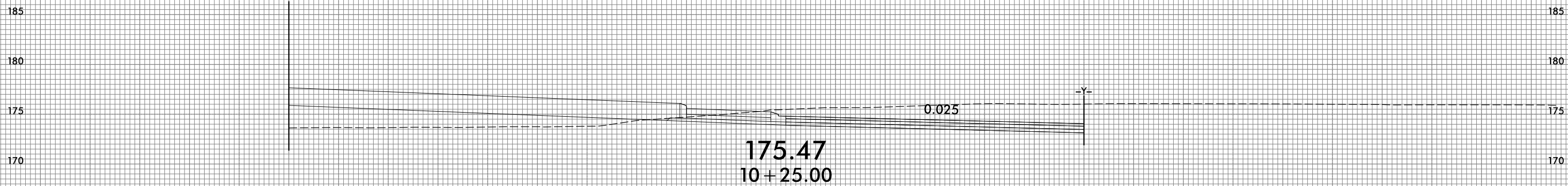

CENTER POINT OF ROUND

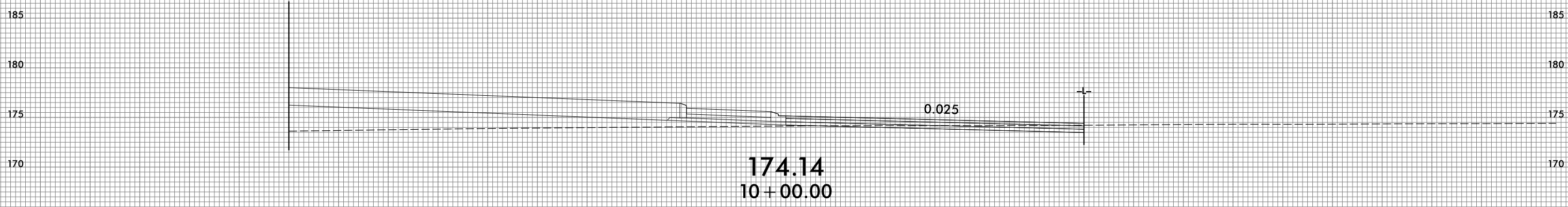

-RND1-

75 70 65 60 55 50 45 40 35 30 25 20 15 10 5 0 5 10 15 20 25 30 35 40 45 50 55 60 65 70 75

75 70 65 60 55 50 45 40 35 30 25 20 15 10 5 0 5 10 15 20 25 30 35 40 45 50 55 60 65 70 75

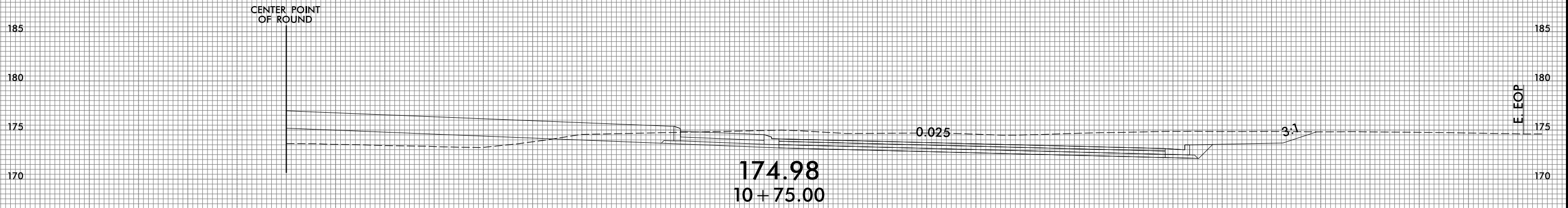
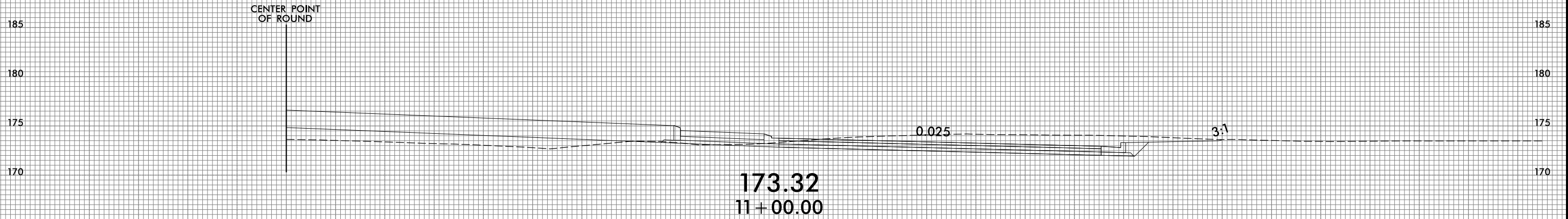
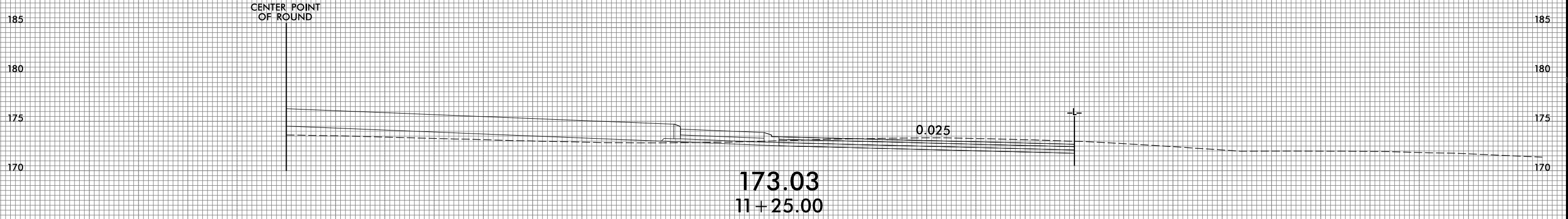

75 70 65 60 55 50 45 40 35 30 25 20 15 10 5 0 5 10 15 20 25 30 35 40 45 50 55 60 65 70 75

-RND1-

E. EOP

75 70 65 60 55 50 45 40 35 30 25 20 15 10 5 0 5 10 15 20 25 30 35 40 45 50 55 60 65 70 75

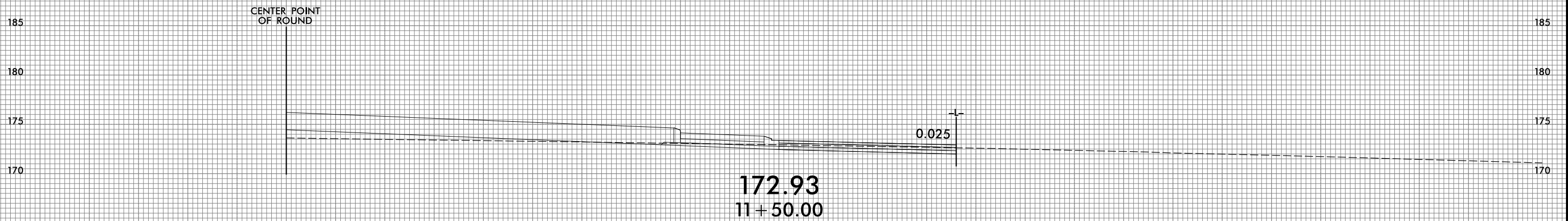
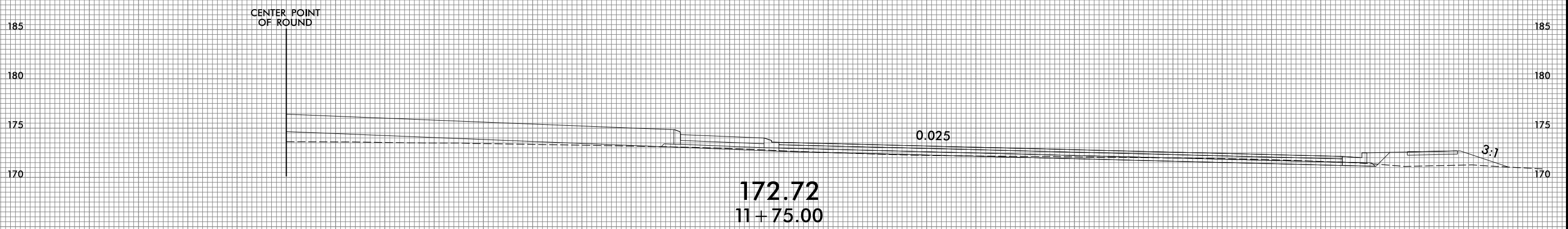
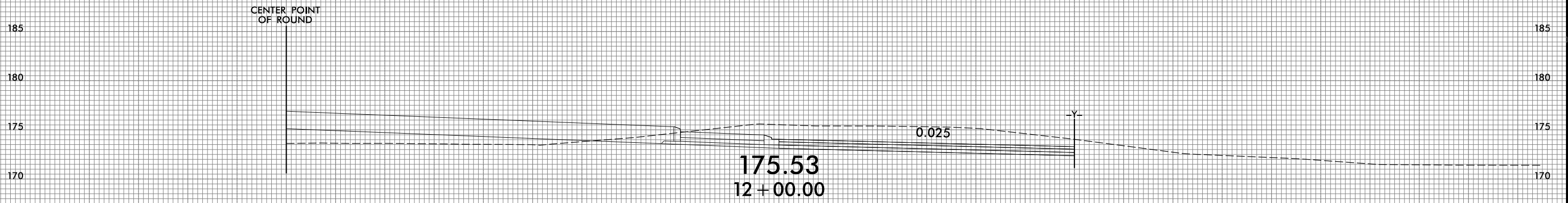

-RND1-

75 70 65 60 55 50 45 40 35 30 25 20 15 10 5 0 5 10 15 20 25 30 35 40 45 50 55 60 65 70 75

75 70 65 60 55 50 45 40 35 30 25 20 15 10 5 0 5 10 15 20 25 30 35 40 45 50 55 60 65 70 75

CENTER POINT OF ROUND

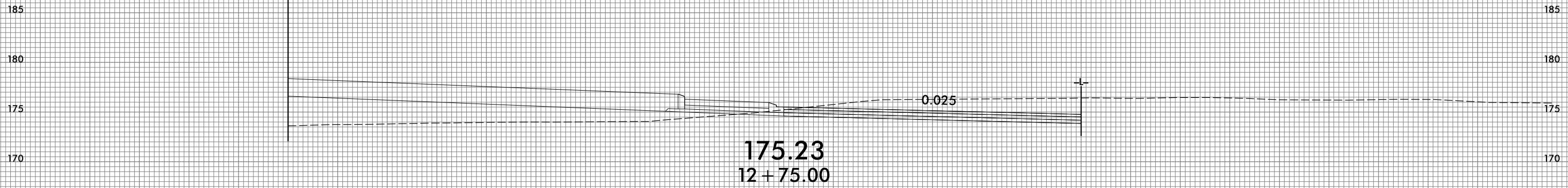

CENTER POINT OF ROUND



CENTER POINT OF ROUND

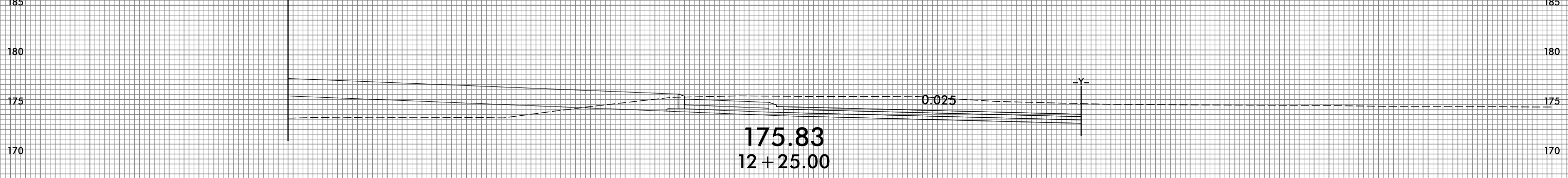

-RND1-

75 70 65 60 55 50 45 40 35 30 25 20 15 10 5 0 5 10 15 20 25 30 35 40 45 50 55 60 65 70 75

75 70 65 60 55 50 45 40 35 30 25 20 15 10 5 0 5 10 15 20 25 30 35 40 45 50 55 60 65 70 75

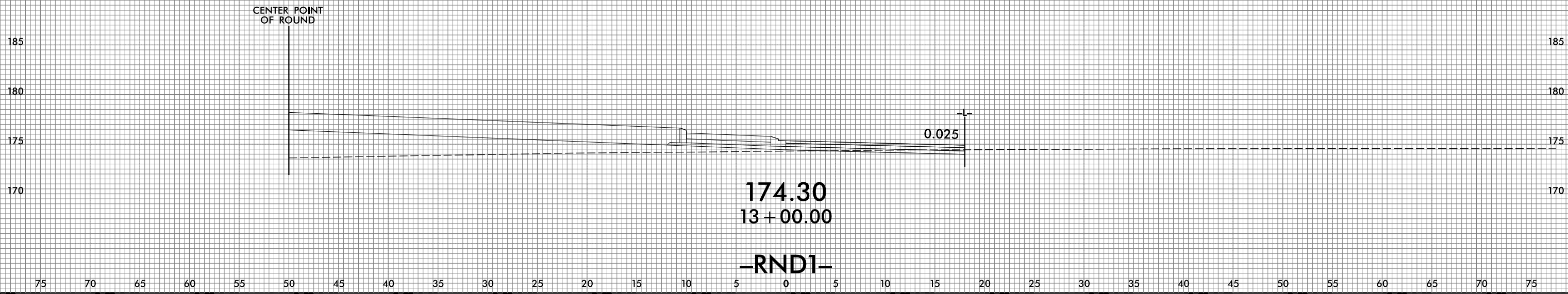

75 70 65 60 55 50 45 40 35 30 25 20 15 10 5 0 5 10 15 20 25 30 35 40 45 50 55 60 65 70 75

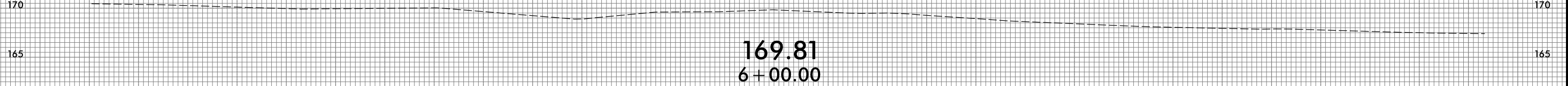
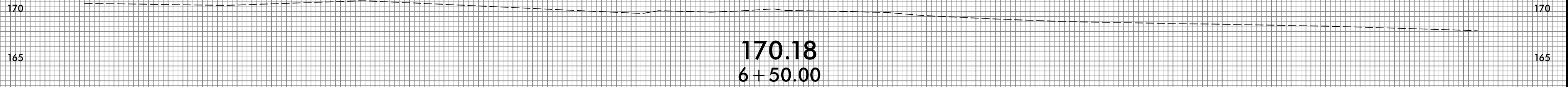
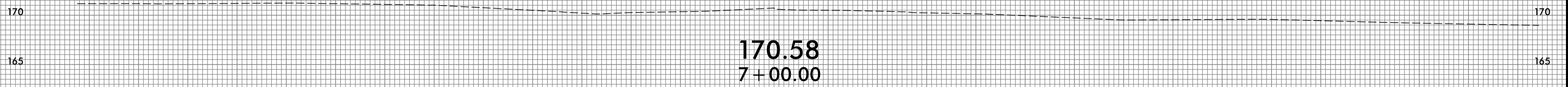
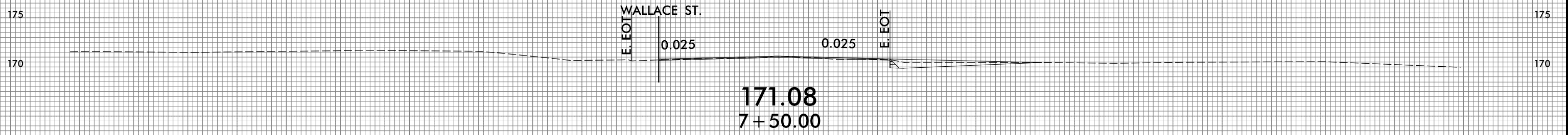
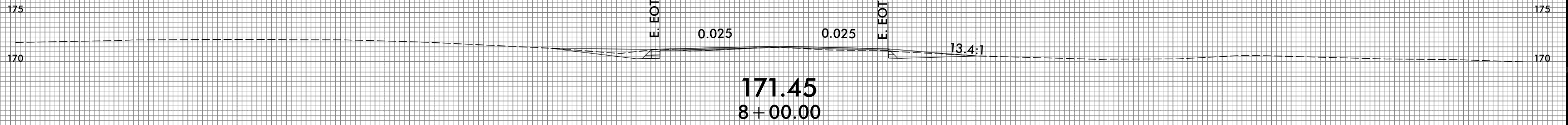

-Y-

75 70 65 60 55 50 45 40 35 30 25 20 15 10 5 0 5 10 15 20 25 30 35 40 45 50 55 60 65 70 75

75 70 65 60 55 50 45 40 35 30 25 20 15 10 5 0 5 10 15 20 25 30 35 40 45 50 55 60 65 70 75

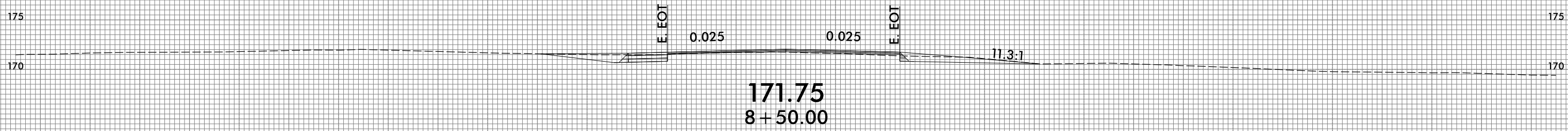
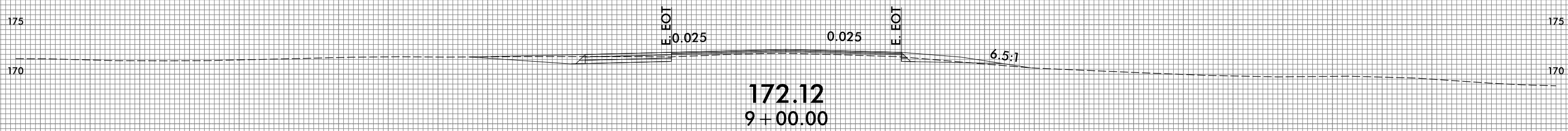
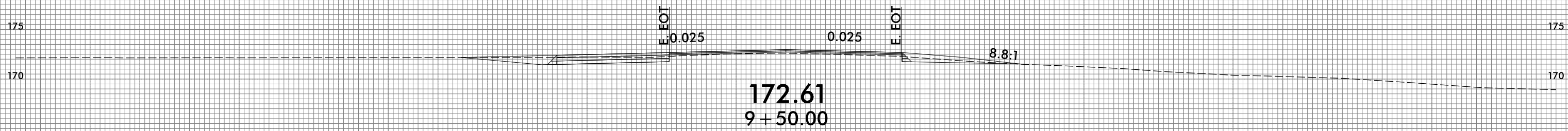
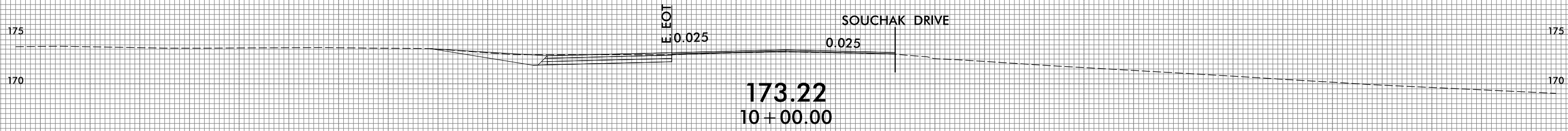

-Y-

75 70 65 60 55 50 45 40 35 30 25 20 15 10 5 0 5 10 15 20 25 30 35 40 45 50 55 60 65 70 75



75 70 65 60 55 50 45 40 35 30 25 20 15 10 5 0 5 10 15 20 25 30 35 40 45 50 55 60 65 70 75

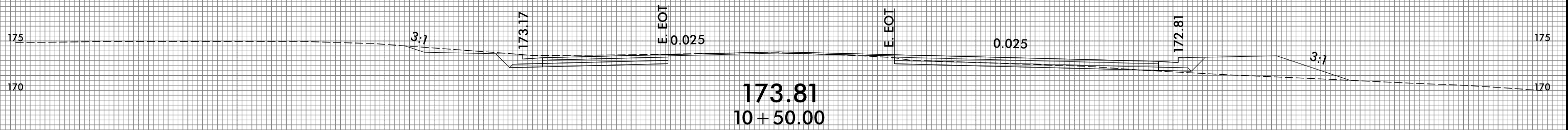
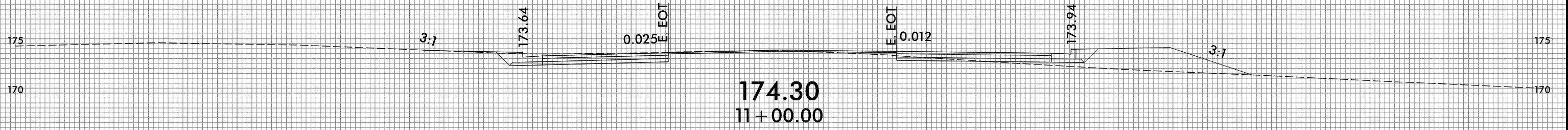
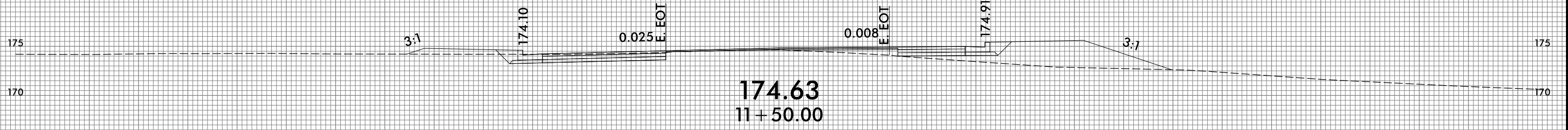
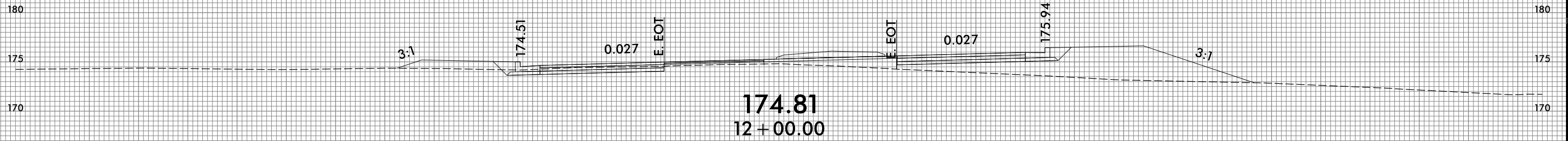

-Y-

75 70 65 60 55 50 45 40 35 30 25 20 15 10 5 0 5 10 15 20 25 30 35 40 45 50 55 60 65 70 75

75 70 65 60 55 50 45 40 35 30 25 20 15 10 5 0 5 10 15 20 25 30 35 40 45 50 55 60 65 70 75

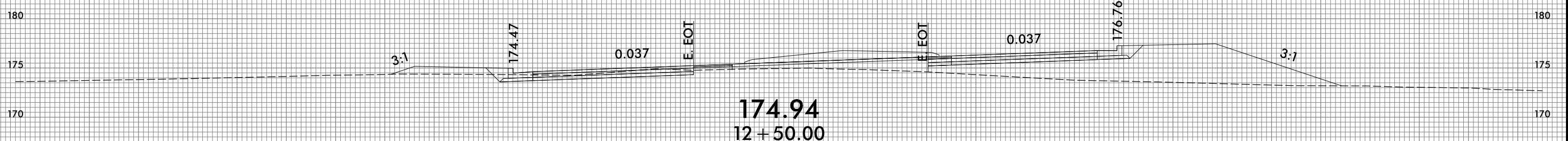
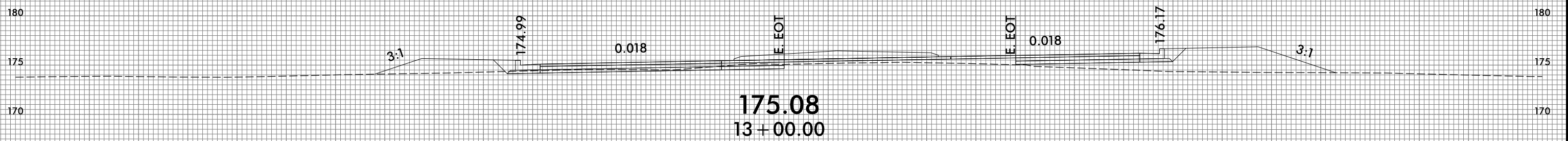
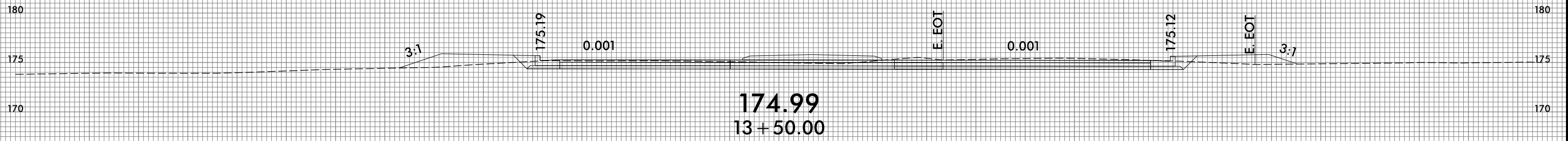
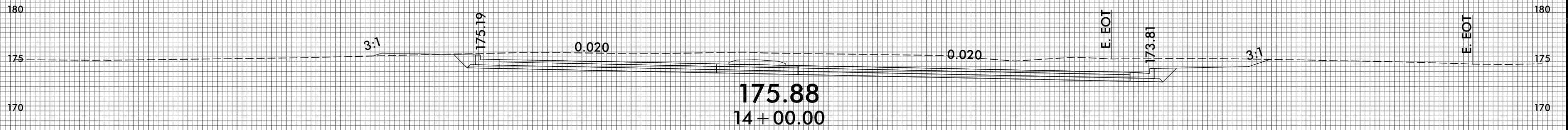

75 70 65 60 55 50 45 40 35 30 25 20 15 10 5 0 5 10 15 20 25 30 35 40 45 50 55 60 65 70 75

-Y-

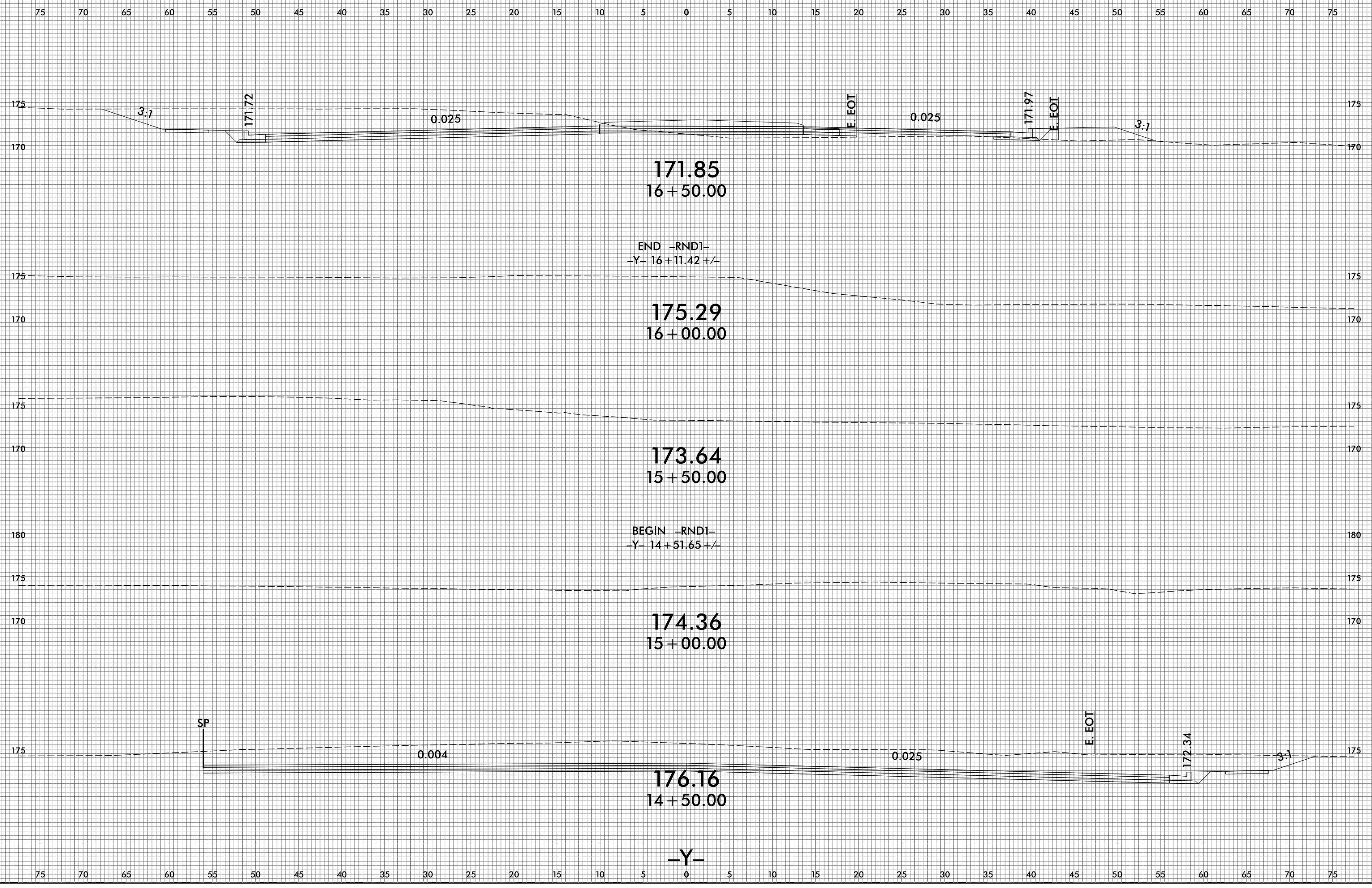



75 70 65 60 55 50 45 40 35 30 25 20 15 10 5 0 5 10 15 20 25 30 35 40 45 50 55 60 65 70 75

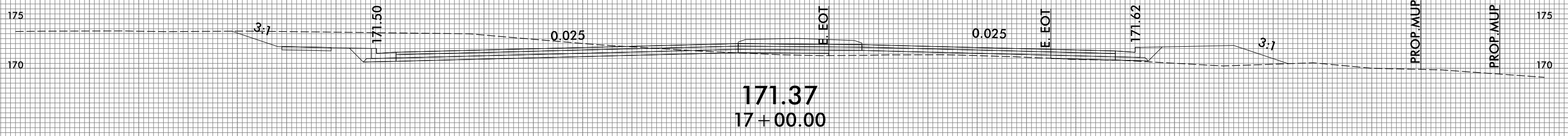
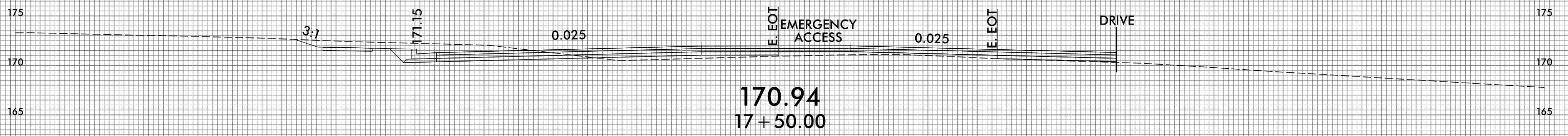
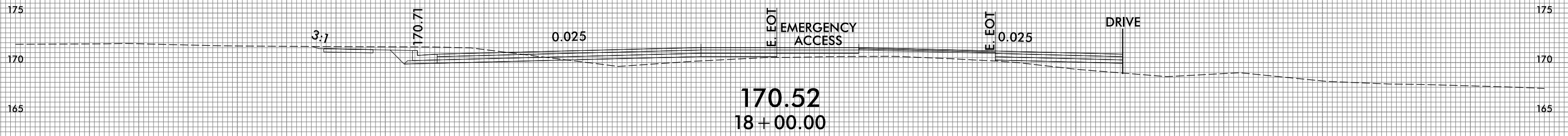
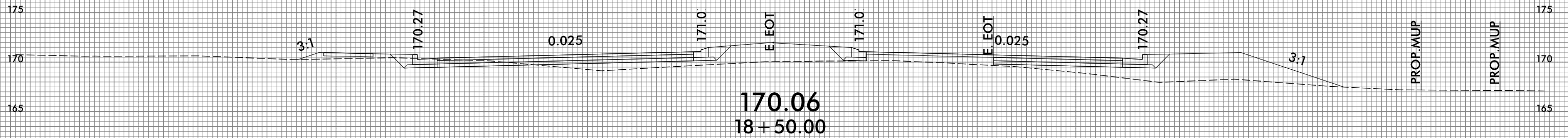

-Y-

75 70 65 60 55 50 45 40 35 30 25 20 15 10 5 0 5 10 15 20 25 30 35 40 45 50 55 60 65 70 75

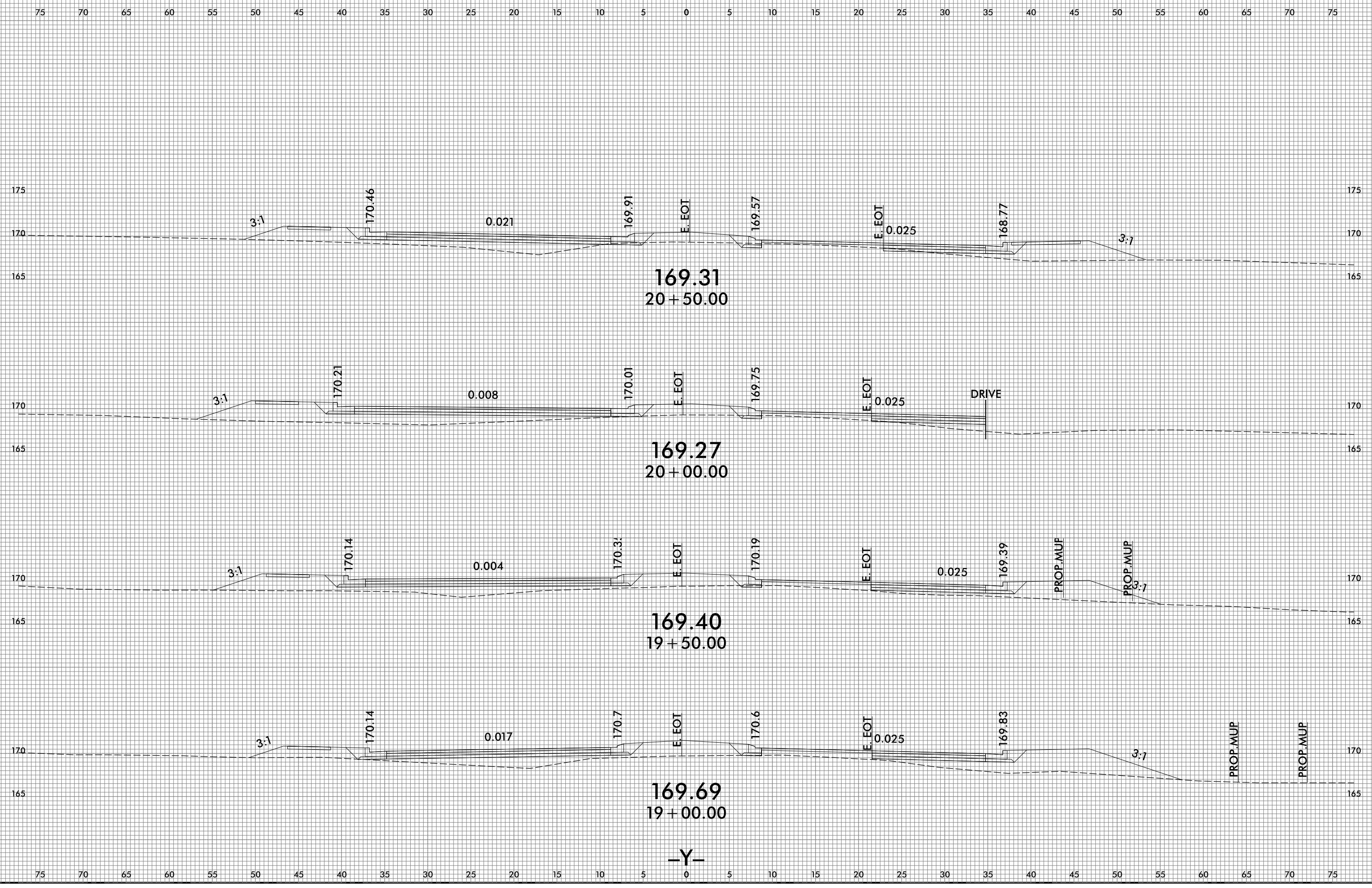

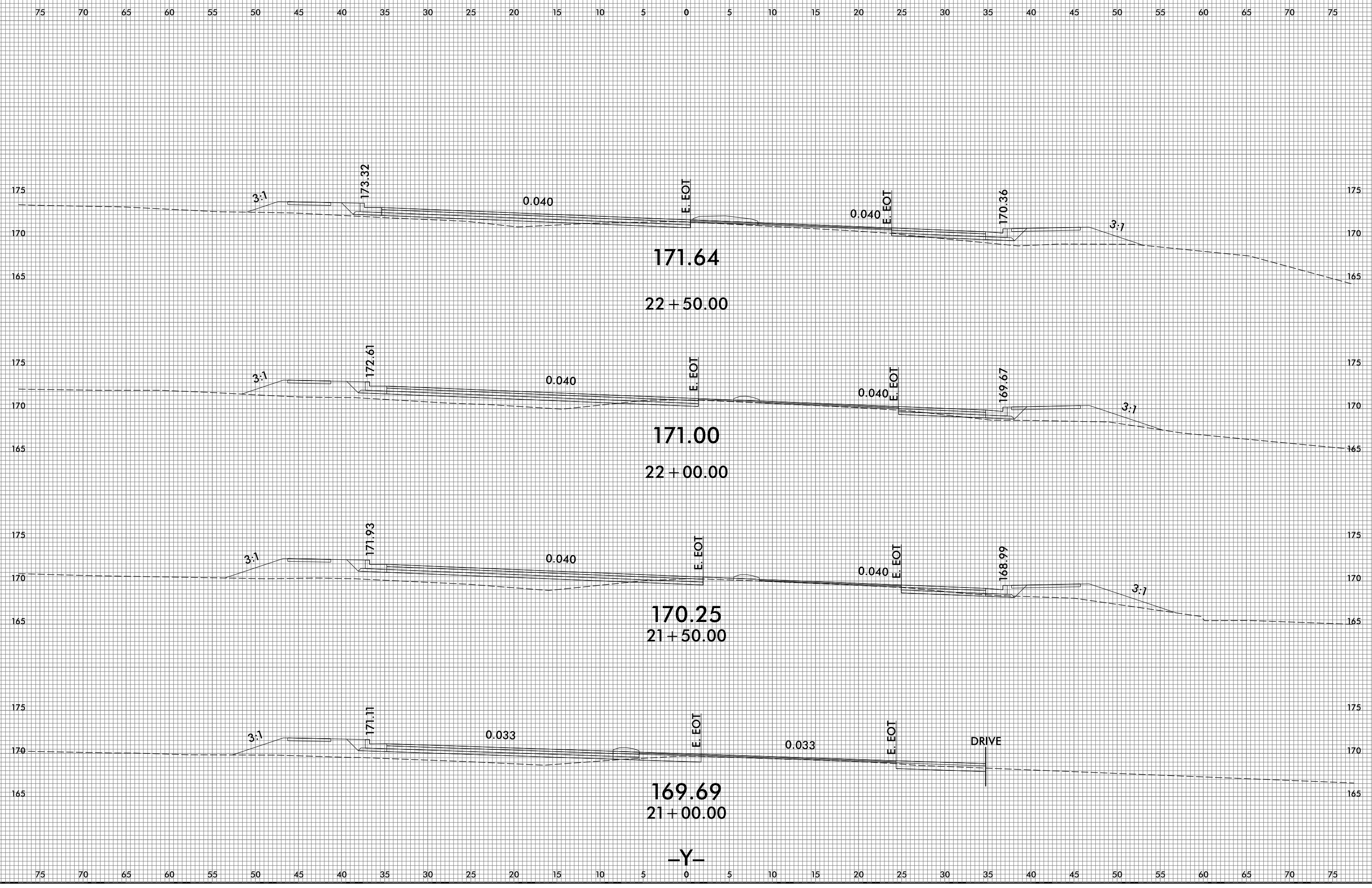

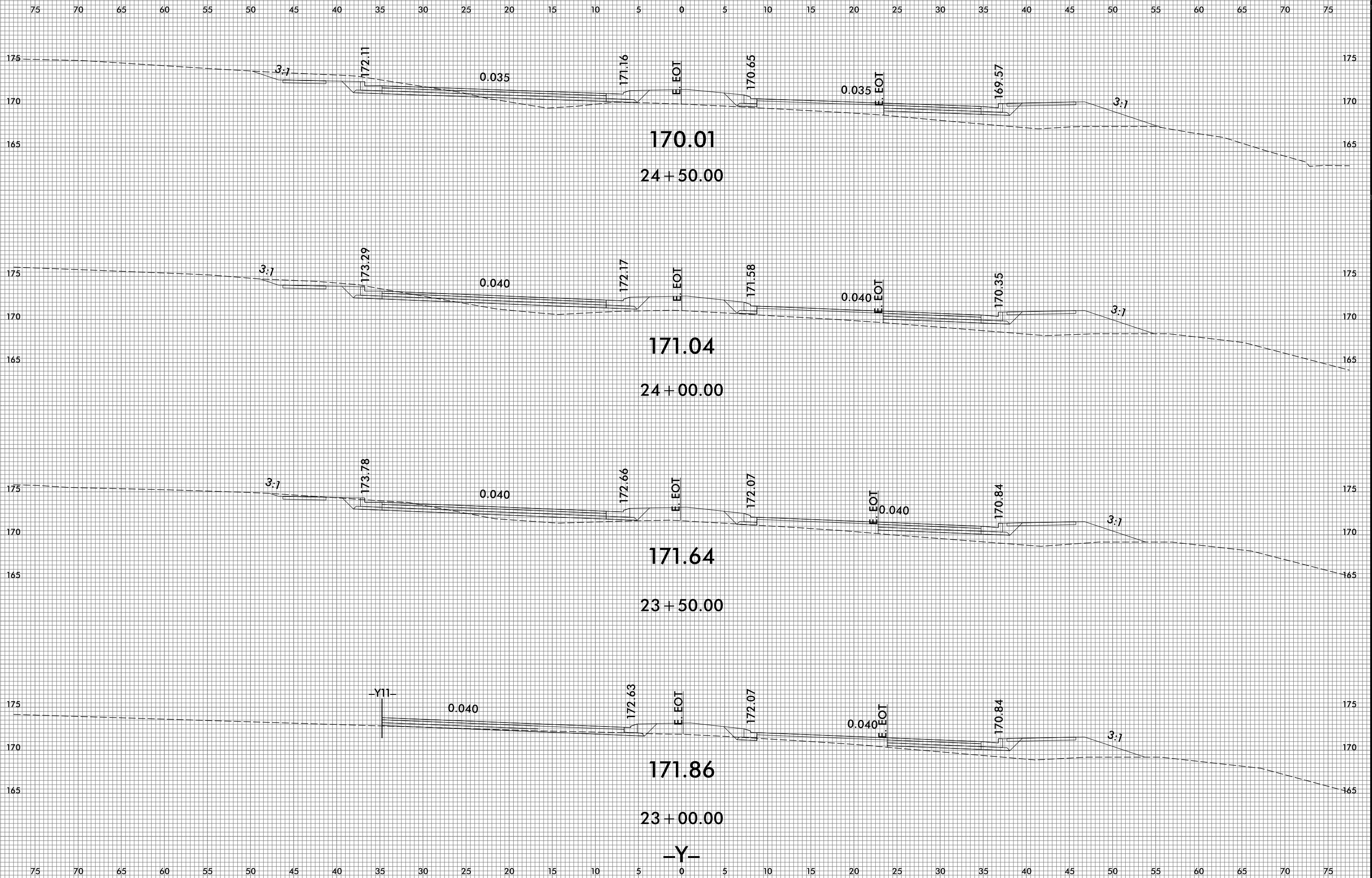



75 70 65 60 55 50 45 40 35 30 25 20 15 10 5 0 5 10 15 20 25 30 35 40 45 50 55 60 65 70 75

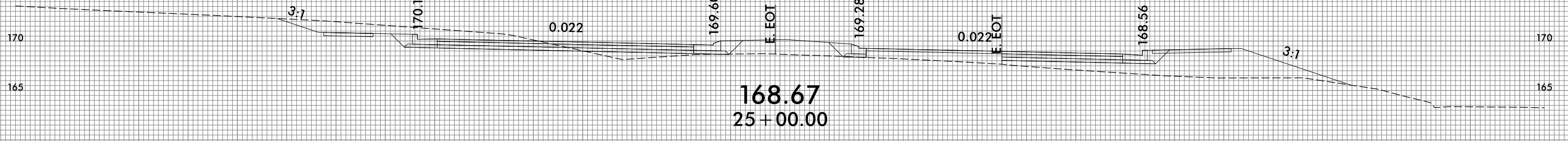
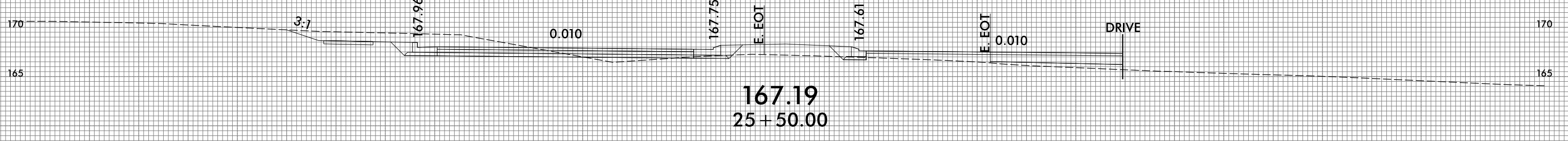
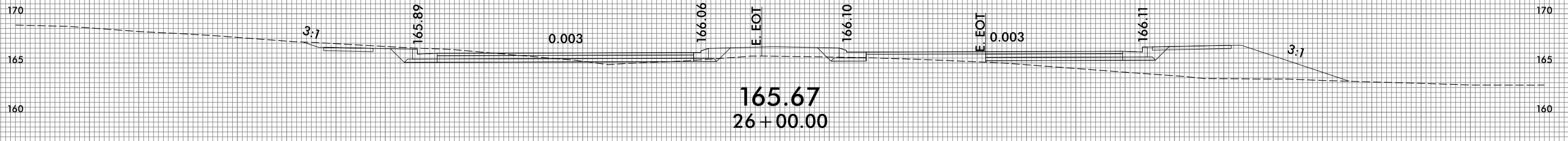
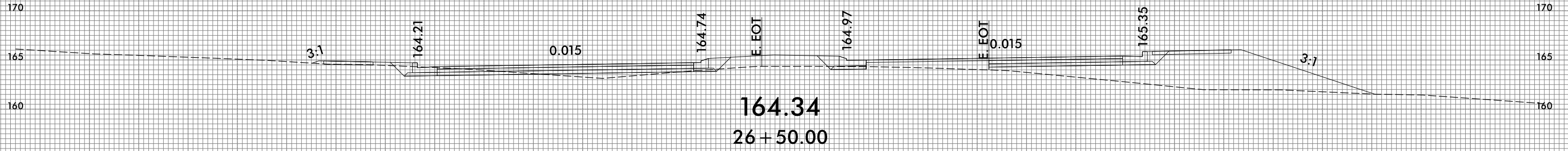

-Y-

75 70 65 60 55 50 45 40 35 30 25 20 15 10 5 0 5 10 15 20 25 30 35 40 45 50 55 60 65 70 75

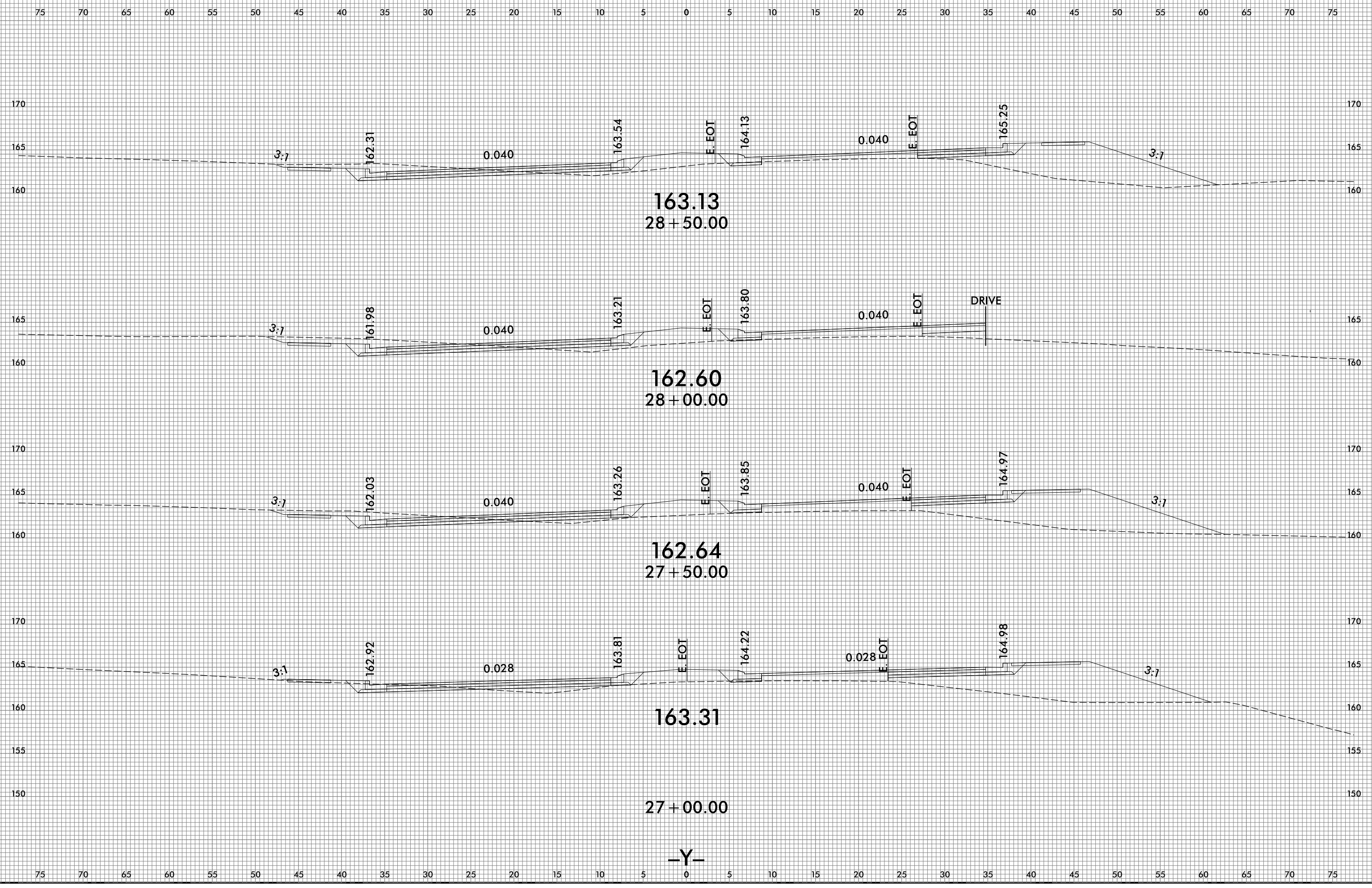

-Y-

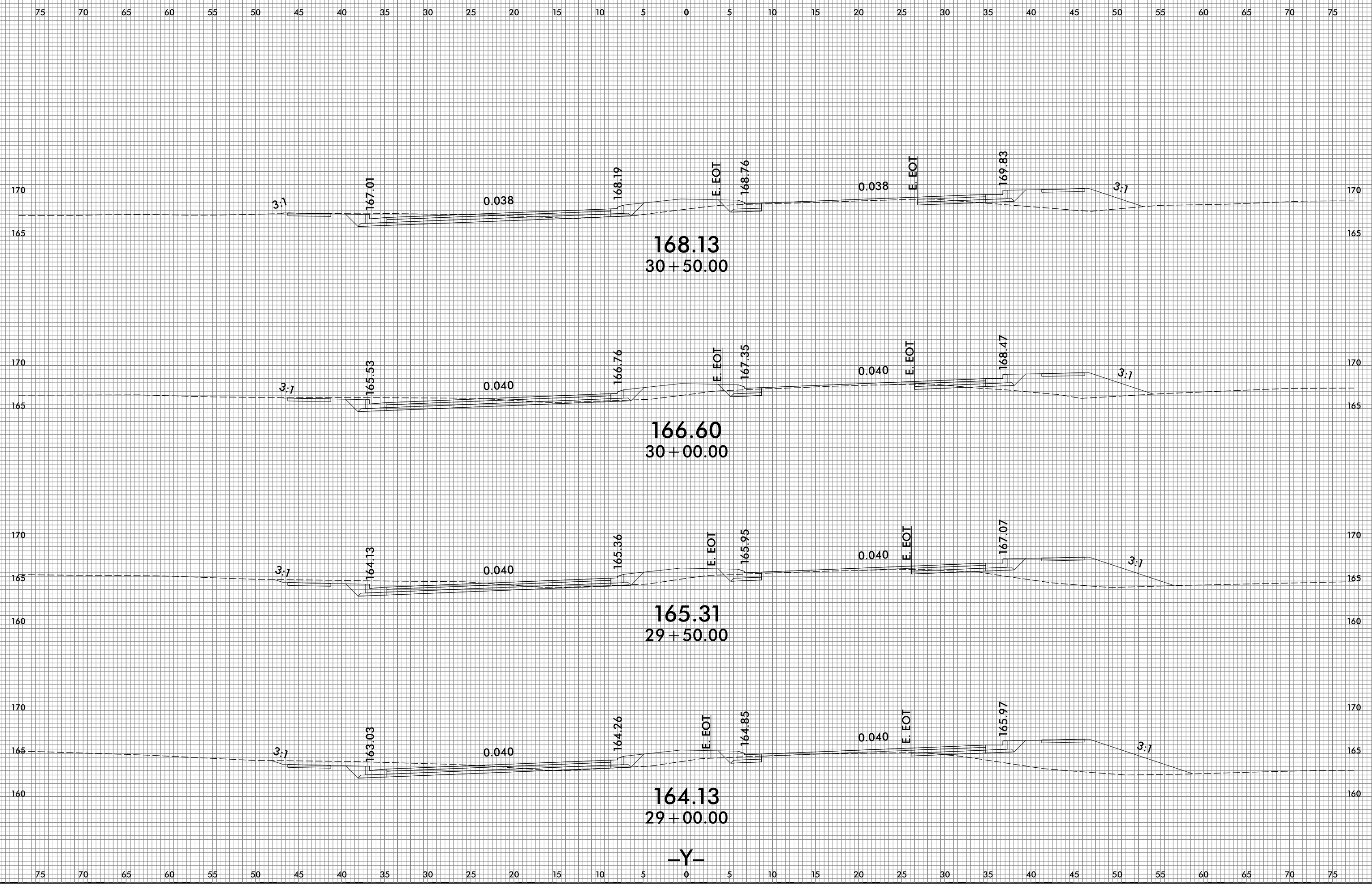

-Y-

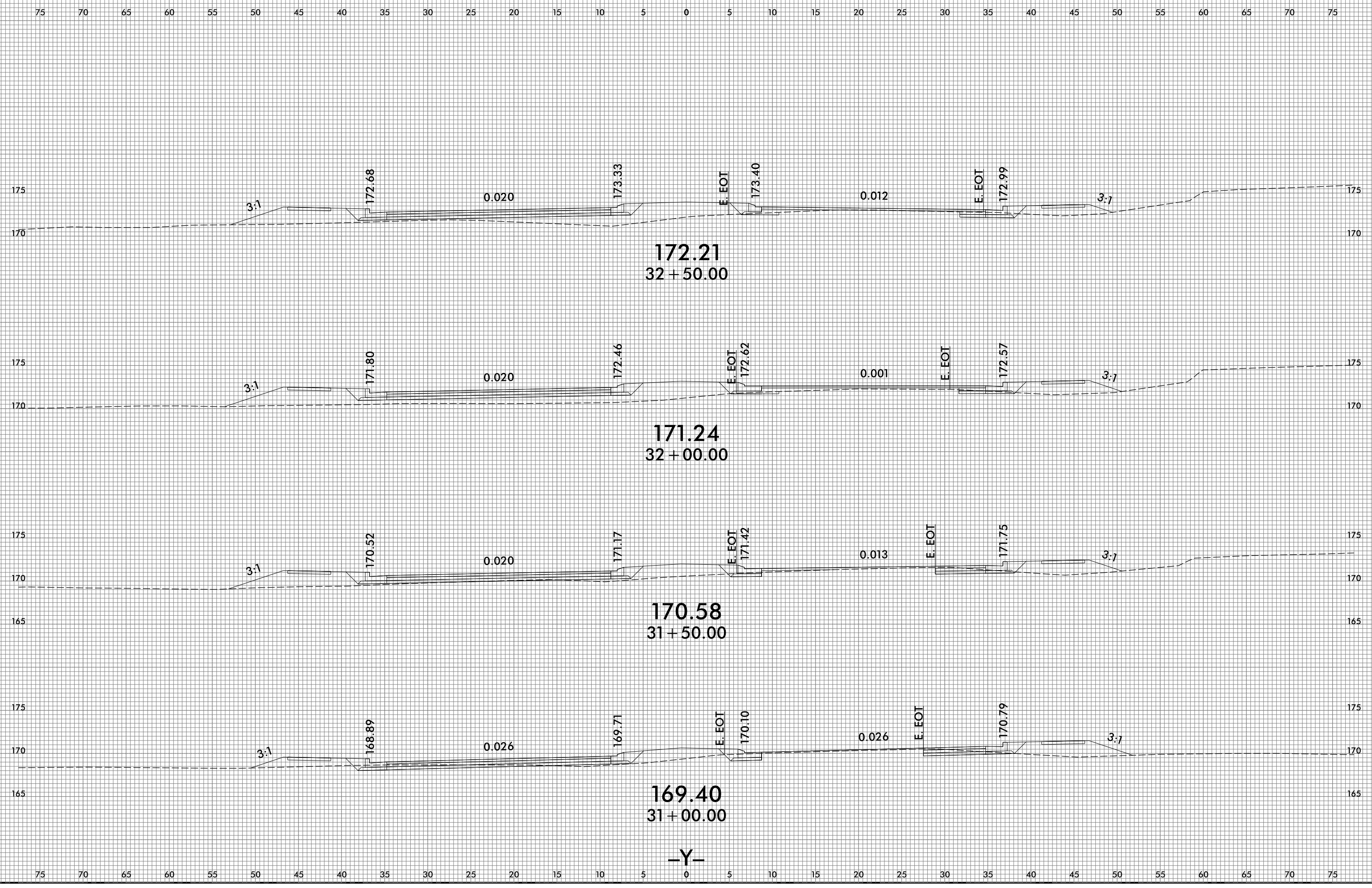

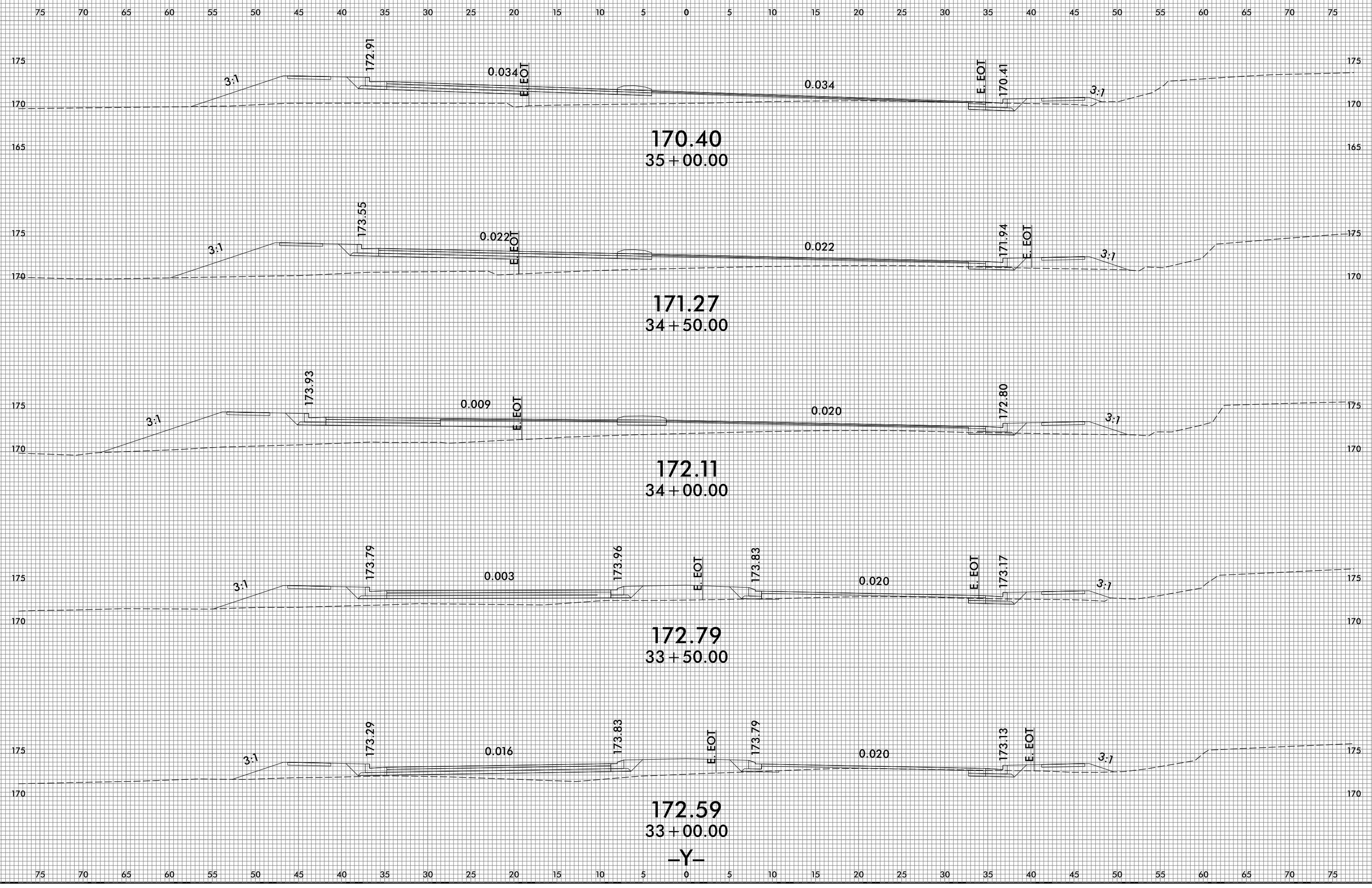

-Y-

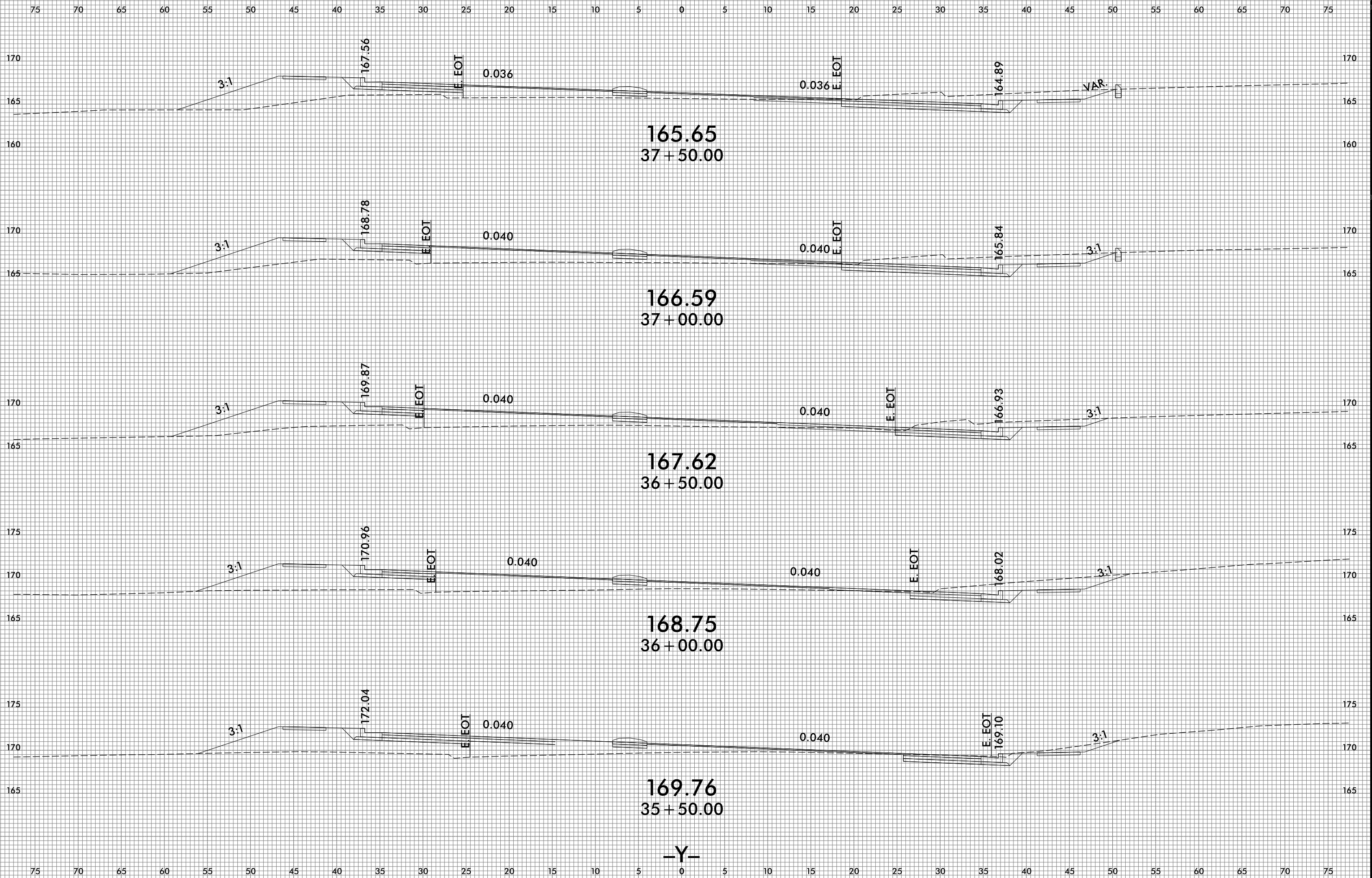

-Y-

75 70 65 60 55 50 45 40 35 30 25 20 15 10 5 0 5 10 15 20 25 30 35 40 45 50 55 60 65 70 75

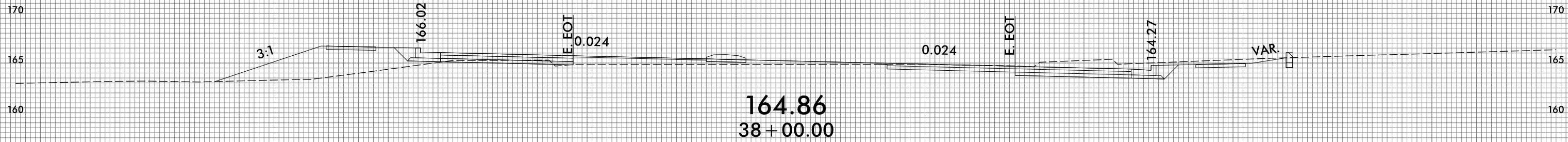
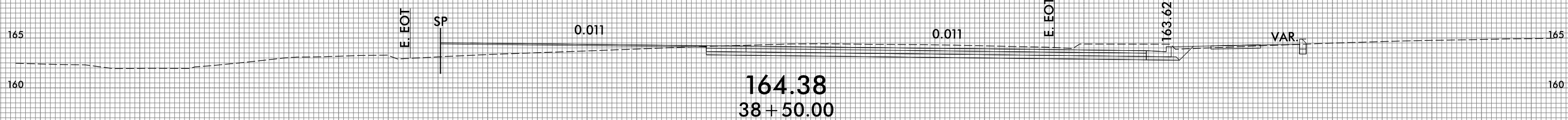
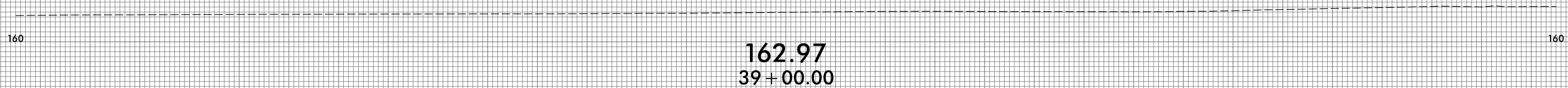
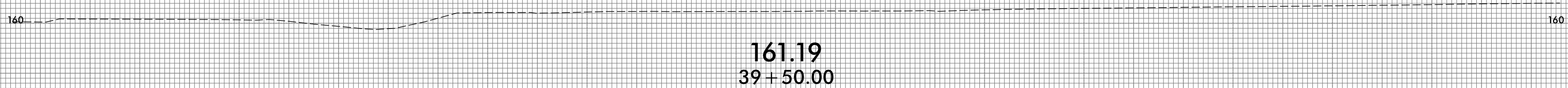
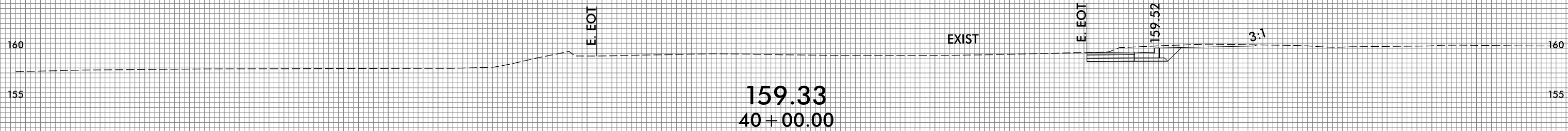

-Y-

75 70 65 60 55 50 45 40 35 30 25 20 15 10 5 0 5 10 15 20 25 30 35 40 45 50 55 60 65 70 75

75 70 65 60 55 50 45 40 35 30 25 20 15 10 5 0 5 10 15 20 25 30 35 40 45 50 55 60 65 70 75

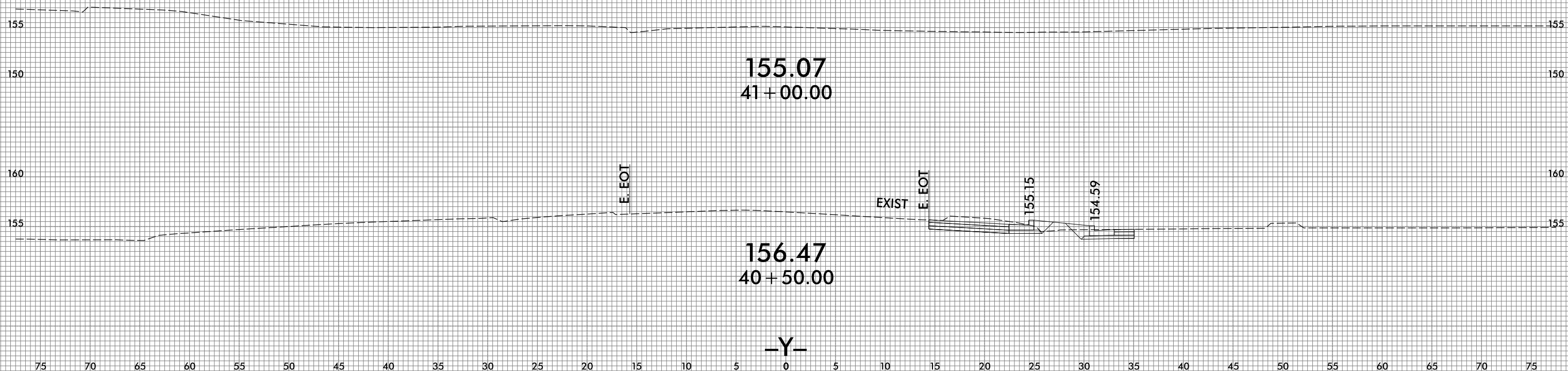

75 70 65 60 55 50 45 40 35 30 25 20 15 10 5 0 5 10 15 20 25 30 35 40 45 50 55 60 65 70 75

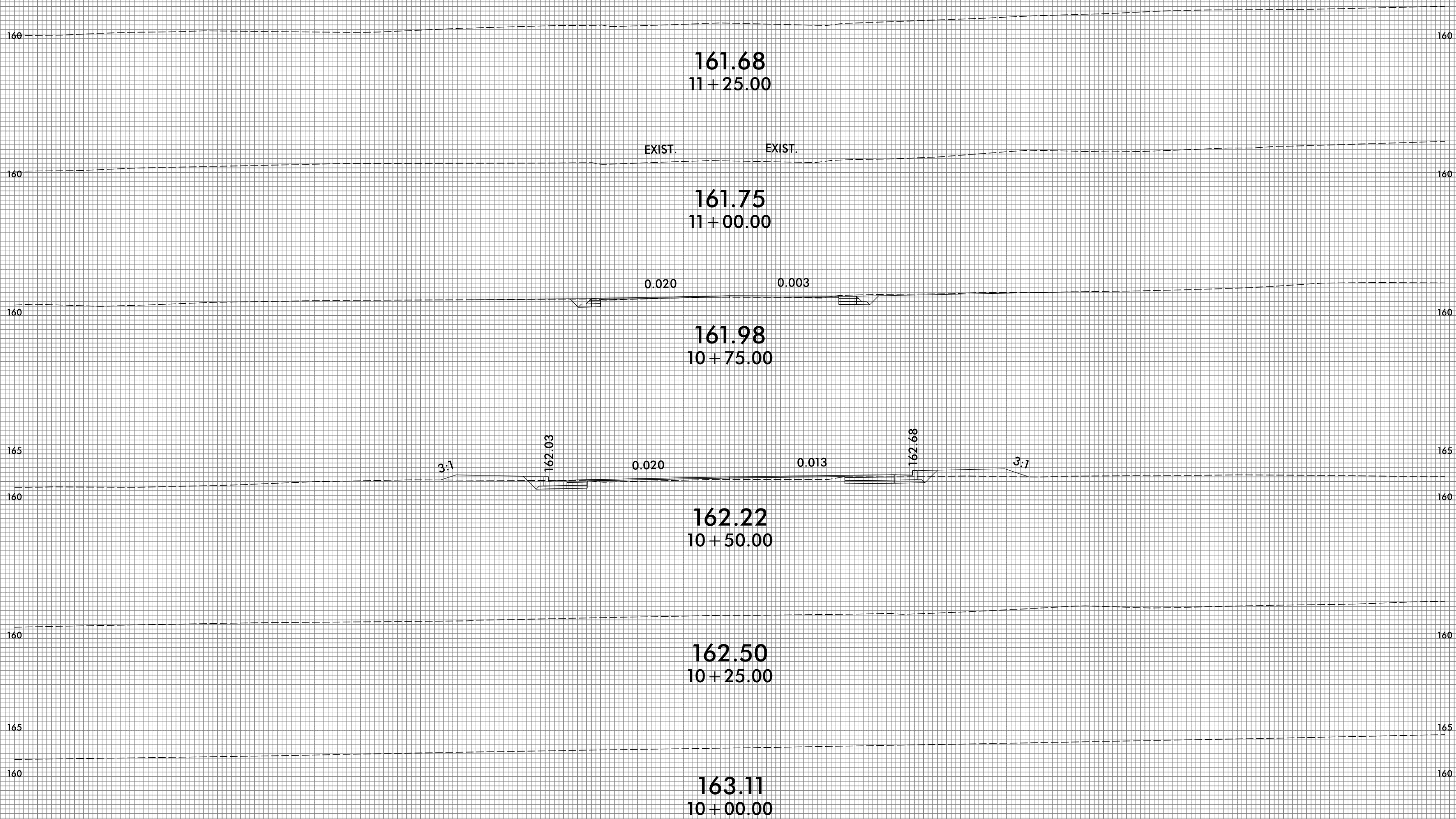

75 70 65 60 55 50 45 40 35 30 25 20 15 10 5 0 5 10 15 20 25 30 35 40 45 50 55 60 65 70 75

75 70 65 60 55 50 45 40 35 30 25 20 15 10 5 0 5 10 15 20 25 30 35 40 45 50 55 60 65 70 75

160 160

161.24
12 + 75.00

160 160

161.26
12 + 50.00

160 160

161.32
12 + 25.00

160 160

161.40
12 + 00.00

160 160

161.55
11 + 75.00

160 160

161.68
11 + 50.00

-Y1-

75 70 65 60 55 50 45 40 35 30 25 20 15 10 5 0 5 10 15 20 25 30 35 40 45 50 55 60 65 70 75

75 70 65 60 55 50 45 40 35 30 25 20 15 10 5 0 5 10 15 20 25 30 35 40 45 50 55 60 65 70 75

160 160

155 155

160 160

155 155

160 160

160 160

160 160

160 160

160.80
14 + 25.00

160.89
14 + 00.00

161.06
13 + 75.00

161.11
13 + 50.00

161.17
13 + 25.00

161.23
13 + 00.00

-Y1-

75 70 65 60 55 50 45 40 35 30 25 20 15 10 5 0 5 10 15 20 25 30 35 40 45 50 55 60 65 70 75

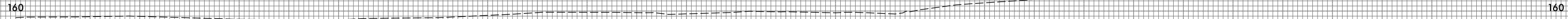

75 70 65 60 55 50 45 40 35 30 25 20 15 10 5 0 5 10 15 20 25 30 35 40 45 50 55 60 65 70 75

159.93
15 + 75.00

160.13
15 + 50.00

160.31
15 + 25.00

160.48
15 + 00.00

160.59
14 + 75.00

160.69
14 + 50.00

-Y1-

75 70 65 60 55 50 45 40 35 30 25 20 15 10 5 0 5 10 15 20 25 30 35 40 45 50 55 60 65 70 75

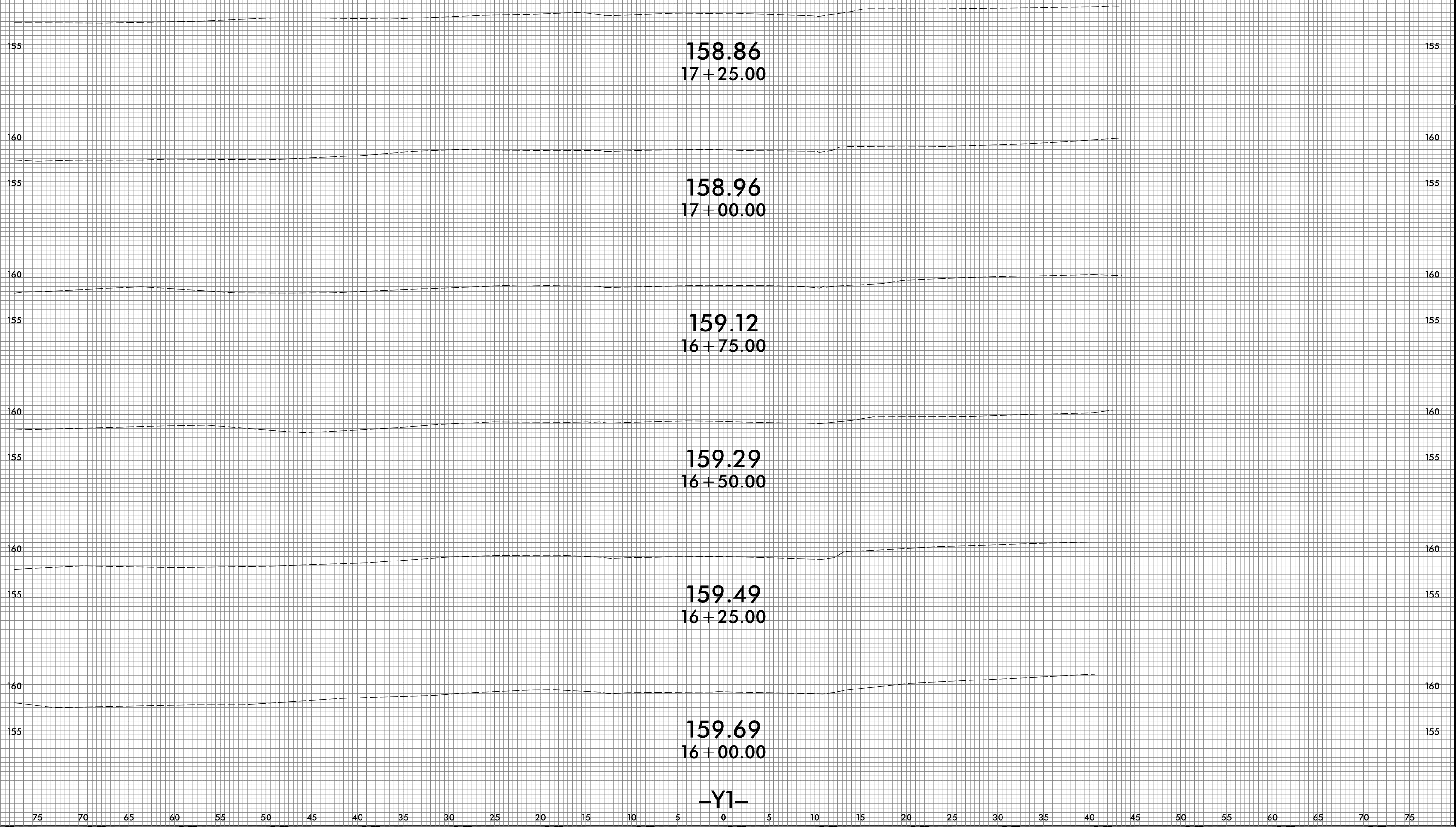



75 70 65 60 55 50 45 40 35 30 25 20 15 10 5 0 5 10 15 20 25 30 35 40 45 50 55 60 65 70 75



158.48
18 + 75.00



158.66
18 + 50.00



158.70
18 + 25.00

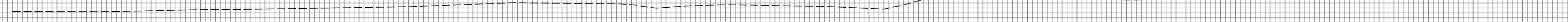

158.73
18 + 00.00



158.80
17 + 75.00



158.85
17 + 50.00

-Y1-

75 70 65 60 55 50 45 40 35 30 25 20 15 10 5 0 5 10 15 20 25 30 35 40 45 50 55 60 65 70 75

75 70 65 60 55 50 45 40 35 30 25 20 15 10 5 0 5 10 15 20 25 30 35 40 45 50 55 60 65 70 75



-Y1-

75 70 65 60 55 50 45 40 35 30 25 20 15 10 5 0 5 10 15 20 25 30 35 40 45 50 55 60 65 70 75

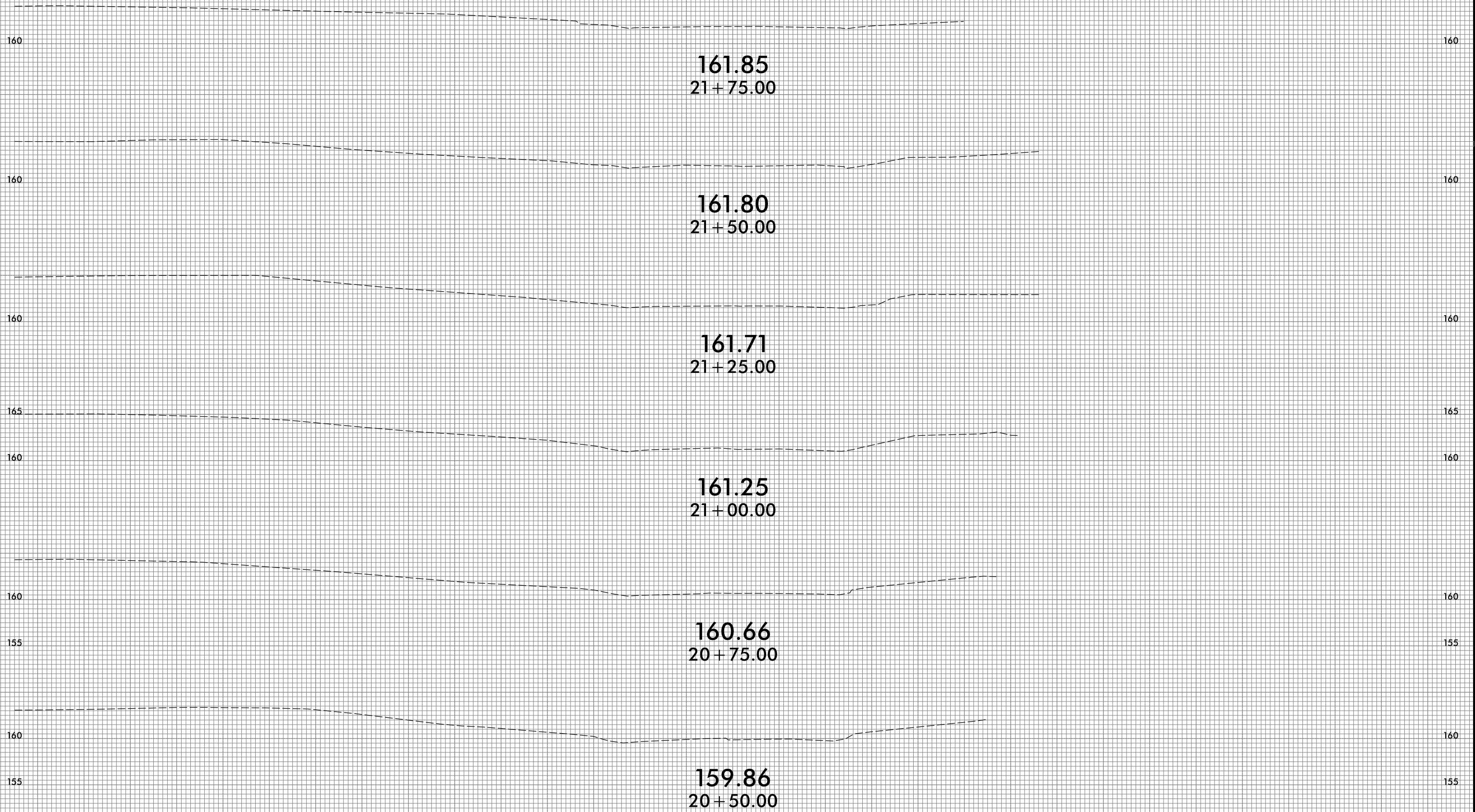

75 70 65 60 55 50 45 40 35 30 25 20 15 10 5 0 5 10 15 20 25 30 35 40 45 50 55 60 65 70 75

-Y1-

75 70 65 60 55 50 45 40 35 30 25 20 15 10 5 0 5 10 15 20 25 30 35 40 45 50 55 60 65 70 75



160

160

155

155

160.45
23 + 25.00

160

160

155

155

160.87
23 + 00.00

160

160

161.30
22 + 75.00

160

160

161.54
22 + 50.00

160

160

161.69
22 + 25.00

160

160

161.80
22 + 00.00

-Y1-

75 70 65 60 55 50 45 40 35 30 25 20 15 10 5 0 5 10 15 20 25 30 35 40 45 50 55 60 65 70 75

75 70 65 60 55 50 45 40 35 30 25 20 15 10 5 0 5 10 15 20 25 30 35 40 45 50 55 60 65 70 75

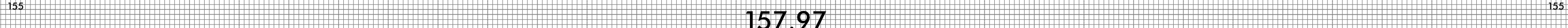

157.97
24 + 75.00



158.36
24 + 50.00

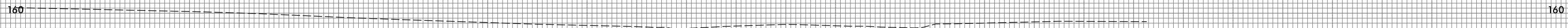

158.87
24 + 25.00

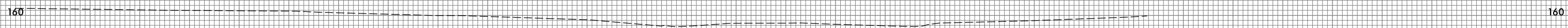

159.22
24 + 00.00



159.57
23 + 75.00

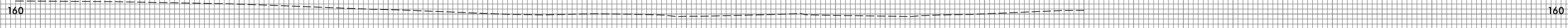

160.00
23 + 50.00

-Y1-

75 70 65 60 55 50 45 40 35 30 25 20 15 10 5 0 5 10 15 20 25 30 35 40 45 50 55 60 65 70 75

75 70 65 60 55 50 45 40 35 30 25 20 15 10 5 0 5 10 15 20 25 30 35 40 45 50 55 60 65 70 75



157.05
25+25.00



157.54
25+00.00

-Y1-

75 70 65 60 55 50 45 40 35 30 25 20 15 10 5 0 5 10 15 20 25 30 35 40 45 50 55 60 65 70 75

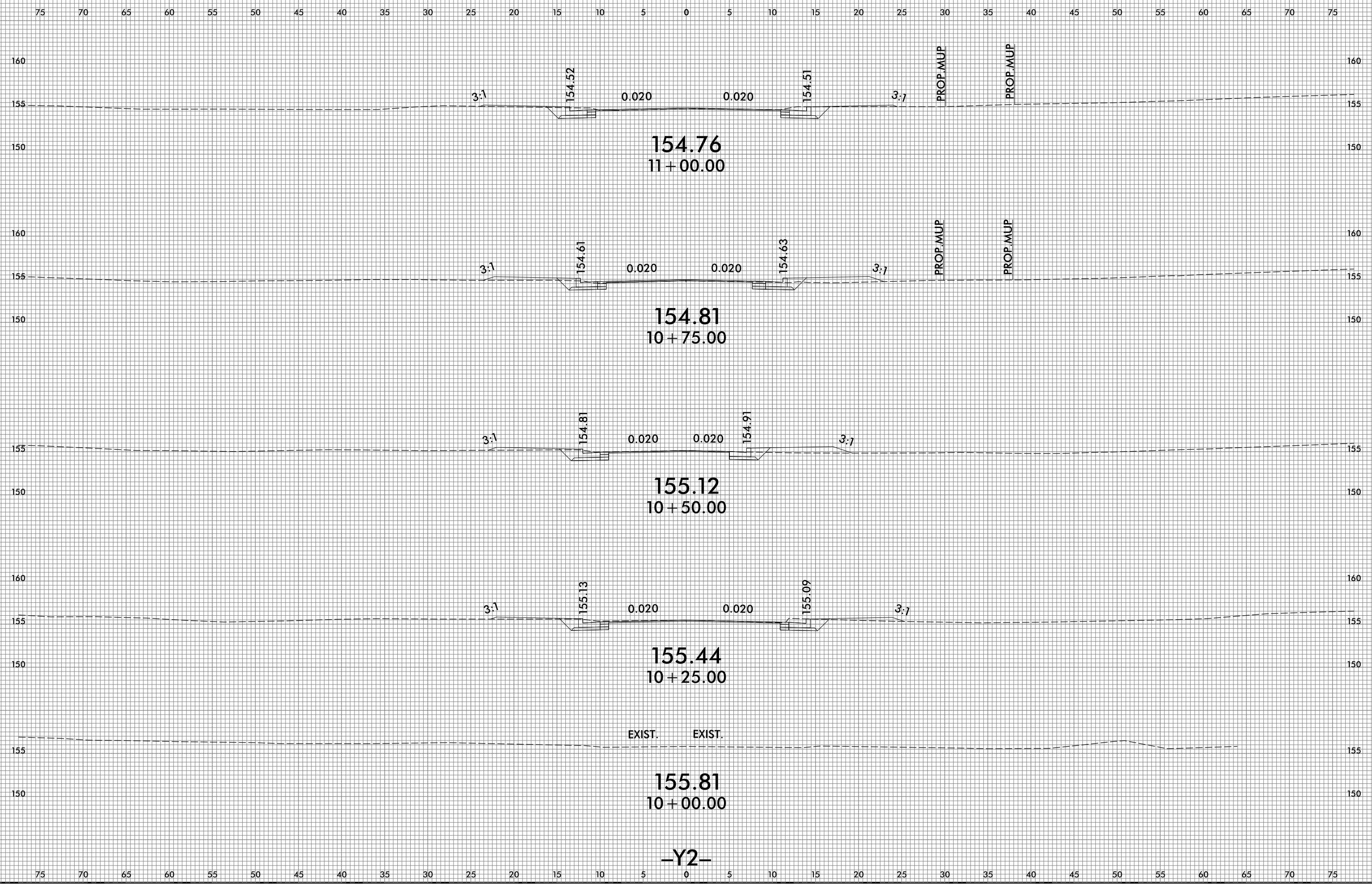

75 70 65 60 55 50 45 40 35 30 25 20 15 10 5 0 5 10 15 20 25 30 35 40 45 50 55 60 65 70 75

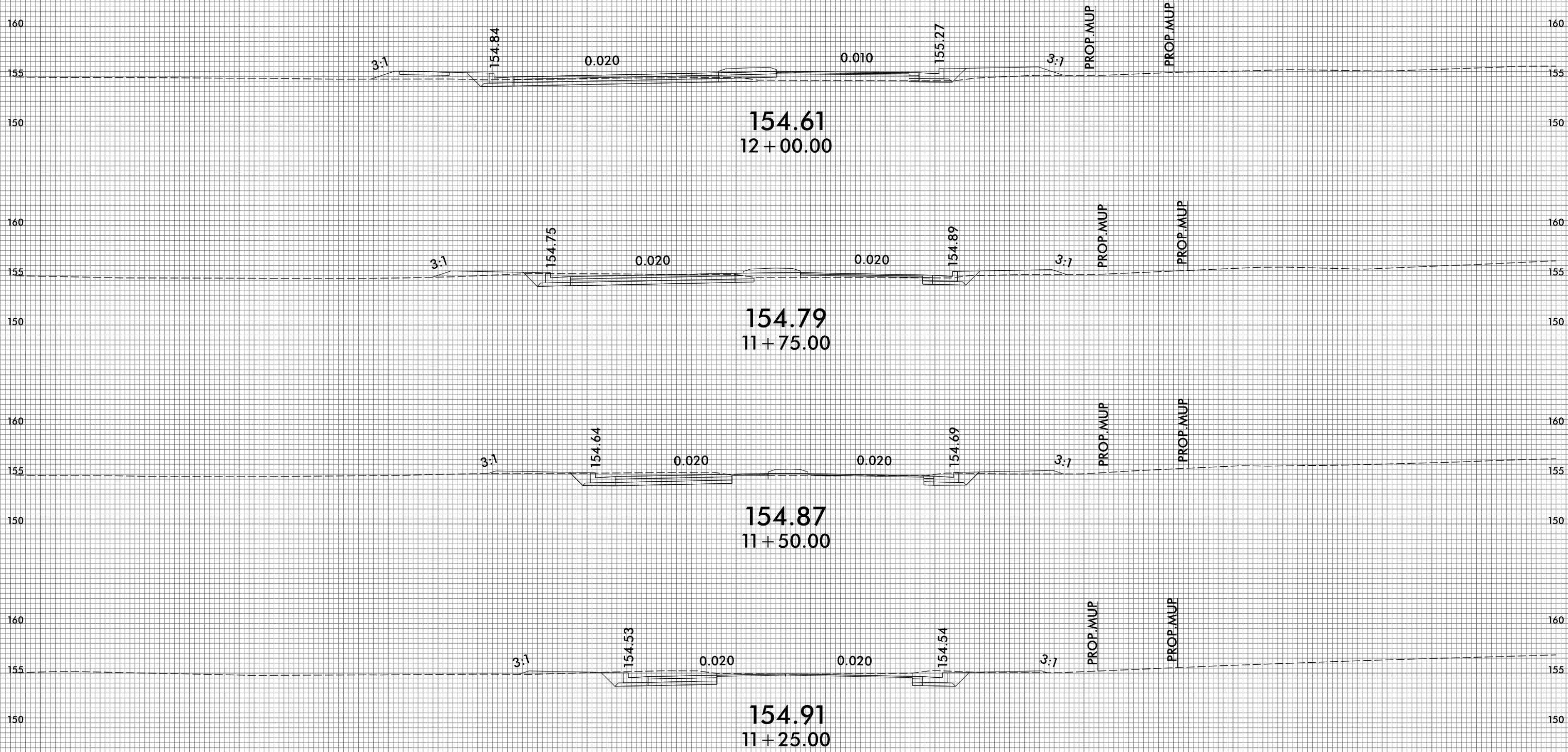

-Y2-

75 70 65 60 55 50 45 40 35 30 25 20 15 10 5 0 5 10 15 20 25 30 35 40 45 50 55 60 65 70 75

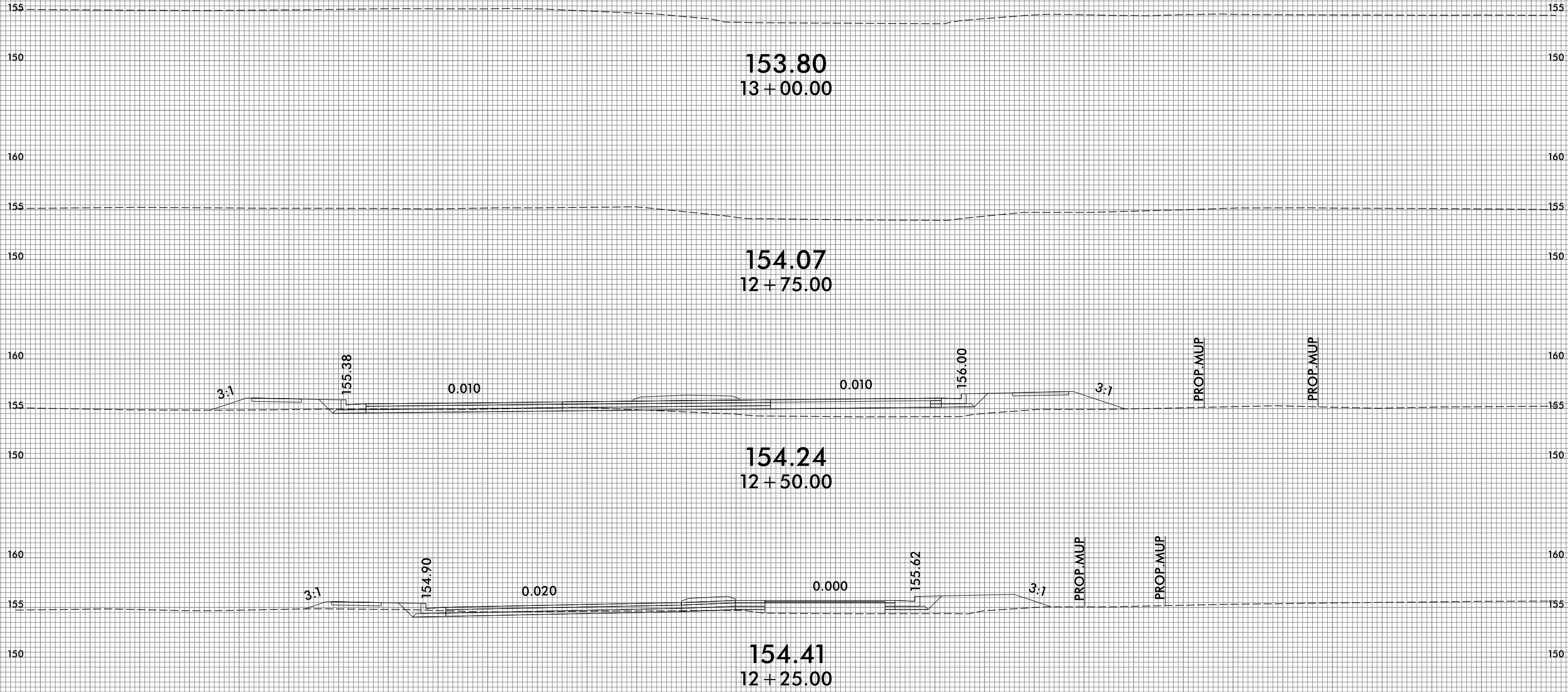

75 70 65 60 55 50 45 40 35 30 25 20 15 10 5 0 5 10 15 20 25 30 35 40 45 50 55 60 65 70 75

-Y2-

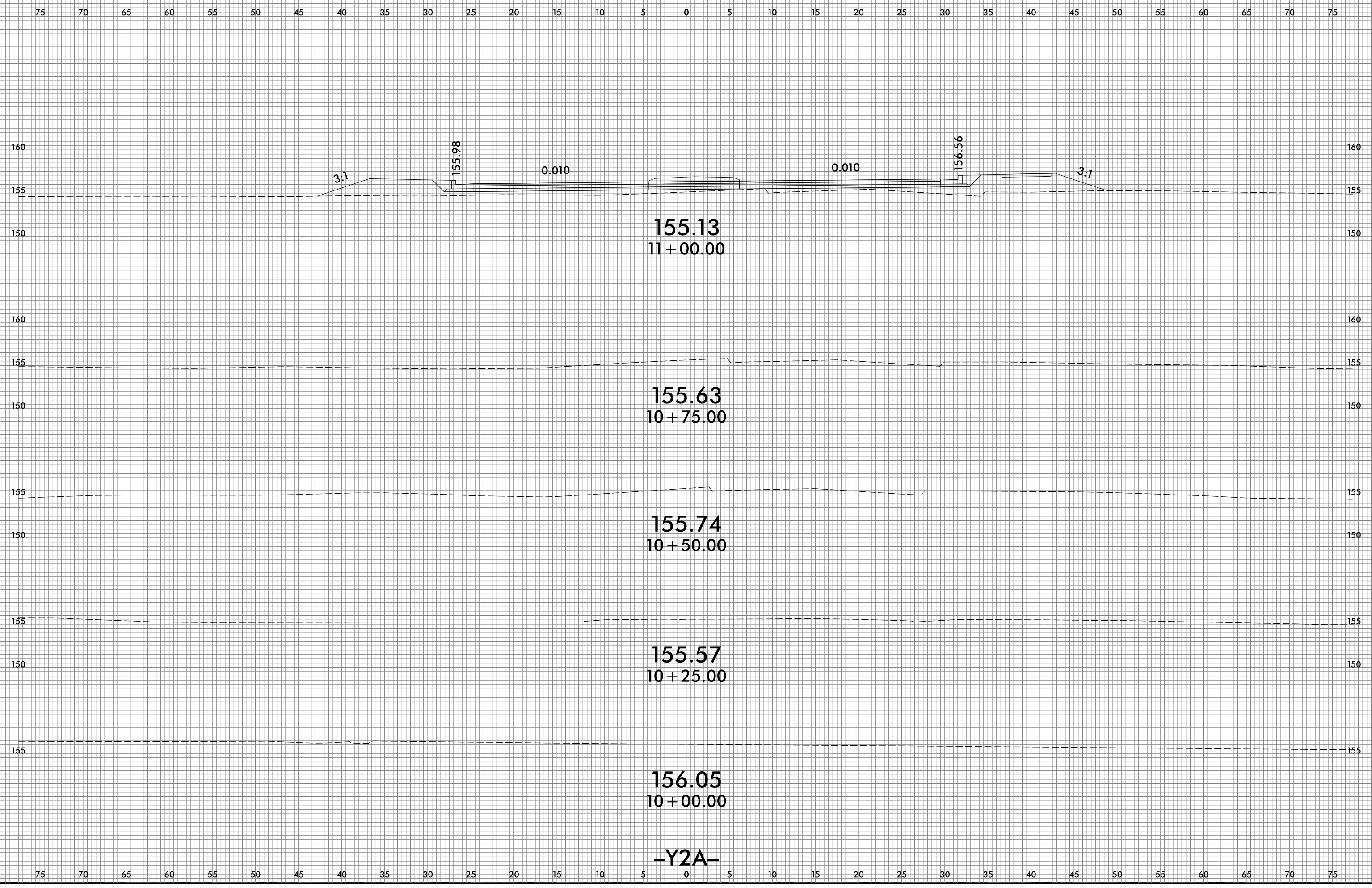

-Y2A-

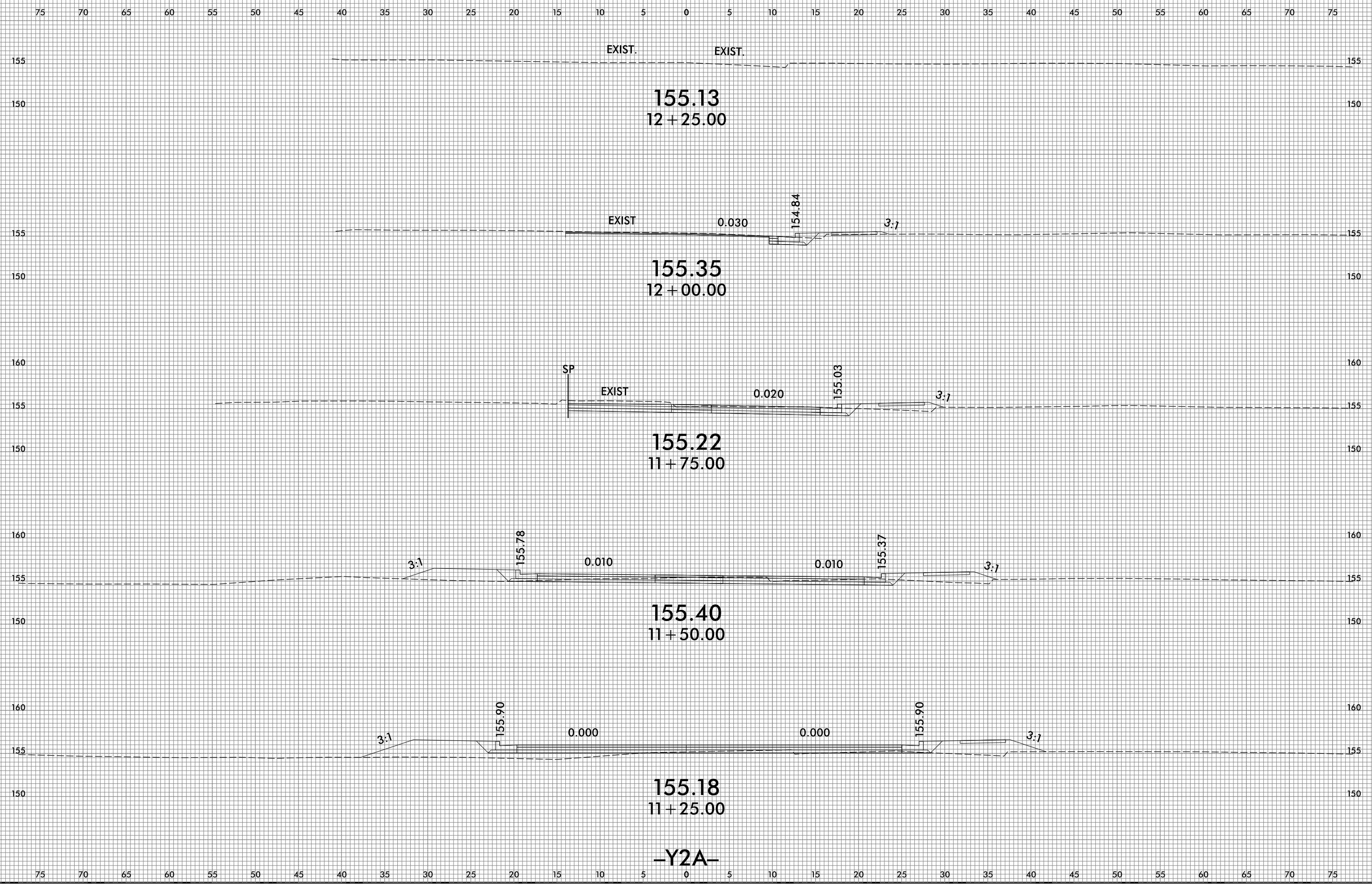

-Y2A-

75 70 65 60 55 50 45 40 35 30 25 20 15 10 5 0 5 10 15 20 25 30 35 40 45 50 55 60 65 70 75

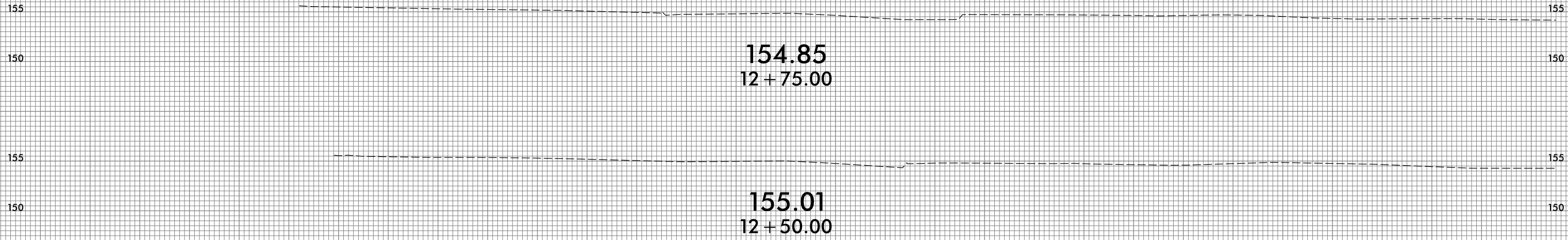

75 70 65 60 55 50 45 40 35 30 25 20 15 10 5 0 5 10 15 20 25 30 35 40 45 50 55 60 65 70 75

-Y2A-

75 70 65 60 55 50 45 40 35 30 25 20 15 10 5 0 5 10 15 20 25 30 35 40 45 50 55 60 65 70 75

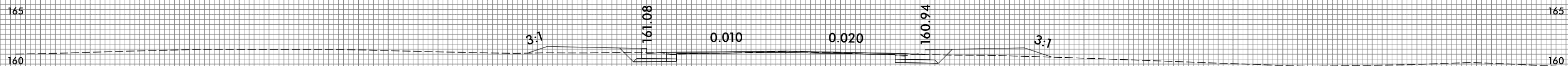

161.26
11 + 25.00

EXIST. EXIST.

161.77
11 + 00.00

162.12
10 + 75.00

162.51
10 + 50.00

163.06
10 + 25.00

163.61
10 + 00.00

-Y3-

75 70 65 60 55 50 45 40 35 30 25 20 15 10 5 0 5 10 15 20 25 30 35 40 45 50 55 60 65 70 75

75 70 65 60 55 50 45 40 35 30 25 20 15 10 5 0 5 10 15 20 25 30 35 40 45 50 55 60 65 70 75

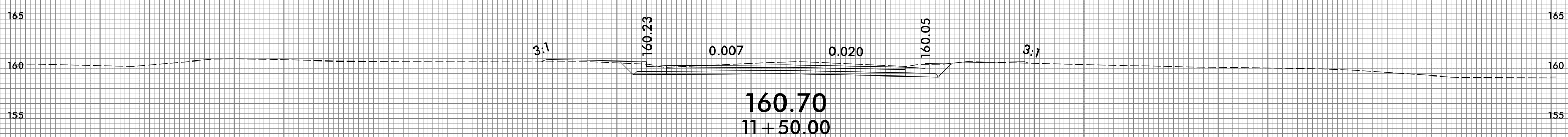
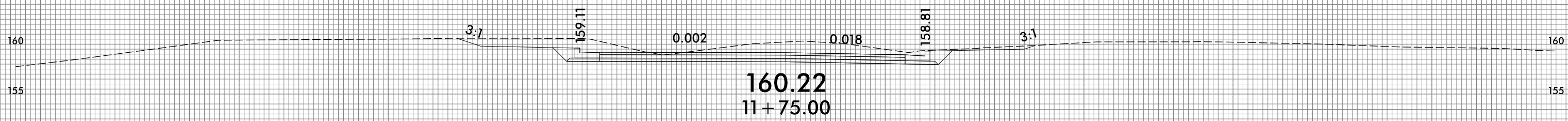
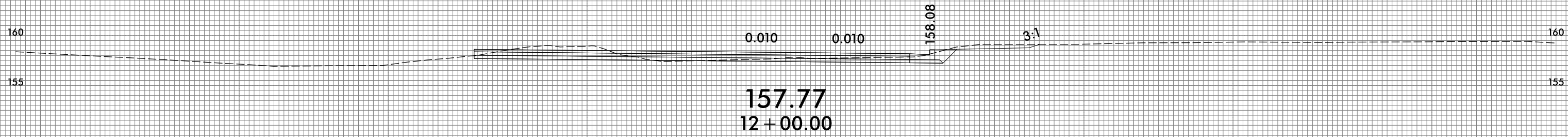
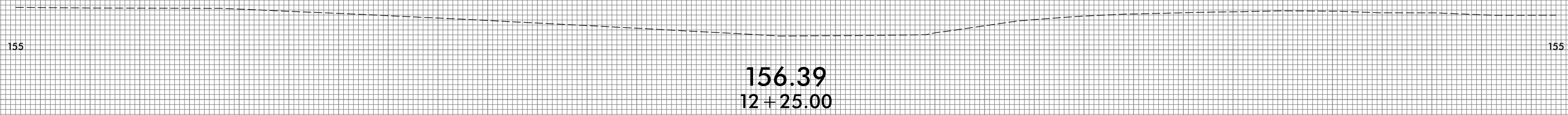
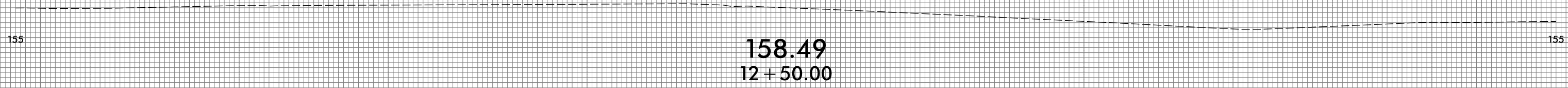

-Y3-

75 70 65 60 55 50 45 40 35 30 25 20 15 10 5 0 5 10 15 20 25 30 35 40 45 50 55 60 65 70 75

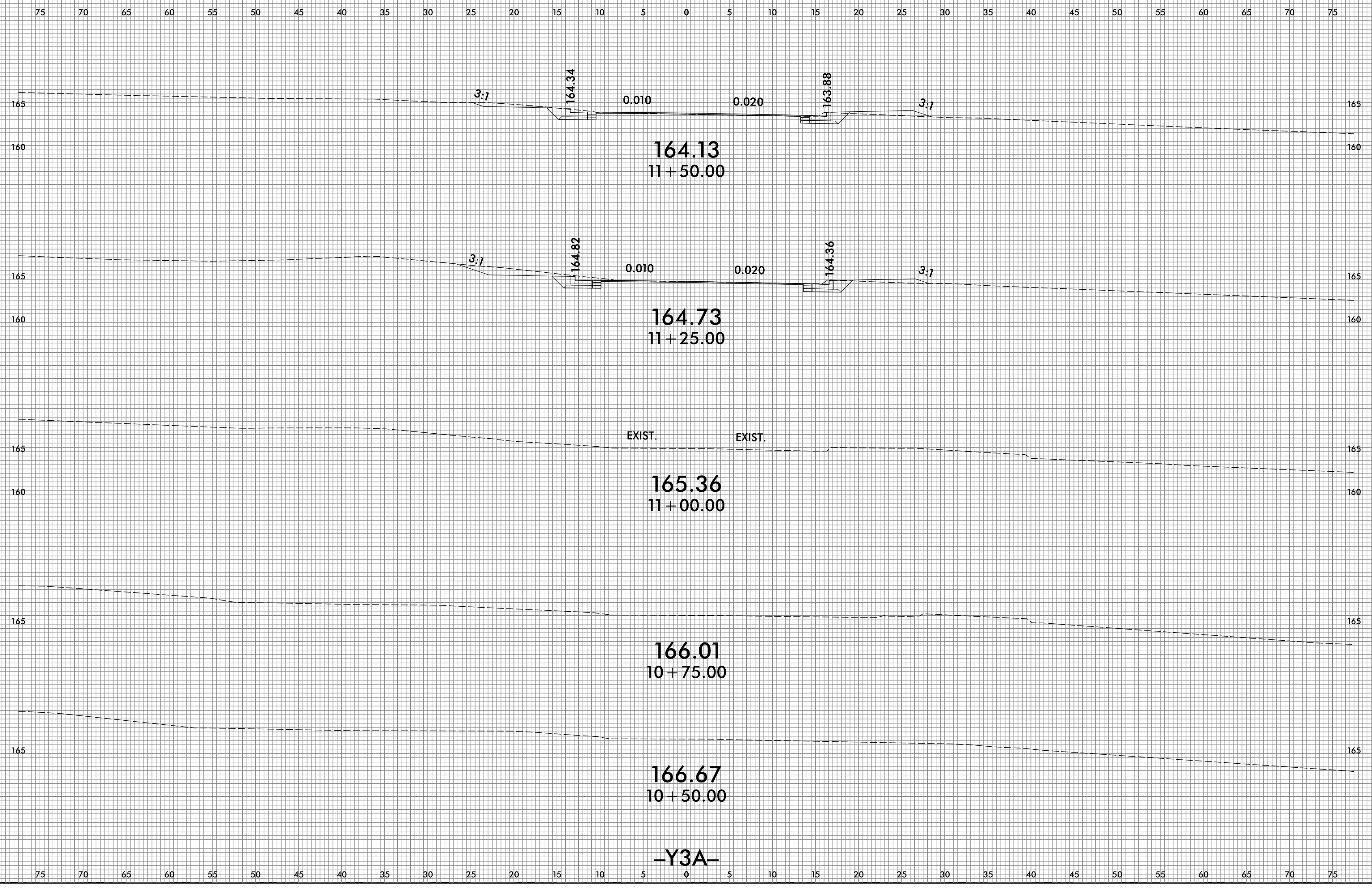

-Y3A-

75 70 65 60 55 50 45 40 35 30 25 20 15 10 5 0 5 10 15 20 25 30 35 40 45 50 55 60 65 70 75

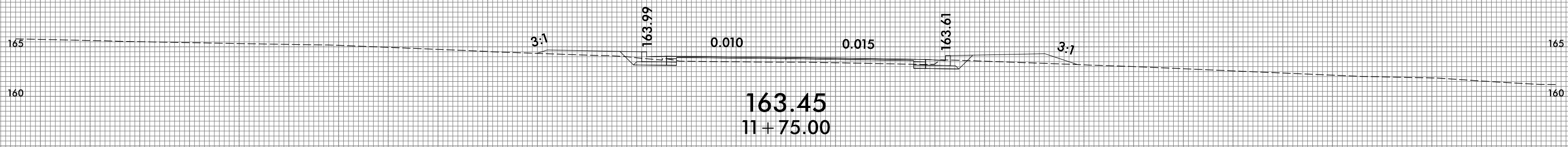
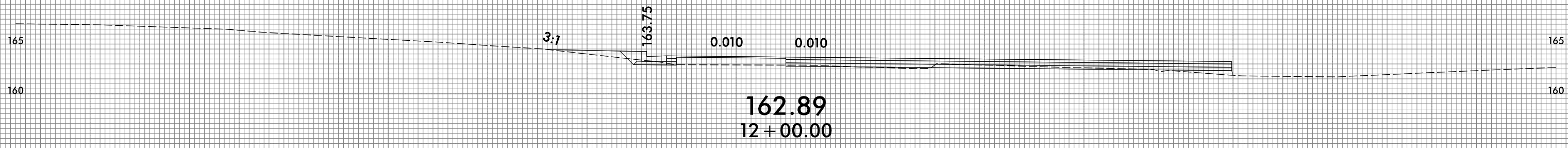
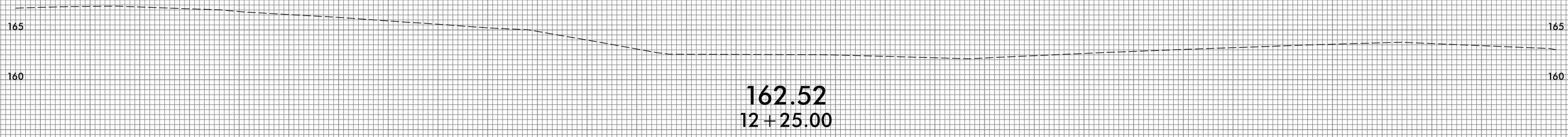
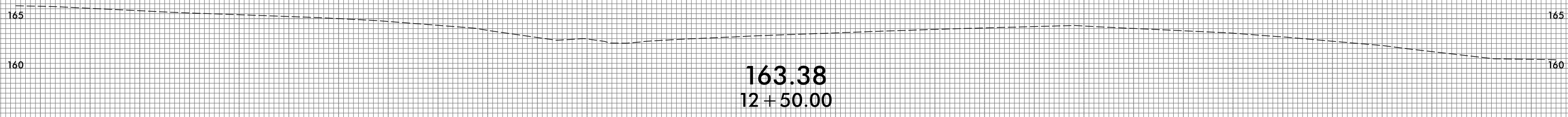

75 70 65 60 55 50 45 40 35 30 25 20 15 10 5 0 5 10 15 20 25 30 35 40 45 50 55 60 65 70 75

-Y3A-

75 70 65 60 55 50 45 40 35 30 25 20 15 10 5 0 5 10 15 20 25 30 35 40 45 50 55 60 65 70 75

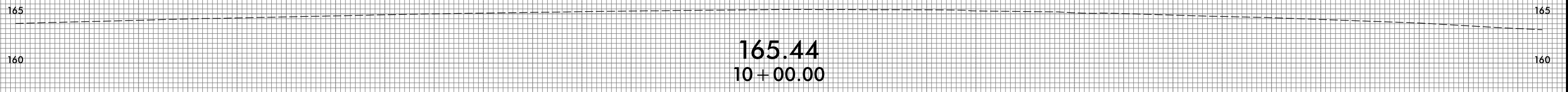
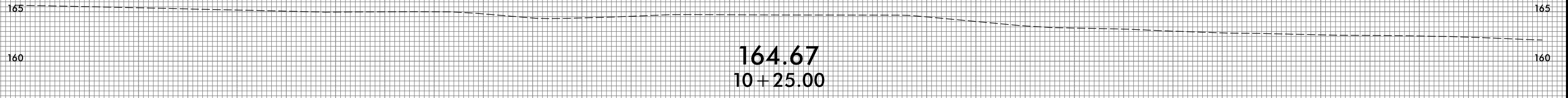
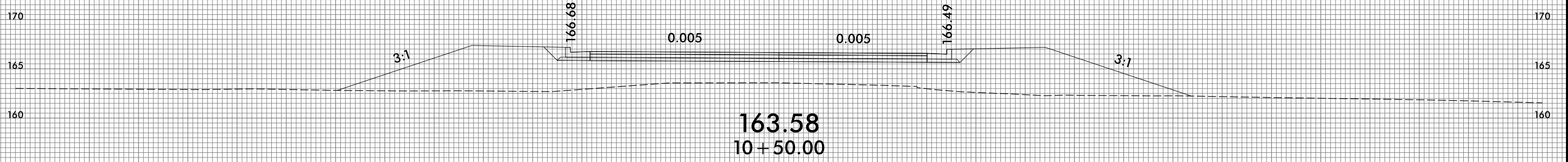
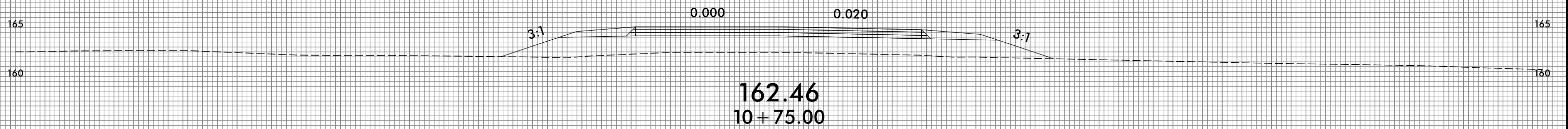
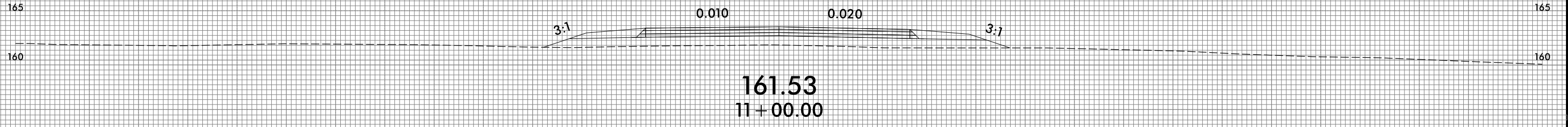

-Y4-

75 70 65 60 55 50 45 40 35 30 25 20 15 10 5 0 5 10 15 20 25 30 35 40 45 50 55 60 65 70 75

75 70 65 60 55 50 45 40 35 30 25 20 15 10 5 0 5 10 15 20 25 30 35 40 45 50 55 60 65 70 75



158.85
12 + 00.00

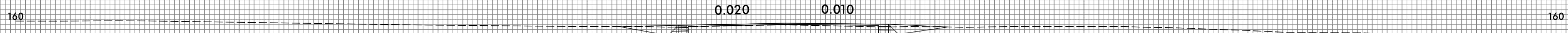

159.48
11 + 75.00

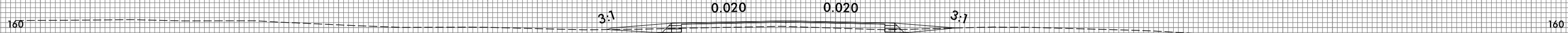

160.11
11 + 50.00

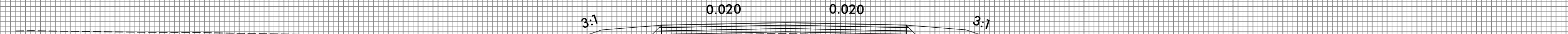

160.82
11 + 25.00

-Y4-

75 70 65 60 55 50 45 40 35 30 25 20 15 10 5 0 5 10 15 20 25 30 35 40 45 50 55 60 65 70 75

75 70 65 60 55 50 45 40 35 30 25 20 15 10 5 0 5 10 15 20 25 30 35 40 45 50 55 60 65 70 75

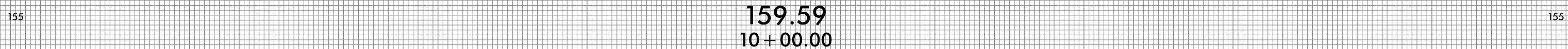
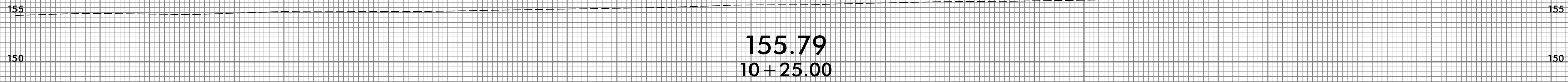
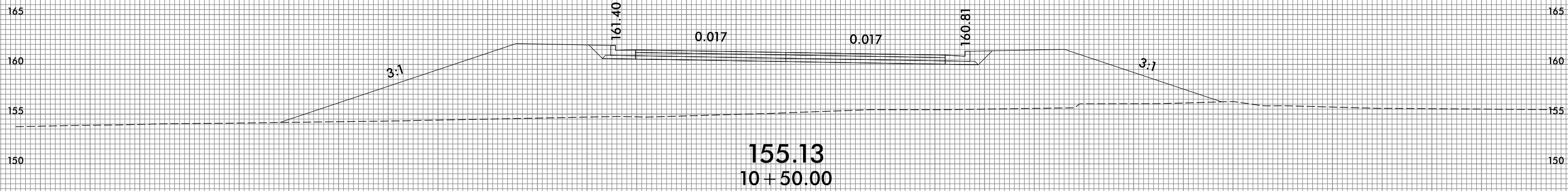
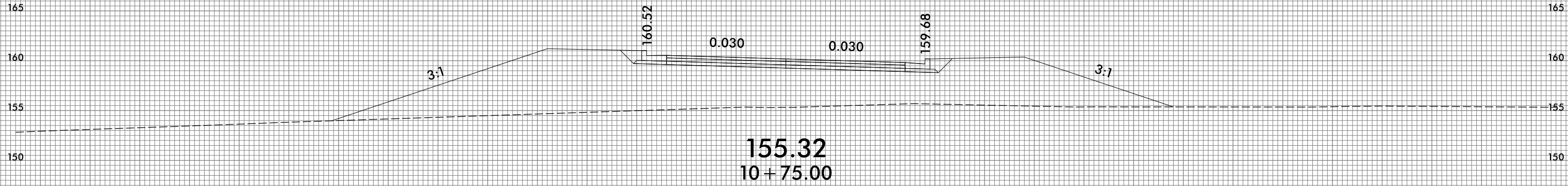

-Y5-

75 70 65 60 55 50 45 40 35 30 25 20 15 10 5 0 5 10 15 20 25 30 35 40 45 50 55 60 65 70 75

75 70 65 60 55 50 45 40 35 30 25 20 15 10 5 0 5 10 15 20 25 30 35 40 45 50 55 60 65 70 75

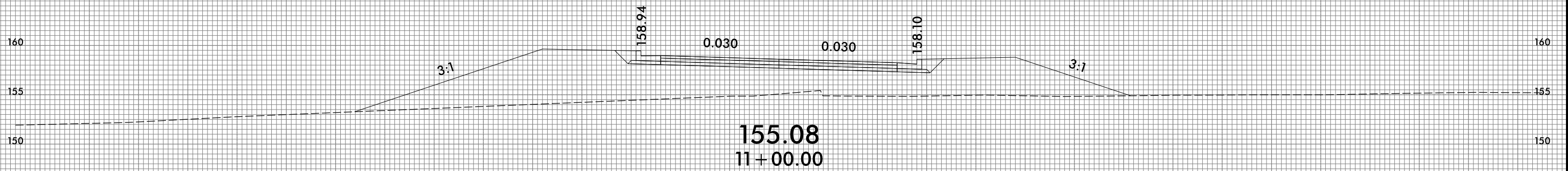
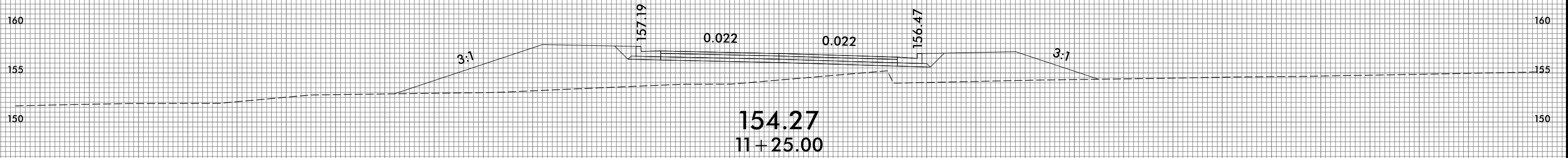
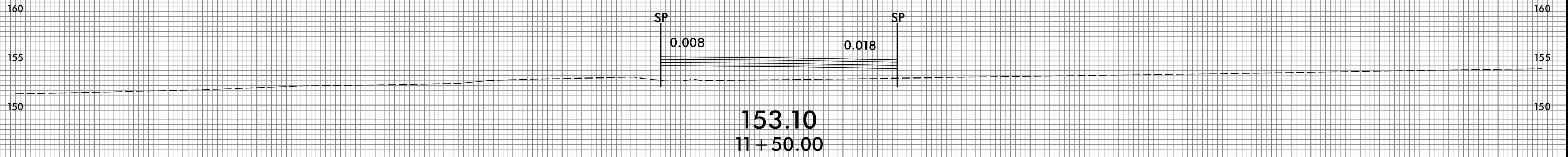
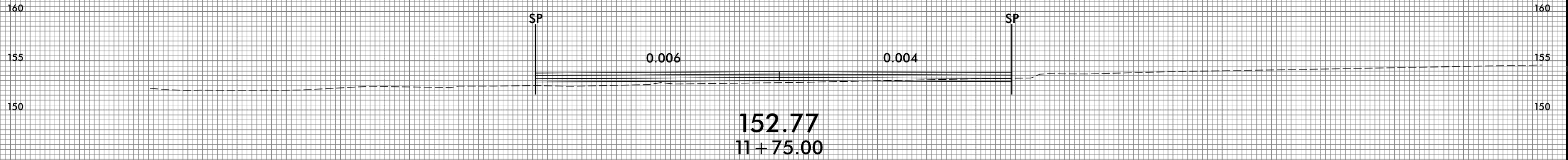

-Y5-

75 70 65 60 55 50 45 40 35 30 25 20 15 10 5 0 5 10 15 20 25 30 35 40 45 50 55 60 65 70 75

75 70 65 60 55 50 45 40 35 30 25 20 15 10 5 0 5 10 15 20 25 30 35 40 45 50 55 60 65 70 75

12 + 25.00

EXIST. EXIST.

152.80
12 + 00.00

-Y5-

155
150

155
150

75 70 65 60 55 50 45 40 35 30 25 20 15 10 5 0 5 10 15 20 25 30 35 40 45 50 55 60 65 70 75

75 70 65 60 55 50 45 40 35 30 25 20 15 10 5 0 5 10 15 20 25 30 35 40 45 50 55 60 65 70 75

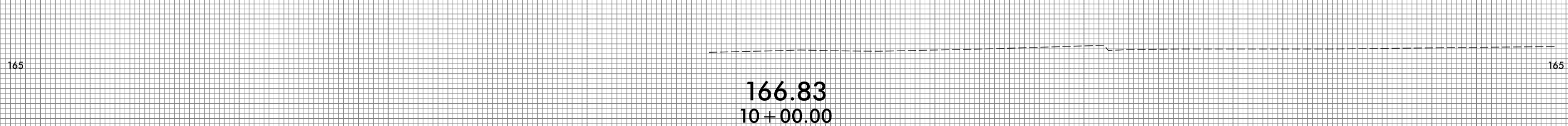
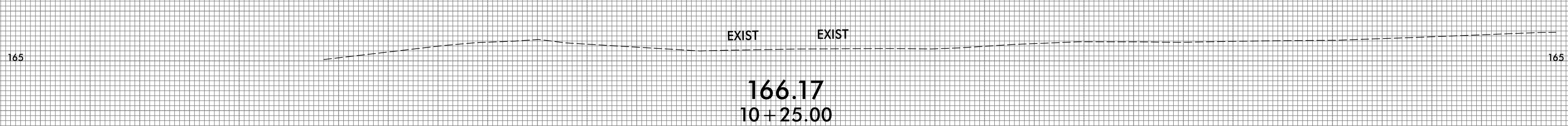
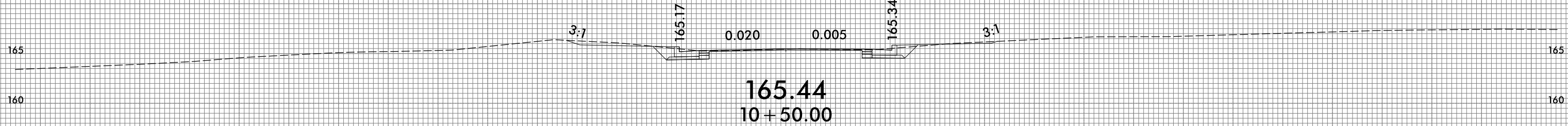
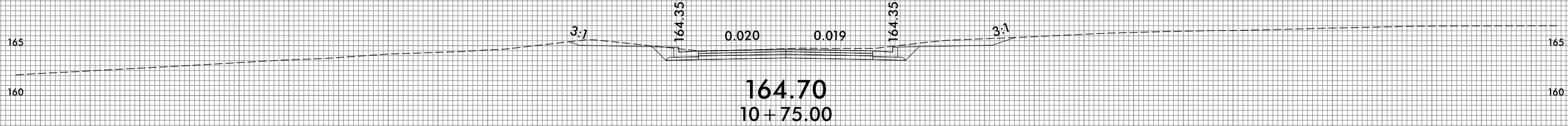
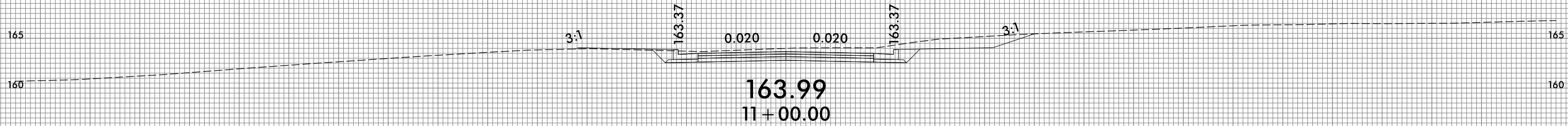
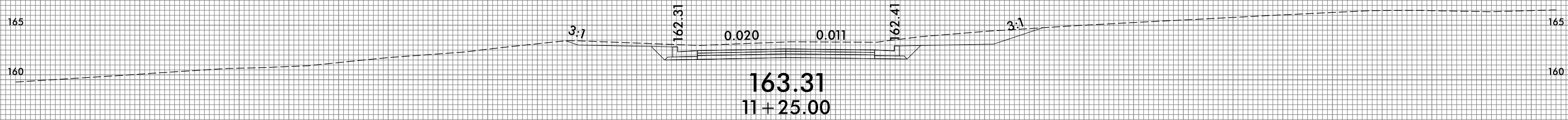

-Y6-

75 70 65 60 55 50 45 40 35 30 25 20 15 10 5 0 5 10 15 20 25 30 35 40 45 50 55 60 65 70 75

75 70 65 60 55 50 45 40 35 30 25 20 15 10 5 0 5 10 15 20 25 30 35 40 45 50 55 60 65 70 75

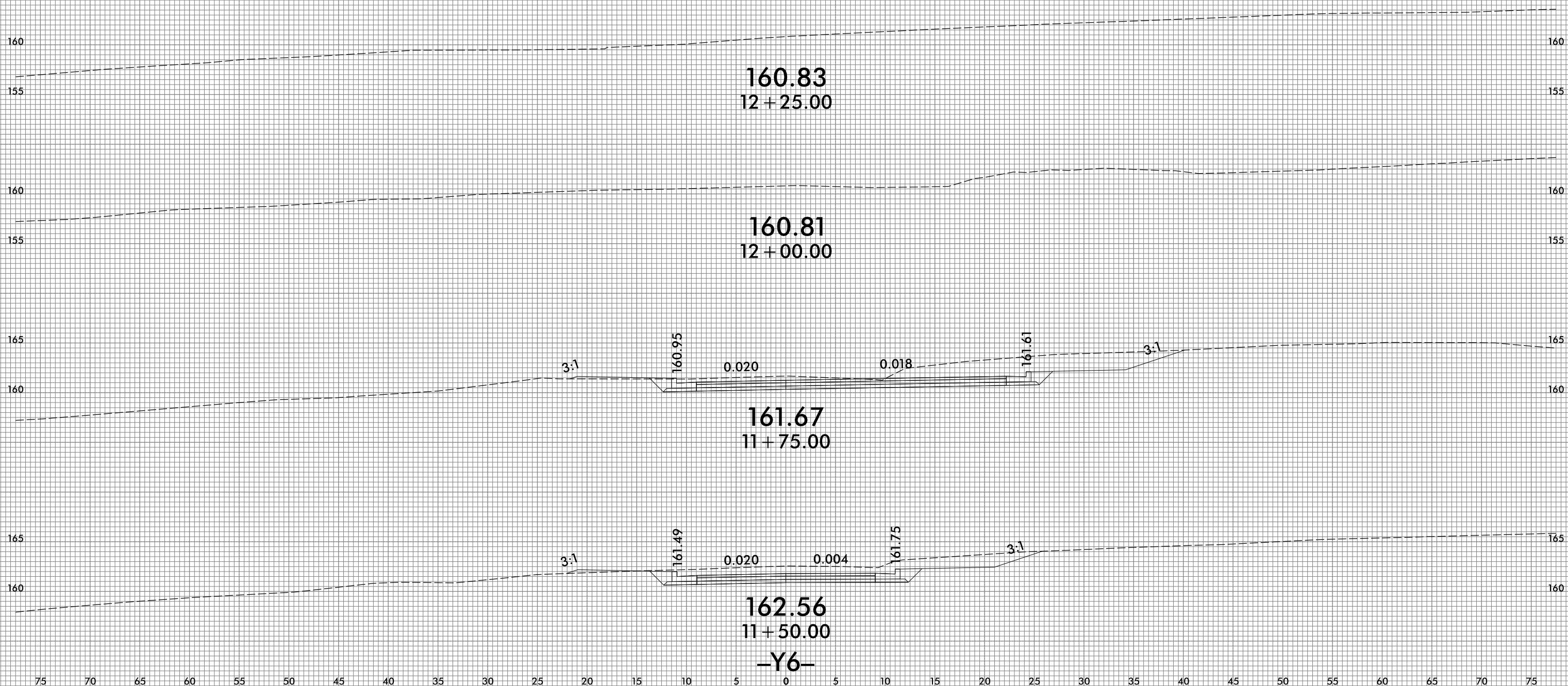

75 70 65 60 55 50 45 40 35 30 25 20 15 10 5 0 5 10 15 20 25 30 35 40 45 50 55 60 65 70 75

75 70 65 60 55 50 45 40 35 30 25 20 15 10 5 0 5 10 15 20 25 30 35 40 45 50 55 60 65 70 75

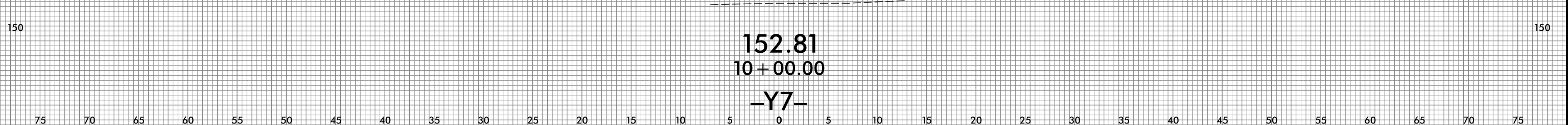
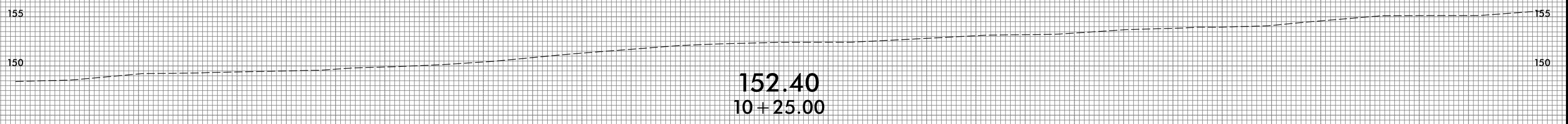
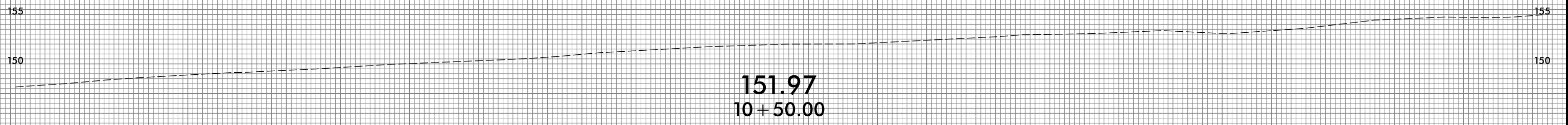
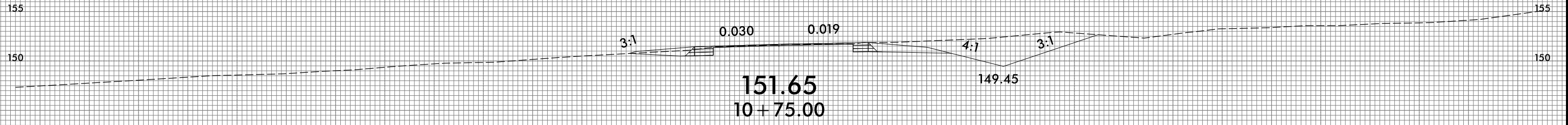
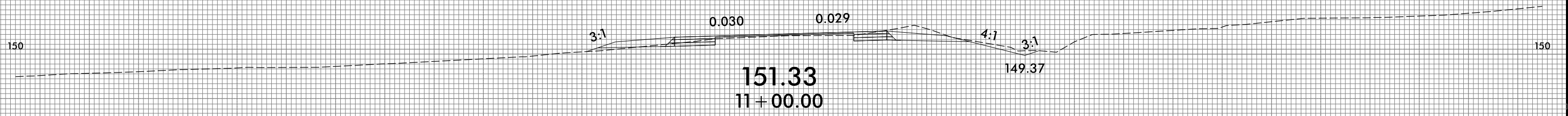

75 70 65 60 55 50 45 40 35 30 25 20 15 10 5 0 5 10 15 20 25 30 35 40 45 50 55 60 65 70 75

75 70 65 60 55 50 45 40 35 30 25 20 15 10 5 0 5 10 15 20 25 30 35 40 45 50 55 60 65 70 75

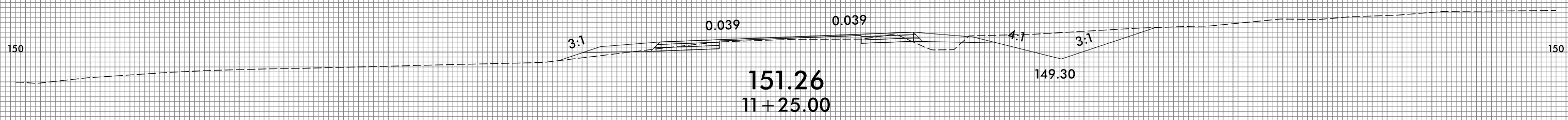
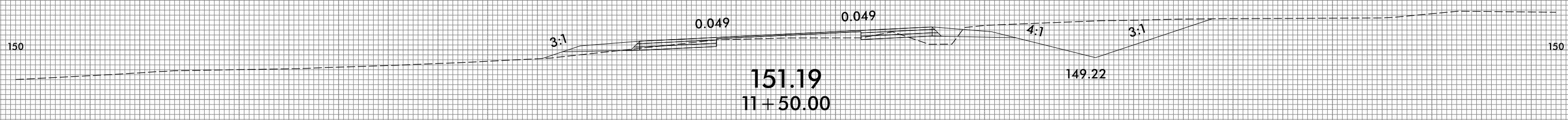
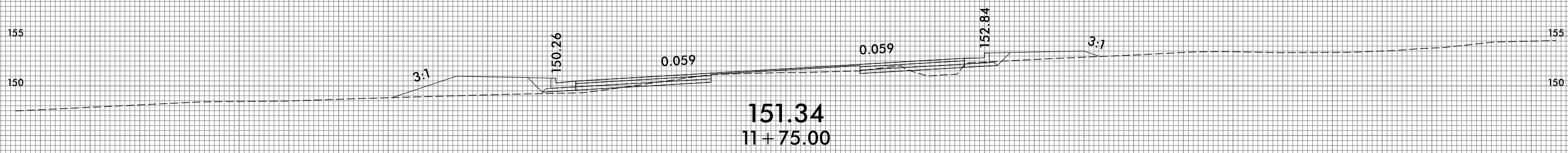
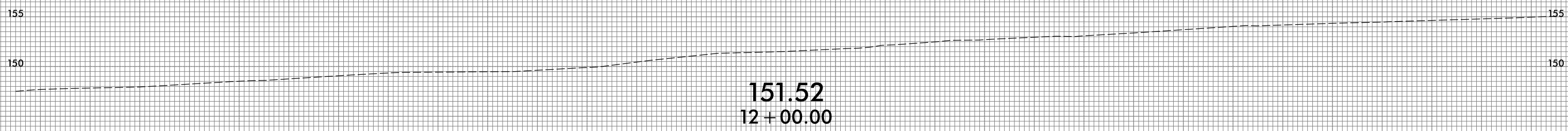
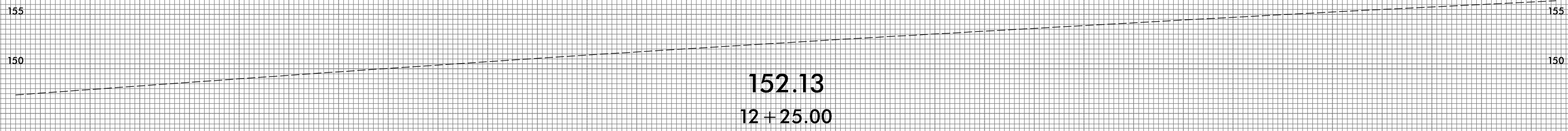

-Y7-

75 70 65 60 55 50 45 40 35 30 25 20 15 10 5 0 5 10 15 20 25 30 35 40 45 50 55 60 65 70 75

75 70 65 60 55 50 45 40 35 30 25 20 15 10 5 0 5 10 15 20 25 30 35 40 45 50 55 60 65 70 75

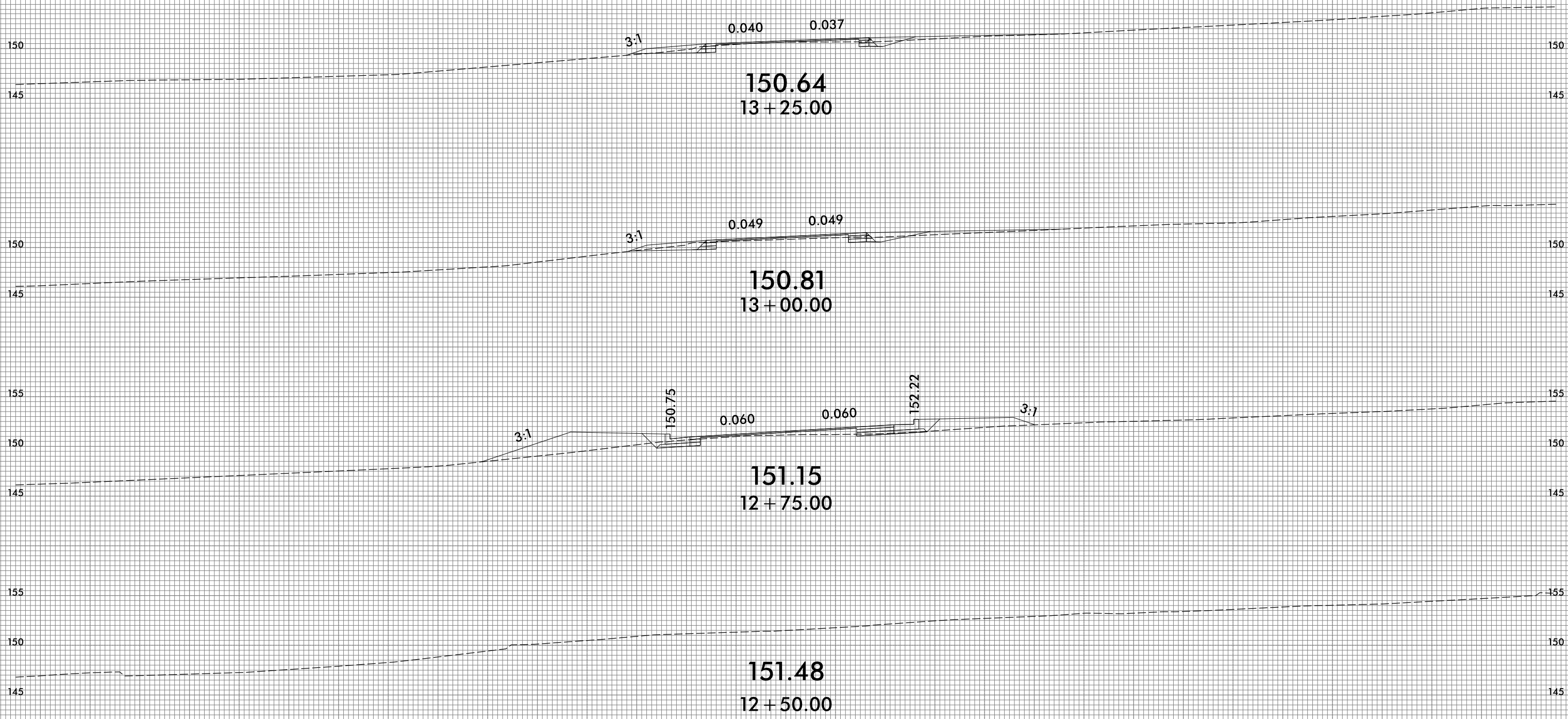

-Y7-

75 70 65 60 55 50 45 40 35 30 25 20 15 10 5 0 5 10 15 20 25 30 35 40 45 50 55 60 65 70 75

75 70 65 60 55 50 45 40 35 30 25 20 15 10 5 0 5 10 15 20 25 30 35 40 45 50 55 60 65 70 75

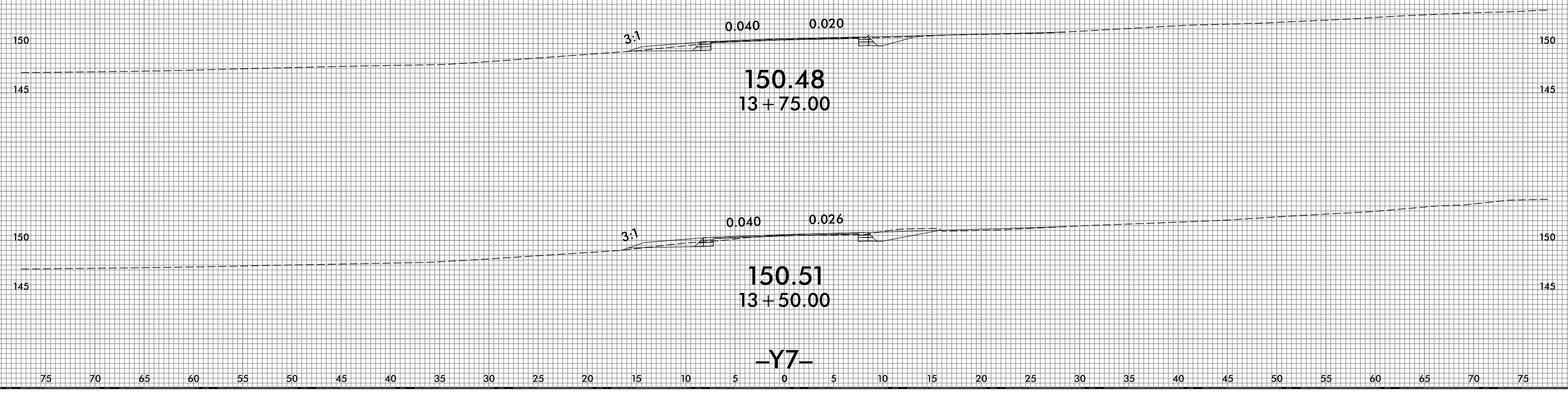

75 70 65 60 55 50 45 40 35 30 25 20 15 10 5 0 5 10 15 20 25 30 35 40 45 50 55 60 65 70 75

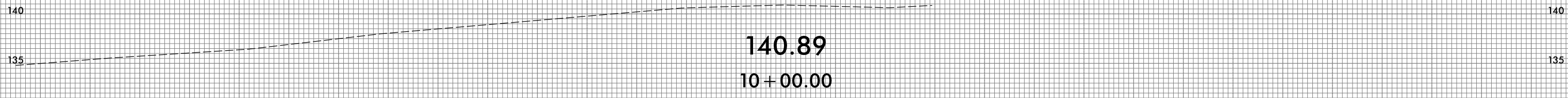
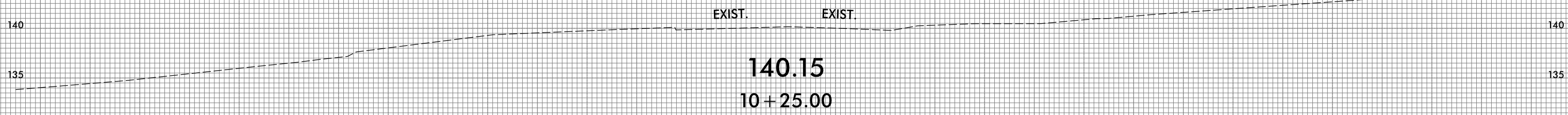
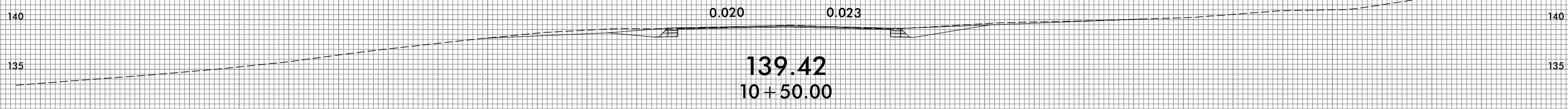
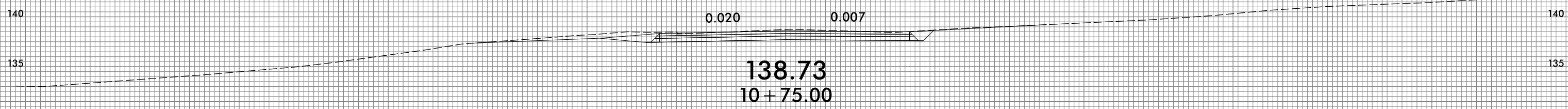
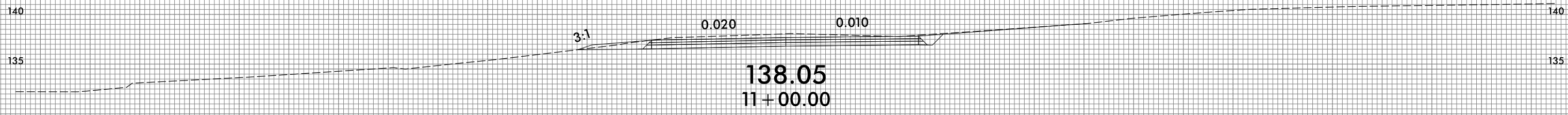

-Y8-

75 70 65 60 55 50 45 40 35 30 25 20 15 10 5 0 5 10 15 20 25 30 35 40 45 50 55 60 65 70 75

75 70 65 60 55 50 45 40 35 30 25 20 15 10 5 0 5 10 15 20 25 30 35 40 45 50 55 60 65 70 75

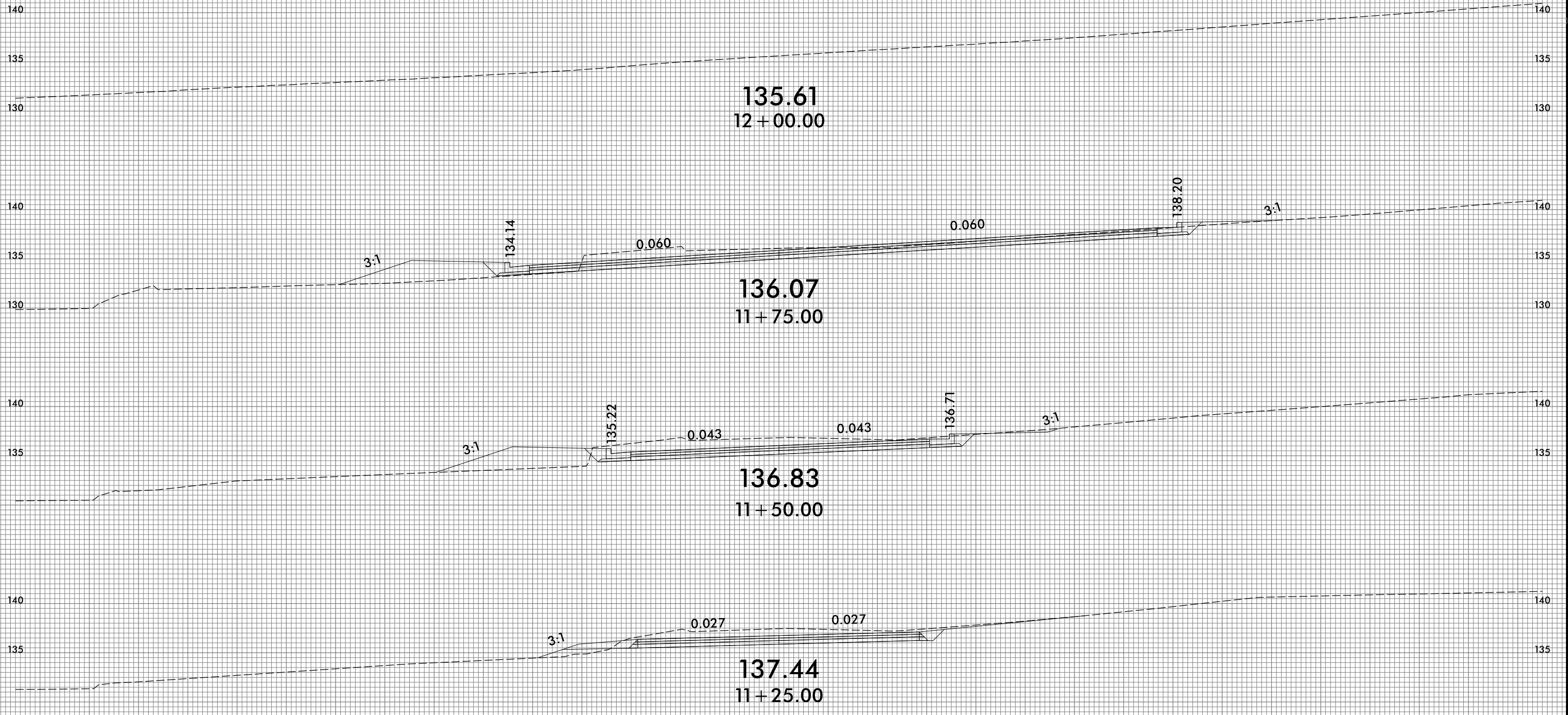

-Y8-

75 70 65 60 55 50 45 40 35 30 25 20 15 10 5 0 5 10 15 20 25 30 35 40 45 50 55 60 65 70 75

75 70 65 60 55 50 45 40 35 30 25 20 15 10 5 0 5 10 15 20 25 30 35 40 45 50 55 60 65 70 75

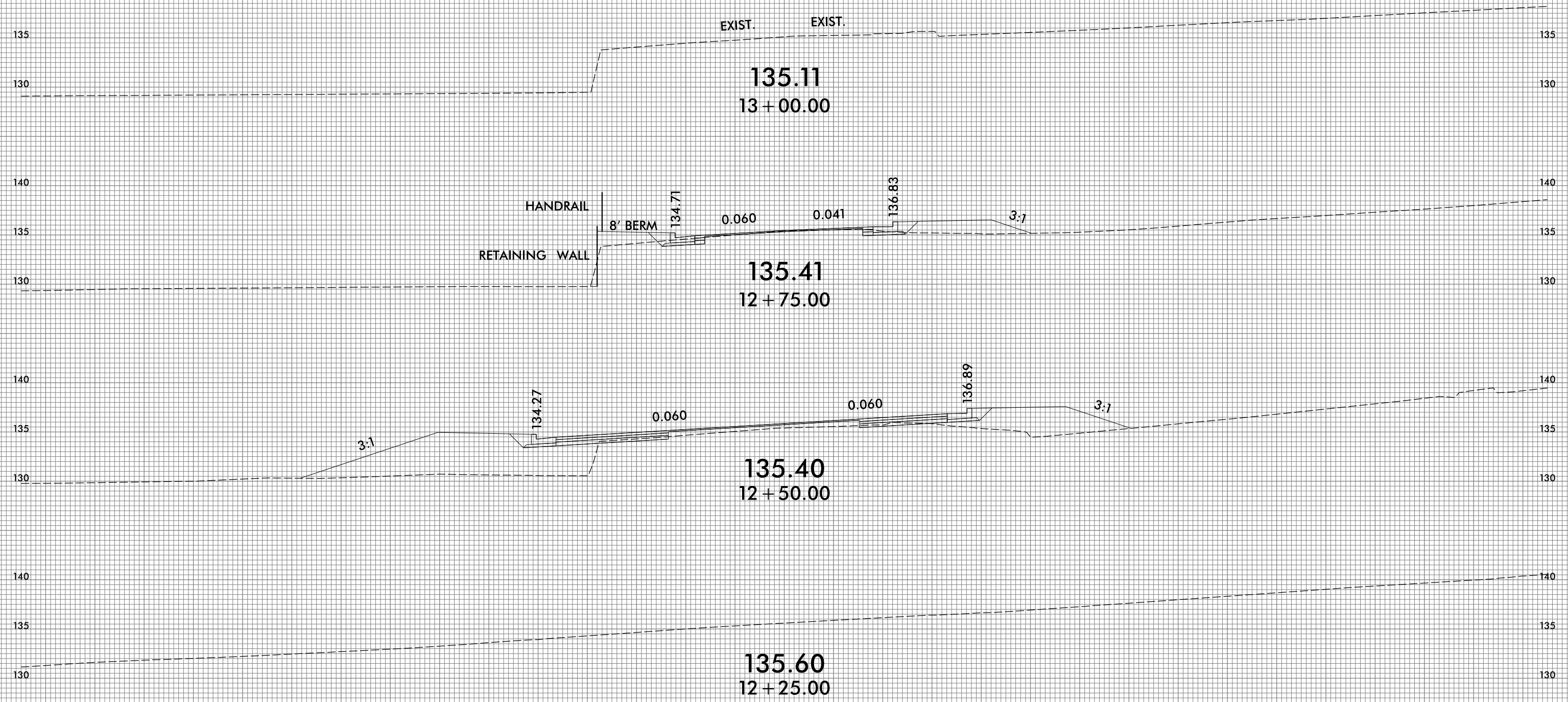

-Y8-

75 70 65 60 55 50 45 40 35 30 25 20 15 10 5 0 5 10 15 20 25 30 35 40 45 50 55 60 65 70 75

75 70 65 60 55 50 45 40 35 30 25 20 15 10 5 0 5 10 15 20 25 30 35 40 45 50 55 60 65 70 75

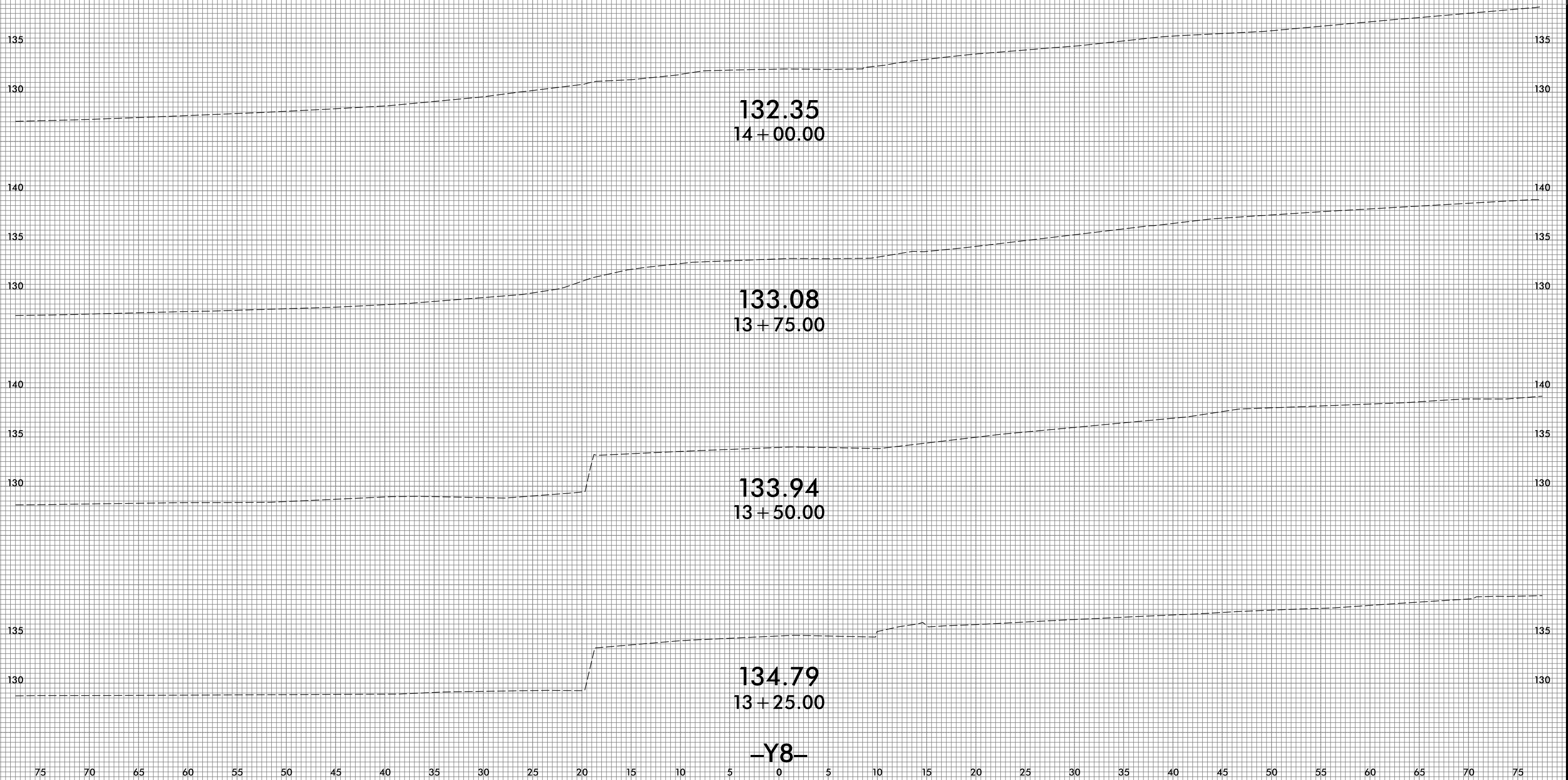

75 70 65 60 55 50 45 40 35 30 25 20 15 10 5 0 5 10 15 20 25 30 35 40 45 50 55 60 65 70 75

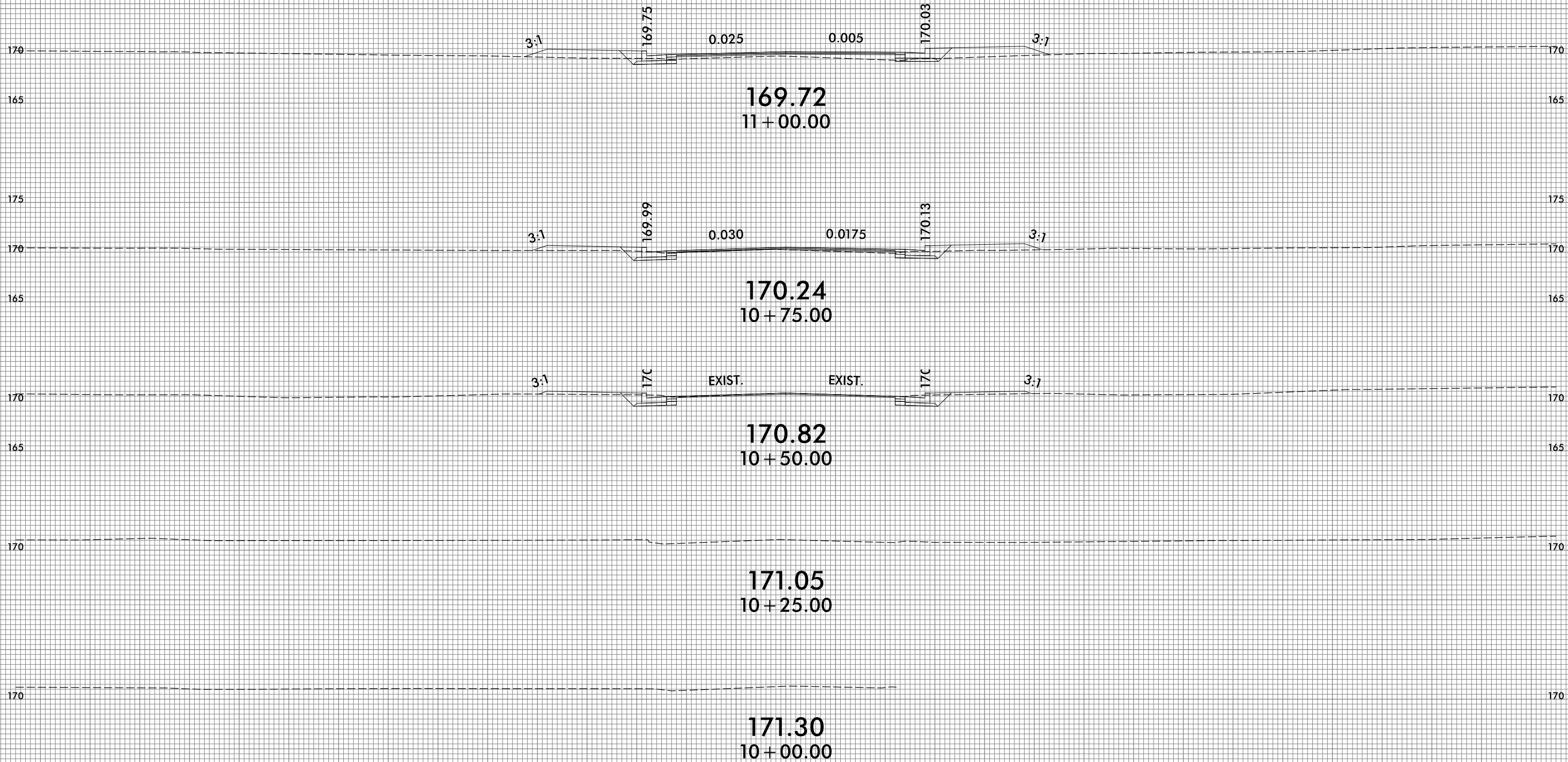

75 70 65 60 55 50 45 40 35 30 25 20 15 10 5 0 5 10 15 20 25 30 35 40 45 50 55 60 65 70 75

-Y10-

75 70 65 60 55 50 45 40 35 30 25 20 15 10 5 0 5 10 15 20 25 30 35 40 45 50 55 60 65 70 75

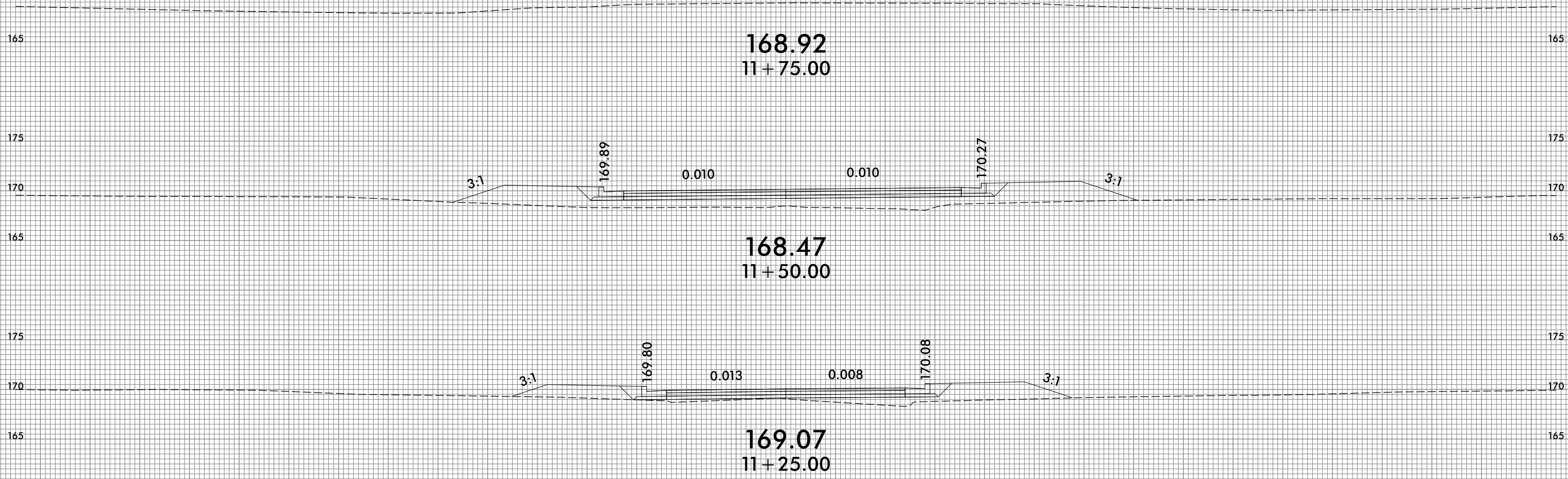

75 70 65 60 55 50 45 40 35 30 25 20 15 10 5 0 5 10 15 20 25 30 35 40 45 50 55 60 65 70 75

-Y10-

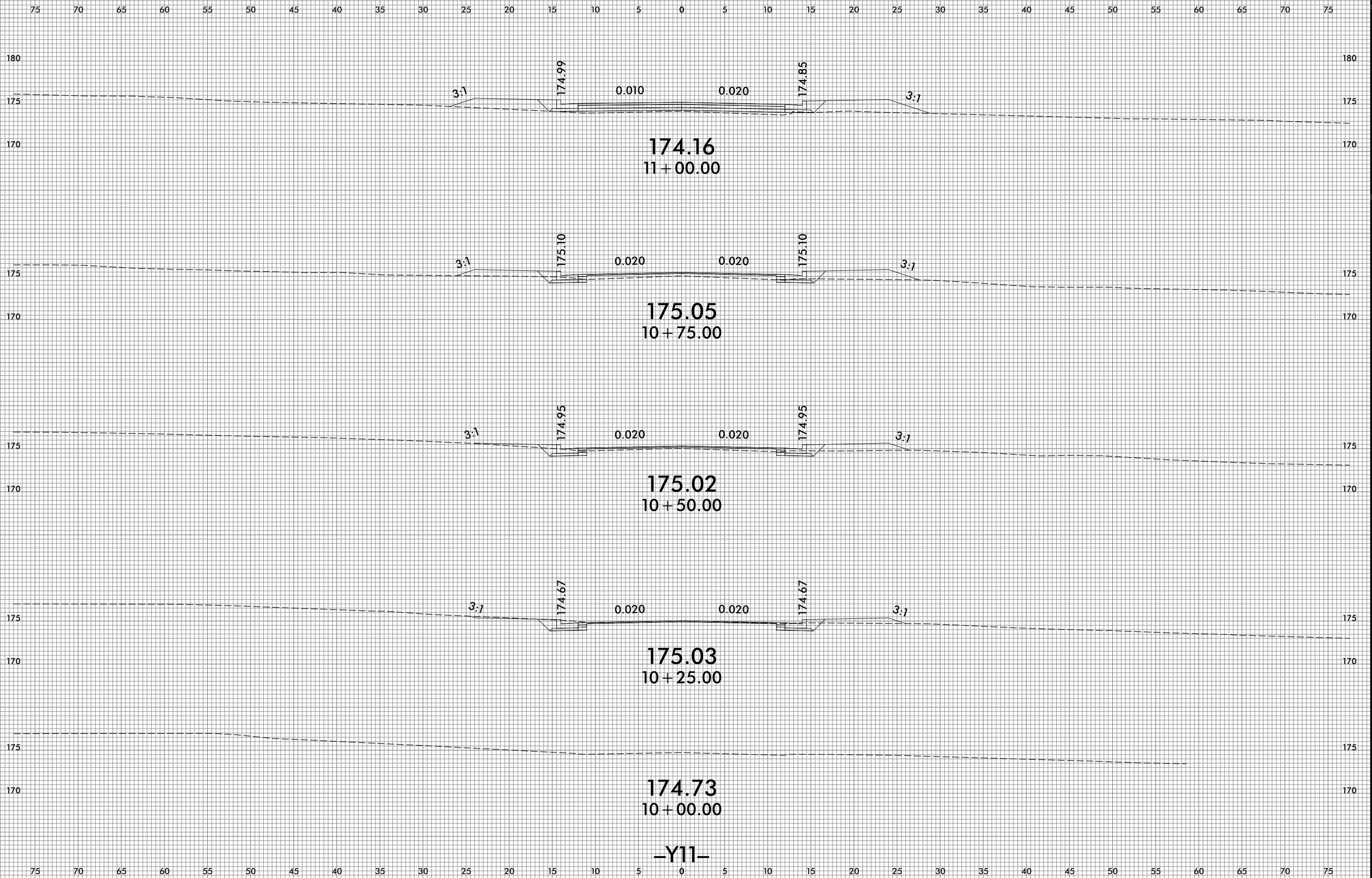

-Y11-

75 70 65 60 55 50 45 40 35 30 25 20 15 10 5 0 5 10 15 20 25 30 35 40 45 50 55 60 65 70 75

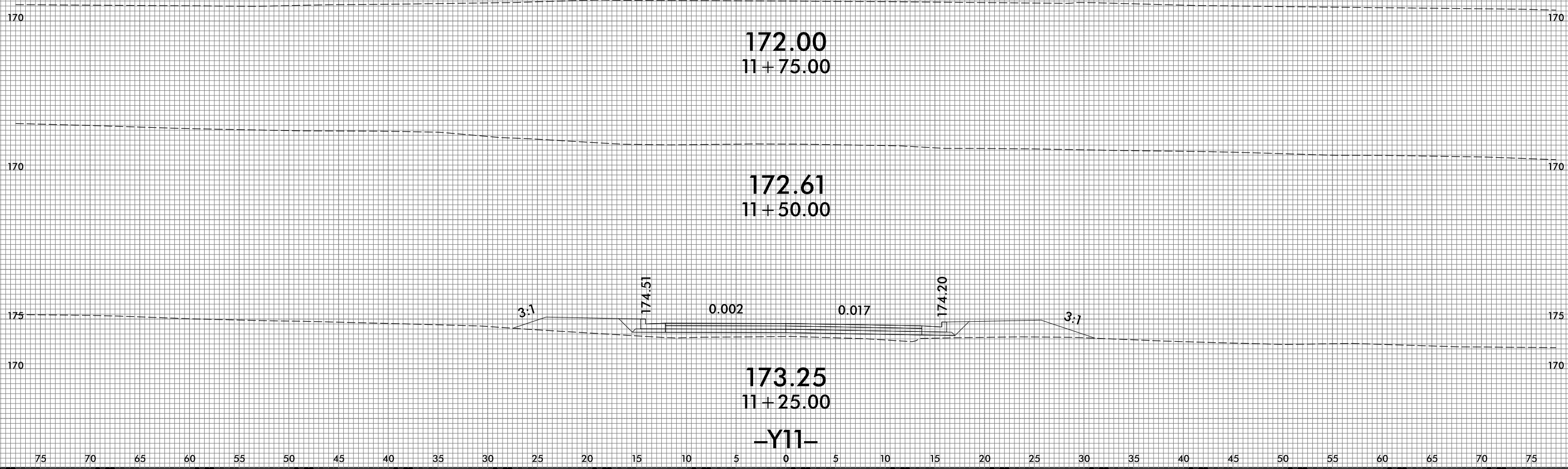

75 70 65 60 55 50 45 40 35 30 25 20 15 10 5 0 5 10 15 20 25 30 35 40 45 50 55 60 65 70 75

75 70 65 60 55 50 45 40 35 30 25 20 15 10 5 0 5 10 15 20 25 30 35 40 45 50 55 60 65 70 75

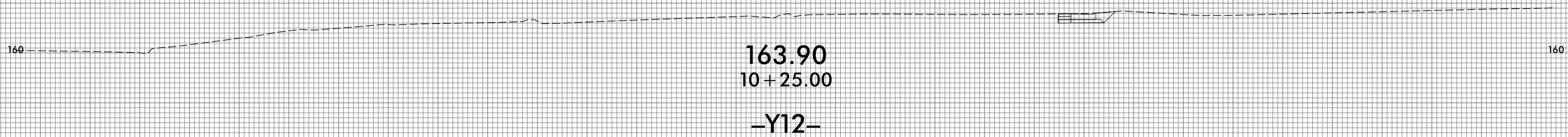
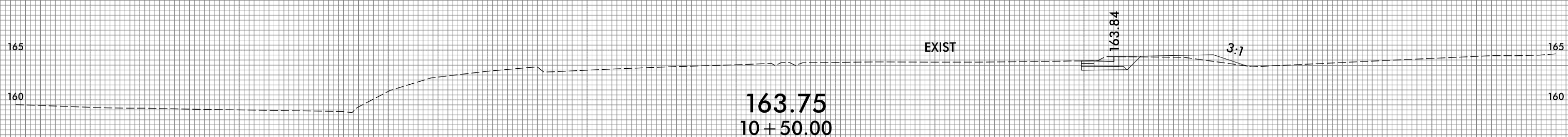
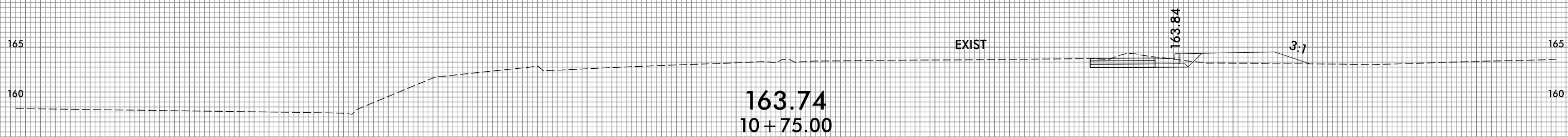
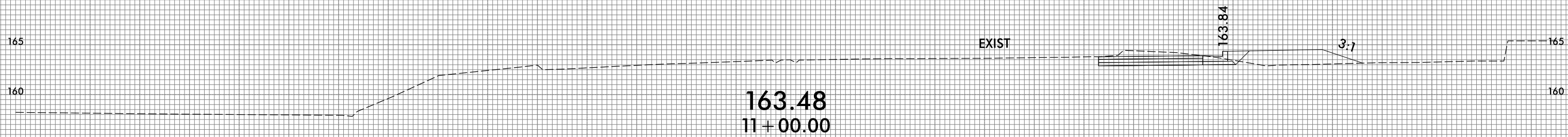
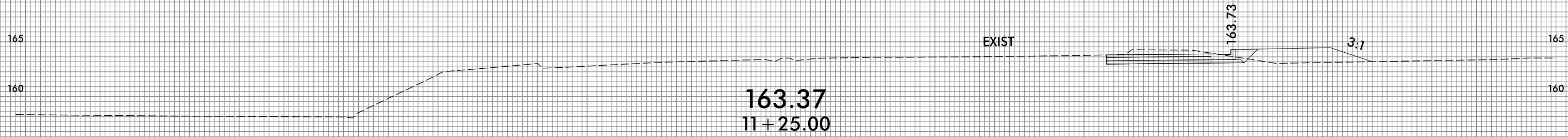

75 70 65 60 55 50 45 40 35 30 25 20 15 10 5 0 5 10 15 20 25 30 35 40 45 50 55 60 65 70 75

-Y12-

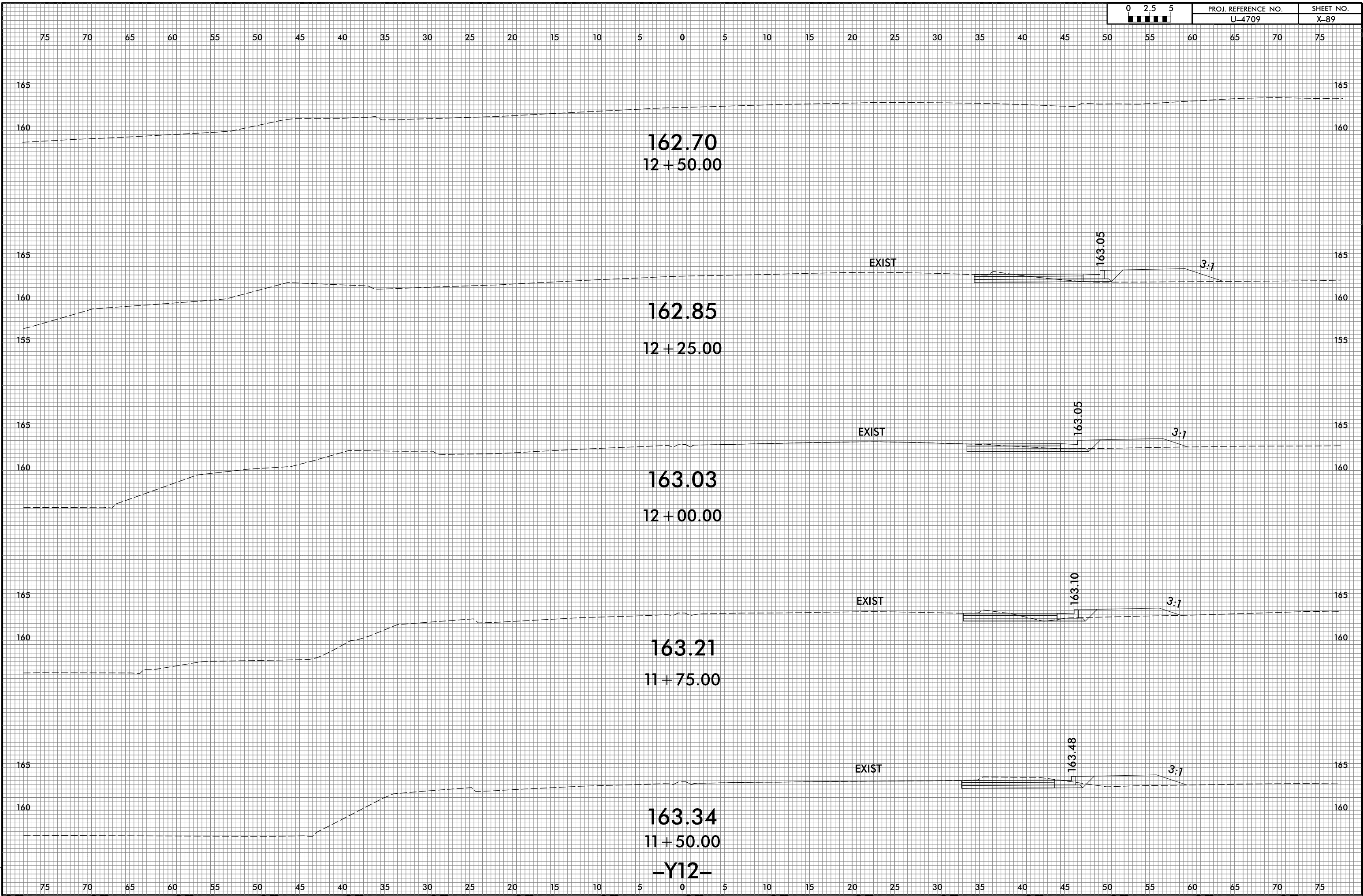

75 70 65 60 55 50 45 40 35 30 25 20 15 10 5 0 5 10 15 20 25 30 35 40 45 50 55 60 65 70 75

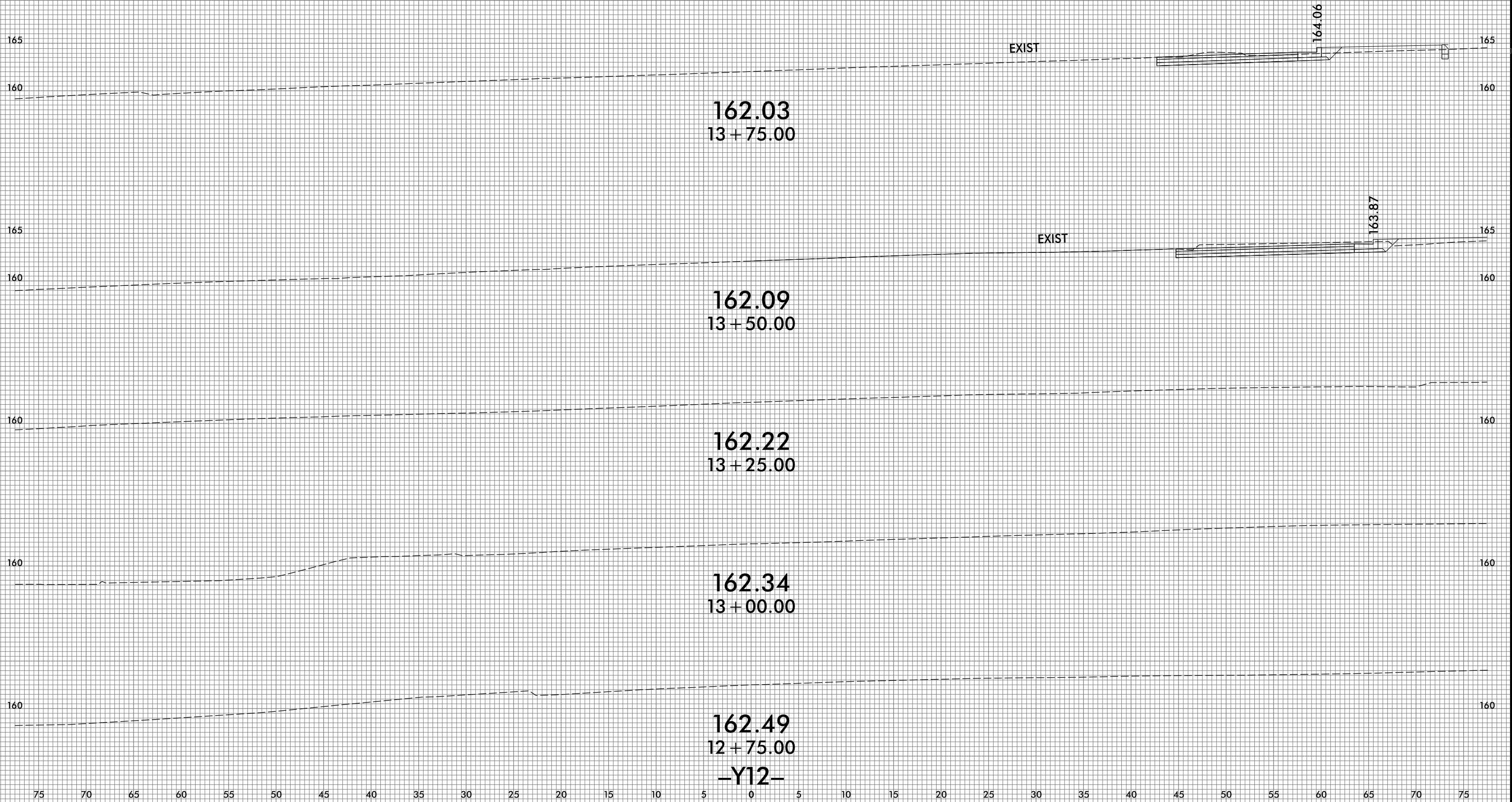

75 70 65 60 55 50 45 40 35 30 25 20 15 10 5 0 5 10 15 20 25 30 35 40 45 50 55 60 65 70 75

75 70 65 60 55 50 45 40 35 30 25 20 15 10 5 0 5 10 15 20 25 30 35 40 45 50 55 60 65 70 75

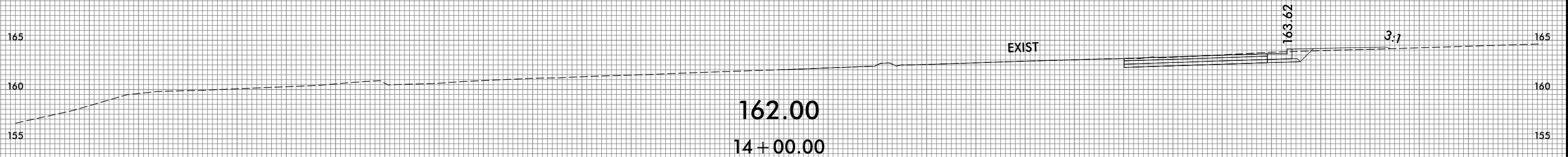
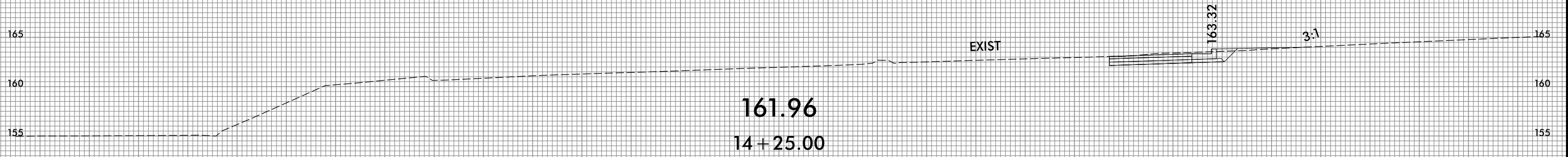
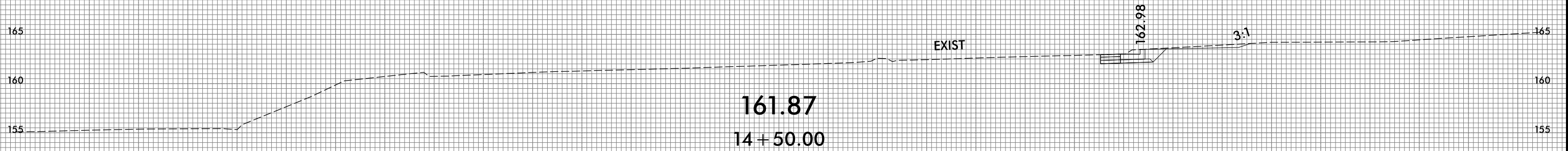
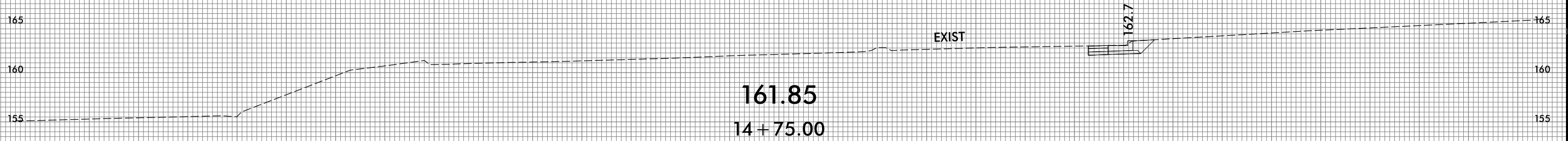

75 70 65 60 55 50 45 40 35 30 25 20 15 10 5 0 5 10 15 20 25 30 35 40 45 50 55 60 65 70 75

-Y12-

75 70 65 60 55 50 45 40 35 30 25 20 15 10 5 0 5 10 15 20 25 30 35 40 45 50 55 60 65 70 75

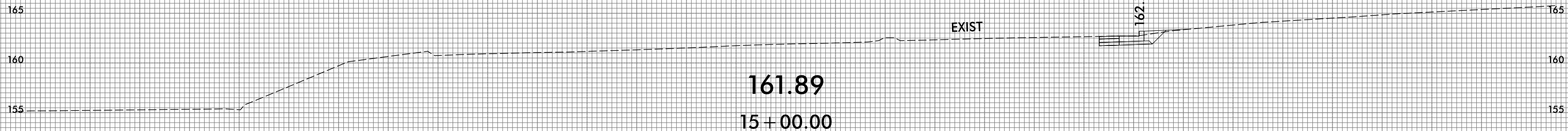

161.89
15 + 00.00

162.71

EXIST

-Y12-

75 70 65 60 55 50 45 40 35 30 25 20 15 10 5 0 5 10 15 20 25 30 35 40 45 50 55 60 65 70 75

75 70 65 60 55 50 45 40 35 30 25 20 15 10 5 0 5 10 15 20 25 30 35 40 45 50 55 60 65 70 75

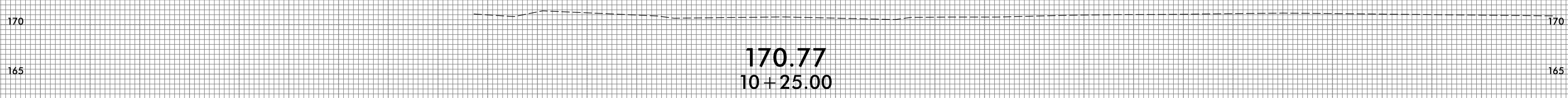
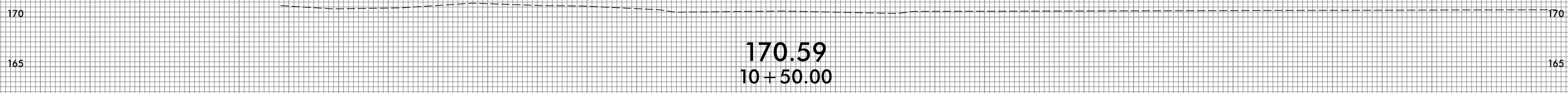
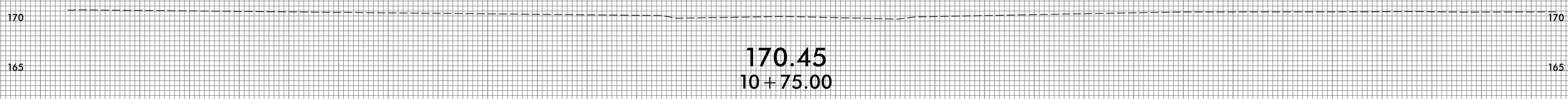
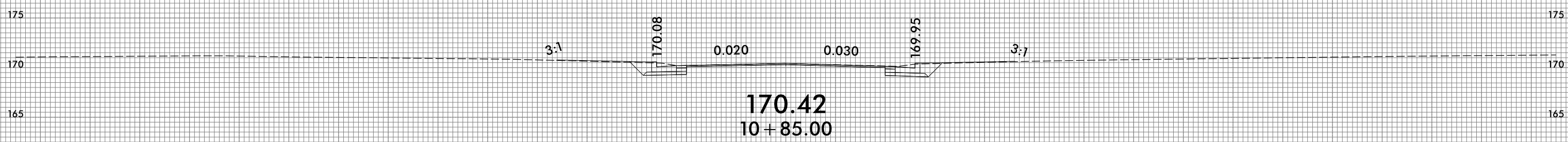
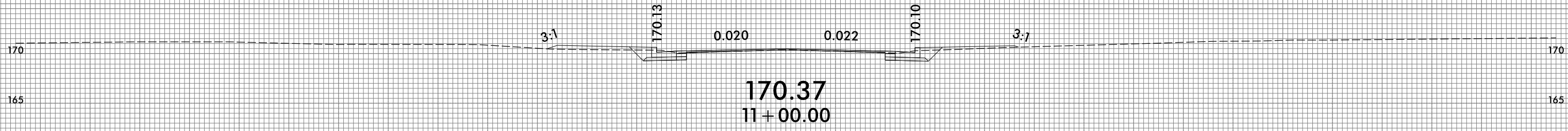

-Y13-

75 70 65 60 55 50 45 40 35 30 25 20 15 10 5 0 5 10 15 20 25 30 35 40 45 50 55 60 65 70 75

75 70 65 60 55 50 45 40 35 30 25 20 15 10 5 0 5 10 15 20 25 30 35 40 45 50 55 60 65 70 75

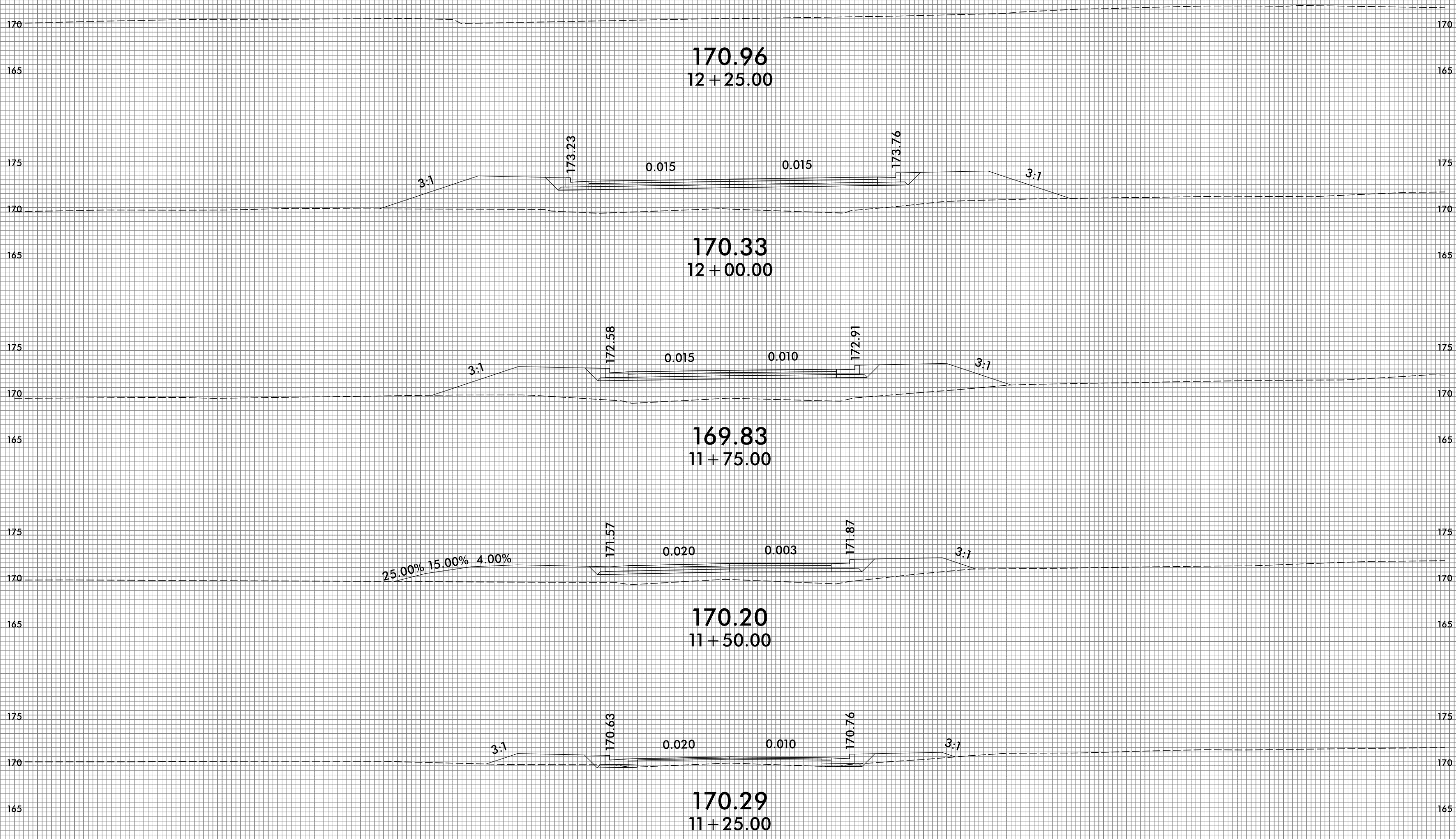

75 70 65 60 55 50 45 40 35 30 25 20 15 10 5 0 5 10 15 20 25 30 35 40 45 50 55 60 65 70 75

-Y13-

75 70 65 60 55 50 45 40 35 30 25 20 15 10 5 0 5 10 15 20 25 30 35 40 45 50 55 60 65 70 75

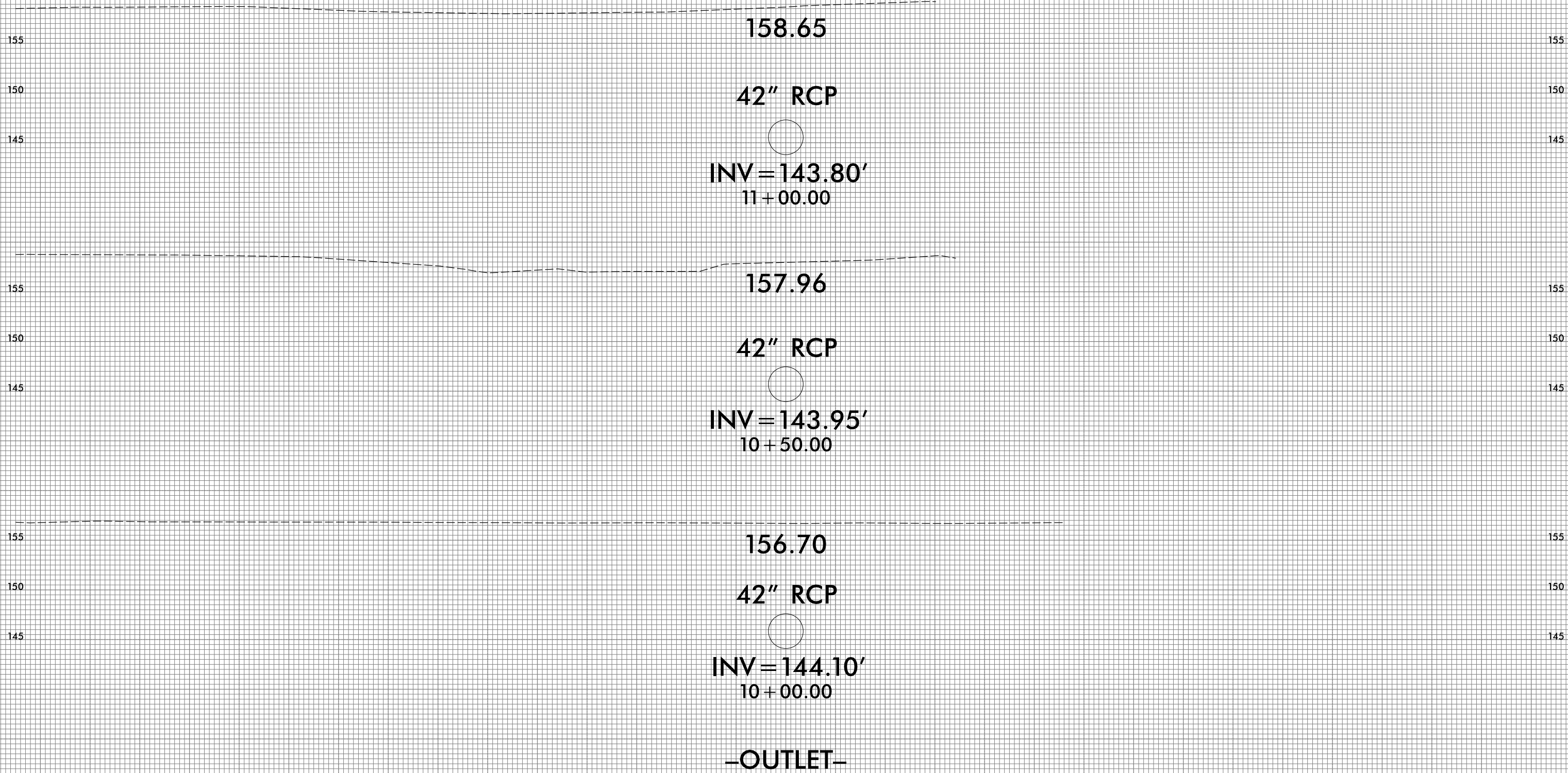

75 70 65 60 55 50 45 40 35 30 25 20 15 10 5 0 5 10 15 20 25 30 35 40 45 50 55 60 65 70 75

75 70 65 60 55 50 45 40 35 30 25 20 15 10 5 0 5 10 15 20 25 30 35 40 45 50 55 60 65 70 75

165 165

160 160

155 155

150 150

145 145

140 140

160 160

155 155

150 150

145 145

140 140

160 160

155 155

150 150

145 145

140 140

75 70 65 60 55 50 45 40 35 30 25 20 15 10 5 0 5 10 15 20 25 30 35 40 45 50 55 60 65 70 75

160.46

42" RCP



INV = 143.35'
12 + 50.00

160.18

42" RCP



INV = 143.50'
12 + 00.00

158.89

42" RCP



INV = 143.65'
11 + 50.00

-OUTLET-

75 70 65 60 55 50 45 40 35 30 25 20 15 10 5 0 5 10 15 20 25 30 35 40 45 50 55 60 65 70 75

160 160

155 155

150 150

145 145

140 140

160 160

155 155

150 150

145 145

140 140

160 160

155 155

150 150

145 145

140 140

75 70 65 60 55 50 45 40 35 30 25 20 15 10 5 0 5 10 15 20 25 30 35 40 45 50 55 60 65 70 75

160.20

42" RCP



INV = 142.90'
14 + 00.00

161.59

42" RCP



INV = 143.05'
13 + 50.00

161.18

42" RCP



INV = 143.20'
13 + 00.00

-OUTLET-

75 70 65 60 55 50 45 40 35 30 25 20 15 10 5 0 5 10 15 20 25 30 35 40 45 50 55 60 65 70 75

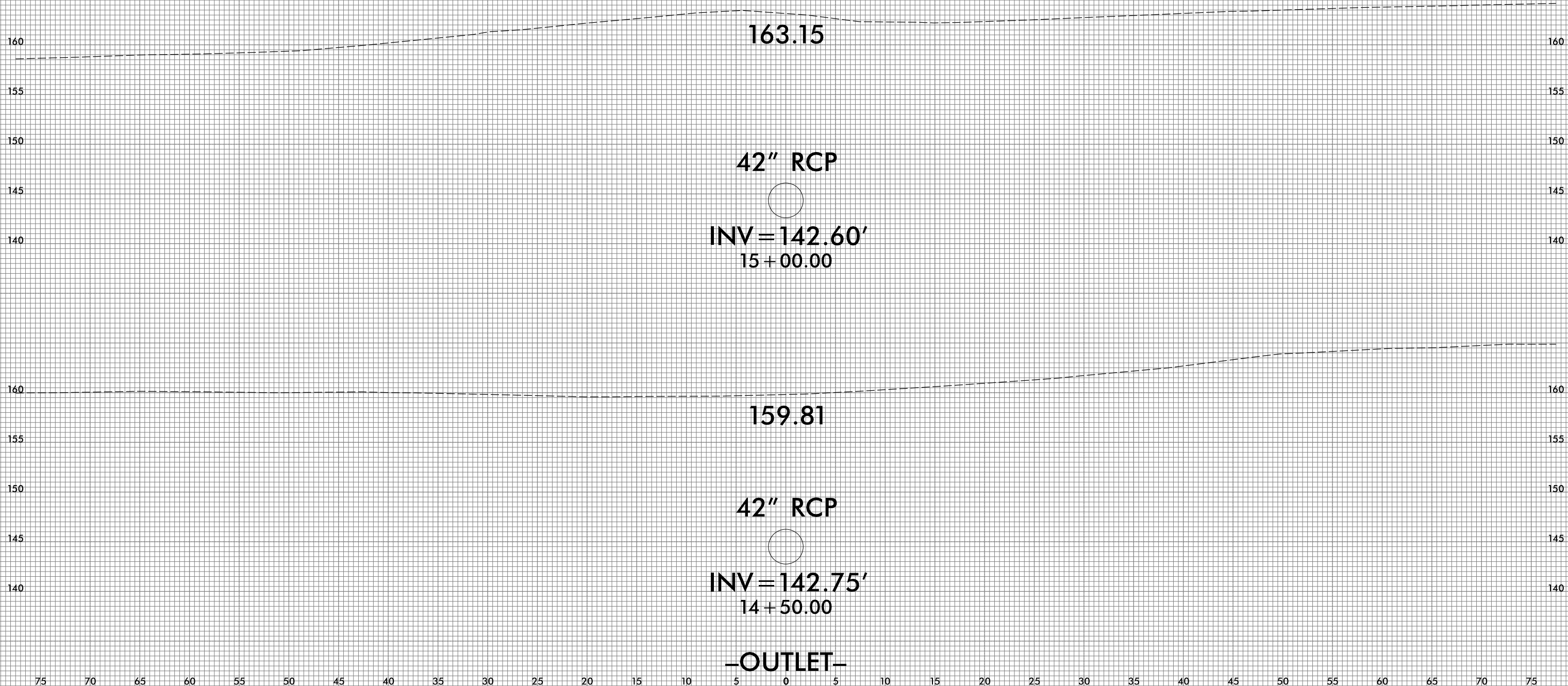

75 70 65 60 55 50 45 40 35 30 25 20 15 10 5 0 5 10 15 20 25 30 35 40 45 50 55 60 65 70 75

75 70 65 60 55 50 45 40 35 30 25 20 15 10 5 0 5 10 15 20 25 30 35 40 45 50 55 60 65 70 75

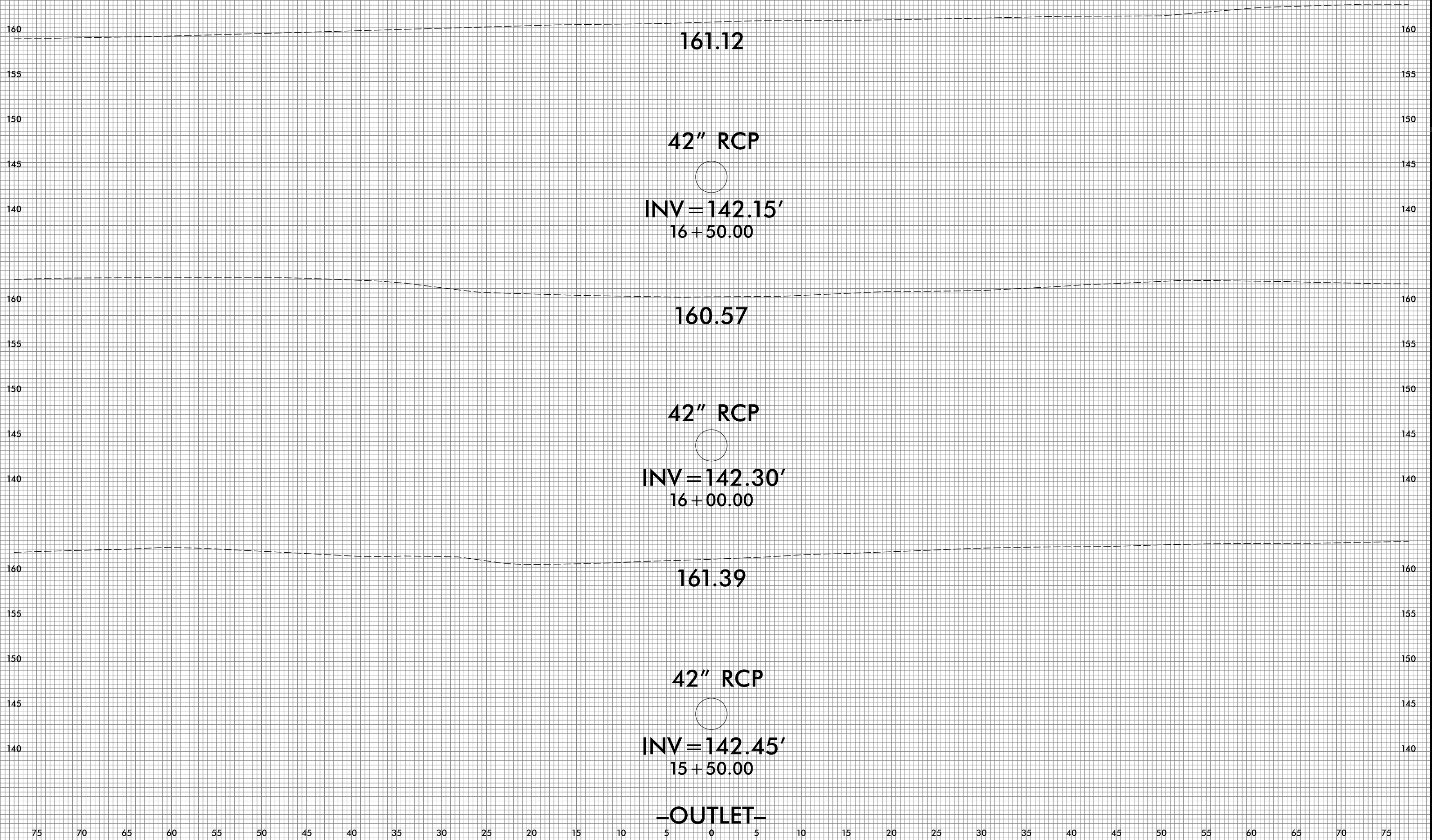

161.12

42" RCP

INV = 142.15'
16 + 50.00

160.57

42" RCP

INV = 142.30'
16 + 00.00

161.39

42" RCP

INV = 142.45'
15 + 50.00

-OUTLET-

75 70 65 60 55 50 45 40 35 30 25 20 15 10 5 0 5 10 15 20 25 30 35 40 45 50 55 60 65 70 75

158.99

42" RCP

INV = 141.70'
18 + 00.00

160.06

42" RCP

INV = 141.85'
17 + 50.00

160.67

42" RCP

INV = 142.00'
17 + 00.00

-OUTLET-

75 70 65 60 55 50 45 40 35 30 25 20 15 10 5 0 5 10 15 20 25 30 35 40 45 50 55 60 65 70 75

75 70 65 60 55 50 45 40 35 30 25 20 15 10 5 0 5 10 15 20 25 30 35 40 45 50 55 60 65 70 75

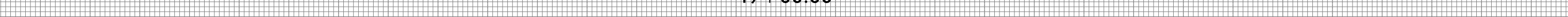
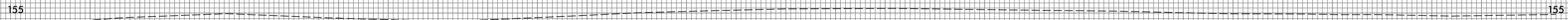

75 70 65 60 55 50 45 40 35 30 25 20 15 10 5 0 5 10 15 20 25 30 35 40 45 50 55 60 65 70 75

155.41

42" RCP



INV = 141.25'

19 + 50.00

155.99

42" RCP



INV = 141.40'

19 + 00.00

157.33

42" RCP



INV = 141.55'

18 + 50.00

-OUTLET-

75 70 65 60 55 50 45 40 35 30 25 20 15 10 5 0 5 10 15 20 25 30 35 40 45 50 55 60 65 70 75

150
145
140
150
145
140
150
145
140

150
145
140
150
145
140
150
145
140

153.83

42" RCP



INV = 140.80'

21 + 00.00

154.45

42" RCP



INV = 140.95'

20 + 50.00

154.58

42" RCP



INV = 141.10'

20 + 00.00

-OUTLET-

75 70 65 60 55 50 45 40 35 30 25 20 15 10 5 0 5 10 15 20 25 30 35 40 45 50 55 60 65 70 75

75 70 65 60 55 50 45 40 35 30 25 20 15 10 5 0 5 10 15 20 25 30 35 40 45 50 55 60 65 70 75

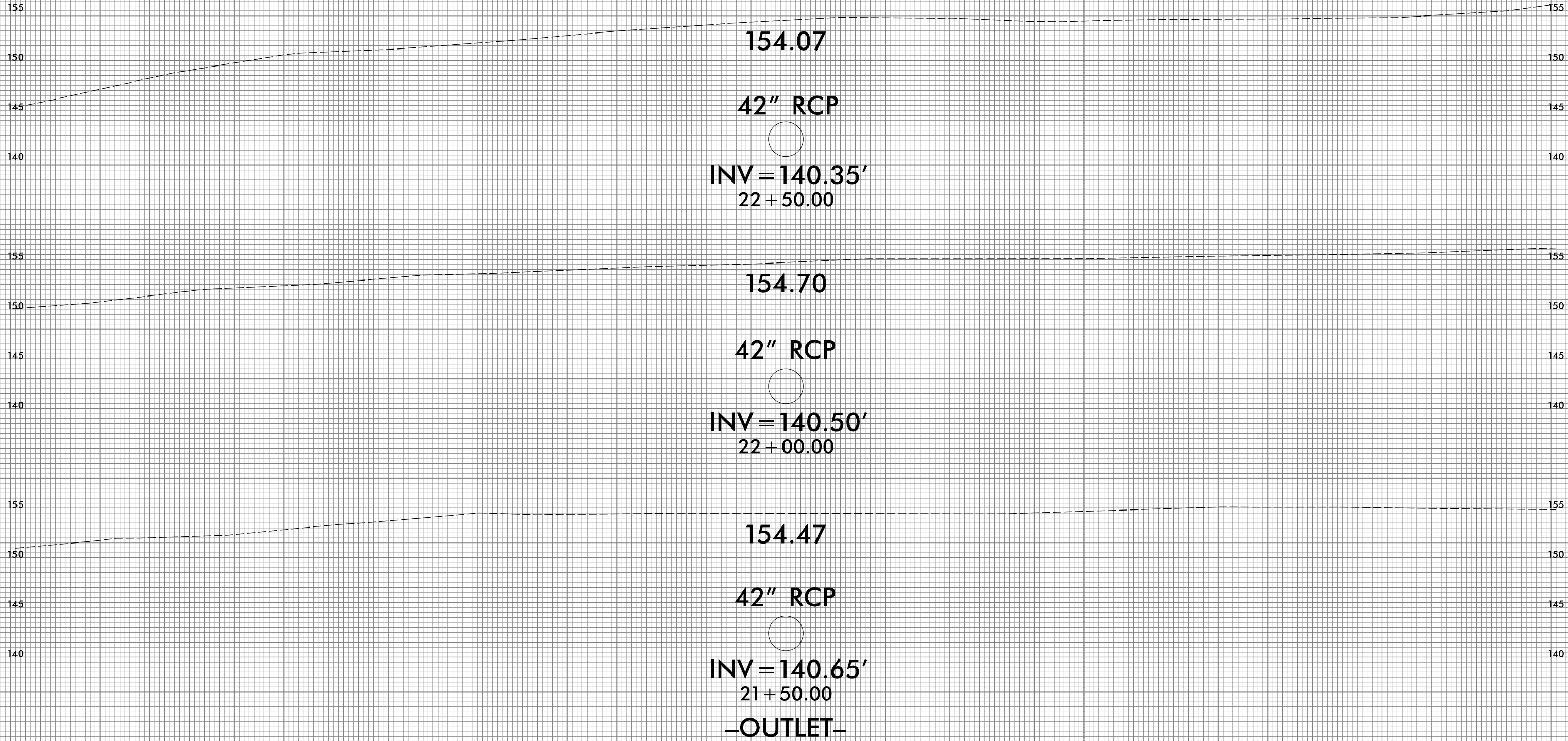

75 70 65 60 55 50 45 40 35 30 25 20 15 10 5 0 5 10 15 20 25 30 35 40 45 50 55 60 65 70 75

75 70 65 60 55 50 45 40 35 30 25 20 15 10 5 0 5 10 15 20 25 30 35 40 45 50 55 60 65 70 75

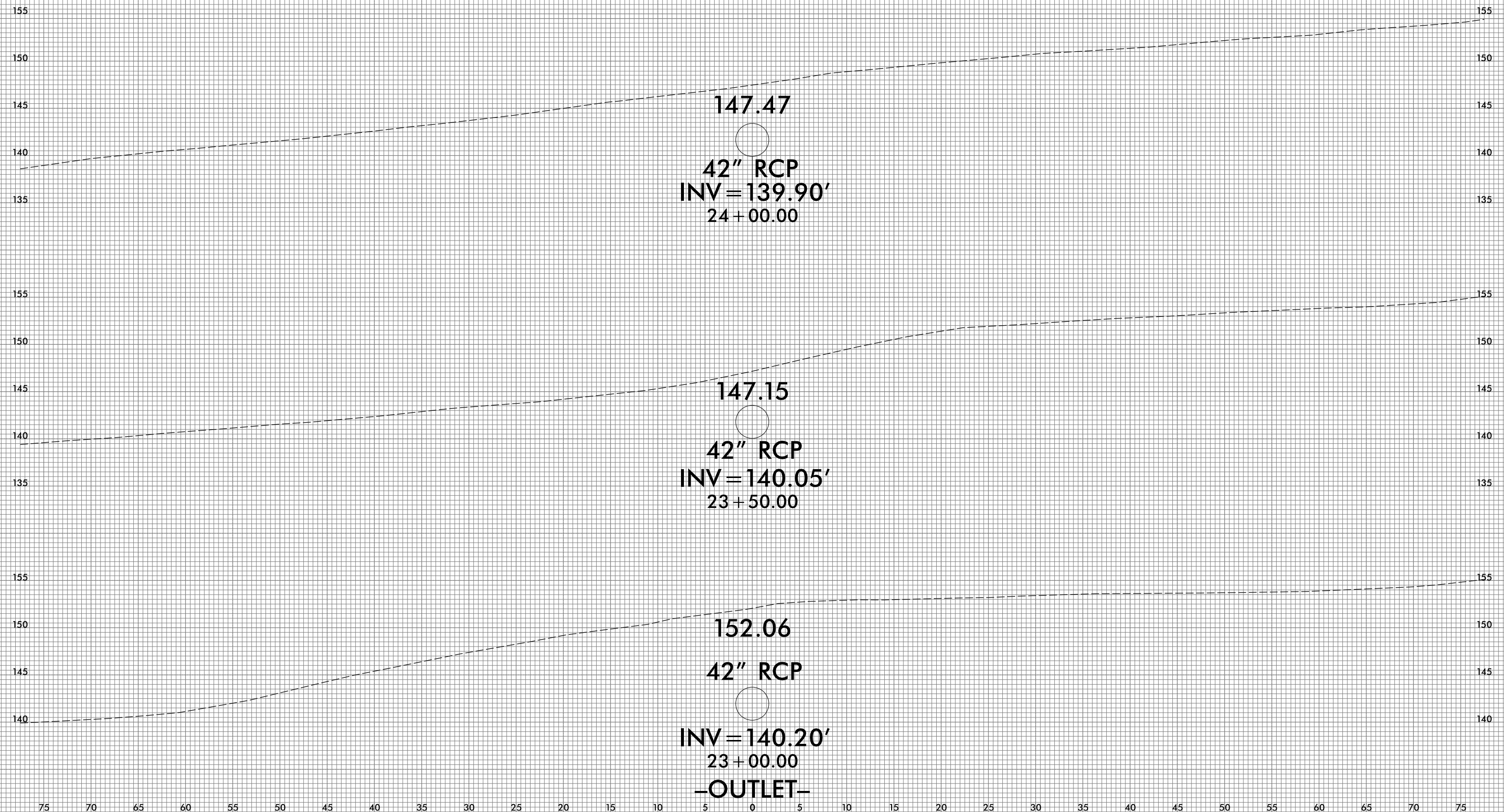

147.47
 42" RCP
 INV = 139.90'
 24 + 00.00

147.15
 42" RCP
 INV = 140.05'
 23 + 50.00

152.06
 42" RCP
 INV = 140.20'
 23 + 00.00
 -OUTLET-

75 70 65 60 55 50 45 40 35 30 25 20 15 10 5 0 5 10 15 20 25 30 35 40 45 50 55 60 65 70 75

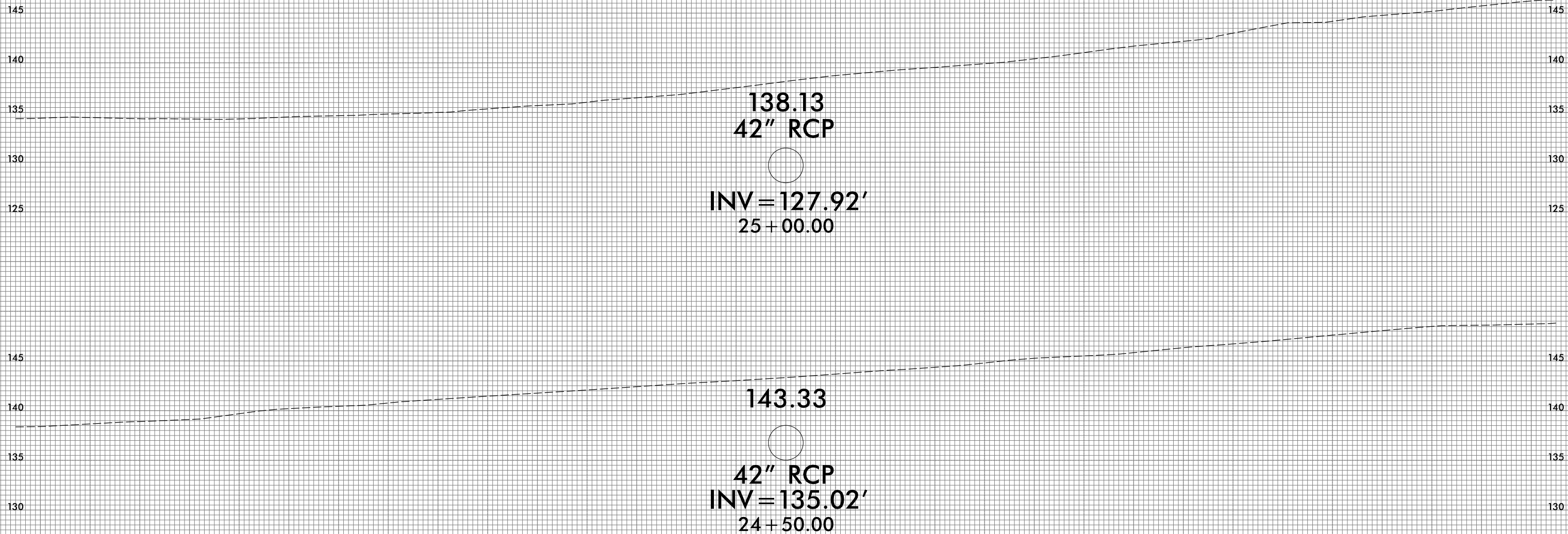

-OUTLET-

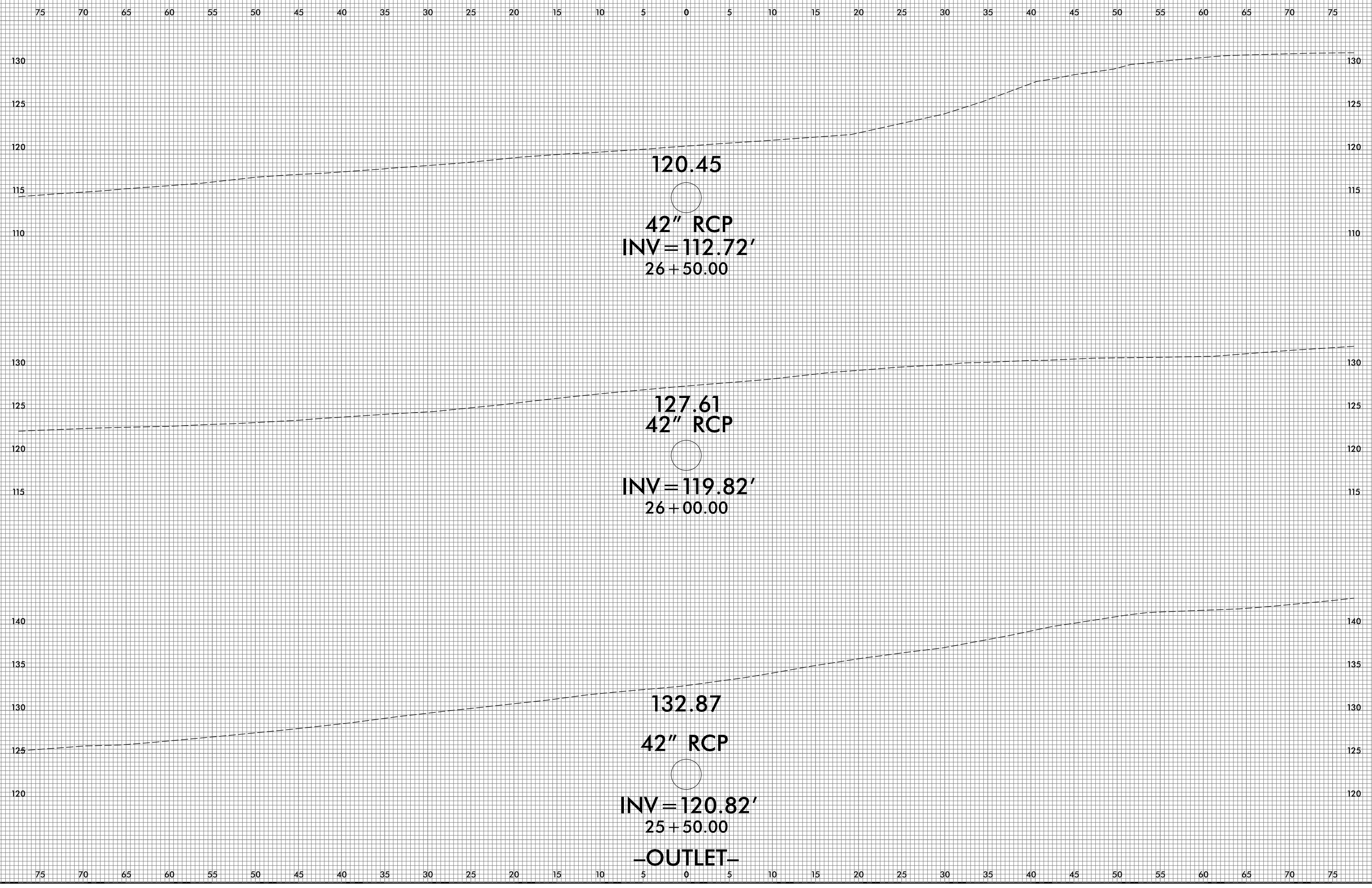

120.45
 ○
 42" RCP
 INV = 112.72'
 26 + 50.00

127.61
 42" RCP
 ○
 INV = 119.82'
 26 + 00.00

132.87
 42" RCP
 ○
 INV = 120.82'
 25 + 50.00
 -OUTLET-

75 70 65 60 55 50 45 40 35 30 25 20 15 10 5 0 5 10 15 20 25 30 35 40 45 50 55 60 65 70 75

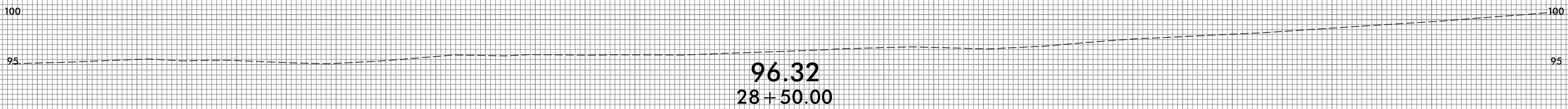

96.32
28+50.00

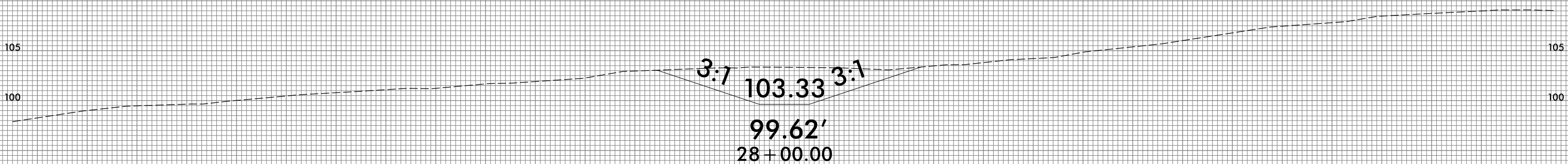

99.62'
28+00.00

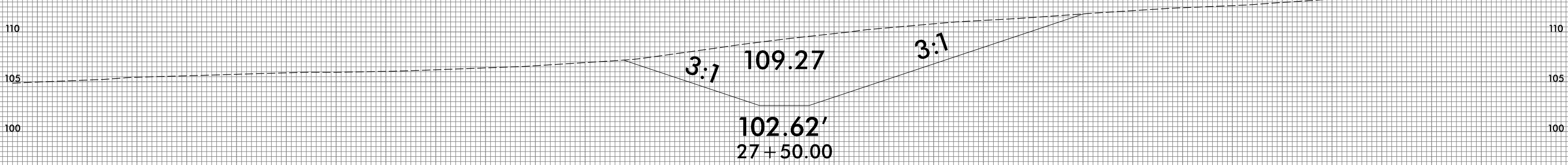

102.62'
27+50.00

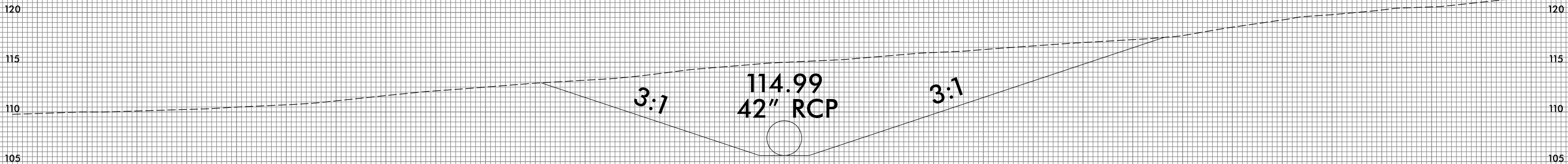

114.99
42" RCP
INV = 105.62
27+00.00

-OUTLET-

75 70 65 60 55 50 45 40 35 30 25 20 15 10 5 0 5 10 15 20 25 30 35 40 45 50 55 60 65 70 75

75 70 65 60 55 50 45 40 35 30 25 20 15 10 5 0 5 10 15 20 25 30 35 40 45 50 55 60 65 70 75

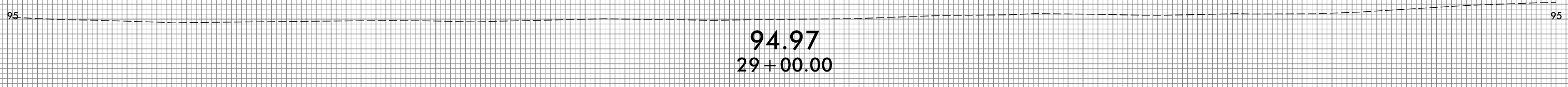
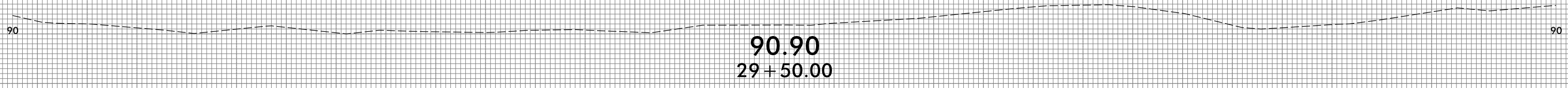

-OUTLET-

75 70 65 60 55 50 45 40 35 30 25 20 15 10 5 0 5 10 15 20 25 30 35 40 45 50 55 60 65 70 75