

CROSS-SECTION INDEX SHEET

| | |
|----------------------------|------------------|
| PROJ. REFERENCE NO. | SHEET NO. |
| U-5783 | X-0 |

| <u>Chain</u> | <u>Beg Sta</u> | <u>End Sta</u> | <u>Sheet No.</u> |
|------------------------------|----------------|----------------|------------------|
| INDEX SHEET | | | X-0 |
| CROSS-SECTION SUMMARY SHEETS | | | X-0A |
| L | 12+00 | 72+20 | X-1 TO X-25 |
| ROUND1 | 10+00 | 12+50 | X-26 TO X-28 |
| ROUND2 | 10+00 | 12+50 | X-29 TO X-31 |
| ROUND3 | 10+00 | 12+50 | X-32 TO X-34 |
| ROUND4 | 10+00 | 12+50 | X-35 TO X-37 |
| Y1 | 10+00 | 16+80 | X-38 TO X-42 |
| Y1A | 20+50 | 22+59.61 | X-43 TO X-44 |
| Y2 | 10+65 | 12+85 | X-45 TO X-46 |
| Y3 | 10+65 | 13+60 | X-47 TO X-49 |
| Y4 | 10+08 | 12+19.85 | X-50 |
| Y5 | 10+00 | 12+32.30 | X-51 TO X-52 |
| Y6 | 10+20 | 11+86.77 | X-53 |
| Y7 | 10+65 | 12+90 | X-54 |
| Y8 | 10+25.60 | 12+70 | X-55 TO X-56 |
| Y9 | 10+25.89 | 12+00 | X-57 |
| Y10 | 10+30 | 11+27.12 | X-58 TO X-59 |
| Y11 | 10+50 | 11+74.25 | X-60 TO X-61 |
| Y12 | 9+00 | 15+62.63 | X-62 TO X-66 |
| Y13 | 10+37.76 | 16+05 | X-67 TO X-70 |
| GREENWAY1 | 201+55 | 206+00 | X-71 TO X-75 |
| GREENWAY 2 | 212+65 | 217+20 | X-76 TO X-78 |

8/23/99

| | | |
|---------|---------------------|-----------|
| 0 2.5 5 | PROJ. REFERENCE NO. | SHEET NO. |
| | U-5783 | X-1 |

75 70 65 60 55 50 45 40 35 30 25 20 15 10 5 0 5 10 15 20 25 30 35 40 45 50 55 60 65 70 75

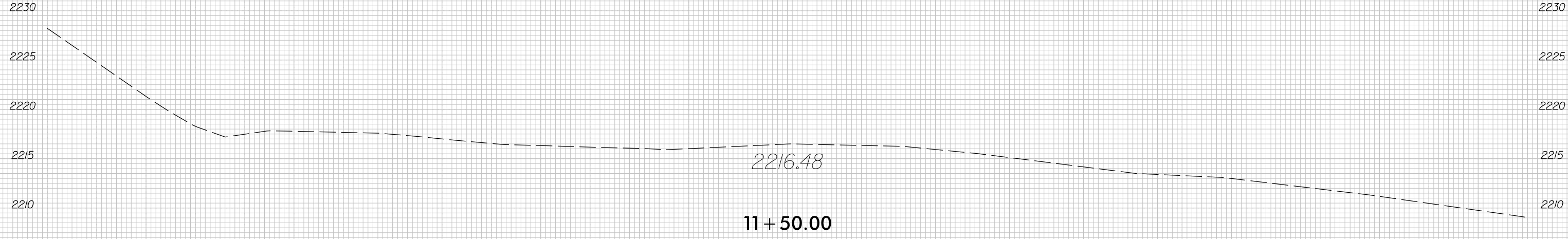
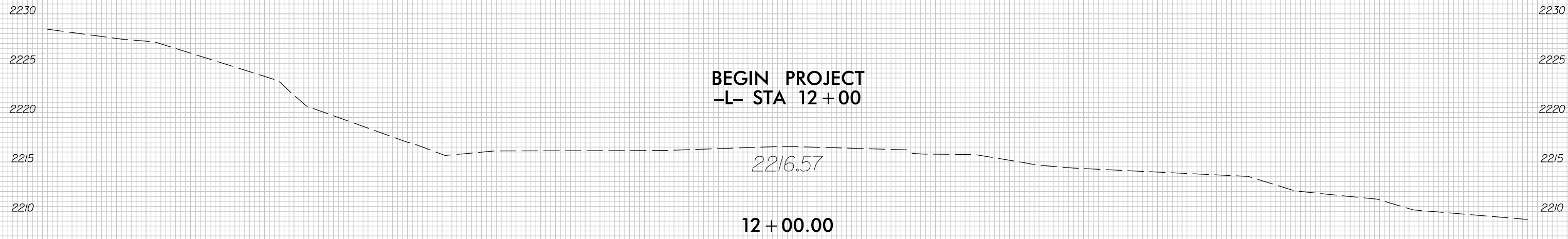
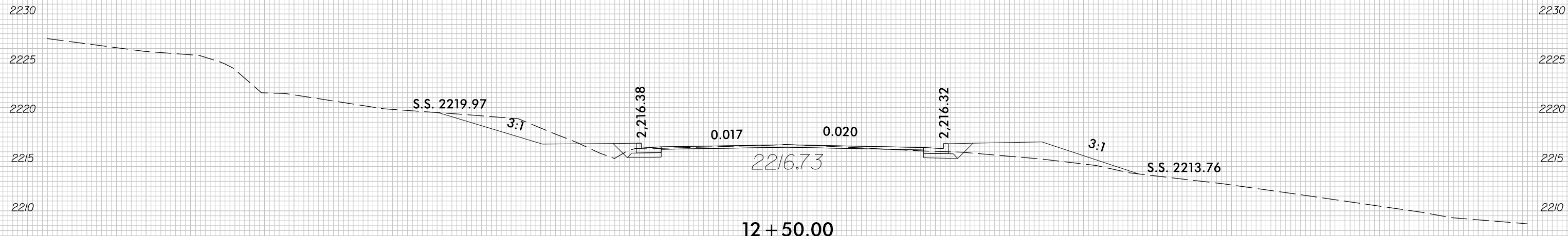

75 70 65 60 55 50 45 40 35 30 25 20 15 10 5 0 5 10 15 20 25 30 35 40 45 50 55 60 65 70 75

2:27:50 PM
I:\3572 US 64 Widening (U-5783)\06 U-5783\Roadway\XSC\U5783-rdy-xpl.L.dgn
Dgross

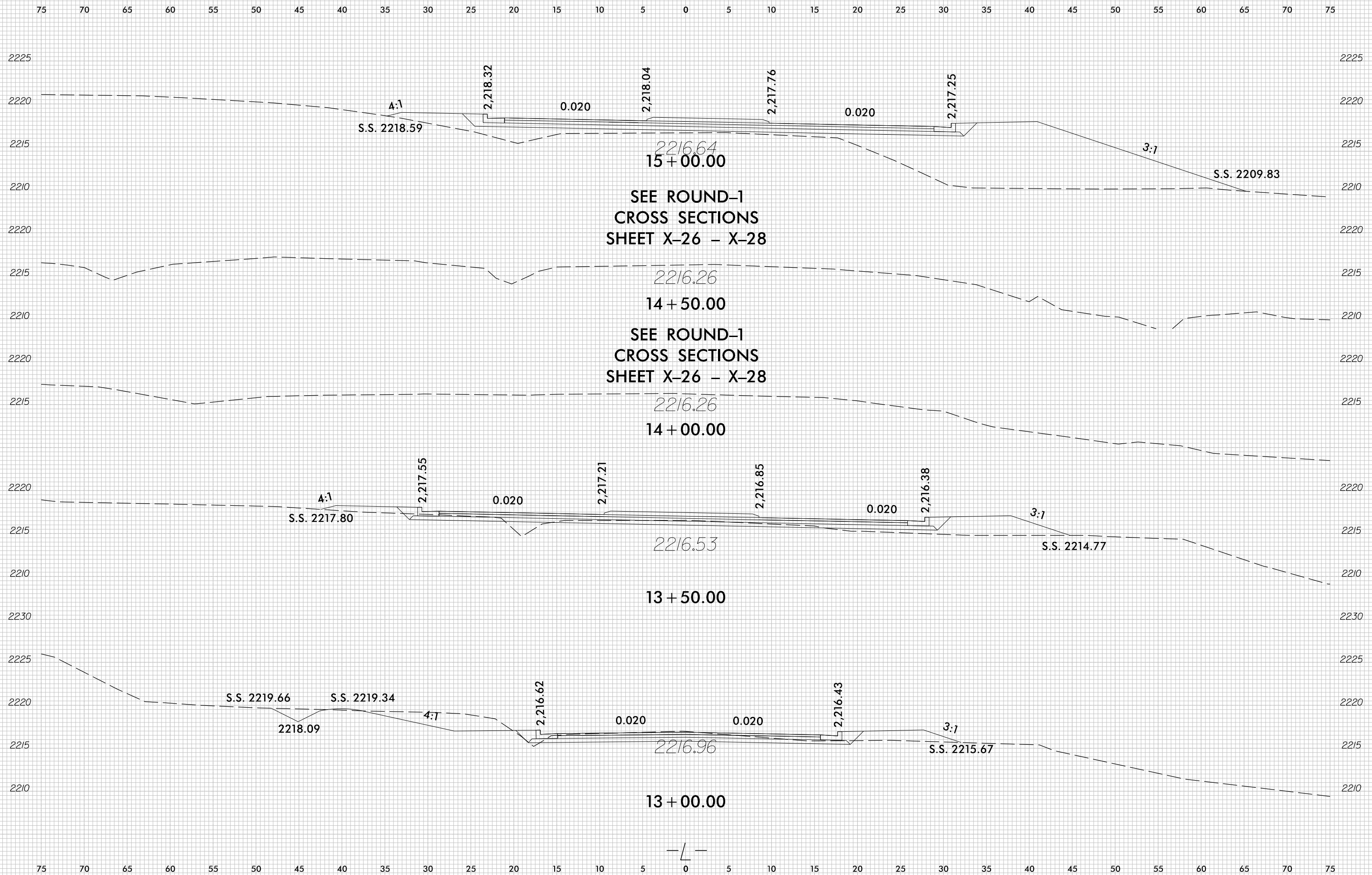

8/23/99

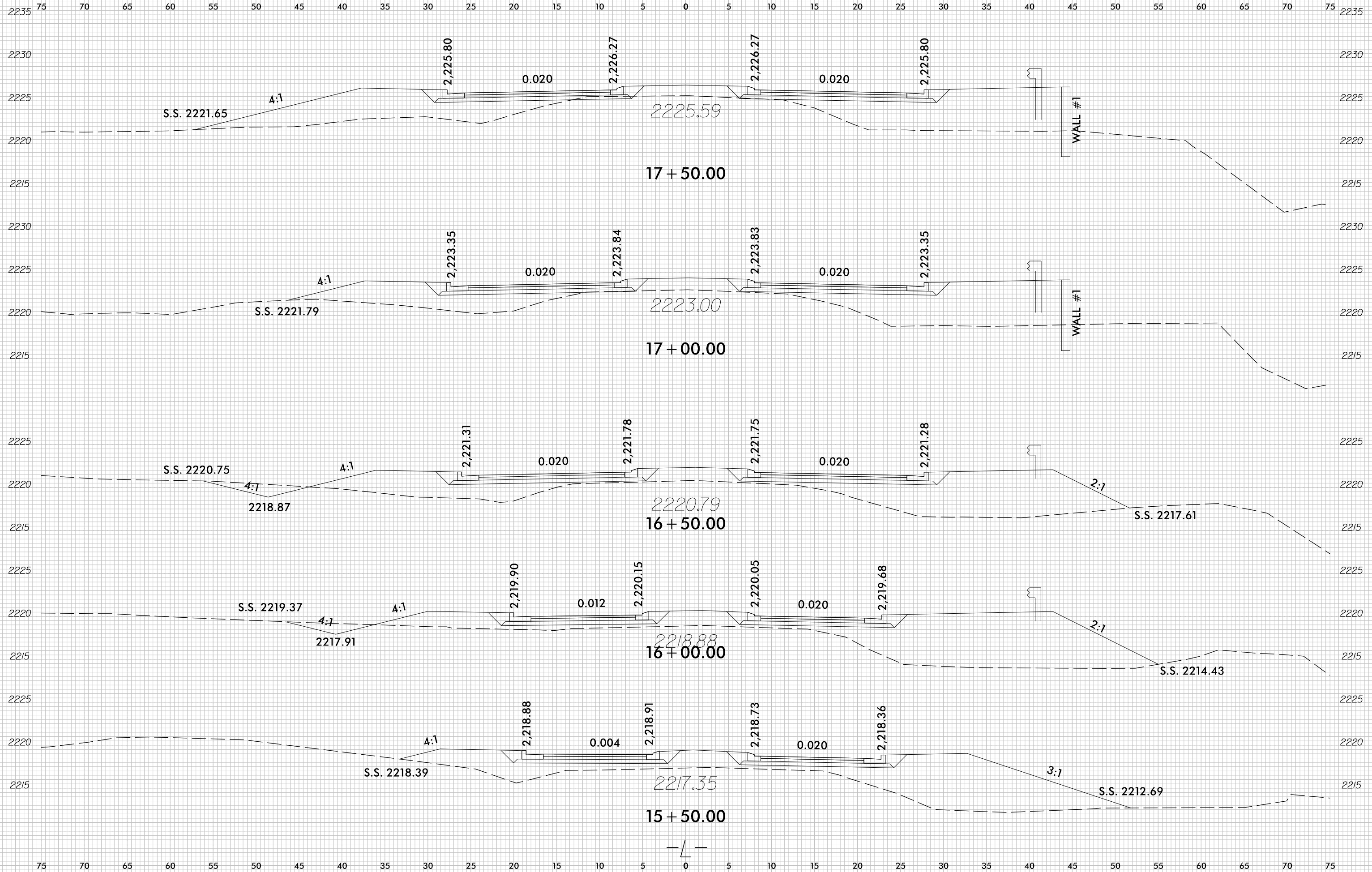

2:27:31 PM 8/23/99 U-5783\Roadway\XSC\U5783.dwg - xpl.L.dgn

8/23/99

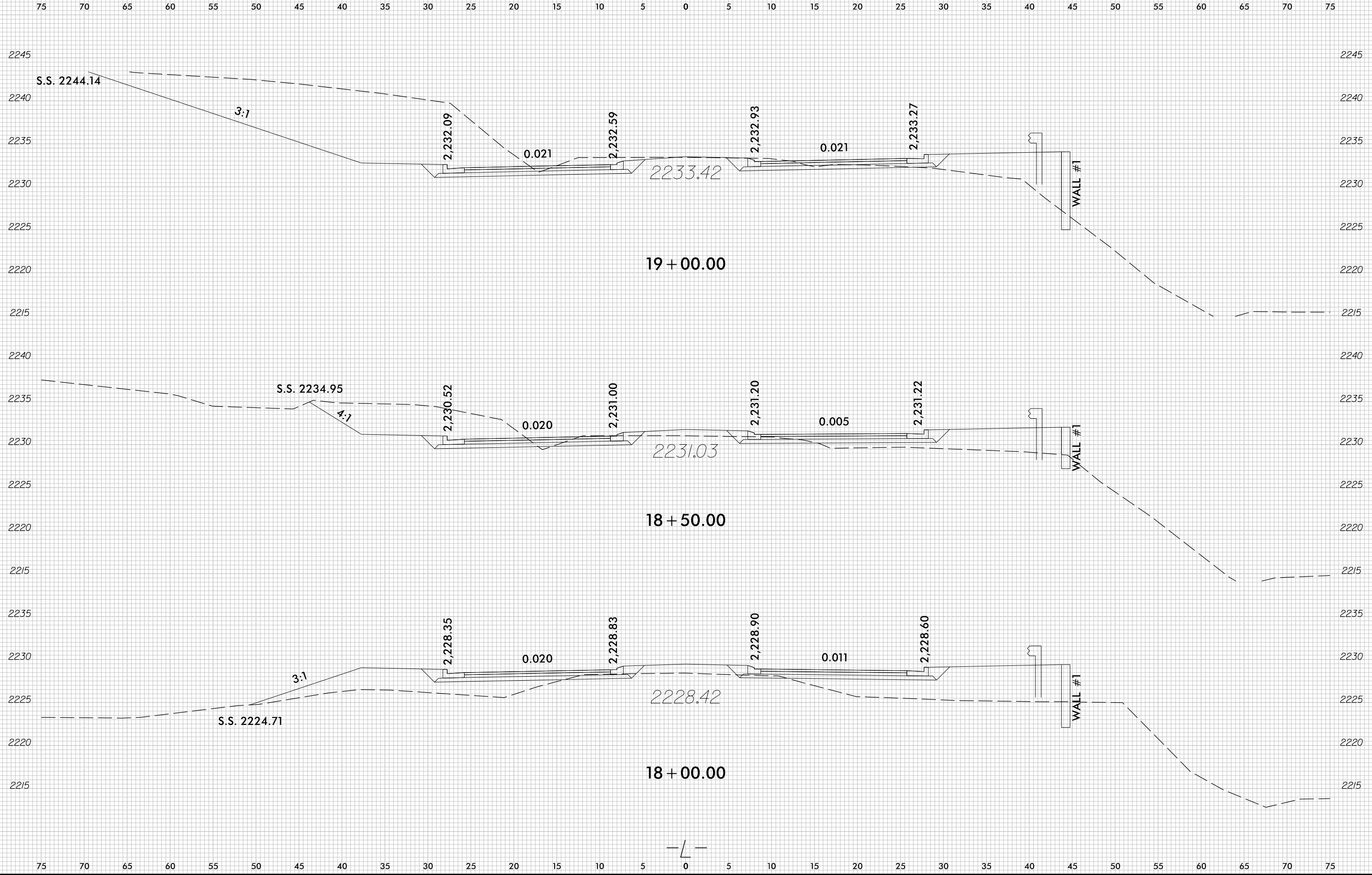

2:27:52 PM
I:\3572 US 64 Widening (U-5783)\06 U-5783\Roadway\XSC\U5783--dy--xp1.L.dgn
Dgross

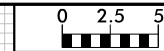

75 70 65 60 55 50 45 40 35 30 25 20 15 10 5 0 5 10 15 20 25 30 35 40 45 50 55 60 65 70 75

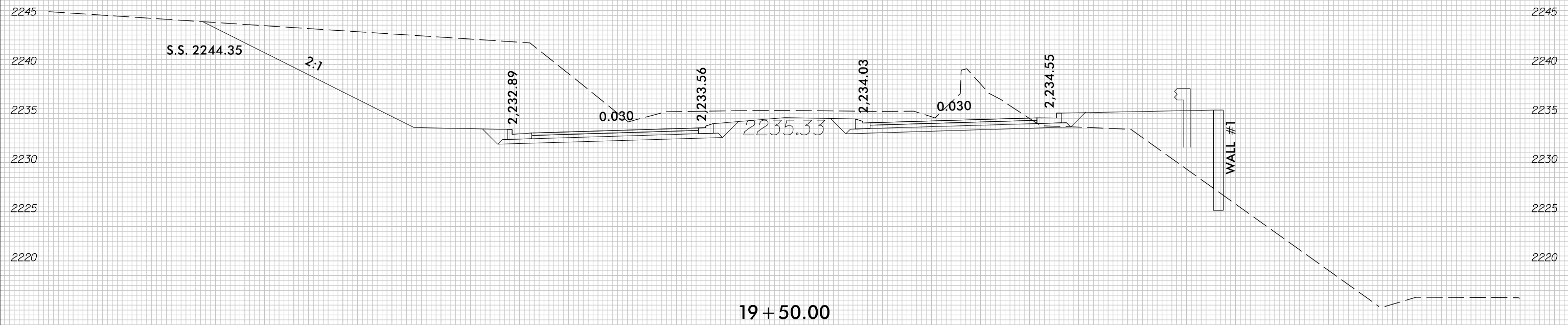
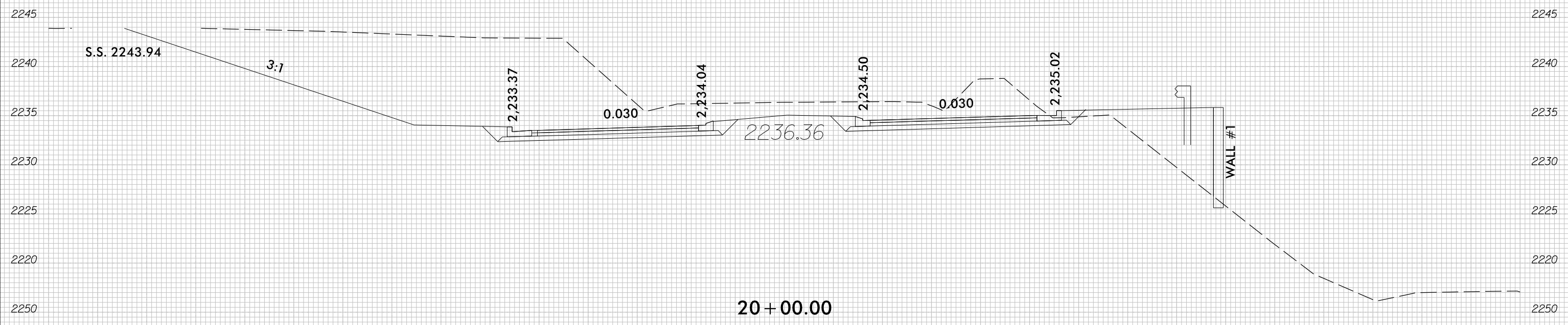

75 70 65 60 55 50 45 40 35 30 25 20 15 10 5 0 5 10 15 20 25 30 35 40 45 50 55 60 65 70 75

8/23/99

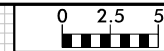

| | |
|---------------------|-----------|
| PROJ. REFERENCE NO. | SHEET NO. |
| U-5783 | X-6 |

75 70 65 60 55 50 45 40 35 30 25 20 15 10 5 0 5 10 15 20 25 30 35 40 45 50 55 60 65 70 75

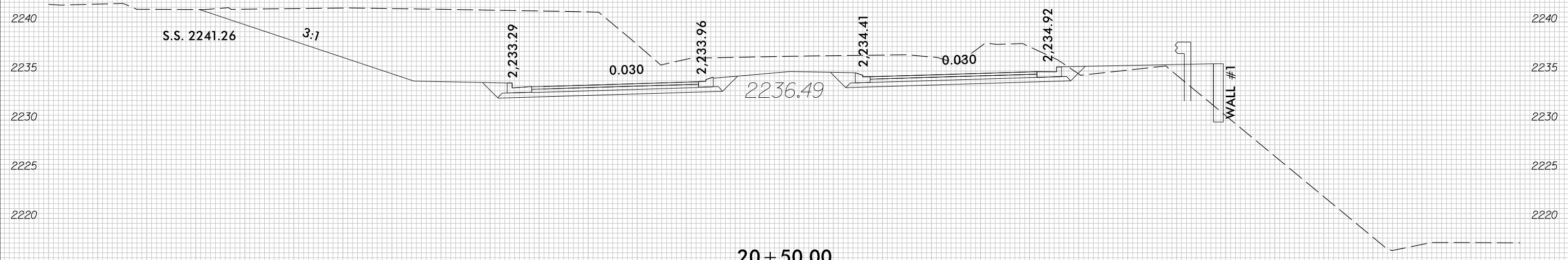
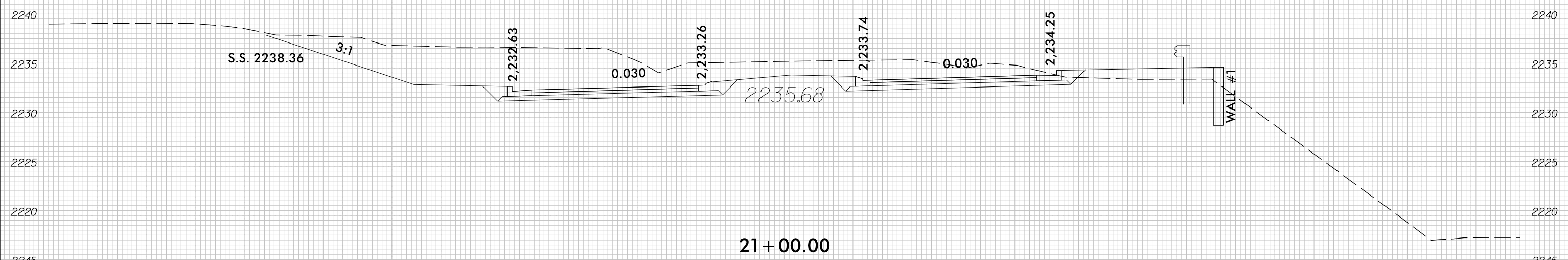
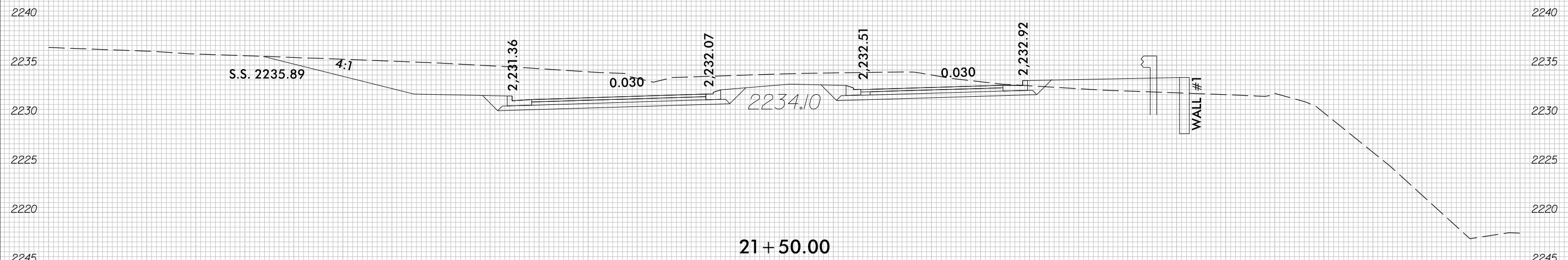

75 70 65 60 55 50 45 40 35 30 25 20 15 10 5 0 5 10 15 20 25 30 35 40 45 50 55 60 65 70 75

2:27:33 PM
 I:\3572 US 64 Widening (U-5783)\06 U-5783\Roadway\XSC\U5783-rdy-xpl.L.dgn
 dgross

8/23/99

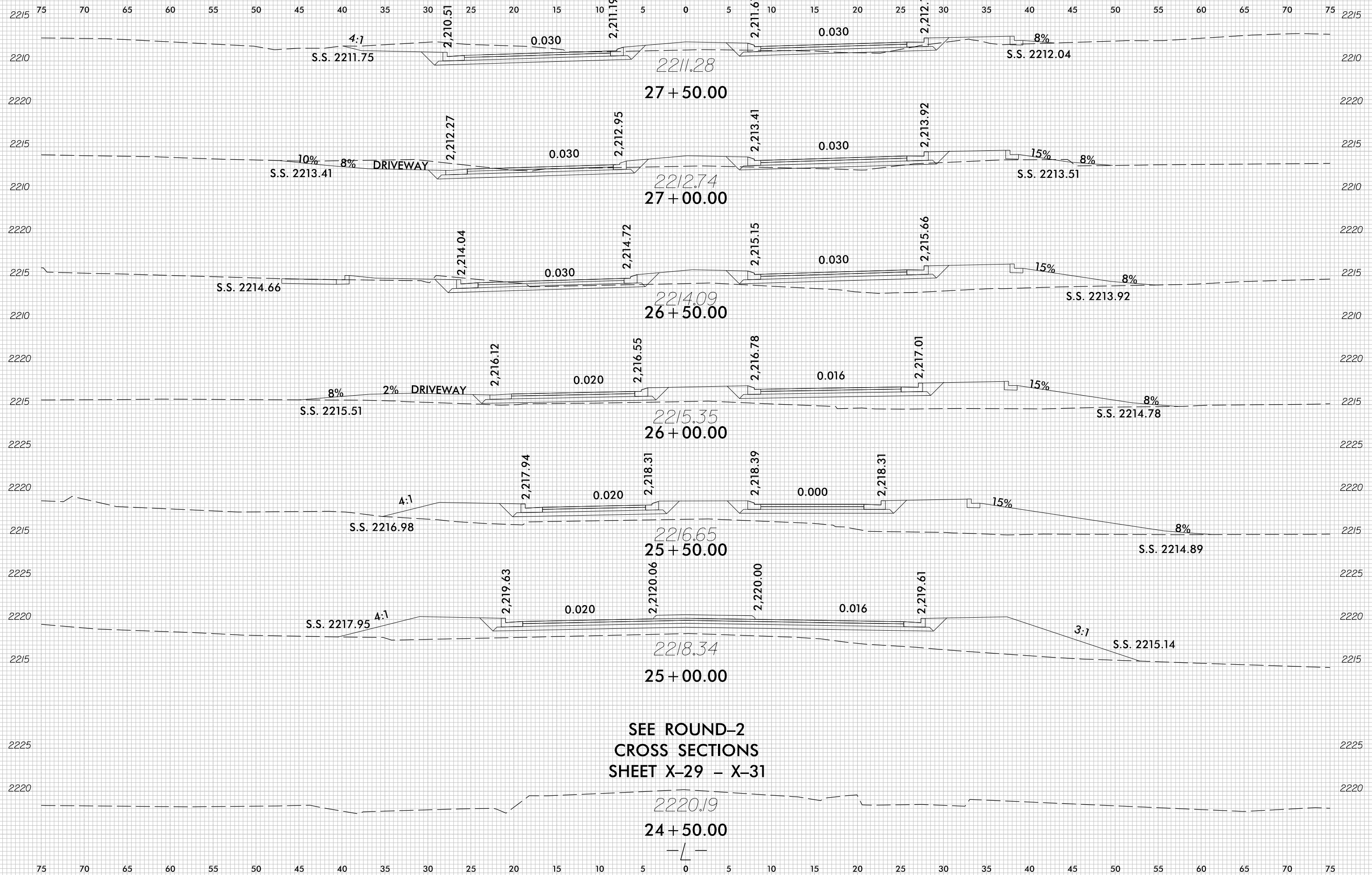

SEE ROUND-2
CROSS SECTIONS
SHEET X-29 - X-31

2:27:34 PM
I:\3572 US 64 Widening (U-5783)\06 U-5783\Roadway\XSC\U5783.dwg -xp1.L.dgn
dgross

8/23/99

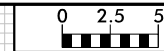

| | |
|---------------------|-----------|
| PROJ. REFERENCE NO. | SHEET NO. |
| U-5783 | X-9 |

75 70 65 60 55 50 45 40 35 30 25 20 15 10 5 0 5 10 15 20 25 30 35 40 45 50 55 60 65 70 75

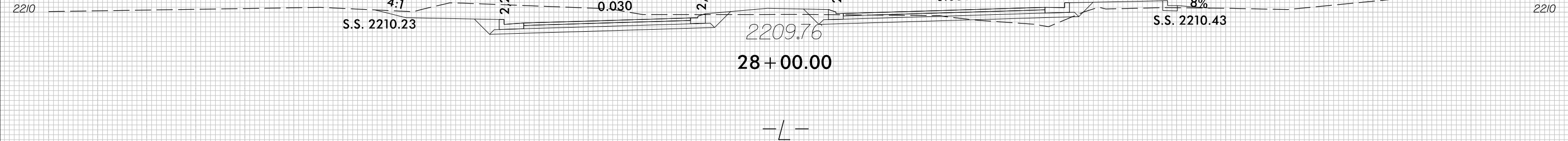
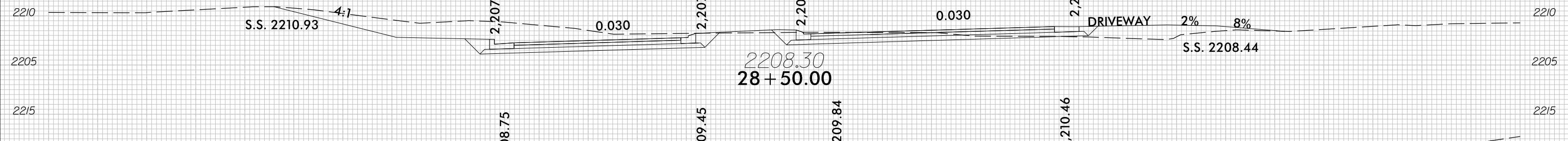
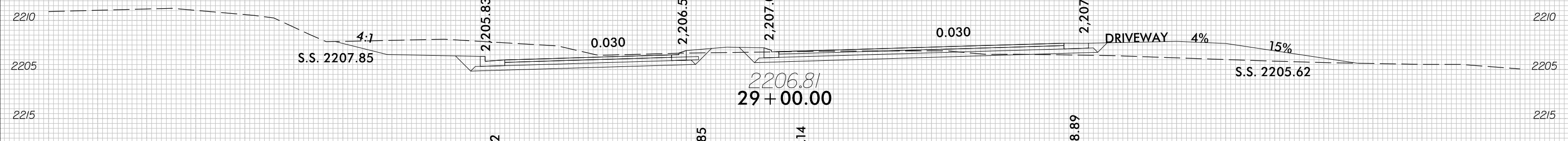
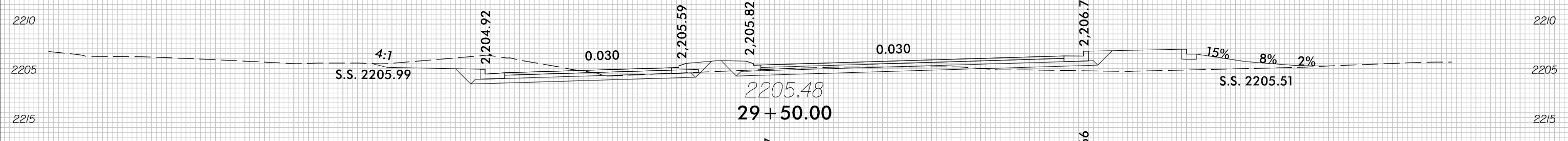
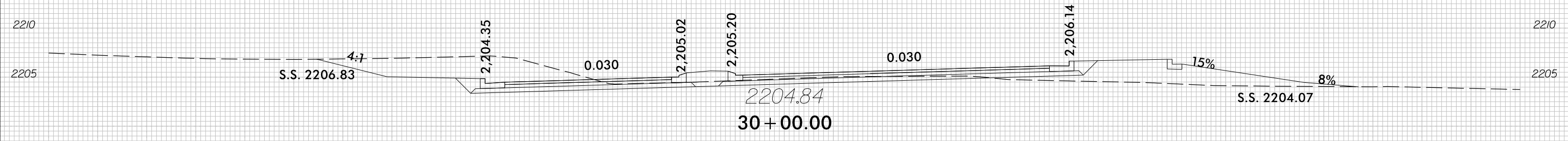
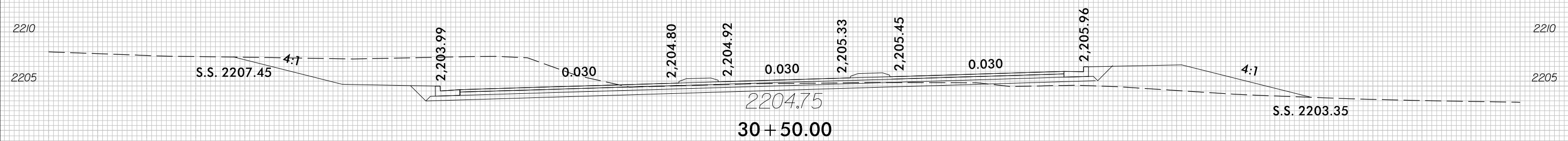

75 70 65 60 55 50 45 40 35 30 25 20 15 10 5 0 5 10 15 20 25 30 35 40 45 50 55 60 65 70 75

2:27:55 PM
 I:\3572 US 64 Widening (U-5783)\06 U-5783\Roadway\XSC\U5783_rdy_xpl.L.dgn
 c:\pross

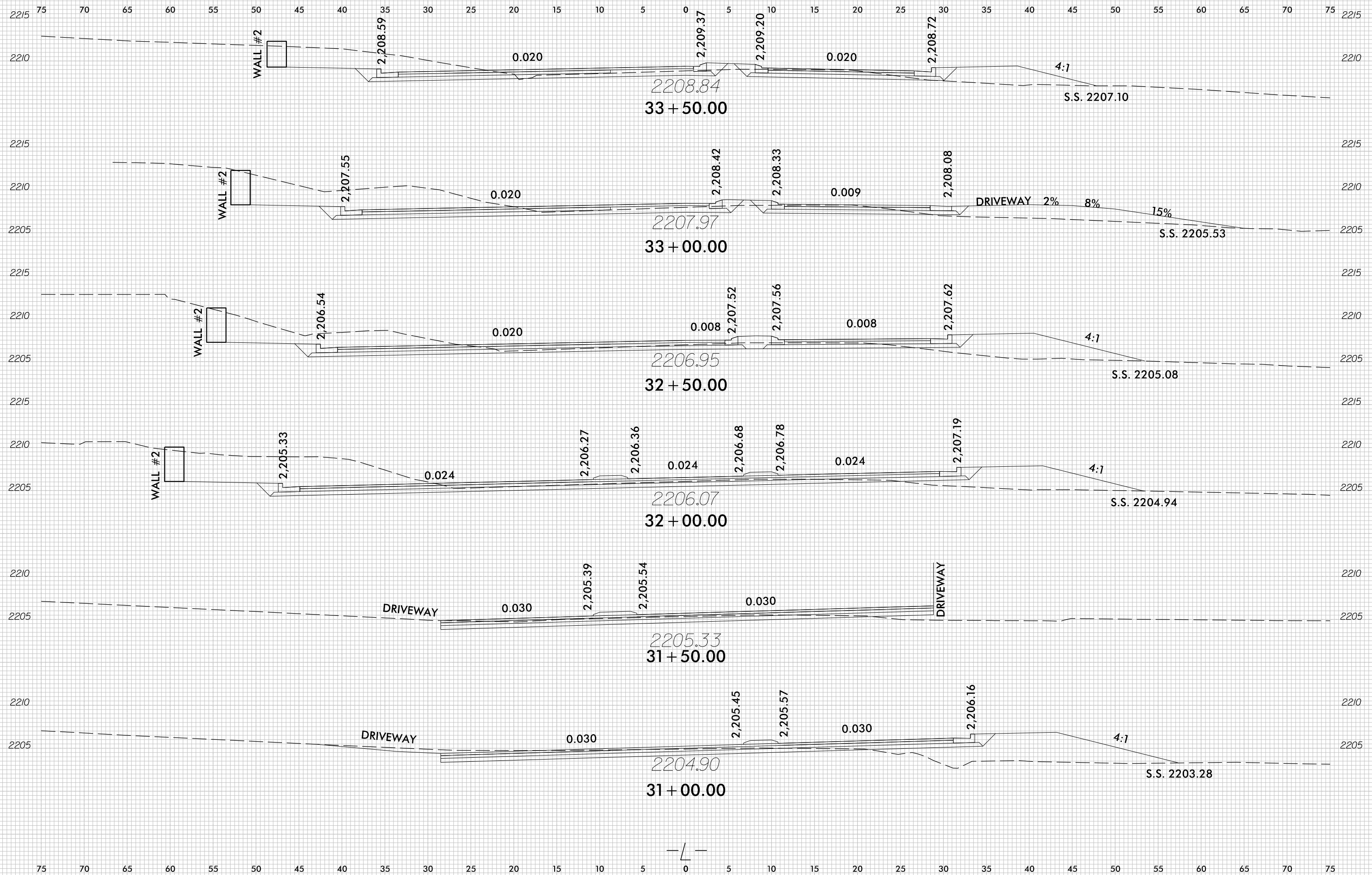

8/23/99

| | | |
|---------|---------------------|-----------|
| 0 2.5 5 | PROJ. REFERENCE NO. | SHEET NO. |
| | U-5783 | X-11 |

75 70 65 60 55 50 45 40 35 30 25 20 15 10 5 0 5 10 15 20 25 30 35 40 45 50 55 60 65 70 75

SEE ROUND-3
CROSS SECTIONS
SHEET X-32 - X-34

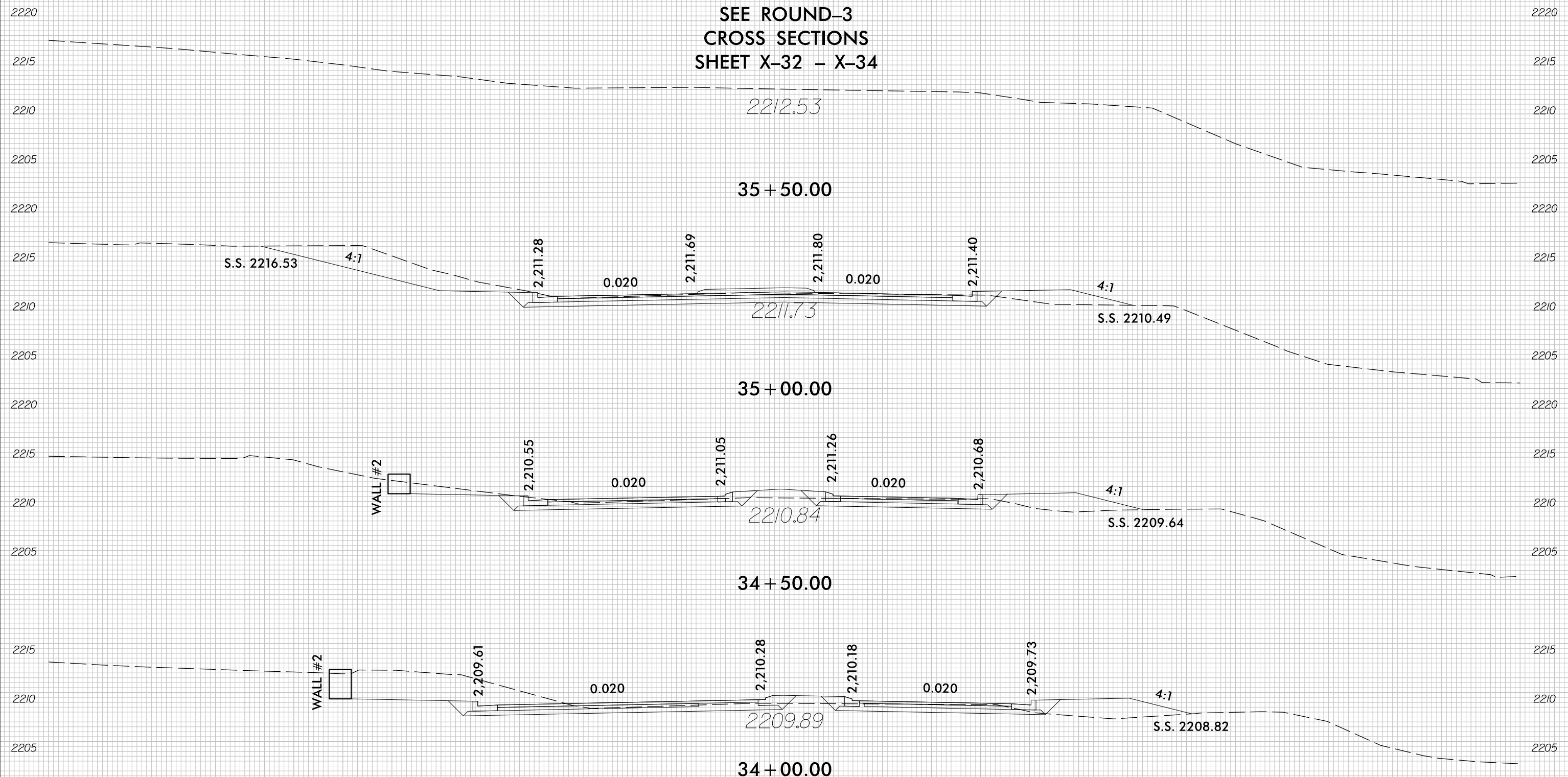

—L—

2:27:56 PM
I:\3572 US 64 Widening (U-5783)\06 U-5783\Roadway\XSC\U5783--dj-xpl.L.dgn
dgross

8/23/99

| | | |
|---------|---------------------|-----------|
| 0 2.5 5 | PROJ. REFERENCE NO. | SHEET NO. |
| | U-5783 | X-12 |

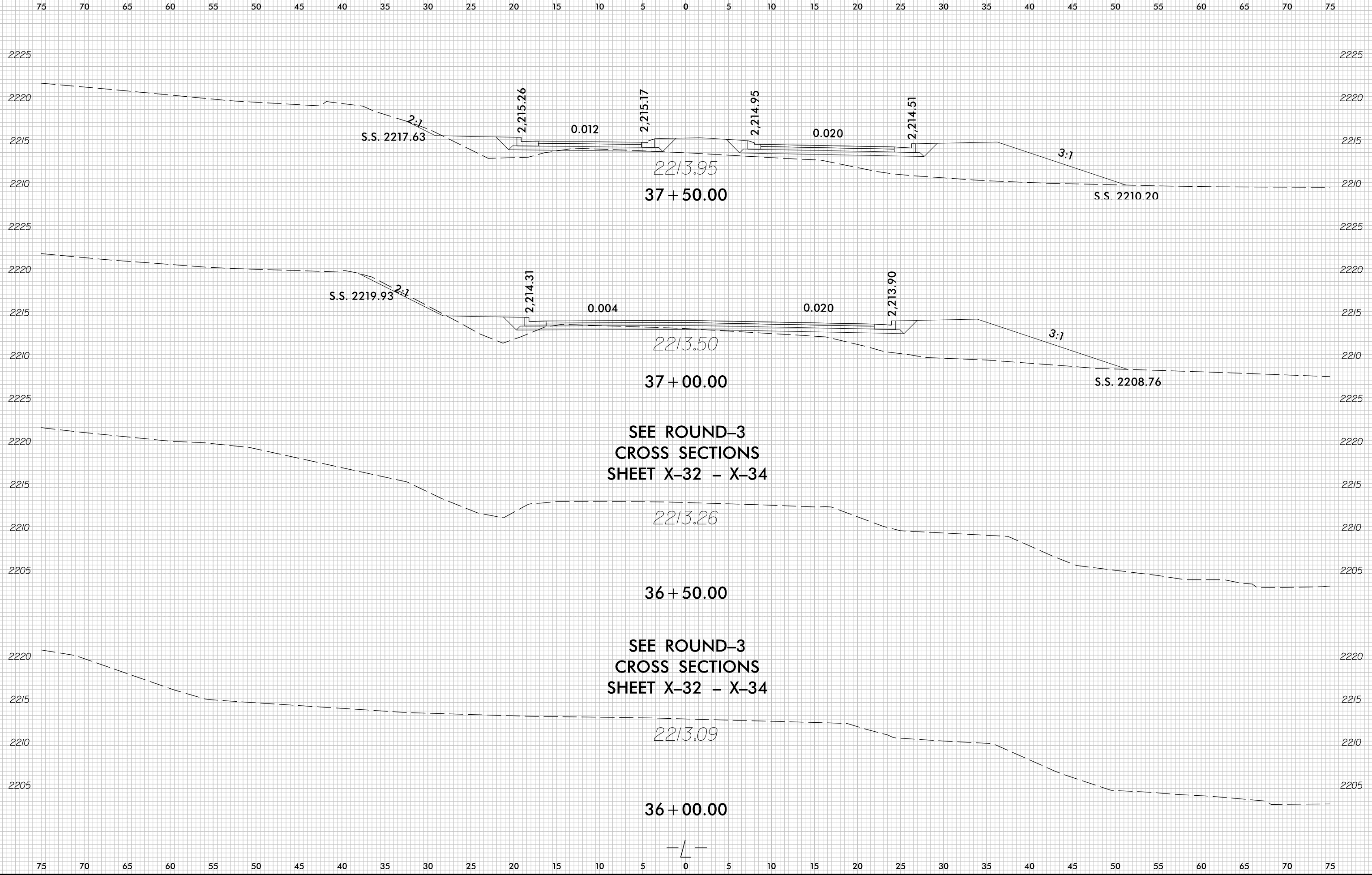

2:27:37 PM
I:\3572 US 64 Widening (U-5783)\06 U-5783\Roadway\XSC\U5783--rdj--xpl.L.dgn
Dgross

8/23/99

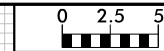

| | |
|---------------------|-----------|
| PROJ. REFERENCE NO. | SHEET NO. |
| U-5783 | X-13 |

75 70 65 60 55 50 45 40 35 30 25 20 15 10 5 0 5 10 15 20 25 30 35 40 45 50 55 60 65 70 75

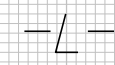
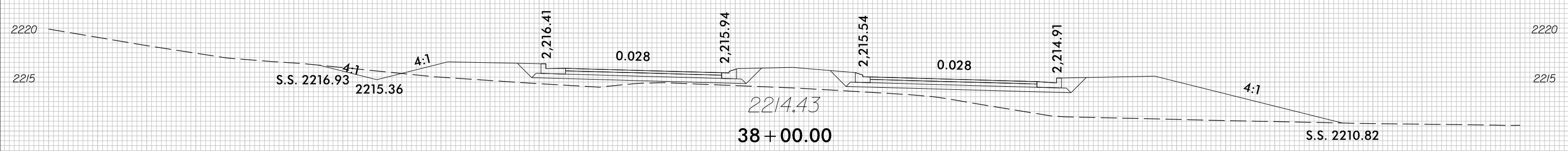
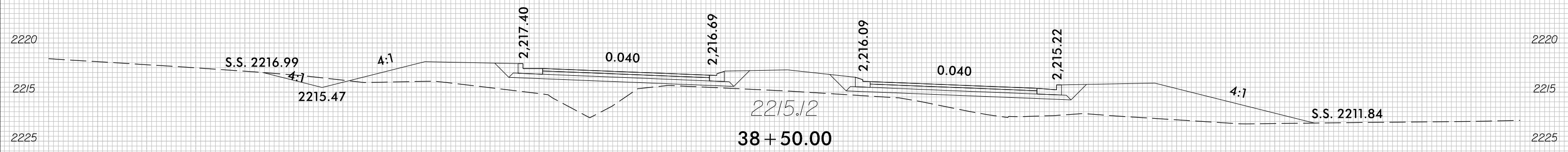
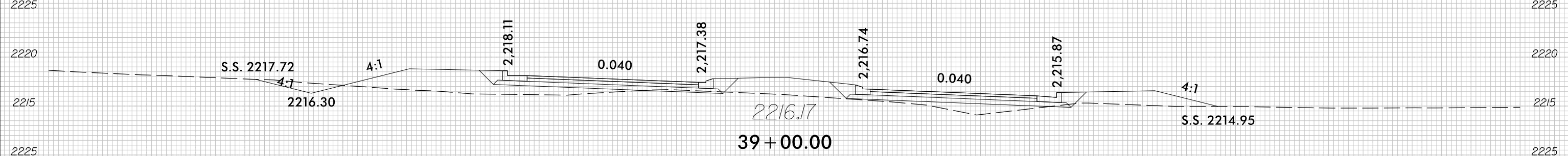
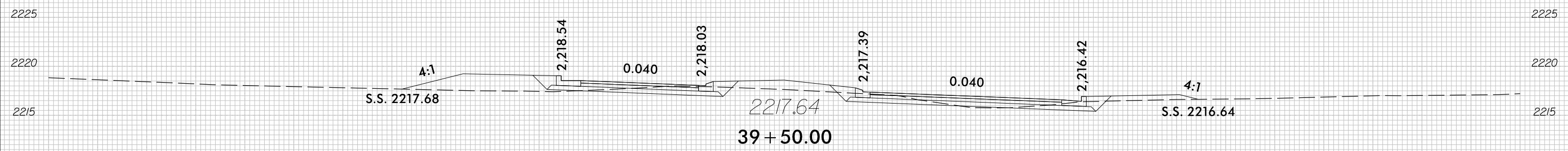
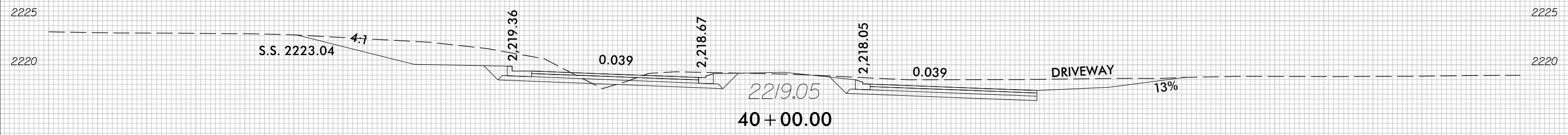

2:27:38 PM
 I:\3572 US 64 Widening (U-5783)\06 U-5783\Roadway\XSC\U5783-rdy-xpl.L.dgn
 c:\p\ross

75 70 65 60 55 50 45 40 35 30 25 20 15 10 5 0 5 10 15 20 25 30 35 40 45 50 55 60 65 70 75

8/23/99

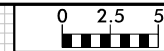

| | |
|---------------------|-----------|
| PROJ. REFERENCE NO. | SHEET NO. |
| U-5783 | X-14 |

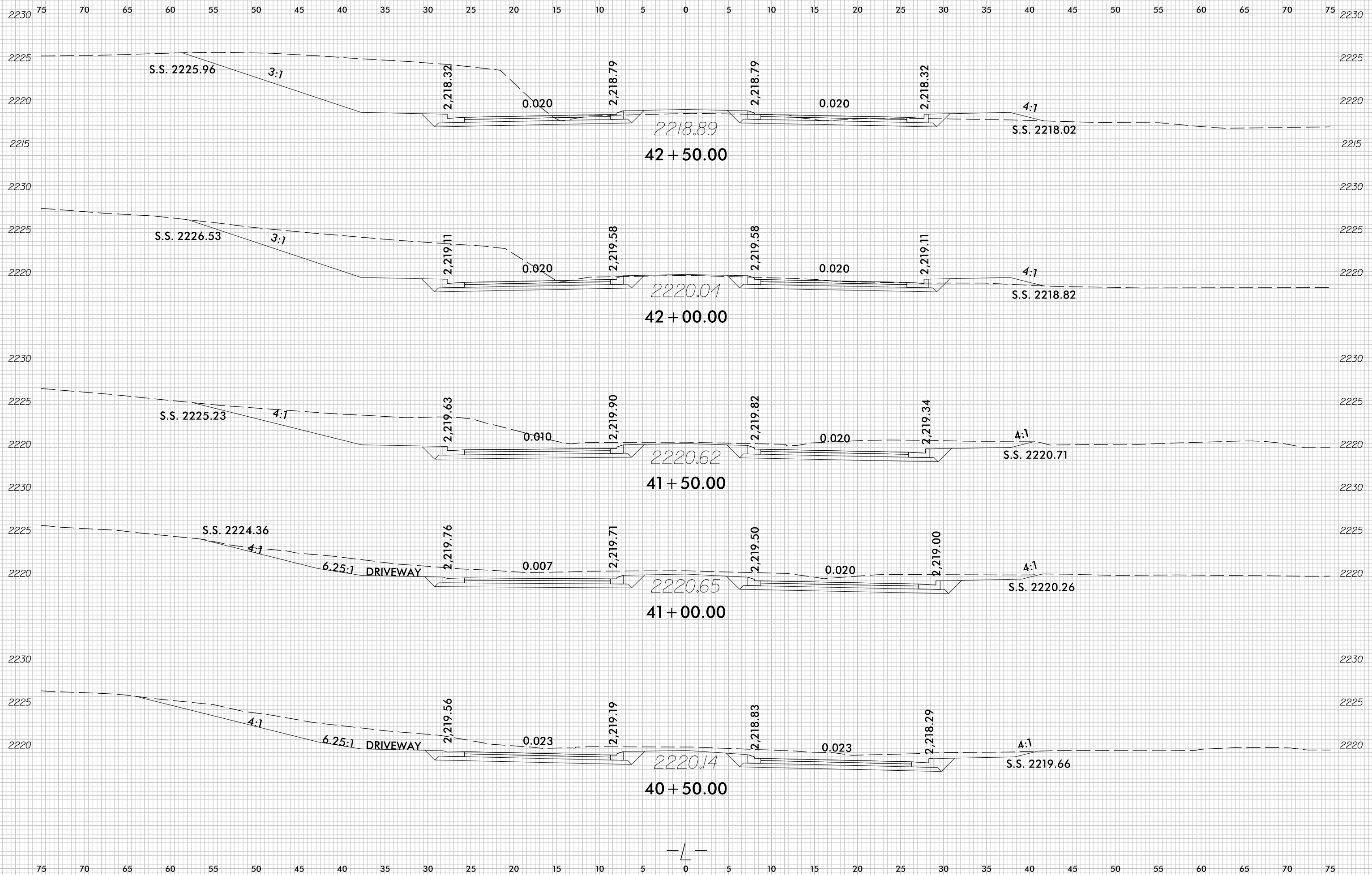

2:27:38 PM
I:\3572 US 64 Widening (U-5783)\06 U-5783\Roadway\XSC\U5783--rdj--xpl.L.dgn
gpross

8/23/99

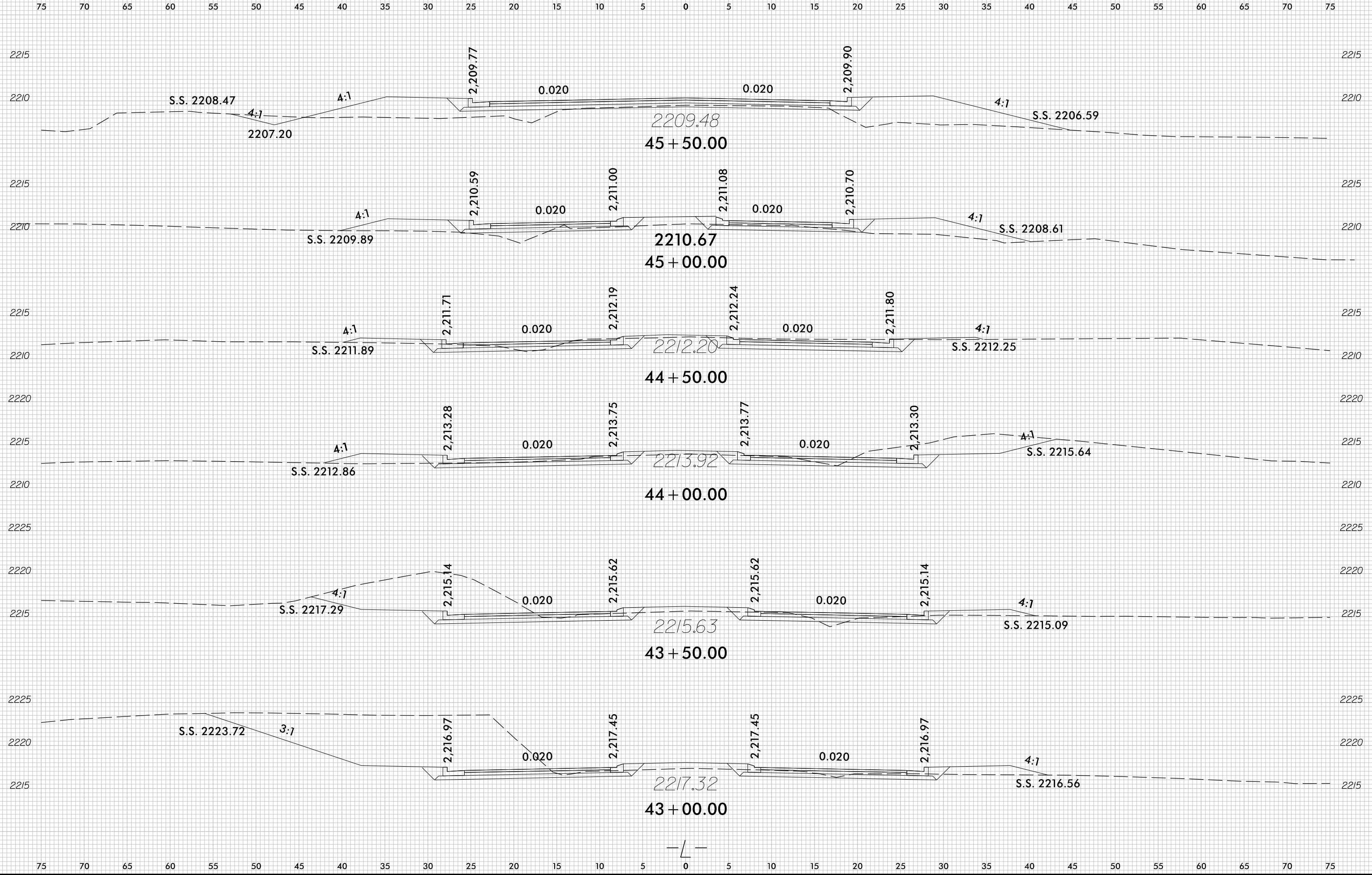

2:27:59 PM
I:\3572 US 64 Widening (U-5783)\06 U-5783\Roadway\XSC\U5783.dwg - xpl.L.dgn
dgross

8/23/99

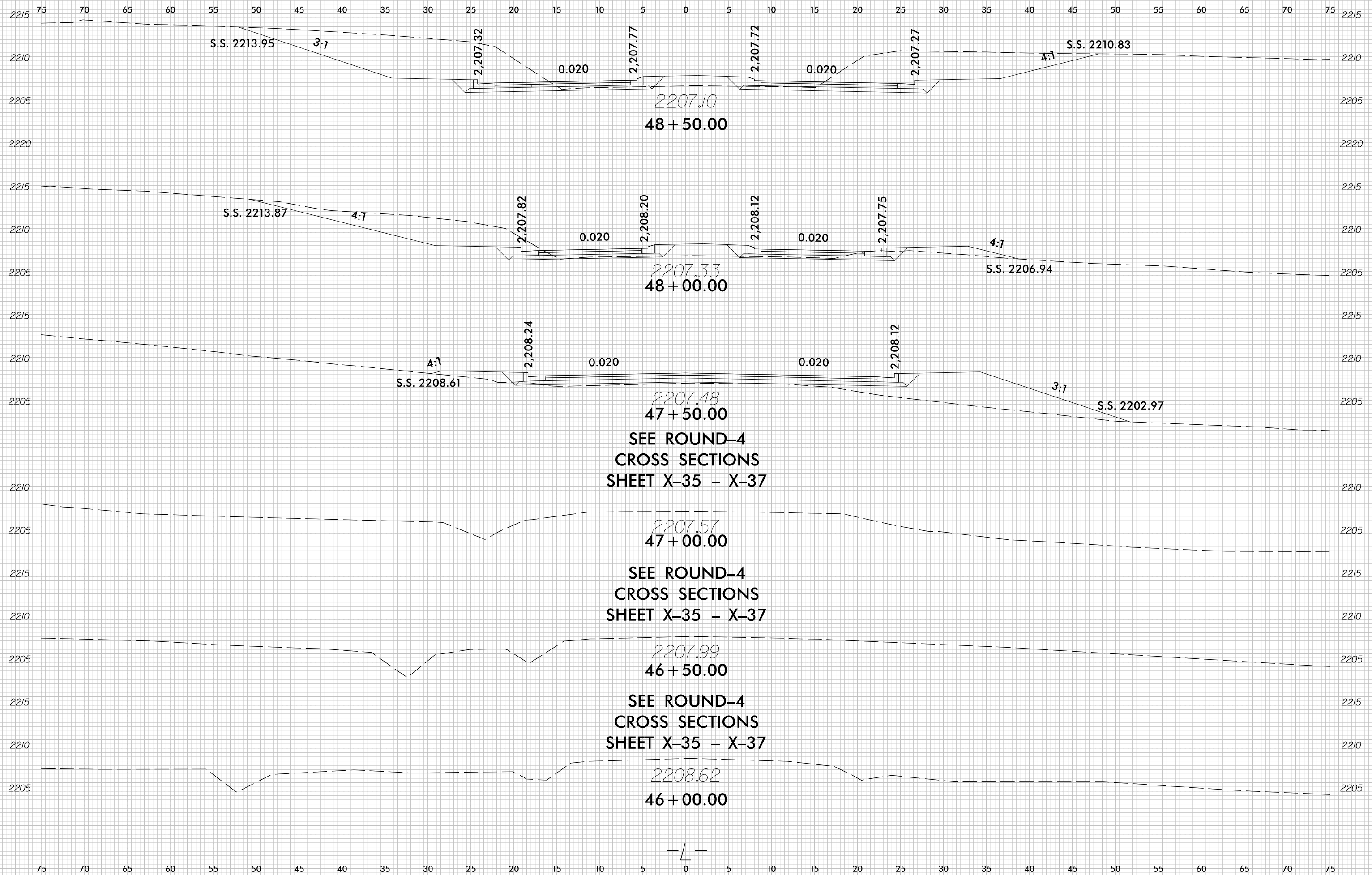

SEE ROUND-4
CROSS SECTIONS
SHEET X-35 - X-37

SEE ROUND-4
CROSS SECTIONS
SHEET X-35 - X-37

SEE ROUND-4
CROSS SECTIONS
SHEET X-35 - X-37

2:27:40 PM
I:\3572 US 64 Widening (U-5783)\06 U-5783\Roadway\XSC\U5783-rdy-xpl.L.dgn
ogross

8/23/99

| | | |
|---------|-------------------------------|-------------------|
| 0 2.5 5 | PROJ. REFERENCE NO. U-5783 | SHEET NO. X-17 |
|---------|-------------------------------|-------------------|

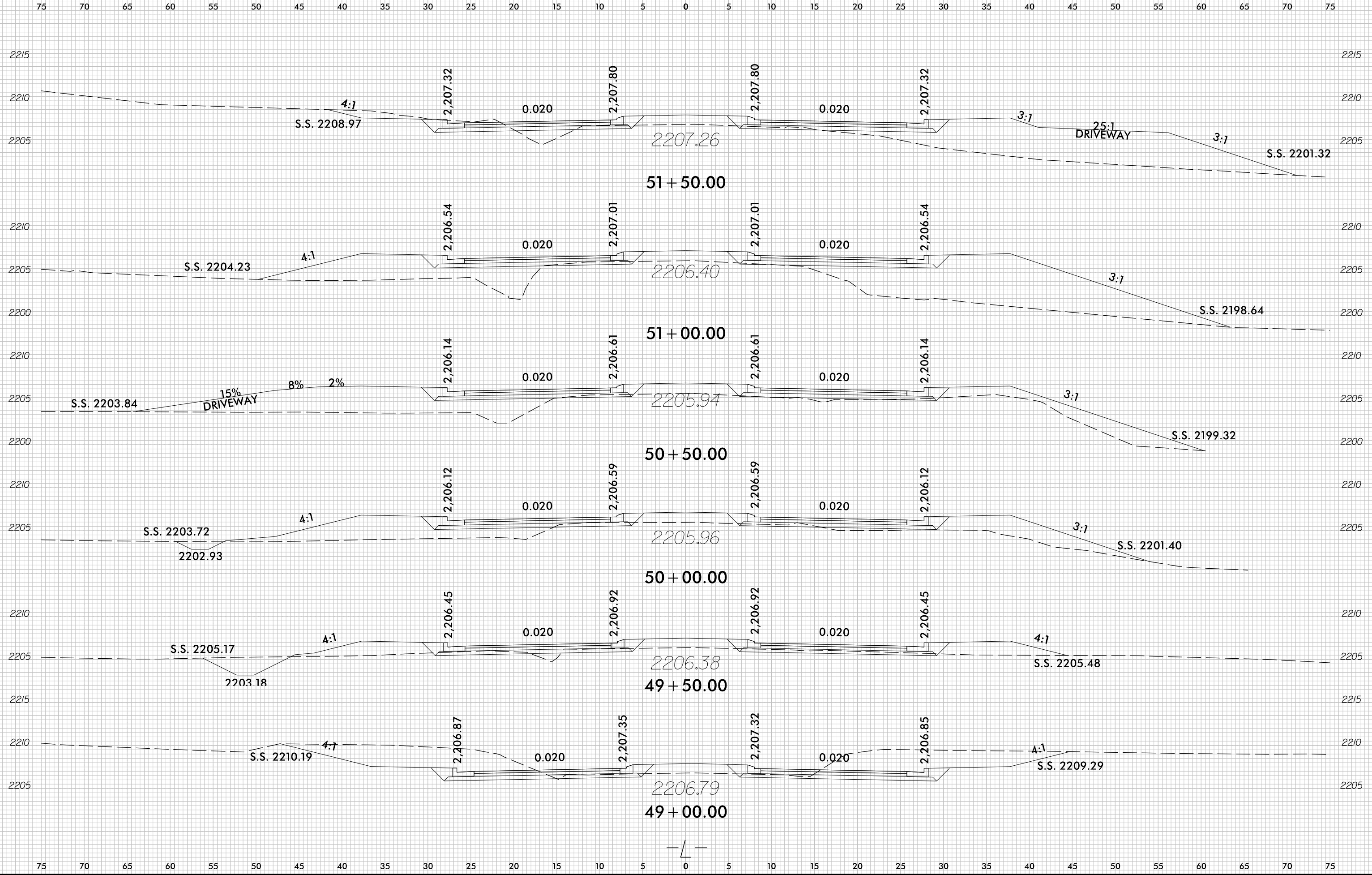

2:27:40 PM
I:\3572 US 64 Widening (U-5783)\06 U-5783\Roadway\XSC\U5783--dy.xpl.L.dgn
D:\gross

8/23/99

| | | |
|---------|-------------------------------|-------------------|
| 0 2.5 5 | PROJ. REFERENCE NO. U-5783 | SHEET NO. X-18 |
|---------|-------------------------------|-------------------|

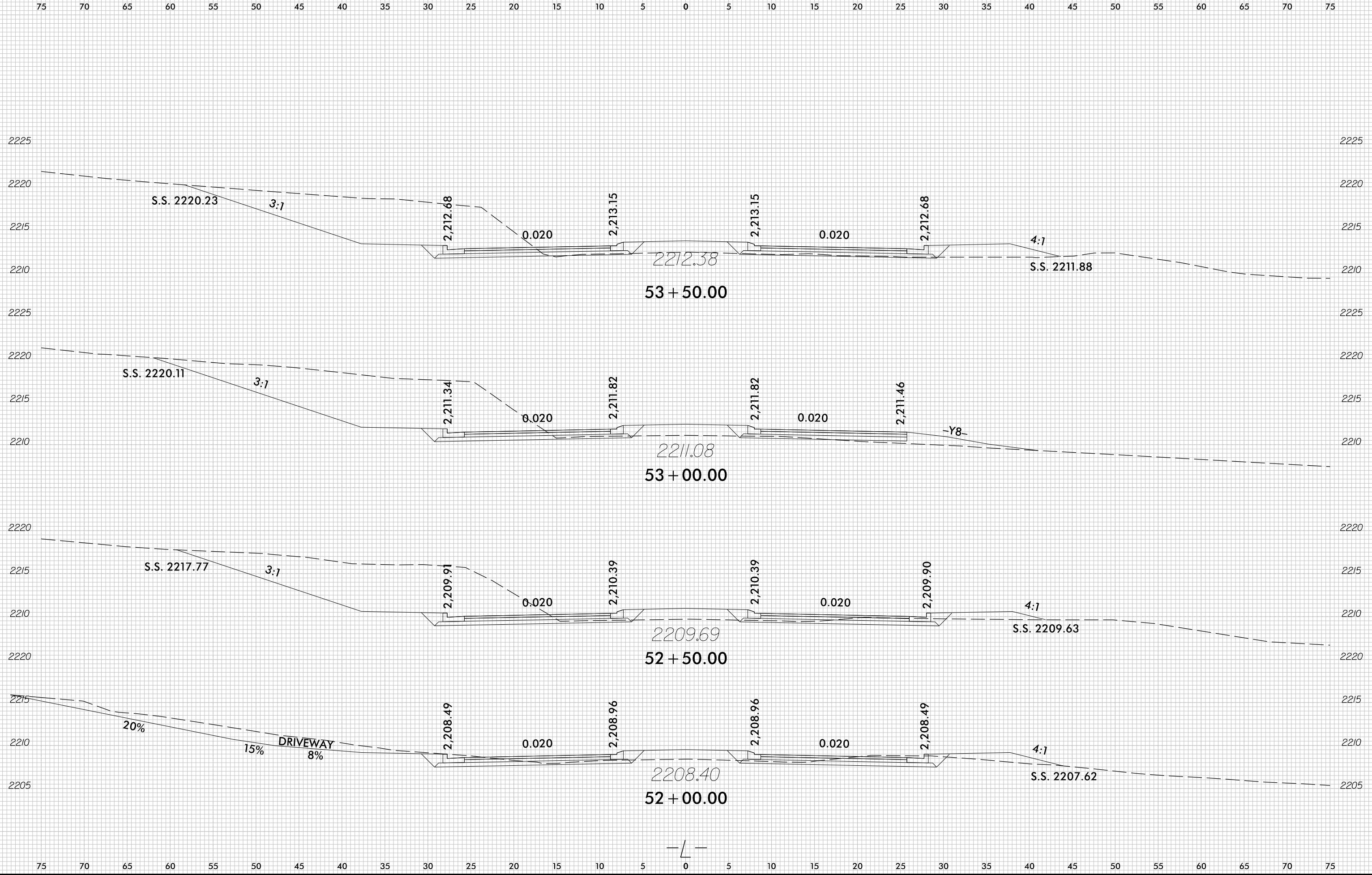

9:39:23 AM At: 7/35/72 US 64 widening U-5783\06 U-5783\Roadway\XSC\U5783-rdy-xpl-L.dgn

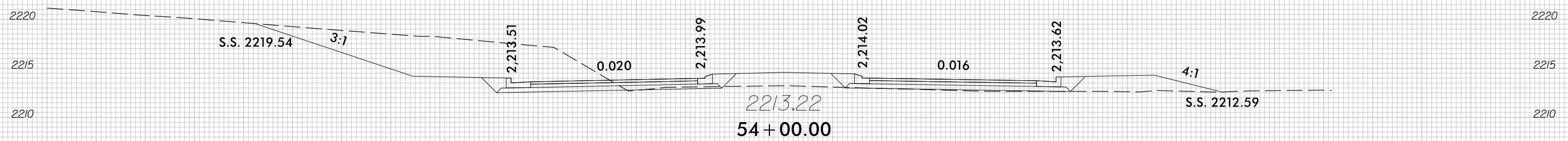
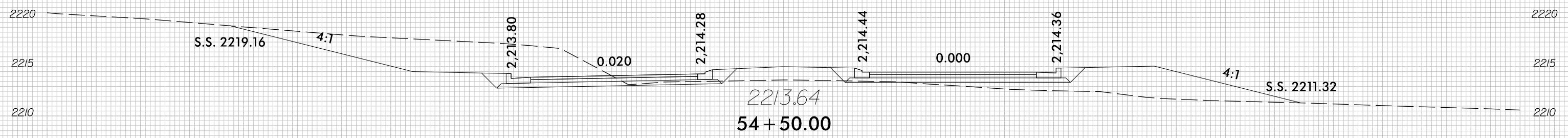
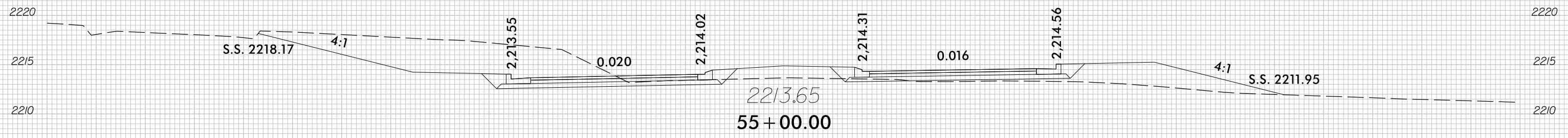
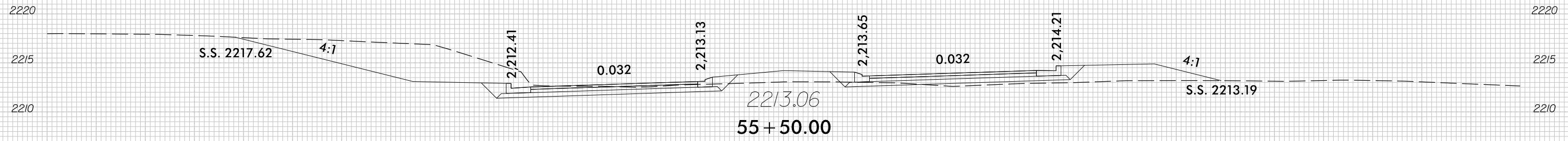
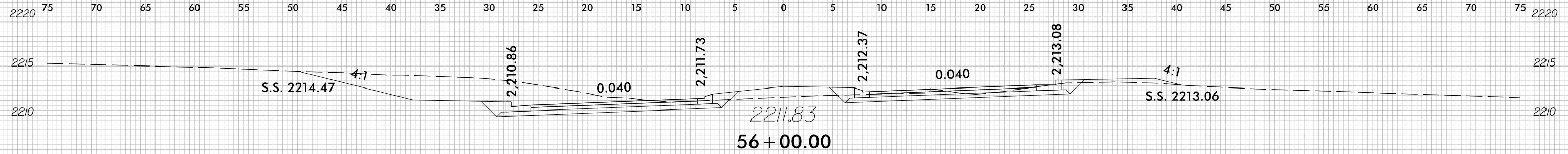

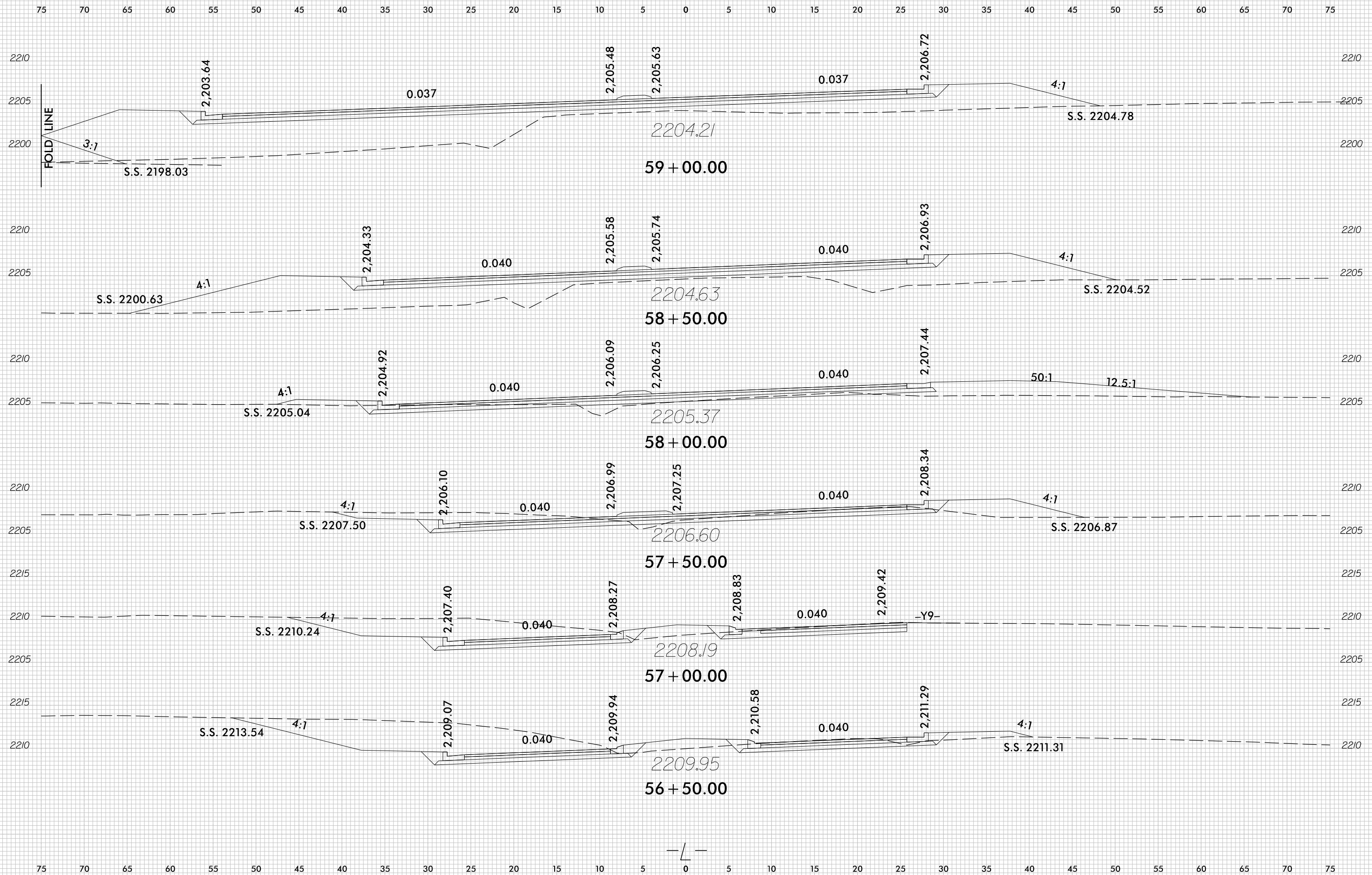

8/23/99

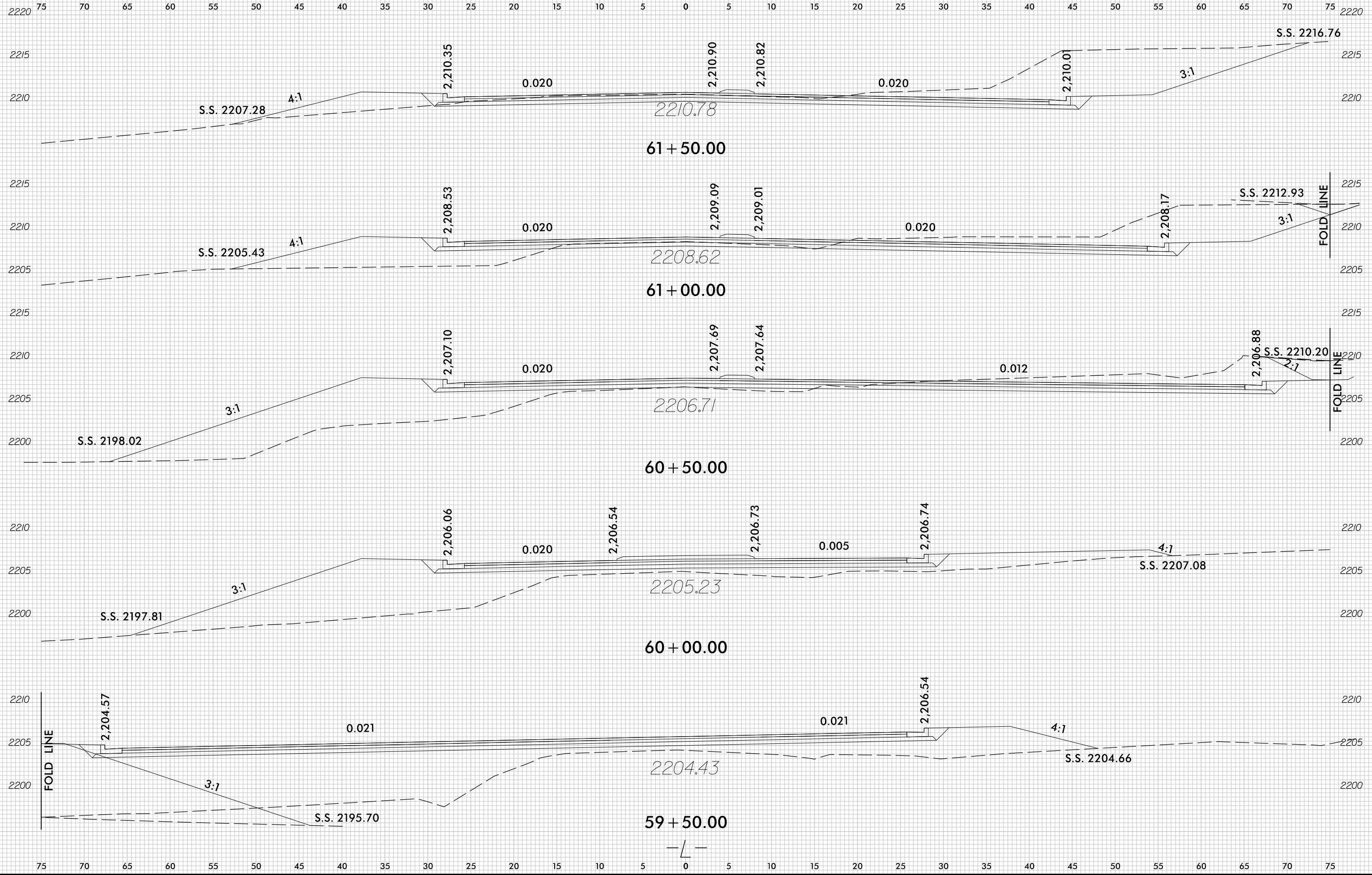

2:27:43 PM
I:\3572 US 64 Widening (U-5783)\06 U-5783\Roadway\XSC\U5783-dj-xpl.L.dgn
Dgross

8/23/99

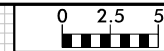

| | |
|---------------------|-----------|
| PROJ. REFERENCE NO. | SHEET NO. |
| U-5783 | X-22 |

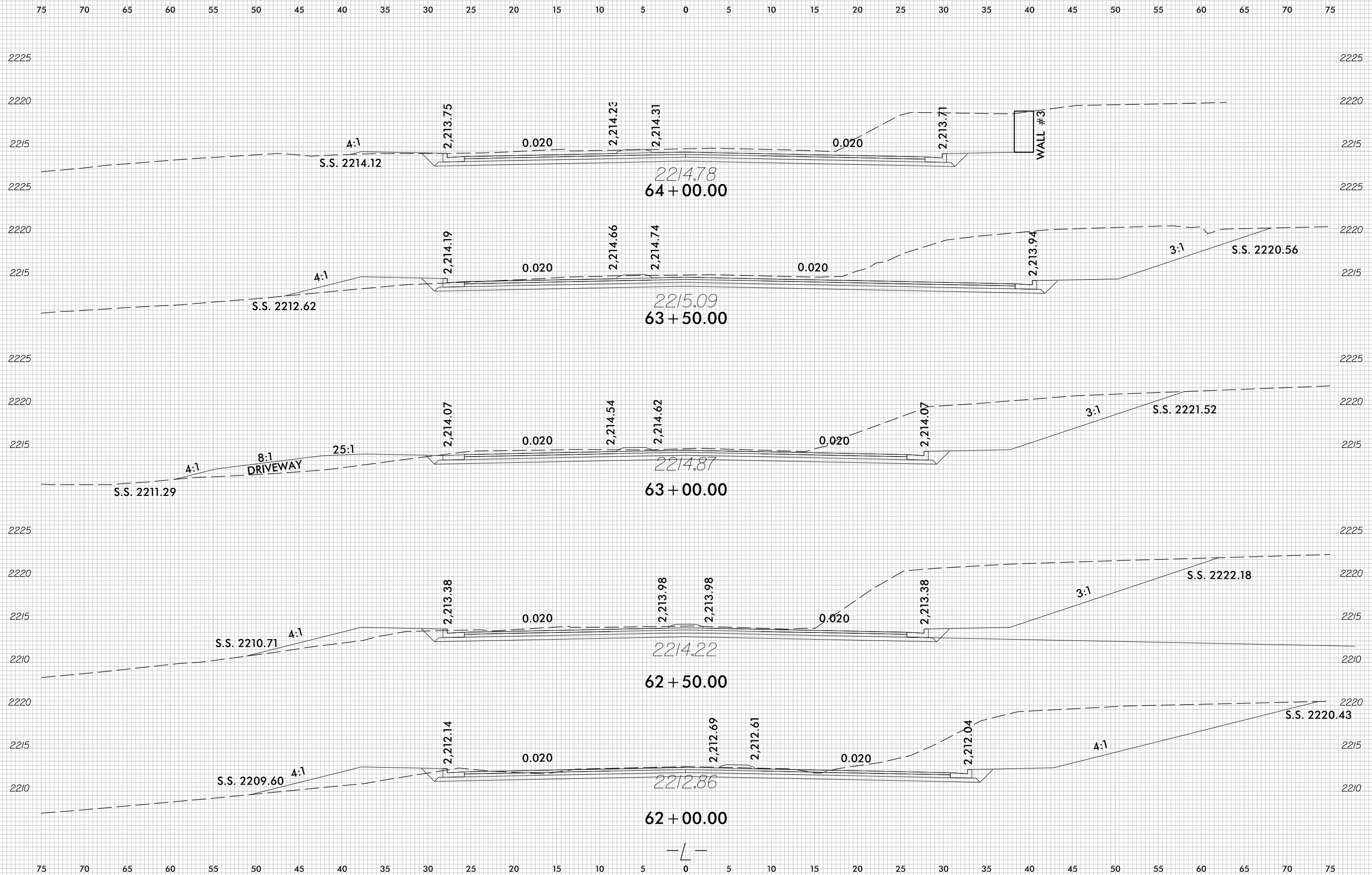

2:27:43 PM
I:\3572 US 64 Widening (U-5783)\06 U-5783\Roadway\XSC\U5783.-rdy.-xp.l.L.dgn
Egross

8/23/99

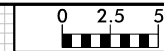

| | |
|---------------------|-----------|
| PROJ. REFERENCE NO. | SHEET NO. |
| U-5783 | X-23 |

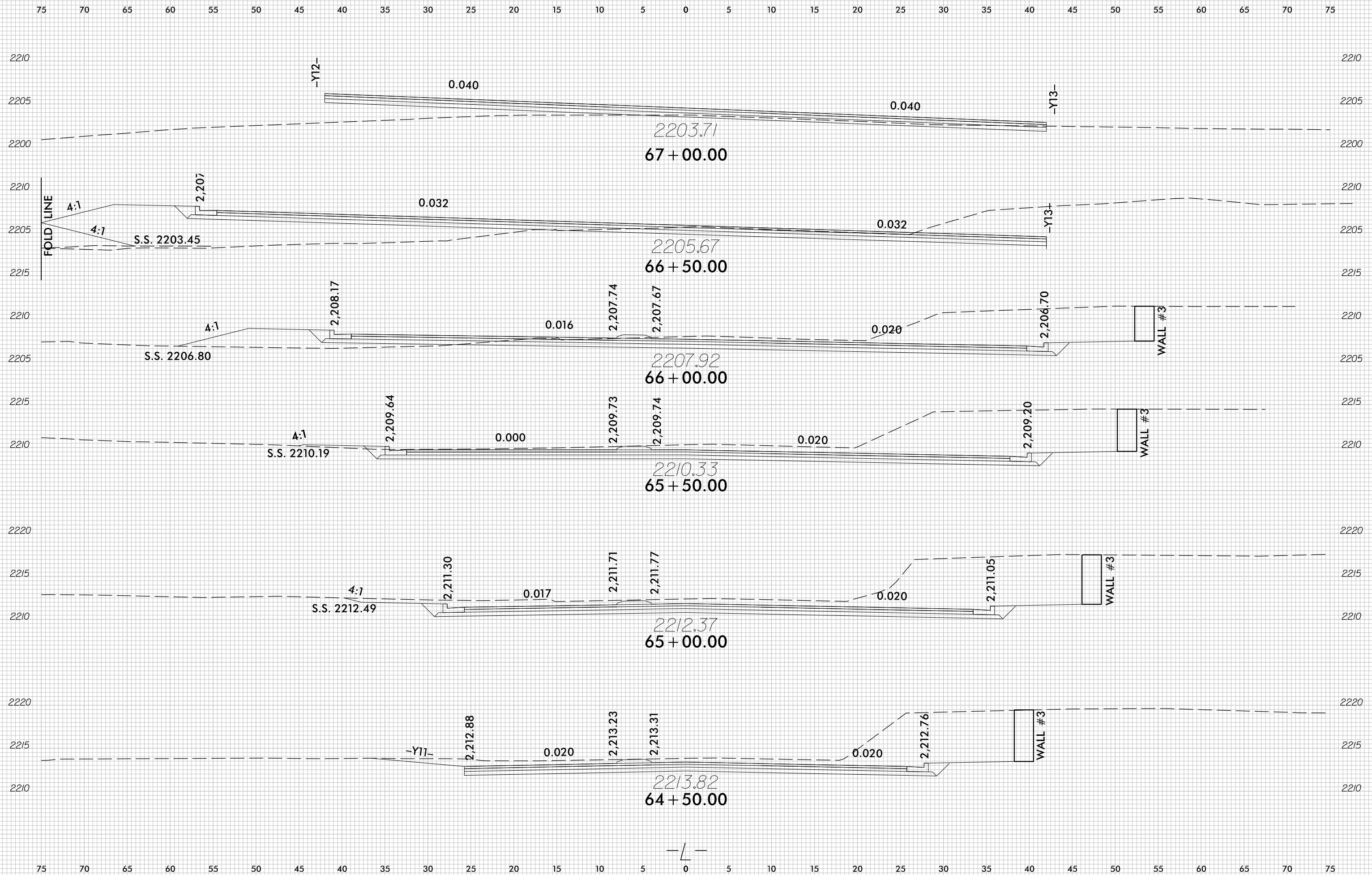

2:27:44 PM
I:\3572 US 64 Widening (U-5783)\06 U-5783\Roadway\XSC\U5783-rdy-xpl.L.dgn
Dgross

8/23/99

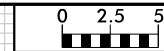

| | |
|---------------------|-----------|
| PROJ. REFERENCE NO. | SHEET NO. |
| U-5783 | X-24 |

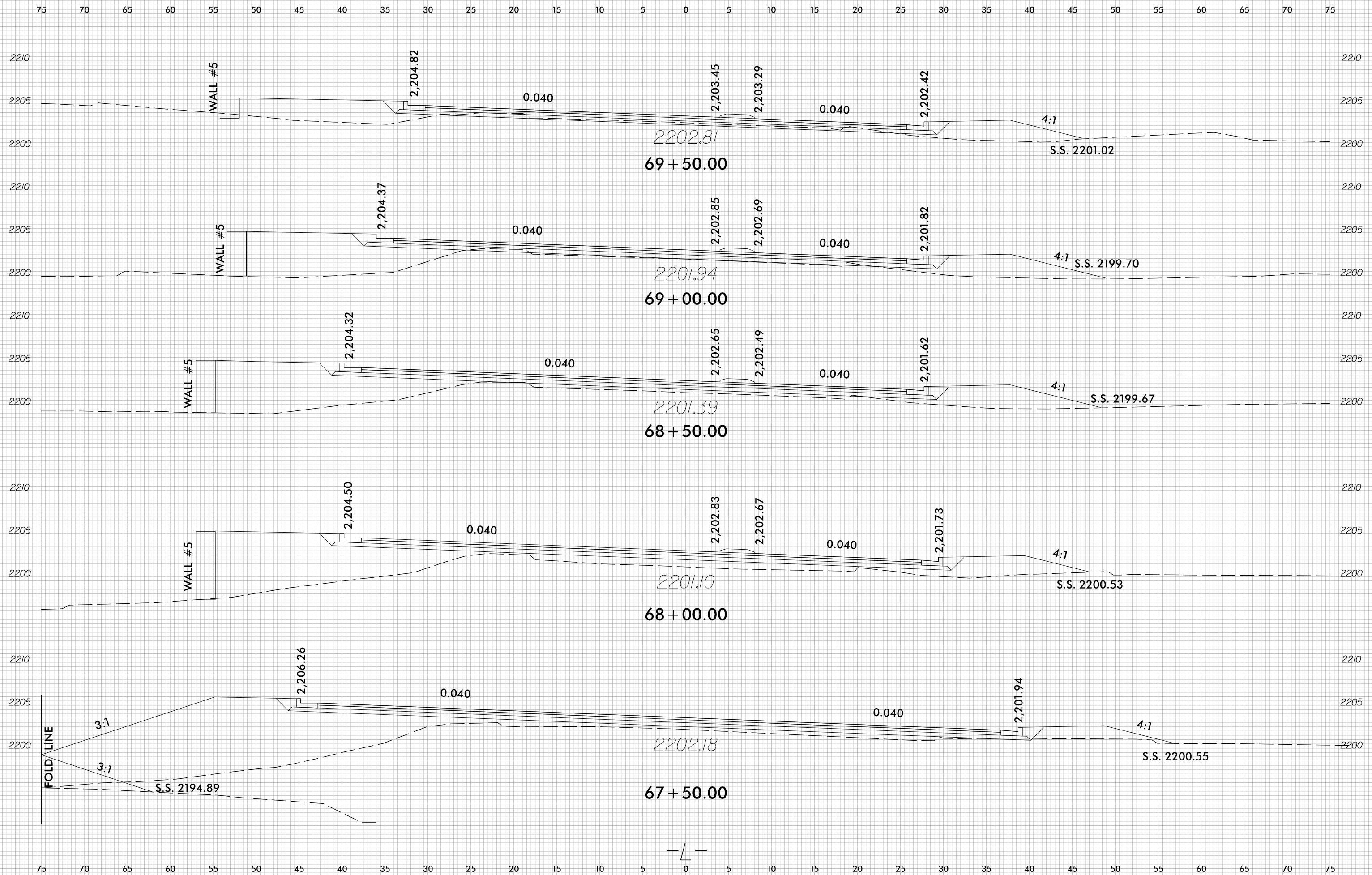

2:27:45 PM
 I:\3572 US 64 Widening (U-5783)\06 U-5783\Roadway\XSC\U5783--rdj--xpl.L.dgn
 dgross

8/23/99

| | | |
|---------|---------------------|-----------|
| 0 2.5 5 | PROJ. REFERENCE NO. | SHEET NO. |
| | U-5783 | X-25 |

75 70 65 60 55 50 45 40 35 30 25 20 15 10 5 0 5 10 15 20 25 30 35 40 45 50 55 60 65 70 75

END PROJECT
-L- STA 73+62

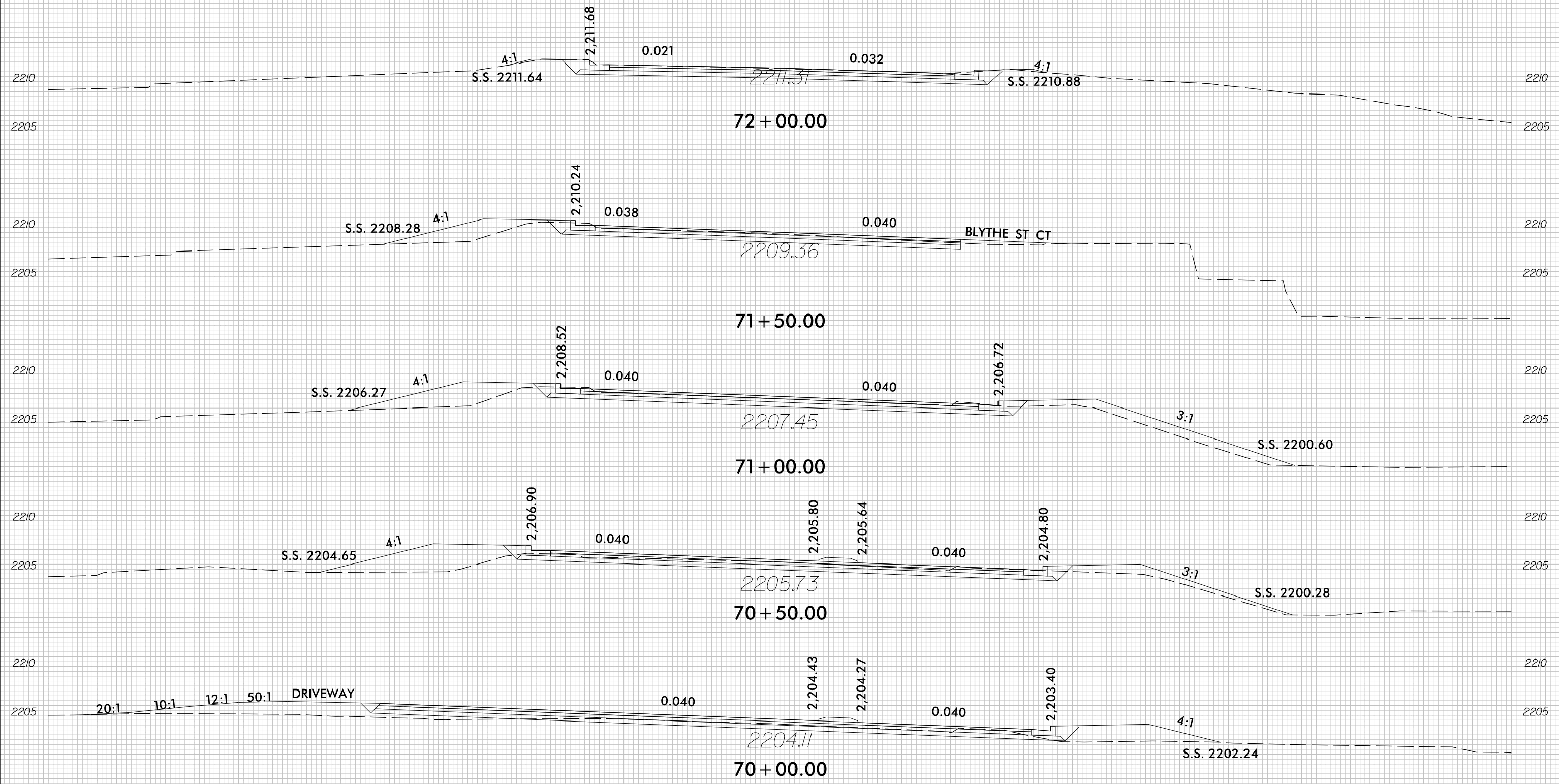

-L-

75 70 65 60 55 50 45 40 35 30 25 20 15 10 5 0 5 10 15 20 25 30 35 40 45 50 55 60 65 70 75

2:27:51PM At: 7:35:72 US 64 widening U-5783\06 U-5783\Roadway\XSC\U5783-rdy-xpl-L.dgn

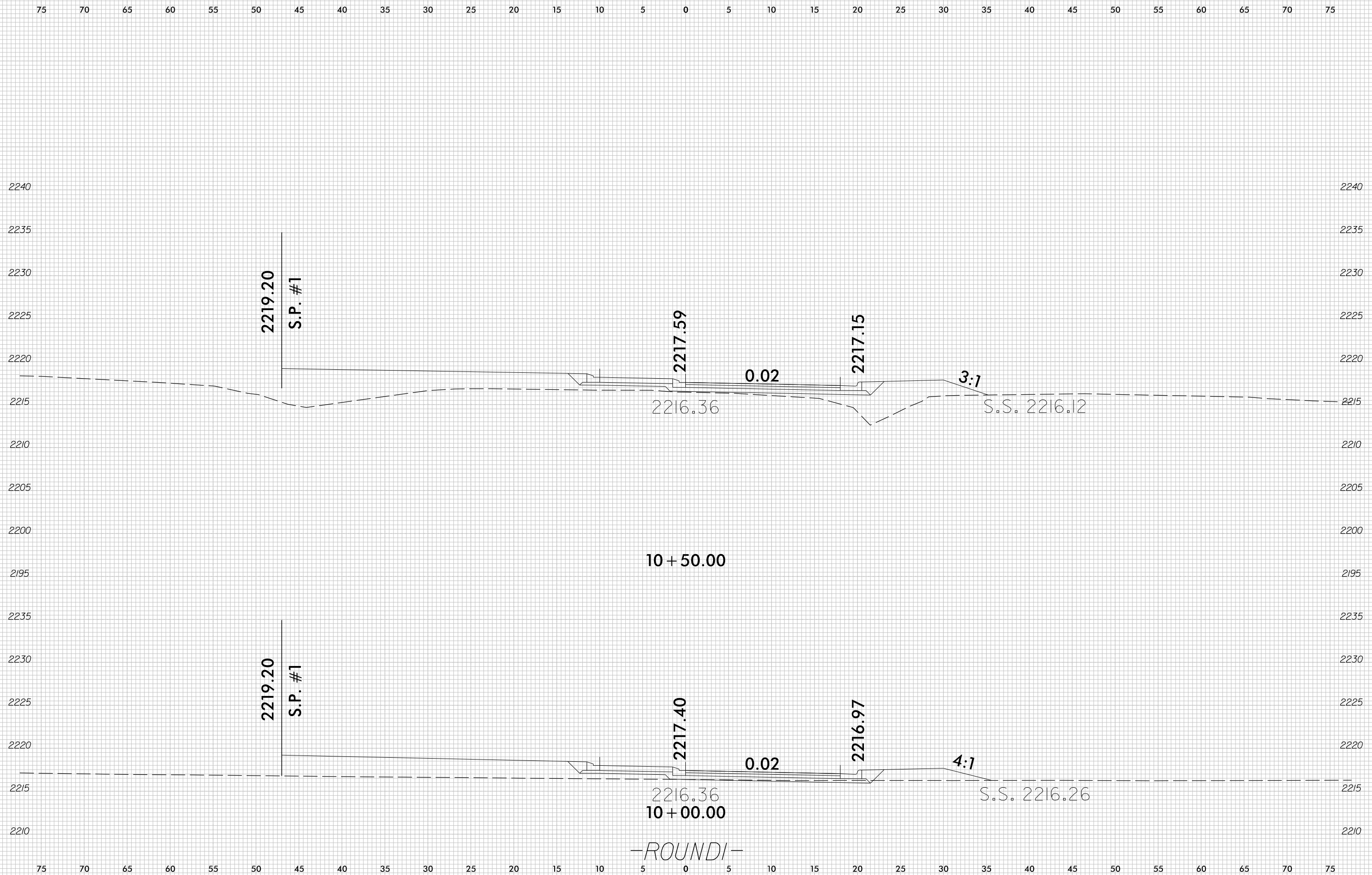

8/23/99

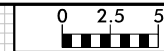

| | |
|---------------------|-----------|
| PROJ. REFERENCE NO. | SHEET NO. |
| U-5783 | X-27 |

75 70 65 60 55 50 45 40 35 30 25 20 15 10 5 0 5 10 15 20 25 30 35 40 45 50 55 60 65 70 75

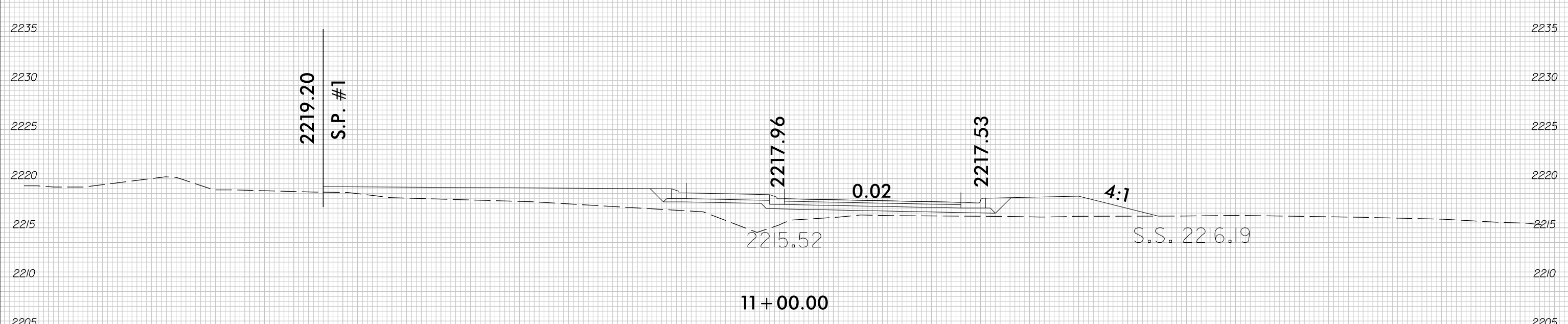
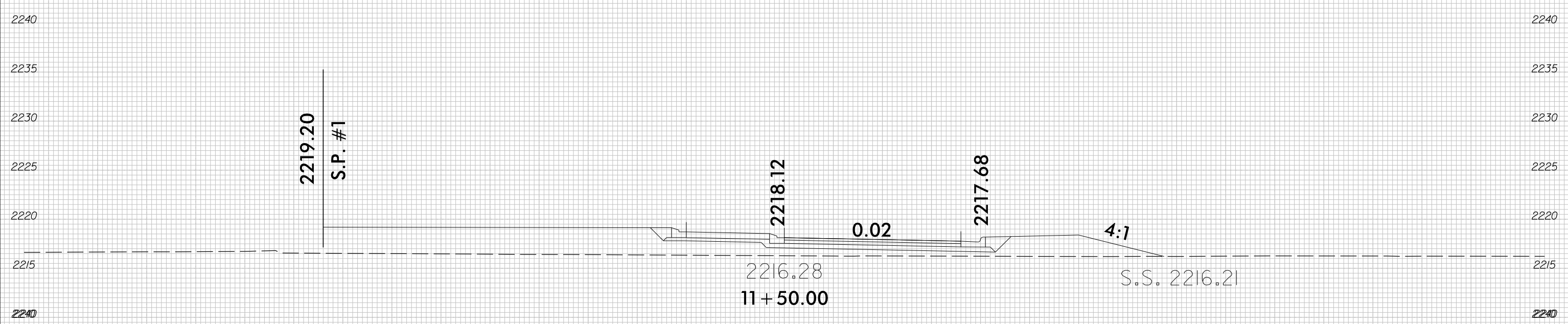

—ROUND—

2:27:47 PM
I:\3572 US 64 Widening (U-5783)\06 U-5783\Roadway\XSC\U5783--dy.XPL_ROUND1.dgn
dgross

75 70 65 60 55 50 45 40 35 30 25 20 15 10 5 0 5 10 15 20 25 30 35 40 45 50 55 60 65 70 75

8/23/99

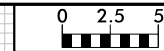

| | |
|---------------------|-----------|
| PROJ. REFERENCE NO. | SHEET NO. |
| U-5783 | X-28 |

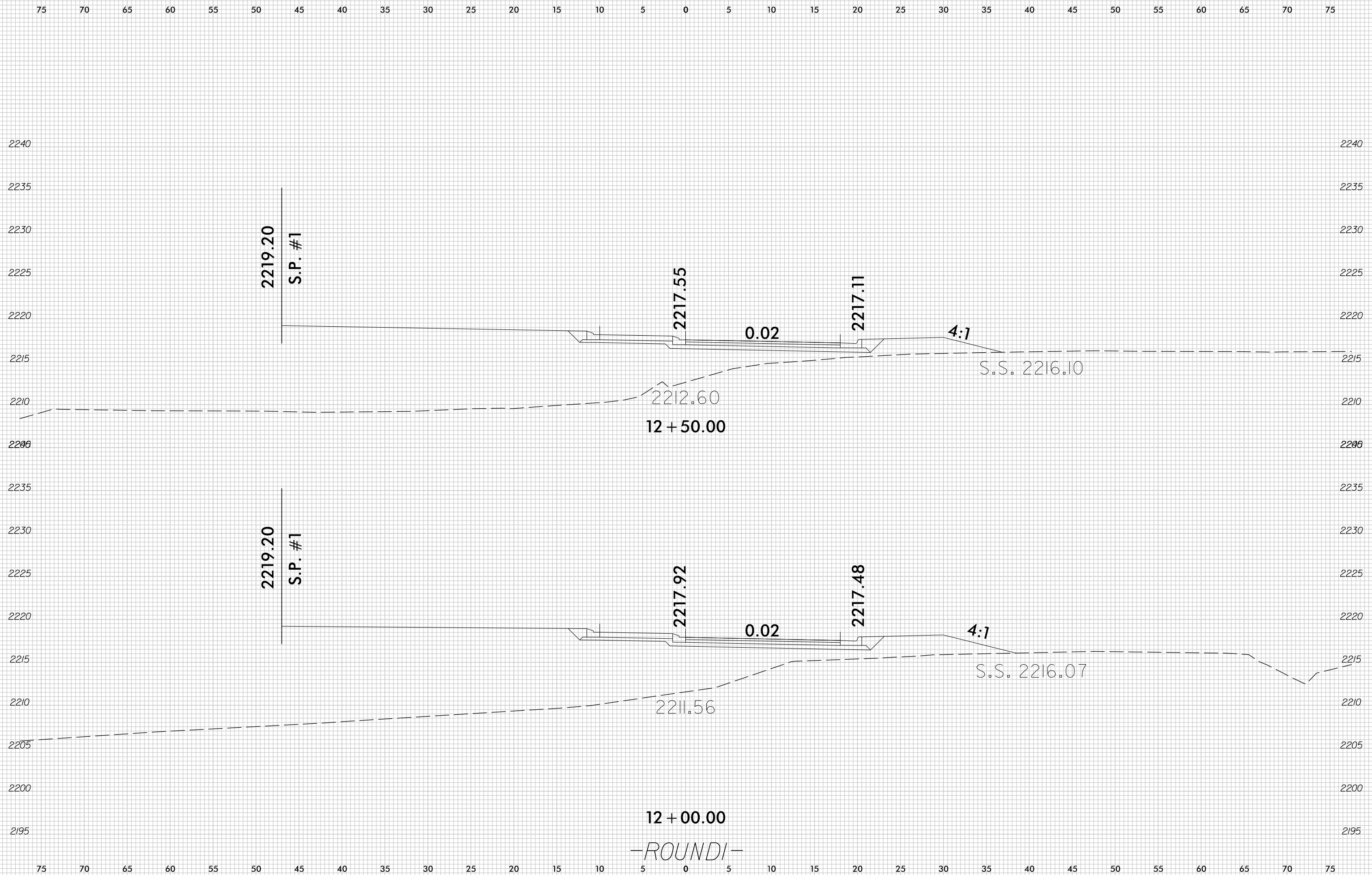

12 + 00.00
 -ROUND-

2:27:47 PM
 I:\3572 US 64 Widening (U-5783)\06 U-5783\Roadway\XSC\U5783--dy_XPL_ROUND1.dgn
 dgross

8/23/99

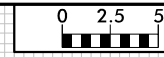

| | |
|---------------------|-----------|
| PROJ. REFERENCE NO. | SHEET NO. |
| U-5783 | X-29 |

75 70 65 60 55 50 45 40 35 30 25 20 15 10 5 0 5 10 15 20 25 30 35 40 45 50 55 60 65 70 75

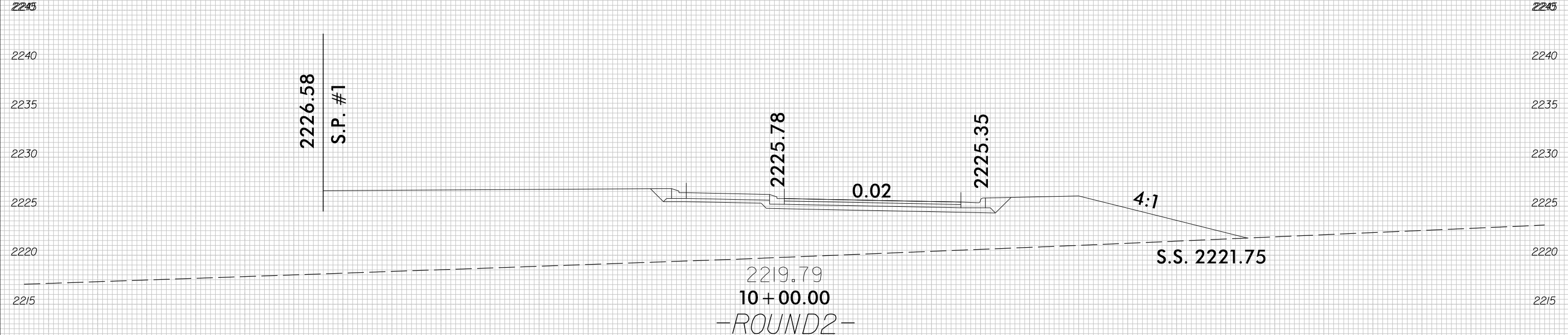
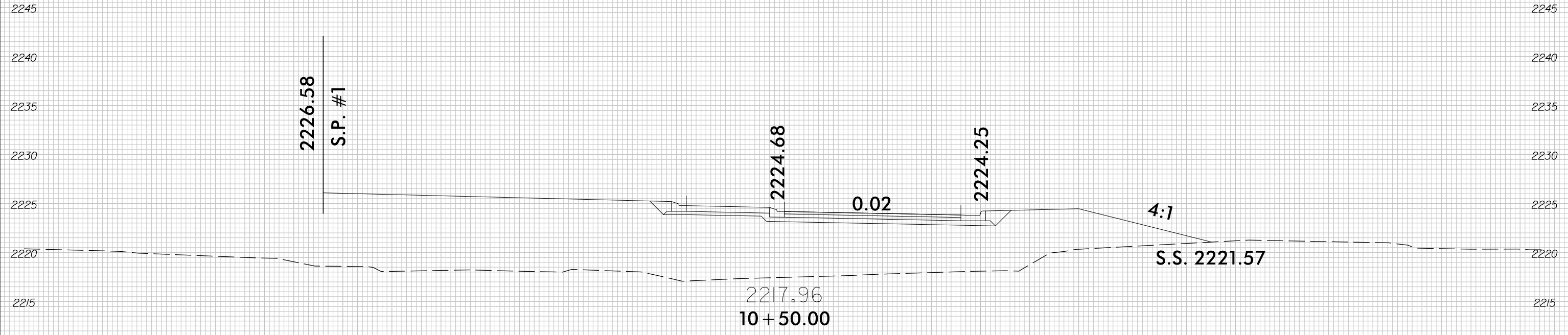

-ROUND2-

2:27:48 PM
I:\3572 US 64 Widening (U-5783)\06 U-5783\Roadway\XSC\U5783--dy-XPL_ROUND2.dgn
dgross

8/23/99

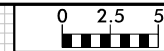

| | |
|---------------------|-----------|
| PROJ. REFERENCE NO. | SHEET NO. |
| U-5783 | X-30 |

75 70 65 60 55 50 45 40 35 30 25 20 15 10 5 0 5 10 15 20 25 30 35 40 45 50 55 60 65 70 75

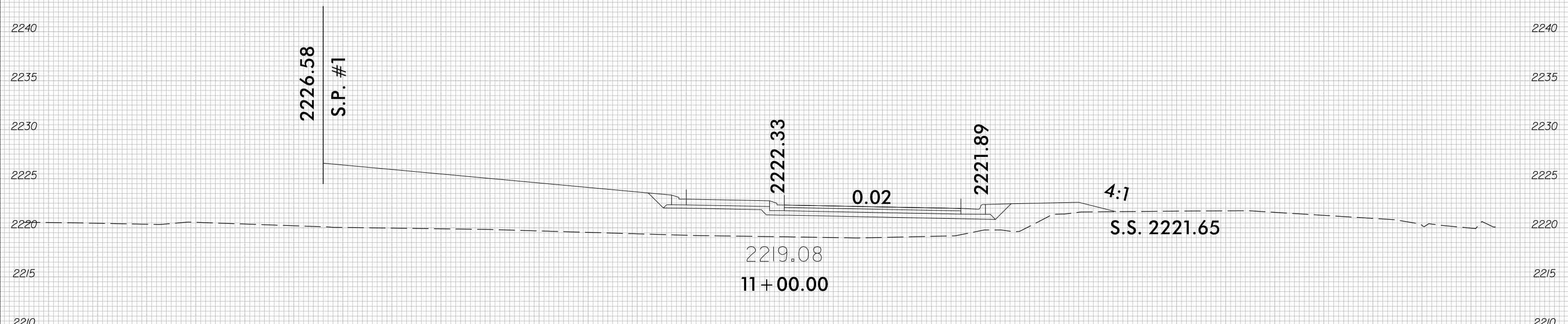
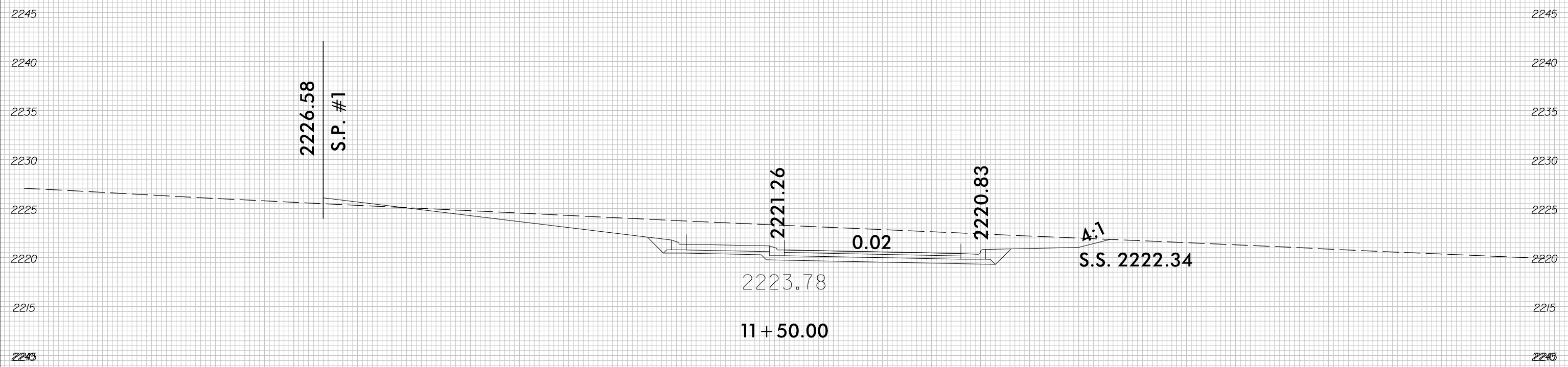

-ROUND2-

2:27:48 PM
I:\3572 US 64 Widening (U-5783)\06 U-5783\Roadway\XSC\U5783--dy-XPL_ROUND2.dgn
Dgross

8/23/99

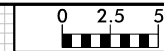

| | |
|---------------------|-----------|
| PROJ. REFERENCE NO. | SHEET NO. |
| U-5783 | X-31 |

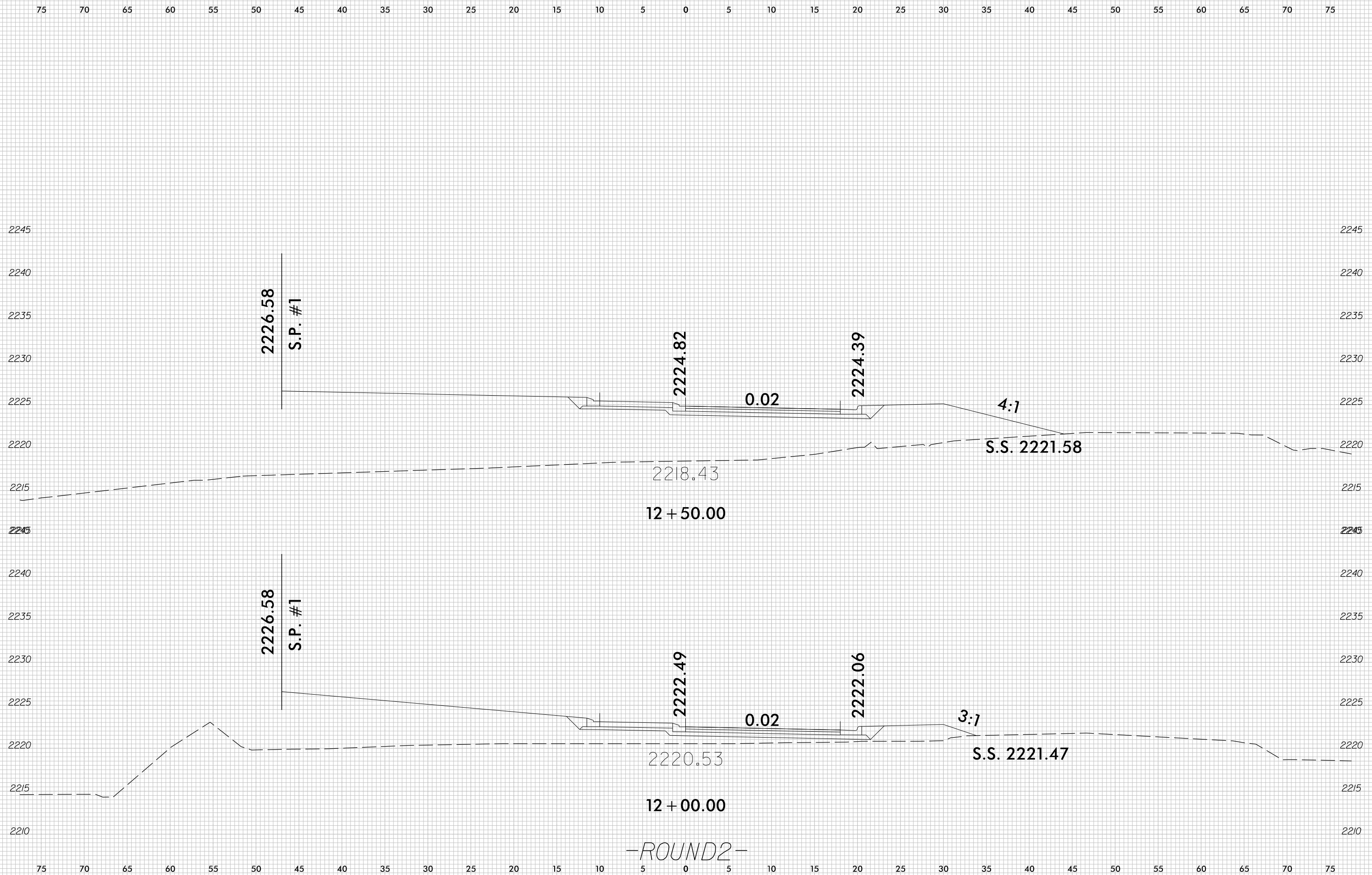

2:27:49 PM
 I:\3572 US 64 Widening (U-5783)\06 U-5783\Roadway\XSC\U5783-r.dg_XPL_ROUND2.dgn
 c:\pross

-ROUND2-

8/23/99

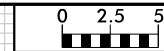

| | |
|---------------------|-----------|
| PROJ. REFERENCE NO. | SHEET NO. |
| U-5783 | X-32 |

75 70 65 60 55 50 45 40 35 30 25 20 15 10 5 0 5 10 15 20 25 30 35 40 45 50 55 60 65 70 75

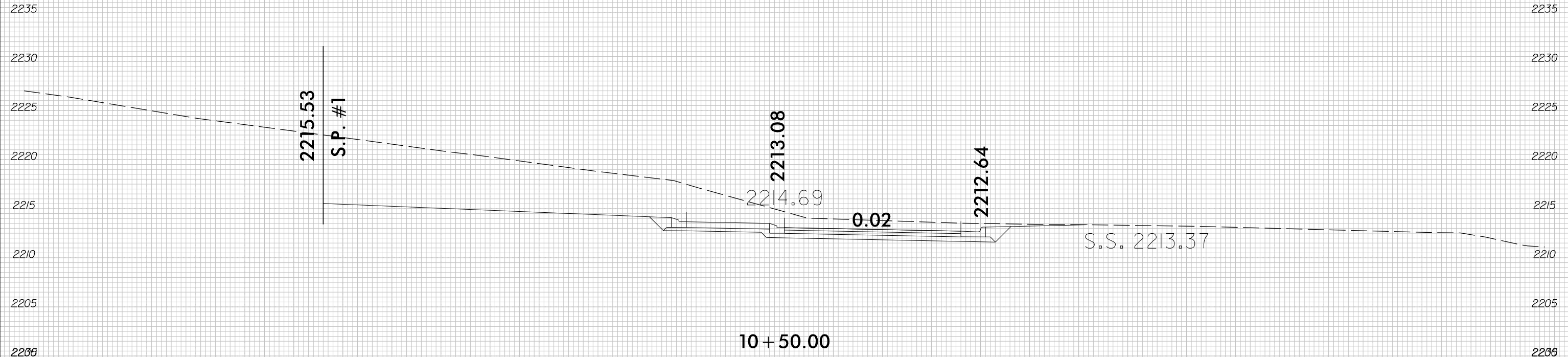

10 + 50.00

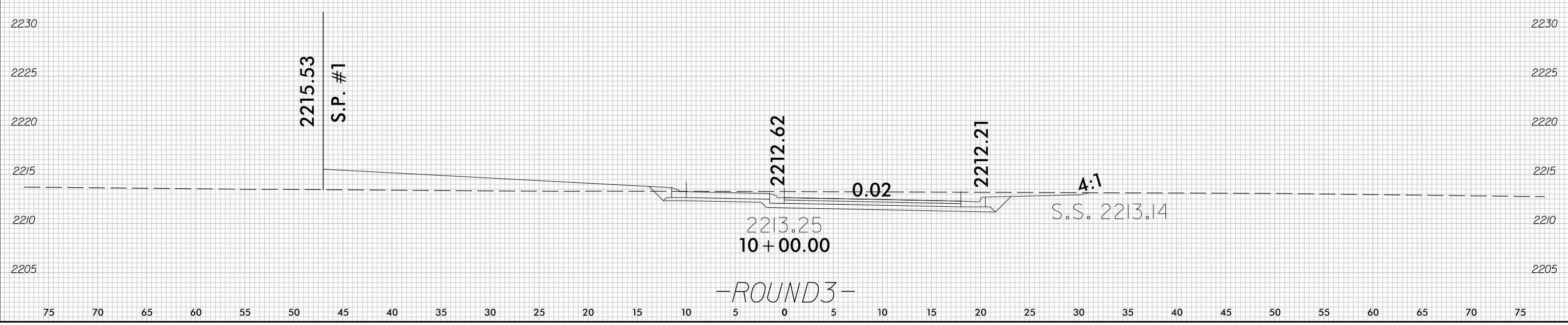

2213.25
10 + 00.00

-ROUND3-

2:27:49 PM
I:\3572 US 64 Widening (U-5783)\06 U-5783\Roadway\XSC\U5783--dy.XPL_ROUND3.dgn
dgross

8/23/99

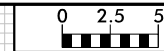

| | |
|---------------------|-----------|
| PROJ. REFERENCE NO. | SHEET NO. |
| U-5783 | X-33 |

75 70 65 60 55 50 45 40 35 30 25 20 15 10 5 0 5 10 15 20 25 30 35 40 45 50 55 60 65 70 75

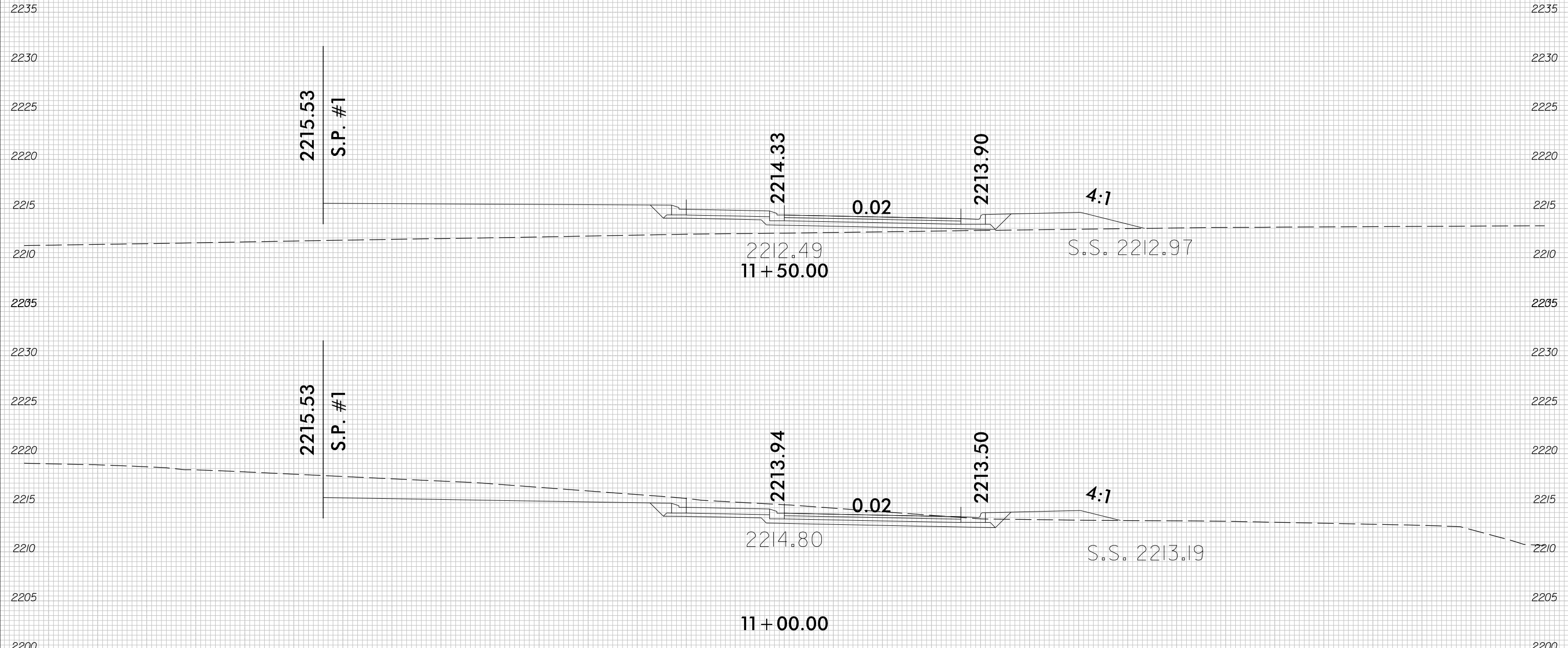

-ROUND3-

2:27:50 PM
 I:\3572 US 64 Widening (U-5783)\06 U-5783\Roadway\XSC\U5783--dy_XPL_ROUND3.dgn
 dgross

75 70 65 60 55 50 45 40 35 30 25 20 15 10 5 0 5 10 15 20 25 30 35 40 45 50 55 60 65 70 75

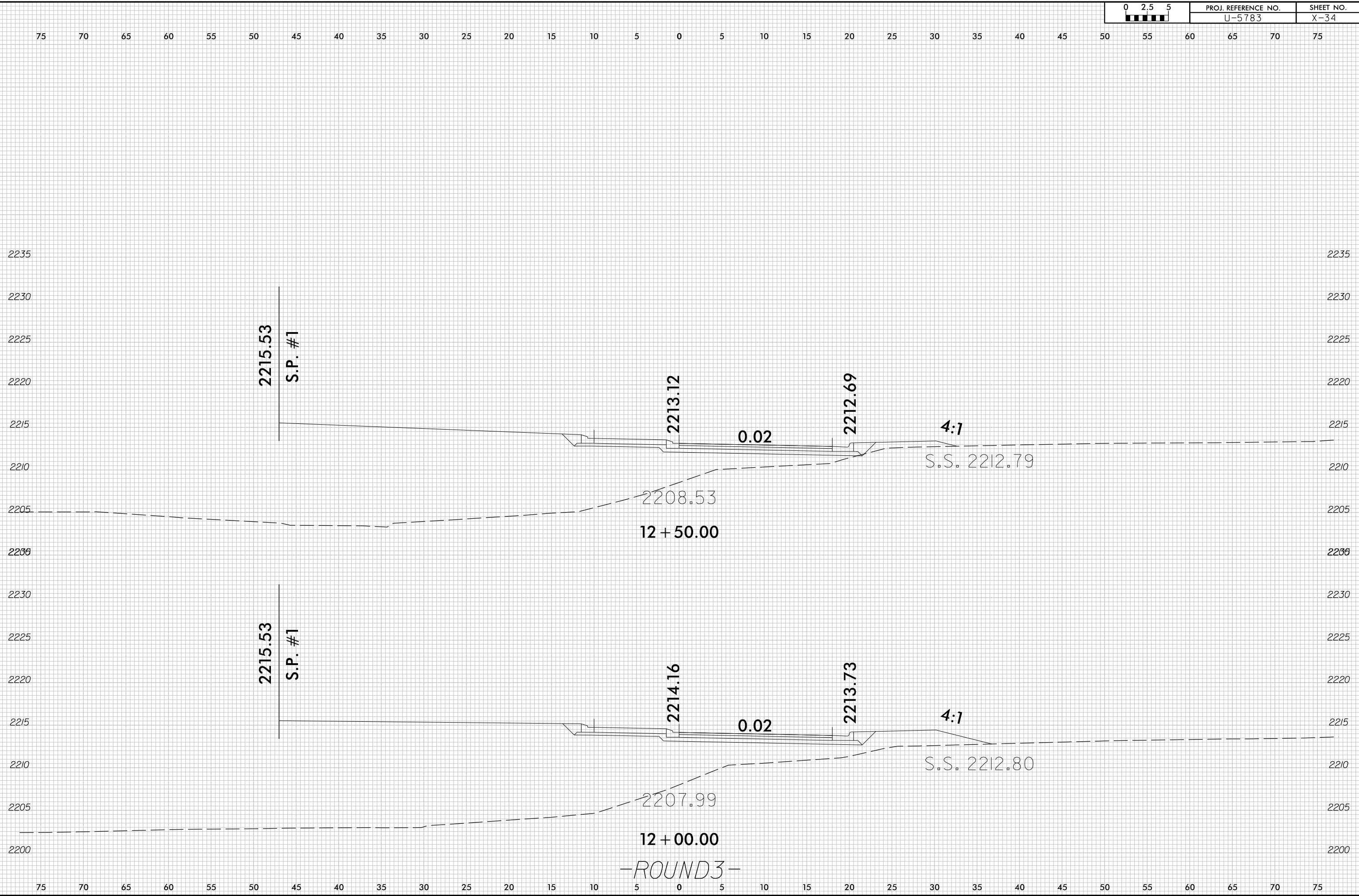

8/23/99

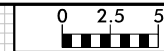

| | |
|---------------------|-----------|
| PROJ. REFERENCE NO. | SHEET NO. |
| U-5783 | X-35 |

75 70 65 60 55 50 45 40 35 30 25 20 15 10 5 0 5 10 15 20 25 30 35 40 45 50 55 60 65 70 75

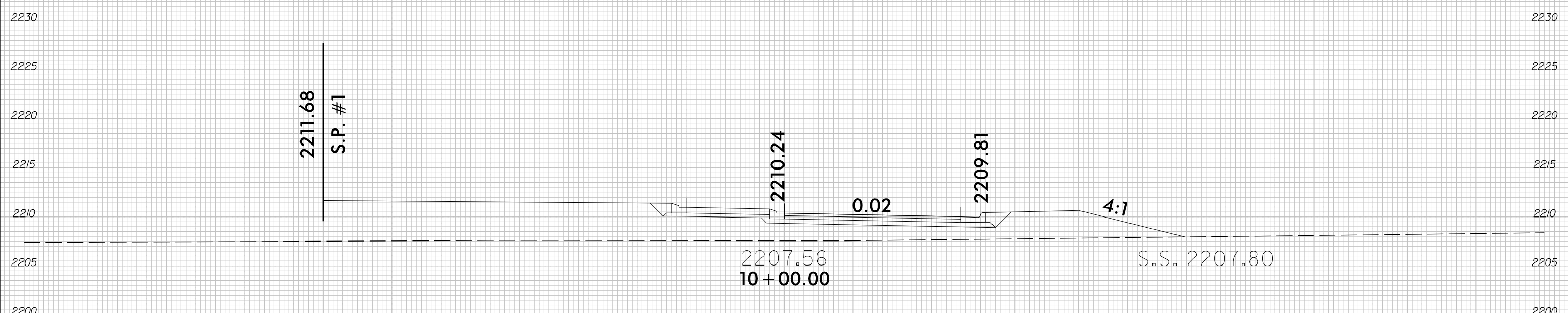

-ROUND4-

75 70 65 60 55 50 45 40 35 30 25 20 15 10 5 0 5 10 15 20 25 30 35 40 45 50 55 60 65 70 75

2:27:51 PM I:\3572 US 64 Widening (U-5783)\06 U-5783\Roadway\XSC\U5783--dy-XPL_ROUND4.dgn

8/23/99

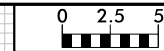

| | |
|---------------------|-----------|
| PROJ. REFERENCE NO. | SHEET NO. |
| U-5783 | X-36 |

75 70 65 60 55 50 45 40 35 30 25 20 15 10 5 0 5 10 15 20 25 30 35 40 45 50 55 60 65 70 75

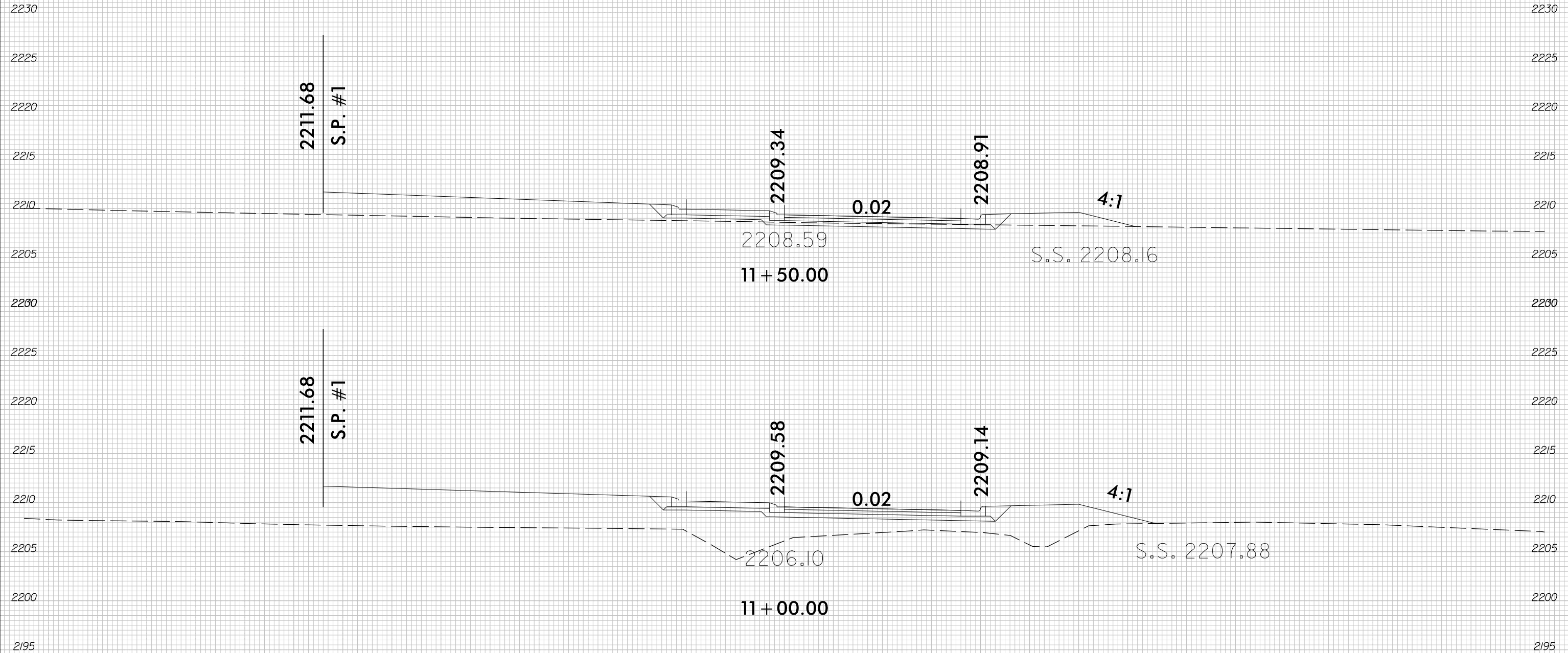

-ROUND4-

75 70 65 60 55 50 45 40 35 30 25 20 15 10 5 0 5 10 15 20 25 30 35 40 45 50 55 60 65 70 75

2:27:51 PM
 I:\3572 US 64 Widening (U-5783)\06 U-5783\Roadway\XSC\U5783--dy-XPL_ROUND4.dgn
 dgross

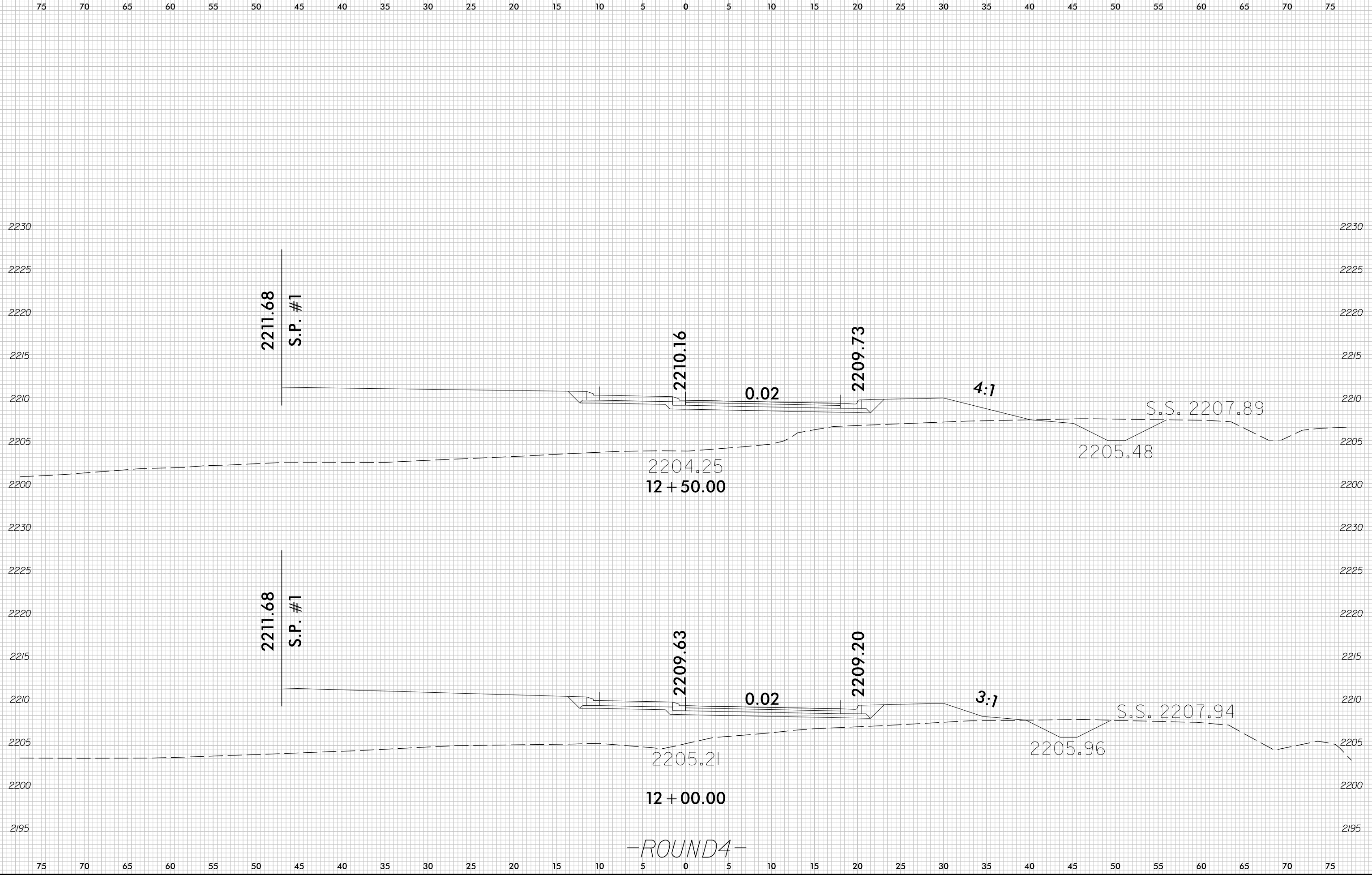

-ROUND4-

8/23/99

| | | |
|---------|---------------------|-----------|
| 0 2.5 5 | PROJ. REFERENCE NO. | SHEET NO. |
| | U-5783 | X-38 |

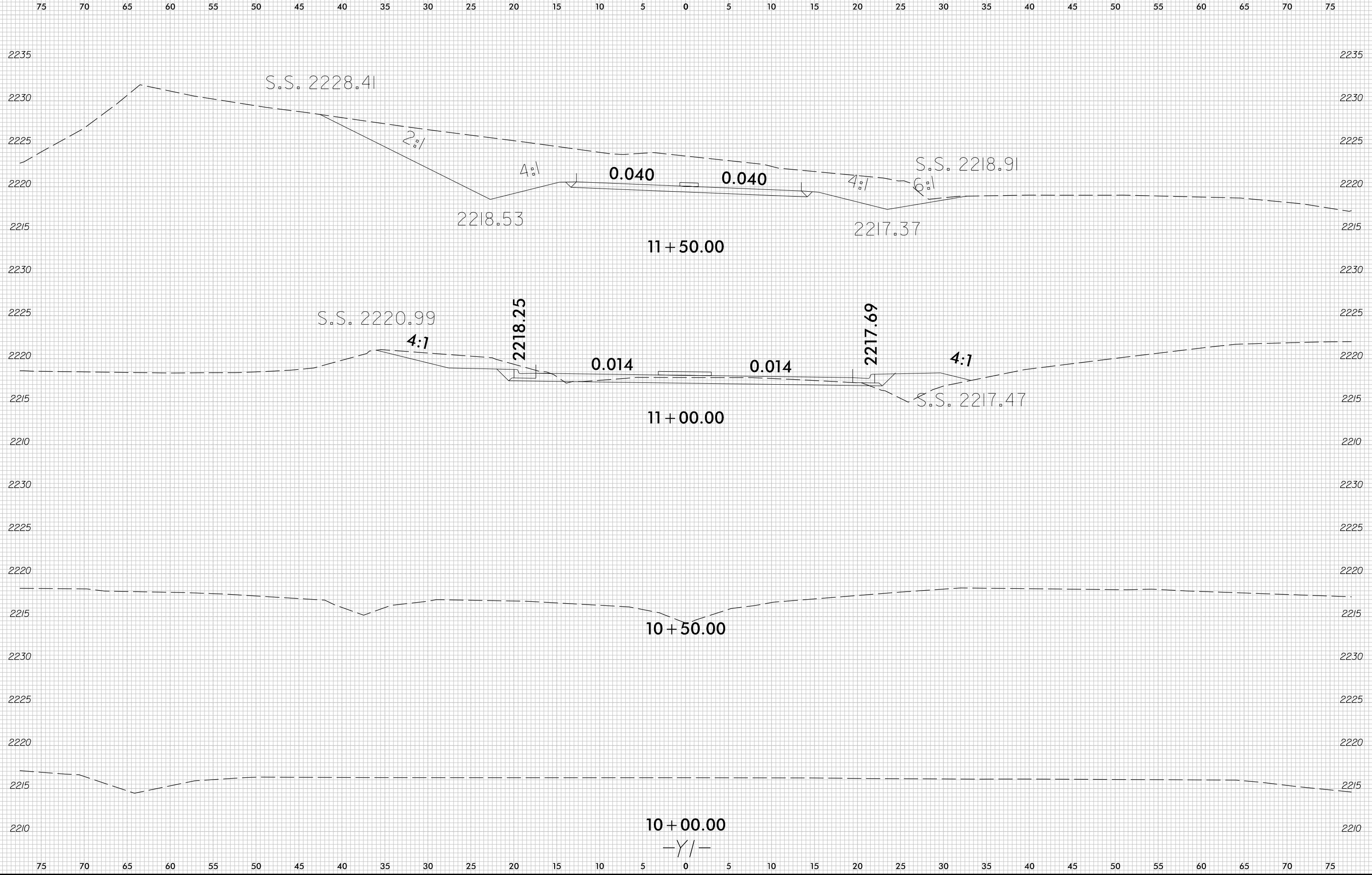

2:54:03 PM
A:\3572 US 64 Widening (U-5783)\06 U-5783\Roadway\XSC\U5783.rdy_XPL_Y1.dgn
mchang

8/23/99

| | | |
|---------|---------------------|-----------|
| 0 2.5 5 | PROJ. REFERENCE NO. | SHEET NO. |
| | U-5783 | X-39 |

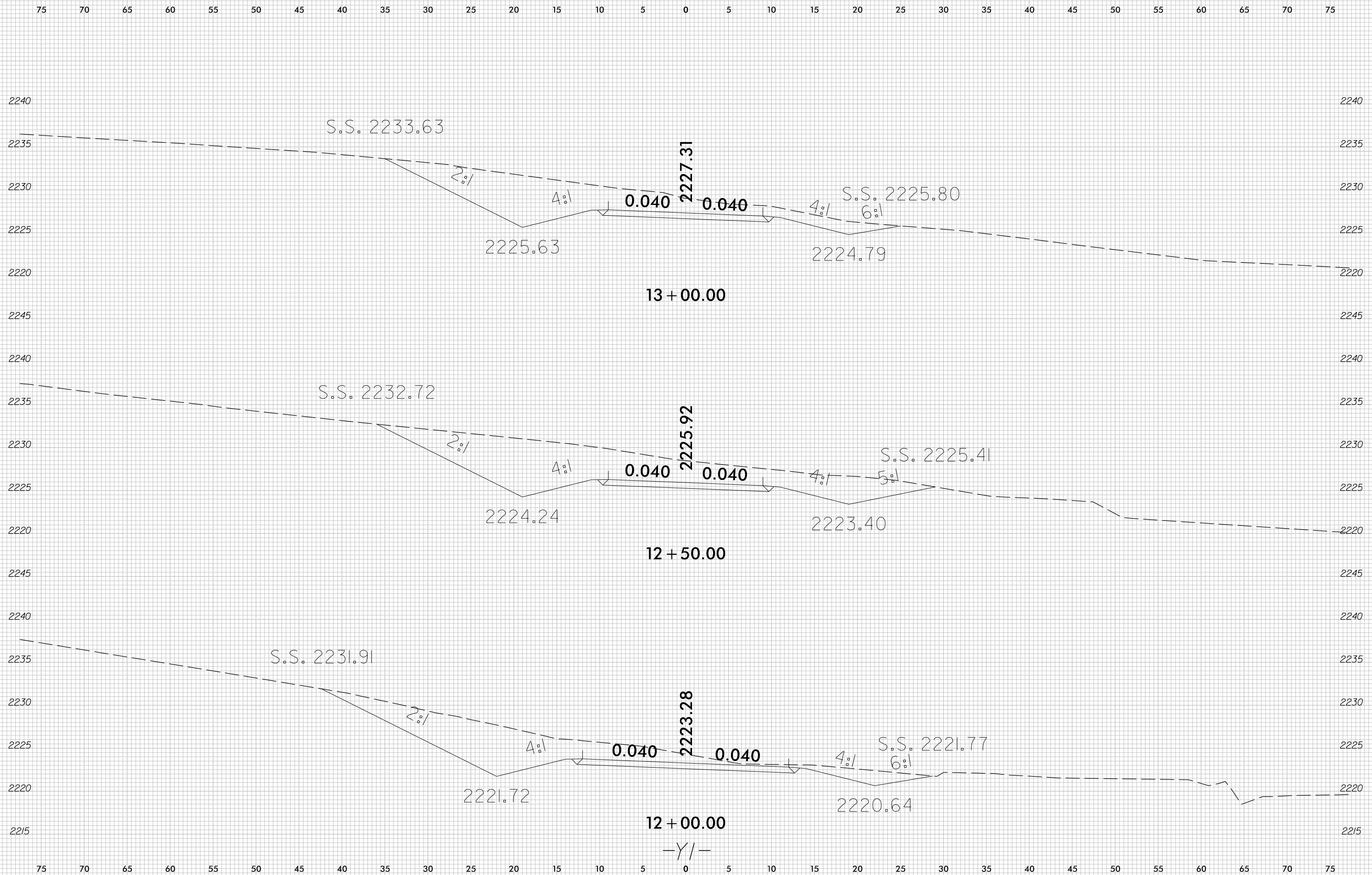

2:27:53 PM
I:\3572 US 64 Widening (U-5783)\06 U-5783\Roadway\XSC\U5783--rdg_XPL_Y1.dgn
ogross

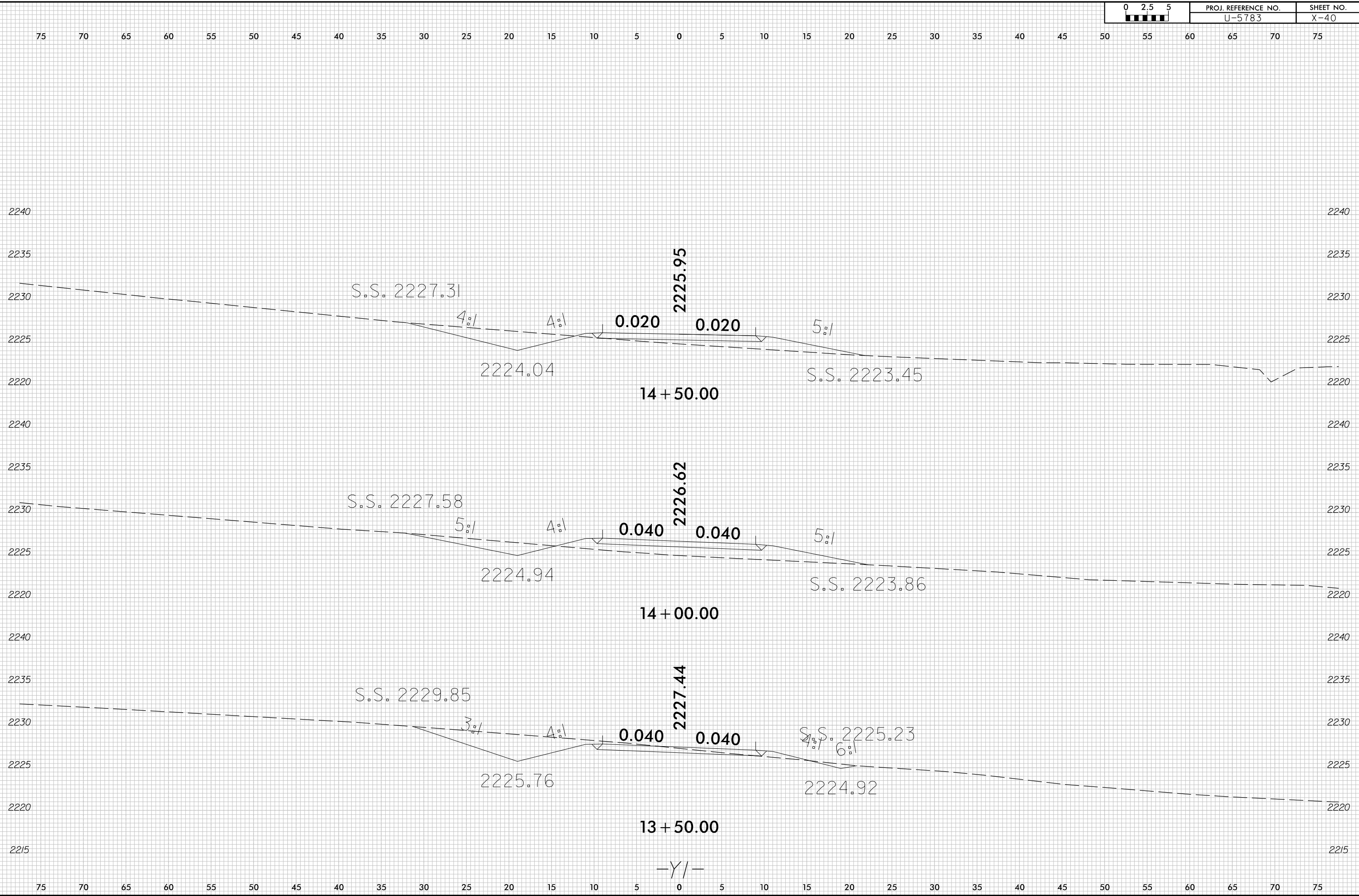

8/23/99

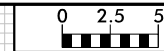

| | |
|---------------------|-----------|
| PROJ. REFERENCE NO. | SHEET NO. |
| U-5783 | X-41 |

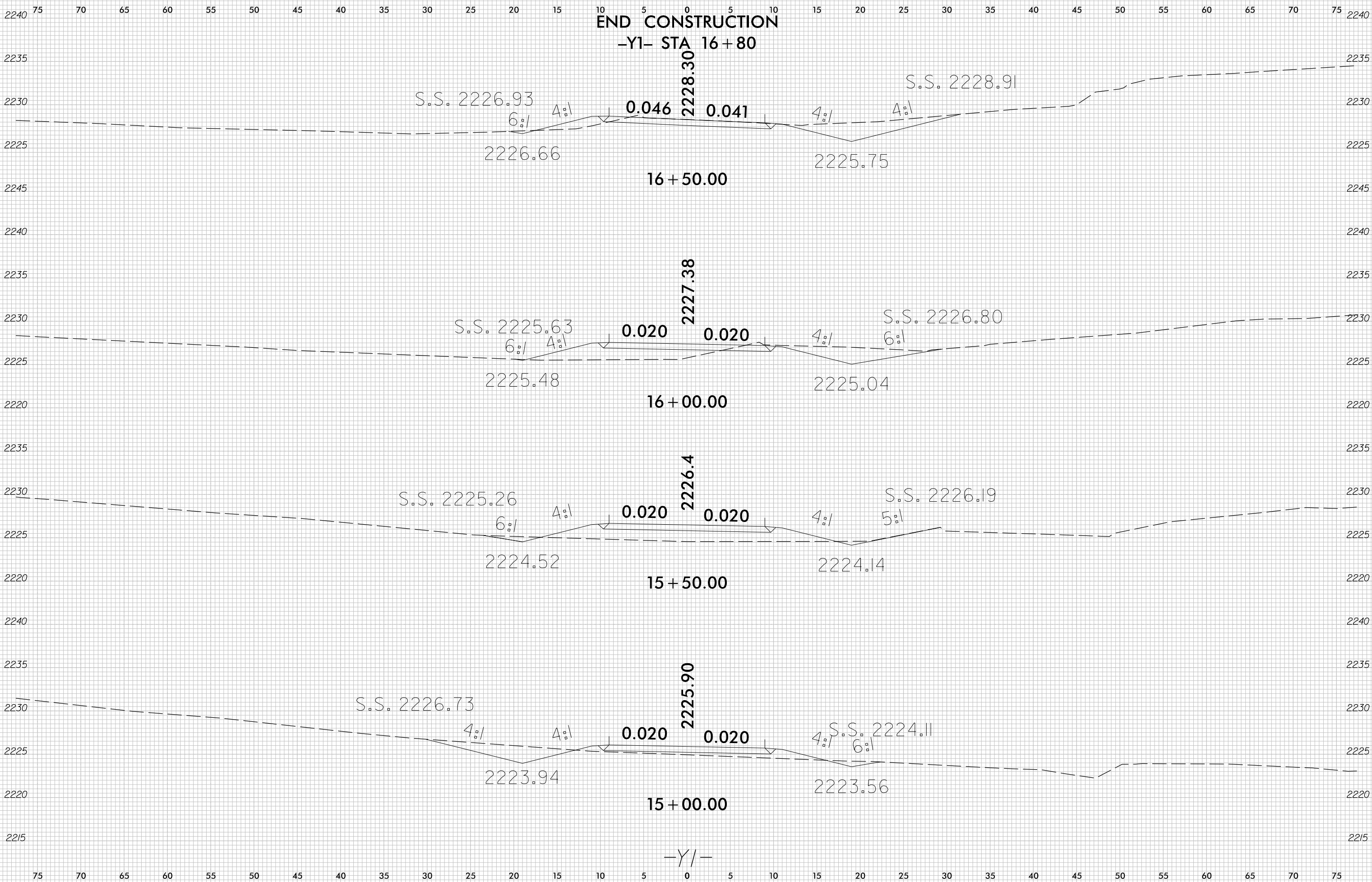

2:27:54 PM
I:\3572 US 64 Widening (U-5783)\06 U-5783\Roadway\XSC\U5783--rdg-XPL-Y1.dgn
D:\gross

8/23/99

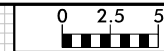

| | |
|---------------------|-----------|
| PROJ. REFERENCE NO. | SHEET NO. |
| U-5783 | X-42 |

75 70 65 60 55 50 45 40 35 30 25 20 15 10 5 0 5 10 15 20 25 30 35 40 45 50 55 60 65 70 75

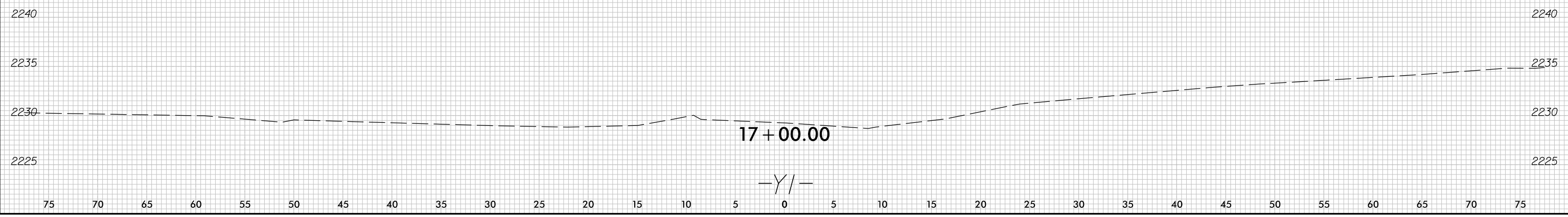

2:27:54 PM
 I:\3572 US 64 Widening (U-5783)\06 U-5783\Roadway\XSC\U5783--rdj-XPL-Y1.dgn
 dgross

8/23/99

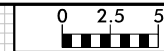

| | |
|---------------------|-----------|
| PROJ. REFERENCE NO. | SHEET NO. |
| U-5783 | X-43 |

75 70 65 60 55 50 45 40 35 30 25 20 15 10 5 0 5 10 15 20 25 30 35 40 45 50 55 60 65 70 75

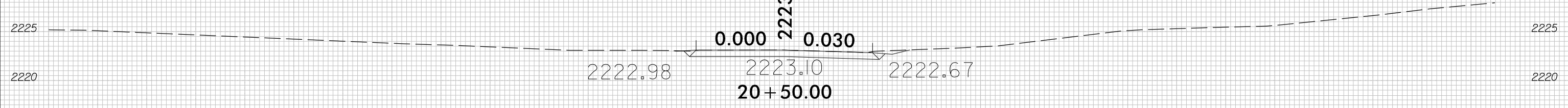
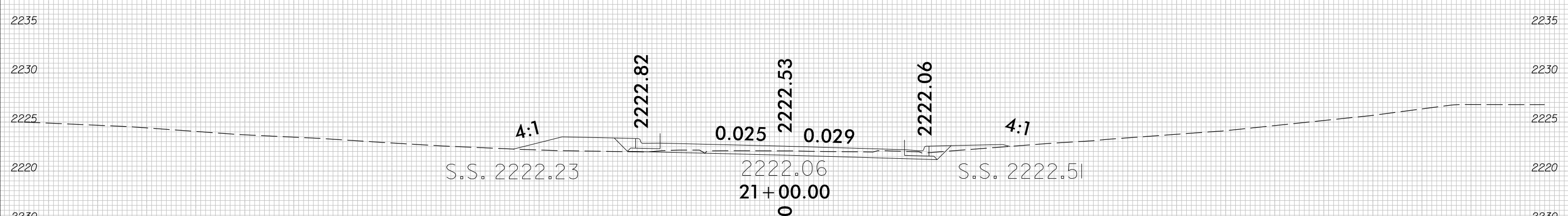
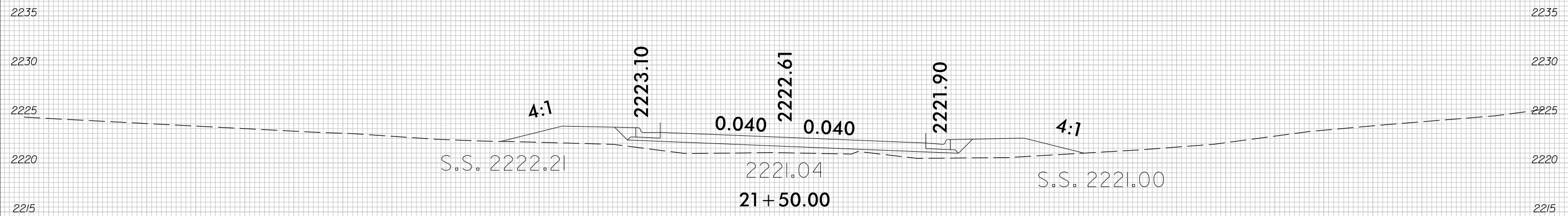

BEGIN CONSTRUCTION
-Y/A- STA 20+50

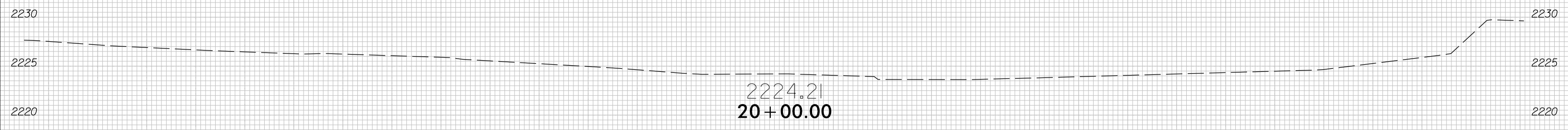

-Y/A-

75 70 65 60 55 50 45 40 35 30 25 20 15 10 5 0 5 10 15 20 25 30 35 40 45 50 55 60 65 70 75

2:27:55 PM
 I:\3572 US 64 Widening (U-5783)\06 U-5783\Roadway\XSC\U5783--rdj-XPL-Y1A.dgn
 c:\pross

8/23/99

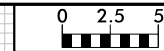

| | |
|---------------------|-----------|
| PROJ. REFERENCE NO. | SHEET NO. |
| U-5783 | X-44 |

75 70 65 60 55 50 45 40 35 30 25 20 15 10 5 0 5 10 15 20 25 30 35 40 45 50 55 60 65 70 75

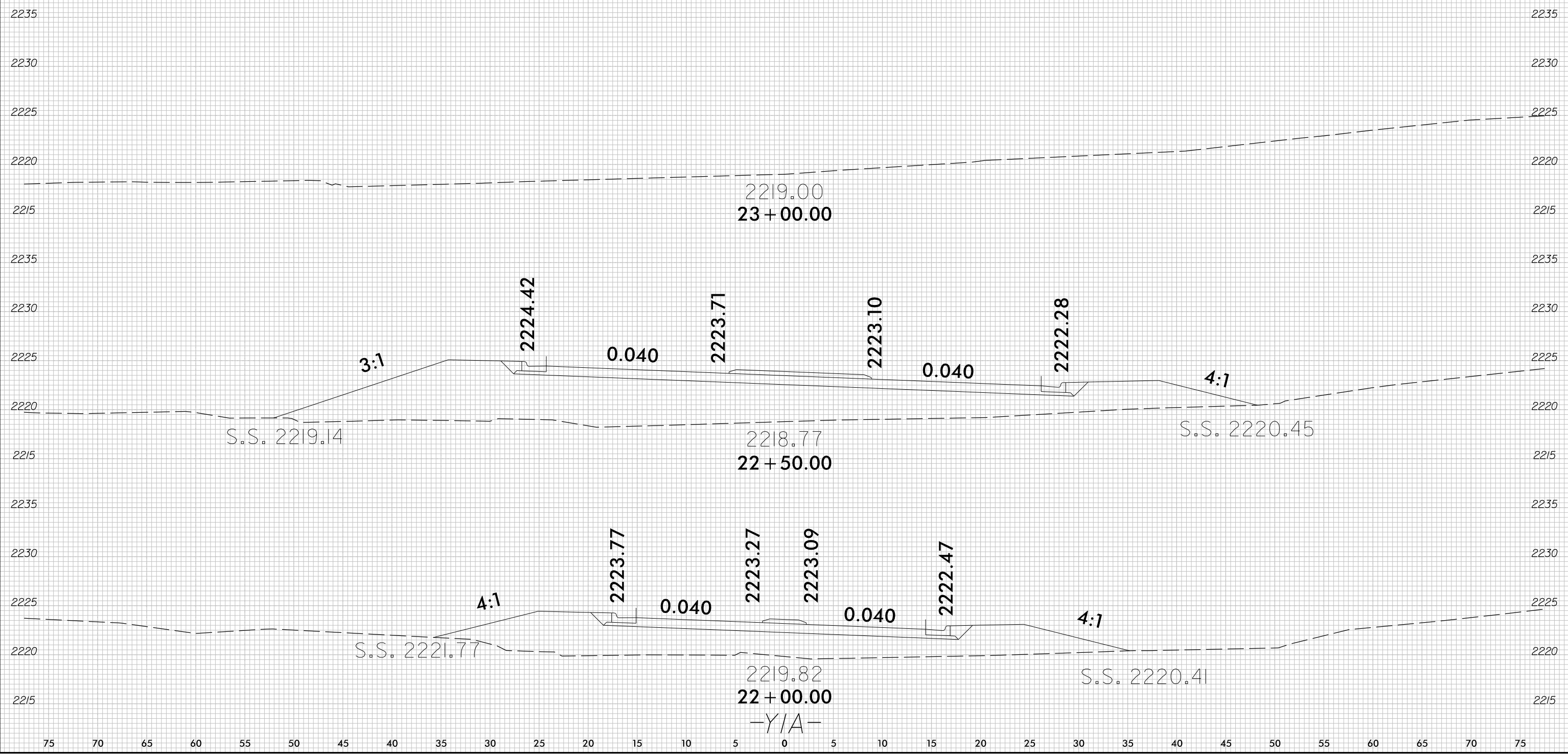

I2:45:00 PM
A: 7:35:72 US
m:\pang

75 70 65 60 55 50 45 40 35 30 25 20 15 10 5 0 5 10 15 20 25 30 35 40 45 50 55 60 65 70 75

8/23/99

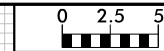

| | |
|---------------------|-----------|
| PROJ. REFERENCE NO. | SHEET NO. |
| U-5783 | X-45 |

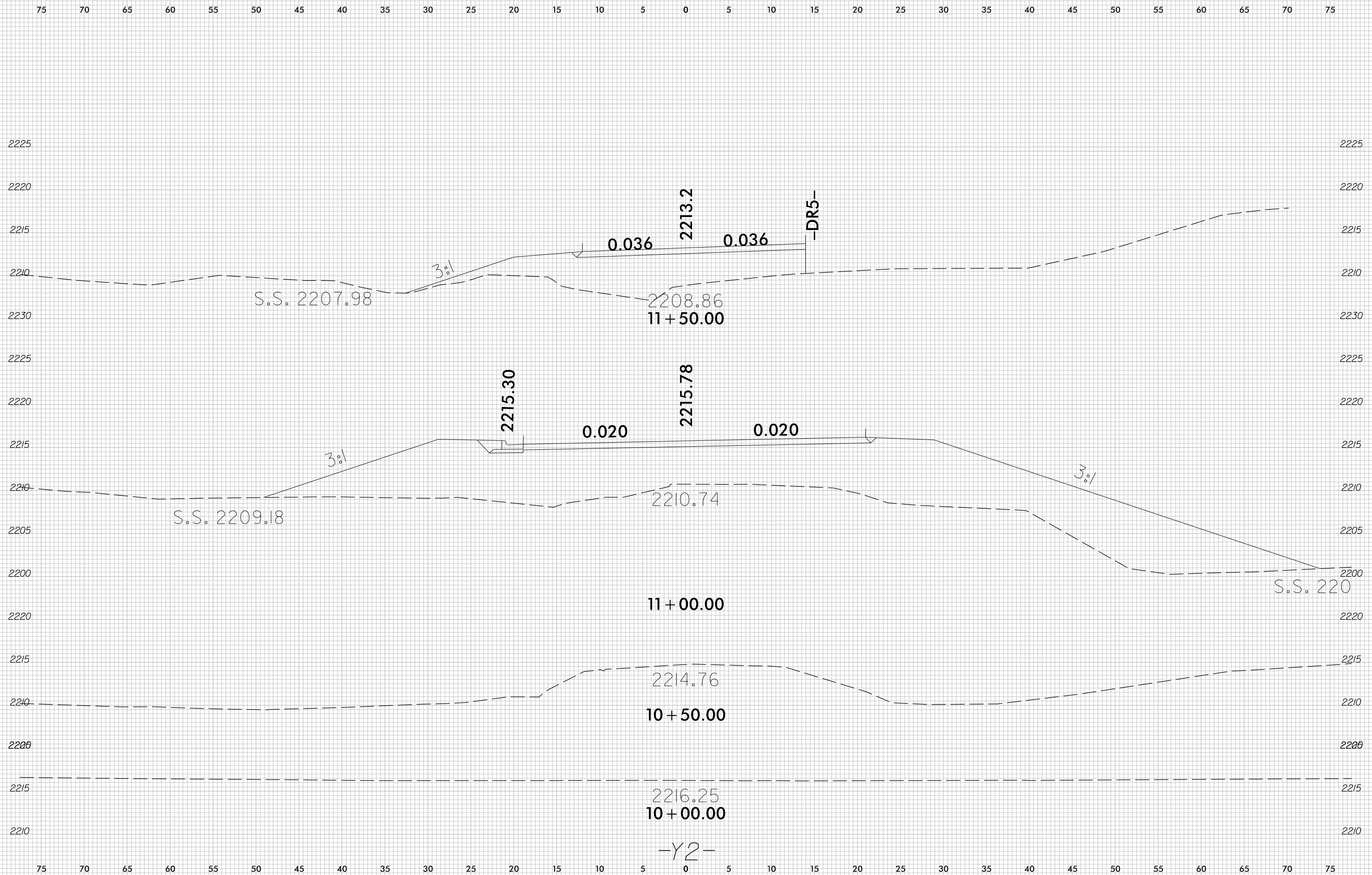

2:27:56 PM
 I:\3572 US 64 Widening (U-5783)\06 U-5783\Roadway\XSC\U5783-rdy-XPL-Y2.dgn
 dgross

8/23/99

| | | |
|---------|---------------------|-----------|
| 0 2.5 5 | PROJ. REFERENCE NO. | SHEET NO. |
| | U-5783 | X-47 |

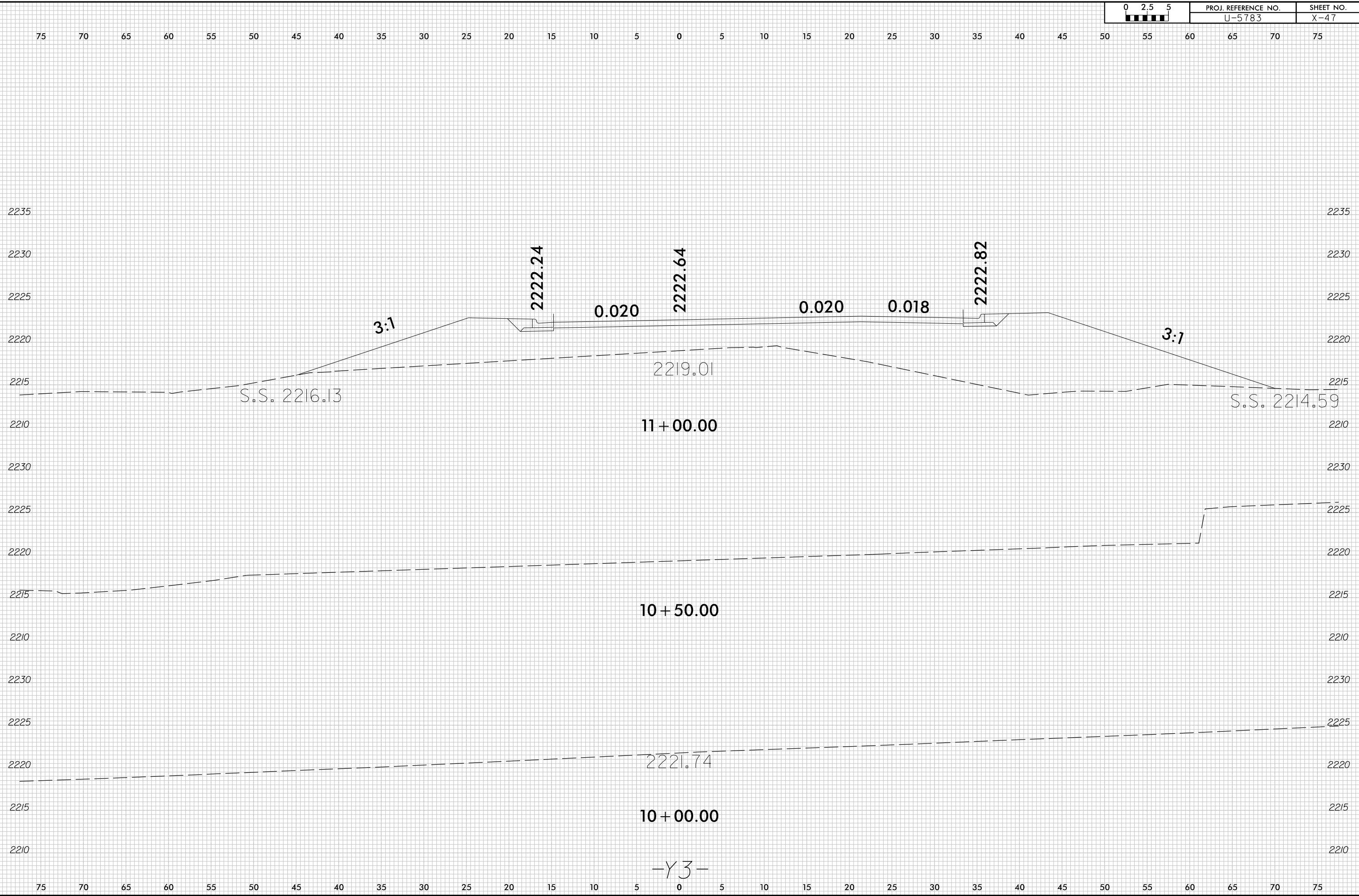

2:27:57 PM
I:\3572 US 64 Widening (U-5783)\06 U-5783\Roadway\XSC\U5783-rdy-XPL-Y3.dgn
dgross

8/23/99

| | | |
|---------|---------------------|-----------|
| 0 2.5 5 | PROJ. REFERENCE NO. | SHEET NO. |
| | U-5783 | X-48 |

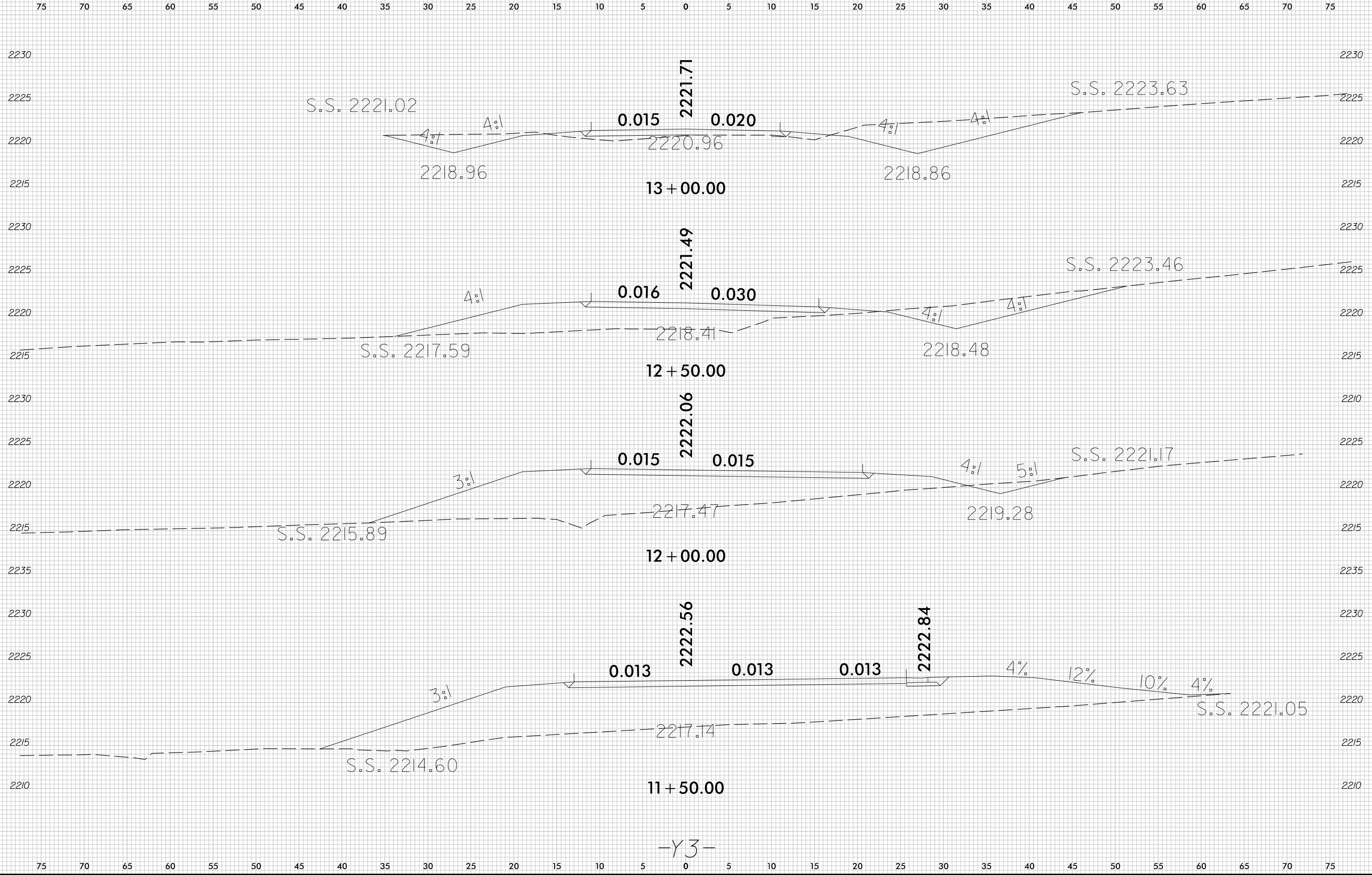

I2:30:44 PM At: 7/35/72 US mlang 64 Wrdemng U-5783\06 U-5783\Roadway\XSC\U5783.rdy.XPL.Y3.dgn

8/23/99

| | | |
|---------|---------------------|-----------|
| 0 2.5 5 | PROJ. REFERENCE NO. | SHEET NO. |
| | U-5783 | X-49 |

75 70 65 60 55 50 45 40 35 30 25 20 15 10 5 0 5 10 15 20 25 30 35 40 45 50 55 60 65 70 75

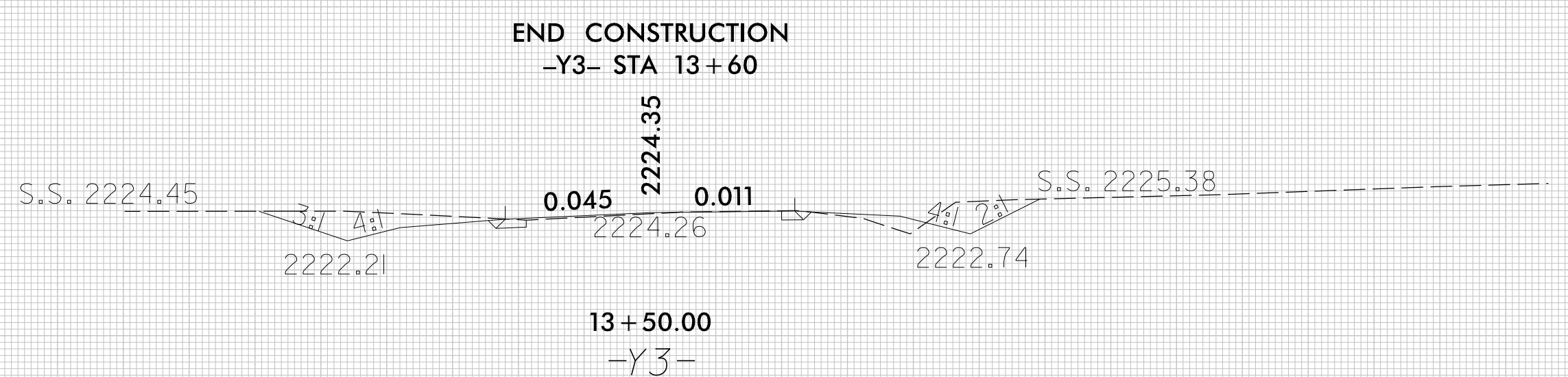

I2:31:29 PM
A: 7:35:72 US 64 widening U-5783\06 U-5783\Roadway\XSC\U5783.rdy.XPL.Y3.dgn
mhang

8/23/99

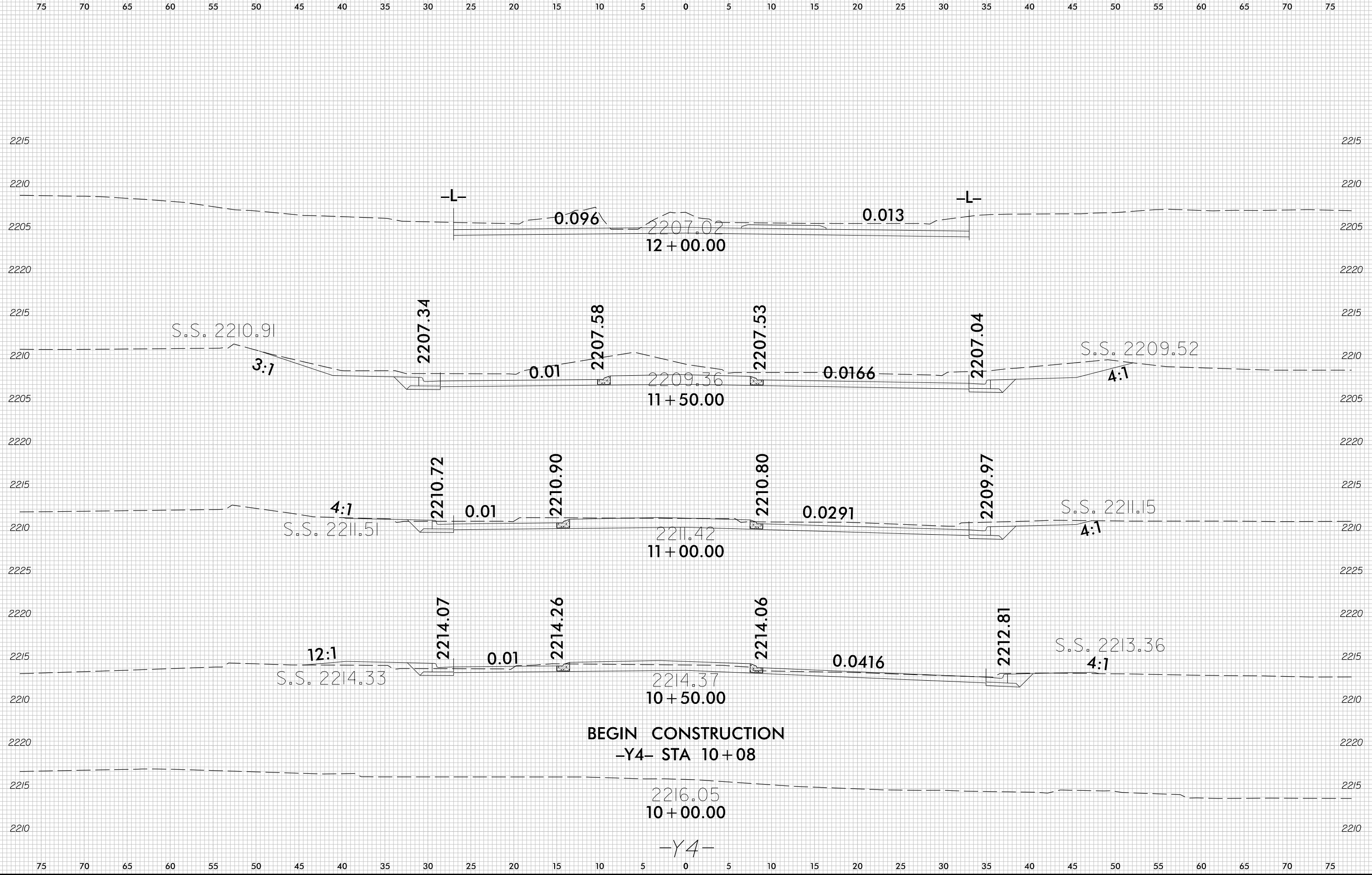

3:33:22 PM
At: 7/31/92 US 64 Widening U-5783\06 U-5783\Roadway\XSC\U5783.rdy.XPL.Y4.dgn
mchang

8/23/99

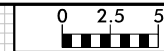

| | |
|---------------------|-----------|
| PROJ. REFERENCE NO. | SHEET NO. |
| U-5783 | X-51 |

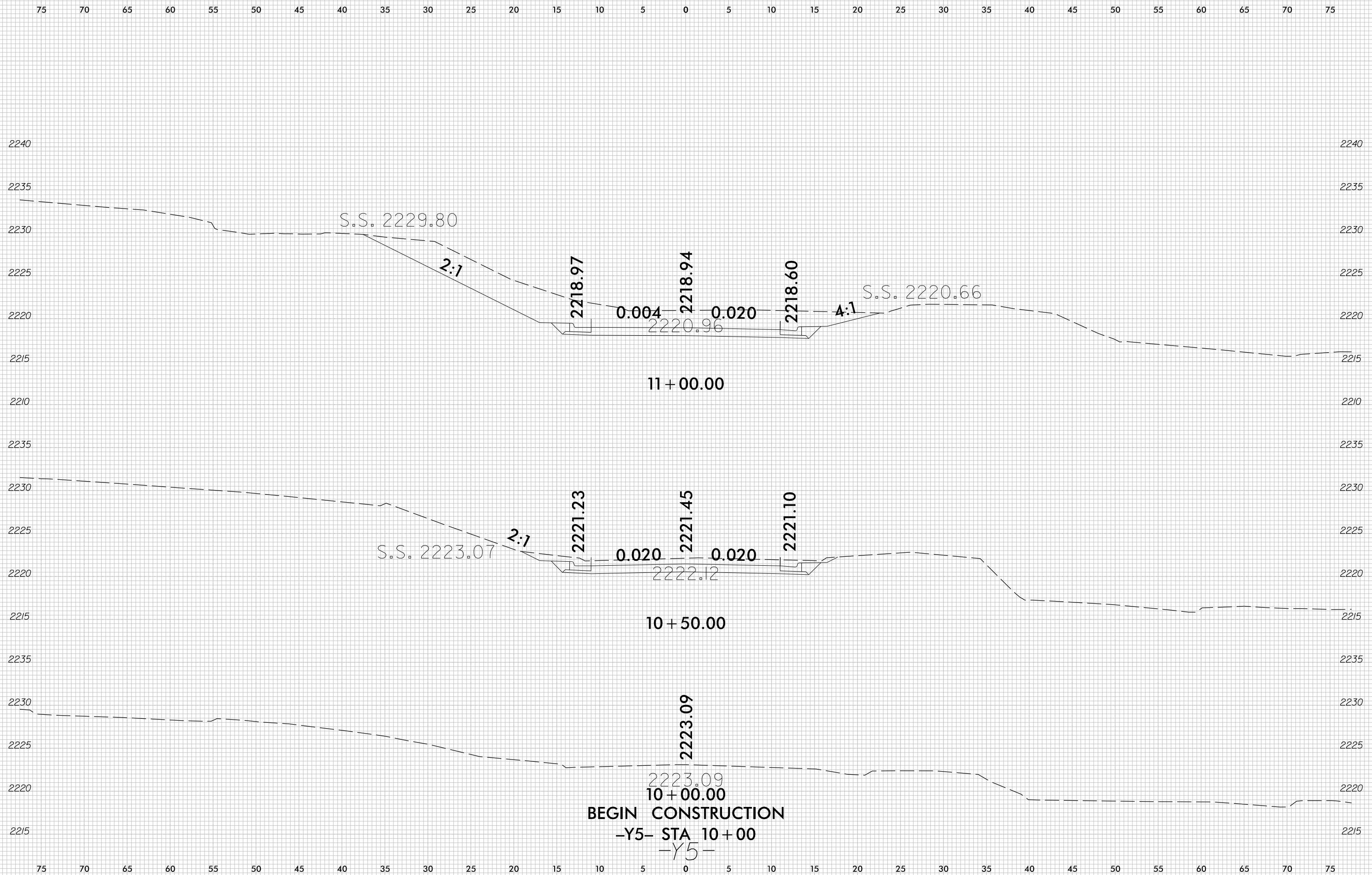

I:\2014\2 PM
 At 3:57:2 US 64 widening U-5783\06 U-5783\Roadway\XSC\U5783.rdy.XPL.Y5.dgn
 mlang

8/23/99

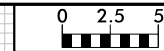

| | |
|---------------------|-----------|
| PROJ. REFERENCE NO. | SHEET NO. |
| U-5783 | X-52 |

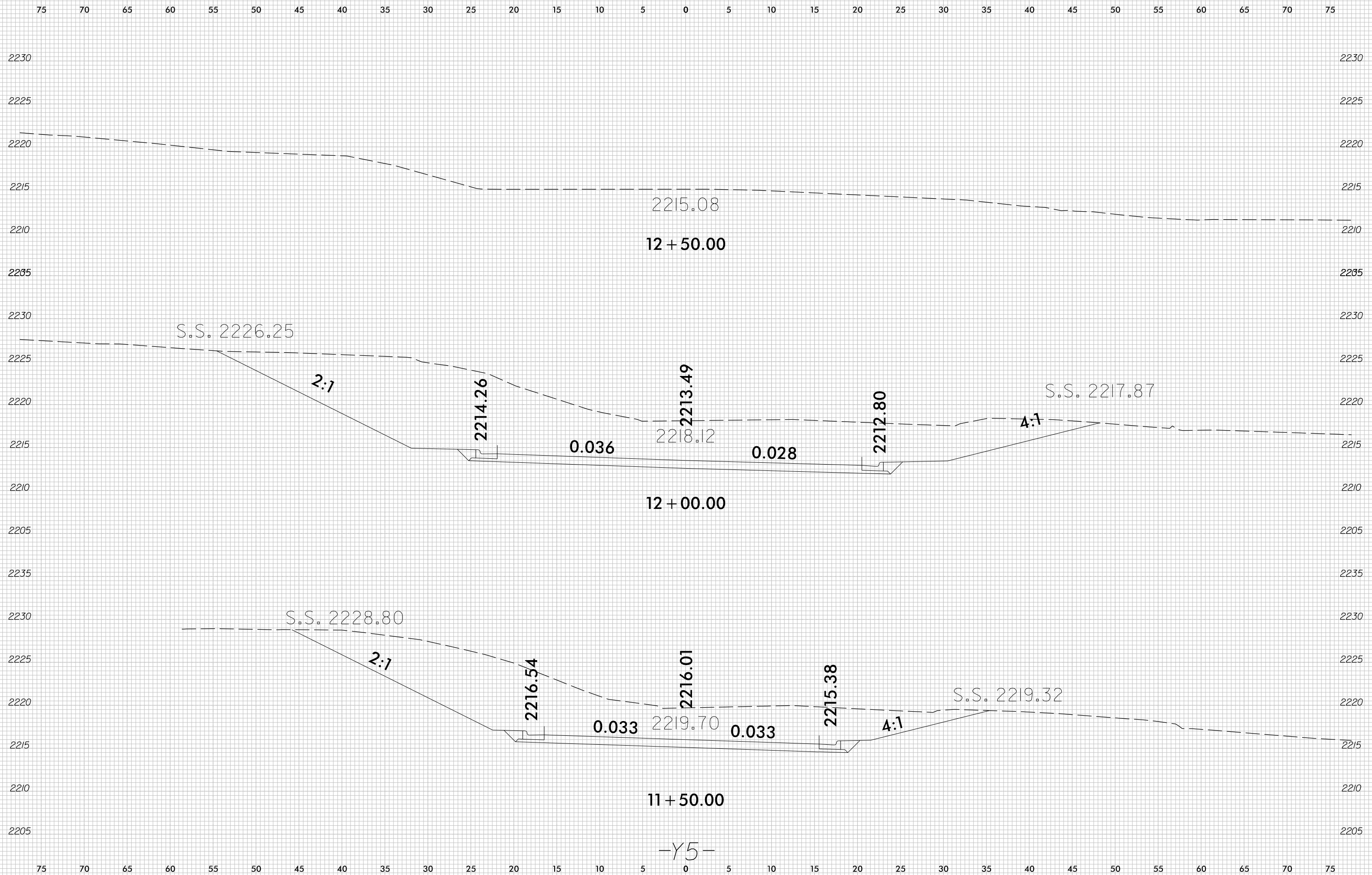

-Y5-

I:\2013\7 PM At 7:35:72 US 64 Widening U-5783\06 U-5783\Roadway\XSC\U5783-r.dj-XPL-Y5.dgn

8/23/99

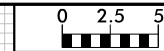

| | |
|---------------------|-----------|
| PROJ. REFERENCE NO. | SHEET NO. |
| U-5783 | X-53 |

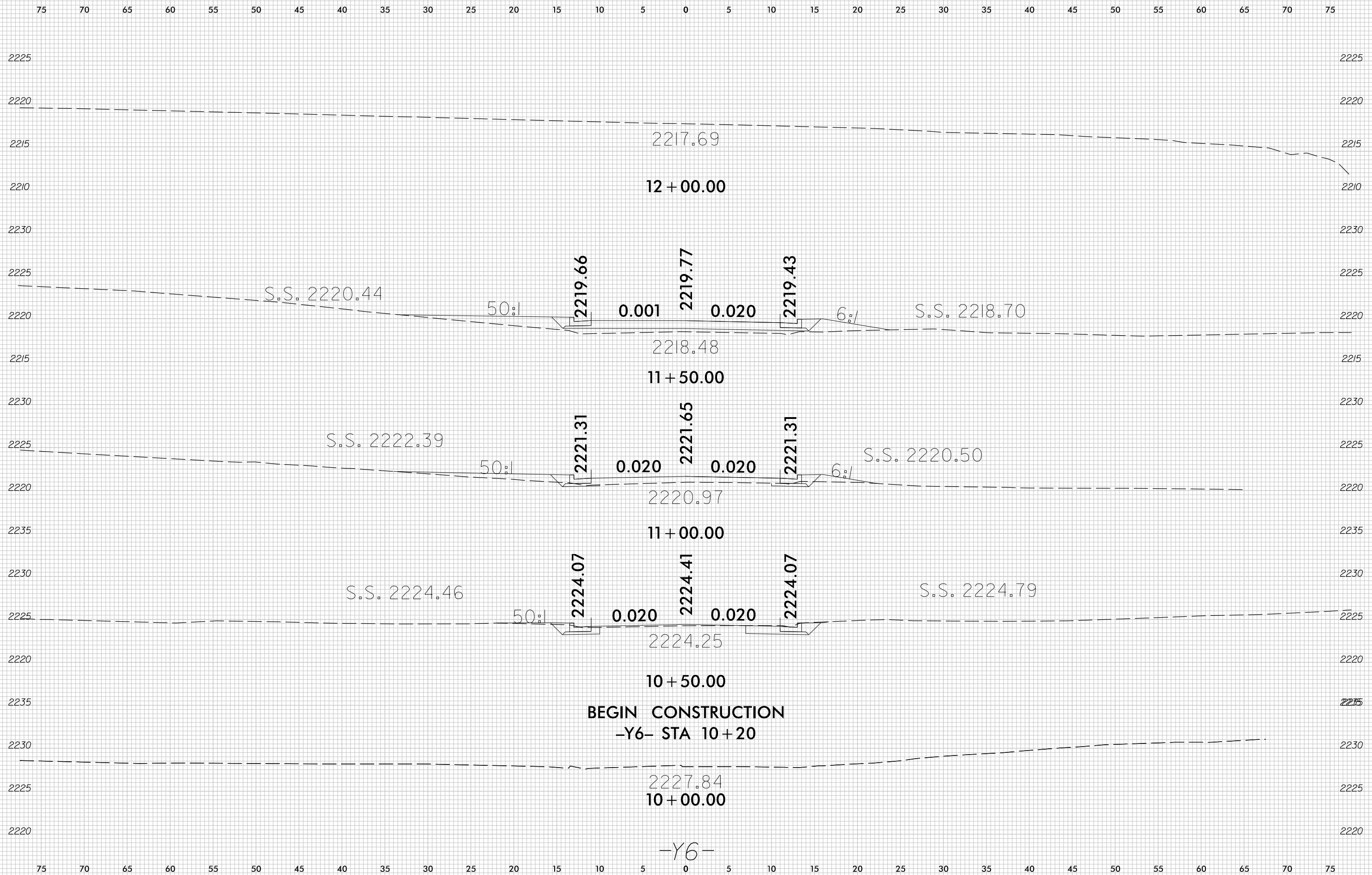

12:09:28 PM At: 73572 US m:\pang U-5783\06 U-5783\Roadway\XSC\U5783-rdy-XPL-Y6.dgn

8/23/99

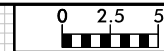

| | |
|---------------------|-----------|
| PROJ. REFERENCE NO. | SHEET NO. |
| U-5783 | X-54 |

75 70 65 60 55 50 45 40 35 30 25 20 15 10 5 0 5 10 15 20 25 30 35 40 45 50 55 60 65 70 75

END CONSTRUCTION
-Y7- STA 12+90.00

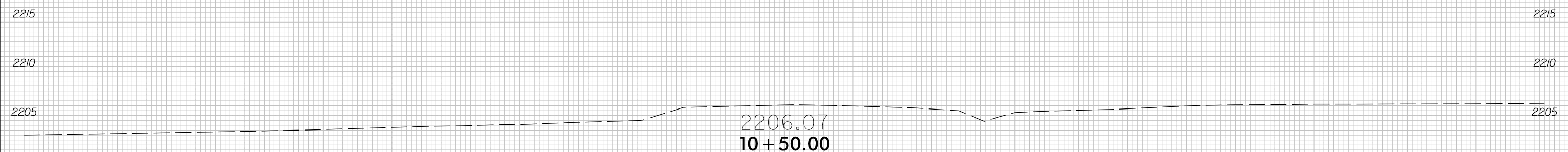
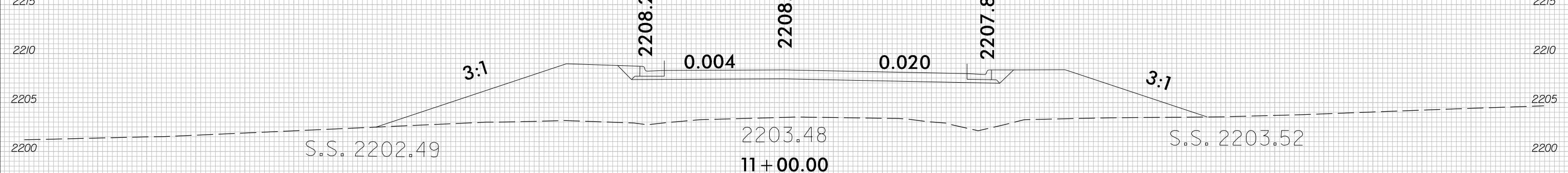
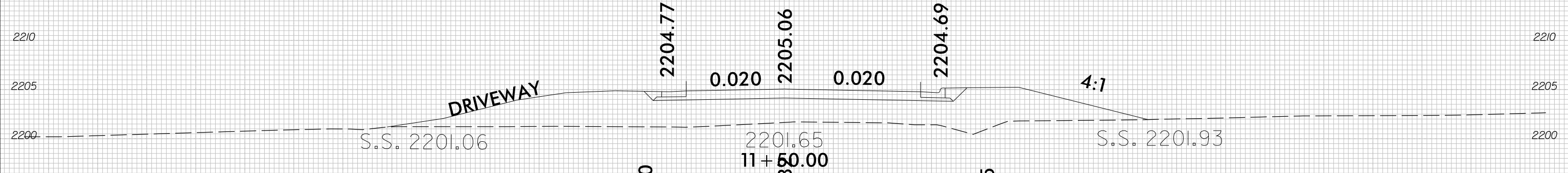
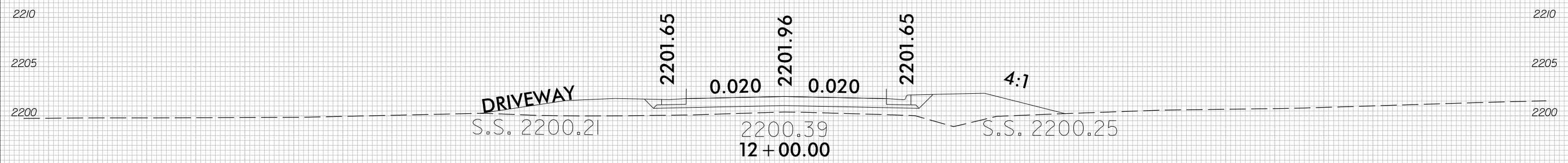
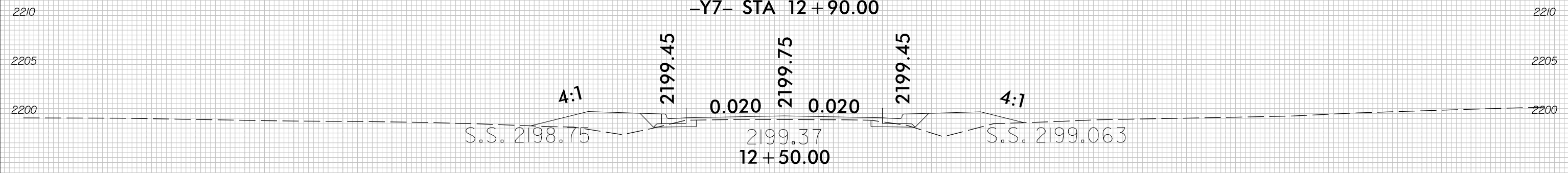

-Y7-

75 70 65 60 55 50 45 40 35 30 25 20 15 10 5 0 5 10 15 20 25 30 35 40 45 50 55 60 65 70 75

I2:10:16 PM At: 3:57:2 US 64 Wrdemng U-5783\06 U-5783\Roadway\XSC\U5783-rdy-XPL-Y7.dgn

8/23/99

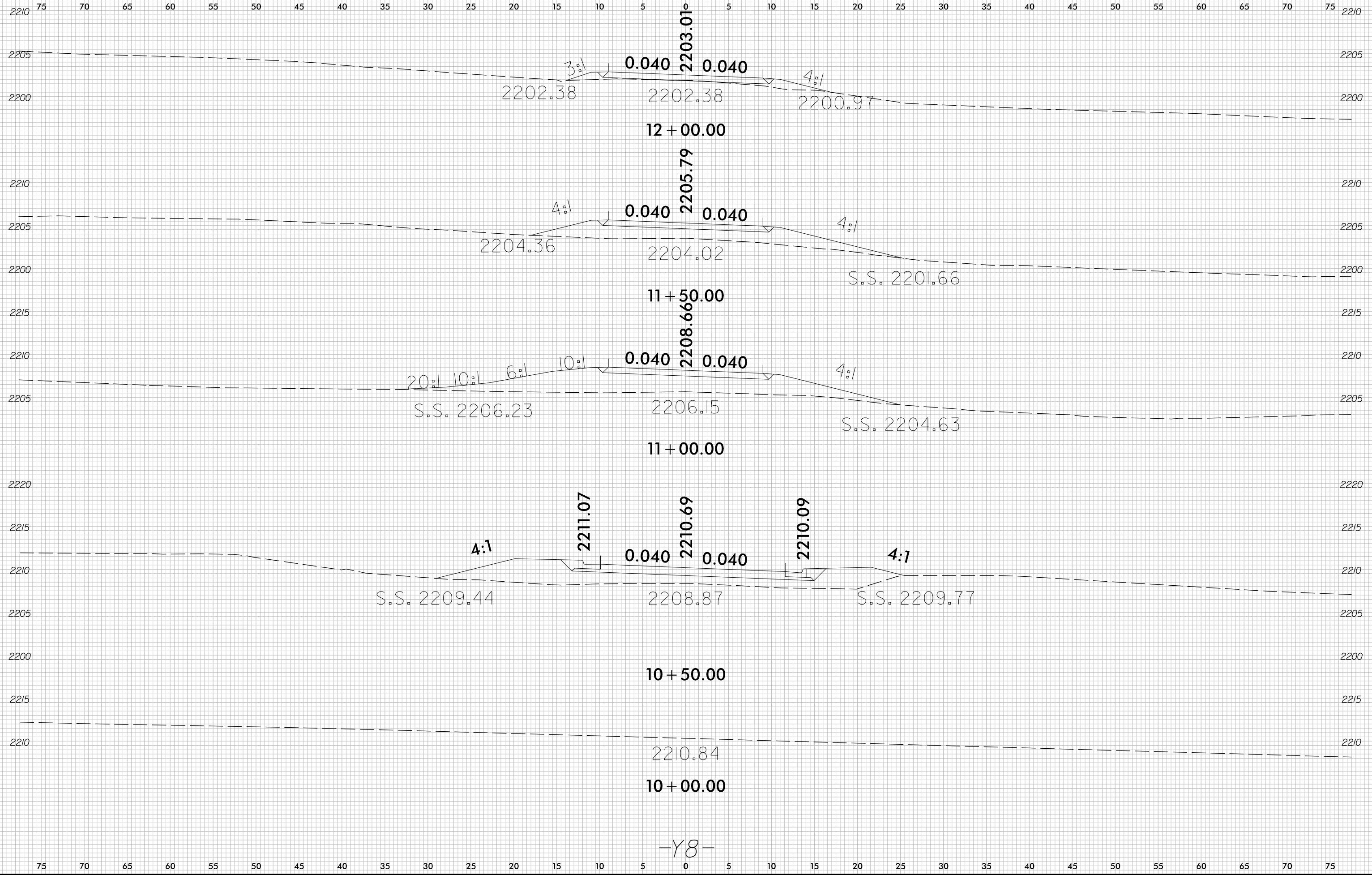

I2:14:13 PM At: 7:35:72 US 64 widening U-5783\06 U-5783\Roadway\XSC\U5783-r.dj-XPL-Y8.dgn

8/23/99

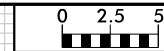

| | |
|---------------------|-----------|
| PROJ. REFERENCE NO. | SHEET NO. |
| U-5783 | X-56 |

75 70 65 60 55 50 45 40 35 30 25 20 15 10 5 0 5 10 15 20 25 30 35 40 45 50 55 60 65 70 75

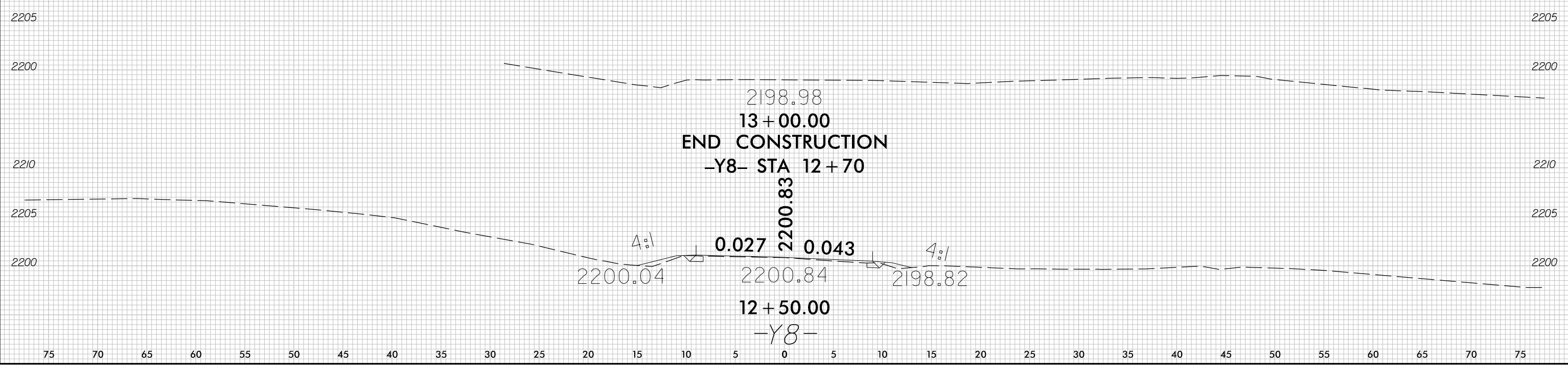

12:13:37 PM
 At: 7/35/92 US 64 widening U-5783\06 U-5783\Roadway\XSC\U5783.rdy-XPL-Y8.dgn
 mlang

8/23/99

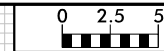

| | |
|---------------------|-----------|
| PROJ. REFERENCE NO. | SHEET NO. |
| U-5783 | X-57 |

75 70 65 60 55 50 45 40 35 30 25 20 15 10 5 0 5 10 15 20 25 30 35 40 45 50 55 60 65 70 75

END CONSTRUCTION
-Y9- STA 12+00

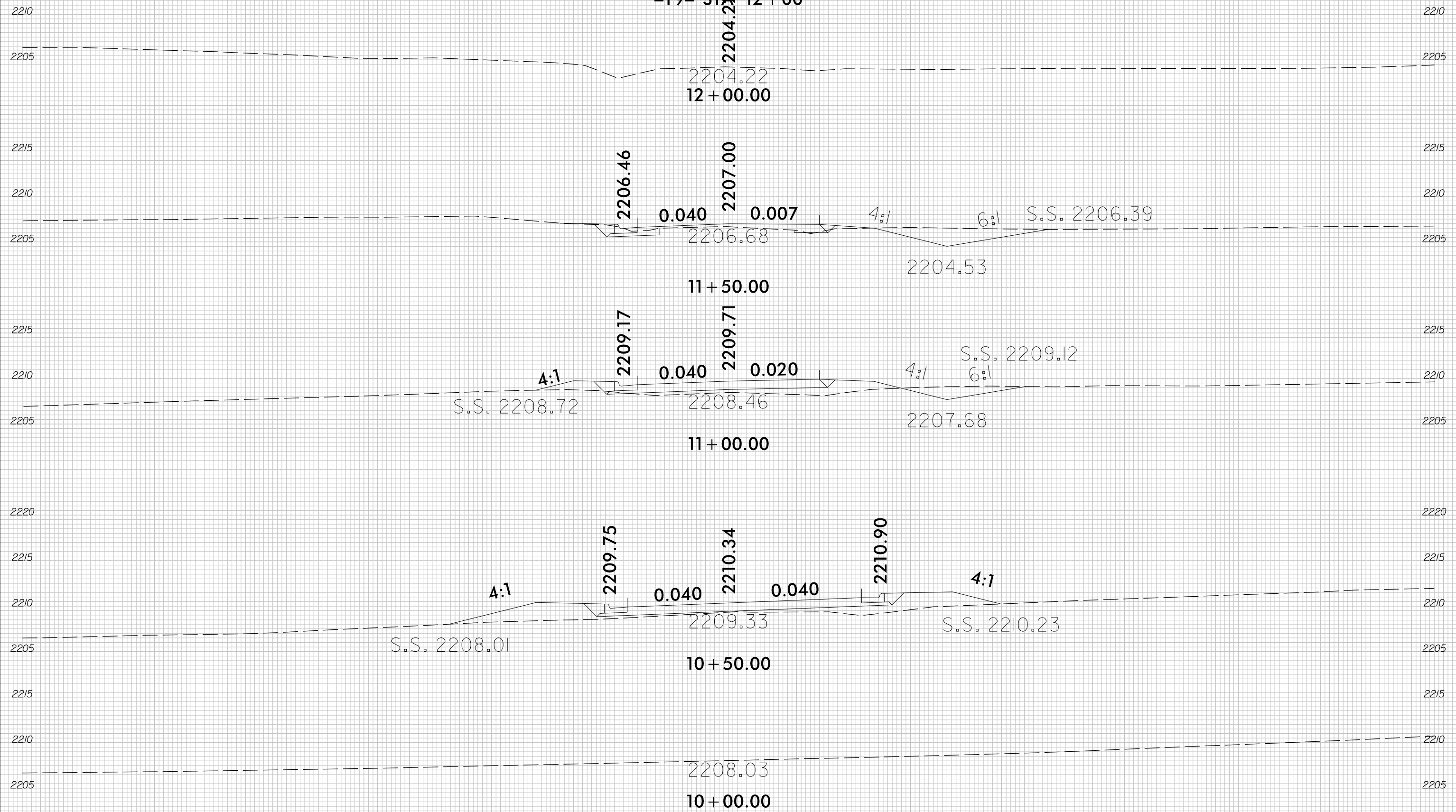

75 70 65 60 55 50 45 40 35 30 25 20 15 10 5 0 5 10 15 20 25 30 35 40 45 50 55 60 65 70 75

-Y9-

I2:2:56 PM
 At: 7:35:22 US
 64 Wrdemng U-5783\06 U-5783\Roadway\XSC\U5783-r.dj-XPL-Y9.dgn
 mlong

8/23/99

| | | |
|---------|---------------------|-----------|
| 0 2.5 5 | PROJ. REFERENCE NO. | SHEET NO. |
| | U-5783 | X-58 |

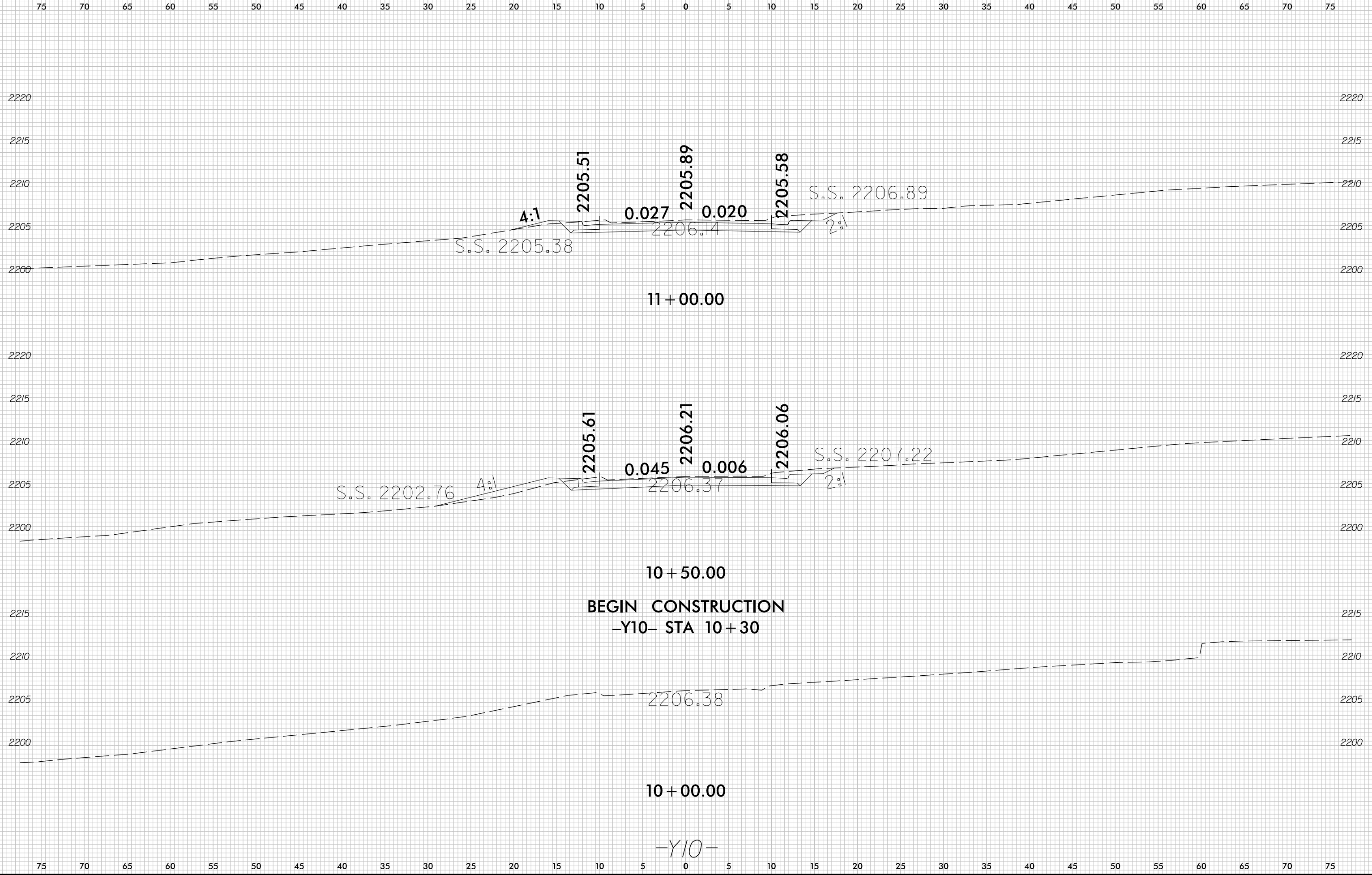

I2:13:55 PM
A: 3572 US 64 Widening U-5783\06 U-5783\Roadway\XSC\U5783-r.dj-XPL-Y10.dgn
mlang

8/23/99

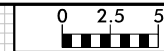

| |
|---------------------|
| PROJ. REFERENCE NO. |
| U-5783 |

| |
|-----------|
| SHEET NO. |
| X-59 |

75 70 65 60 55 50 45 40 35 30 25 20 15 10 5 0 5 10 15 20 25 30 35 40 45 50 55 60 65 70 75

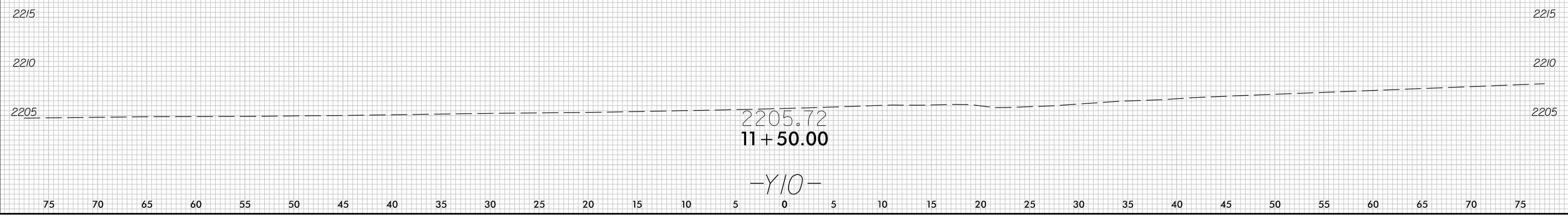

I2:4:35 PM
A: 73572 US
64 Widening U-5783\06 U-5783\Roadway\XSC\U5783.rdy.XPL-Y10.dgn
mhang

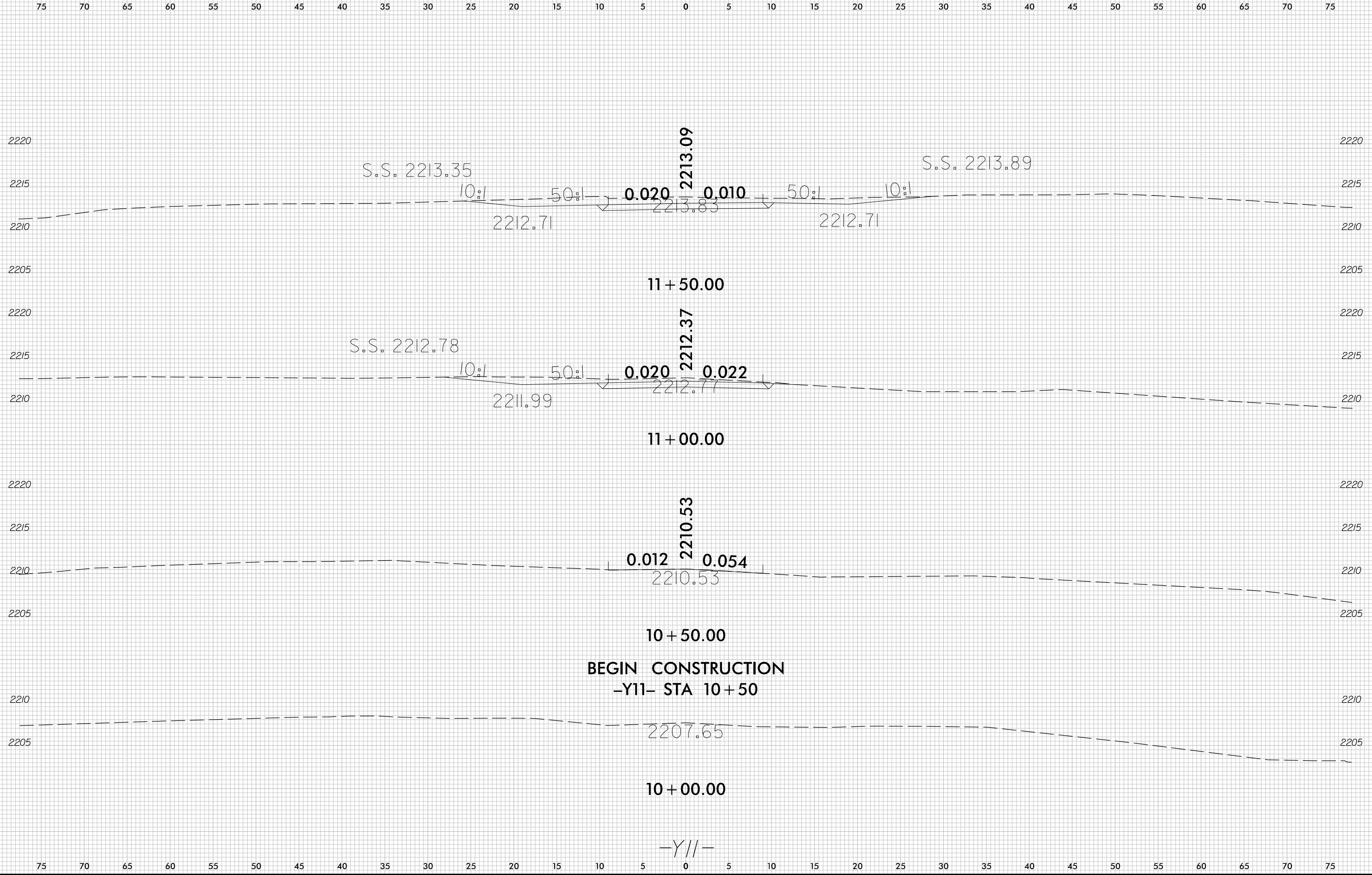

8/23/99

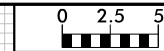

| | |
|---------------------|-----------|
| PROJ. REFERENCE NO. | SHEET NO. |
| U-5783 | X-61 |

| | |
|---------------------|-----------|
| PROJ. REFERENCE NO. | SHEET NO. |
| U-5783 | X-61 |

75 70 65 60 55 50 45 40 35 30 25 20 15 10 5 0 5 10 15 20 25 30 35 40 45 50 55 60 65 70 75

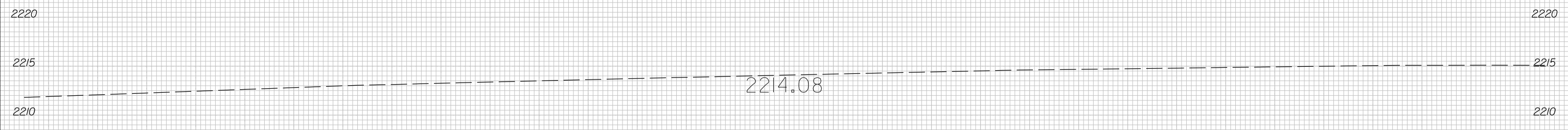

12 + 00.00
-Y//-

75 70 65 60 55 50 45 40 35 30 25 20 15 10 5 0 5 10 15 20 25 30 35 40 45 50 55 60 65 70 75

2:28:07 PM
I:\3572 US 64 Widening (U-5783)\06 U-5783\Roadway\XSC\U5783--rdg-XPL-Y11.dgn
dgross

8/23/99

| | | |
|---------|---------------------|-----------|
| 0 2.5 5 | PROJ. REFERENCE NO. | SHEET NO. |
| | U-5783 | X-62 |

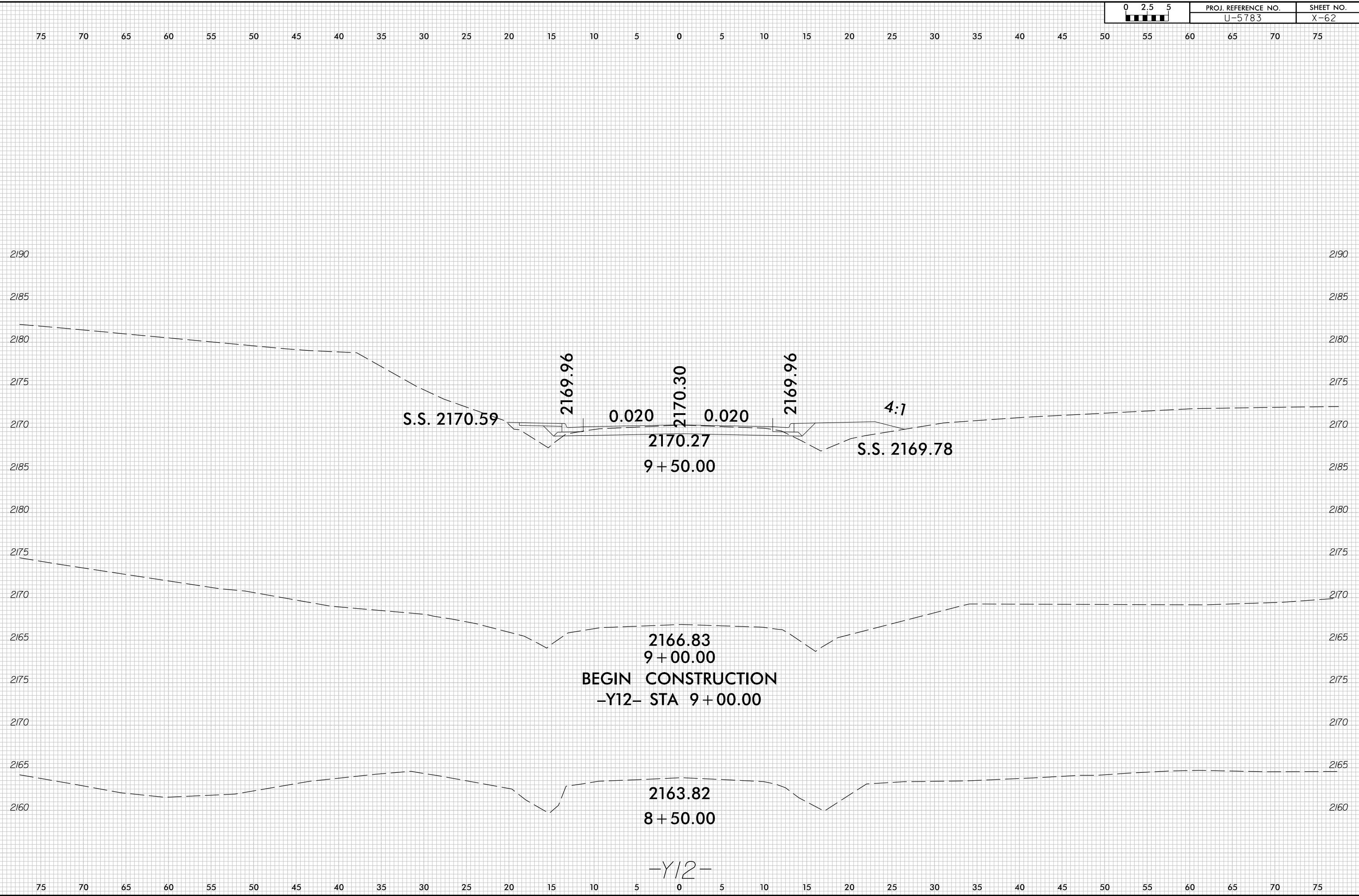

I2:16:12 PM At: 7:35:12 US 64 Widening U-5783\06 U-5783\Roadway\XSC\U5783.rdy-XPL-Y12.dgn

-Y12-

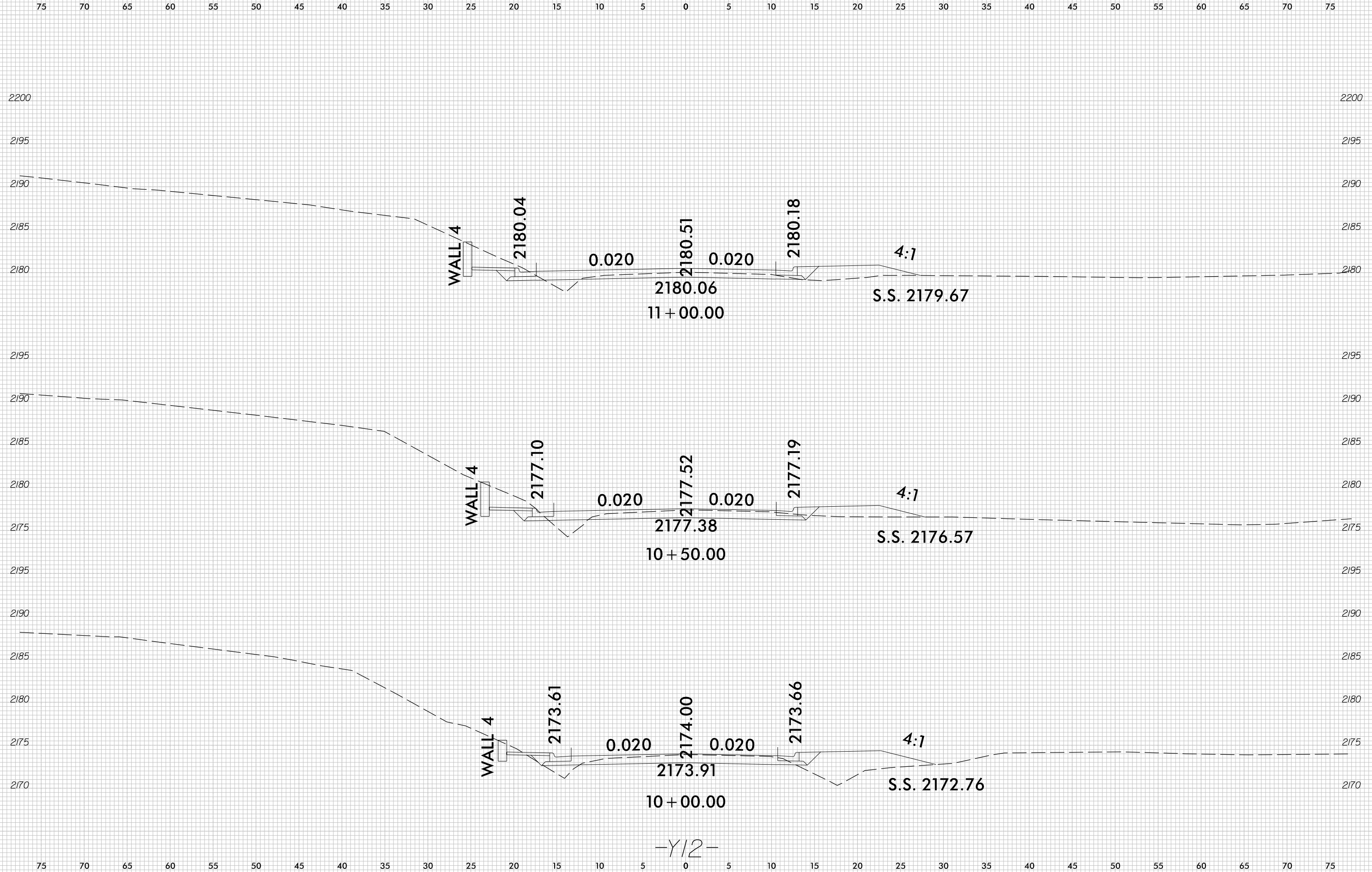

-Y12-

8/23/99

| | | |
|---------|---------------------|-----------|
| 0 2.5 5 | PROJ. REFERENCE NO. | SHEET NO. |
| | U-5783 | X-64 |

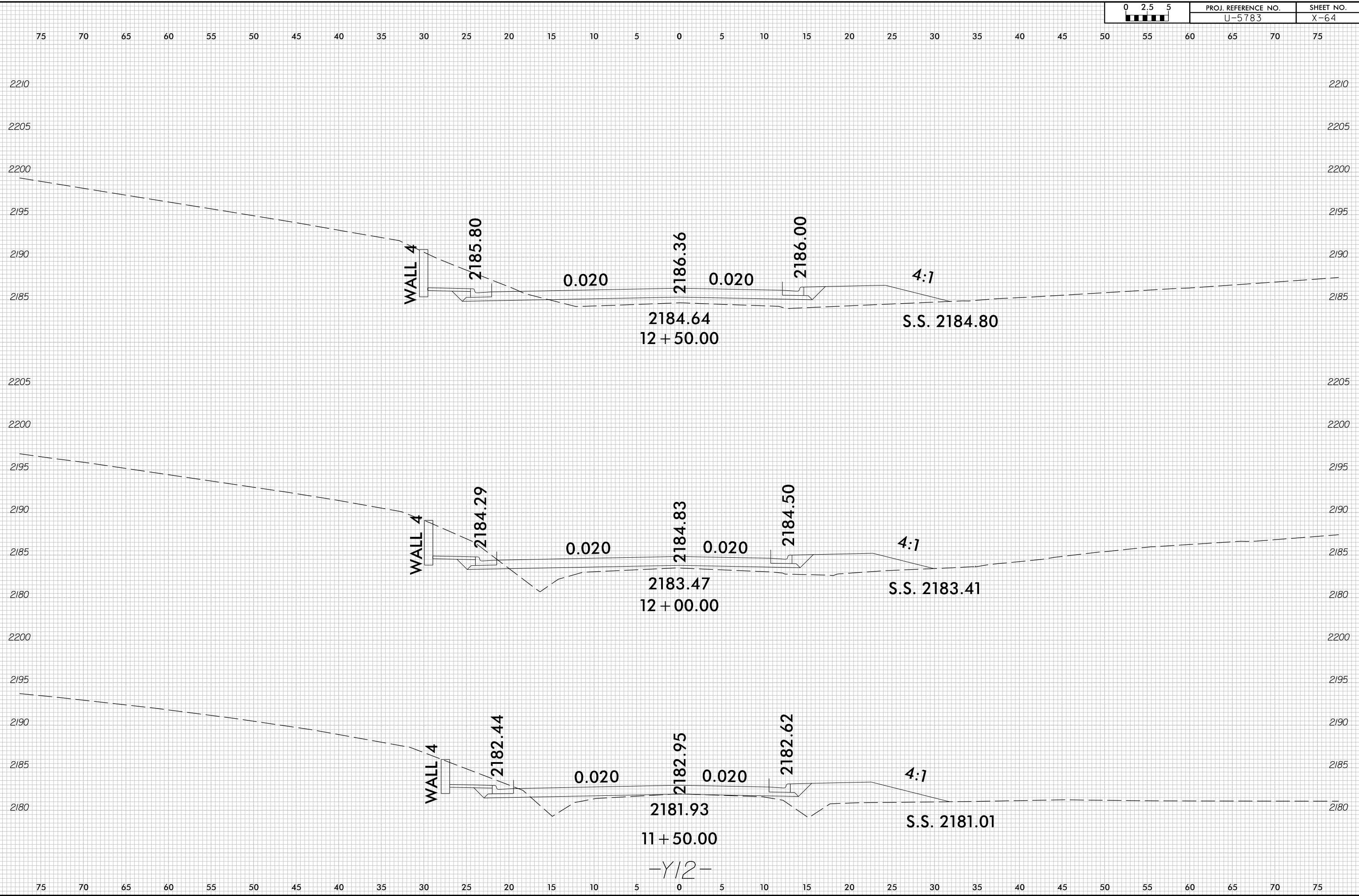

2:28:09 PM
I:\3572 US 64 Widening (U-5783)\06 U-5783\Roadway\XSC\U5783--dy_XPL_Y12.dgn
ogross

-Y12-

8/23/99

| | | |
|---------|---------------------|-----------|
| 0 2.5 5 | PROJ. REFERENCE NO. | SHEET NO. |
| | U-5783 | X-65 |

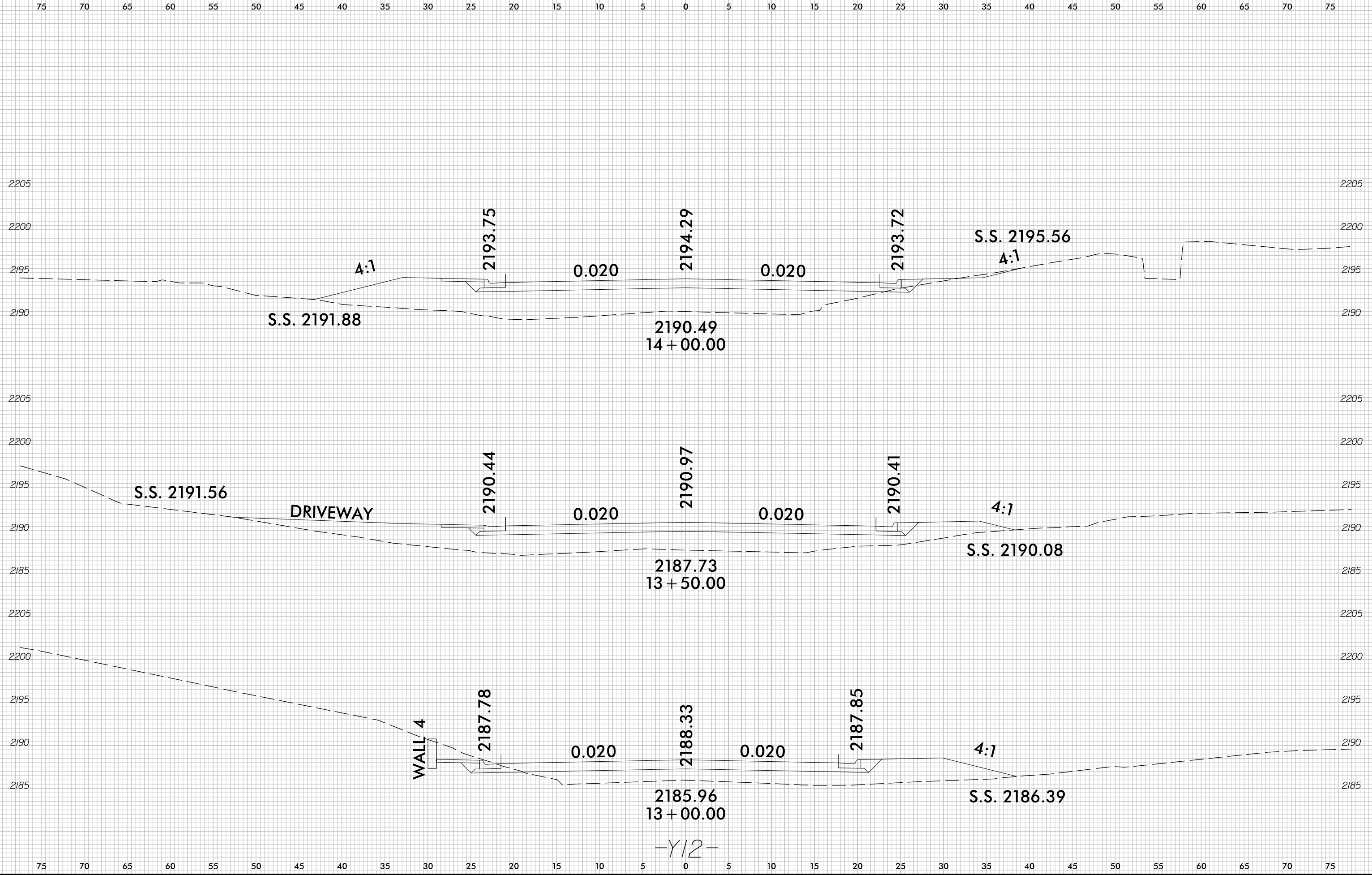

2:28:17 PM
I:\3572 US 64 Widening (U-5783)\06 U-5783\Roadway\XSC\U5783--rdg_XPL_Y12.dgn
dgr055

-Y12-

8/23/99

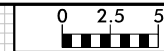

| | |
|---------------------|-----------|
| PROJ. REFERENCE NO. | SHEET NO. |
| U-5783 | X-66 |

75 70 65 60 55 50 45 40 35 30 25 20 15 10 5 0 5 10 15 20 25 30 35 40 45 50 55 60 65 70 75

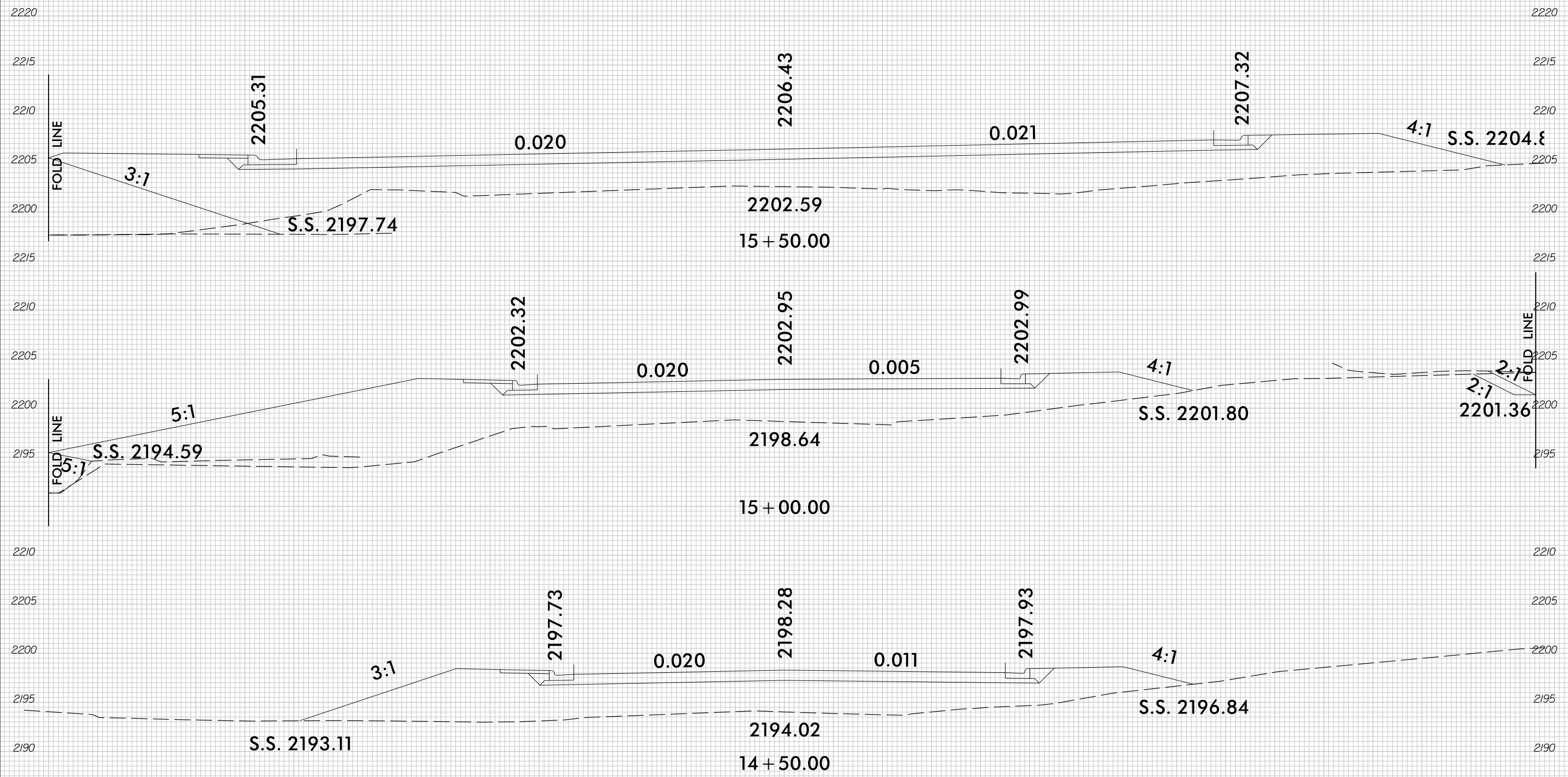

-Y12-

2:38:57 PM
 I:\3572 US 64 Widening (U-5783)\06 U-5783\Roadway\XSC\U5783-rdy-XPL-Y12.dgn
 gprcss

8/23/99

75 70 65 60 55 50 45 40 35 30 25 20 15 10 5 0 5 10 15 20 25 30 35 40 45 50 55 60 65 70 75

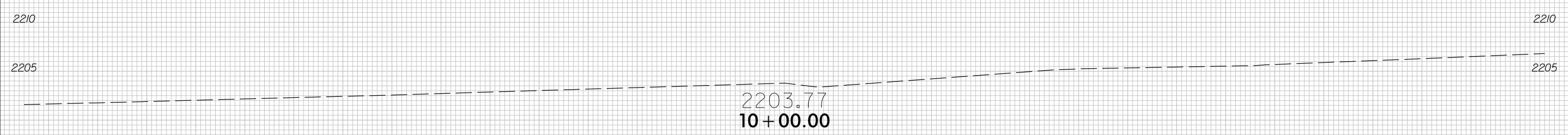
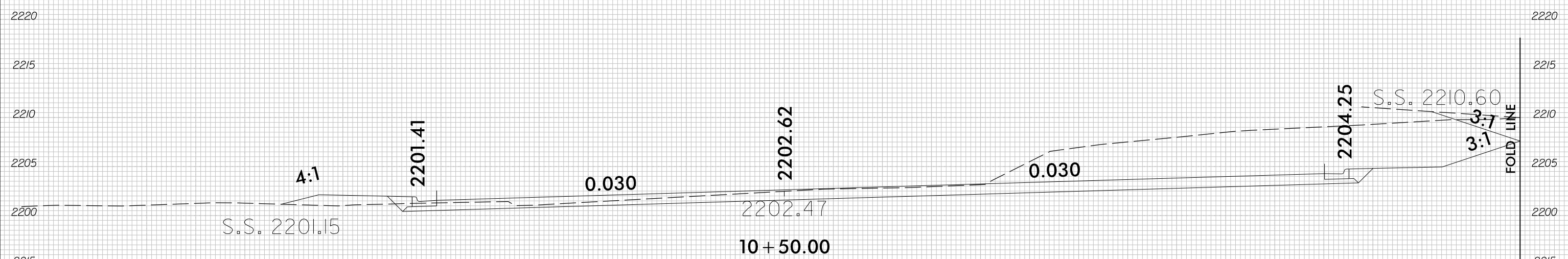
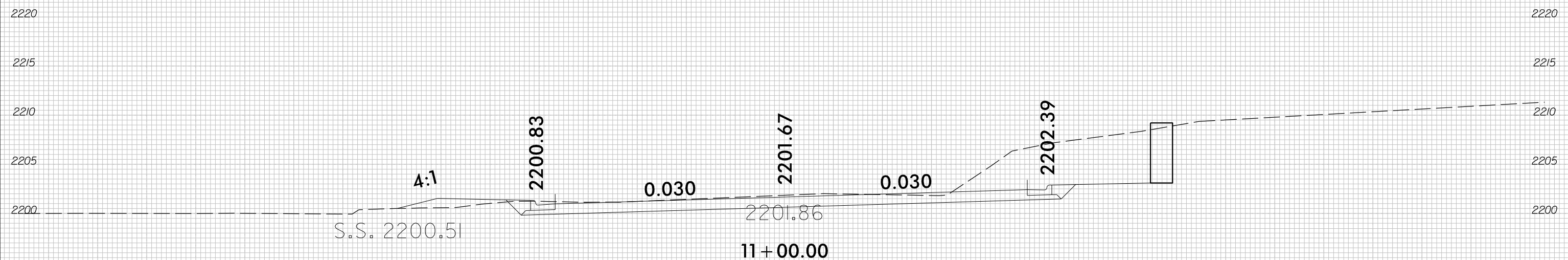

-Y13-

2:41:29 PM
I:\3572 US 64 Widening (U-5783)\06 U-5783\Roadway\XSC\U5783.dwg_XPL_Y13.dgn
dgross

8/23/99

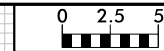

| | |
|---------------------|-----------|
| PROJ. REFERENCE NO. | SHEET NO. |
| U-5783 | X-68 |

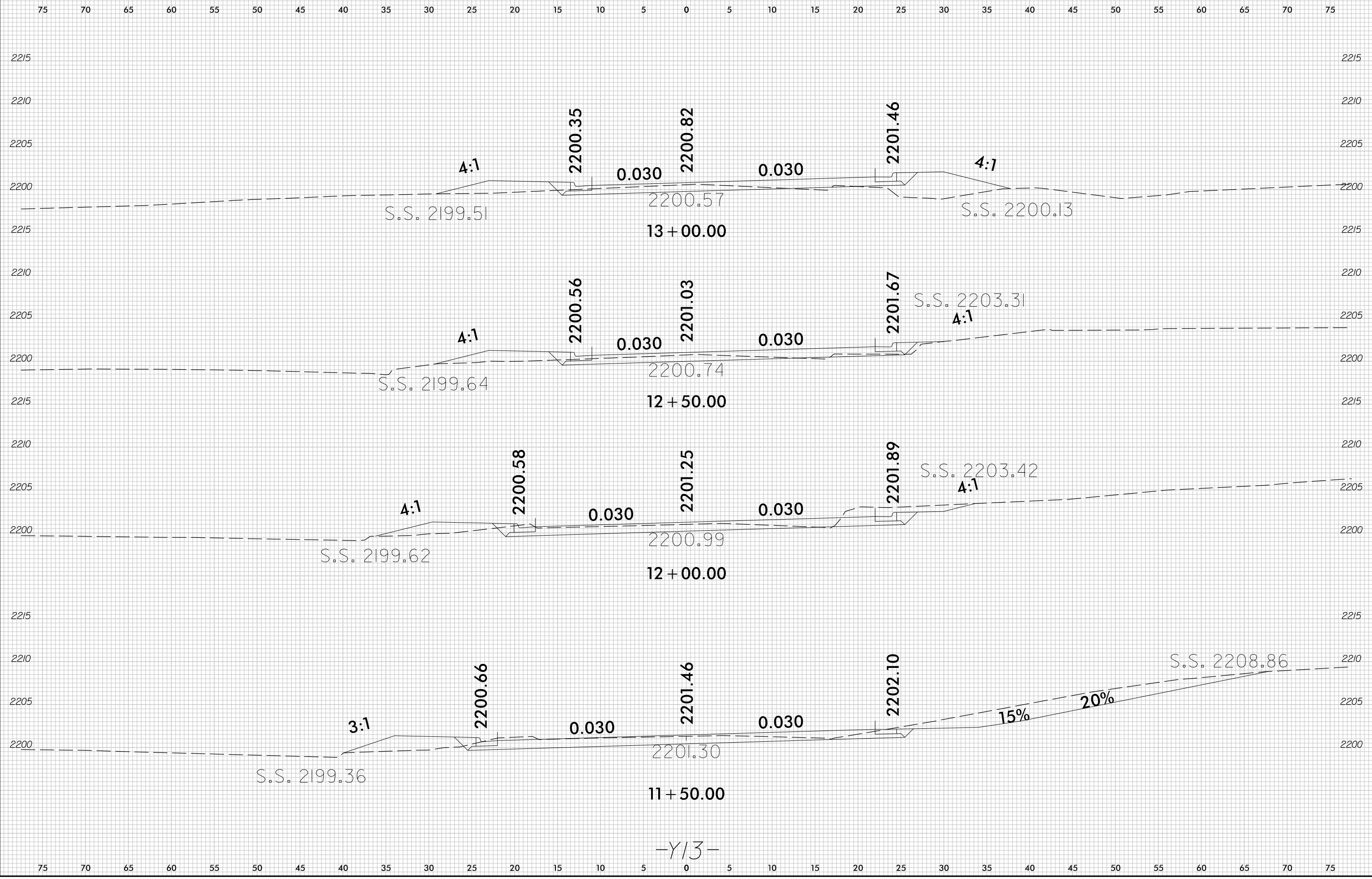

2:42:22 PM
I:\3572 US 64 Widening (U-5783)\06 U-5783\Roadway\XSC\U5783--dy_XPL_Y13.dgn
dgr038

-Y13-

8/23/99

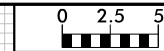

| | |
|---------------------|-----------|
| PROJ. REFERENCE NO. | SHEET NO. |
| U-5783 | X-69 |

75 70 65 60 55 50 45 40 35 30 25 20 15 10 5 0 5 10 15 20 25 30 35 40 45 50 55 60 65 70 75

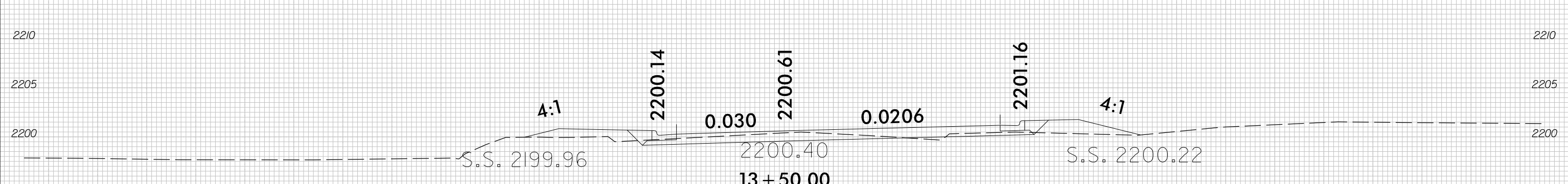
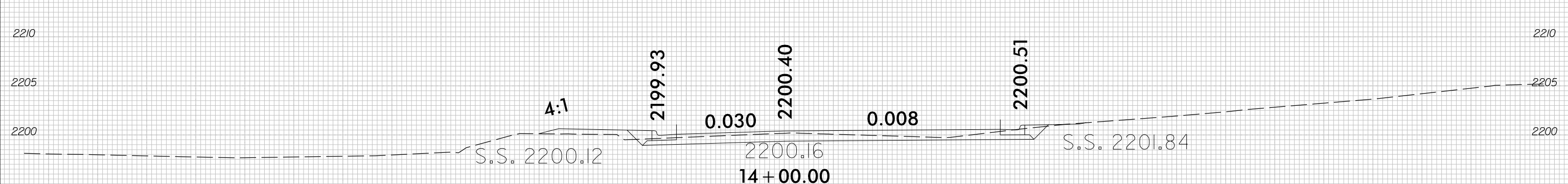
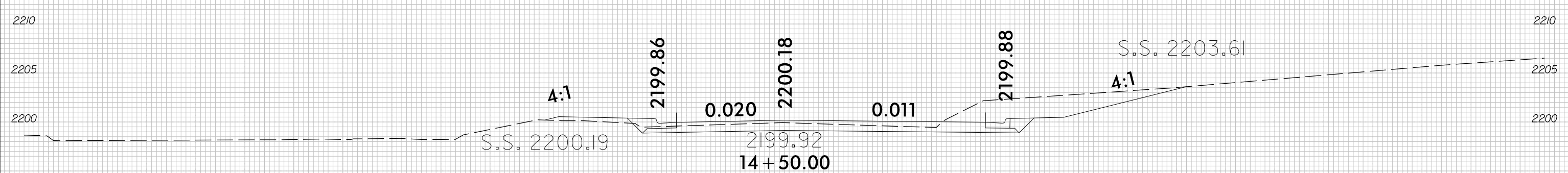
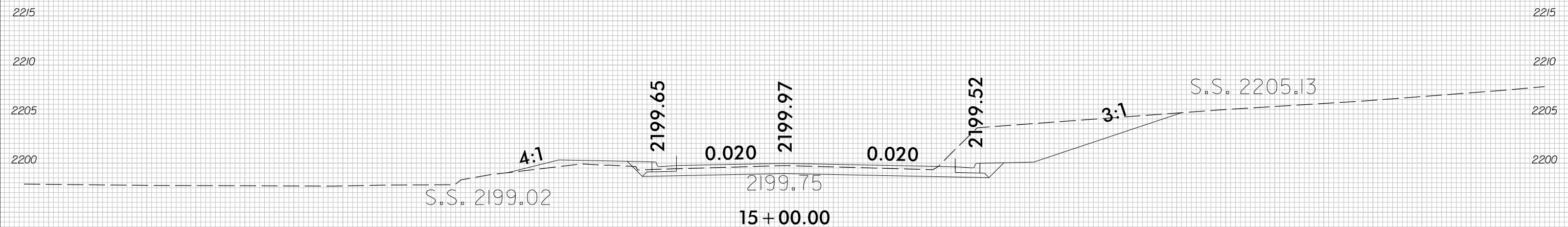

75 70 65 60 55 50 45 40 35 30 25 20 15 10 5 0 5 10 15 20 25 30 35 40 45 50 55 60 65 70 75

2:44:21 PM
 I:\3572 US 64 Widening (U-5783)\06 U-5783\Roadway\XSC\U5783--dy_XPL_Y13.dgn
 c:\pross

-Y13-

8/23/99

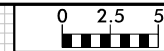

| | |
|---------------------|-----------|
| PROJ. REFERENCE NO. | SHEET NO. |
| U-5783 | X-70 |

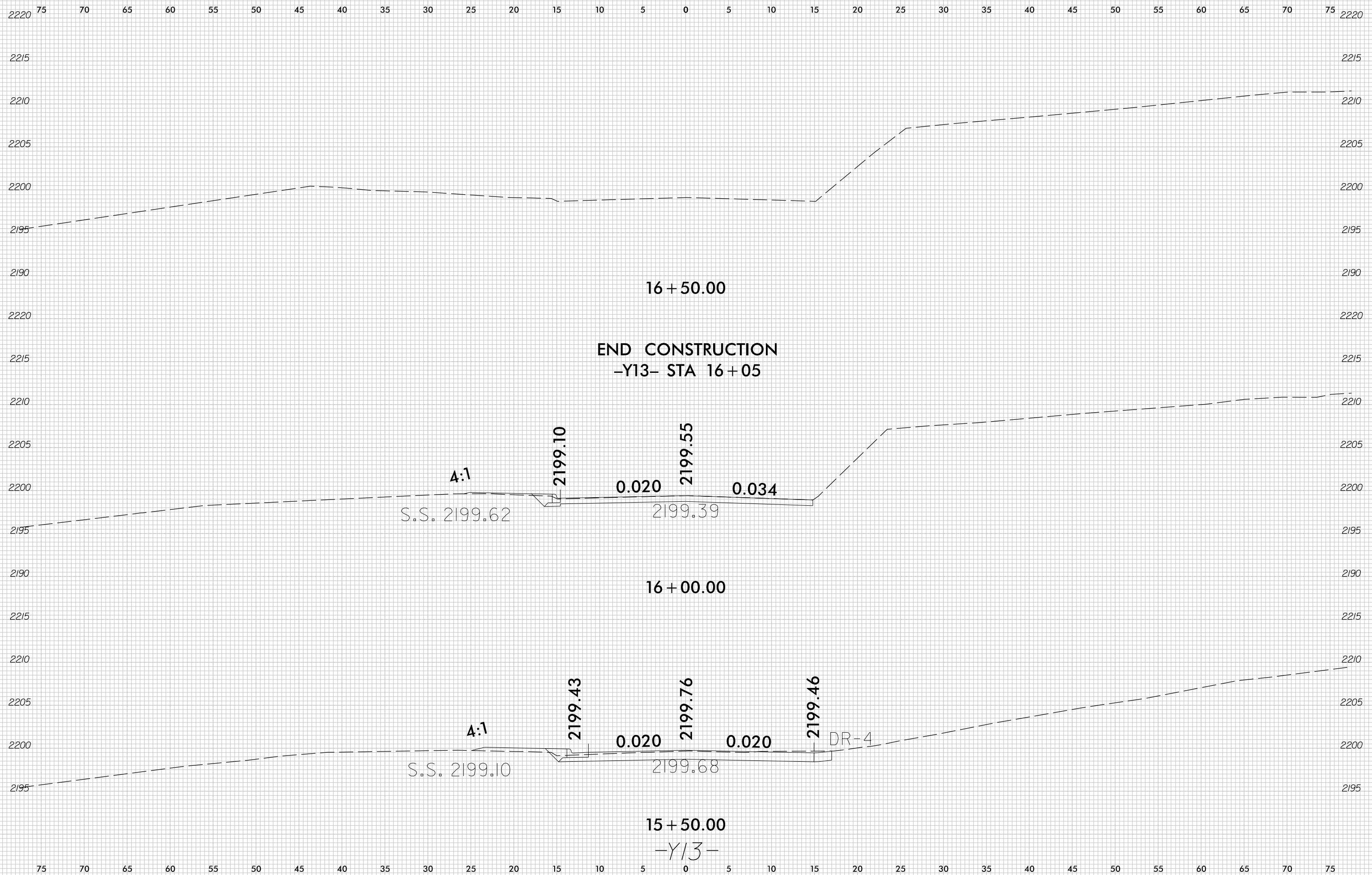

2:45:09 PM
 I:\3572 US 64 Widening (U-5783)\06 U-5783\Roadway\XSC\U5783-r.dwg_XPL_Y13.dgn
 cgr055

6/23/16

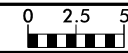

| | |
|---------------------|-----------|
| PROJ. REFERENCE NO. | SHEET NO. |
| U-5783 | X-71 |

75 70 65 60 55 50 45 40 35 30 25 20 15 10 5 0 5 10 15 20 25 30 35 40 45 50 55 60 65 70 75

2235 2235

2230 2230

2225 2225

2220 2220

2215 2215

2210 2210

2205 2205

2200 2200

2195 2195

2190 2190

2185 2185

2220 2220

2215 2215

2210 2210

2205 2205

2200 2200

2195 2195

2190 2190

75 70 65 60 55 50 45 40 35 30 25 20 15 10 5 0 5 10 15 20 25 30 35 40 45 50 55 60 65 70 75

202 + 00.00

BEGIN CONSTRUCTION
-GREENWAY 1- STA 201+55

201 + 50.00

-GREENWAY 1-

WALL #6

0.020 0.020

2:1

2204.56

S.S. 2202.69

2203.64

I:\2:46:34 PM At: 7:35:72 US 64 Wrdmng (U-5783)\06 U-5783\Roadway\XSC\U5783-r.dwg-XPL_GWI.dgn

6/23/16

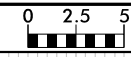

| | |
|---------------------|-----------|
| PROJ. REFERENCE NO. | SHEET NO. |
| U-5783 | X-72 |

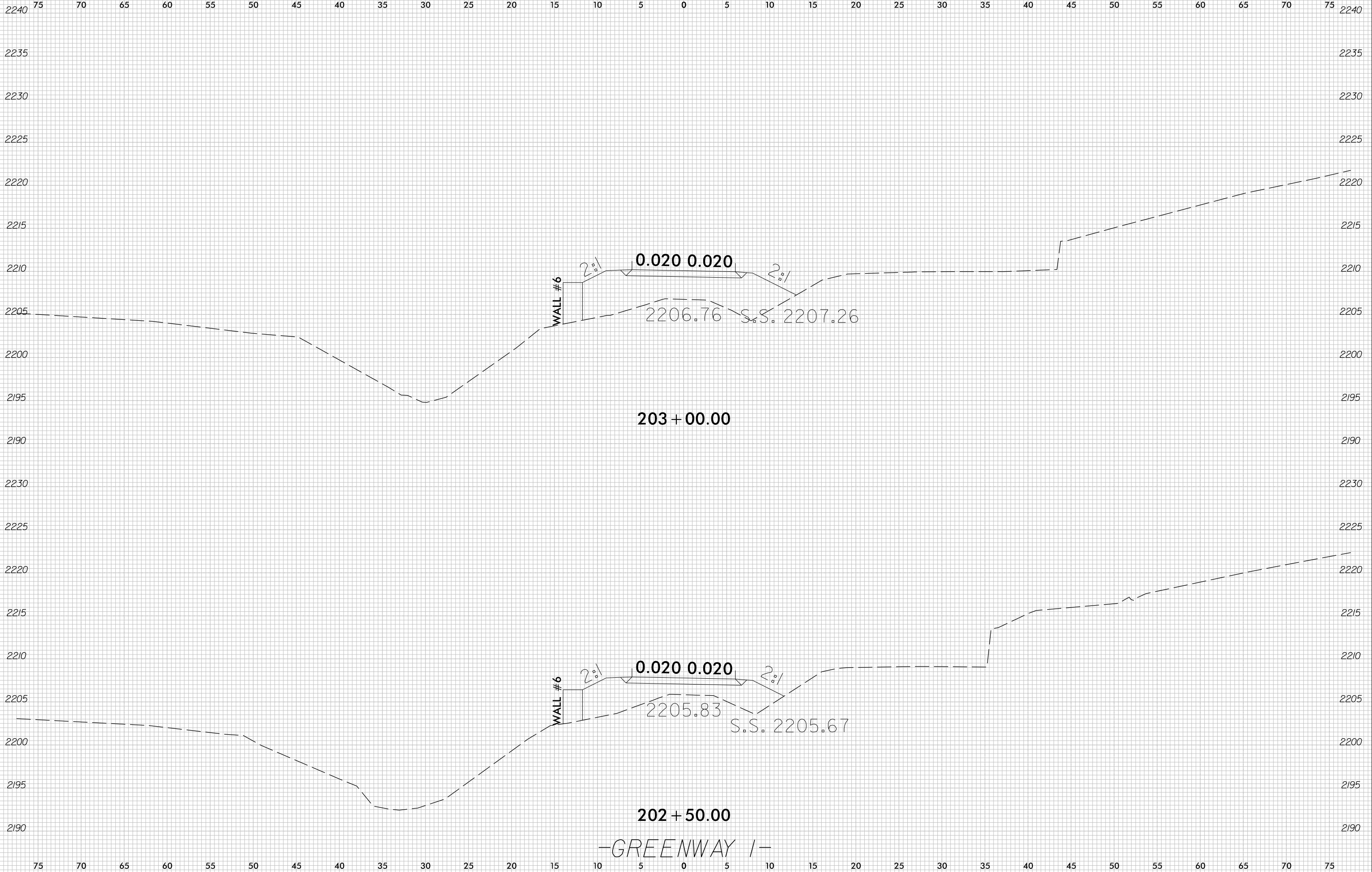

I2:41:07 PM
 At: 7:35:12 US
 64 Wrdemng (U-5783)\06 U-5783\Roadway\XSC\U5783.r.djv.XPL_GWI.dgn
 mpanag

6/23/16

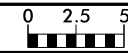

| | |
|---------------------|-----------|
| PROJ. REFERENCE NO. | SHEET NO. |
| U-5783 | X-73 |

75 70 65 60 55 50 45 40 35 30 25 20 15 10 5 0 5 10 15 20 25 30 35 40 45 50 55 60 65 70 75

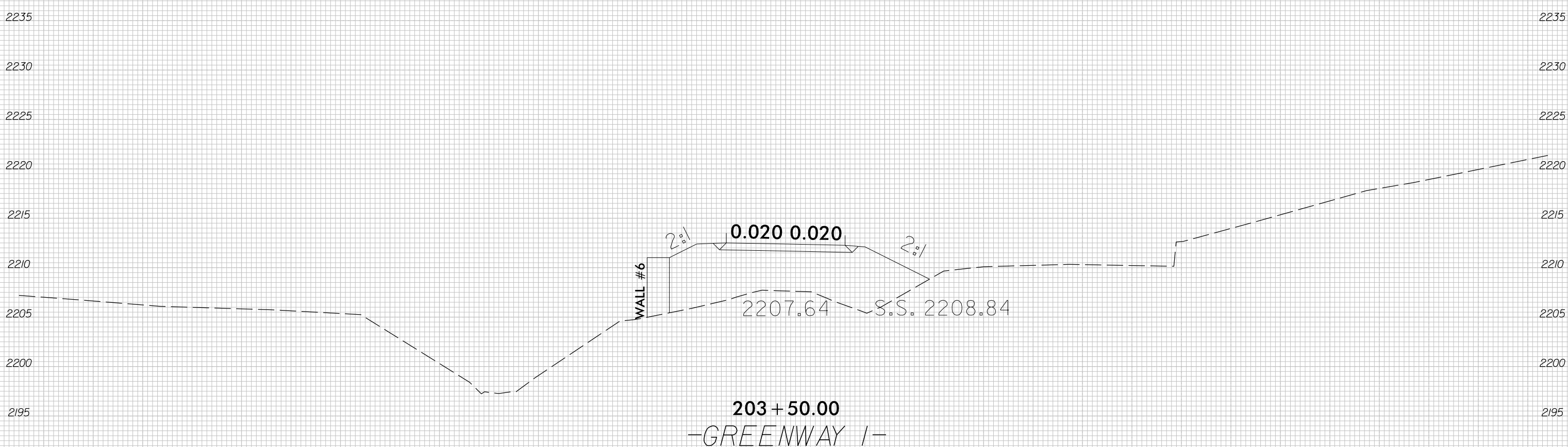
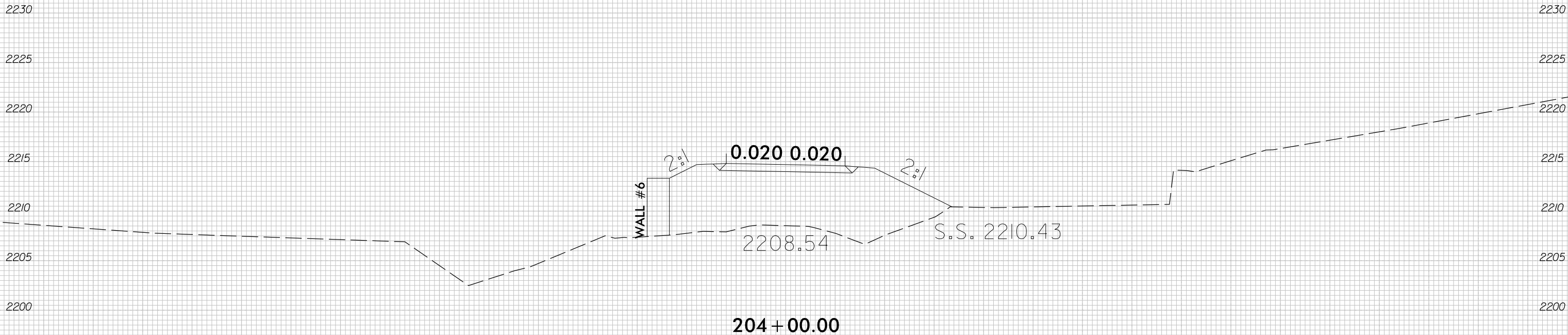

75 70 65 60 55 50 45 40 35 30 25 20 15 10 5 0 5 10 15 20 25 30 35 40 45 50 55 60 65 70 75

I2:41:26 PM
At: 3/5/12 US 64 Widening (U-5783)\06 U-5783\Roadway\XSC\U5783-r.dj-XPL_GWI.dgn
mpang

6/23/16
12:47:17 PM
At: X:\572 US 64 Widening (U-5783)\06 U-5783\Roadway\XSC\U5783-r.dwg-XPL_GWI.dgn
mpang

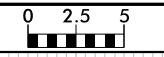
| | | |
|---|---------------------|-----------|
|  | PROJ. REFERENCE NO. | SHEET NO. |
| | U-5783 | X-74 |

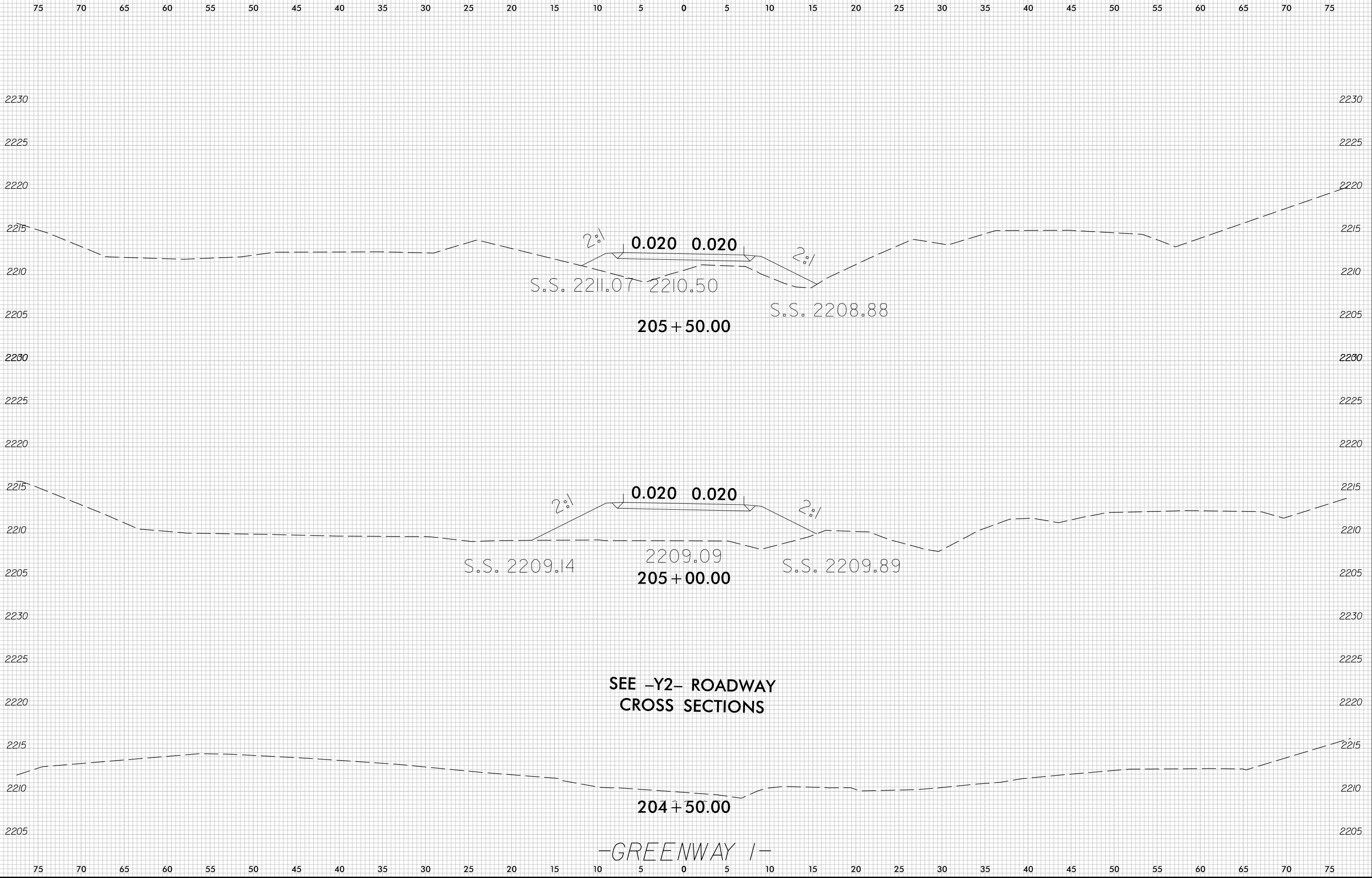

SEE -Y2- ROADWAY
CROSS SECTIONS

-GREENWAY I-

6/23/16
12:46:07 PM
At: X:\572 US 64 Widening (U-5783)\06 U-5783\Roadway\XSC\U5783-r.dwg-XPL_GWI.dgn
imfang

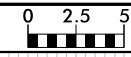

| PROJ. REFERENCE NO. | SHEET NO. |
|---------------------|-----------|
| U-5783 | X-75 |

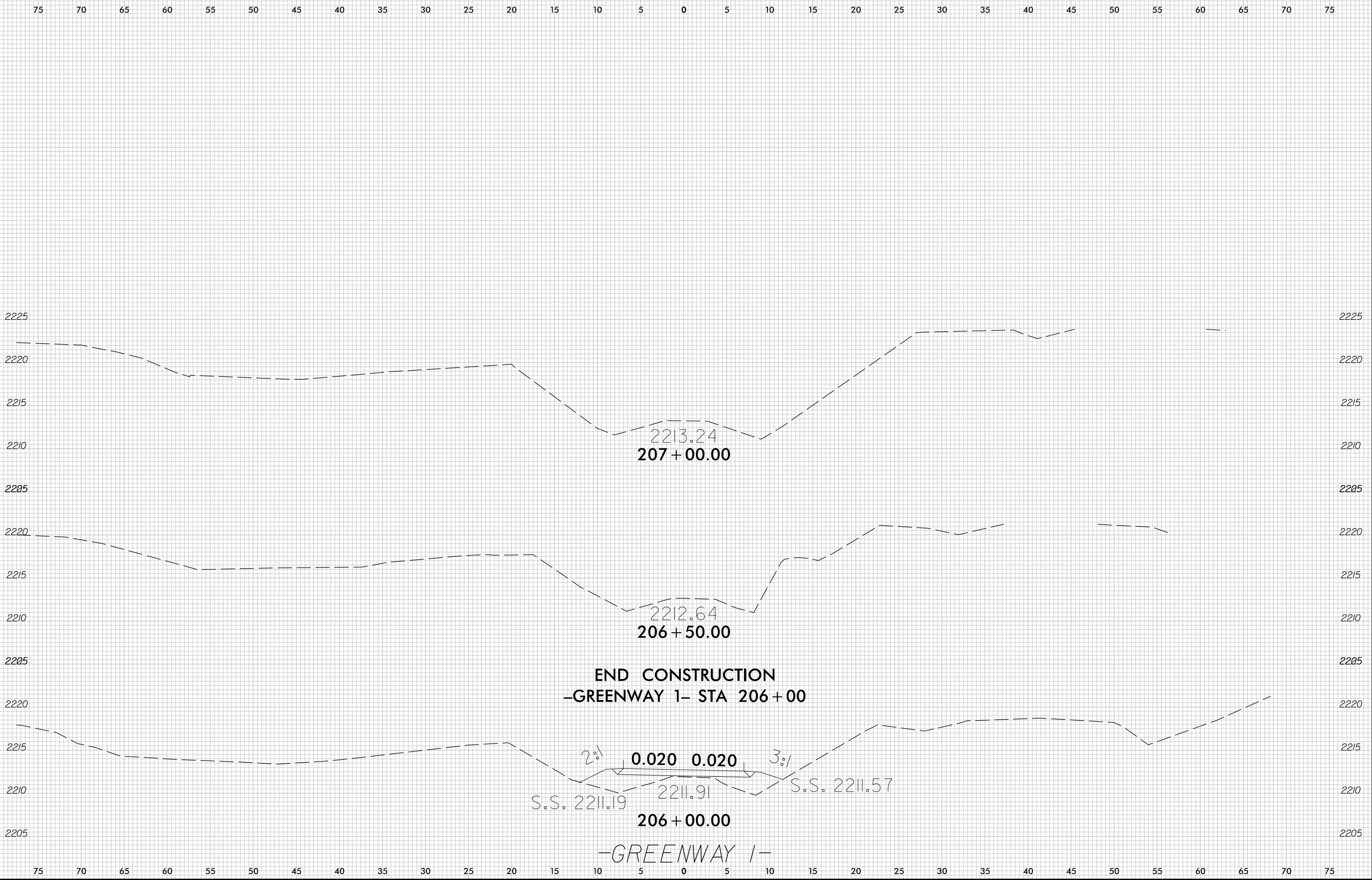

6/23/16

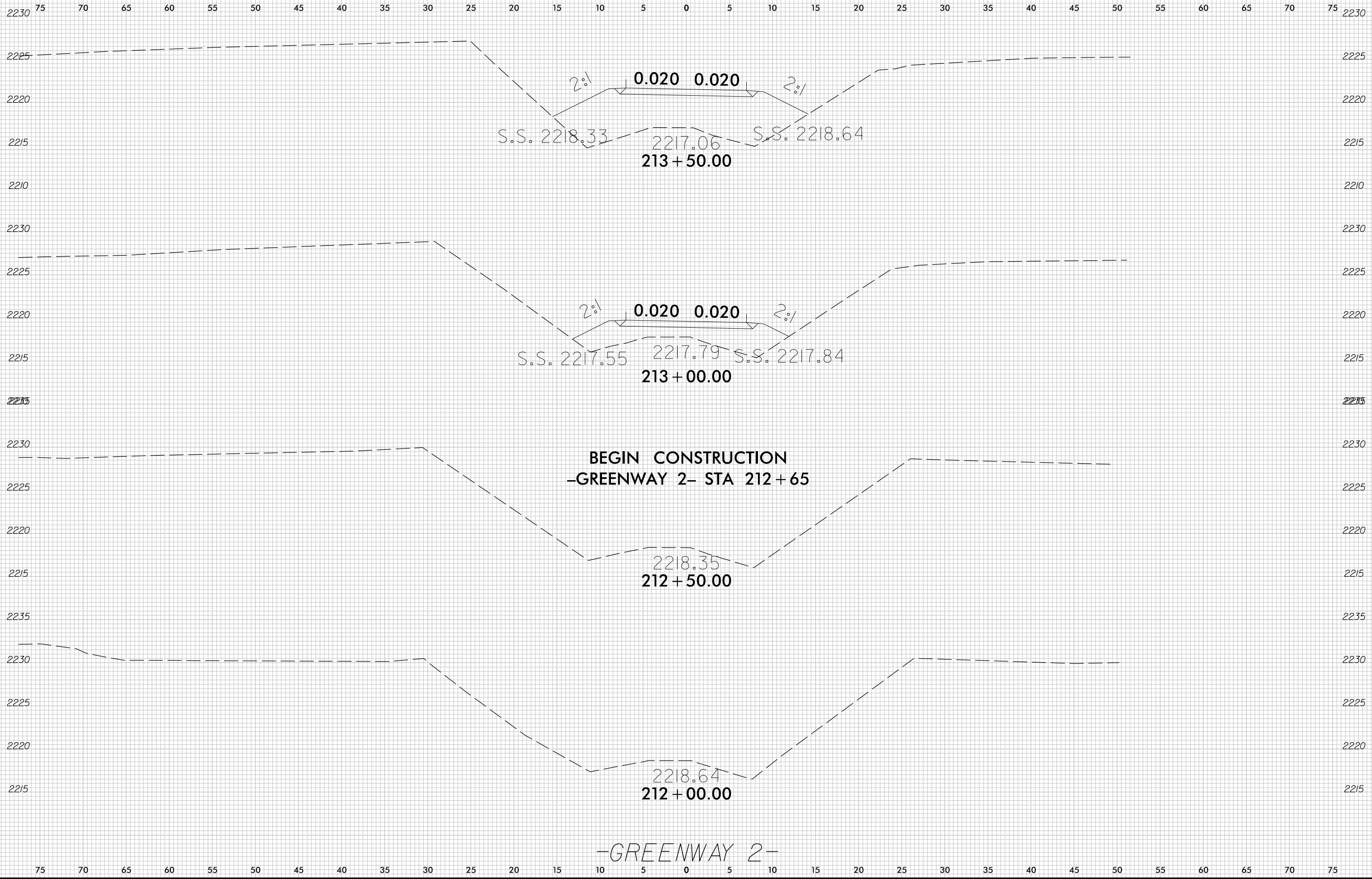

2:52:38 PM 6/23/16 U:\5783\Roadway\XSC\U5783.rdj_XPL_GW2.dgn

-GREENWAY 2-

75 70 65 60 55 50 45 40 35 30 25 20 15 10 5 0 5 10 15 20 25 30 35 40 45 50 55 60 65 70 75

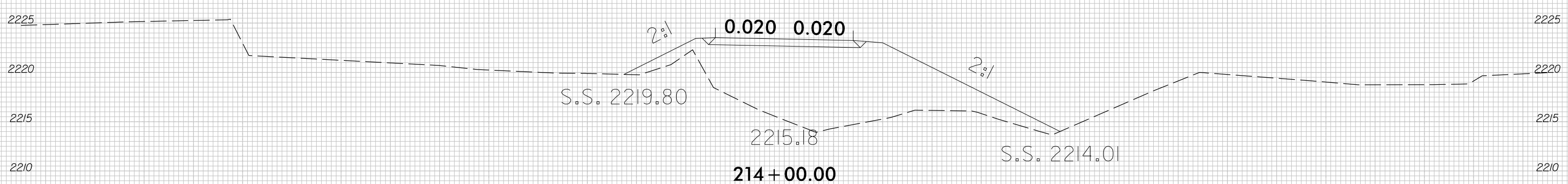
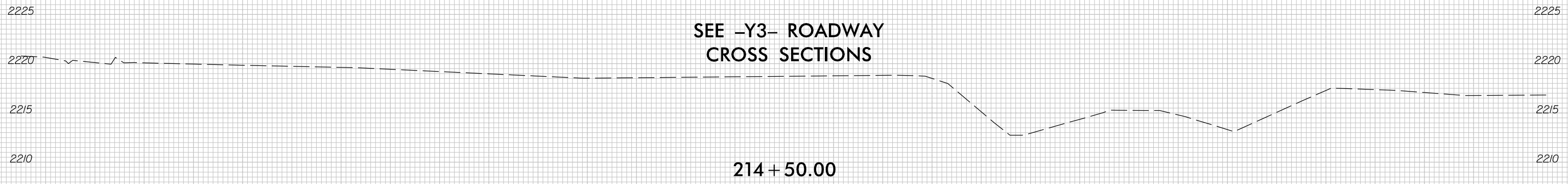
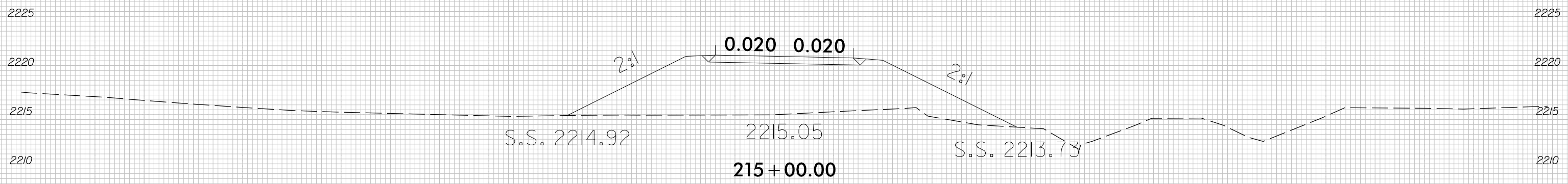

-GREENWAY 2-

75 70 65 60 55 50 45 40 35 30 25 20 15 10 5 0 5 10 15 20 25 30 35 40 45 50 55 60 65 70 75

**END CONSTRUCTION
-GREENWAY 2- STA 217+20**

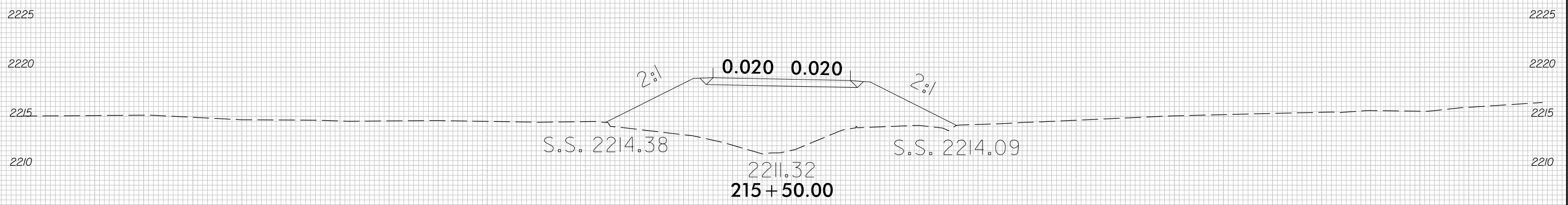
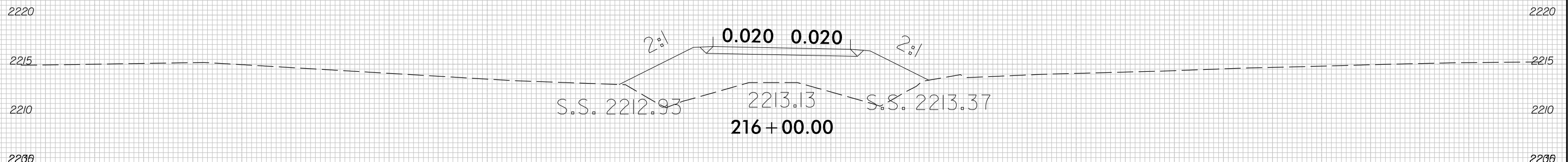
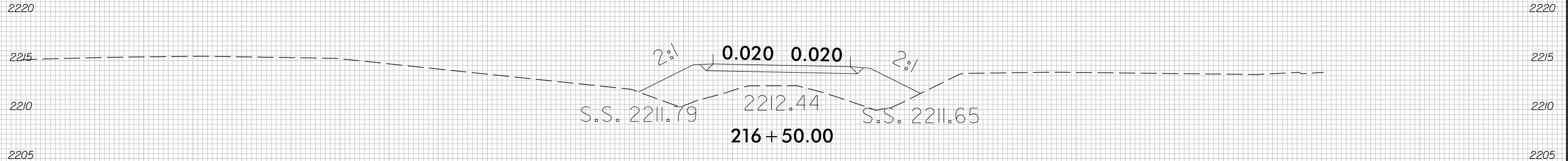
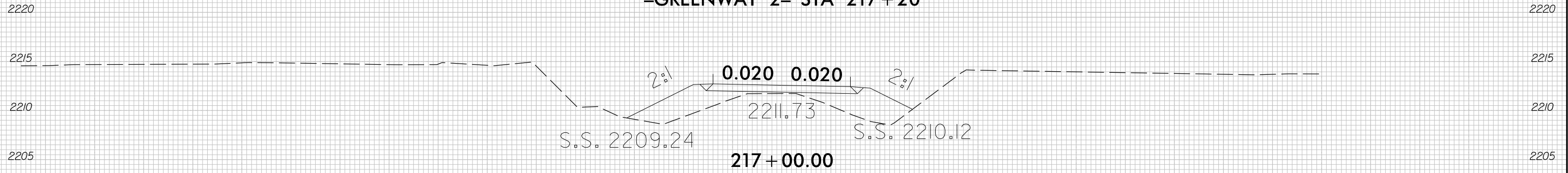

-GREENWAY 2-

75 70 65 60 55 50 45 40 35 30 25 20 15 10 5 0 5 10 15 20 25 30 35 40 45 50 55 60 65 70 75