

STATE OF NORTH CAROLINA  
DIVISION OF HIGHWAYS

PROJ. REFERENCE NO.	SHEET NO.
HB-0002	X-1

# ***HB-0002 CROSS SECTIONS (X-1 THRU X-129)***

## ***INDEX OF SHEETS***

	CROSS SECTION INDEX OF SHEETS
X-1	CROSS SECTION SUMMARY
X-1A THRU X-1B	
X-2 THRU X-24	-L-PHASE 1
X-25 THRU X-47	-L- PHASE 2
X-48 THRU X-70	-L- PHASE 3
X-71 THRU X-93	-L- PHASE 4
X-94 THRU X-116	-L- PHASE 5
X-117 THRU X-120	-Y1-
X-121 THRU X-126	-Y2-
X-127 THRU X-129	-Y3-

STATE OF NORTH CAROLINA  
DIVISION OF HIGHWAYS

PROJ. REFERENCE NO.	SHEET NO.
HB-0002	X-1A

NOTE: EMBANKMENT COLUMN DOES NOT INCLUDE BACKFILL FOR UNDERCUT.

# CROSS-SECTION SUMMARY

Quantities are approximate only. The Resident Engineer will recross-section the work accurately when the project is staked out. These cross-section notes will be used in computing the final quantities for which the contractor will be paid.

Station	Uncl. Exc. (cu. yd.)	Embt (cu. yd.)	Undercut (cu. yd.)	Station	Uncl. Exc. (cu. yd.)	Embt (cu. yd.)	Undercut (cu. yd.)	Station	Uncl. Exc. (cu. yd.)	Embt (cu. yd.)	Undercut (cu. yd.)	Station	Uncl. Exc. (cu. yd.)	Embt (cu. yd.)	Undercut (cu. yd.)
<b>Phase 1 - L - LT - 303+00 to 316+00</b>				324+00.00	32	256	0	320+00.00	0	82	0	316+50.00	2	1788	0
303+00.00	0	0	0	324+50.00	32	181	0	320+50.00	0	34	0	<b>Phase 3 - L -RT - 316+50 to 331+50</b>			
303+50.00	537	3	0	325+00.00	31	129	0	321+00.00	0	33	0	316+50.00	0	0	0
304+00.00	1112	1	0	325+50.00	29	99	0	321+50.00	0	40	0	317+00.00	2	1225	0
304+50.00	1293	1	0	326+00.00	30	74	0	322+00.00	0	51	0	317+50.00	2	1194	0
305+00.00	1477	0	0	326+50.00	36	43	0	322+50.00	7	57	0	318+00.00	1	909	0
305+50.00	1600	0	0	327+00.00	40	17	0	323+00.00	15	67	0	318+50.00	1	866	0
306+00.00	1580	0	0	327+50.00	43	10	0	323+50.00	14	76	0	319+00.00	7	577	0
306+50.00	1478	0	0	328+00.00	41	4	0	324+00.00	15	63	0	319+50.00	22	286	0
307+00.00	1380	0	0	328+50.00	37	6	0	324+50.00	18	42	0	320+00.00	15	396	0
307+50.00	1312	0	0	329+00.00	35	9	0	325+00.00	18	42	0	320+50.00	0	496	0
308+00.00	1261	0	0	329+50.00	33	9	0	325+50.00	20	35	0	321+00.00	0	427	0
308+50.00	1024	0	0	330+00.00	33	8	0	326+00.00	23	16	0	321+50.00	0	335	0
309+00.00	717	0	0	330+50.00	32	7	0	326+50.00	25	3	0	322+00.00	2	253	0
309+50.00	581	1	0	331+00.00	32	8	0	327+00.00	22	0	0	322+50.00	8	198	0
310+00.00	505	2	0	331+50.00	31	6	0	327+50.00	16	0	0	323+00.00	16	159	0
310+50.00	350	12	0	<b>Phase 2 - DET-EBL - L- 307+00 to 316+00</b>				328+00.00	15	0	0	323+50.00	27	120	0
311+00.00	132	34	0	307+00.00	0	0	0	<b>Phase 3 - L -RT - 303+00 to 316+50</b>				324+00.00	39	93	0
311+50.00	11	224	0	307+50.00	0	0	0	303+00.00	0	0	0	324+50.00	49	72	0
312+00.00	0	745	0	308+00.00	0	0	0	303+50.00	50	5	0	325+00.00	55	52	0
312+50.00	0	1330	0	308+50.00	3	0	0	304+00.00	44	9	0	325+50.00	57	50	0
313+00.00	0	1793	0	309+00.00	6	0	0	304+50.00	39	15	0	326+00.00	57	46	0
313+50.00	0	2166	0	309+50.00	8	0	0	305+00.00	36	19	0	326+50.00	55	31	0
314+00.00	0	2433	0	310+00.00	9	0	0	305+50.00	36	22	0	327+00.00	50	24	0
314+50.00	0	2099	0	310+50.00	7	0	0	306+00.00	36	22	0	327+50.00	48	20	0
315+00.00	0	1644	0	311+00.00	3	0	0	306+50.00	33	23	0	328+00.00	54	16	0
315+50.00	0	2008	0	311+50.00	2	0	0	307+00.00	29	27	0	328+50.00	83	6	0
316+00.00	0	1466	0	312+00.00	3	0	0	307+50.00	27	28	0	329+00.00	77	2	0
<b>Phase 1 - L - LT - 316+00 to 331+50</b>				312+50.00	2	3	0	308+00.00	26	22	0	329+50.00	47	3	0
316+00.00	0	0	0	313+00.00	0	14	0	308+50.00	24	20	0	330+00.00	50	2	0
316+50.00	0	1835	0	313+50.00	0	49	0	309+00.00	22	25	0	330+50.00	50	0	0
317+00.00	0	2517	0	314+00.00	0	119	0	309+50.00	21	33	0	331+00.00	48	1	0
317+50.00	0	1819	0	314+50.00	0	196	0	310+00.00	16	54	0	331+50.00	48	0	0
318+00.00	0	1624	0	315+00.00	0	254	0	310+50.00	6	75	0	<b>Phase 4 -L - Median - 306+50 to 316+00</b>			
318+50.00	0	1430	0	315+50.00	0	636	0	311+00.00	0	109	0	306+50.00	0	0	0
319+00.00	0	1243	0	316+00.00	0	616	0	311+50.00	0	159	0	307+00.00	7	0	0
319+50.00	0	1071	0	<b>Phase 2 - DET-EBL - L- 316+00 to 328+00</b>				312+00.00	0	220	0	307+50.00	7	0	0
320+00.00	1	966	0	316+00.00	0	0	0	312+50.00	0	349	0	308+00.00	7	0	0
320+50.00	1	922	0	316+50.00	0	1027	0	313+00.00	0	482	0	308+50.00	7	0	0
321+00.00	1	849	0	317+00.00	0	1084	0	313+50.00	0	626	0	309+00.00	7	0	0
321+50.00	1	712	0	317+50.00	0	333	0	314+00.00	0	820	0	309+50.00	11	0	0
322+00.00	2	569	0	318+00.00	0	293	0	314+50.00	0	957	0	310+00.00	15	0	0
322+50.00	20	463	0	318+50.00	0	248	0	315+00.00	0	1067	0	310+50.00	18	0	0
323+00.00	35	395	0	319+00.00	0	197	0	315+50.00	17	1424	0	311+00.00	18	0	0
323+50.00	33	333	0	319+50.00	0	152	0	316+00.00	18	2142	0	311+50.00	9	0	0

2/16/2024 10:51:33 AM  
I:\B0002\_r\dj\_xpl\index.dgn

STATE OF NORTH CAROLINA  
DIVISION OF HIGHWAYS

PROJ. REFERENCE NO.	SHEET NO.
HB-0002	X-1B

NOTE: EMBANKMENT COLUMN DOES NOT INCLUDE BACKFILL FOR UNDERCUT.

# CROSS-SECTION SUMMARY

Quantities are approximate only. The Resident Engineer will recross-section the work accurately when the project is staked out. These cross-section notes will be used in computing the final quantities for which the contractor will be paid.

Station	Uncl. Exc. (cu. yd.)	Embt (cu. yd.)	Undercut (cu. yd.)	Station	Uncl. Exc. (cu. yd.)	Embt (cu. yd.)	Undercut (cu. yd.)	Station	Uncl. Exc. (cu. yd.)	Embt (cu. yd.)	Undercut (cu. yd.)	Station	Uncl. Exc. (cu. yd.)	Embt (cu. yd.)	Undercut (cu. yd.)
312+00.00	0	0	0	312+00.00	57	0	0	12+78.00	4	1	0				
312+50.00	0	0	0	312+50.00	66	0	0	Y2							
313+00.00	0	0	0	313+00.00	72	0	0	10+26.00	0	0	0				
313+50.00	0	0	0	313+50.00	81	0	0	10+50.00	22	20	0				
314+00.00	9	0	0	314+00.00	78	0	0	11+00.00	53	15	0				
314+50.00	24	0	0	314+50.00	84	0	0	11+50.00	19	16	0				
315+00.00	27	0	0	315+00.00	92	0	0	12+00.00	2	10	0				
315+50.00	24	0	0	315+50.00	84	0	0	12+50.00	2	3	0				
316+00.00	28	0	0	316+00.00	85	0	0	13+00.00	2	2	0				
Phase 4 -L - Median - 316+00 to 328+00				Phase 5 - L - LT - 316+00 to 325+50				13+50.00	2	3	0				
316+00.00	0	0	0	316+00.00	0	0	0	14+00.00	2	5	0				
316+50.00	33	0	0	316+50.00	80	0	0	14+50.00	3	9	0				
317+00.00	31	0	0	317+00.00	72	0	0	15+00.00	2	42	0				
317+50.00	26	0	0	317+50.00	72	0	0	15+50.00	1	50	0				
318+00.00	21	0	0	318+00.00	73	0	0	16+00.00	0	39	0				
318+50.00	13	0	0	318+50.00	73	0	0	16+50.00	1	47	0				
319+00.00	5	0	0	319+00.00	73	0	0	17+00.00	2	38	0				
319+50.00	1	5	0	319+50.00	71	0	0	17+50.00	5	19	0				
320+00.00	0	9	0	320+00.00	68	0	0	18+00.00	9	4	0				
320+50.00	0	9	0	320+50.00	68	0	0	Y3							
321+00.00	6	5	0	321+00.00	55	0	0	23+00.00	0	0	0				
321+50.00	18	0	0	321+50.00	39	0	0	23+50.00	12	31	0				
322+00.00	29	2	0	322+00.00	33	0	0	24+00.00	9	94	0				
322+50.00	74	2	0	322+50.00	43	0	0	24+50.00	12	126	0				
323+00.00	129	0	0	323+00.00	51	0	0	25+00.00	7	139	0				
323+50.00	143	0	0	323+50.00	42	0	0	25+25.00	1	97	0				
324+00.00	150	0	0	324+00.00	33	0	0	25+50.00	0	130	0				
324+50.00	161	0	0	324+50.00	24	0	0	26+00.00	0	441	0				
325+00.00	155	0	0	325+00.00	18	0	0	26+50.00	0	486	0				
325+50.00	132	0	0	325+50.00	15	0	0	26+85.00	3	133	0				
326+00.00	100	0	0	Y1											
326+50.00	77	0	0	7+00.00	0	0	0								
327+00.00	65	0	0	7+50.00	5	5	0								
327+50.00	60	1	0	8+00.00	24	15	0								
328+00.00	52	0	0	8+43.00	20	27	0								
Phase 5 - L - LT - 307+00 to 316+00				8+50.00	0	6	0								
307+50.00	0	0	0	9+00.00	0	53	0								
308+00.00	21	0	0	9+50.00	0	55	0								
308+50.00	27	0	0	10+00.00	1	39	0								
309+00.00	37	0	0	10+42.68	3	18	0								
309+50.00	51	0	0	10+50.00	1	2	0								
310+00.00	67	0	0	11+00.00	4	22	0								
310+50.00	61	0	0	11+50.00	9	19	0								
311+00.00	59	0	0	12+00.00	9	13	0								
311+50.00	62	0	0	12+50.00	10	10	0								

2/16/2024  
1:51:13 PM  
I:\HB\002\_r\dj\_xpl\_index.dgn

8/23/99

	PROJ. REFERENCE NO.	SHEET NO.
	HB-0002	X-2

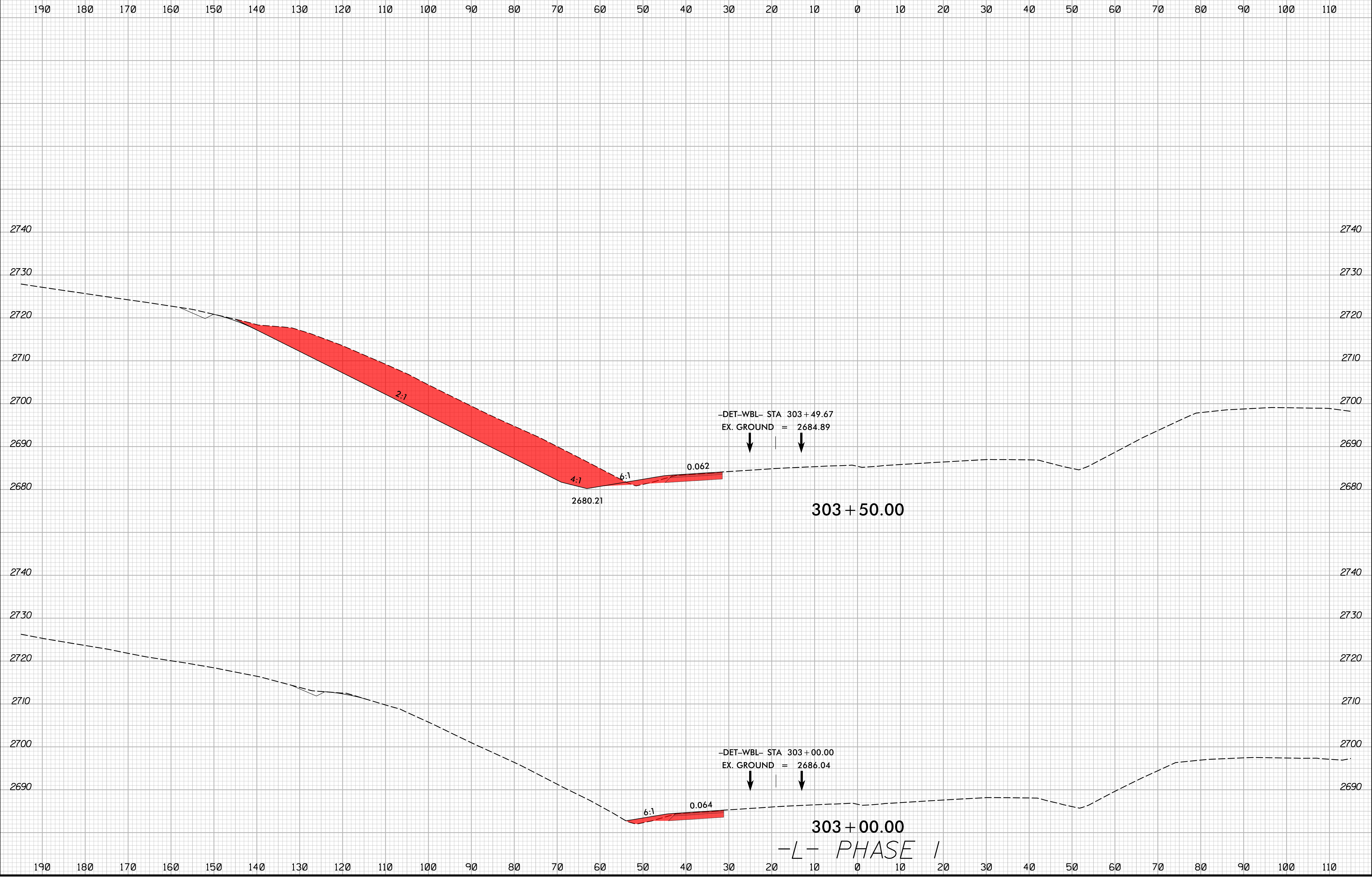

2/16/2024  
I:\HB\0002\_rdy\_xpl\_L\_phase1.dgn  
JSE

8/23/99

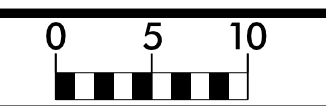

PROJ. REFERENCE NO.	SHEET NO.
HB-0002	X-3

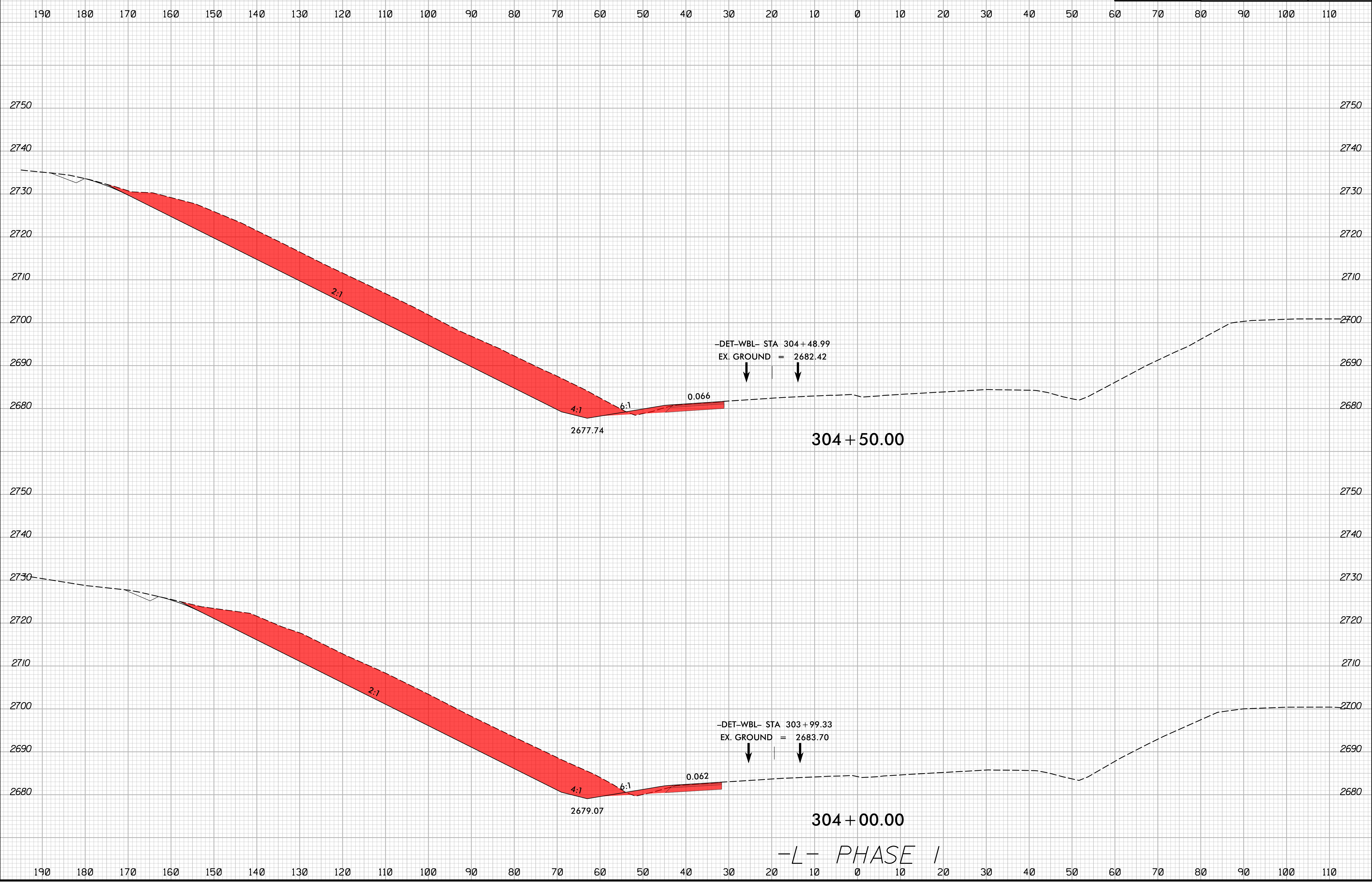

-L- PHASE I

2/16/2024  
I:\HB\0002\_rdy\_xpl\_L\_phase-1.dgn  
JSE/ETG



8/23/99

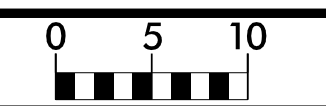

PROJ. REFERENCE NO.	SHEET NO.
HB-0002	X-4

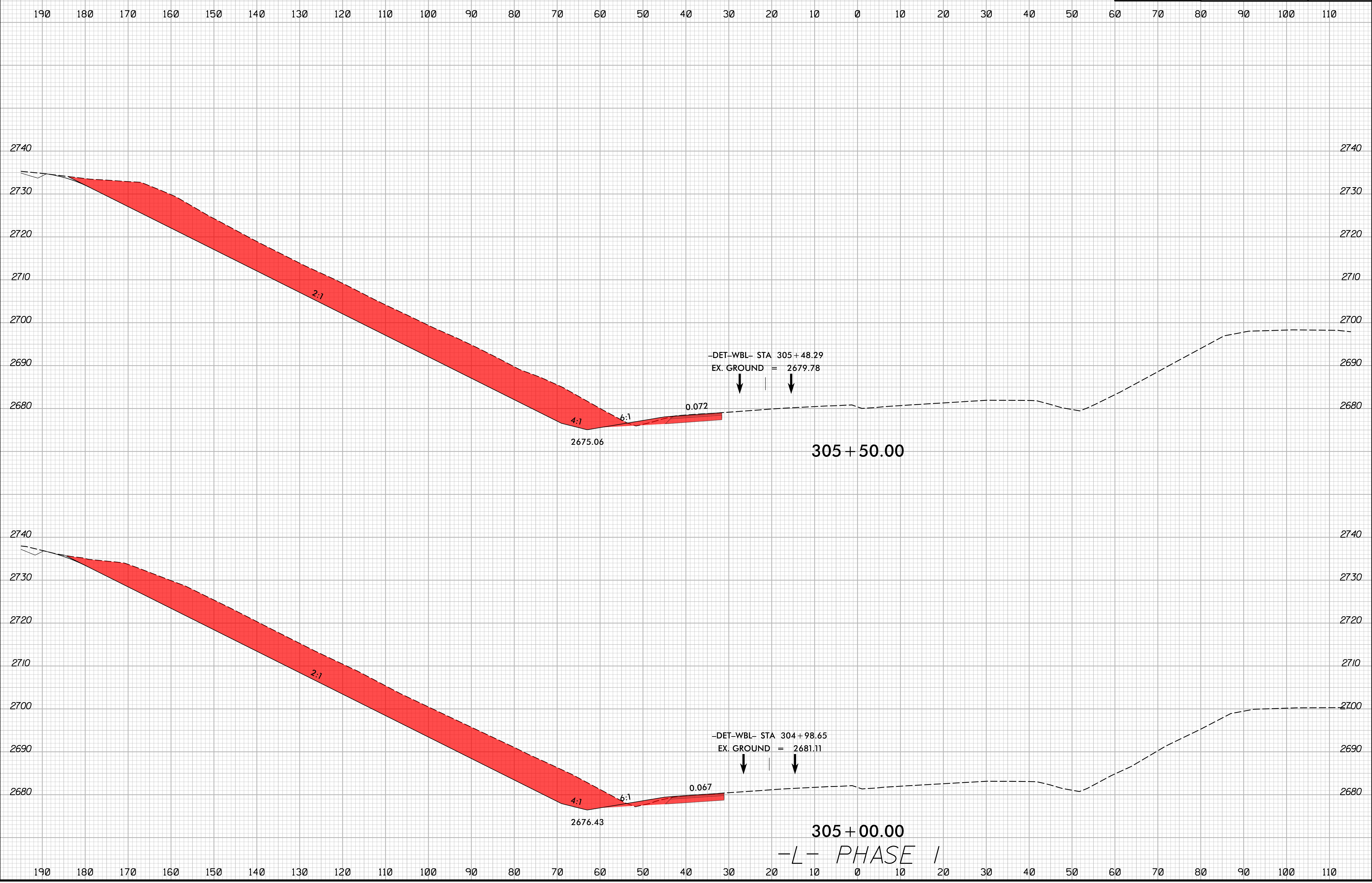

2/16/2024  
1:51:13 PM  
I:\Projects\HB0002\rdy\_xpl\_L\_phase-1.dgn

-L- PHASE 1

8/23/99

	PROJ. REFERENCE NO.	SHEET NO.
	HB-0002	X-5

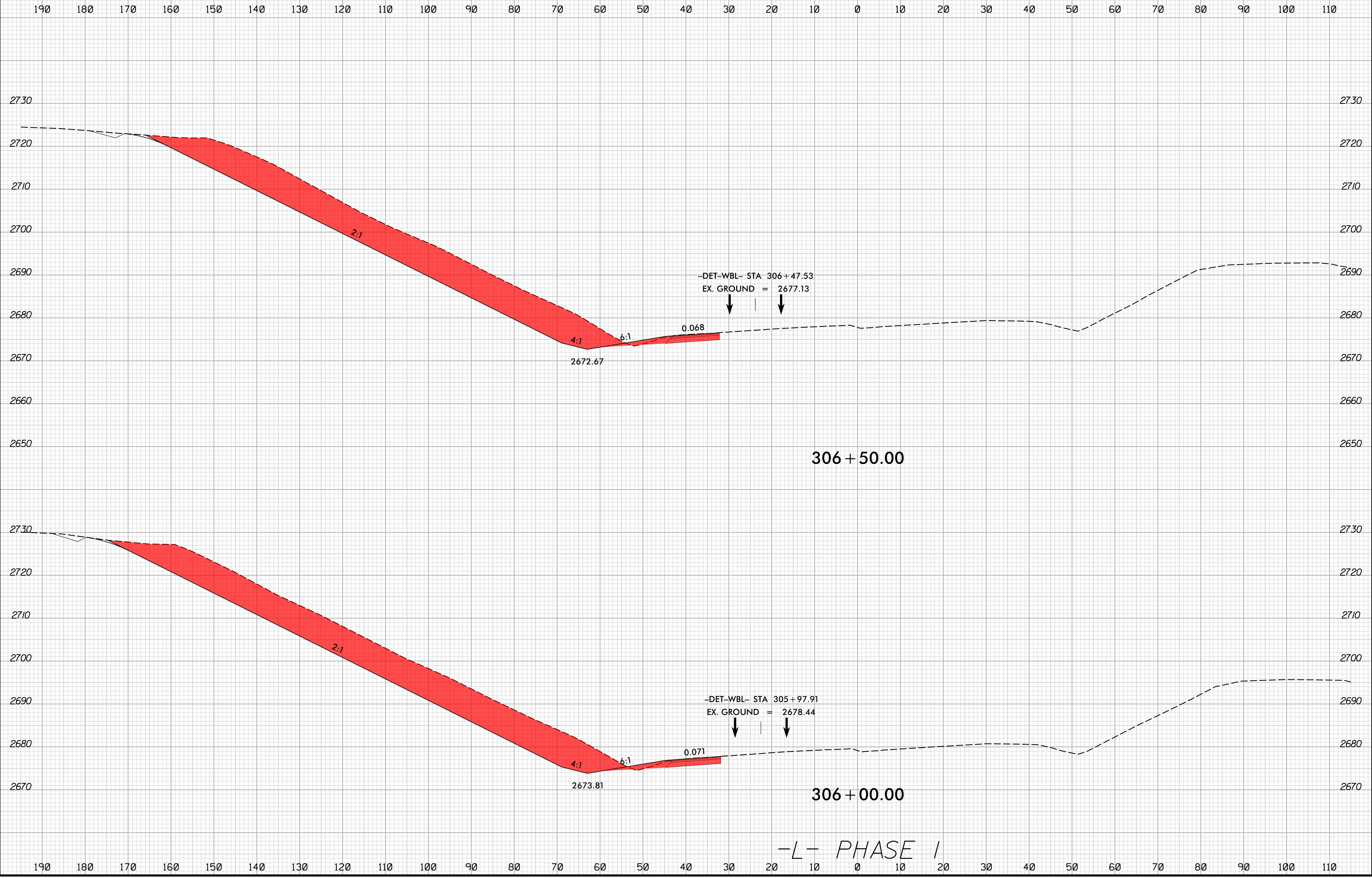

-L- PHASE I

2/16/2024  
1:51:13 PM  
I:\Projects\2024\115\HB0002\_rdy\_xpl\_L\_phase-1.dgn

8/23/99

	PROJ. REFERENCE NO.	SHEET NO.
	HB-0002	X-6

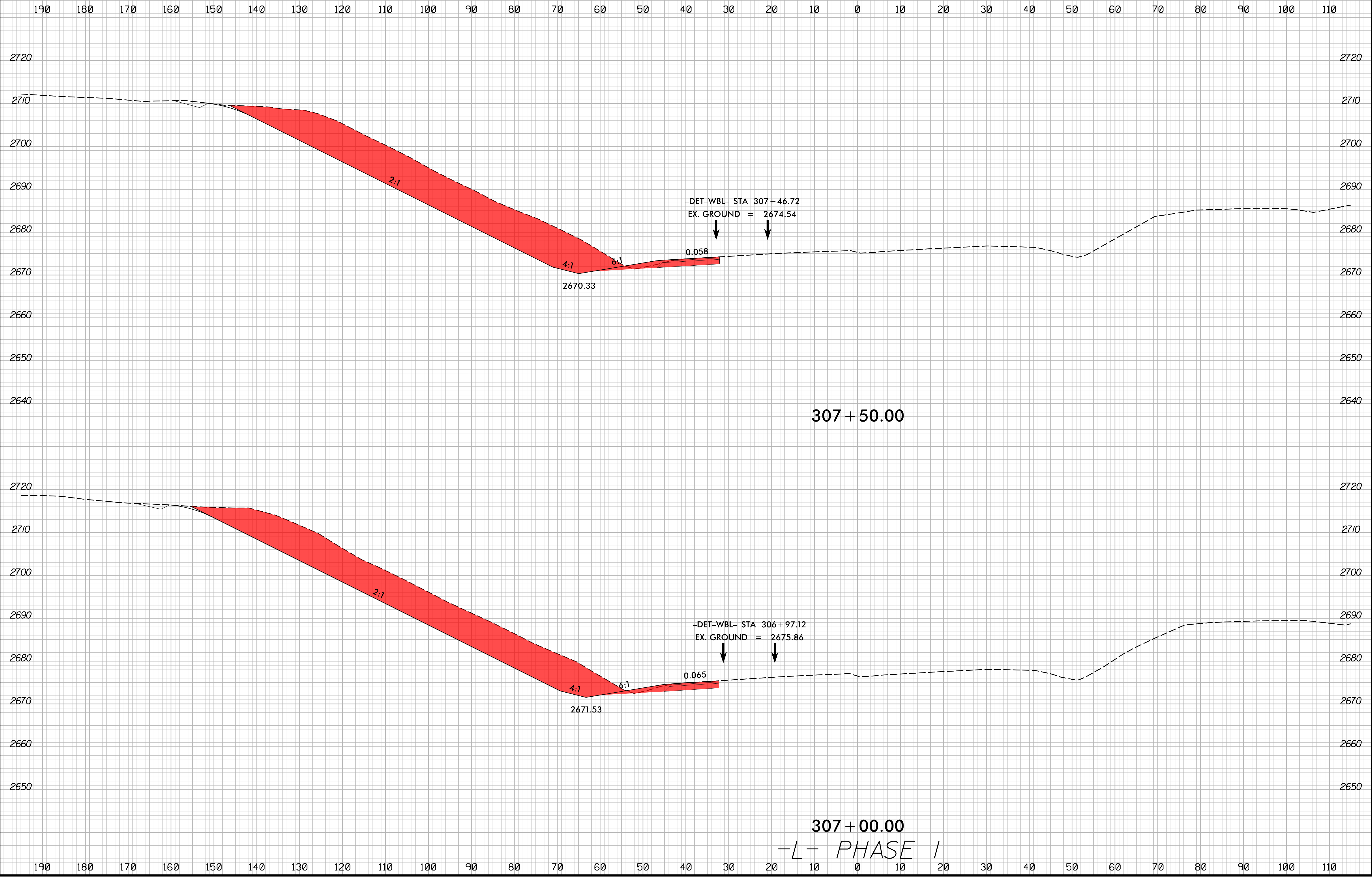

2/16/2024  
I:\S\HB0002\_rdy\_xpl\_L\_phase-1.dgn  
JSE/13/16/2024



8/23/99

0 5 10	PROJ. REFERENCE NO.	SHEET NO.
	HB-0002	X-7

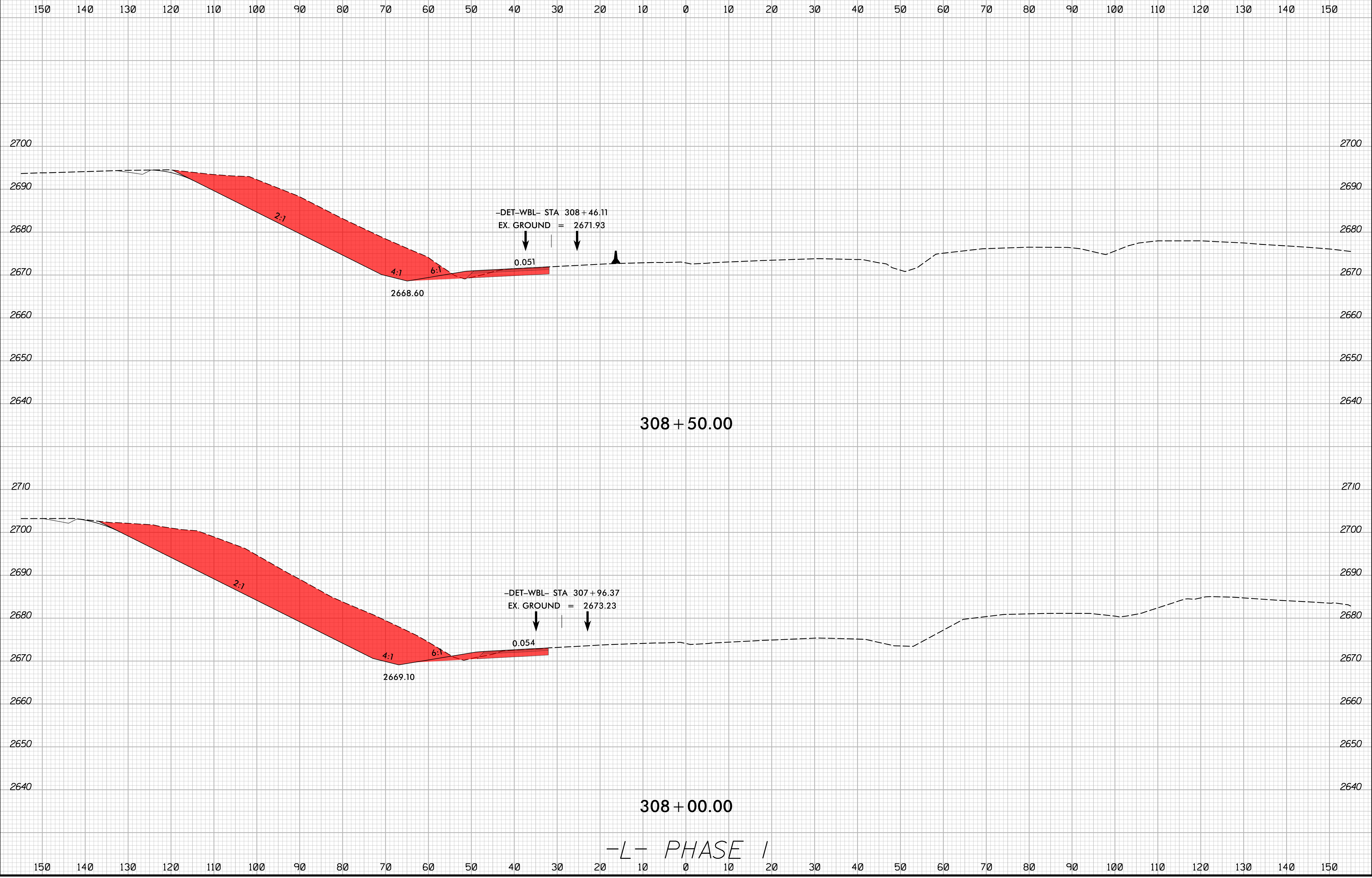

2/16/2024  
1:51:13 PM  
I:\S:\HB\0002\_rdy\_xpl\_L\_phase-1.dgn

150 140 130 120 110 100 90 80 70 60 50 40 30 20 10 0 10 20 30 40 50 60 70 80 90 100 110 120 130 140 150

8/23/99

	PROJ. REFERENCE NO.	SHEET NO.
	HB-0002	X-8

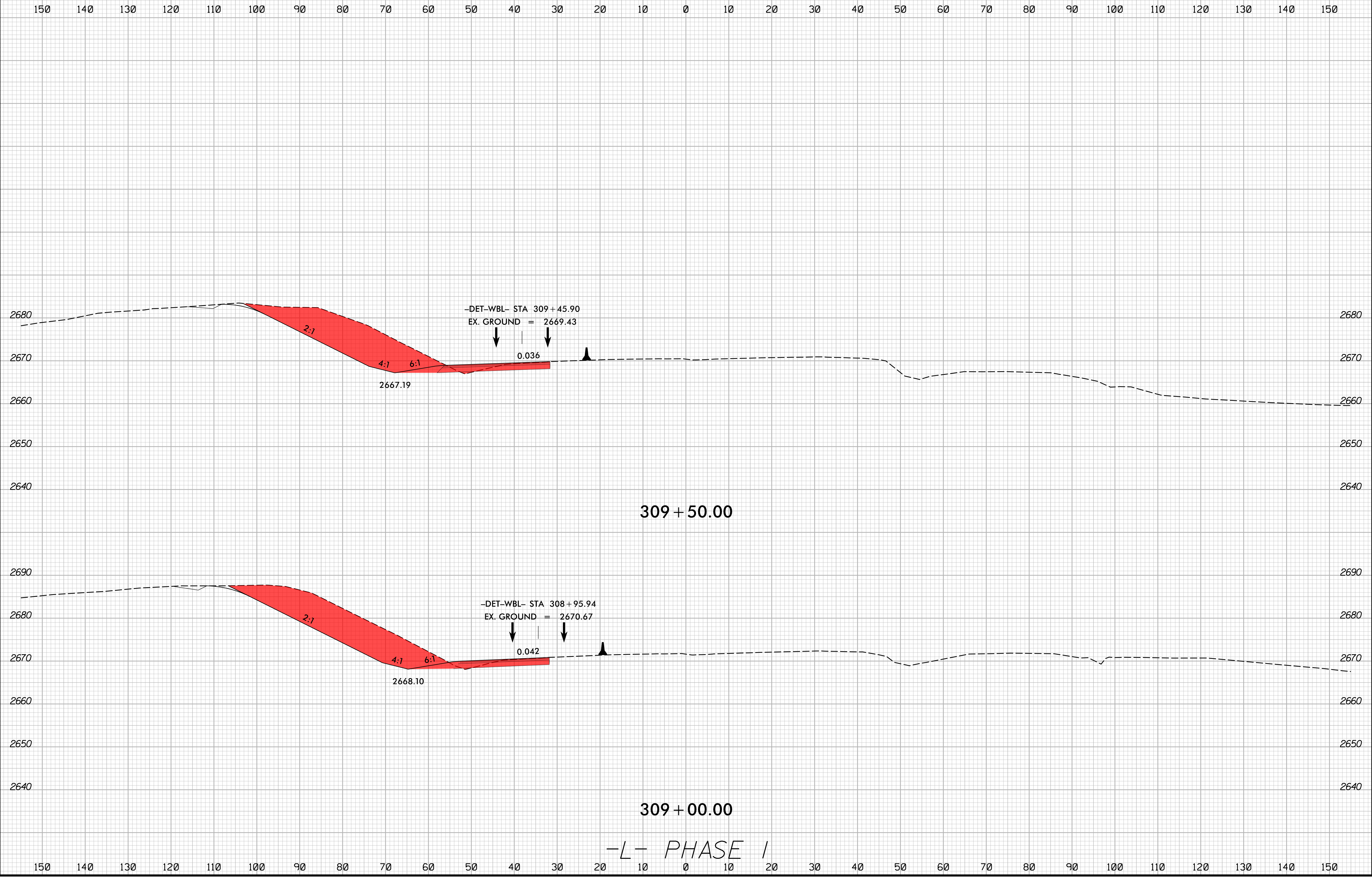

-L- PHASE I

2/16/2024  
I:\HB\0002\_rdy\_xpl\_L\_phase-1.dgn  
JSE/13/16/2024

8/23/99

	PROJ. REFERENCE NO.	SHEET NO.
	HB-0002	X-9

150 140 130 120 110 100 90 80 70 60 50 40 30 20 10 0 10 20 30 40 50 60 70 80 90 100 110 120 130 140 150

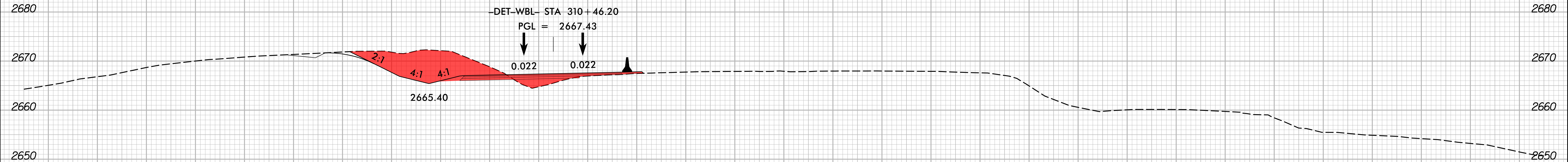

310 + 50.00

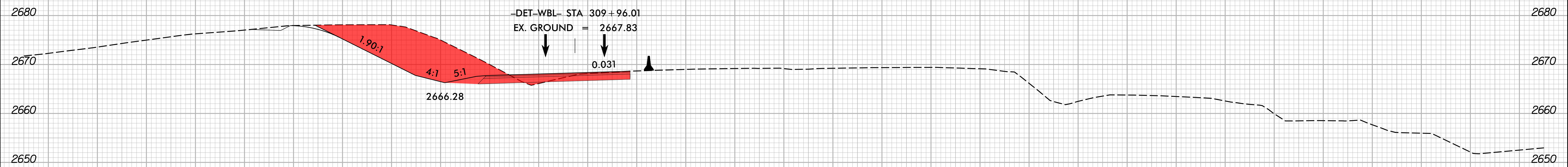

310 + 00.00

-L- PHASE I

150 140 130 120 110 100 90 80 70 60 50 40 30 20 10 0 10 20 30 40 50 60 70 80 90 100 110 120 130 140 150

2/16/2024 1:51:13 PM I:\HB\0002\_rdy\_xpl\_L\_phase-1.dgn

8/23/99

0 5 10	PROJ. REFERENCE NO.	SHEET NO.
	HB-0002	X-10

150 140 130 120 110 100 90 80 70 60 50 40 30 20 10 0 10 20 30 40 50 60 70 80 90 100 110 120 130 140 150

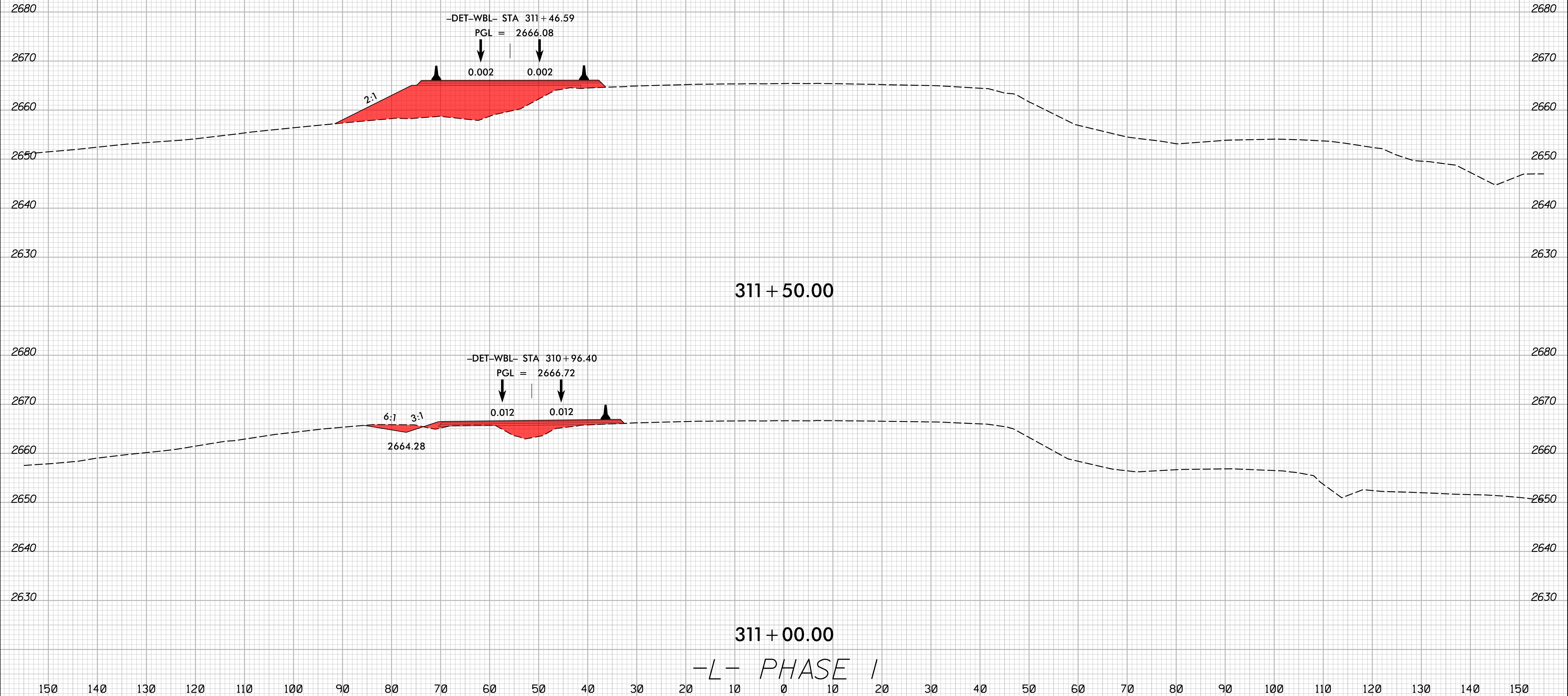

2/16/2024  
1:51:13  
I:\S:\HB\0002\_rdy\_xpl\_L\_phase-1.dgn

8/23/99

	PROJ. REFERENCE NO.	SHEET NO.
	HB-0002	X-11

150 140 130 120 110 100 90 80 70 60 50 40 30 20 10 0 10 20 30 40 50 60 70 80 90 100 110 120 130 140 150

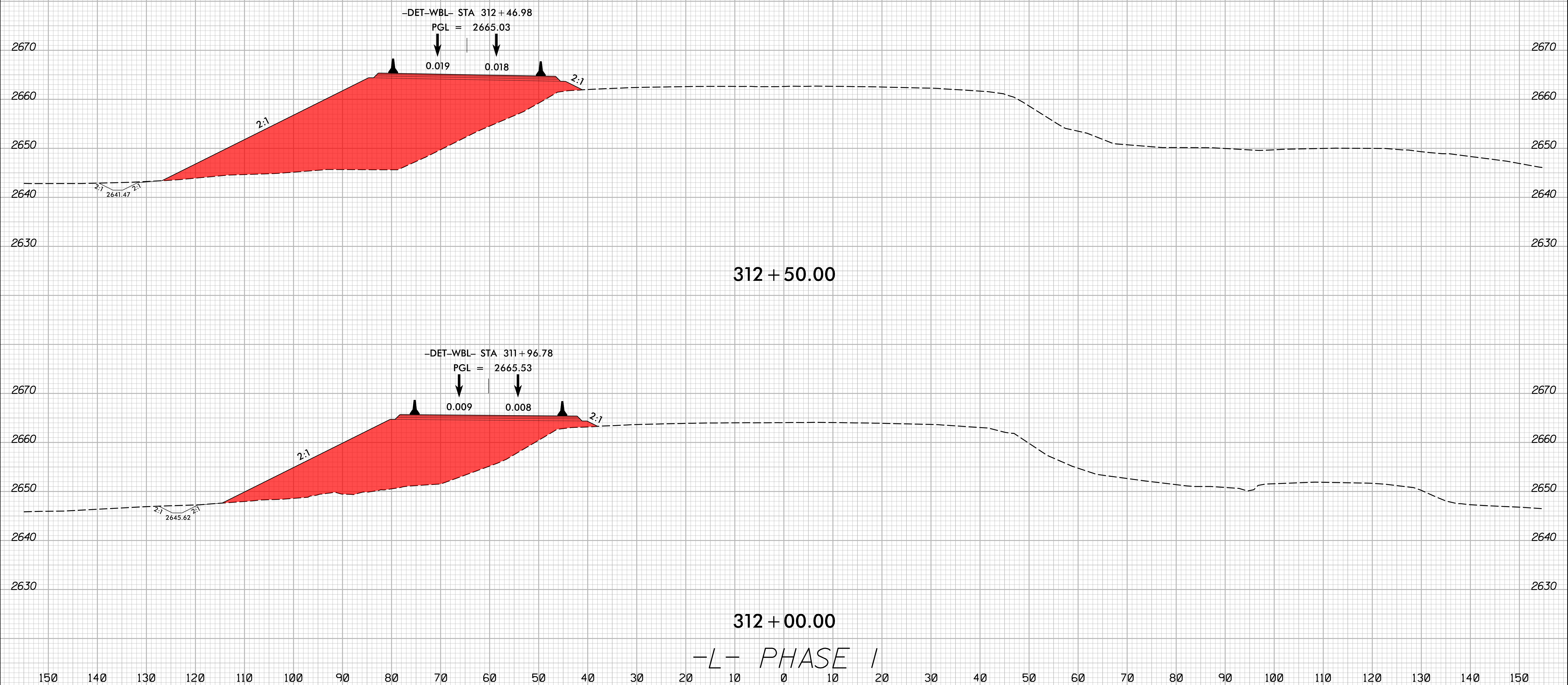

2/16/2024  
1:51:13 PM  
I:\S:\HB\002\_rdy\_xpl\_L\_phase-1.dgn

150 140 130 120 110 100 90 80 70 60 50 40 30 20 10 0 10 20 30 40 50 60 70 80 90 100 110 120 130 140 150



8/23/99

0 5 10	PROJ. REFERENCE NO.	SHEET NO.
	HB-0002	X-12

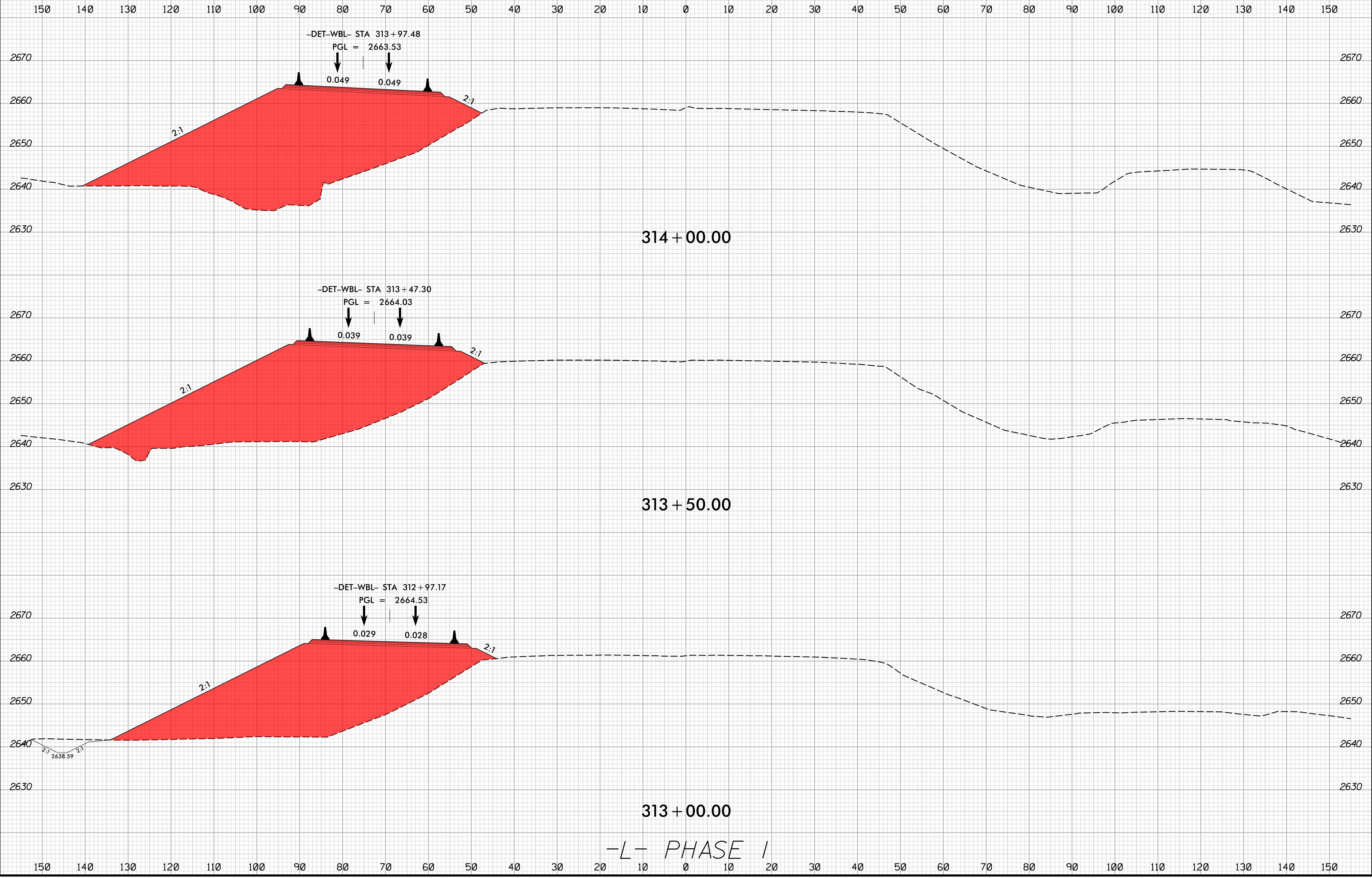

-L- PHASE I

2/16/2024  
1:51:13 PM  
I:\S:\HB\0002\_rdy\_xpl\_L\_phase-1.dgn

8/23/99

0 5 10	PROJ. REFERENCE NO.	SHEET NO.
	HB-0002	X-13

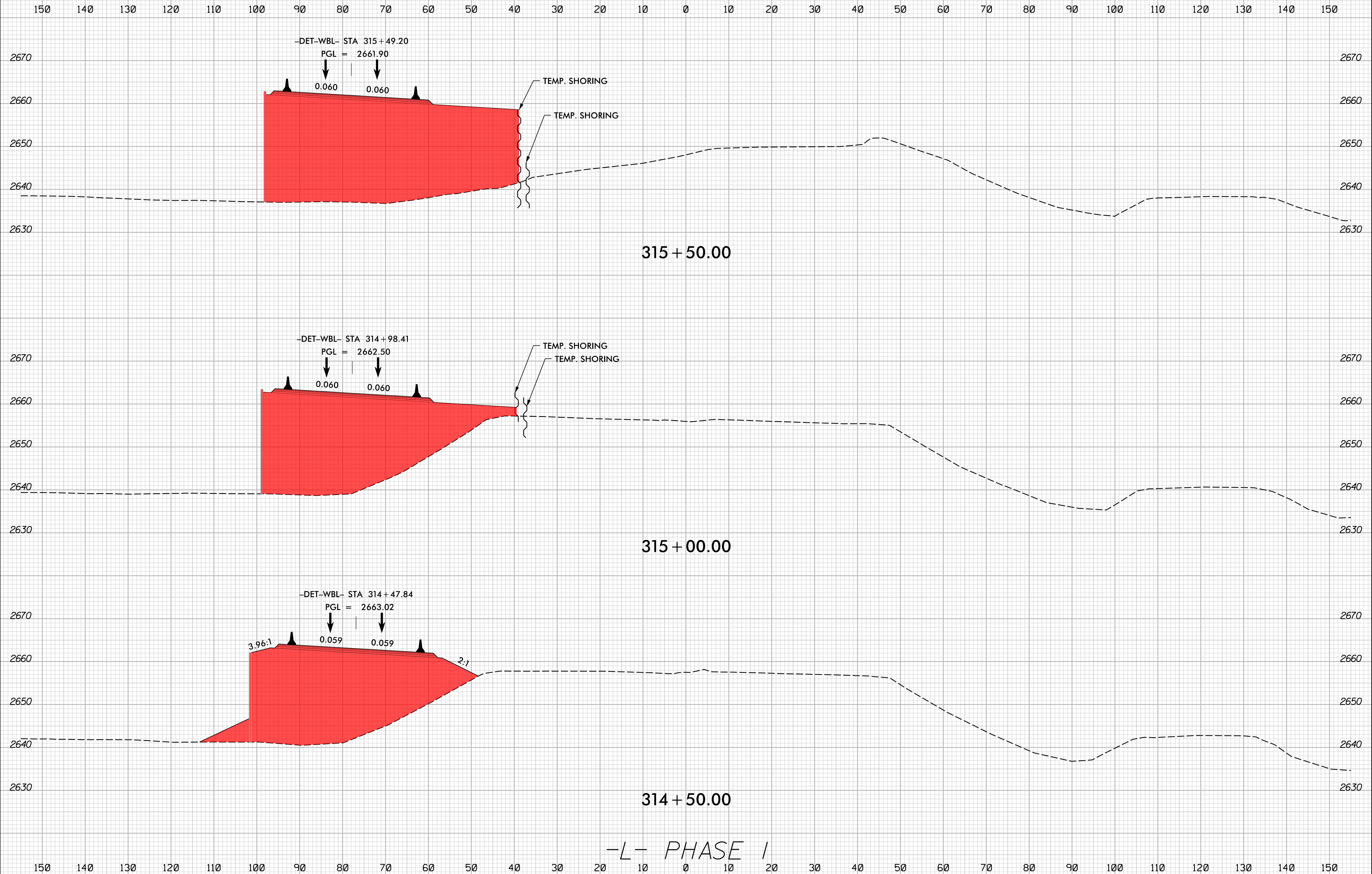

5/13/2024 10:51:13 AM HB0002\_rdy\_xpl\_L\_phase1.dgn

8/23/99

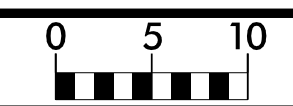

PROJ. REFERENCE NO.	SHEET NO.
HB-0002	X-14

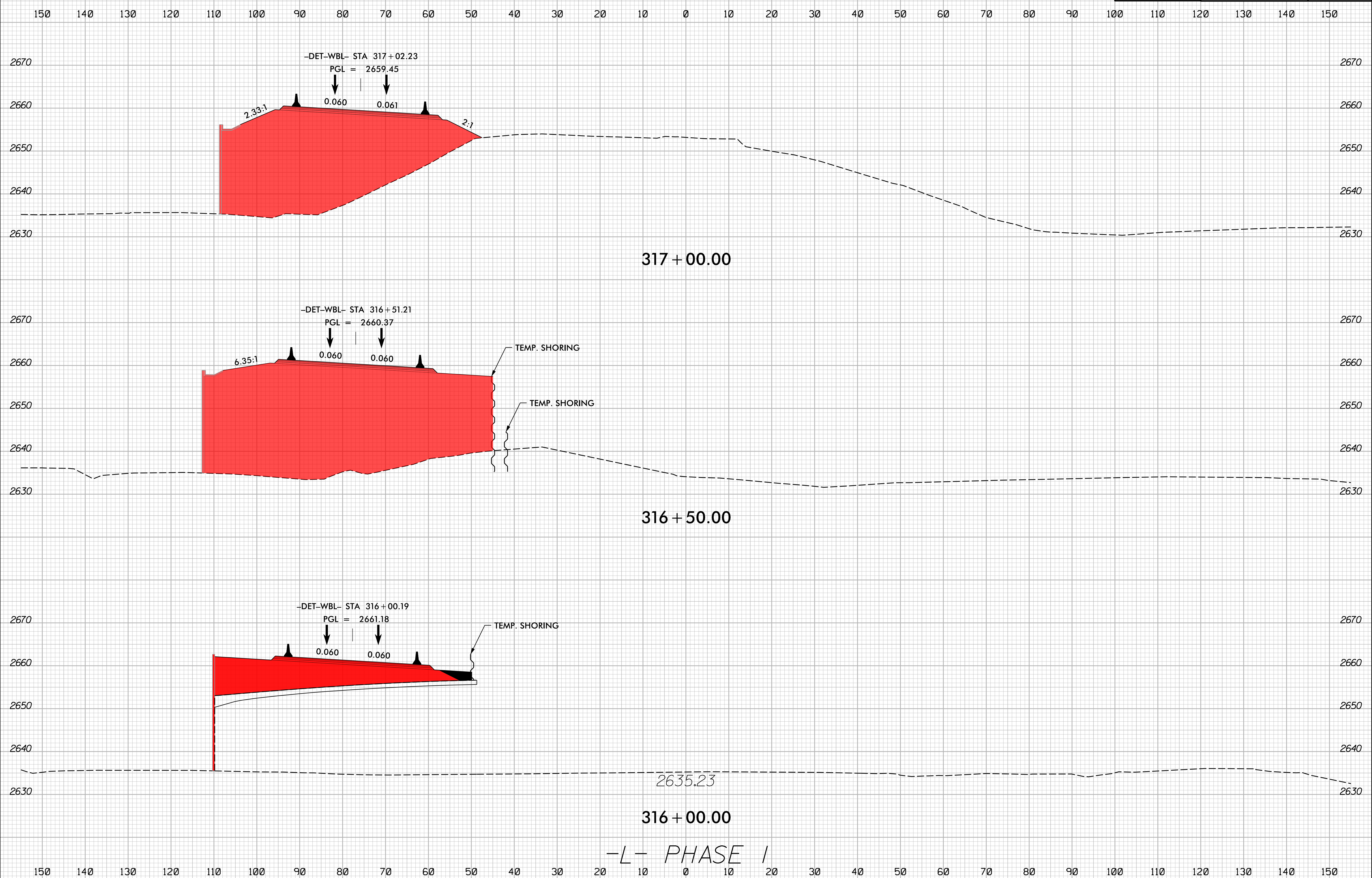

-L- PHASE I

5/13/2024  
1:51:13 PM  
I:\HB\0002\_rdy\_xpl\_L\_phase-1.dgn

8/23/99

	PROJ. REFERENCE NO.	SHEET NO.
	HB-0002	X-15

150 140 130 120 110 100 90 80 70 60 50 40 30 20 10 0 10 20 30 40 50 60 70 80 90 100 110 120 130 140 150

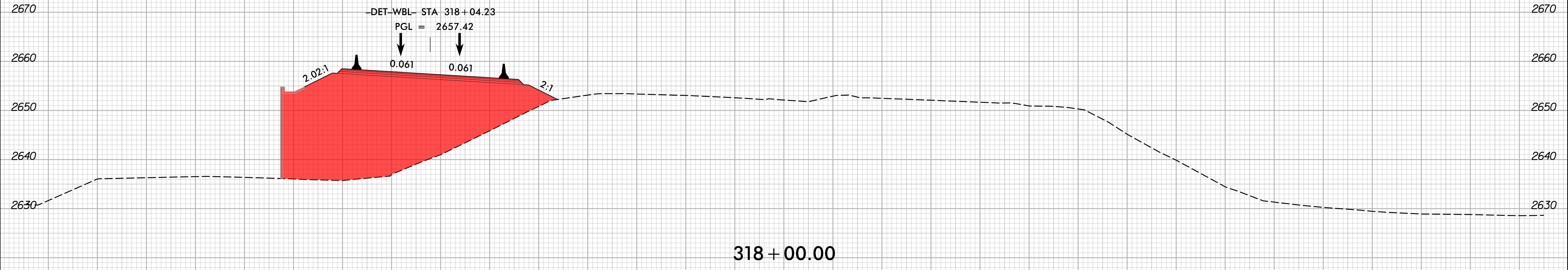

-L- PHASE I

150 140 130 120 110 100 90 80 70 60 50 40 30 20 10 0 10 20 30 40 50 60 70 80 90 100 110 120 130 140 150

2/16/2024 1:51:13 PM I:\Projects\HB0002\_rdy\_xpl\_L\_phase-1.dgn



8/23/99

0 5 10	PROJ. REFERENCE NO.	SHEET NO.
	HB-0002	X-16

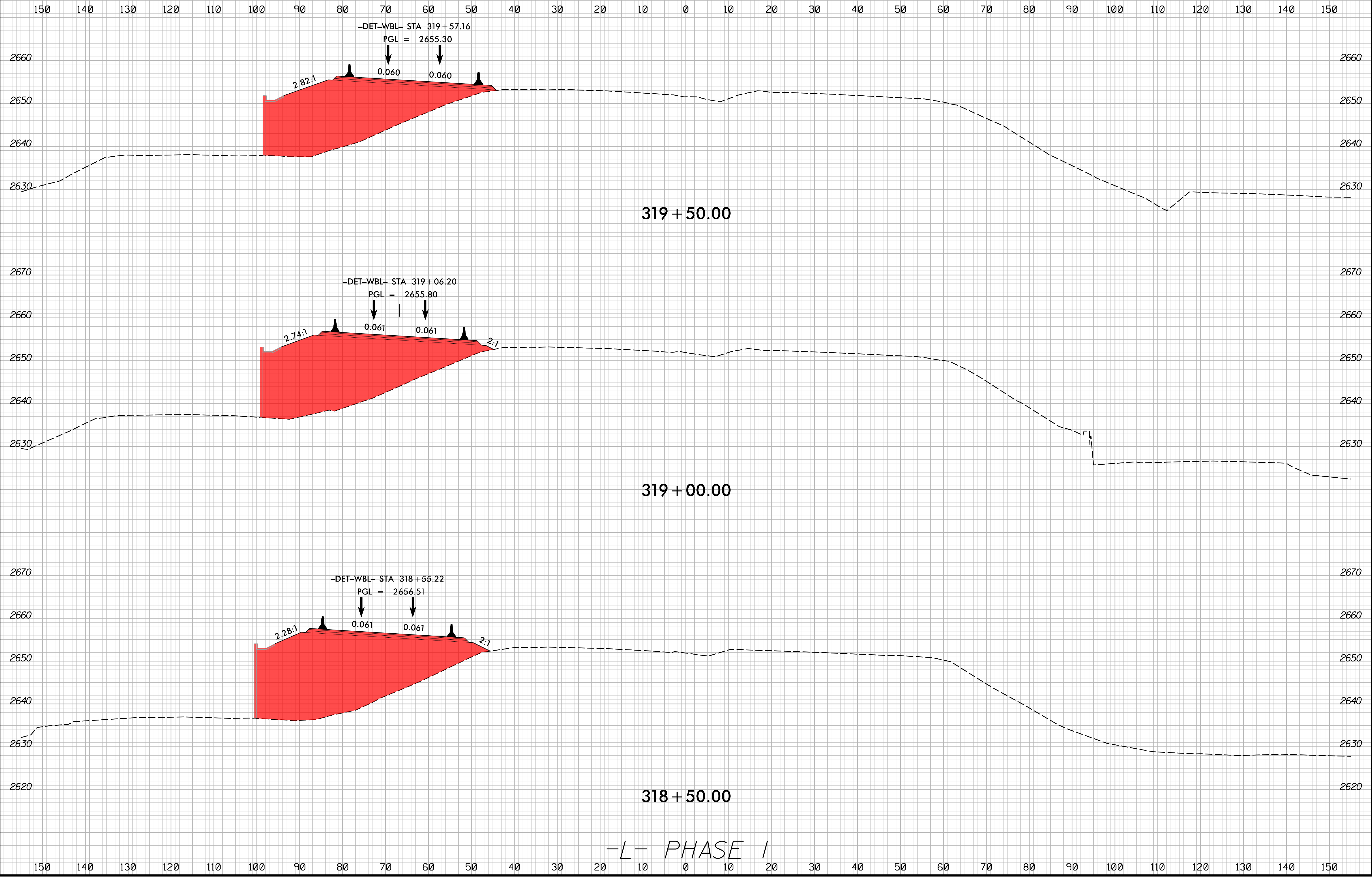

-L- PHASE I

2/16/2024  
I:\HB0002\_rdy\_xpl\_L\_phase-1.dgn  
JSE:rlf



8/23/99

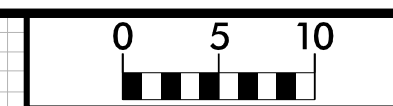

PROJ. REFERENCE NO.	SHEET NO.
HB-0002	X-17

150 140 130 120 110 100 90 80 70 60 50 40 30 20 10 0 10 20 30 40 50 60 70 80 90 100 110 120 130 140 150

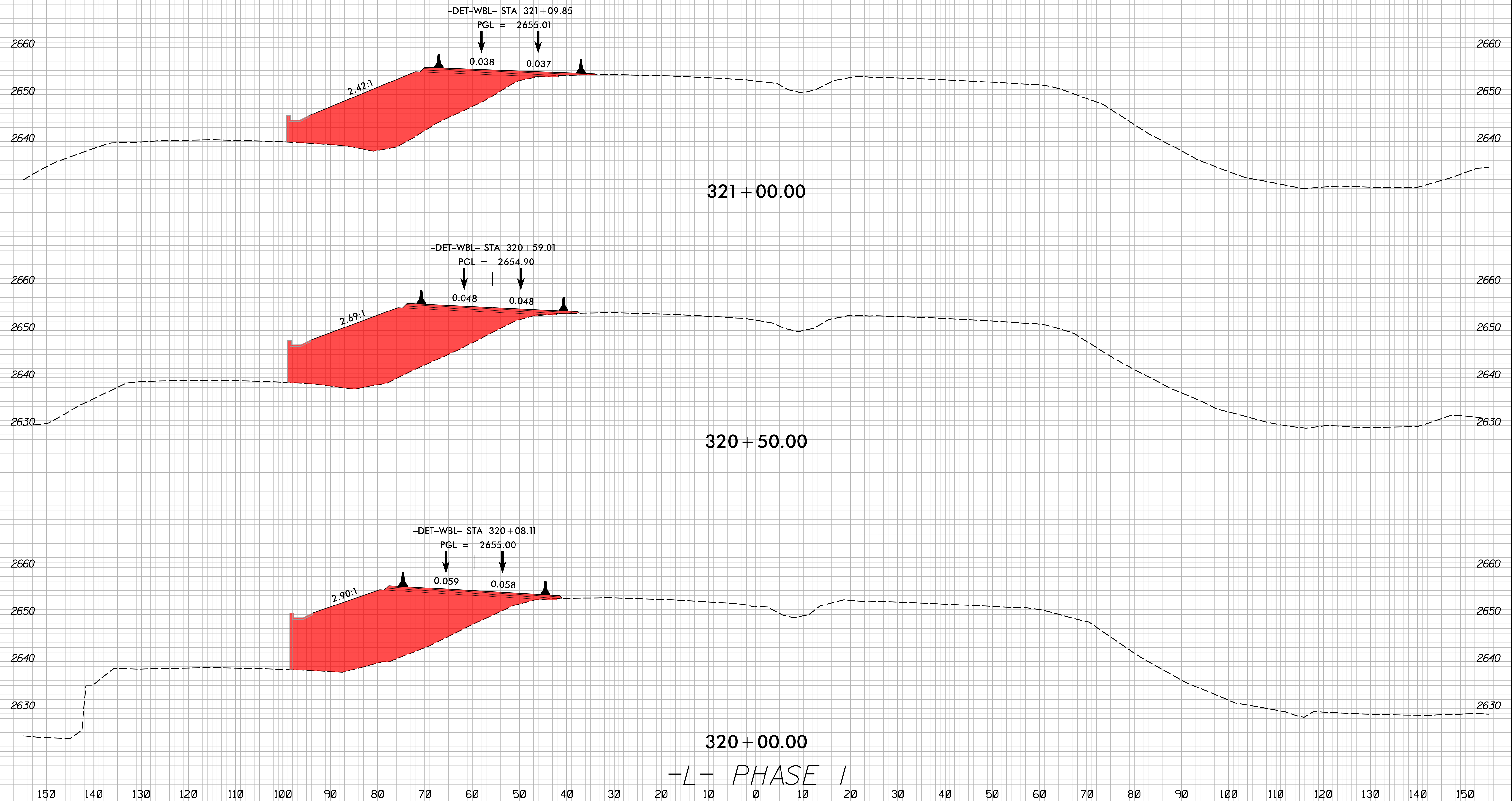

-L- PHASE I

2/16/2024  
I:\HB\0002\_rdy\_xpl\_L\_phase-1.dgn  
JSE

8/23/99

	PROJ. REFERENCE NO.	SHEET NO.
	HB-0002	X-18

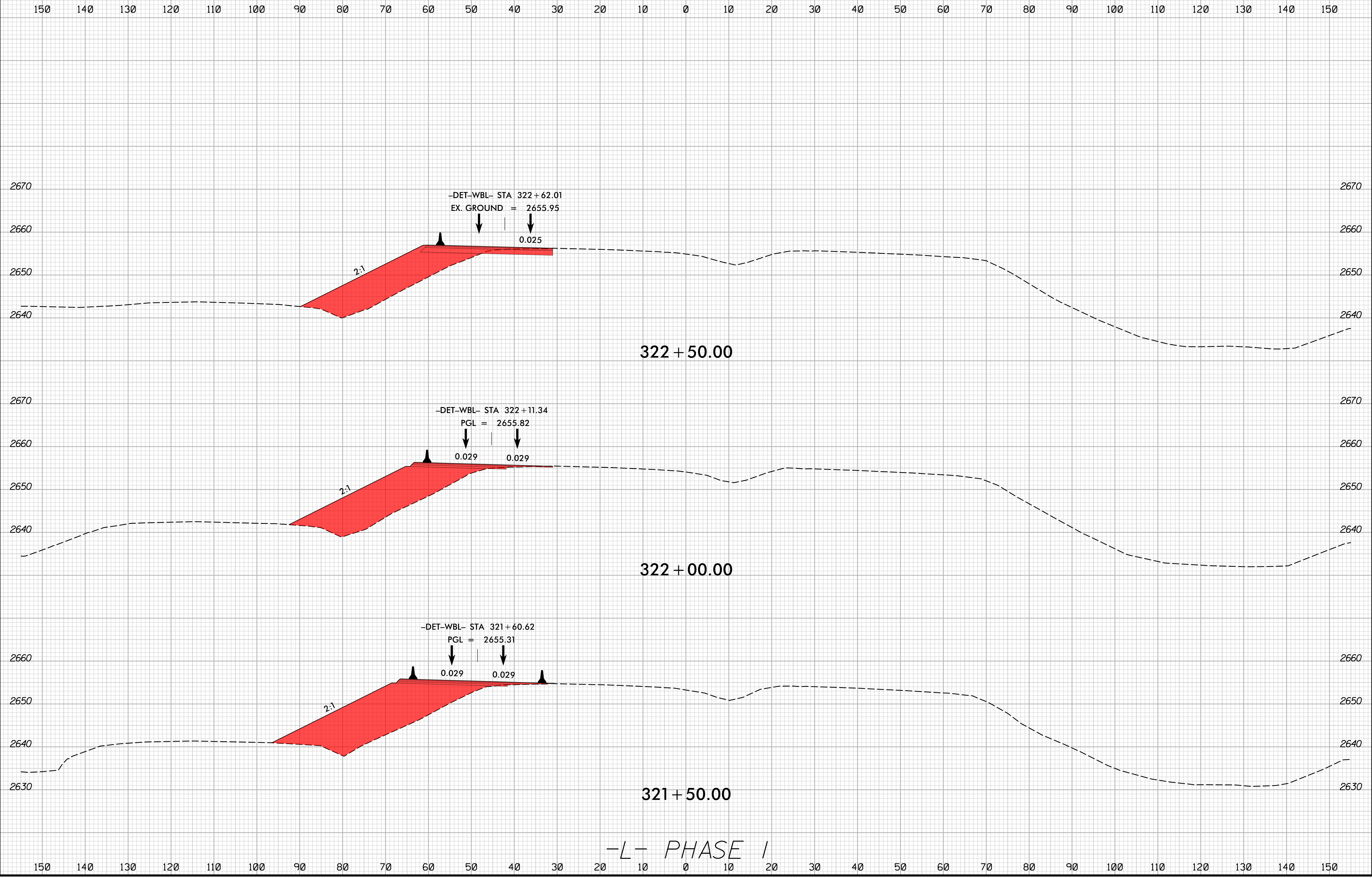

-L- PHASE I

2/16/2024  
I:\HB\0002\_rdy\_xpl\_L\_phase-1.dgn  
JSE/ETG

8/23/99

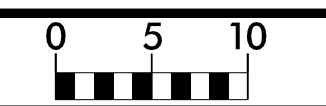

PROJ. REFERENCE NO.	SHEET NO.
HB-0002	X-19

150 140 130 120 110 100 90 80 70 60 50 40 30 20 10 0 10 20 30 40 50 60 70 80 90 100 110 120 130 140 150

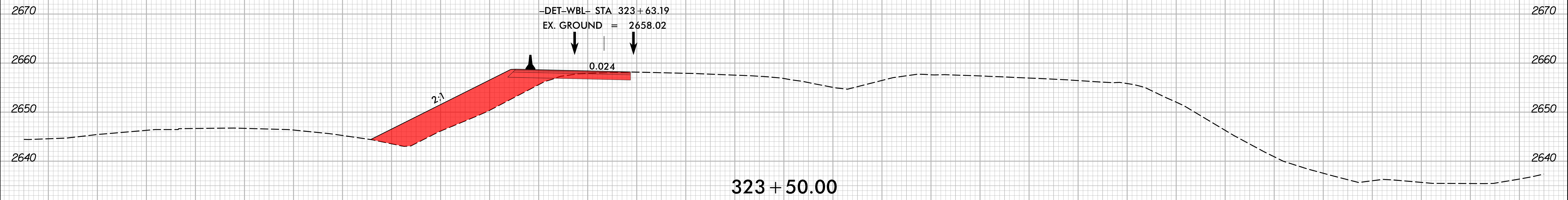
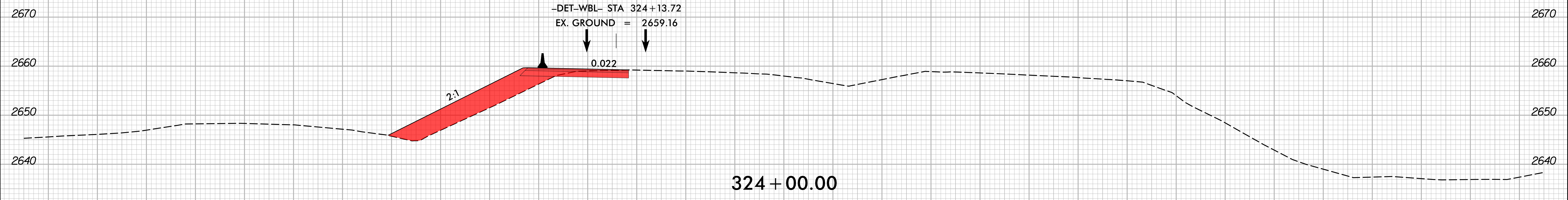

-L- PHASE I

150 140 130 120 110 100 90 80 70 60 50 40 30 20 10 0 10 20 30 40 50 60 70 80 90 100 110 120 130 140 150

2/16/2024  
1:51:13  
I:\HB\0002\_rdy\_xpl\_L\_phase-1.dgn

8/23/99

0 5 10	PROJ. REFERENCE NO.	SHEET NO.
	HB-0002	X-20

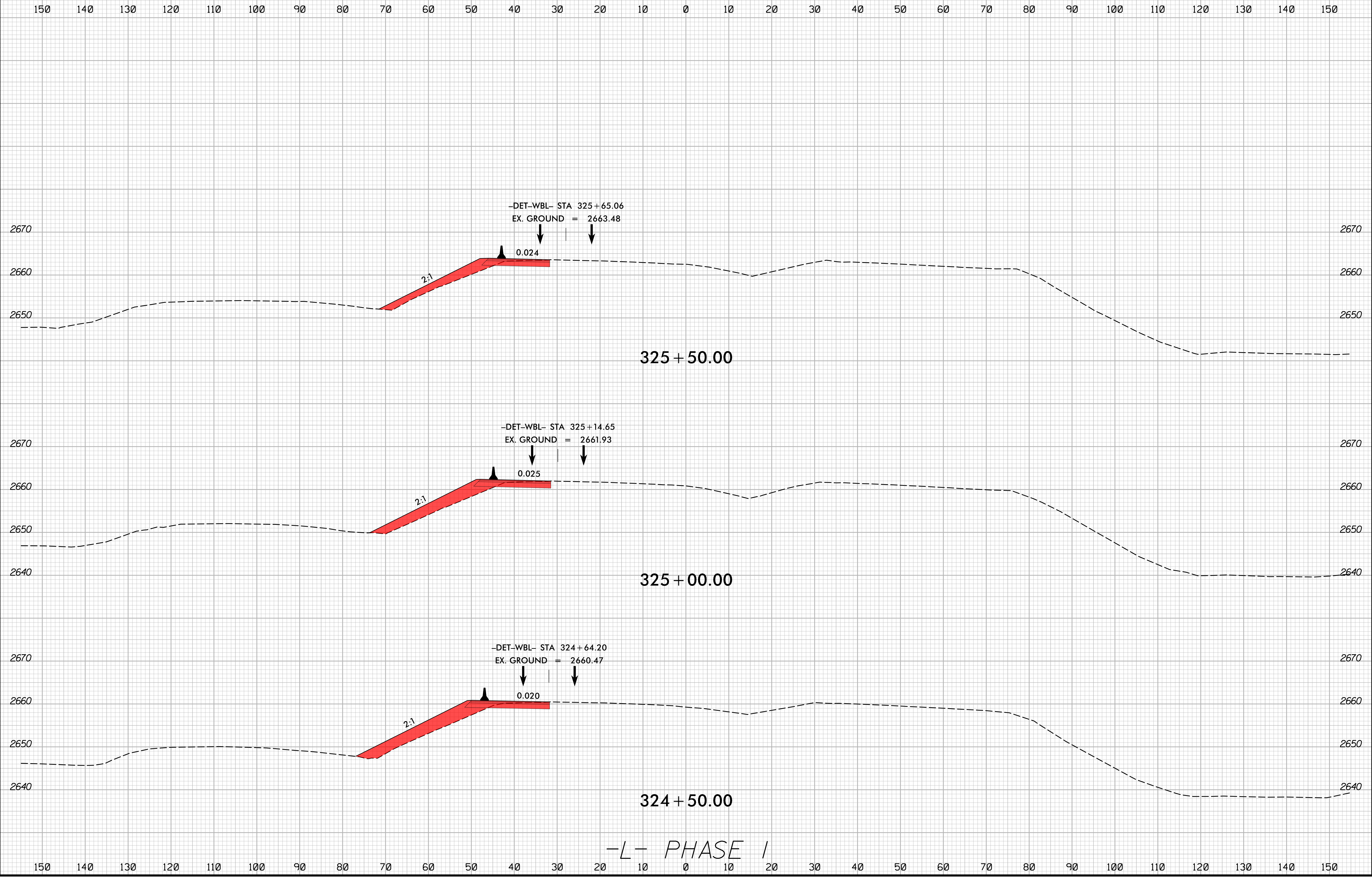

-L- PHASE I

2/16/2024  
1:5:18:00  
I:\Projects\HB0002\_rdy\_xpl\_L\_phase-1.dgn



8/23/99

	PROJ. REFERENCE NO.	SHEET NO.
	HB-0002	X-21

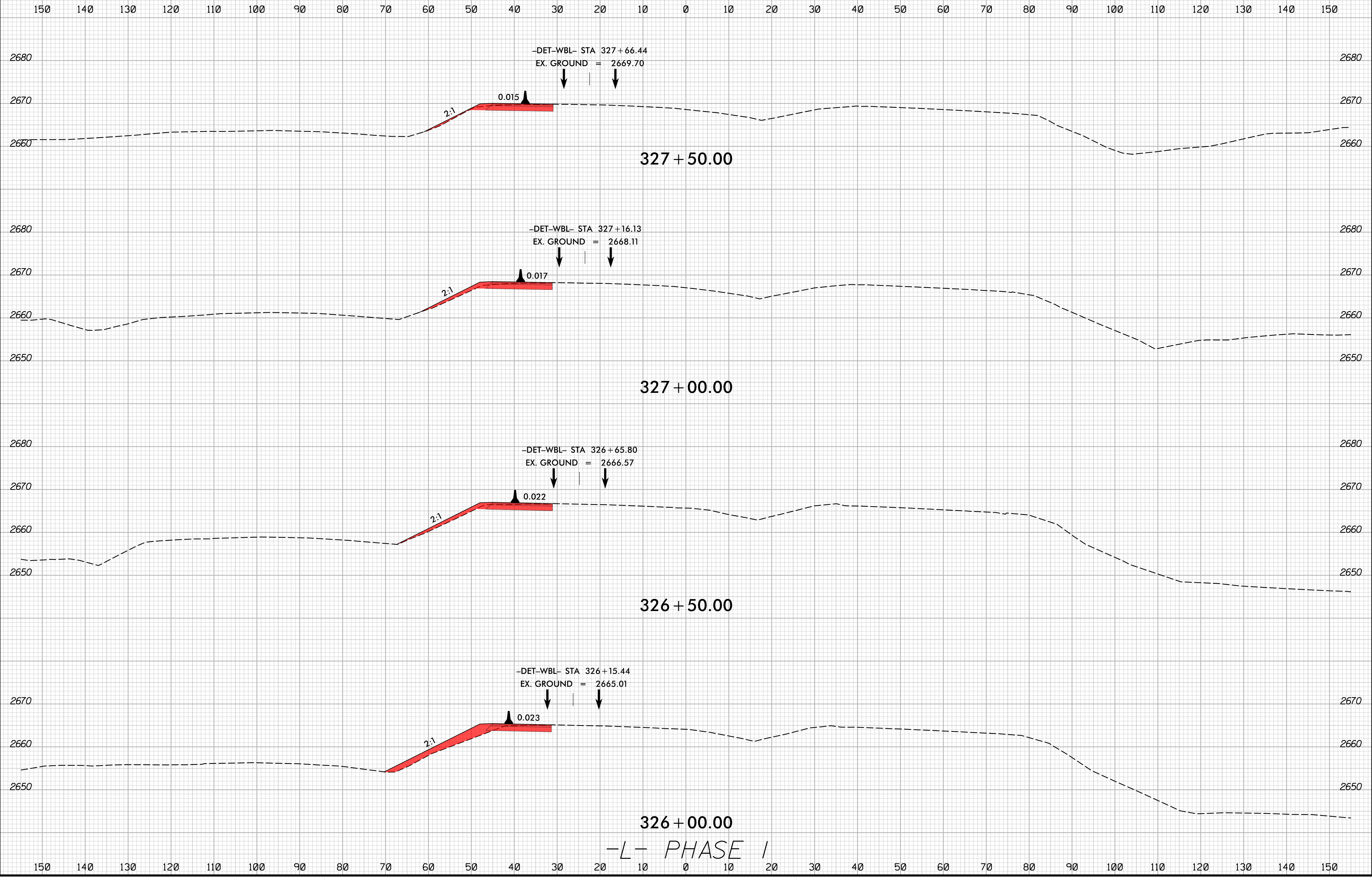

-L- PHASE I

2/16/2024  
I:\HB\0002\_rdy\_xpl\_L\_phase-1.dgn  
JTB



8/23/99

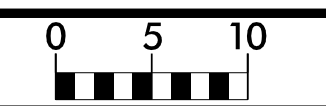

PROJ. REFERENCE NO.	SHEET NO.
HB-0002	X-22

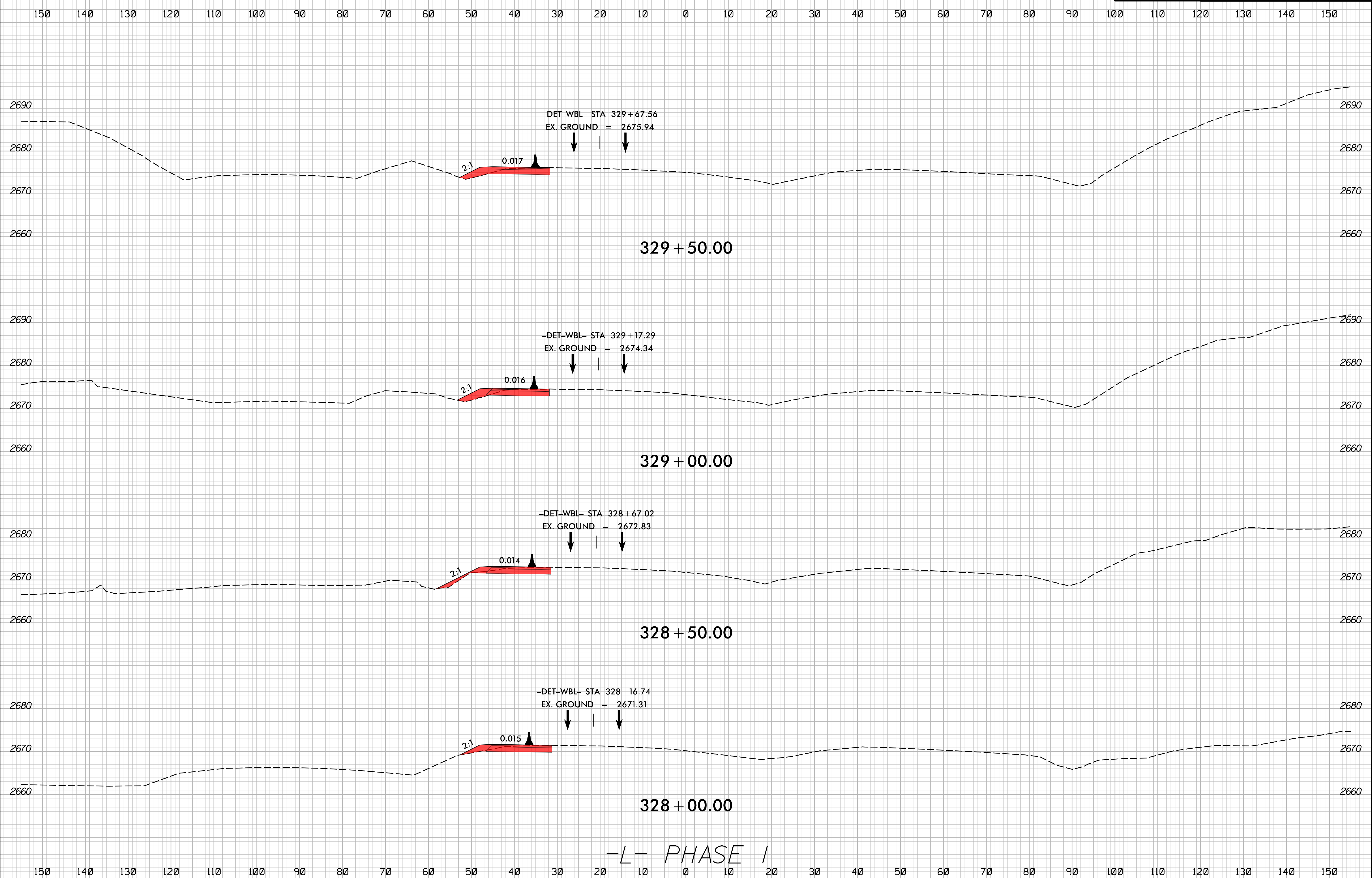

-L- PHASE I

2/16/2024  
1:51:13 PM  
I:\Projects\HB0002\_rdy\_xpl\_L\_phase1.dgn

8/23/99

	PROJ. REFERENCE NO.	SHEET NO.
	HB-0002	X-23

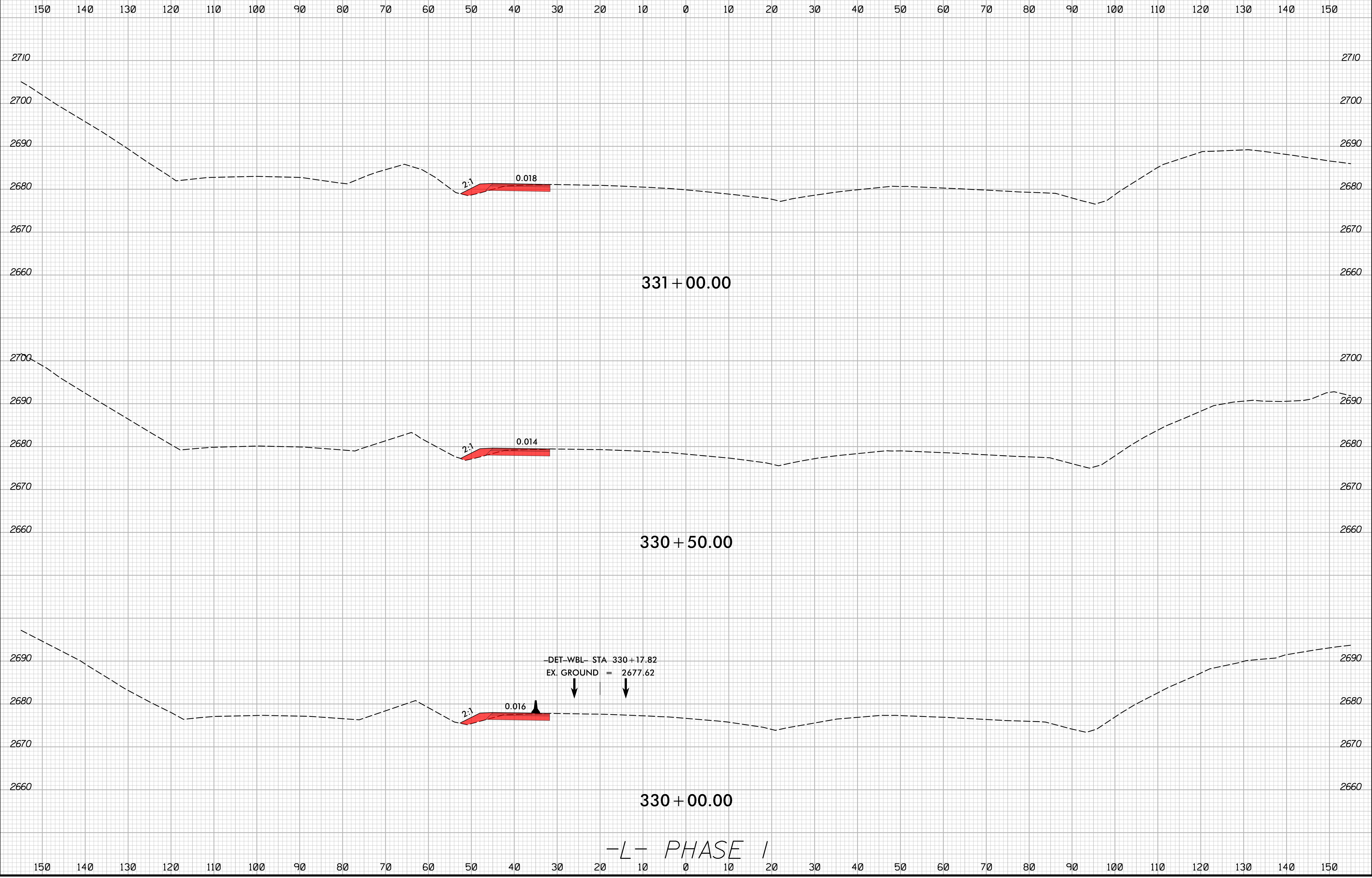

2/16/2024  
I:\HB\0002\_rdy\_xpl\_L\_phase-1.dgn  
J:\ERIC\refiner

-L- PHASE I

8/23/99

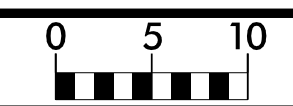

PROJ. REFERENCE NO.	SHEET NO.
HB-0002	X-24

150 140 130 120 110 100 90 80 70 60 50 40 30 20 10 0 10 20 30 40 50 60 70 80 90 100 110 120 130 140 150

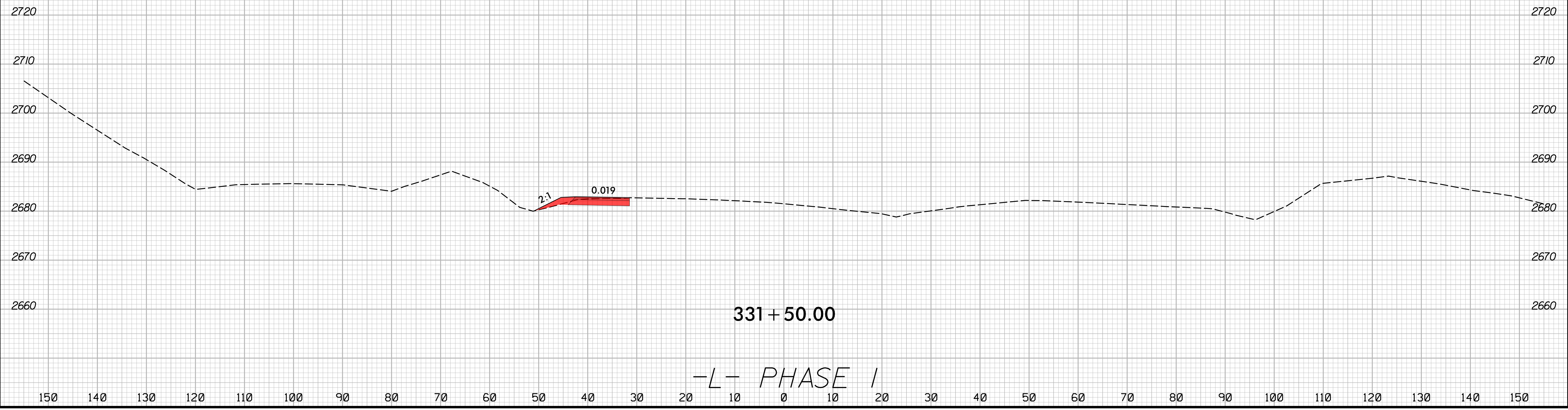

2/16/2024  
 I:\HB\0002\_rdy\_xpl\_L\_phase-1.dgn  
 JSE:rlg

8/23/99

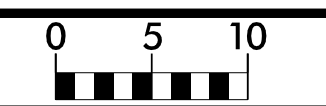

PROJ. REFERENCE NO.	SHEET NO.
HB-0002	X-25

190 180 170 160 150 140 130 120 110 100 90 80 70 60 50 40 30 20 10 0 10 20 30 40 50 60 70 80 90 100 110

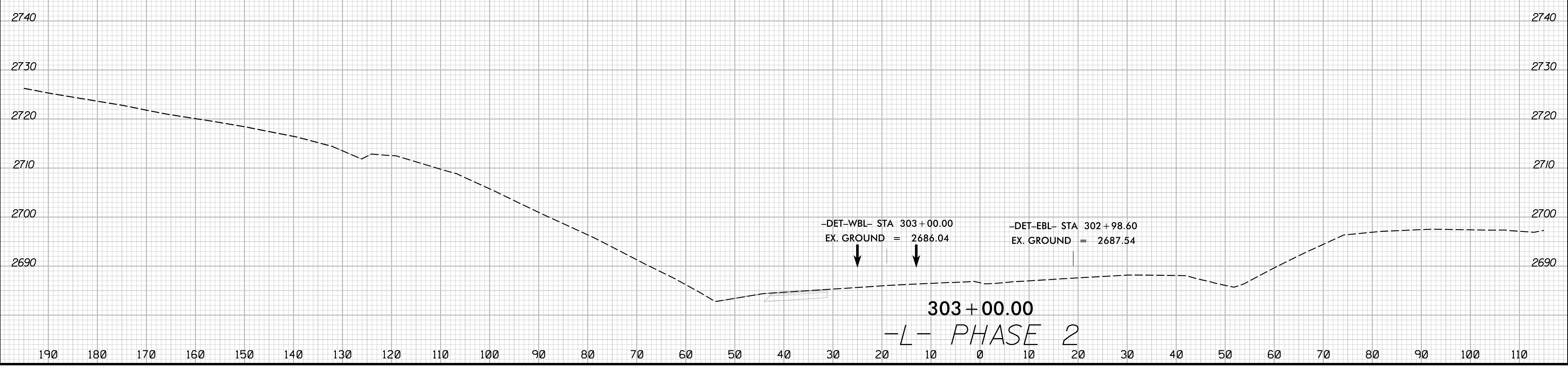
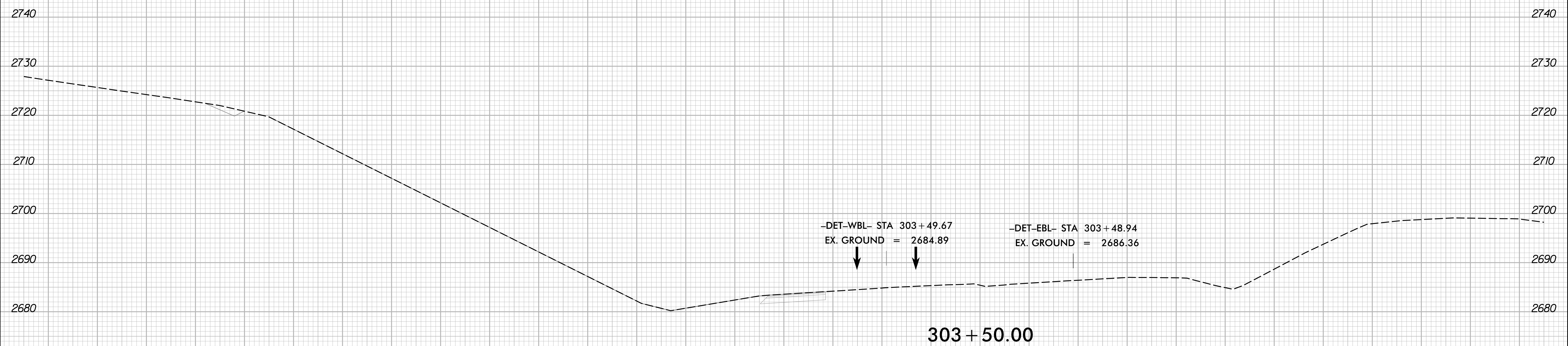

2/16/2024  
1:51:13 PM  
I:\Projects\HB0002\_rdy\_xpl\_L\_phase-2.dgn

8/23/99

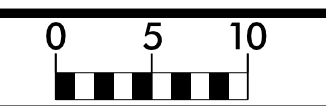

PROJ. REFERENCE NO.	SHEET NO.
HB-0002	X-26

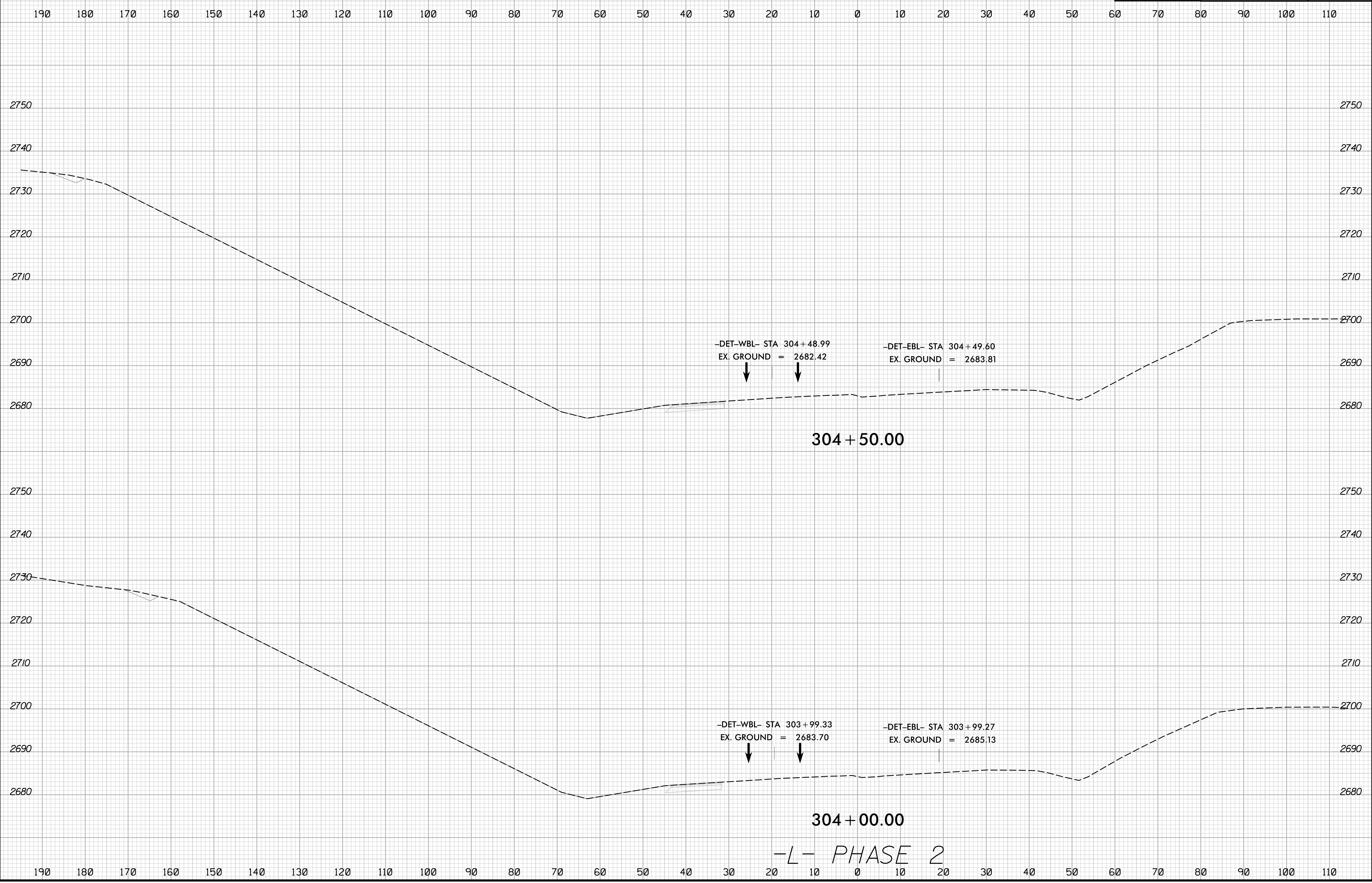

2/16/2024  
I:\HB\0002\_rdy\_xpl\_L\_phase-2.dgn  
JSE/ETG



8/23/99

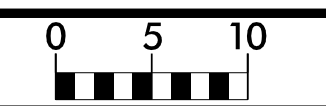

PROJ. REFERENCE NO.	SHEET NO.
HB-0002	X-27

190 180 170 160 150 140 130 120 110 100 90 80 70 60 50 40 30 20 10 0 10 20 30 40 50 60 70 80 90 100 110

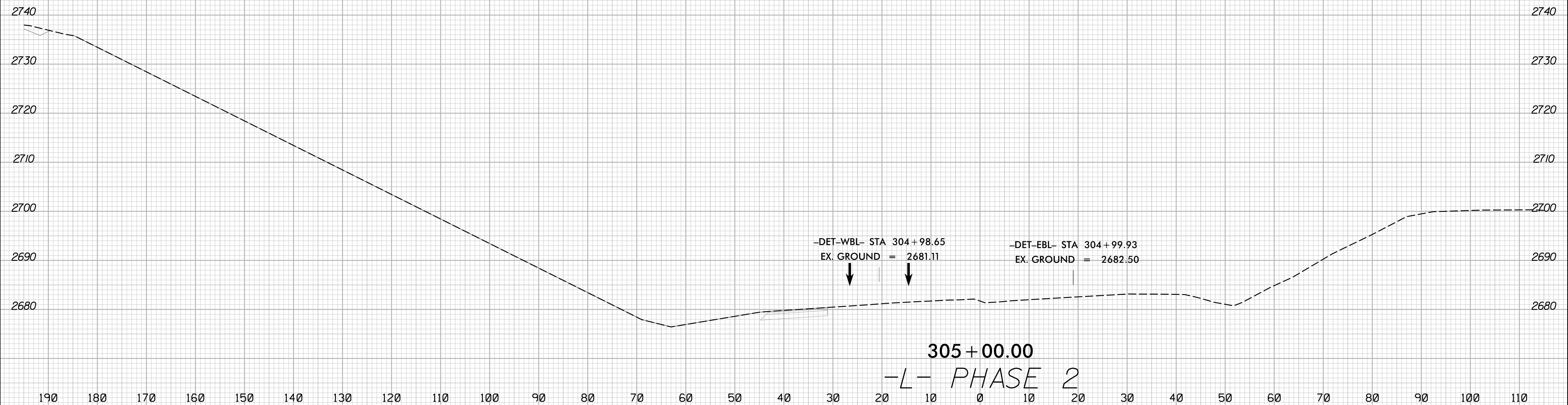
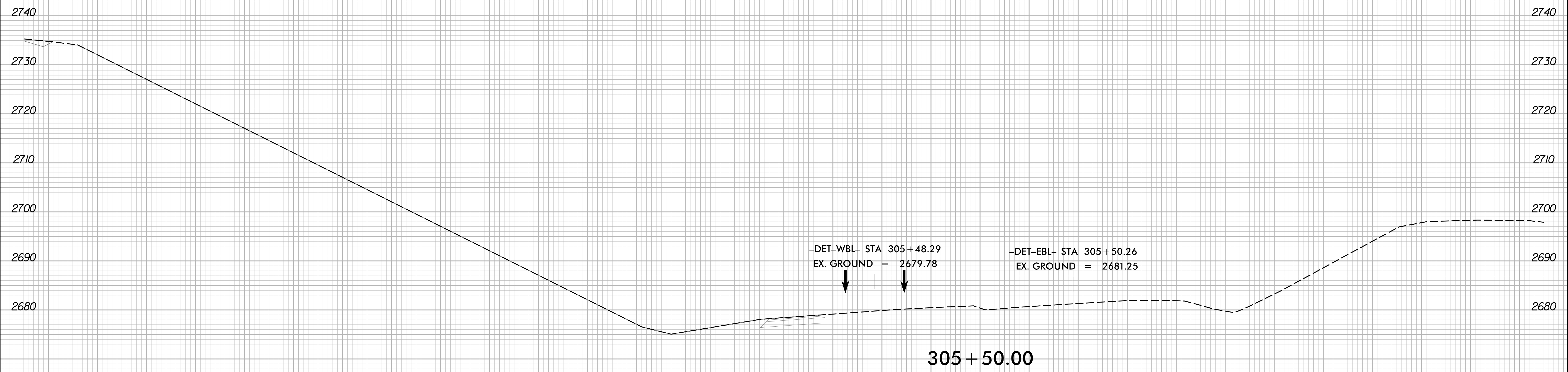

2/16/2024  
1:51:13 PM  
I:\Projects\HB0002\_rdy\_xpl\_L\_phase-2.dgn

8/23/99

	PROJ. REFERENCE NO.	SHEET NO.
	HB-0002	X-28

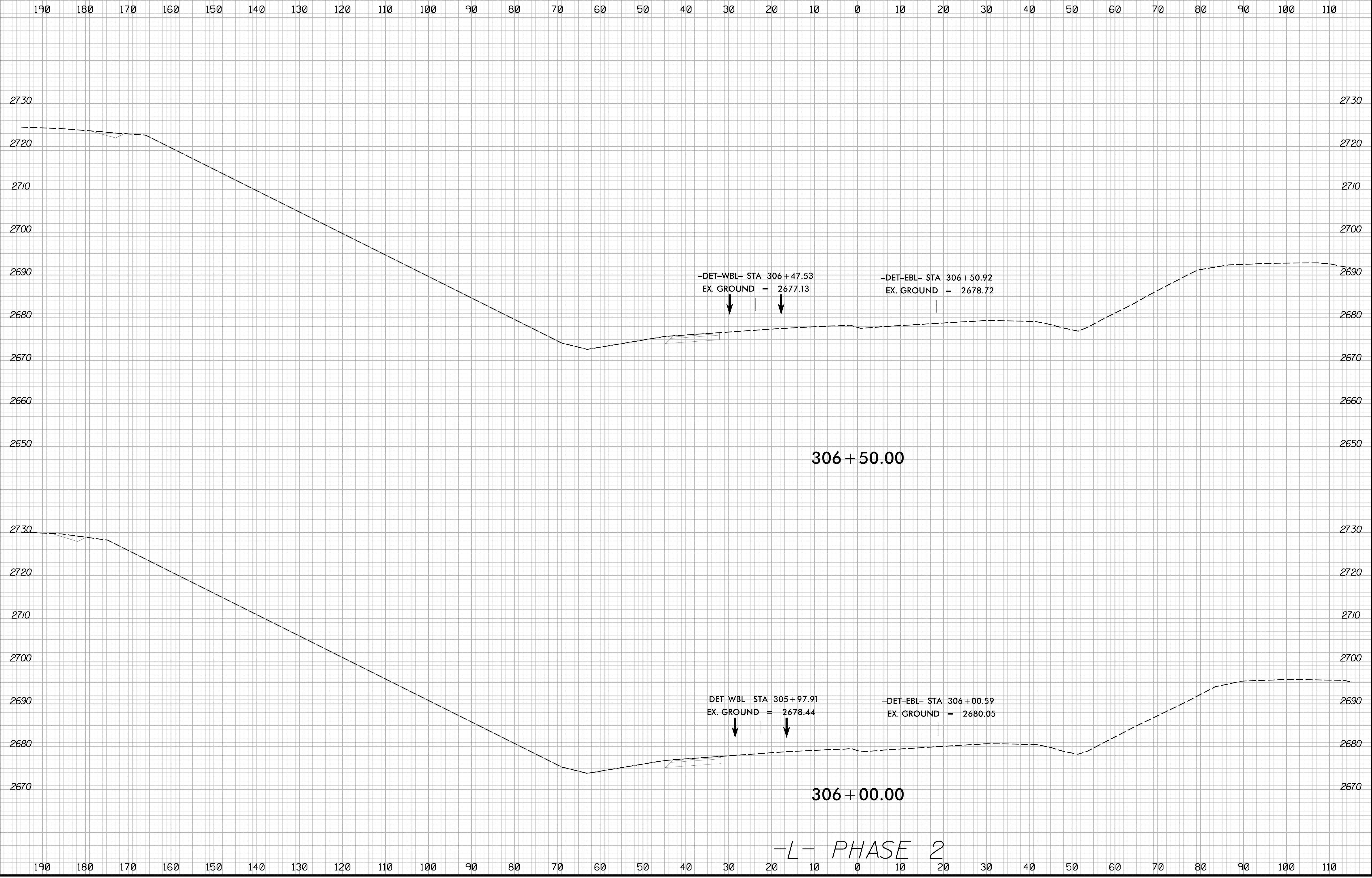

2/16/2024  
1:51:13 PM  
I:\Projects\HB0002\_rdy\_xpl\_L\_phase-2.dgn

8/23/99

	PROJ. REFERENCE NO.	SHEET NO.
	HB-0002	X-29

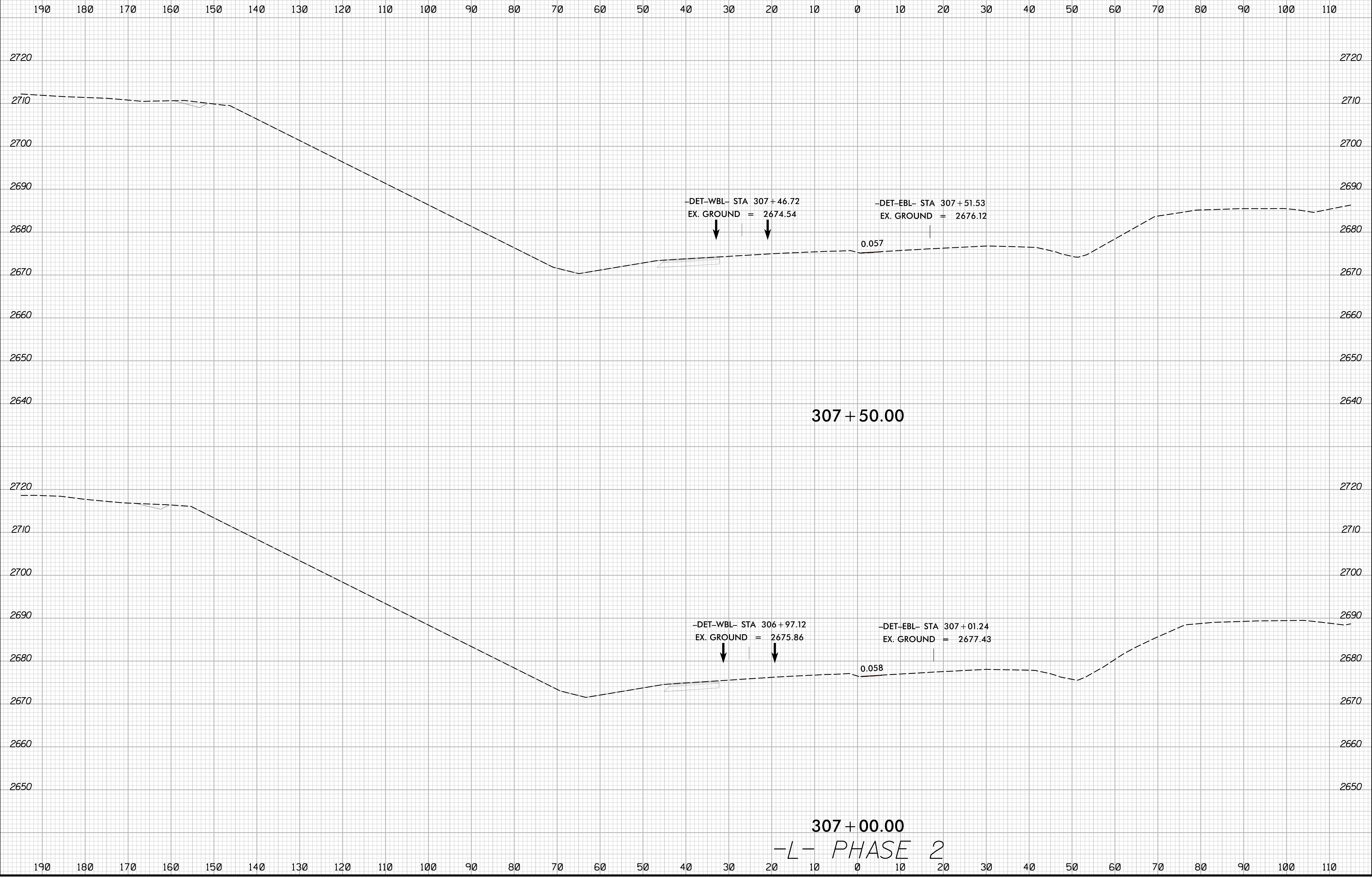

2/16/2024  
1:51:13 PM  
I:\S\HB\0002\_rdy\_xpl\_L\_phase-2.dgn

8/23/99

	PROJ. REFERENCE NO.	SHEET NO.
	HB-0002	X-30

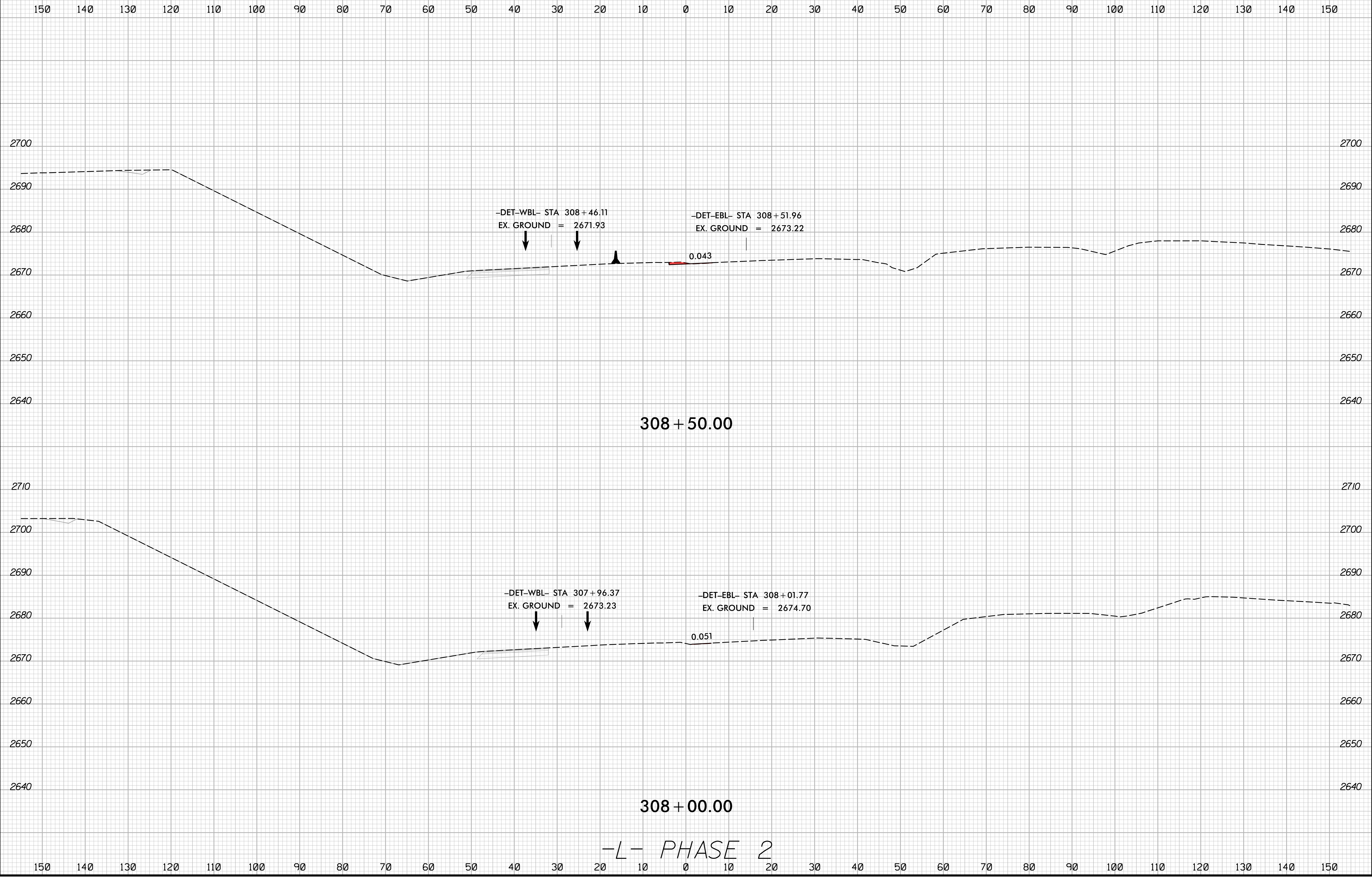

2/16/2024  
I:\S:\HB\0002\_rdy\_xpl\_L\_phase-2.dgn  
JSE/13/10/2024

8/23/99

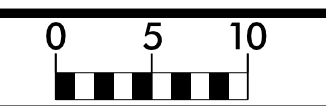

PROJ. REFERENCE NO.	SHEET NO.
HB-0002	X-31

150 140 130 120 110 100 90 80 70 60 50 40 30 20 10 0 10 20 30 40 50 60 70 80 90 100 110 120 130 140 150

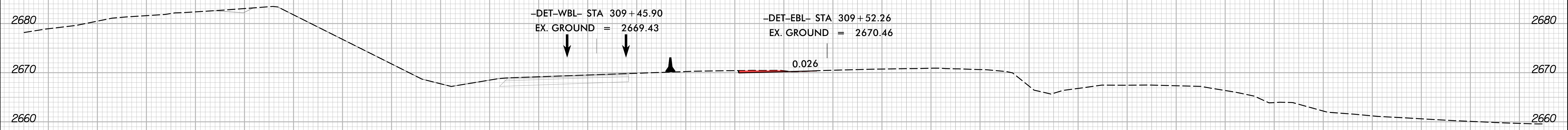

309 + 50.00

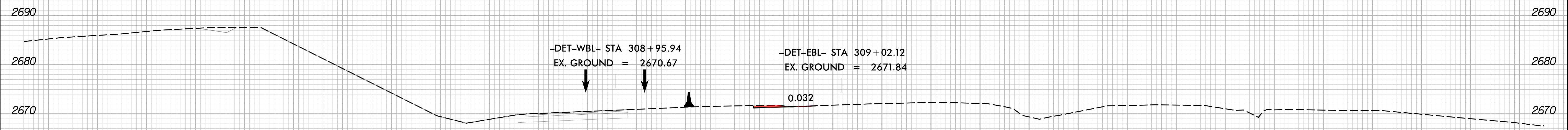

309 + 00.00

-L- PHASE 2

150 140 130 120 110 100 90 80 70 60 50 40 30 20 10 0 10 20 30 40 50 60 70 80 90 100 110 120 130 140 150

2/16/2024 1:51:13 PM I:\HB\0002\_rdy\_xpl\_L\_phase-2.dgn



8/23/99

	PROJ. REFERENCE NO.	SHEET NO.
	HB-0002	X-32

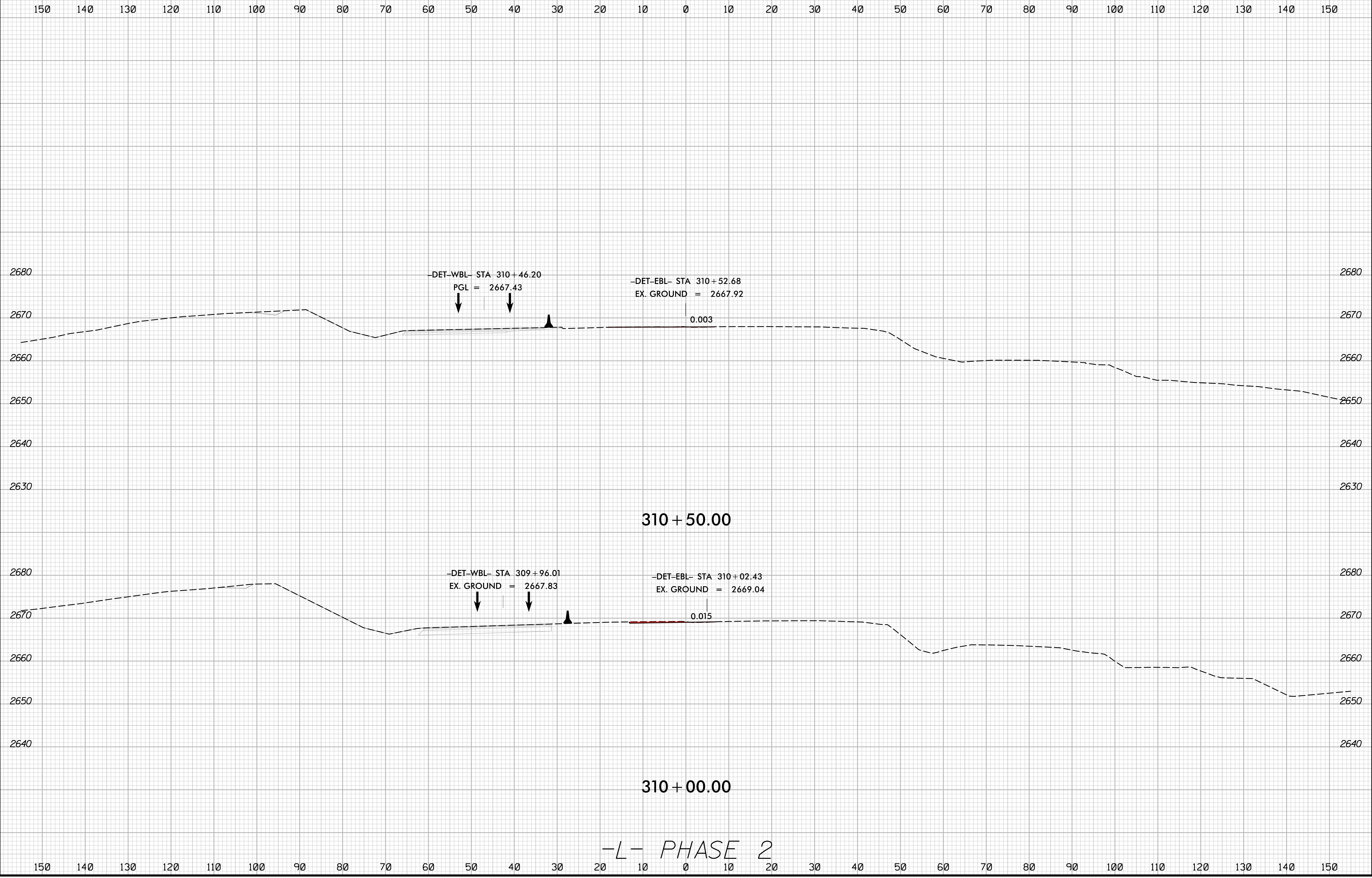

2/16/2024  
1:51:13 PM  
I:\Projects\HB0002\_rdy\_xpl\_L\_phase-2.dgn

8/23/99

	PROJ. REFERENCE NO.	SHEET NO.
	HB-0002	X-33

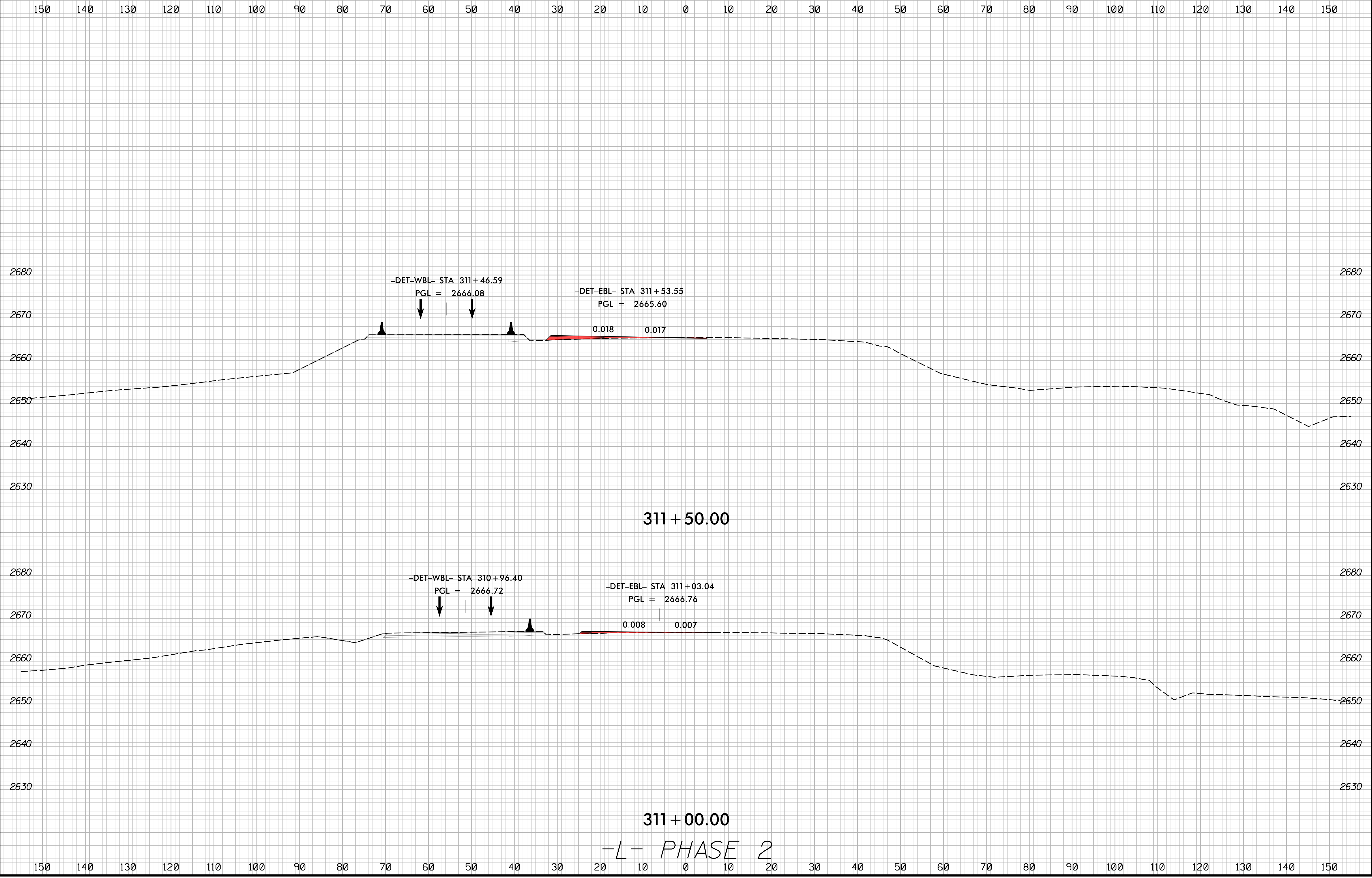

2/16/2024  
1:51:13 PM  
I:\Projects\HB0002\_rdy\_xpl\_L\_phase-2.dgn

8/23/99

0 5 10	PROJ. REFERENCE NO.	SHEET NO.
	HB-0002	X-34

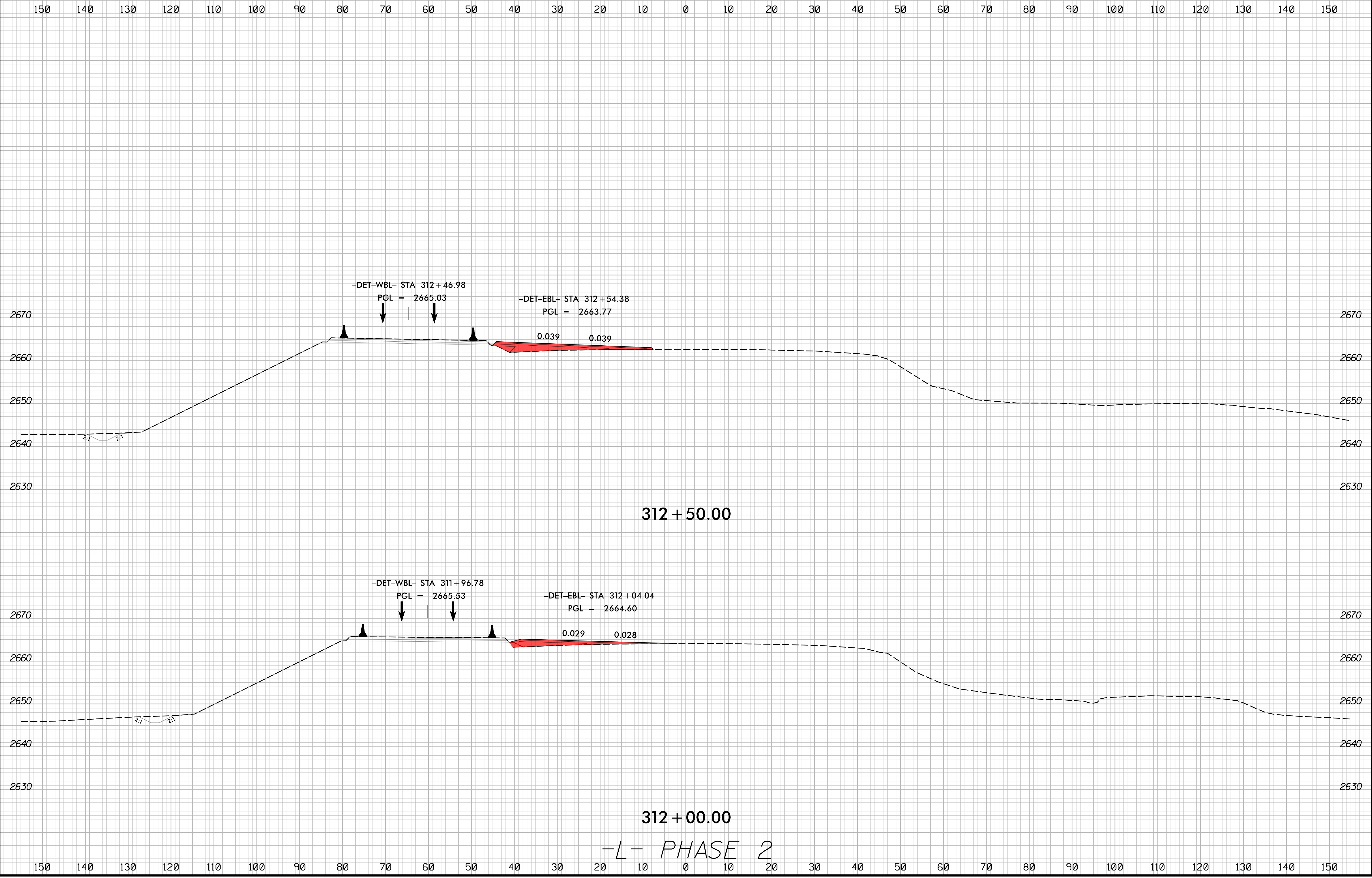

2/16/2024  
1:51:13 PM  
I:\S:\HB\0002\_rdy\_xpl\_L\_phase-2.dgn

8/23/99

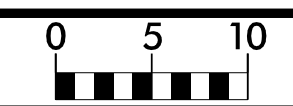

PROJ. REFERENCE NO.	SHEET NO.
HB-0002	X-35

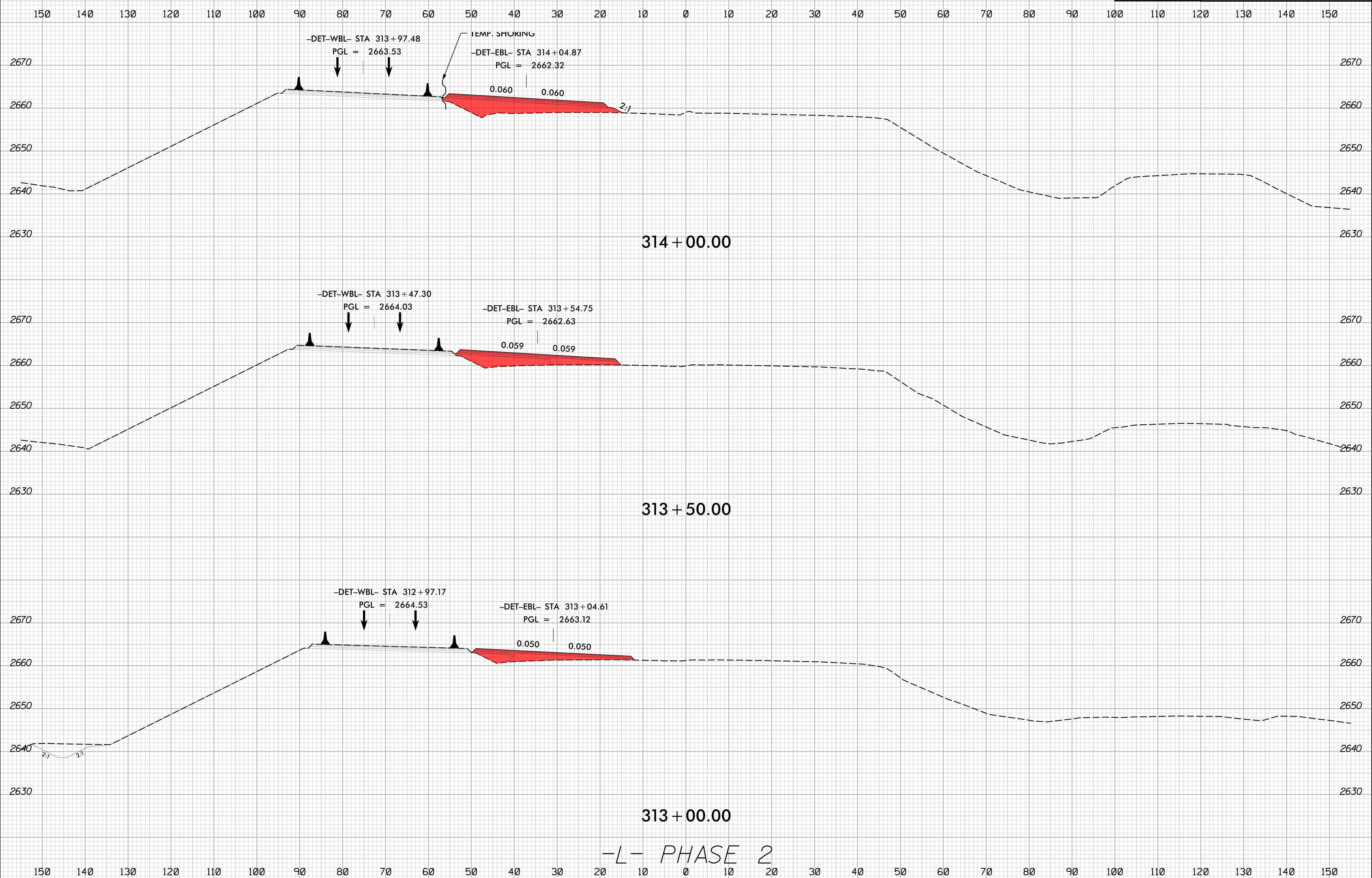

5/13/2024  
1:51:13 PM  
I:\Projects\HB0002\rdy\_xpl\_L\_phase-2.dgn



8/23/99

0 5 10	PROJ. REFERENCE NO.	SHEET NO.
	HB-0002	X-36

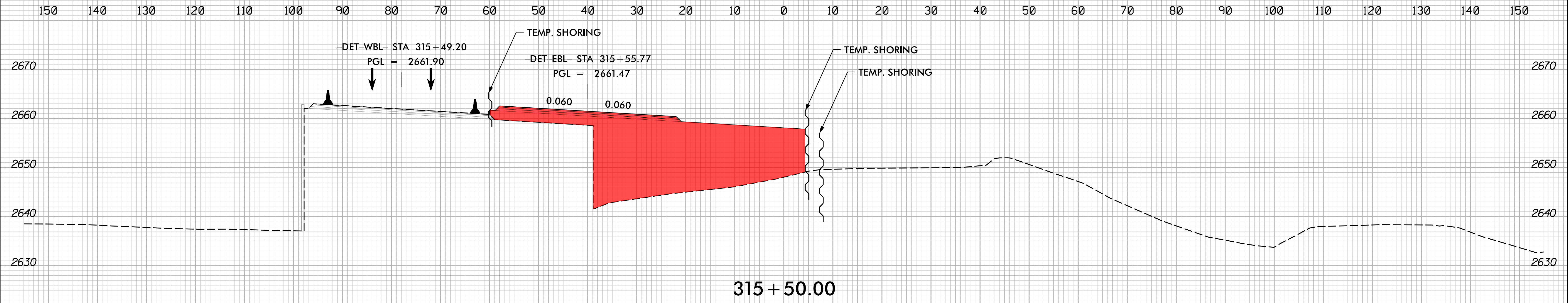

315 + 50.00

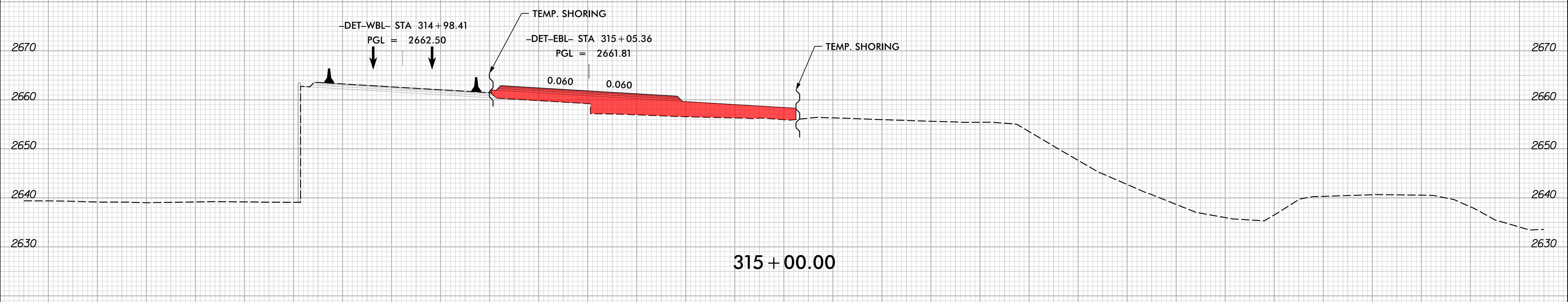

315 + 00.00



314 + 50.00

-L- PHASE 2

5/13/2024 1:51:13 PM HB0002\_rdy\_xpl\_L\_phase-2.dgn



8/23/99

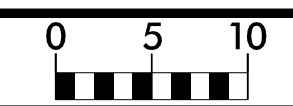

PROJ. REFERENCE NO.	SHEET NO.
HB-0002	X-37

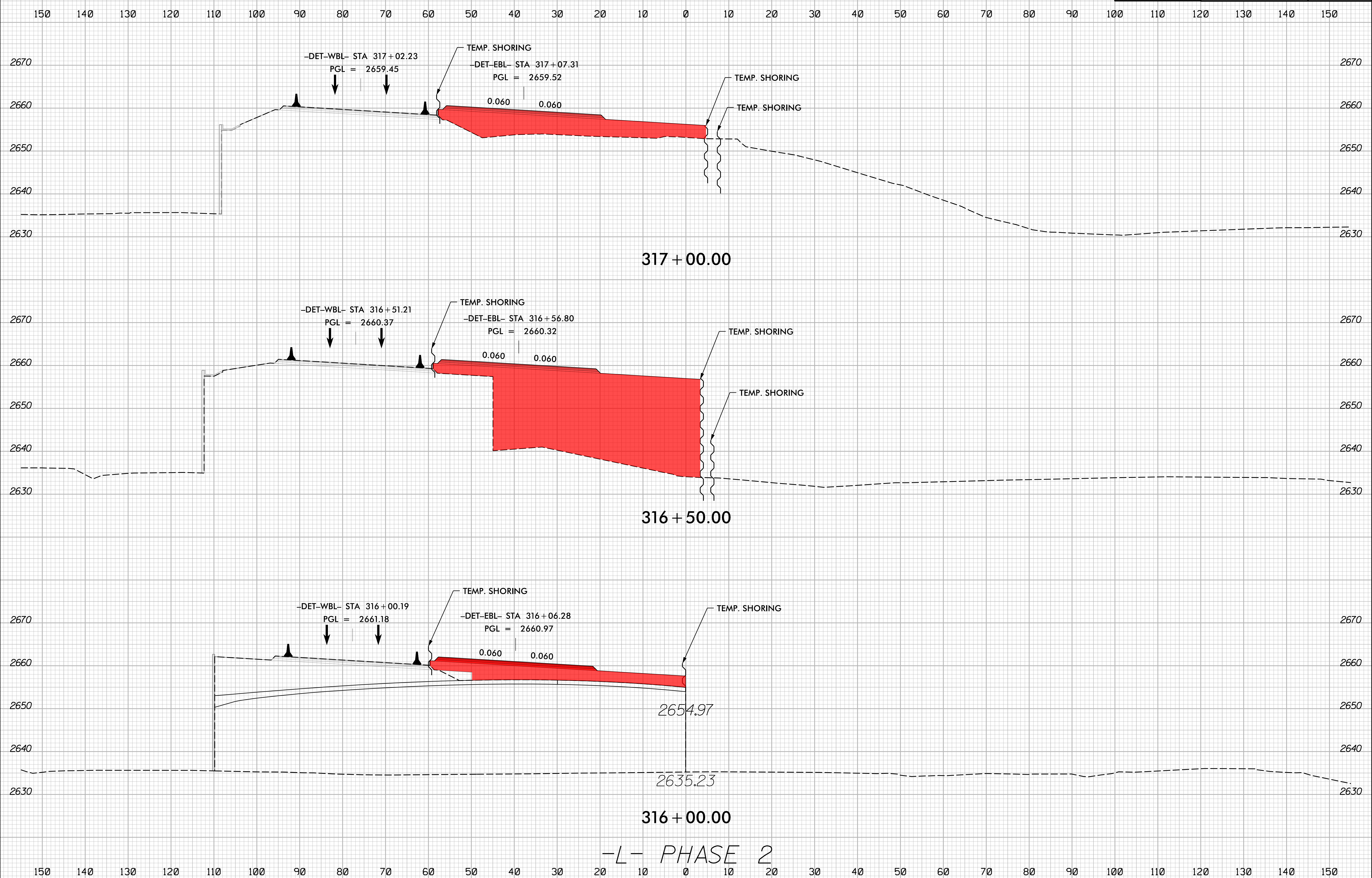

-L- PHASE 2

5/13/2024  
1:51:13 PM  
I:\Projects\2024\115\HB0002\_rdy\_xpl\_L\_phase-2.dgn

8/23/99

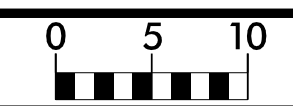

PROJ. REFERENCE NO.	SHEET NO.
HB-0002	X-38

150 140 130 120 110 100 90 80 70 60 50 40 30 20 10 0 10 20 30 40 50 60 70 80 90 100 110 120 130 140 150

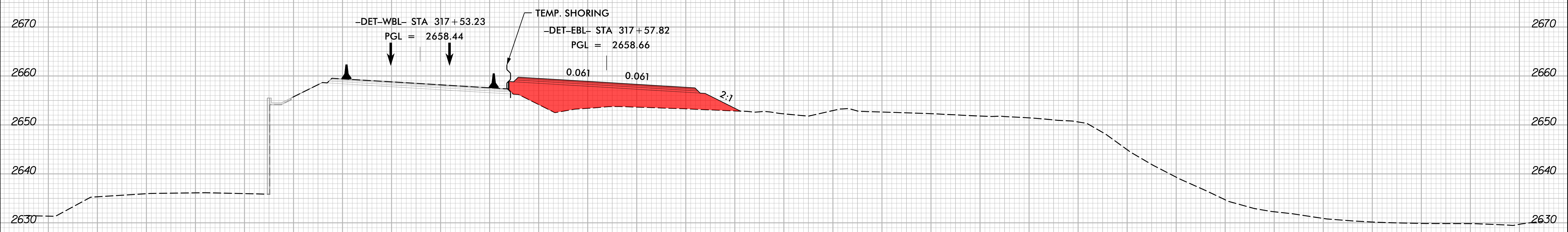

-L- PHASE 2

150 140 130 120 110 100 90 80 70 60 50 40 30 20 10 0 10 20 30 40 50 60 70 80 90 100 110 120 130 140 150

5/13/2024 10:51:33 AM I:\HB\0002\_rdy\_xpl\_L\_phase-2.dgn

8/23/99

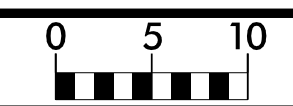

PROJ. REFERENCE NO.	SHEET NO.
HB-0002	X-39

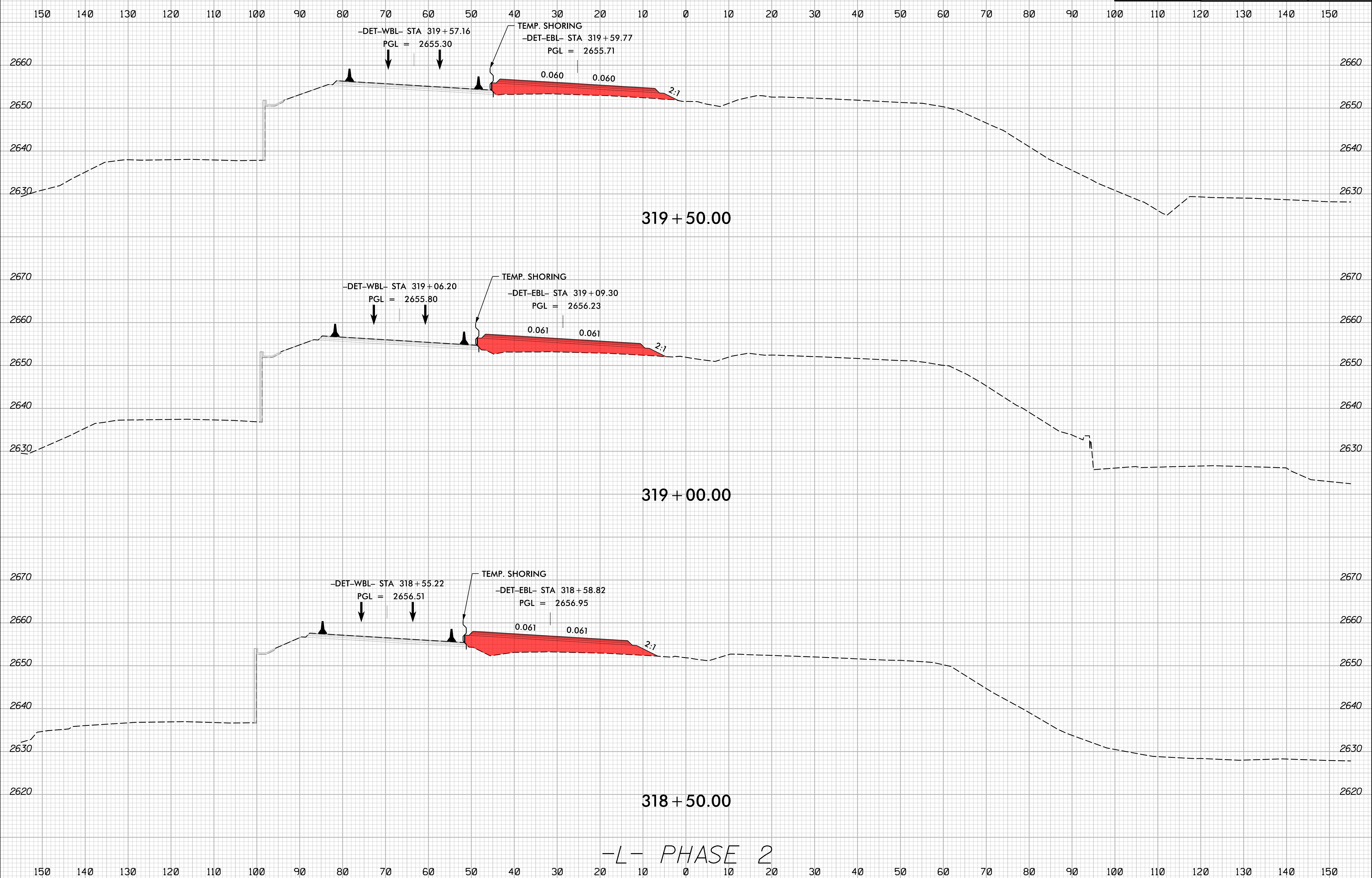

-L- PHASE 2

5/13/2024  
1:51:13 PM  
I:\HB0002\_rdy\_xpl\_L\_phase-2.dgn

8/23/99

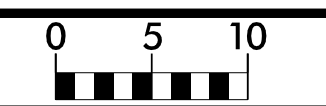

PROJ. REFERENCE NO.	SHEET NO.
HB-0002	X-40

150 140 130 120 110 100 90 80 70 60 50 40 30 20 10 0 10 20 30 40 50 60 70 80 90 100 110 120 130 140 150

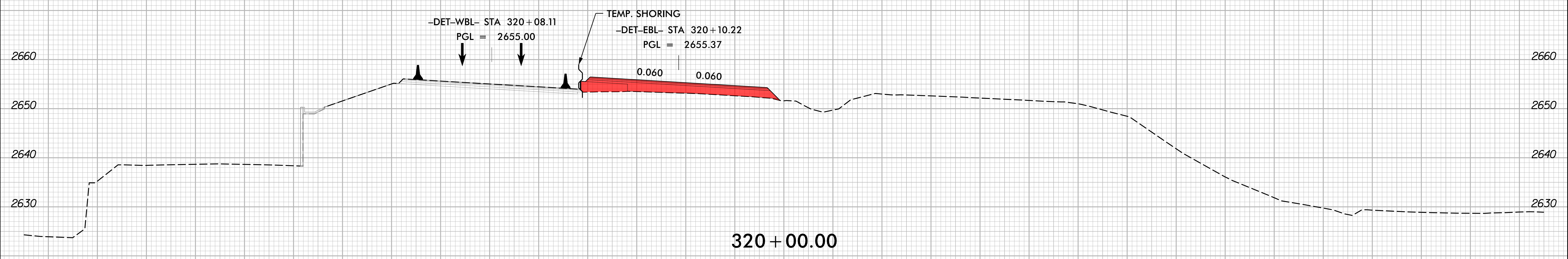
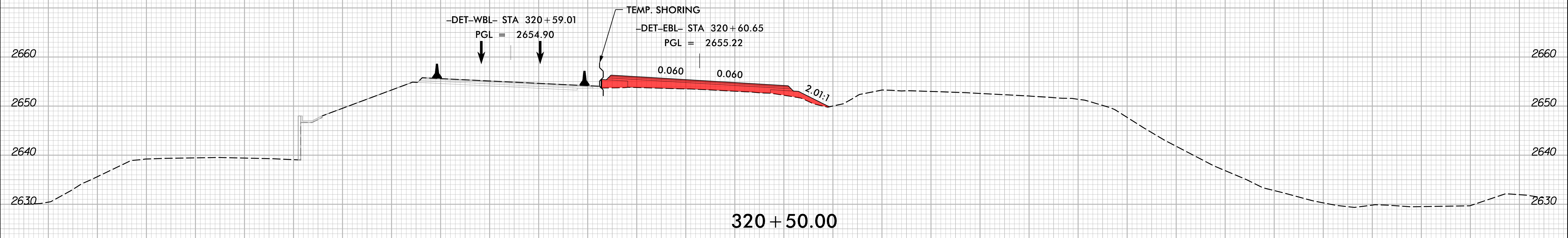
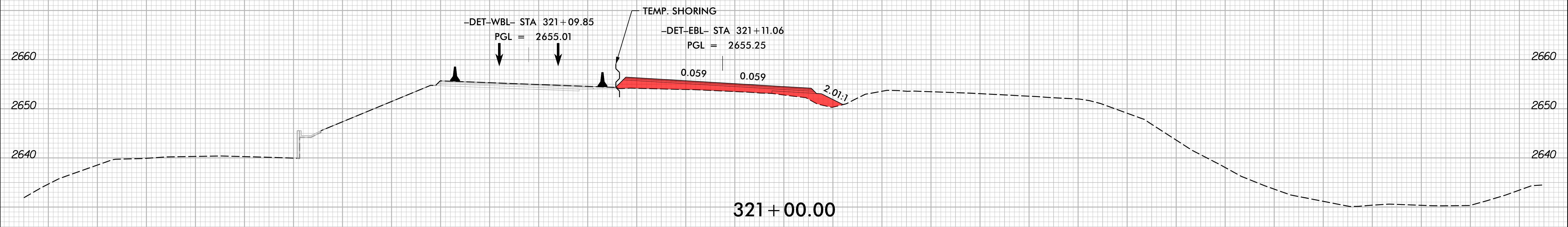

-L- PHASE 2

5/13/2024 1:51:13 PM I:\HB\0002\_rdy\_xpl\_L\_phase-2.dgn

150 140 130 120 110 100 90 80 70 60 50 40 30 20 10 0 10 20 30 40 50 60 70 80 90 100 110 120 130 140 150



8/23/99

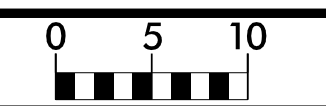

PROJ. REFERENCE NO.	SHEET NO.
HB-0002	X-41

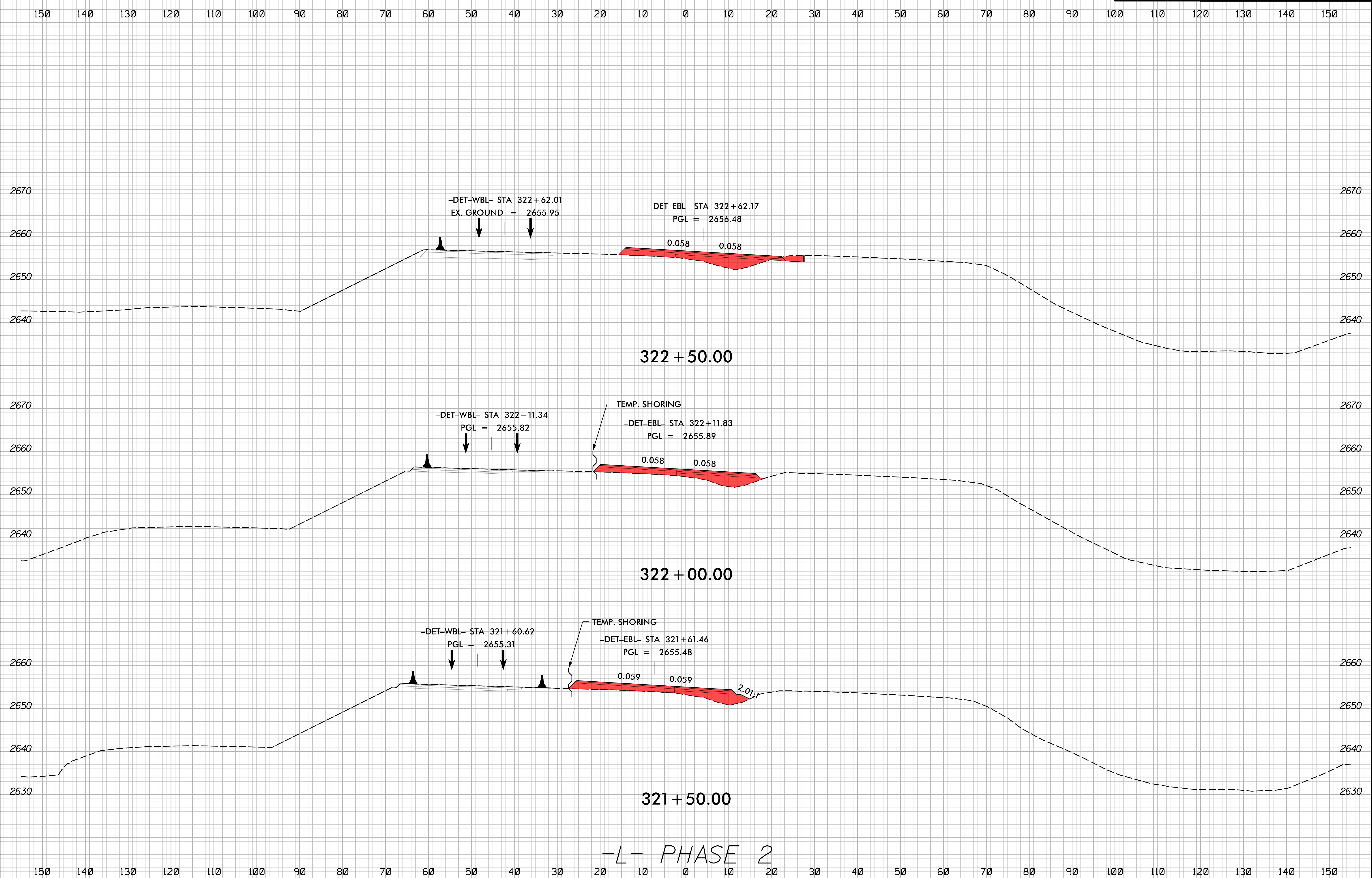

5/13/2024 1:51:13 PM HB0002\_r.dwg xpl.L\_phase-2.dgn



8/23/99

0 5 10	PROJ. REFERENCE NO.	SHEET NO.
	HB-0002	X-42

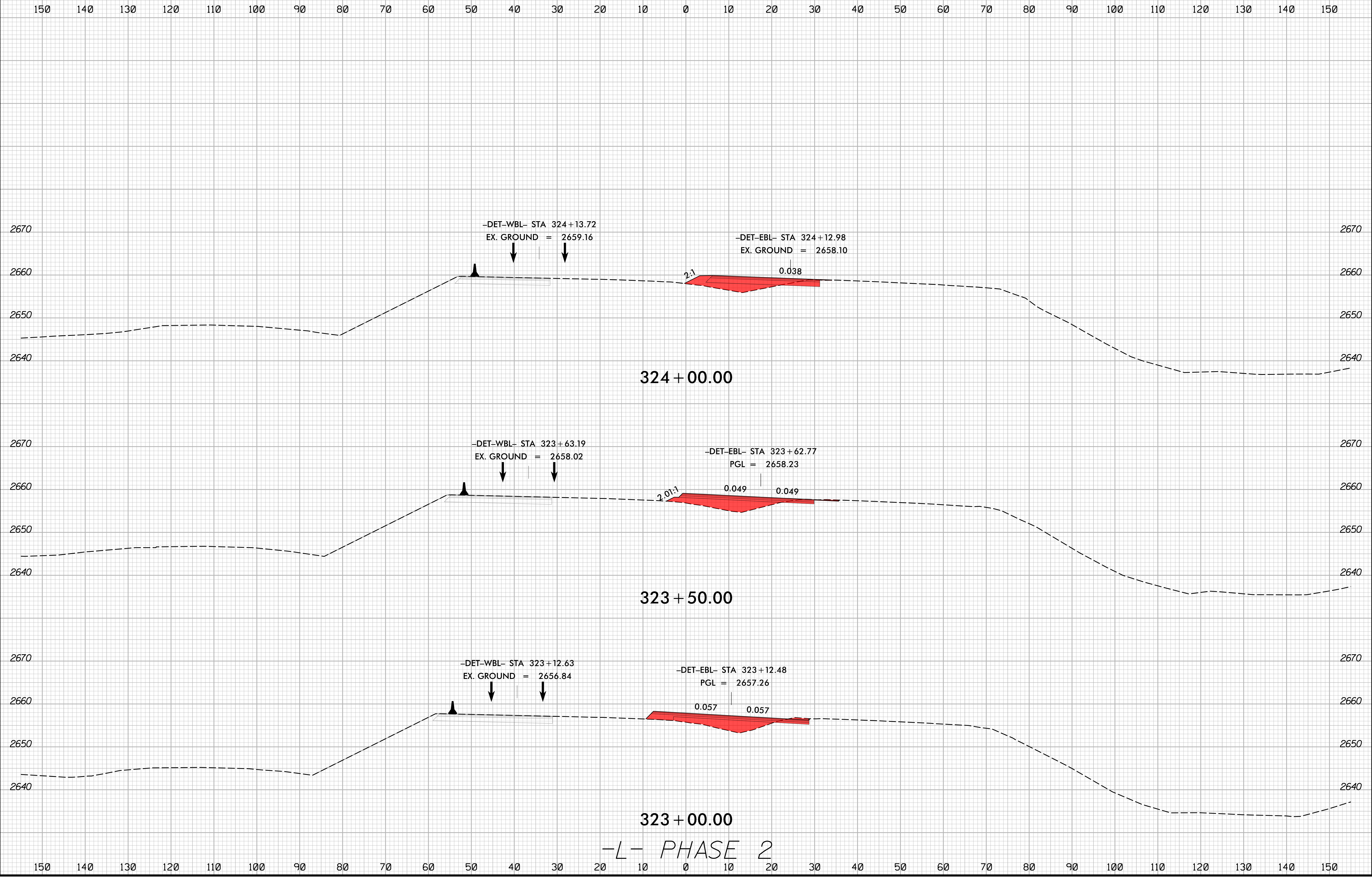

-L- PHASE 2

2/16/2024  
I:\HB\0002\_rdy\_xpl\_L\_phase-2.dgn  
JSE

8/23/99

0 5 10	PROJ. REFERENCE NO.	SHEET NO.
	HB-0002	X-43

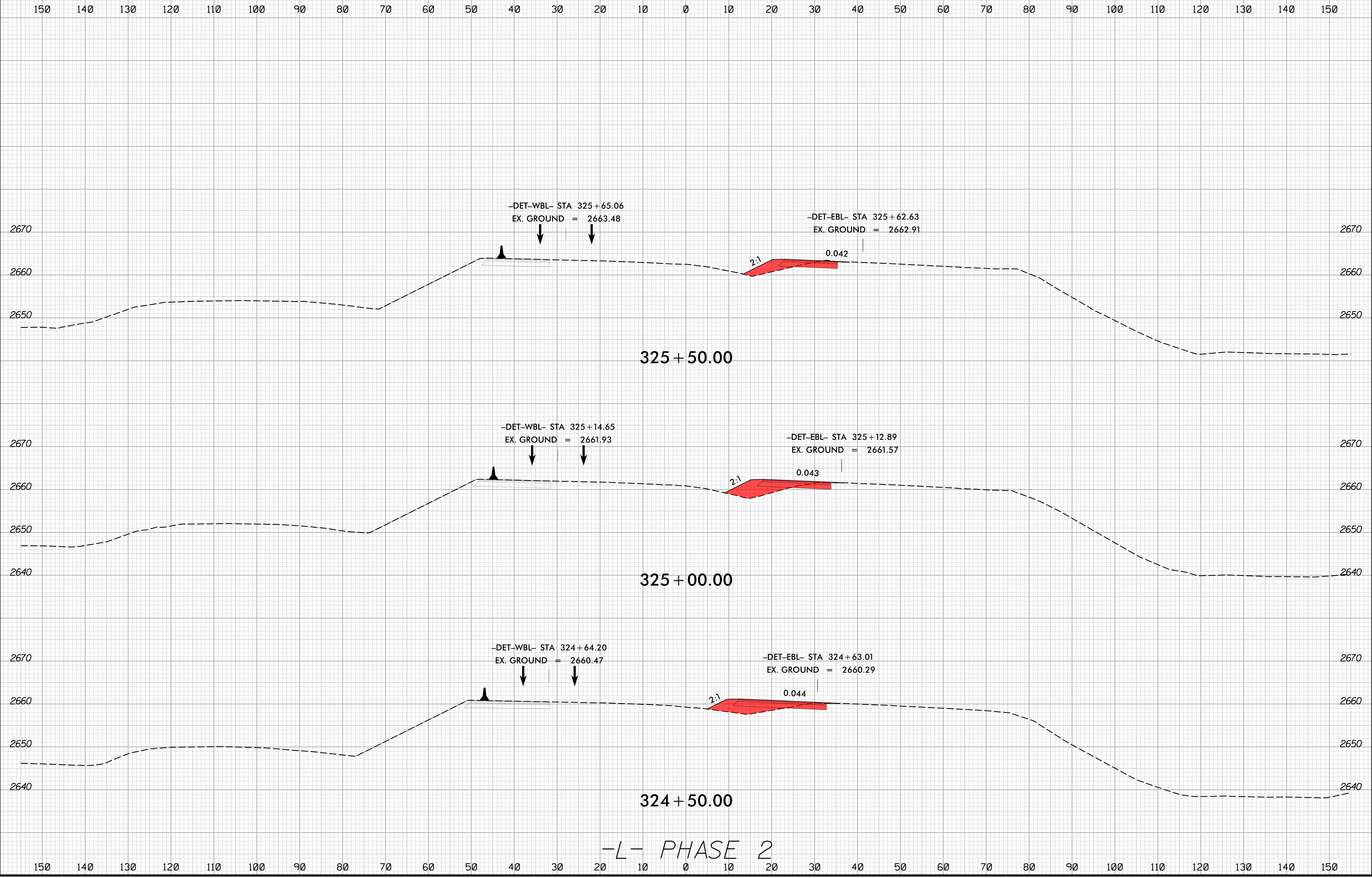

-L- PHASE 2

2/16/2024 1:51:13 PM HB0002\_rdy\_xpl.L\_phase-2.dgn

8/23/99

	PROJ. REFERENCE NO.	SHEET NO.
	HB-0002	X-44

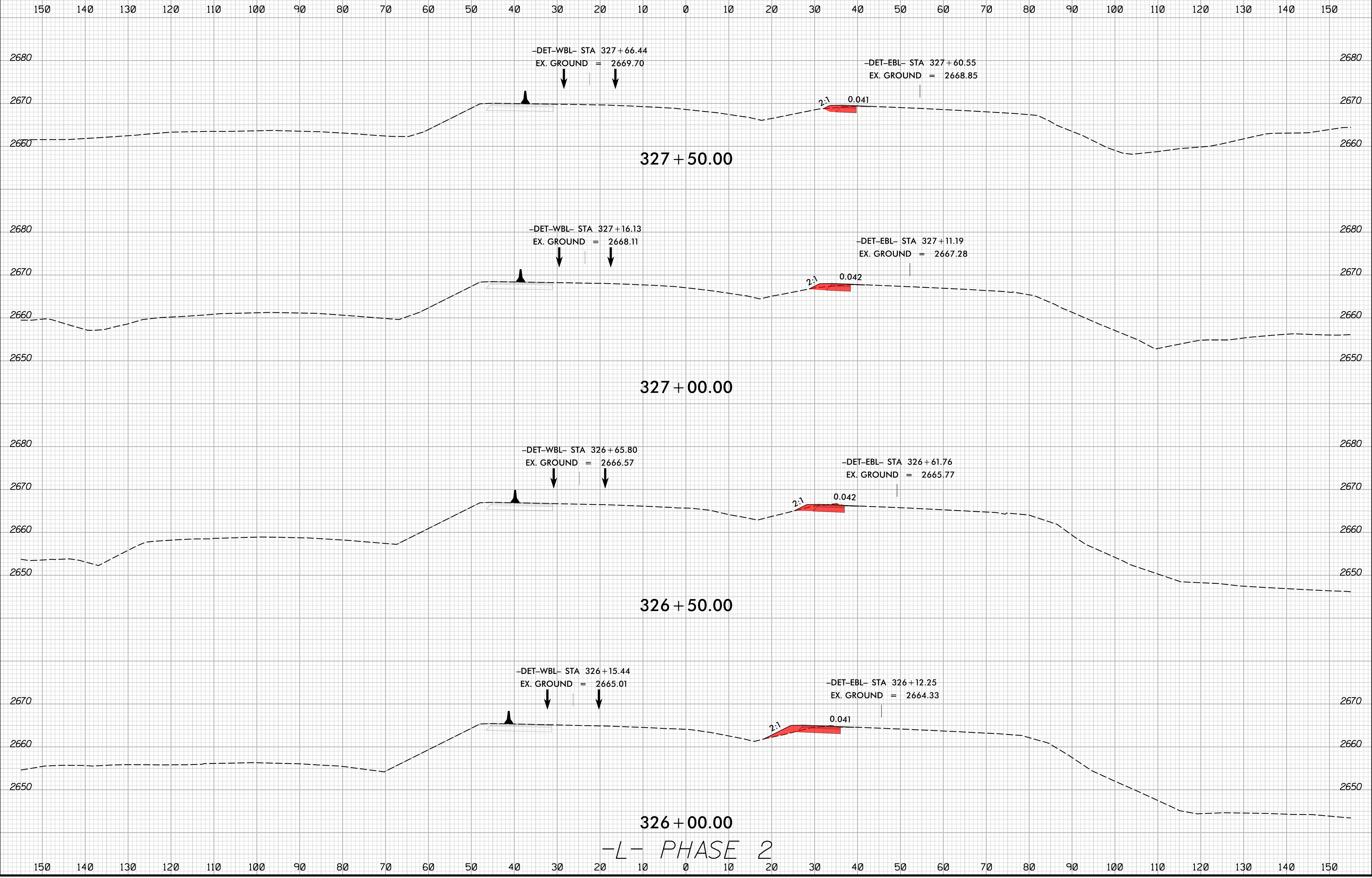

-L- PHASE 2

2/16/2024  
I:\HB\0002\_rdy\_xpl\_L\_phase-2.dgn  
JTB

8/23/99

0 5 10	PROJ. REFERENCE NO. HB-0002	SHEET NO. X-45
--------	--------------------------------	-------------------

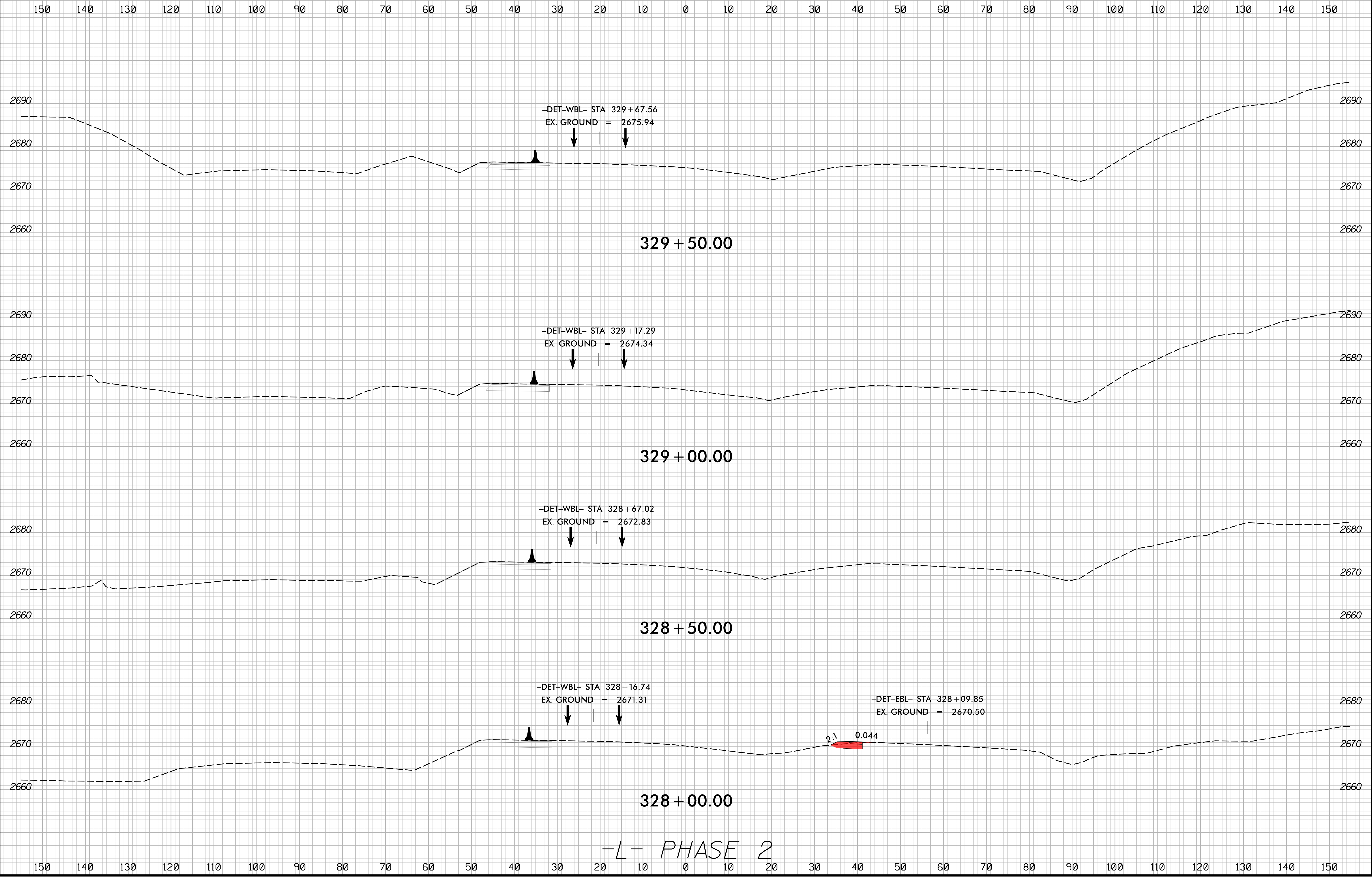

-L- PHASE 2

2/16/2024  
1:51:13 PM  
I:\S\HB\0002\_rdy\_xpl\_L\_phase-2.dgn



8/23/99

	PROJ. REFERENCE NO.	SHEET NO.
	HB-0002	X-46

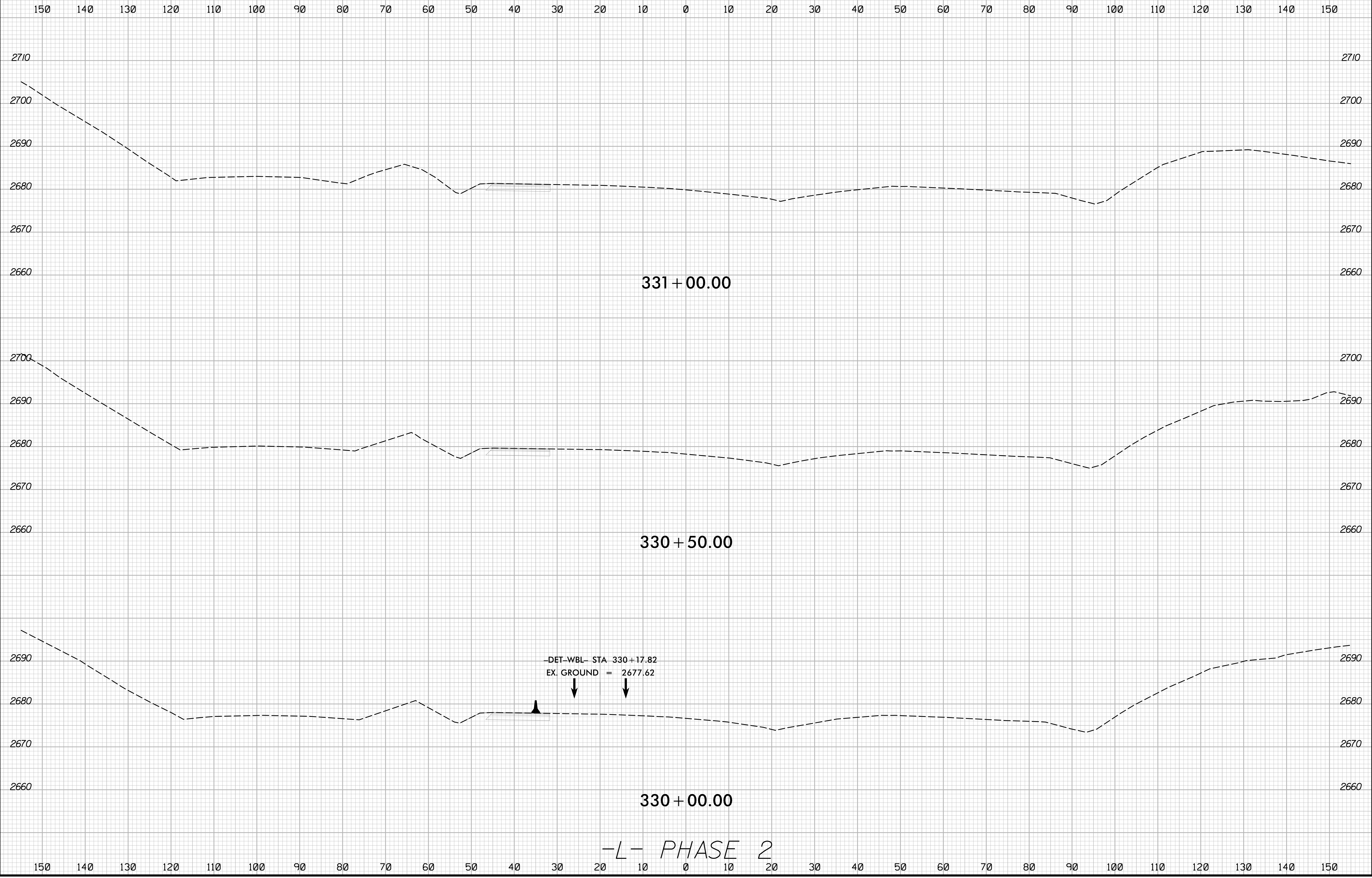

2/16/2024  
I:\HB\0002\_rdy\_xpl\_L\_phase-2.dgn  
JSE

-L- PHASE 2

8/23/99

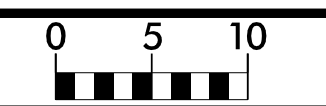

PROJ. REFERENCE NO.	SHEET NO.
HB-0002	X-47

150 140 130 120 110 100 90 80 70 60 50 40 30 20 10 0 10 20 30 40 50 60 70 80 90 100 110 120 130 140 150

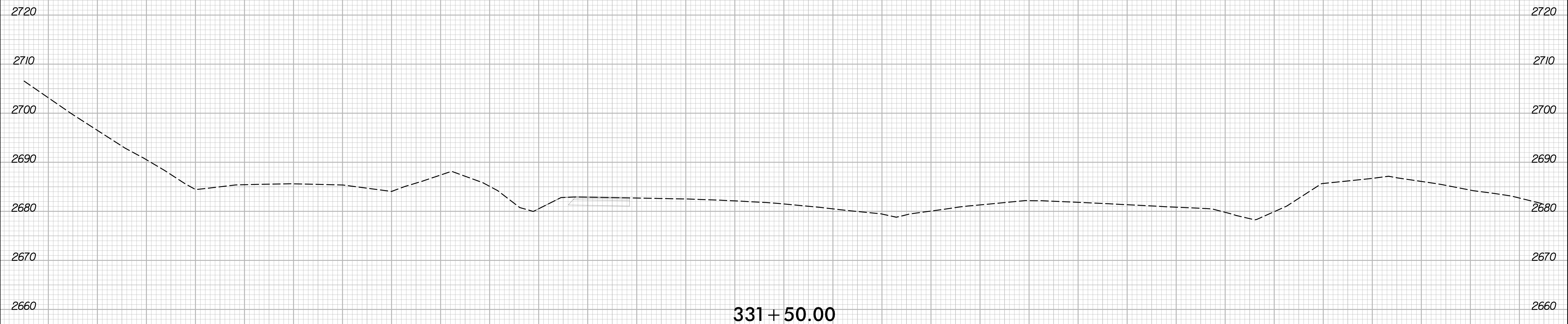

331 + 50.00

-L- PHASE 2

2/16/2024  
I:\HB\0002\_rdy\_xpl\_L\_phase-2.dgn  
JSE/ETG

150 140 130 120 110 100 90 80 70 60 50 40 30 20 10 0 10 20 30 40 50 60 70 80 90 100 110 120 130 140 150

8/23/99

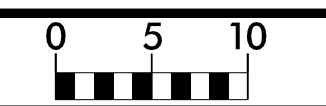

PROJ. REFERENCE NO.	SHEET NO.
HB-0002	X-48

190 180 170 160 150 140 130 120 110 100 90 80 70 60 50 40 30 20 10 0 10 20 30 40 50 60 70 80 90 100 110

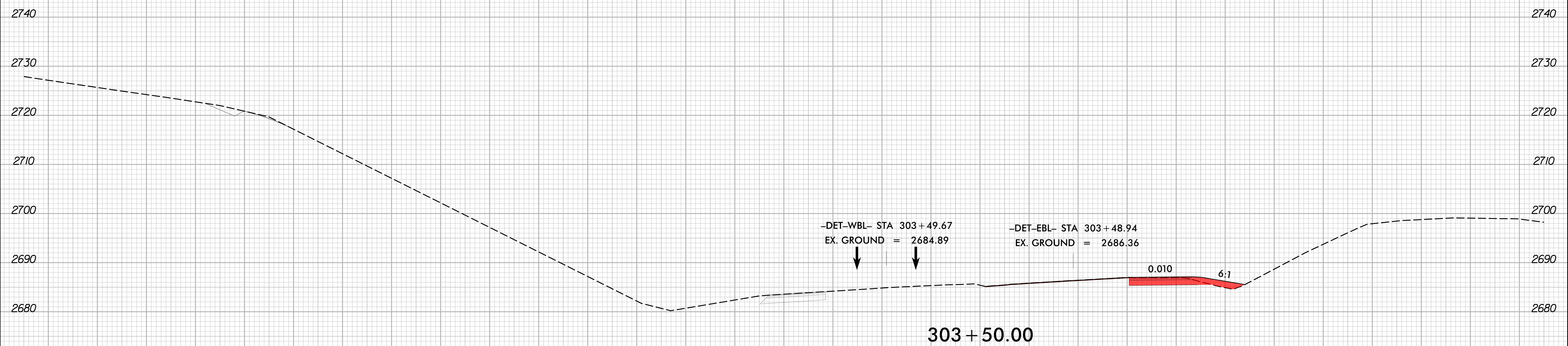

303+50.00

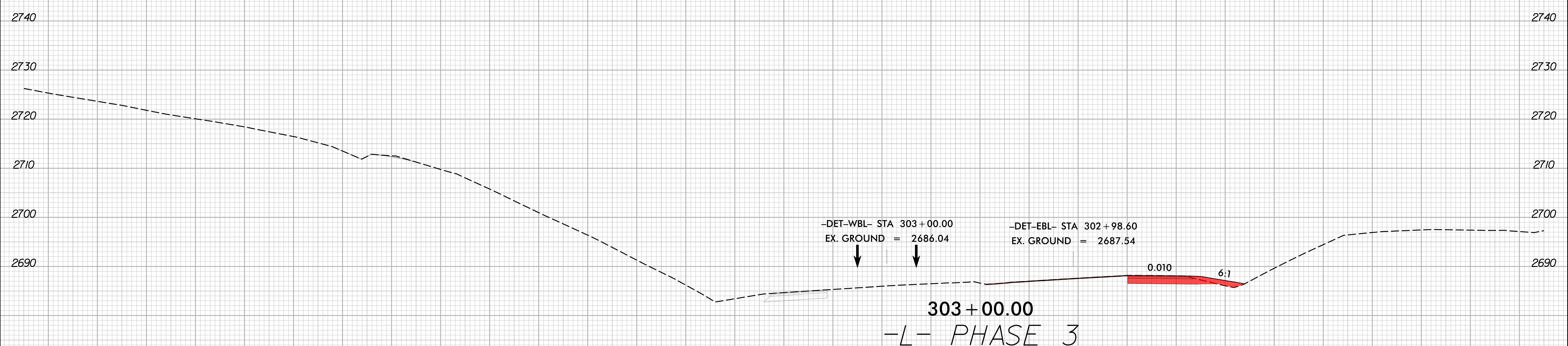

303+00.00

-L- PHASE 3

190 180 170 160 150 140 130 120 110 100 90 80 70 60 50 40 30 20 10 0 10 20 30 40 50 60 70 80 90 100 110

2/16/2024  
I:\HB\0002\_rdy\_xpl\_L\_phase-3.dgn  
JSE

8/23/99

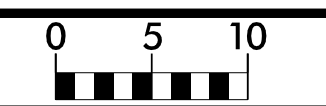

PROJ. REFERENCE NO.	SHEET NO.
HB-0002	X-49

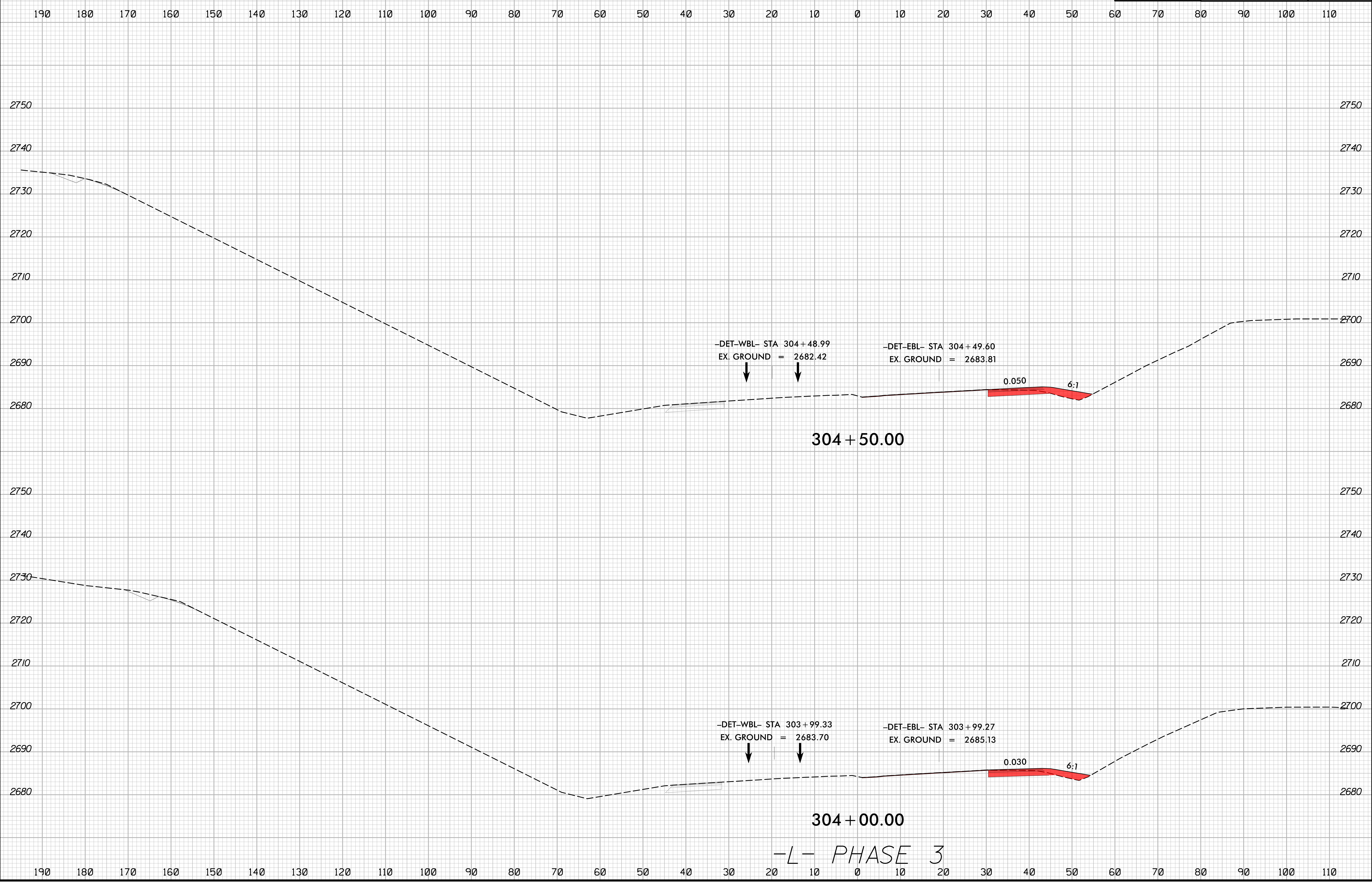

2/16/2024  
I:\HB0002\_rdy\_xpl\_L\_phase-3.dgn  
JSE/16/2024

8/23/99

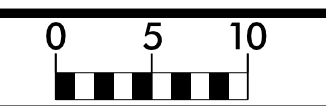

PROJ. REFERENCE NO.	SHEET NO.
HB-0002	X-50

190 180 170 160 150 140 130 120 110 100 90 80 70 60 50 40 30 20 10 0 10 20 30 40 50 60 70 80 90 100 110

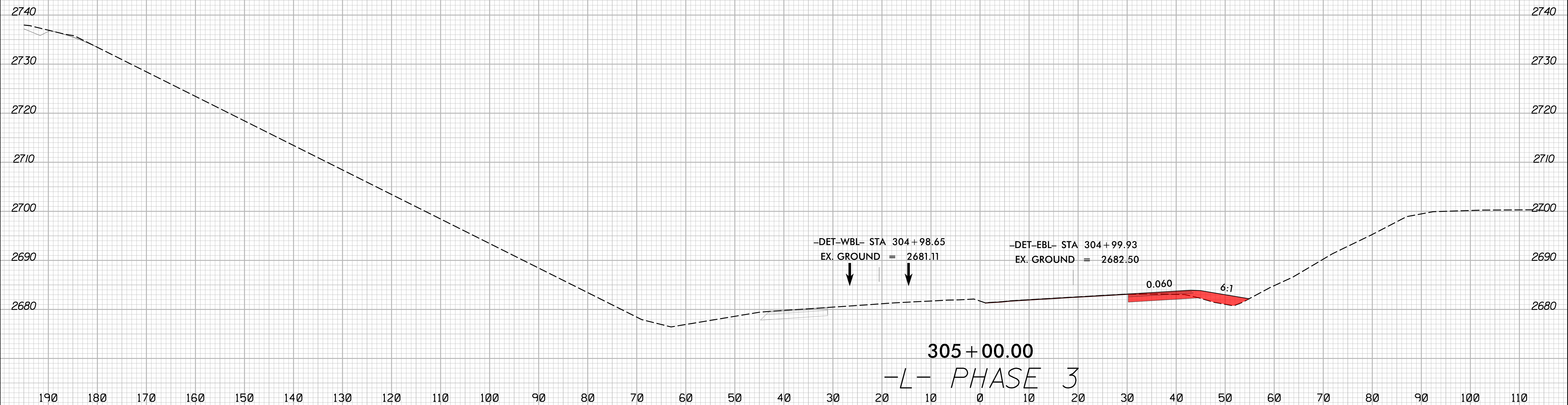
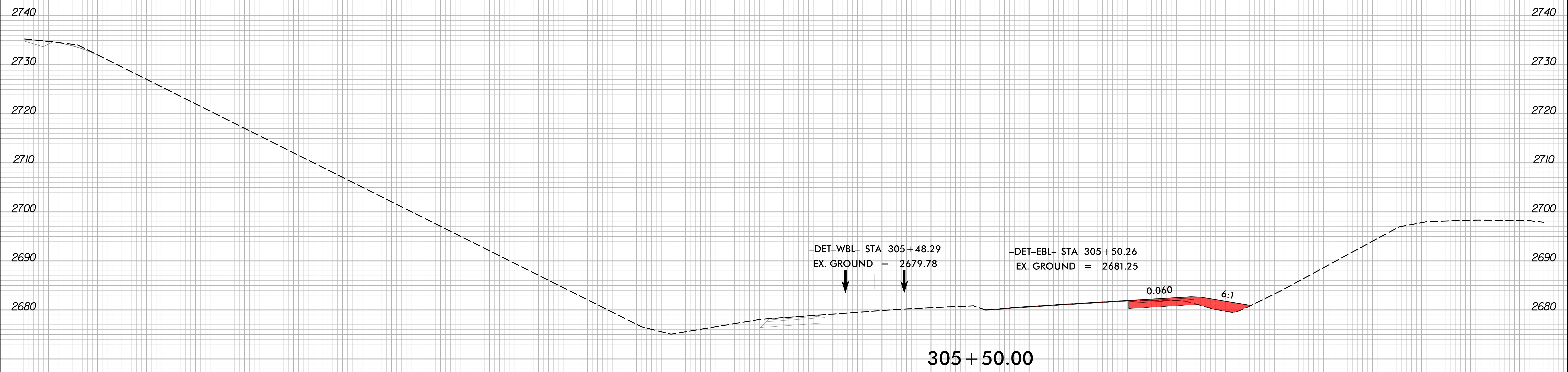

2/16/2024  
1:51:13  
I:\HB\0002\_rdy\_xpl\_L\_phase-3.dgn



8/23/99

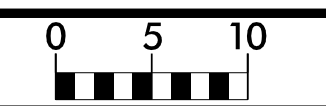

PROJ. REFERENCE NO.	SHEET NO.
HB-0002	X-51

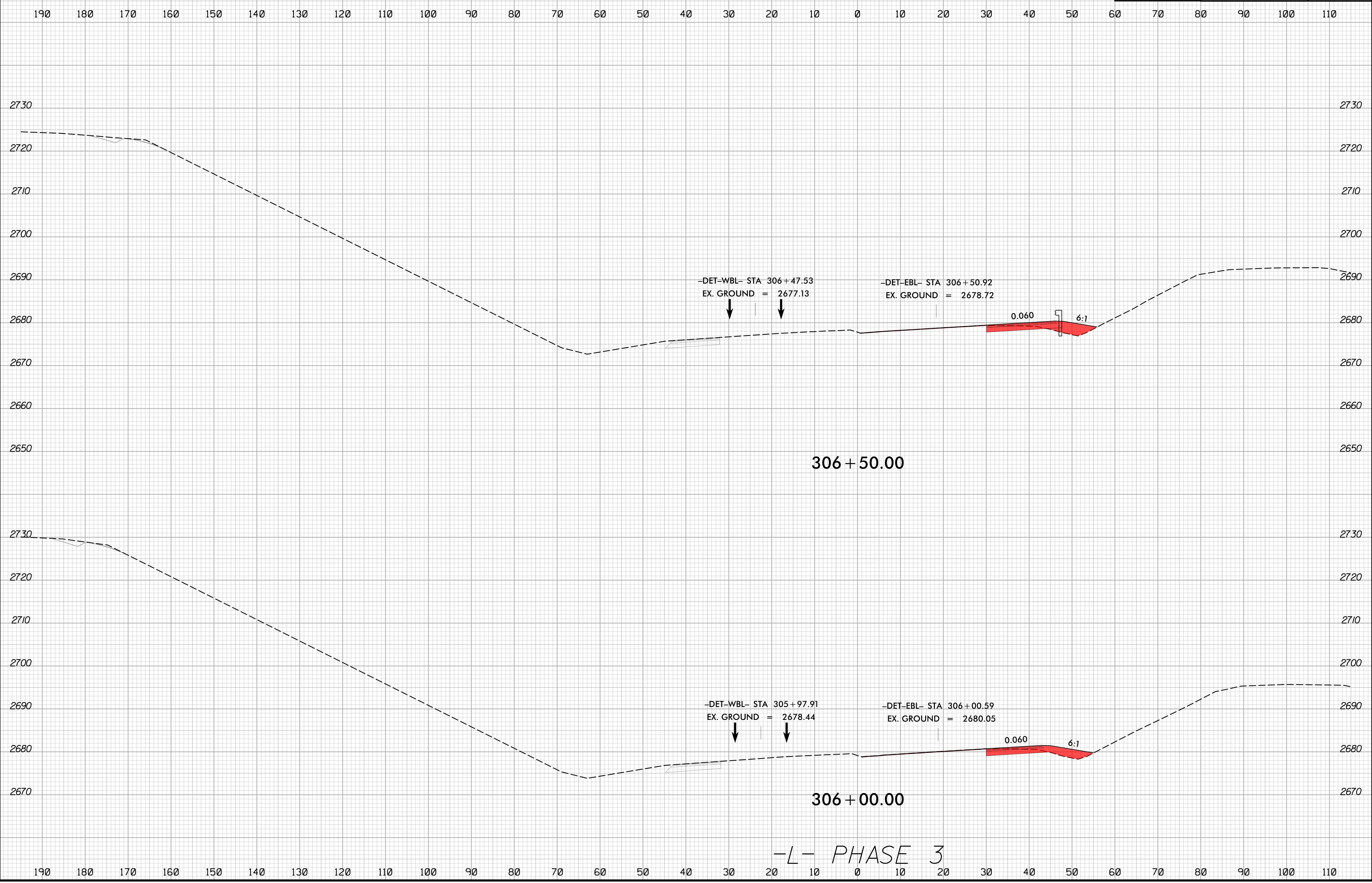

2/16/2024  
1:51:13 PM  
I:\Projects\2024\115\115-115-002-rdy\_xpl\_L\_phase-3.dgn

8/23/99

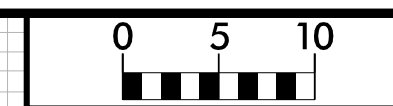

PROJ. REFERENCE NO.	SHEET NO.
HB-0002	X-52

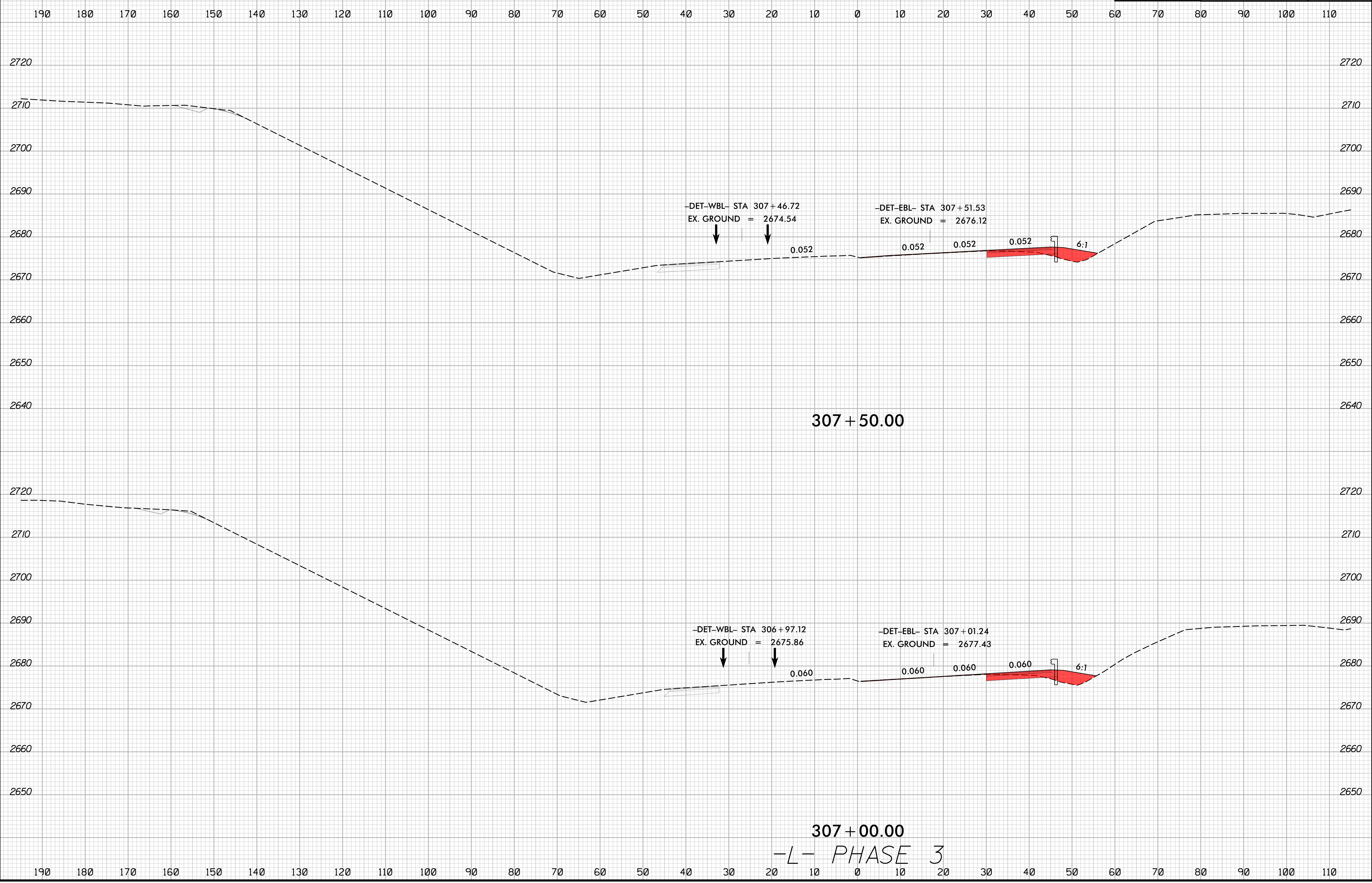

2/16/2024  
1:51:13 PM  
I:\S:\HB\0002\_rdy\_xpl\_L\_phase-3.dgn

8/23/99

	PROJ. REFERENCE NO.	SHEET NO.
	HB-0002	X-53

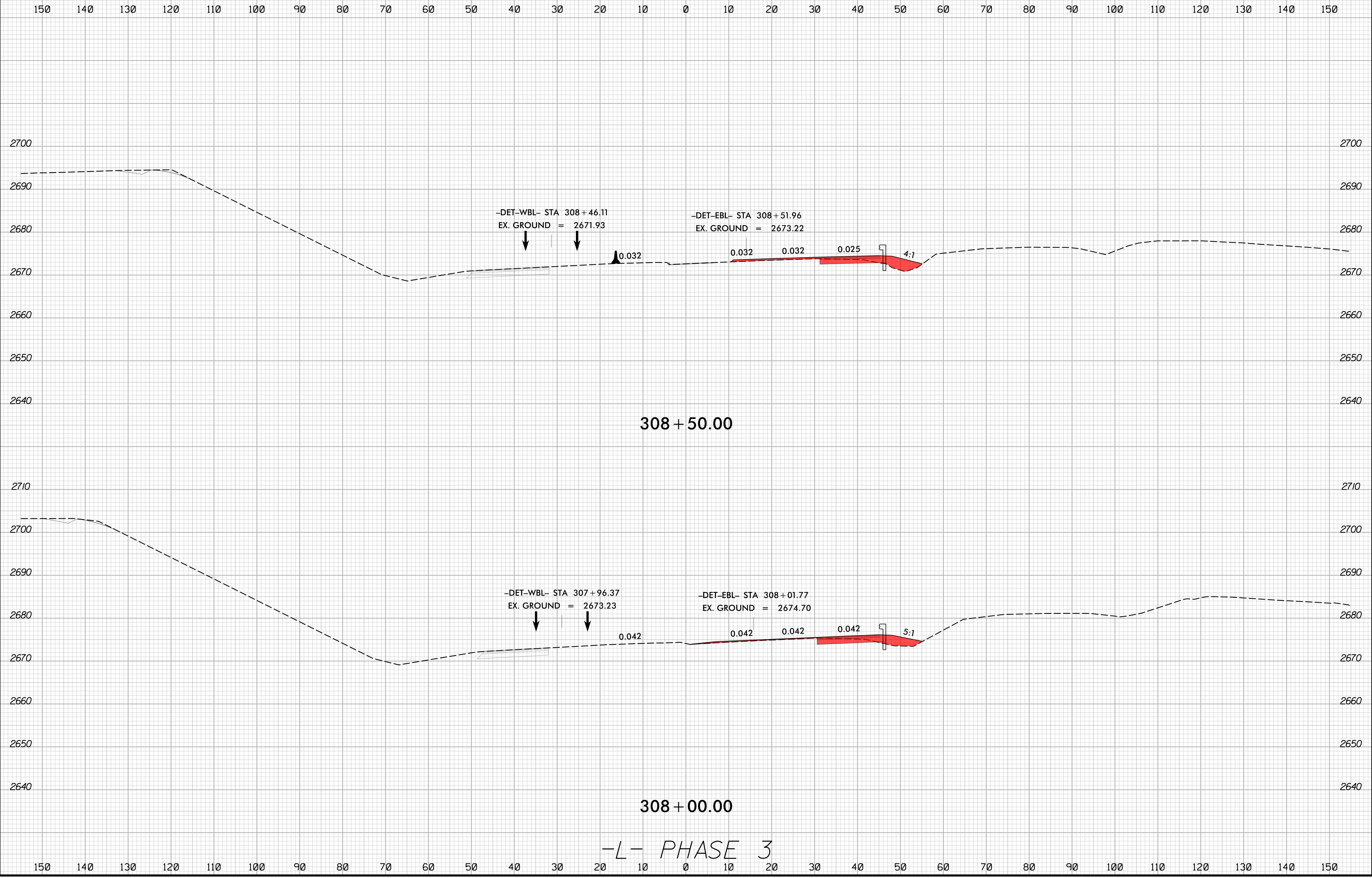

2/16/2024  
1:51:13 PM  
I:\S\1303\1303-002-rdy\_xpl.L\_phase-3.dgn

8/23/99

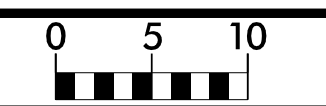

PROJ. REFERENCE NO.	SHEET NO.
HB-0002	X-54

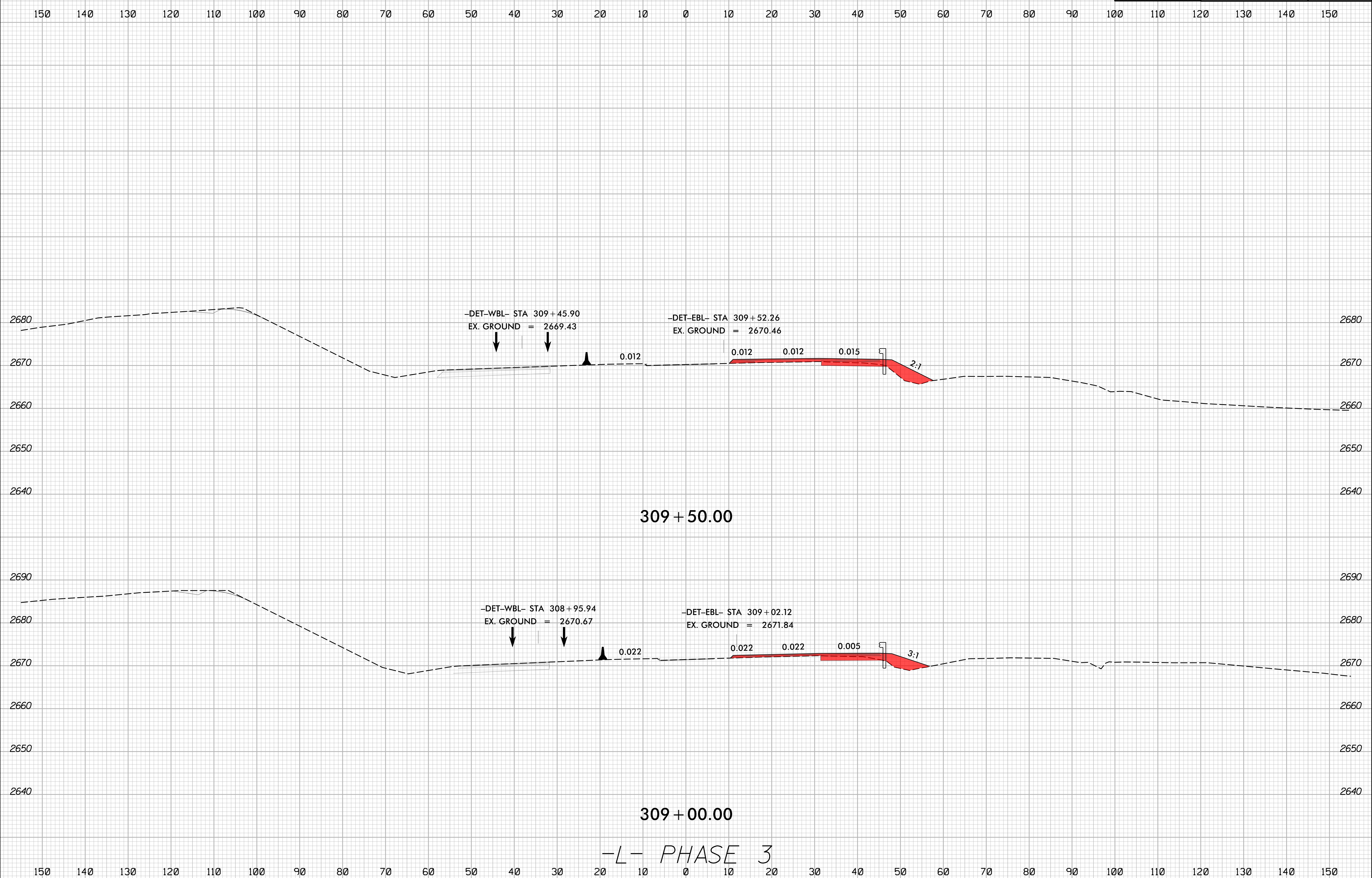

2/16/2024  
I:\HB\0002\_rdy\_xpl\_L\_phase-3.dgn  
J:\ERIC\ref



8/23/99

	PROJ. REFERENCE NO.	SHEET NO.
	HB-0002	X-55

150 140 130 120 110 100 90 80 70 60 50 40 30 20 10 0 10 20 30 40 50 60 70 80 90 100 110 120 130 140 150

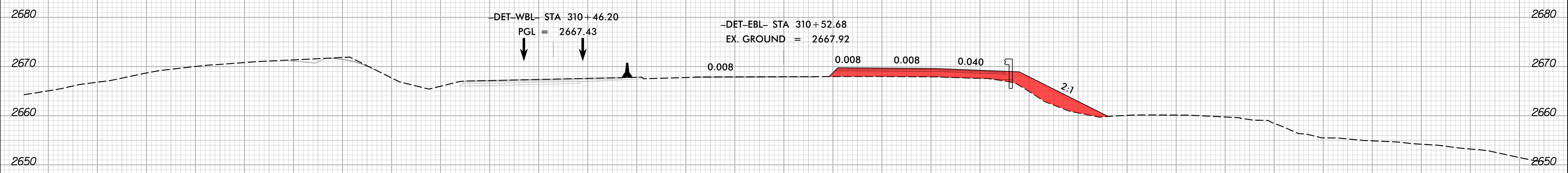

310 + 50.00

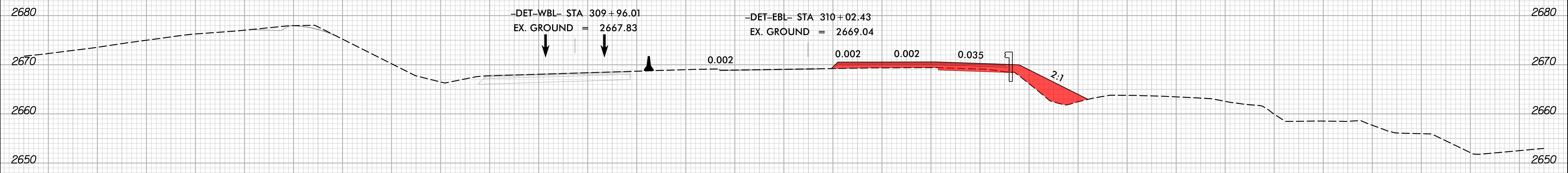

310 + 00.00

-L- PHASE 3

150 140 130 120 110 100 90 80 70 60 50 40 30 20 10 0 10 20 30 40 50 60 70 80 90 100 110 120 130 140 150

2/16/2024  
1:51:13 PM  
I:\Projects\HB0002\_rdy\_xpl\_L\_phase-3.dgn

8/23/99

	PROJ. REFERENCE NO.	SHEET NO.
	HB-0002	X-56

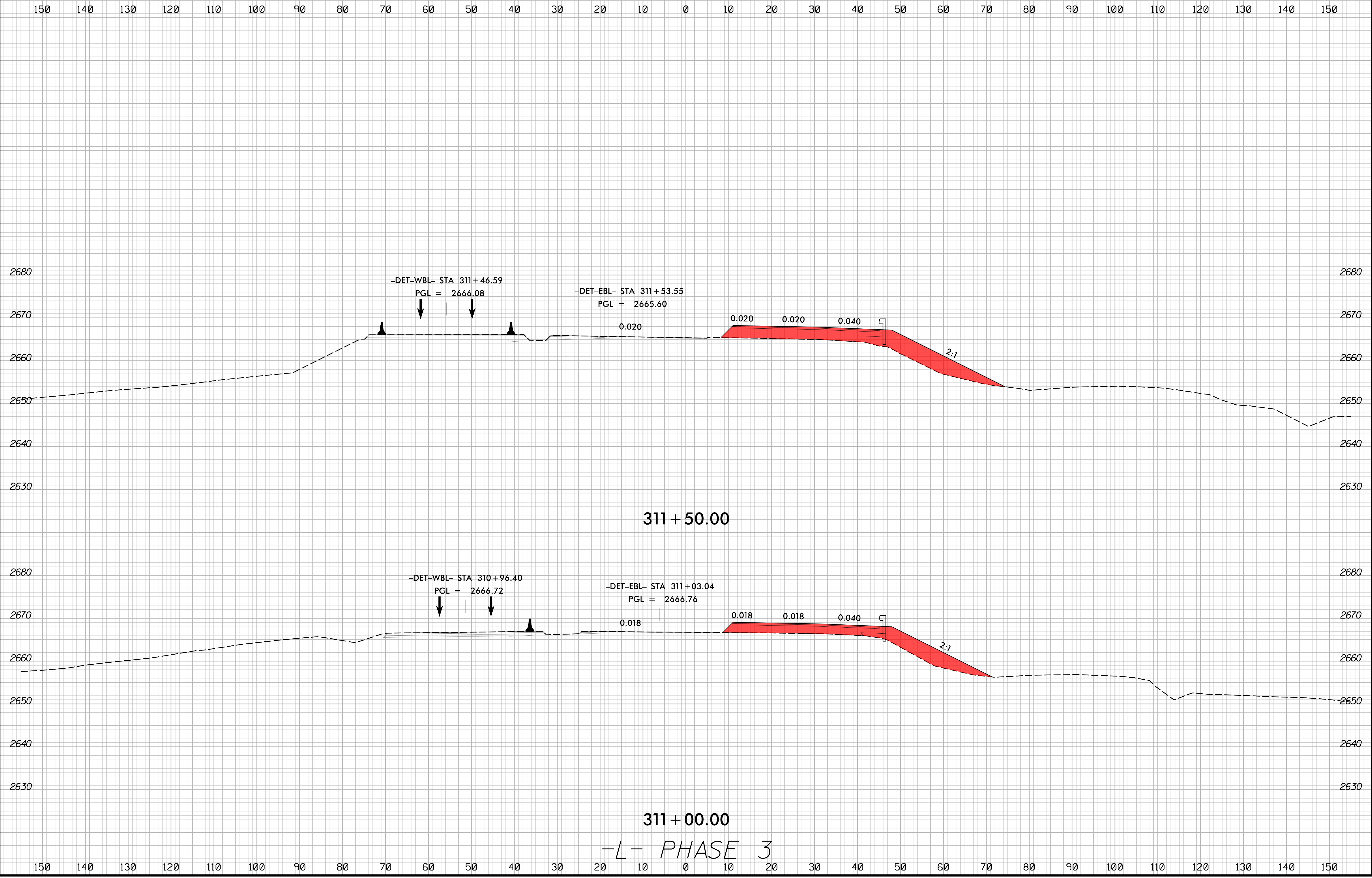

2/16/2024  
1:51:13 PM  
I:\Projects\HB0002\_rdy\_xpl\_L\_phase-3.dgn

8/23/99

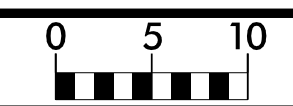

PROJ. REFERENCE NO.	SHEET NO.
HB-0002	X-57

150 140 130 120 110 100 90 80 70 60 50 40 30 20 10 0 10 20 30 40 50 60 70 80 90 100 110 120 130 140 150

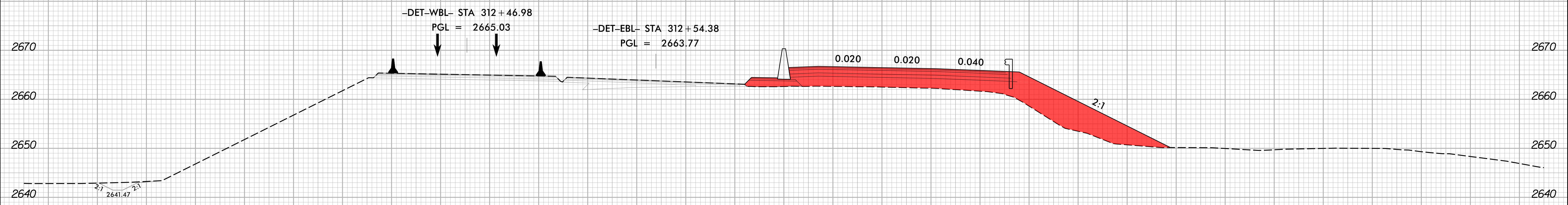

312 + 50.00

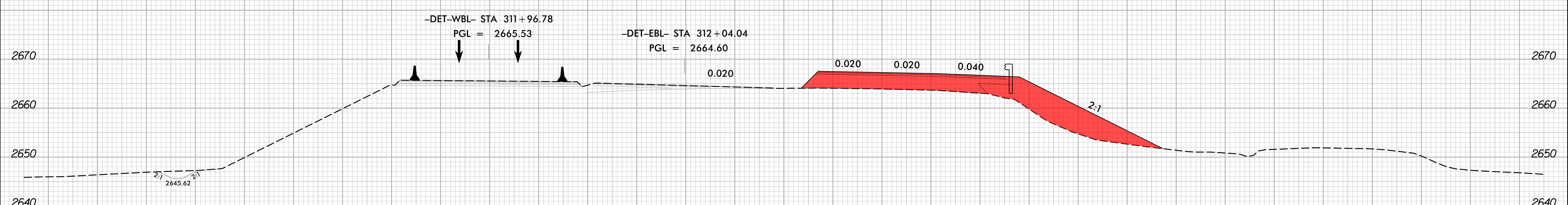

312 + 00.00

-L- PHASE 3

150 140 130 120 110 100 90 80 70 60 50 40 30 20 10 0 10 20 30 40 50 60 70 80 90 100 110 120 130 140 150

2/16/2024 1:51:13 PM I:\HB\0002\_rdy\_xpl\_L\_phase-3.dgn

8/23/99

0 5 10	PROJ. REFERENCE NO.	SHEET NO.
	HB-0002	X-58

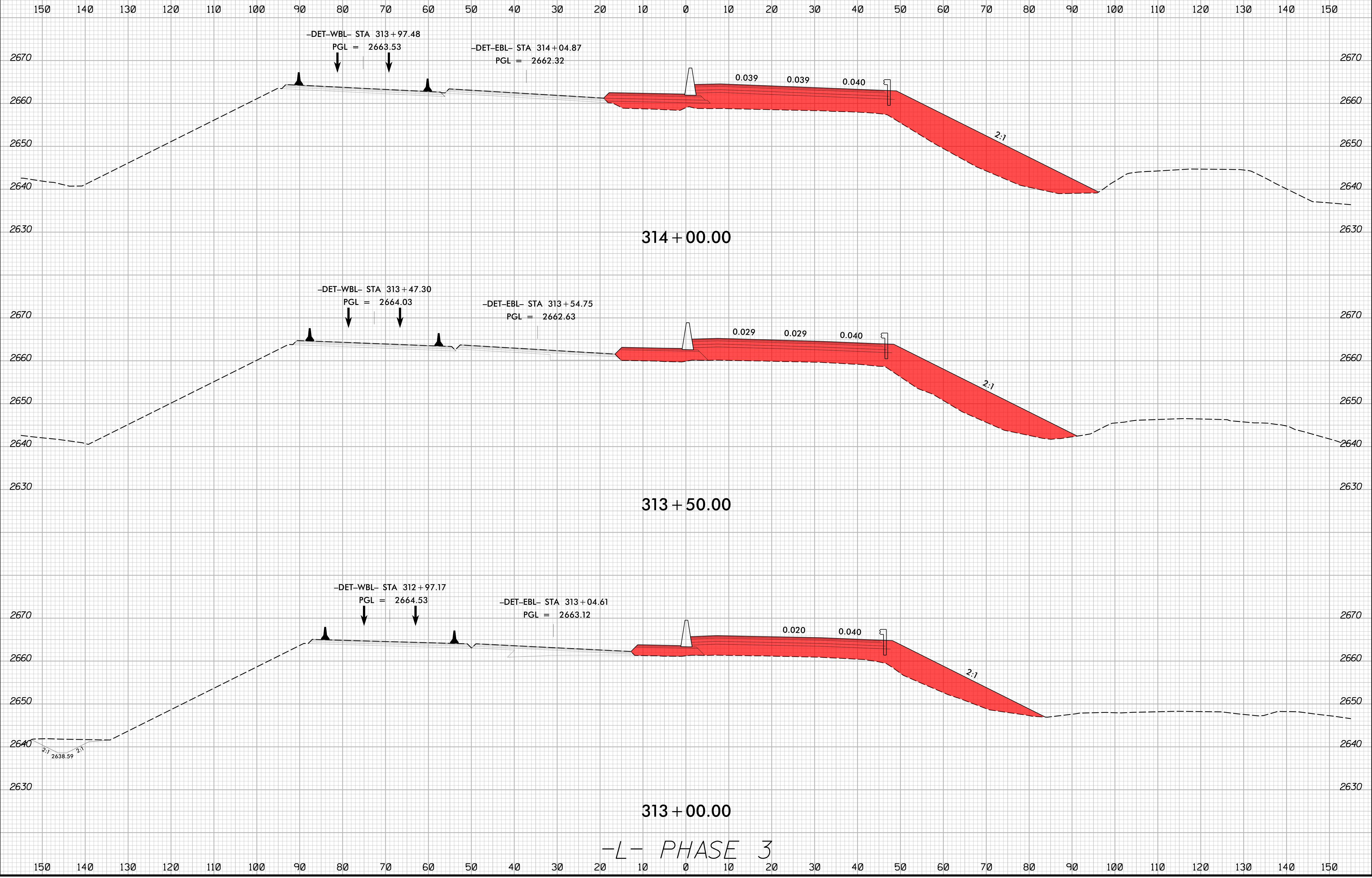

-L- PHASE 3

2/16/2024 1:51:13 PM I:\Projects\HB0002\_rdy\_xpl\_L\_phase-3.dgn



8/23/99

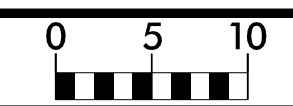

PROJ. REFERENCE NO.	SHEET NO.
HB-0002	X-59

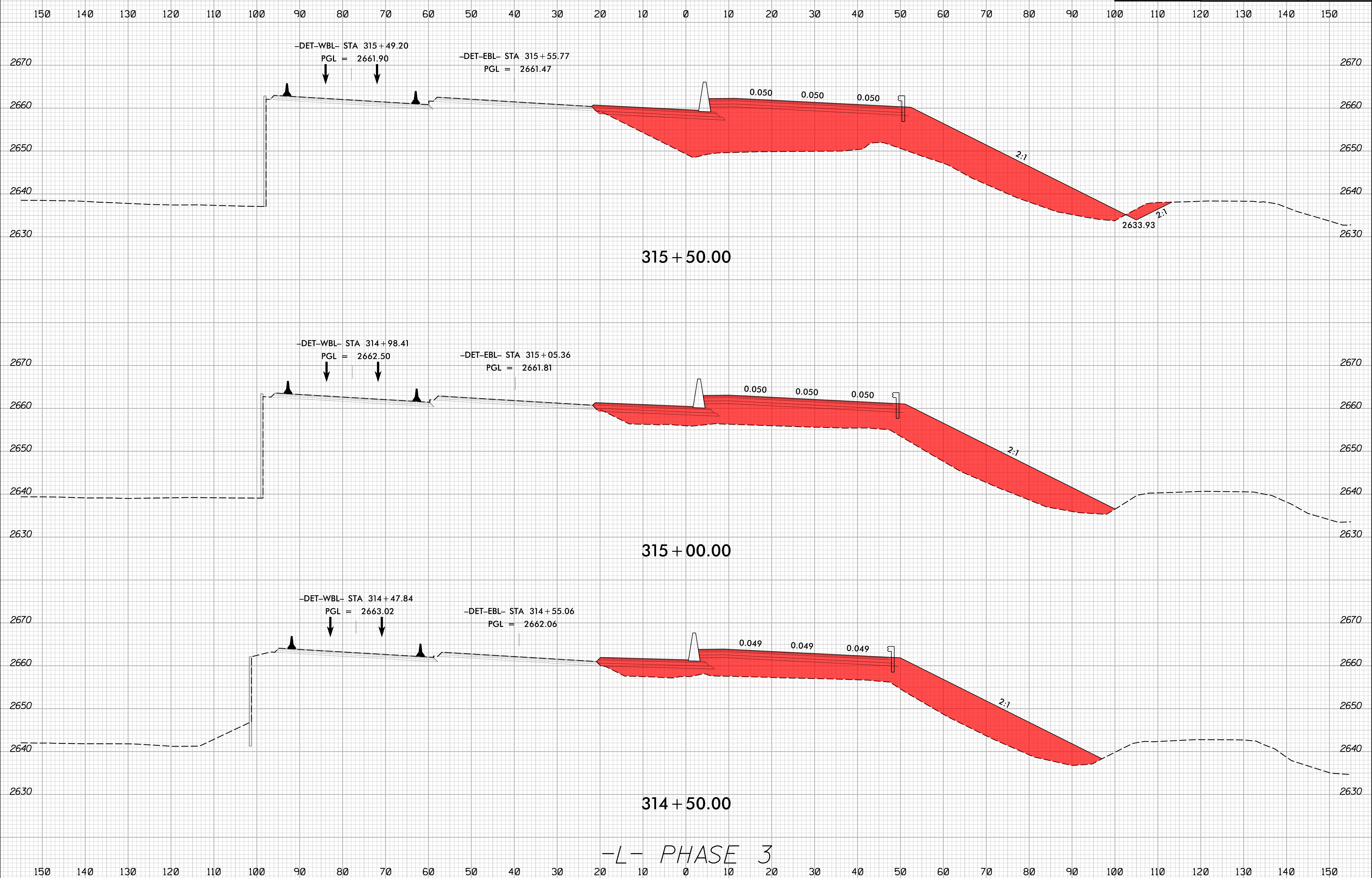

2/16/2024  
1:51:13 PM  
I:\HB\0002\_rdy\_xpl\_L\_phase-3.dgn

8/23/99

	PROJ. REFERENCE NO.	SHEET NO.
	HB-0002	X-60

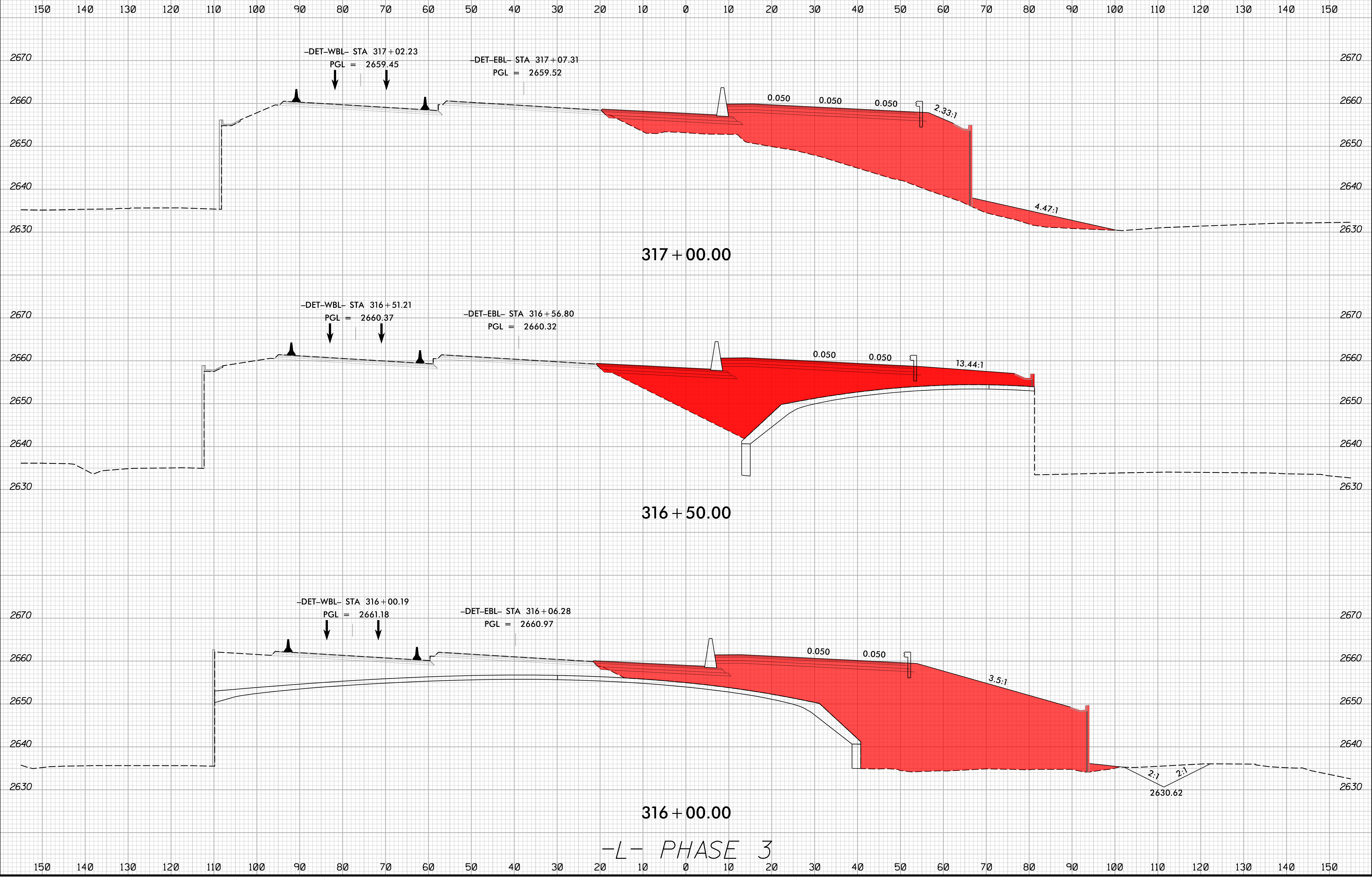

-L- PHASE 3

2/16/2024  
I:\HB\0002\_rdy\_xpl\_L\_phase-3.dgn  
JSE:rlf

8/23/99

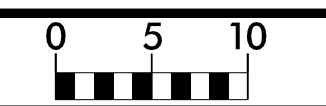

PROJ. REFERENCE NO.	SHEET NO.
HB-0002	X-61

150 140 130 120 110 100 90 80 70 60 50 40 30 20 10 0 10 20 30 40 50 60 70 80 90 100 110 120 130 140 150

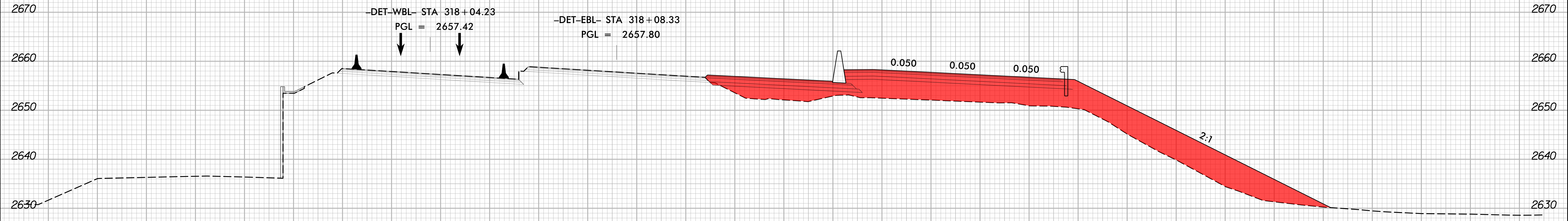

318 + 00.00

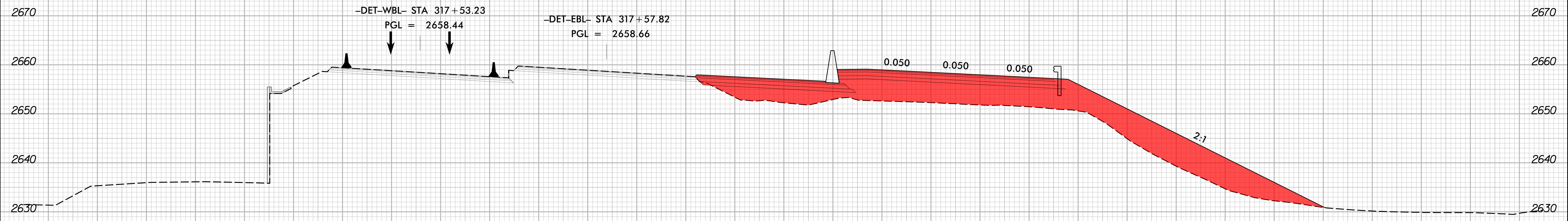

317 + 50.00

-L- PHASE 3

150 140 130 120 110 100 90 80 70 60 50 40 30 20 10 0 10 20 30 40 50 60 70 80 90 100 110 120 130 140 150

2/16/2024 1:51:13 PM I:\HB\0002\_rdy\_xpl\_L\_phase-3.dgn



8/23/99

0 5 10	PROJ. REFERENCE NO. HB-0002	SHEET NO. X-62
--------	--------------------------------	-------------------

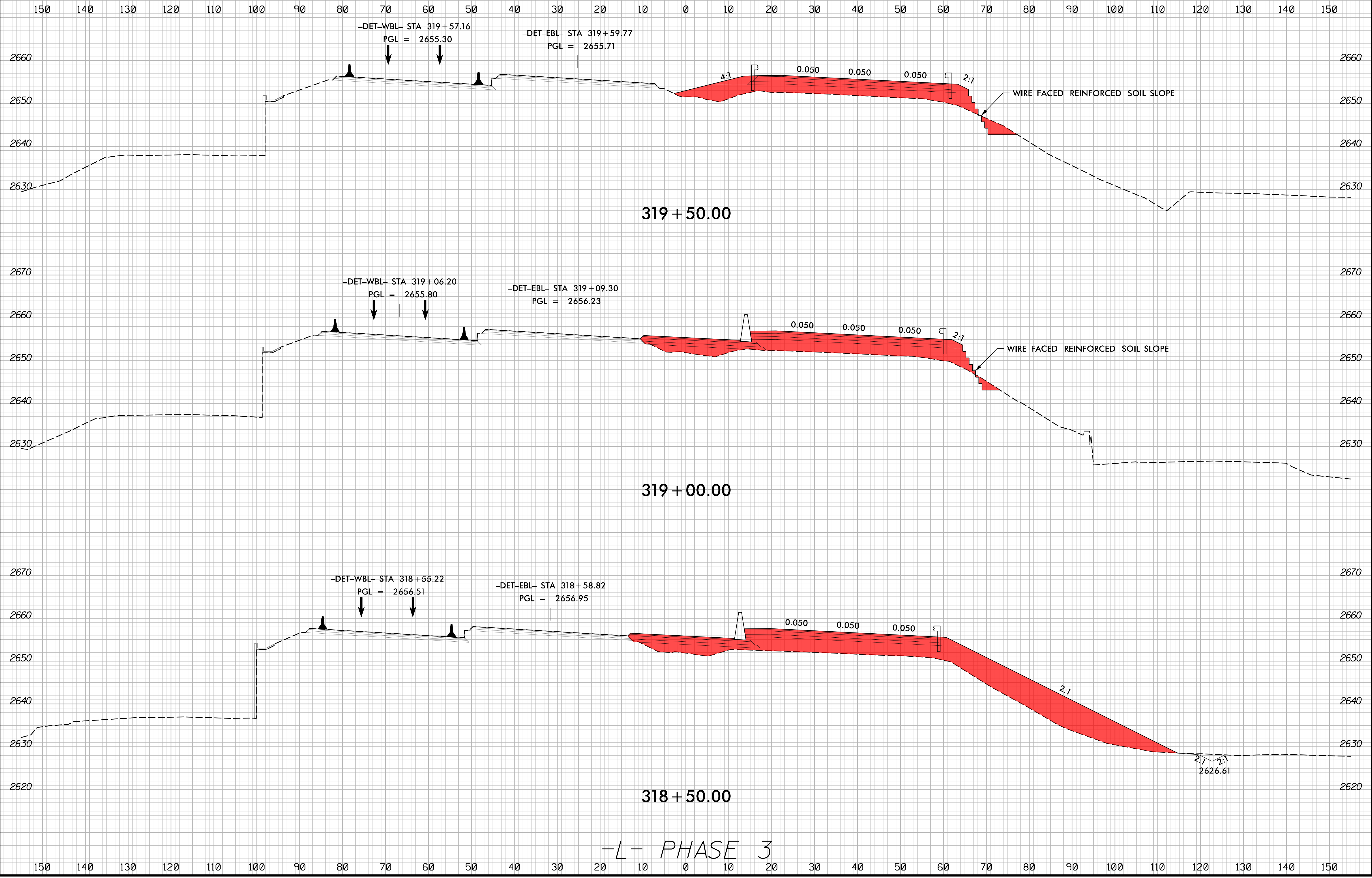

-L- PHASE 3

2/16/2024  
I:\HB0002\_rdy\_xpl\_L\_phase-3.dgn  
JSE/rlr



8/23/99

0 5 10	PROJ. REFERENCE NO.	SHEET NO.
	HB-0002	X-63

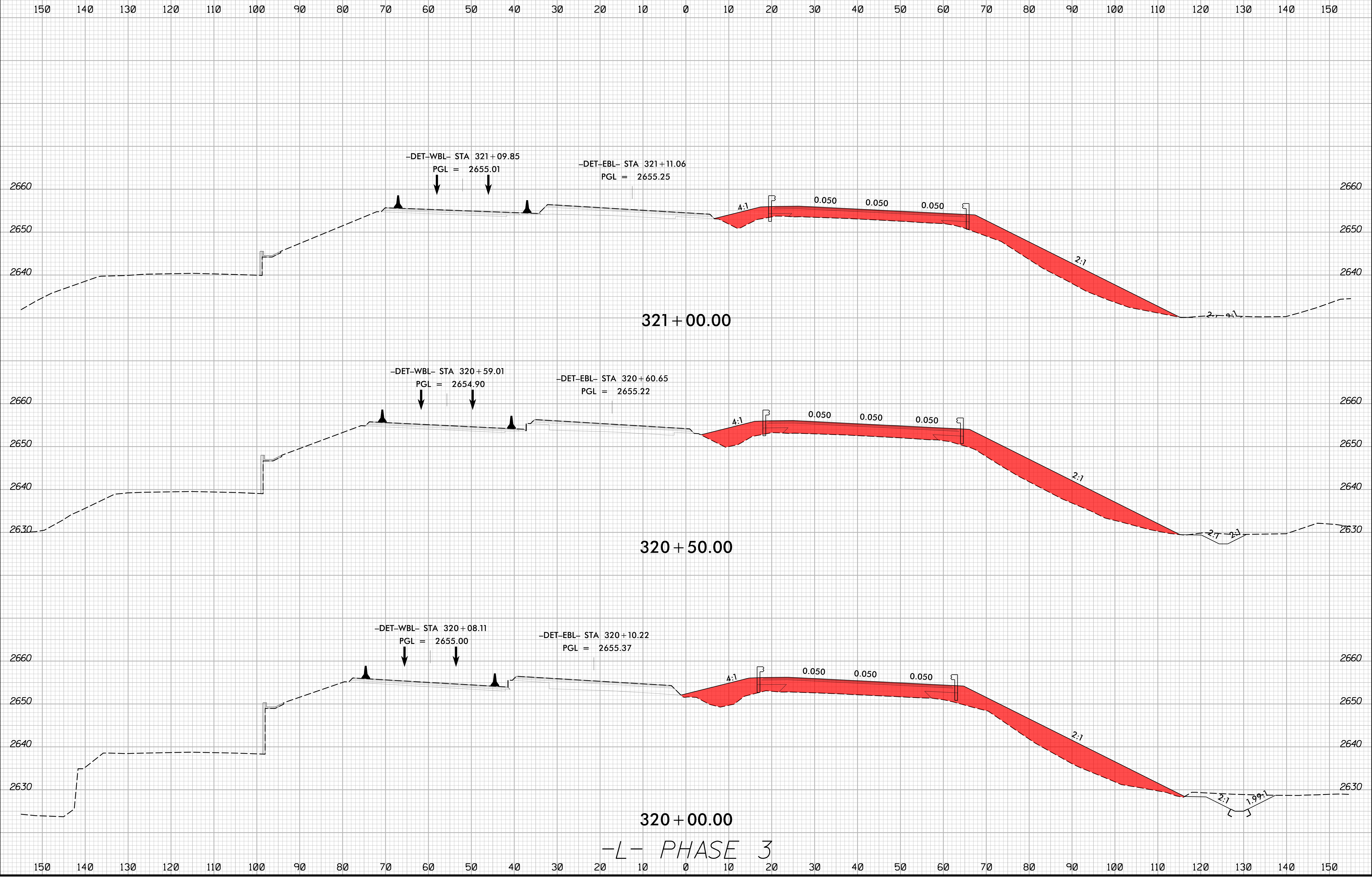

2/16/2024  
I:\HB0002\_rdy\_xpl\_L\_phase-3.dgn  
JSE:rlr

8/23/99

	PROJ. REFERENCE NO.	SHEET NO.
	HB-0002	X-64

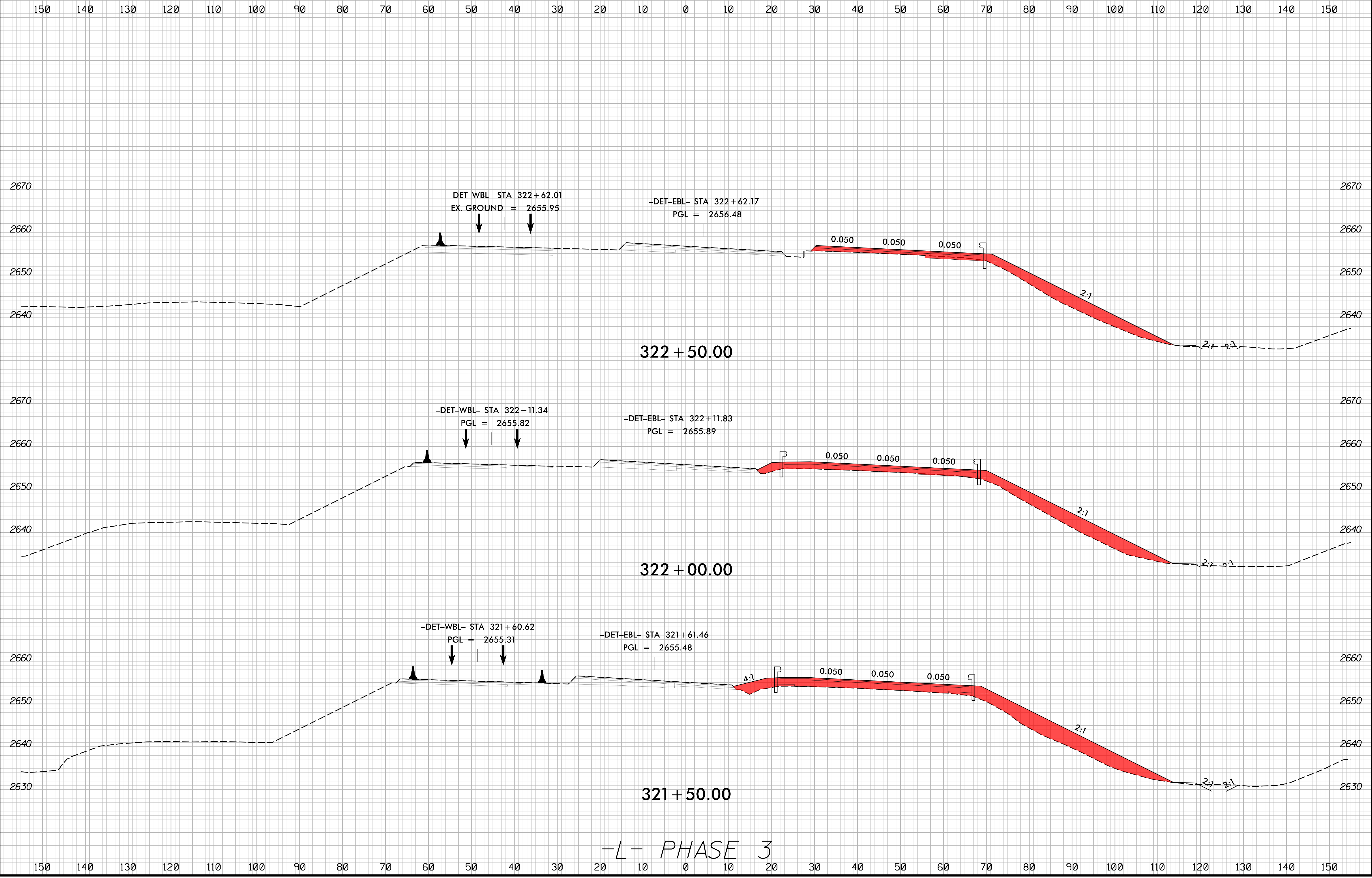

-L- PHASE 3

2/16/2024  
I:\HB\0002\_rdy\_xpl\_L\_phase-3.dgn  
JSE

8/23/99

0 5 10	PROJ. REFERENCE NO.	SHEET NO.
	HB-0002	X-65

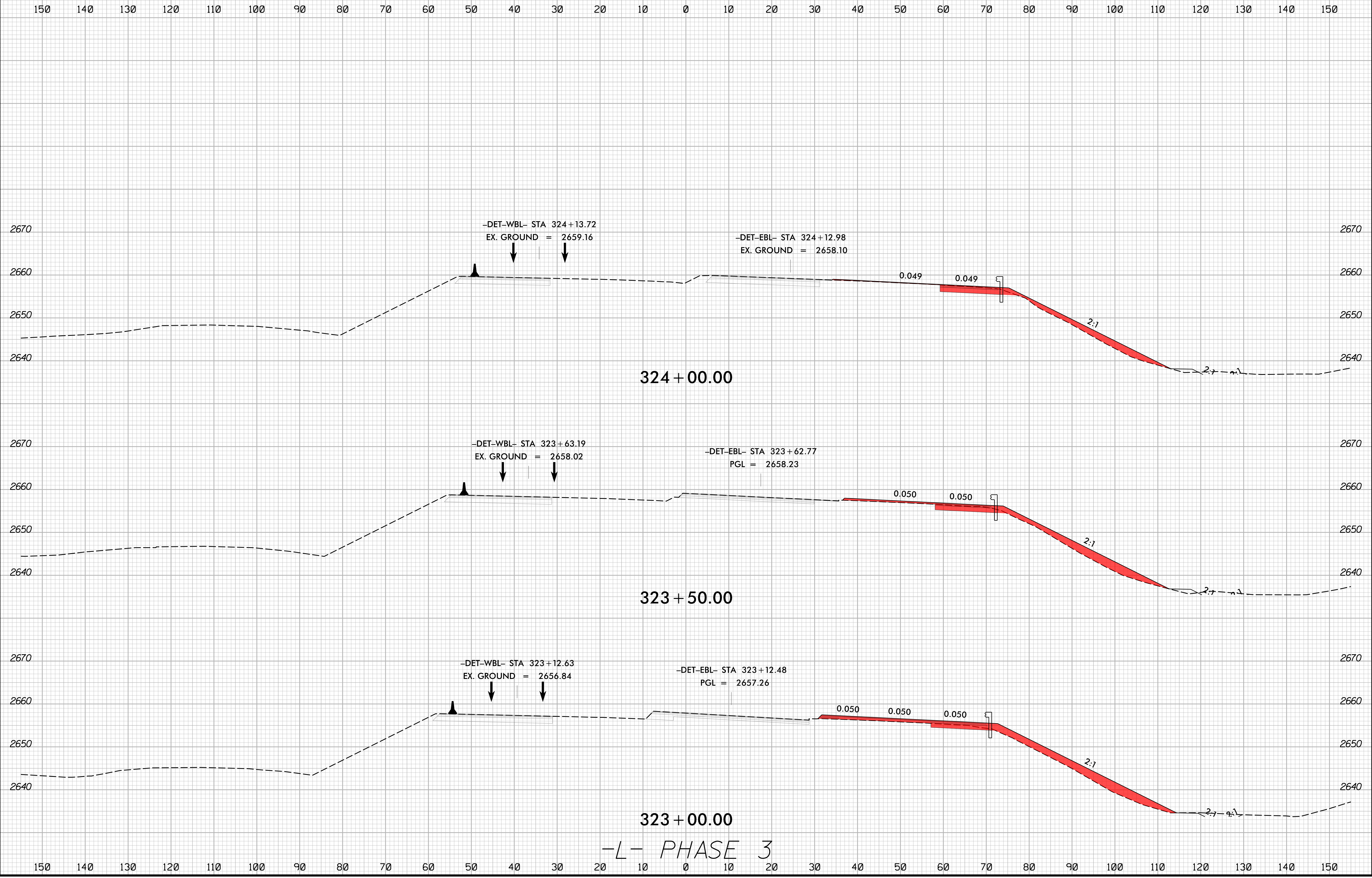

-L- PHASE 3

2/16/2024  
I:\S\HB0002\_rdy\_xpl\_L\_phase-3.dgn  
JSE/10/16/2024



8/23/99

	PROJ. REFERENCE NO.	SHEET NO.
	HB-0002	X-66

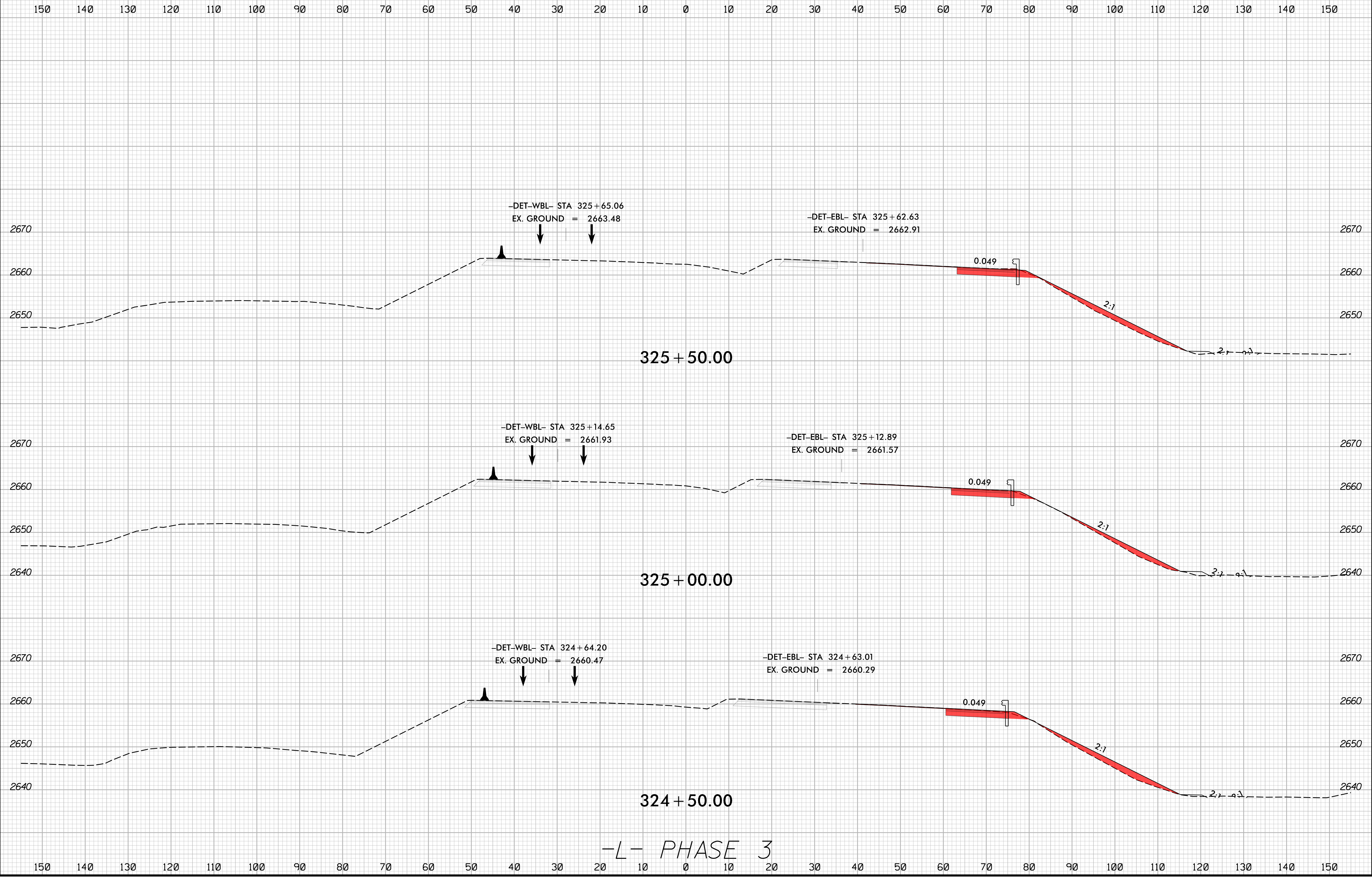

-L- PHASE 3

2/16/2024  
I:\HB\0002\_rdy\_xpl.L\_phase-3.dgn  
JSE



8/23/99

0 5 10	PROJ. REFERENCE NO. HB-0002	SHEET NO. X-67
--------	--------------------------------	-------------------

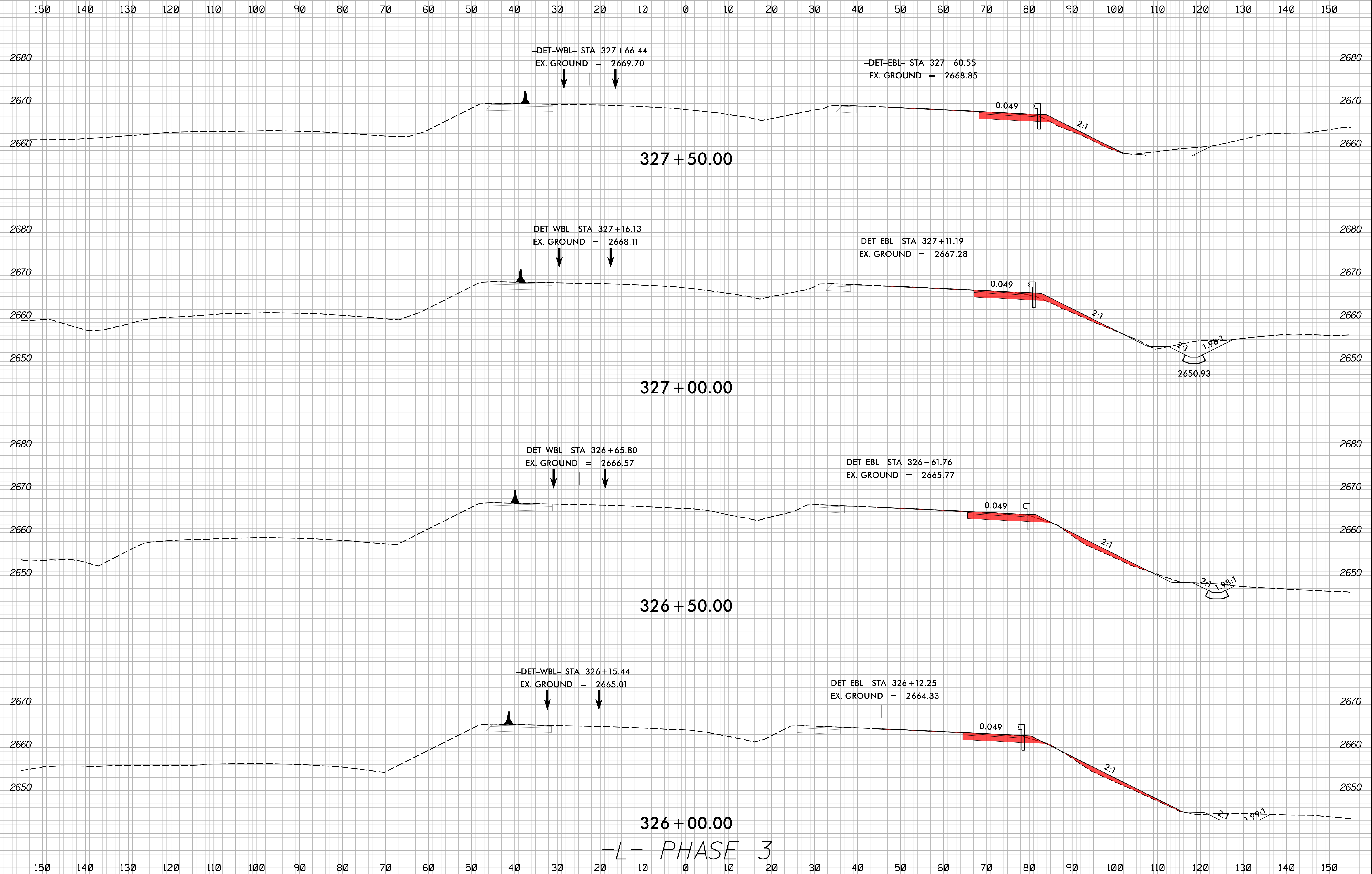

-L- PHASE 3

2/16/2024  
1:51:13  
I:\S\180002\_rdy\_xpl\_L\_phase-3.dgn

8/23/99

0 5 10	PROJ. REFERENCE NO. HB-0002	SHEET NO. X-68
--------	--------------------------------	-------------------

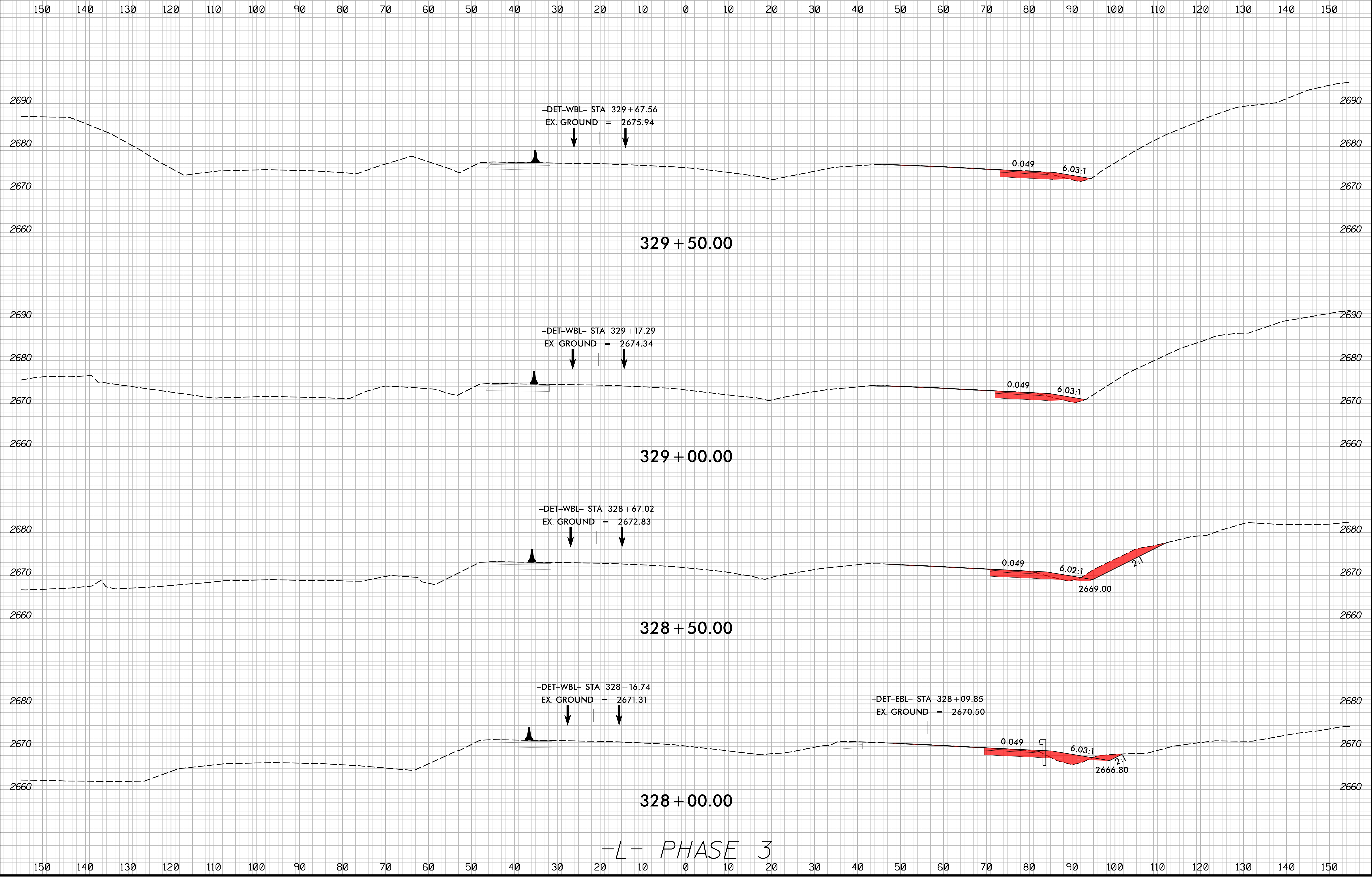

2/16/2024  
1:51:13 PM  
I:\Projects\002\_rdy\_xpl\_L\_phase-3.dgn

8/23/99

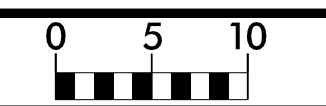

PROJ. REFERENCE NO.	SHEET NO.
HB-0002	X-69

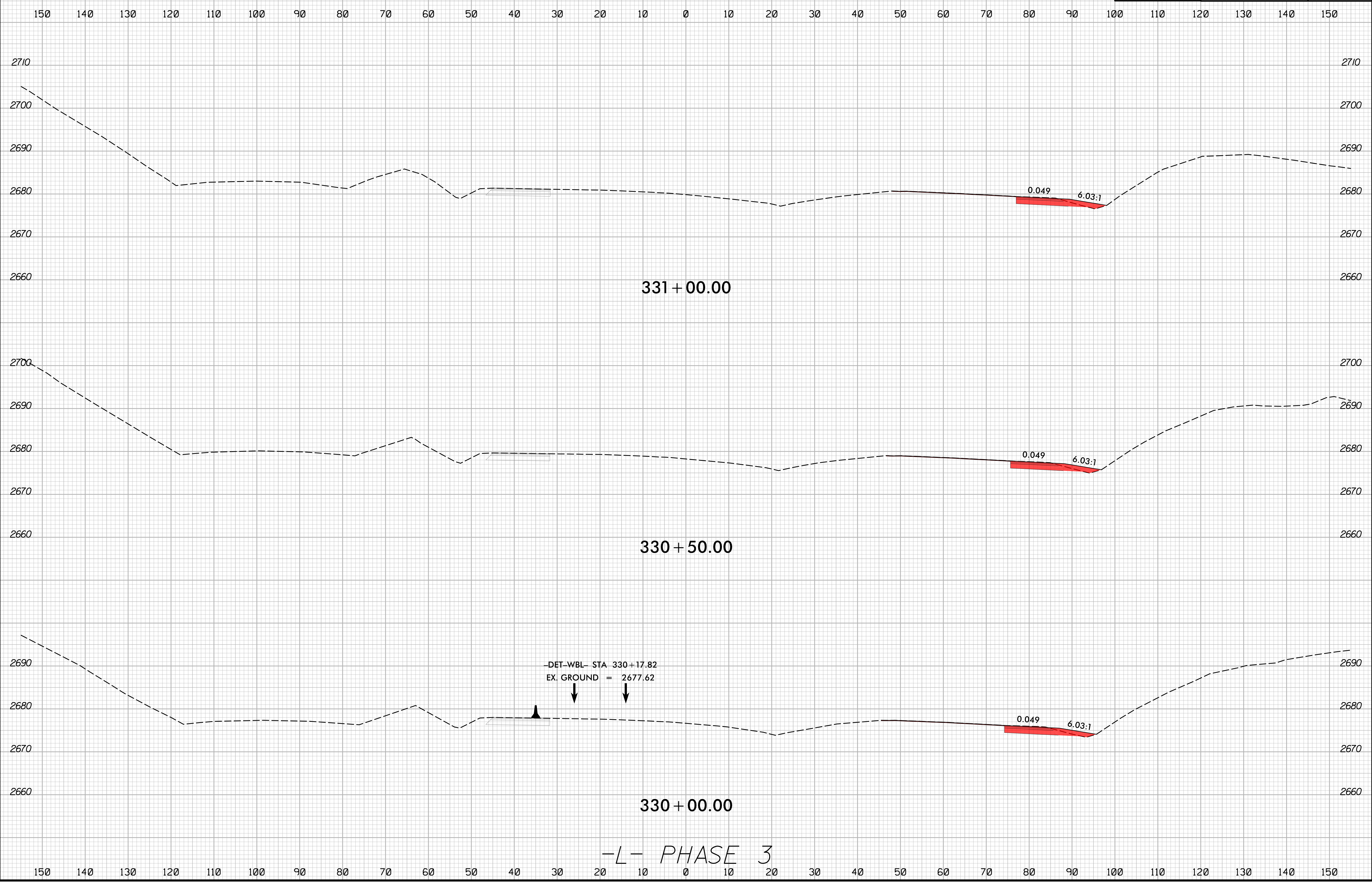

-L- PHASE 3

2/16/2024  
I:\HB\0002\_rdy\_xpl\_L\_phase-3.dgn  
JSE

8/23/99

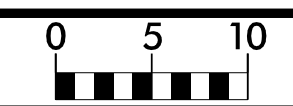

PROJ. REFERENCE NO.	SHEET NO.
HB-0002	X-70

150 140 130 120 110 100 90 80 70 60 50 40 30 20 10 0 10 20 30 40 50 60 70 80 90 100 110 120 130 140 150

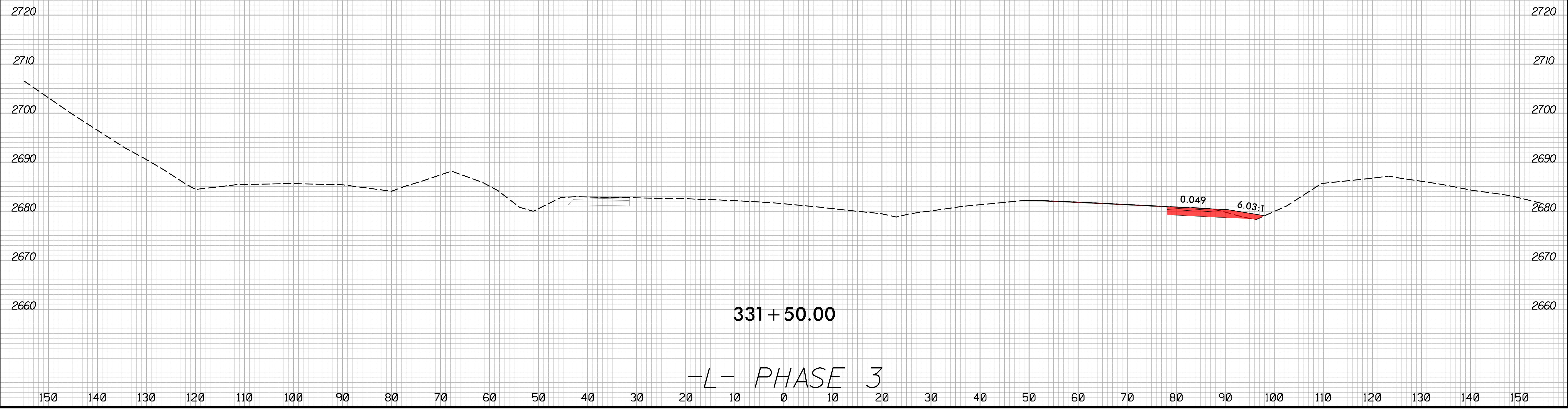

2/16/2024  
 I:\HB\0002\_rdy\_xpl\_L\_phase-3.dgn  
 J:\ERIC\ref



8/23/99

	PROJ. REFERENCE NO.	SHEET NO.
	HB-0002	X-71

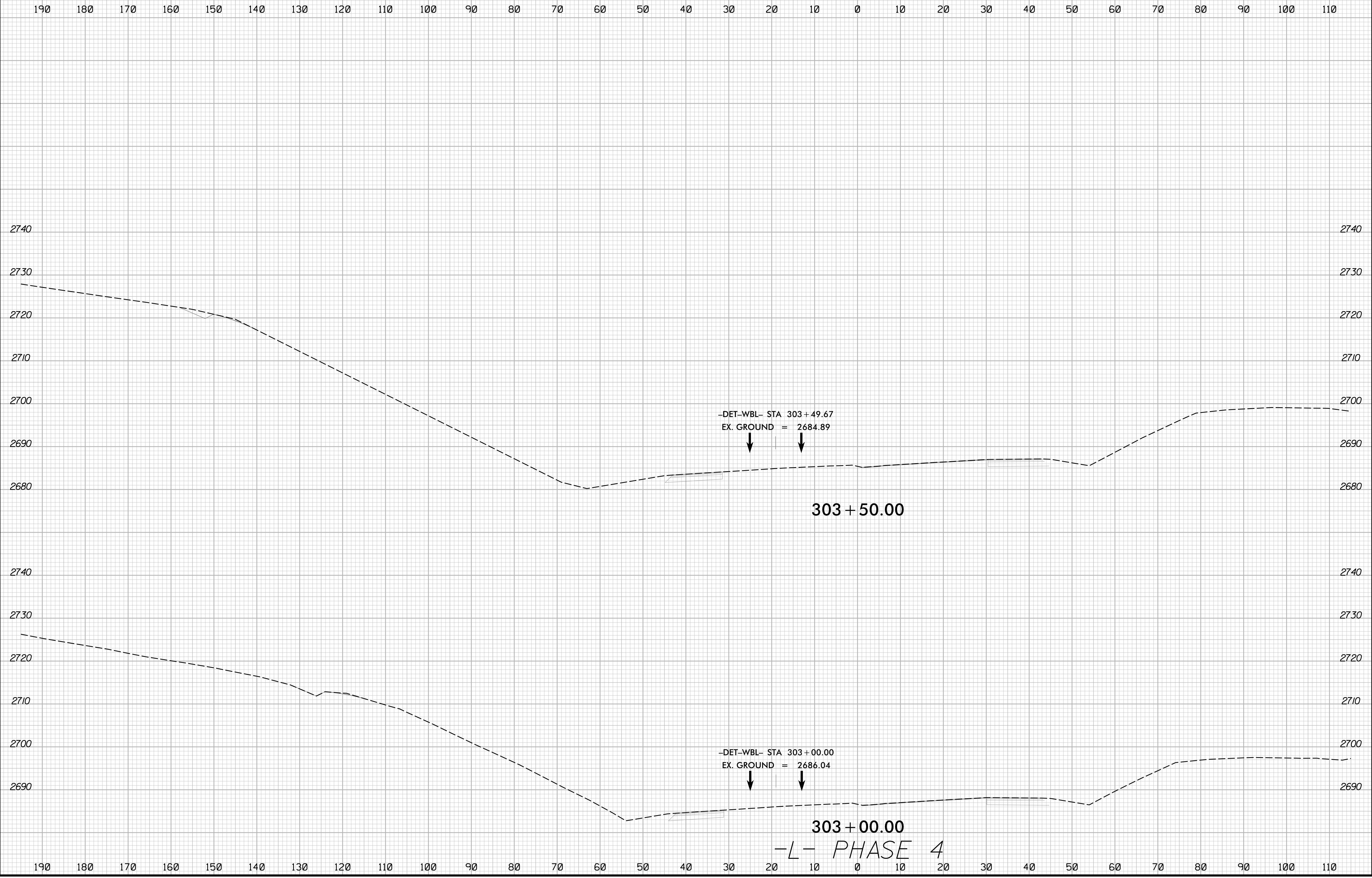

2/16/2024  
I:\HB\0002\_rdy\_xpl\_L\_phase\_4.dgn  
JSE

8/23/99

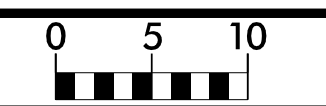

PROJ. REFERENCE NO.	SHEET NO.
HB-0002	X-72

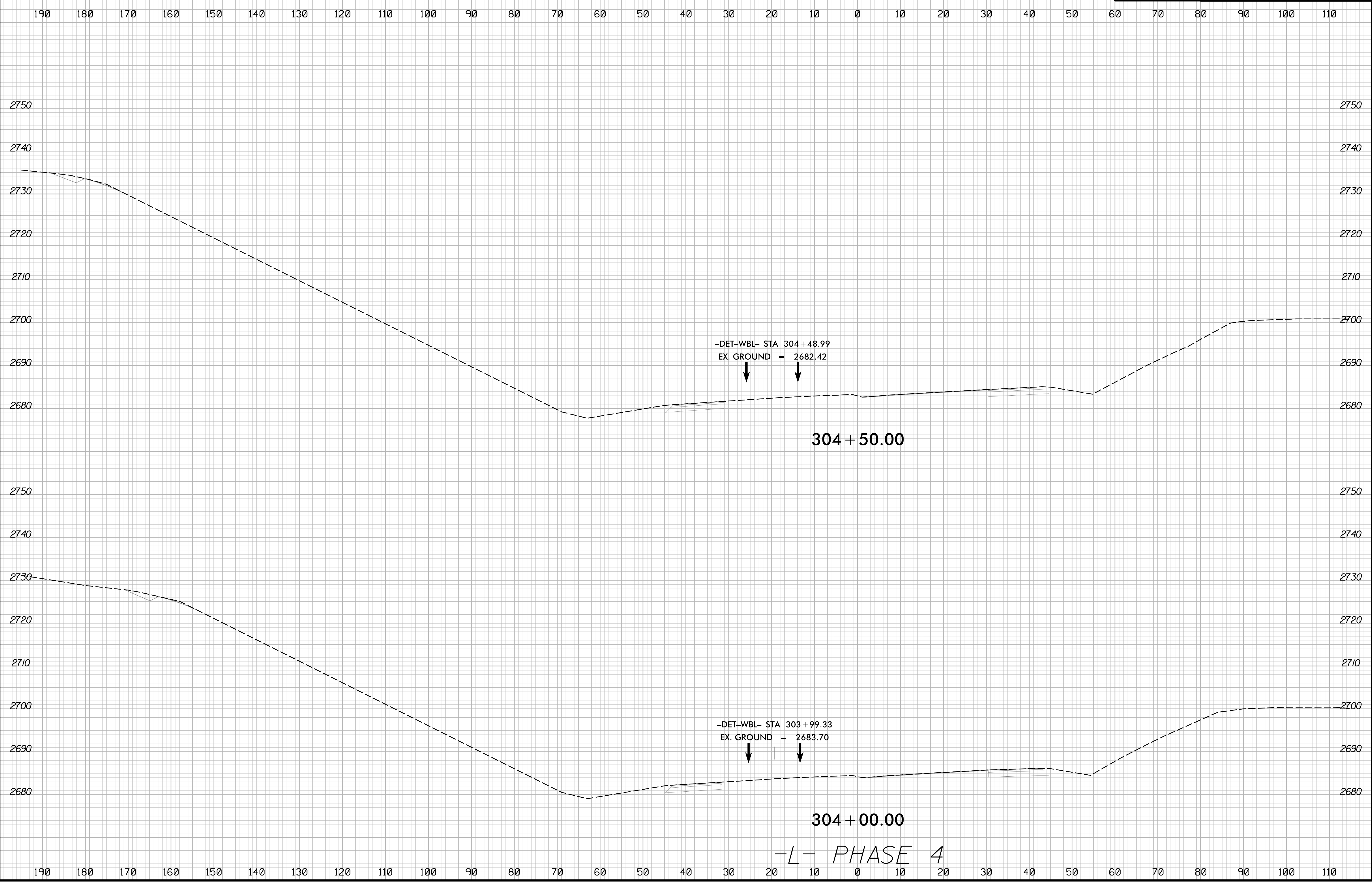

2/16/2024  
I:\HB0002\_rdy\_xpl\_L\_phase\_4.dgn  
JSE/ETC

8/23/99

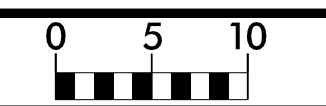

PROJ. REFERENCE NO.	SHEET NO.
HB-0002	X-73

190 180 170 160 150 140 130 120 110 100 90 80 70 60 50 40 30 20 10 0 10 20 30 40 50 60 70 80 90 100 110

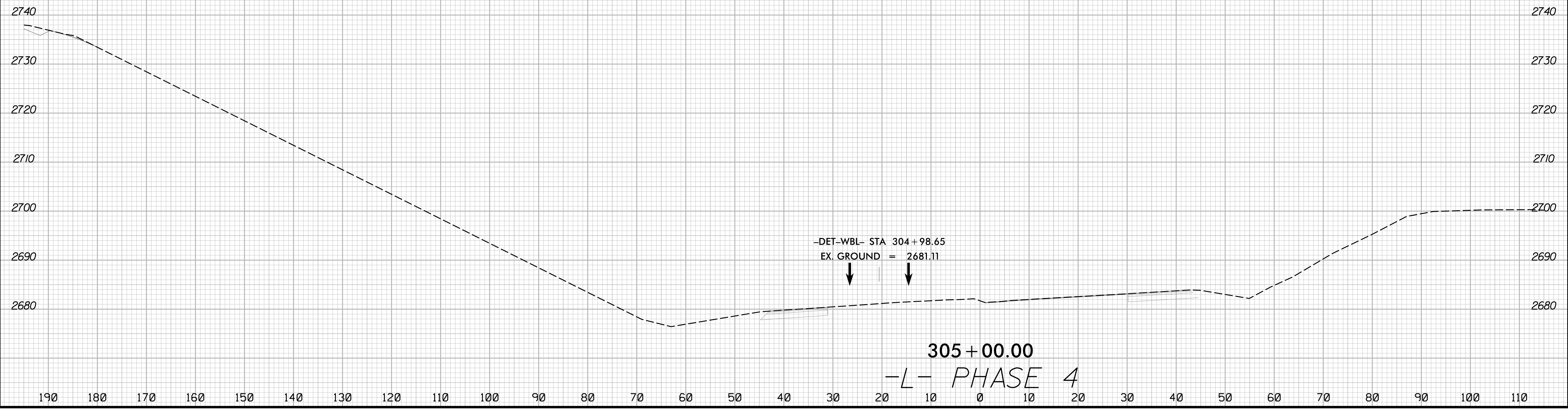

2/16/2024  
1:51:13 PM  
I:\S:\HB\0002\_rdy\_xpl.L\_phase 4.dgn

8/23/99

	PROJ. REFERENCE NO.	SHEET NO.
	HB-0002	X-74

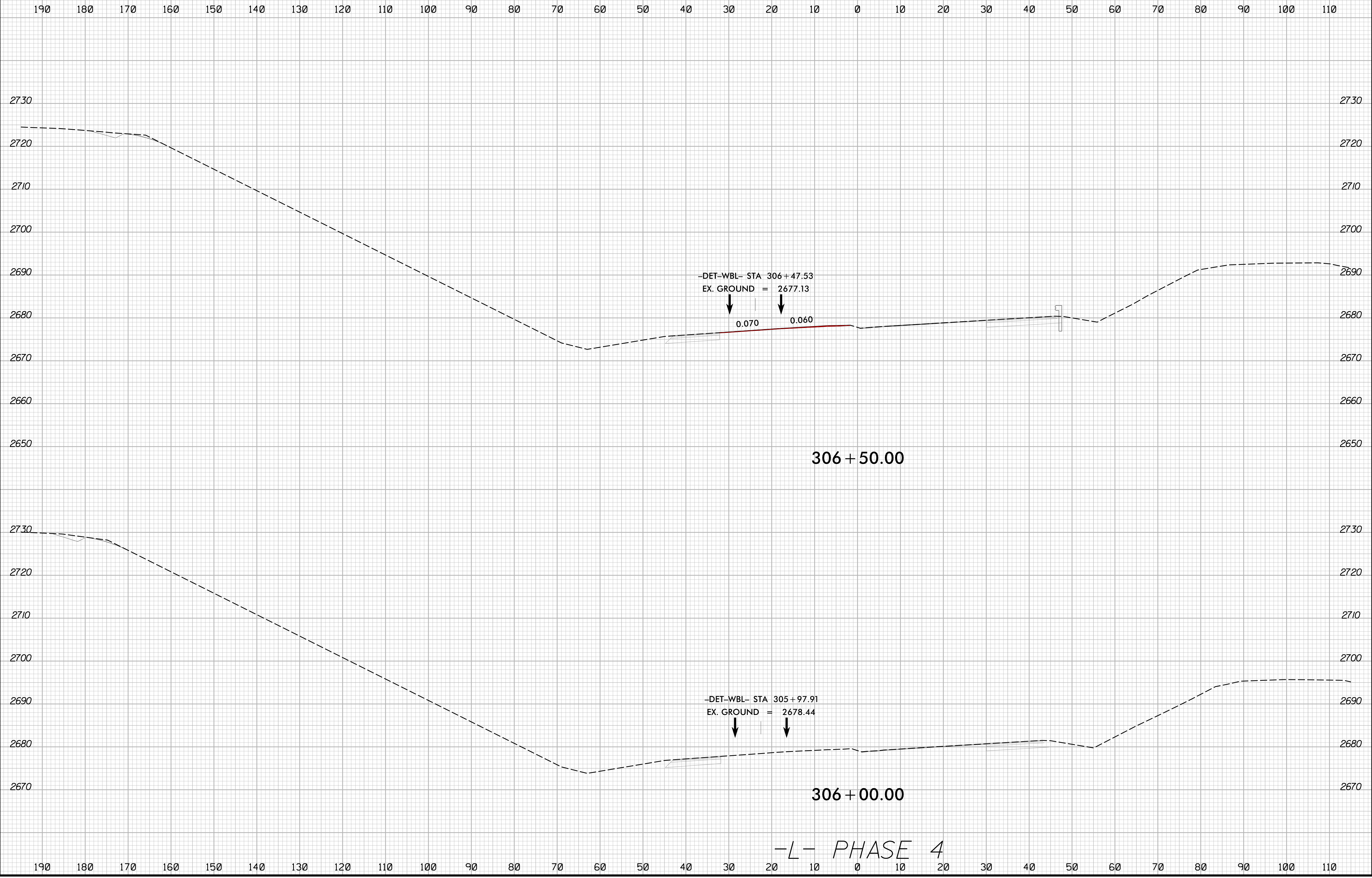

2/16/2024  
1:51:13 PM  
I:\Projects\HB0002\_rdy\_xpl\_L\_phase\_4.dgn

-L- PHASE 4



8/23/99

	PROJ. REFERENCE NO.	SHEET NO.
	HB-0002	X-75

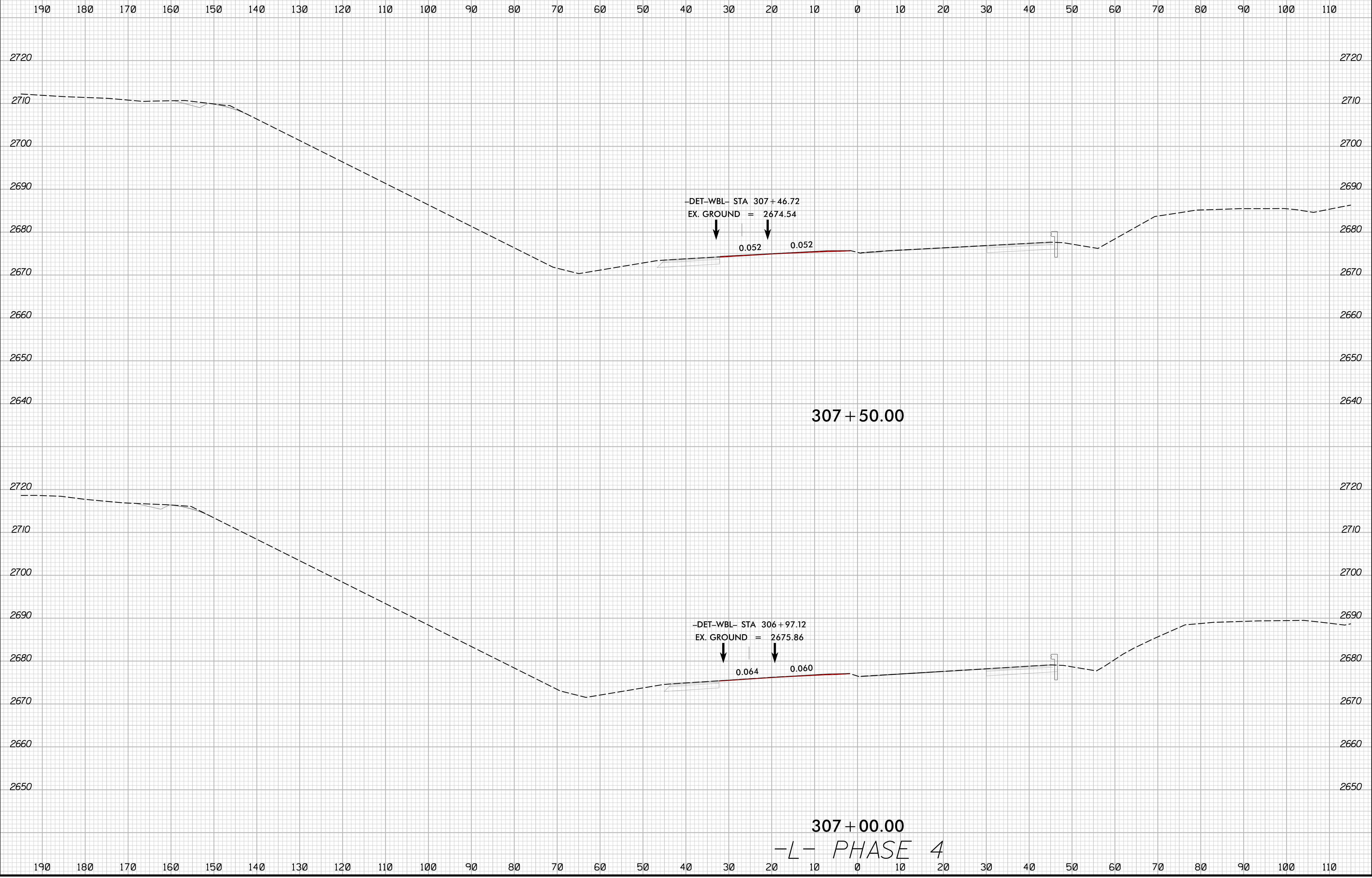

2/16/2024  
I:\S:\HB\0002\_rdy\_xpl\_L\_phase\_4.dgn  
JSE/16/2024

8/23/99

	PROJ. REFERENCE NO.	SHEET NO.
	HB-0002	X-76

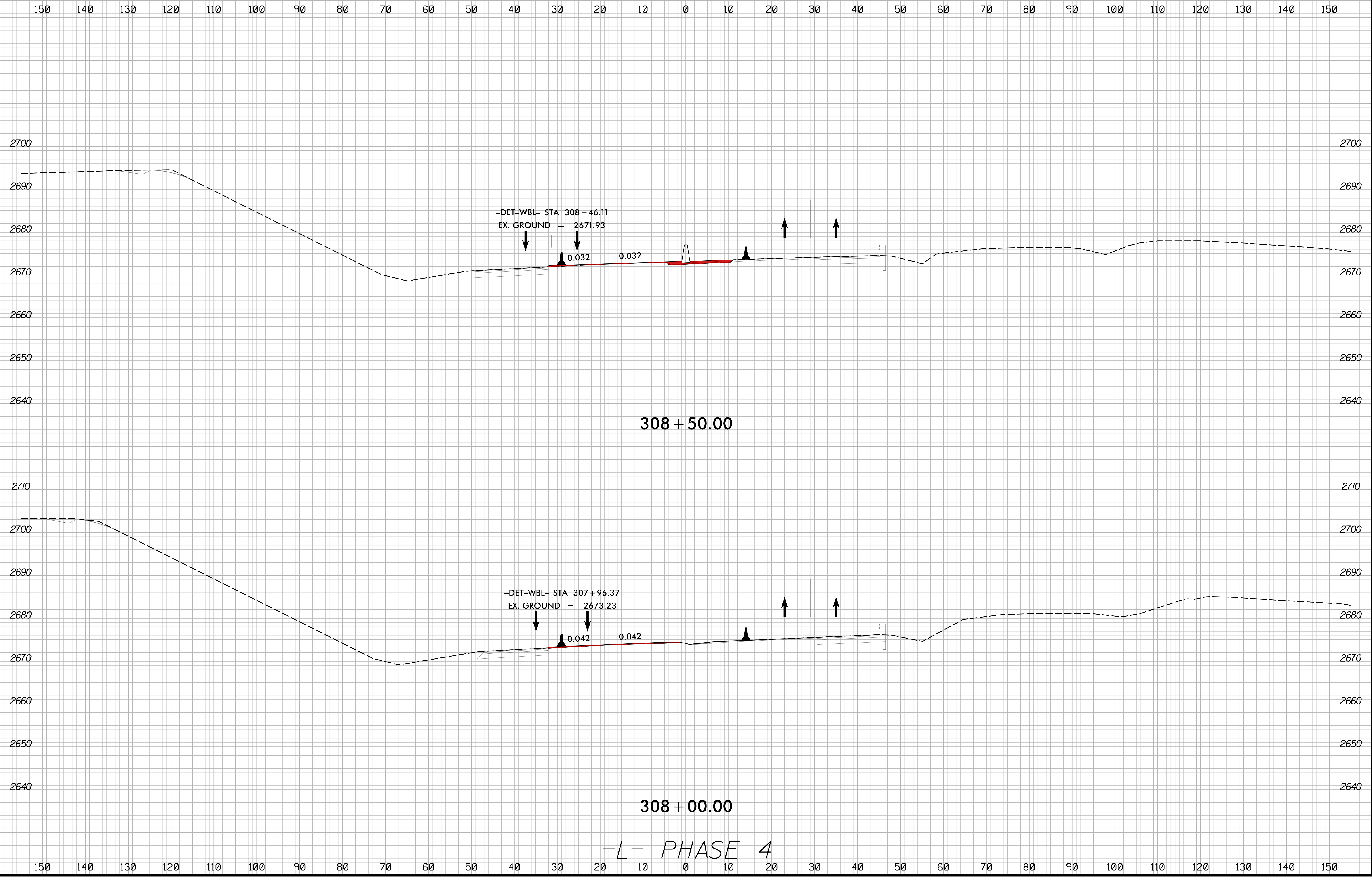

2/16/2024  
I:\HB\0002\_rdy\_xpl.L\_phase 4.dgn  
JSE

-L- PHASE 4

8/23/99

	PROJ. REFERENCE NO.	SHEET NO.
	HB-0002	X-77

150 140 130 120 110 100 90 80 70 60 50 40 30 20 10 0 10 20 30 40 50 60 70 80 90 100 110 120 130 140 150

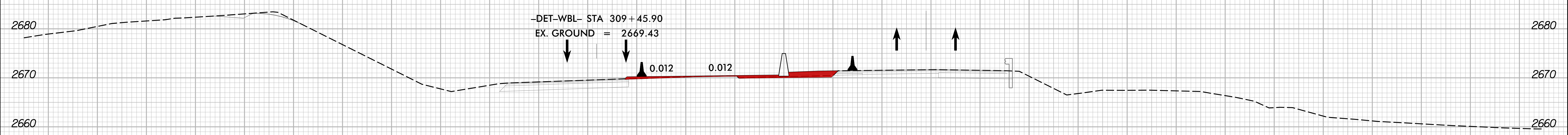

309 + 50.00

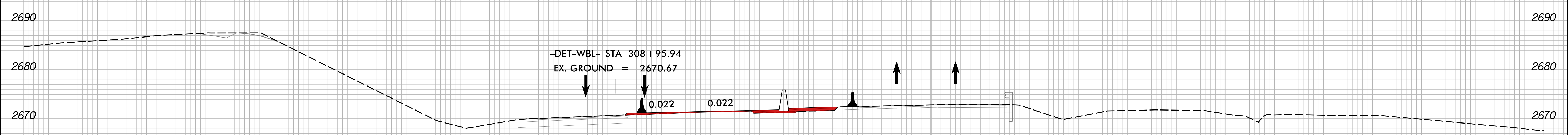

309 + 00.00

-L- PHASE 4

150 140 130 120 110 100 90 80 70 60 50 40 30 20 10 0 10 20 30 40 50 60 70 80 90 100 110 120 130 140 150

2/16/2024  
I:\HB\0002\_rdy\_xpl\_L\_phase\_4.dgn  
JSE:rlg

8/23/99

	PROJ. REFERENCE NO.	SHEET NO.
	HB-0002	X-78

150 140 130 120 110 100 90 80 70 60 50 40 30 20 10 0 10 20 30 40 50 60 70 80 90 100 110 120 130 140 150

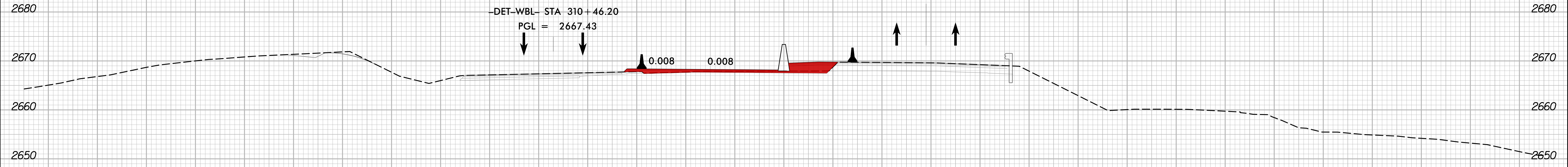

310 + 50.00

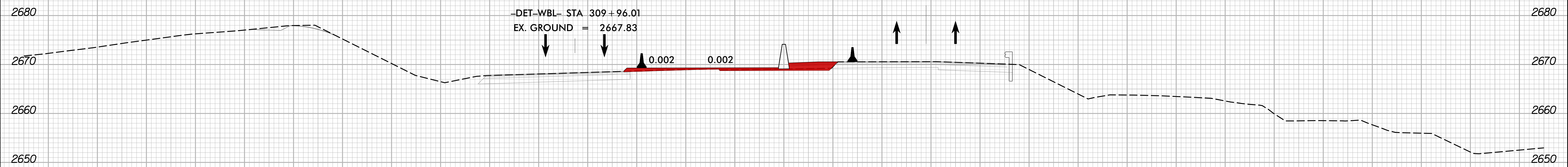

310 + 00.00

-L- PHASE 4

150 140 130 120 110 100 90 80 70 60 50 40 30 20 10 0 10 20 30 40 50 60 70 80 90 100 110 120 130 140 150

2/16/2024  
I:\HB\0002\_rdy\_xpl\_L\_phase\_4.dgn  
JSE/ETG



8/23/99

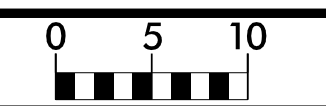

PROJ. REFERENCE NO.	SHEET NO.
HB-0002	X-79

150 140 130 120 110 100 90 80 70 60 50 40 30 20 10 0 10 20 30 40 50 60 70 80 90 100 110 120 130 140 150

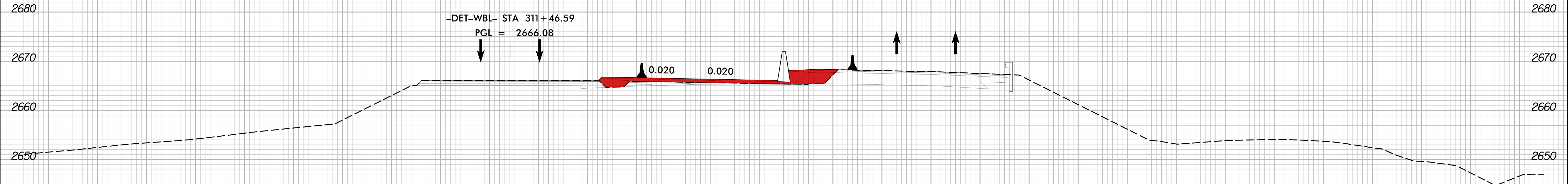

311 + 50.00

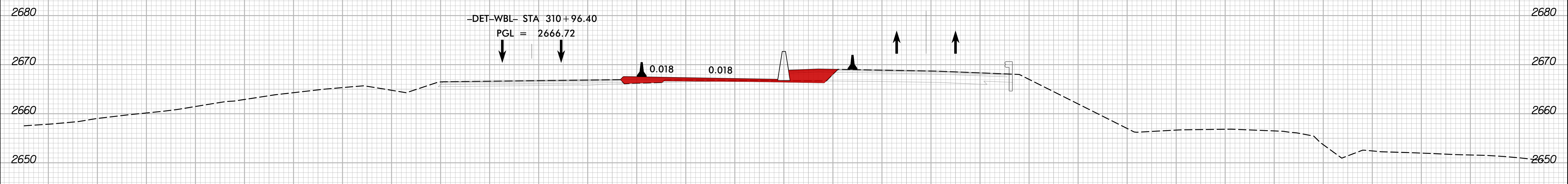

311 + 00.00

-L- PHASE 4

150 140 130 120 110 100 90 80 70 60 50 40 30 20 10 0 10 20 30 40 50 60 70 80 90 100 110 120 130 140 150

2/16/2024 1:51:13 PM I:\HB\0002\_rdy\_xpl\_L\_phase\_4.dgn

8/23/99

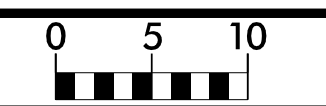

PROJ. REFERENCE NO.	SHEET NO.
HB-0002	X-80

150 140 130 120 110 100 90 80 70 60 50 40 30 20 10 0 10 20 30 40 50 60 70 80 90 100 110 120 130 140 150

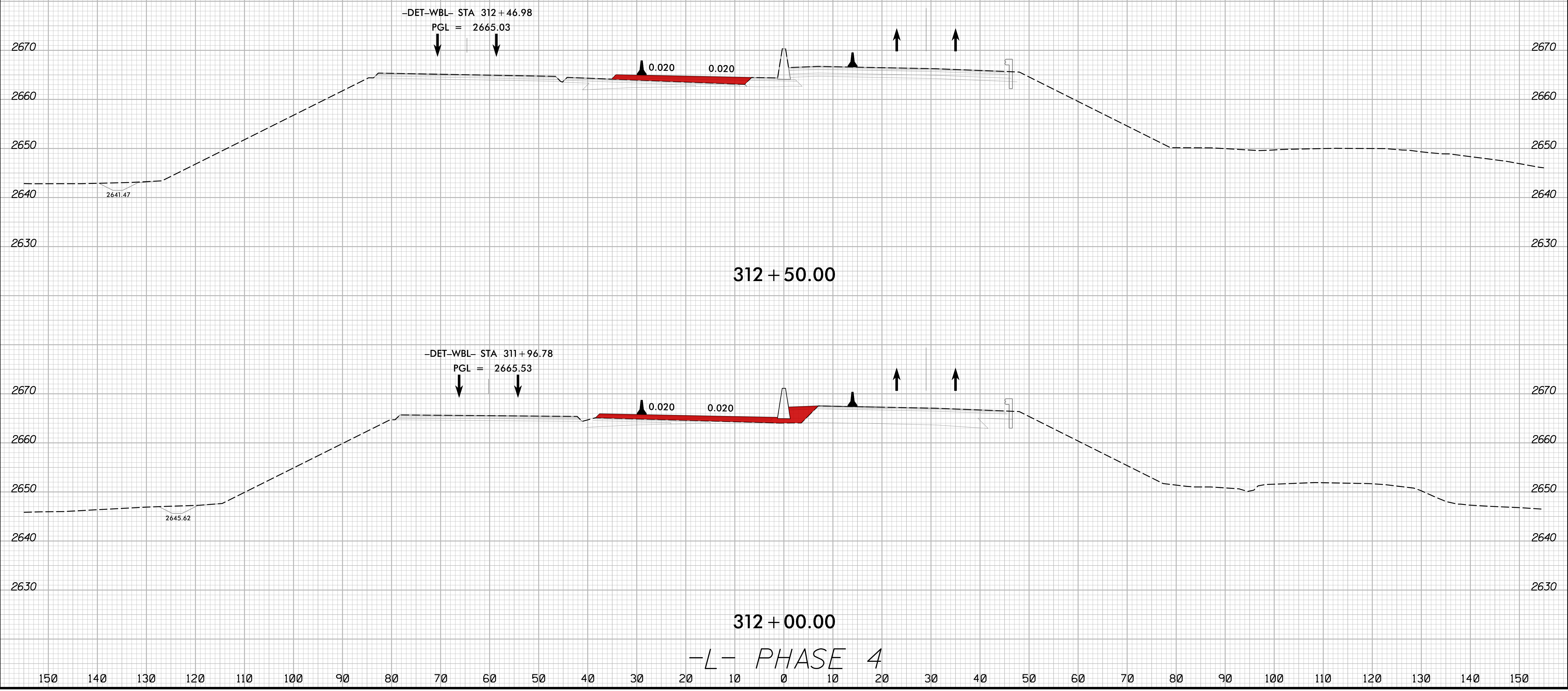

150 140 130 120 110 100 90 80 70 60 50 40 30 20 10 0 10 20 30 40 50 60 70 80 90 100 110 120 130 140 150

2/16/2024  
I:\HB\0002\_rdy\_xpl\_L\_phase\_4.dgn  
JSE/ET/ET

8/23/99

0 5 10	PROJ. REFERENCE NO.	SHEET NO.
	HB-0002	X-81

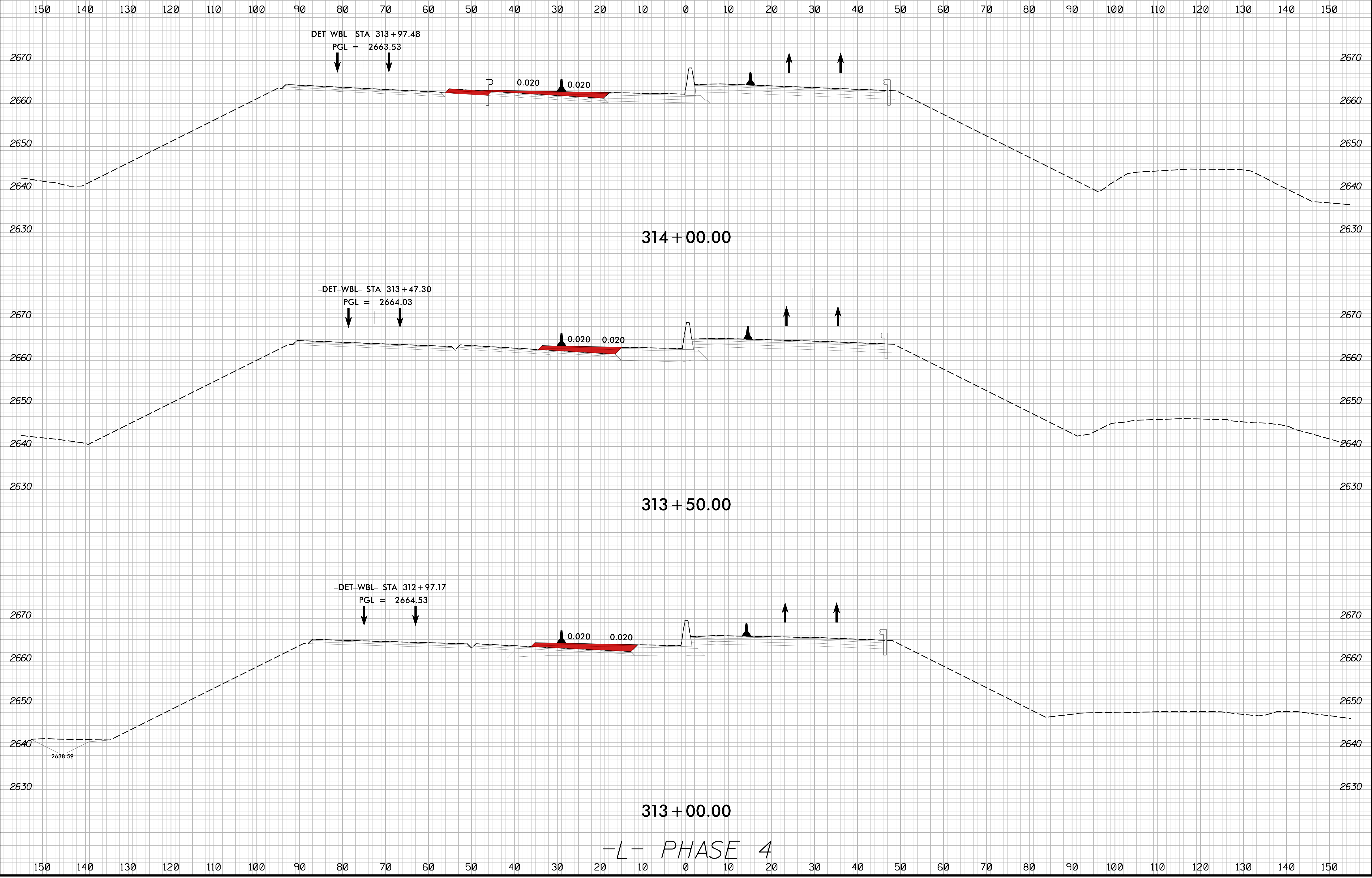

-L- PHASE 4

2/16/2024  
1:51:13 PM  
I:\S:\HB\0002\_rdy\_xpl\_L\_phase\_4.dgn

8/23/99

0 5 10	PROJ. REFERENCE NO.	SHEET NO.
	HB-0002	X-82

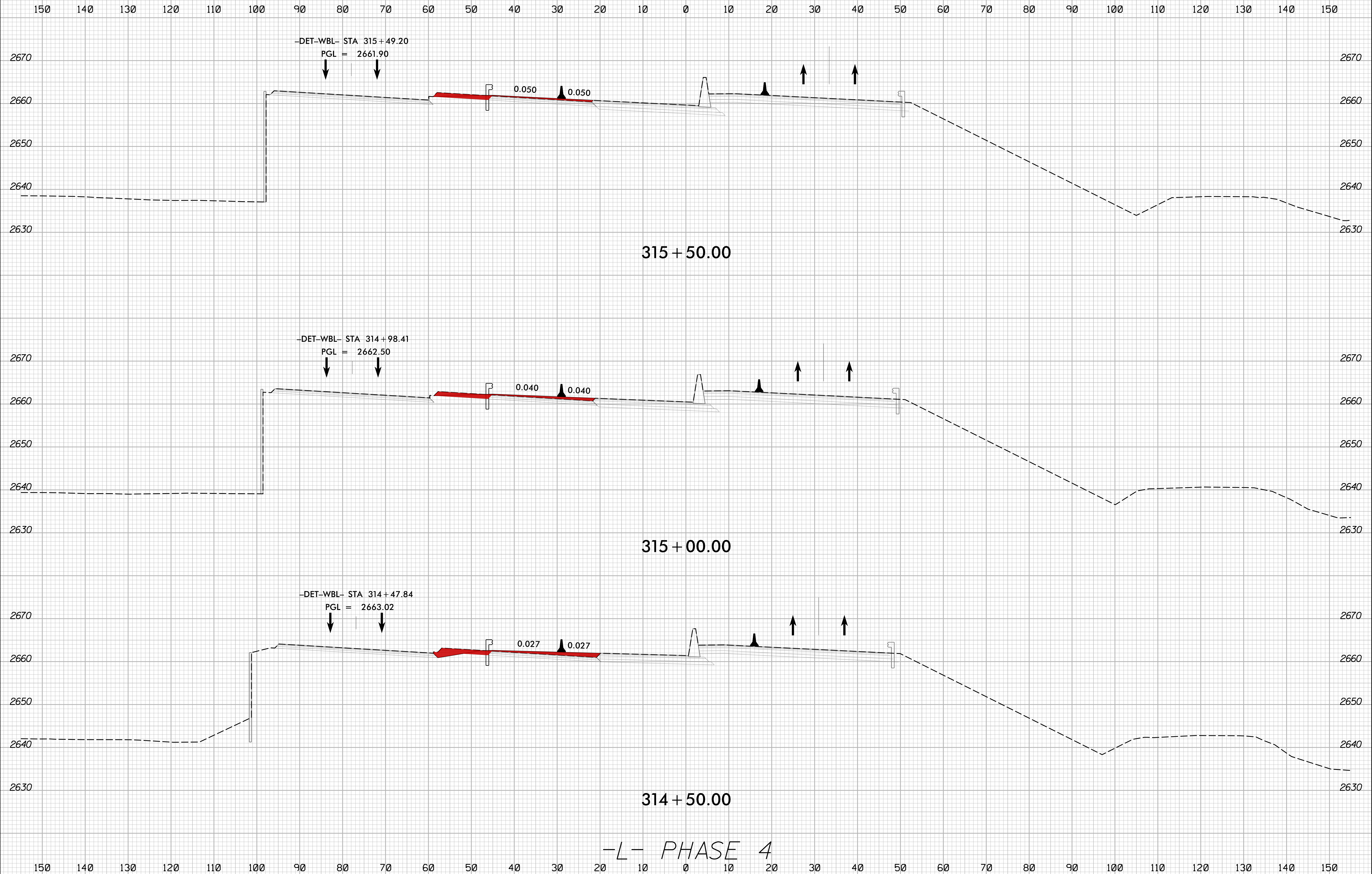

-L- PHASE 4

2/16/2024  
1:51:13 PM  
I:\Projects\2024\24-0002-rdy\_xpl\_L\_phase\_4.dgn



8/23/99

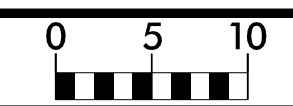

PROJ. REFERENCE NO.	SHEET NO.
HB-0002	X-83

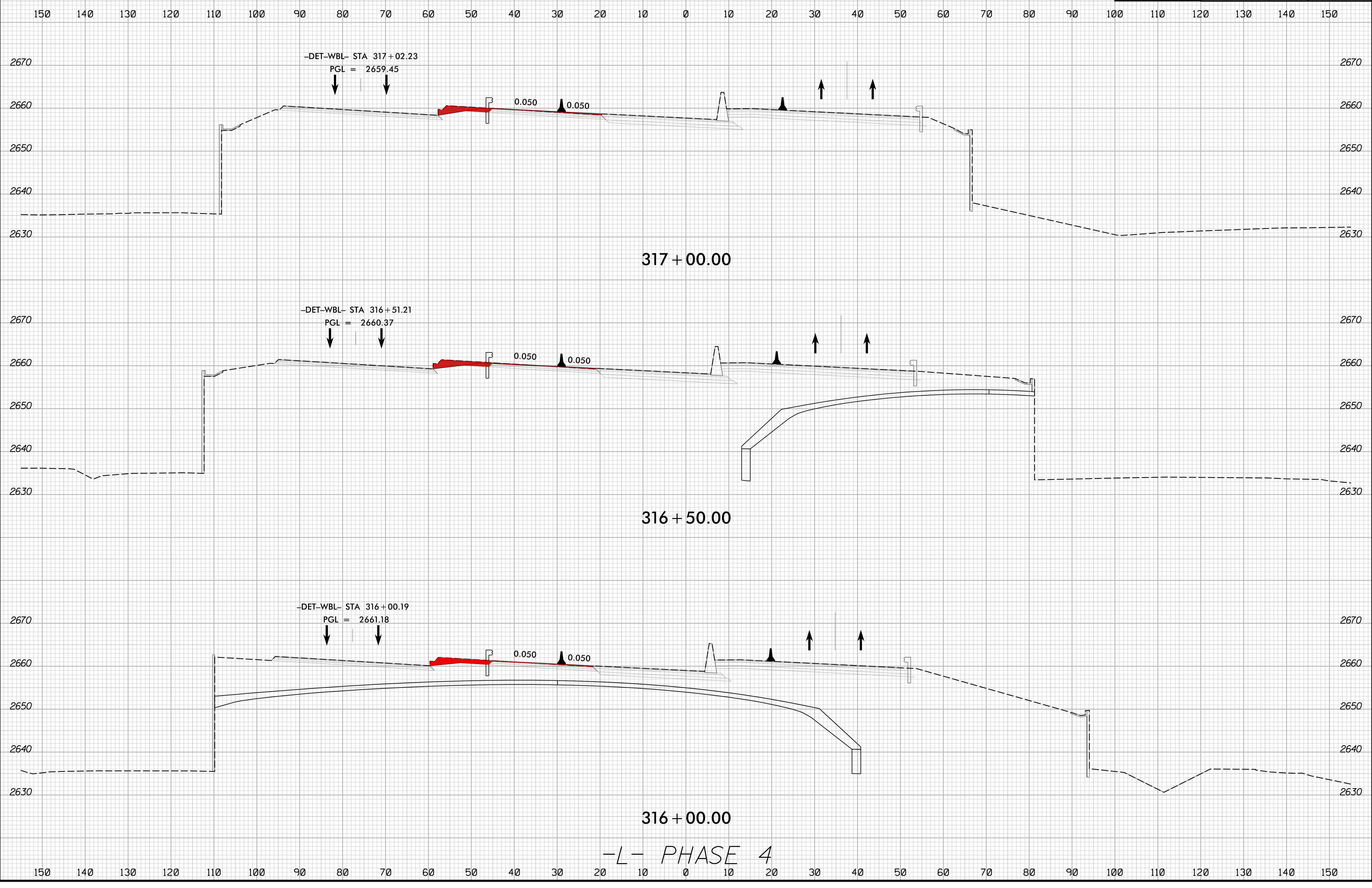

-L- PHASE 4

2/16/2024  
I:\HB\0002\_rdy\_xpl\_L\_phase\_4.dgn  
JSE/ET/ET

8/23/99

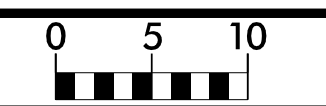

PROJ. REFERENCE NO.	SHEET NO.
HB-0002	X-84

150 140 130 120 110 100 90 80 70 60 50 40 30 20 10 0 10 20 30 40 50 60 70 80 90 100 110 120 130 140 150

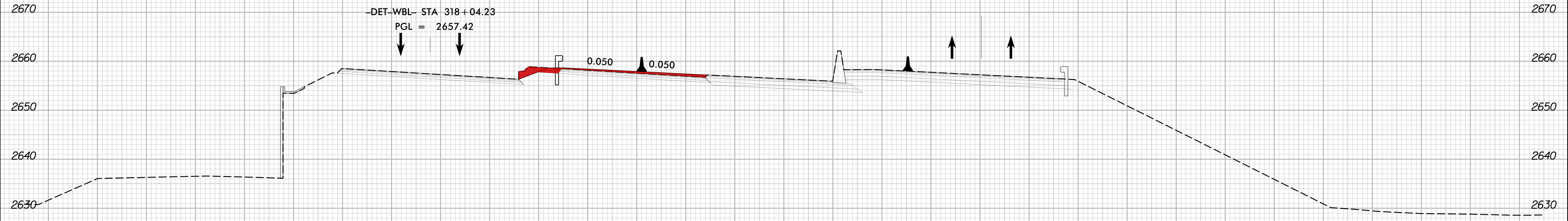

318 + 00.00

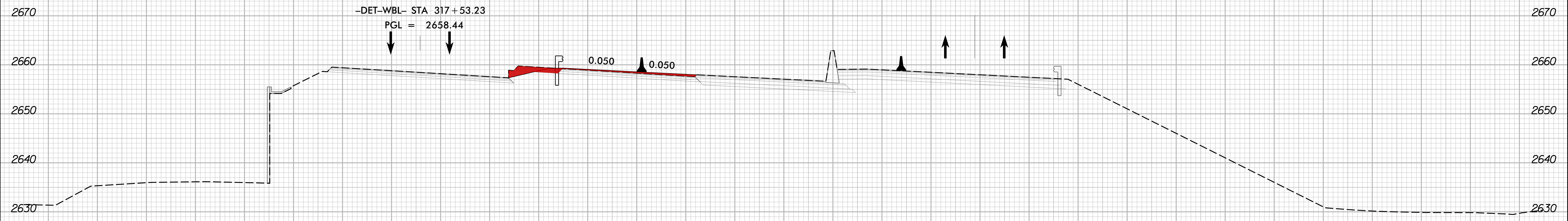

317 + 50.00

-L- PHASE 4

150 140 130 120 110 100 90 80 70 60 50 40 30 20 10 0 10 20 30 40 50 60 70 80 90 100 110 120 130 140 150

2/16/2024 1:51:13 PM I:\HB\0002\_rdy\_xpl.L\_phase 4.dgn

8/23/99

0 5 10	PROJ. REFERENCE NO. HB-0002	SHEET NO. X-85
--------	--------------------------------	-------------------

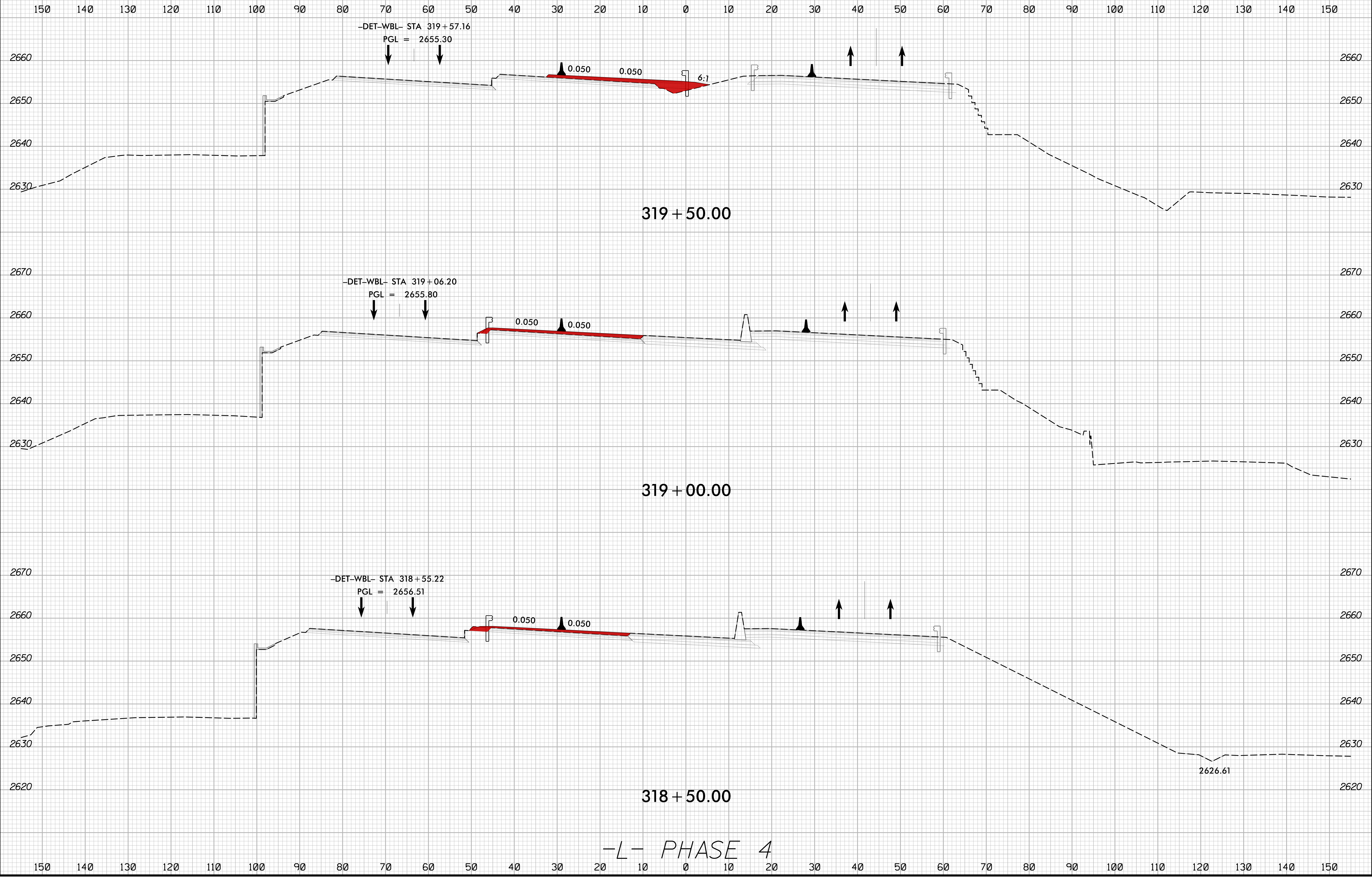

-L- PHASE 4

2/16/2024  
J:\HB0002\_rdy\_xpl\_L\_phase\_4.dgn  
J:\HB0002\_rdy\_xpl\_L\_phase\_4.dgn

8/23/99

0 5 10	PROJ. REFERENCE NO.	SHEET NO.
	HB-0002	X-86

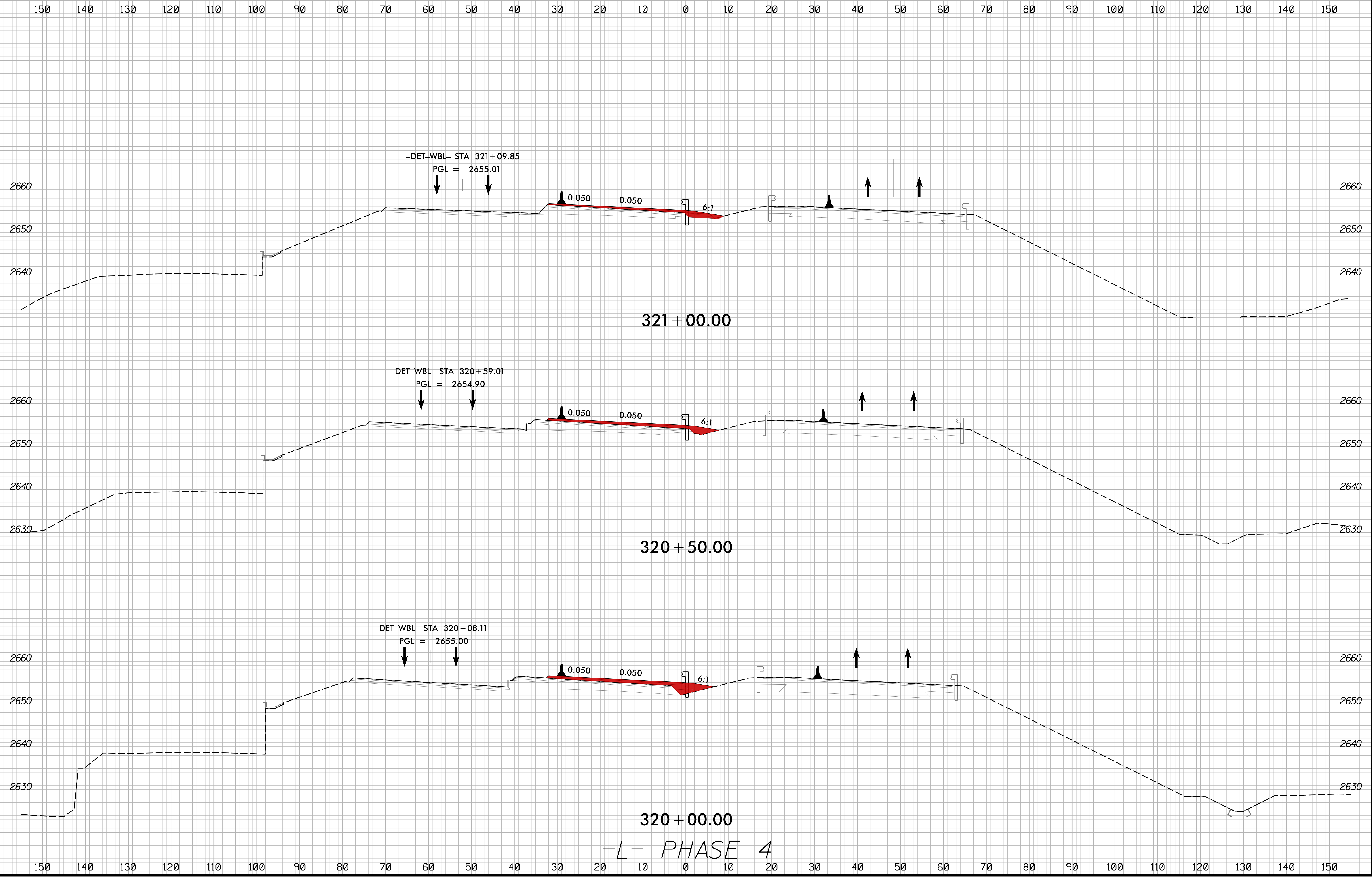

-L- PHASE 4

2/16/2024  
I:\HB\0002\_rdy\_xpl\_L\_phase\_4.dgn  
JSE:rlr



8/23/99

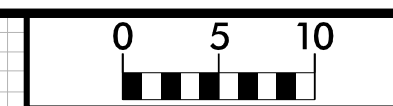

PROJ. REFERENCE NO.	SHEET NO.
HB-0002	X-87

150 140 130 120 110 100 90 80 70 60 50 40 30 20 10 0 10 20 30 40 50 60 70 80 90 100 110 120 130 140 150

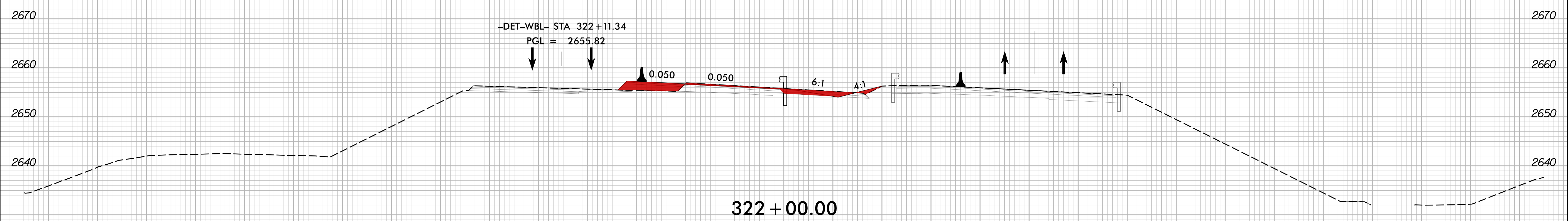
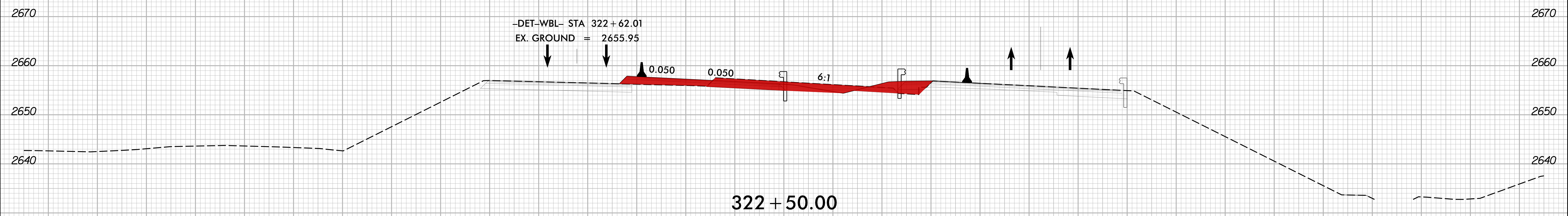

-L- PHASE 4

150 140 130 120 110 100 90 80 70 60 50 40 30 20 10 0 10 20 30 40 50 60 70 80 90 100 110 120 130 140 150

2/16/2024  
I:\HB\0002\_rdy\_xpl\_L\_phase\_4.dgn  
J:\ERIC\ref

8/23/99

	PROJ. REFERENCE NO.	SHEET NO.
	HB-0002	X-88

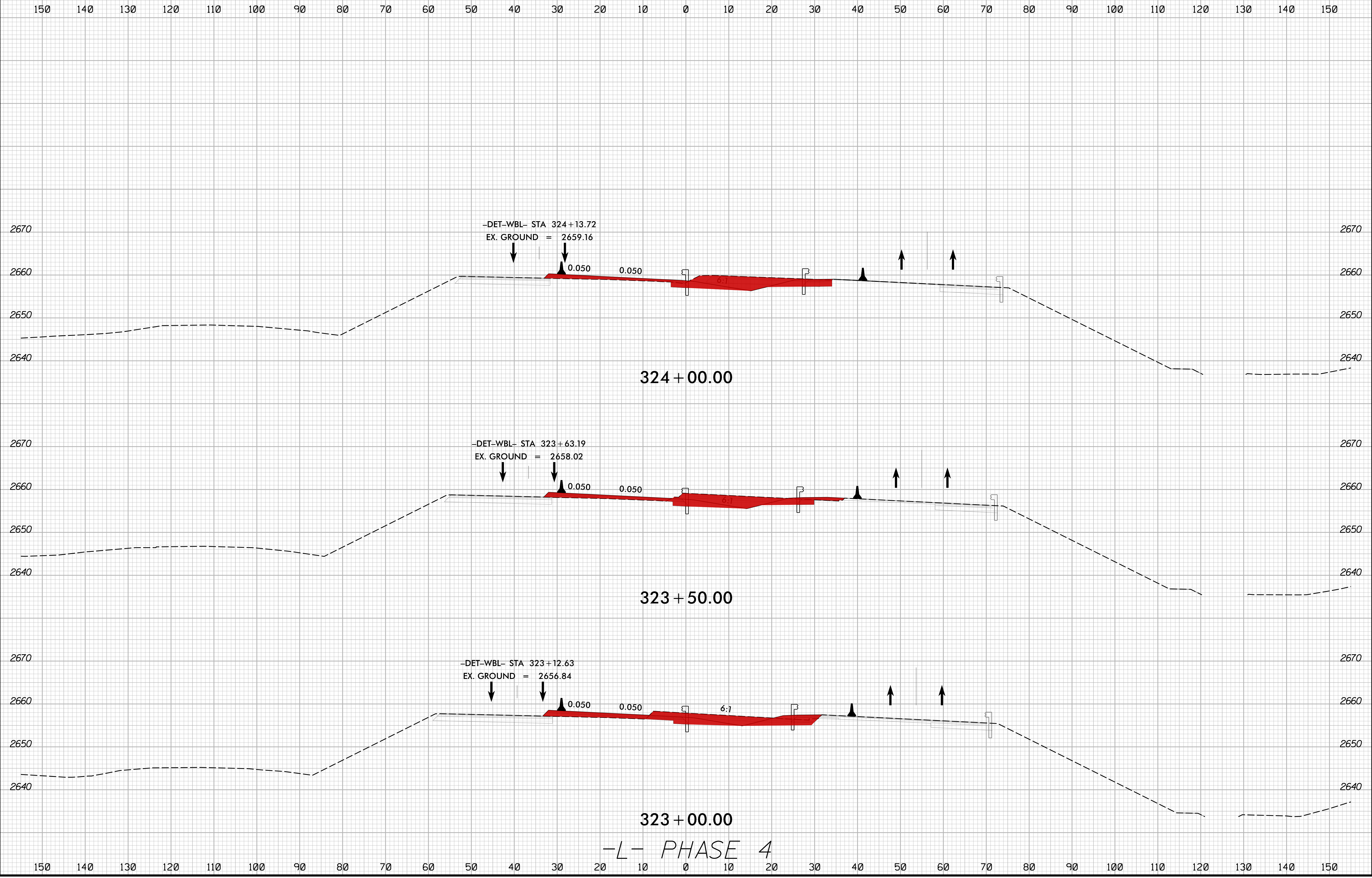

-L- PHASE 4

2/16/2024  
I:\S\180002\_rdy\_xpl\_L\_phase\_4.dgn  
JSE

8/23/99

0 5 10	PROJ. REFERENCE NO.	SHEET NO.
	HB-0002	X-89

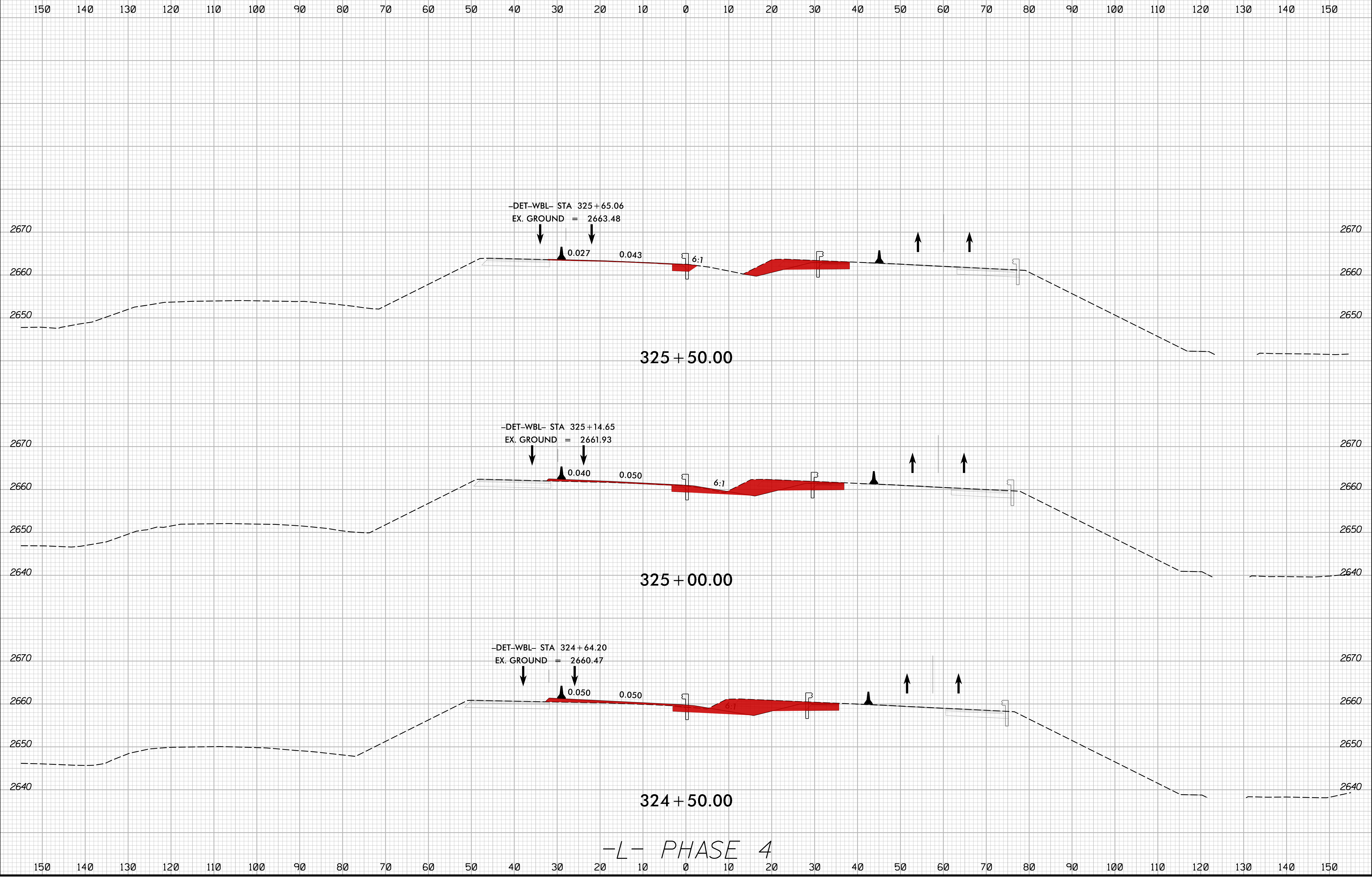

-L- PHASE 4

2/16/2024  
I:\S:\HB\0002\_rdy\_xpl.L\_phase 4.dgn  
JSE/10/16/2024

8/23/99

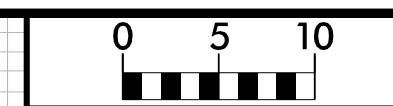

PROJ. REFERENCE NO.	SHEET NO.
HB-0002	X-90

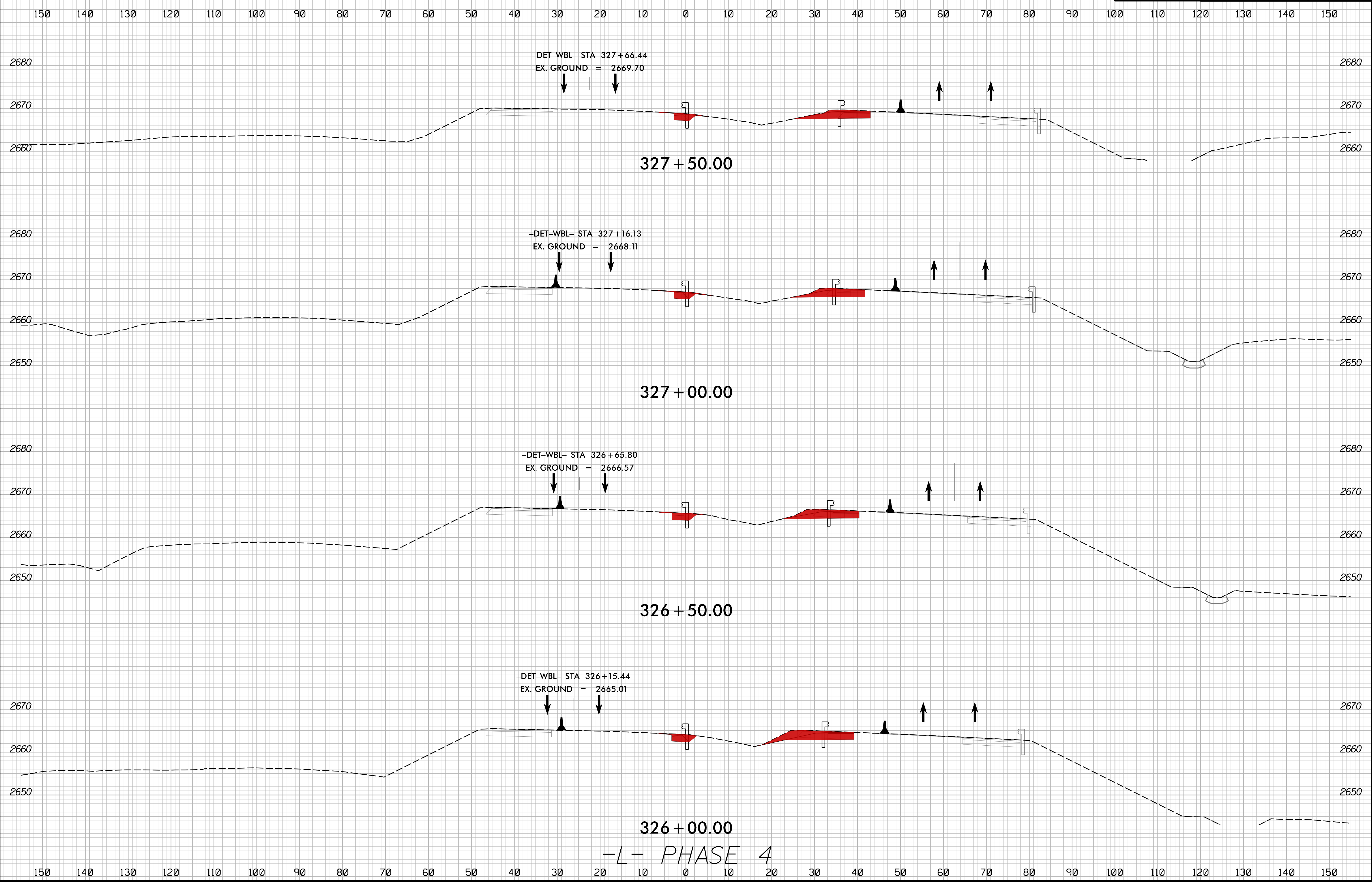

-L- PHASE 4

2/16/2024  
I:\HB\0002\_rdy\_xpl\_L\_phase\_4.dgn  
JTB



8/23/99

	PROJ. REFERENCE NO.	SHEET NO.
	HB-0002	X-91

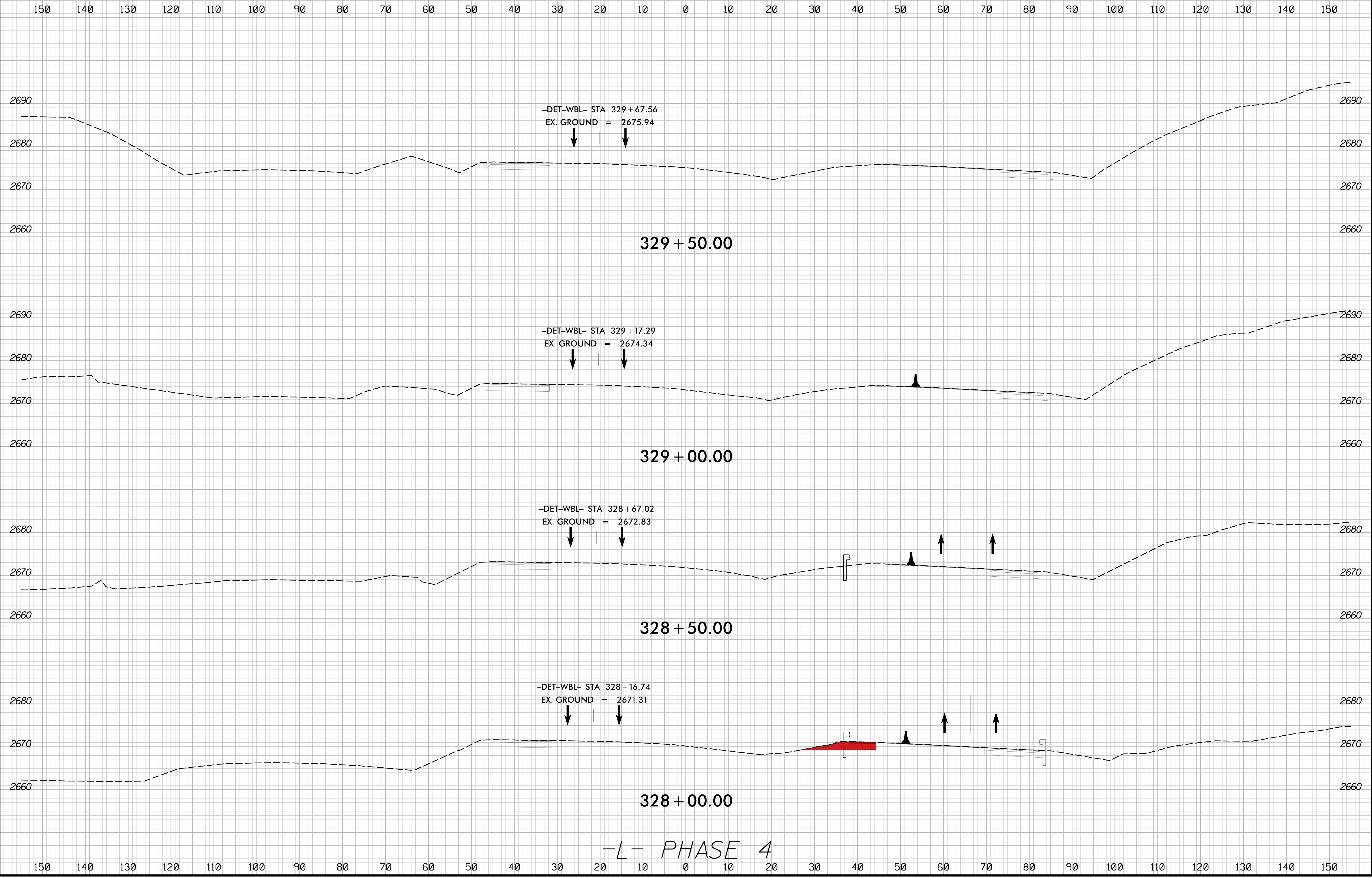

-L- PHASE 4

2/16/2024  
I:\HB\0002\_rdy\_xpl\_L\_phase 4.dgn  
JSE

8/23/99

	PROJ. REFERENCE NO.	SHEET NO.
	HB-0002	X-92

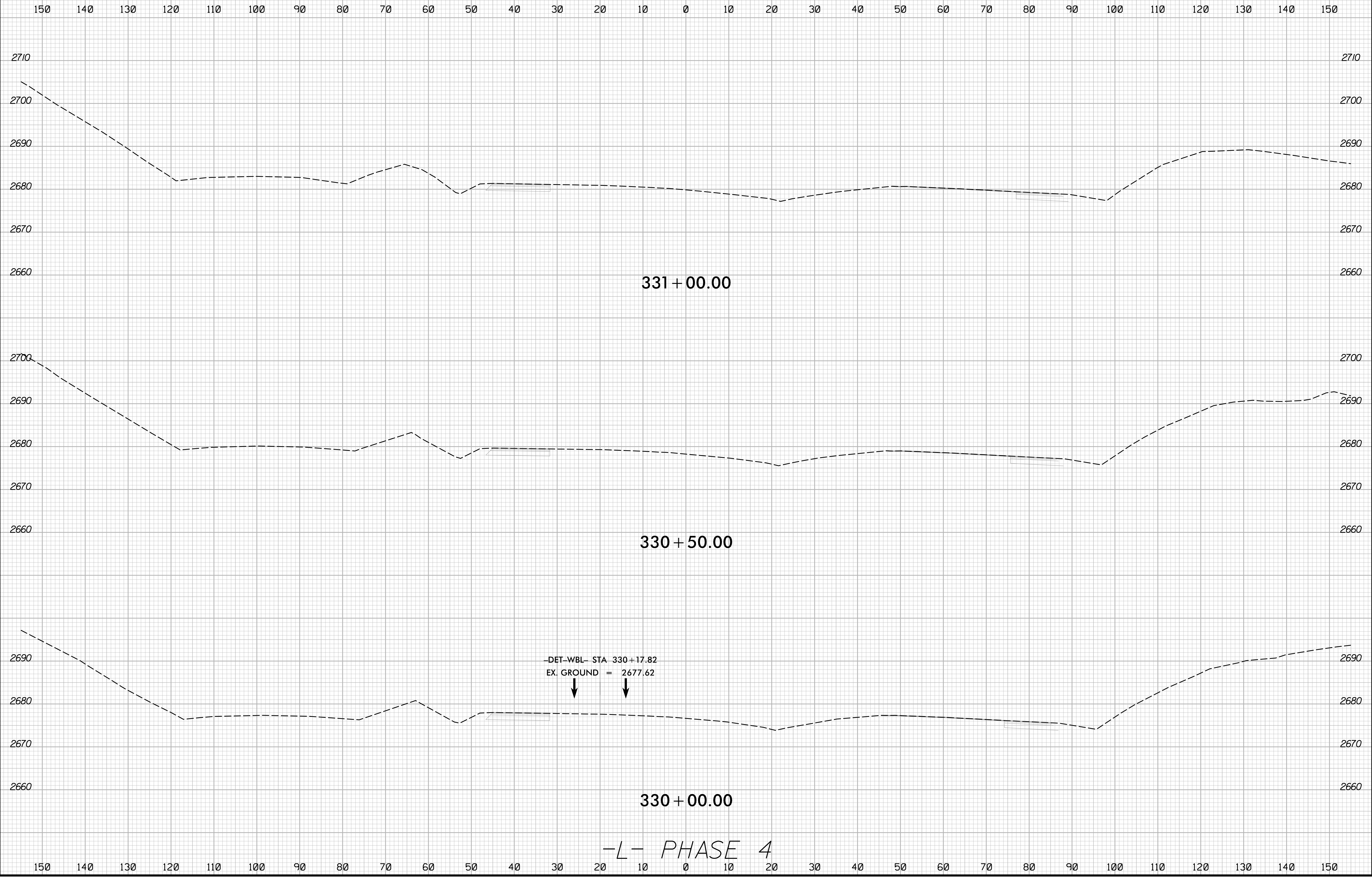

-L- PHASE 4

2/16/2024  
I:\HB0002\_rdy\_xpl\_L\_phase\_4.dgn  
JSE/ETC

8/23/99

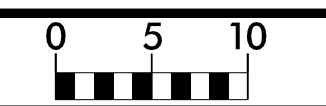

PROJ. REFERENCE NO.	SHEET NO.
HB-0002	X-93

150 140 130 120 110 100 90 80 70 60 50 40 30 20 10 0 10 20 30 40 50 60 70 80 90 100 110 120 130 140 150

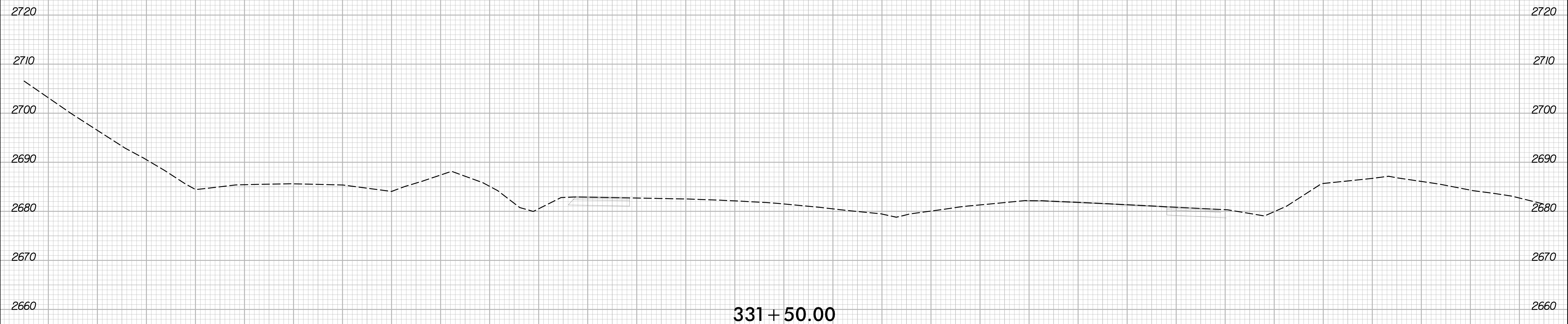

331 + 50.00

-L- PHASE 4

150 140 130 120 110 100 90 80 70 60 50 40 30 20 10 0 10 20 30 40 50 60 70 80 90 100 110 120 130 140 150

2/16/2024  
I:\HB\0002\_rdy\_xpl.L\_phase 4.dgn  
JSE:rlg

8/23/99

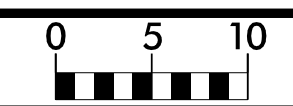

PROJ. REFERENCE NO.	SHEET NO.
HB-0002	X-94

190 180 170 160 150 140 130 120 110 100 90 80 70 60 50 40 30 20 10 0 10 20 30 40 50 60 70 80 90 100 110

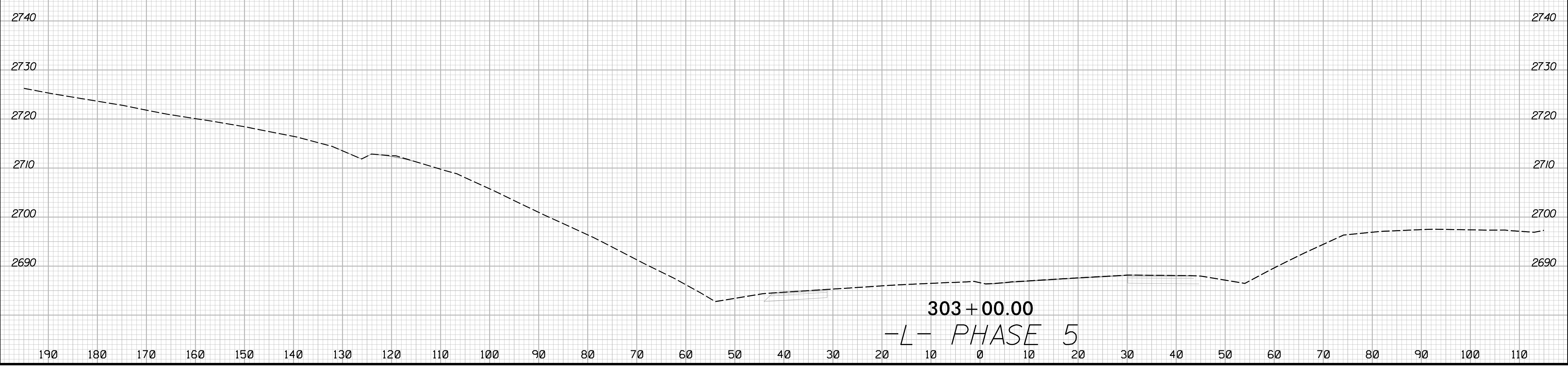

2/16/2024  
I:\HB\0002\_rdy\_xpl.L\_phase-5.dgn  
JSE/16/2024



8/23/99

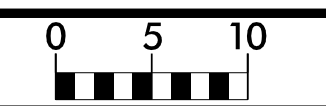

PROJ. REFERENCE NO.	SHEET NO.
HB-0002	X-95

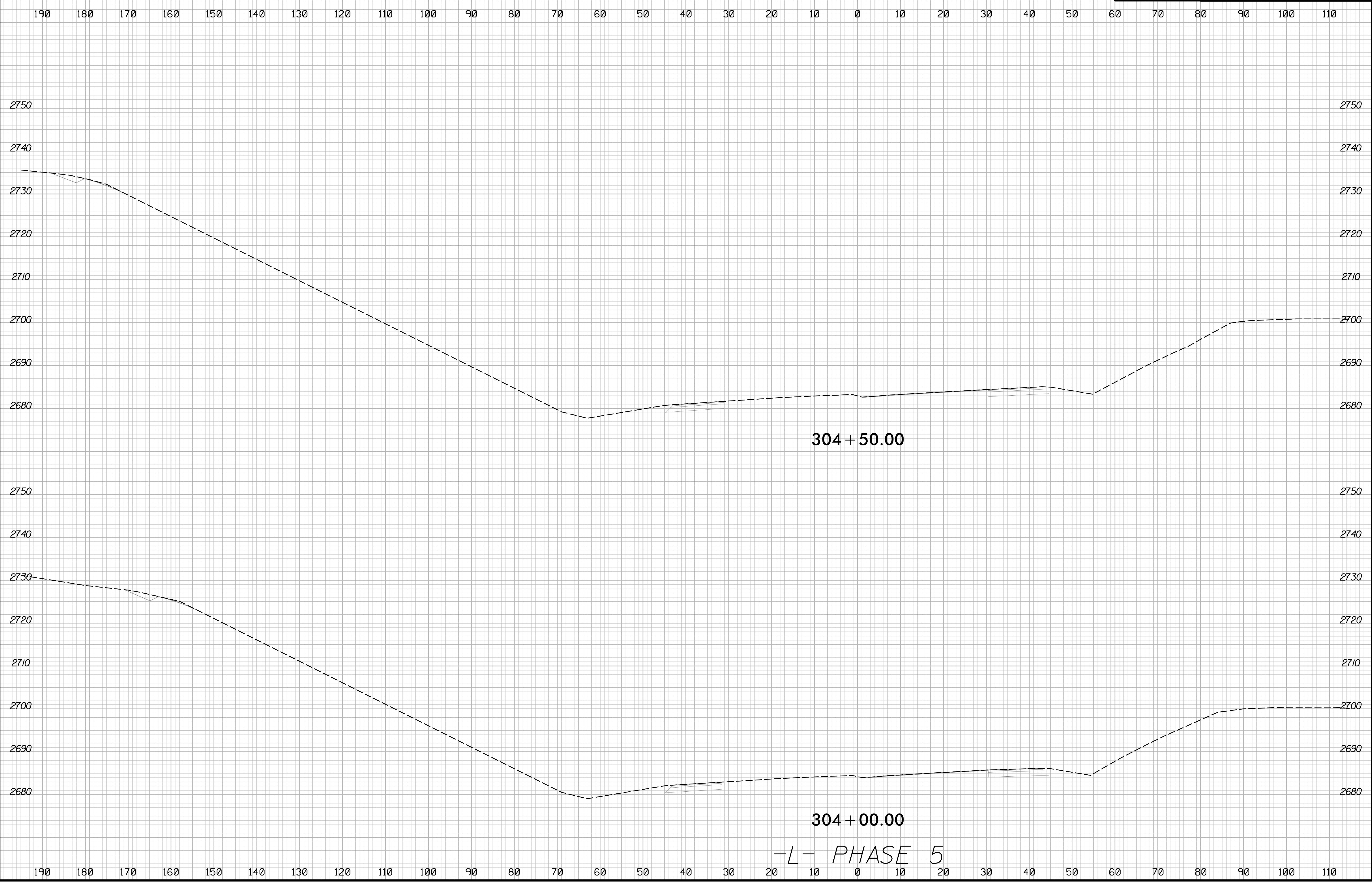

2/16/2024  
I:\HB\0002\_rdy\_xpl\_L\_phase-5.dgn  
JSE/16/2024

8/23/99

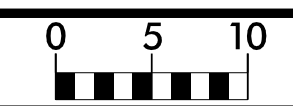

PROJ. REFERENCE NO.	SHEET NO.
HB-0002	X-96

190 180 170 160 150 140 130 120 110 100 90 80 70 60 50 40 30 20 10 0 10 20 30 40 50 60 70 80 90 100 110

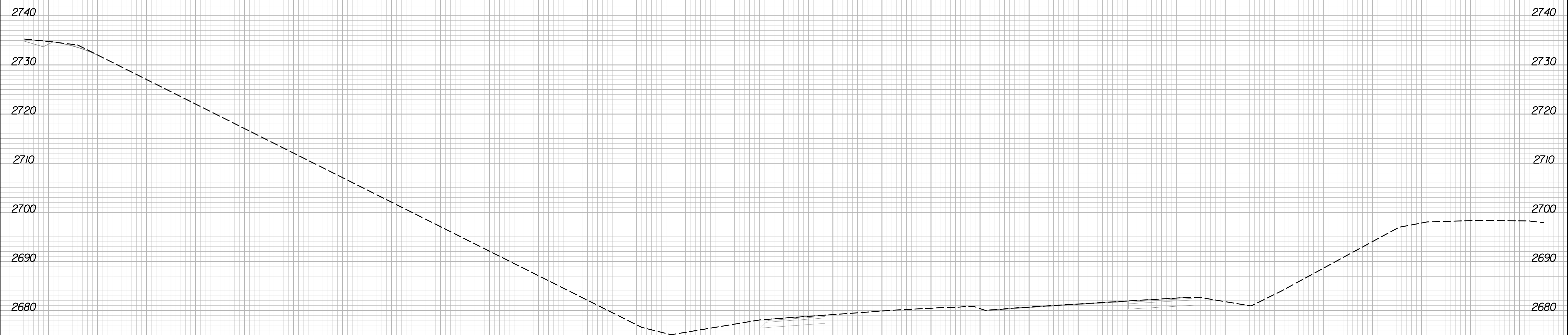

305 + 50.00

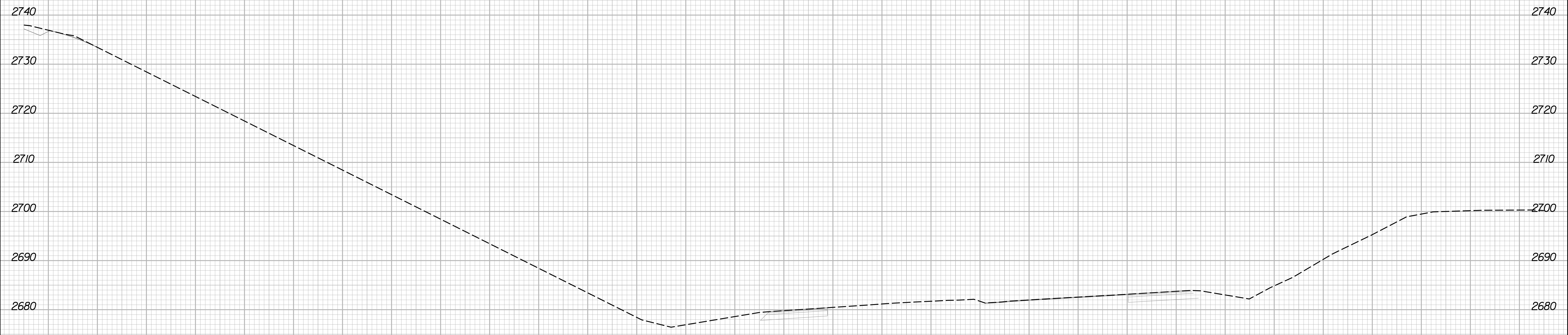

305 + 00.00

-L- PHASE 5

190 180 170 160 150 140 130 120 110 100 90 80 70 60 50 40 30 20 10 0 10 20 30 40 50 60 70 80 90 100 110

2/16/2024 1:51:13 PM I:\HB\0002\_rdy\_xpl.L\_phase-5.dgn

8/23/99

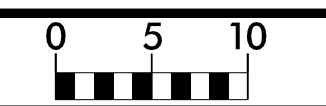

PROJ. REFERENCE NO.	SHEET NO.
HB-0002	X-97

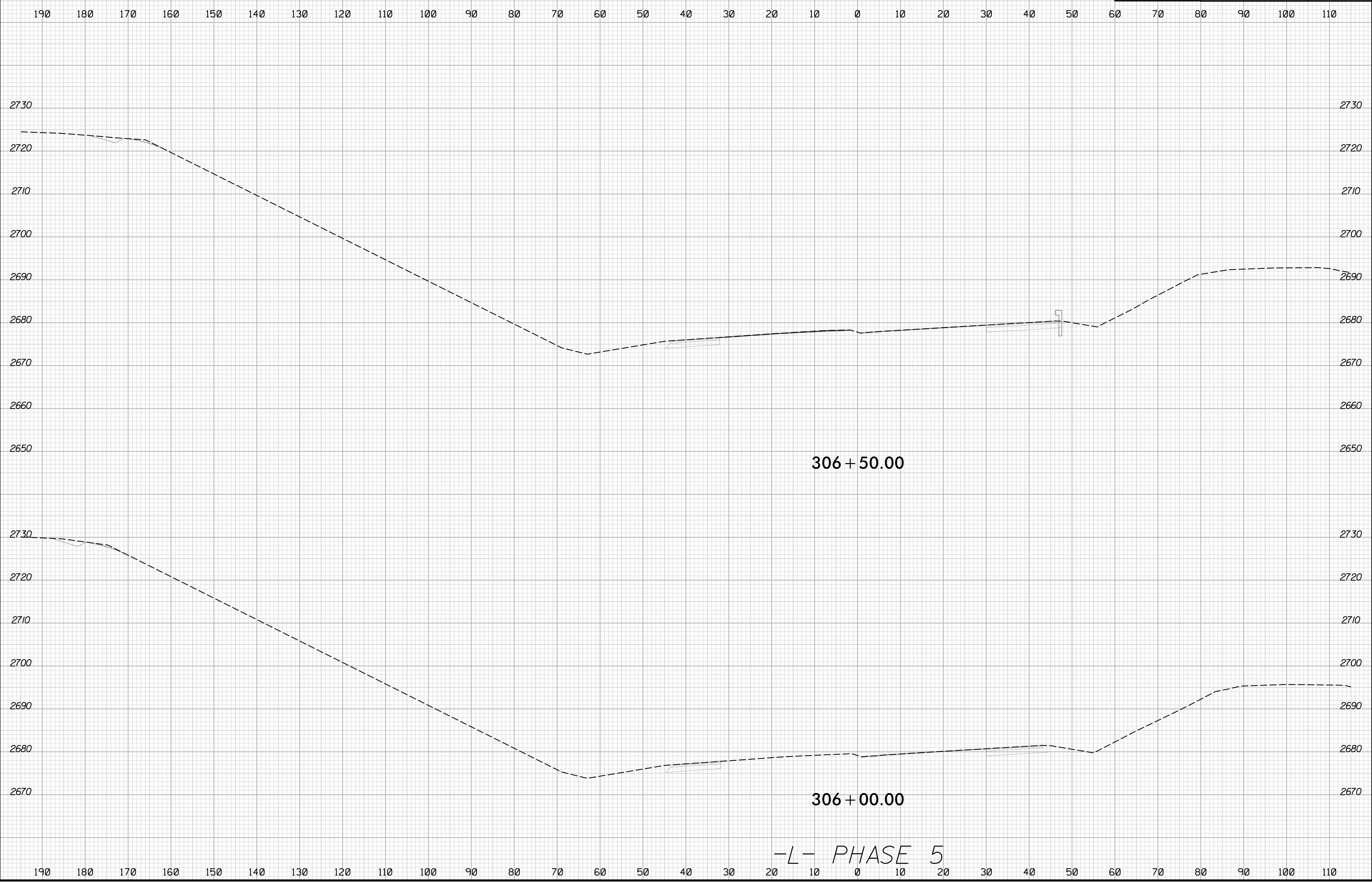

2/16/2024  
I:\HB\0002\_r.dwg - phase 5.dgn

8/23/99

	PROJ. REFERENCE NO.	SHEET NO.
	HB-0002	X-98

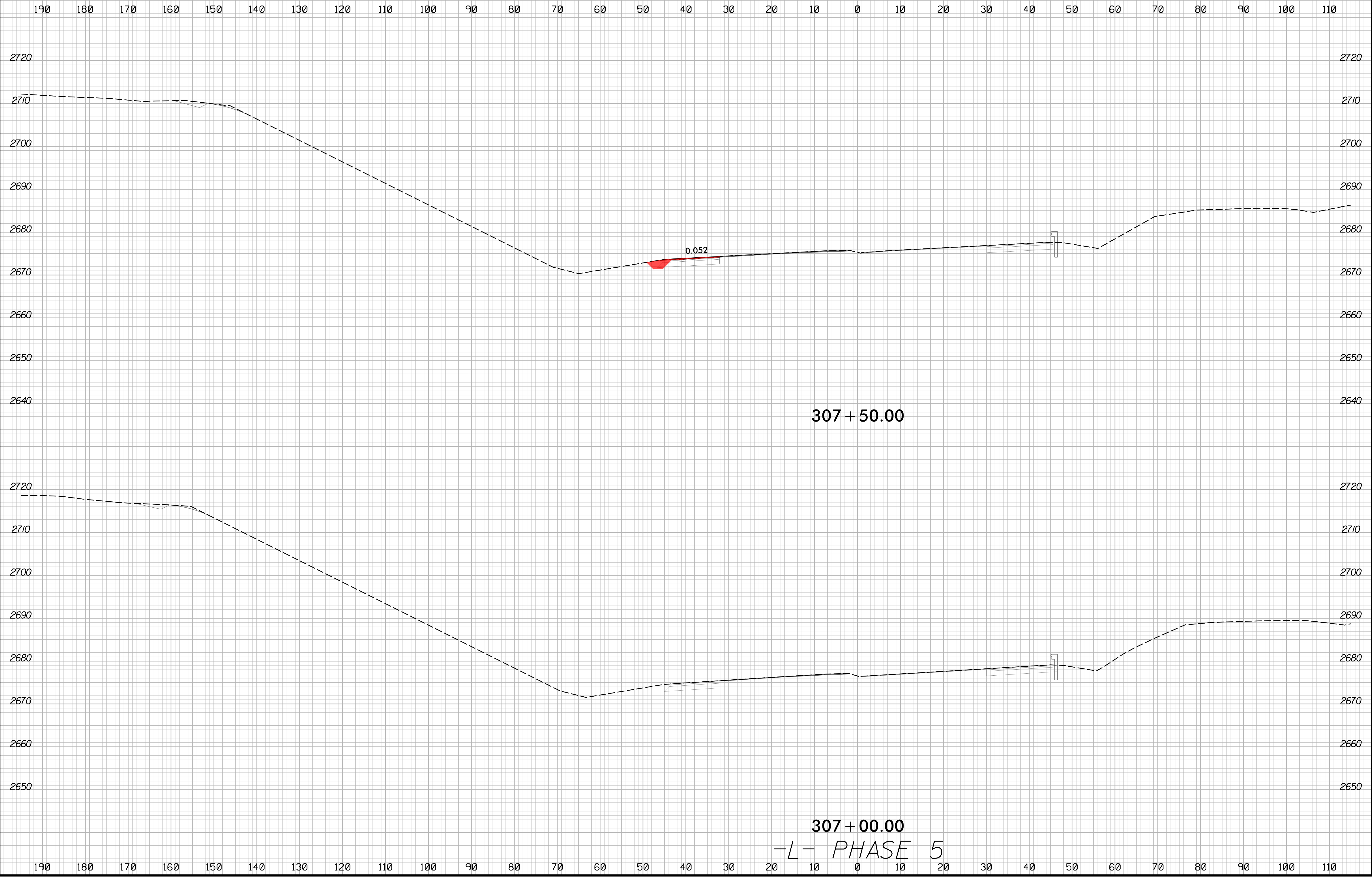

2/16/2024  
I:\HB\0002\_rdy\_xpl\_L\_phase-5.dgn  
JSE/16/2024

307 + 00.00  
-L- PHASE 5



8/23/99

0 5 10	PROJ. REFERENCE NO.	SHEET NO.
	HB-0002	X-99

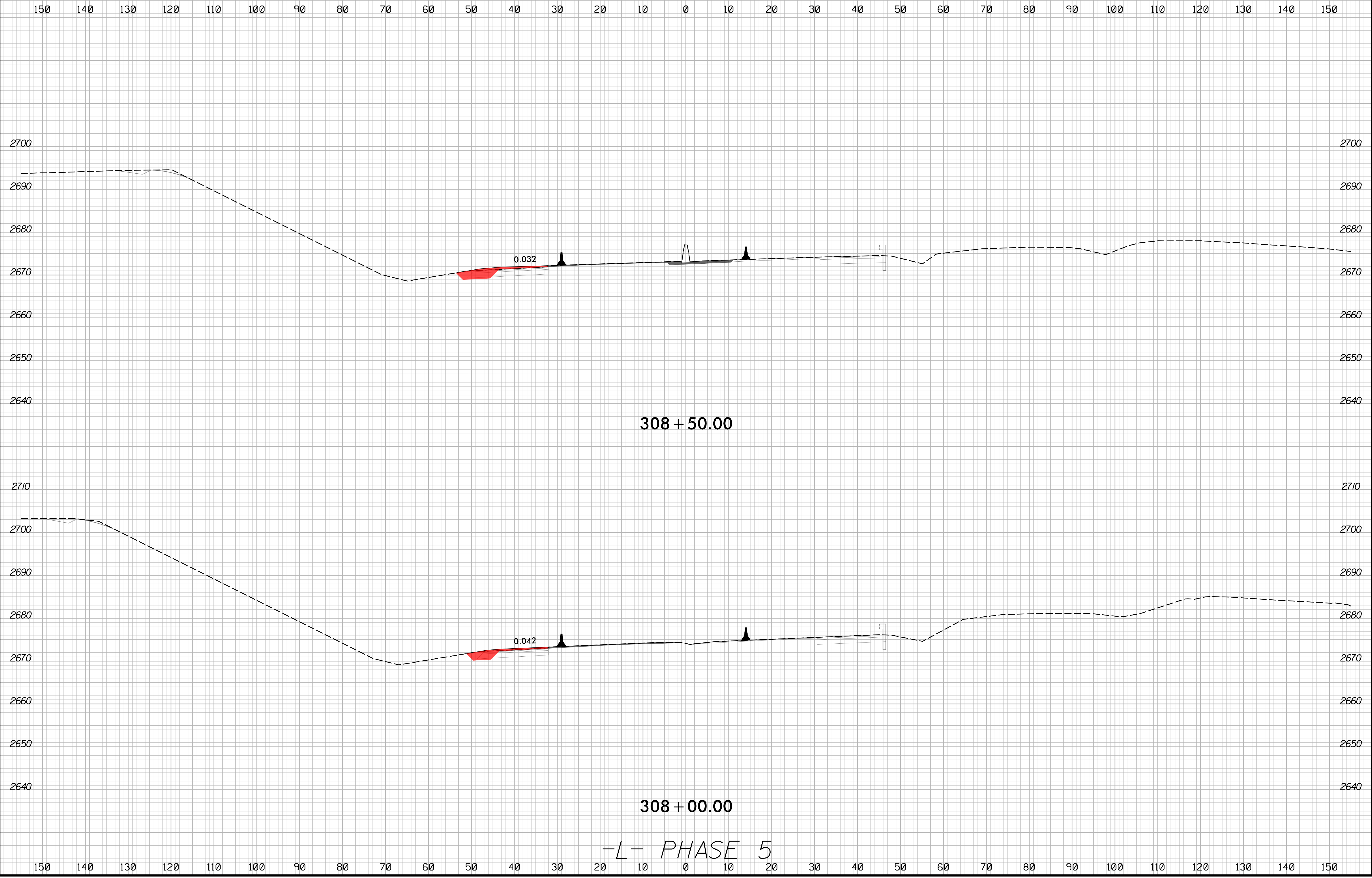

2/16/2024  
I:\S\HB\0002\_rdy\_xpl.L\_phase-5.dgn

-L- PHASE 5

8/23/99

	PROJ. REFERENCE NO.	SHEET NO.
	HB-0002	X-100

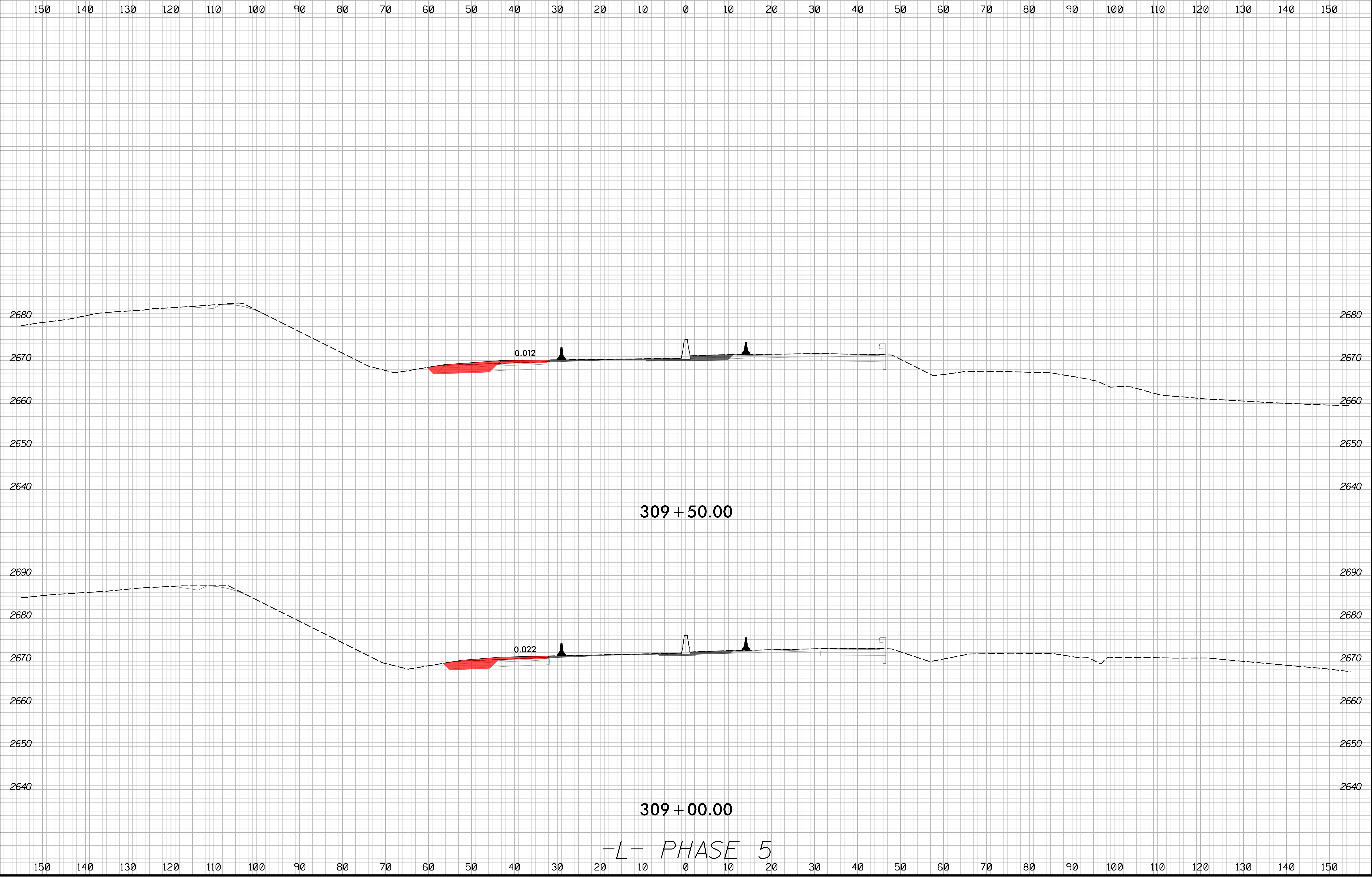

2/16/2024  
I:\HB\0002\_rdy\_xpl.L\_phase-5.dgn  
JSE

-L- PHASE 5

8/23/99

0 5 10	PROJ. REFERENCE NO.	SHEET NO.
	HB-0002	X-101

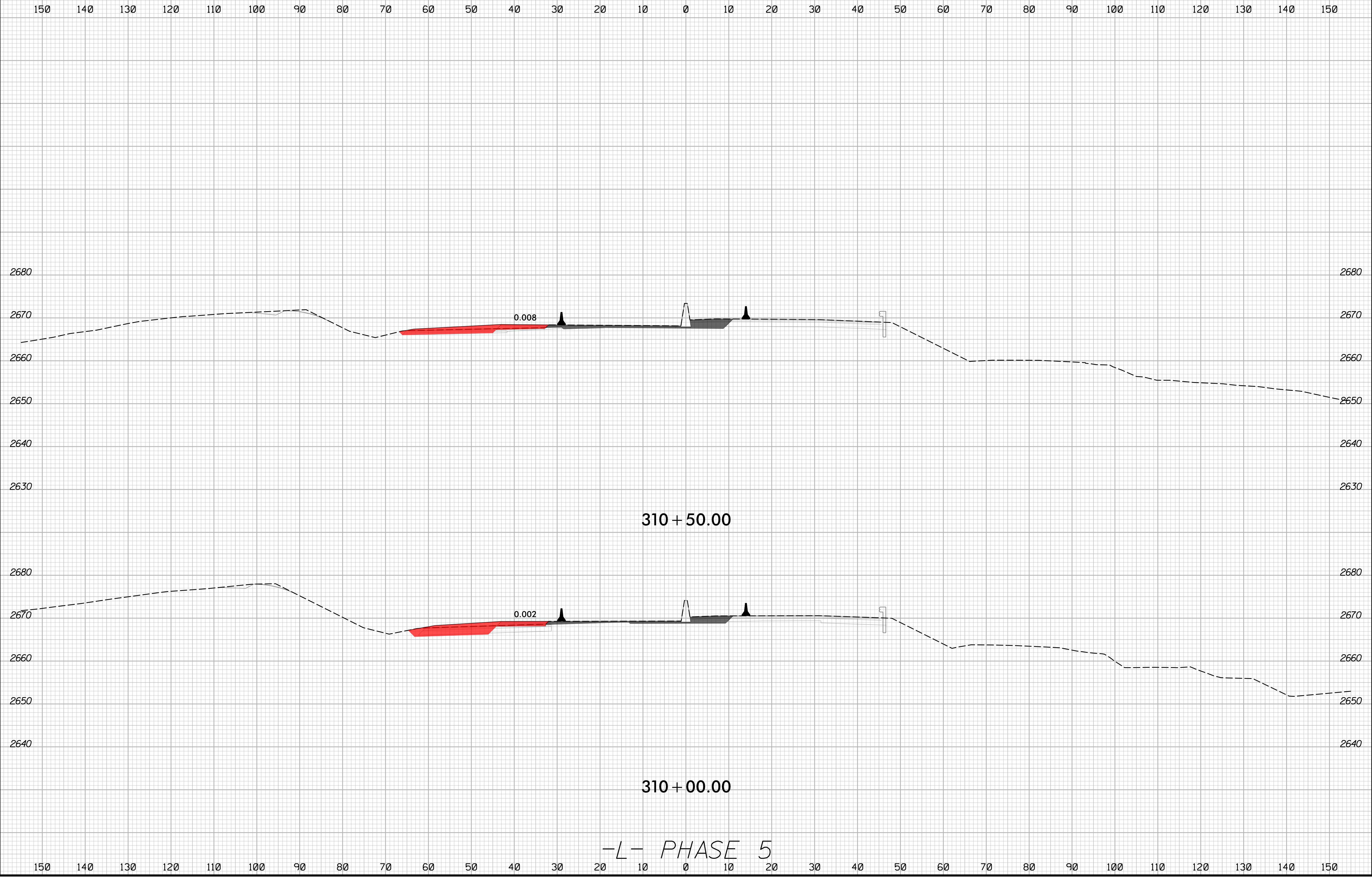

2/16/2024  
I:\HB\0002\_rdy\_xpl\_L\_phase-5.dgn  
JSE

-L- PHASE 5

8/23/99

0 5 10	PROJ. REFERENCE NO.	SHEET NO.
	HB-0002	X-102

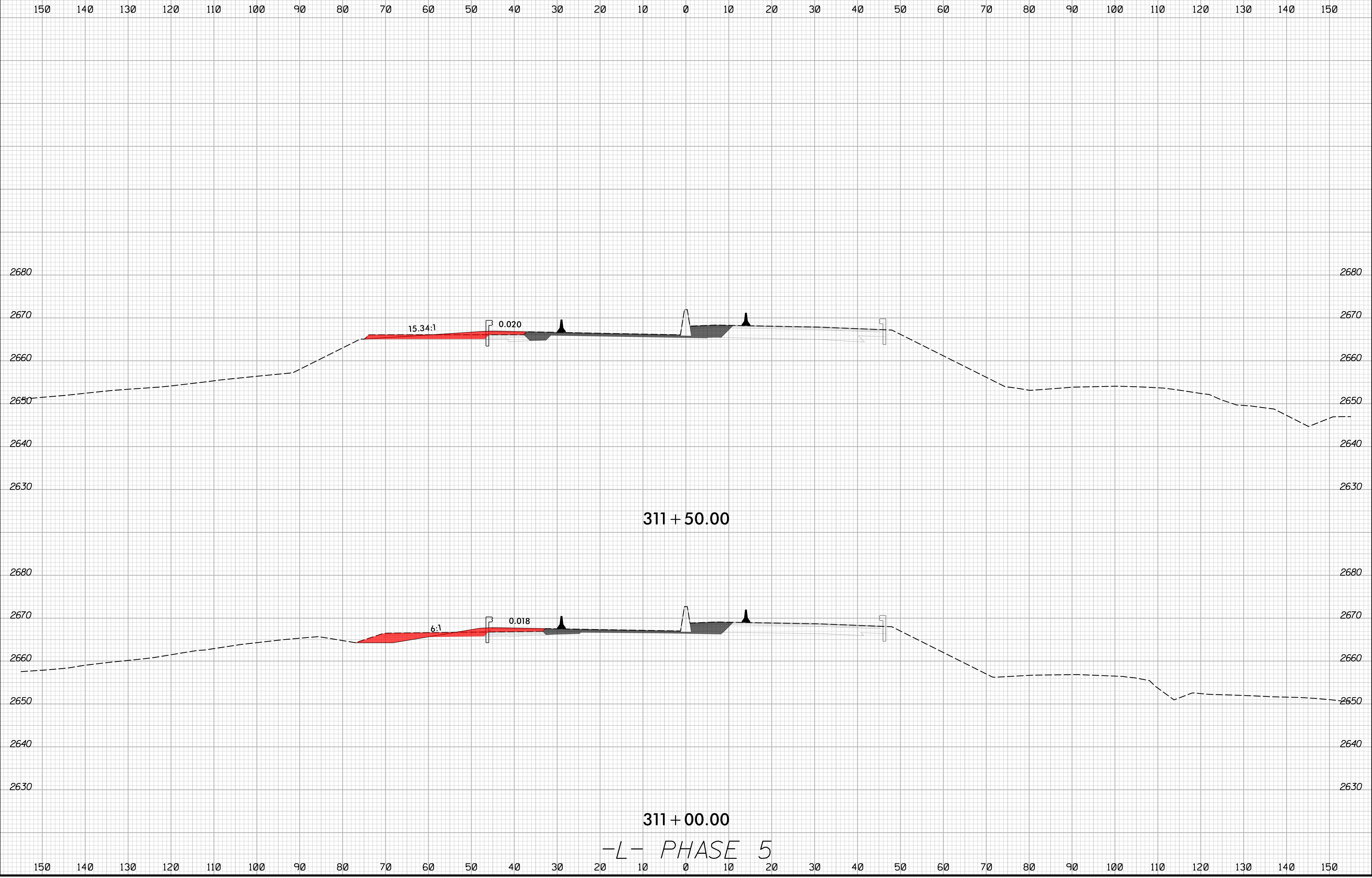

2/16/2024  
I:\HB\0002\_rdy\_xpl\_L\_phase-5.dgn  
JSE



8/23/99

	PROJ. REFERENCE NO.	SHEET NO.
	HB-0002	X-103

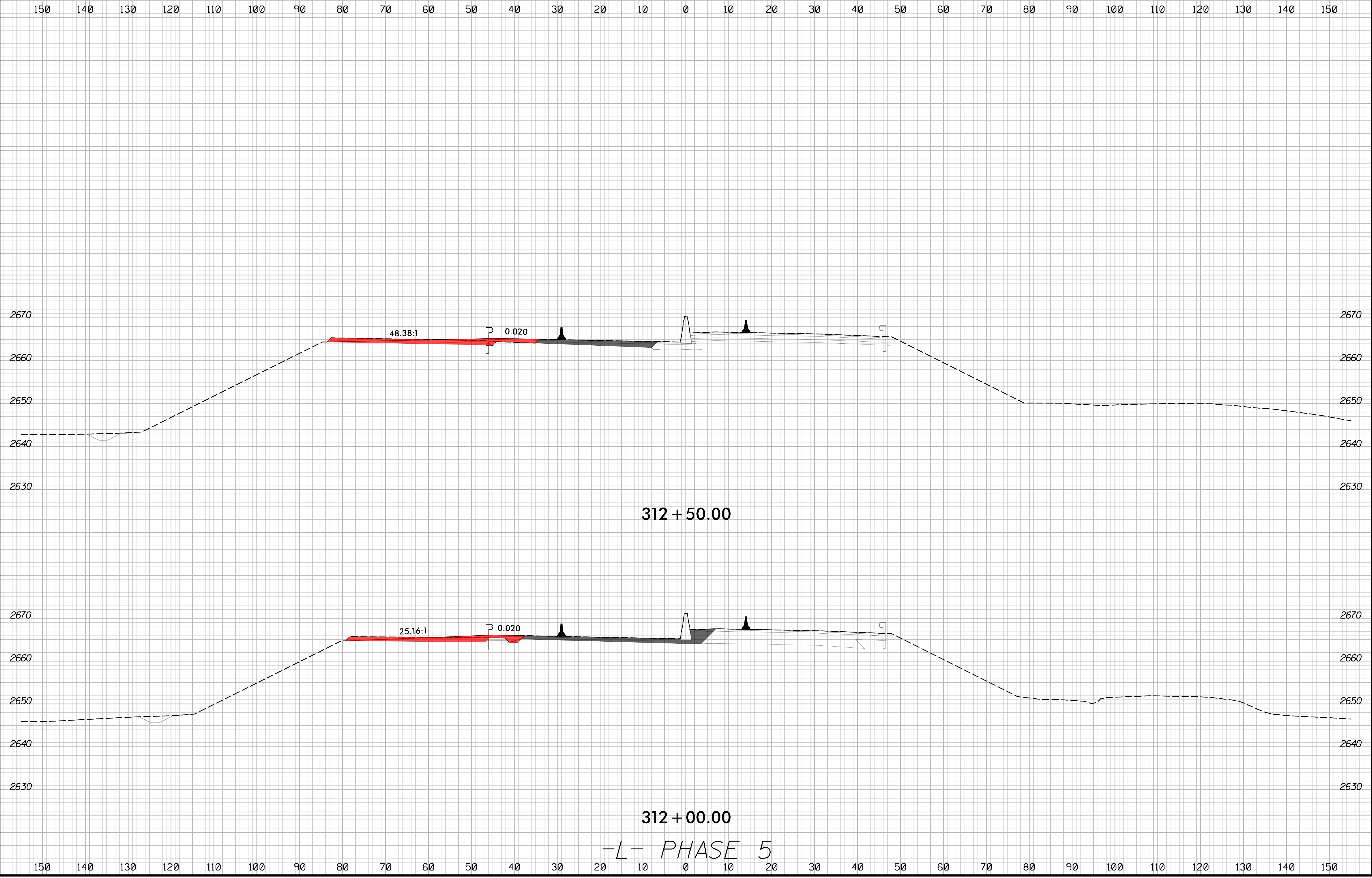

2/16/2024  
I:\HB\0002\_rdy\_xpl\_L\_phase-5.dgn  
JSE

8/23/99

0 5 10	PROJ. REFERENCE NO.	SHEET NO.
	HB-0002	X-104

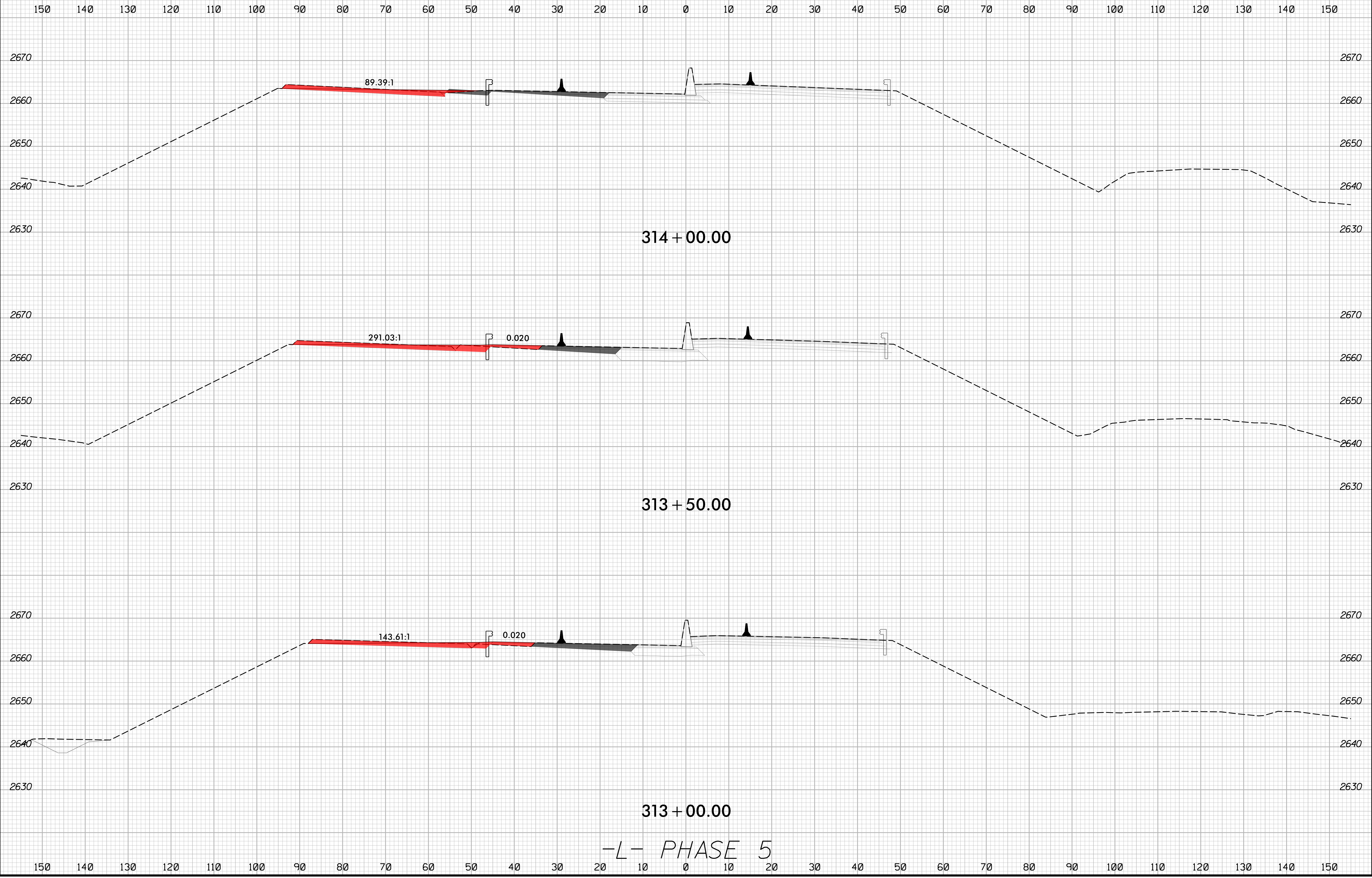

2/16/2024  
1:51:13 PM  
I:\S:\HB\0002\_rdy\_xpl\_L\_phase-5.dgn

-L- PHASE 5

8/23/99

0 5 10	PROJ. REFERENCE NO.	SHEET NO.
	HB-0002	X-105

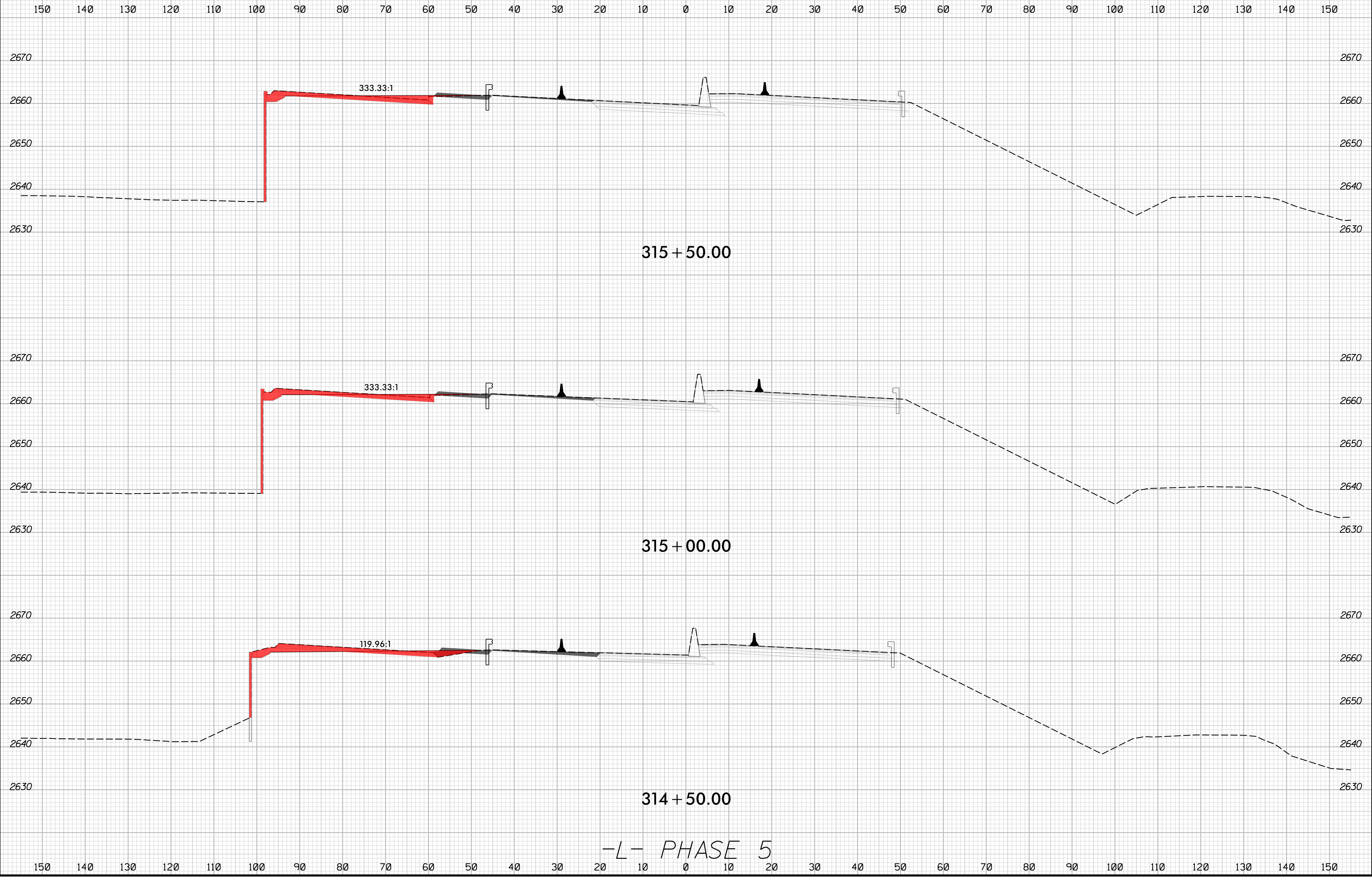

-L- PHASE 5

2/16/2024  
1:51:13 PM  
I:\Projects\HB002\_rdy\_xpl\_L\_phase-5.dgn

8/23/99

	PROJ. REFERENCE NO.	SHEET NO.
	HB-0002	X-106

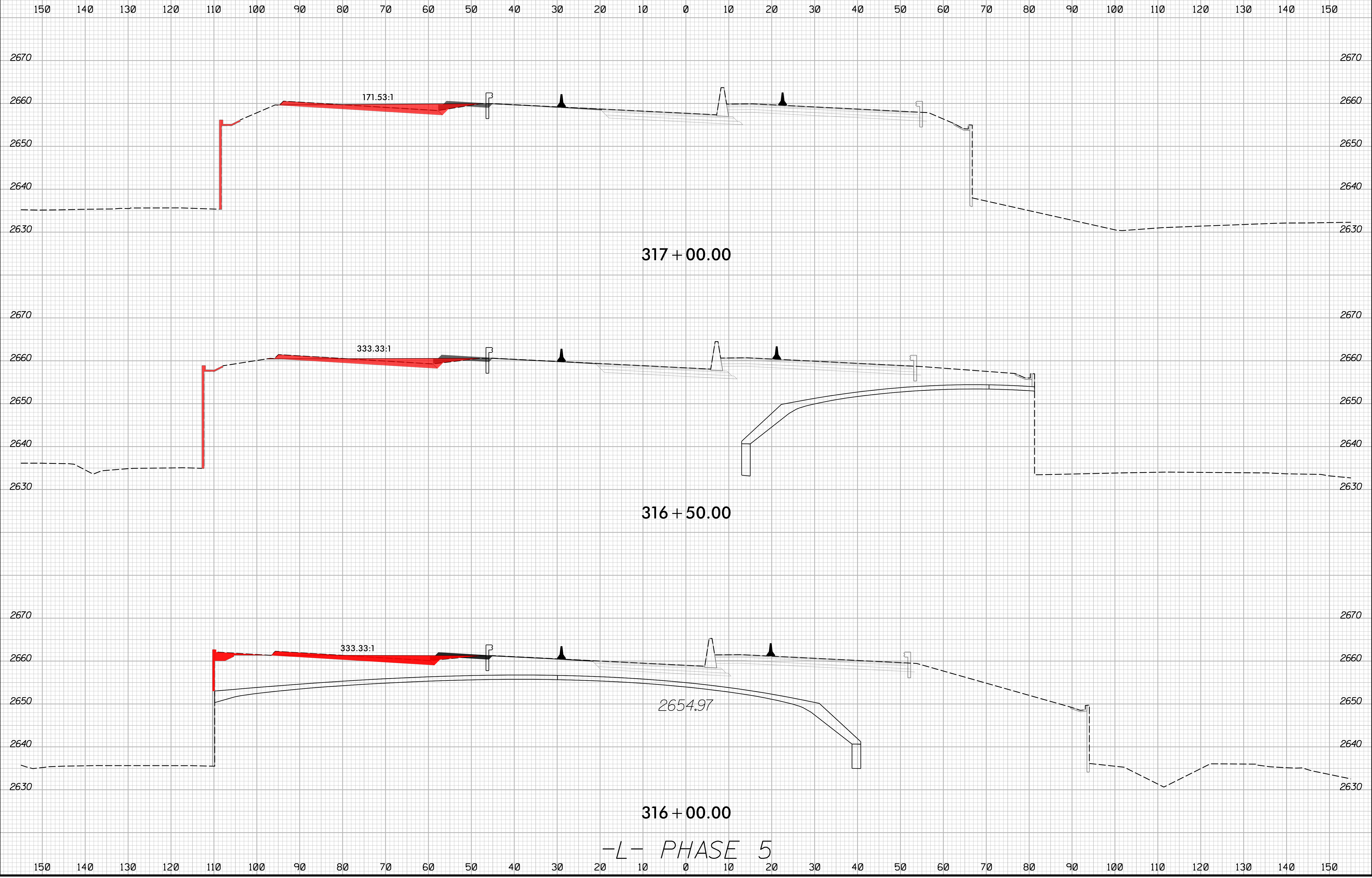

2/16/2024  
I:\HB\0002\_rdy\_xpl\_L\_phase-5.dgn  
JSE



8/23/99

	PROJ. REFERENCE NO.	SHEET NO.
	HB-0002	X-107

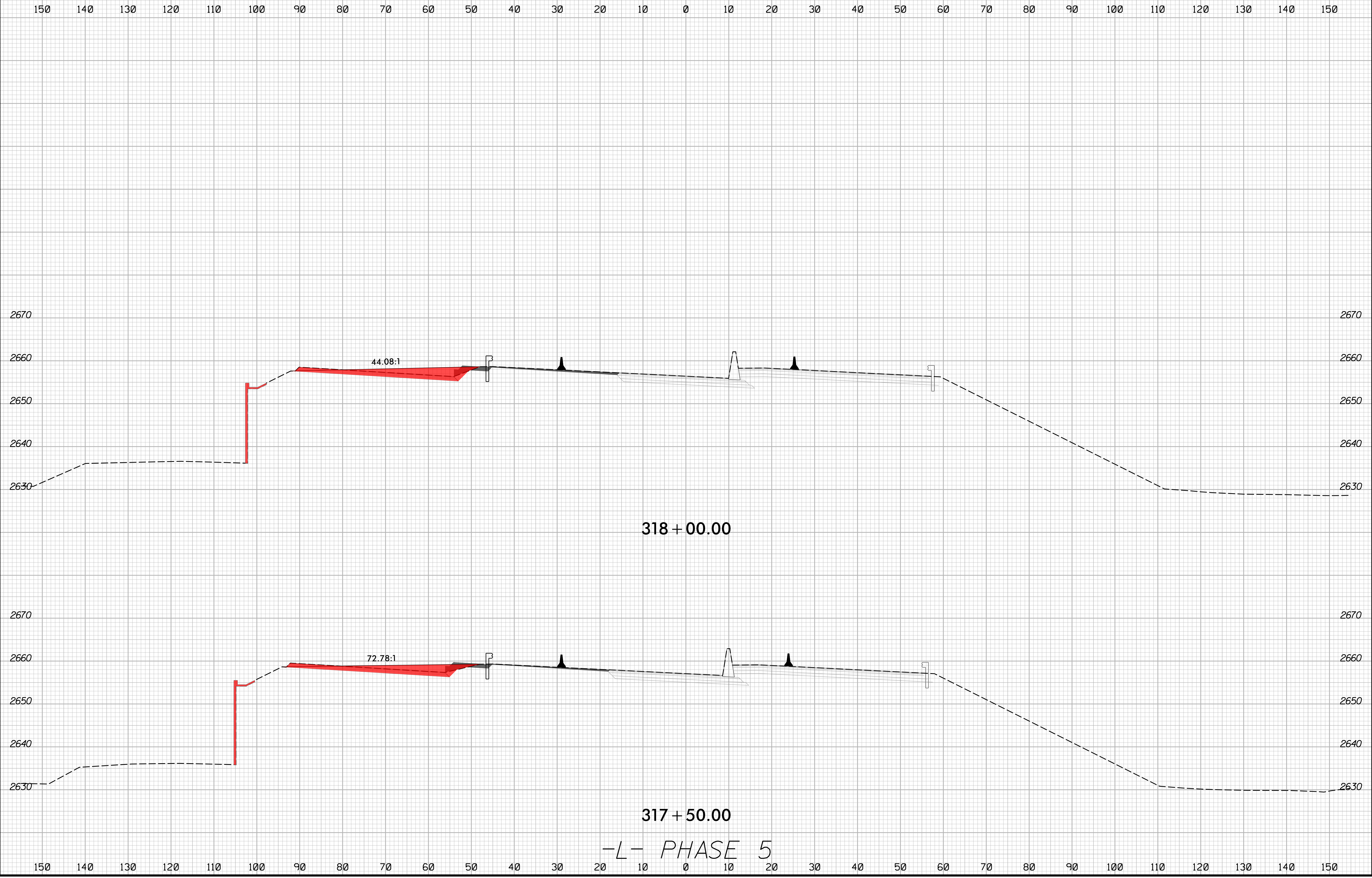

2/16/2024  
I:\HB\0002\_rdy\_xpl\_L\_phase-5.dgn  
JSE:rlr

8/23/99

	PROJ. REFERENCE NO.	SHEET NO.
	HB-0002	X-108

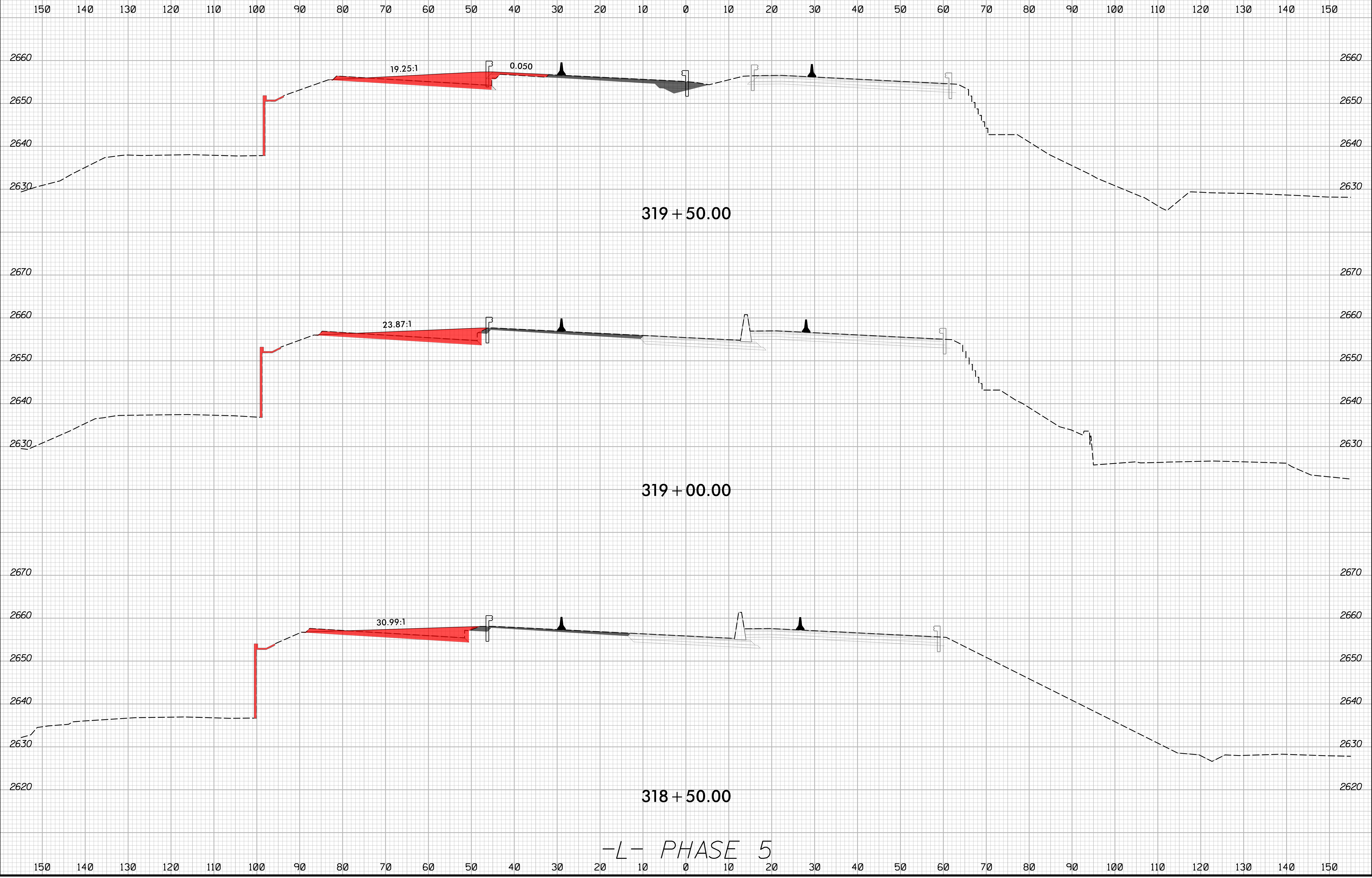

2/16/2024  
I:\HB\0002\_rdy\_xpl\_L\_phase-5.dgn  
JSE

8/23/99

	PROJ. REFERENCE NO.	SHEET NO.
	HB-0002	X-109

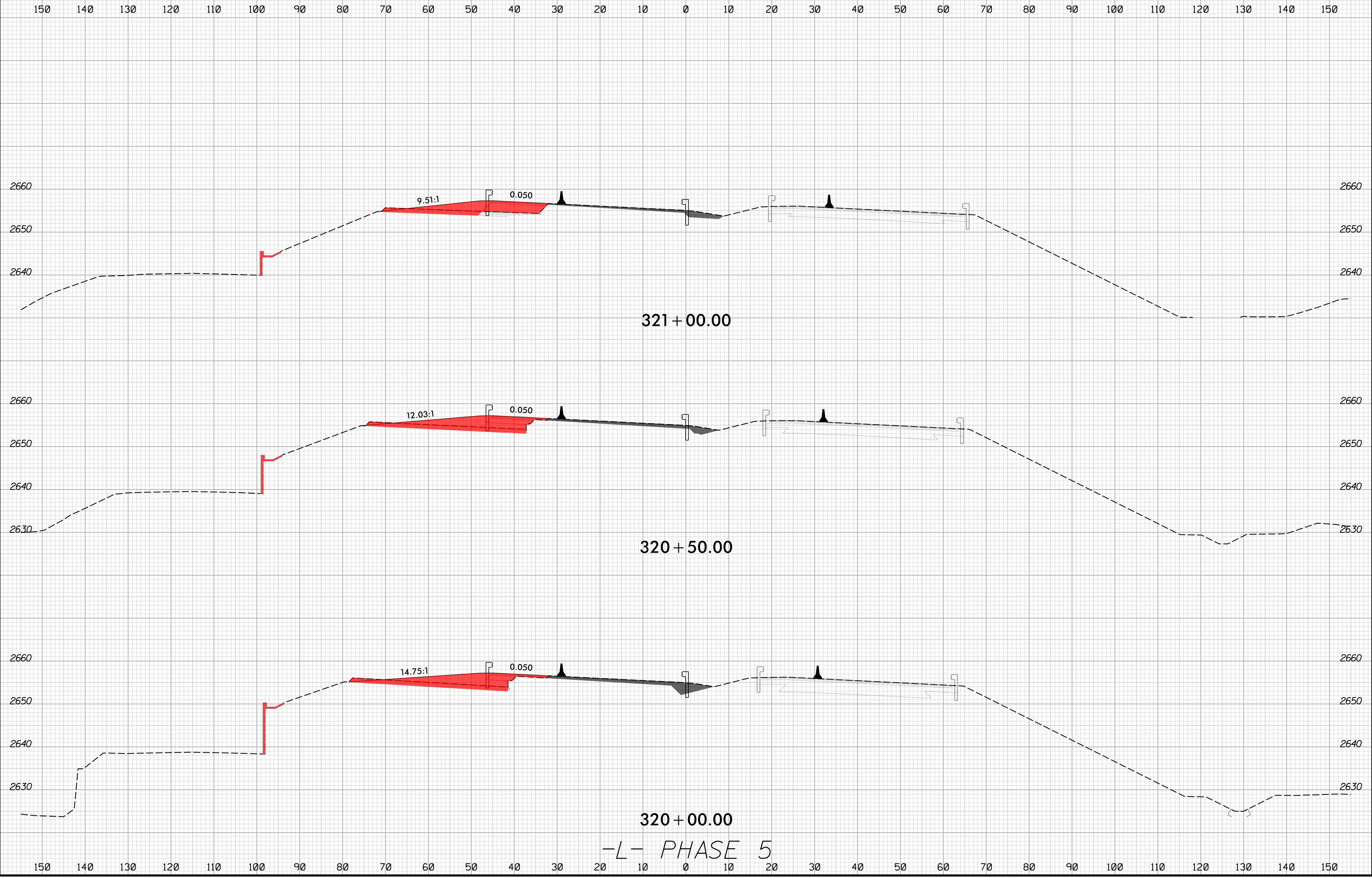

-L- PHASE 5

2/16/2024  
I:\HB\0002\_rdy\_xpl\_L\_phase-5.dgn  
JSE

8/23/99

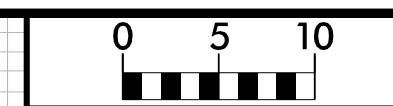

PROJ. REFERENCE NO.	SHEET NO.
HB-0002	X-110

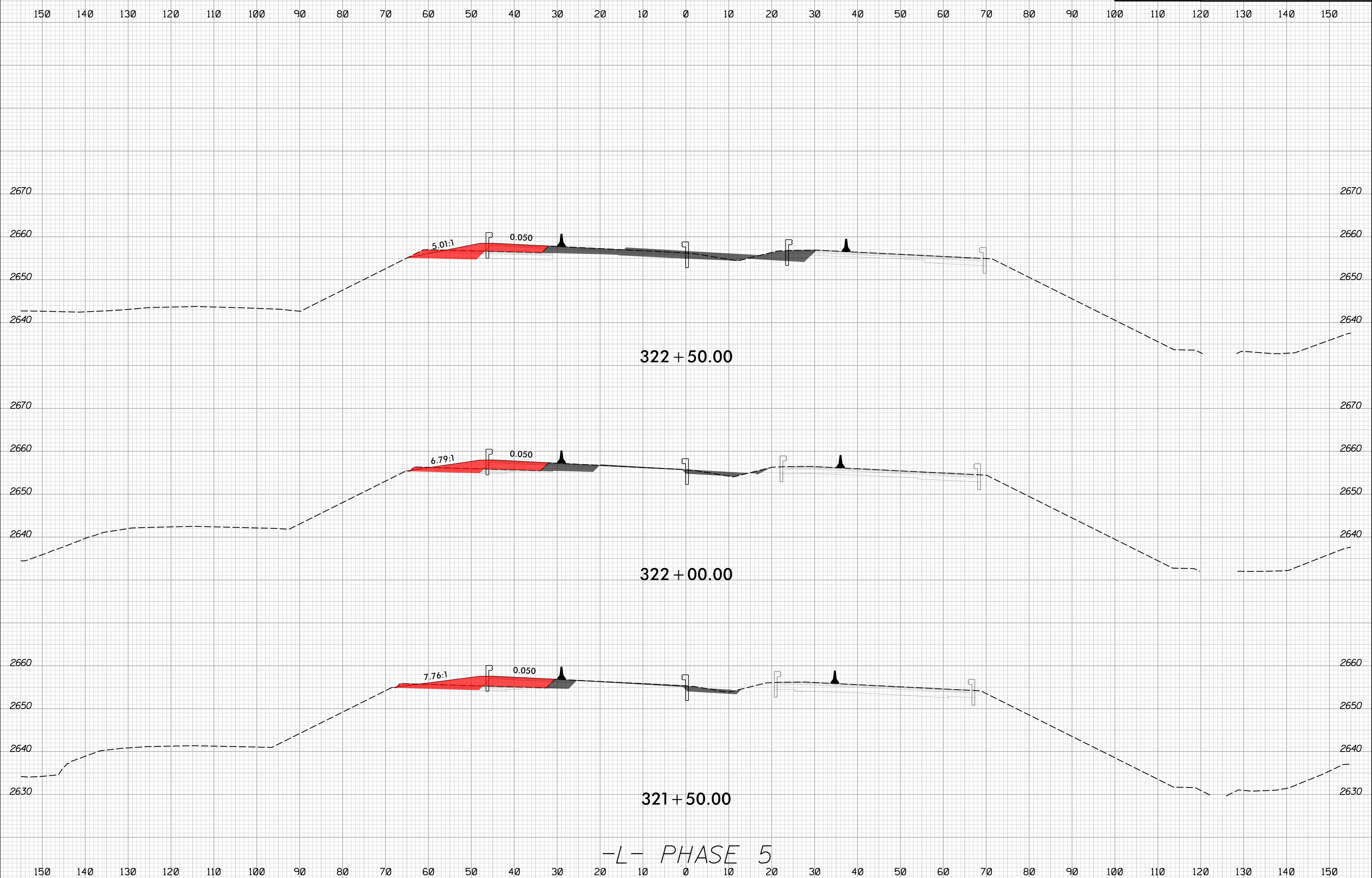

-L- PHASE 5

2/16/2024  
I:\HB\0002\_rdy\_xpl\_L\_phase-5.dgn  
JSE/ETC/etf



8/23/99

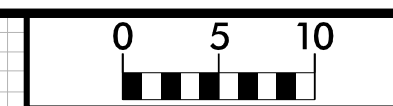

PROJ. REFERENCE NO.	SHEET NO.
HB-0002	X-111

150 140 130 120 110 100 90 80 70 60 50 40 30 20 10 0 10 20 30 40 50 60 70 80 90 100 110 120 130 140 150

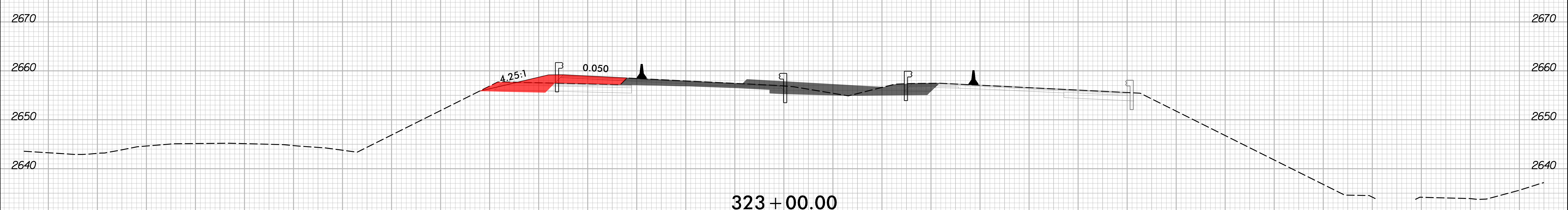
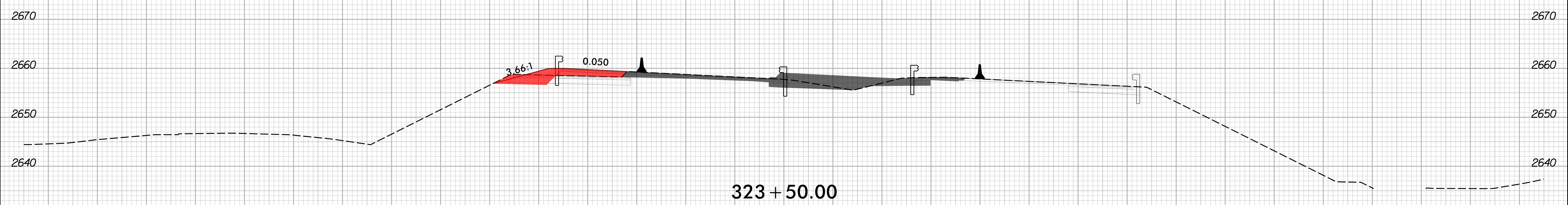
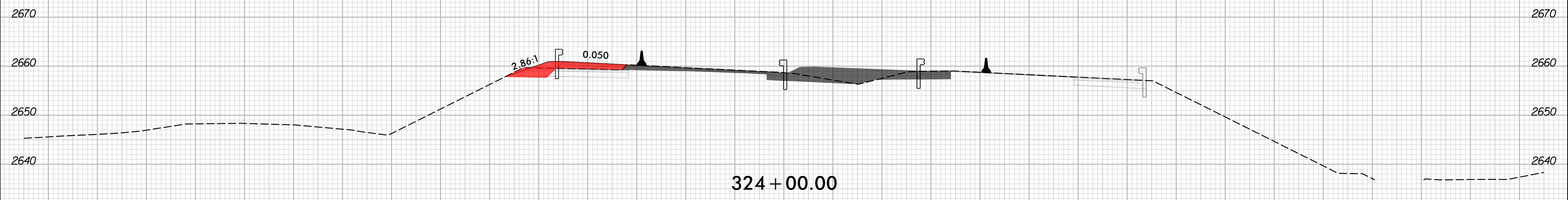

-L- PHASE 5

2/16/2024  
I:\HB\0002\_rdy\_xpl\_L\_phase-5.dgn  
JSE/ETG

8/23/99

	PROJ. REFERENCE NO.	SHEET NO.
	HB-0002	X-112

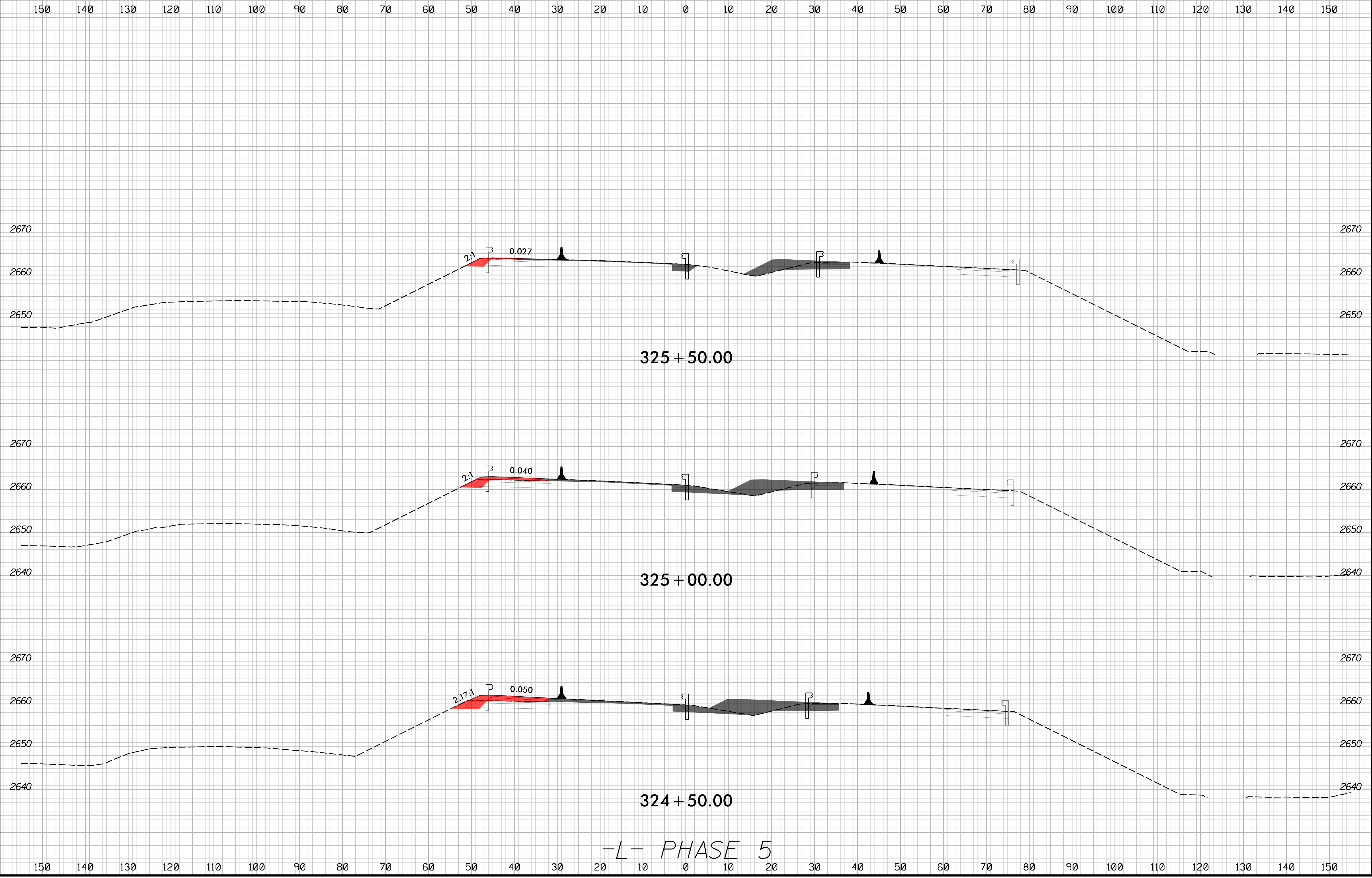

-L- PHASE 5

2/16/2024  
I:\HB\0002\_rdy\_xpl\_L\_phase-5.dgn  
JSE/13/11/2024

8/23/99

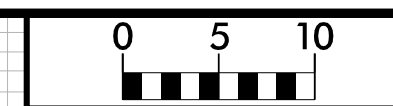

PROJ. REFERENCE NO.	SHEET NO.
HB-0002	X-113

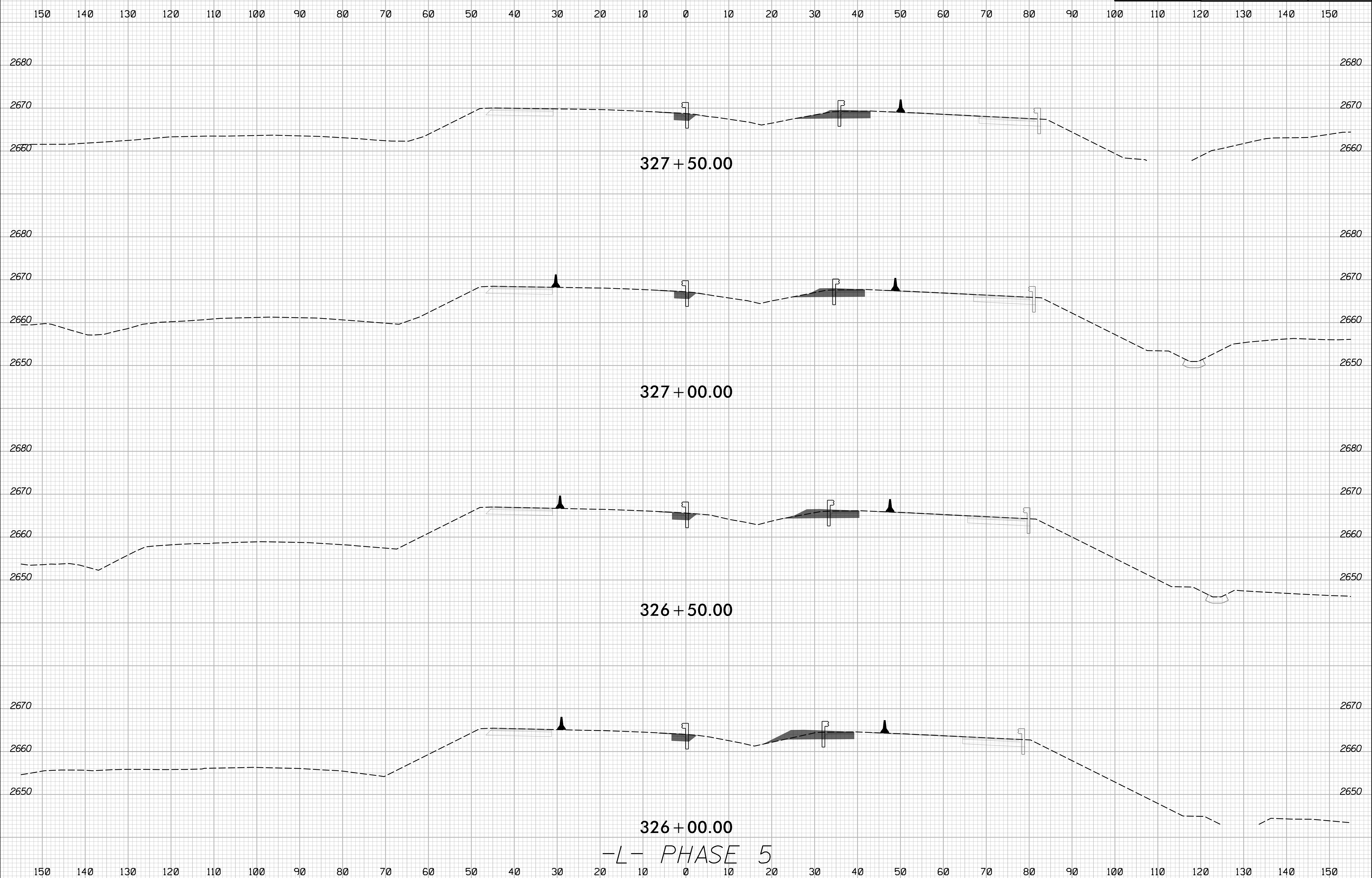

2/16/2024  
I:\S:\HB\0002\_rdy\_xpl.L\_phase-5.dgn  
JSE/ETG

8/23/99

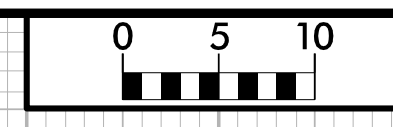

PROJ. REFERENCE NO.	SHEET NO.
HB-0002	X-114

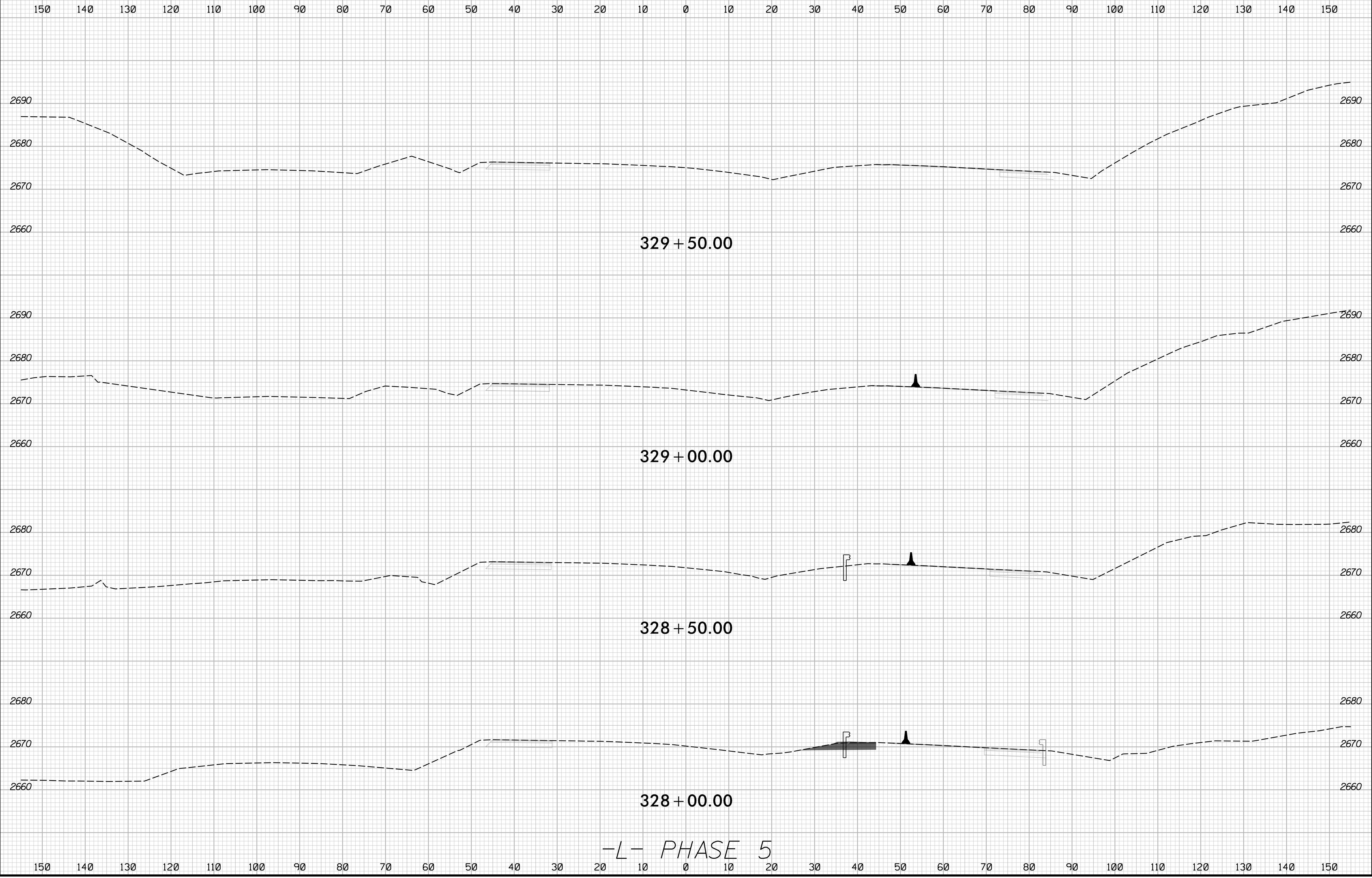

2/16/2024  
I:\HB\0002\_rdy\_xpl\_L\_phase-5.dgn  
JSE



8/23/99

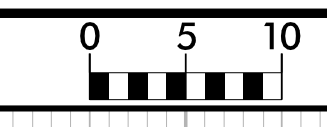

PROJ. REFERENCE NO.	SHEET NO.
HB-0002	X-115

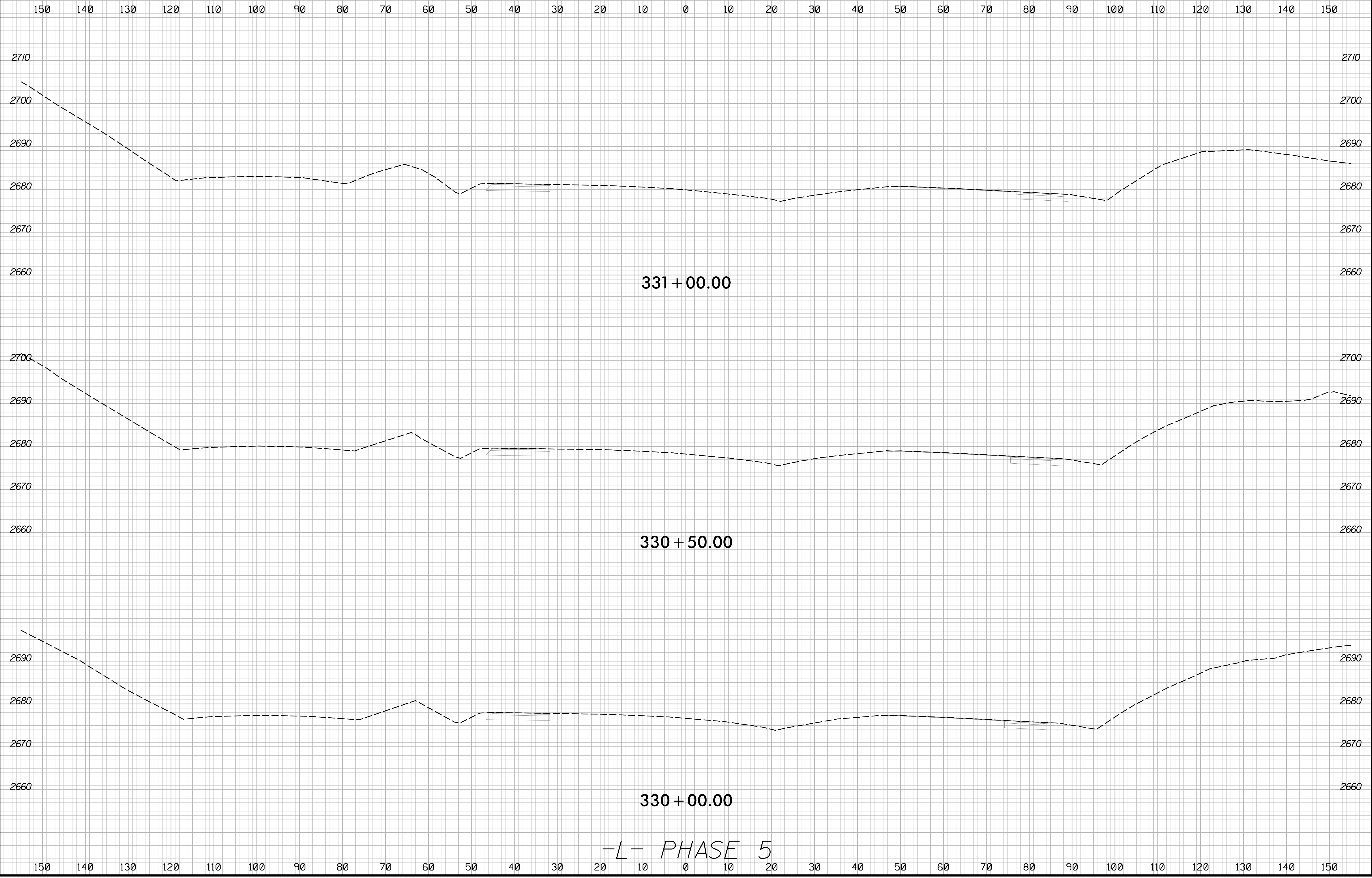

-L- PHASE 5

2/16/2024  
I:\HB\0002\_rdy\_xpl\_L\_phase-5.dgn  
JSE

8/23/99

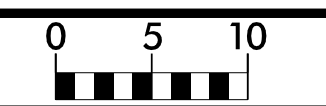

PROJ. REFERENCE NO.	SHEET NO.
HB-0002	X-116

150 140 130 120 110 100 90 80 70 60 50 40 30 20 10 0 10 20 30 40 50 60 70 80 90 100 110 120 130 140 150

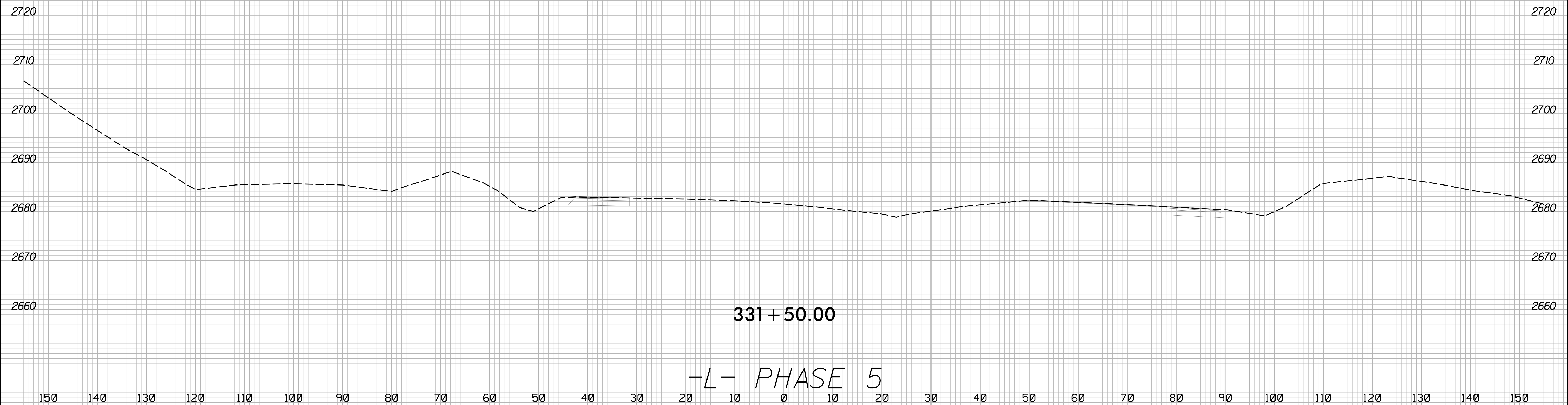

2/16/2024  
 I:\HB\0002\_rdy\_xpl.L\_phase-5.dgn  
 J:\ERIC\ref

8/23/99

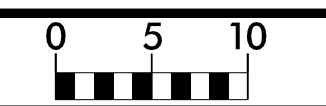

PROJ. REFERENCE NO.	SHEET NO.
HB-0002	X-117

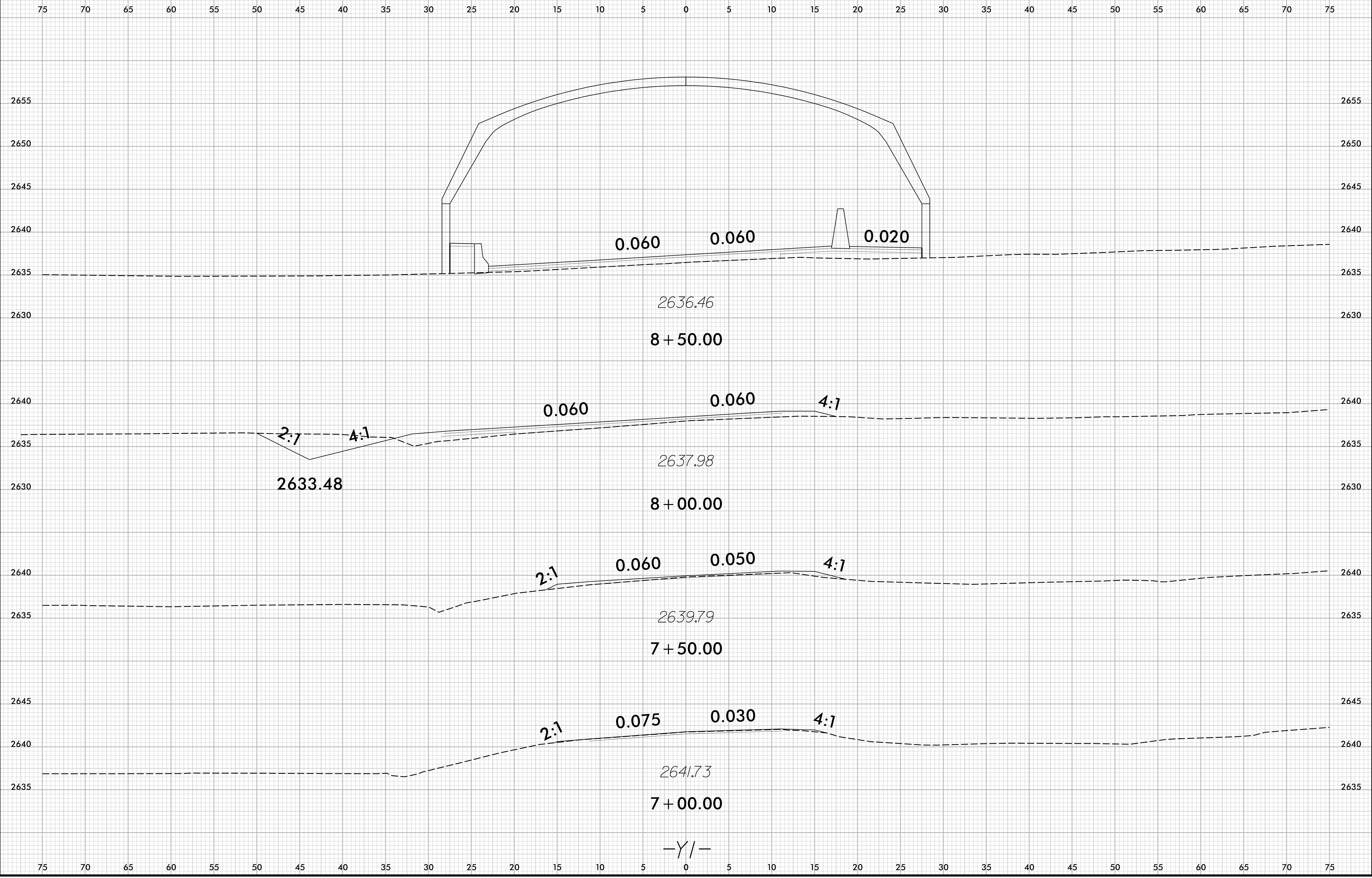

2/16/2024  
1:5:18:00  
1:5:18:00  
1:5:18:00

8/23/99

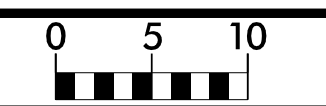

PROJ. REFERENCE NO.	SHEET NO.
HB-0002	X-118

75 70 65 60 55 50 45 40 35 30 25 20 15 10 5 0 5 10 15 20 25 30 35 40 45 50 55 60 65 70 75

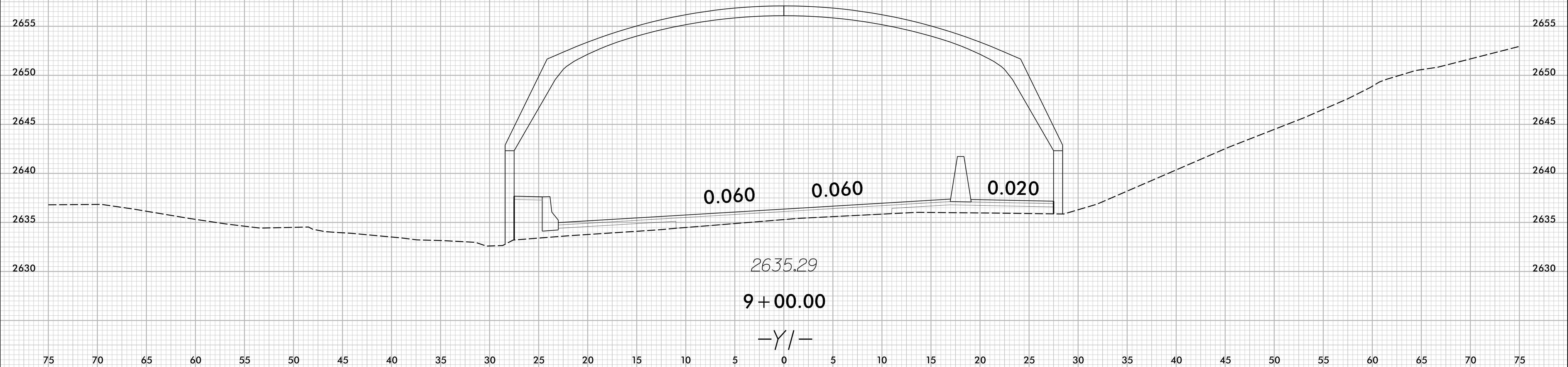
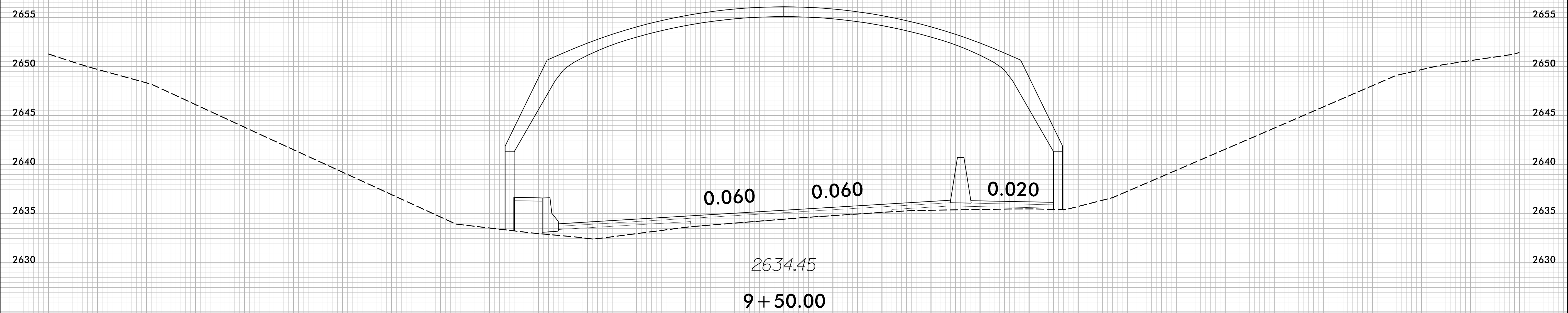

75 70 65 60 55 50 45 40 35 30 25 20 15 10 5 0 5 10 15 20 25 30 35 40 45 50 55 60 65 70 75

2/16/2024  
I:\HB\0002\_r.dwg\_xpl.y1.dgn  
JSE/ETG

8/23/99

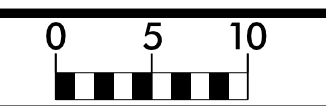

PROJ. REFERENCE NO.	SHEET NO.
HB-0002	X-119

75 70 65 60 55 50 45 40 35 30 25 20 15 10 5 0 5 10 15 20 25 30 35 40 45 50 55 60 65 70 75

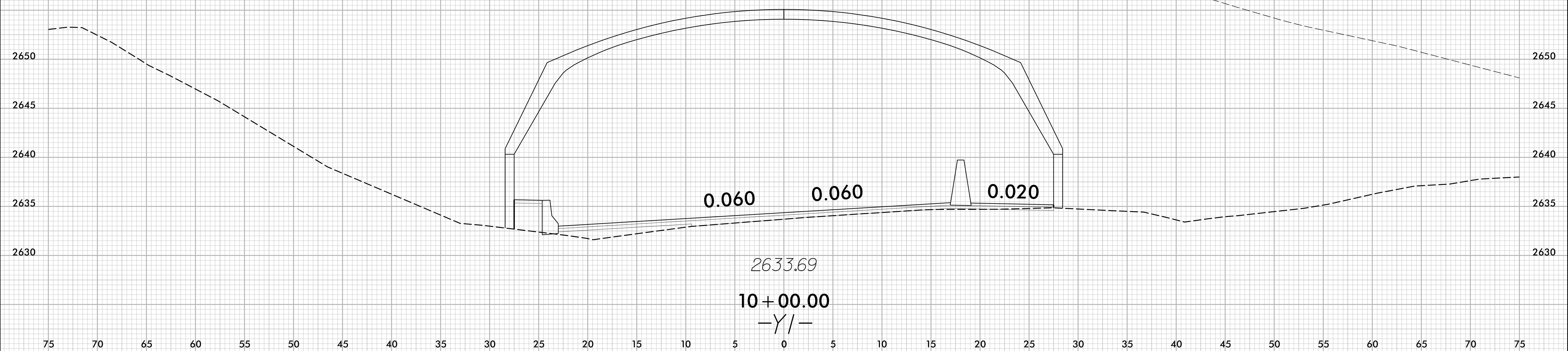
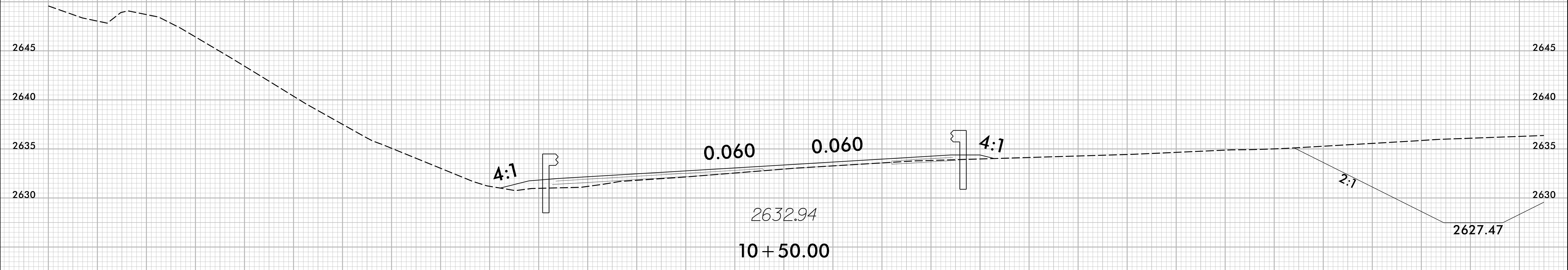
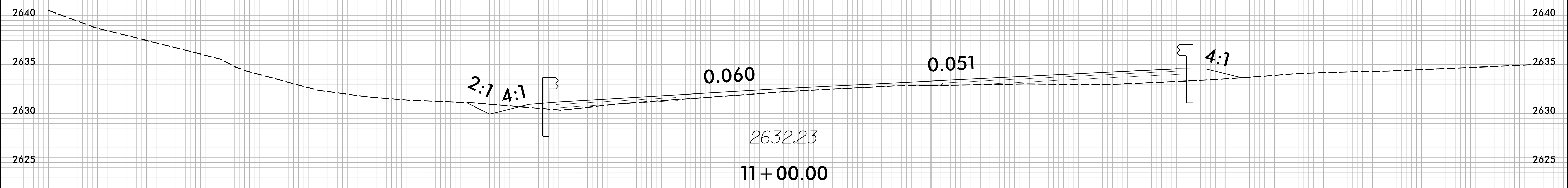

75 70 65 60 55 50 45 40 35 30 25 20 15 10 5 0 5 10 15 20 25 30 35 40 45 50 55 60 65 70 75

2/16/2024  
1:51:13  
I:\S\18002-ar.dwg\_xpl.y1.dgn



8/23/99

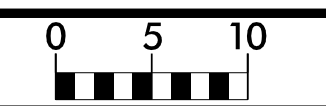

PROJ. REFERENCE NO.	SHEET NO.
HB-0002	X-120

75 70 65 60 55 50 45 40 35 30 25 20 15 10 5 0 5 10 15 20 25 30 35 40 45 50 55 60 65 70 75

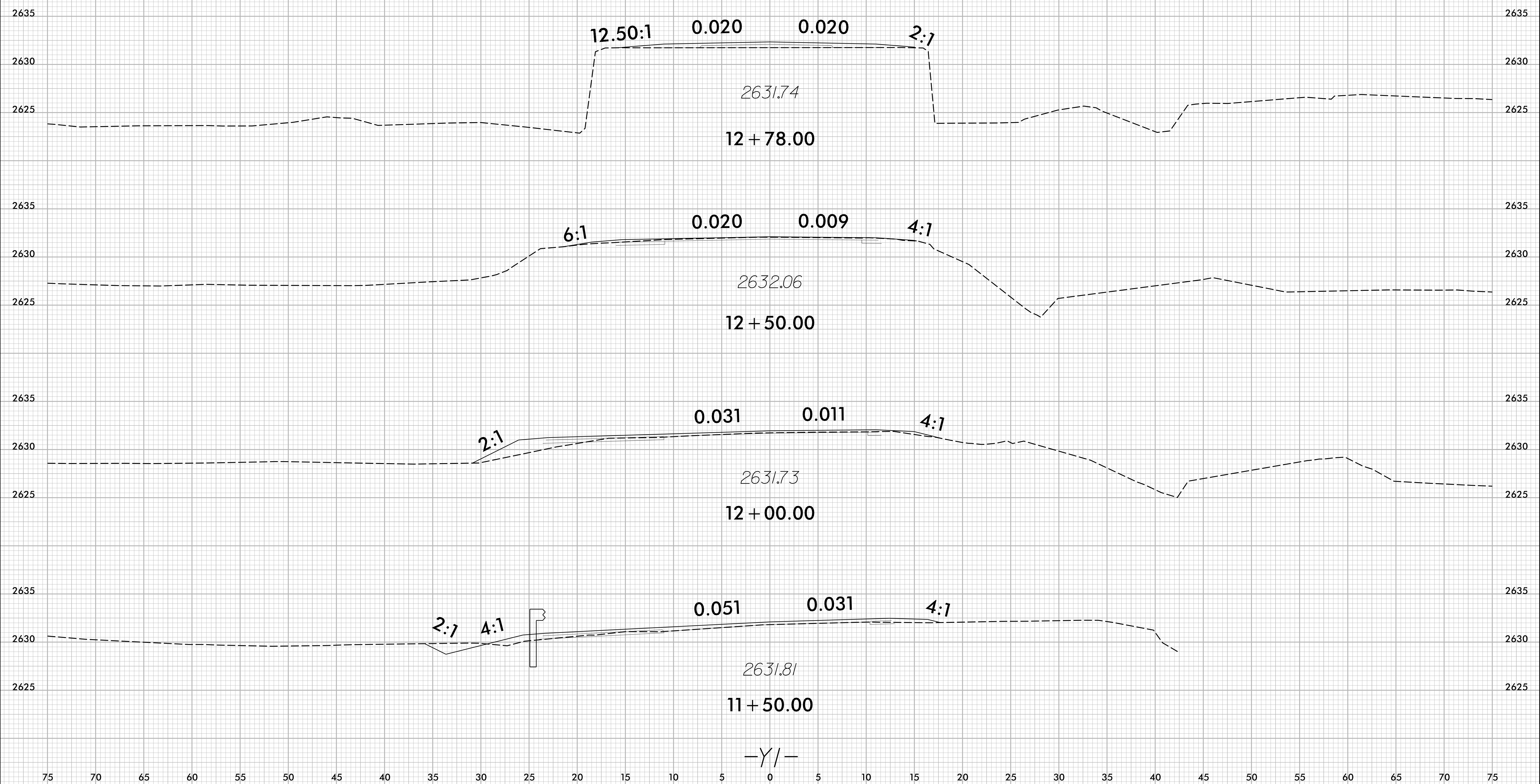

2/16/2024  
 13:18:02  
 I:\HB\0002\_r\dj\_xpl.y1.dgn

8/23/99

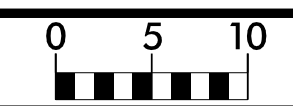

PROJ. REFERENCE NO.	SHEET NO.
HB-0002	X-121

75 70 65 60 55 50 45 40 35 30 25 20 15 10 5 0 5 10 15 20 25 30 35 40 45 50 55 60 65 70 75

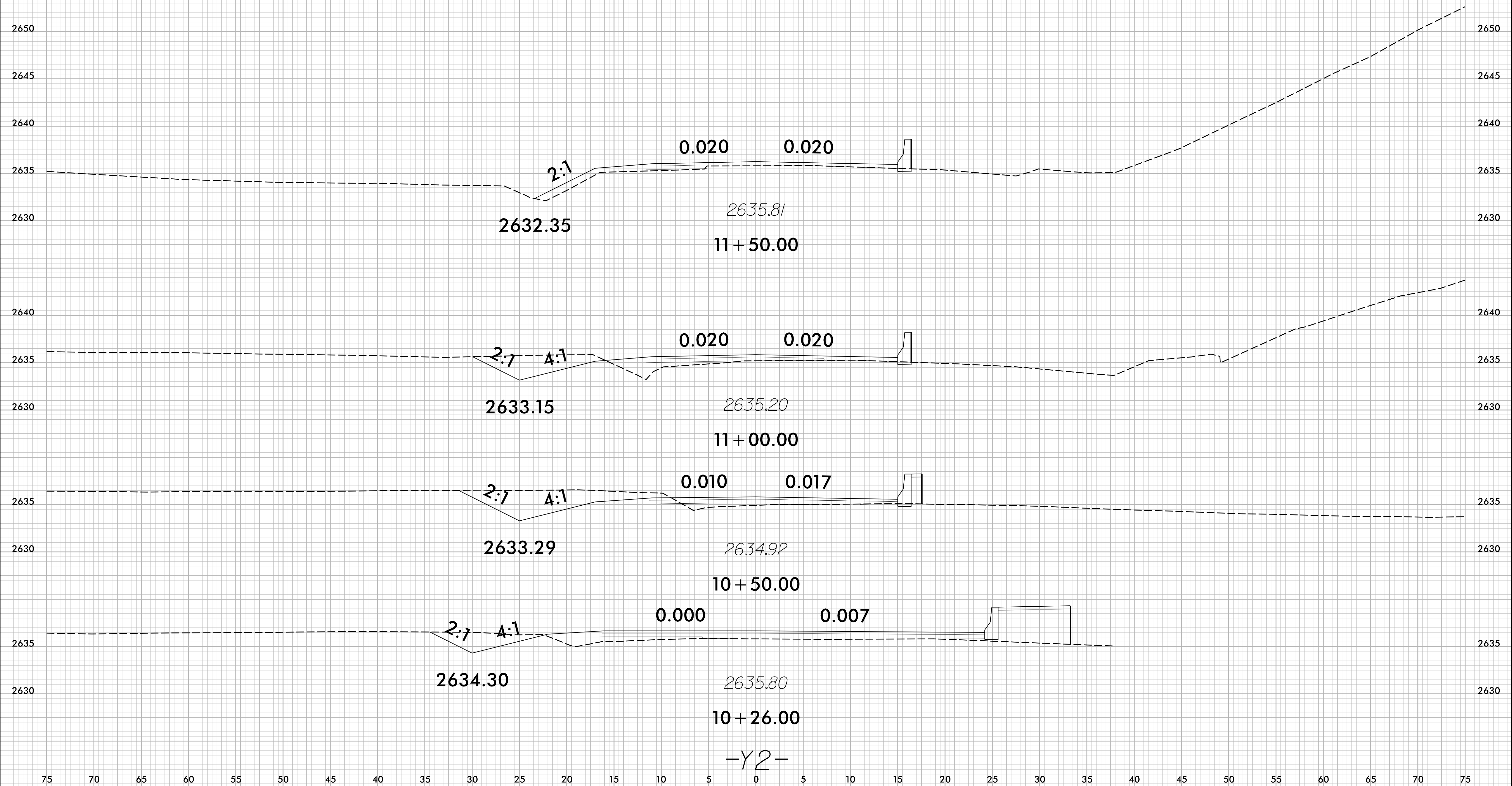

75 70 65 60 55 50 45 40 35 30 25 20 15 10 5 0 5 10 15 20 25 30 35 40 45 50 55 60 65 70 75

2/16/2024  
1:51:13 PM  
I:\S\180002\_r.dwg\_xpl\_v2.dgn

-Y2-

8/23/99

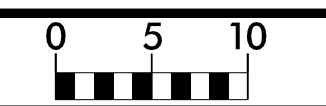

PROJ. REFERENCE NO.	SHEET NO.
HB-0002	X-122

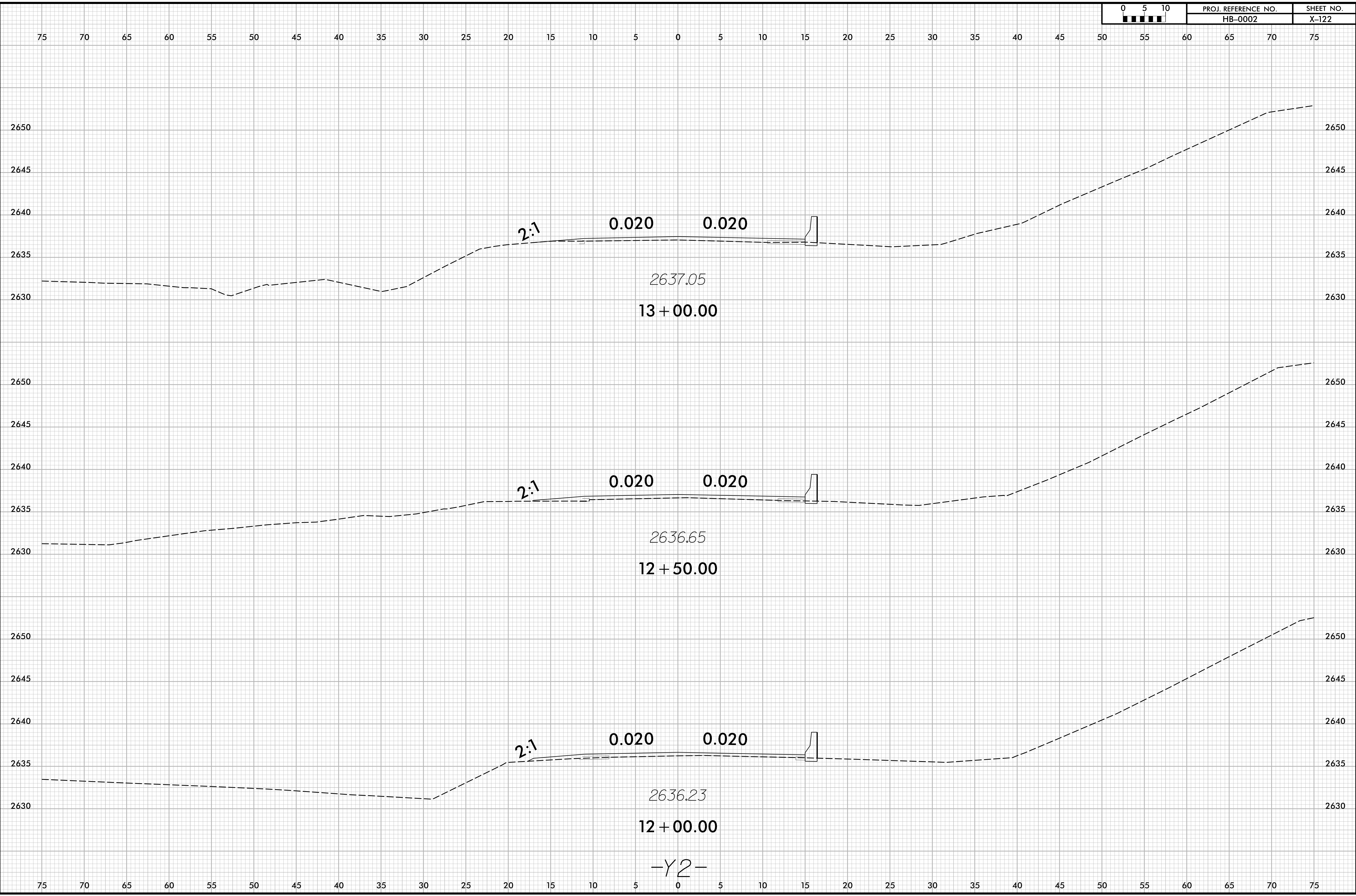

2/16/2024  
1:51:13 PM  
I:\S\HB\0002\_r.dwg\_xpl\_Y2.dgn