

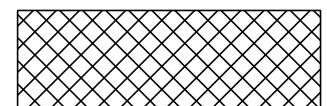

US 158 FORSYTH COUNTY

T.I.P. PROJECT R-2577A
STATE PROJECT # 37405.1.2

<u>LINE</u>	<u>SHEET NO.</u>	<u>LINE</u>	<u>SHEET NO.</u>
-L-	X-1 THRU X-184	-Y15-	X-300 THRU X-301
-L2-	X-185 THRU X-202	-Y16-	X-302
-L-	X-203 THRU X-258	-Y17-	X-303
-Y1A-	X-259 THRU X-261	-Y17A-	X-304
-Y1B-	X-262 THRU X-265	-Y18-	X-305
-Y1C-	X-266	-Y19-	X-306
-Y1D-	X-267	-Y19A-	X-307
-Y1E-	X-268 THRU X-269	-Y20-	X-308 THRU X-309
-Y2-	X-270 THRU X-270A	-Y21-	X-310
-Y3-	X-271	-Y22-	X-311
-Y4-	X-272 THRU X-273	-Y23-	X-312 THRU X-314
-Y5-	X-274 THRU X-279	-Y23A-	X-315
-Y5A-	X-280 THRU X-282	-Y24-	X-316 THRU X-320
-Y6-	X-283	-Y25-	X-321 THRU X-322
-Y7-	X-284	-X-OVER1-	X-254 THRU X-258 & X-323
-Y8-	X-285 THRU X-286	-D1-	X-324
-Y9-	X-287 THRU X-289	-D2-	X-325
-Y10-	X-290 THRU X-291	-D3-	X-326
-Y11-	X-292 THRU X-293	-D4-	X-327
-Y12-	X-294 THRU X-295	-D5-	X-328 THRU X-329
-Y13-	X-296 THRU X-297	-D6-	X-330 THRU X-331
-Y14-	X-298 THRU X-299	-D7-	X-332

UNDERCUT EXCAVATION	
SHALLOW UNDERCUT EXCAVATION	

DOCUMENT NOT CONSIDERED FINAL
UNLESS ALL SIGNATURES COMPLETED

2/26/2024
R:\Roadway\XSC\VR-2577A_Rdwy-1_Index.dgn
mouser

STATE OF NORTH CAROLINA
DIVISION OF HIGHWAYS
CROSS-SECTION SUMMARY

NOTE: EMBANKMENT DOES NOT INCLUDE BACKFILL FOR UNDERCUT

Station L	Uncl. Exc. (cu. yd.)	Undercut Exc (cu. yd.)	Embt (cu. yd.)	Station L	Uncl. Exc. (cu. yd.)	Undercut Exc (cu. yd.)	Embt (cu. yd.)	Station L	Uncl. Exc. (cu. yd.)	Undercut Exc (cu. yd.)	Embt (cu. yd.)	Station L	Uncl. Exc. (cu. yd.)	Undercut Exc (cu. yd.)	Embt (cu. yd.)	Station L	Uncl. Exc. (cu. yd.)	Undercut Exc (cu. yd.)	Embt (cu. yd.)
0+00.00	0		0	26+50.00	0		491	20+50.00	62		18	44+00.00	0		214	37+00.00	0		217
0+50.00	3		53	27+00.00	0		252	21+00.00	100		5	44+50.00	1		180	37+50.00	0		177
1+00.00	4		80	27+50.00	4		98	21+50.00	83		1	45+00.00	10		71	38+00.00	1		88
1+50.00	5		91	28+00.00	5		59	22+00.00	51		7	45+50.00	25		31	38+50.00	44		26
2+00.00	5		75	28+50.00	1		165	22+50.00	13		24	46+00.00	34		33	39+00.00	145		13
2+50.00	5		103	29+00.00	0		257	23+00.00	3		48	46+50.00	77		33	39+50.00	210		14
3+00.00	4		187	29+50.00	3		222	23+50.00	3		37	46+85.00	76		15	40+00.00	186		16
3+50.00	2		406	30+00.00	6		238	24+00.00	44		24	47+00.00	39		5	40+50.00	115		16
4+00.00	2		626					24+50.00	50		32	47+50.00	186		16	41+00.00	71		17
4+50.00	3		601	Station	Uncl. Exc.	Undercut Exc	Embt	25+00.00	29		31	48+00.00	180		13	41+50.00	49		21
5+00.00	4		434					25+50.00	36		31	48+50.00	123		6	42+00.00	26		34
5+50.00	6		251	L	(cu. yd.)	(cu. yd.)	(cu. yd.)	26+00.00	30		31	49+00.00	75	62	2	42+50.00	20		48
6+00.00	7		110	0+00.00	0		0	26+50.00	32		34	49+50.00	39	108	5	43+00.00	31		38
6+50.00	7		57	0+50.00	4		42	27+00.00	36		29	50+00.00	13	87	56	43+50.00	38		25
7+00.00	7		56	1+00.00	3		110	27+50.00	37		19	50+50.00	0	65	136	44+00.00	29		27
7+50.00	7		54	1+50.00	4		187	28+00.00	44		14	51+00.00	0		196	44+50.00	26		27
8+00.00	7		59	2+00.00	5		511	28+50.00	79		12	51+50.00	0		255	45+00.00	24		30
8+50.00	6		71	2+50.00	4		1157	29+00.00	103		13	52+00.00	0		262	45+50.00	23		38
9+00.00	5		148	3+00.00	3		1370	29+50.00	99		13	52+50.00	0		217	46+00.00	26		56
9+50.00	5		285	3+50.00	3		1026	30+00.00	93		13	53+00.00	0		249	46+50.00	21		57
10+00.00	6		553	4+00.00	2		652					53+50.00	0		497	46+85.00	6		30
10+50.00	3		392	4+50.00	2		468	Station	Uncl. Exc.	Undercut Exc	Embt	54+00.00	0		788	47+00.00	2		12
11+00.00	0		36	5+00.00	2		456					54+50.00	0		673	47+50.00	9		33
11+50.00	0		325	5+50.00	2		495	L	(cu. yd.)	(cu. yd.)	(cu. yd.)	55+00.00	0		378	48+00.00	6		36
12+00.00	0		526	6+00.00	2		521	30+00.00	0		0	55+50.00	0		268	48+50.00	4		94
12+50.00	0		410	6+50.00	2		531	30+50.00	5		217	56+00.00	0		196	49+00.00	1		181
13+00.00	0		340	7+00.00	2		516	30+65.00	1		58	56+50.00	0		126	49+50.00	2		202
13+50.00	0		301	7+50.00	1		472	31+00.00	1		108	57+00.00	3		91	50+00.00	2		177
14+00.00	0		265	8+00.00	2		421	31+50.00	3		102	57+50.00	4		76	50+50.00	1	48	115
14+50.00	0		208	8+50.00	3		387	32+00.00	3		96	58+00.00	0		82	51+00.00	2	74	61
15+00.00	0		157	9+00.00	2		371	32+50.00	0		132	58+50.00	0		107	51+50.00	13	35	61
15+50.00	0		101	9+50.00	1		463	33+00.00	1		116	59+00.00	0		135	52+00.00	13		44
16+00.00	0		88	10+00.00	1		741	33+50.00	16		52	59+50.00	0		169	52+50.00	1	33	70
16+50.00	0		100	10+50.00	1		1078	34+00.00	15		94	60+00.00	0		192	53+00.00	0	33	62
17+00.00	1		86	11+00.00	2		1316	34+50.00	0		166					53+50.00	1		84
17+50.00	1		76	11+50.00	5		1365	35+00.00	0		450	Station	Uncl. Exc.	Undercut Exc	Embt	54+00.00	4		94
18+00.00	0		75	12+00.00	7		1280	35+50.00	0		909					54+50.00	10		22
18+50.00	2		60	12+50.00	6		1167	36+00.00	0		1475	L	(cu. yd.)	(cu. yd.)	(cu. yd.)	55+00.00	12		35
19+00.00	6		39	13+00.00	9		1026	36+50.00	0		1647	30+00.00	0		0	55+50.00	14		48
19+50.00	15		29	13+50.00	12		900	37+00.00	0		1308	30+50.00	108		13	56+00.00	27		37
20+00.00	26		33	14+00.00	9		808	37+50.00	0		965	30+65.00	48		4	56+50.00	63		29
20+50.00	26		69	14+50.00	8		660	38+00.00	0		587	31+00.00	142		10	57+00.00	84		25
21+00.00	18		84	15+00.00	12		442	38+50.00	94		221	31+50.00	242		15	57+50.00	95		21
21+50.00	10		83	15+50.00	8		163	39+00.00	213		17	32+00.00	295		19	58+00.00	82		19
22+00.00	6		133	16+00.00	3		0	39+50.00	156		16	32+50.00	351		24	58+50.00	31		24
22+50.00	2		397	16+50.00	7		25	40+00.00	55		36	33+00.00	377		30	59+00.00	5		31
23+00.00	0		869	17+00.00	8		45	40+50.00	18		98	33+50.00	188		32	59+50.00	2		38
23+50.00	0		1248	17+50.00	6		72	41+00.00	2		303	34+00.00	110		50	60+00.00	1		48
24+00.00	0		891	18+00.00	4		88	41+50.00	2		771	34+50.00	141		87				
24+50.00	0		367	18+50.00	4		71	42+00.00	0		752	35+00.00	32		139				
25+00.00	0		351	19+00.00	5		63	42+50.00	0		392	35+50.00	0		219				
25+50.00	0		436	19+50.00	7		49	43+00.00	0		337	36+00.00	0		262				
26+00.00	0		543	20+00.00	9		34	43+50.00	0		245	36+50.00	0		239				

STATE OF NORTH CAROLINA
DIVISION OF HIGHWAYS
CROSS-SECTION SUMMARY

NOTE: EMBANKMENT DOES NOT INCLUDE BACKFILL FOR UNDERCUT

Station L	Uncl. Exc. (cu. yd.)	Undercut Exc (cu. yd.)	Embt (cu. yd.)	Station L	Uncl. Exc. (cu. yd.)	Undercut Exc (cu. yd.)	Embt (cu. yd.)	Station L	Uncl. Exc. (cu. yd.)	Undercut Exc (cu. yd.)	Embt (cu. yd.)	Station L	Uncl. Exc. (cu. yd.)	Undercut Exc (cu. yd.)	Embt (cu. yd.)	Station L	Uncl. Exc. (cu. yd.)	Undercut Exc (cu. yd.)	Embt (cu. yd.)
60+00.00	0		0	85+00.00	427		21	77+38.00	1		75	100+00.00	0		888	93+00.00	12		1
60+50.00	0		203	85+38.00	174		32	77+50.00	0		20	100+50.00	0		481	93+50.00	115		21
61+00.00	0		257	85+50.00	16		18	78+00.00	1		97	101+00.00	0		1134	94+00.00	88		40
61+50.00	0		391	86+00.00	193		53	78+50.00	1		117	101+50.00	0		1263	94+50.00	64		62
62+00.00	0		402	86+50.00	504		14	79+00.00	2		65	102+00.00	0		501	95+00.00	37		90
62+50.00	0		283	87+00.00	757		13	79+50.00	4		39	102+50.00	165		92	95+50.00	11		114
63+00.00	0		385	87+50.00	735		20	80+00.00	6		43	103+00.00	473		17	96+00.00	0		153
63+50.00	0		345	88+00.00	323		38	80+50.00	8		47	103+50.00	737		14	96+50.00	0		203
64+00.00	0		153	88+50.00	12		100	81+00.00	7		55	104+00.00	943		12	97+00.00	0		255
64+50.00	0		120	89+00.00	0		155	81+50.00	4		129	104+50.00	1069		6	97+50.00	0		315
65+00.00	21		73	89+50.00	0		117	82+00.00	1		187	105+00.00	1158		2	98+00.00	0		391
65+50.00	40		44	90+00.00	105		46	82+50.00	0		225	105+50.00	1079		4	98+50.00	0		508
66+00.00	26		44					83+00.00	0		175	106+00.00	708		9	99+00.00	0		549
66+50.00	7		92	Station	Uncl. Exc.	Undercut	Embt	83+50.00	0		163	106+50.00	232		286	99+50.00	0		515
67+00.00	0		151	L	(cu. yd.)	Exc	(cu. yd.)	84+00.00	0		237	107+00.00	0		929	100+00.00	0		678
67+50.00	0		166	L	(cu. yd.)	Exc	(cu. yd.)	84+50.00	0		206	107+50.00	0		1519	100+50.00	0		732
67+90.00	0		157	60+00.00	0		0	85+00.00	0		182	108+00.00	0		1717	101+00.00	0		710
68+00.00	0		40	60+50.00	1		57	85+38.00	0		175	108+50.00	0		1685	101+50.00	0		655
68+50.00	0		156	61+00.00	0		74	85+50.00	0		45	109+00.00	0		1485	102+00.00	0		345
69+00.00	0		126	61+50.00	0		88	86+00.00	2		95	109+50.00	0		973	102+50.00	4		121
69+50.00	4		77	62+00.00	0		124	86+50.00	5		73	110+00.00	0		509	103+00.00	7		83
70+00.00	5		49	62+50.00	0		144	87+00.00	7		67	110+50.00	0		436	103+50.00	8		86
70+50.00	17		38	63+00.00	0		127	87+50.00	4		47	111+00.00	0		499	104+00.00	7		81
71+00.00	25		21	63+50.00	0		160	88+00.00	2		126	111+05.00	0		59	104+50.00	5		83
71+50.00	10		39	64+00.00	0		145	88+50.00	4		161	111+50.00	0		514	105+00.00	3		85
72+00.00	6		42	64+50.00	0		97	89+00.00	30		80	112+00.00	0		406	105+50.00	2		102
72+50.00	15		25	65+00.00	0		101	89+50.00	72		67	112+50.00	0		398	106+00.00	1		227
73+00.00	20		24	65+50.00	1		100	90+00.00	113		35	113+00.00	0		467	106+50.00	0		408
73+50.00	22		27	66+00.00	1		81					113+50.00	0	40	398	107+00.00	0		581
74+00.00	70		13	66+50.00	10		58	Station	Uncl. Exc.	Undercut	Embt	114+00.00	0	45	320	107+50.00	0		596
74+50.00	121		1	67+00.00	25		48	L	(cu. yd.)	Exc	(cu. yd.)	114+50.00	0	68	297	108+00.00	0		487
75+00.00	122		1	67+50.00	16		45	115+00.00	0	125	237	108+50.00	0	73	237	108+50.00	0		481
75+50.00	112		2	67+90.00	3		44	90+00.00	0		0	115+50.00	0	73	146	109+00.00	0		464
75+93.00	54		9	68+00.00	1		13	90+50.00	269		16	116+00.00	1		53	109+50.00	0		443
76+00.00	5		2	68+50.00	6		60	91+00.00	371		10	116+50.00	1		129	110+00.00	0		371
76+50.00	51		11	69+00.00	10		53	91+50.00	431		5	117+00.00	0		320	110+50.00	0		304
77+00.00	52		15	69+50.00	67		33	92+00.00	424		5	117+50.00	0		522	111+00.00	0	58	273
77+38.00	30		12	70+00.00	80		23	92+50.00	358		6	118+00.00	0		661	111+05.00	0		26
77+50.00	9		2	70+50.00	22		53	92+95.00	239		4	118+50.00	0		697	111+50.00	0	123	226
78+00.00	139		4	71+00.00	5		65	93+00.00	21		0	119+00.00	0		657	112+00.00	0	144	218
78+50.00	413		2	71+50.00	5		81	93+50.00	283		12	119+50.00	0		549	112+50.00	0	144	149
79+00.00	406		0	72+00.00	4		85	94+00.00	396		25	120+00.00	0		386	113+00.00	0	71	93
79+50.00	195		1	72+50.00	5		61	94+50.00	482		18					113+50.00	0		78
80+00.00	216		8	73+00.00	6		52	95+00.00	653		19	Station	Uncl. Exc.	Undercut	Embt	114+00.00	0		60
80+50.00	228		13	73+50.00	6		55	95+50.00	813		29	L	(cu. yd.)	Exc	(cu. yd.)	114+50.00	0		57
81+00.00	201		22	74+00.00	6		49	96+00.00	891		37	L	(cu. yd.)	Exc	(cu. yd.)	115+00.00	1		54
81+50.00	99		152	74+50.00	6		53	96+50.00	878		44	90+00.00	0		0	115+50.00	3		48
82+00.00	0		523	75+00.00	6		62	97+00.00	690		52	90+50.00	192		14	116+00.00	5		43
82+50.00	0		758	75+50.00	5		88	97+50.00	379		61	91+00.00	301		11	116+50.00	9		35
83+00.00	0		531	75+93.00	3		118	98+00.00	103		131	91+50.00	248		5	117+00.00	10		32
83+50.00	97		185	76+00.00	0		13	98+50.00	0		397	92+00.00	138		6	117+50.00	8		41
84+00.00	312		38	76+50.00	4		62	99+00.00	0		729	92+50.00	144		10	118+00.00	6		51
84+50.00	460		23	77+00.00	3		79	99+50.00	0		1127	92+95.00	122		11	118+50.00	4		63

STATE OF NORTH CAROLINA
DIVISION OF HIGHWAYS
CROSS-SECTION SUMMARY

NOTE: EMBANKMENT DOES NOT INCLUDE BACKFILL FOR UNDERCUT

Station	Uncl. Exc.	Undercut	Embt	Station	Uncl. Exc.	Undercut	Embt	Station	Uncl. Exc.	Undercut	Embt	Station	Uncl. Exc.	Undercut	Embt	Station	Uncl. Exc.	Undercut	Embt
L	(cu. yd.)	Exc (cu. yd.)	(cu. yd.)	L	(cu. yd.)	Exc (cu. yd.)	(cu. yd.)	L	(cu. yd.)	Exc (cu. yd.)	(cu. yd.)	L	(cu. yd.)	Exc (cu. yd.)	(cu. yd.)	L	(cu. yd.)	Exc (cu. yd.)	(cu. yd.)
119+00.00	3		69	120+00.00	0		0	144+50.00	13		482	178+50.00	1		147	202+25.00	71	39	22
119+50.00	2		73	120+50.00	2		80	145+00.00	61		319	179+00.00	0		133				
120+00.00	2		79	121+00.00	1		79	145+50.00	125		140	179+50.00	10		106	Station	Uncl. Exc.	Undercut	Embt
				121+50.00	2		77	146+00.00	175		103	180+00.00	35		86	L	(cu. yd.)	Exc	(cu. yd.)
Station	Uncl. Exc.	Undercut	Embt	122+00.00	2		79	146+50.00	215		63	180+40.00	110		34				
L	(cu. yd.)	Exc	(cu. yd.)	122+50.00	2		77	147+00.00	236		23	180+50.00	40		0	172+57.48	0		0
				123+00.00	4		65	147+50.00	228		2	181+00.00	128		36	173+00.00	5		0
120+00.00	0		0	123+50.00	8		49	148+00.00	185		2	181+50.00	72		76	173+50.00	10		3
120+50.00	0		247	124+00.00	11		40	148+50.00	131		10	182+00.00	57		83	174+00.00	9		7
121+00.00	0		195	124+35.00	5		38	149+00.00	94		27	182+50.00	26		118	174+50.00	8		9
121+50.00	0		188	124+50.00	1		20	149+50.00	72		101	183+00.00	0		200	175+00.00	7		11
122+00.00	0		166	125+00.00	3		76	150+00.00	67		93	183+50.00	0		235	175+50.00	7		11
122+50.00	3		104	125+50.00	0		97	150+25.00	17		6	184+00.00	38		139	176+00.00	7		12
123+00.00	54		38	126+00.00	0		119					184+50.00	154		47	176+50.00	38		78
123+50.00	193		10	126+50.00	0		130	Station	Uncl. Exc.	Undercut	Embt	185+00.00	203		45	177+00.00	68		90
124+00.00	286		3	127+00.00	0		129	L	(cu. yd.)	Exc	(cu. yd.)	185+50.00	154		54	177+50.00	63		35
124+35.00	263		1	127+50.00	0		122					186+00.00	161		59	178+00.00	59		32
124+50.00	130		1	128+00.00	0		106	141+31.60	0		0	186+50.00	216		59	178+50.00	62		30
125+00.00	424		5	128+50.00	0		100	141+50.00	0		335	187+00.00	260	92	52	179+00.00	66		28
125+50.00	464		7	129+00.00	1		184	142+00.00	0		819	187+50.00	285	183	47	179+50.00	40		65
126+00.00	566		7	129+50.00	1		245	142+50.00	0		503	188+00.00	288	183	45	180+00.00	11		98
126+50.00	874		7	130+00.00	2		247	143+00.00	0		260	188+50.00	316	183	41	180+40.00	5		58
127+00.00	1305		7	130+50.00	3		234	143+50.00	10		154	189+00.00	388	183	31	180+50.00	2		13
127+50.00	1616		8	131+00.00	4		205	144+00.00	62		39	189+50.00	415	183	29	181+00.00	17		66
128+00.00	1184		10	131+50.00	6		222	144+50.00	154		7	190+00.00	372	183	32	181+50.00	13		61
128+50.00	522		10	132+00.00	6		272	145+00.00	244		0	190+50.00	338	183	33	182+00.00	10		83
129+00.00	302		14	132+50.00	5		296	145+50.00	313		0	190+87.00	224		27	182+50.00	9		118
129+50.00	121		32	133+00.00	5		186	146+00.00	358		0	191+00.00	74	92	9	183+00.00	9		132
130+00.00	20		103	133+50.00	3		78	146+50.00	371		0	191+50.00	325		37	183+50.00	8		133
130+50.00	0		219	134+00.00	1		71	147+00.00	342		0	192+00.00	371		37	184+00.00	7		141
131+00.00	0		391	134+15.00	0		39	147+50.00	285		0	192+50.00	263		24	184+50.00	6		164
131+50.00	0		477	134+50.00	0		96	148+00.00	212		2	193+00.00	267		16	185+00.00	4		174
132+00.00	12		234	135+00.00	0		105	148+50.00	147		8	193+50.00	468		10	185+50.00	2		176
132+50.00	69		15	135+50.00	0		129	149+00.00	102		16	193+68.00	215		1	186+00.00	1		151
133+00.00	176		11	136+00.00	0		200	149+50.00	49		29	194+00.00	357		0	186+50.00	1		146
133+50.00	285		8	136+50.00	0		325	150+00.00	13		24	194+50.00	380		4	187+00.00	2		140
134+00.00	395		7	137+00.00	0		491	150+25.00	3		3	195+00.00	207		13	187+50.00	3		101
134+15.00	135		3	137+50.00	0		667					195+50.00	55		57	188+00.00	4		115
134+50.00	339		10	137+55.00	0		85	Station	Uncl. Exc.	Undercut	Embt	196+00.00	23		48	188+50.00	5		106
135+00.00	535		15	138+00.00	0		806	L	(cu. yd.)	Exc	(cu. yd.)	196+50.00	24		35	189+00.00	6		76
135+50.00	501		33	138+50.00	0		1010					197+00.00	3		77	189+50.00	6		101
136+00.00	489		70	139+00.00	0		1515	172+57.48	0		0	197+50.00	6		74	190+00.00	7		119
136+50.00	262		173	139+13.91	0		515	173+00.00	7		32	197+80.00	7		37	190+50.00	7		85
137+00.00	24		200					173+50.00	15		76	198+00.00	8		19	190+87.00	4		52
137+50.00	24		256	Station	Uncl. Exc.	Undercut	Embt	174+00.00	14		94	198+50.00	33		32	191+00.00	1		18
137+55.00	0		42	L	(cu. yd.)	Exc	(cu. yd.)	174+50.00	13		122	199+00.00	56	93	23	191+50.00	9		55
138+00.00	0		686					175+00.00	14		135	199+10.00	13		5	192+00.00	10		49
138+50.00	0		1046	141+65.09	0		0	175+50.00	14		120	199+50.00	56	183	22	192+50.00	10		48
139+00.00	0		1036	142+00.00	0		597	176+00.00	10		78	200+00.00	96	143	32	193+00.00	9		47
139+47.40	0		972	142+50.00	0		752	176+50.00	8		98	200+50.00	124	140	38	193+50.00	9		49
				143+00.00	0		592	177+00.00	9		149	201+00.00	117	140	19	193+68.00	3		15
				143+50.00	0		494	177+50.00	8		163	201+50.00	136	92	18	194+00.00	5		18
				144+00.00	0		470	178+00.00	3		162	202+00.00	160	78	40	194+50.00	8		266

STATE OF NORTH CAROLINA
DIVISION OF HIGHWAYS
CROSS-SECTION SUMMARY

NOTE: EMBANKMENT DOES NOT INCLUDE BACKFILL FOR UNDERCUT

Station	Uncl. Exc.	Undercut	Embt	Station	Uncl. Exc.	Undercut	Embt	Station	Uncl. Exc.	Undercut	Embt	Station	Uncl. Exc.	Undercut	Embt	Station	Uncl. Exc.	Undercut	Embt
L	(cu. yd.)	Exc (cu. yd.)	(cu. yd.)	L2	(cu. yd.)	Exc (cu. yd.)	(cu. yd.)	L2	(cu. yd.)	Exc (cu. yd.)	(cu. yd.)	L2	(cu. yd.)	Exc (cu. yd.)	(cu. yd.)	L	(cu. yd.)	Exc (cu. yd.)	(cu. yd.)
195+00.00	7		473	217+50.00	27		240	210+00.00	13		89	233+00.00	0		0	244+50.00	0		167
195+50.00	16		239	218+00.00	13		256	210+50.00	21		40	233+50.00	71		11	245+00.00	0		95
196+00.00	17		37	218+50.00	6		110	211+00.00	42		16	234+00.00	51		12	245+50.00	0		158
196+50.00	9		39	219+00.00	67		14	211+50.00	85		15	234+50.00	42		18	246+00.00	0		264
197+00.00	6		66	219+50.00	160		12	212+00.00	158		17	235+00.00	23		89	246+50.00	0		267
197+50.00	4		79	220+00.00	191		10	212+50.00	229		12	235+50.00	5		135	247+00.00	0	78	192
197+80.00	1		60	220+50.00	194		9	213+00.00	254		5	236+00.00	3		135	247+50.00	0	130	203
198+00.00	1		42	221+00.00	196		8	213+50.00	254		3	236+50.00	2		143	248+00.00	0	53	308
198+50.00	2		83	221+50.00	183		8	214+00.00	235		4	237+00.00	1		133	248+50.00	0		493
199+00.00	5		83	222+00.00	153		8	214+50.00	198		2	237+50.00	16		94	249+00.00	0		549
199+10.00	1		28	222+50.00	107		9	215+00.00	155		0	238+00.00	33		59	249+50.00	0		461
199+50.00	3		109	223+00.00	73		9	215+50.00	76		20	238+50.00	21		67	250+00.00	0		302
200+00.00	5		74	223+50.00	60		9	216+00.00	21		197	239+00.00	4		121	250+50.00	0		125
200+50.00	5		53	224+00.00	54		10	216+50.00	16		426	239+50.00	0		313	251+00.00	0		147
201+00.00	7		41	224+50.00	39		13	217+00.00	14		578	240+00.00	0		562	251+50.00	0		260
201+50.00	8		45	225+00.00	17		32	217+50.00	15		676	240+50.00	0		742	252+00.00	0		350
202+00.00	8		48	225+50.00	5		81	218+00.00	8		791	241+00.00	0		883	252+50.00	0		399
202+25.00	4		25	226+00.00	0		275	218+50.00	1		803	241+50.00	0		695	253+00.00	0		387
				226+50.00	0		445	219+00.00	1		624	242+00.00	0		431	253+50.00	0		316
Station	Uncl. Exc.	Undercut	Embt	227+00.00	0		459	219+50.00	3		358	242+09.26	0		77	254+00.00	0		156
				227+30.00	0		294	220+00.00	9		136					254+50.00	7		73
L2	(cu. yd.)	(cu. yd.)	(cu. yd.)	227+50.00	0		207	220+50.00	16		92	Station	Uncl. Exc.	Undercut	Embt	255+00.00	27		76
202+25.00	0		0	228+00.00	0		580	221+00.00	26		59	L2	(cu. yd.)	(cu. yd.)	(cu. yd.)	255+50.00	31		44
202+50.00	60	57	15	228+50.00	0		681	221+50.00	53		16					256+00.00	38		28
203+00.00	113	119	31	229+00.00	0	49	821	222+00.00	46		22	233+00.00	0		0	256+50.00	111		11
203+50.00	92	128	34	229+50.00	0	99	812	222+50.00	25		26	233+50.00	228		11	257+00.00	126		9
204+00.00	74	120	33	230+00.00	0	23	545	223+00.00	34		15	234+00.00	205		13	257+50.00	43		82
204+50.00	47	137	37	230+50.00	2		260	223+50.00	59		11	234+50.00	142		12	257+78.00	0		184
205+00.00	14	168	69	231+00.00	8		101	224+00.00	83		12	235+00.00	79		12	258+00.00	0		213
205+50.00	3	86	86	231+50.00	29		36	224+50.00	80		15	235+50.00	47		14	258+50.00	0		784
206+00.00	3		109	232+00.00	62		7	225+00.00	39		44	236+00.00	27		21	259+00.00	0		1488
206+50.00	3		113	232+50.00	90		8	225+50.00	3		191	236+50.00	18		31	259+50.00	0		1660
207+00.00	0		82	233+00.00	94		10	226+00.00	0		406	237+00.00	14		33	260+00.00	0		1207
207+50.00	6		66					226+50.00	0		545	237+50.00	12		29	260+50.00	0		861
208+00.00	7		134	Station	Uncl. Exc.	Undercut	Embt	227+00.00	0		556	238+00.00	11		28	261+00.00	0		707
208+50.00	2		230					227+30.00	0		325	238+50.00	11		29	261+50.00	0		619
209+00.00	6		124	L2	(cu. yd.)	(cu. yd.)	(cu. yd.)	227+50.00	0		201	239+00.00	12		30	262+00.00	0		441
209+50.00	7		6	202+25.00	0		0	228+00.00	0		576	239+50.00	8		35	262+50.00	8		224
210+00.00	4		36	202+50.00	3		30	228+50.00	0		834	240+00.00	6		47	263+00.00	42		87
210+50.00	3		110	203+00.00	6		49	229+00.00	0	133	1130	240+50.00	9		49	263+50.00	46		40
211+00.00	4	99	105	203+50.00	6		33	229+50.00	0	111	1051	241+00.00	8		34	264+00.00	12		101
211+50.00	34	158	30	204+00.00	7		20	230+00.00	0		554	241+50.00	8		25	264+50.00	0		230
212+00.00	119	58	3	204+50.00	12		15	230+50.00	1		203	242+00.00	7		29	265+00.00	0		432
212+50.00	224		0	205+00.00	16		47	231+00.00	9		74	242+09.26	1		7	265+50.00	0		650
213+00.00	304		0	205+50.00	18		52	231+50.00	25		32					266+00.00	0		831
213+50.00	314		0	206+00.00	16		34	232+00.00	90		16	Station	Uncl. Exc.	Undercut	Embt	266+50.00	0		1066
214+00.00	235		0	206+50.00	10		37	232+50.00	169		11	L	(cu. yd.)	(cu. yd.)	(cu. yd.)	267+00.00	0		1253
214+50.00	159		0	207+00.00	7		41	233+00.00	212		10					267+50.00	0		1350
215+00.00	112		0	207+50.00	6		24					242+08.28	0		0	268+00.00	0		1346
215+50.00	69		4	208+00.00	6		0					242+50.00	0		500	268+50.00	0		1126
216+00.00	47		30	208+50.00	4		123					243+00.00	0		596	269+00.00	0		761
216+50.00	36		77	209+00.00	5		204					243+50.00	0		509	269+50.00	0		407
217+00.00	34		138	209+50.00	11		140					244+00.00	0		335	270+00.00	0		220

3/1/2024 8:23:09 R:\Roadway\XSC\NR-2577A_RdJ-xp1_Index.dgn

STATE OF NORTH CAROLINA
DIVISION OF HIGHWAYS
CROSS-SECTION SUMMARY

NOTE: EMBANKMENT DOES NOT INCLUDE BACKFILL FOR UNDERCUT

Station	Uncl. Exc.	Undercut	Embt	Station	Uncl. Exc.	Undercut	Embt	Station	Uncl. Exc.	Undercut	Embt	Station	Uncl. Exc.	Undercut	Embt	Station	Uncl. Exc.	Undercut	Embt
L	(cu. yd.)	(cu. yd.)	(cu. yd.)	L	(cu. yd.)	(cu. yd.)	(cu. yd.)	L	(cu. yd.)	(cu. yd.)	(cu. yd.)	L	(cu. yd.)	(cu. yd.)	(cu. yd.)	L	(cu. yd.)	(cu. yd.)	(cu. yd.)
270+50.00	0		156	264+00.00	2		103	287+50.00	15		43	278+50.00	5		141	304+50.00	1		36
271+00.00	0		127	264+50.00	2		118	288+00.00	12		44	279+00.00	6		156	305+00.00	6		11
271+50.00	0		116	265+00.00	2		129	288+50.00	13		43	279+50.00	7		118				
272+00.00	0		173	265+50.00	3		129	289+00.00	8		81	279+65.00	2		31				
				266+00.00	3		131	289+50.00	0		161	280+00.00	3		67	Station	Uncl. Exc.	Undercut	Embt
				266+50.00	3		151	290+00.00	0		220	280+50.00	5		104	Y1A	(cu. yd.)	(cu. yd.)	(cu. yd.)
				267+00.00	3		162	290+50.00	0		187	281+00.00	9		110	10+00.00	0		0
				267+50.00	4		154	291+00.00	0		138	281+50.00	9		94	10+50.00	18		4
242+08.28	0		0	268+00.00	4		151	291+50.00	0		173	282+00.00	5		95	11+00.00	19		8
242+50.00	0		16	268+50.00	4		146	292+00.00	0		279	282+50.00	8		73	11+50.00	24		18
243+00.00	0		20	269+00.00	5		141	292+50.00	0		324	283+00.00	8		52	12+00.00	25		36
243+50.00	2		30	269+50.00	4		126	293+00.00	1		252	283+50.00	8		64	12+50.00	64		34
244+00.00	3		41	270+00.00	5		110	293+50.00	9		189	284+00.00	7		83	13+00.00	153	132	11
244+50.00	2		44	270+50.00	5		108	294+00.00	8		238	284+50.00	6		69	13+50.00	243	265	0
245+00.00	1		48	271+00.00	5		107	294+50.00	1		432	285+00.00	6		58	14+00.00	262	262	0
245+50.00	0		52	271+50.00	5		103	295+00.00	0		726	285+50.00	5		61	14+50.00	585	212	0
246+00.00	0		57	272+00.00	5		100	295+50.00	0		1046	286+00.00	7		51	15+00.00	929	156	0
246+50.00	0		38					296+00.00	0		1404	286+50.00	8		41	15+50.00	883	207	0
247+00.00	0		15	Station	Uncl. Exc.	Undercut	Embt	296+50.00	0		1577	287+00.00	6		45	16+00.00	419	157	792
247+50.00	0		41	L	(cu. yd.)	Exc	(cu. yd.)	297+00.00	0		1511	287+50.00	5		56	16+50.00	0	24	1088
248+00.00	0		61					297+50.00	0		1466	288+00.00	5		59	16+61.40	0		135
248+50.00	0		56	272+00.00	0		0	298+00.00	0		1373	288+50.00	5		63				
249+00.00	2		54	272+50.00	0		215	298+50.00	0		1445	289+00.00	4		72	Station	Uncl. Exc.	Undercut	Embt
249+50.00	5		40	273+00.00	0		319	299+00.00	0		1816	289+50.00	4		73	Y1B	(cu. yd.)	(cu. yd.)	(cu. yd.)
250+00.00	6		30	273+50.00	0		586	299+50.00	0		2029	290+00.00	4		75				
250+50.00	3		17	274+00.00	0		846	300+00.00	0		1467	290+50.00	2		57	10+40.64	0		0
251+00.00	0		8	274+50.00	0		1063	300+50.00	0		708	291+00.00	0		28	11+00.00	98		1038
251+50.00	3		14	275+00.00	0		1161	301+00.00	0		315	291+50.00	3		29	11+50.00	58		1047
252+00.00	6		20	275+50.00	0		1066	301+50.00	13		61	292+00.00	7		61	12+00.00	30		1221
252+50.00	7		37	276+00.00	0		880	302+00.00	57		3	292+50.00	8		91	12+50.00	25		943
253+00.00	8		53	276+50.00	0		768	302+50.00	103		0	293+00.00	7		98	13+00.00	28		381
253+50.00	8		54	277+00.00	0		742	303+00.00	112		0	293+50.00	7		106	13+50.00	61		62
254+00.00	8		51	277+50.00	0		688	303+50.00	100		14	294+00.00	19		97	14+00.00	98		20
254+50.00	8		55	278+00.00	0		546	304+00.00	90		23	294+50.00	18		91	14+50.00	203		19
255+00.00	4		56	278+50.00	0		409	304+50.00	66		9	295+00.00	4		103	15+00.00	184		40
255+50.00	0		48	279+00.00	0	32	325	305+00.00	30		0	295+50.00	2		114	15+50.00	78		57
256+00.00	4		53	279+50.00	0	67	282					296+00.00	2		158	16+00.00	70		57
256+50.00	8		65	279+65.00	0	94	127	Station	Uncl. Exc.	Undercut	Embt	296+50.00	2		140	16+50.00	41		45
257+00.00	9		77	280+00.00	0	126	287	L	(cu. yd.)	Exc	(cu. yd.)	297+00.00	3		86	17+00.00	57		25
257+50.00	13		90	280+50.00	0	154	244					297+50.00	2		93	17+50.00	173		16
257+78.00	7		62	281+00.00	0	87	219	272+00.00	0		0	298+00.00	3		94	18+00.00	132		7
258+00.00	5		50	281+50.00	4		128	272+50.00	4		96	298+50.00	4		117				
258+50.00	16		118	282+00.00	14		43	273+00.00	4		103	299+00.00	7		118	Station	Uncl. Exc.	Undercut	Embt
259+00.00	17		142	282+50.00	91		18	273+50.00	4		122	299+50.00	8		98	Y1C	(cu. yd.)	(cu. yd.)	(cu. yd.)
259+50.00	18		150	283+00.00	239		2	274+00.00	4		137	300+00.00	11		105				
260+00.00	9		118	283+50.00	303		3	274+50.00	5		147	300+50.00	20		123	10+00.00	0		0
260+50.00	0		80	284+00.00	297		4	275+00.00	5		141	301+00.00	12		89	10+50.00	11		2
261+00.00	2		76	284+50.00	223		5	275+50.00	5		127	301+50.00	0		36	11+00.00	46		5
261+50.00	3		85	285+00.00	125		7	276+00.00	5		115	302+00.00	1		25	11+44.28	63		6
262+00.00	3		90	285+50.00	137		6	276+50.00	5		132	302+50.00	2		19				
262+50.00	3		93	286+00.00	186		4	277+00.00	5		129	303+00.00	1		23				
263+00.00	3		90	286+50.00	131		11	277+50.00	5		116	303+50.00	0		33				
263+50.00	3		94	287+00.00	35		30	278+00.00	5		124	304+00.00	0		45				

8/23/99
3/1/2024
P:\Roadway\XSC\NR-2577A_RdJ-xp1_Index.dgn
mrouser

STATE OF NORTH CAROLINA
DIVISION OF HIGHWAYS
CROSS-SECTION SUMMARY

NOTE: EMBANKMENT DOES NOT INCLUDE BACKFILL FOR UNDERCUT

Station	Uncl. Exc.	Undercut	Embt	Station	Uncl. Exc.	Undercut	Embt	Station	Uncl. Exc.	Undercut	Embt	Station	Uncl. Exc.	Undercut	Embt	Station	Uncl. Exc.	Undercut	Embt
Y1D	(cu. yd.)	(cu. yd.)	(cu. yd.)	Y4	(cu. yd.)	(cu. yd.)	(cu. yd.)	Y6	(cu. yd.)	(cu. yd.)	(cu. yd.)	Y11	(cu. yd.)	(cu. yd.)	(cu. yd.)	Y15	(cu. yd.)	(cu. yd.)	(cu. yd.)
12+00.00	0		0	13+50.00	16		21	10+35.50	0		0	12+00.00	0		0	15+00.00	673		0
12+50.00	19		5	14+00.00	3		6	10+50.00	42		12	12+50.00	41		13	15+36.12	561		0
13+00.00	60		4					11+00.00	139		30	13+00.00	14		33				
13+50.00	99		1	Station	Uncl. Exc.	Undercut	Embt	11+50.00	100		13	13+50.00	75		24	Station	Uncl. Exc.	Undercut	Embt
13+96.53	97		0	Y5	(cu. yd.)	(cu. yd.)	(cu. yd.)	12+26.34	50		5	14+00.00	102		20	Y16	(cu. yd.)	(cu. yd.)	(cu. yd.)
				10+15.82	0		0	Station	Uncl. Exc.	Undercut	Embt	14+50.00	37		96	12+75.00	0		0
Station	Uncl. Exc.	Undercut	Embt	10+50.00	6		2	Y7	(cu. yd.)	(cu. yd.)	(cu. yd.)	14+91.91	0		128	13+00.00	0		16
Y1E	(cu. yd.)	(cu. yd.)	(cu. yd.)	11+00.00	56		5	10+35.55	0		0	Station	Uncl. Exc.	Undercut	Embt	13+23.00	2		27
12+17.38	0		0	11+50.00	175		7	10+50.00	0		156	Y12	(cu. yd.)	(cu. yd.)	(cu. yd.)	13+24.00	0		1
12+50.00	83		82	12+00.00	217		14	10+50.00	0		139	21+50.00	0		0	13+50.00	4		28
13+00.00	106		77	12+50.00	219		20	11+00.00	26		368	22+00.00	145		3	14+00.00	4		86
13+50.00	45		37	13+00.00	219		26	11+50.00	26		56	22+50.00	446		4	14+50.00	0		93
14+00.00	26		40	13+50.00	186		30	12+00.00	6		23+00.00	737		4	15+00.00	0		66	
14+50.00	42		37	14+00.00	203		20	Station	Uncl. Exc.	Undercut	Embt	23+50.00	820		48	15+27.14	0		37
15+00.00	54		36	14+50.00	223		6	Y8	(cu. yd.)	(cu. yd.)	(cu. yd.)	24+00.00	678		140	Station	Uncl. Exc.	Undercut	Embt
15+50.00	214		17	15+00.00	248		0	10+35.50	0		0	24+23.18	246		87	Y17	(cu. yd.)	(cu. yd.)	(cu. yd.)
16+00.00	511		0	15+50.00	345		0	10+50.00	0		50	Station	Uncl. Exc.	Undercut	Embt	12+23.63	0		0
16+27.29	364		0	16+00.00	573		0	10+50.00	0		183	Y13	(cu. yd.)	(cu. yd.)	(cu. yd.)	12+50.00	0		144
				16+50.00	683		0	11+00.00	0		148	10+39.18	0		0	13+00.00	0		347
Station	Uncl. Exc.	Undercut	Embt	17+00.00	988		0	11+50.00	0		72	10+50.00	0		157	13+50.00	0		264
Y2	(cu. yd.)	(cu. yd.)	(cu. yd.)	17+50.00	1559		0	12+00.00	10		20	11+00.00	0		527	14+00.00	0		53
12+00.00	0		0	18+00.00	1996		0	12+50.00	10		20	11+50.00	48		255	14+50.00	0		0
12+50.00	15		7	18+50.00	2447		0	Station	Uncl. Exc.	Undercut	Embt	12+00.00	62		101	Station	Uncl. Exc.	Undercut	Embt
13+00.00	26		14	19+00.00	2785		0	Y9	(cu. yd.)	(cu. yd.)	(cu. yd.)	12+50.00	21		11	Y17A	(cu. yd.)	(cu. yd.)	(cu. yd.)
13+50.00	11		100	19+50.00	2962		0	10+35.75	0		0	13+00.00	7		2	10+50.00	0		0
14+00.00	11		247	20+00.00	3159		0	10+50.00	6		1	Station	Uncl. Exc.	Undercut	Embt	11+00.00	1		8
14+11.53	5		71	20+50.00	3183		0	11+00.00	35		4	Y14	(cu. yd.)	(cu. yd.)	(cu. yd.)	11+50.00	0		38
				21+00.00	3181		0	11+50.00	21		20	10+16.01	0		0	11+64.01	0		18
Station	Uncl. Exc.	Undercut	Embt	21+50.00	2966		0	12+00.00	8		75	10+50.00	42		0	Station	Uncl. Exc.	Undercut	Embt
Y3	(cu. yd.)	(cu. yd.)	(cu. yd.)	22+00.00	2569		0	13+00.00	2		139	11+00.00	164		0	Y18	(cu. yd.)	(cu. yd.)	(cu. yd.)
10+35.51	0		0	22+50.00	1998		0	13+50.00	1		122	11+50.00	244		0	10+39.00	0		0
10+50.00	152		0	23+00.00	1171		0	14+00.00	0		199	12+00.00	333		0	10+50.00	12		2
11+00.00	337		2	23+50.00	941		3	14+50.00	0	29	356	12+50.00	607		0	11+00.00	41		5
11+10.00	42		0	23+88.65	395		2	Y5A	(cu. yd.)	(cu. yd.)	(cu. yd.)	13+00.00	395		12	11+50.00	4		0
11+50.00	157		2					15+00.00	0	76	951	13+50.00	10		37				
11+60.00	20		1	10+00.00	0		0	15+50.00	0	47	2419								
12+00.00	60		11	10+50.00	5		11	15+64.40	0		976								
12+50.00	51		12	11+00.00	36		18	Station	Uncl. Exc.	Undercut	Embt	Station	Uncl. Exc.	Undercut	Embt	Station	Uncl. Exc.	Undercut	Embt
12+97.48	13		0	11+50.00	53		14	Y10	(cu. yd.)	(cu. yd.)	(cu. yd.)	Y15	(cu. yd.)	(cu. yd.)	(cu. yd.)	Y19	(cu. yd.)	(cu. yd.)	(cu. yd.)
				12+00.00	41		18	10+39.51	0		0	11+25.00	0		0	10+39.00	0		0
Station	Uncl. Exc.	Undercut	Embt	12+50.00	58		26	10+50.00	0		67	11+50.00	8		2	10+50.00	7		2
Y4	(cu. yd.)	(cu. yd.)	(cu. yd.)	13+00.00	86		24	11+00.00	1		184	12+00.00	34		11	11+00.00	34		7
10+35.50	0		0	13+50.00	167		9	11+50.00	11		26	12+50.00	51		11	11+15.00	5		0
10+50.00	0		220	14+00.00	366		0	11+85.00	30		2	13+00.00	74		11				
11+00.00	0		530	14+50.00	798		0	12+00.00	20		0	13+50.00	109		9				
11+50.00	2		239	15+00.00	1569		0	12+50.00	52		2	14+00.00	205		2				
12+00.00	3		143	15+50.00	1792		0	12+77.76	11		1	14+50.00	420		0				
12+50.00	29		77	16+00.00	1599		0												
13+00.00	40		36	16+32.00	1053		0												

STATE OF NORTH CAROLINA
DIVISION OF HIGHWAYS
CROSS-SECTION SUMMARY

NOTE: EMBANKMENT DOES NOT INCLUDE BACKFILL FOR UNDERCUT

Station	Uncl. Exc.	Undercut Exc	Embt	Station	Uncl. Exc.	Undercut Exc	Embt	Station	Uncl. Exc.	Undercut Exc	Embt	Station	Uncl. Exc.	Undercut Exc	Embt
Y19A	(cu. yd.)	(cu. yd.)	(cu. yd.)	Y23	(cu. yd.)	(cu. yd.)	(cu. yd.)	D1	(cu. yd.)	(cu. yd.)	(cu. yd.)	D6	(cu. yd.)	(cu. yd.)	(cu. yd.)
10+51.00	0		0	15+50.00	198		4	10+14.35	0		0	11+50.00	3		85
10+75.00	0		34	16+00.00	68		16	10+50.00	2		4	11+55.00	1		0
11+00.00	1		22	16+50.00	15		26	11+00.00	2		4				
11+25.00	3		11	17+03.30	2		14	11+38.50	2		1				
11+36.00	1		3												
Station	Uncl. Exc.	Undercut Exc	Embt	Station	Uncl. Exc.	Undercut Exc	Embt	Station	Uncl. Exc.	Undercut Exc	Embt	Station	Uncl. Exc.	Undercut Exc	Embt
Y20	(cu. yd.)	(cu. yd.)	(cu. yd.)	Y23A	(cu. yd.)	(cu. yd.)	(cu. yd.)	D2	(cu. yd.)	(cu. yd.)	(cu. yd.)	D7	(cu. yd.)	(cu. yd.)	(cu. yd.)
96+40.00	0		0	10+00.00	0		0	10+40.35	0		0	10+08.96	0		0
96+50.00	0		37	10+50.00	16		16	10+50.00	0		25	10+25.00	2		91
97+00.00	1		279	11+00.00	53		36	11+00.00	2		68	10+50.00	2		217
97+50.00	1		173	11+50.00	235		23	11+20.00	2		1	10+75.00	0		210
98+00.00	0		231	11+79.90	236		4	11+40.00	3		0	11+00.00	0		66
98+28.73	0		176					11+50.00	2		0	11+25.00	0		2
Station	Uncl. Exc.	Undercut Exc	Embt	Station	Uncl. Exc.	Undercut Exc	Embt	Station	Uncl. Exc.	Undercut Exc	Embt	Station	Uncl. Exc.	Undercut Exc	Embt
Y20	(cu. yd.)	(cu. yd.)	(cu. yd.)	Y24	(cu. yd.)	(cu. yd.)	(cu. yd.)	D3	(cu. yd.)	(cu. yd.)	(cu. yd.)	X-Over1	(cu. yd.)	(cu. yd.)	(cu. yd.)
98+68.84	0		0	13+08.65	0		0	12+00.00	6		49	305+00.00	0		0
99+50.00	26		27	13+50.00	34		11	12+23.91	0		45	305+50.00	21		1
100+00.00	45		21	14+00.00	54		15					306+00.00	14		26
100+30.60	45		15	14+50.00	96		18					306+41.51	3		22
				15+00.00	123		29								
				15+50.00	109		80								
				16+00.00	48	36	231								
				16+50.00	0	55	343								
				17+00.00	0	25	362								
				17+50.00	0	6	384								
				18+00.00	0		406								
				18+50.00	0		362								
				19+00.00	46		244								
				19+50.00	92		141								
				20+00.00	56		76								
				20+50.00	40		70								
				21+00.00	94		74								
				21+50.00	162		57								
				22+00.00	240		37								
				22+50.00	341		16								
				23+00.00	286		10								
				23+50.00	140		45								
				23+93.99	91		66								
Station	Uncl. Exc.	Undercut Exc	Embt	Station	Uncl. Exc.	Undercut Exc	Embt	Station	Uncl. Exc.	Undercut Exc	Embt	Station	Uncl. Exc.	Undercut Exc	Embt
Y23	(cu. yd.)	(cu. yd.)	(cu. yd.)	Y25	(cu. yd.)	(cu. yd.)	(cu. yd.)	D5	(cu. yd.)	(cu. yd.)	(cu. yd.)	D6	(cu. yd.)	(cu. yd.)	(cu. yd.)
10+41.50	0		0	10+35.50	0		0	10+41.50	0		0	10+41.50	0		0
11+00.00	142		7	10+50.00	114		8	10+50.00	0		2	10+50.00	0		51
11+50.00	532		3	11+00.00	517		13	11+00.00	5		113	11+00.00	0		81
12+00.00	1174		0	11+50.00	487		0	11+20.00	5		0	13+50.00	0		0
12+50.00	1281		0	12+00.00	253		0	11+40.00	5		0	14+00.00	11		7
13+00.00	1107		0	12+50.00	53		0	12+00.00	6		70	14+05.05	1		0
13+50.00	1041		0	12+18.00	63		1	12+10.39	0		29				
14+00.00	1181		0	12+50.00	63		1								
14+50.00	1201		0	13+00.00	37		2								
15+00.00	675		0												

6/23/16



PROJ. REFERENCE NO.
R-2577A

SHEET NO.
X-1

150 140 130 120 110 100 90 80 70 60 50 40 30 20 10 0 10 20 30 40 50 60 70 80 90 100 110 120 130 140 150

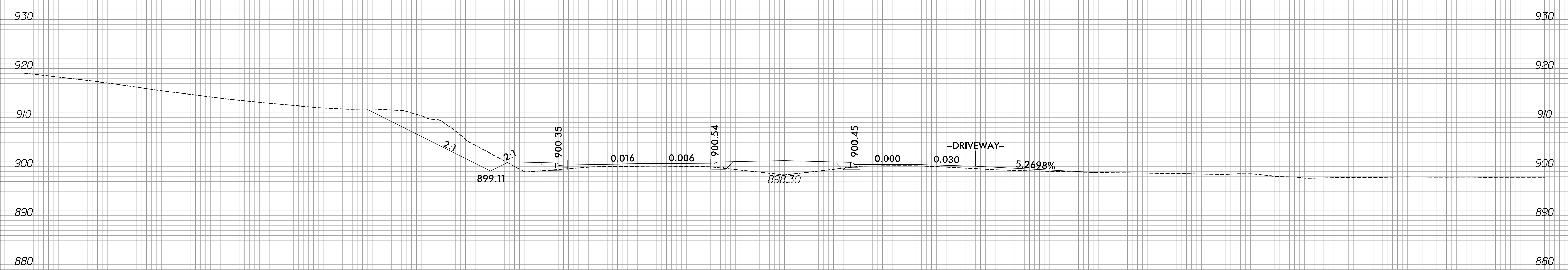

0 + 50.00

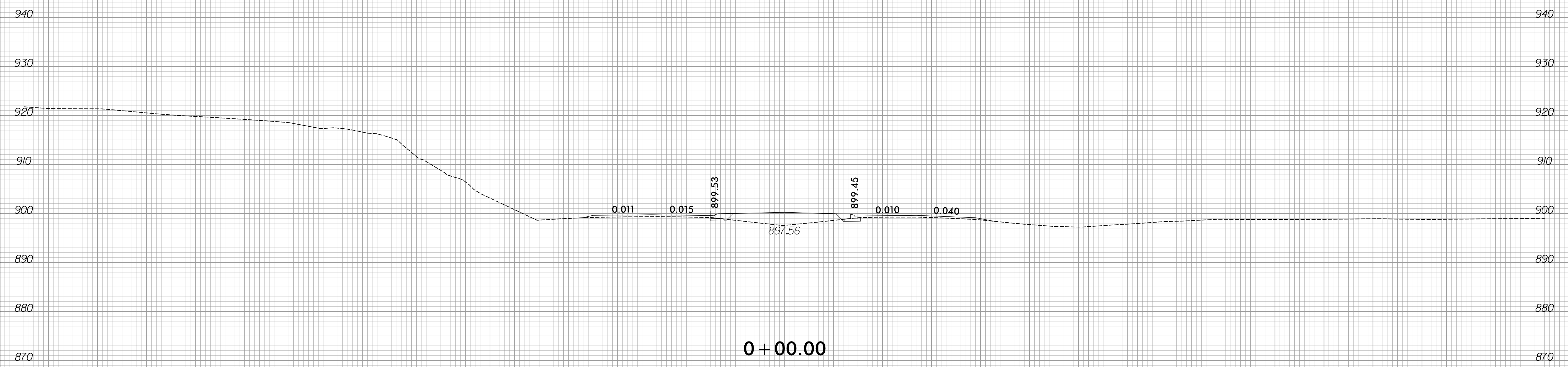

0 + 00.00

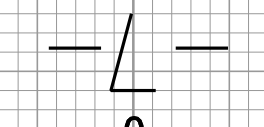

150 140 130 120 110 100 90 80 70 60 50 40 30 20 10 0 10 20 30 40 50 60 70 80 90 100 110 120 130 140 150

12/2/2023
R:\Roadway\XSC\R-2577A_Rdu_xpl.dgn
amc@pfs.com



150 140 130 120 110 100 90 80 70 60 50 40 30 20 10 0 10 20 30 40 50 60 70 80 90 100 110 120 130 140 150

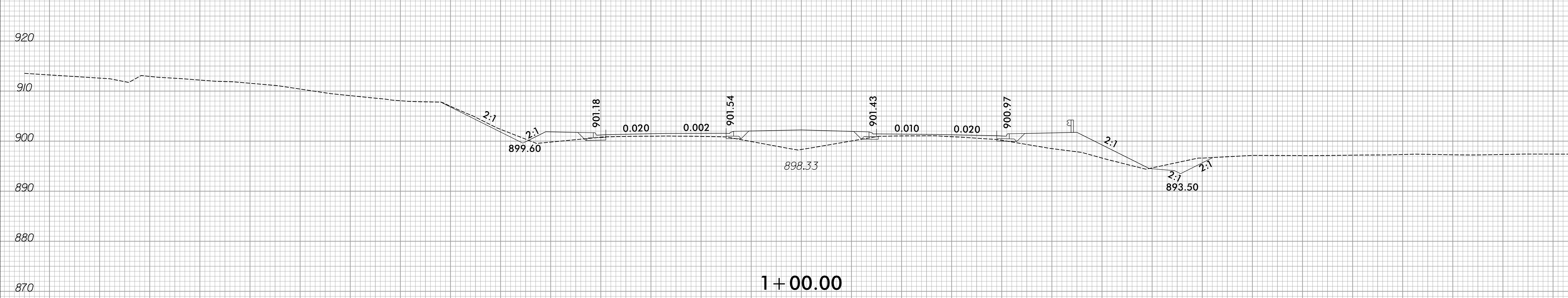
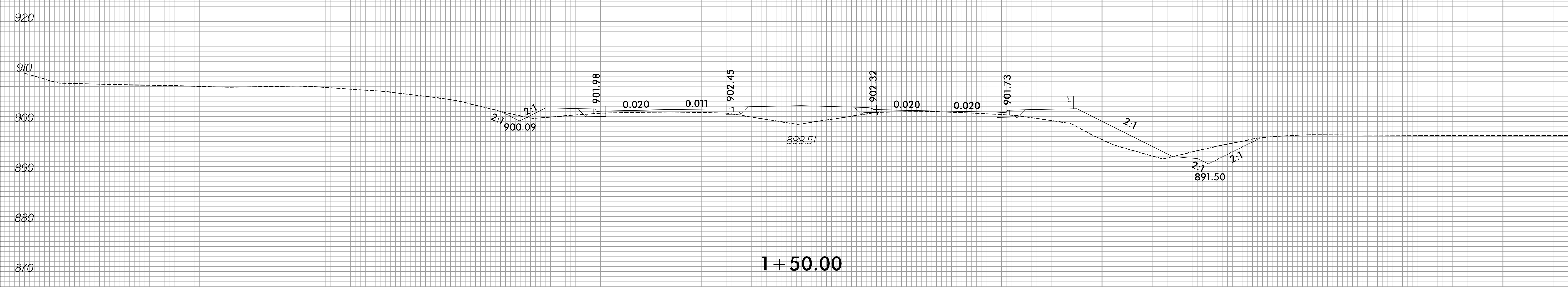
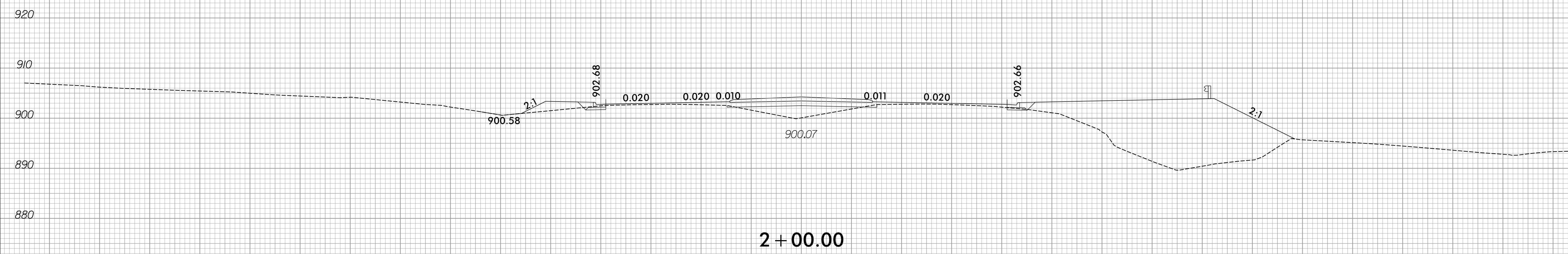

150 140 130 120 110 100 90 80 70 60 50 40 30 20 10 0 10 20 30 40 50 60 70 80 90 100 110 120 130 140 150

150 140 130 120 110 100 90 80 70 60 50 40 30 20 10 0 10 20 30 40 50 60 70 80 90 100 110 120 130 140 150

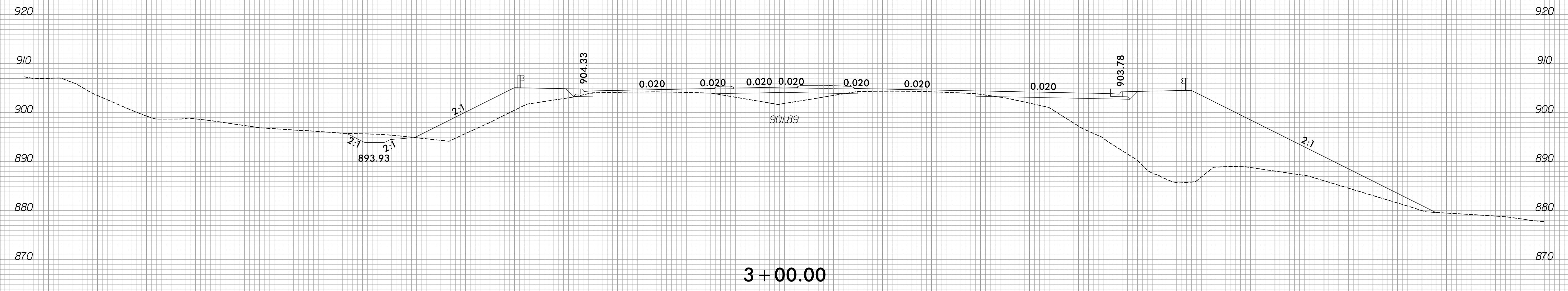

3 + 00.00

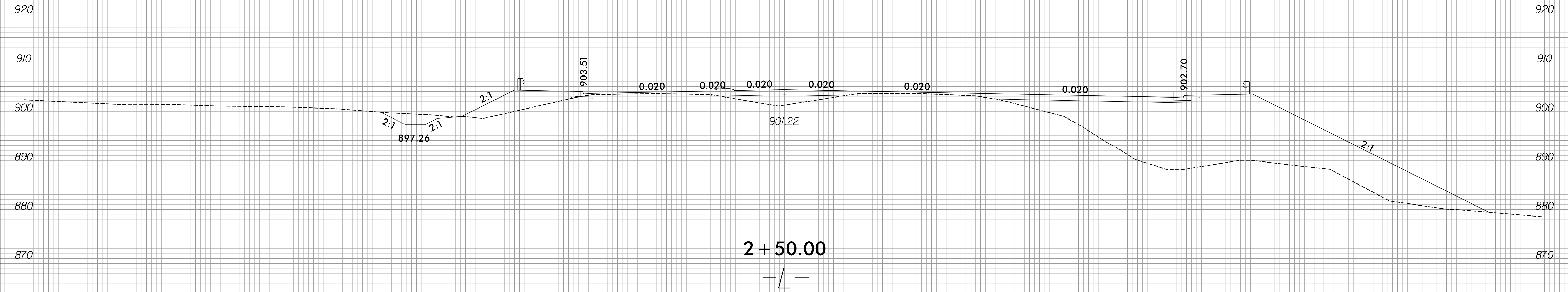

2 + 50.00

150 140 130 120 110 100 90 80 70 60 50 40 30 20 10 0 10 20 30 40 50 60 70 80 90 100 110 120 130 140 150

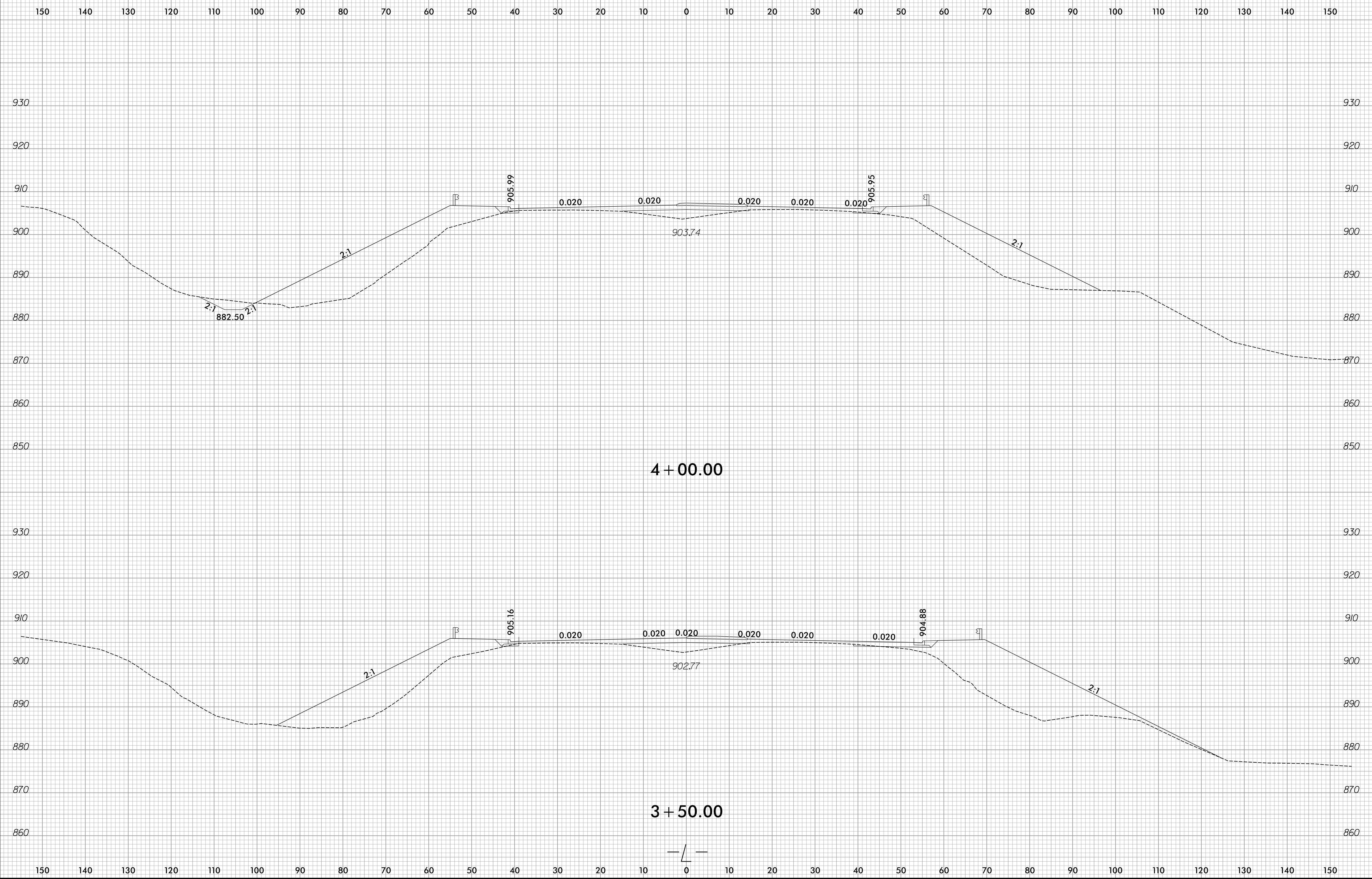

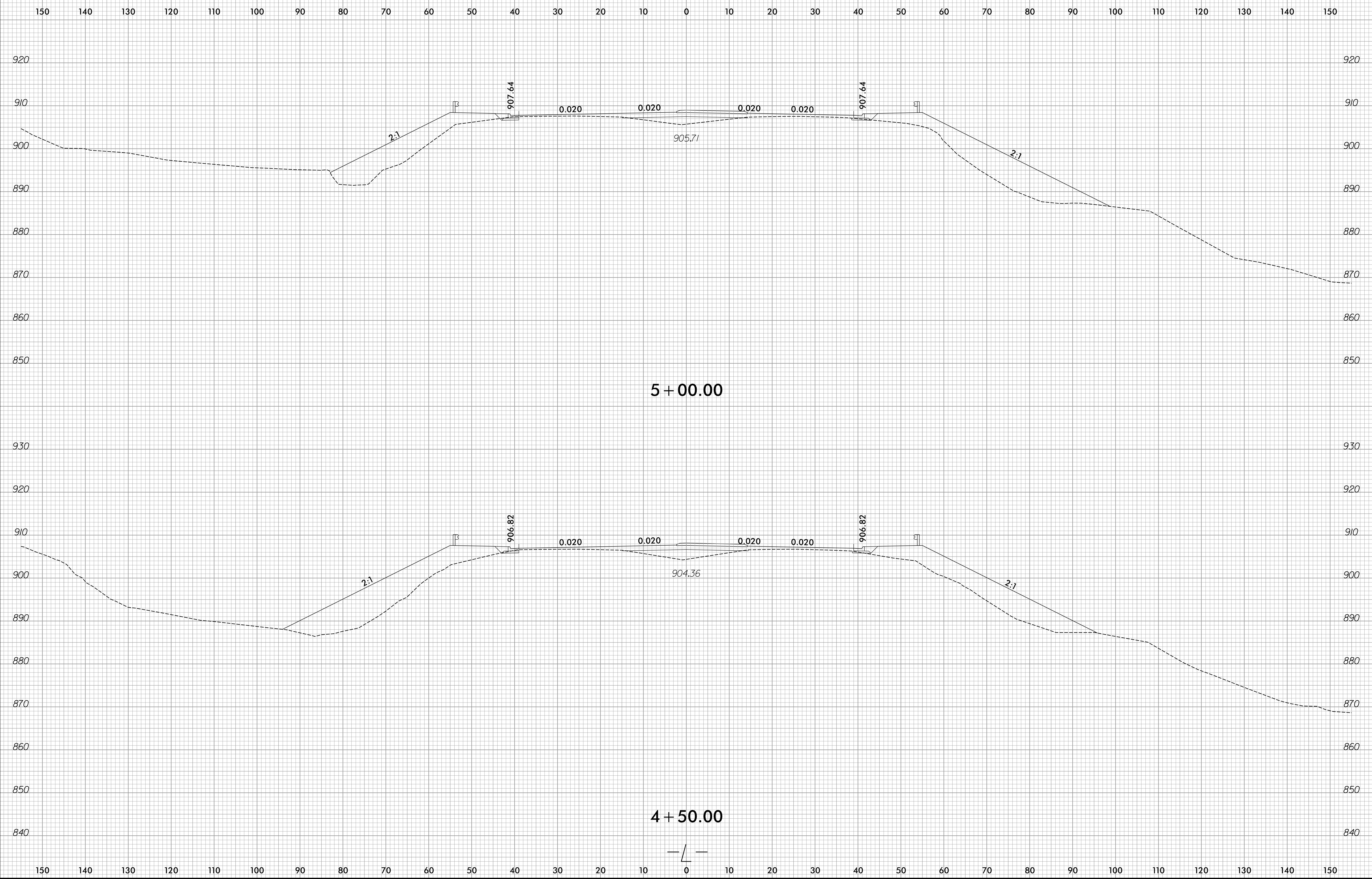

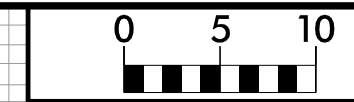

150 140 130 120 110 100 90 80 70 60 50 40 30 20 10 0 10 20 30 40 50 60 70 80 90 100 110 120 130 140 150

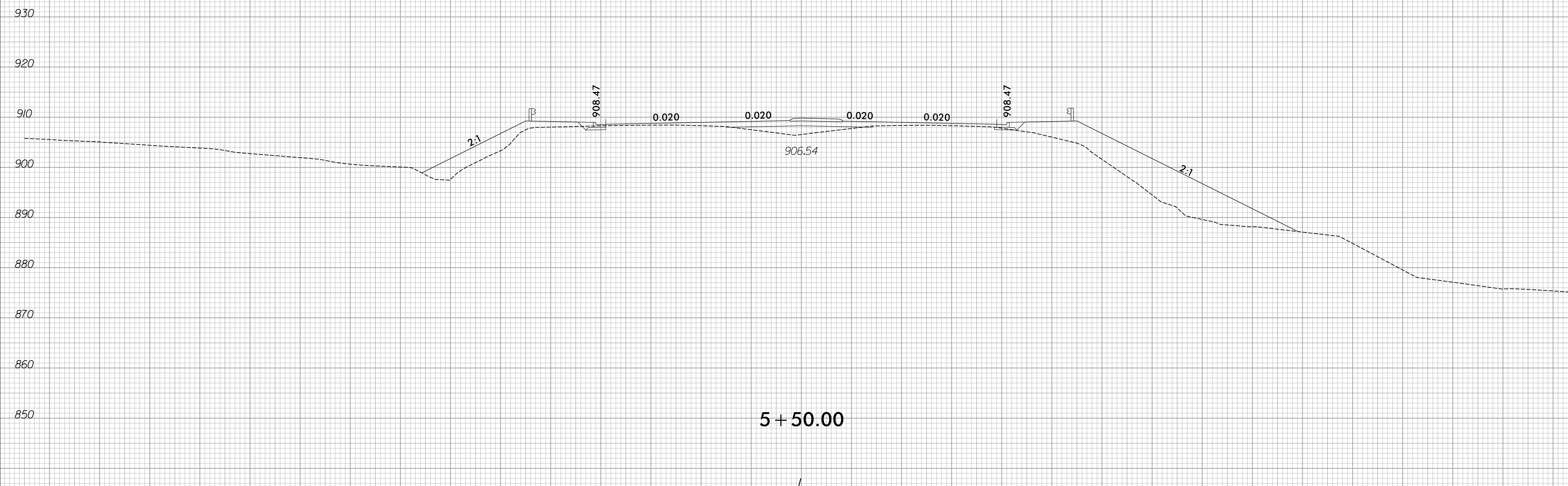
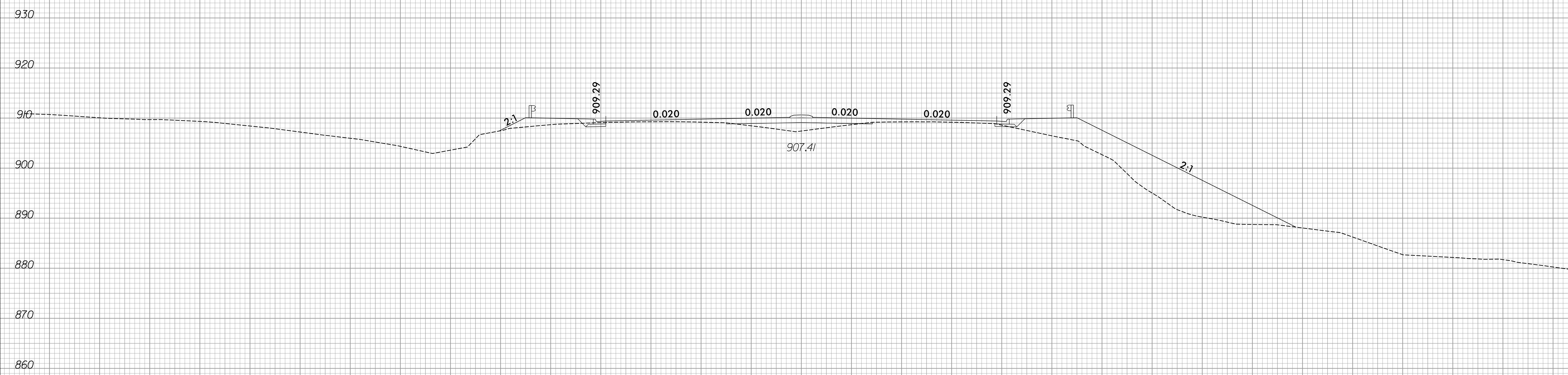

150 140 130 120 110 100 90 80 70 60 50 40 30 20 10 0 10 20 30 40 50 60 70 80 90 100 110 120 130 140 150

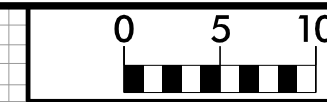

150 140 130 120 110 100 90 80 70 60 50 40 30 20 10 0 10 20 30 40 50 60 70 80 90 100 110 120 130 140 150

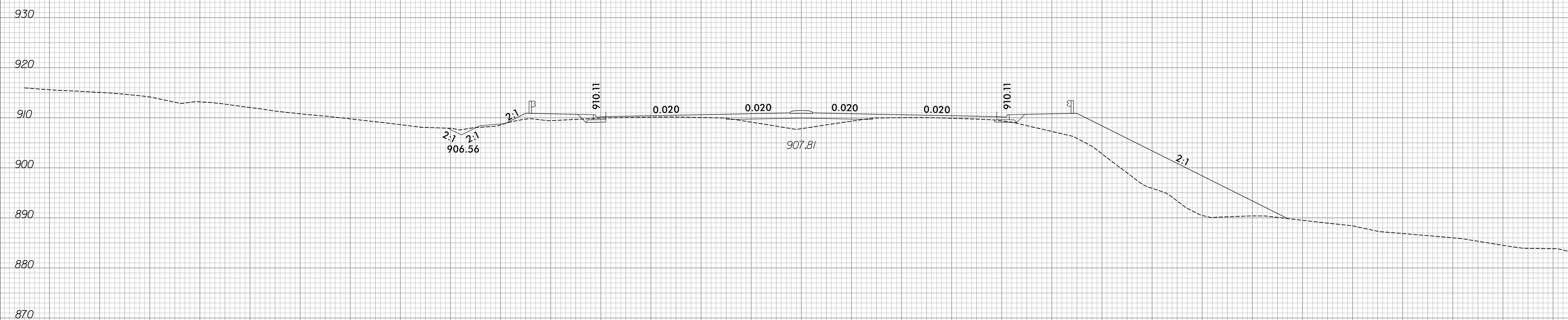
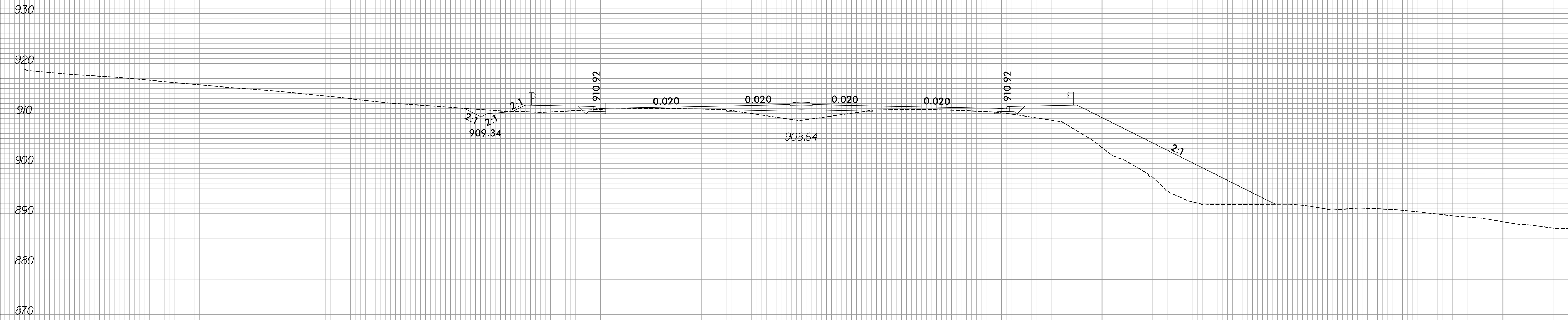

150 140 130 120 110 100 90 80 70 60 50 40 30 20 10 0 10 20 30 40 50 60 70 80 90 100 110 120 130 140 150

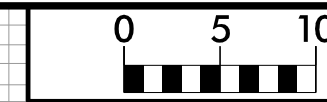

150 140 130 120 110 100 90 80 70 60 50 40 30 20 10 0 10 20 30 40 50 60 70 80 90 100 110 120 130 140 150

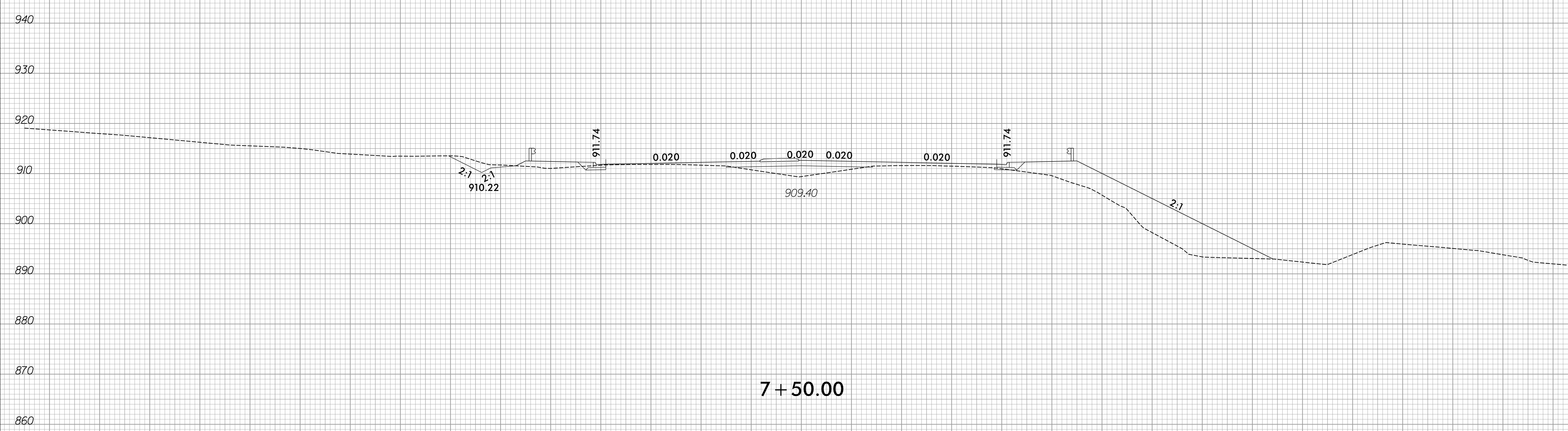
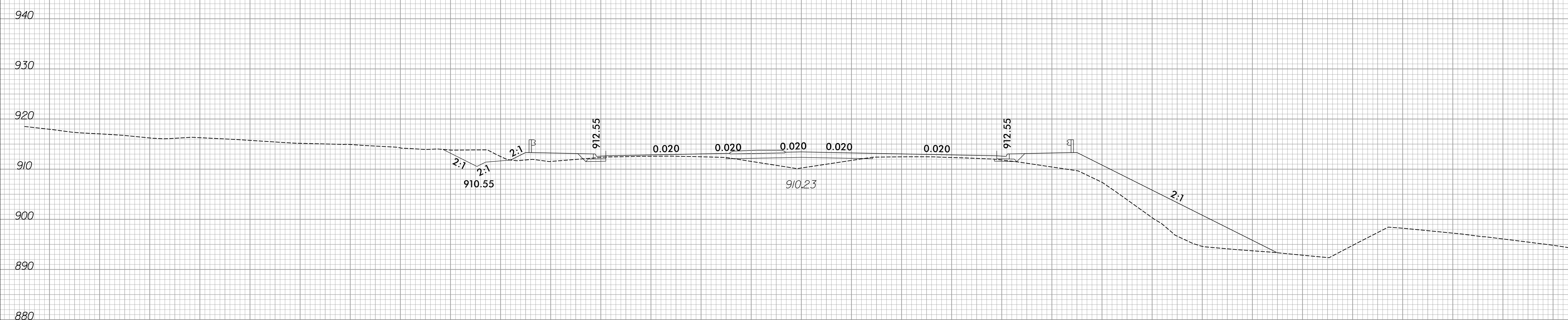

150 140 130 120 110 100 90 80 70 60 50 40 30 20 10 0 10 20 30 40 50 60 70 80 90 100 110 120 130 140 150



150 140 130 120 110 100 90 80 70 60 50 40 30 20 10 0 10 20 30 40 50 60 70 80 90 100 110 120 130 140 150

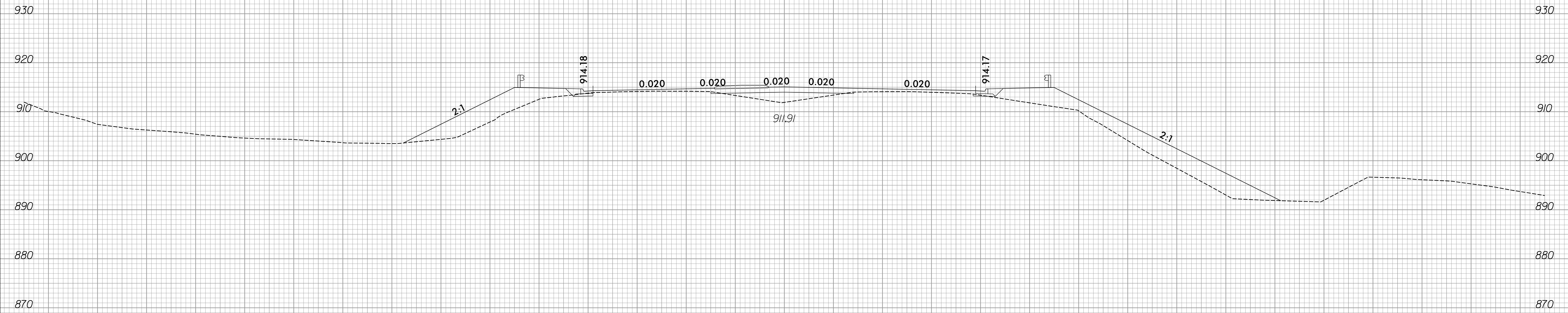

9 + 00.00

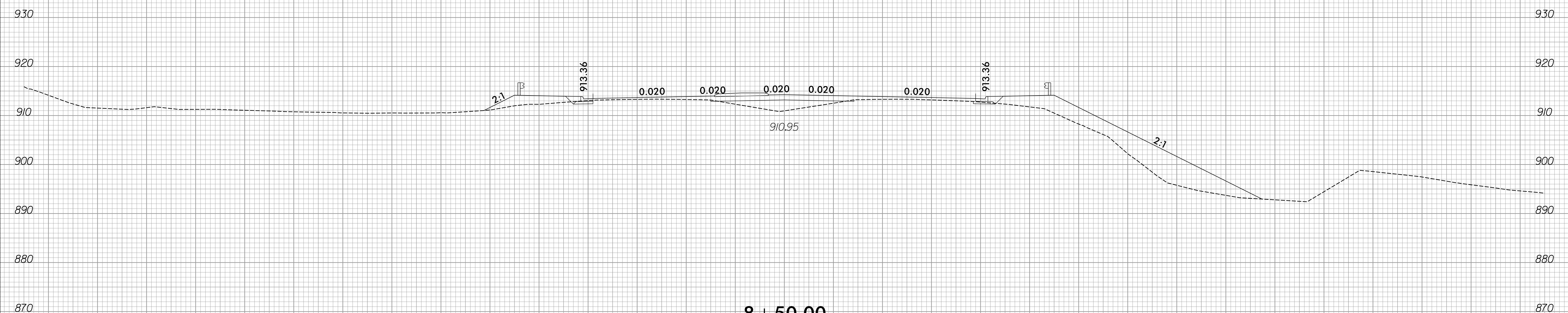

8 + 50.00

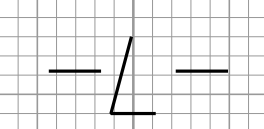

150 140 130 120 110 100 90 80 70 60 50 40 30 20 10 0 10 20 30 40 50 60 70 80 90 100 110 120 130 140 150

150 140 130 120 110 100 90 80 70 60 50 40 30 20 10 0 10 20 30 40 50 60 70 80 90 100 110 120 130 140 150



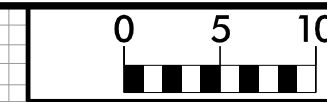

150 140 130 120 110 100 90 80 70 60 50 40 30 20 10 0 10 20 30 40 50 60 70 80 90 100 110 120 130 140 150

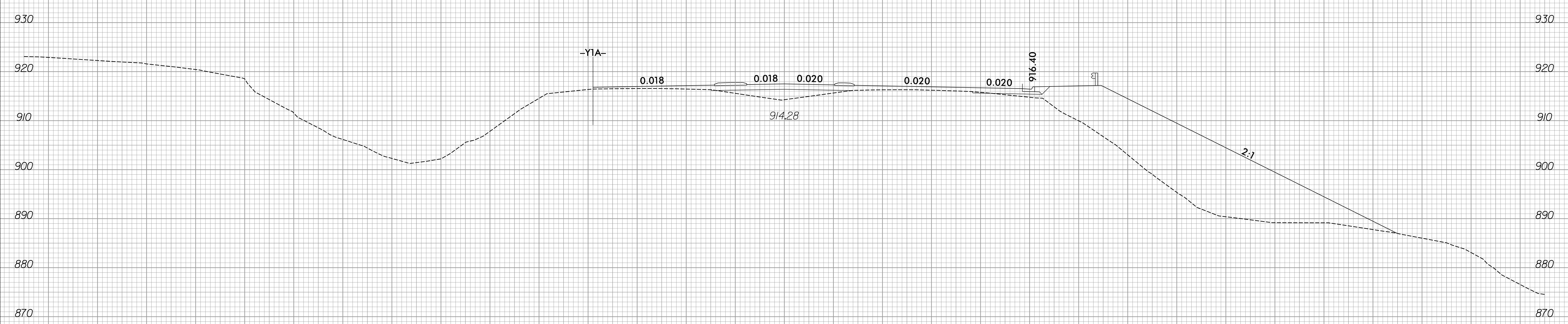
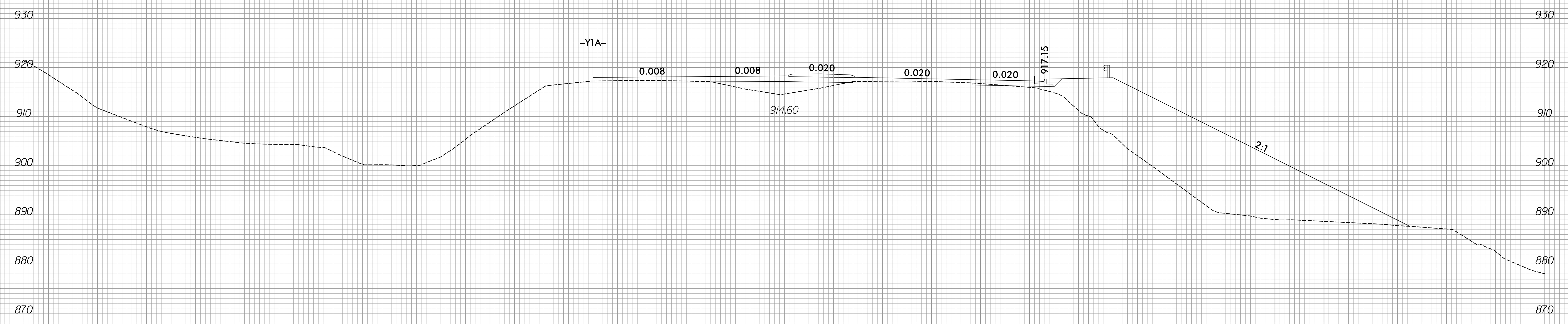

150 140 130 120 110 100 90 80 70 60 50 40 30 20 10 0 10 20 30 40 50 60 70 80 90 100 110 120 130 140 150

6/23/16



PROJ. REFERENCE NO.
R-2577A

SHEET NO.
X-12

150 140 130 120 110 100 90 80 70 60 50 40 30 20 10 0 10 20 30 40 50 60 70 80 90 100 110 120 130 140 150

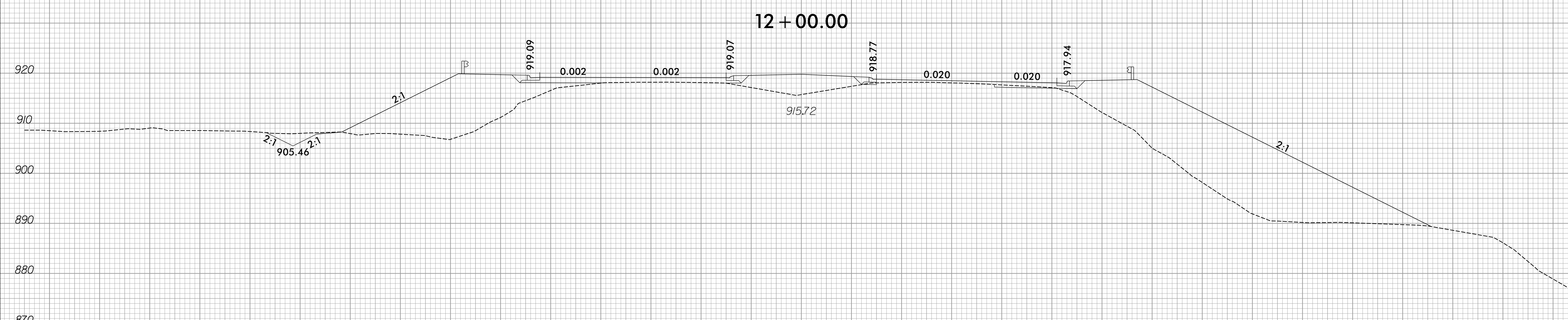
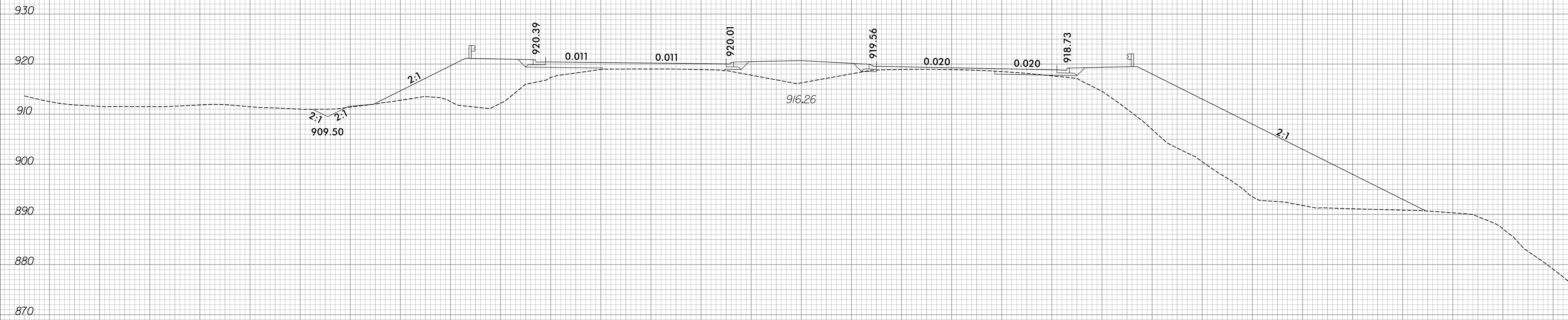

150 140 130 120 110 100 90 80 70 60 50 40 30 20 10 0 10 20 30 40 50 60 70 80 90 100 110 120 130 140 150

12/2/2023
R:\Roadway\XSC\R-2577A_Rdu_xpl.dgn
amcpherson



150 140 130 120 110 100 90 80 70 60 50 40 30 20 10 0 10 20 30 40 50 60 70 80 90 100 110 120 130 140 150

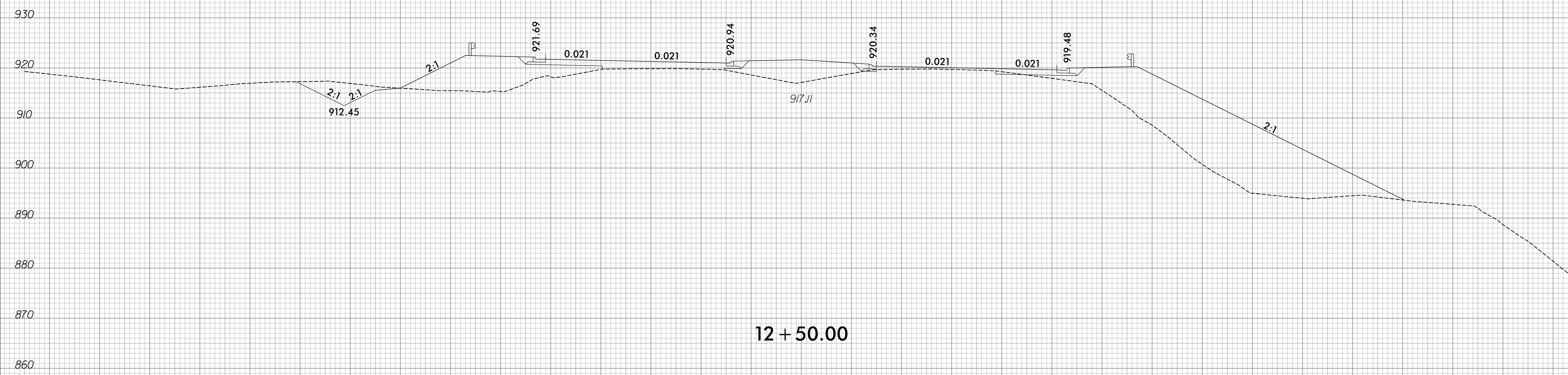
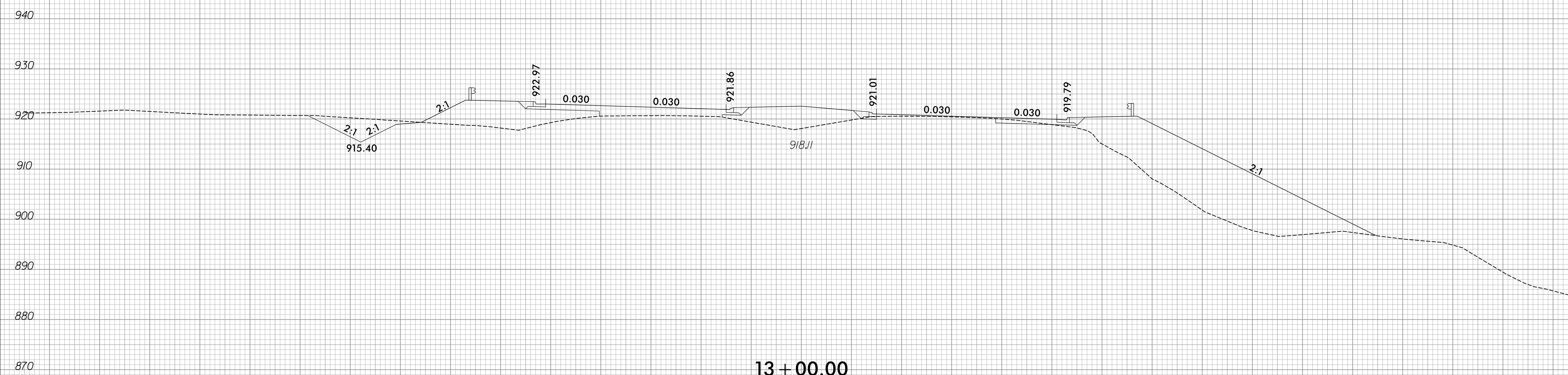

150 140 130 120 110 100 90 80 70 60 50 40 30 20 10 0 10 20 30 40 50 60 70 80 90 100 110 120 130 140 150

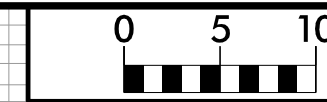

150 140 130 120 110 100 90 80 70 60 50 40 30 20 10 0 10 20 30 40 50 60 70 80 90 100 110 120 130 140 150

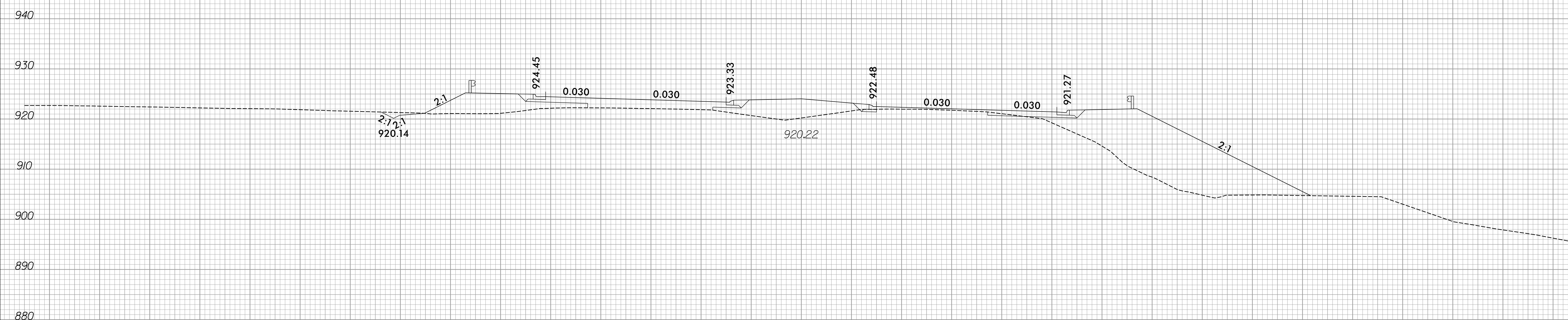

150 140 130 120 110 100 90 80 70 60 50 40 30 20 10 0 10 20 30 40 50 60 70 80 90 100 110 120 130 140 150

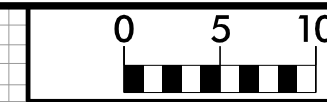

150 140 130 120 110 100 90 80 70 60 50 40 30 20 10 0 10 20 30 40 50 60 70 80 90 100 110 120 130 140 150

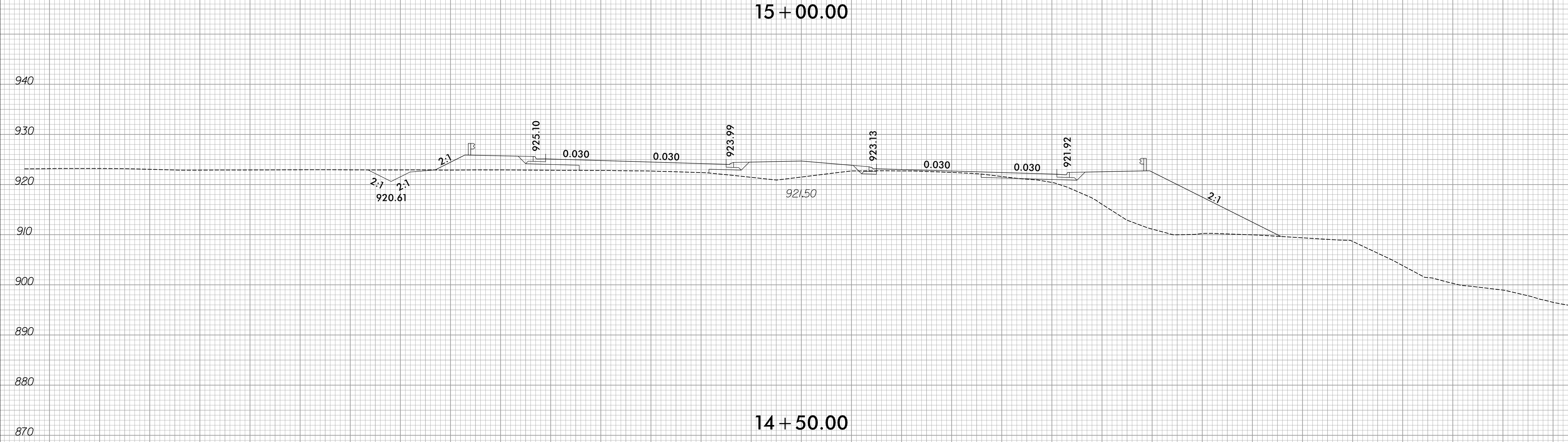
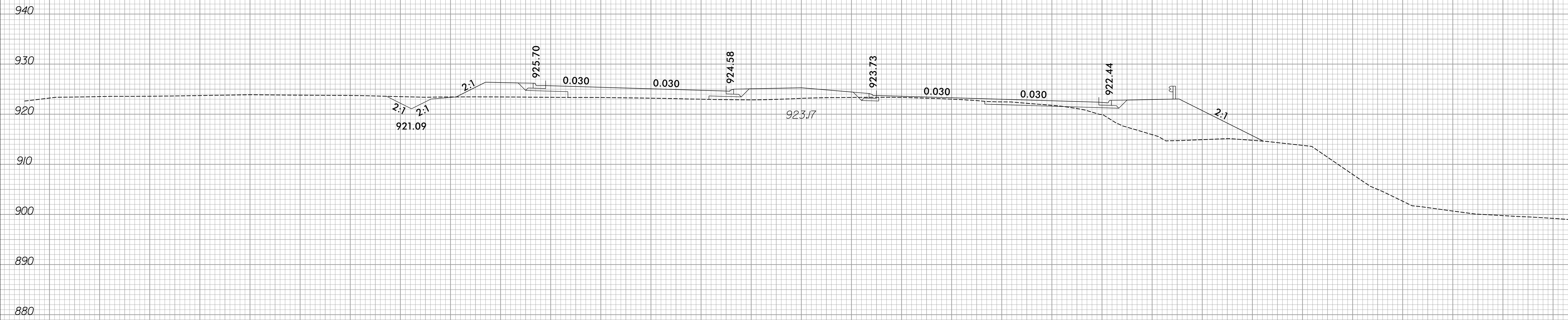

150 140 130 120 110 100 90 80 70 60 50 40 30 20 10 0 10 20 30 40 50 60 70 80 90 100 110 120 130 140 150

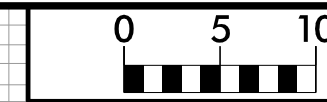

150 140 130 120 110 100 90 80 70 60 50 40 30 20 10 0 10 20 30 40 50 60 70 80 90 100 110 120 130 140 150

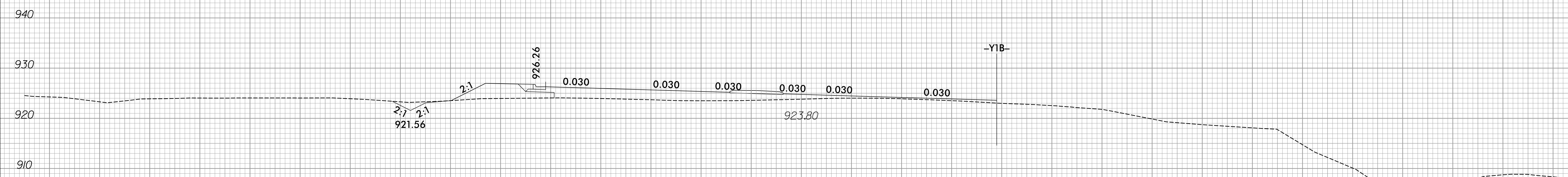
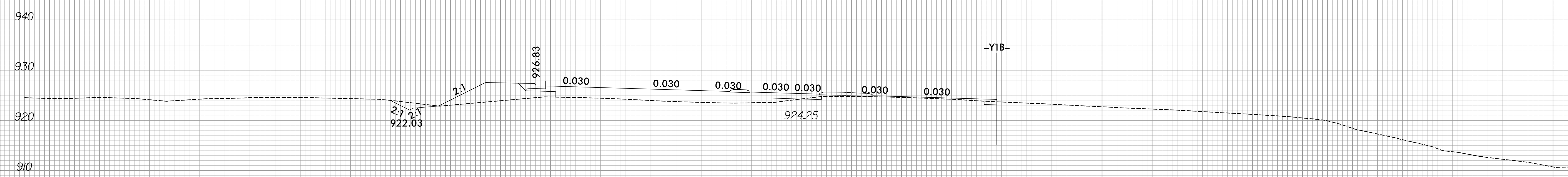

870 880 890 900 910 920 930 940

150 140 130 120 110 100 90 80 70 60 50 40 30 20 10 0 10 20 30 40 50 60 70 80 90 100 110 120 130 140 150



150 140 130 120 110 100 90 80 70 60 50 40 30 20 10 0 10 20 30 40 50 60 70 80 90 100 110 120 130 140 150

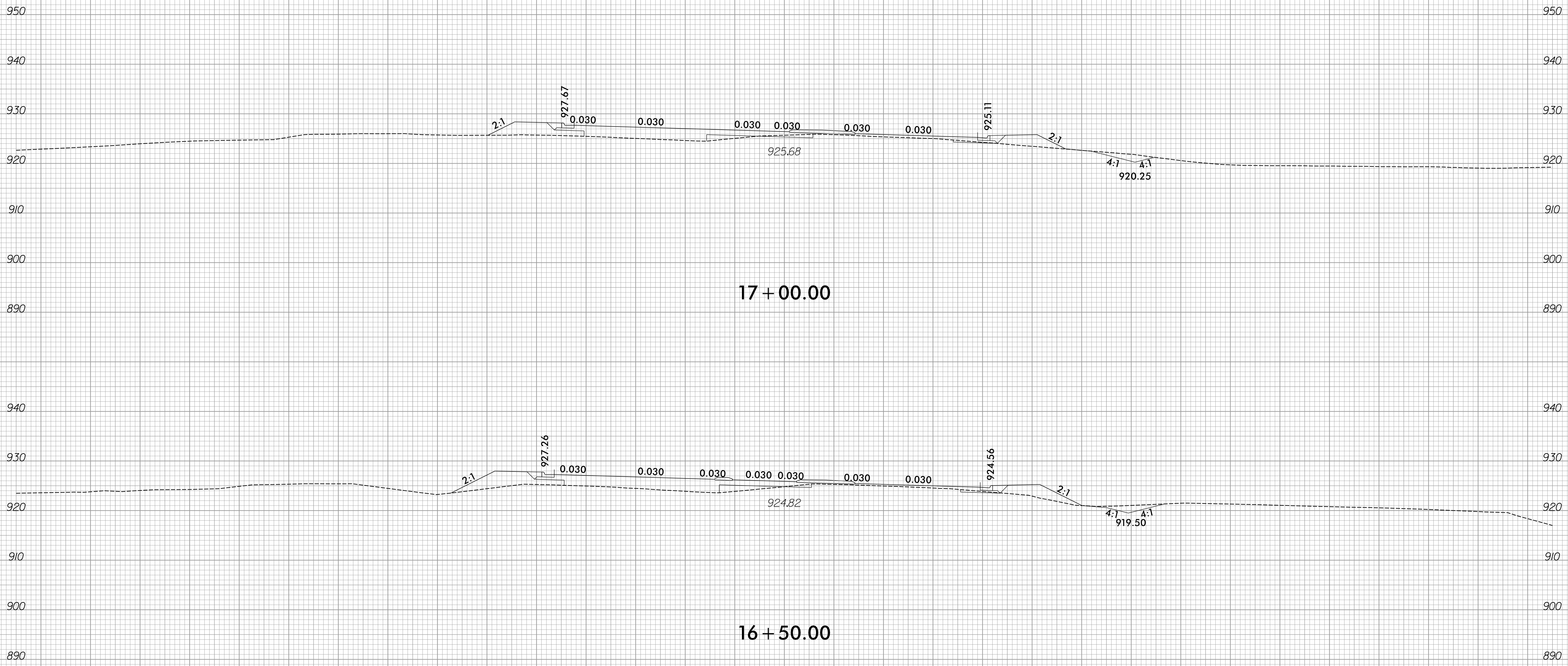

17 + 00.00

16 + 50.00

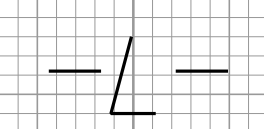



150 140 130 120 110 100 90 80 70 60 50 40 30 20 10 0 10 20 30 40 50 60 70 80 90 100 110 120 130 140 150

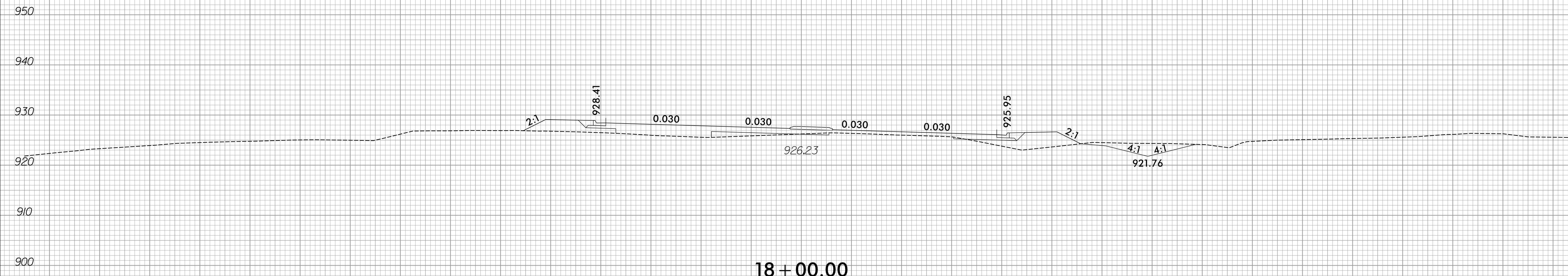

150 140 130 120 110 100 90 80 70 60 50 40 30 20 10 0 10 20 30 40 50 60 70 80 90 100 110 120 130 140 150

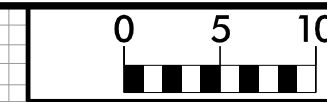

150 140 130 120 110 100 90 80 70 60 50 40 30 20 10 0 10 20 30 40 50 60 70 80 90 100 110 120 130 140 150

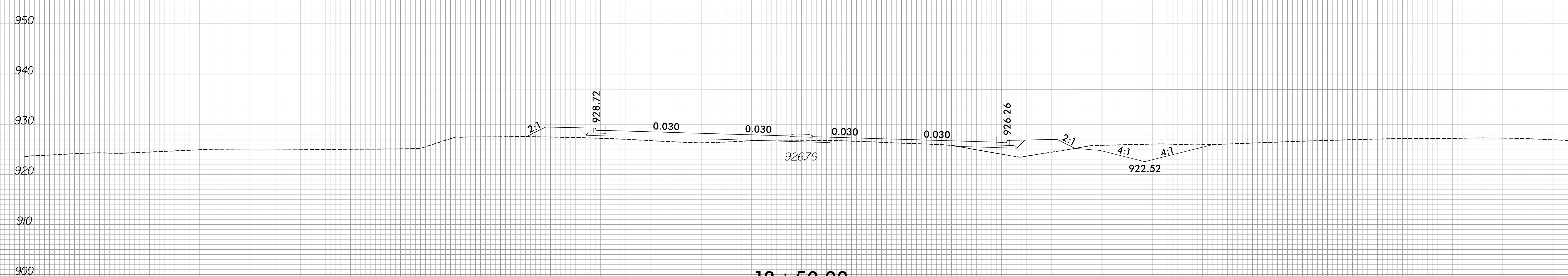
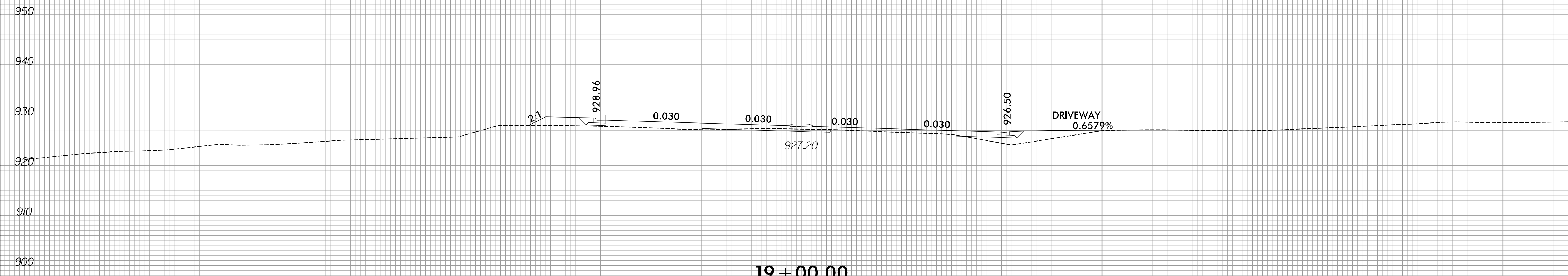

150 140 130 120 110 100 90 80 70 60 50 40 30 20 10 0 10 20 30 40 50 60 70 80 90 100 110 120 130 140 150

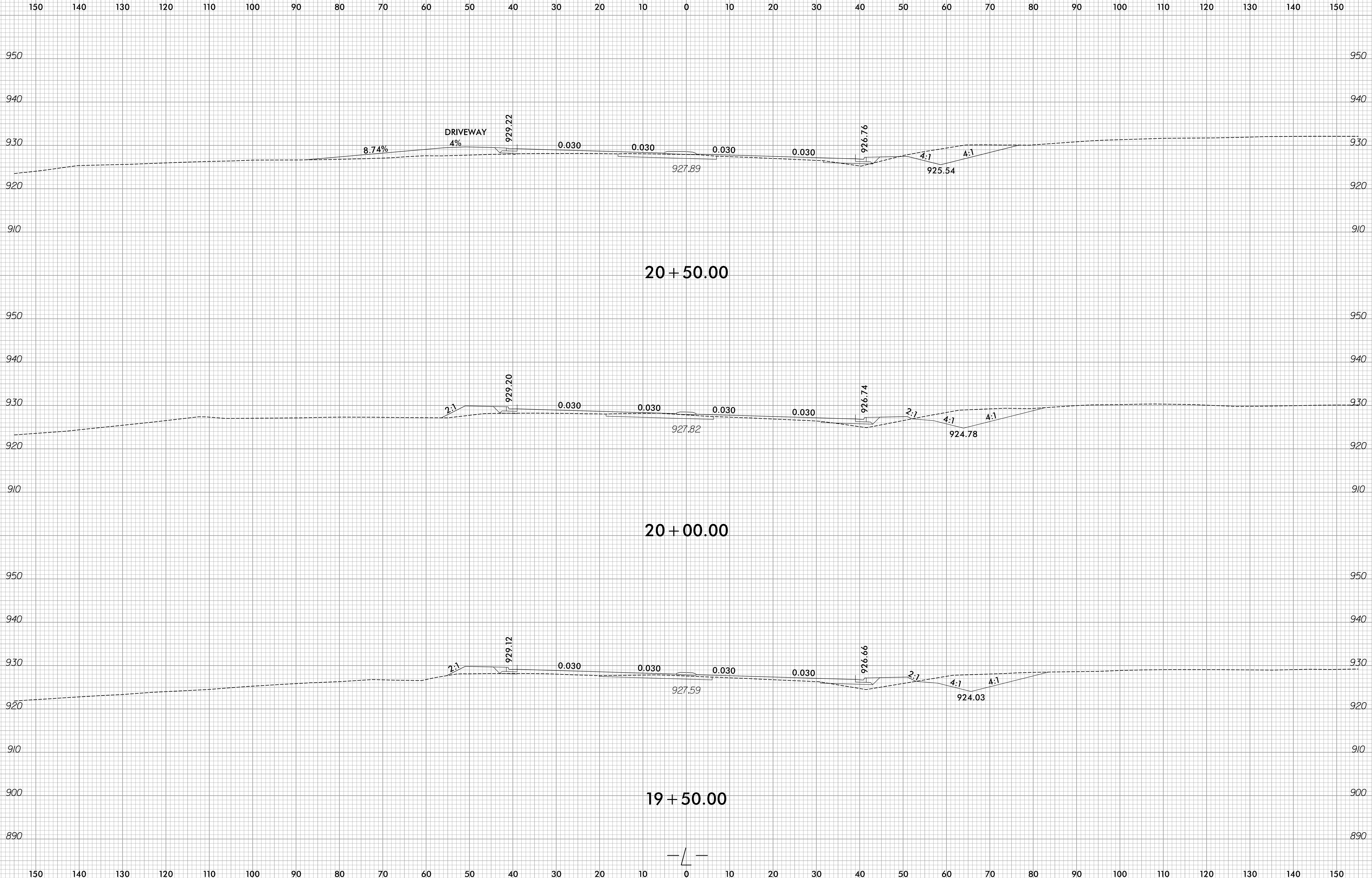



150 140 130 120 110 100 90 80 70 60 50 40 30 20 10 0 10 20 30 40 50 60 70 80 90 100 110 120 130 140 150

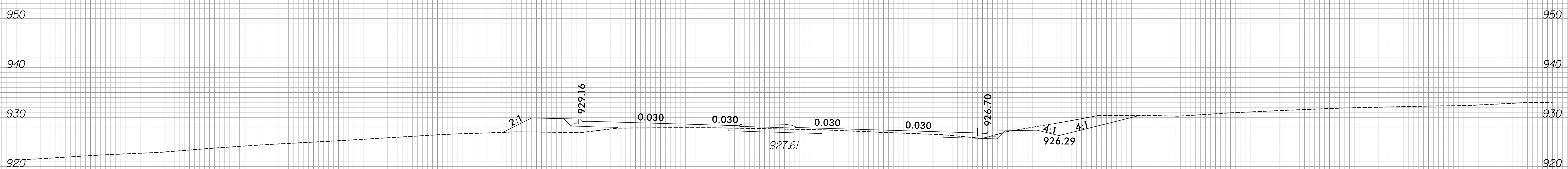
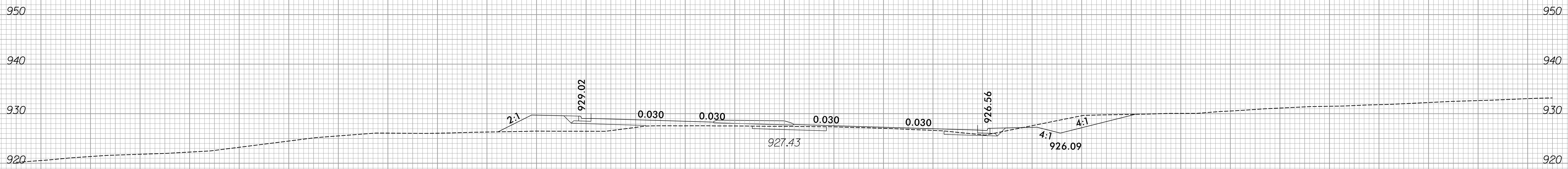

150 140 130 120 110 100 90 80 70 60 50 40 30 20 10 0 10 20 30 40 50 60 70 80 90 100 110 120 130 140 150

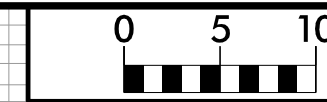

150 140 130 120 110 100 90 80 70 60 50 40 30 20 10 0 10 20 30 40 50 60 70 80 90 100 110 120 130 140 150

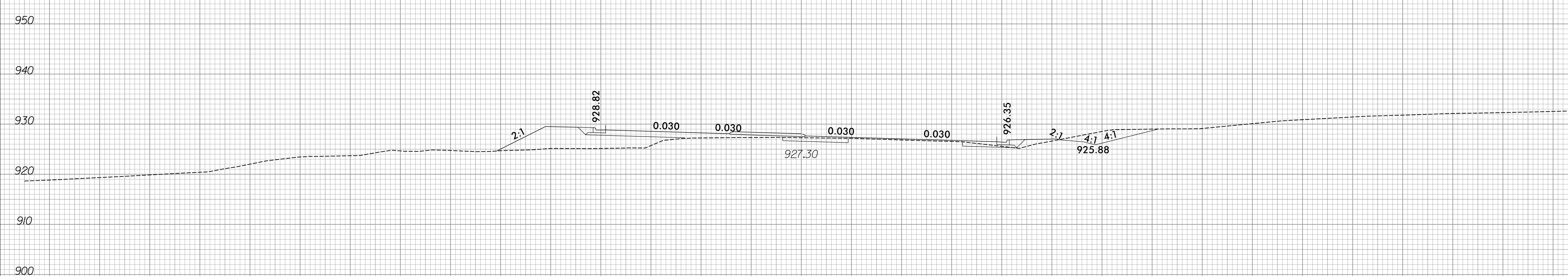
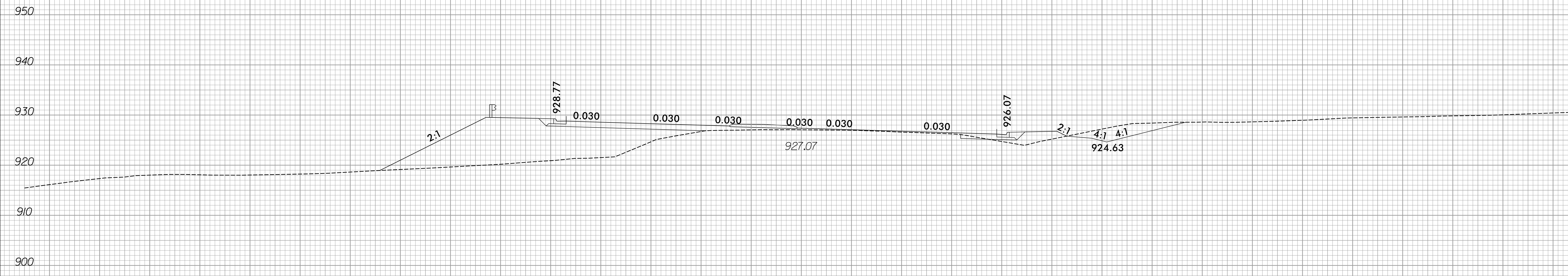

150 140 130 120 110 100 90 80 70 60 50 40 30 20 10 0 10 20 30 40 50 60 70 80 90 100 110 120 130 140 150

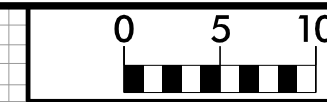

150 140 130 120 110 100 90 80 70 60 50 40 30 20 10 0 10 20 30 40 50 60 70 80 90 100 110 120 130 140 150

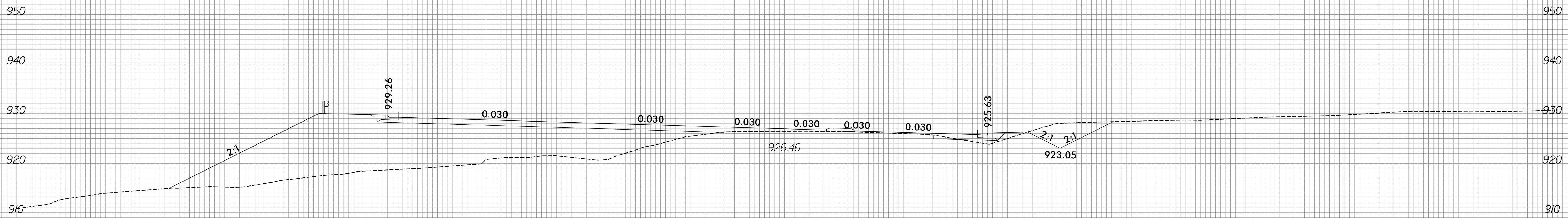

23 + 50.00

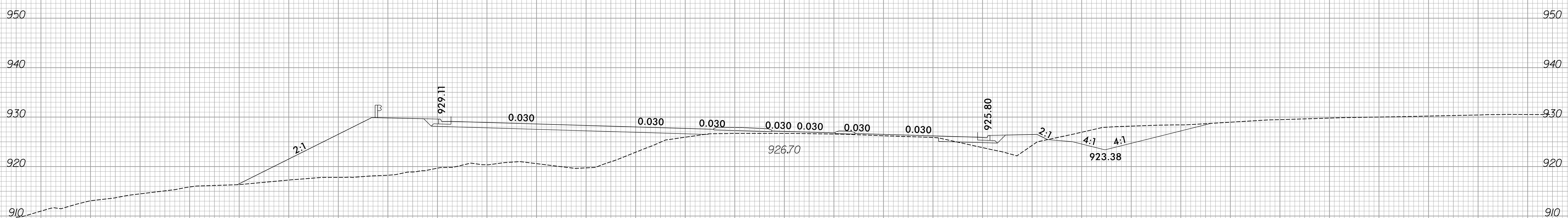

23 + 00.00

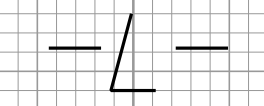

150 140 130 120 110 100 90 80 70 60 50 40 30 20 10 0 10 20 30 40 50 60 70 80 90 100 110 120 130 140 150

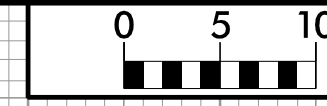

150 140 130 120 110 100 90 80 70 60 50 40 30 20 10 0 10 20 30 40 50 60 70 80 90 100 110 120 130 140 150

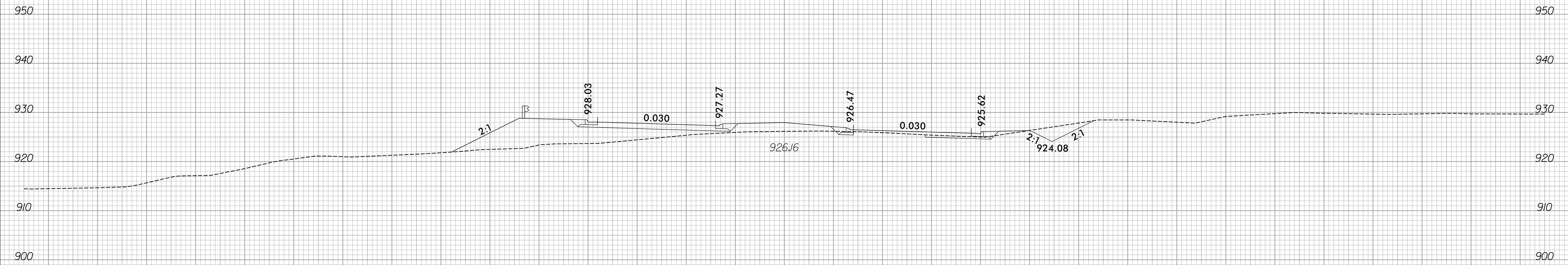

24 + 50.00

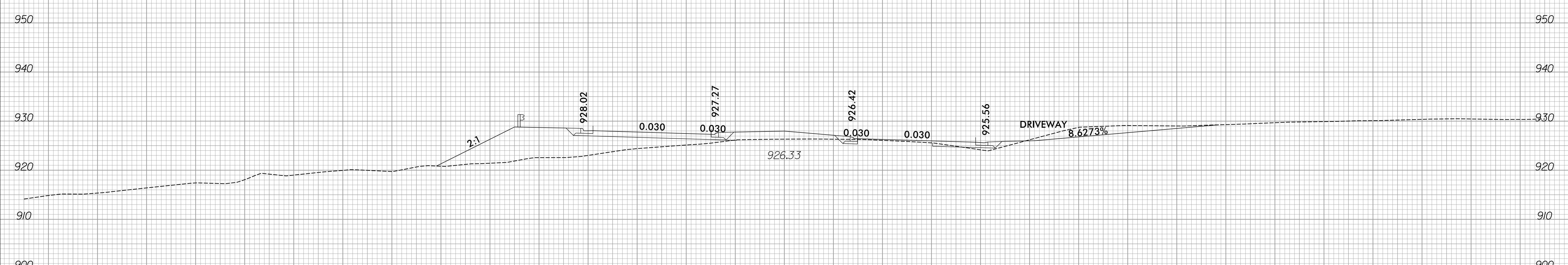

24 + 00.00

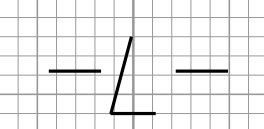

150 140 130 120 110 100 90 80 70 60 50 40 30 20 10 0 10 20 30 40 50 60 70 80 90 100 110 120 130 140 150

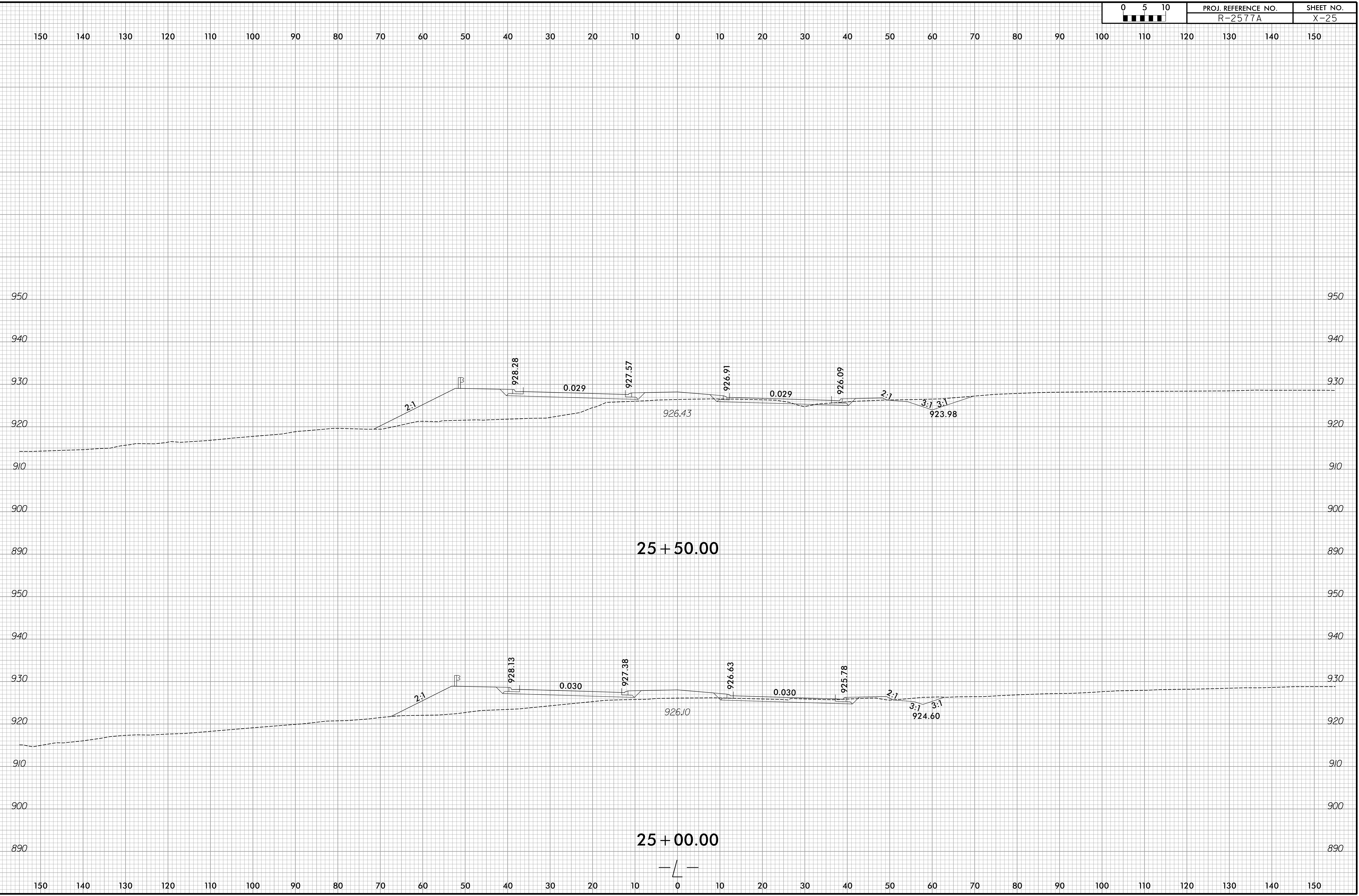
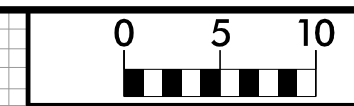

150 140 130 120 110 100 90 80 70 60 50 40 30 20 10 0 10 20 30 40 50 60 70 80 90 100 110 120 130 140 150

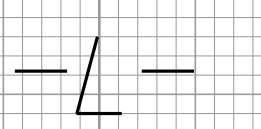
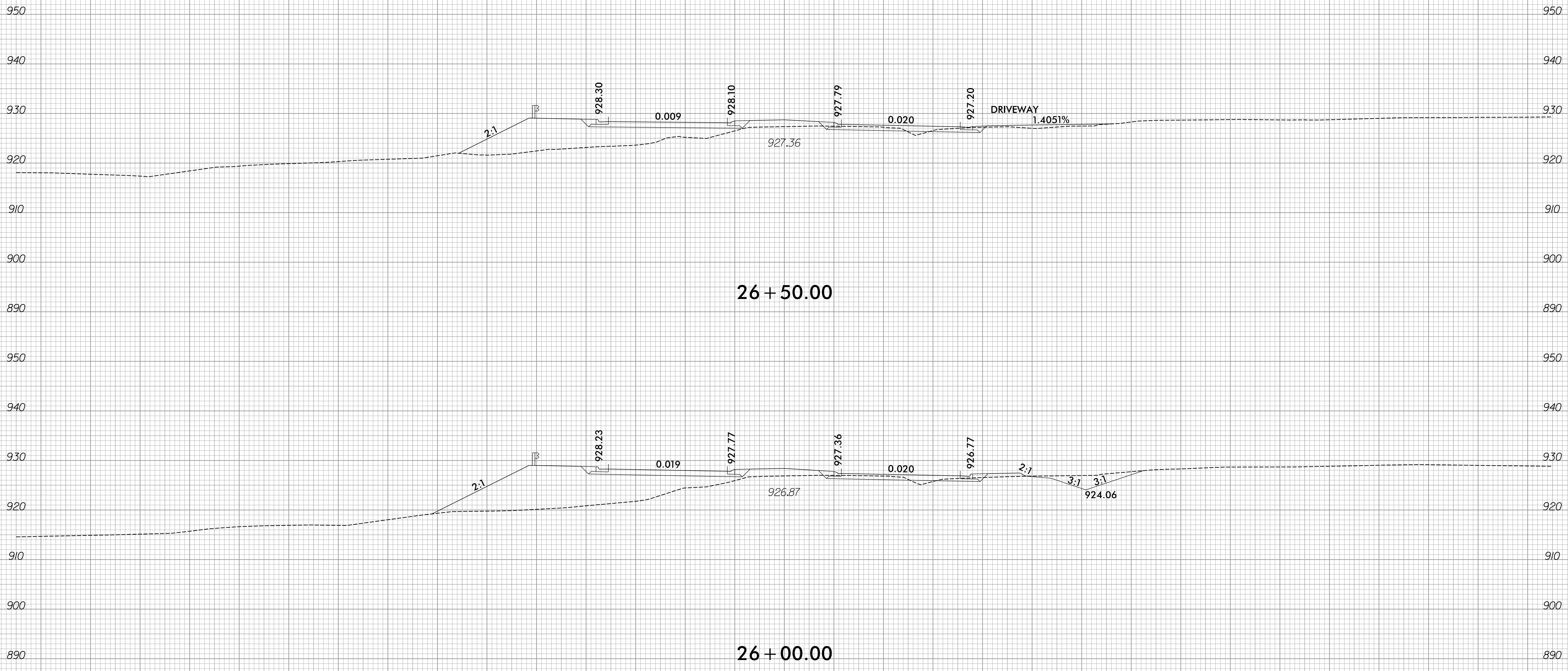

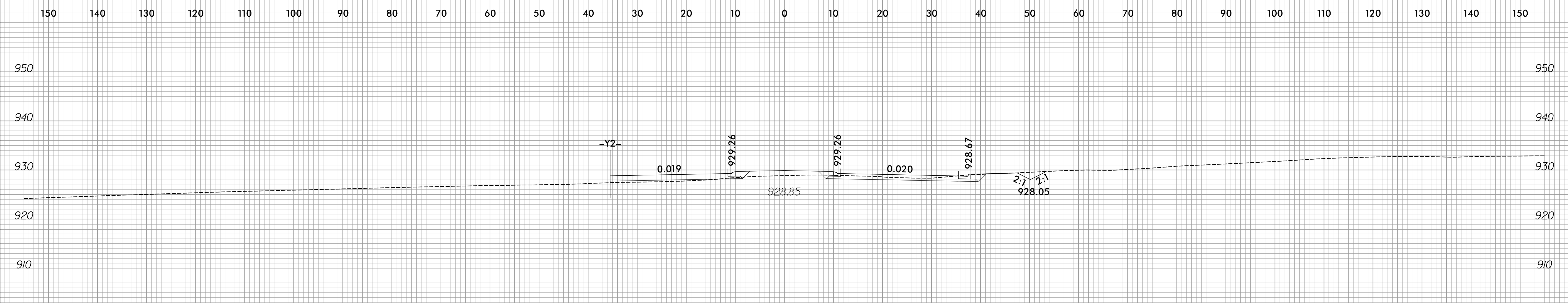

28 + 00.00

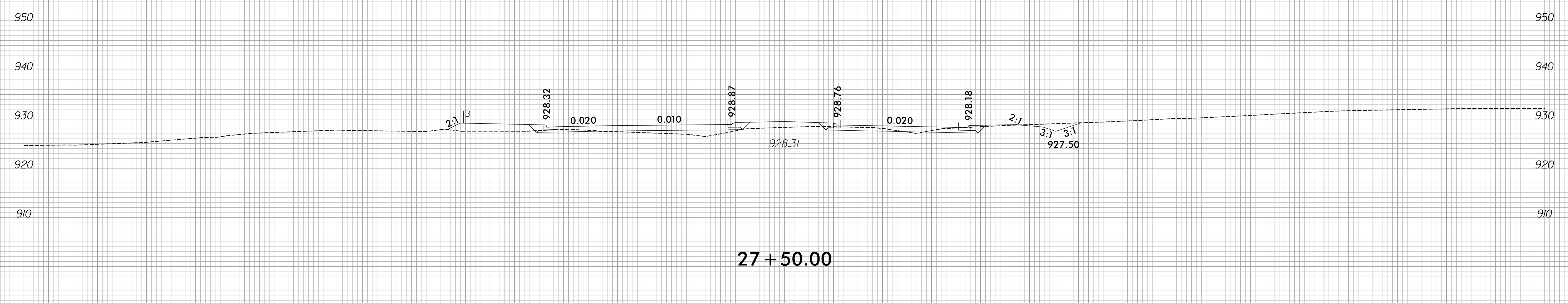

27 + 50.00

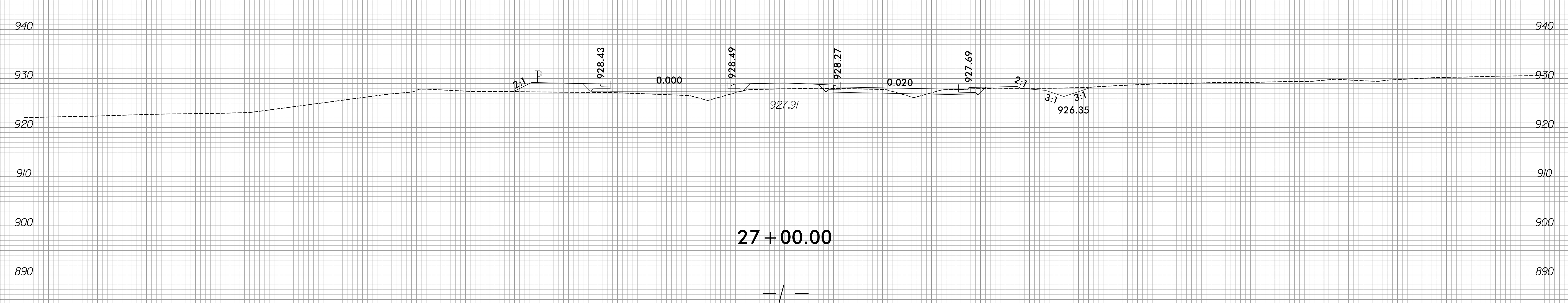

27 + 00.00

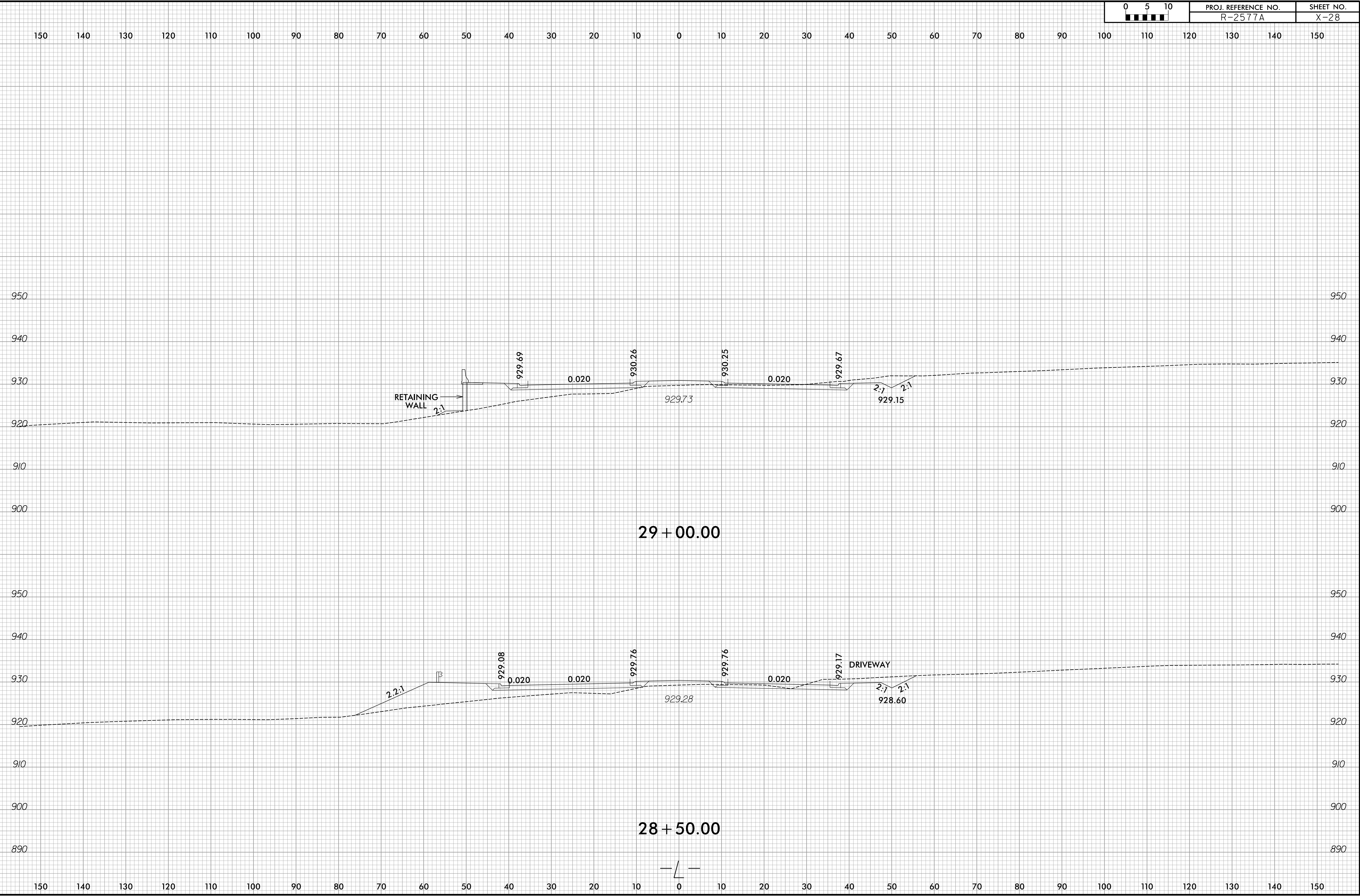
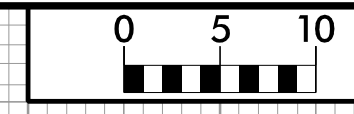



150 140 130 120 110 100 90 80 70 60 50 40 30 20 10 0 10 20 30 40 50 60 70 80 90 100 110 120 130 140 150

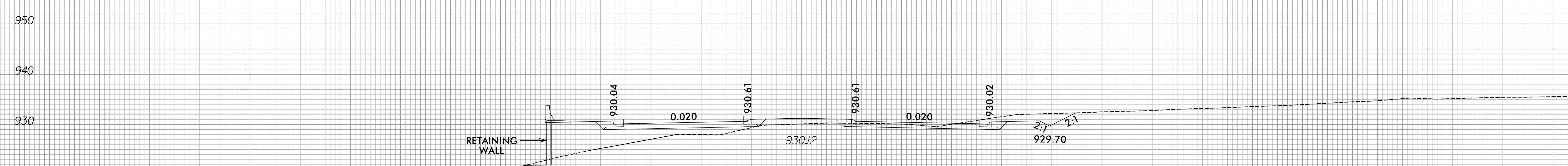
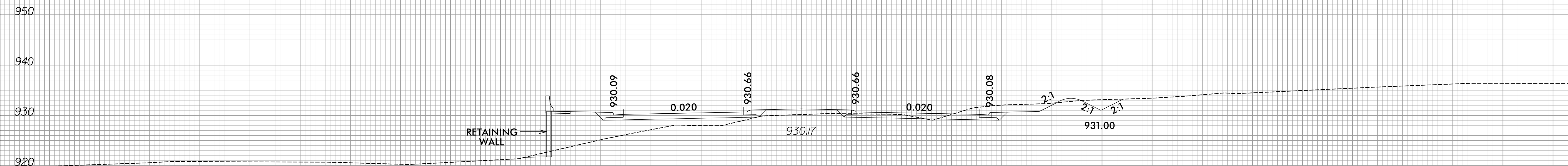

150 140 130 120 110 100 90 80 70 60 50 40 30 20 10 0 10 20 30 40 50 60 70 80 90 100 110 120 130 140 150

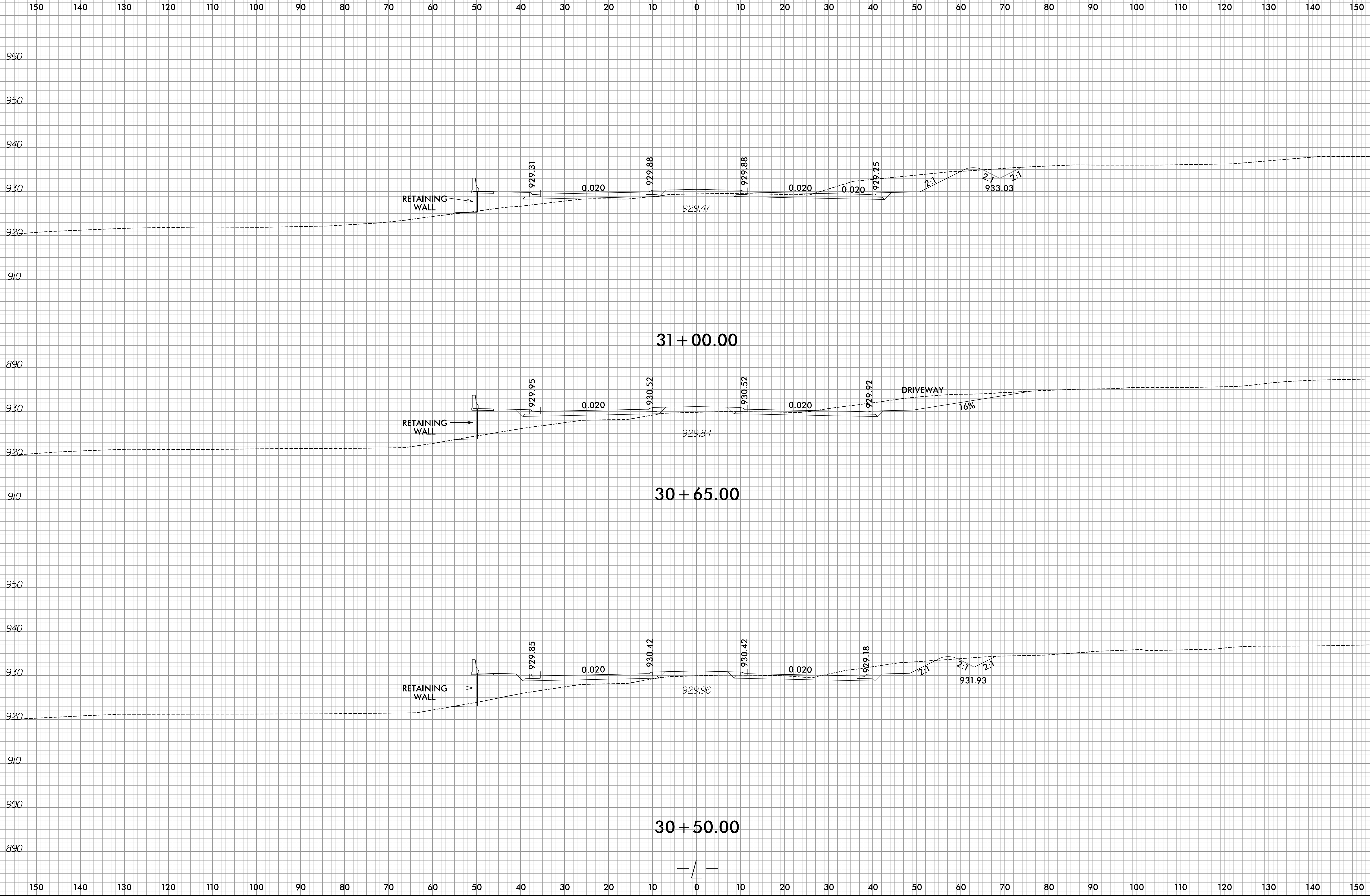

6/23/16

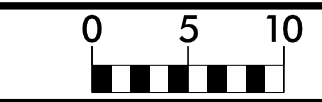

PROJ. REFERENCE NO.
R-2577A

SHEET NO.
X-31

150 140 130 120 110 100 90 80 70 60 50 40 30 20 10 0 10 20 30 40 50 60 70 80 90 100 110 120 130 140 150

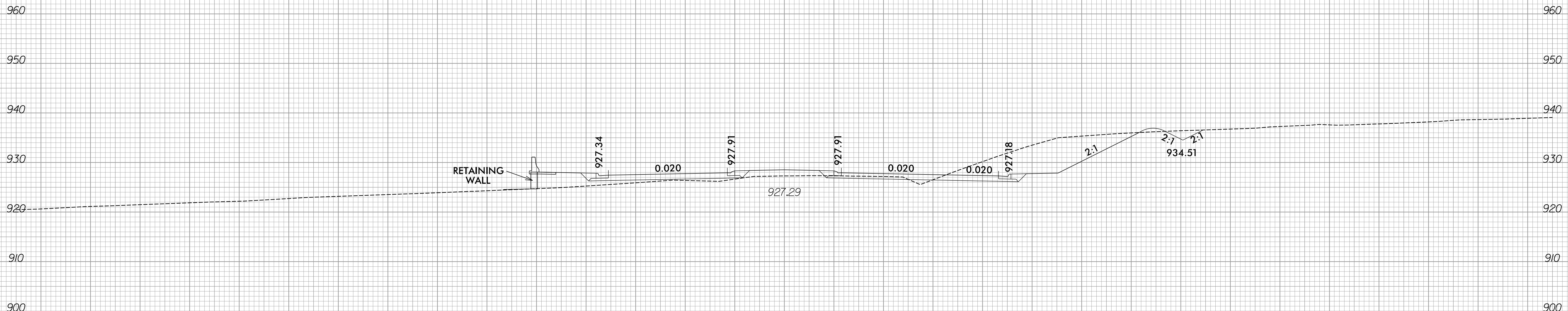

32 + 00.00

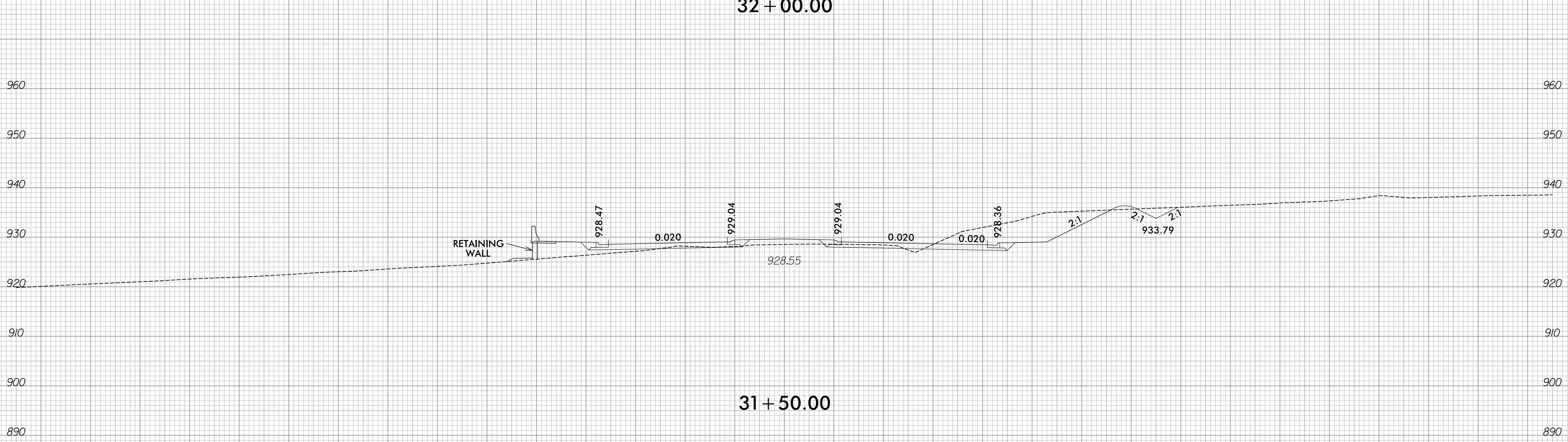

31 + 50.00

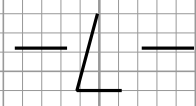

150 140 130 120 110 100 90 80 70 60 50 40 30 20 10 0 10 20 30 40 50 60 70 80 90 100 110 120 130 140 150

150 140 130 120 110 100 90 80 70 60 50 40 30 20 10 0 10 20 30 40 50 60 70 80 90 100 110 120 130 140 150

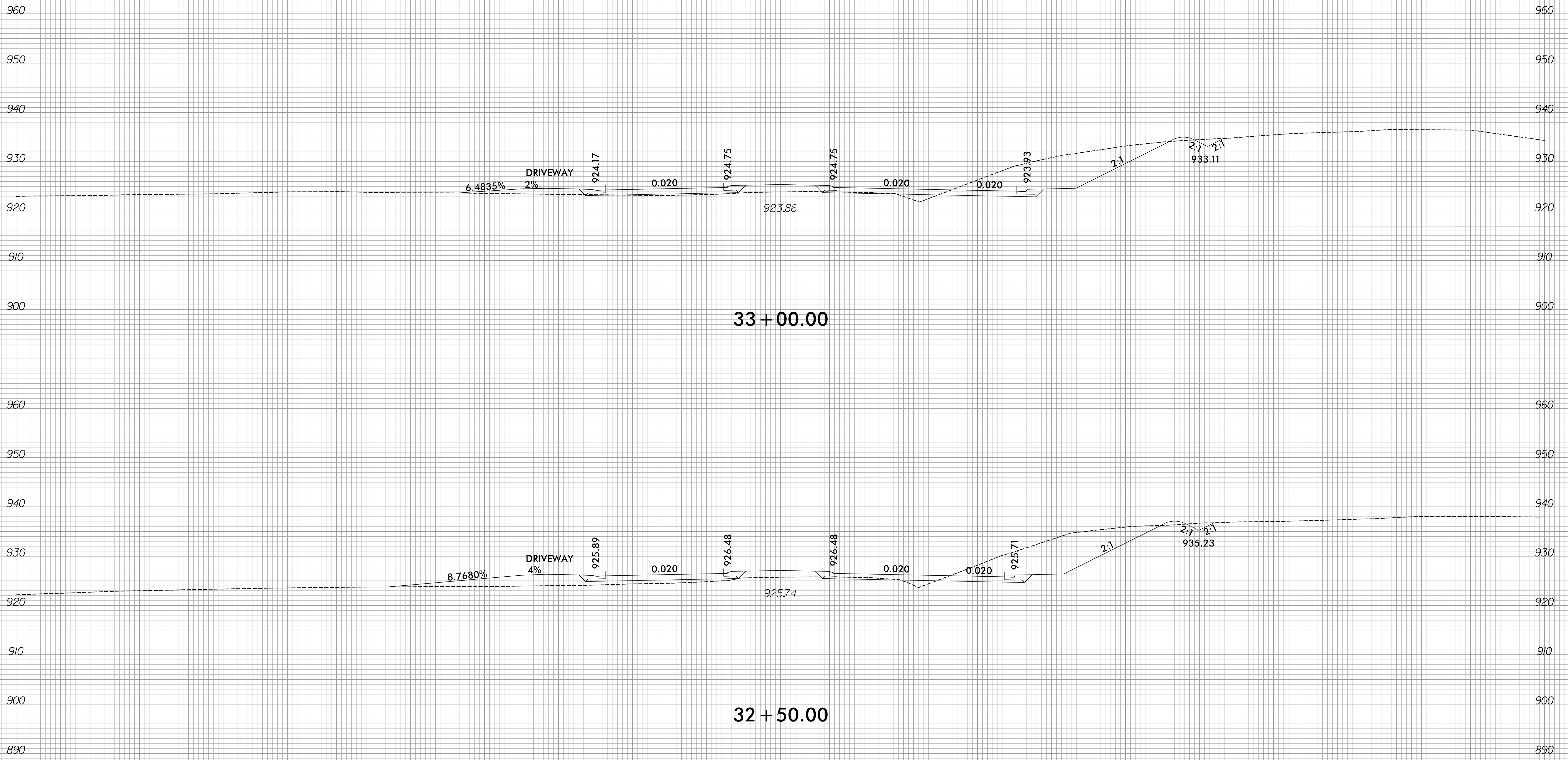

33 + 00.00

32 + 50.00

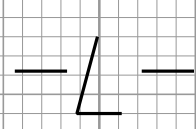



150 140 130 120 110 100 90 80 70 60 50 40 30 20 10 0 10 20 30 40 50 60 70 80 90 100 110 120 130 140 150

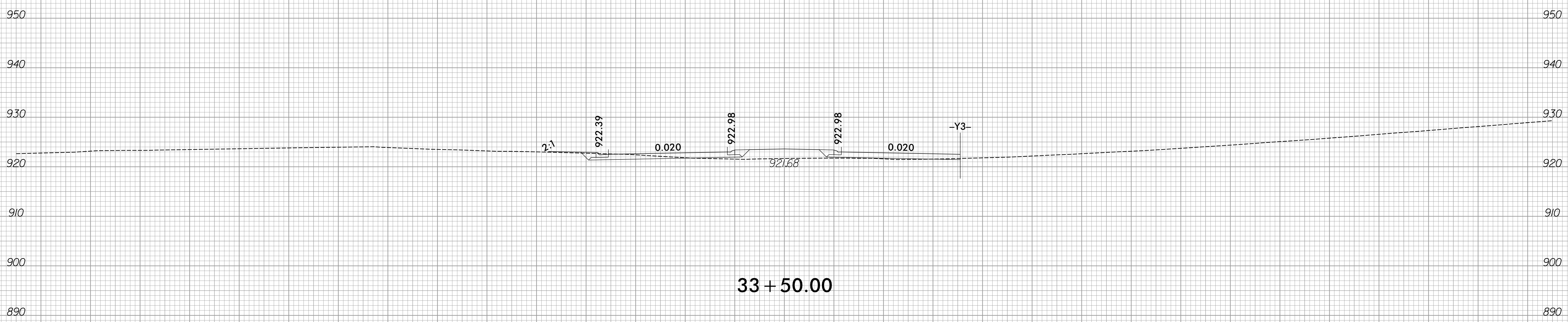
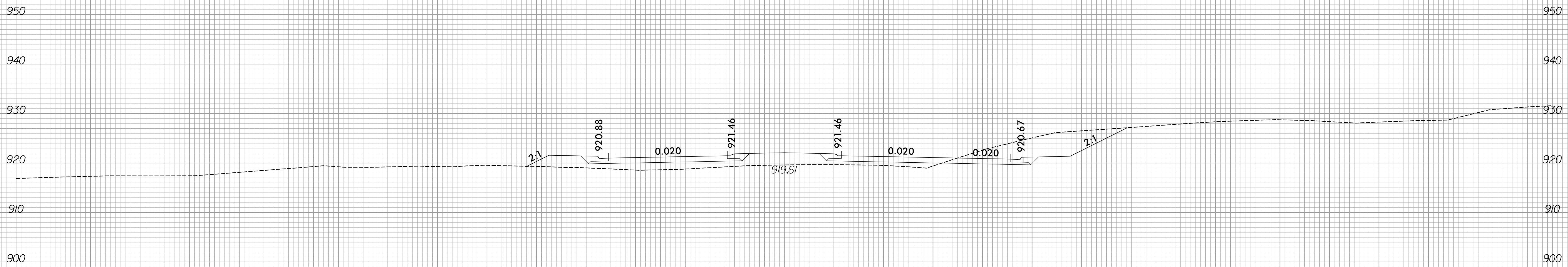

— / —



150 140 130 120 110 100 90 80 70 60 50 40 30 20 10 0 10 20 30 40 50 60 70 80 90 100 110 120 130 140 150

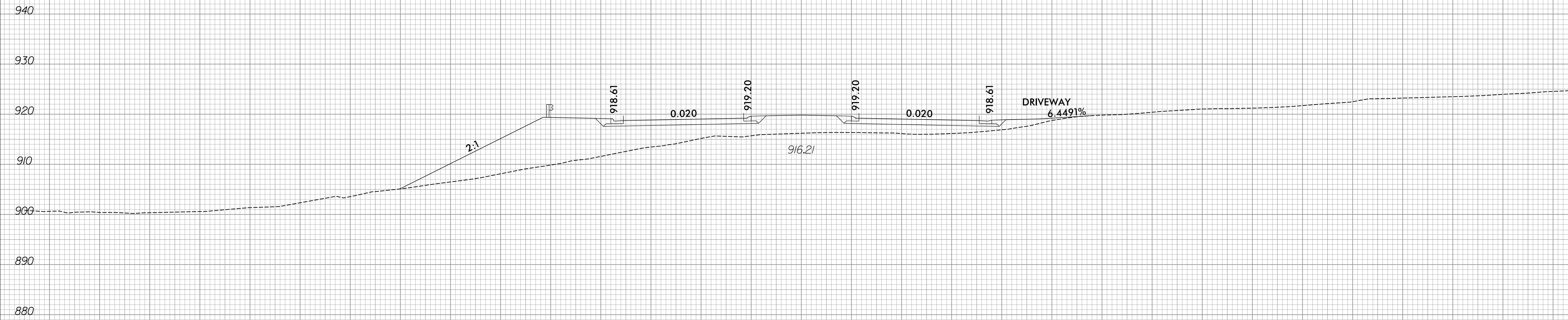

150 140 130 120 110 100 90 80 70 60 50 40 30 20 10 0 10 20 30 40 50 60 70 80 90 100 110 120 130 140 150

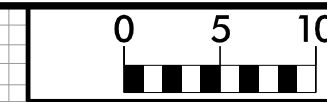

150 140 130 120 110 100 90 80 70 60 50 40 30 20 10 0 10 20 30 40 50 60 70 80 90 100 110 120 130 140 150

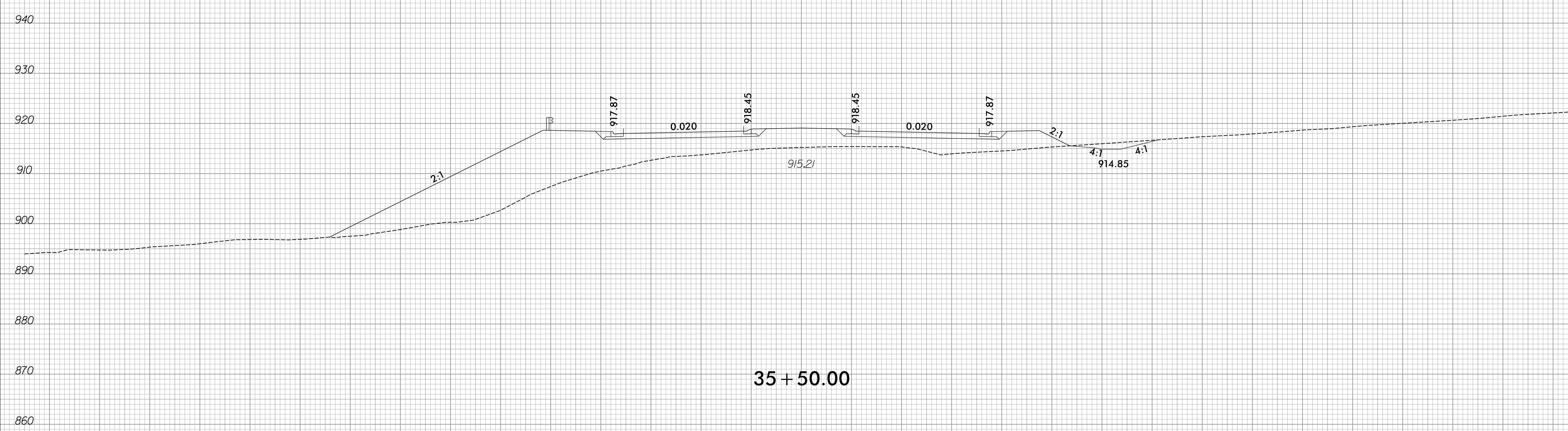
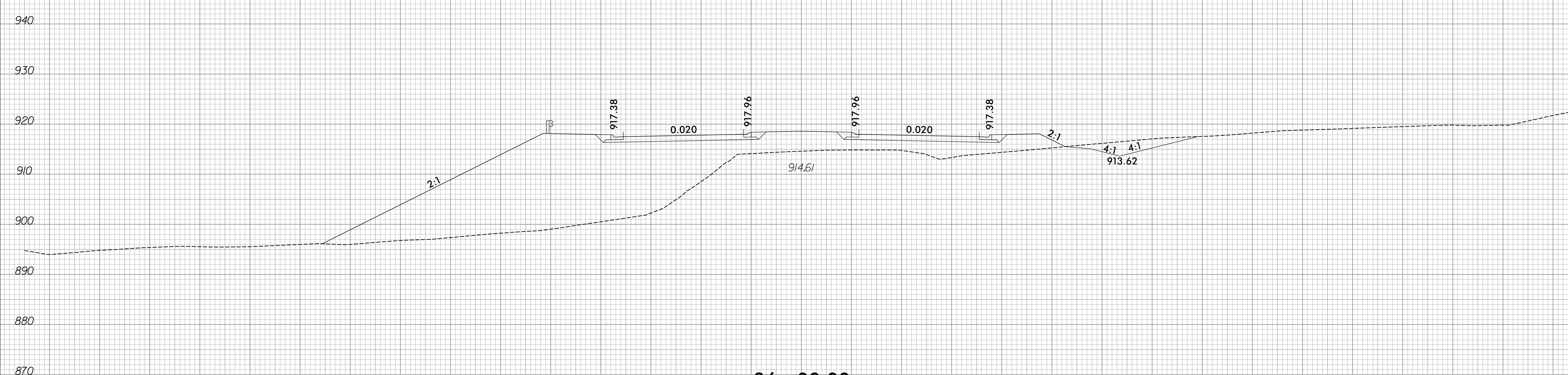

150 140 130 120 110 100 90 80 70 60 50 40 30 20 10 0 10 20 30 40 50 60 70 80 90 100 110 120 130 140 150



150 140 130 120 110 100 90 80 70 60 50 40 30 20 10 0 10 20 30 40 50 60 70 80 90 100 110 120 130 140 150

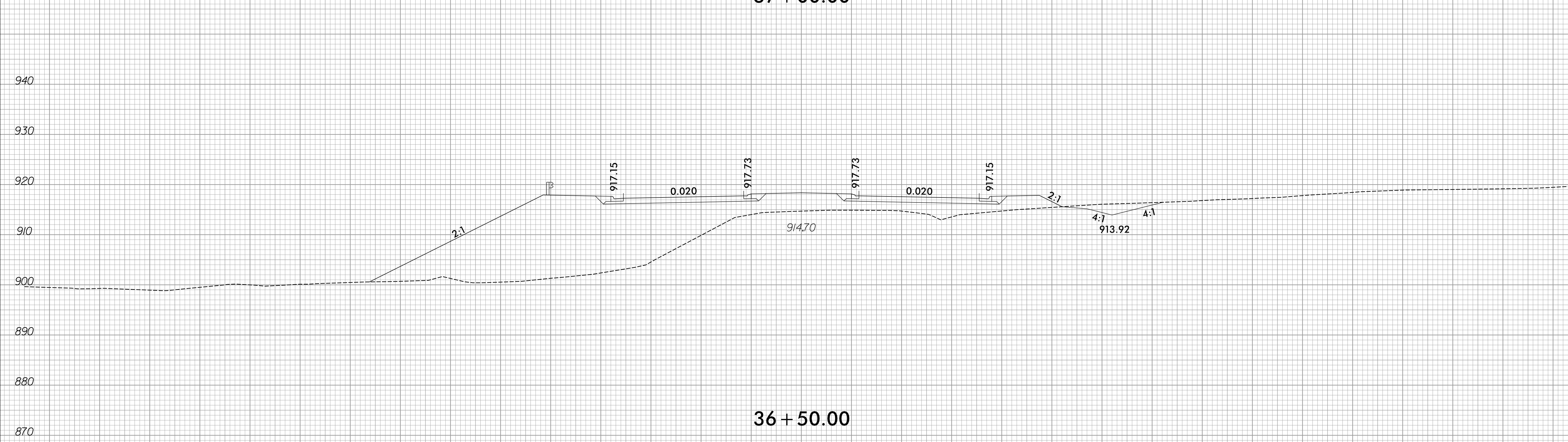
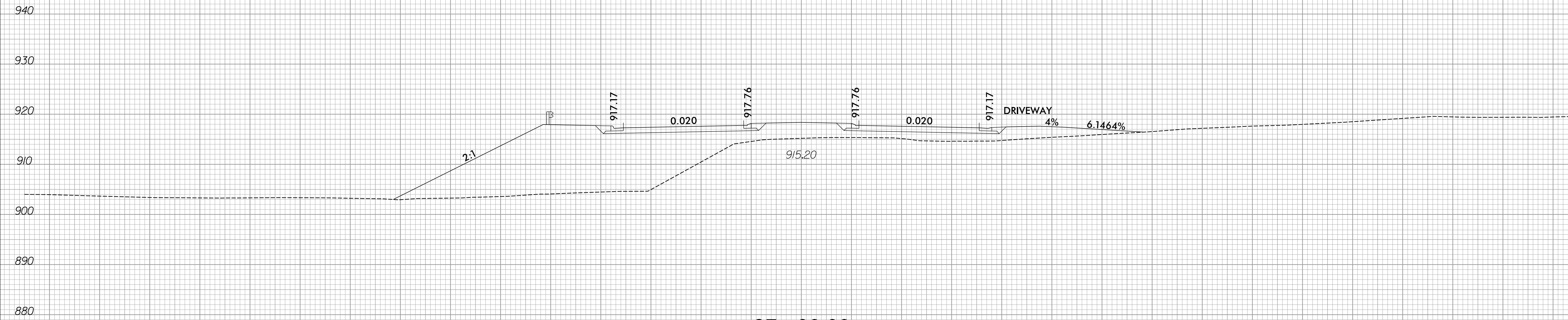

150 140 130 120 110 100 90 80 70 60 50 40 30 20 10 0 10 20 30 40 50 60 70 80 90 100 110 120 130 140 150



150 140 130 120 110 100 90 80 70 60 50 40 30 20 10 0 10 20 30 40 50 60 70 80 90 100 110 120 130 140 150

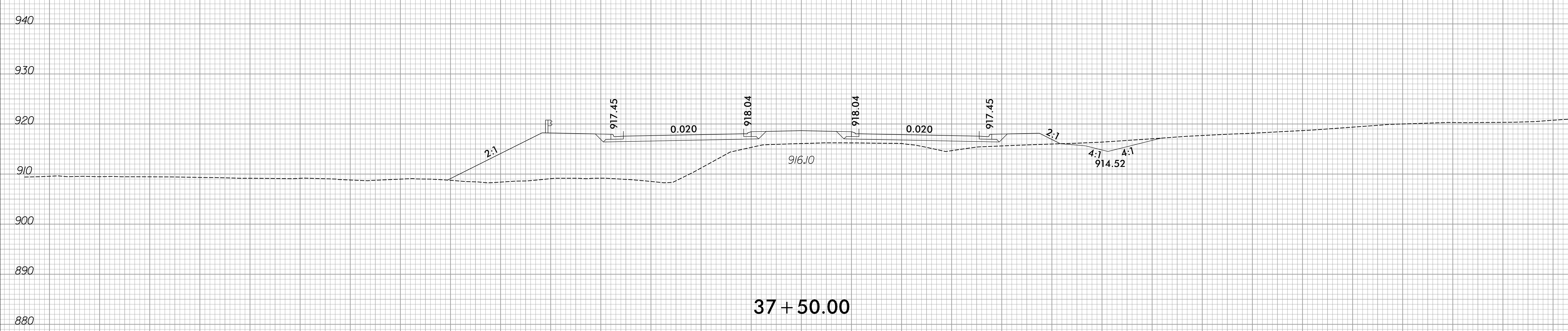
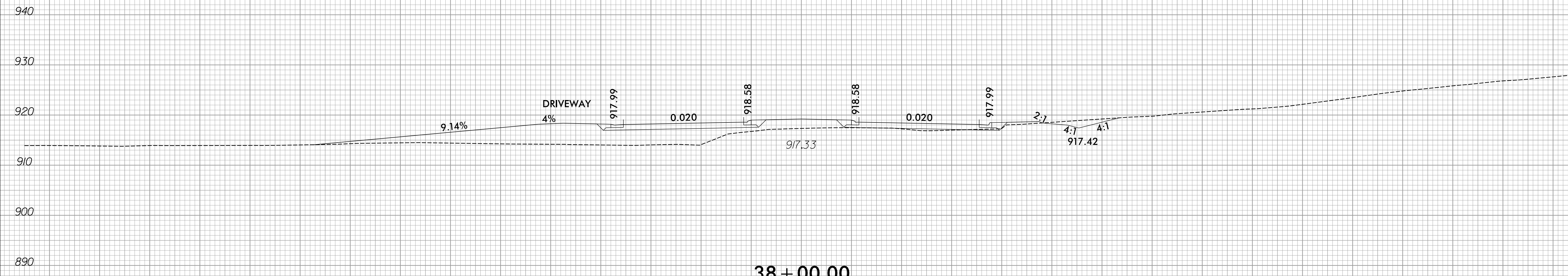

150 140 130 120 110 100 90 80 70 60 50 40 30 20 10 0 10 20 30 40 50 60 70 80 90 100 110 120 130 140 150

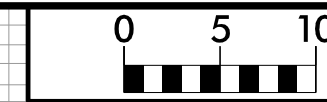

150 140 130 120 110 100 90 80 70 60 50 40 30 20 10 0 10 20 30 40 50 60 70 80 90 100 110 120 130 140 150

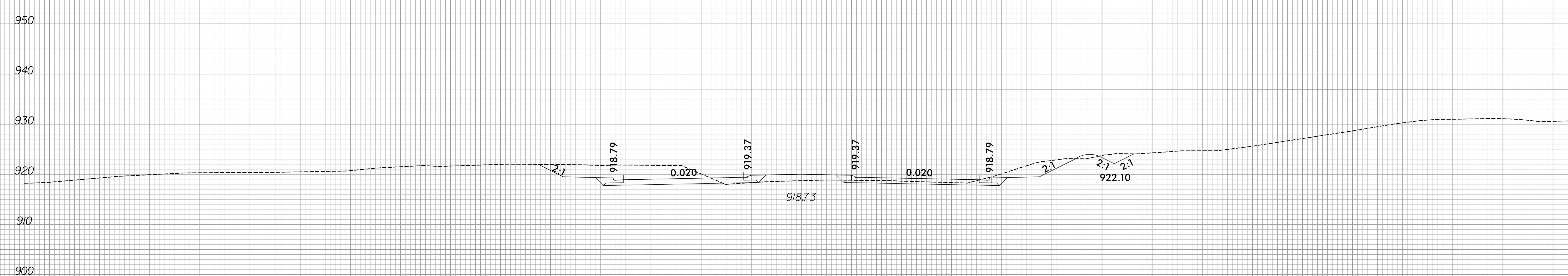
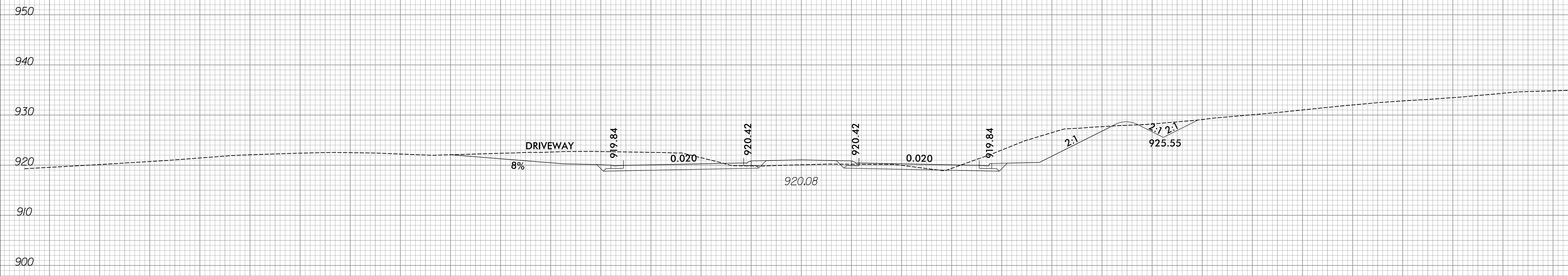

150 140 130 120 110 100 90 80 70 60 50 40 30 20 10 0 10 20 30 40 50 60 70 80 90 100 110 120 130 140 150

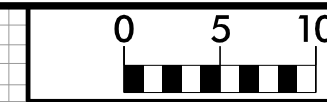

150 140 130 120 110 100 90 80 70 60 50 40 30 20 10 0 10 20 30 40 50 60 70 80 90 100 110 120 130 140 150

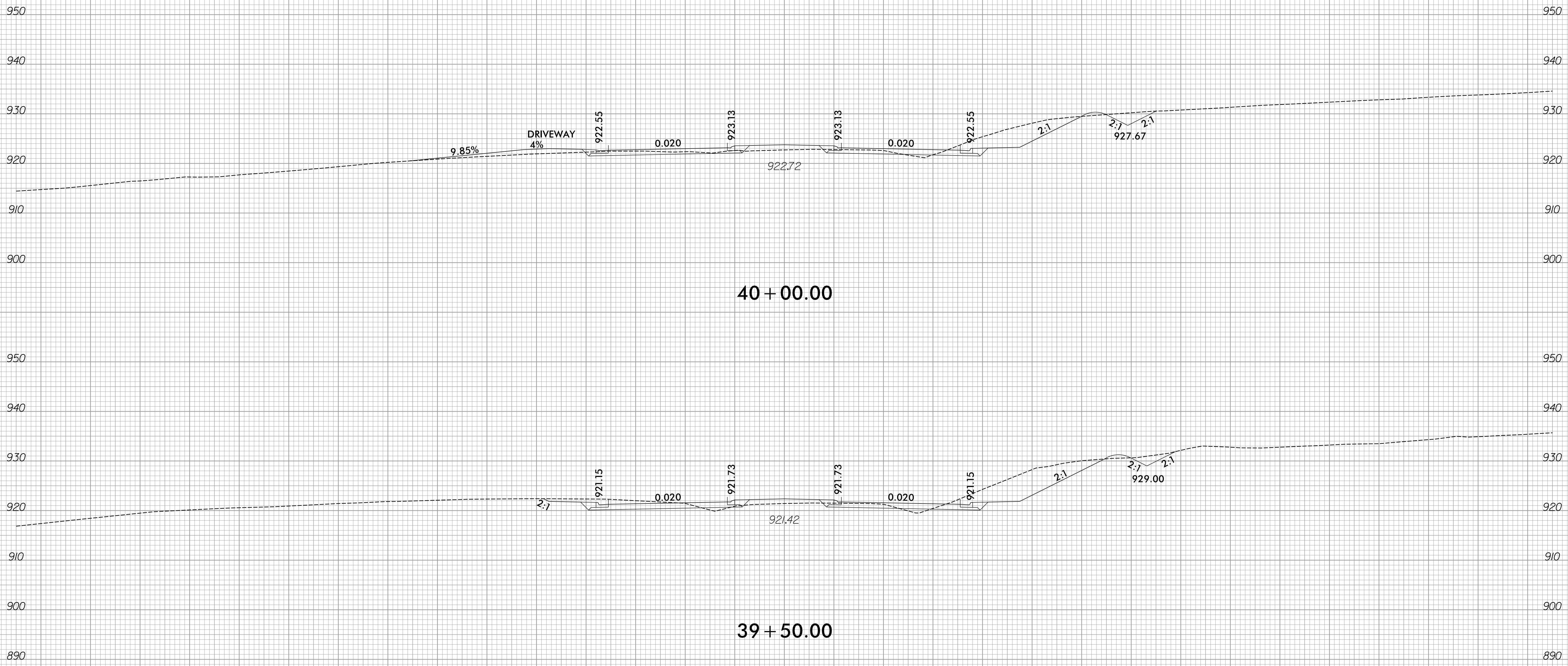

150 140 130 120 110 100 90 80 70 60 50 40 30 20 10 0 10 20 30 40 50 60 70 80 90 100 110 120 130 140 150

150 140 130 120 110 100 90 80 70 60 50 40 30 20 10 0 10 20 30 40 50 60 70 80 90 100 110 120 130 140 150

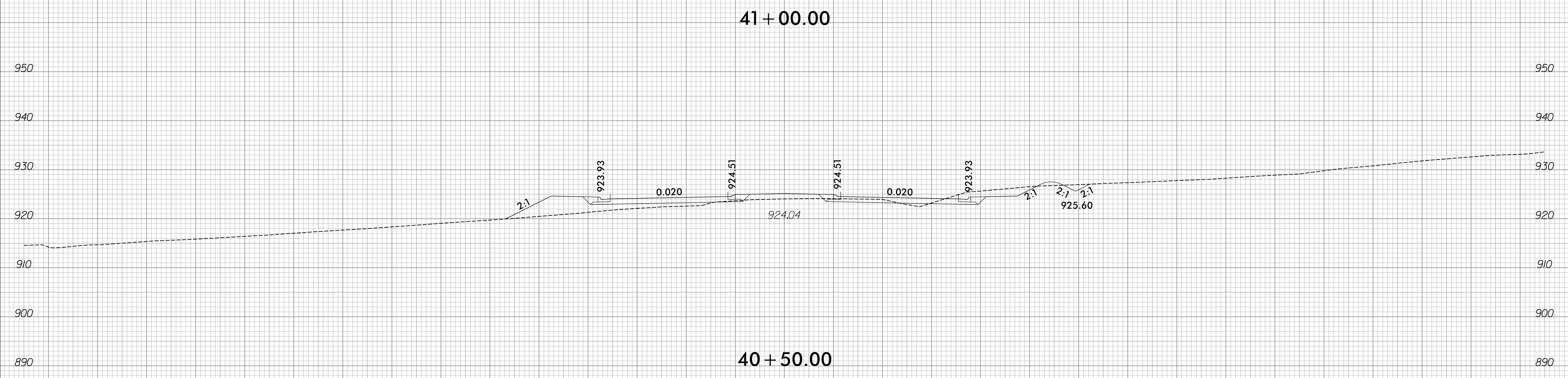

150 140 130 120 110 100 90 80 70 60 50 40 30 20 10 0 10 20 30 40 50 60 70 80 90 100 110 120 130 140 150



150 140 130 120 110 100 90 80 70 60 50 40 30 20 10 0 10 20 30 40 50 60 70 80 90 100 110 120 130 140 150

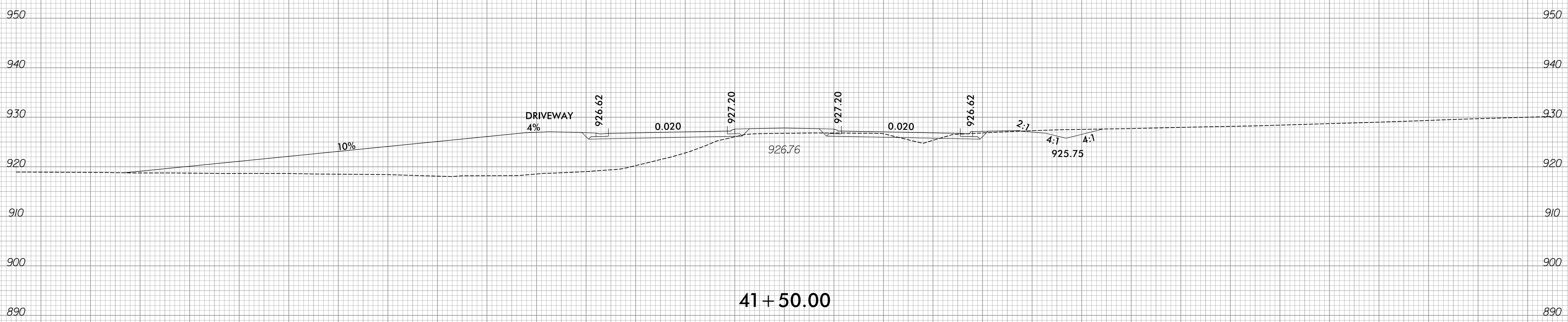
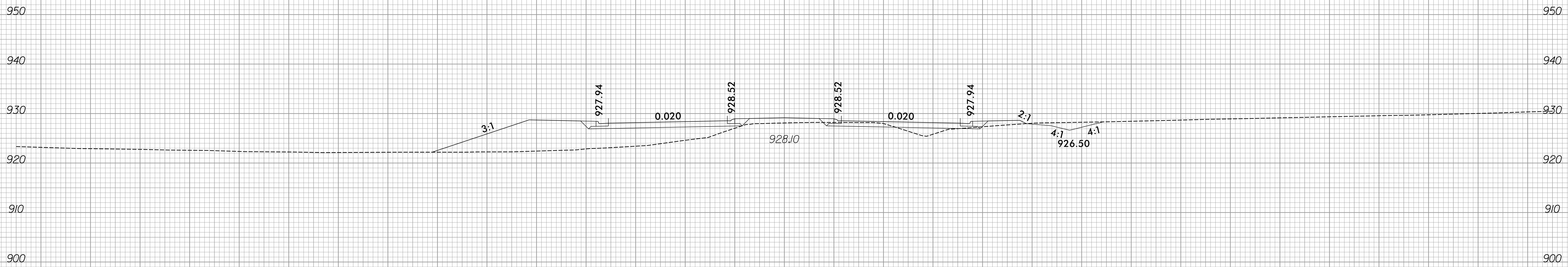

150 140 130 120 110 100 90 80 70 60 50 40 30 20 10 0 10 20 30 40 50 60 70 80 90 100 110 120 130 140 150



150 140 130 120 110 100 90 80 70 60 50 40 30 20 10 0 10 20 30 40 50 60 70 80 90 100 110 120 130 140 150

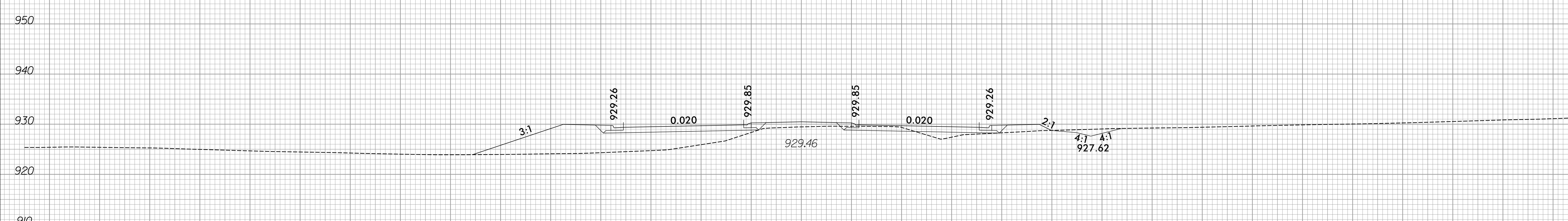
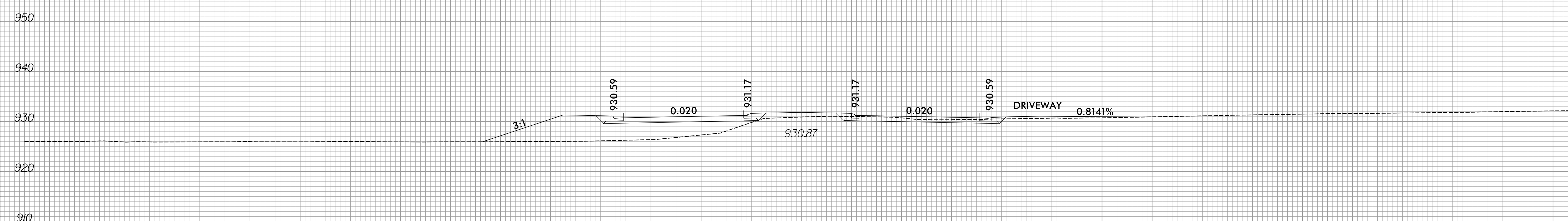
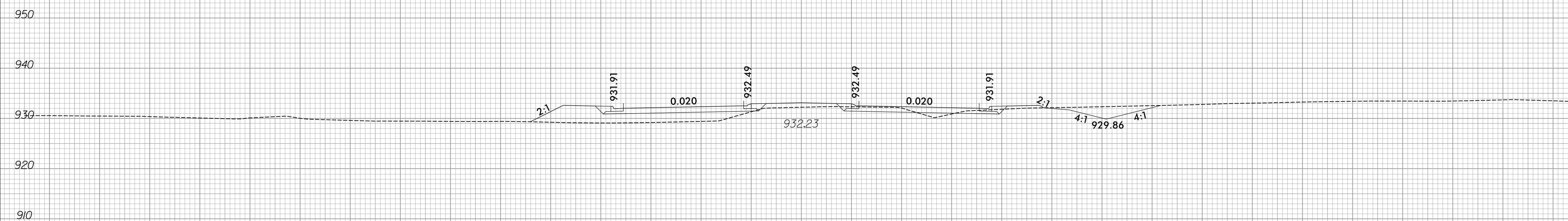

150 140 130 120 110 100 90 80 70 60 50 40 30 20 10 0 10 20 30 40 50 60 70 80 90 100 110 120 130 140 150

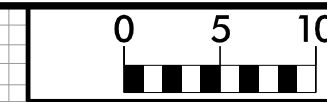

150 140 130 120 110 100 90 80 70 60 50 40 30 20 10 0 10 20 30 40 50 60 70 80 90 100 110 120 130 140 150

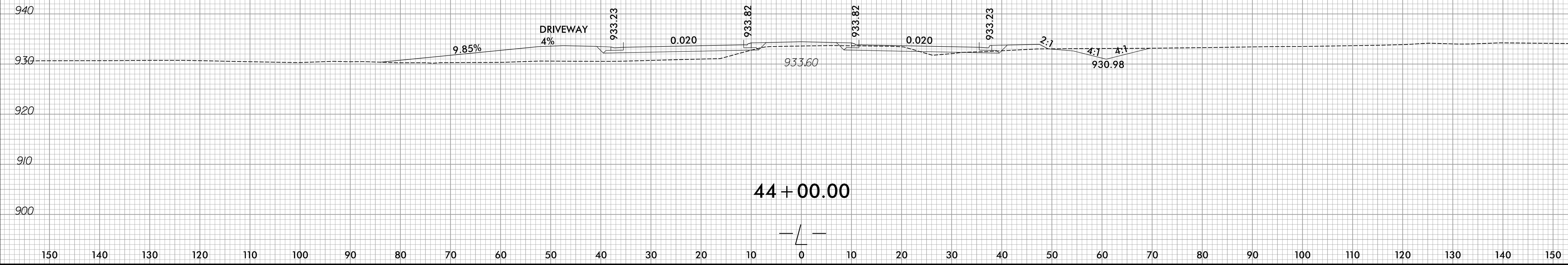
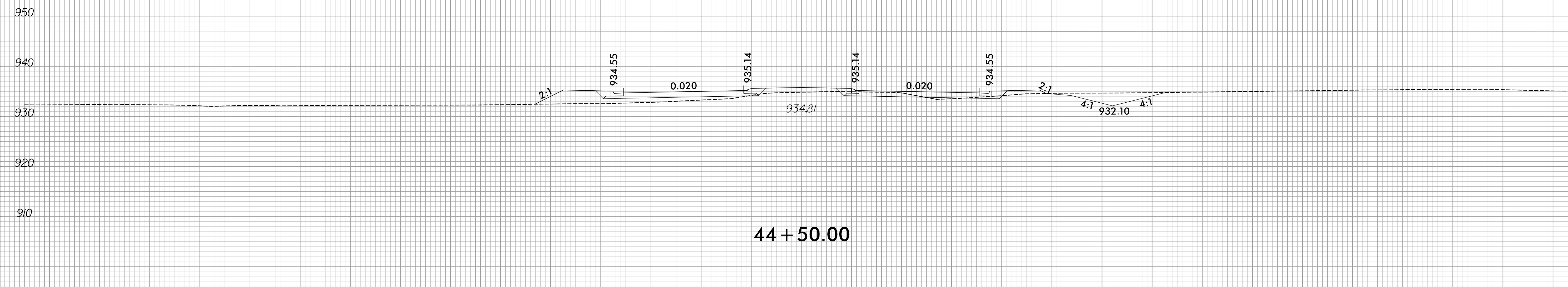
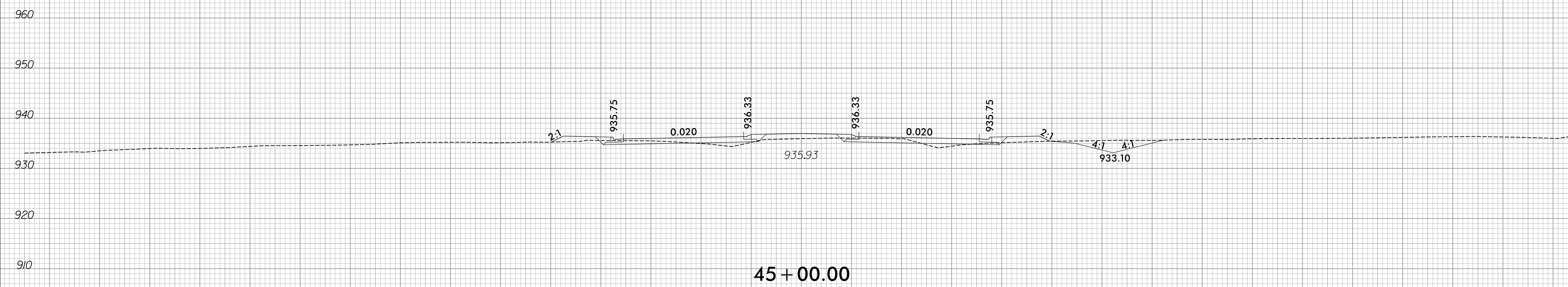

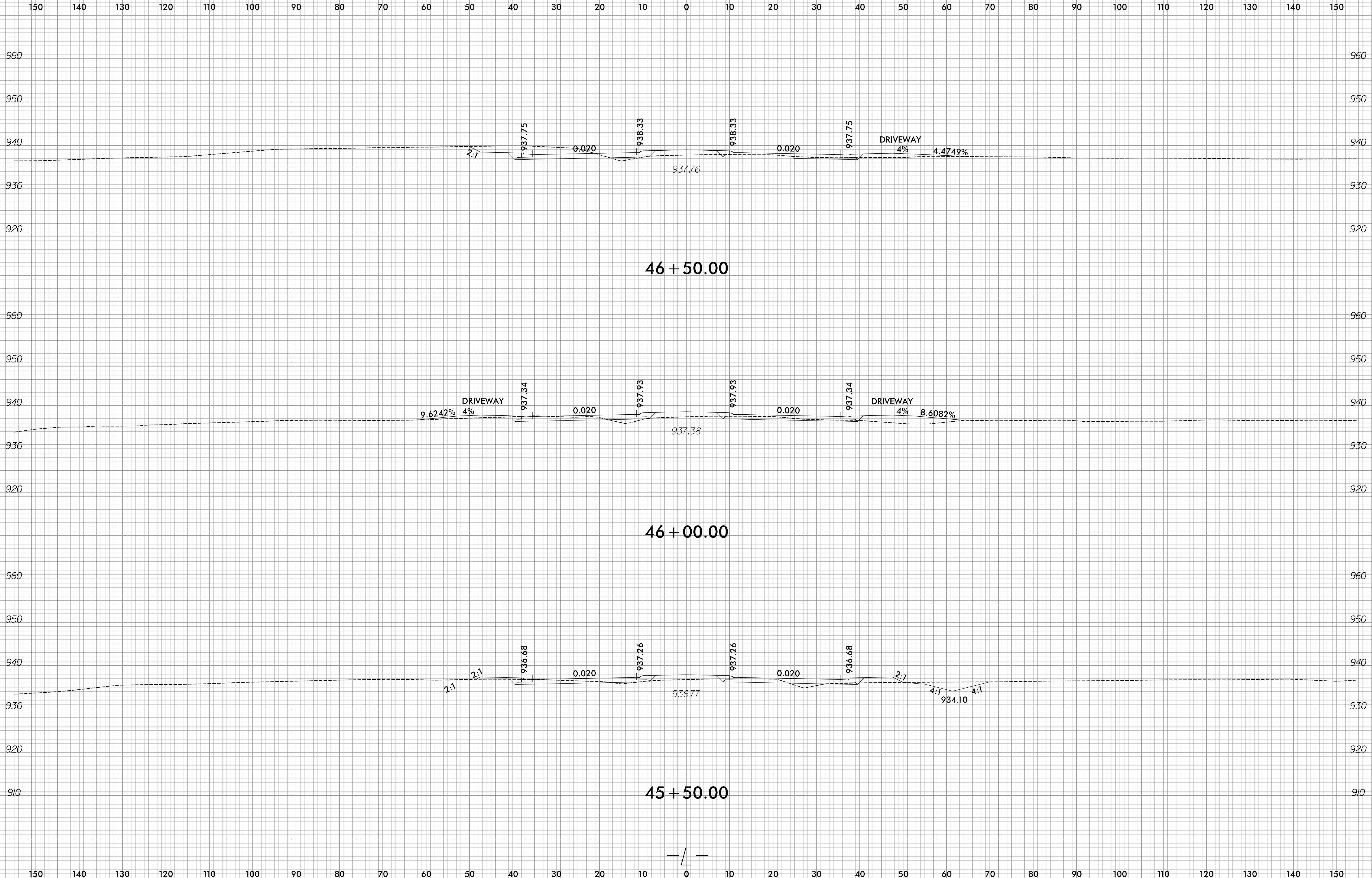



150 140 130 120 110 100 90 80 70 60 50 40 30 20 10 0 10 20 30 40 50 60 70 80 90 100 110 120 130 140 150

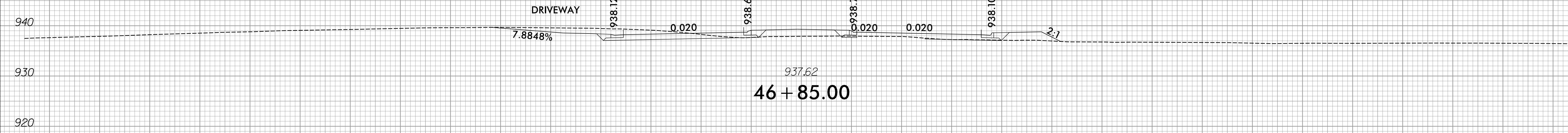
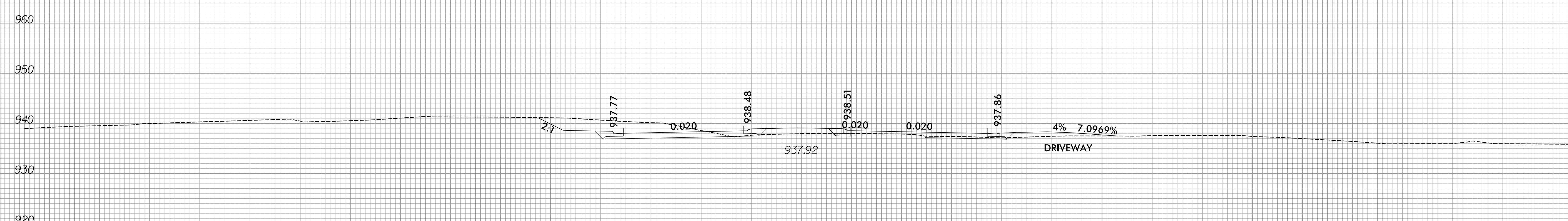
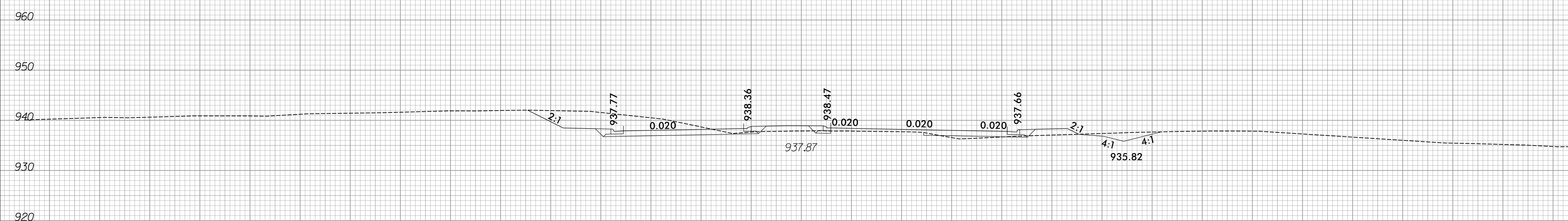

150 140 130 120 110 100 90 80 70 60 50 40 30 20 10 0 10 20 30 40 50 60 70 80 90 100 110 120 130 140 150

6/23/16

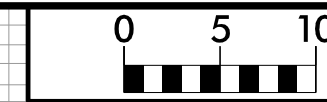

PROJ. REFERENCE NO.
R-2577A

SHEET NO.
X-46

150 140 130 120 110 100 90 80 70 60 50 40 30 20 10 0 10 20 30 40 50 60 70 80 90 100 110 120 130 140 150

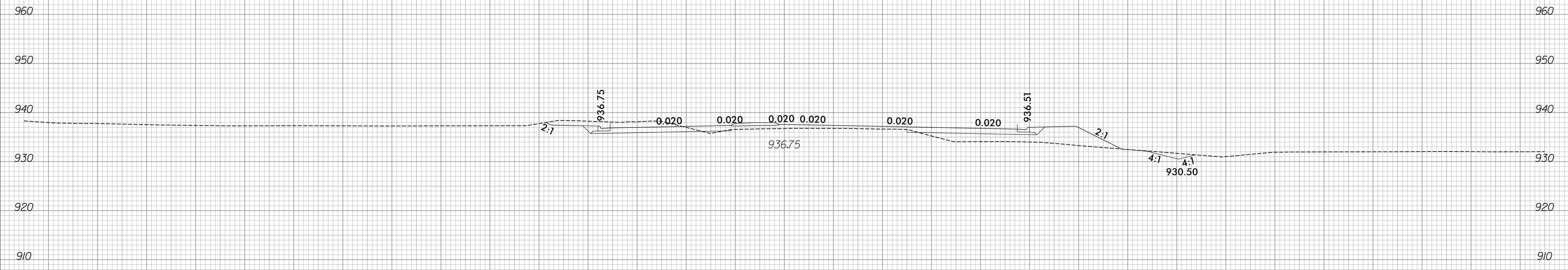

48 + 50.00

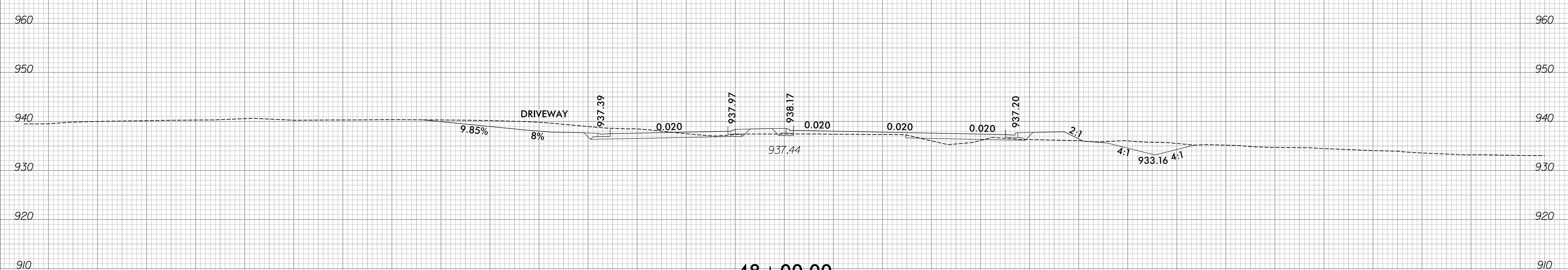

48 + 00.00

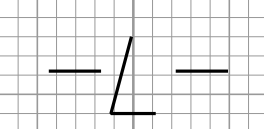

12/2/2023
R:\Roadway\XSC\R-2577A_Rdy_xpl.dgn
amcpherson

150 140 130 120 110 100 90 80 70 60 50 40 30 20 10 0 10 20 30 40 50 60 70 80 90 100 110 120 130 140 150

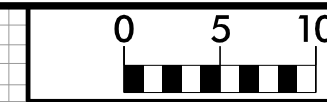

150 140 130 120 110 100 90 80 70 60 50 40 30 20 10 0 10 20 30 40 50 60 70 80 90 100 110 120 130 140 150

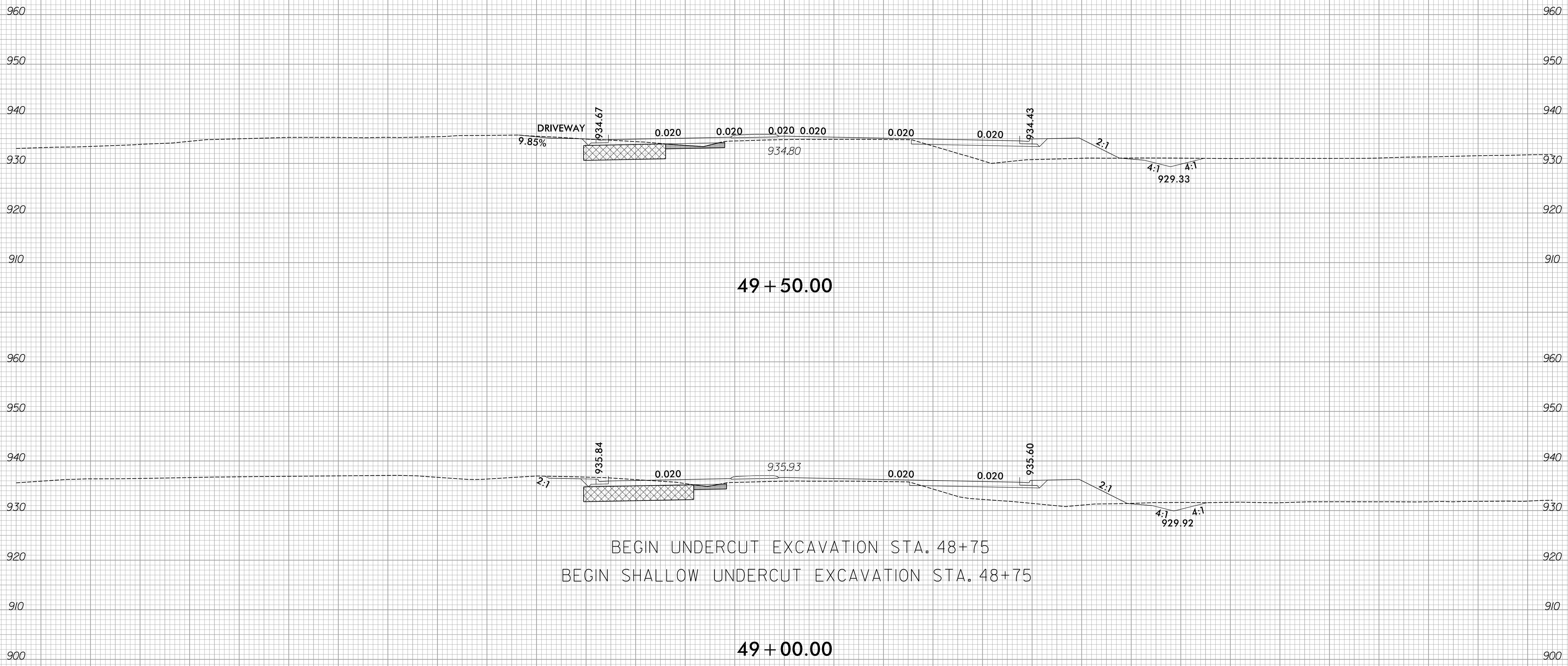

150 140 130 120 110 100 90 80 70 60 50 40 30 20 10 0 10 20 30 40 50 60 70 80 90 100 110 120 130 140 150

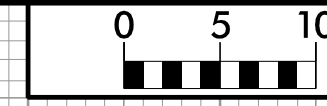

150 140 130 120 110 100 90 80 70 60 50 40 30 20 10 0 10 20 30 40 50 60 70 80 90 100 110 120 130 140 150

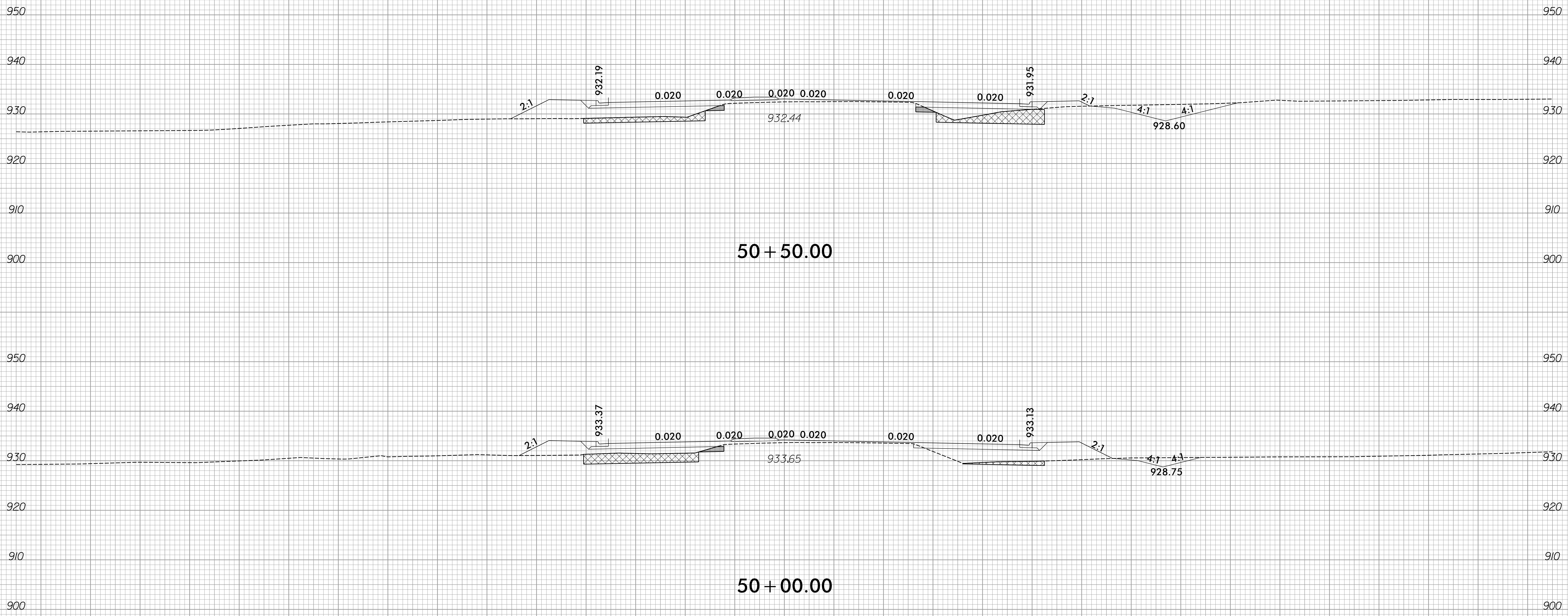

150 140 130 120 110 100 90 80 70 60 50 40 30 20 10 0 10 20 30 40 50 60 70 80 90 100 110 120 130 140 150

150 140 130 120 110 100 90 80 70 60 50 40 30 20 10 0 10 20 30 40 50 60 70 80 90 100 110 120 130 140 150

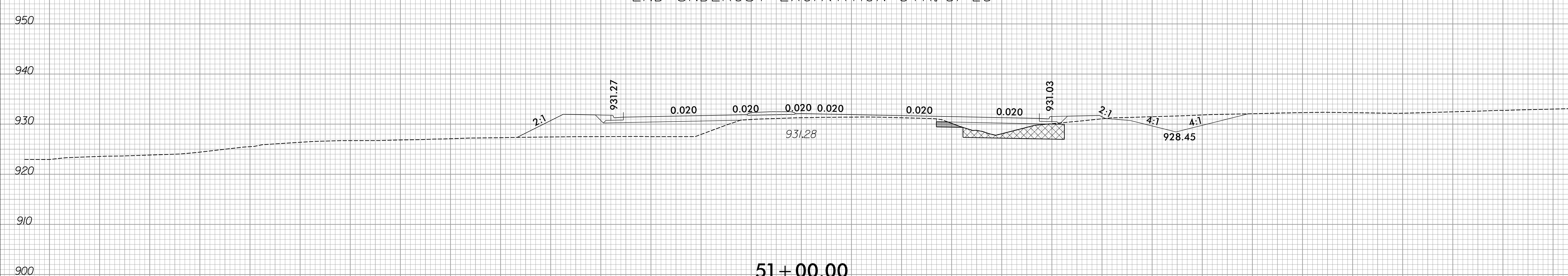
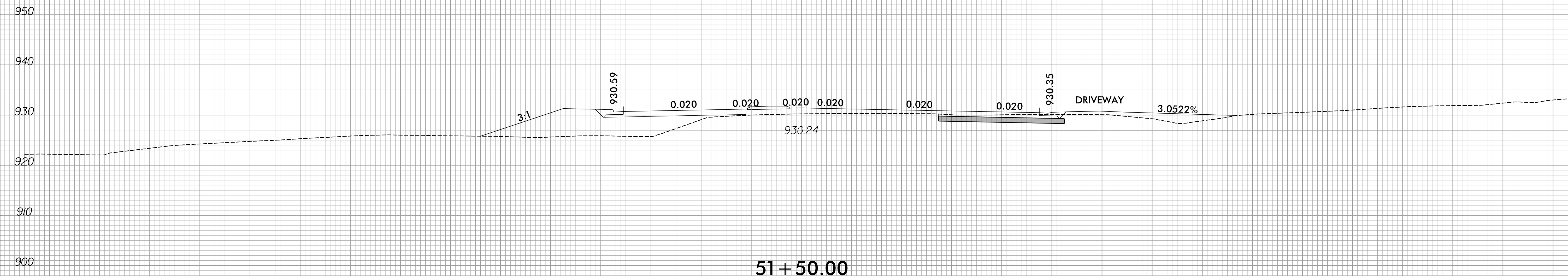

150 140 130 120 110 100 90 80 70 60 50 40 30 20 10 0 10 20 30 40 50 60 70 80 90 100 110 120 130 140 150



150 140 130 120 110 100 90 80 70 60 50 40 30 20 10 0 10 20 30 40 50 60 70 80 90 100 110 120 130 140 150

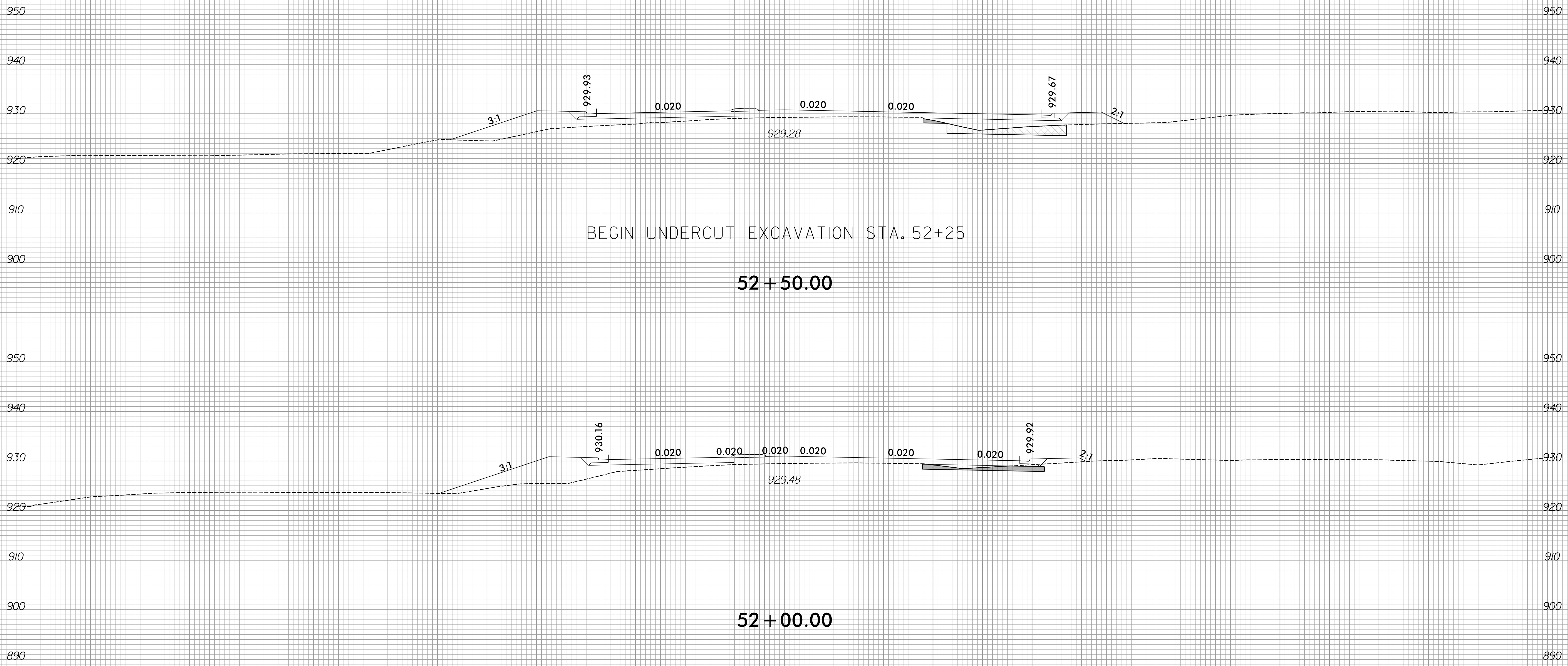

150 140 130 120 110 100 90 80 70 60 50 40 30 20 10 0 10 20 30 40 50 60 70 80 90 100 110 120 130 140 150

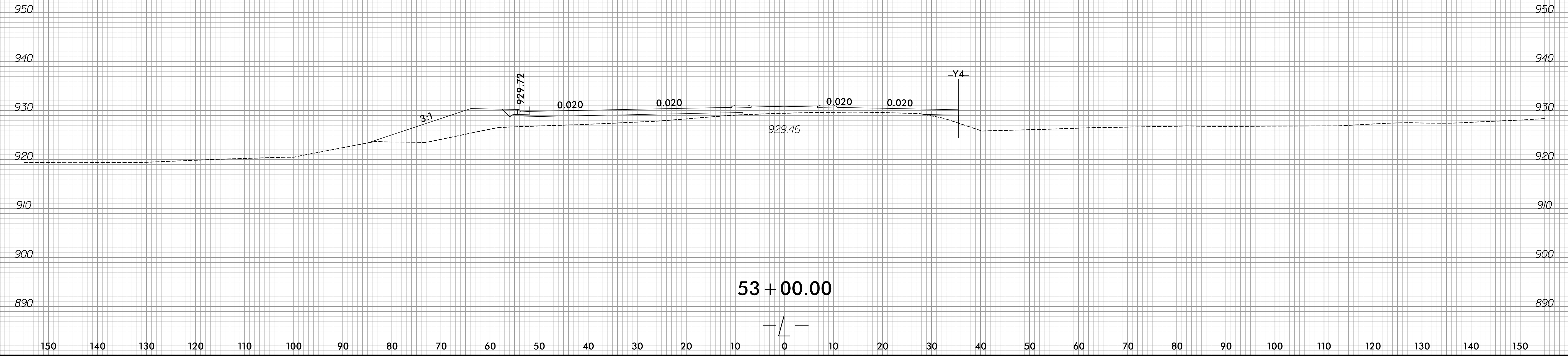
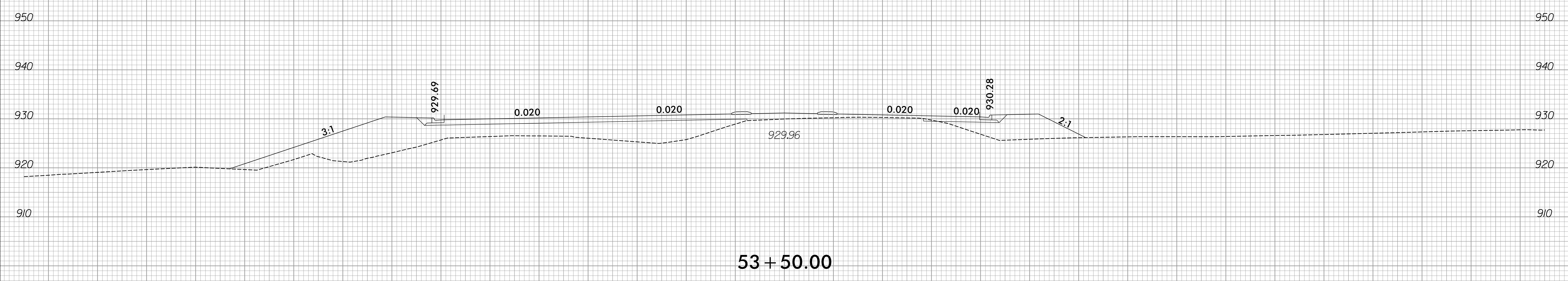
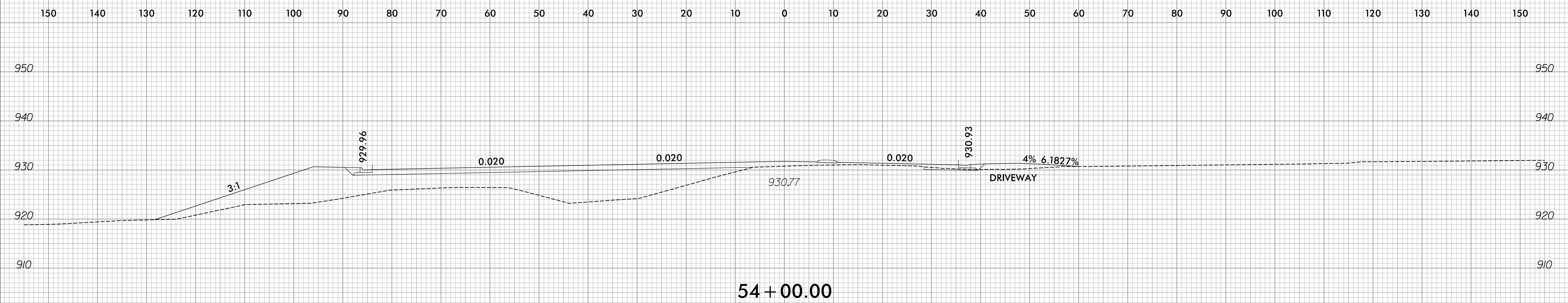
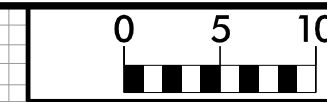



150 140 130 120 110 100 90 80 70 60 50 40 30 20 10 0 10 20 30 40 50 60 70 80 90 100 110 120 130 140 150

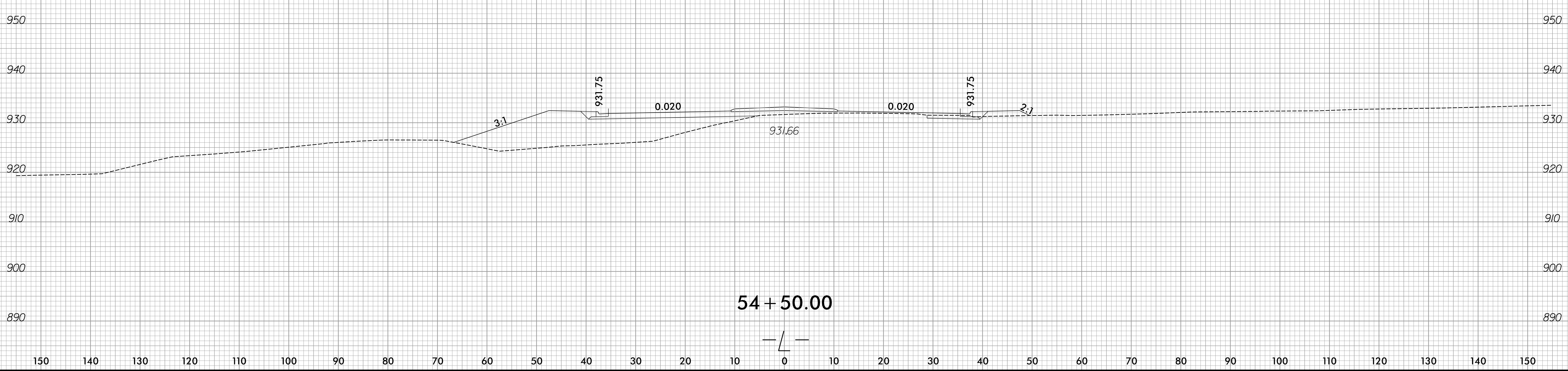
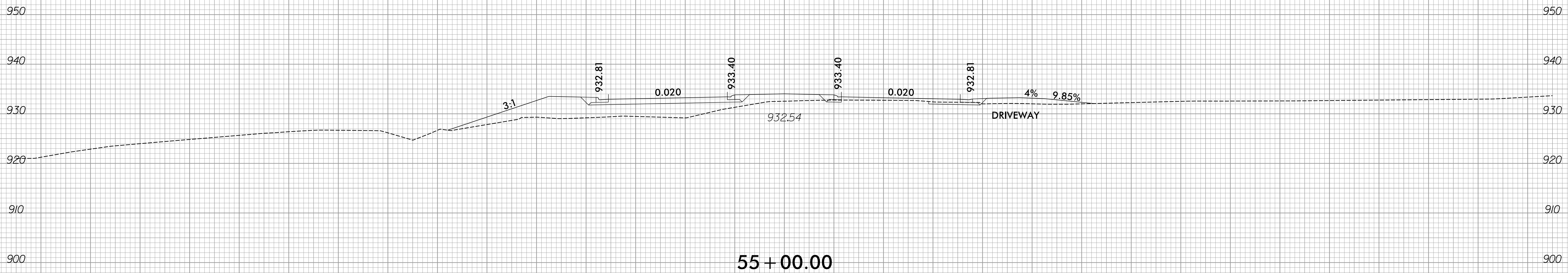



150 140 130 120 110 100 90 80 70 60 50 40 30 20 10 0 10 20 30 40 50 60 70 80 90 100 110 120 130 140 150

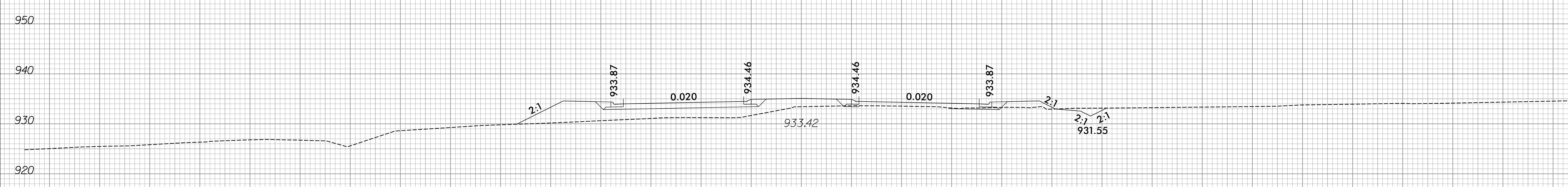
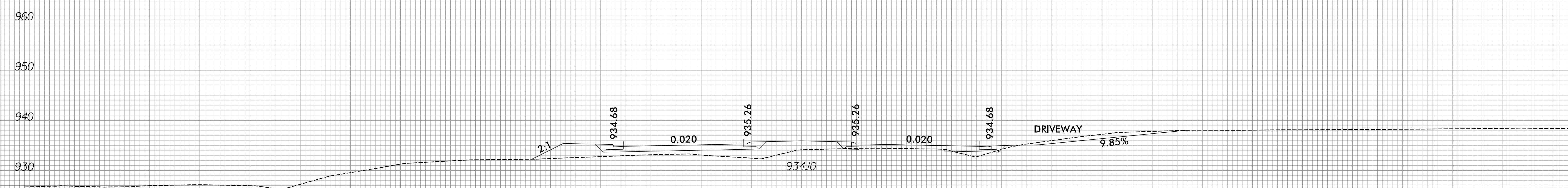

150 140 130 120 110 100 90 80 70 60 50 40 30 20 10 0 10 20 30 40 50 60 70 80 90 100 110 120 130 140 150

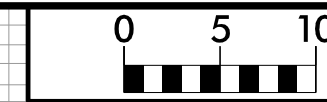

150 140 130 120 110 100 90 80 70 60 50 40 30 20 10 0 10 20 30 40 50 60 70 80 90 100 110 120 130 140 150

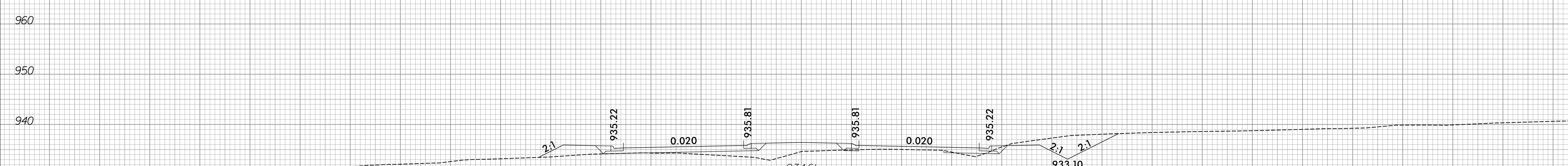
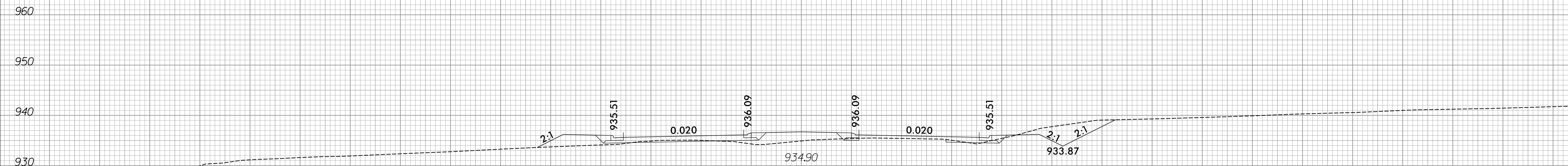

150 140 130 120 110 100 90 80 70 60 50 40 30 20 10 0 10 20 30 40 50 60 70 80 90 100 110 120 130 140 150

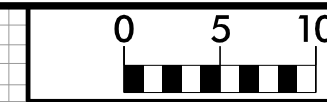

150 140 130 120 110 100 90 80 70 60 50 40 30 20 10 0 10 20 30 40 50 60 70 80 90 100 110 120 130 140 150

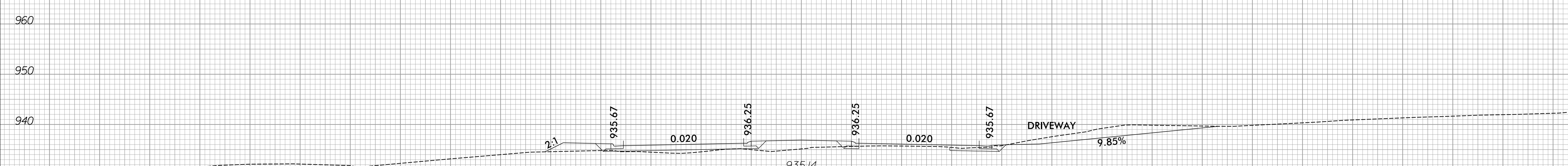
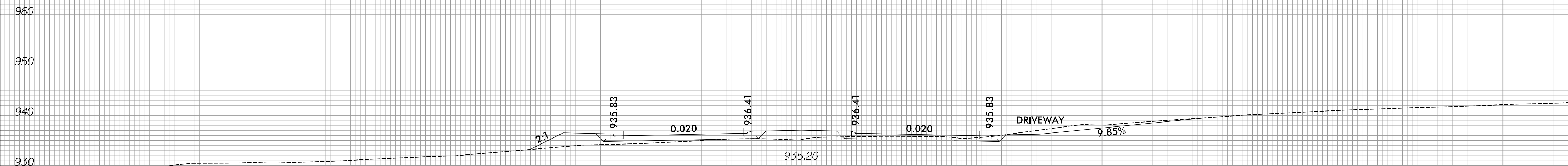

150 140 130 120 110 100 90 80 70 60 50 40 30 20 10 0 10 20 30 40 50 60 70 80 90 100 110 120 130 140 150

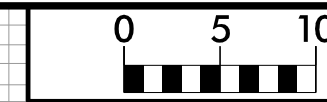

150 140 130 120 110 100 90 80 70 60 50 40 30 20 10 0 10 20 30 40 50 60 70 80 90 100 110 120 130 140 150

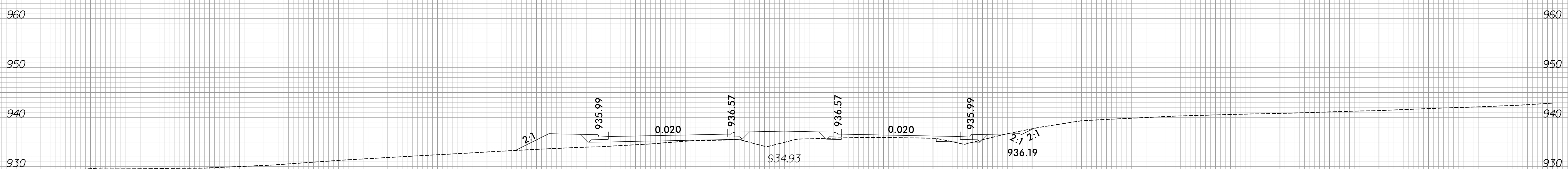
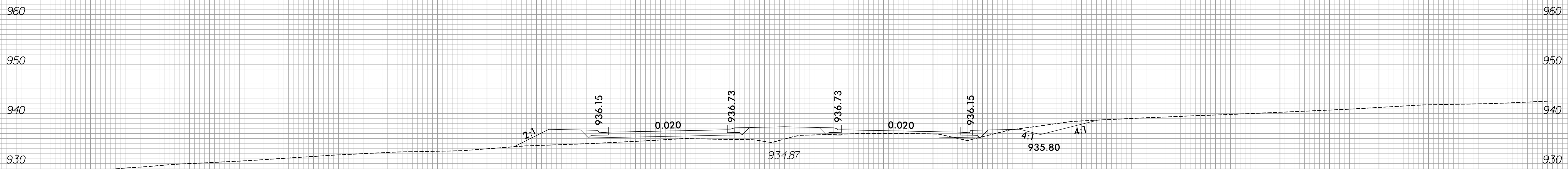

150 140 130 120 110 100 90 80 70 60 50 40 30 20 10 0 10 20 30 40 50 60 70 80 90 100 110 120 130 140 150



150 140 130 120 110 100 90 80 70 60 50 40 30 20 10 0 10 20 30 40 50 60 70 80 90 100 110 120 130 140 150

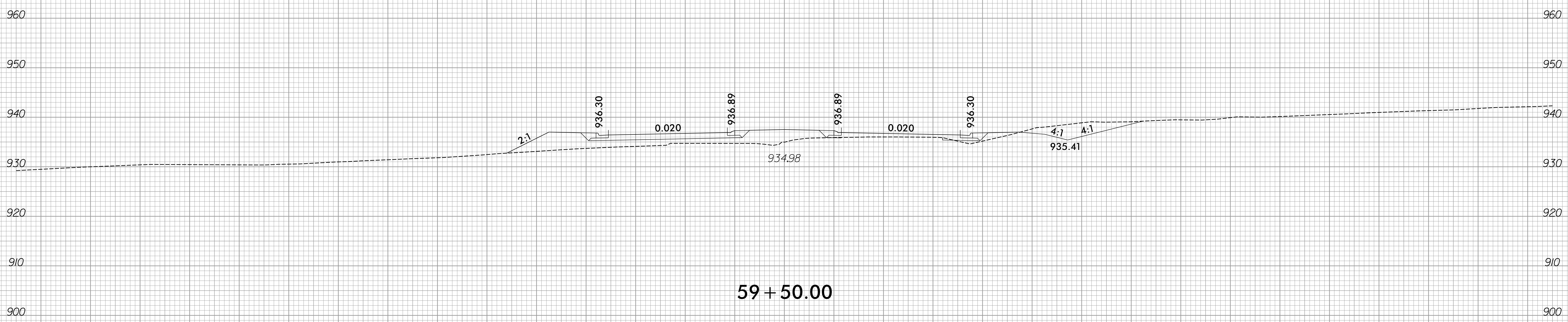
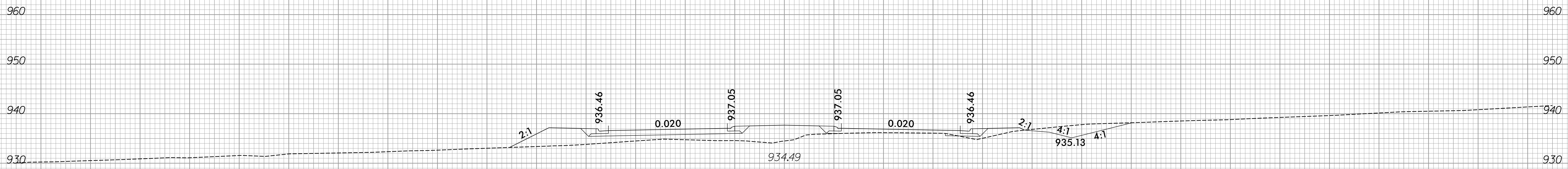

150 140 130 120 110 100 90 80 70 60 50 40 30 20 10 0 10 20 30 40 50 60 70 80 90 100 110 120 130 140 150



150 140 130 120 110 100 90 80 70 60 50 40 30 20 10 0 10 20 30 40 50 60 70 80 90 100 110 120 130 140 150

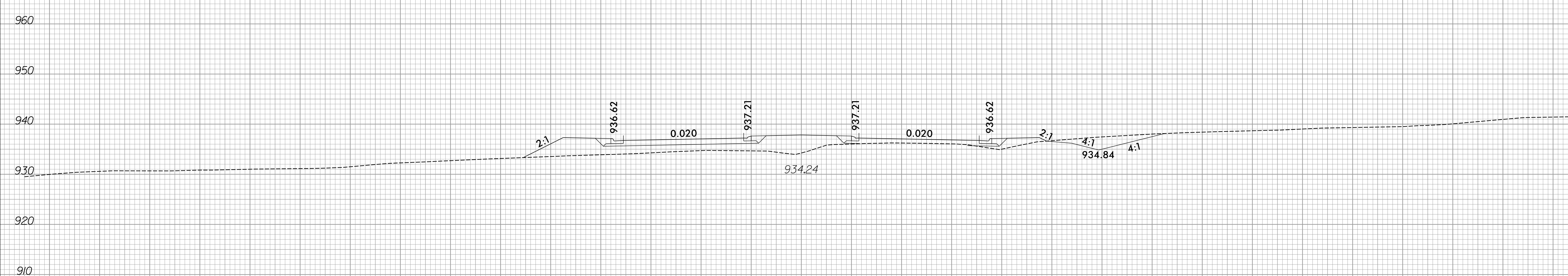
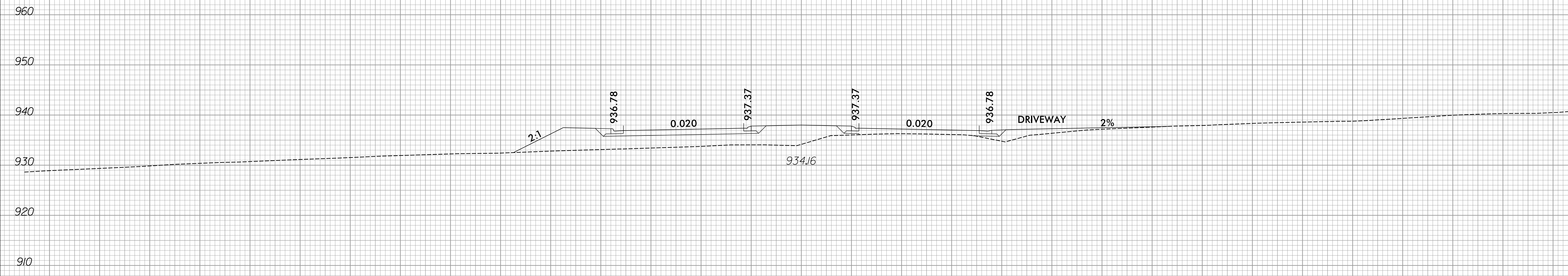

150 140 130 120 110 100 90 80 70 60 50 40 30 20 10 0 10 20 30 40 50 60 70 80 90 100 110 120 130 140 150

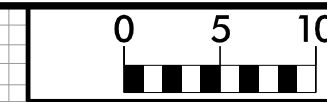

150 140 130 120 110 100 90 80 70 60 50 40 30 20 10 0 10 20 30 40 50 60 70 80 90 100 110 120 130 140 150

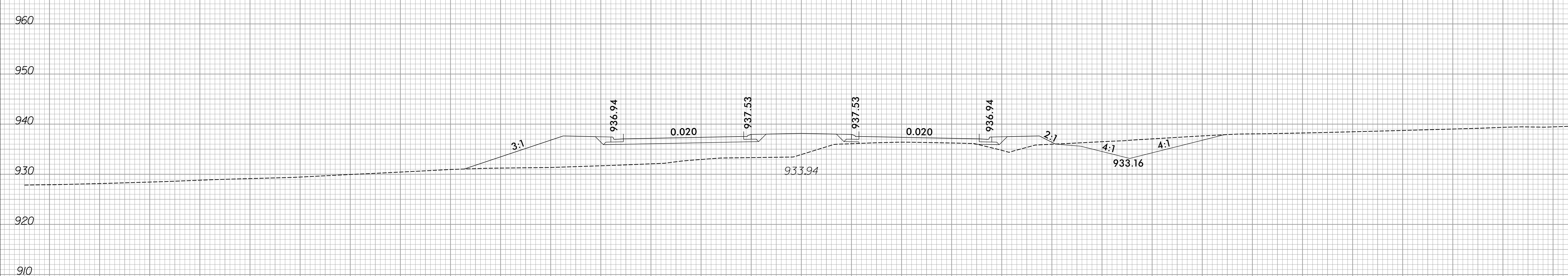
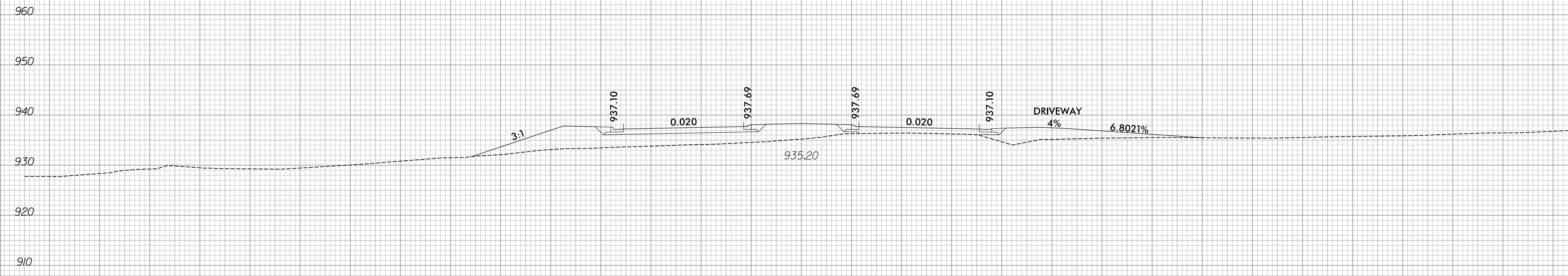

150 140 130 120 110 100 90 80 70 60 50 40 30 20 10 0 10 20 30 40 50 60 70 80 90 100 110 120 130 140 150

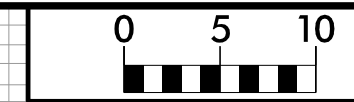

150 140 130 120 110 100 90 80 70 60 50 40 30 20 10 0 10 20 30 40 50 60 70 80 90 100 110 120 130 140 150

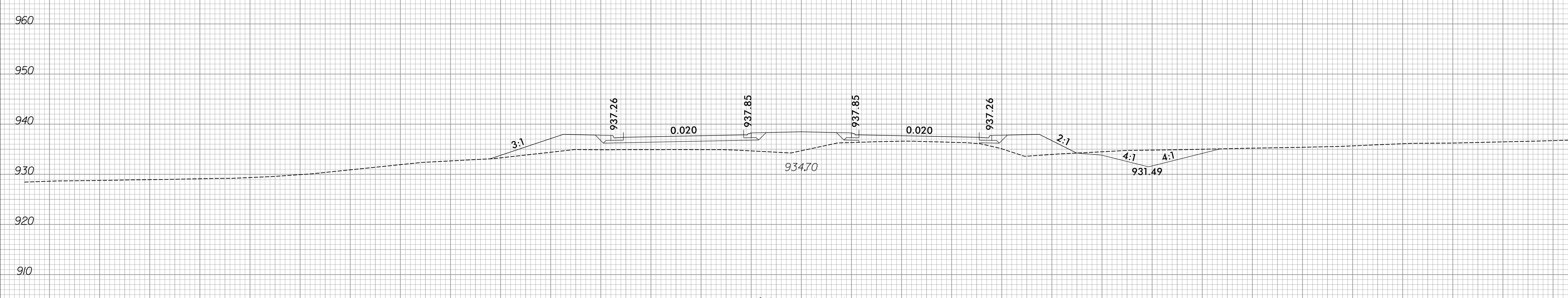
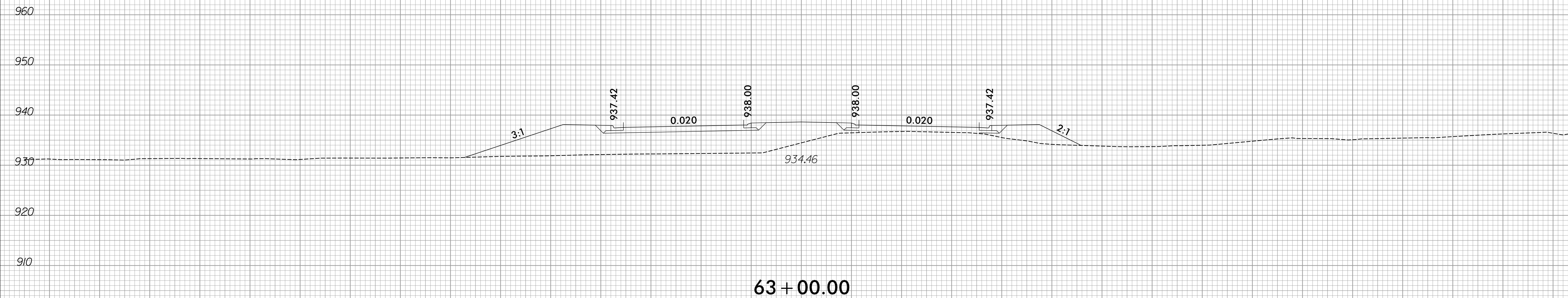

150 140 130 120 110 100 90 80 70 60 50 40 30 20 10 0 10 20 30 40 50 60 70 80 90 100 110 120 130 140 150

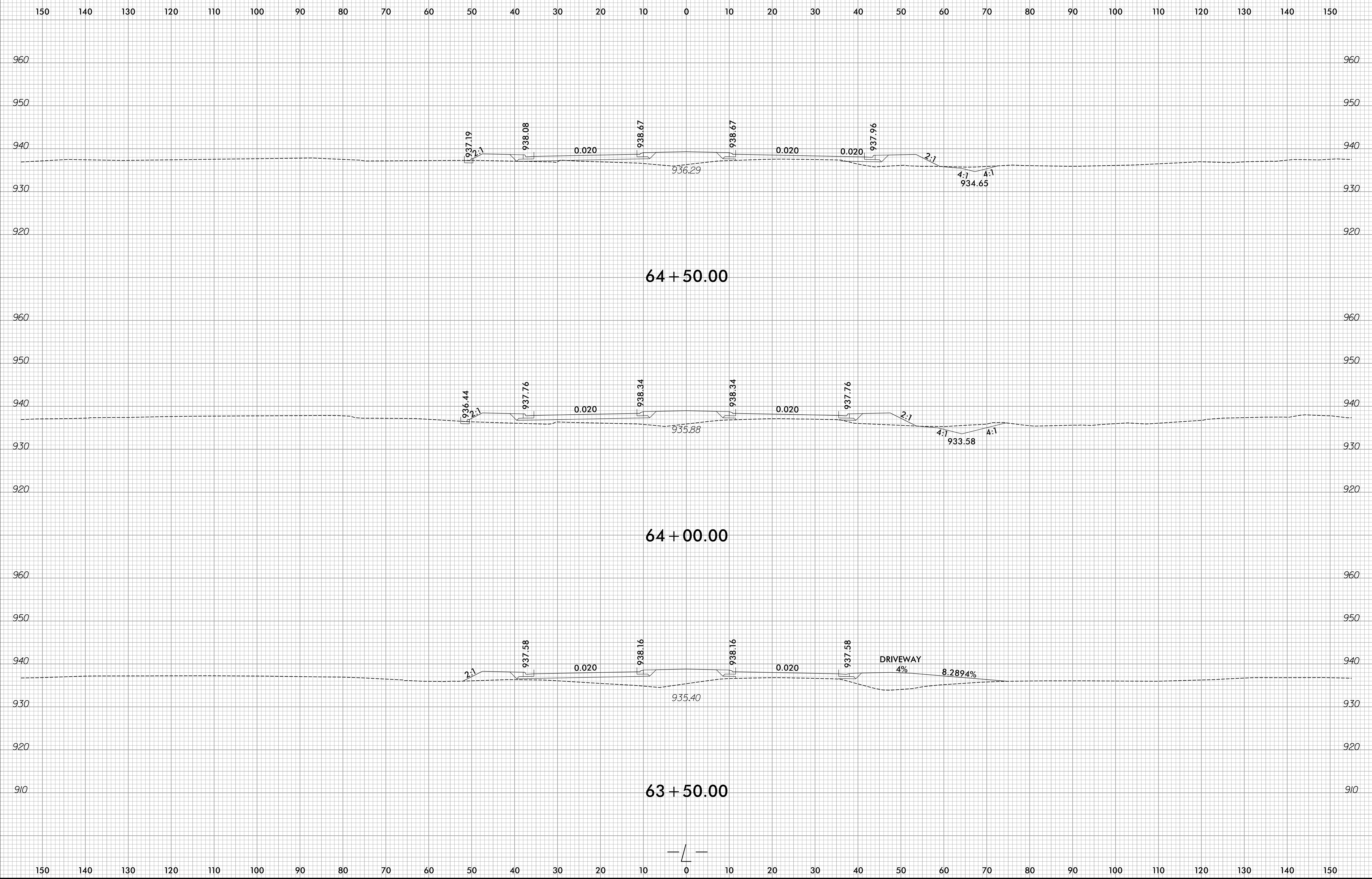

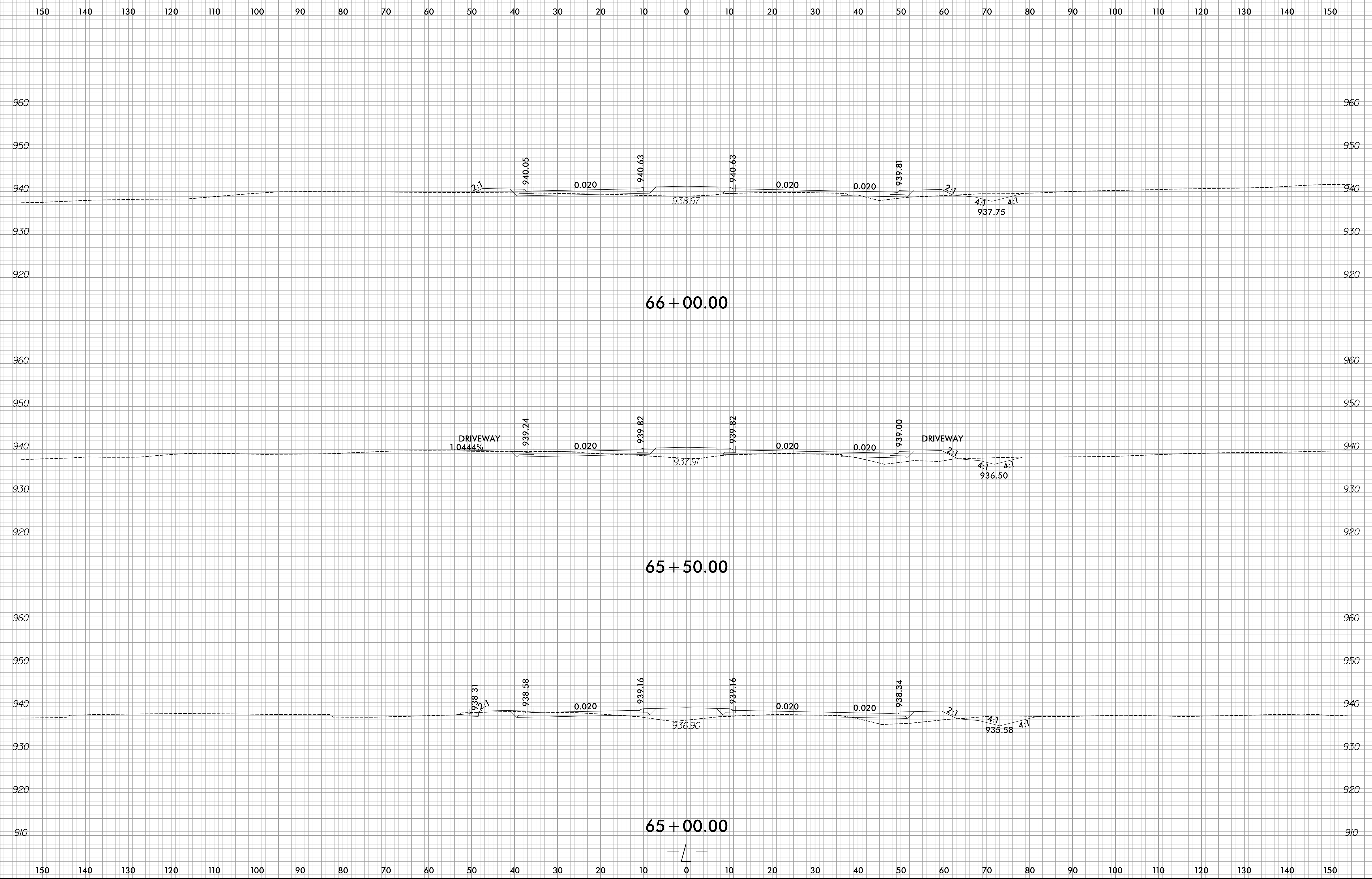
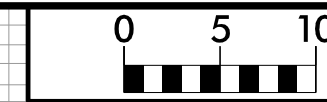

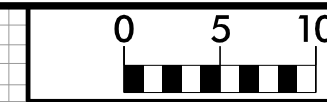

150 140 130 120 110 100 90 80 70 60 50 40 30 20 10 0 10 20 30 40 50 60 70 80 90 100 110 120 130 140 150

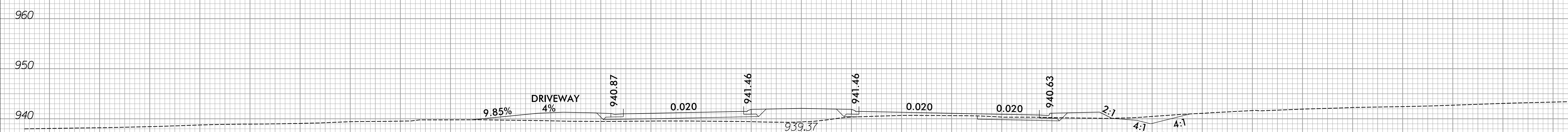
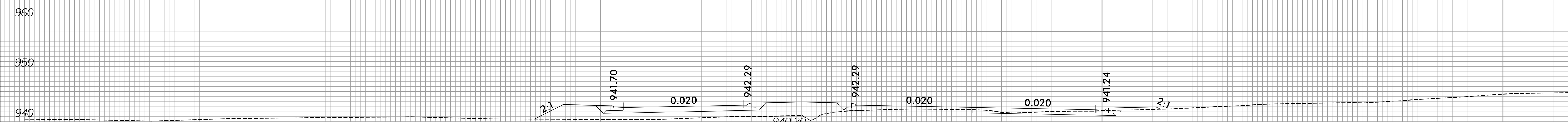
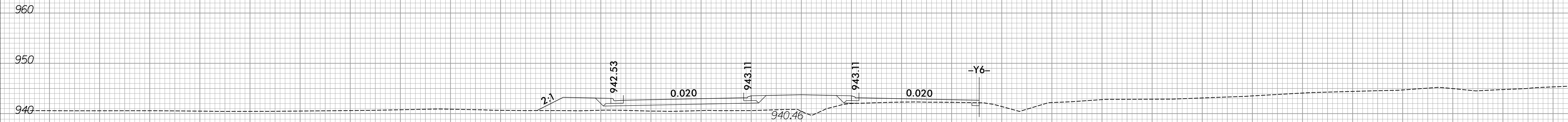

150 140 130 120 110 100 90 80 70 60 50 40 30 20 10 0 10 20 30 40 50 60 70 80 90 100 110 120 130 140 150

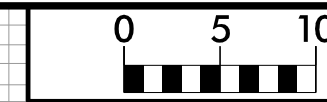

150 140 130 120 110 100 90 80 70 60 50 40 30 20 10 0 10 20 30 40 50 60 70 80 90 100 110 120 130 140 150

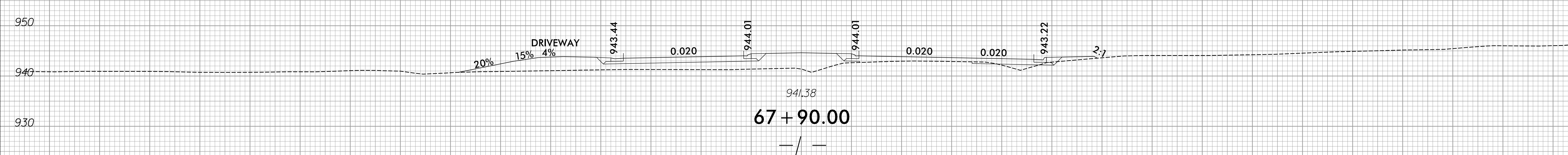
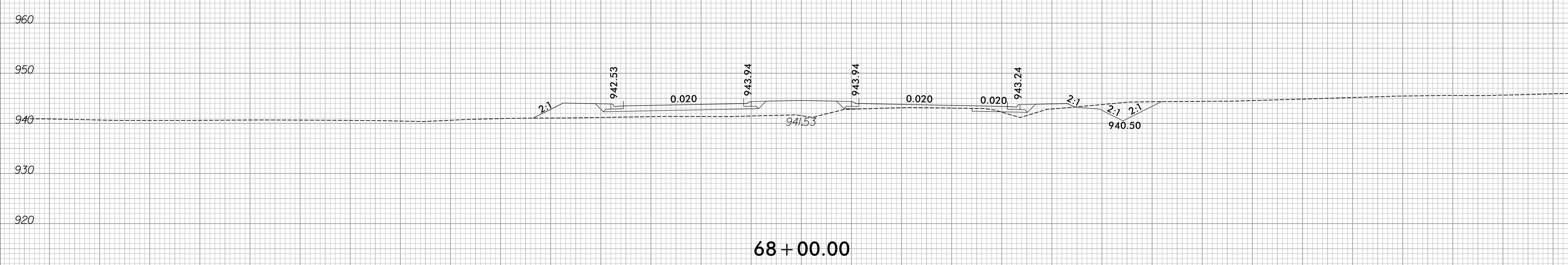
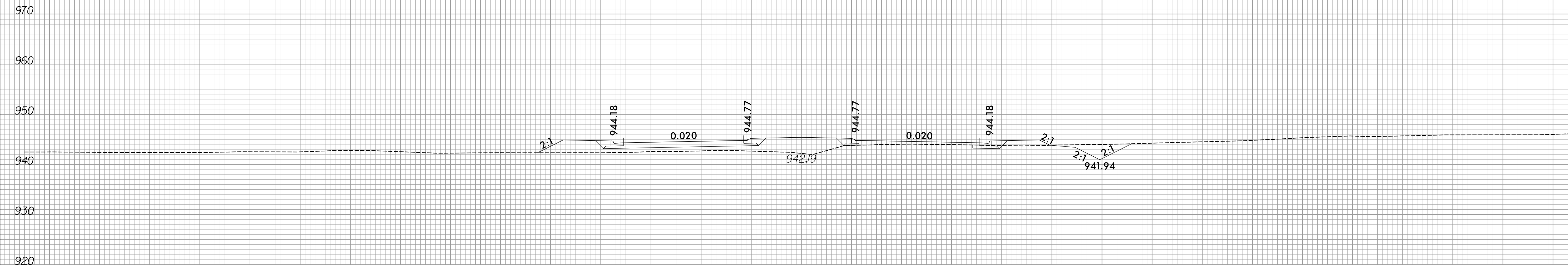

150 140 130 120 110 100 90 80 70 60 50 40 30 20 10 0 10 20 30 40 50 60 70 80 90 100 110 120 130 140 150



150 140 130 120 110 100 90 80 70 60 50 40 30 20 10 0 10 20 30 40 50 60 70 80 90 100 110 120 130 140 150

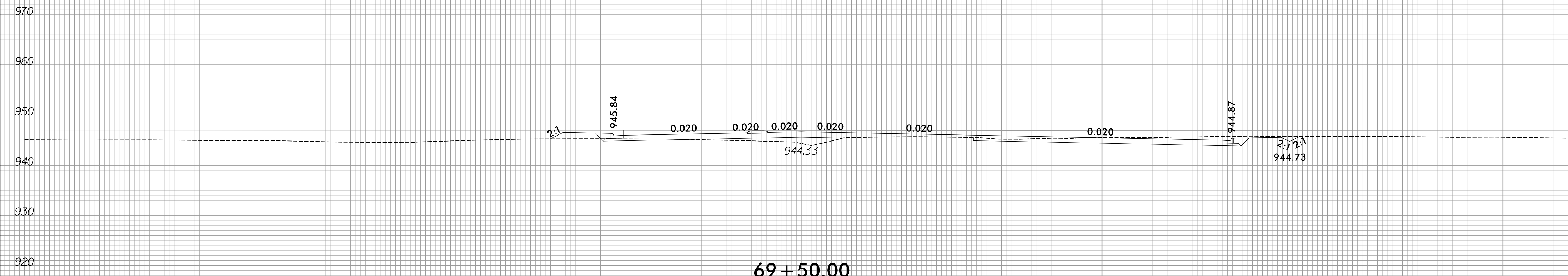

69 + 50.00

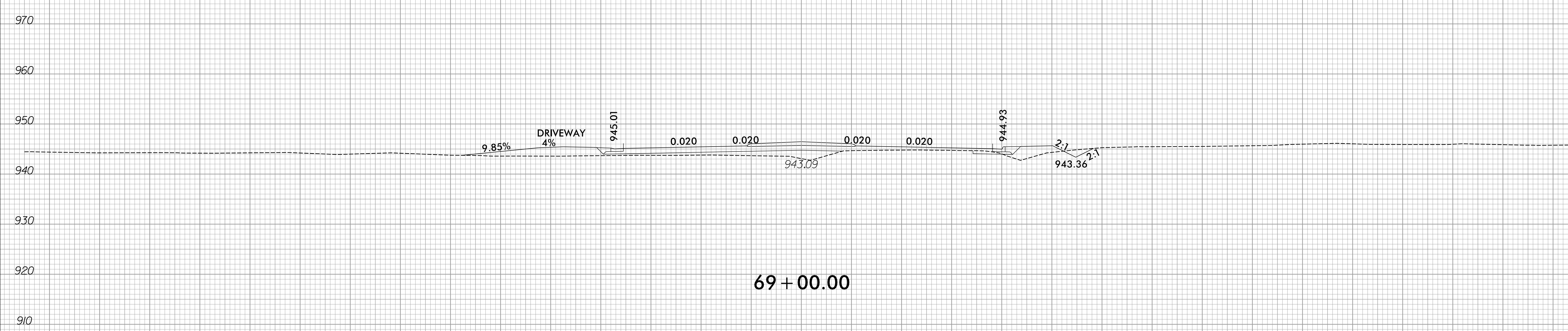

69 + 00.00

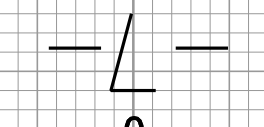

150 140 130 120 110 100 90 80 70 60 50 40 30 20 10 0 10 20 30 40 50 60 70 80 90 100 110 120 130 140 150



150 140 130 120 110 100 90 80 70 60 50 40 30 20 10 0 10 20 30 40 50 60 70 80 90 100 110 120 130 140 150

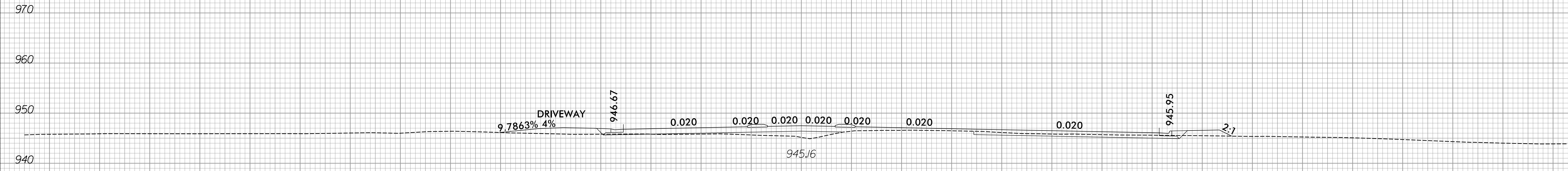
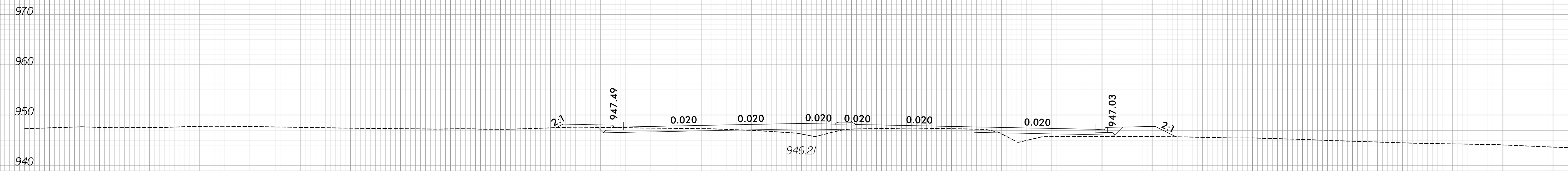

150 140 130 120 110 100 90 80 70 60 50 40 30 20 10 0 10 20 30 40 50 60 70 80 90 100 110 120 130 140 150

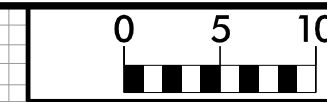

150 140 130 120 110 100 90 80 70 60 50 40 30 20 10 0 10 20 30 40 50 60 70 80 90 100 110 120 130 140 150

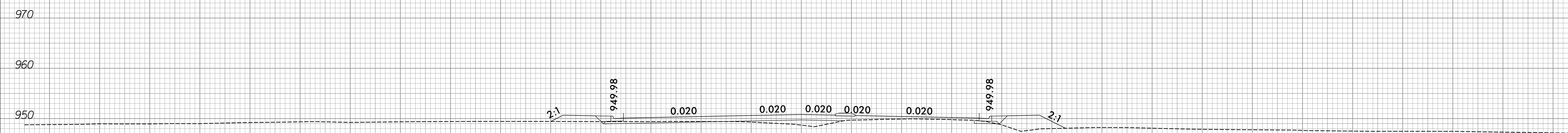

72 + 00.00

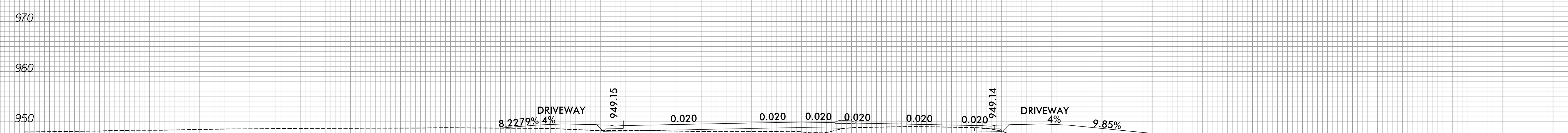

71 + 50.00

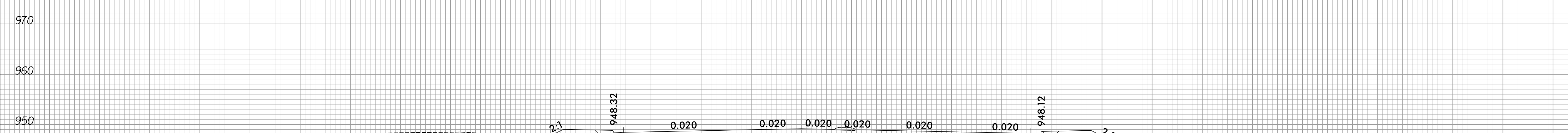

71 + 00.00

150 140 130 120 110 100 90 80 70 60 50 40 30 20 10 0 10 20 30 40 50 60 70 80 90 100 110 120 130 140 150



150 140 130 120 110 100 90 80 70 60 50 40 30 20 10 0 10 20 30 40 50 60 70 80 90 100 110 120 130 140 150

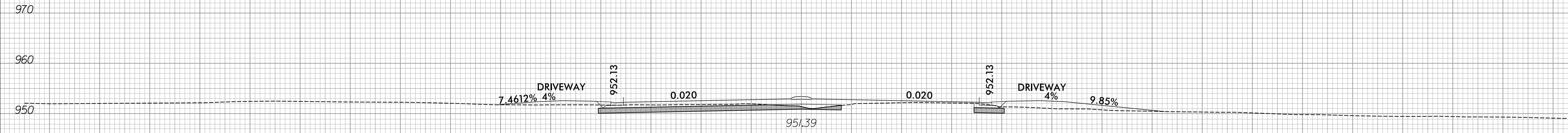

73 + 50.00

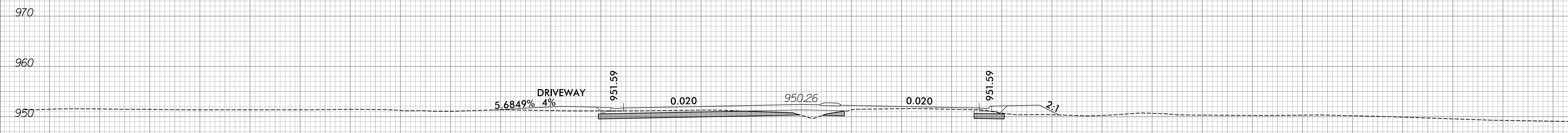

BEGIN SHALLOW UNDERCUT EXCAVATION STA. 72+75

73 + 00.00

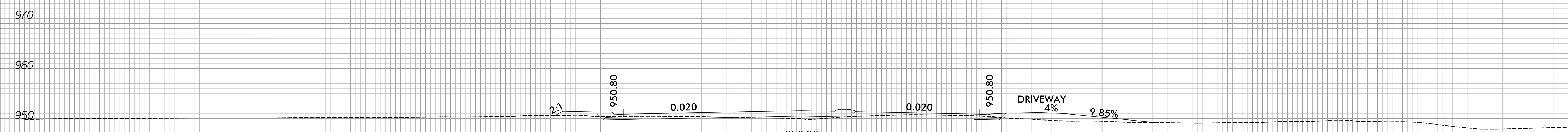

72 + 50.00

150 140 130 120 110 100 90 80 70 60 50 40 30 20 10 0 10 20 30 40 50 60 70 80 90 100 110 120 130 140 150

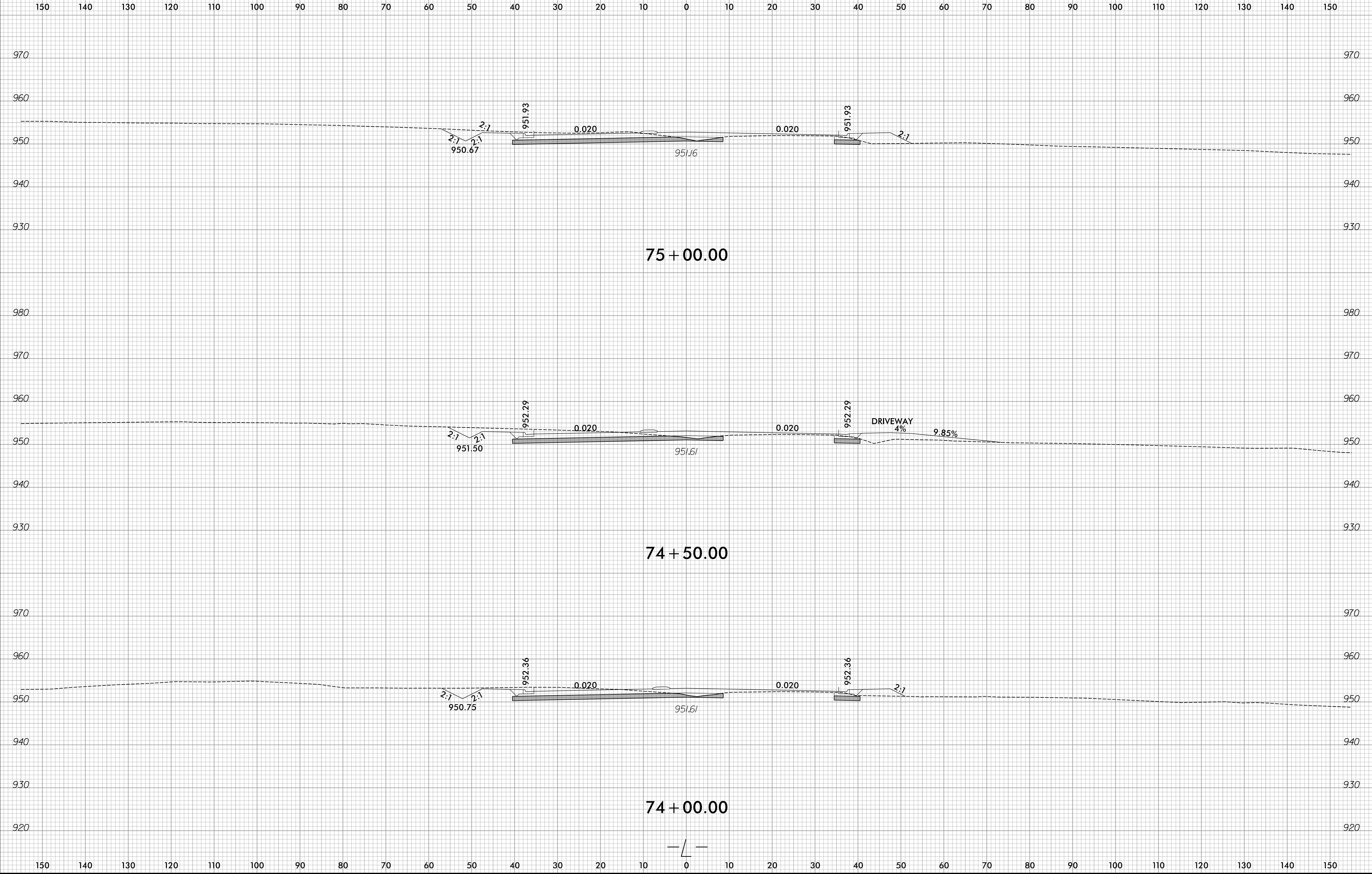

6/23/16

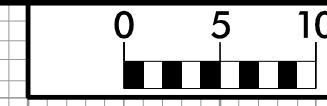

PROJ. REFERENCE NO.
R-2577A

SHEET NO.
X-70

150 140 130 120 110 100 90 80 70 60 50 40 30 20 10 0 10 20 30 40 50 60 70 80 90 100 110 120 130 140 150

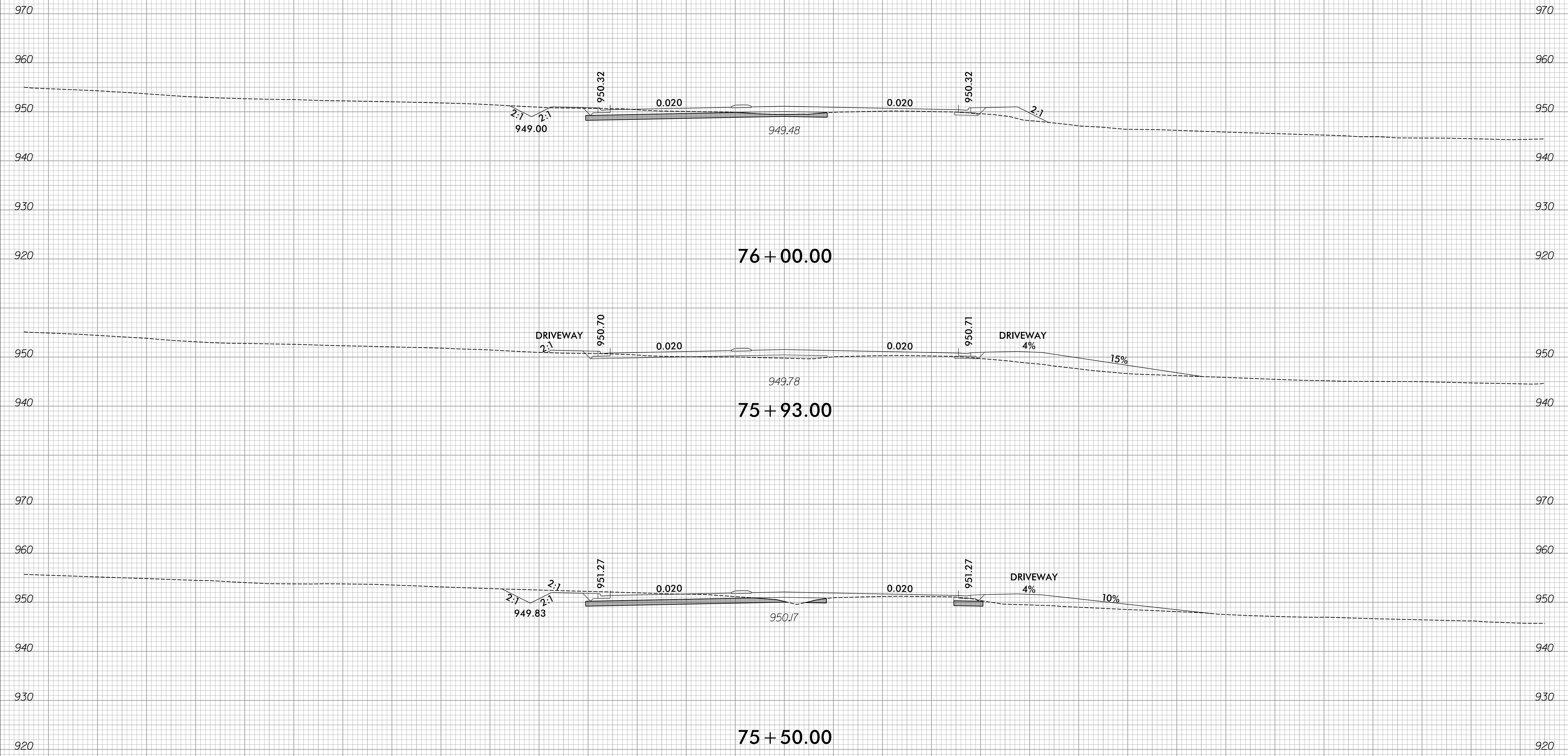

150 140 130 120 110 100 90 80 70 60 50 40 30 20 10 0 10 20 30 40 50 60 70 80 90 100 110 120 130 140 150

12/2/2023
R:\Roadway\XSC\R-2577A_Rdy_xp1.L.dgn
amcpherson

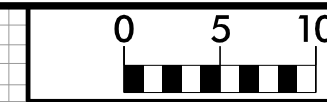

150 140 130 120 110 100 90 80 70 60 50 40 30 20 10 0 10 20 30 40 50 60 70 80 90 100 110 120 130 140 150

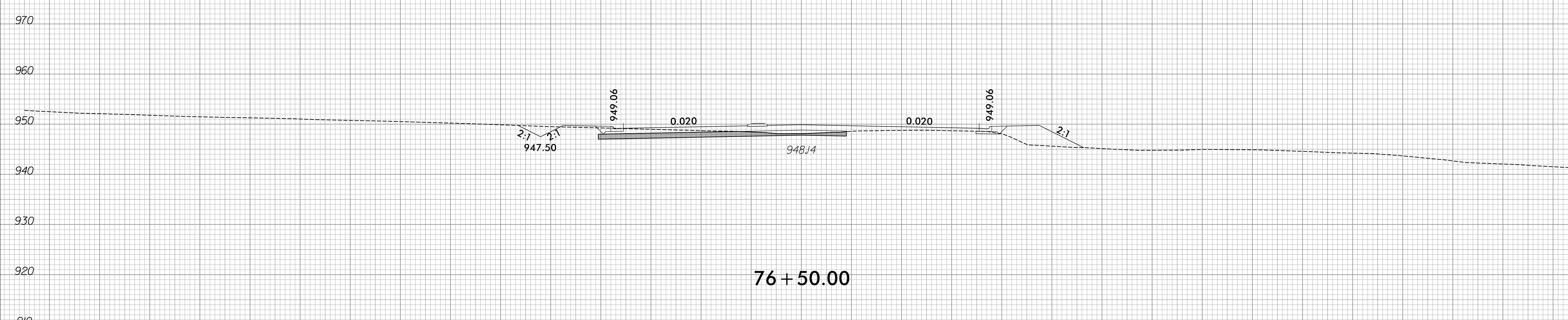
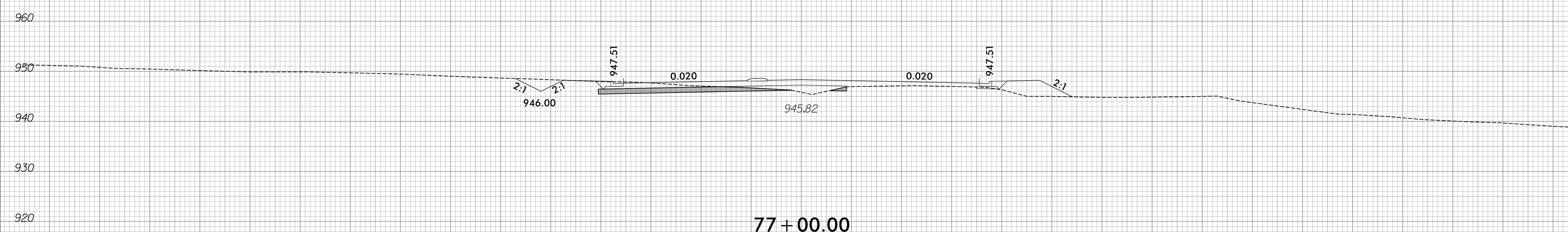
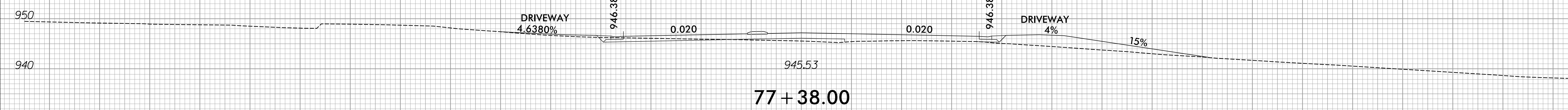

150 140 130 120 110 100 90 80 70 60 50 40 30 20 10 0 10 20 30 40 50 60 70 80 90 100 110 120 130 140 150

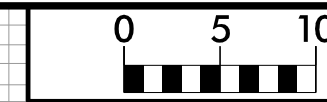

150 140 130 120 110 100 90 80 70 60 50 40 30 20 10 0 10 20 30 40 50 60 70 80 90 100 110 120 130 140 150

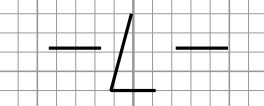
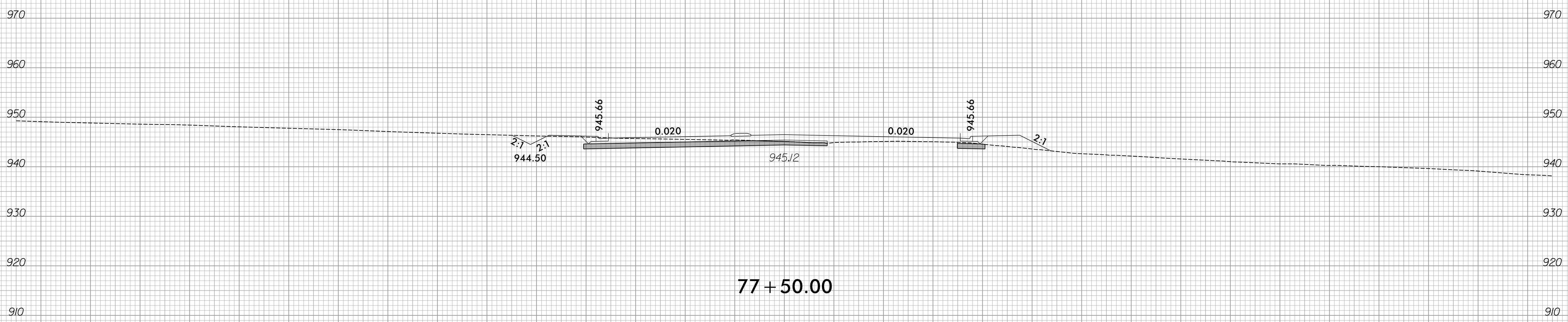

150 140 130 120 110 100 90 80 70 60 50 40 30 20 10 0 10 20 30 40 50 60 70 80 90 100 110 120 130 140 150

150 140 130 120 110 100 90 80 70 60 50 40 30 20 10 0 10 20 30 40 50 60 70 80 90 100 110 120 130 140 150

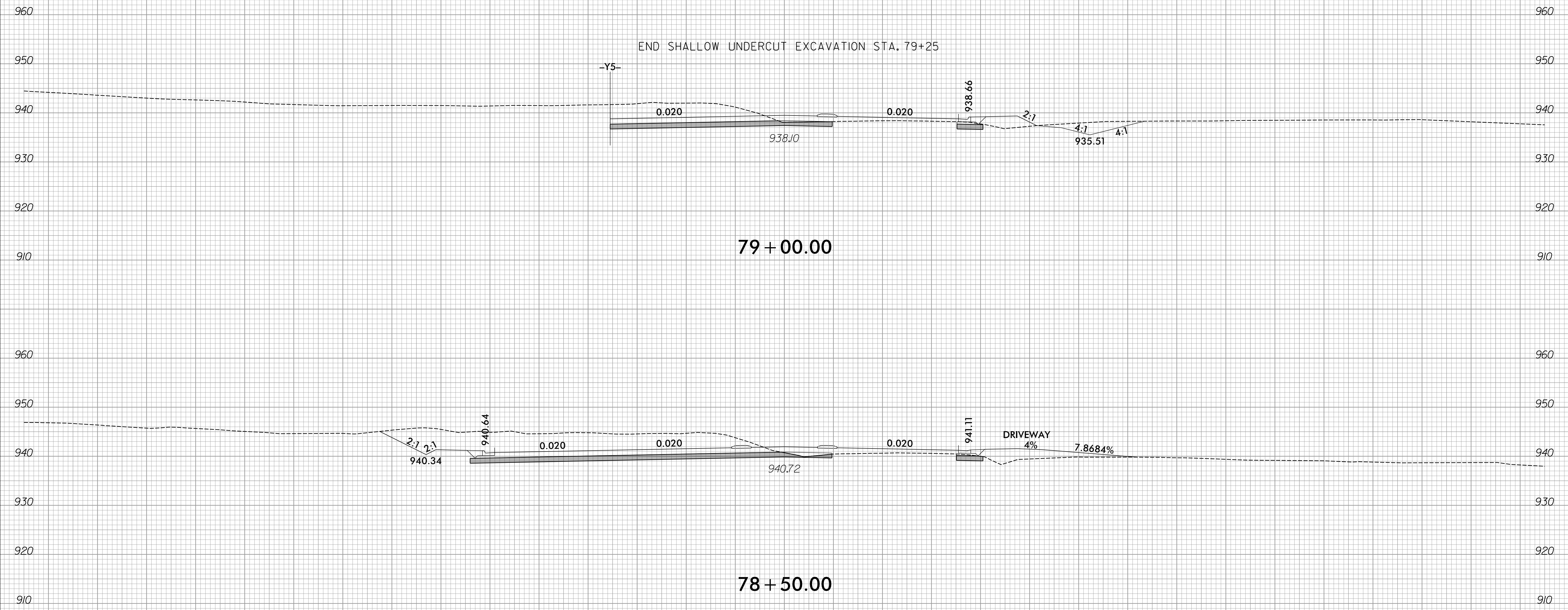

150 140 130 120 110 100 90 80 70 60 50 40 30 20 10 0 10 20 30 40 50 60 70 80 90 100 110 120 130 140 150



150 140 130 120 110 100 90 80 70 60 50 40 30 20 10 0 10 20 30 40 50 60 70 80 90 100 110 120 130 140 150

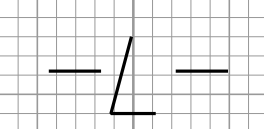
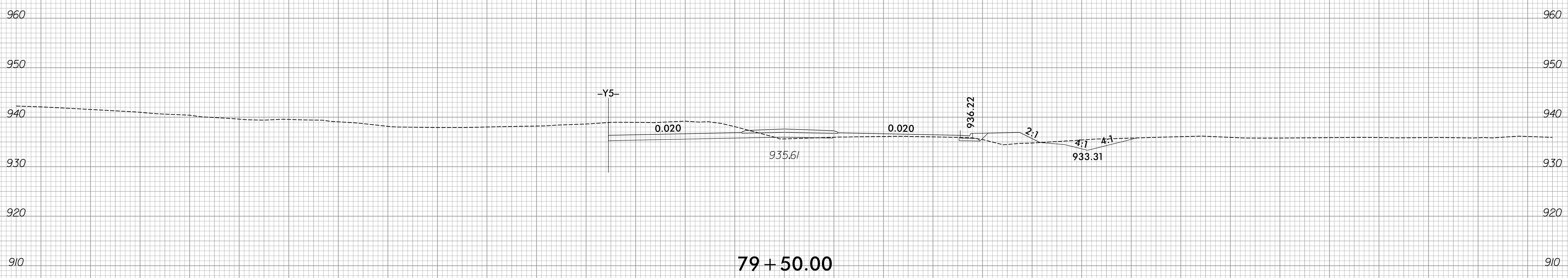
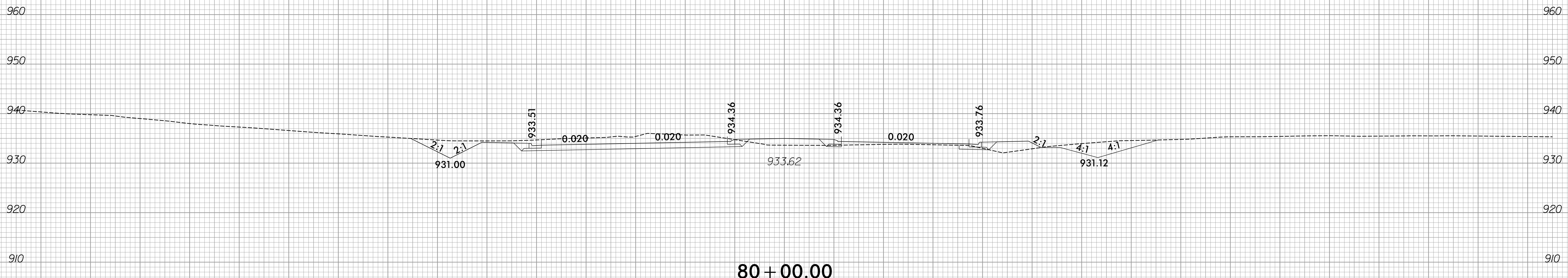

150 140 130 120 110 100 90 80 70 60 50 40 30 20 10 0 10 20 30 40 50 60 70 80 90 100 110 120 130 140 150

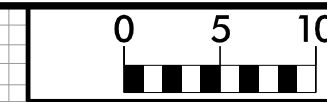

150 140 130 120 110 100 90 80 70 60 50 40 30 20 10 0 10 20 30 40 50 60 70 80 90 100 110 120 130 140 150

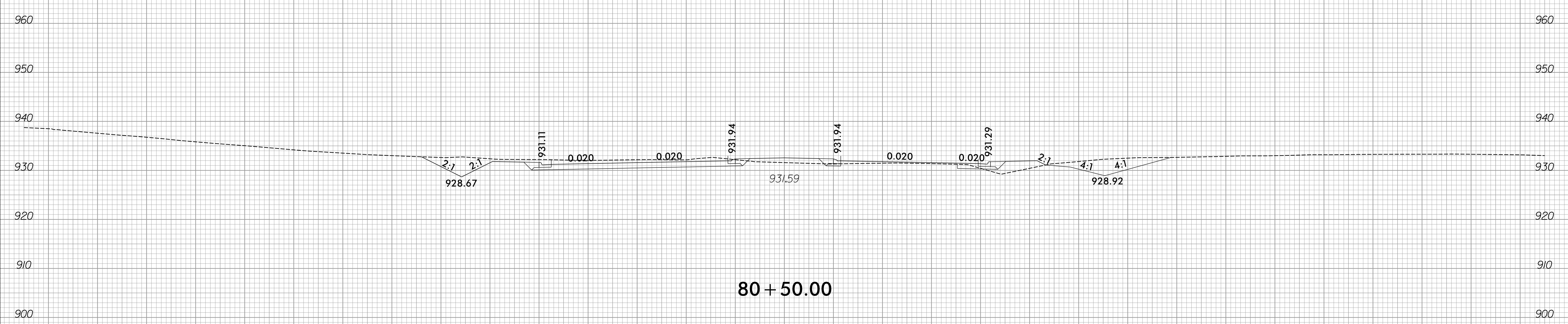
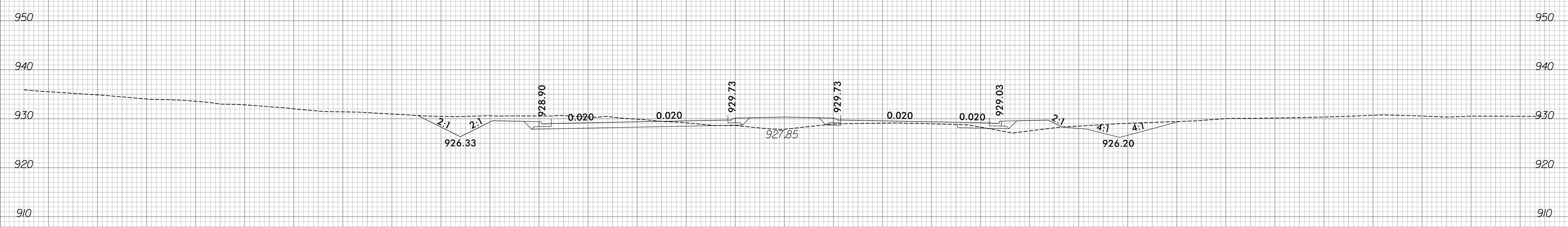

150 140 130 120 110 100 90 80 70 60 50 40 30 20 10 0 10 20 30 40 50 60 70 80 90 100 110 120 130 140 150



PROJ. REFERENCE NO. R-2577A	SHEET NO. X-76
--------------------------------	-------------------

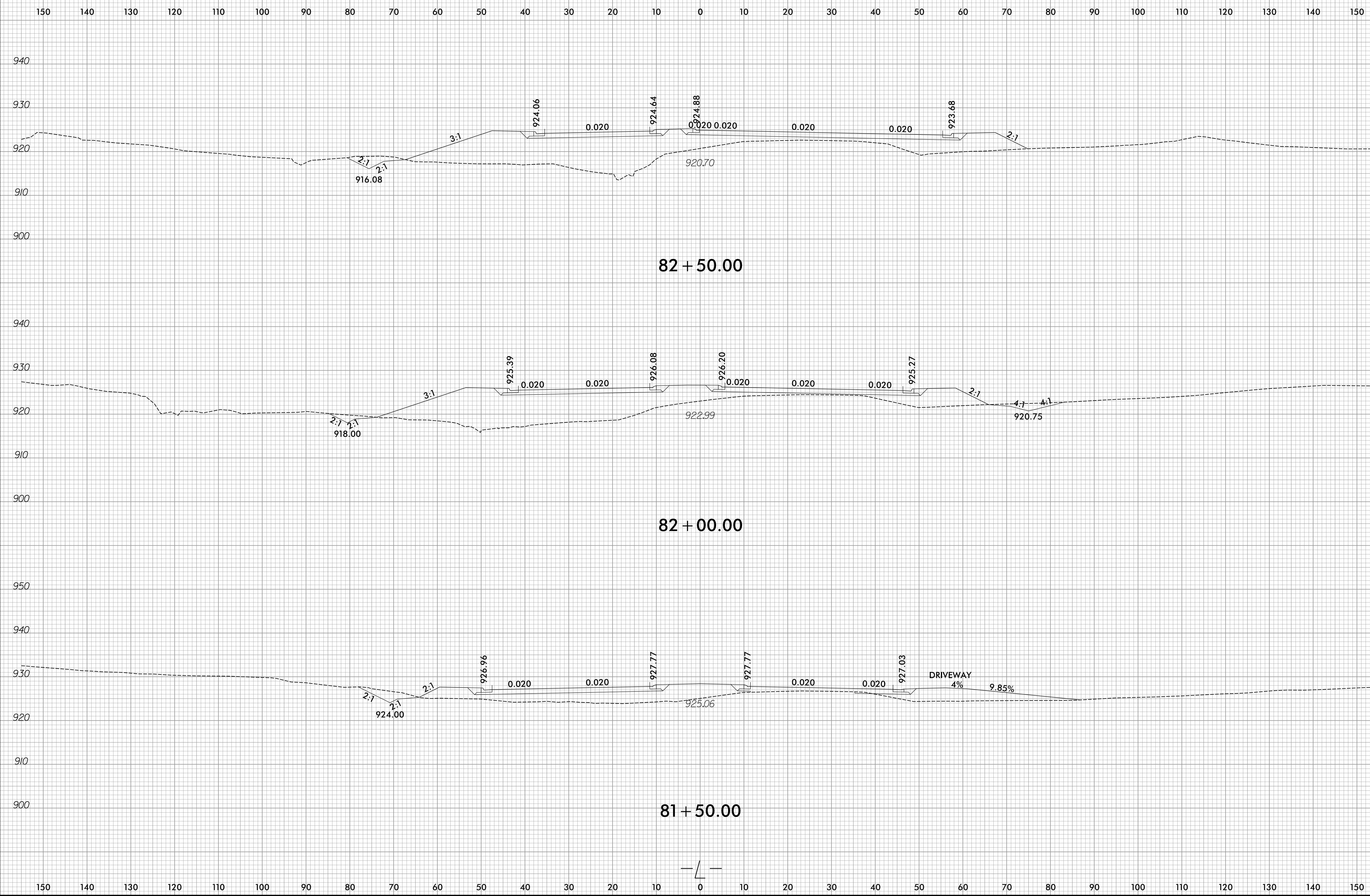

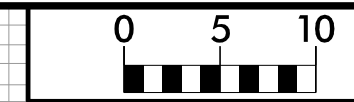

150 140 130 120 110 100 90 80 70 60 50 40 30 20 10 0 10 20 30 40 50 60 70 80 90 100 110 120 130 140 150

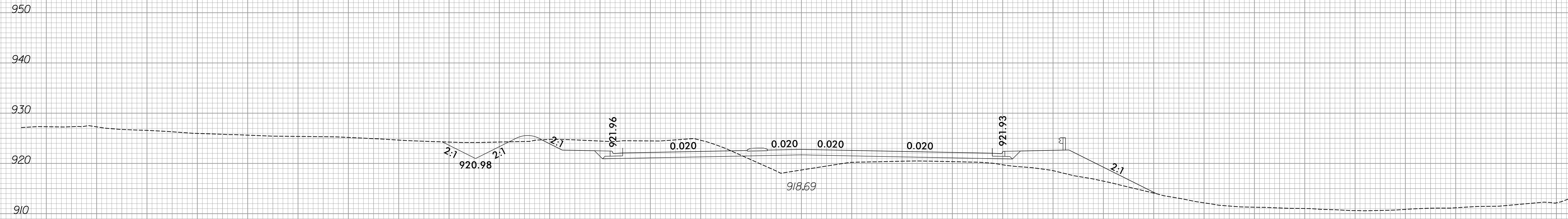

150 140 130 120 110 100 90 80 70 60 50 40 30 20 10 0 10 20 30 40 50 60 70 80 90 100 110 120 130 140 150

150 140 130 120 110 100 90 80 70 60 50 40 30 20 10 0 10 20 30 40 50 60 70 80 90 100 110 120 130 140 150

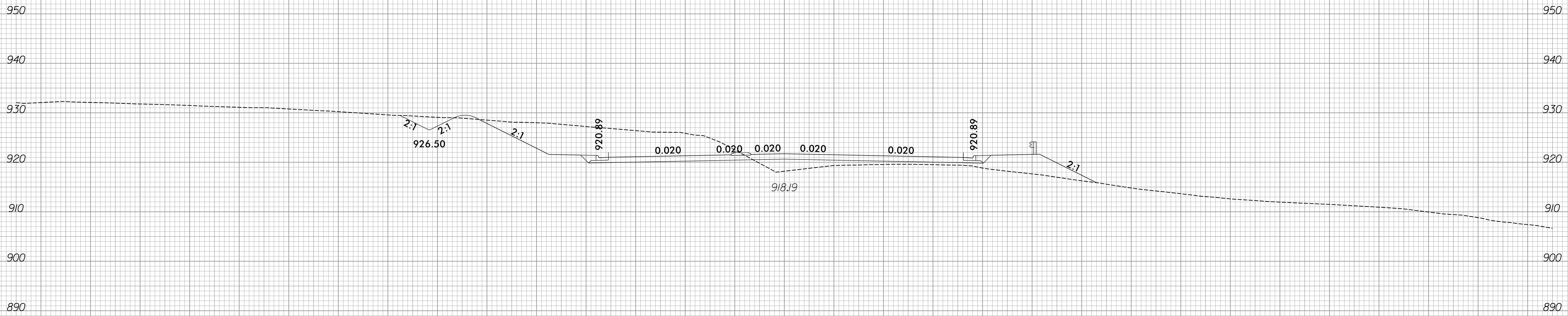

84 + 50.00

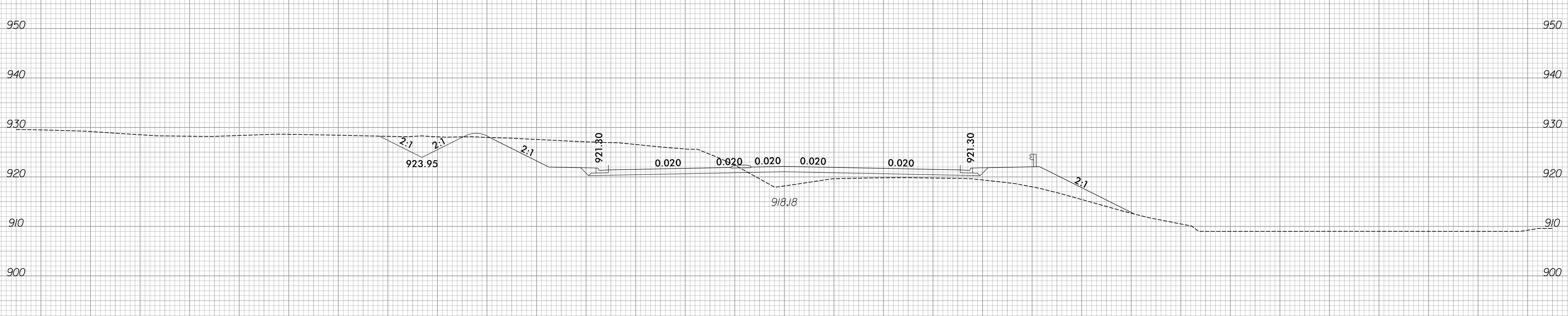

84 + 00.00

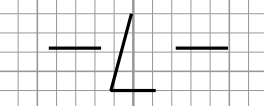

150 140 130 120 110 100 90 80 70 60 50 40 30 20 10 0 10 20 30 40 50 60 70 80 90 100 110 120 130 140 150

150 140 130 120 110 100 90 80 70 60 50 40 30 20 10 0 10 20 30 40 50 60 70 80 90 100 110 120 130 140 150

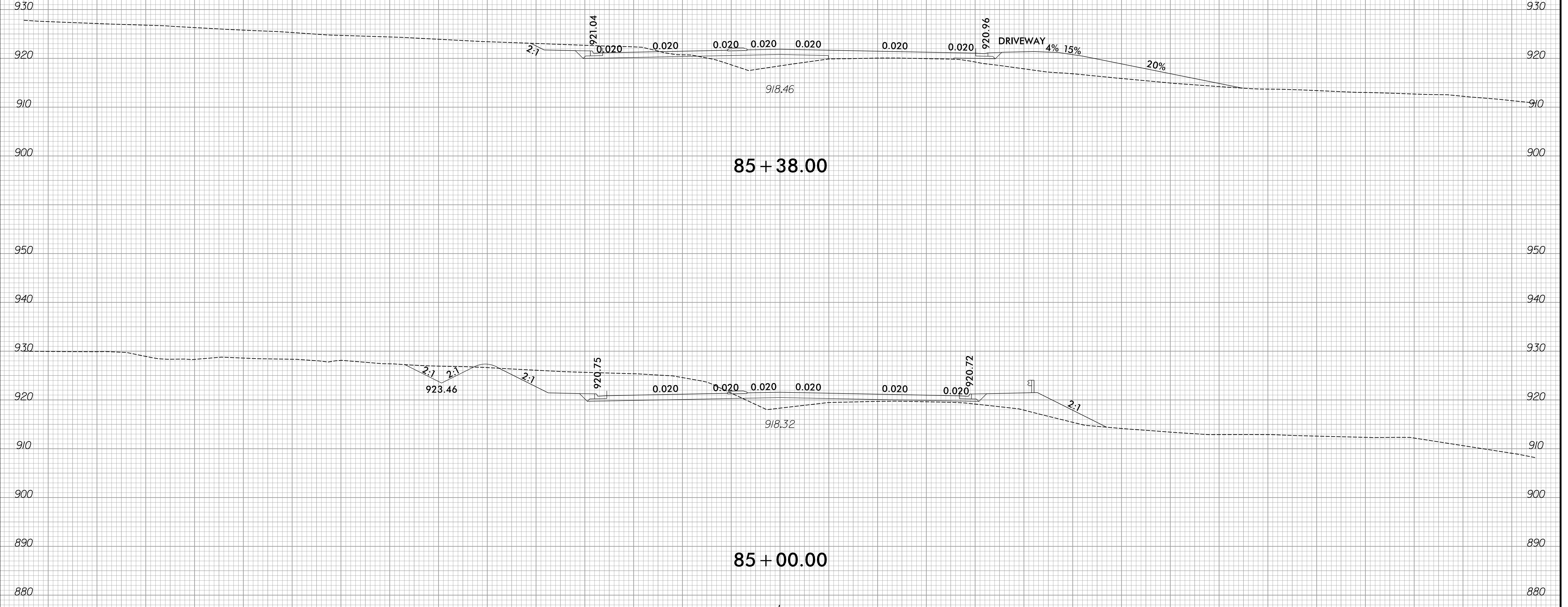

150 140 130 120 110 100 90 80 70 60 50 40 30 20 10 0 10 20 30 40 50 60 70 80 90 100 110 120 130 140 150

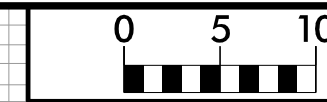

150 140 130 120 110 100 90 80 70 60 50 40 30 20 10 0 10 20 30 40 50 60 70 80 90 100 110 120 130 140 150

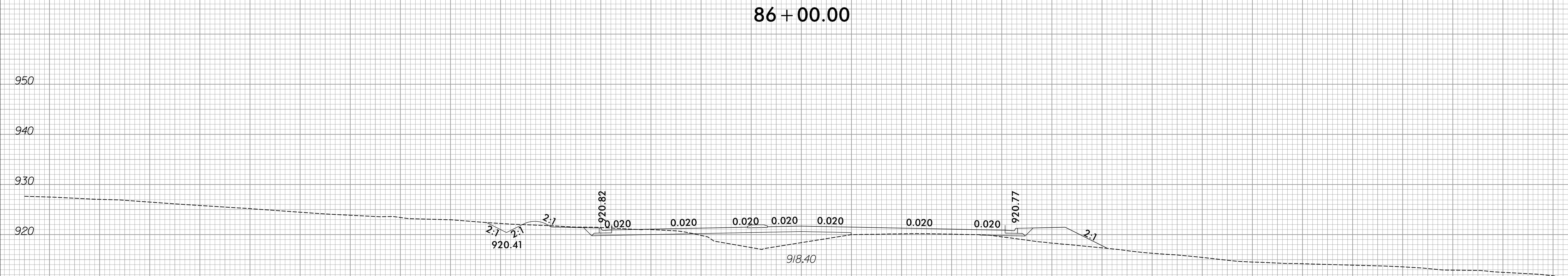
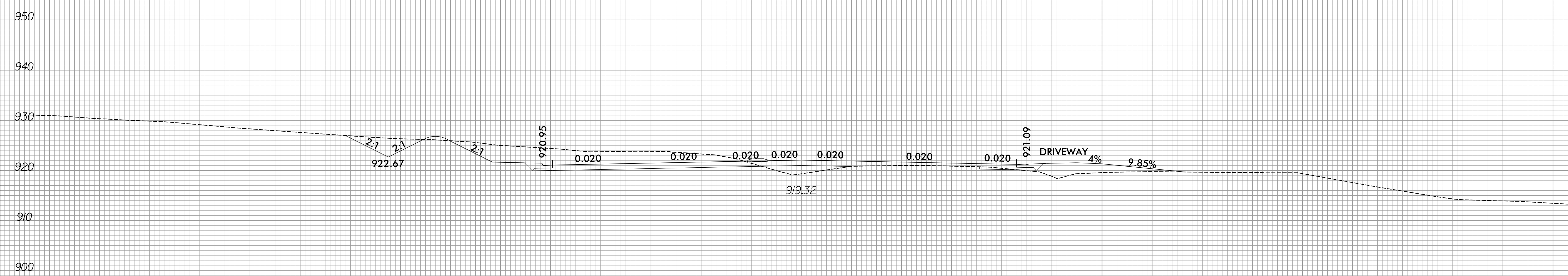

150 140 130 120 110 100 90 80 70 60 50 40 30 20 10 0 10 20 30 40 50 60 70 80 90 100 110 120 130 140 150



150 140 130 120 110 100 90 80 70 60 50 40 30 20 10 0 10 20 30 40 50 60 70 80 90 100 110 120 130 140 150

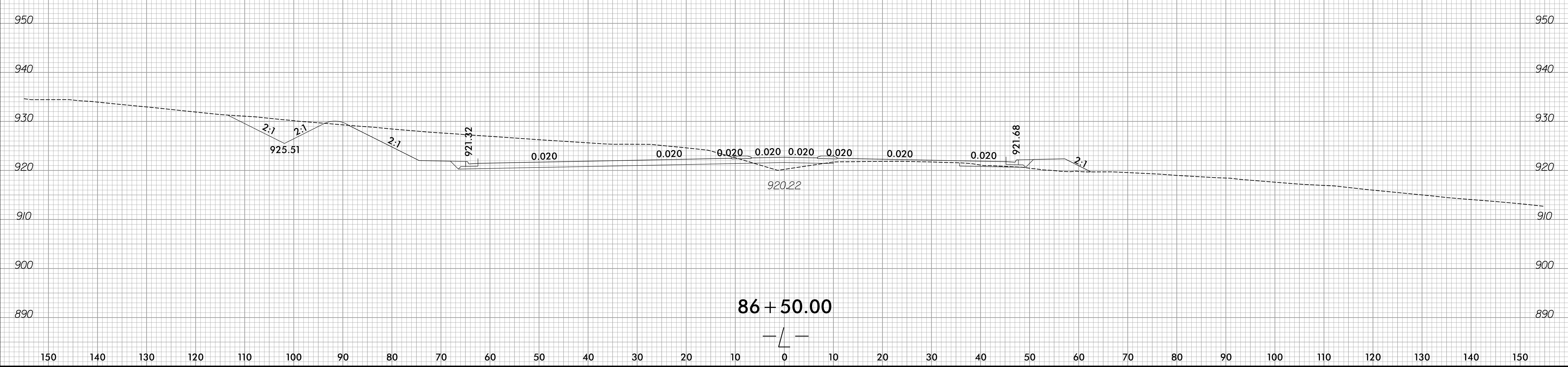
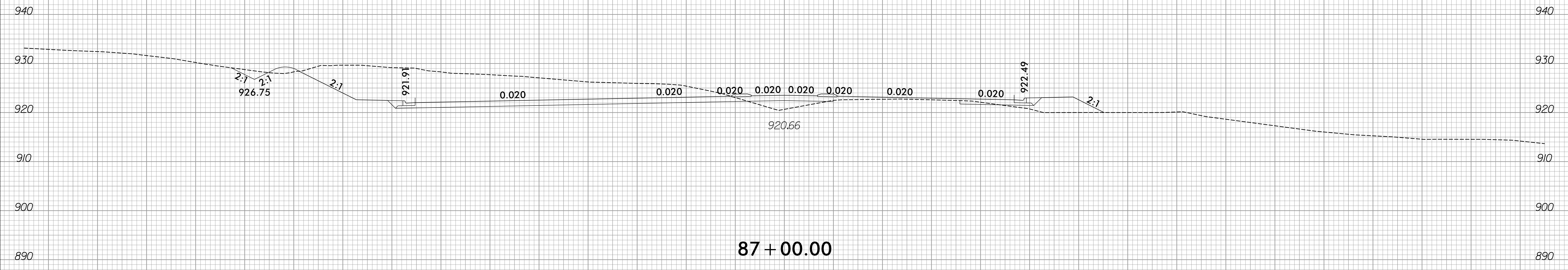

150 140 130 120 110 100 90 80 70 60 50 40 30 20 10 0 10 20 30 40 50 60 70 80 90 100 110 120 130 140 150

6/23/16



PROJ. REFERENCE NO.
R-2577A

SHEET NO.
X-82

150 140 130 120 110 100 90 80 70 60 50 40 30 20 10 0 10 20 30 40 50 60 70 80 90 100 110 120 130 140 150

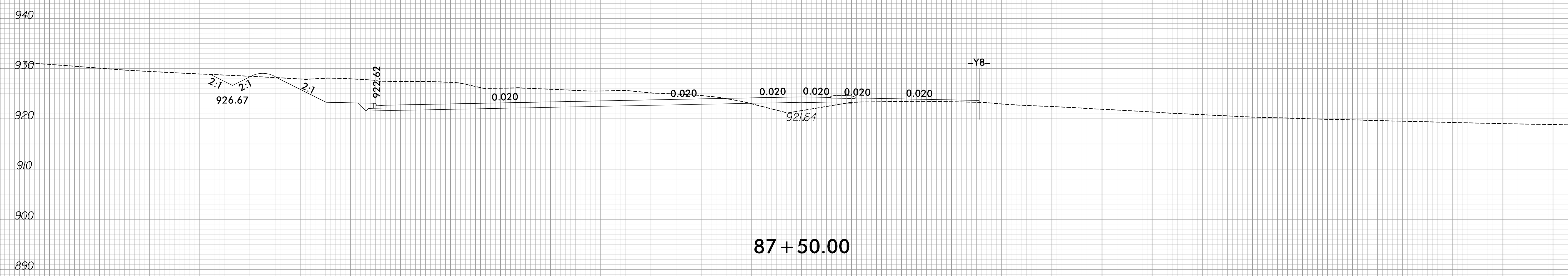
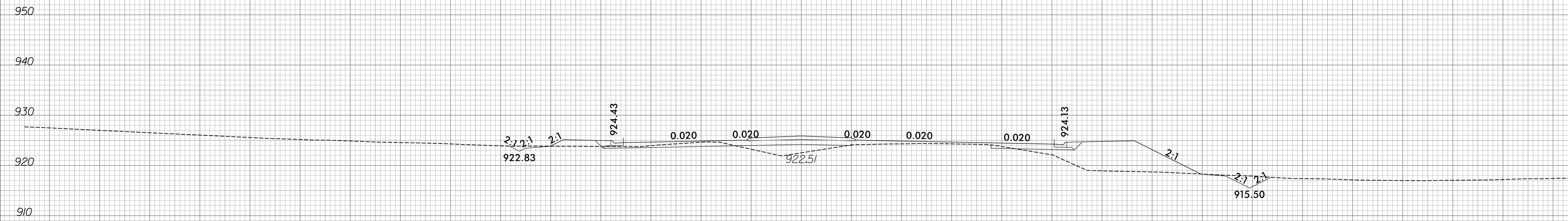

150 140 130 120 110 100 90 80 70 60 50 40 30 20 10 0 10 20 30 40 50 60 70 80 90 100 110 120 130 140 150

12/2/2023
R:\Roadway\XSC\R-2577A_Rdu_xp1.L.dgn
amc@pfs.com

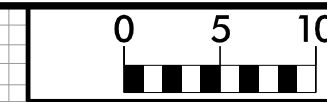

150 140 130 120 110 100 90 80 70 60 50 40 30 20 10 0 10 20 30 40 50 60 70 80 90 100 110 120 130 140 150

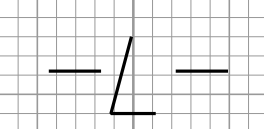
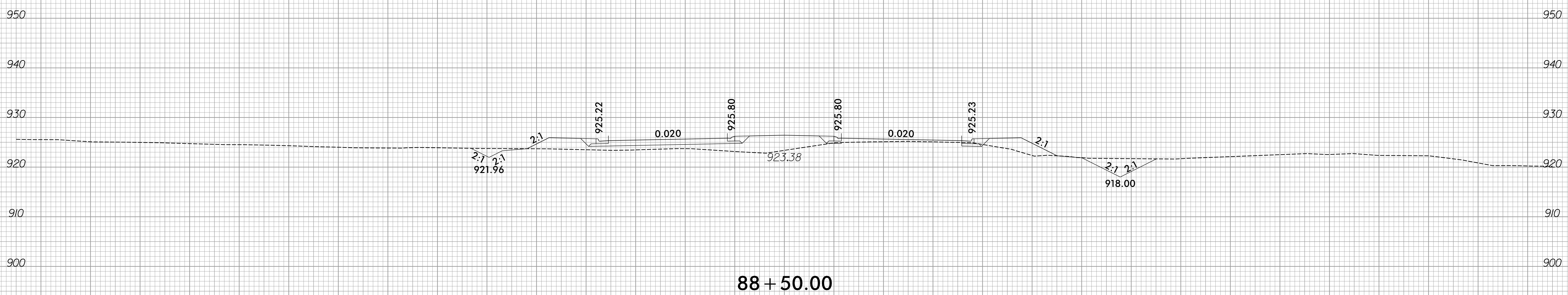
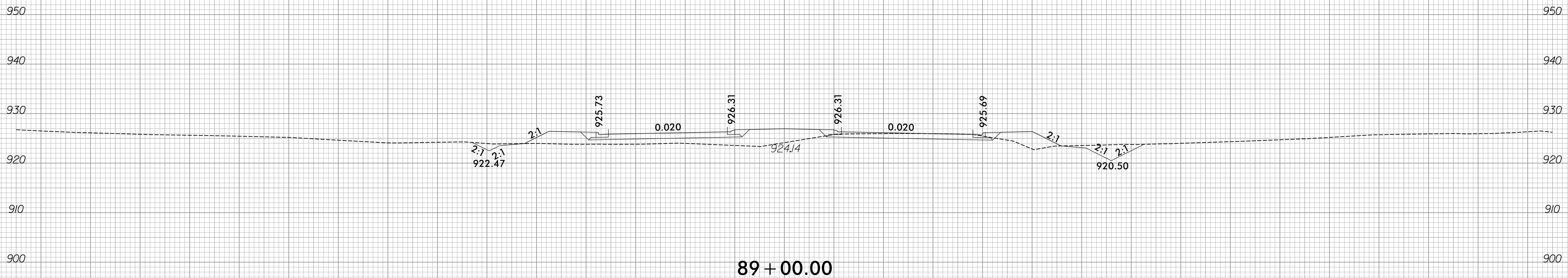

150 140 130 120 110 100 90 80 70 60 50 40 30 20 10 0 10 20 30 40 50 60 70 80 90 100 110 120 130 140 150

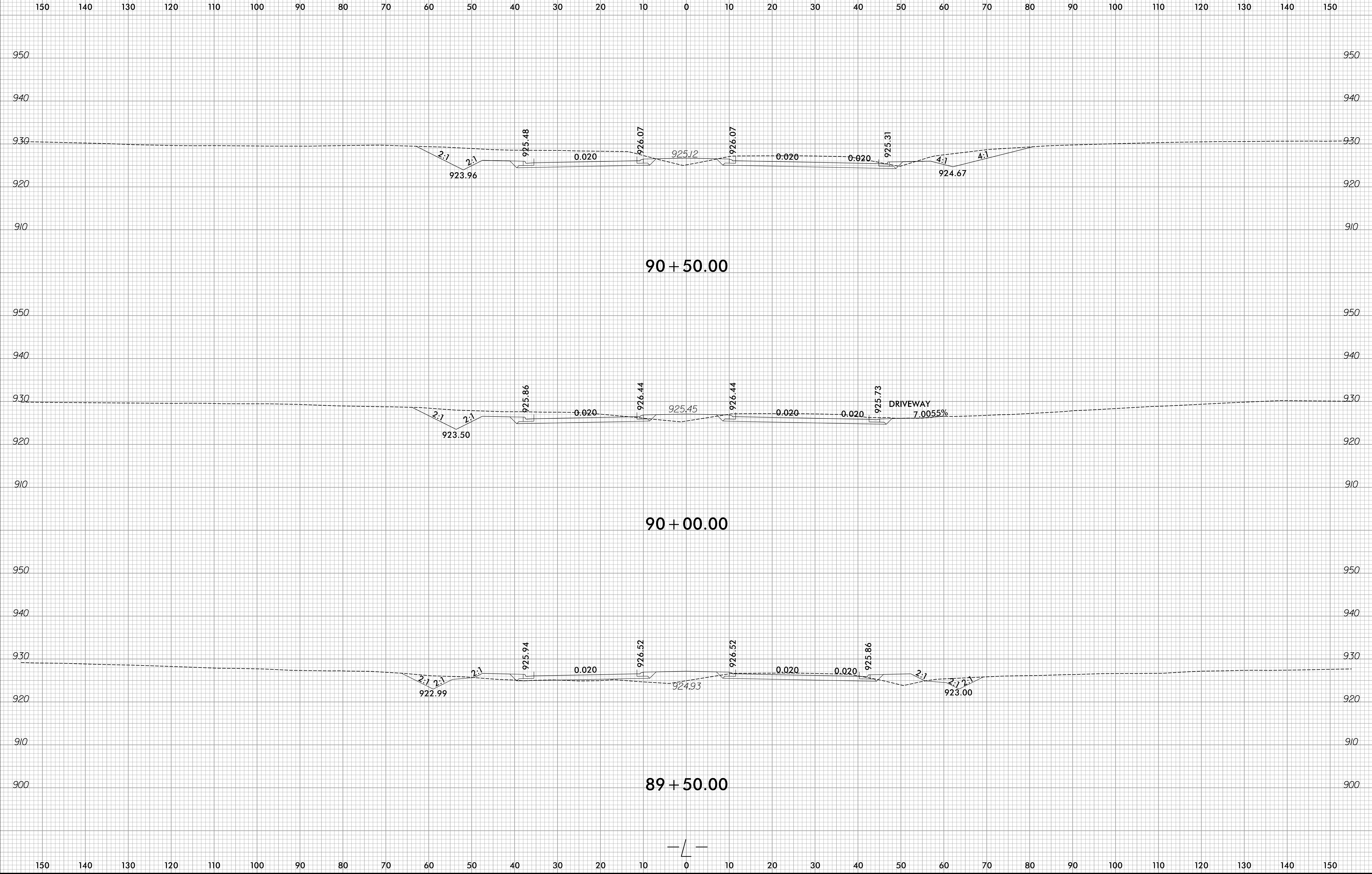



150 140 130 120 110 100 90 80 70 60 50 40 30 20 10 0 10 20 30 40 50 60 70 80 90 100 110 120 130 140 150



91 + 50.00

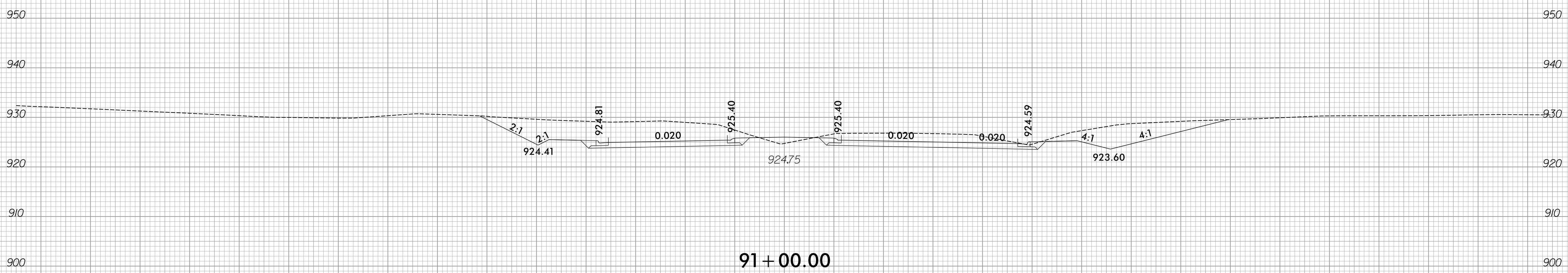

91 + 00.00

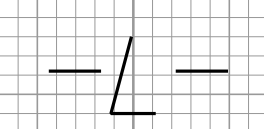

150 140 130 120 110 100 90 80 70 60 50 40 30 20 10 0 10 20 30 40 50 60 70 80 90 100 110 120 130 140 150

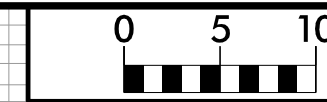

150 140 130 120 110 100 90 80 70 60 50 40 30 20 10 0 10 20 30 40 50 60 70 80 90 100 110 120 130 140 150

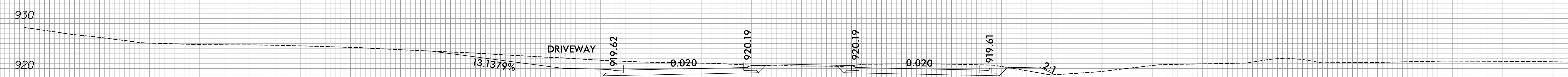

92 + 95.00

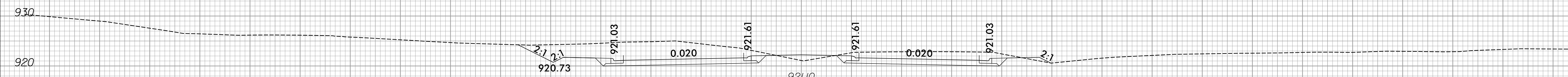

92 + 50.00

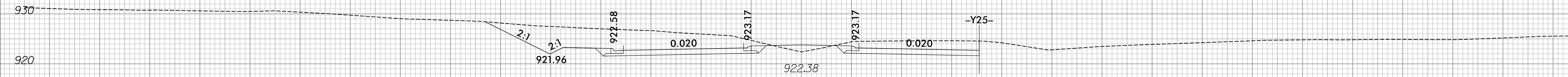

92 + 00.00

150 140 130 120 110 100 90 80 70 60 50 40 30 20 10 0 10 20 30 40 50 60 70 80 90 100 110 120 130 140 150

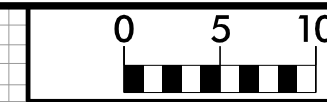

150 140 130 120 110 100 90 80 70 60 50 40 30 20 10 0 10 20 30 40 50 60 70 80 90 100 110 120 130 140 150

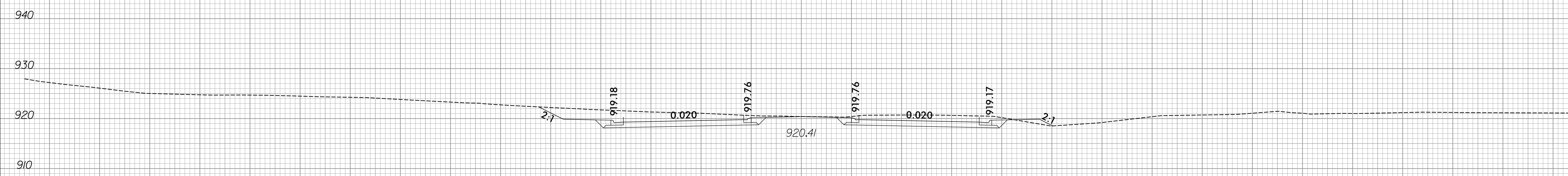
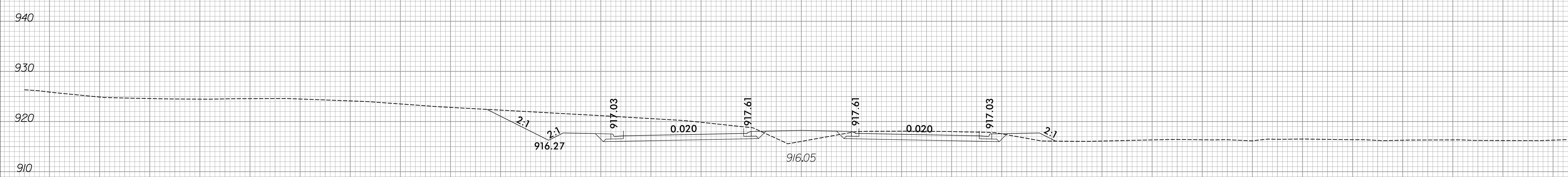

150 140 130 120 110 100 90 80 70 60 50 40 30 20 10 0 10 20 30 40 50 60 70 80 90 100 110 120 130 140 150

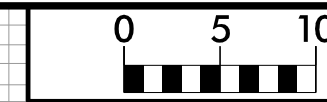

150 140 130 120 110 100 90 80 70 60 50 40 30 20 10 0 10 20 30 40 50 60 70 80 90 100 110 120 130 140 150

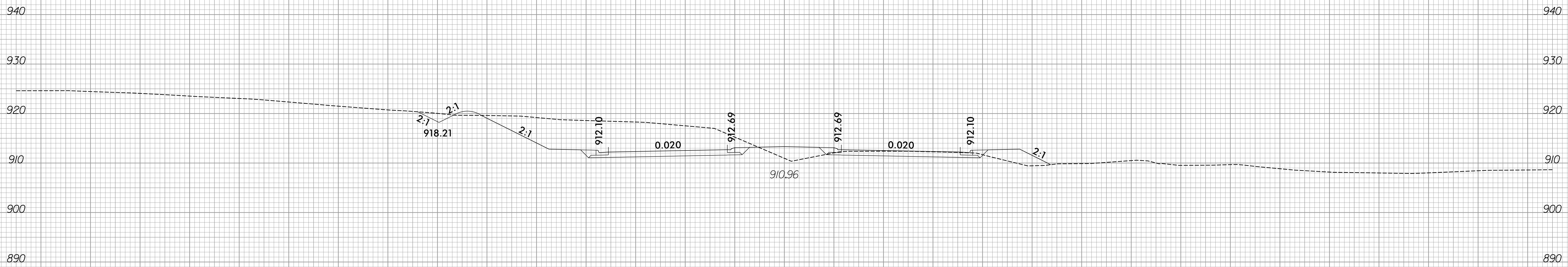

94 + 50.00

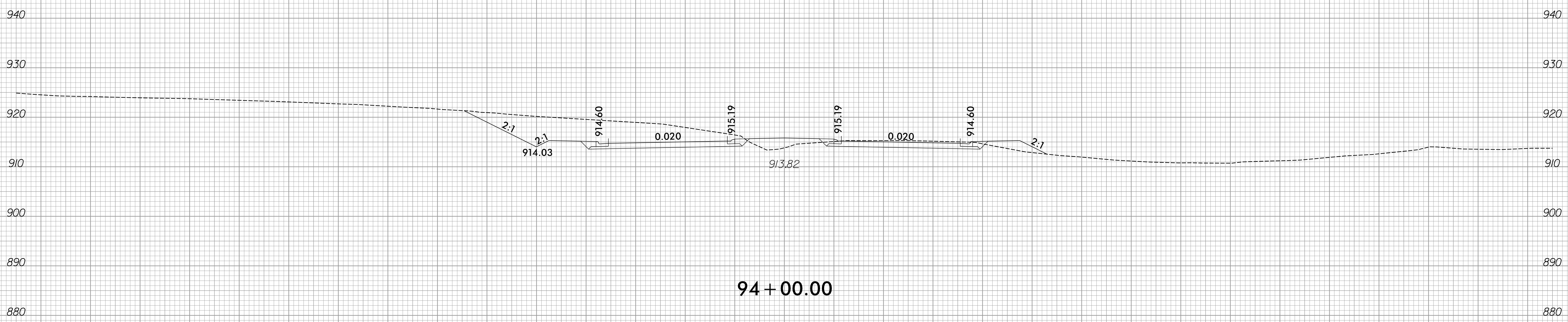

94 + 00.00

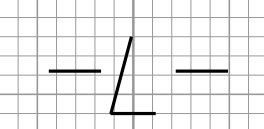

150 140 130 120 110 100 90 80 70 60 50 40 30 20 10 0 10 20 30 40 50 60 70 80 90 100 110 120 130 140 150



150 140 130 120 110 100 90 80 70 60 50 40 30 20 10 0 10 20 30 40 50 60 70 80 90 100 110 120 130 140 150

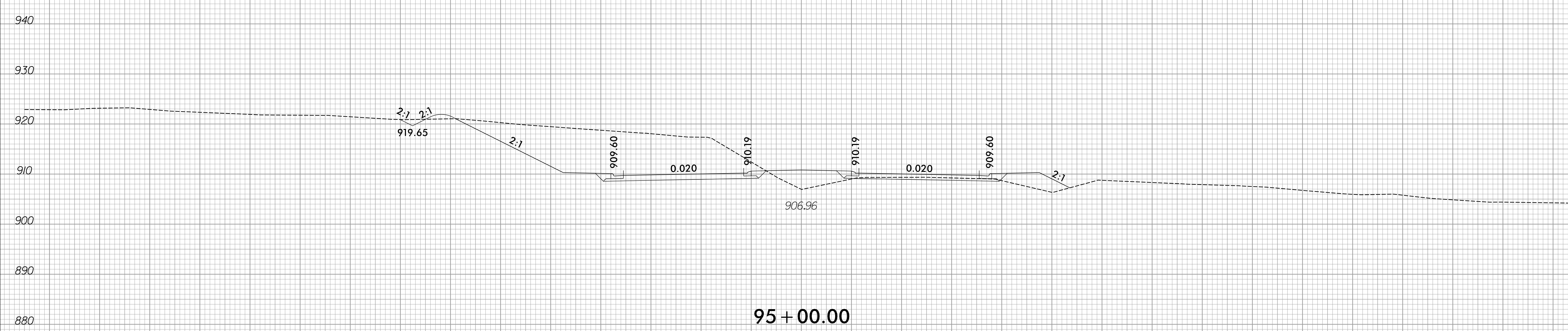
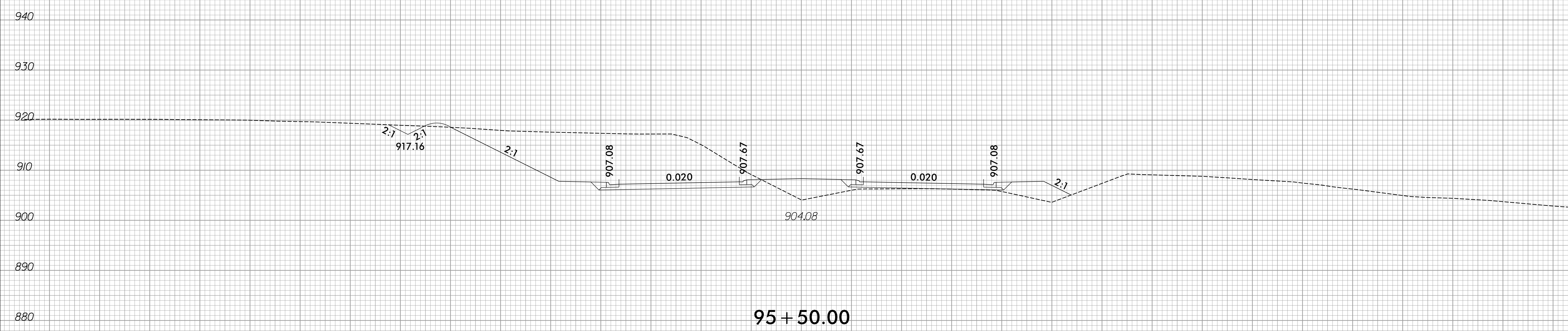

150 140 130 120 110 100 90 80 70 60 50 40 30 20 10 0 10 20 30 40 50 60 70 80 90 100 110 120 130 140 150

6/23/16

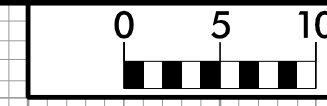

PROJ. REFERENCE NO.
R-2577A

SHEET NO.
X-90

150 140 130 120 110 100 90 80 70 60 50 40 30 20 10 0 10 20 30 40 50 60 70 80 90 100 110 120 130 140 150

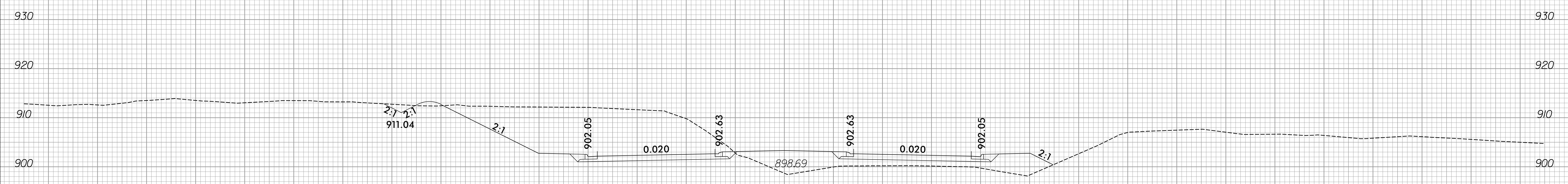

96 + 50.00



96 + 00.00

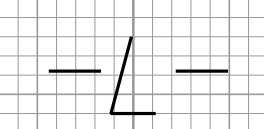

150 140 130 120 110 100 90 80 70 60 50 40 30 20 10 0 10 20 30 40 50 60 70 80 90 100 110 120 130 140 150

12/2/2023
 R:\Roadway\XSC\R-2577A_Rdu_xp1.L.dgn
 amcpherson

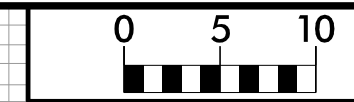

150 140 130 120 110 100 90 80 70 60 50 40 30 20 10 0 10 20 30 40 50 60 70 80 90 100 110 120 130 140 150

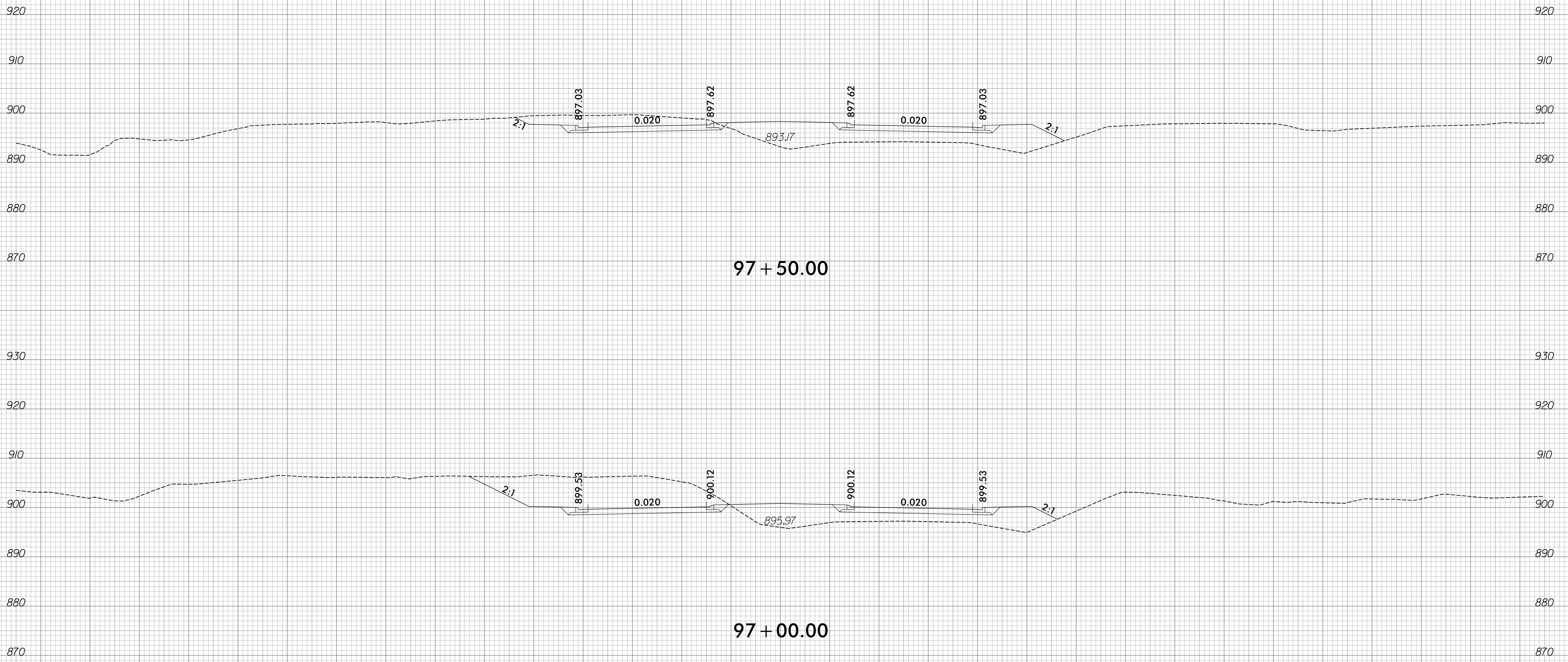

150 140 130 120 110 100 90 80 70 60 50 40 30 20 10 0 10 20 30 40 50 60 70 80 90 100 110 120 130 140 150



150 140 130 120 110 100 90 80 70 60 50 40 30 20 10 0 10 20 30 40 50 60 70 80 90 100 110 120 130 140 150

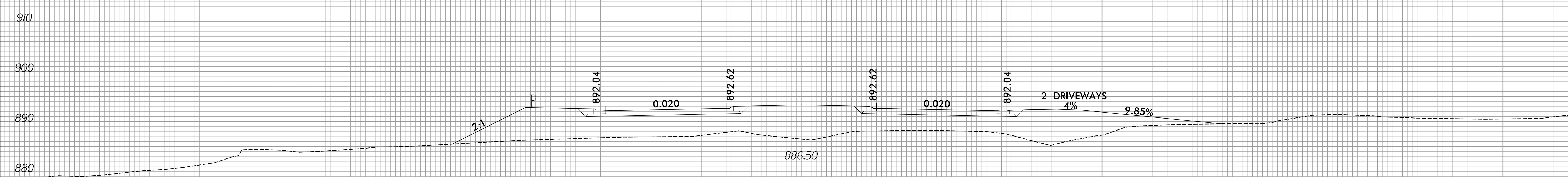

98 + 50.00

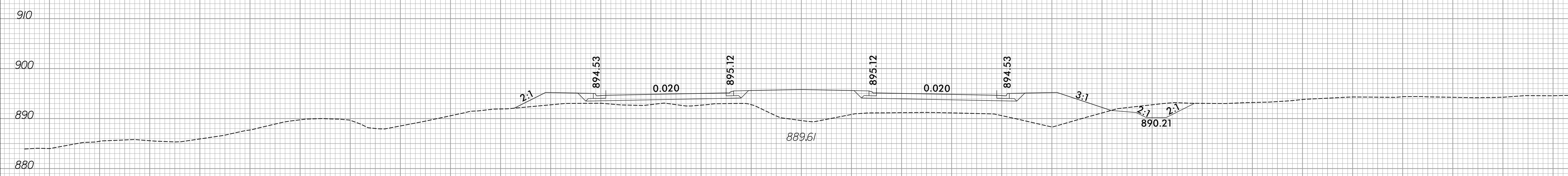

98 + 00.00

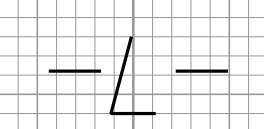

150 140 130 120 110 100 90 80 70 60 50 40 30 20 10 0 10 20 30 40 50 60 70 80 90 100 110 120 130 140 150

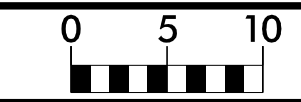

150 140 130 120 110 100 90 80 70 60 50 40 30 20 10 0 10 20 30 40 50 60 70 80 90 100 110 120 130 140 150

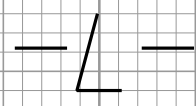
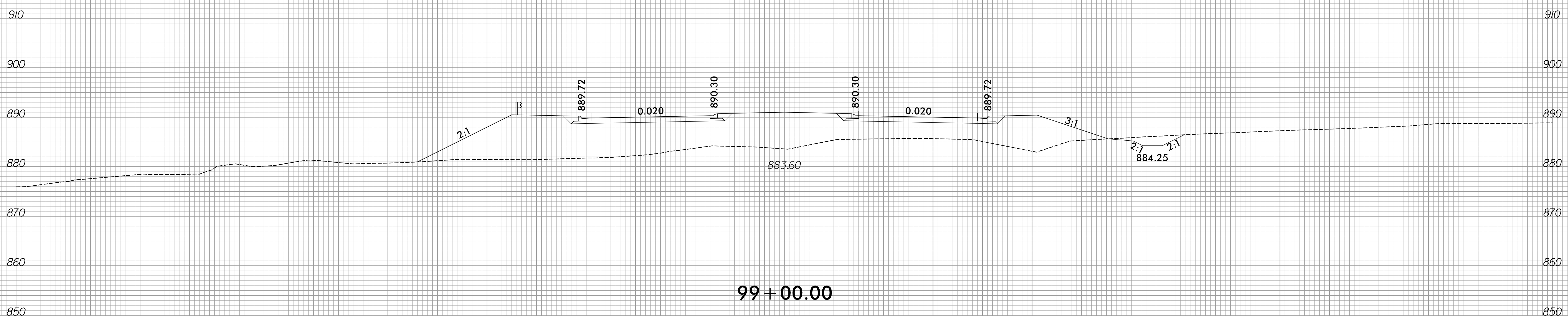
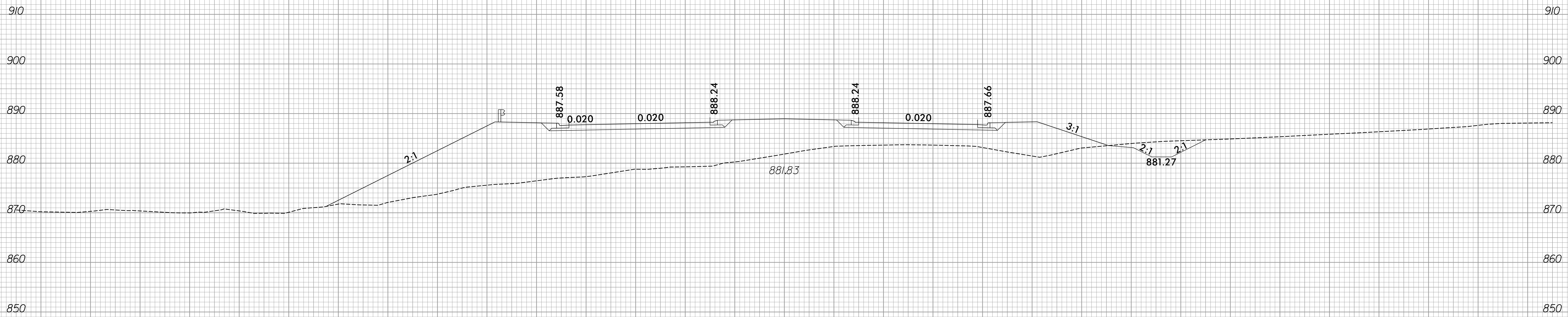

6/23/16

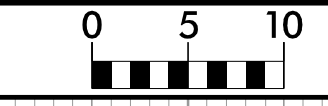

150 140 130 120 110 100 90 80 70 60 50 40 30 20 10 0 10 20 30 40 50 60 70 80 90 100 110 120 130 140 150

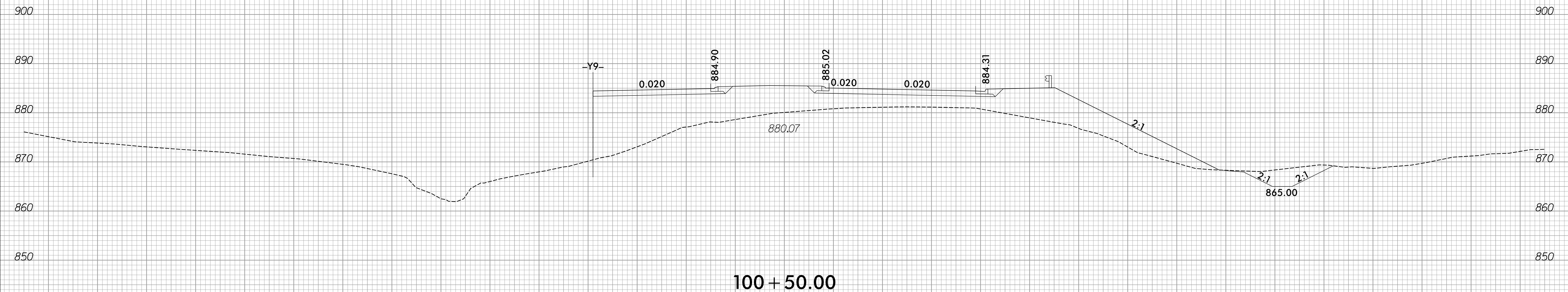

100 + 50.00

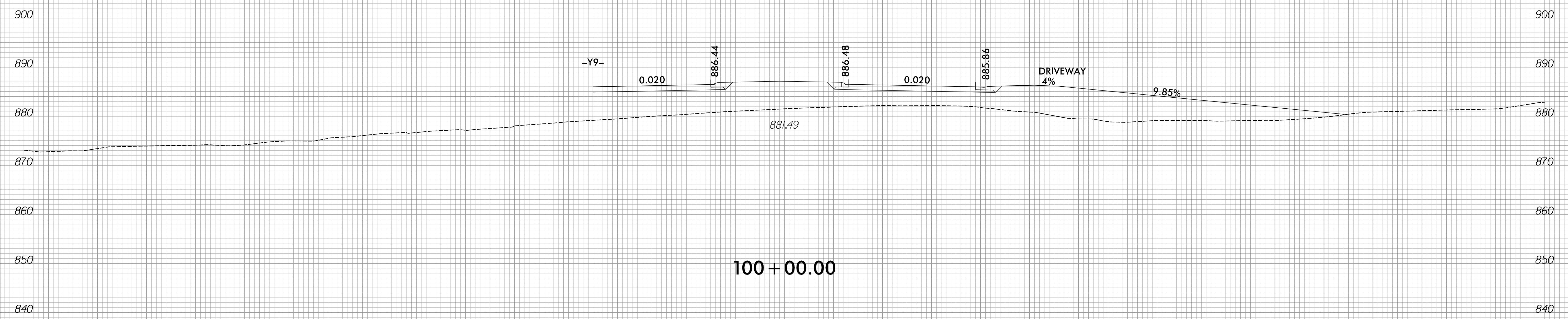

100 + 00.00

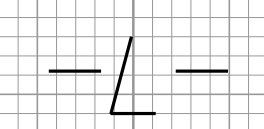

150 140 130 120 110 100 90 80 70 60 50 40 30 20 10 0 10 20 30 40 50 60 70 80 90 100 110 120 130 140 150

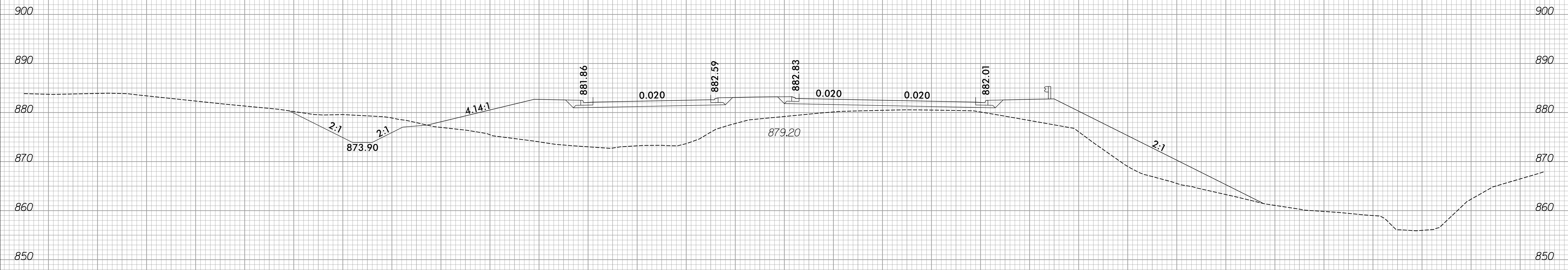

101 + 50.00

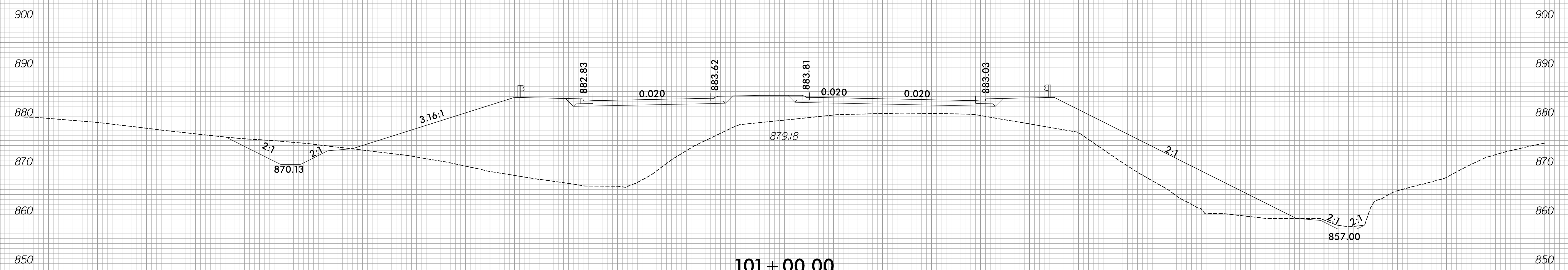

101 + 00.00

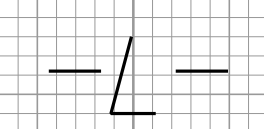

150 140 130 120 110 100 90 80 70 60 50 40 30 20 10 0 10 20 30 40 50 60 70 80 90 100 110 120 130 140 150

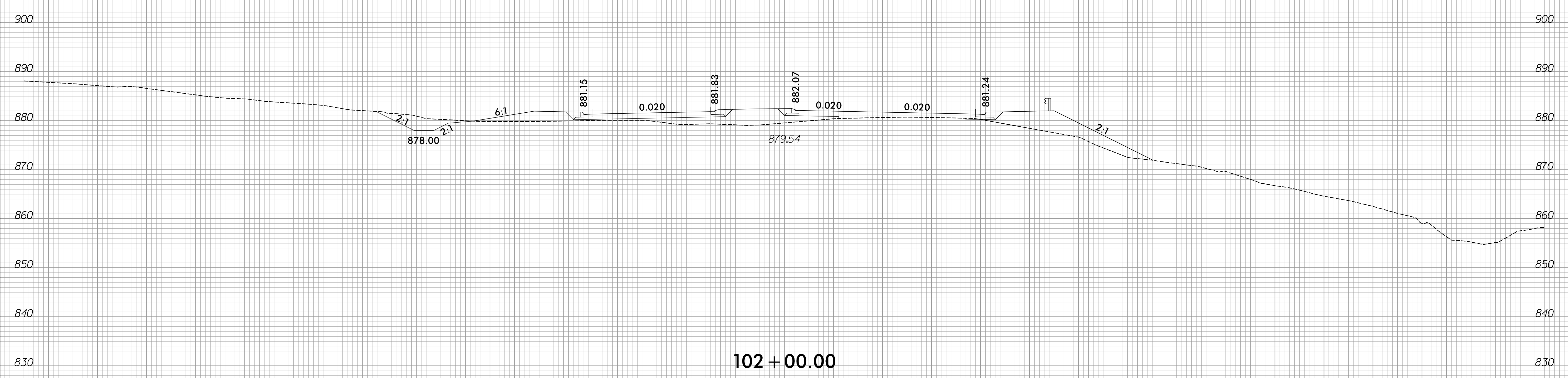
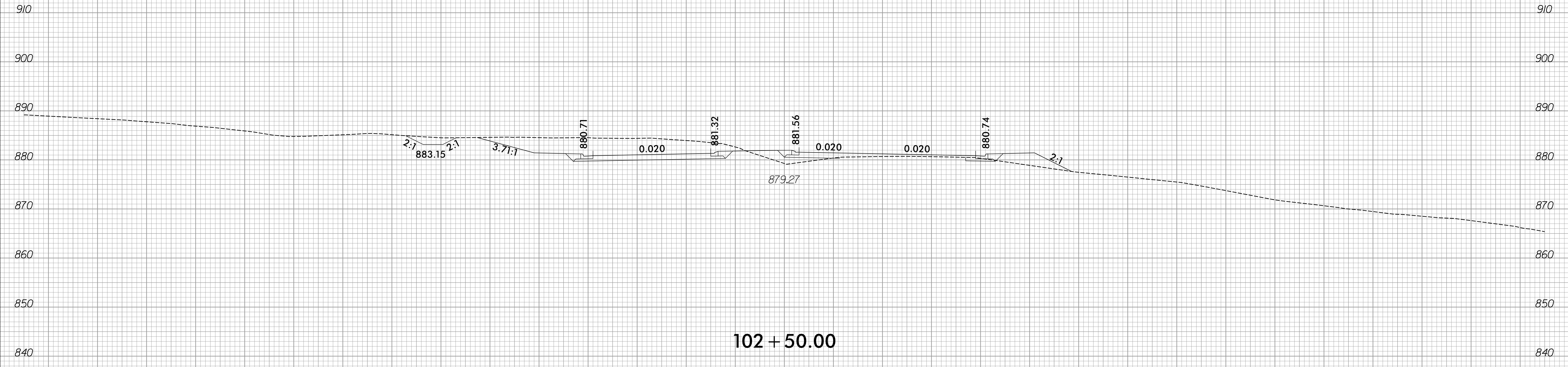

150 140 130 120 110 100 90 80 70 60 50 40 30 20 10 0 10 20 30 40 50 60 70 80 90 100 110 120 130 140 150

150 140 130 120 110 100 90 80 70 60 50 40 30 20 10 0 10 20 30 40 50 60 70 80 90 100 110 120 130 140 150

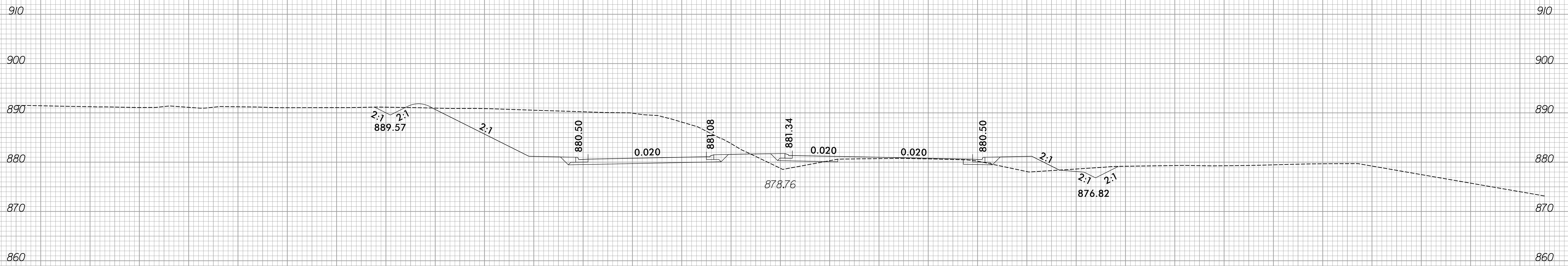

103 + 50.00

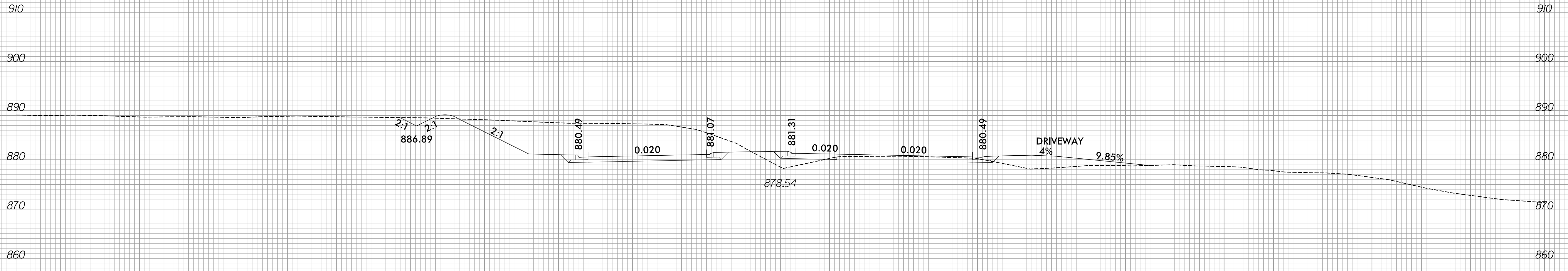

103 + 00.00

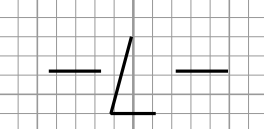

150 140 130 120 110 100 90 80 70 60 50 40 30 20 10 0 10 20 30 40 50 60 70 80 90 100 110 120 130 140 150

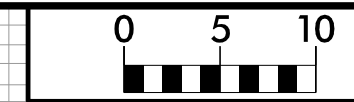

150 140 130 120 110 100 90 80 70 60 50 40 30 20 10 0 10 20 30 40 50 60 70 80 90 100 110 120 130 140 150

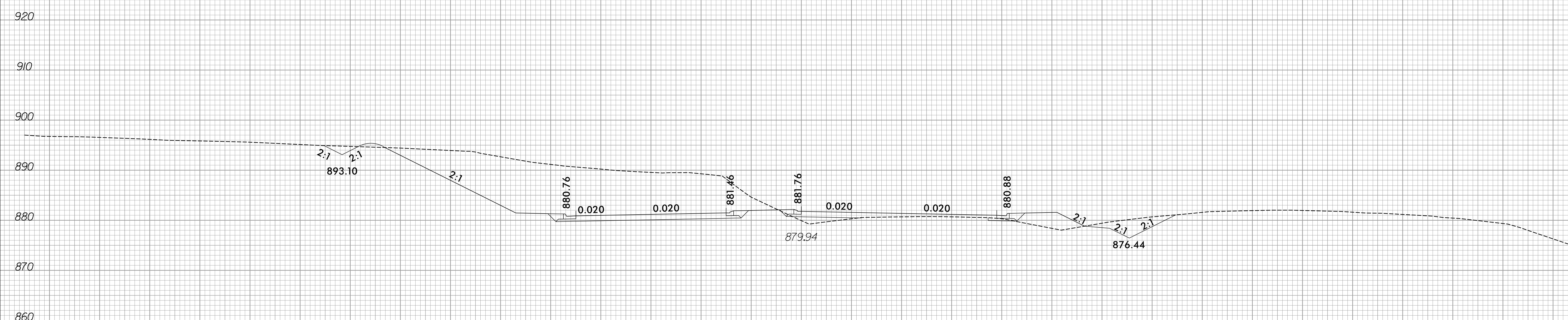

104 + 50.00

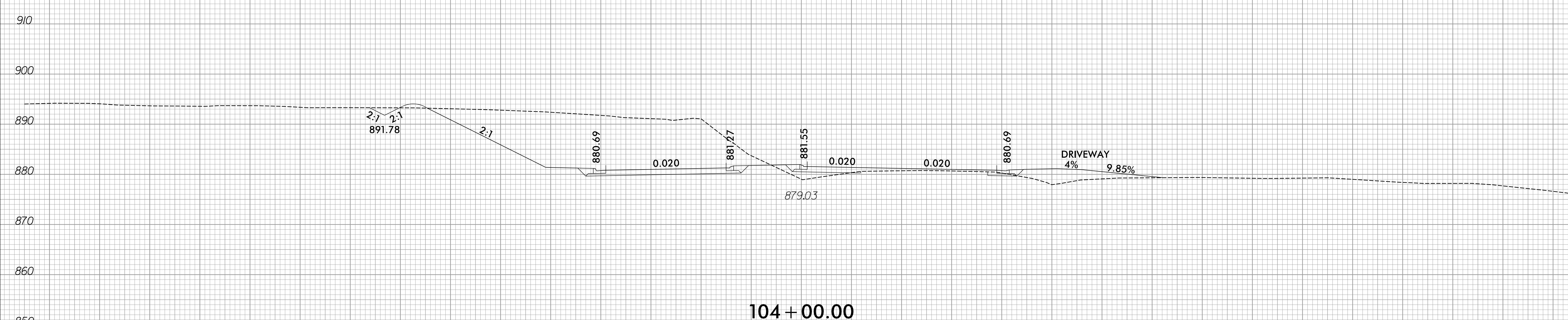

104 + 00.00

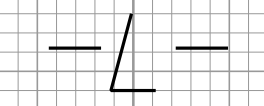

150 140 130 120 110 100 90 80 70 60 50 40 30 20 10 0 10 20 30 40 50 60 70 80 90 100 110 120 130 140 150

150 140 130 120 110 100 90 80 70 60 50 40 30 20 10 0 10 20 30 40 50 60 70 80 90 100 110 120 130 140 150

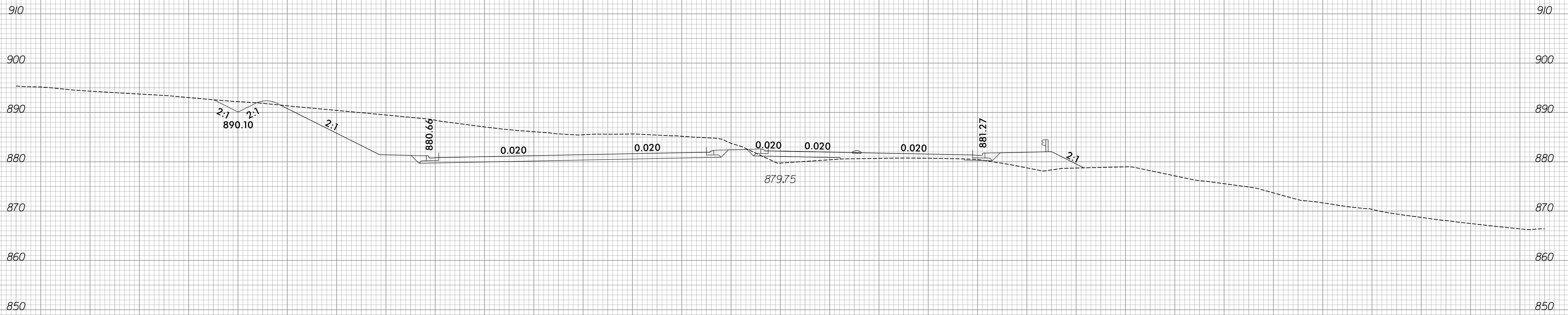

105 + 50.00

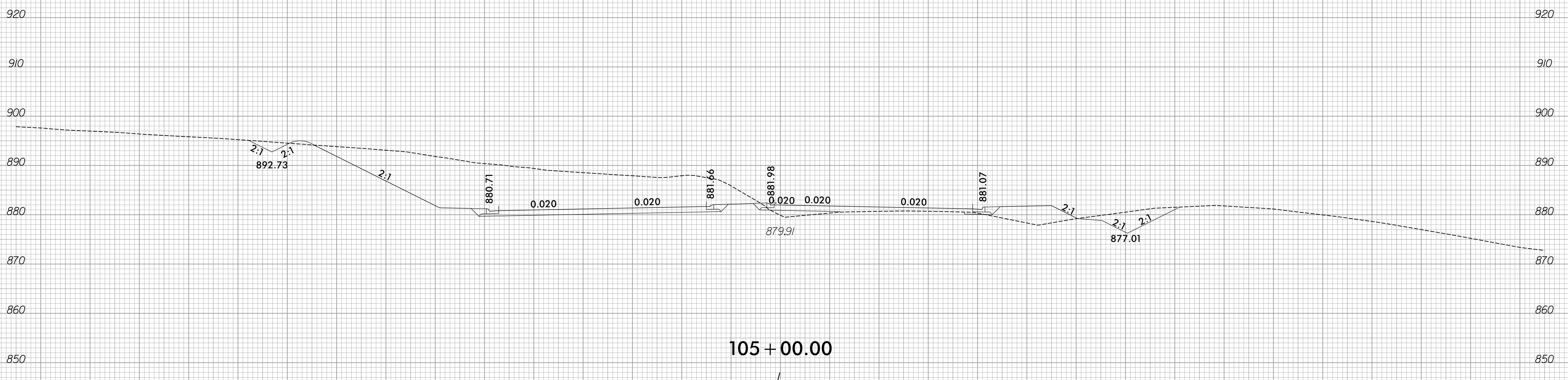

105 + 00.00

150 140 130 120 110 100 90 80 70 60 50 40 30 20 10 0 10 20 30 40 50 60 70 80 90 100 110 120 130 140 150

6/23/16

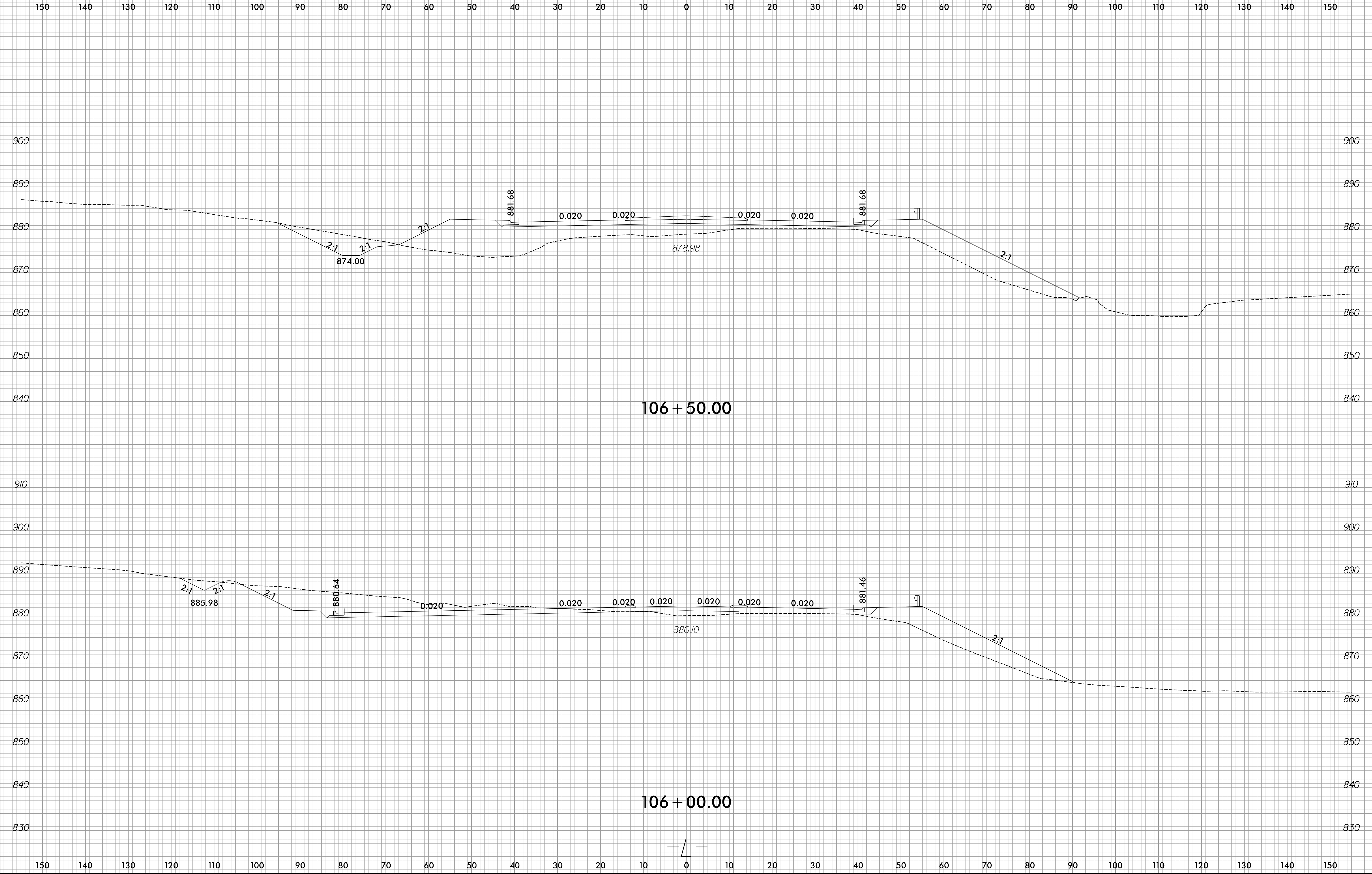

12/21/2023
R:\Roadway\XSC\R-2577A_Rdy_xp1.dgn
amc@pfs.com

6/23/16

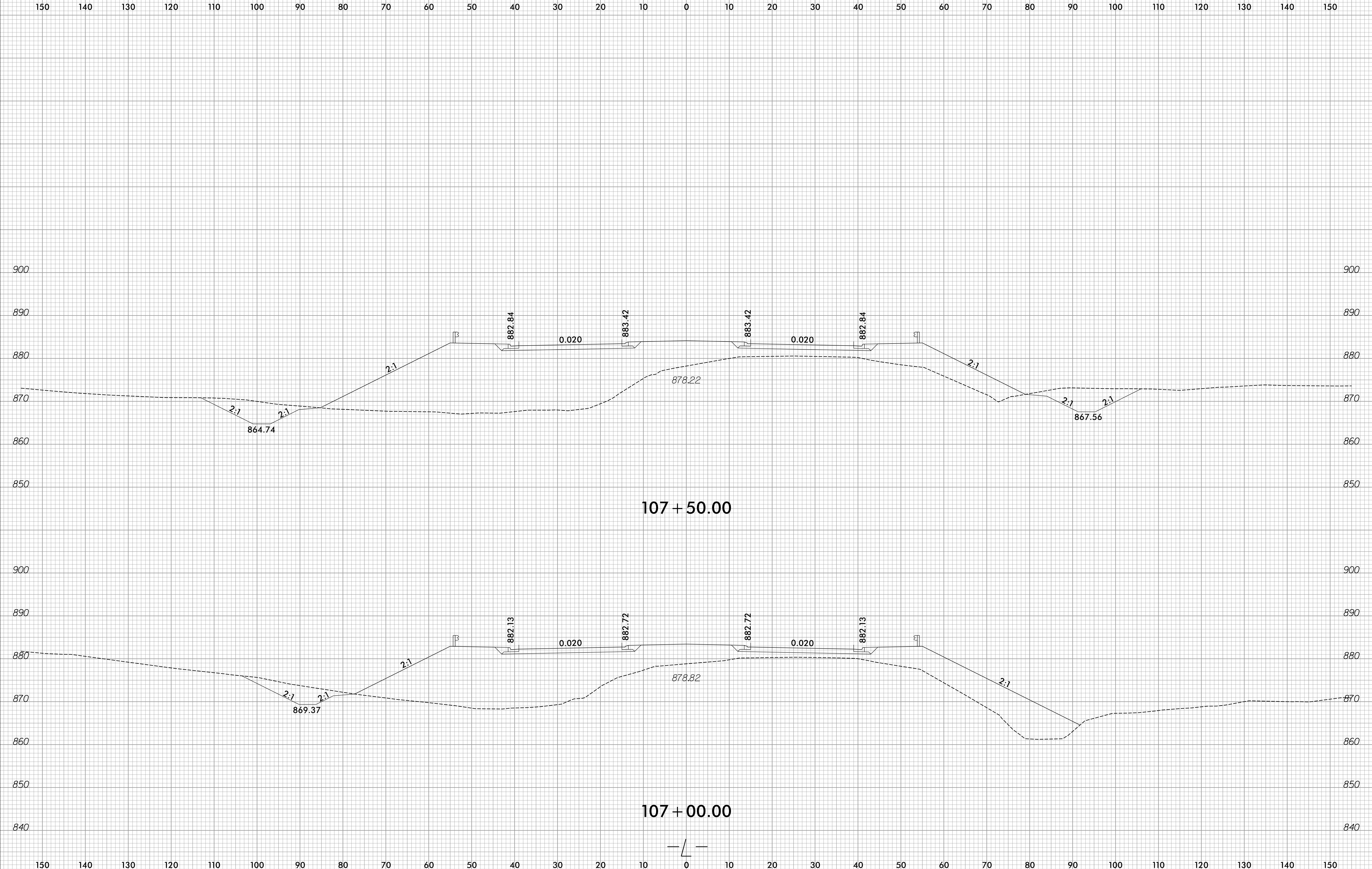

12/2/2023 R:\Roadway\XSC\IR-2577A_Rd\p1.dgn amc\pers\son

150 140 130 120 110 100 90 80 70 60 50 40 30 20 10 0 10 20 30 40 50 60 70 80 90 100 110 120 130 140 150

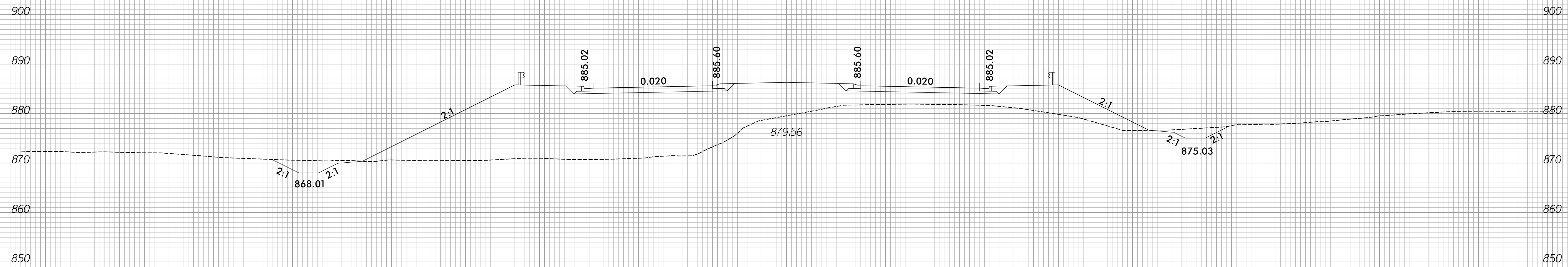

108 + 50.00

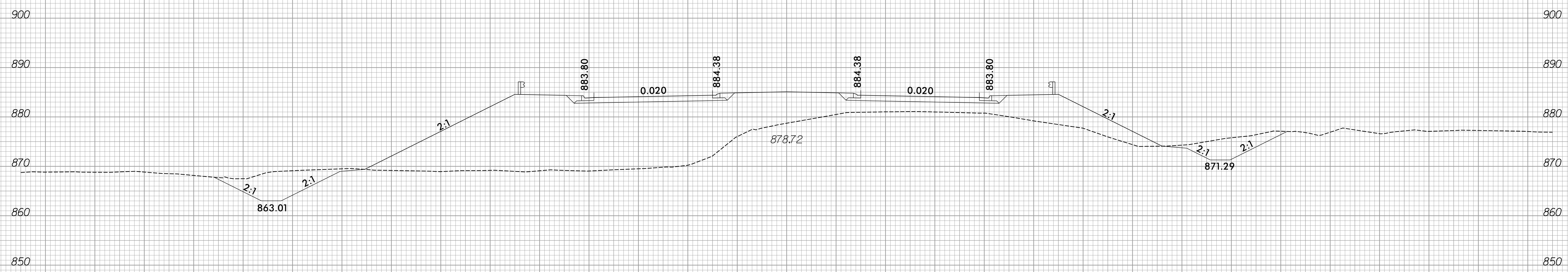

108 + 00.00

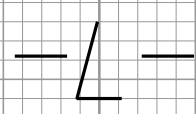

150 140 130 120 110 100 90 80 70 60 50 40 30 20 10 0 10 20 30 40 50 60 70 80 90 100 110 120 130 140 150

6/23/16

0 5 10	PROJ. REFERENCE NO. R-2577A	SHEET NO. X-103
--------	--------------------------------	--------------------

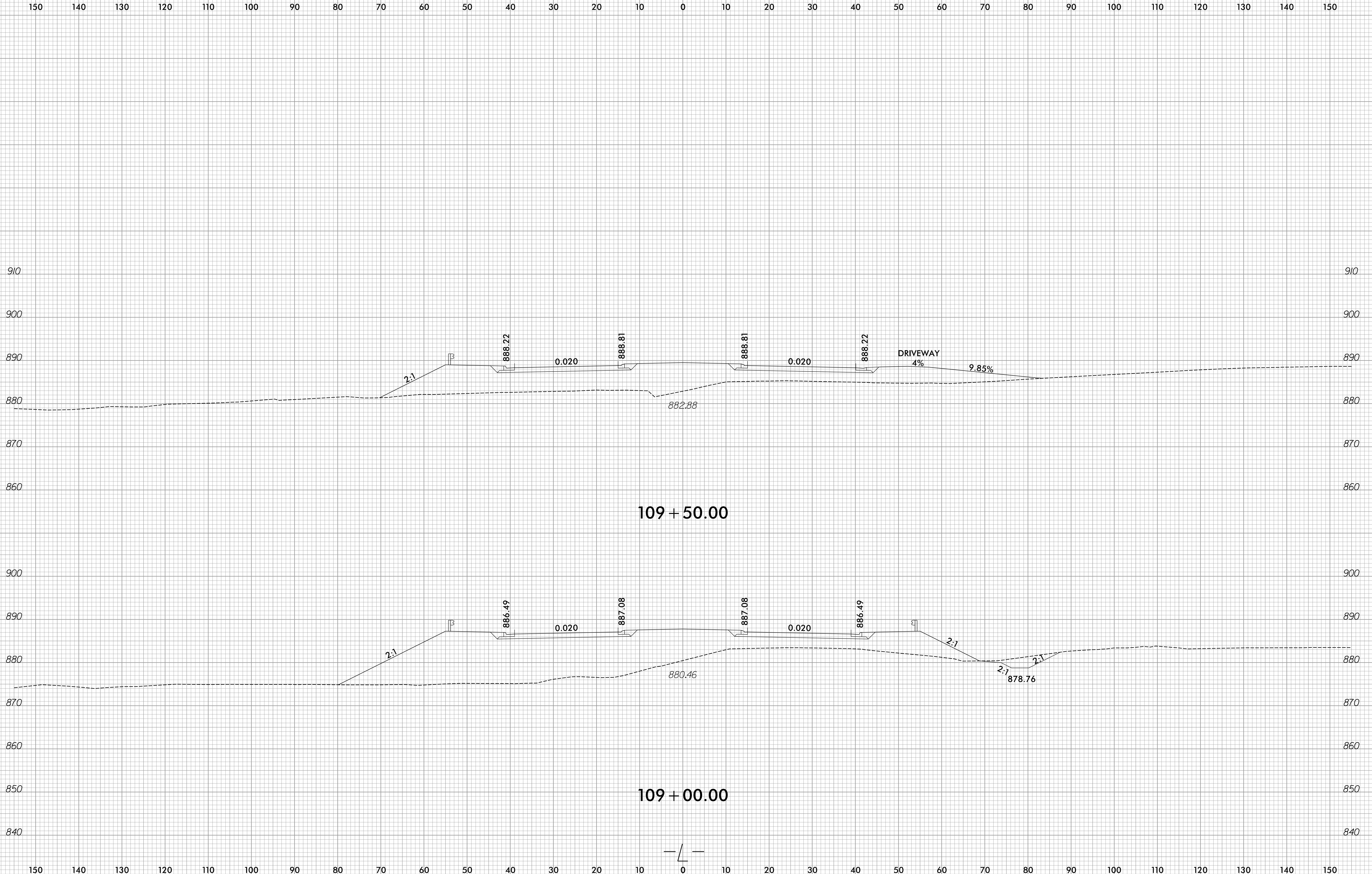

12/2/2023
R:\Roadway\XSC\R-2577A_Rdu_xpl.dgn
amc@peterson

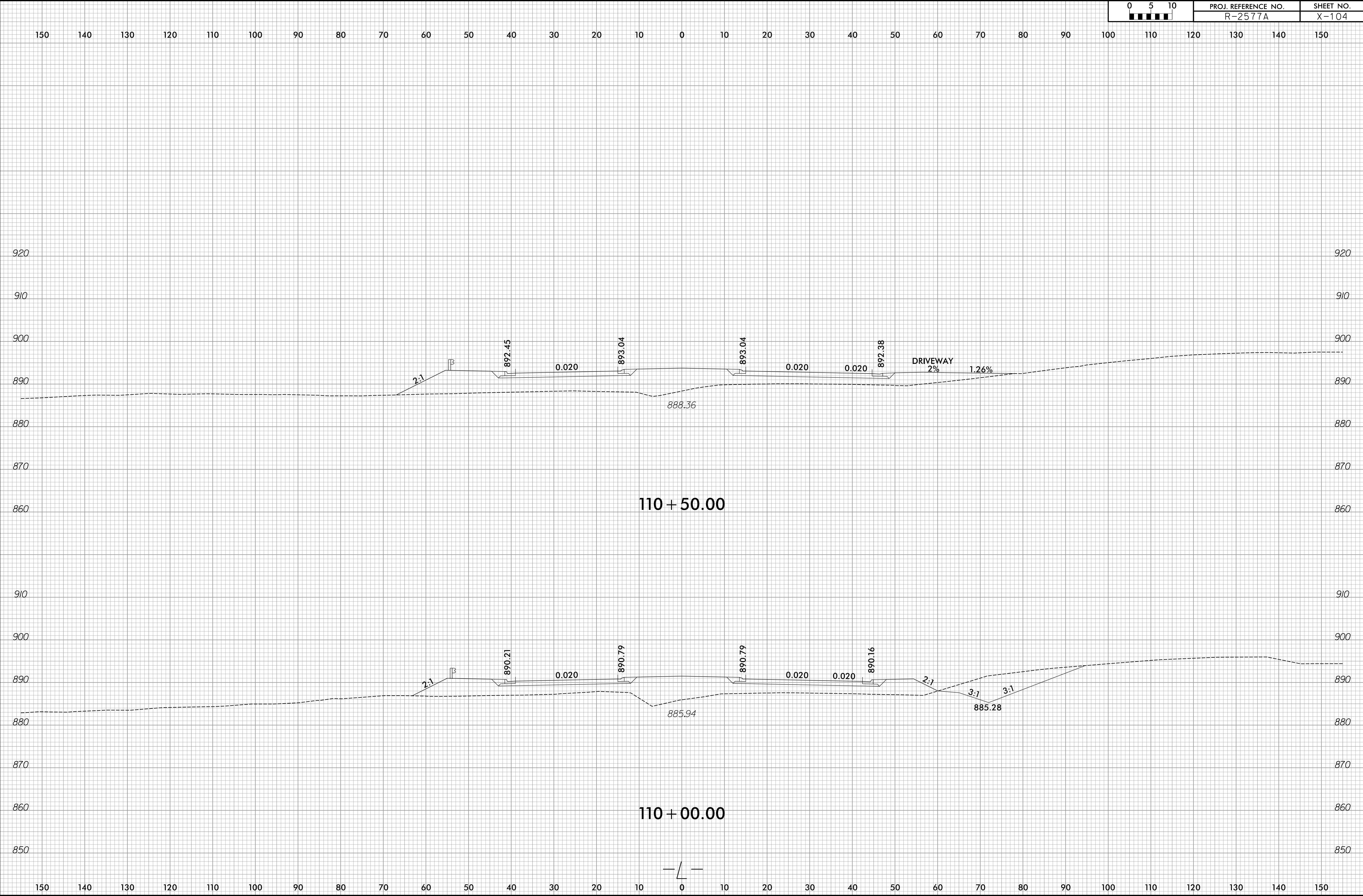



150 140 130 120 110 100 90 80 70 60 50 40 30 20 10 0 10 20 30 40 50 60 70 80 90 100 110 120 130 140 150

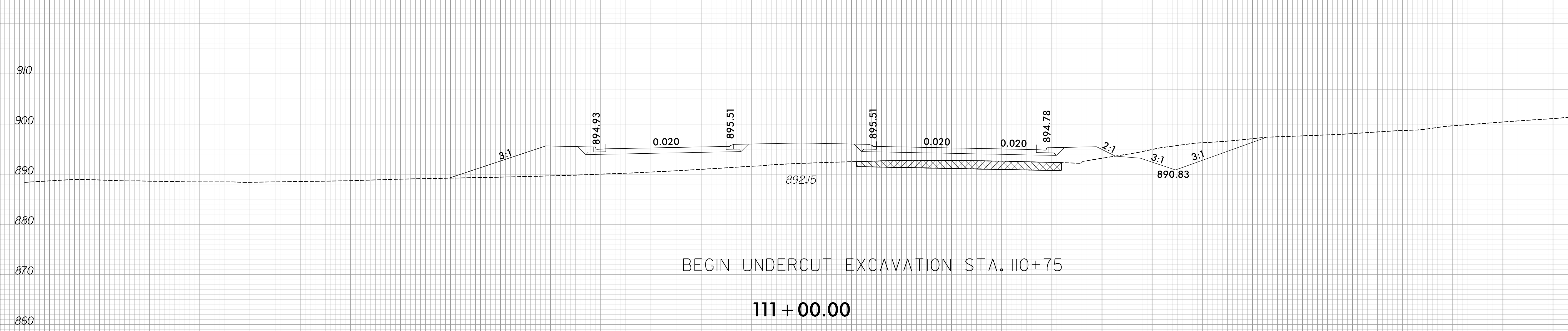
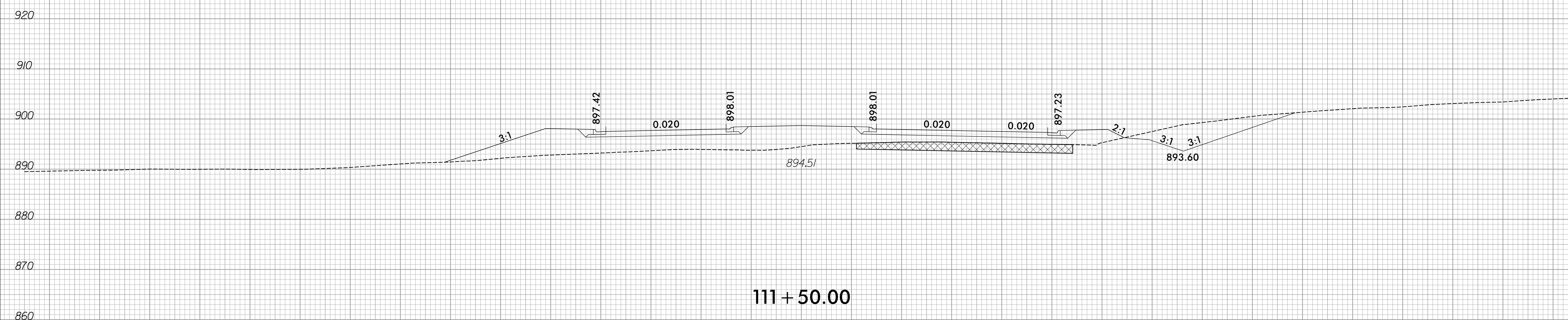

BEGIN UNDERCUT EXCAVATION STA. 110+75

150 140 130 120 110 100 90 80 70 60 50 40 30 20 10 0 10 20 30 40 50 60 70 80 90 100 110 120 130 140 150



150 140 130 120 110 100 90 80 70 60 50 40 30 20 10 0 10 20 30 40 50 60 70 80 90 100 110 120 130 140 150

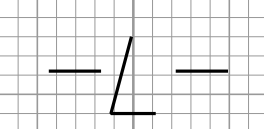
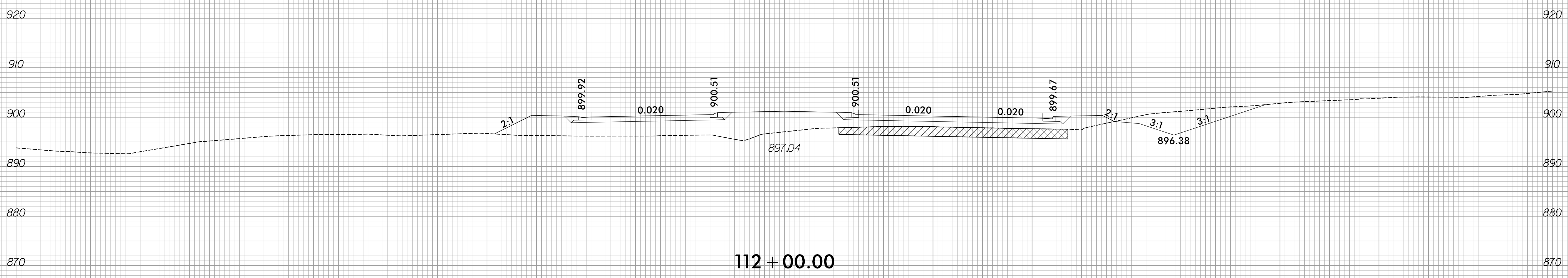
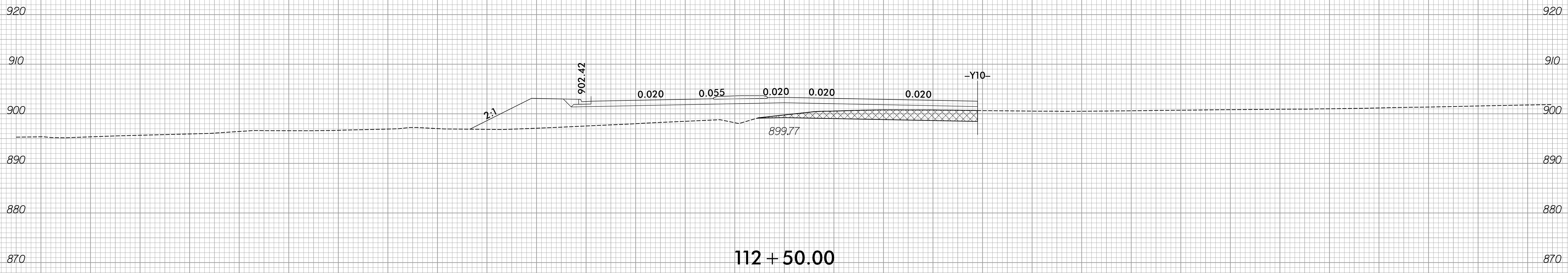

150 140 130 120 110 100 90 80 70 60 50 40 30 20 10 0 10 20 30 40 50 60 70 80 90 100 110 120 130 140 150

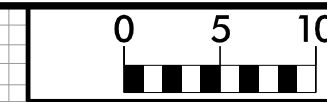

150 140 130 120 110 100 90 80 70 60 50 40 30 20 10 0 10 20 30 40 50 60 70 80 90 100 110 120 130 140 150

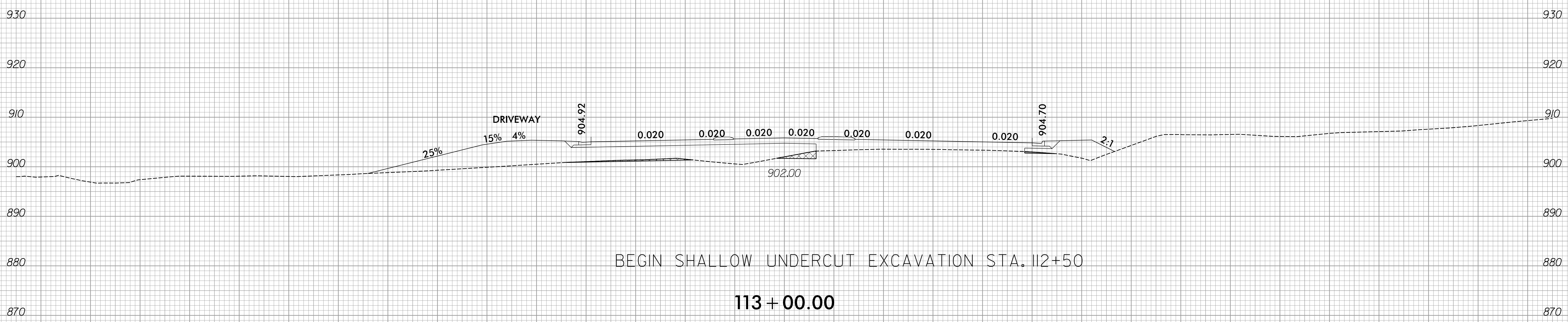

150 140 130 120 110 100 90 80 70 60 50 40 30 20 10 0 10 20 30 40 50 60 70 80 90 100 110 120 130 140 150

150 140 130 120 110 100 90 80 70 60 50 40 30 20 10 0 10 20 30 40 50 60 70 80 90 100 110 120 130 140 150

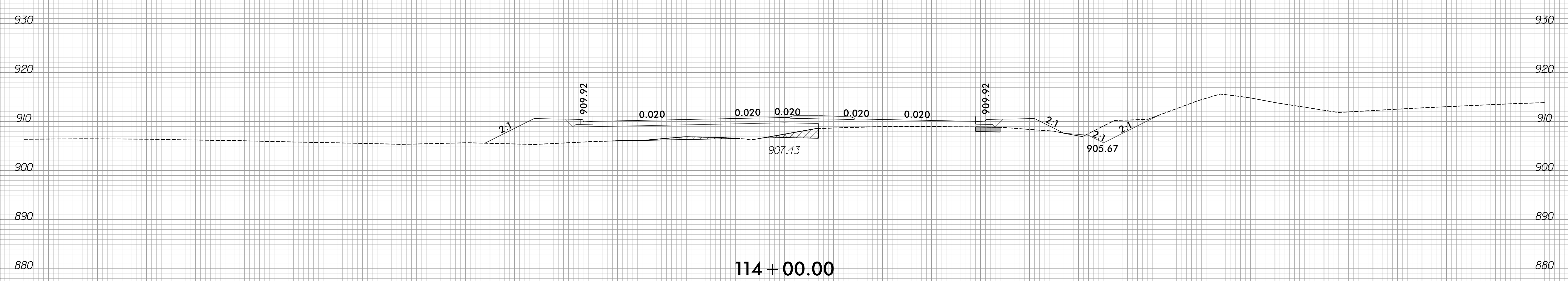
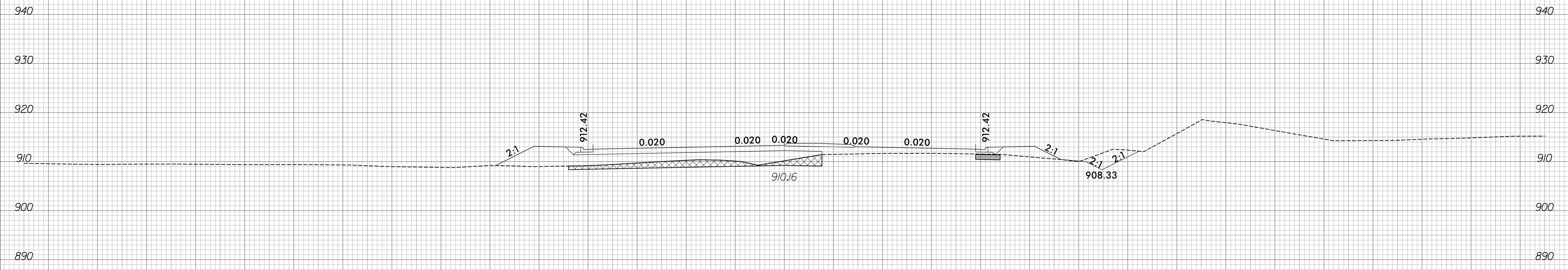

150 140 130 120 110 100 90 80 70 60 50 40 30 20 10 0 10 20 30 40 50 60 70 80 90 100 110 120 130 140 150



150 140 130 120 110 100 90 80 70 60 50 40 30 20 10 0 10 20 30 40 50 60 70 80 90 100 110 120 130 140 150

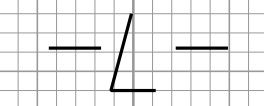
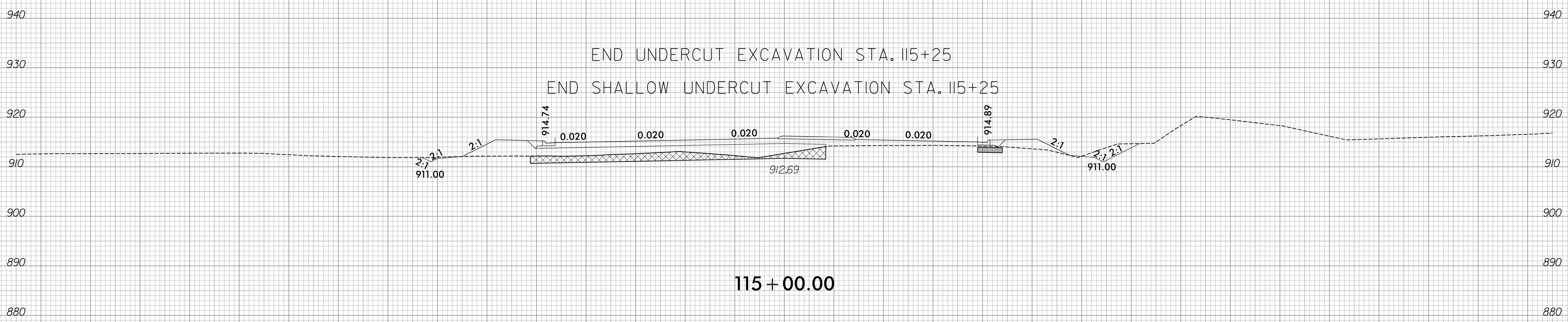
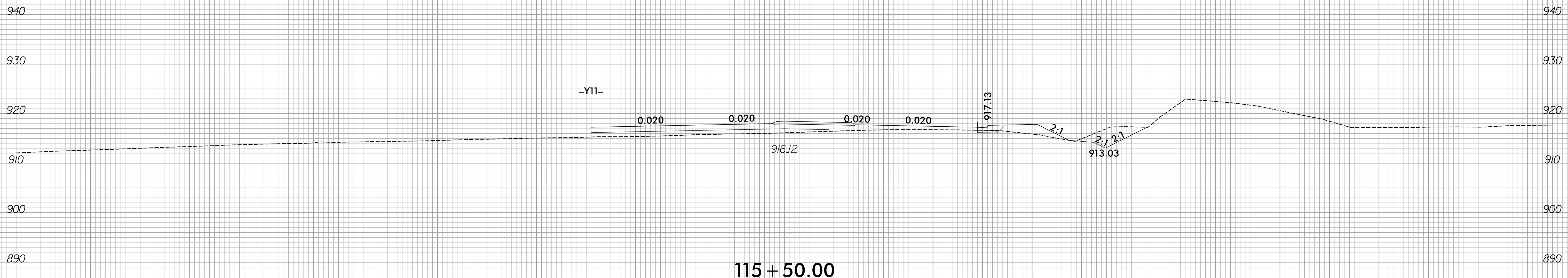

150 140 130 120 110 100 90 80 70 60 50 40 30 20 10 0 10 20 30 40 50 60 70 80 90 100 110 120 130 140 150

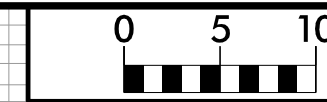

150 140 130 120 110 100 90 80 70 60 50 40 30 20 10 0 10 20 30 40 50 60 70 80 90 100 110 120 130 140 150

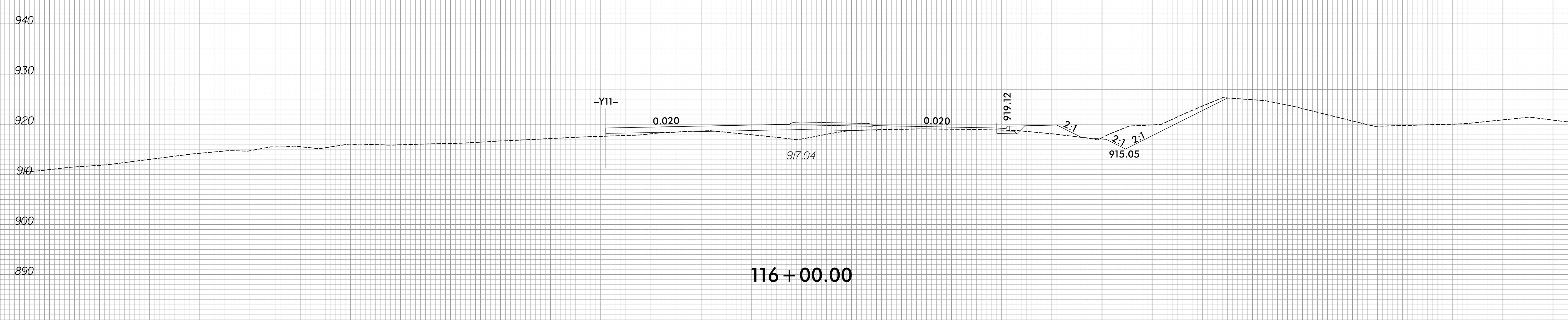
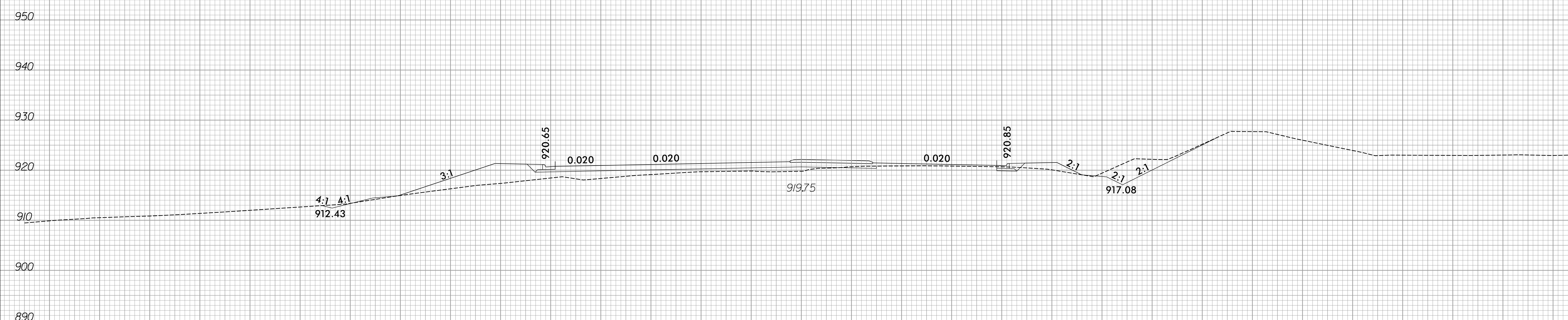

150 140 130 120 110 100 90 80 70 60 50 40 30 20 10 0 10 20 30 40 50 60 70 80 90 100 110 120 130 140 150

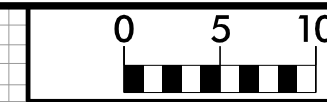

150 140 130 120 110 100 90 80 70 60 50 40 30 20 10 0 10 20 30 40 50 60 70 80 90 100 110 120 130 140 150

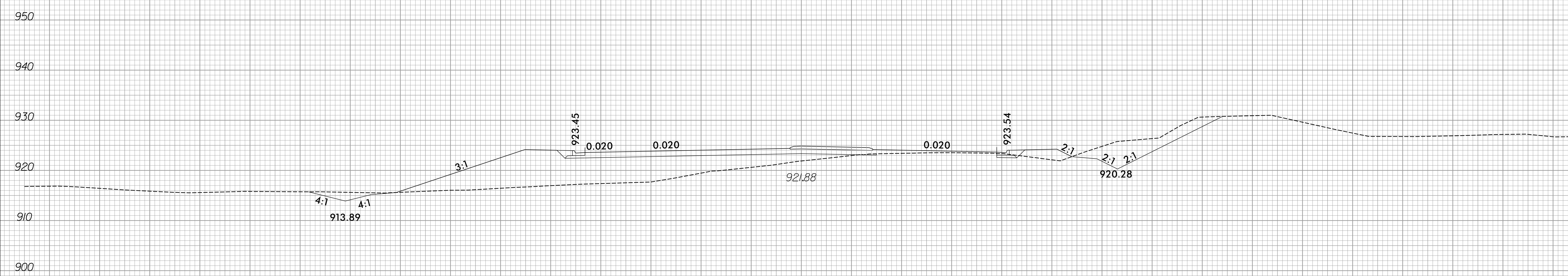

150 140 130 120 110 100 90 80 70 60 50 40 30 20 10 0 10 20 30 40 50 60 70 80 90 100 110 120 130 140 150

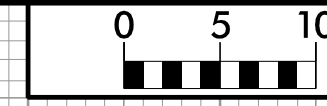

150 140 130 120 110 100 90 80 70 60 50 40 30 20 10 0 10 20 30 40 50 60 70 80 90 100 110 120 130 140 150

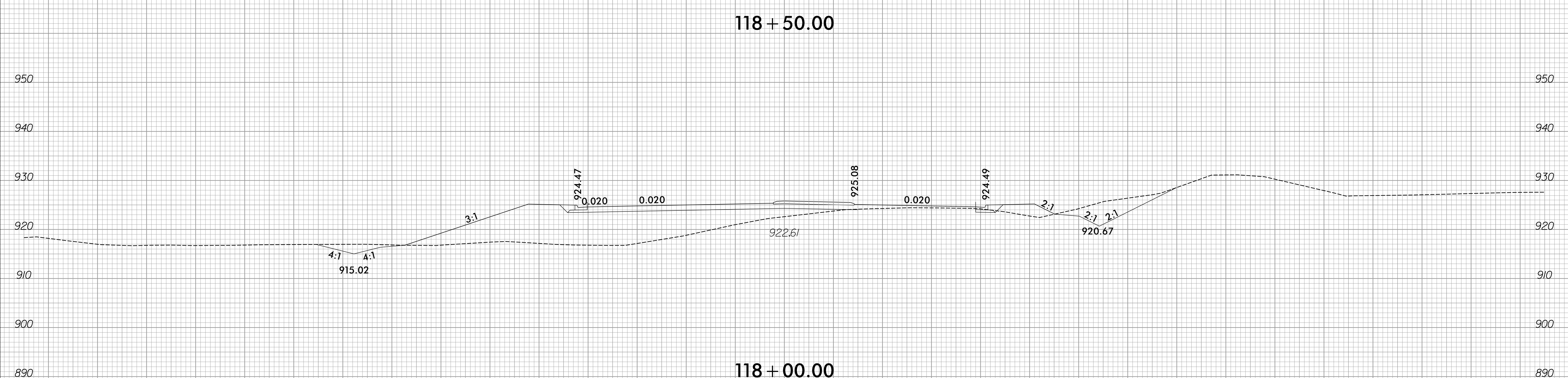
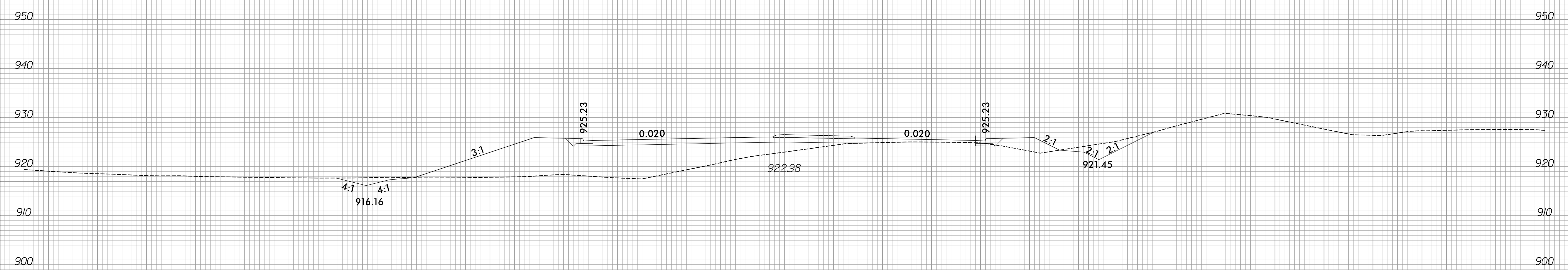

150 140 130 120 110 100 90 80 70 60 50 40 30 20 10 0 10 20 30 40 50 60 70 80 90 100 110 120 130 140 150

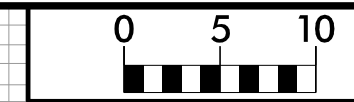

150 140 130 120 110 100 90 80 70 60 50 40 30 20 10 0 10 20 30 40 50 60 70 80 90 100 110 120 130 140 150

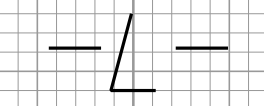
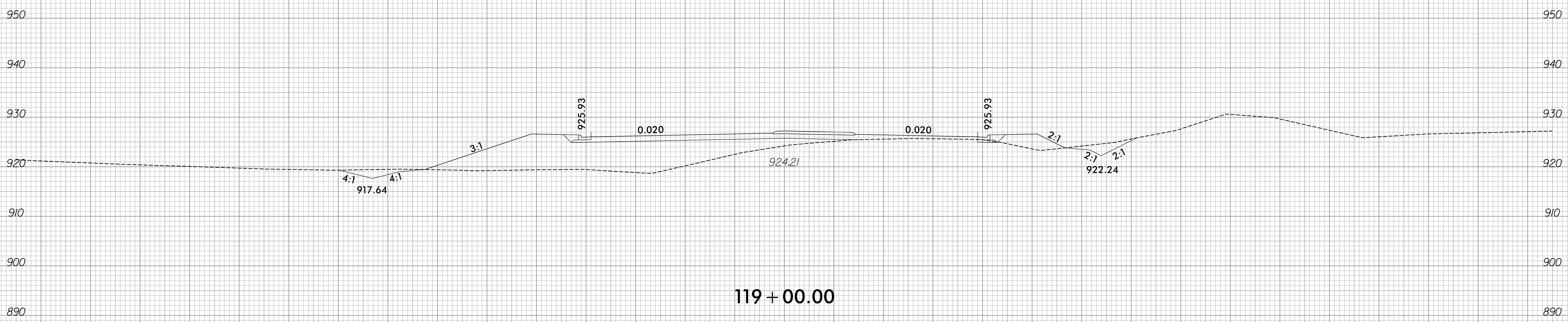
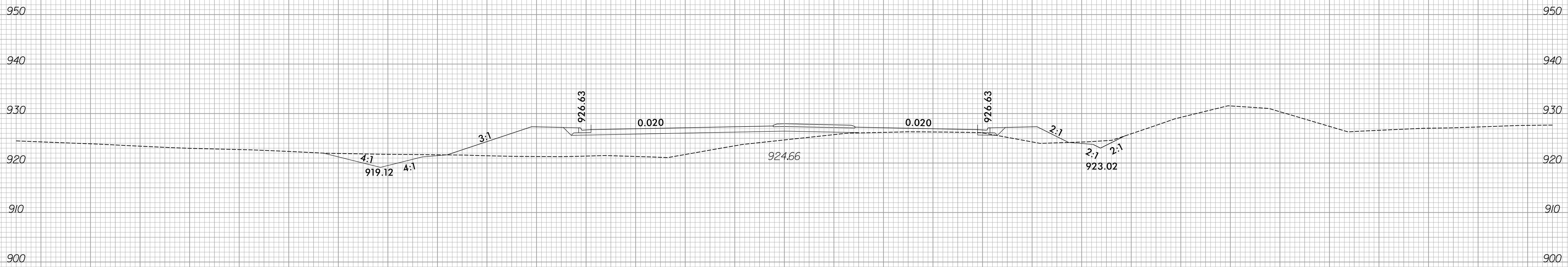

150 140 130 120 110 100 90 80 70 60 50 40 30 20 10 0 10 20 30 40 50 60 70 80 90 100 110 120 130 140 150

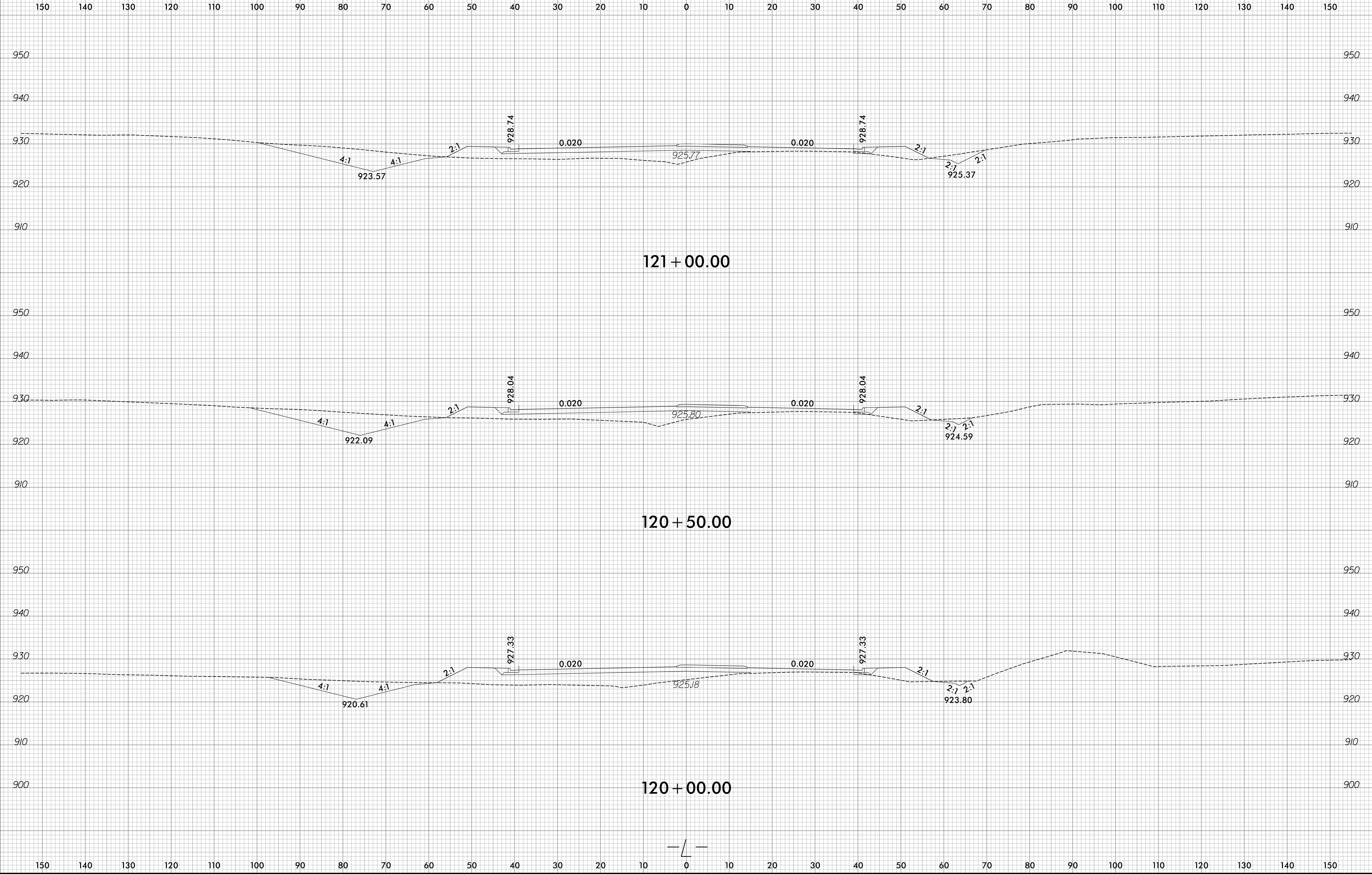

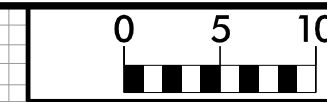

150 140 130 120 110 100 90 80 70 60 50 40 30 20 10 0 10 20 30 40 50 60 70 80 90 100 110 120 130 140 150

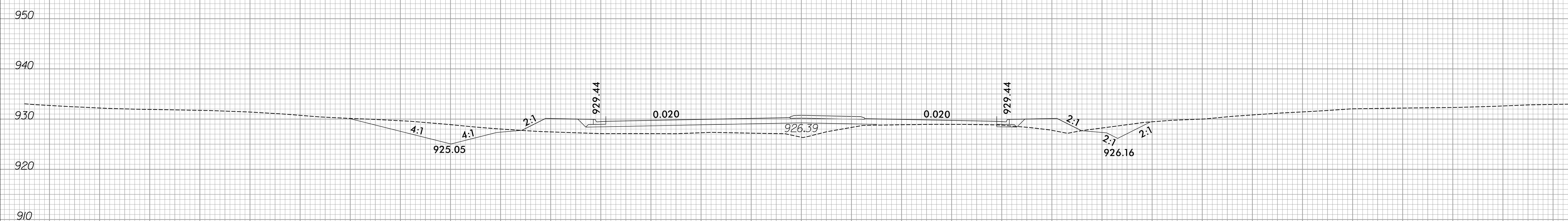
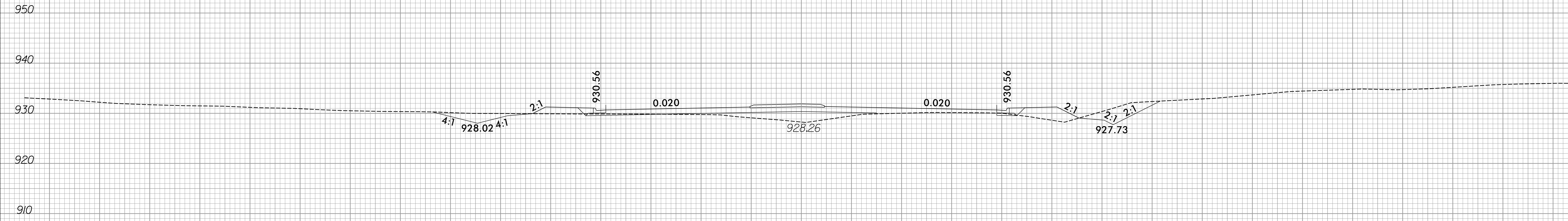

150 140 130 120 110 100 90 80 70 60 50 40 30 20 10 0 10 20 30 40 50 60 70 80 90 100 110 120 130 140 150

150 140 130 120 110 100 90 80 70 60 50 40 30 20 10 0 10 20 30 40 50 60 70 80 90 100 110 120 130 140 150

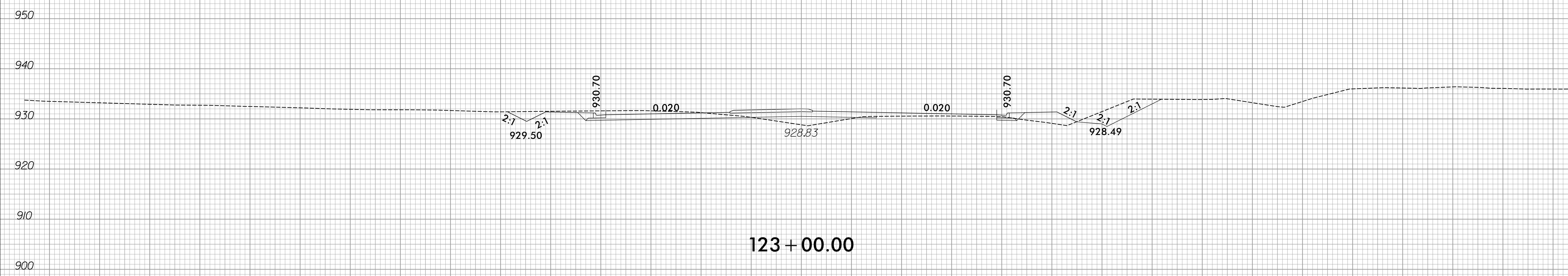
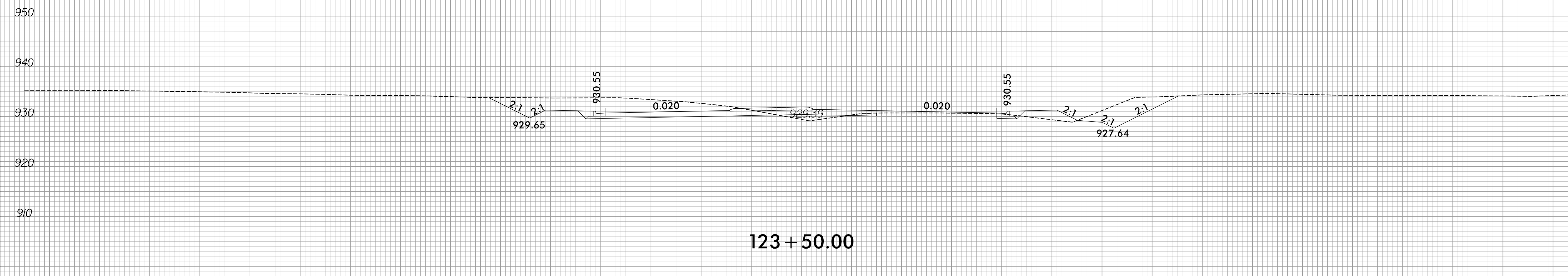
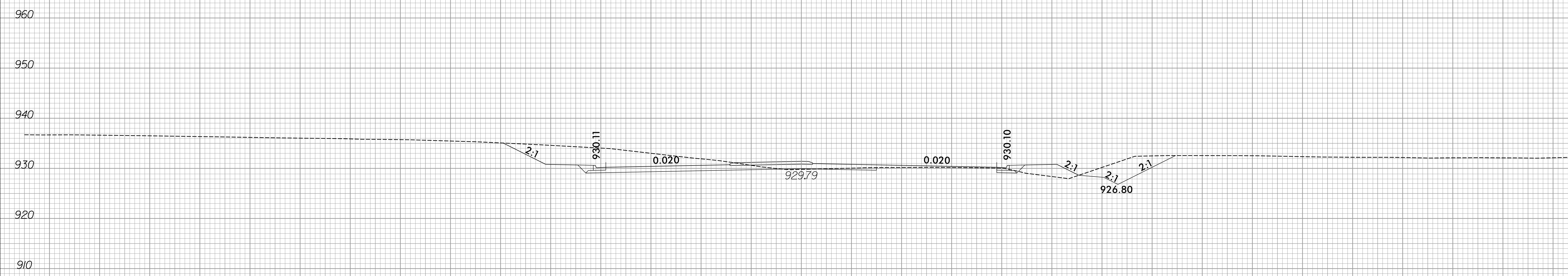

150 140 130 120 110 100 90 80 70 60 50 40 30 20 10 0 10 20 30 40 50 60 70 80 90 100 110 120 130 140 150



150 140 130 120 110 100 90 80 70 60 50 40 30 20 10 0 10 20 30 40 50 60 70 80 90 100 110 120 130 140 150

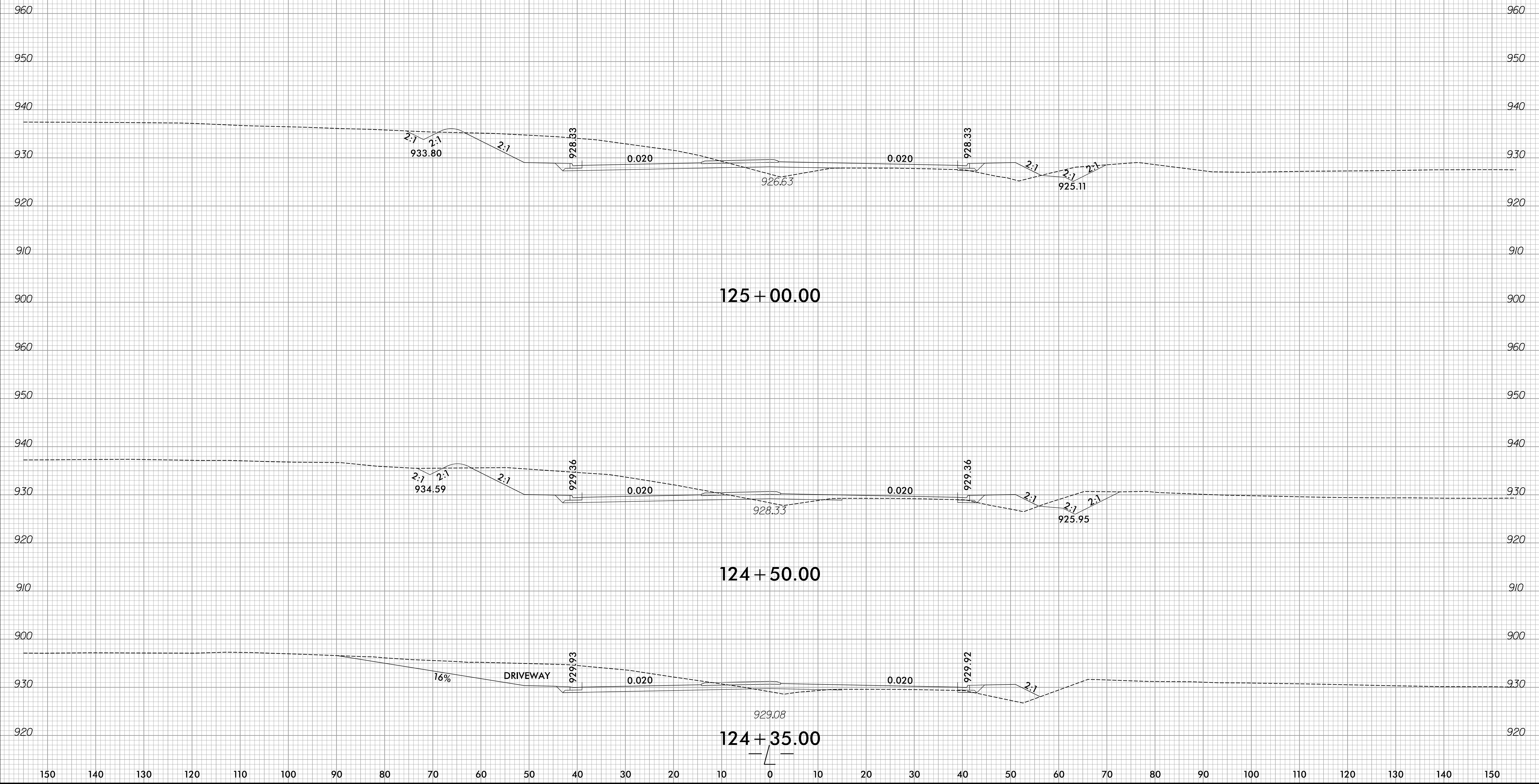

150 140 130 120 110 100 90 80 70 60 50 40 30 20 10 0 10 20 30 40 50 60 70 80 90 100 110 120 130 140 150

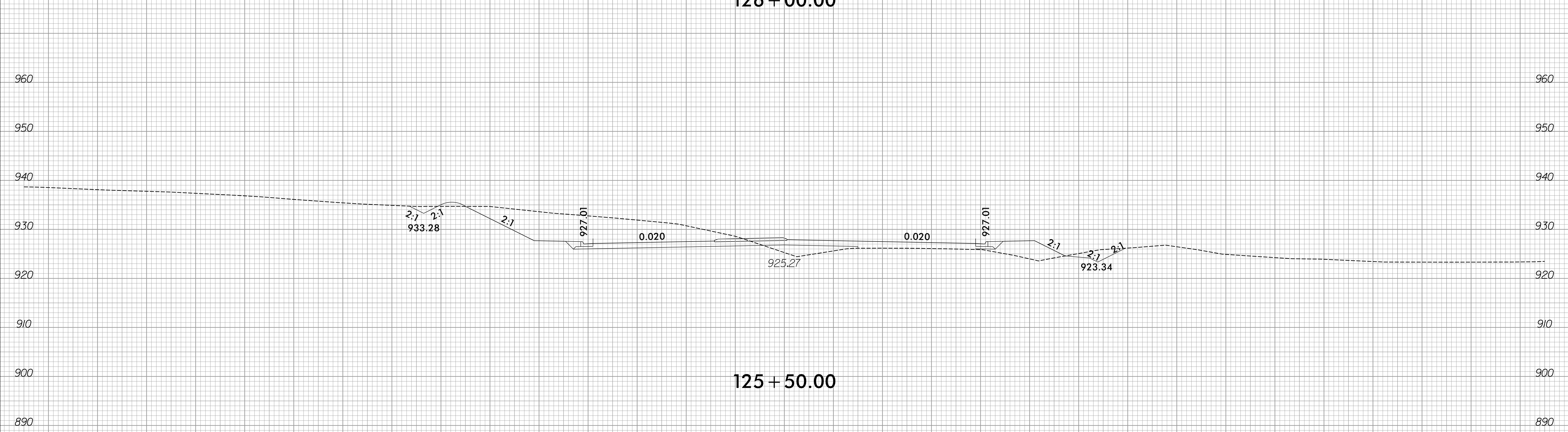
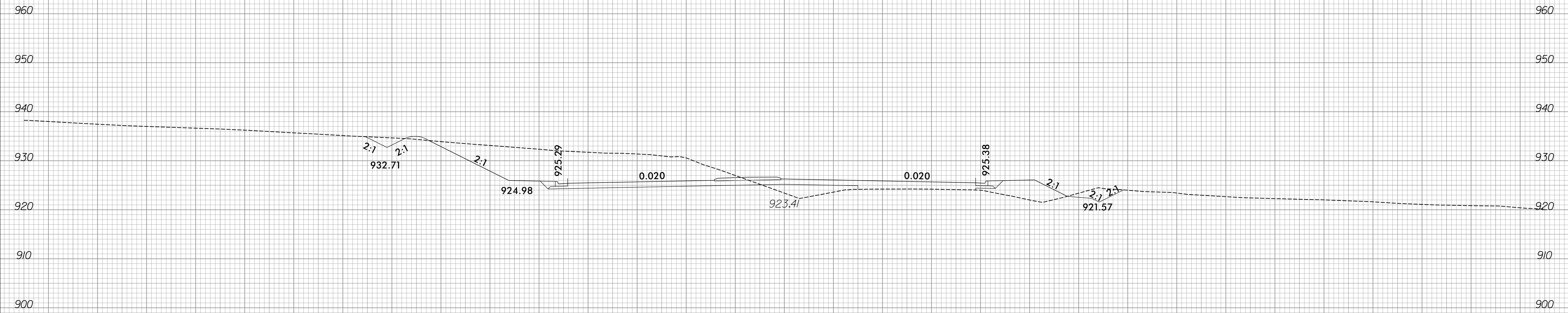

150 140 130 120 110 100 90 80 70 60 50 40 30 20 10 0 10 20 30 40 50 60 70 80 90 100 110 120 130 140 150

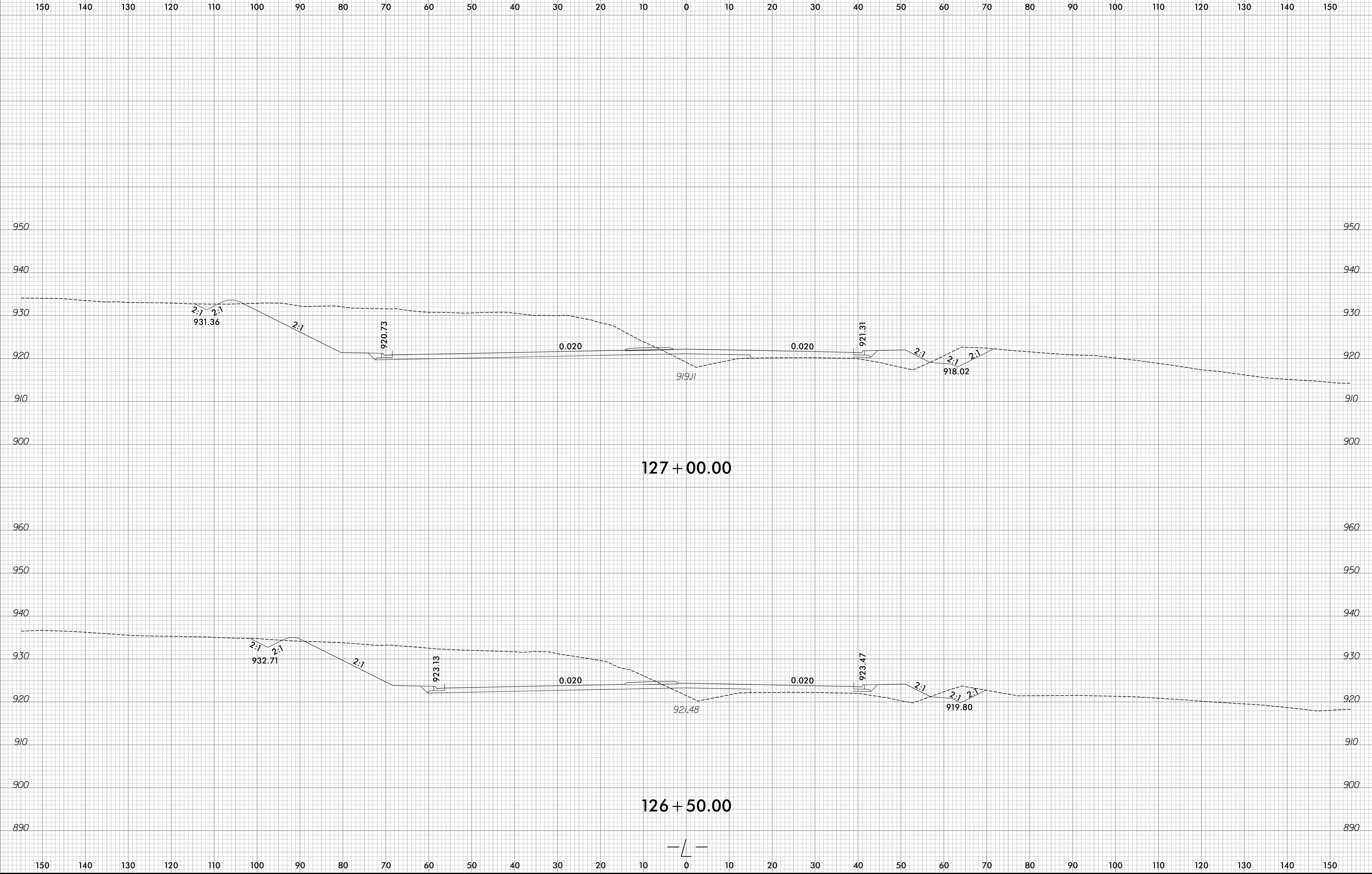

6/23/16

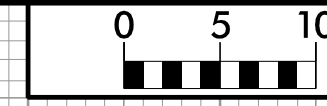

PROJ. REFERENCE NO.
R-2577A

SHEET NO.
X-120

150 140 130 120 110 100 90 80 70 60 50 40 30 20 10 0 10 20 30 40 50 60 70 80 90 100 110 120 130 140 150

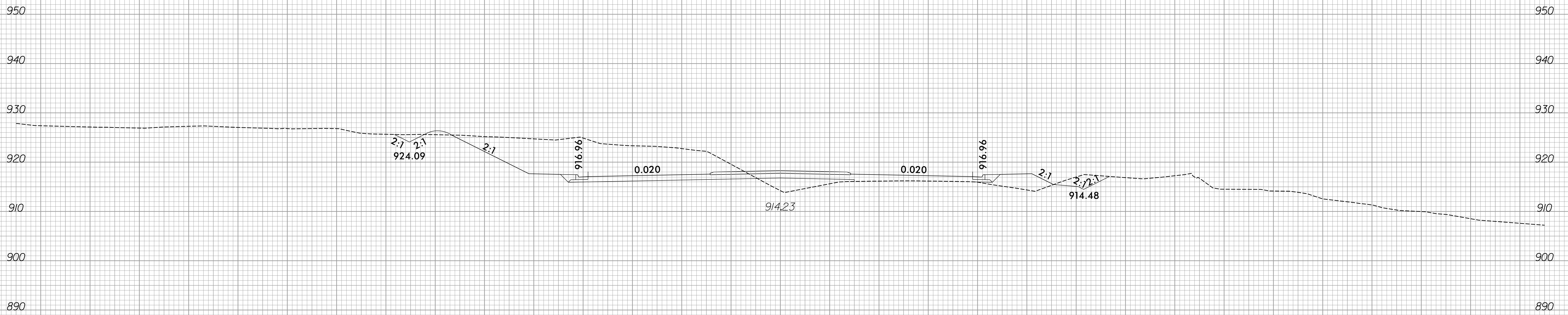

128 + 00.00



127 + 50.00

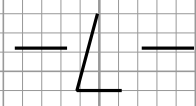

12/2/2023
R:\Roadway\XSC\R-2577A_Rdy_xpl.dgn
amcpherson

150 140 130 120 110 100 90 80 70 60 50 40 30 20 10 0 10 20 30 40 50 60 70 80 90 100 110 120 130 140 150



150 140 130 120 110 100 90 80 70 60 50 40 30 20 10 0 10 20 30 40 50 60 70 80 90 100 110 120 130 140 150

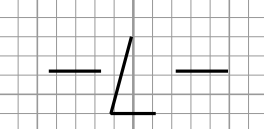
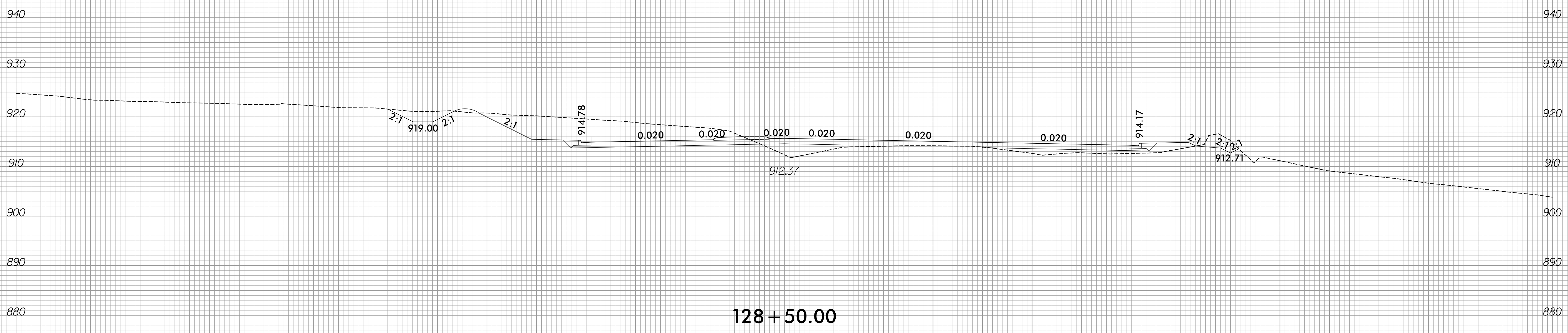
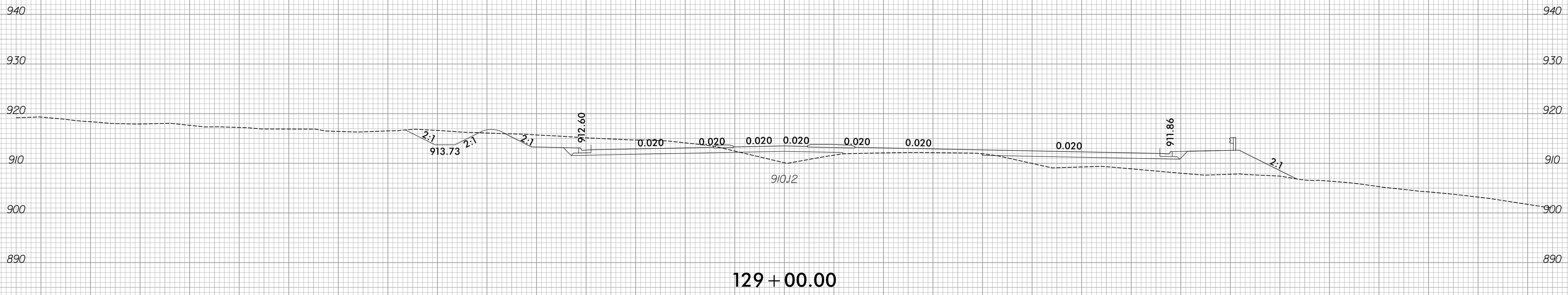

150 140 130 120 110 100 90 80 70 60 50 40 30 20 10 0 10 20 30 40 50 60 70 80 90 100 110 120 130 140 150



150 140 130 120 110 100 90 80 70 60 50 40 30 20 10 0 10 20 30 40 50 60 70 80 90 100 110 120 130 140 150

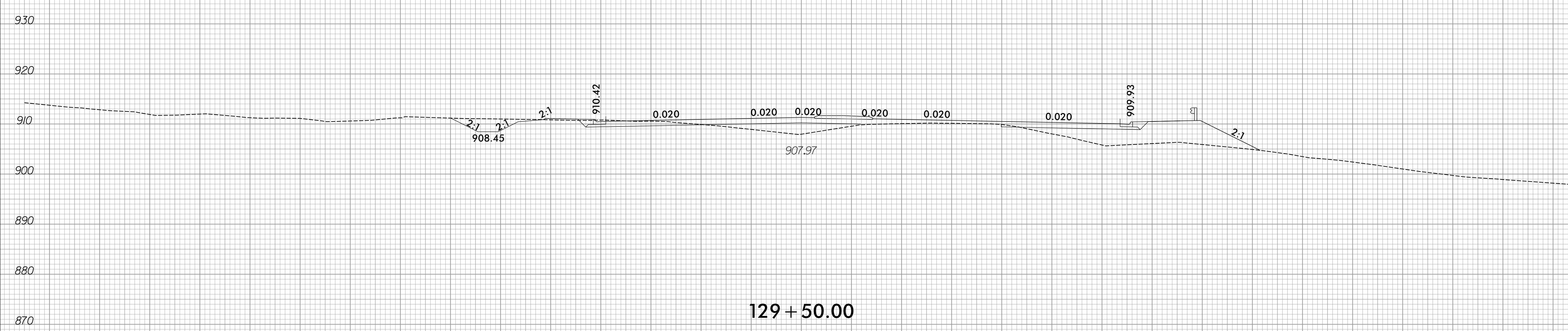
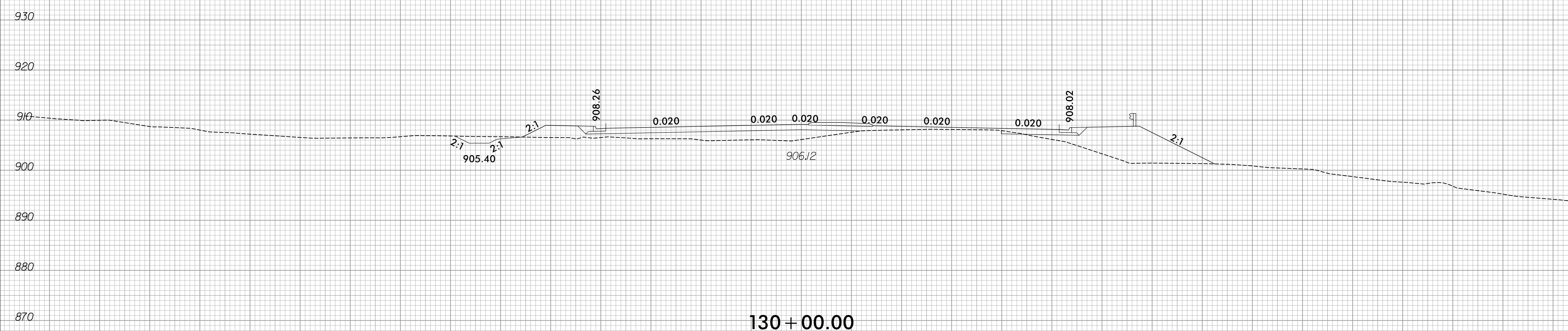

150 140 130 120 110 100 90 80 70 60 50 40 30 20 10 0 10 20 30 40 50 60 70 80 90 100 110 120 130 140 150



150 140 130 120 110 100 90 80 70 60 50 40 30 20 10 0 10 20 30 40 50 60 70 80 90 100 110 120 130 140 150

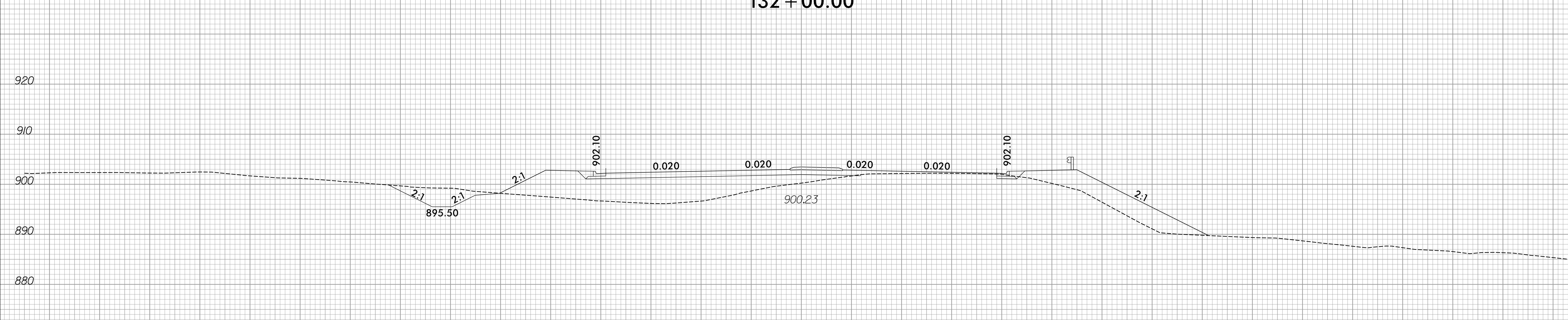
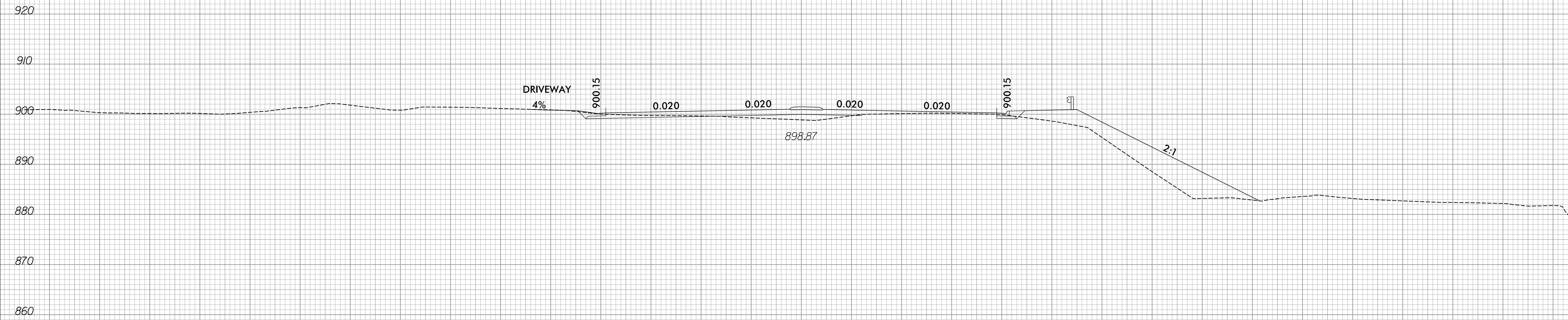

150 140 130 120 110 100 90 80 70 60 50 40 30 20 10 0 10 20 30 40 50 60 70 80 90 100 110 120 130 140 150

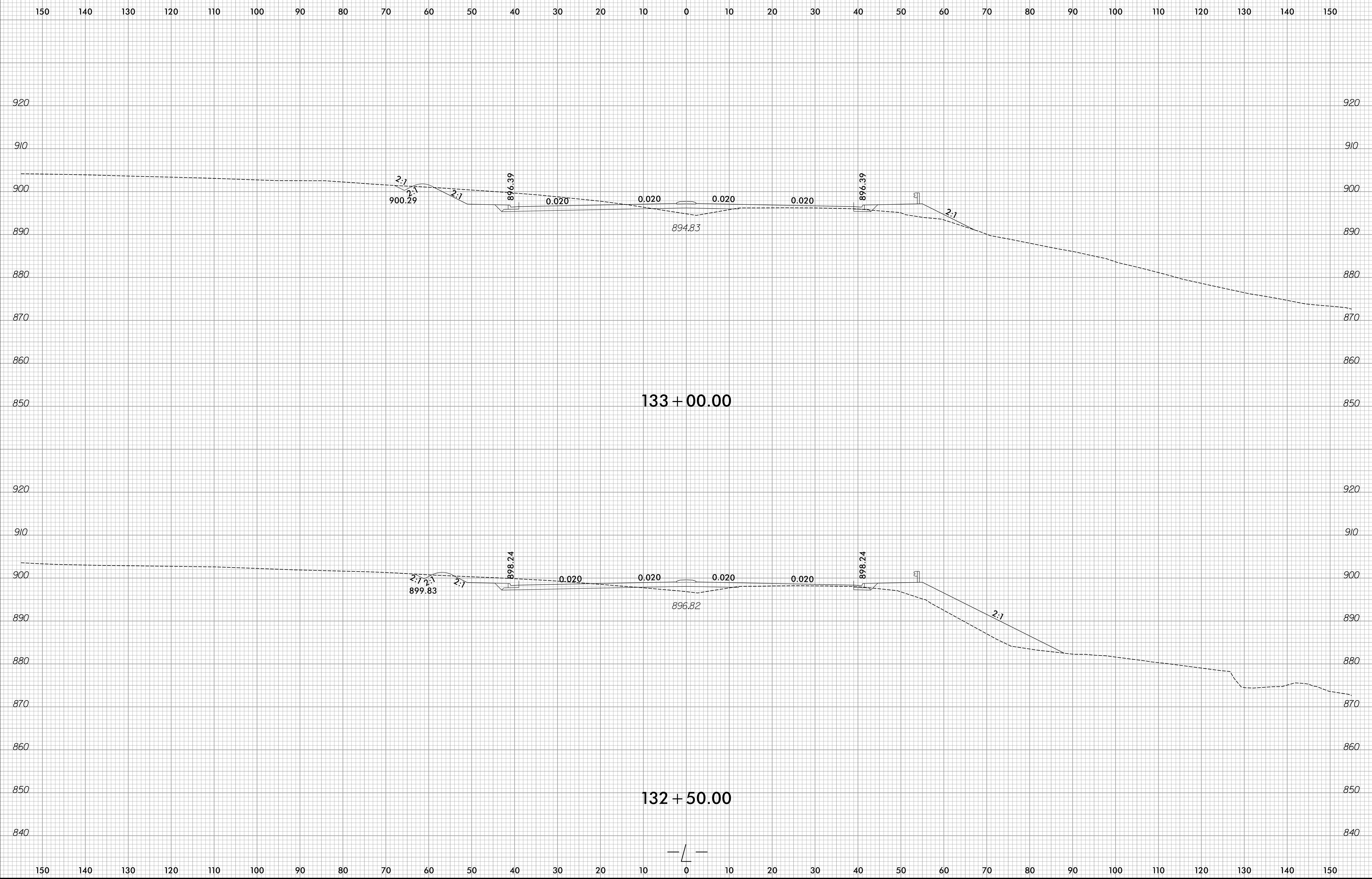

150 140 130 120 110 100 90 80 70 60 50 40 30 20 10 0 10 20 30 40 50 60 70 80 90 100 110 120 130 140 150



150 140 130 120 110 100 90 80 70 60 50 40 30 20 10 0 10 20 30 40 50 60 70 80 90 100 110 120 130 140 150

150 140 130 120 110 100 90 80 70 60 50 40 30 20 10 0 10 20 30 40 50 60 70 80 90 100 110 120 130 140 150



134 + 50.00

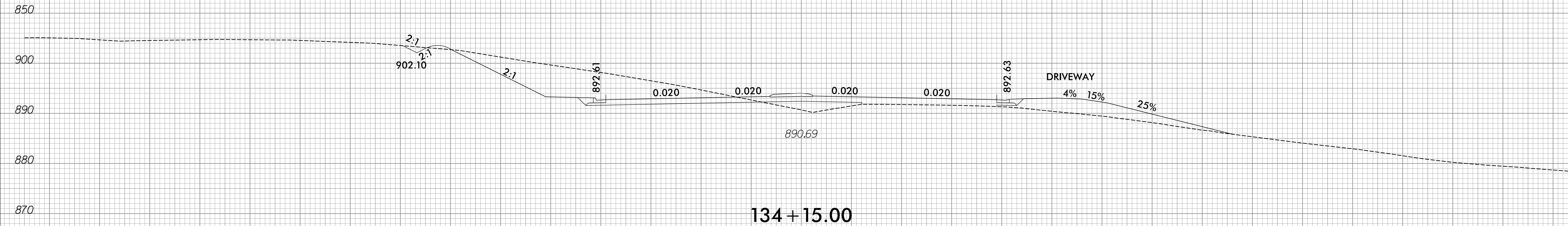

134 + 15.00

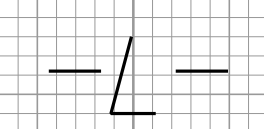

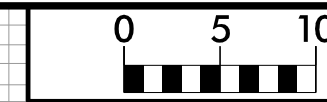

150 140 130 120 110 100 90 80 70 60 50 40 30 20 10 0 10 20 30 40 50 60 70 80 90 100 110 120 130 140 150

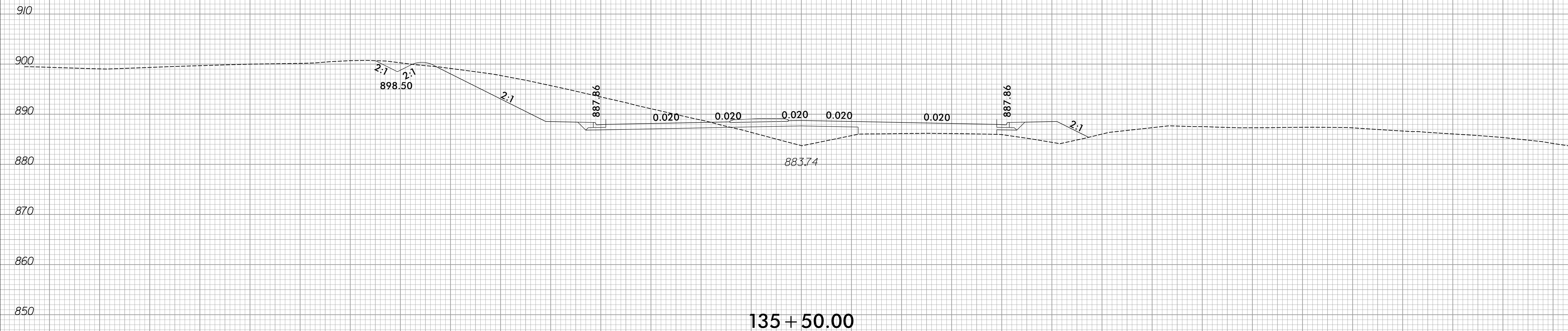

150 140 130 120 110 100 90 80 70 60 50 40 30 20 10 0 10 20 30 40 50 60 70 80 90 100 110 120 130 140 150

150 140 130 120 110 100 90 80 70 60 50 40 30 20 10 0 10 20 30 40 50 60 70 80 90 100 110 120 130 140 150

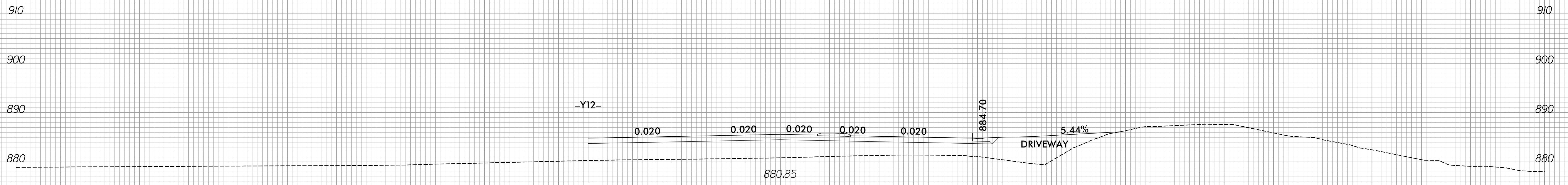

136 + 50.00

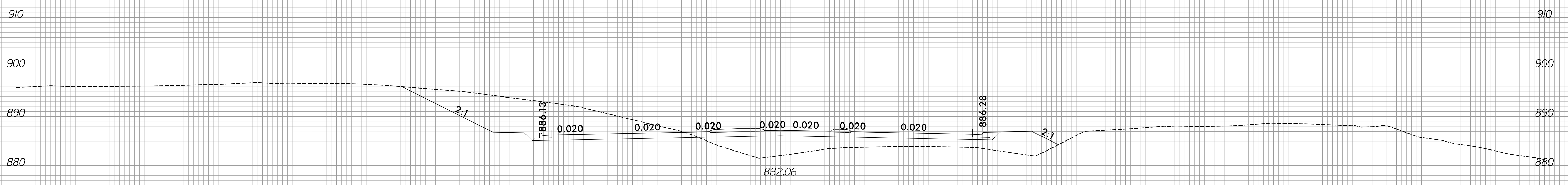

136 + 00.00

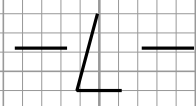

150 140 130 120 110 100 90 80 70 60 50 40 30 20 10 0 10 20 30 40 50 60 70 80 90 100 110 120 130 140 150

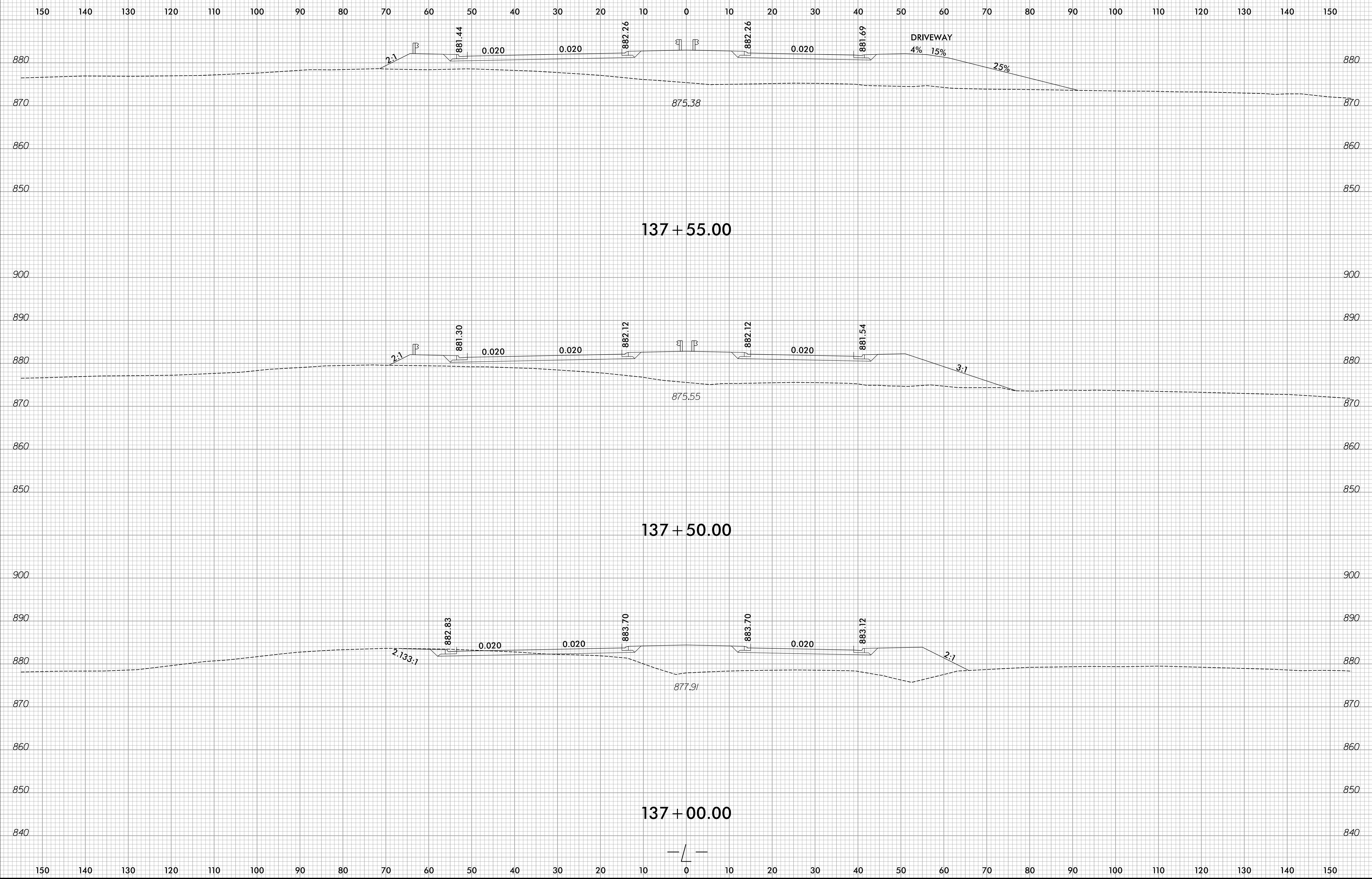

6/23/16

150 140 130 120 110 100 90 80 70 60 50 40 30 20 10 0 10 20 30 40 50 60 70 80 90 100 110 120 130 140 150

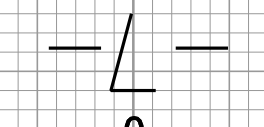
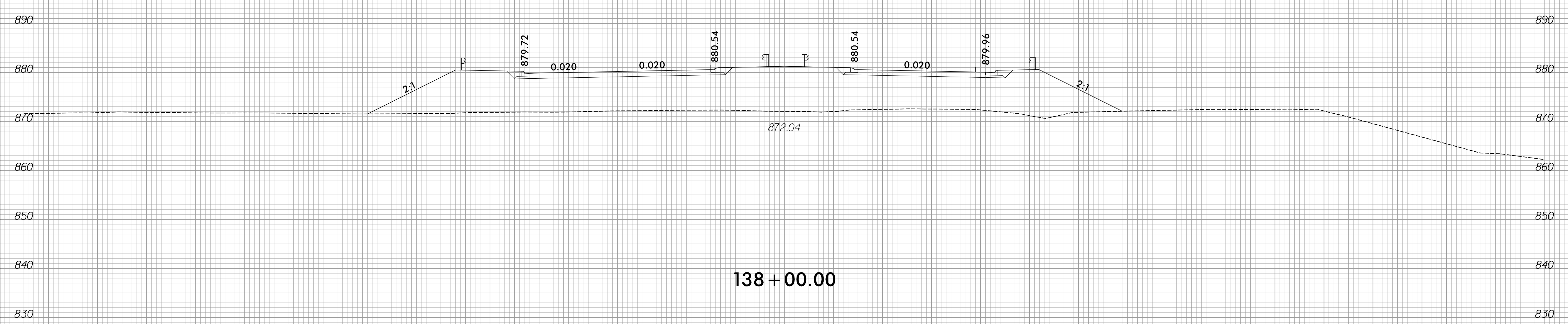
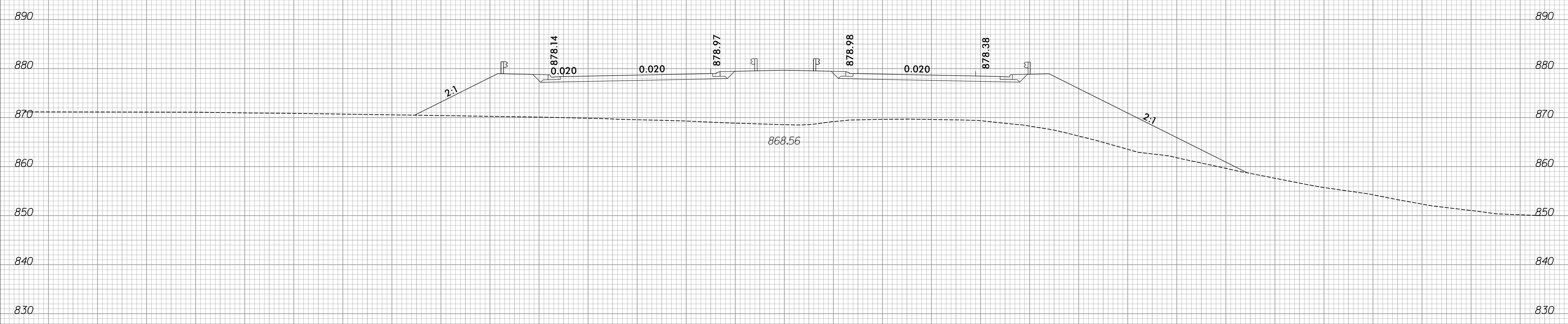

12/21/2023
R:\Roadway\XSC\R-2577A_Rdy_xpl.dgn
respinso

150 140 130 120 110 100 90 80 70 60 50 40 30 20 10 0 10 20 30 40 50 60 70 80 90 100 110 120 130 140 150

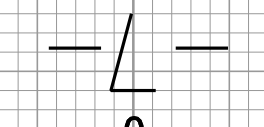
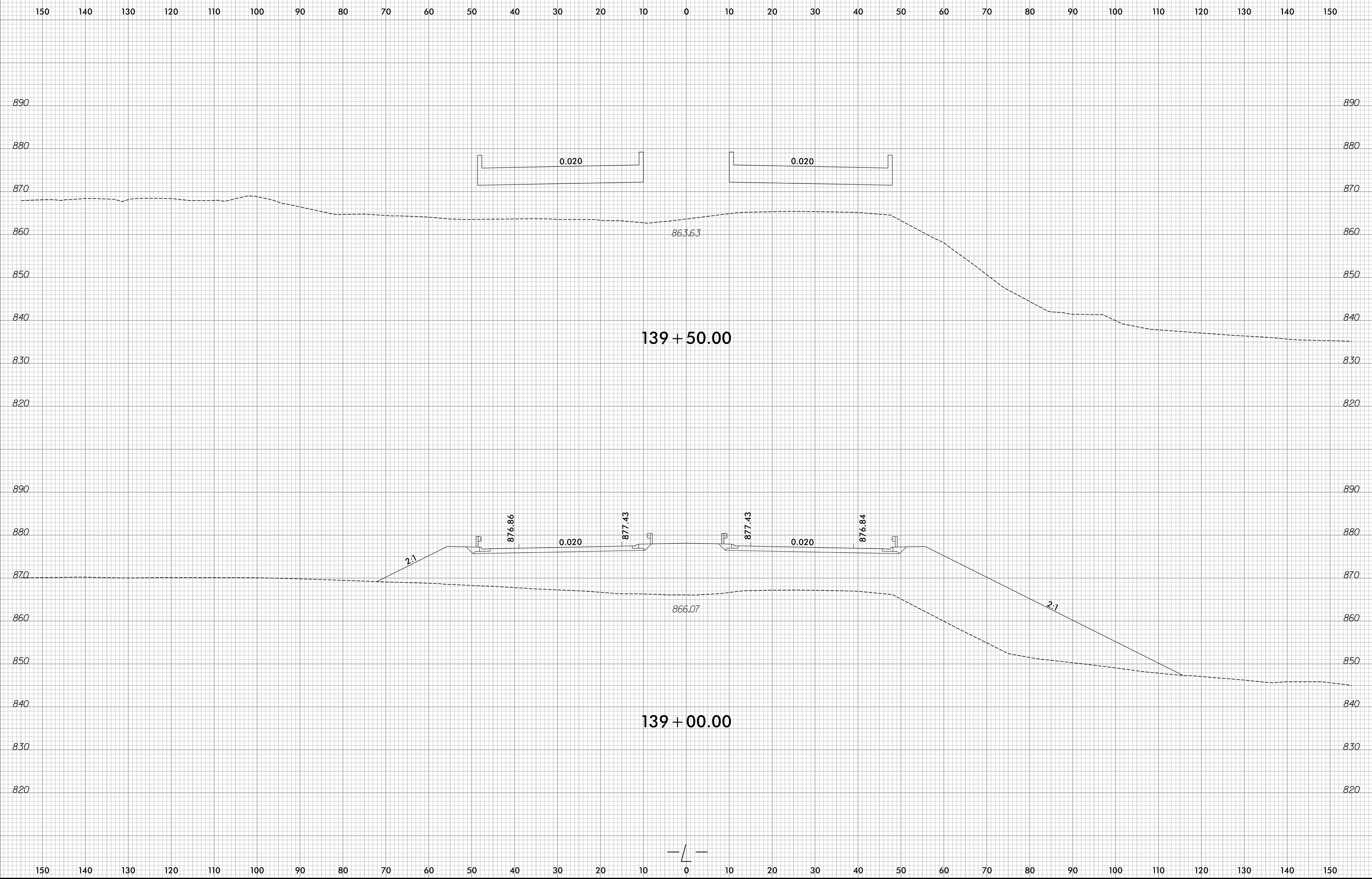

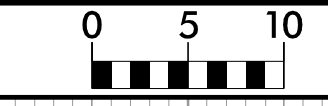

150 140 130 120 110 100 90 80 70 60 50 40 30 20 10 0 10 20 30 40 50 60 70 80 90 100 110 120 130 140 150

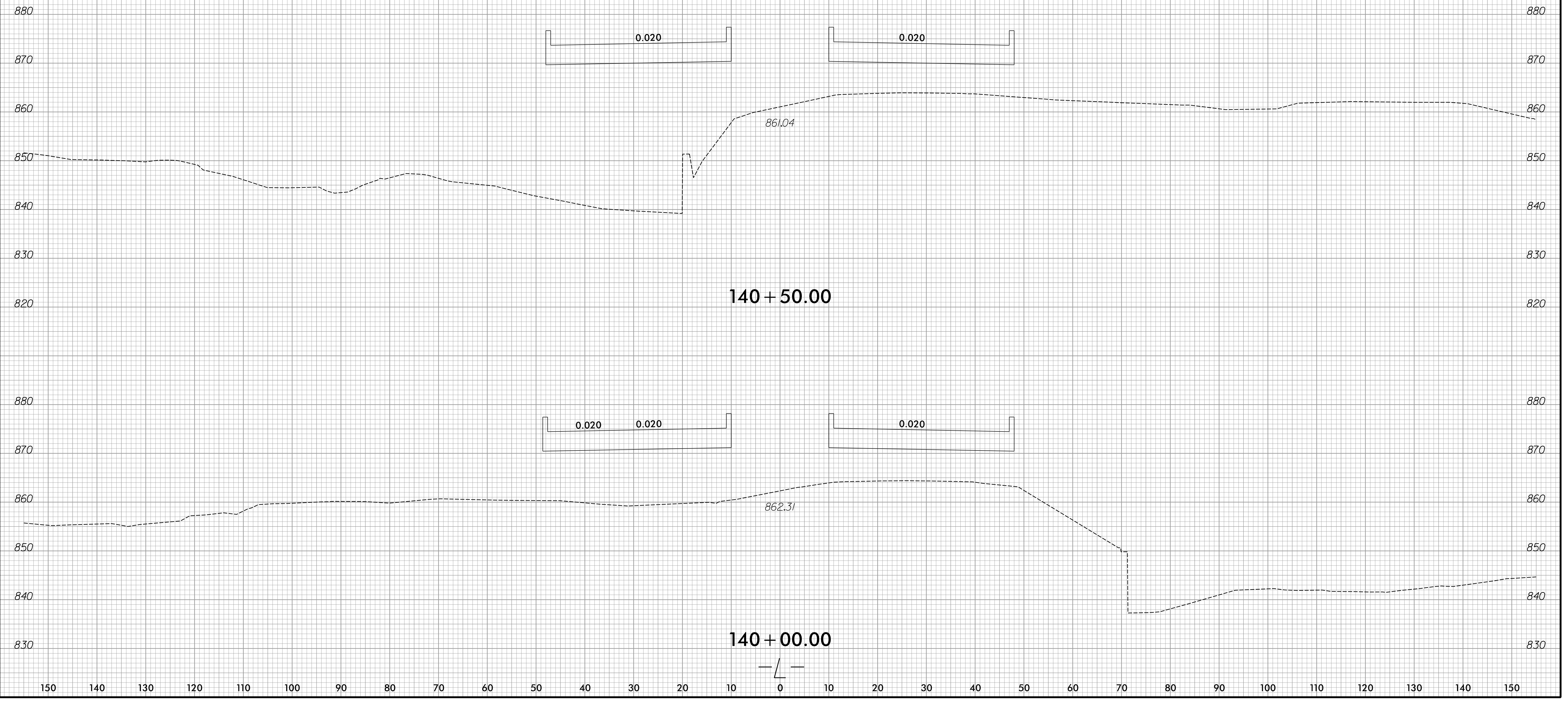

6/23/16

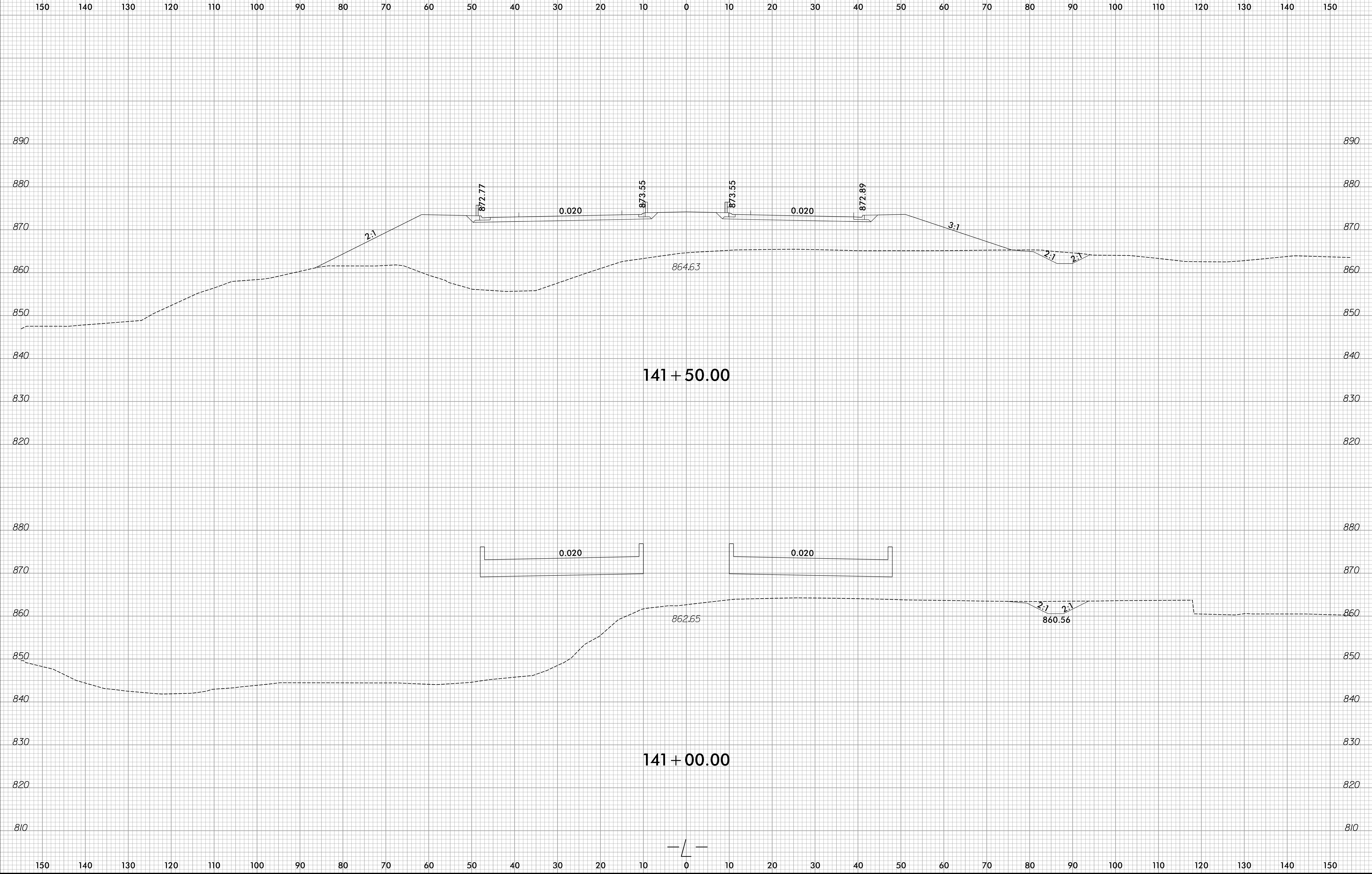

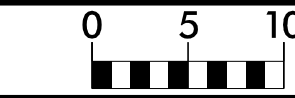

150 140 130 120 110 100 90 80 70 60 50 40 30 20 10 0 10 20 30 40 50 60 70 80 90 100 110 120 130 140 150

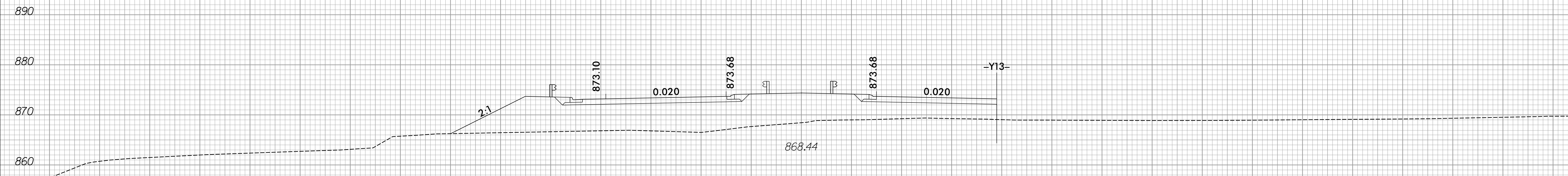

142 + 50.00



142 + 00.00

150 140 130 120 110 100 90 80 70 60 50 40 30 20 10 0 10 20 30 40 50 60 70 80 90 100 110 120 130 140 150

150 140 130 120 110 100 90 80 70 60 50 40 30 20 10 0 10 20 30 40 50 60 70 80 90 100 110 120 130 140 150

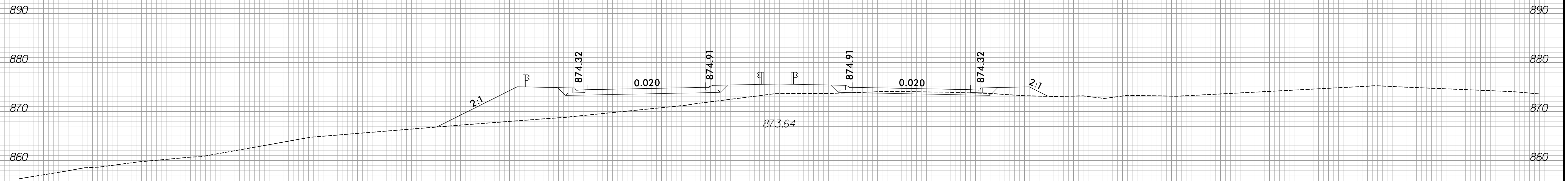

143 + 50.00

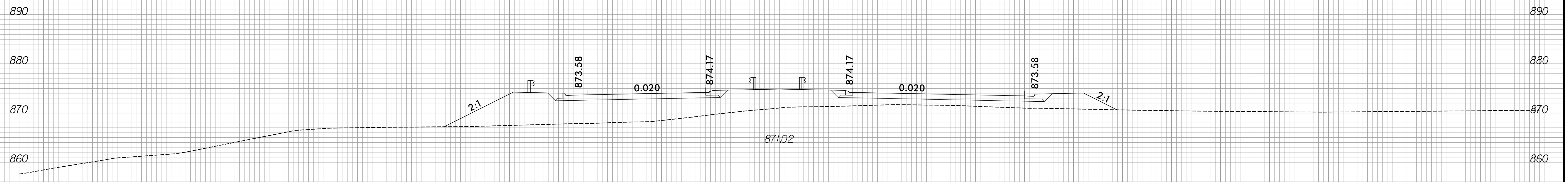

143 + 00.00

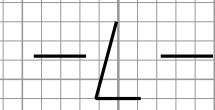

150 140 130 120 110 100 90 80 70 60 50 40 30 20 10 0 10 20 30 40 50 60 70 80 90 100 110 120 130 140 150

6/23/16

150 140 130 120 110 100 90 80 70 60 50 40 30 20 10 0 10 20 30 40 50 60 70 80 90 100 110 120 130 140 150

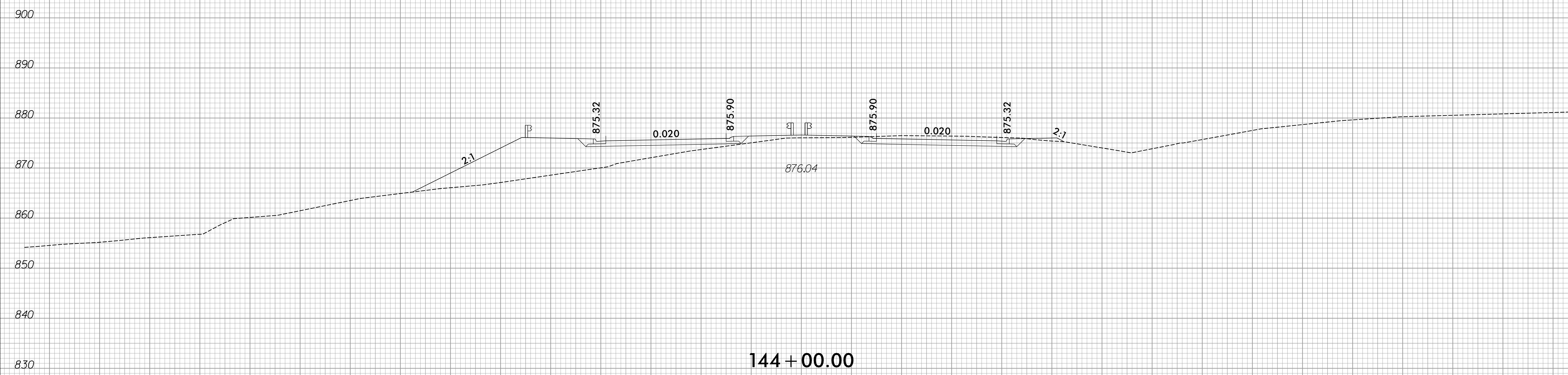
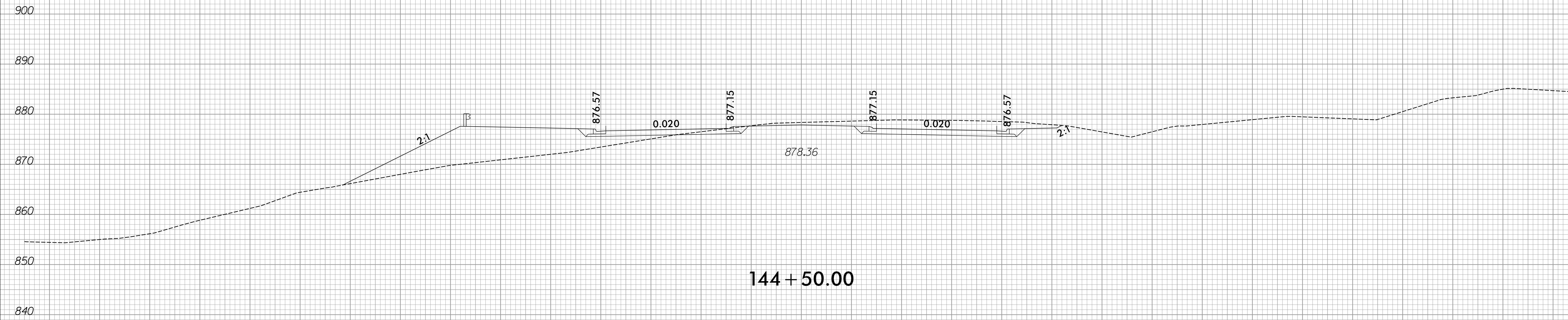

150 140 130 120 110 100 90 80 70 60 50 40 30 20 10 0 10 20 30 40 50 60 70 80 90 100 110 120 130 140 150

12/2/2023
R:\Roadway\XSC\R-2577A_Rdu_xpl.dgn
amcpherson



150 140 130 120 110 100 90 80 70 60 50 40 30 20 10 0 10 20 30 40 50 60 70 80 90 100 110 120 130 140 150

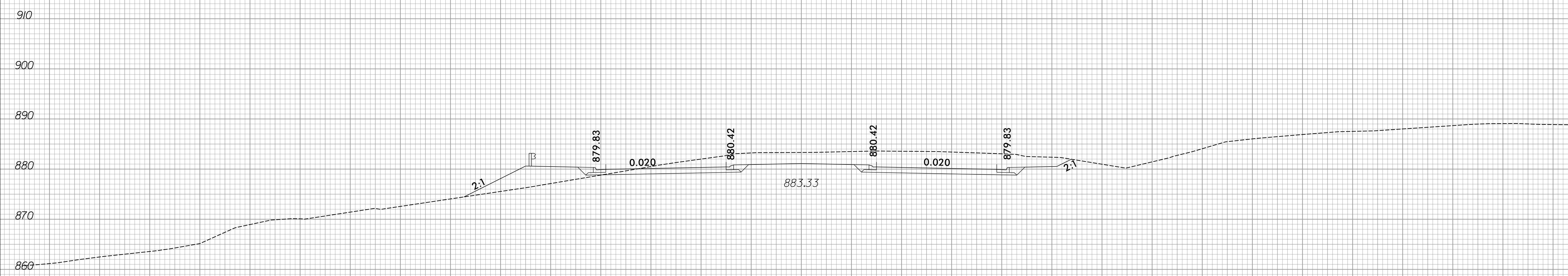

145 + 50.00

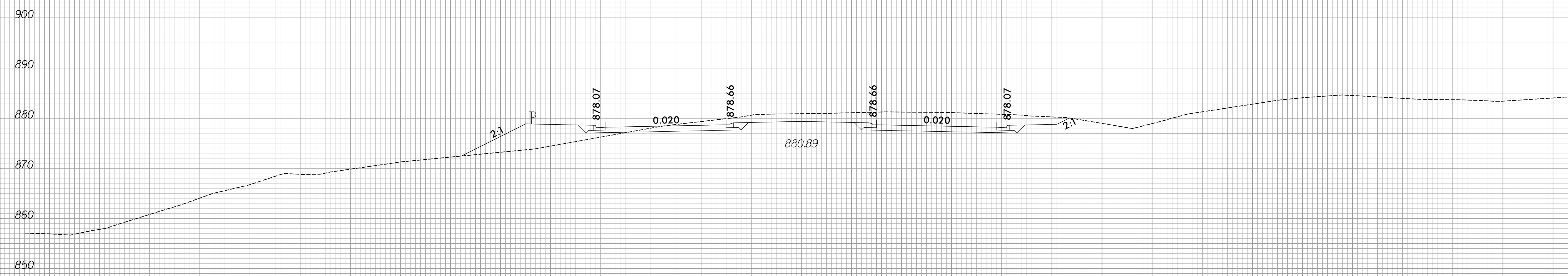

145 + 00.00

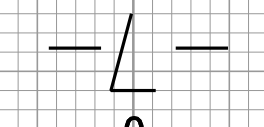

150 140 130 120 110 100 90 80 70 60 50 40 30 20 10 0 10 20 30 40 50 60 70 80 90 100 110 120 130 140 150

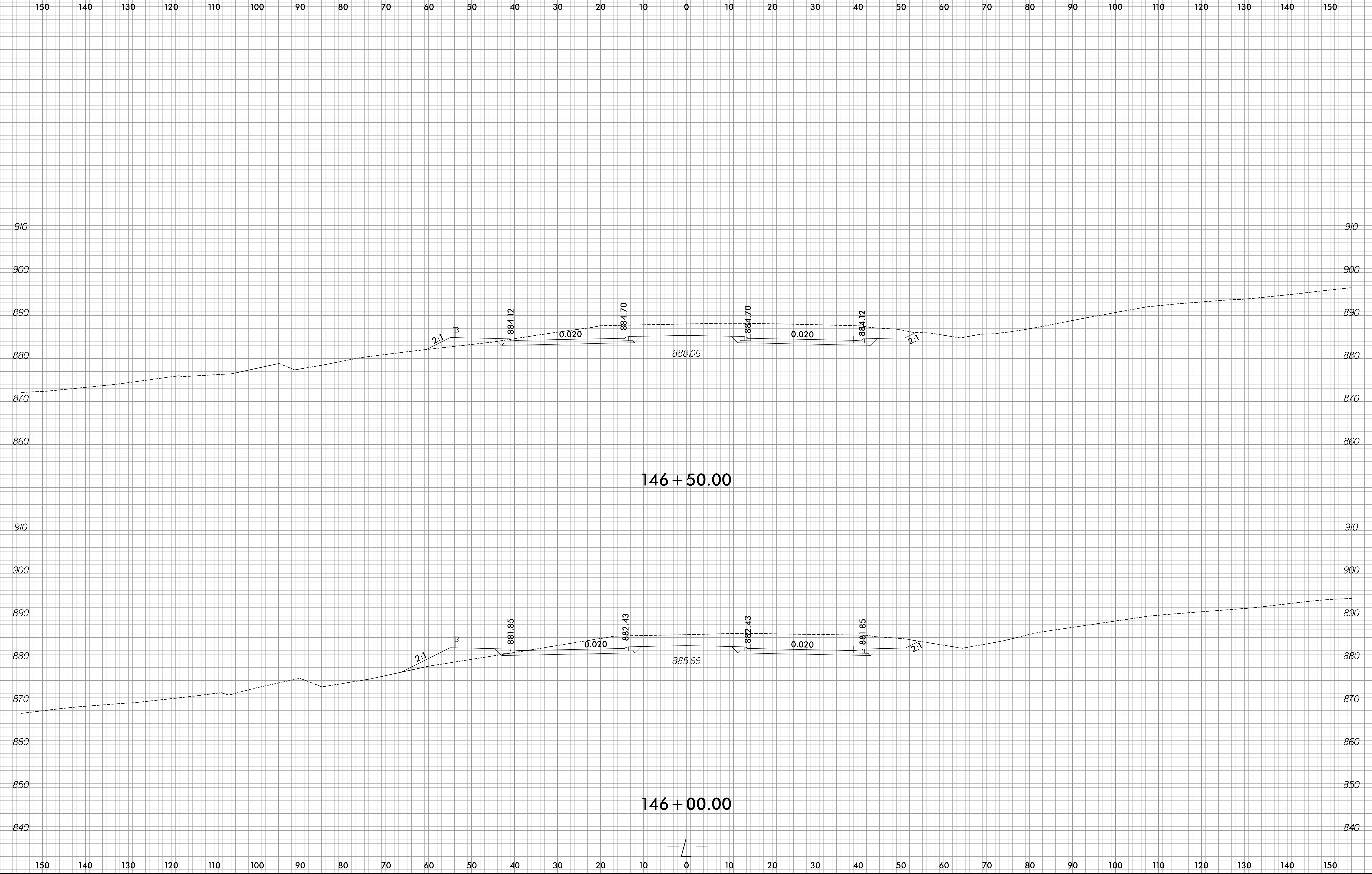

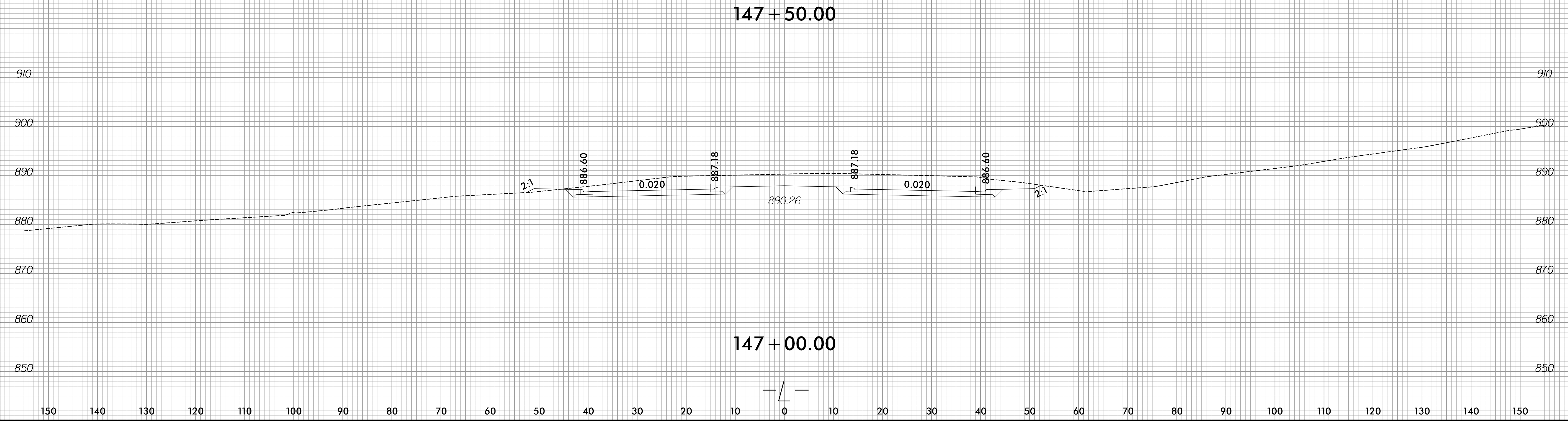
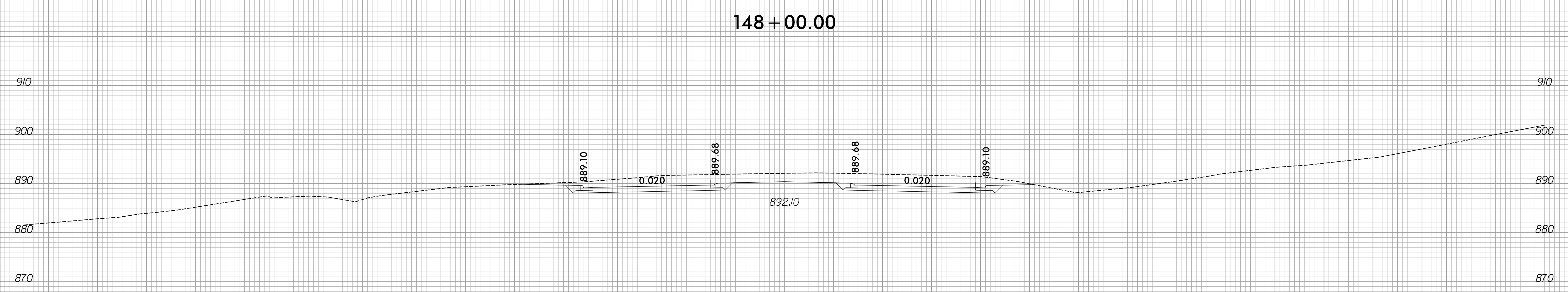
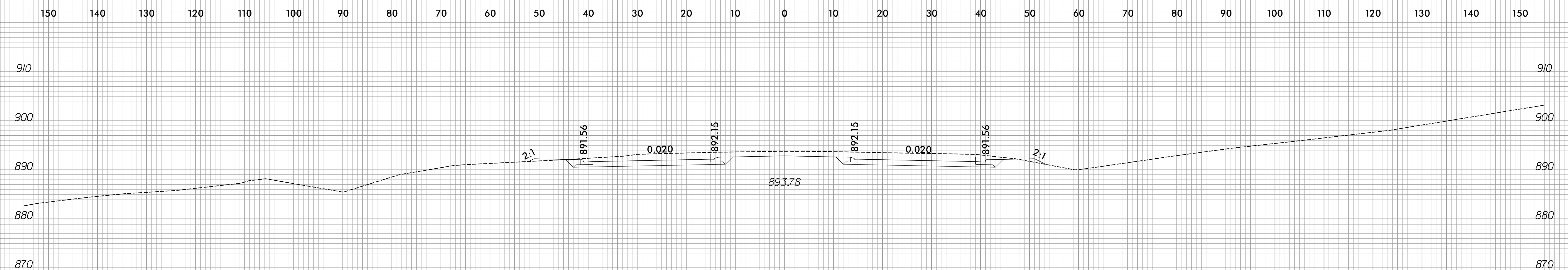
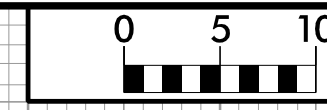

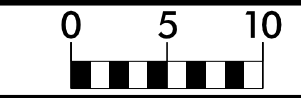

150 140 130 120 110 100 90 80 70 60 50 40 30 20 10 0 10 20 30 40 50 60 70 80 90 100 110 120 130 140 150

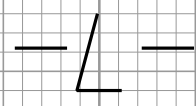
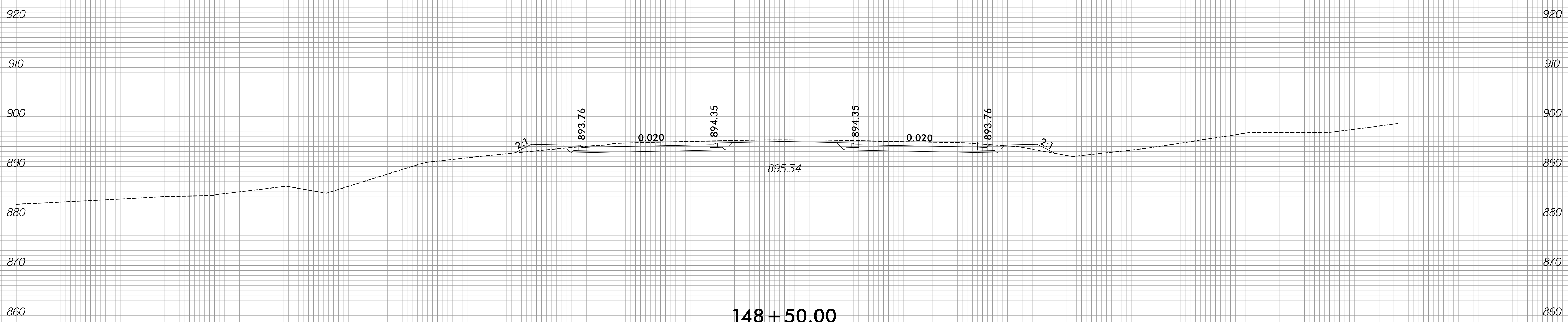
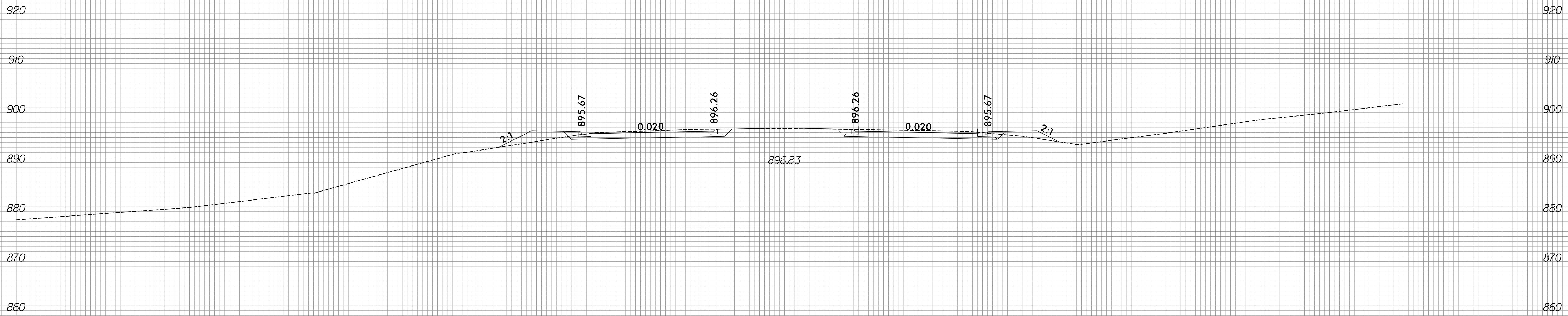

150 140 130 120 110 100 90 80 70 60 50 40 30 20 10 0 10 20 30 40 50 60 70 80 90 100 110 120 130 140 150

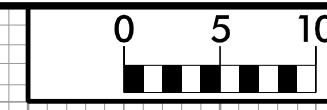

150 140 130 120 110 100 90 80 70 60 50 40 30 20 10 0 10 20 30 40 50 60 70 80 90 100 110 120 130 140 150

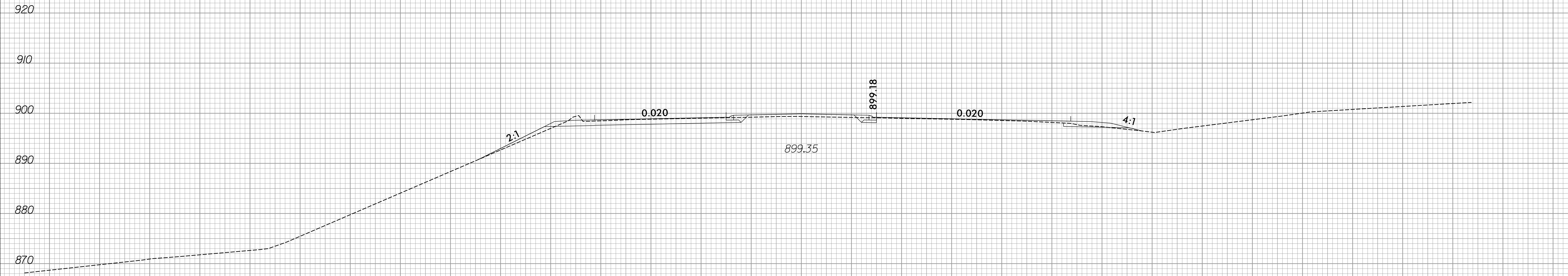

150 + 00.00

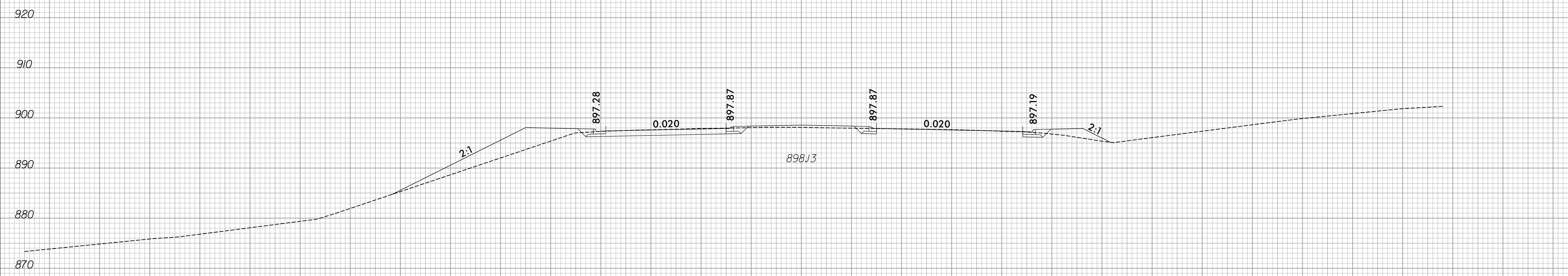

149 + 50.00

150 140 130 120 110 100 90 80 70 60 50 40 30 20 10 0 10 20 30 40 50 60 70 80 90 100 110 120 130 140 150

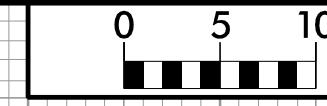

150 140 130 120 110 100 90 80 70 60 50 40 30 20 10 0 10 20 30 40 50 60 70 80 90 100 110 120 130 140 150



151 + 00.00

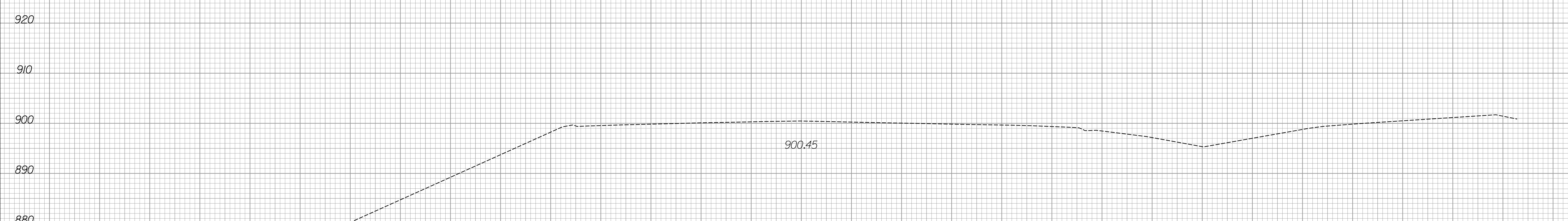

150 + 50.00

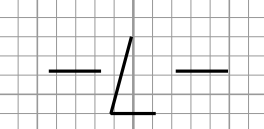

150 140 130 120 110 100 90 80 70 60 50 40 30 20 10 0 10 20 30 40 50 60 70 80 90 100 110 120 130 140 150

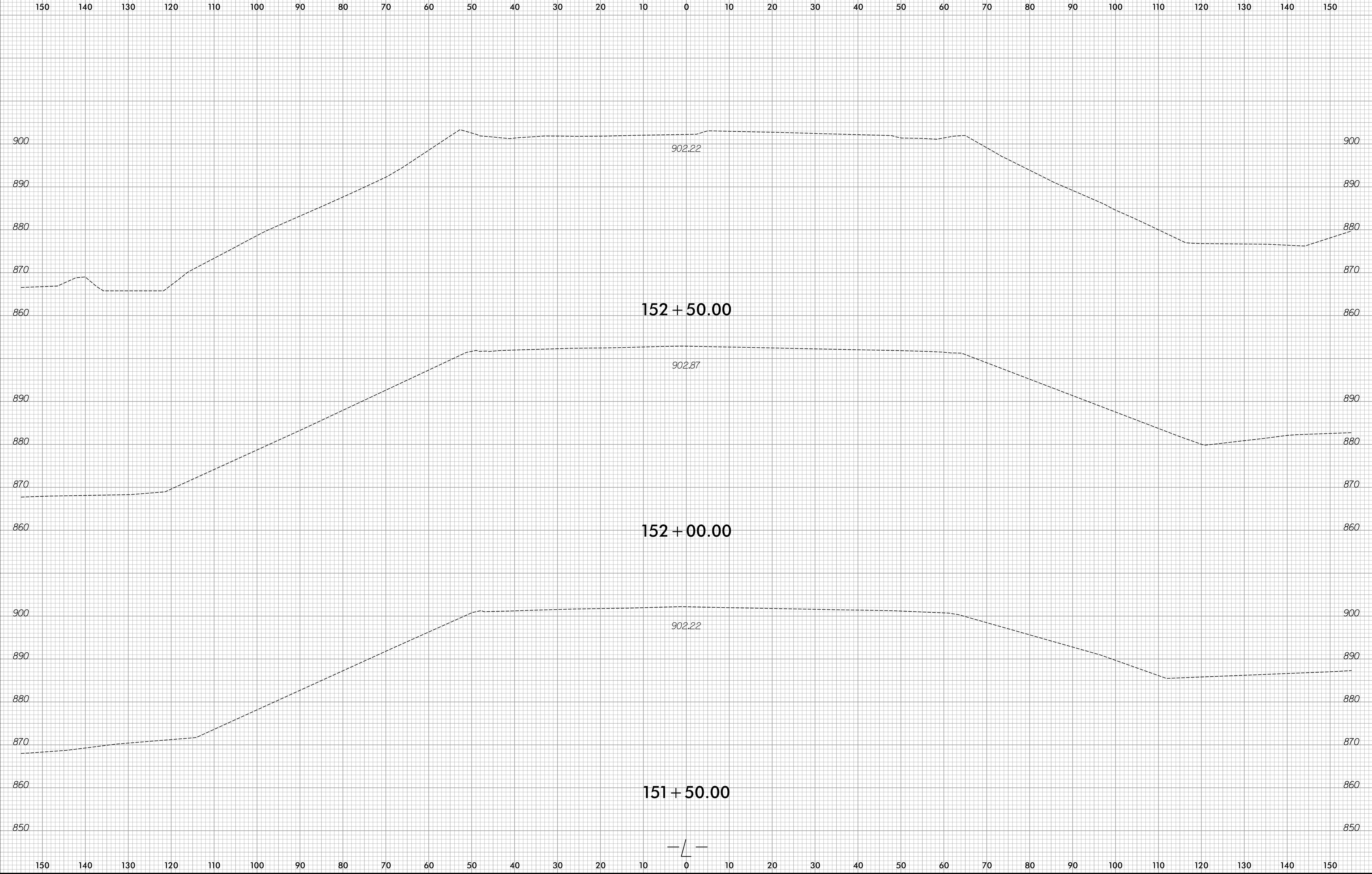

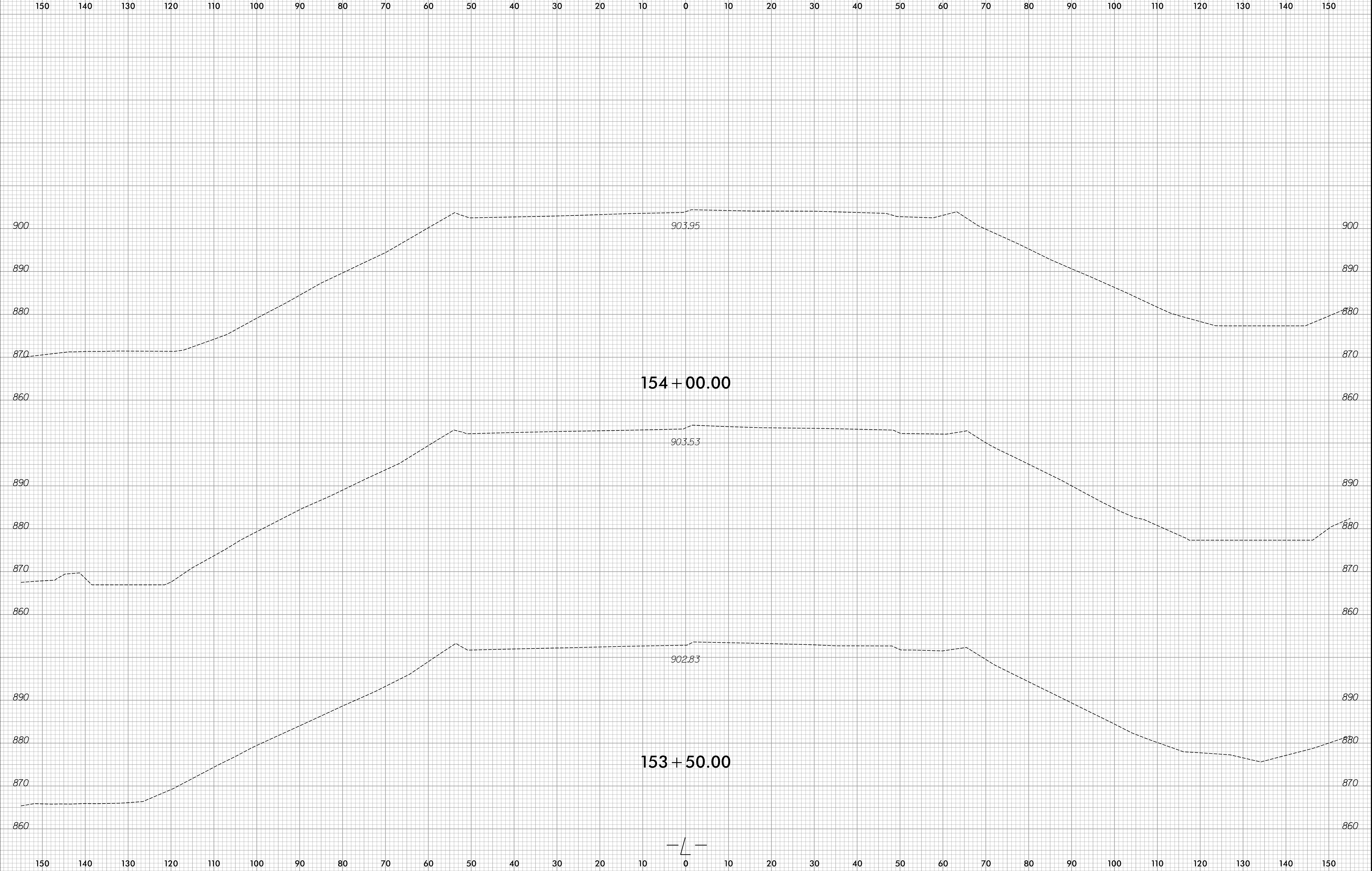
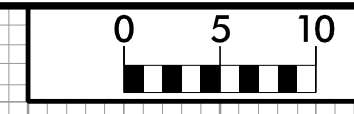

6/23/16

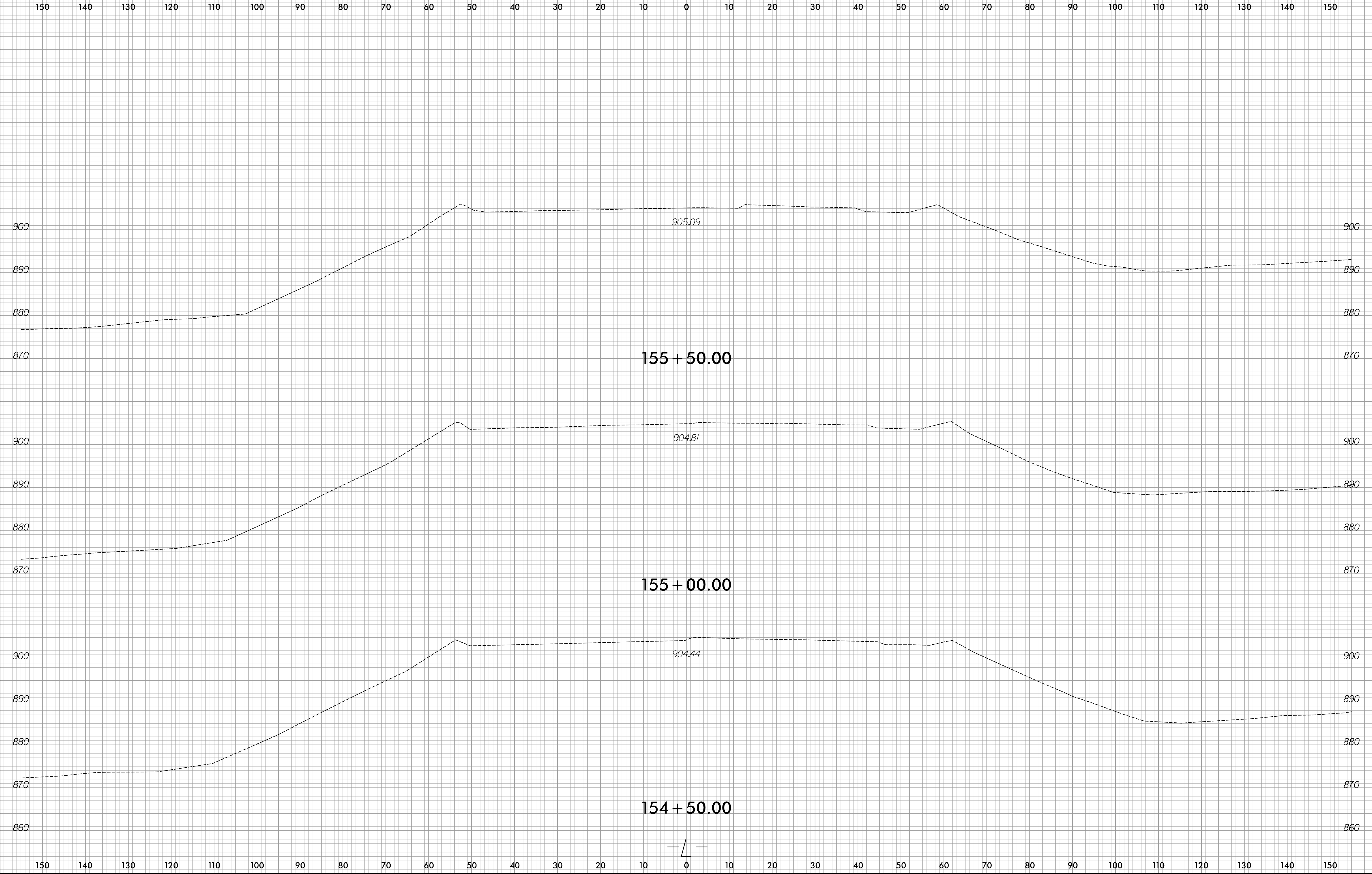

12/2/2023
R:\Roadway\XSC\R-2577A_Rdu_xp1.L.dgn
amcpherson

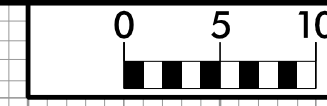

150 140 130 120 110 100 90 80 70 60 50 40 30 20 10 0 10 20 30 40 50 60 70 80 90 100 110 120 130 140 150

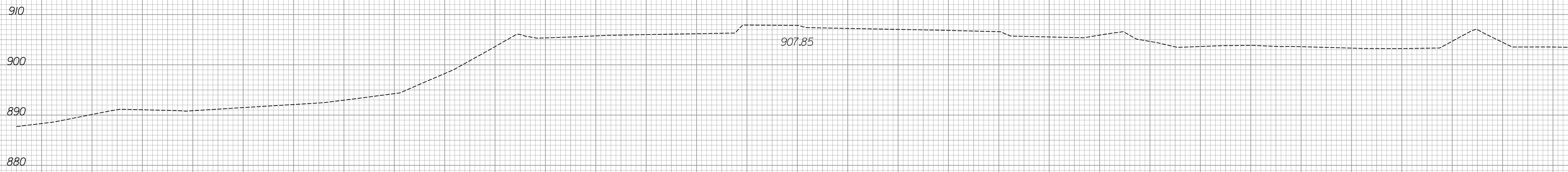

157 + 00.00



156 + 50.00

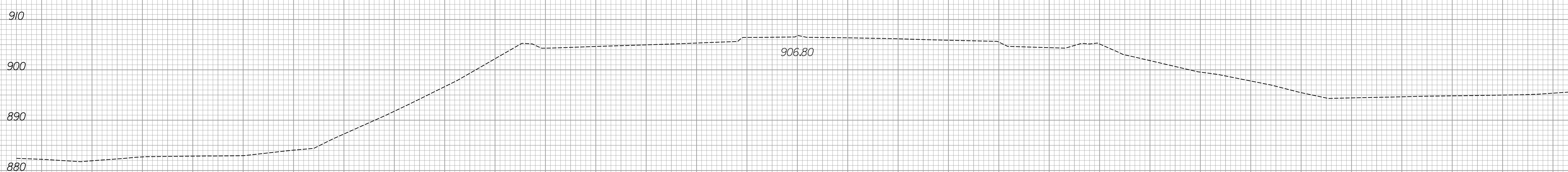

156 + 00.00

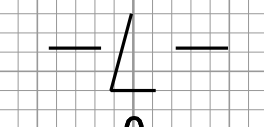

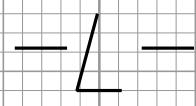
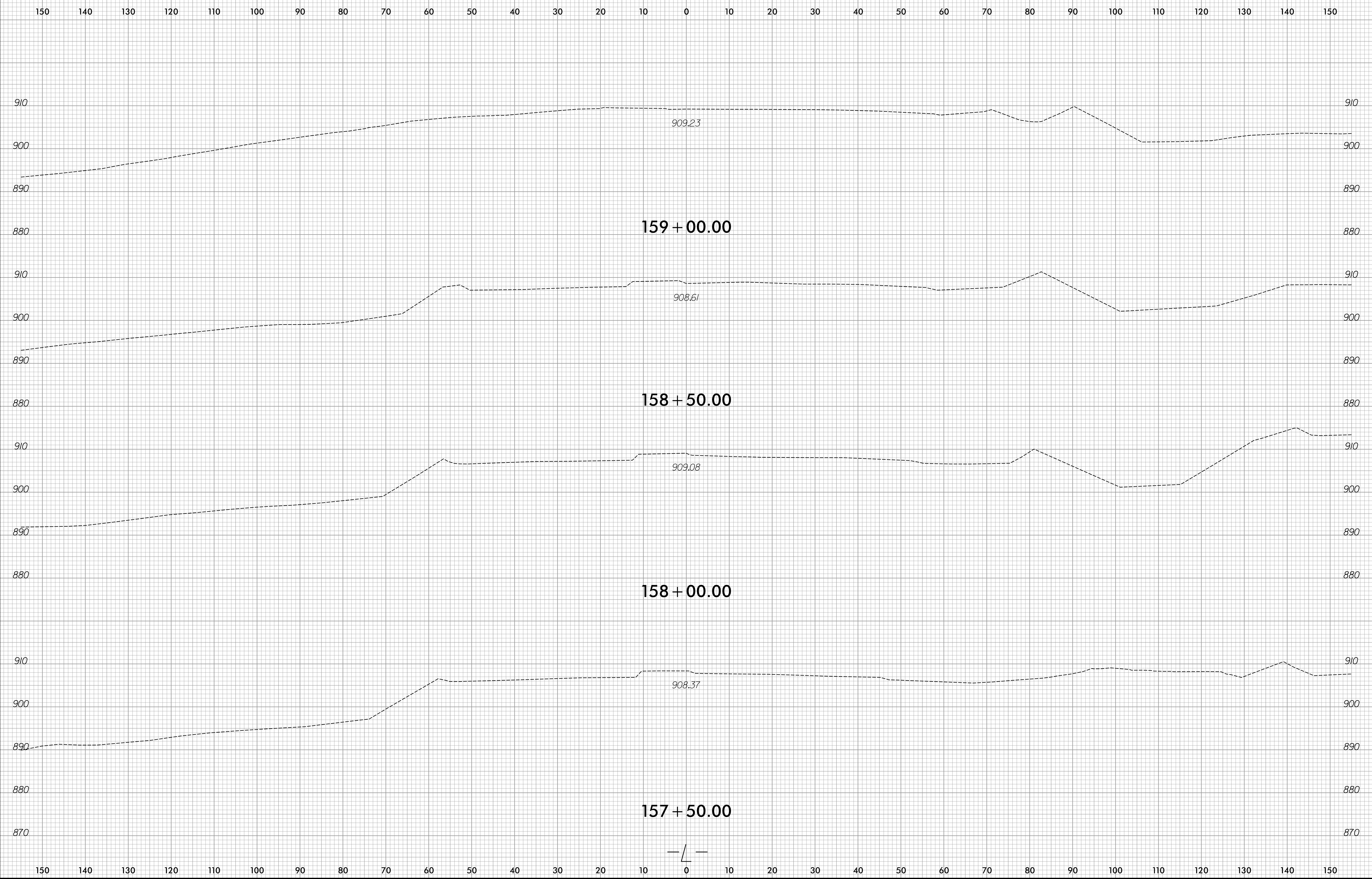

6/23/16

0 5 10	PROJ. REFERENCE NO. R-2577A	SHEET NO. X-149
--------	--------------------------------	--------------------

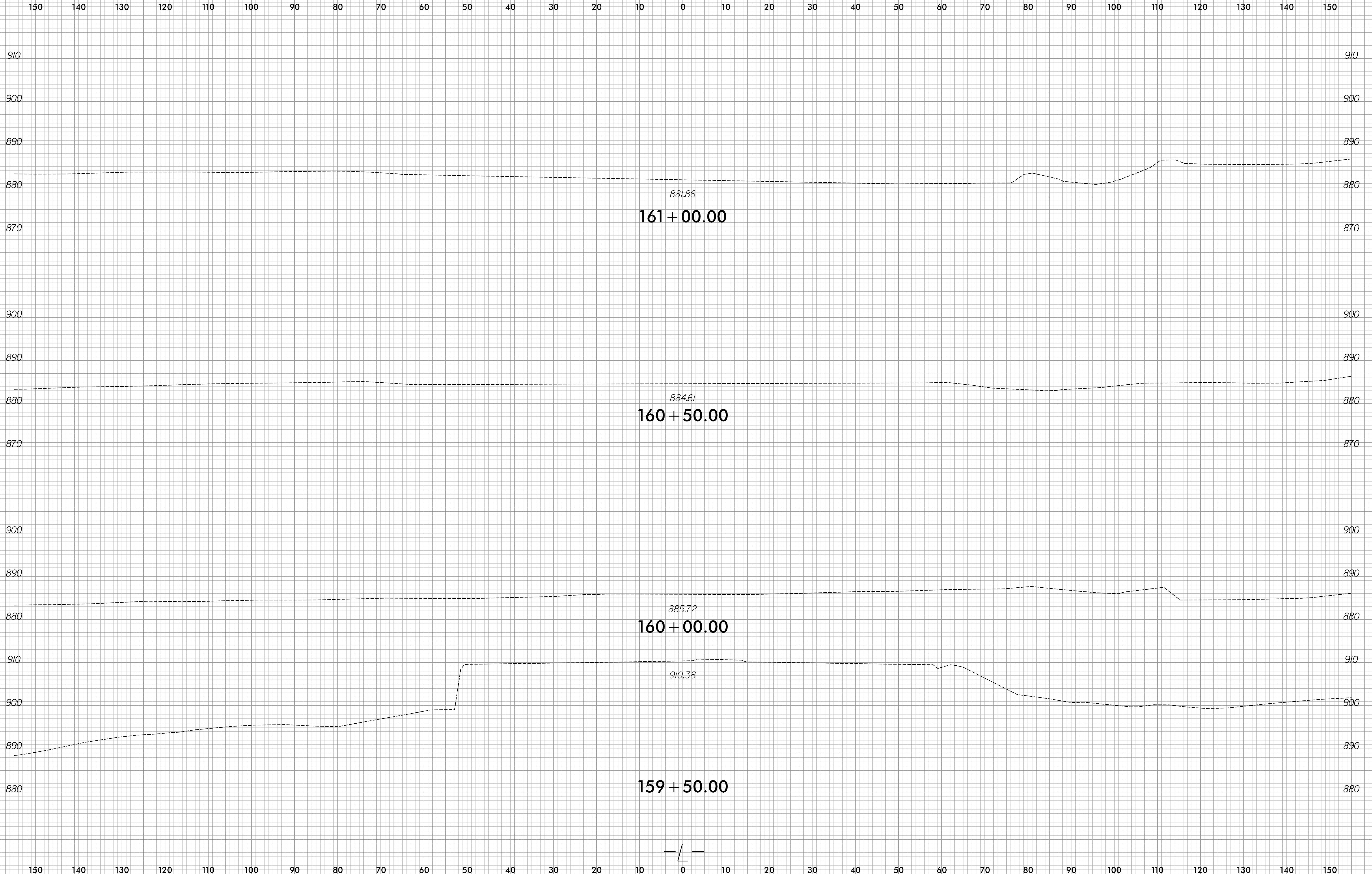

12/2/2023
R:\Roadway\XSC\R-2577A_Rdwy_xpl.dgn
amc@pfs.com

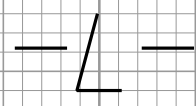

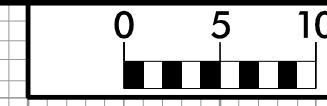

PROJ. REFERENCE NO.
R-2577A

SHEET NO.
X-150

150 140 130 120 110 100 90 80 70 60 50 40 30 20 10 0 10 20 30 40 50 60 70 80 90 100 110 120 130 140 150

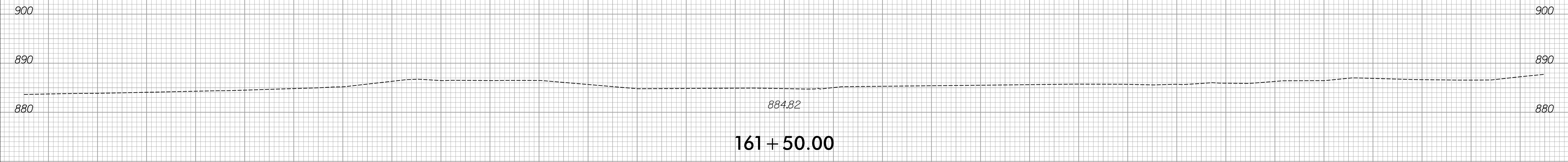
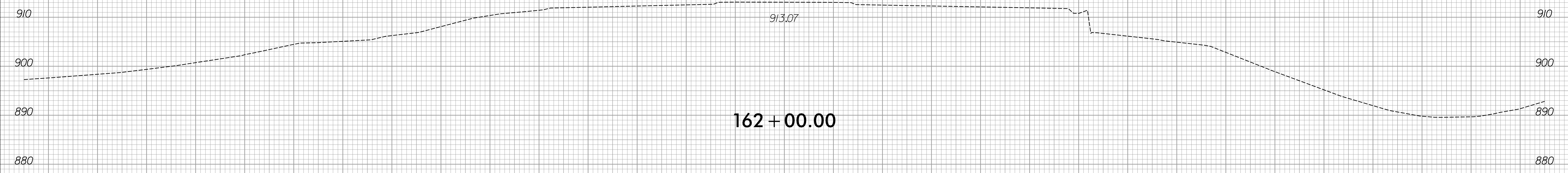
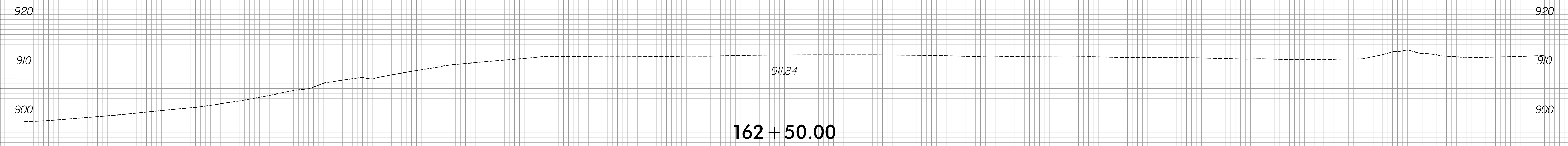
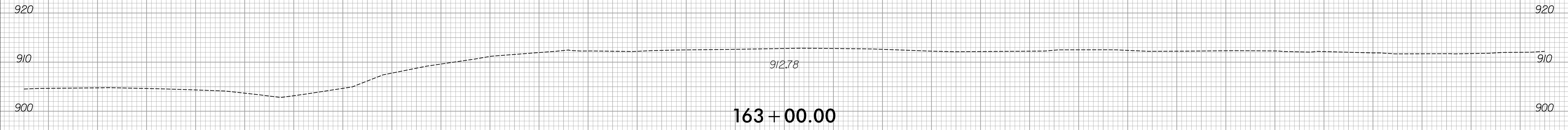

150 140 130 120 110 100 90 80 70 60 50 40 30 20 10 0 10 20 30 40 50 60 70 80 90 100 110 120 130 140 150

6/23/16

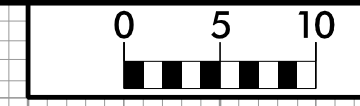

PROJ. REFERENCE NO.
R-2577A

SHEET NO.
X-151

150 140 130 120 110 100 90 80 70 60 50 40 30 20 10 0 10 20 30 40 50 60 70 80 90 100 110 120 130 140 150

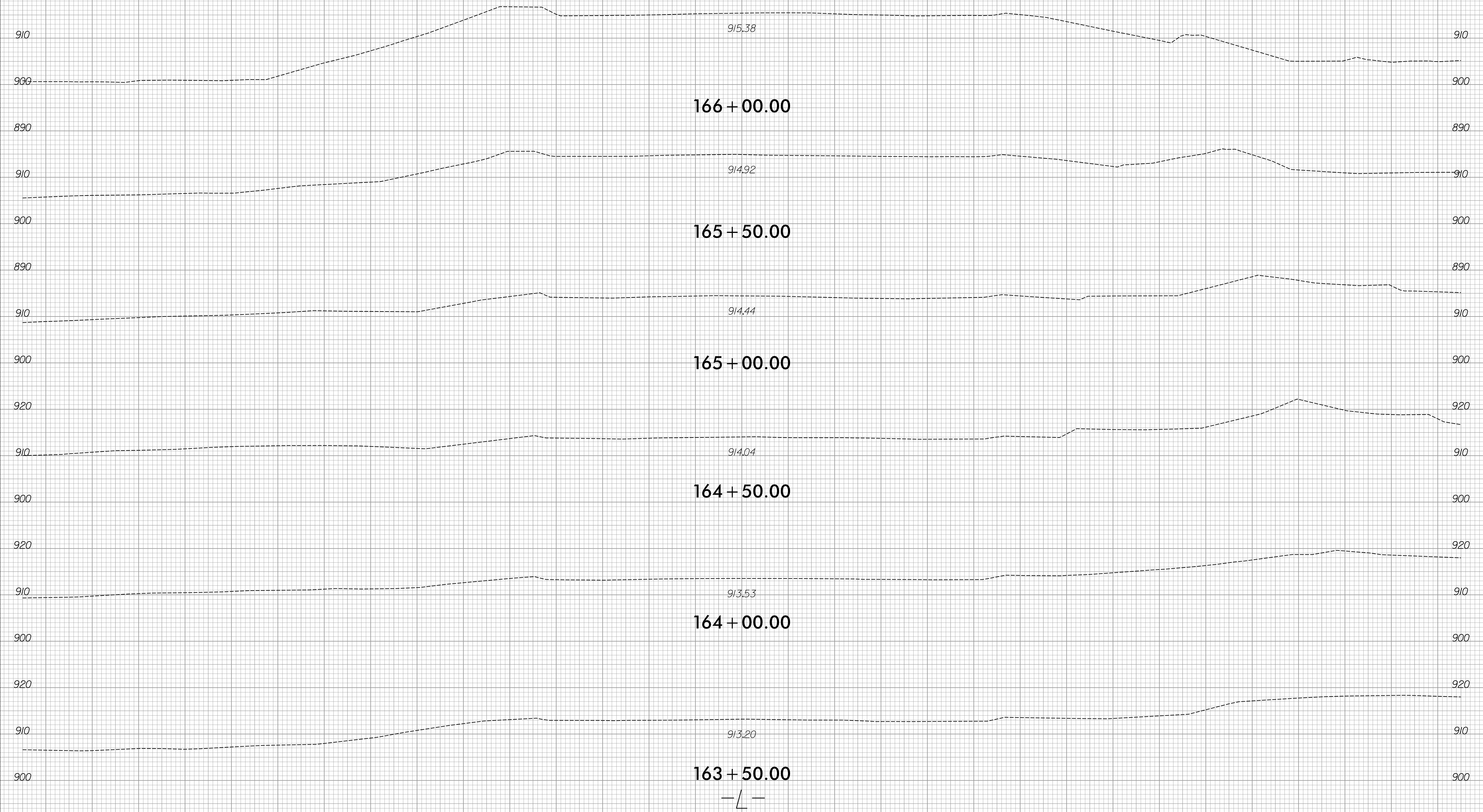

12/21/2023
R:\Roadway\XSC\R-2577A_Rdy_xpl.dgn
amcpherson

150 140 130 120 110 100 90 80 70 60 50 40 30 20 10 0 10 20 30 40 50 60 70 80 90 100 110 120 130 140 150

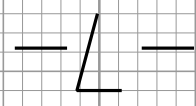
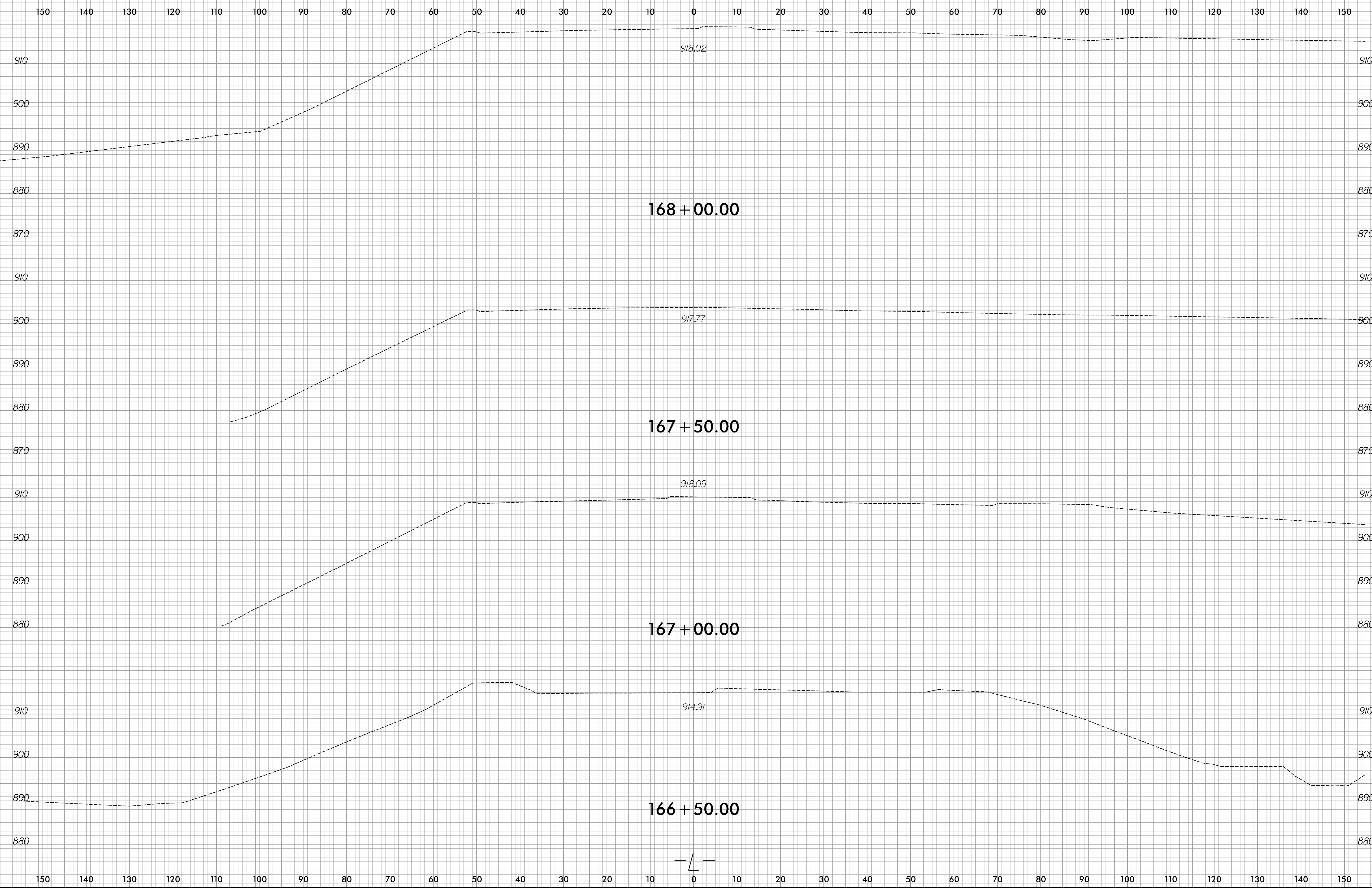

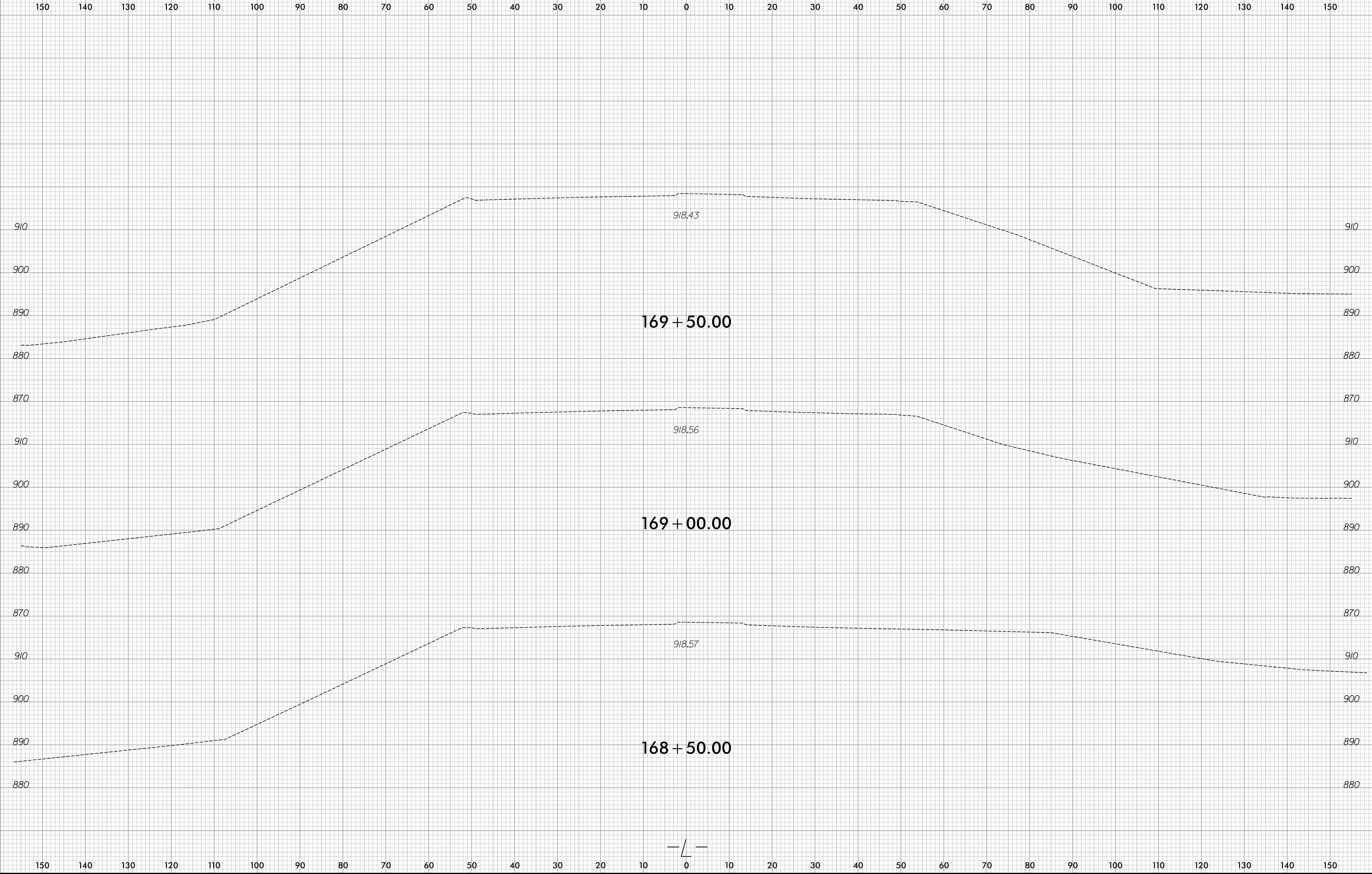

6/23/16

0 5 10 [Scale Bars]	PROJ. REFERENCE NO. R-2577A	SHEET NO. X-154
------------------------	--------------------------------	--------------------

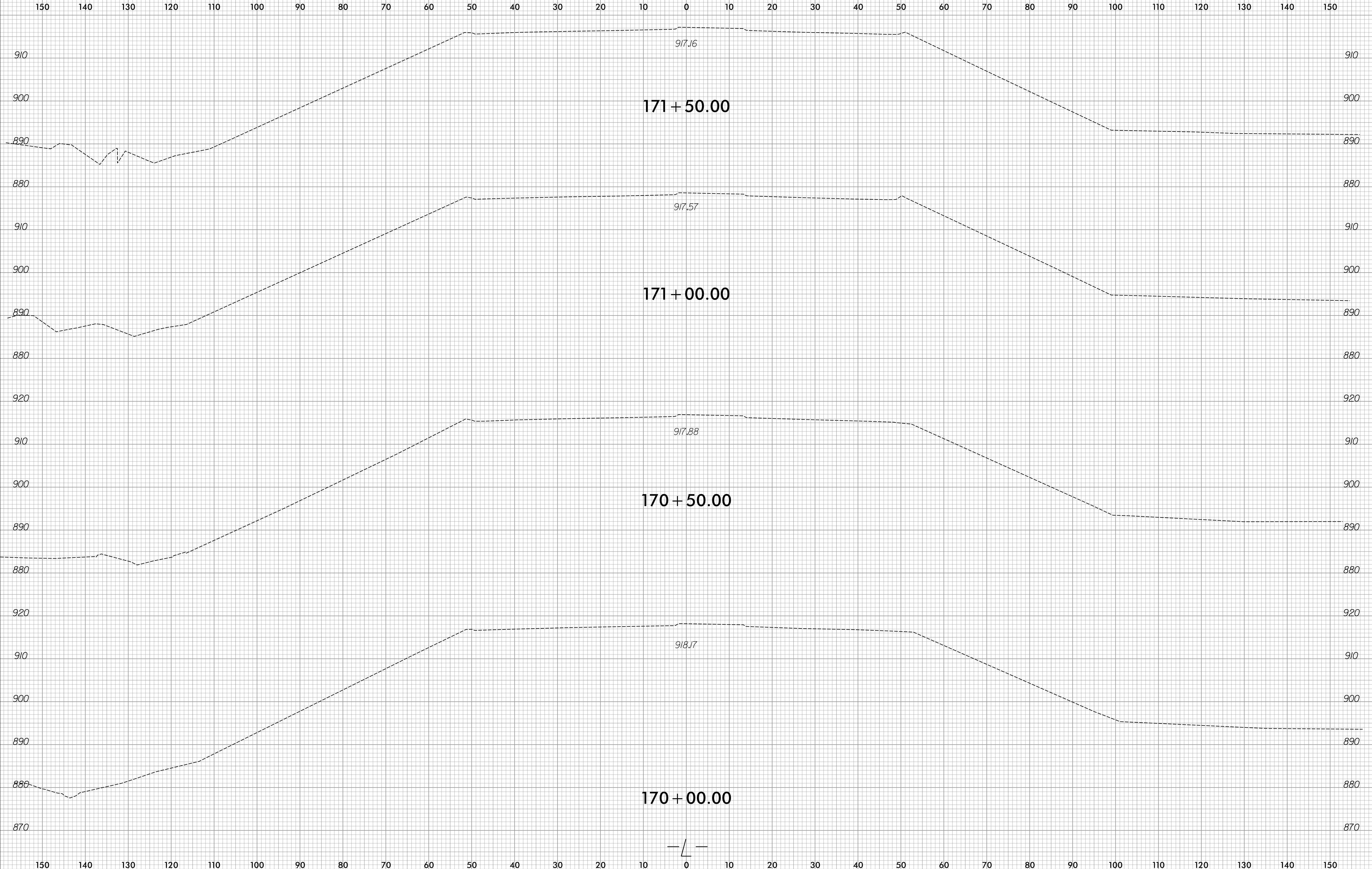

12/2/2023
R:\Roadway\XSC\R-2577A_RdJ_xp1.L.dgn
amcpherson

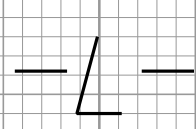

6/23/16

0 5 10	PROJ. REFERENCE NO.	SHEET NO.
	R-2577A	X-155

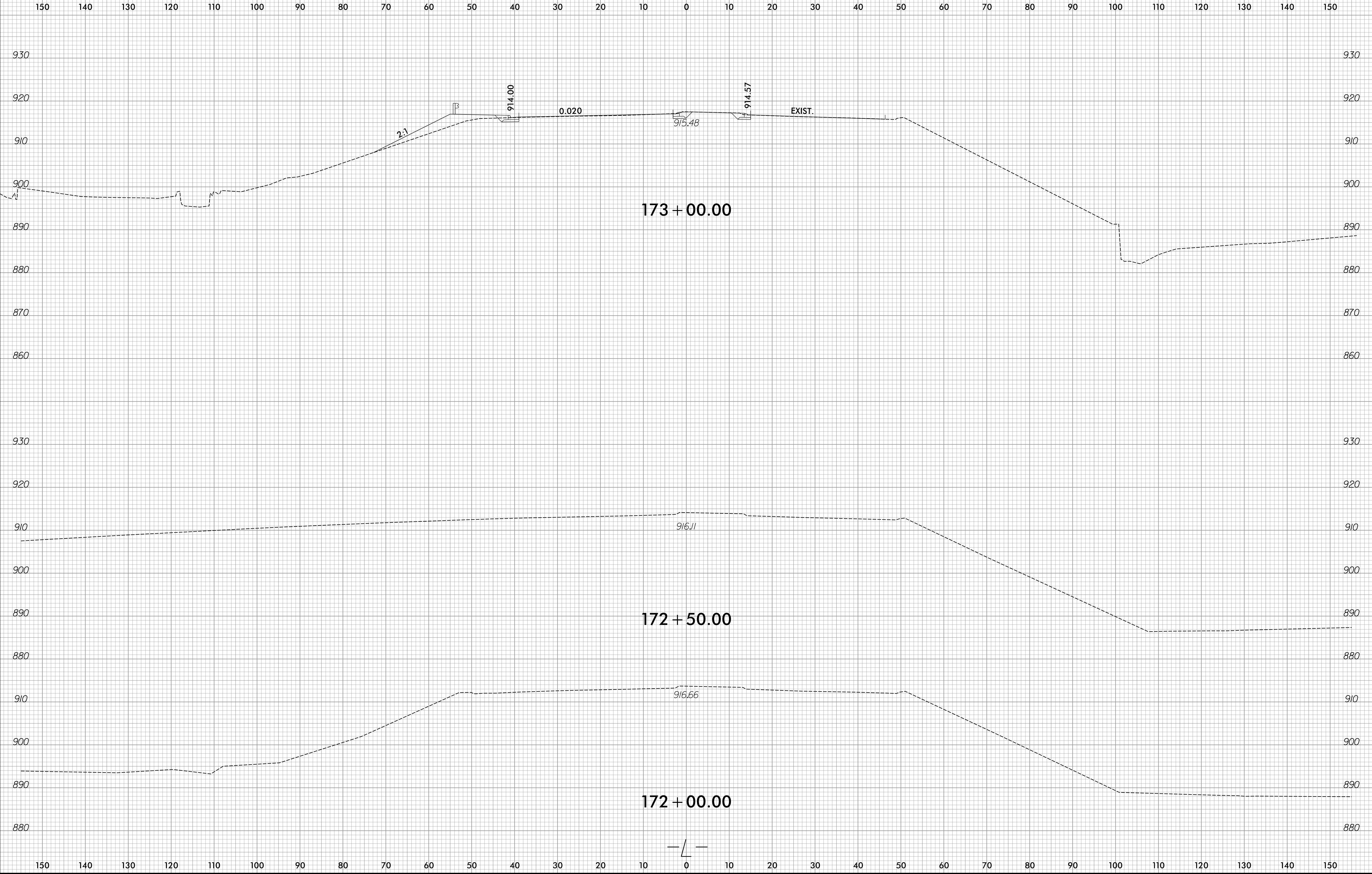

12/2/2023
R:\Roadway\XSC\R-2577A_Rdy_xpl.dgn
amcpherson

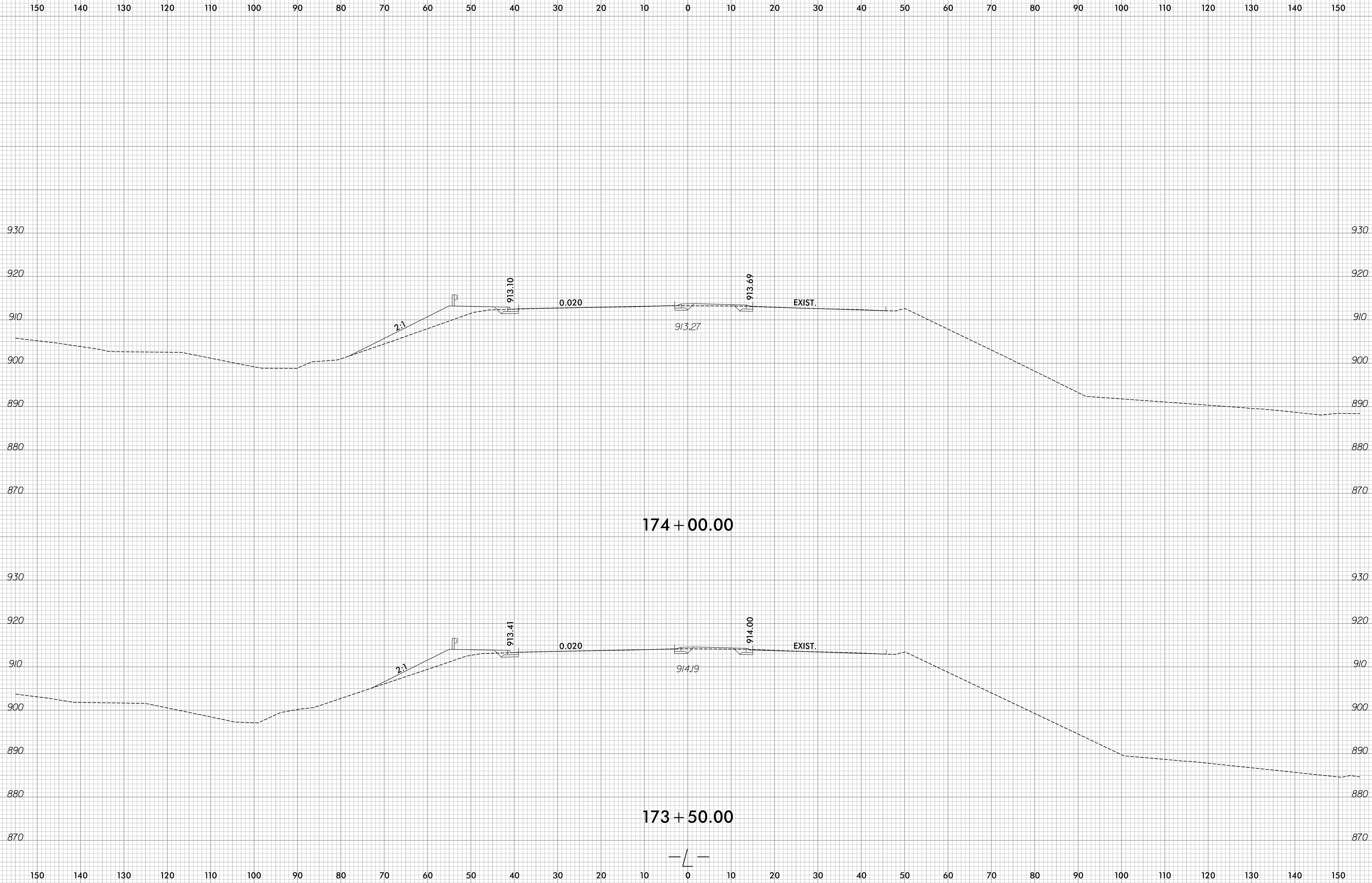

6/23/16

	PROJ. REFERENCE NO.	SHEET NO.
	R-2577A	X-157

150 140 130 120 110 100 90 80 70 60 50 40 30 20 10 0 10 20 30 40 50 60 70 80 90 100 110 120 130 140 150



175 + 00.00

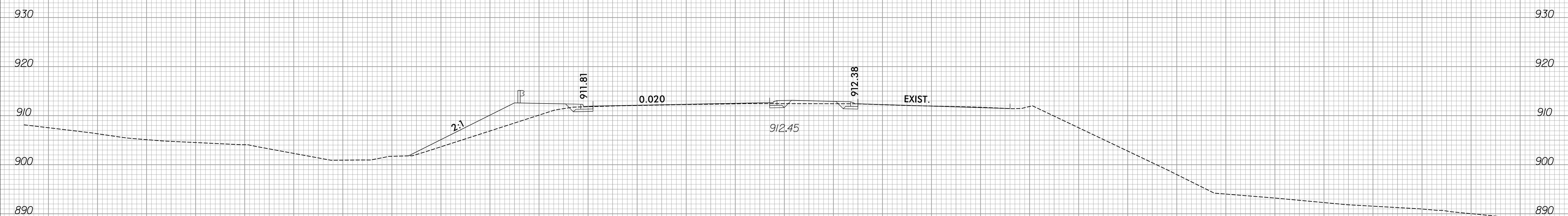

174 + 50.00

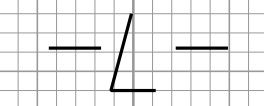

12/2/2023
R:\Roadway\XSC\R-2577A_Rdy_xpl.dgn
amcpherson

150 140 130 120 110 100 90 80 70 60 50 40 30 20 10 0 10 20 30 40 50 60 70 80 90 100 110 120 130 140 150

150 140 130 120 110 100 90 80 70 60 50 40 30 20 10 0 10 20 30 40 50 60 70 80 90 100 110 120 130 140 150

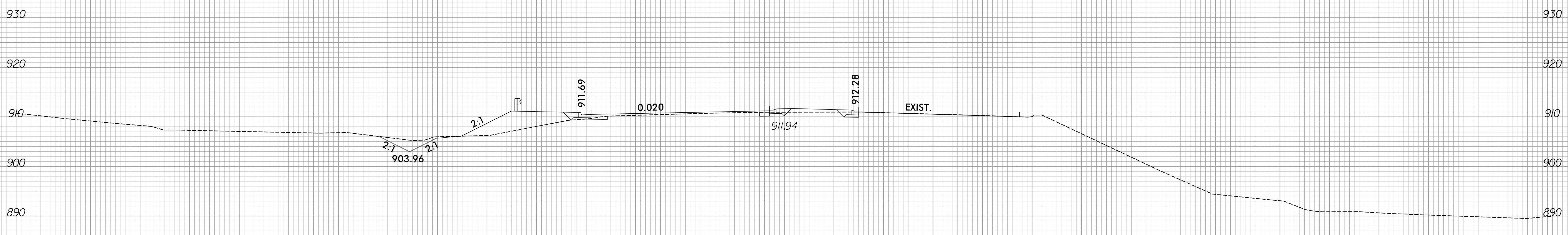
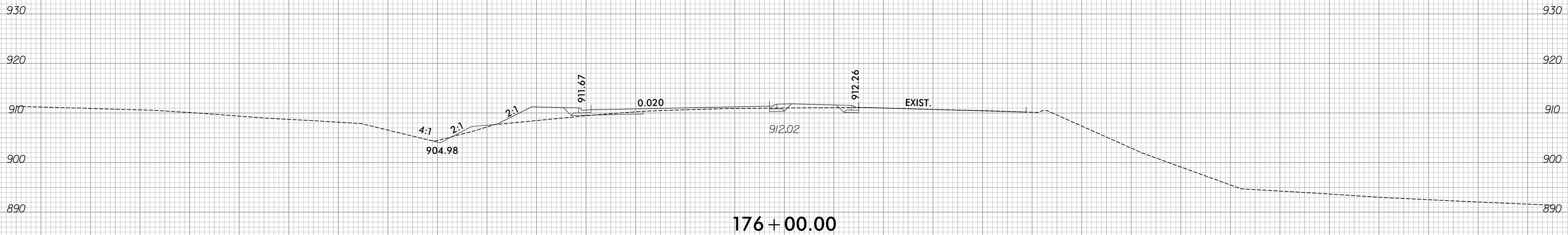

150 140 130 120 110 100 90 80 70 60 50 40 30 20 10 0 10 20 30 40 50 60 70 80 90 100 110 120 130 140 150

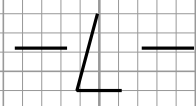

150 140 130 120 110 100 90 80 70 60 50 40 30 20 10 0 10 20 30 40 50 60 70 80 90 100 110 120 130 140 150

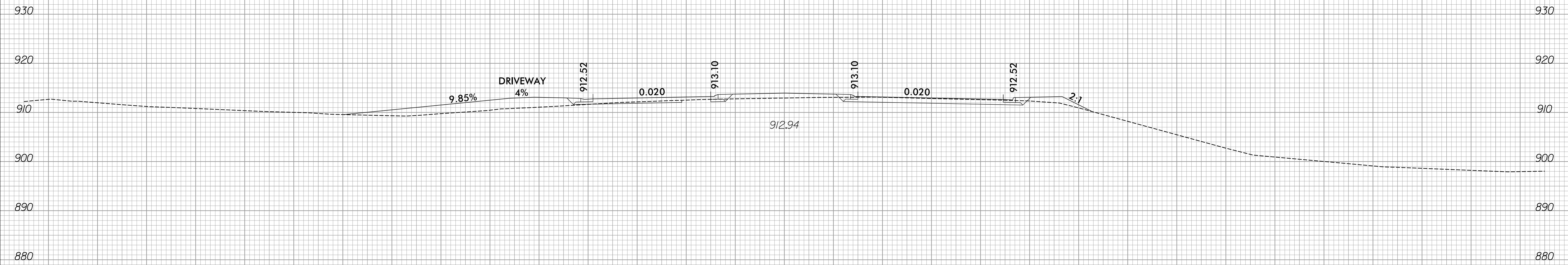

177 + 00.00

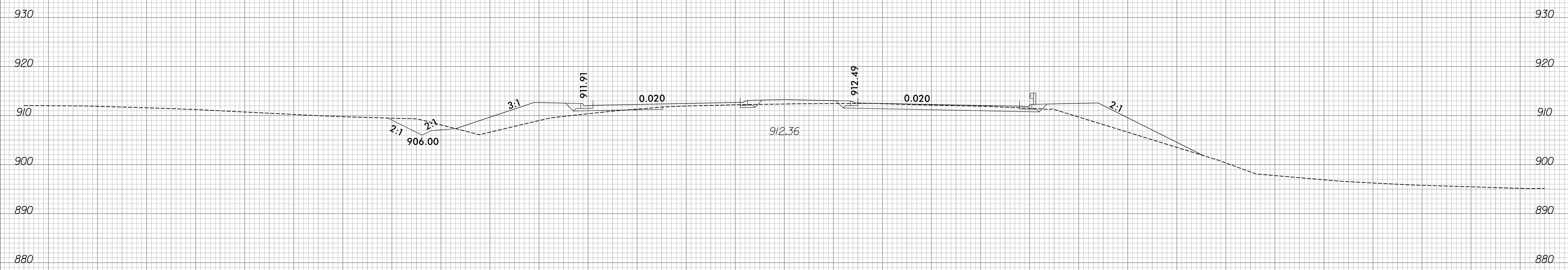

176 + 50.00

150 140 130 120 110 100 90 80 70 60 50 40 30 20 10 0 10 20 30 40 50 60 70 80 90 100 110 120 130 140 150

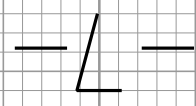

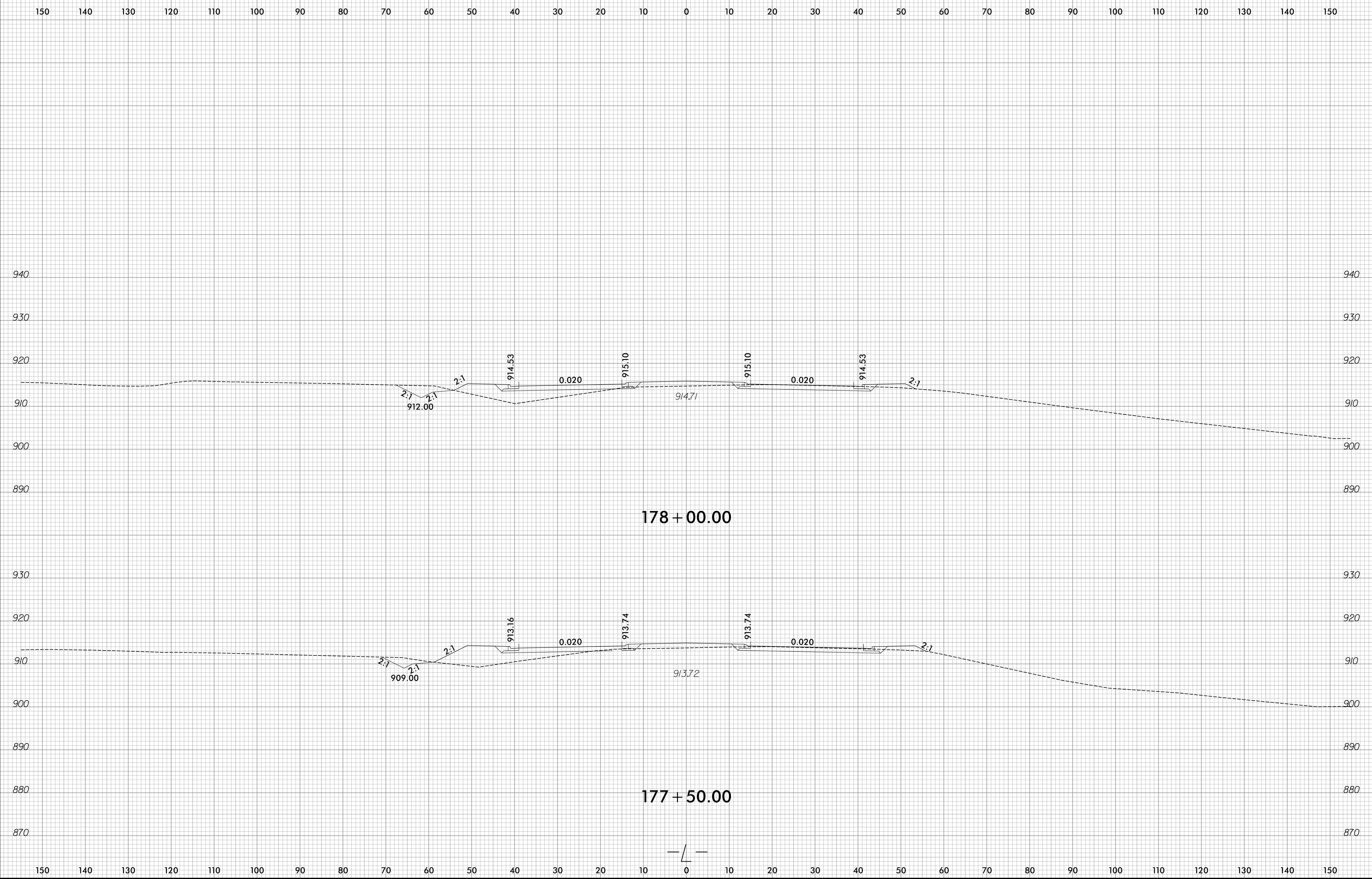



150 140 130 120 110 100 90 80 70 60 50 40 30 20 10 0 10 20 30 40 50 60 70 80 90 100 110 120 130 140 150

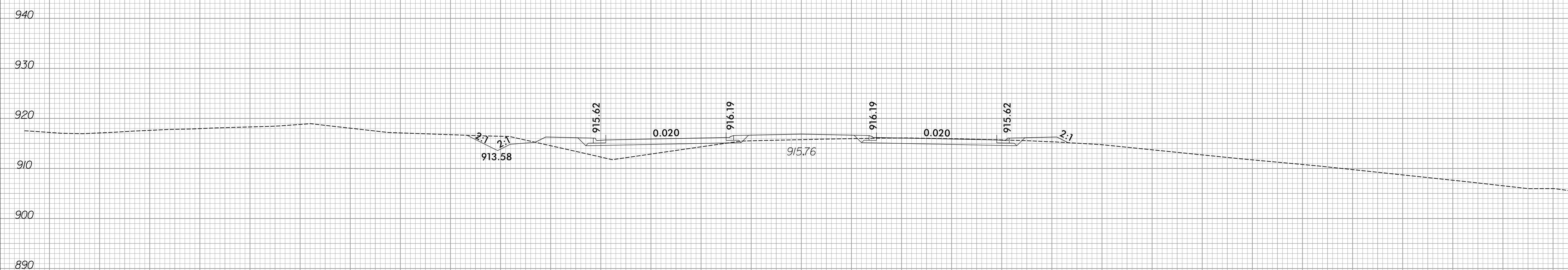
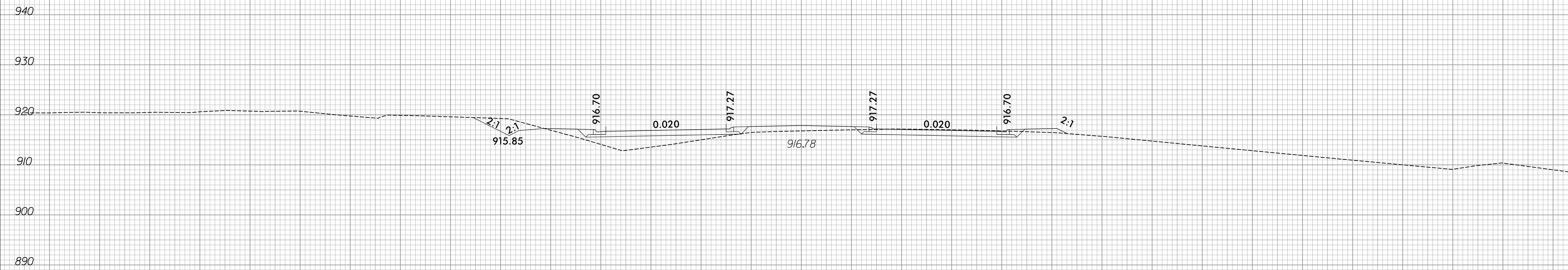

150 140 130 120 110 100 90 80 70 60 50 40 30 20 10 0 10 20 30 40 50 60 70 80 90 100 110 120 130 140 150

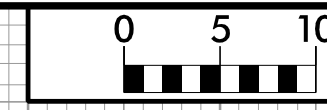

150 140 130 120 110 100 90 80 70 60 50 40 30 20 10 0 10 20 30 40 50 60 70 80 90 100 110 120 130 140 150

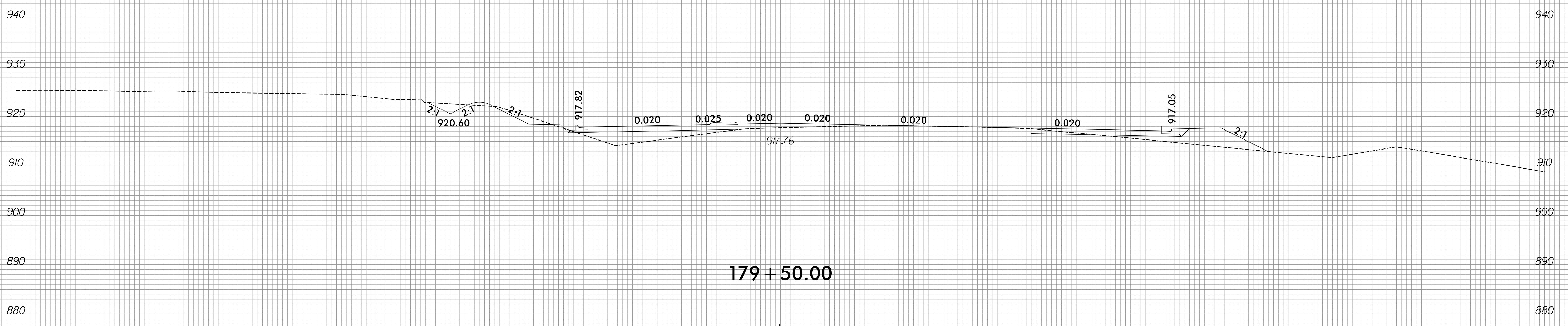
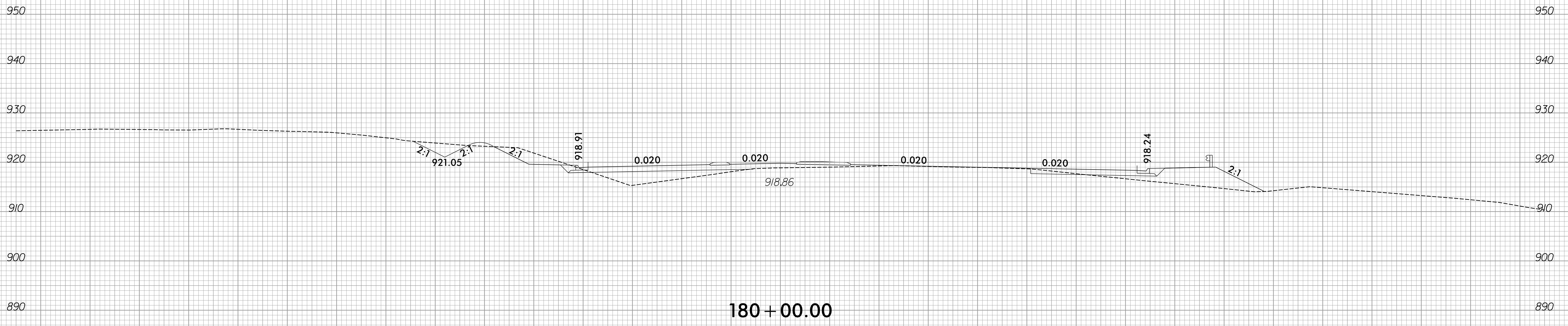

150 140 130 120 110 100 90 80 70 60 50 40 30 20 10 0 10 20 30 40 50 60 70 80 90 100 110 120 130 140 150

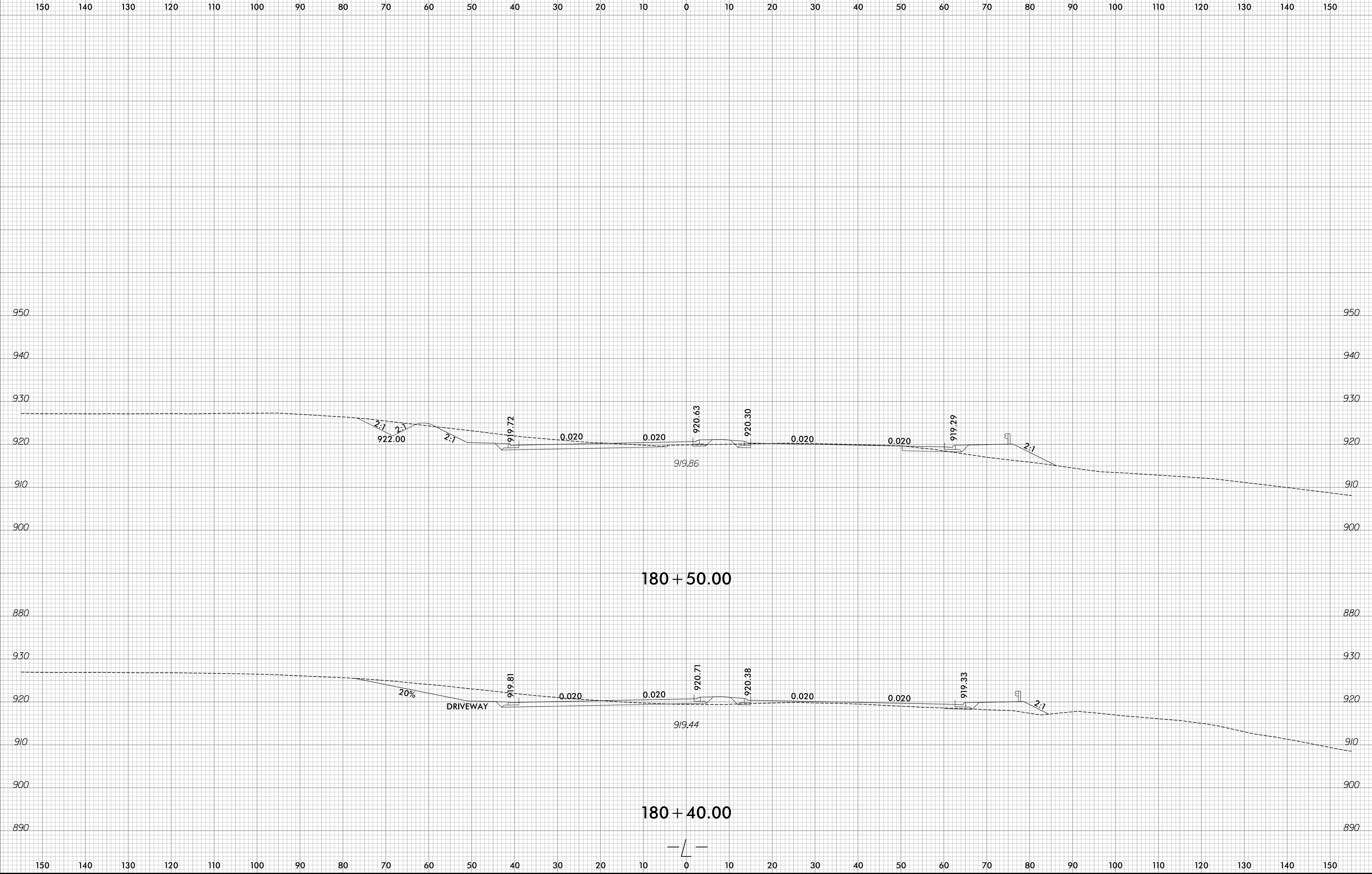

150 140 130 120 110 100 90 80 70 60 50 40 30 20 10 0 10 20 30 40 50 60 70 80 90 100 110 120 130 140 150

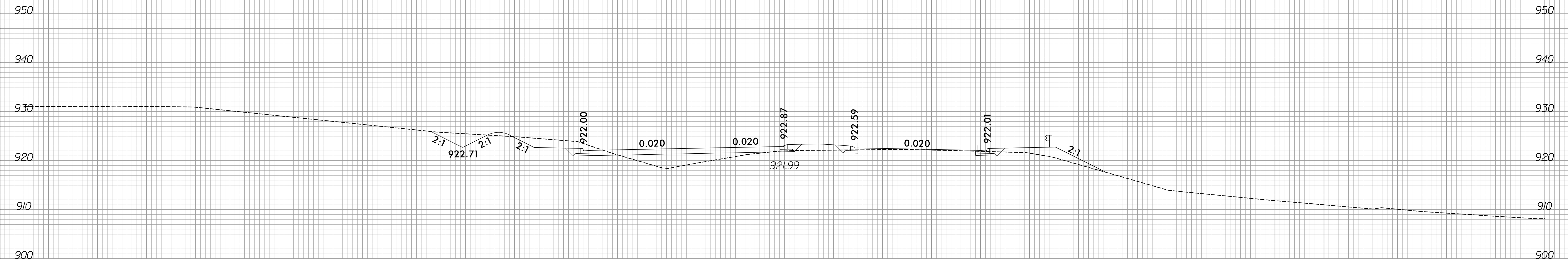

181 + 50.00

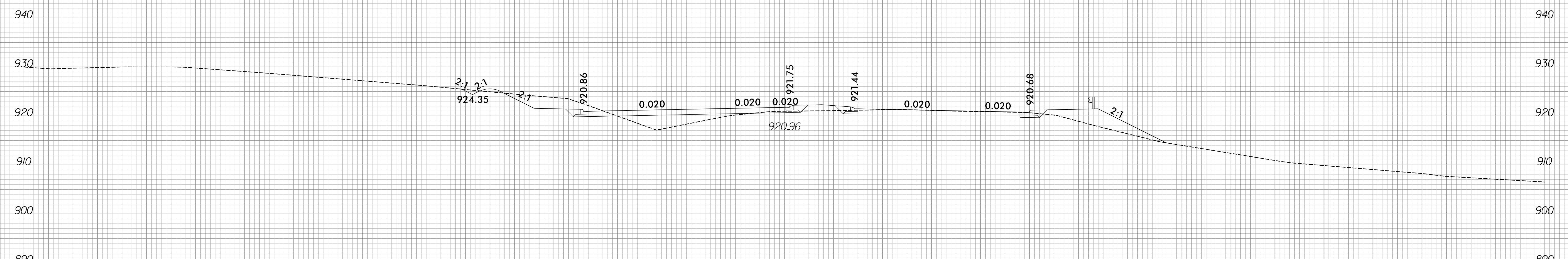

181 + 00.00

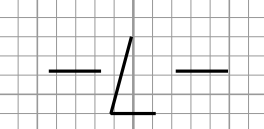

150 140 130 120 110 100 90 80 70 60 50 40 30 20 10 0 10 20 30 40 50 60 70 80 90 100 110 120 130 140 150

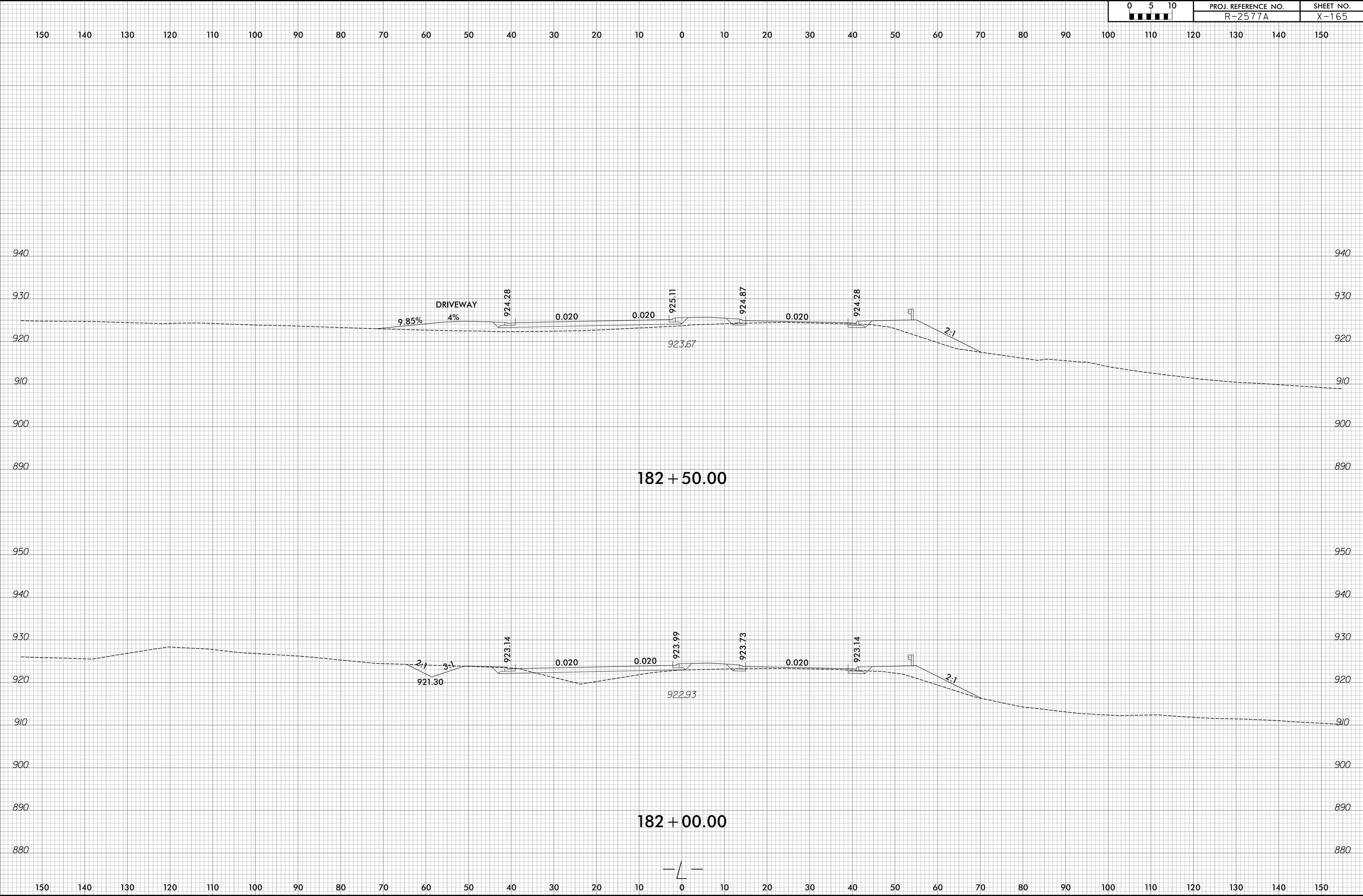
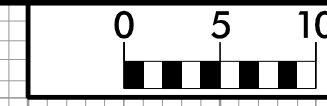

182 + 50.00

182 + 00.00

DRIVEWAY

9.85%

4%

924.28

0.020

0.020

925.11

924.87

0.020

924.28

91

2:1

923.67

2:1

3:1

923.14

0.020

0.020

923.99

923.73

0.020

923.14

91

2:1

922.93

921.30

150 140 130 120 110 100 90 80 70 60 50 40 30 20 10 0 10 20 30 40 50 60 70 80 90 100 110 120 130 140 150

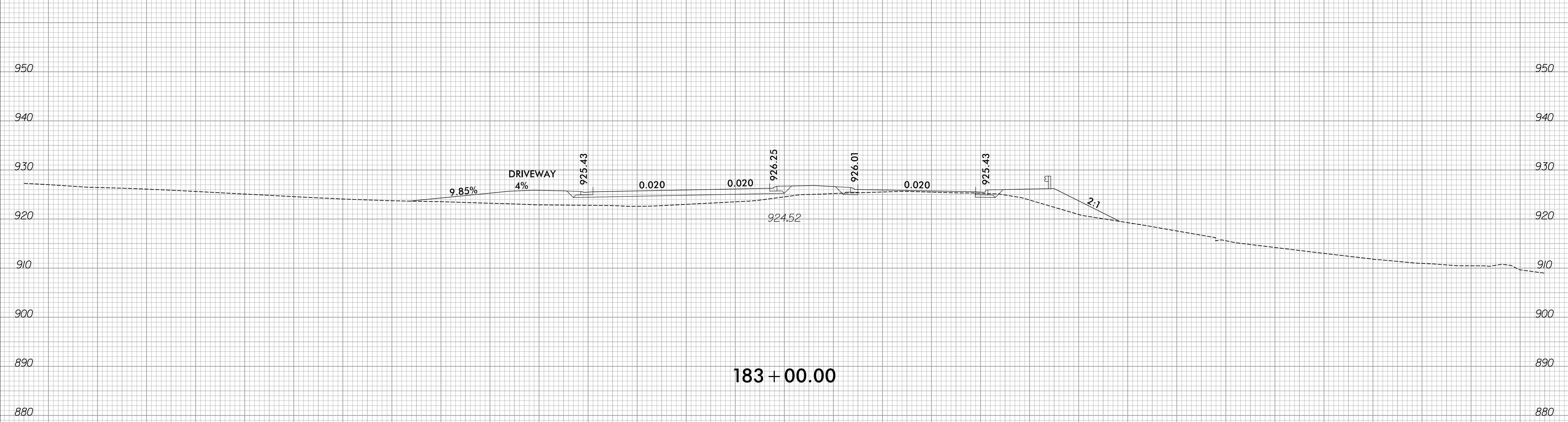
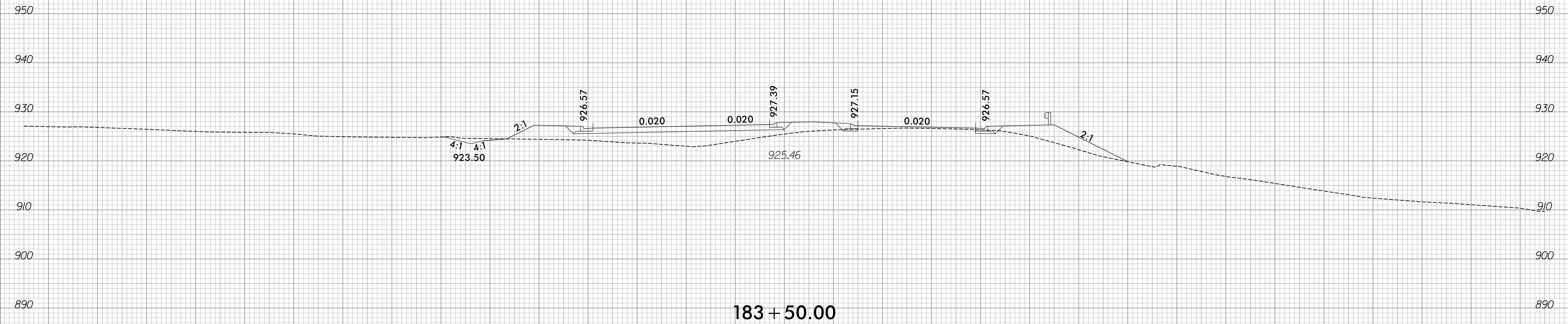

150 140 130 120 110 100 90 80 70 60 50 40 30 20 10 0 10 20 30 40 50 60 70 80 90 100 110 120 130 140 150

6/23/16

0 5 10	PROJ. REFERENCE NO. R-2577A	SHEET NO. X-167
--------	--------------------------------	--------------------

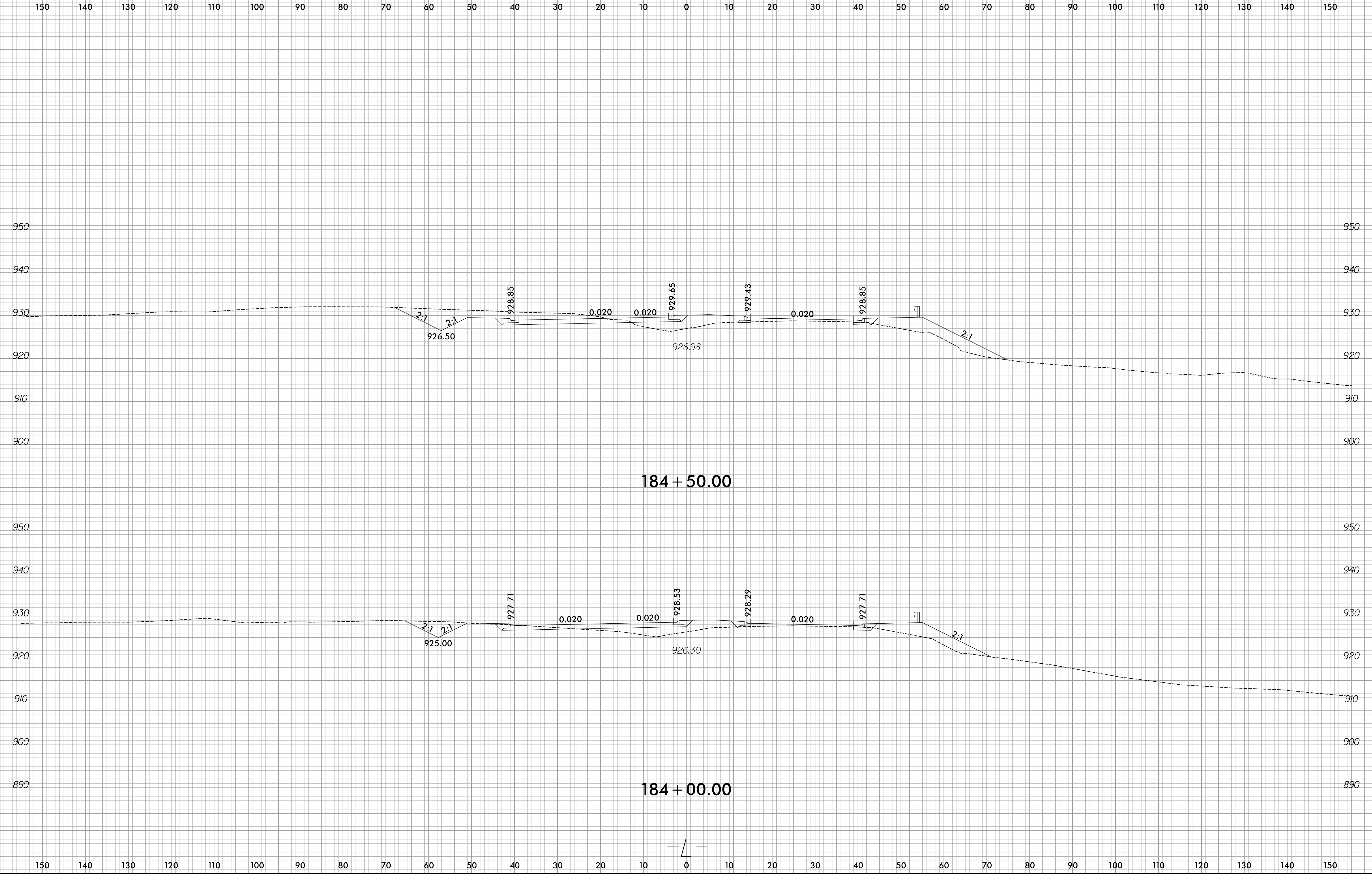

12/2/2023
R:\Roadway\XSC\R-2577A_Rdwy_xpl.dgn
amc@pfe.com

150 140 130 120 110 100 90 80 70 60 50 40 30 20 10 0 10 20 30 40 50 60 70 80 90 100 110 120 130 140 150

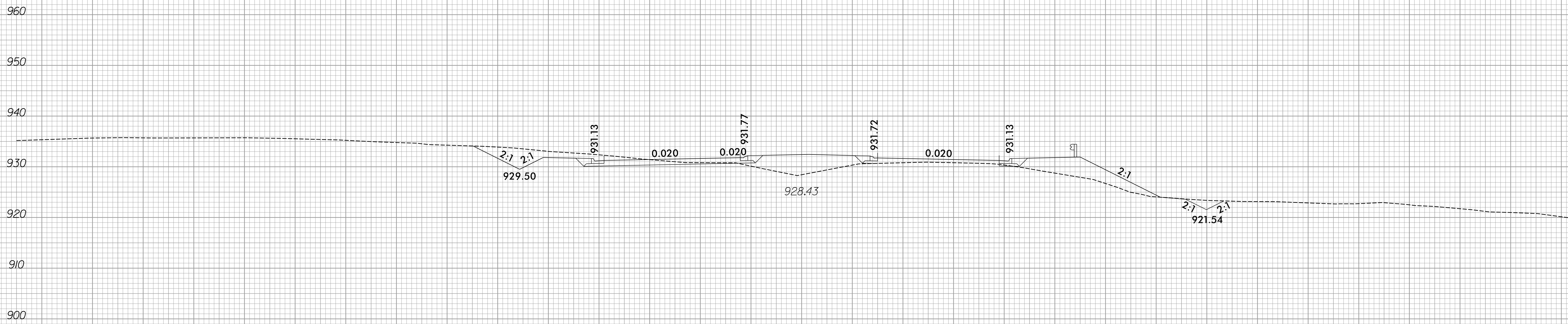

185 + 50.00

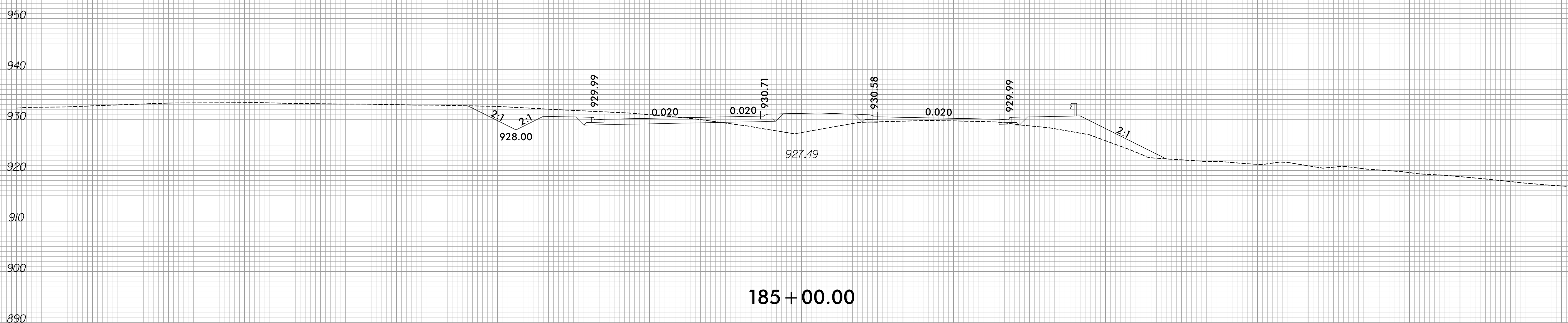

185 + 00.00

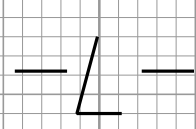

150 140 130 120 110 100 90 80 70 60 50 40 30 20 10 0 10 20 30 40 50 60 70 80 90 100 110 120 130 140 150

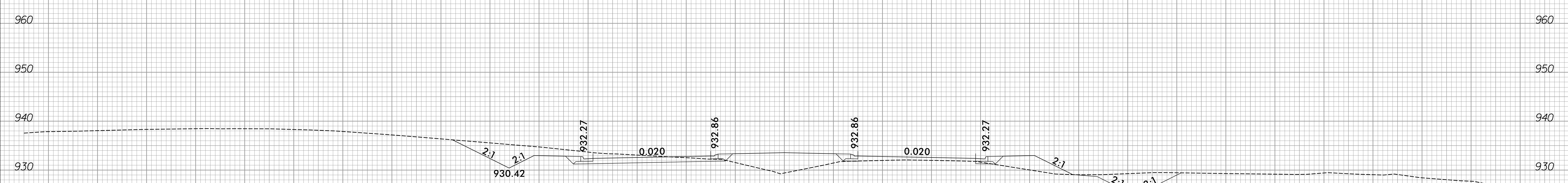
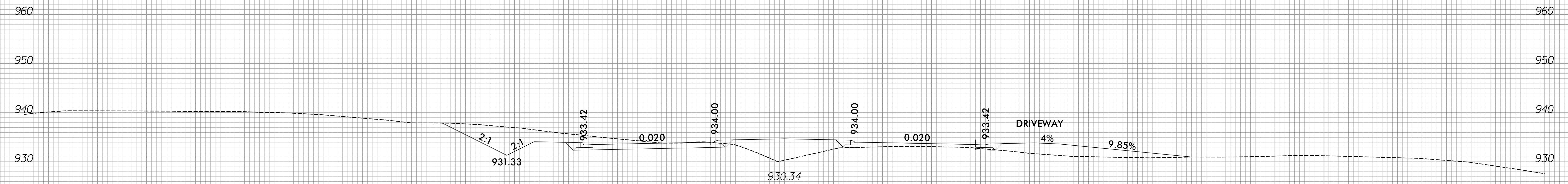

150 140 130 120 110 100 90 80 70 60 50 40 30 20 10 0 10 20 30 40 50 60 70 80 90 100 110 120 130 140 150

6/23/16

150 140 130 120 110 100 90 80 70 60 50 40 30 20 10 0 10 20 30 40 50 60 70 80 90 100 110 120 130 140 150

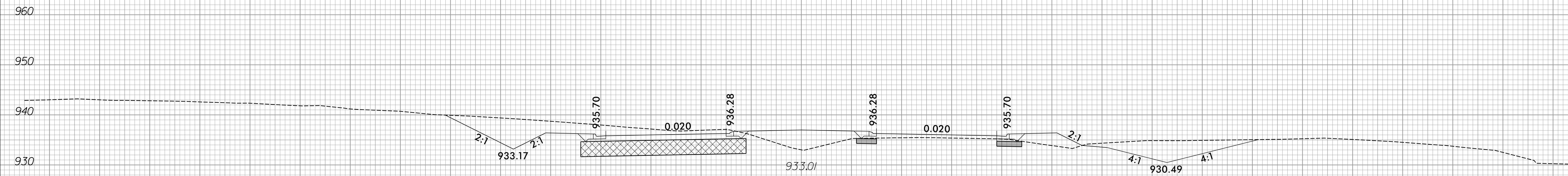

187 + 50.00

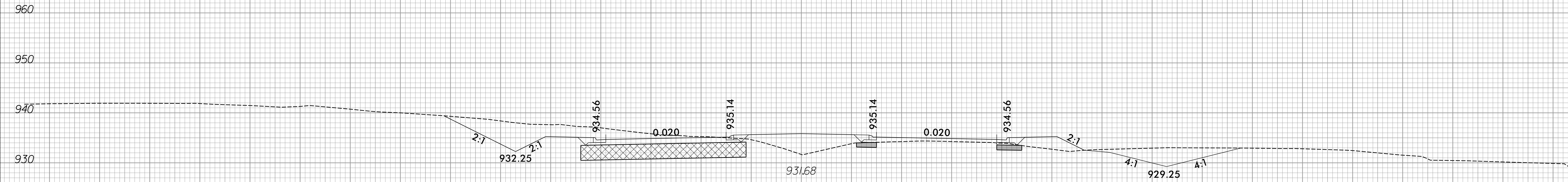

BEGIN UNDERCUT EXCAVATION STA. 186+75
BEGIN SHALLOW UNDERCUT EXCAVATION STA. 186+75

187 + 00.00

150 140 130 120 110 100 90 80 70 60 50 40 30 20 10 0 10 20 30 40 50 60 70 80 90 100 110 120 130 140 150

12/21/2023
R:\Roadway\XSC\R-2577A\Fduj_xpl.dgn
amcdpfe@son

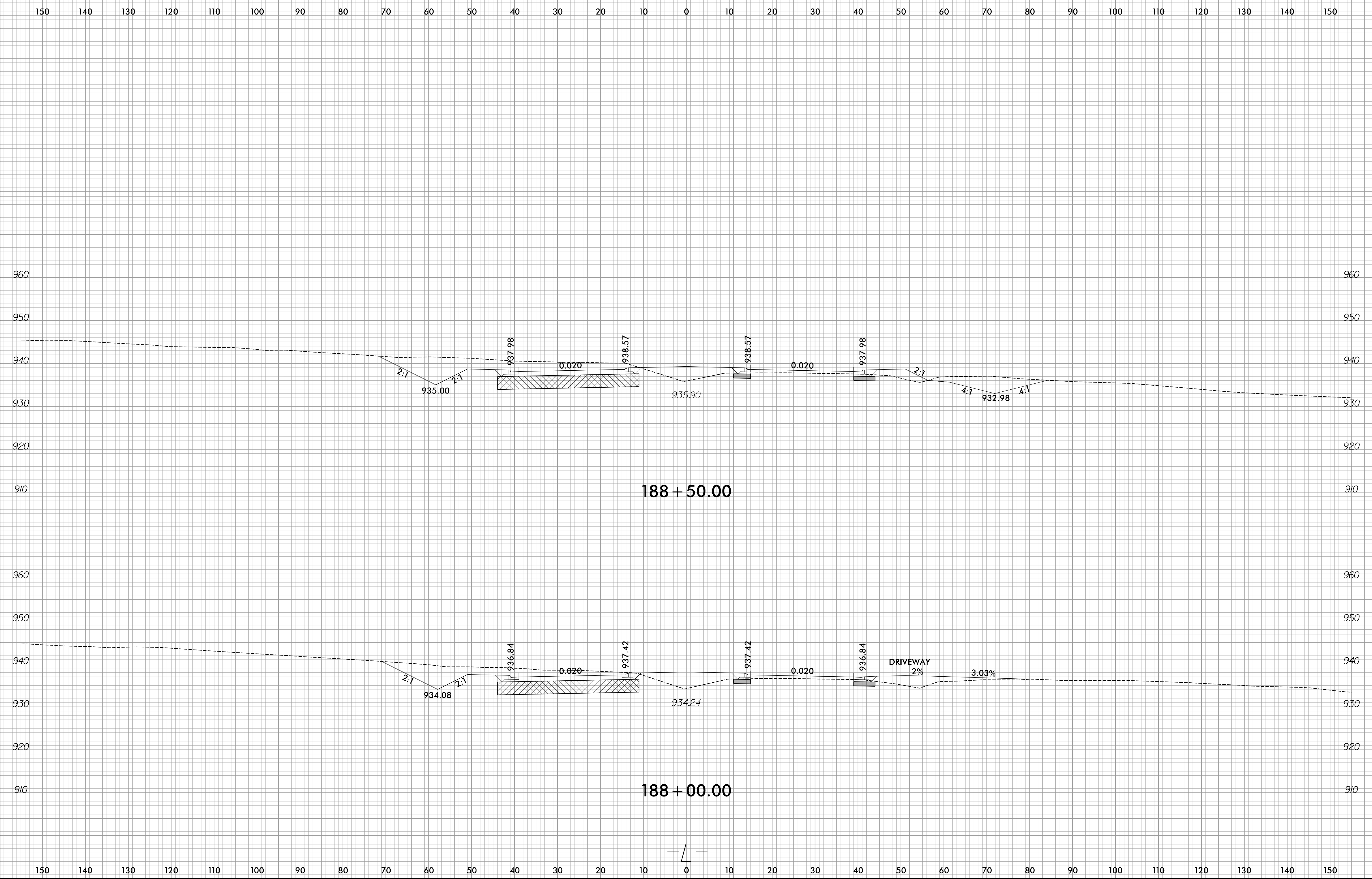

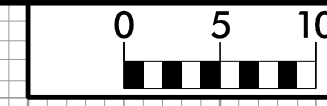

150 140 130 120 110 100 90 80 70 60 50 40 30 20 10 0 10 20 30 40 50 60 70 80 90 100 110 120 130 140 150

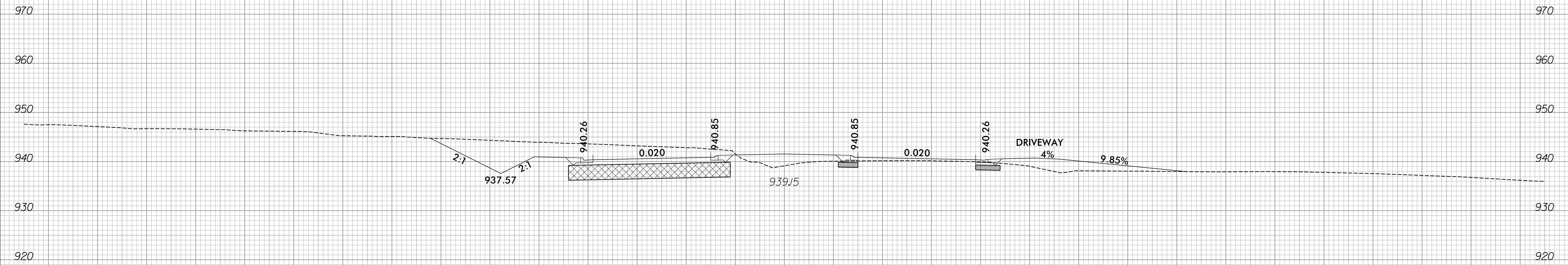

189 + 50.00

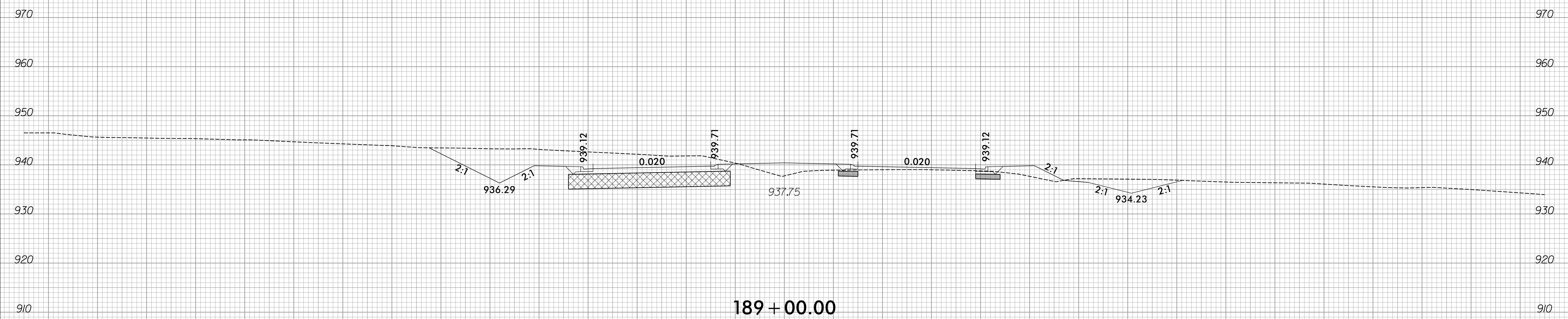

189 + 00.00

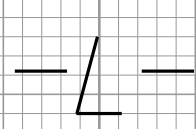

150 140 130 120 110 100 90 80 70 60 50 40 30 20 10 0 10 20 30 40 50 60 70 80 90 100 110 120 130 140 150

6/23/16
12/2/2023
R:\Roadway\XSC\R-2577A_Rdu_xp1.L.dgn
amcbr/psm

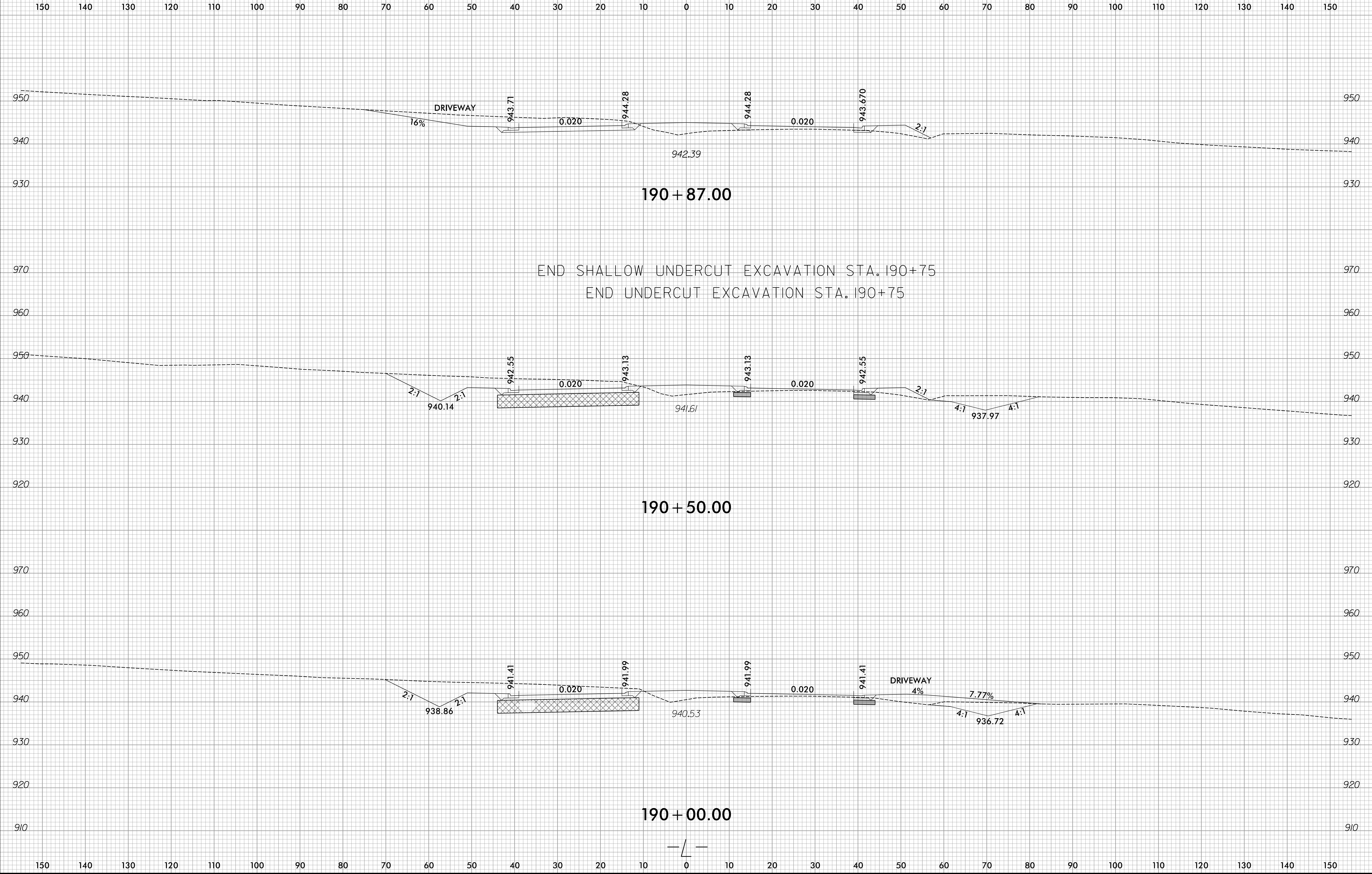

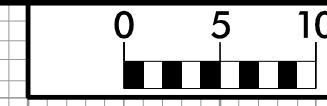

150 140 130 120 110 100 90 80 70 60 50 40 30 20 10 0 10 20 30 40 50 60 70 80 90 100 110 120 130 140 150

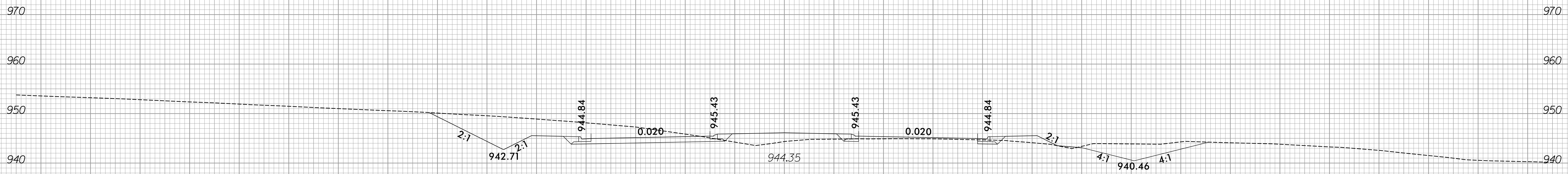

191 + 50.00



191 + 00.00

150 140 130 120 110 100 90 80 70 60 50 40 30 20 10 0 10 20 30 40 50 60 70 80 90 100 110 120 130 140 150

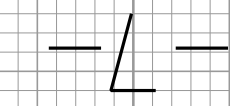

6/23/16

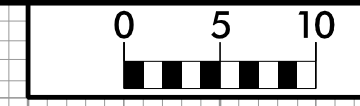

PROJ. REFERENCE NO.
R-2577A

SHEET NO.
X-175

150 140 130 120 110 100 90 80 70 60 50 40 30 20 10 0 10 20 30 40 50 60 70 80 90 100 110 120 130 140 150

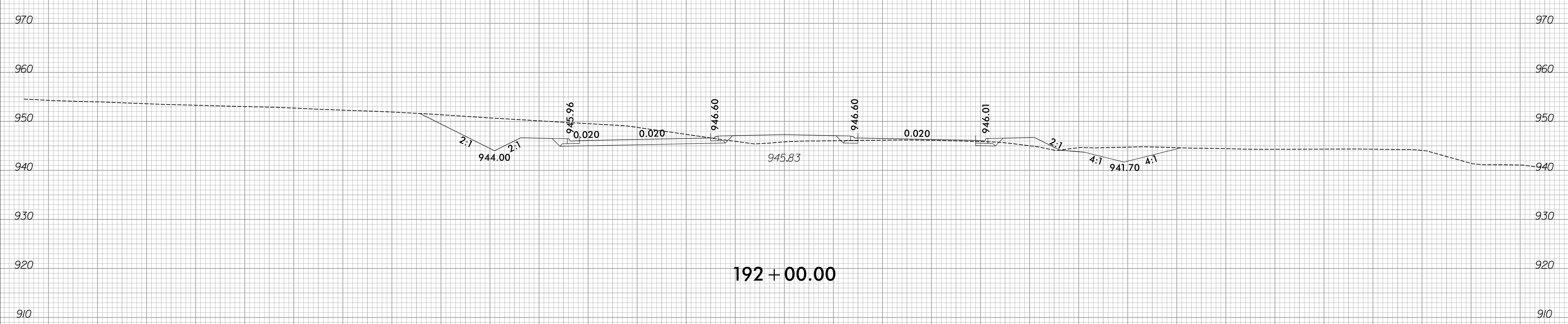
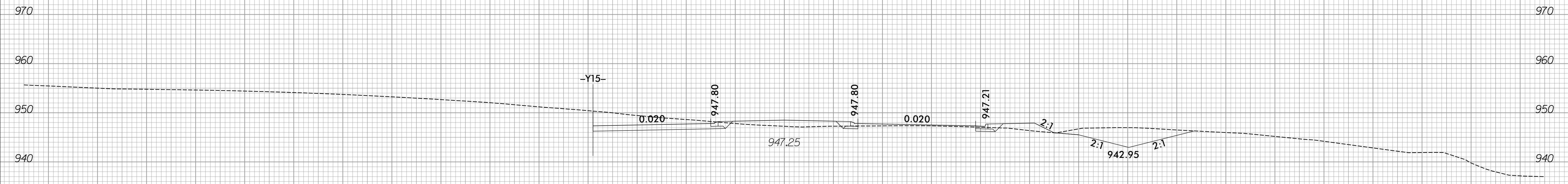

150 140 130 120 110 100 90 80 70 60 50 40 30 20 10 0 10 20 30 40 50 60 70 80 90 100 110 120 130 140 150

12/21/2023
R:\Roadway\XSC\R-2577A_Rdu_xpl.dgn
amcpherson

6/23/16

	PROJ. REFERENCE NO. R-2577A	SHEET NO. X-176
--	--------------------------------	--------------------

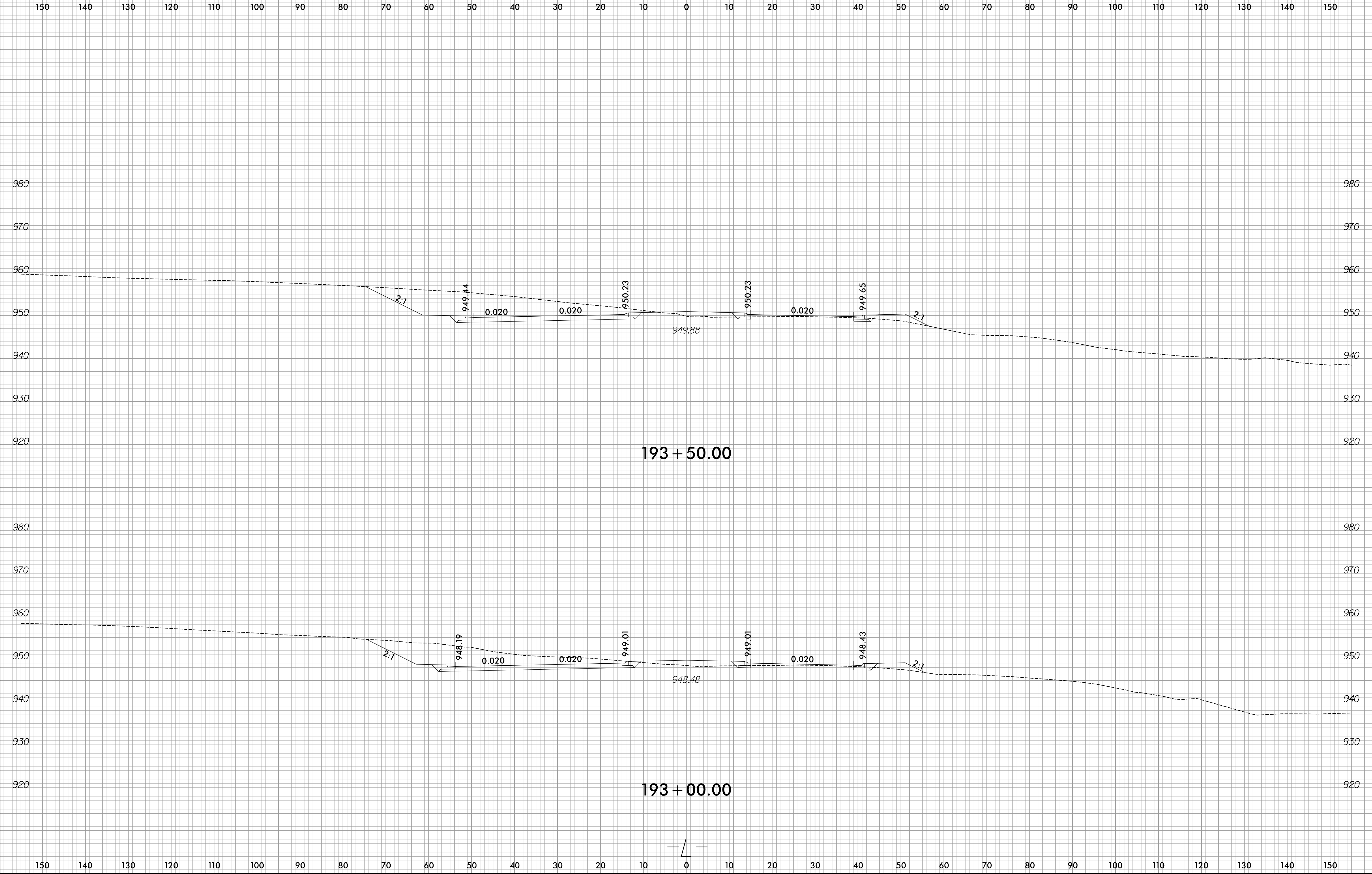

12/2/2023
R:\Roadway\XSC\R-2577A_Rdy_xpl.dgn
amcsp@psd.com

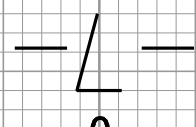

150 140 130 120 110 100 90 80 70 60 50 40 30 20 10 0 10 20 30 40 50 60 70 80 90 100 110 120 130 140 150

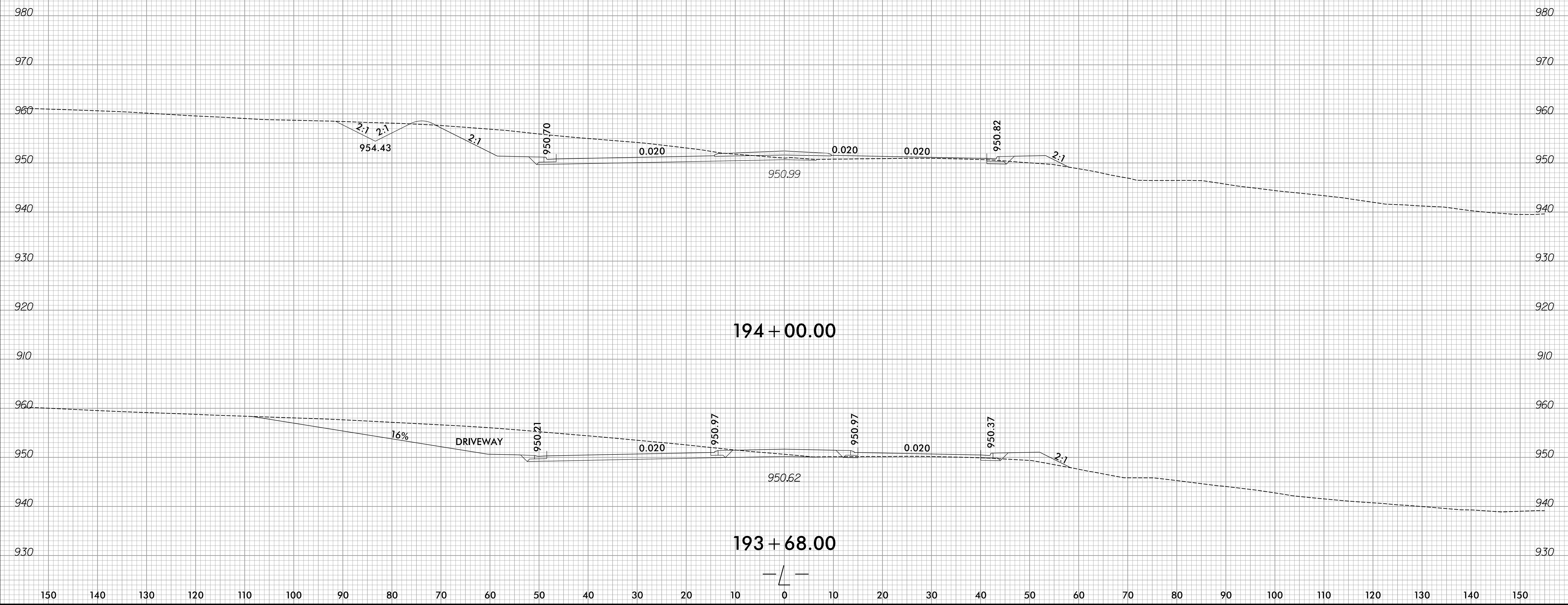

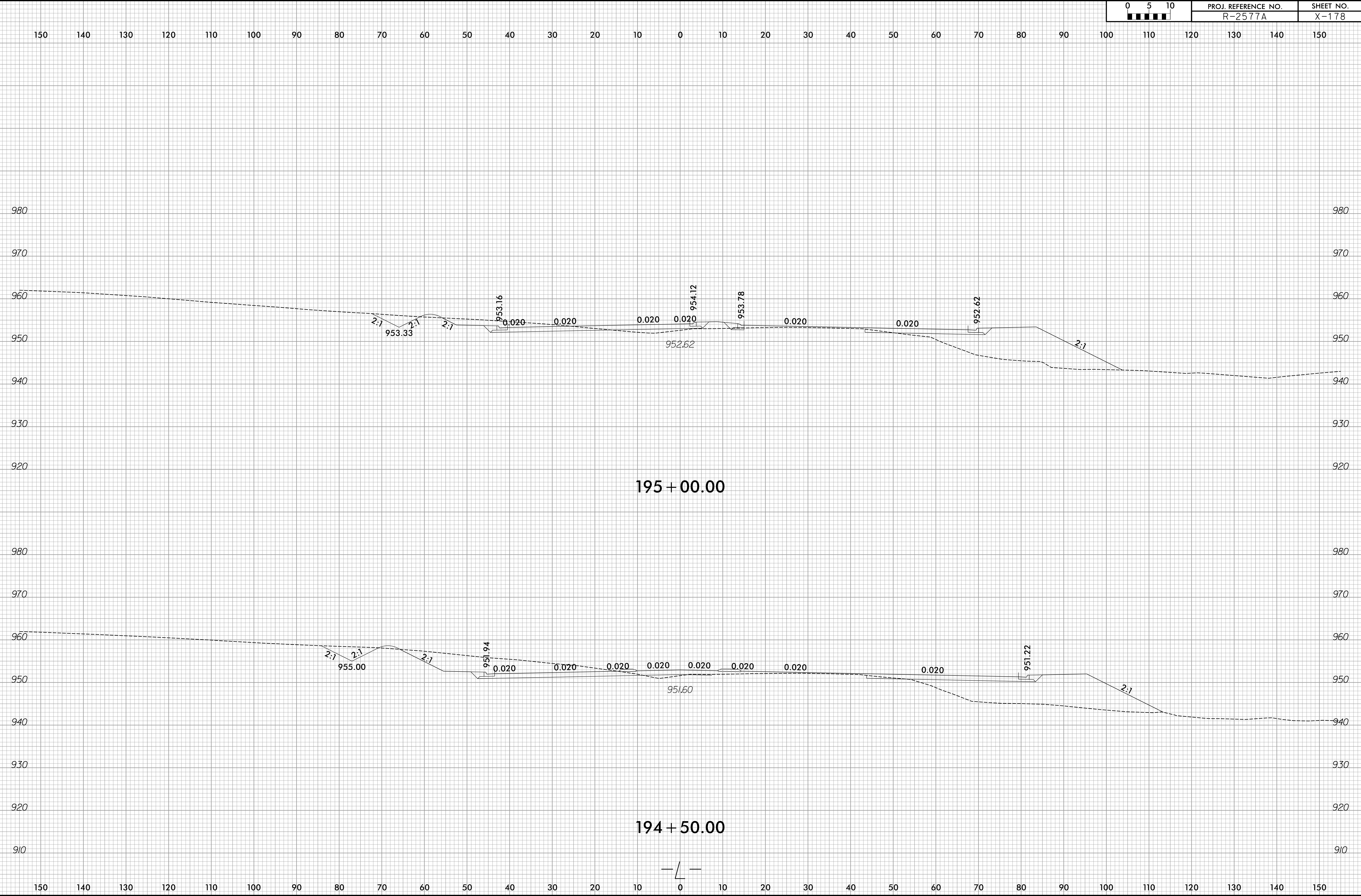

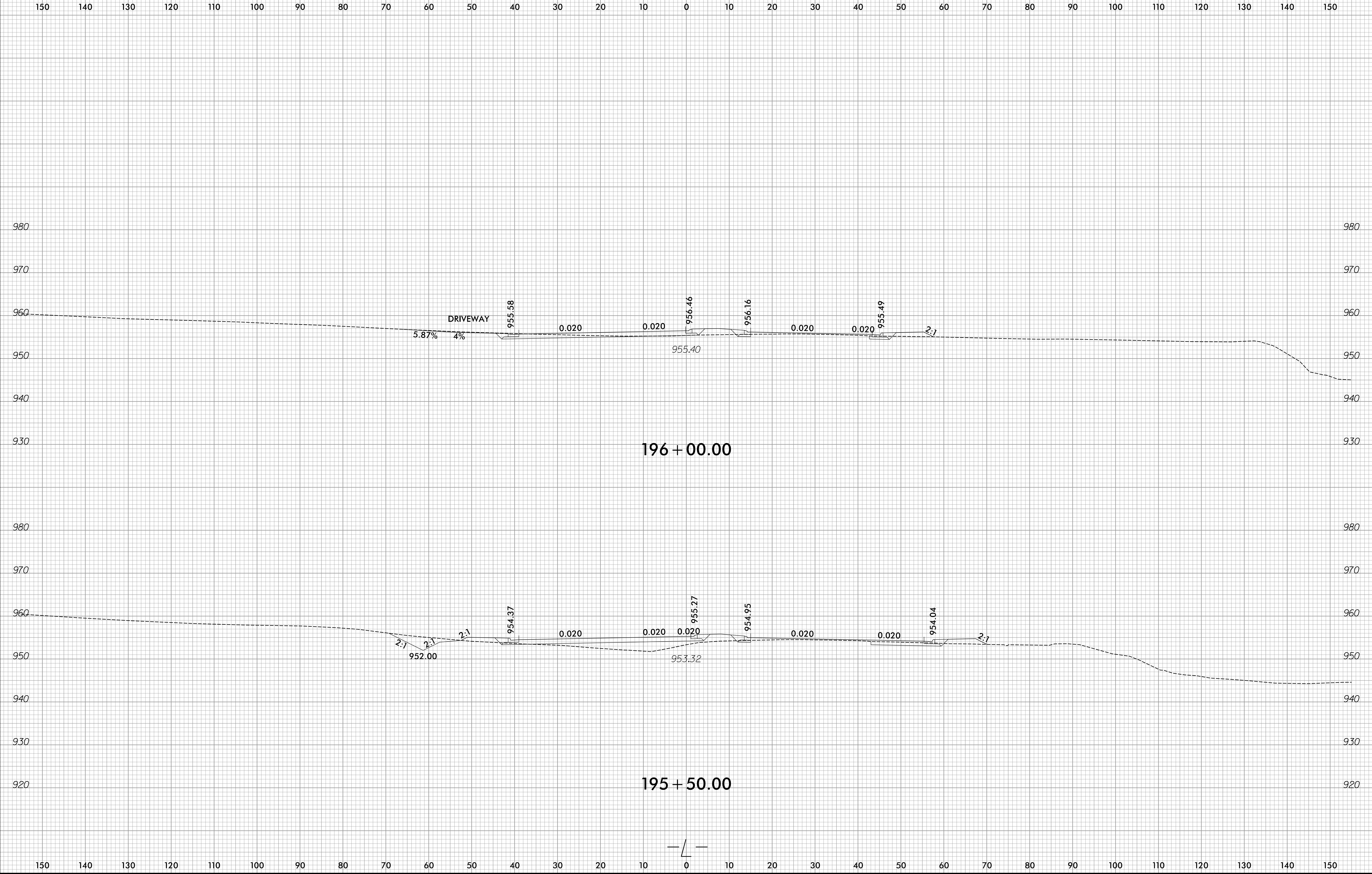

150 140 130 120 110 100 90 80 70 60 50 40 30 20 10 0 10 20 30 40 50 60 70 80 90 100 110 120 130 140 150

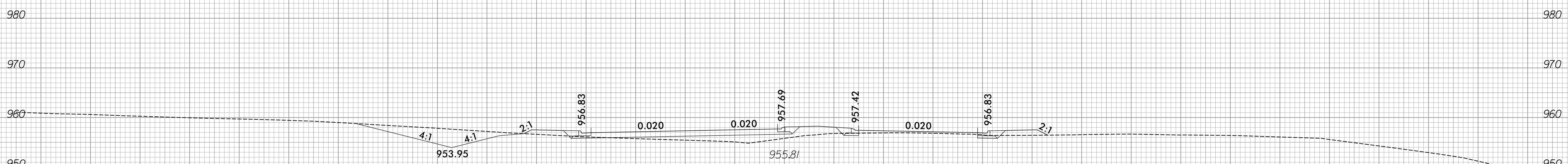
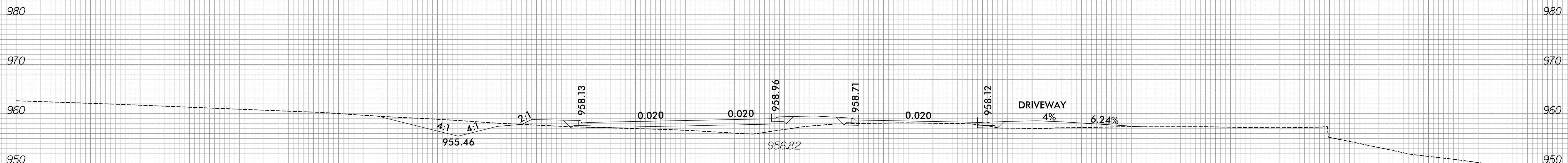
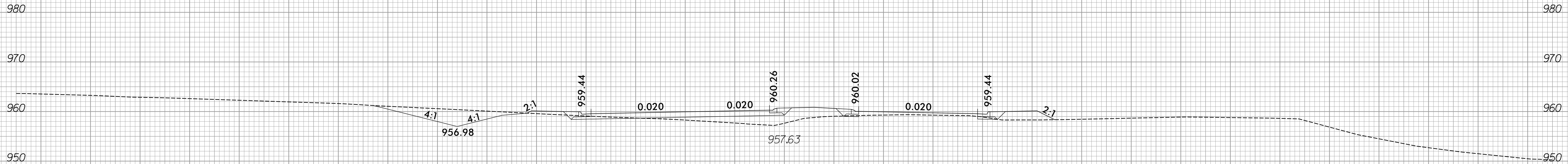

150 140 130 120 110 100 90 80 70 60 50 40 30 20 10 0 10 20 30 40 50 60 70 80 90 100 110 120 130 140 150

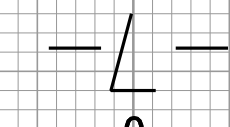

6/23/16

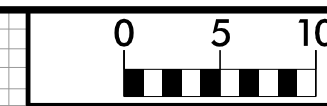

PROJ. REFERENCE NO.	SHEET NO.
R-2577A	X-181

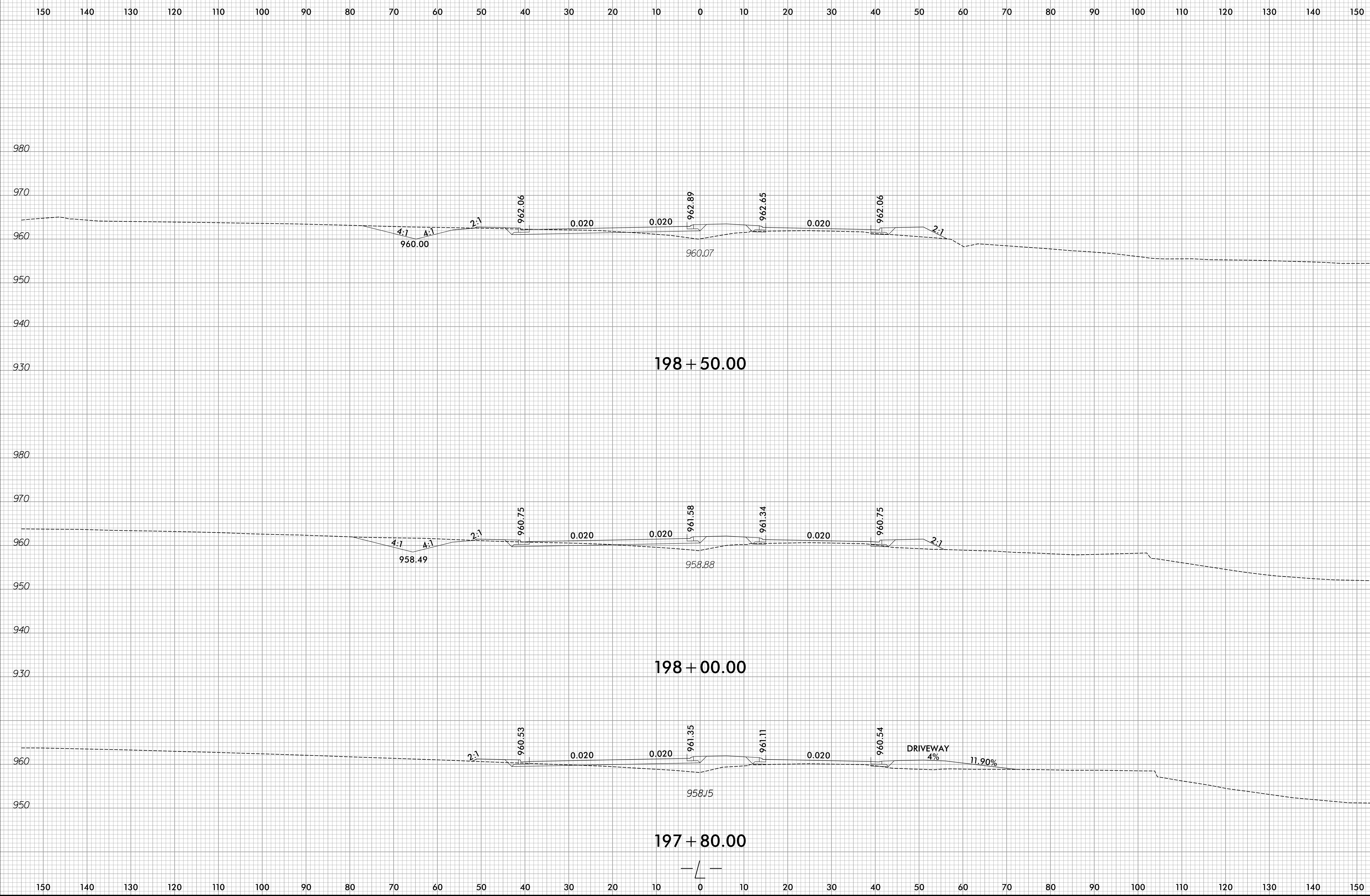

12/21/2023
R:\Roadway\XSC\R-2577A_Rdy_xpl.dgn
amcpherson

6/23/16

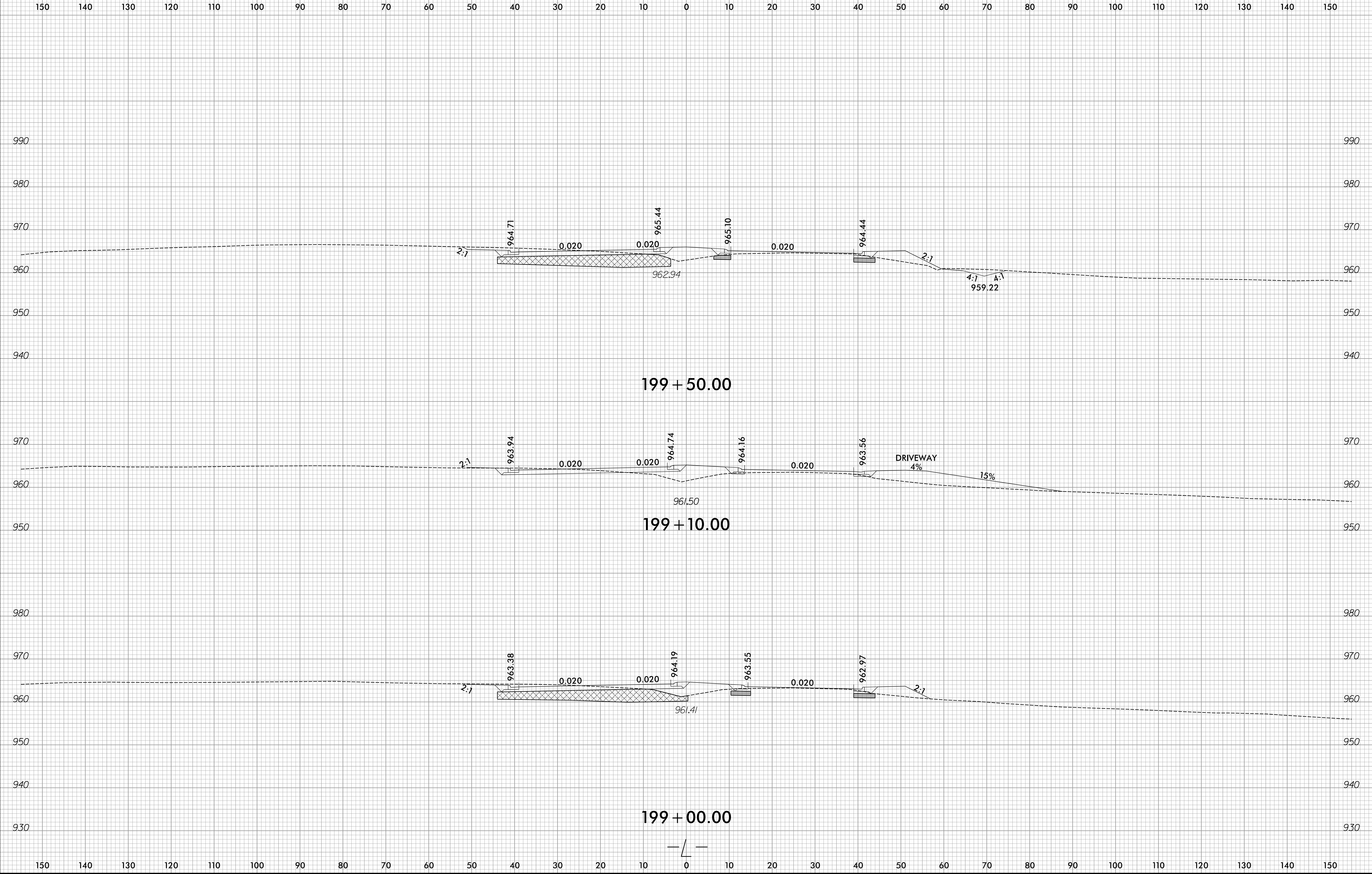

12/2/2023
R:\Roadway\XSC\R-2577A_Rdu_xpl.dgn
amcpherson

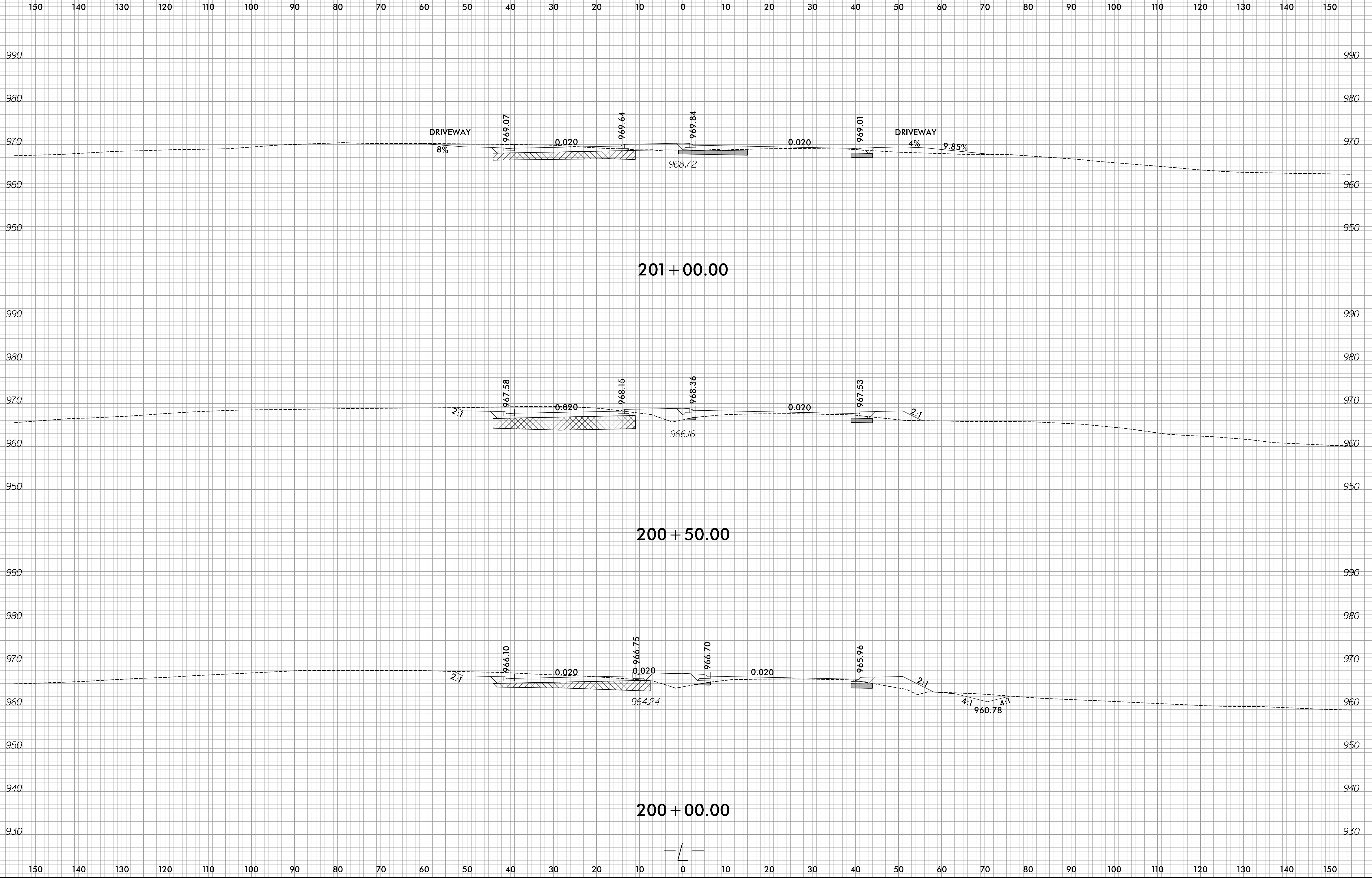

6/23/16

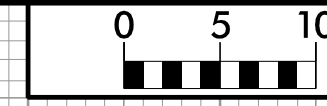

PROJ. REFERENCE NO. R-2577A	SHEET NO. X-184
--------------------------------	--------------------

150 140 130 120 110 100 90 80 70 60 50 40 30 20 10 0 10 20 30 40 50 60 70 80 90 100 110 120 130 140 150

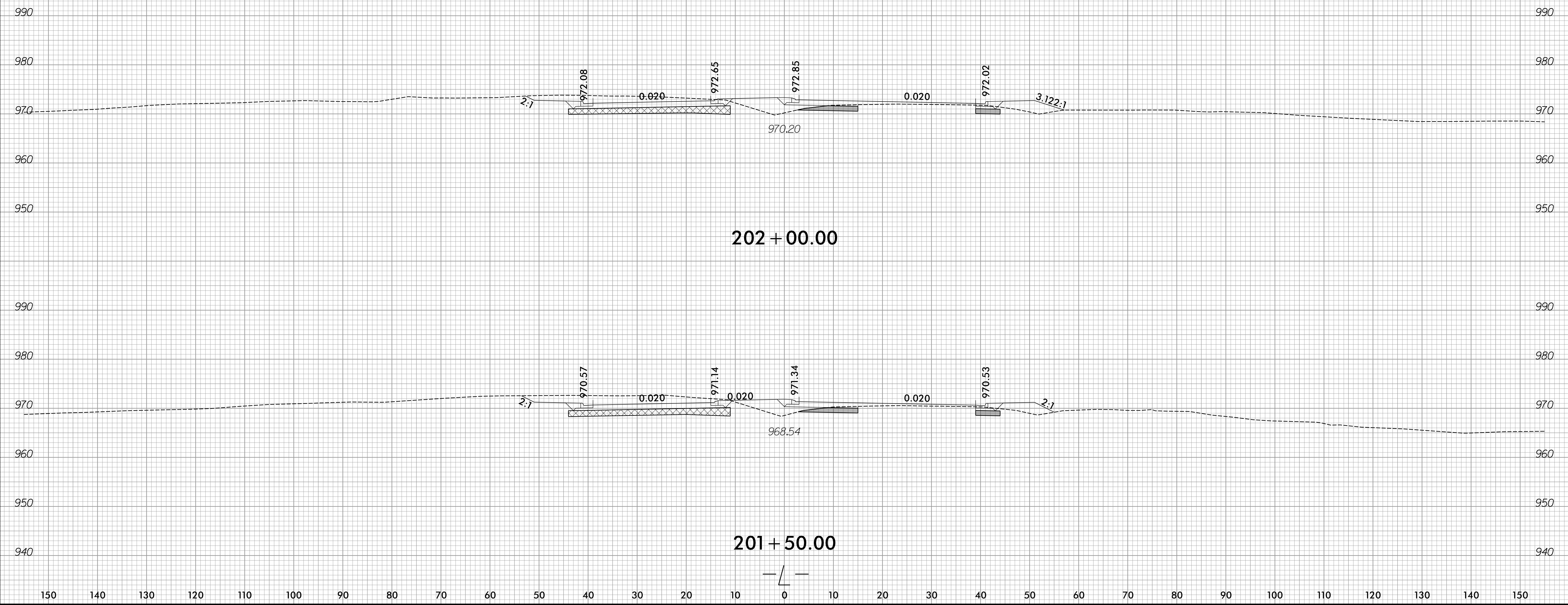

12/2/2023 R:\Roadway\XSC\R-2577A_Rdu_xp1.L.dgn amc@peterson

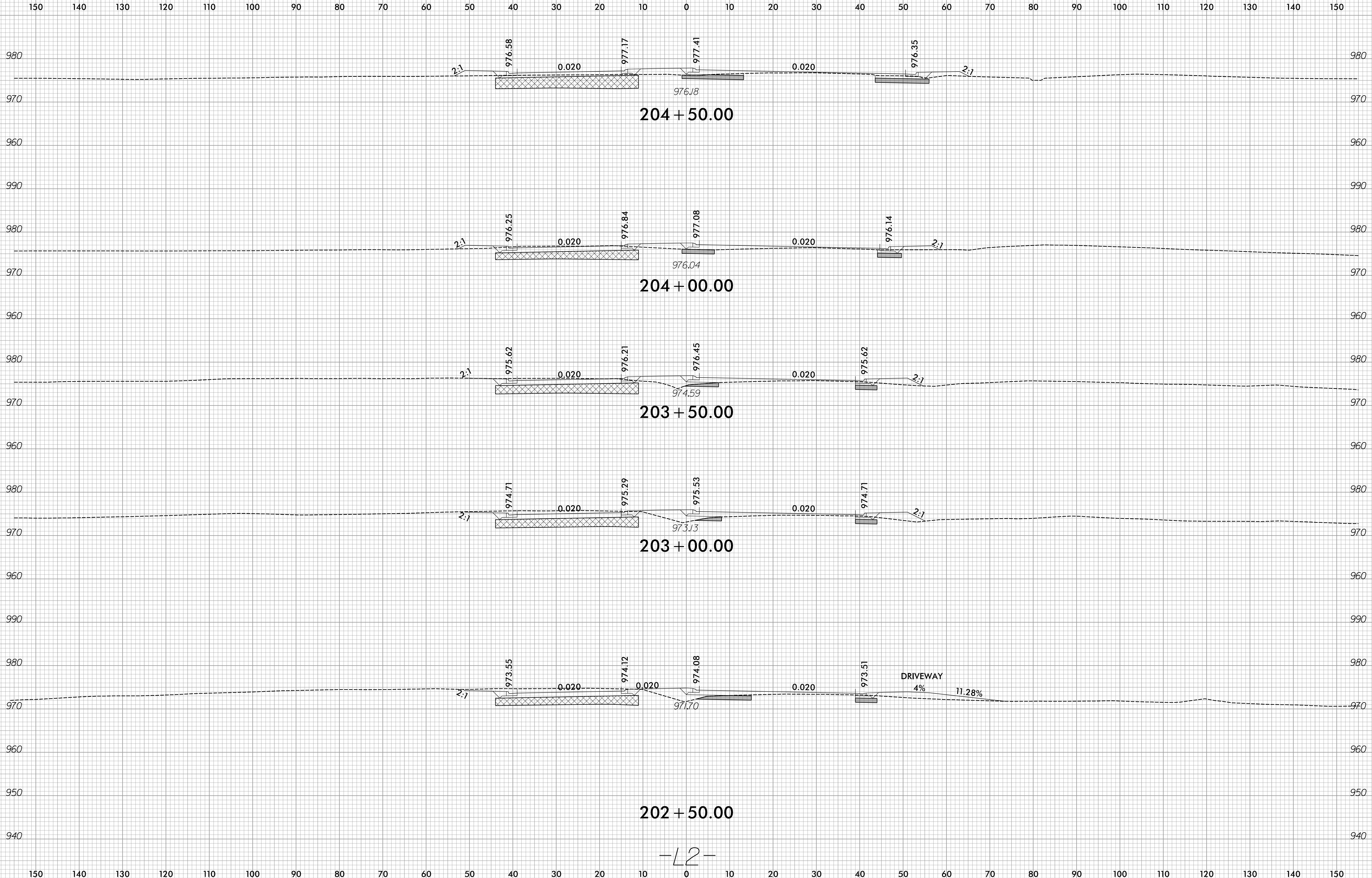



150 140 130 120 110 100 90 80 70 60 50 40 30 20 10 0 10 20 30 40 50 60 70 80 90 100 110 120 130 140 150

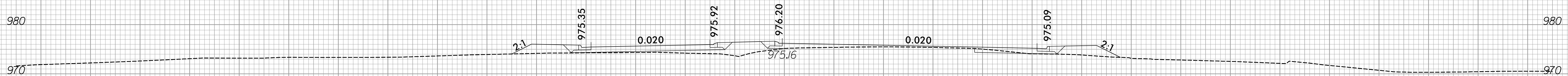

206 + 50.00

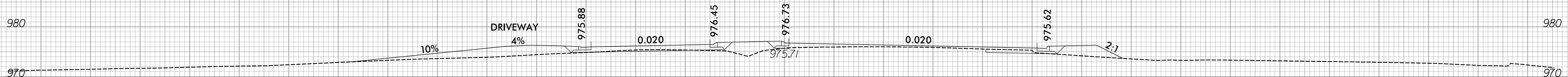

206 + 00.00

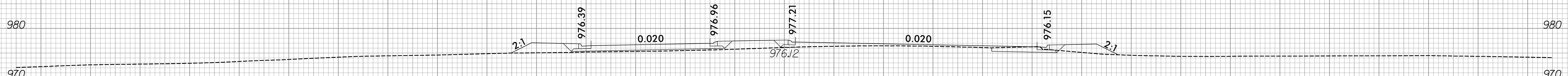

205 + 50.00

END UNDERCUT EXCAVATION STA. 205+25

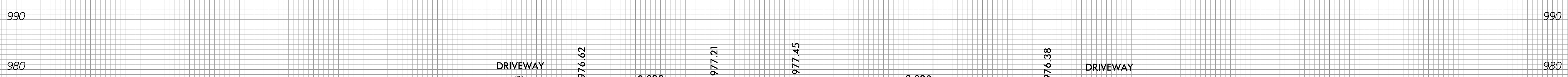

205 + 00.00

150 140 130 120 110 100 90 80 70 60 50 40 30 20 10 0 10 20 30 40 50 60 70 80 90 100 110 120 130 140 150

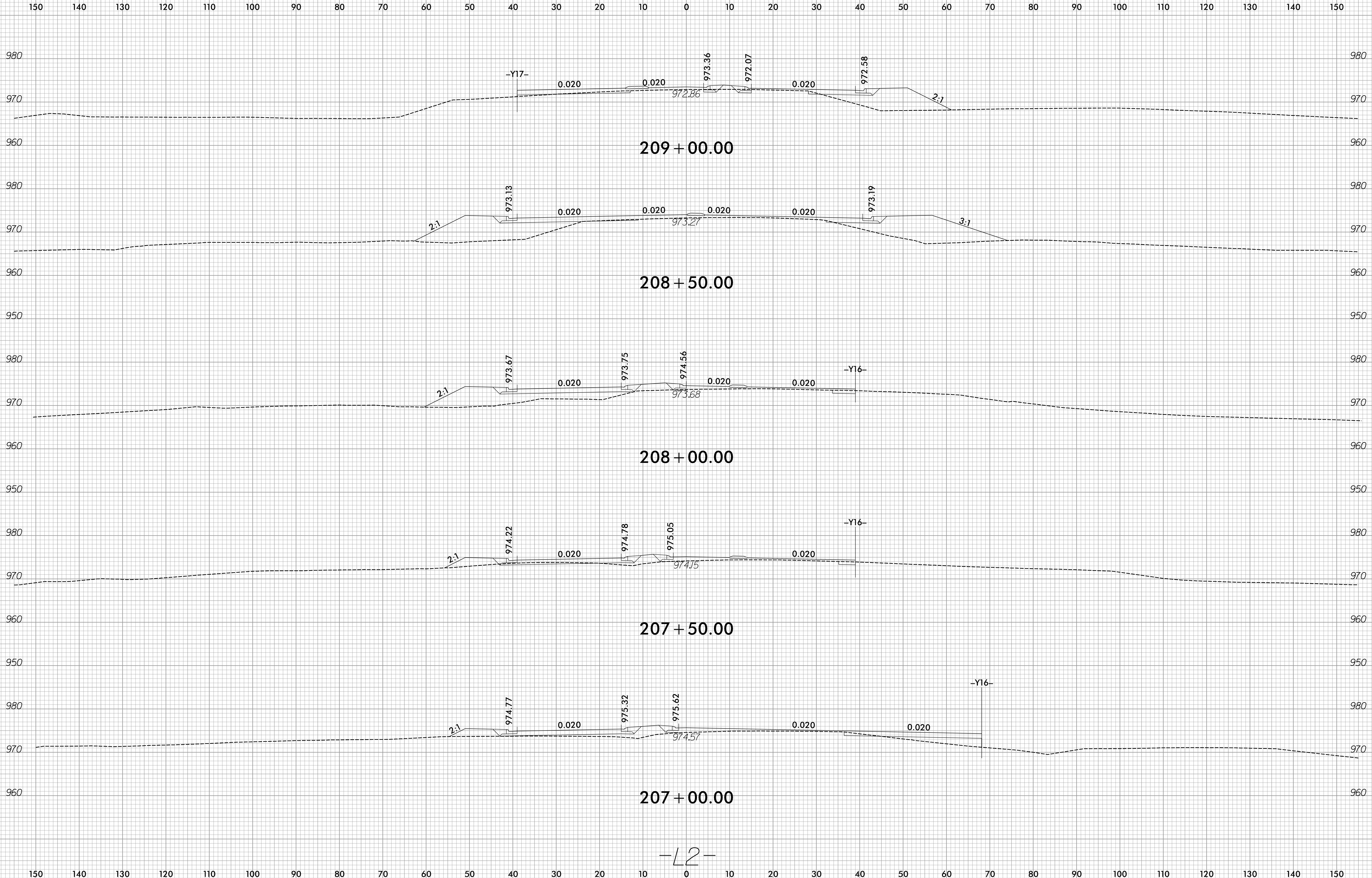



150 140 130 120 110 100 90 80 70 60 50 40 30 20 10 0 10 20 30 40 50 60 70 80 90 100 110 120 130 140 150

END SHALLOW UNDERCUT EXCAVATION STA. 211+75
 END UNDERCUT EXCAVATION STA. 211+75

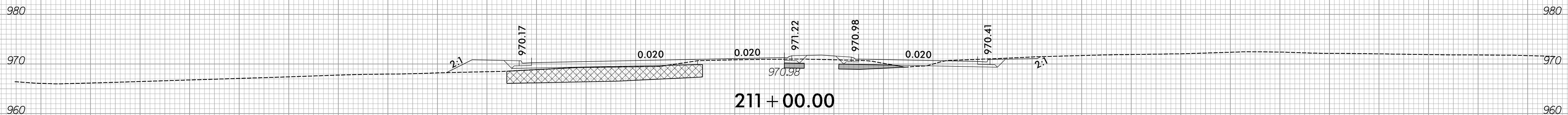
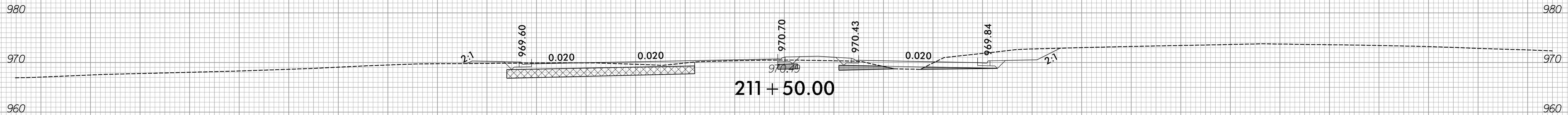

BEGIN UNDERCUT EXCAVATION STA. 210+75
 BEGIN SHALLOW UNDERCUT EXCAVATION STA. 210+75

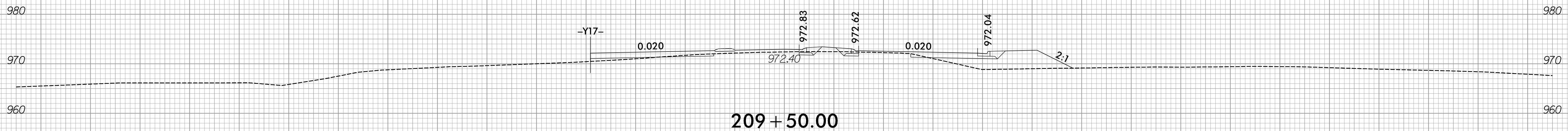
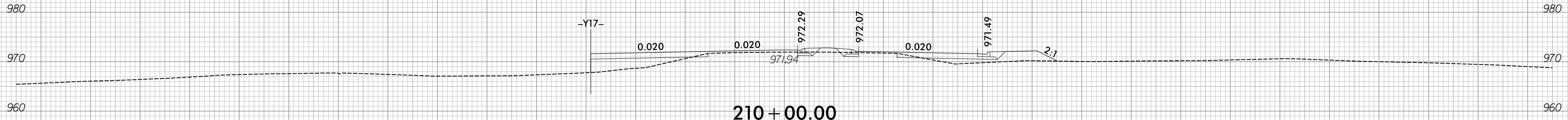
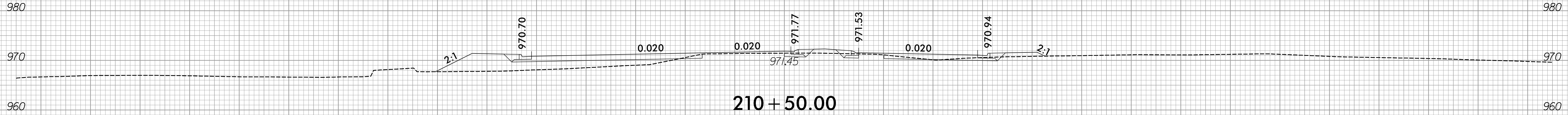

-L2-

150 140 130 120 110 100 90 80 70 60 50 40 30 20 10 0 10 20 30 40 50 60 70 80 90 100 110 120 130 140 150

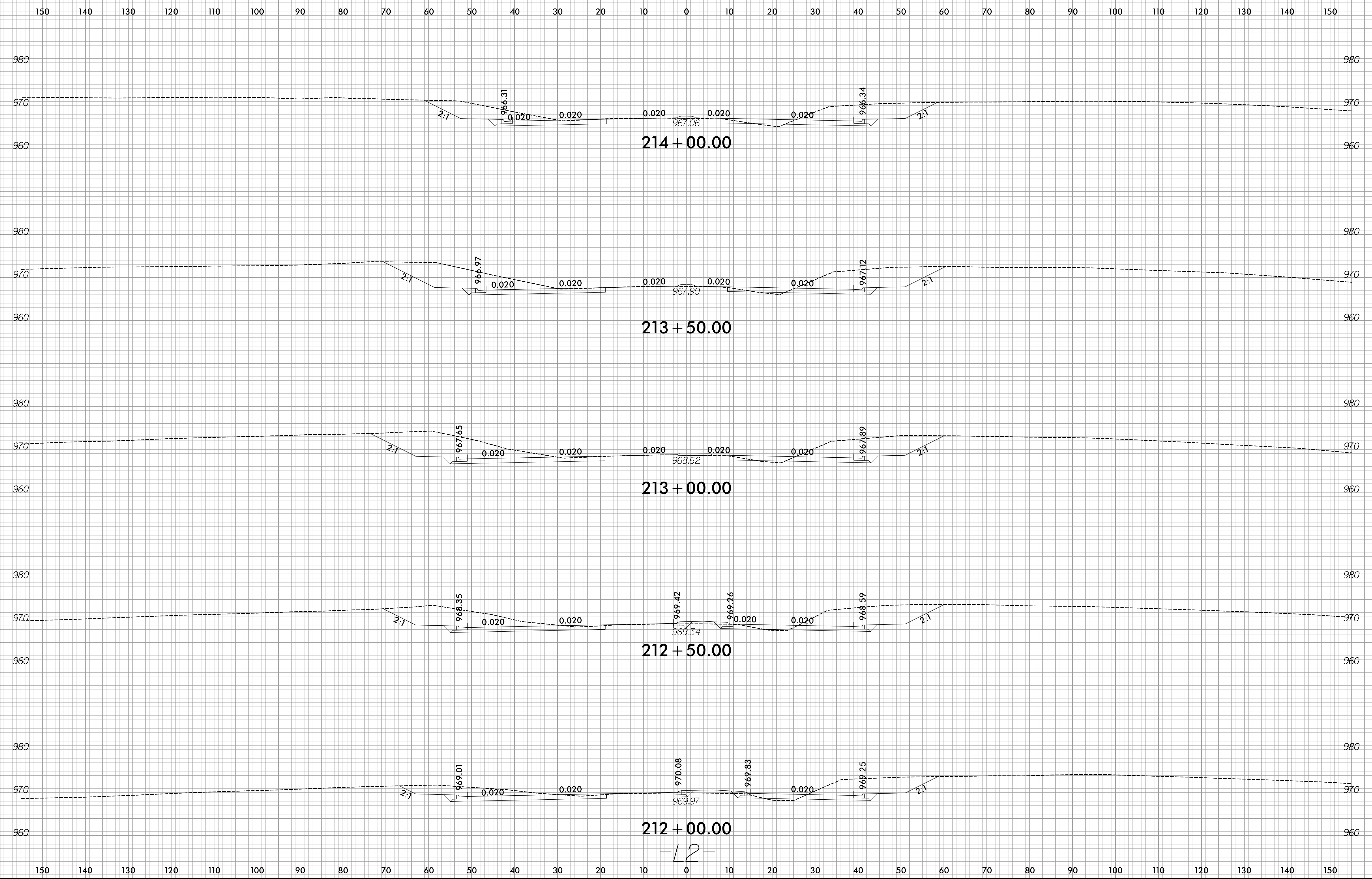

214 + 00.00

213 + 50.00

213 + 00.00

212 + 50.00

212 + 00.00

-12-

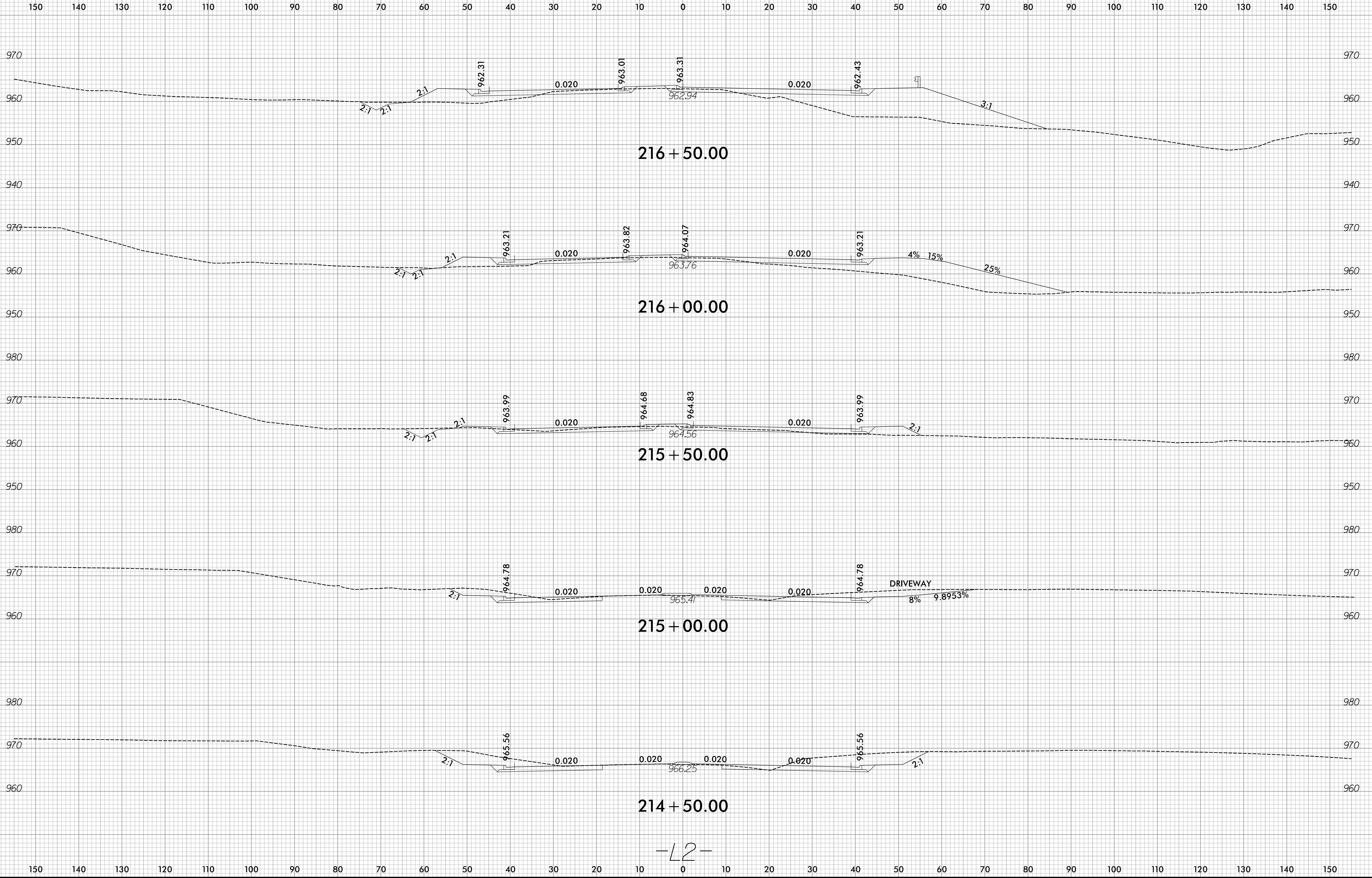

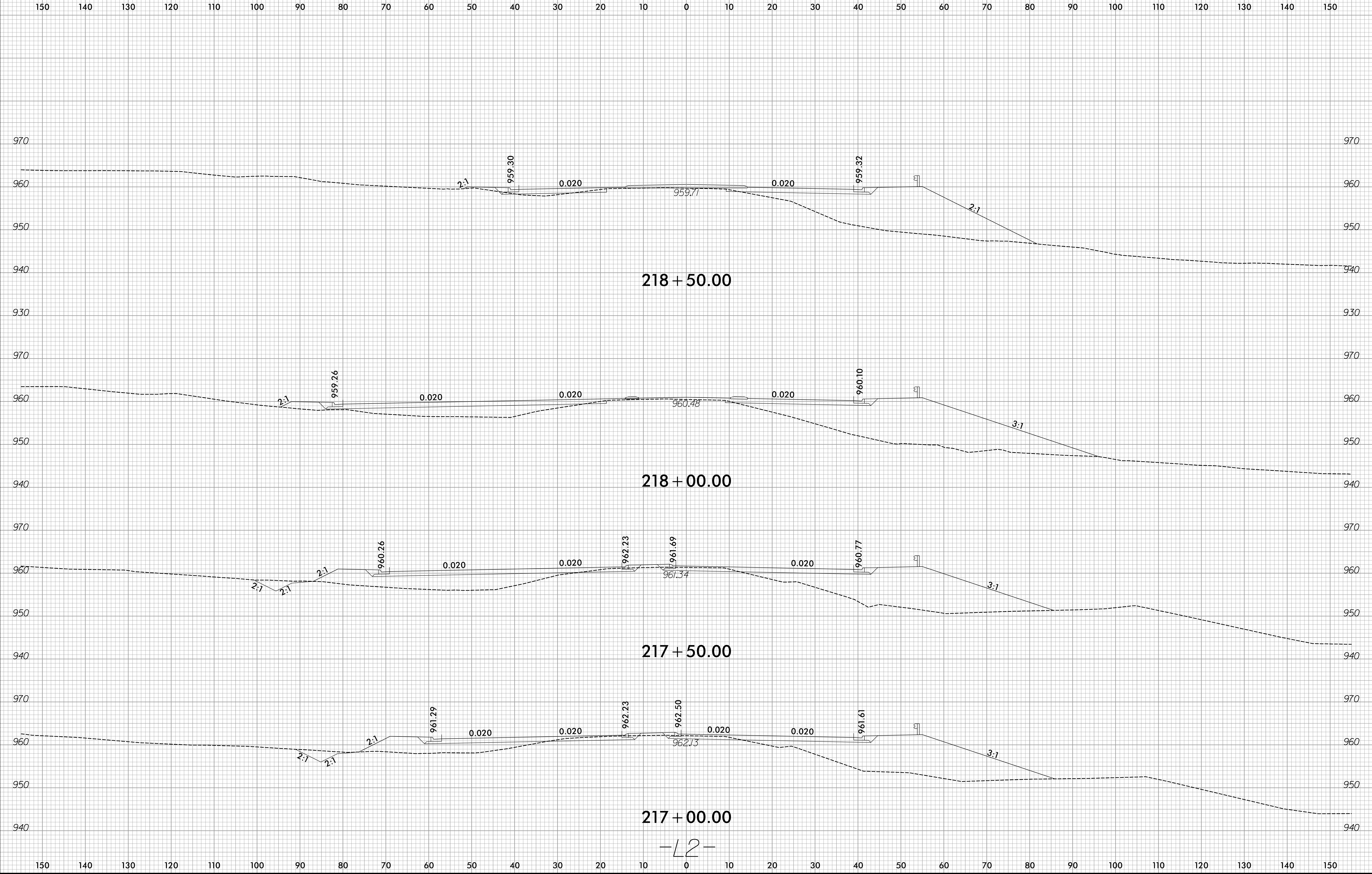

218 + 50.00

218 + 00.00

217 + 50.00

217 + 00.00

-L2-

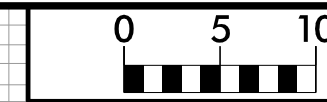

150 140 130 120 110 100 90 80 70 60 50 40 30 20 10 0 10 20 30 40 50 60 70 80 90 100 110 120 130 140 150

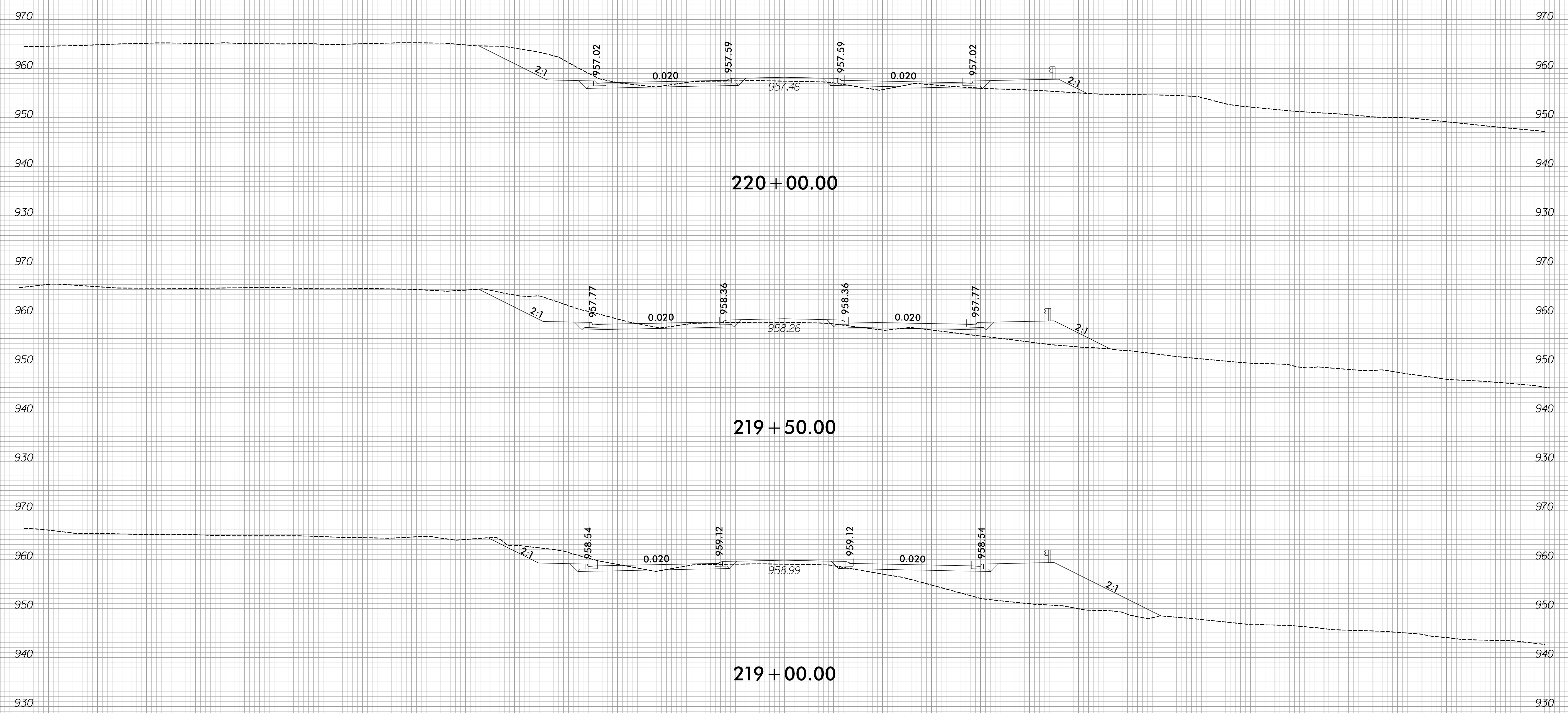

220 + 00.00

219 + 50.00

219 + 00.00

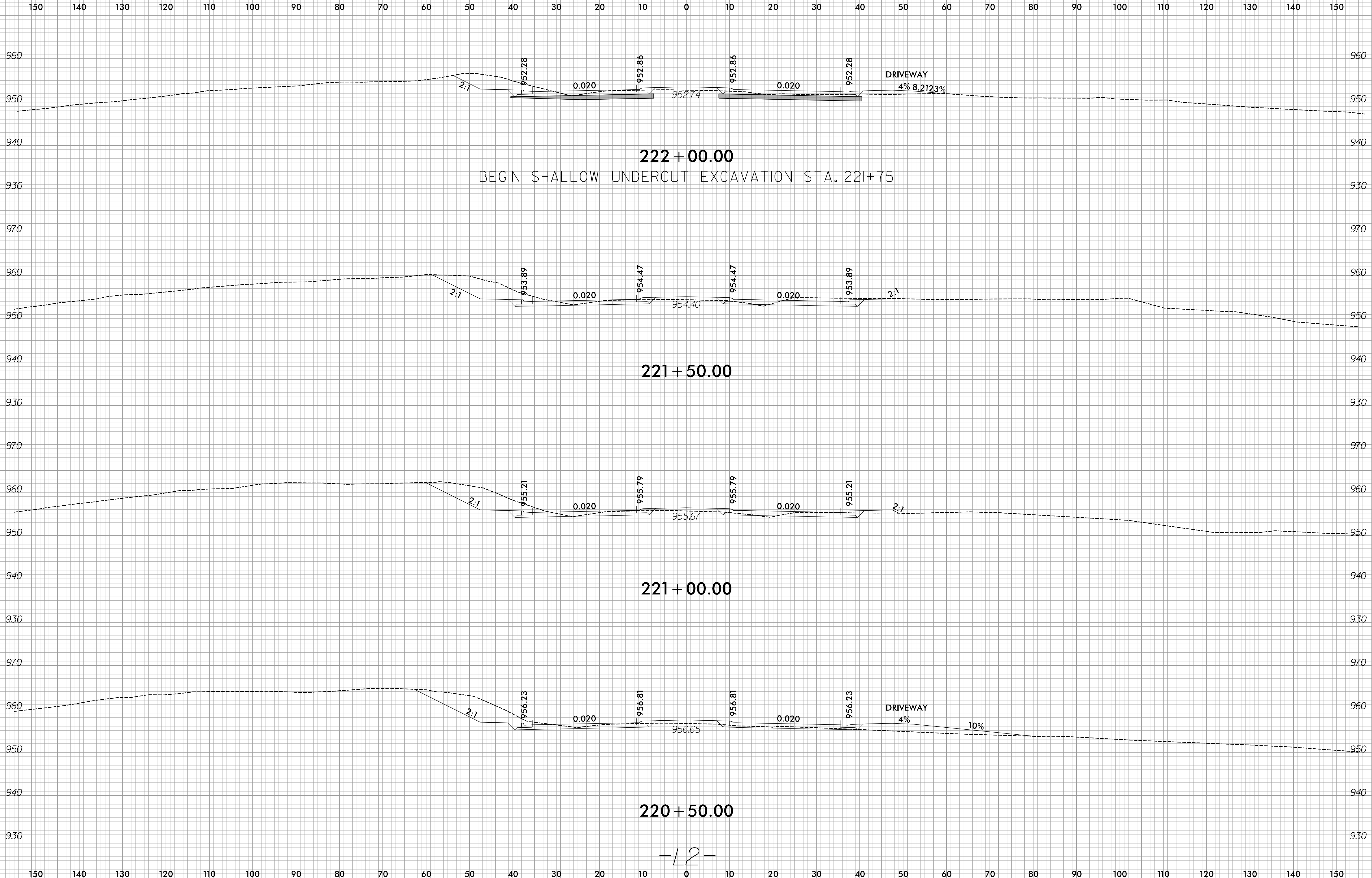

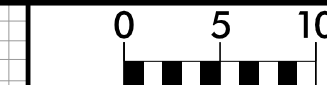

150 140 130 120 110 100 90 80 70 60 50 40 30 20 10 0 10 20 30 40 50 60 70 80 90 100 110 120 130 140 150

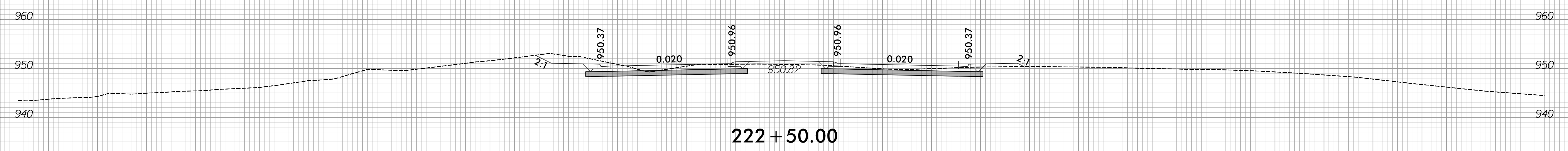
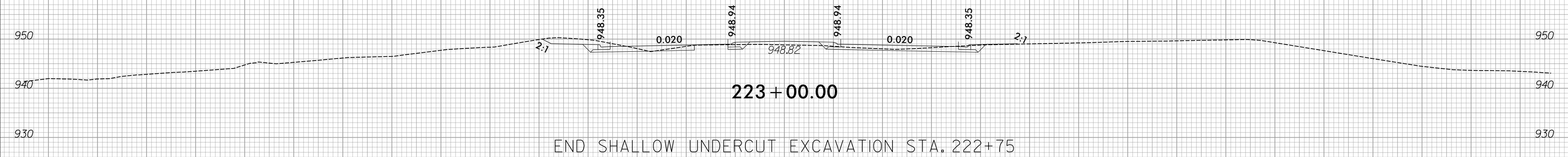
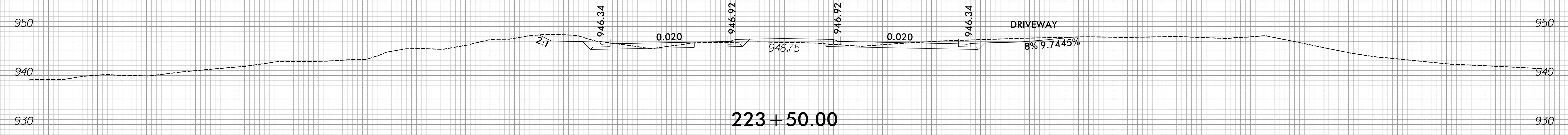
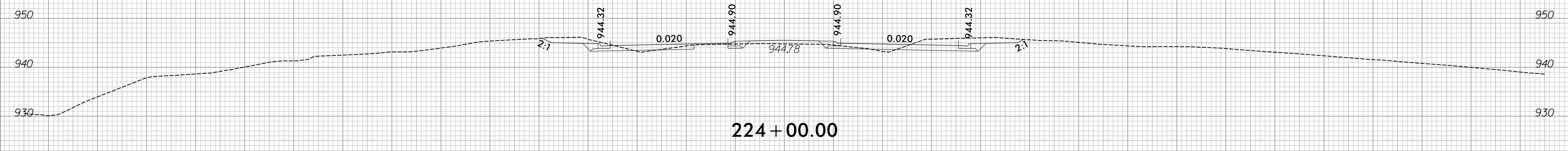

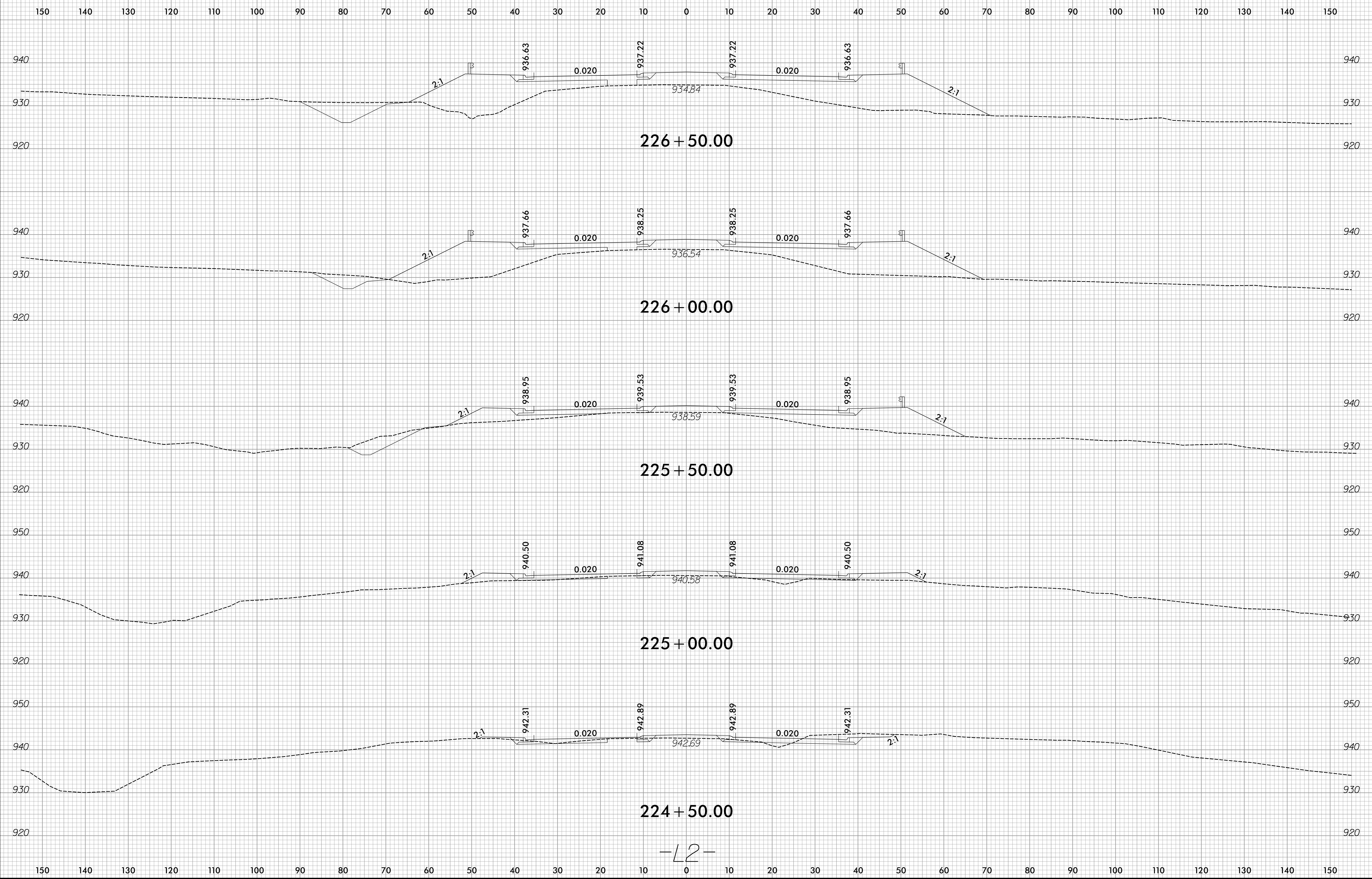

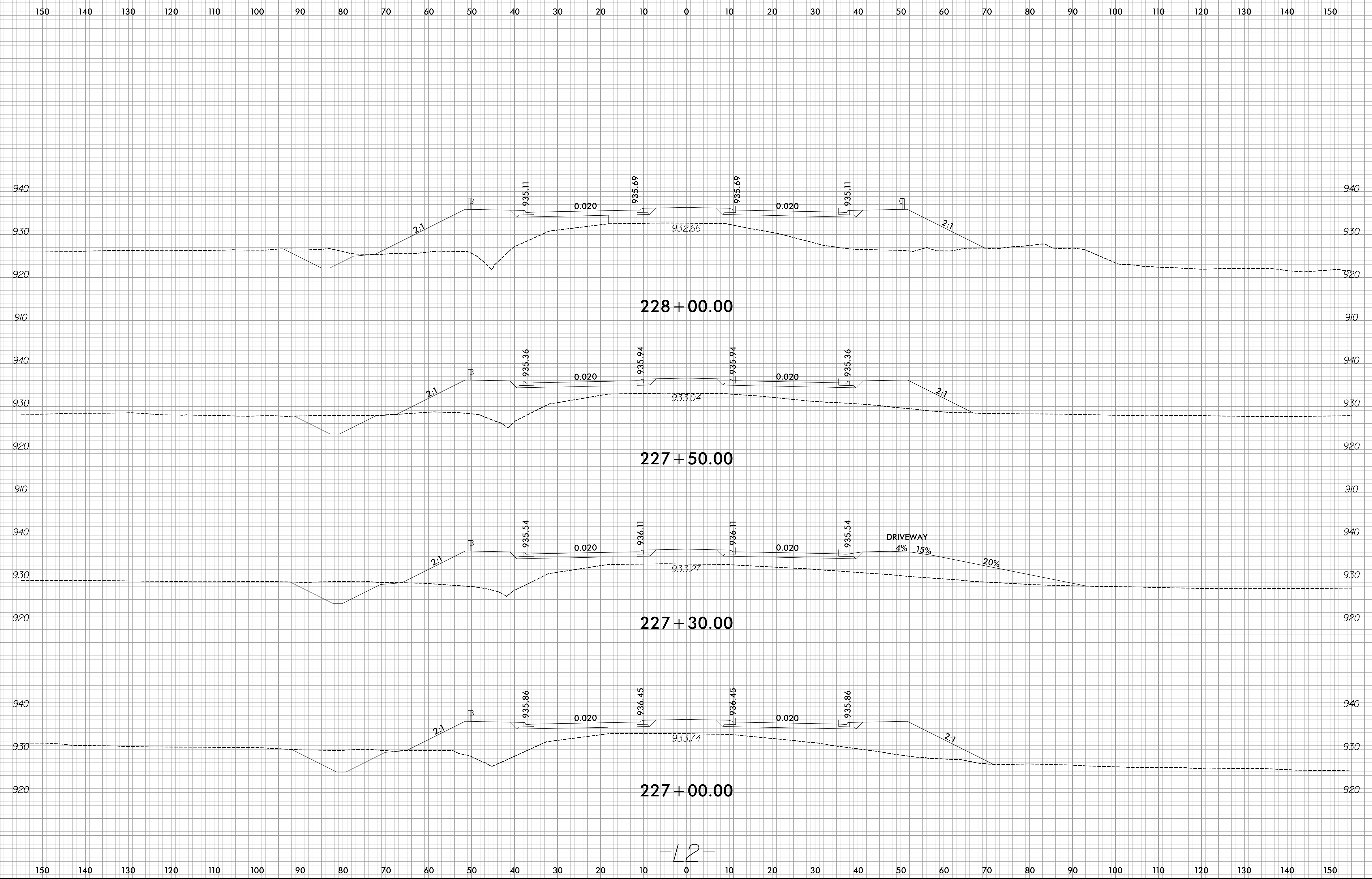

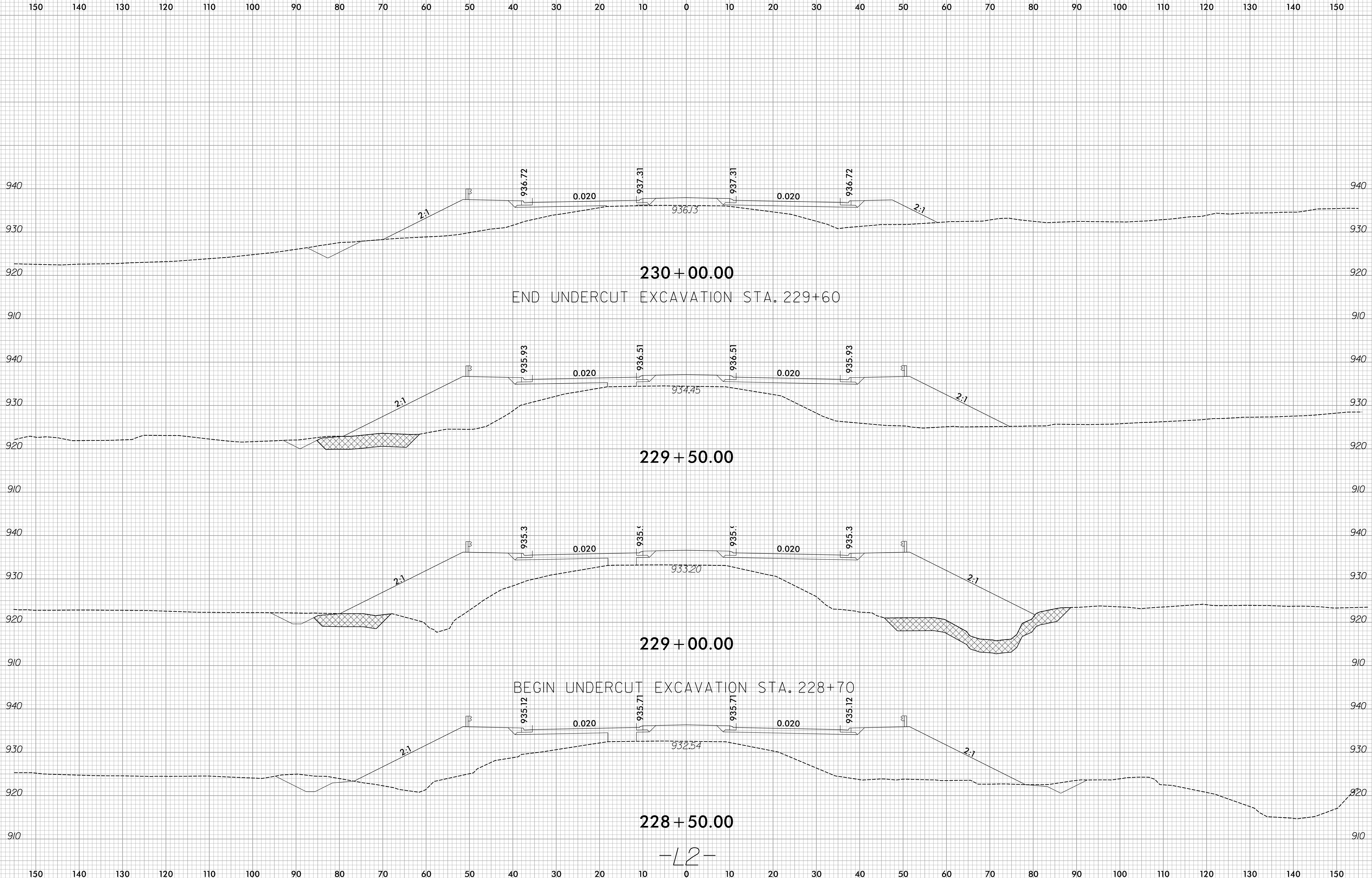

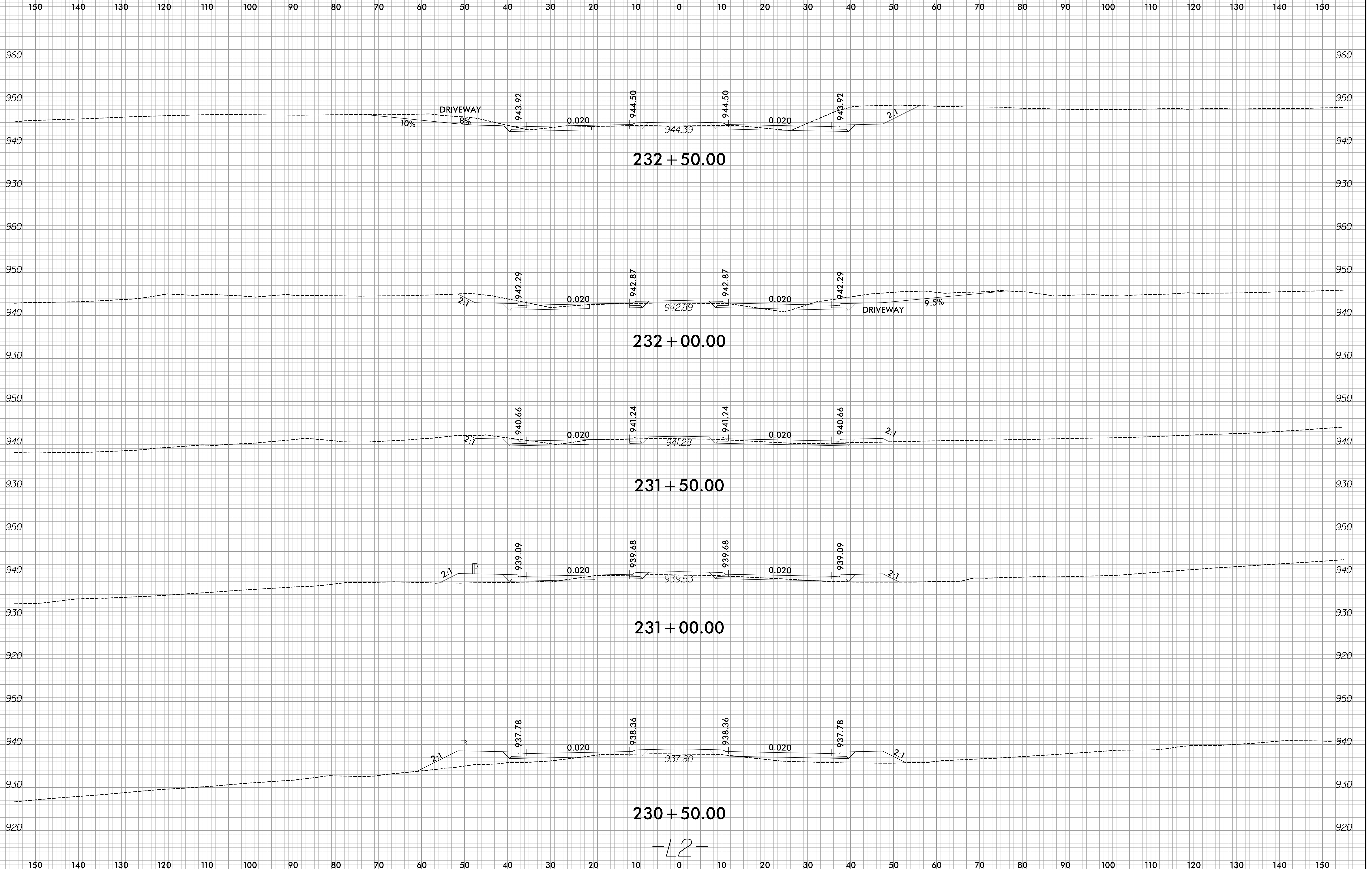

232 + 50.00

232 + 00.00

231 + 50.00

231 + 00.00

230 + 50.00

-L2-

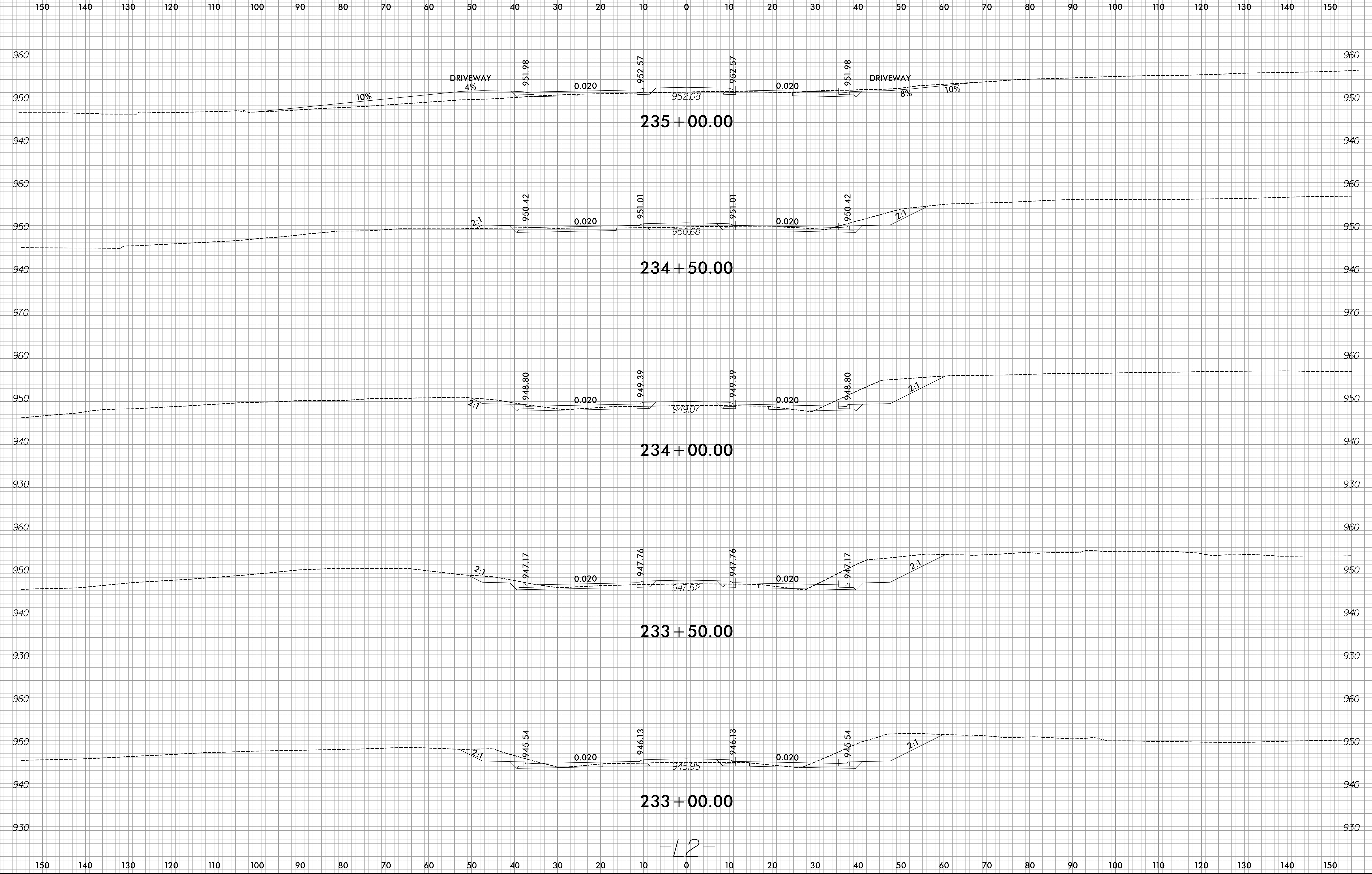

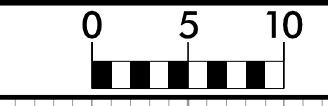

150 140 130 120 110 100 90 80 70 60 50 40 30 20 10 0 10 20 30 40 50 60 70 80 90 100 110 120 130 140 150

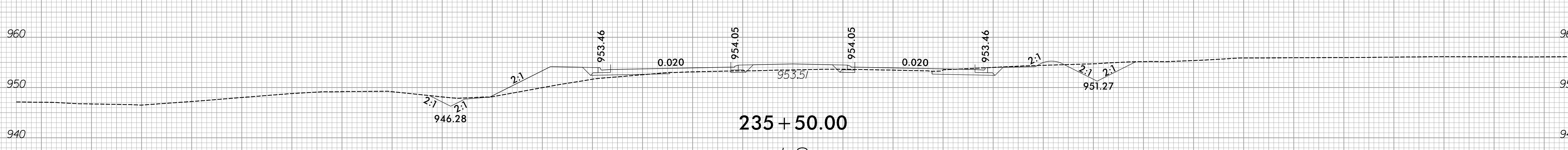
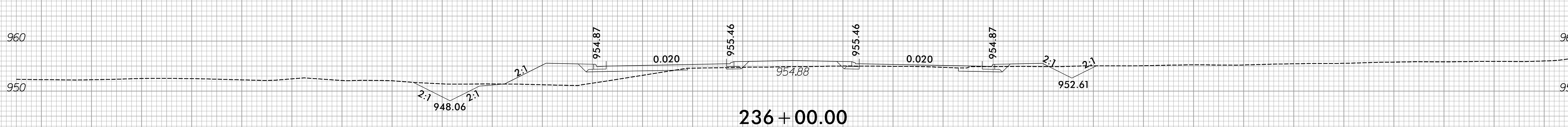
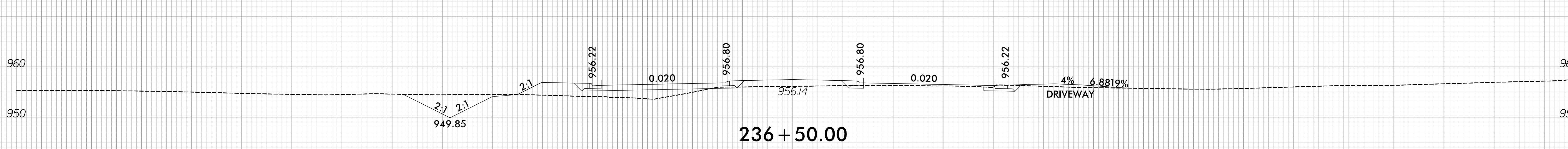
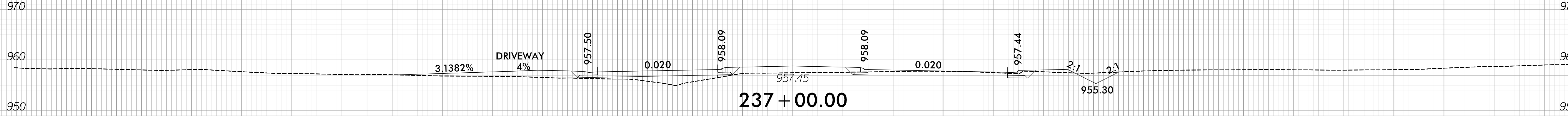
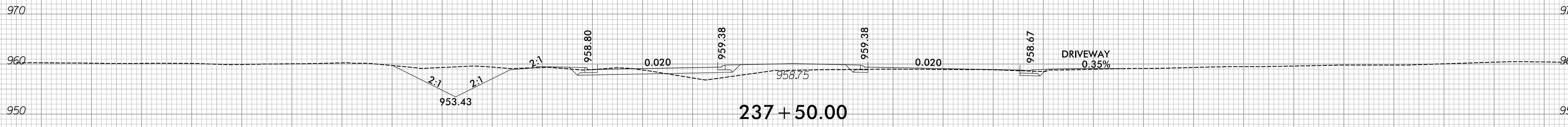
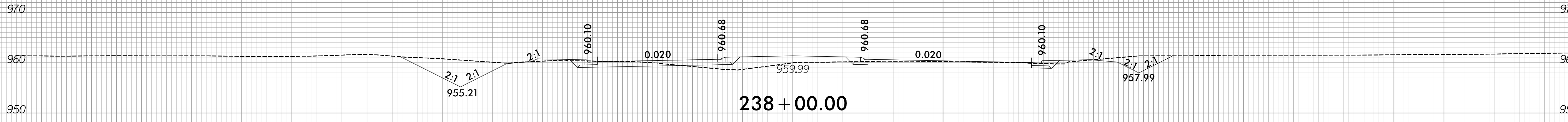

-12-

6/23/16



PROJ. REFERENCE NO.
R-2577A

SHEET NO.
X-201

150 140 130 120 110 100 90 80 70 60 50 40 30 20 10 0 10 20 30 40 50 60 70 80 90 100 110 120 130 140 150

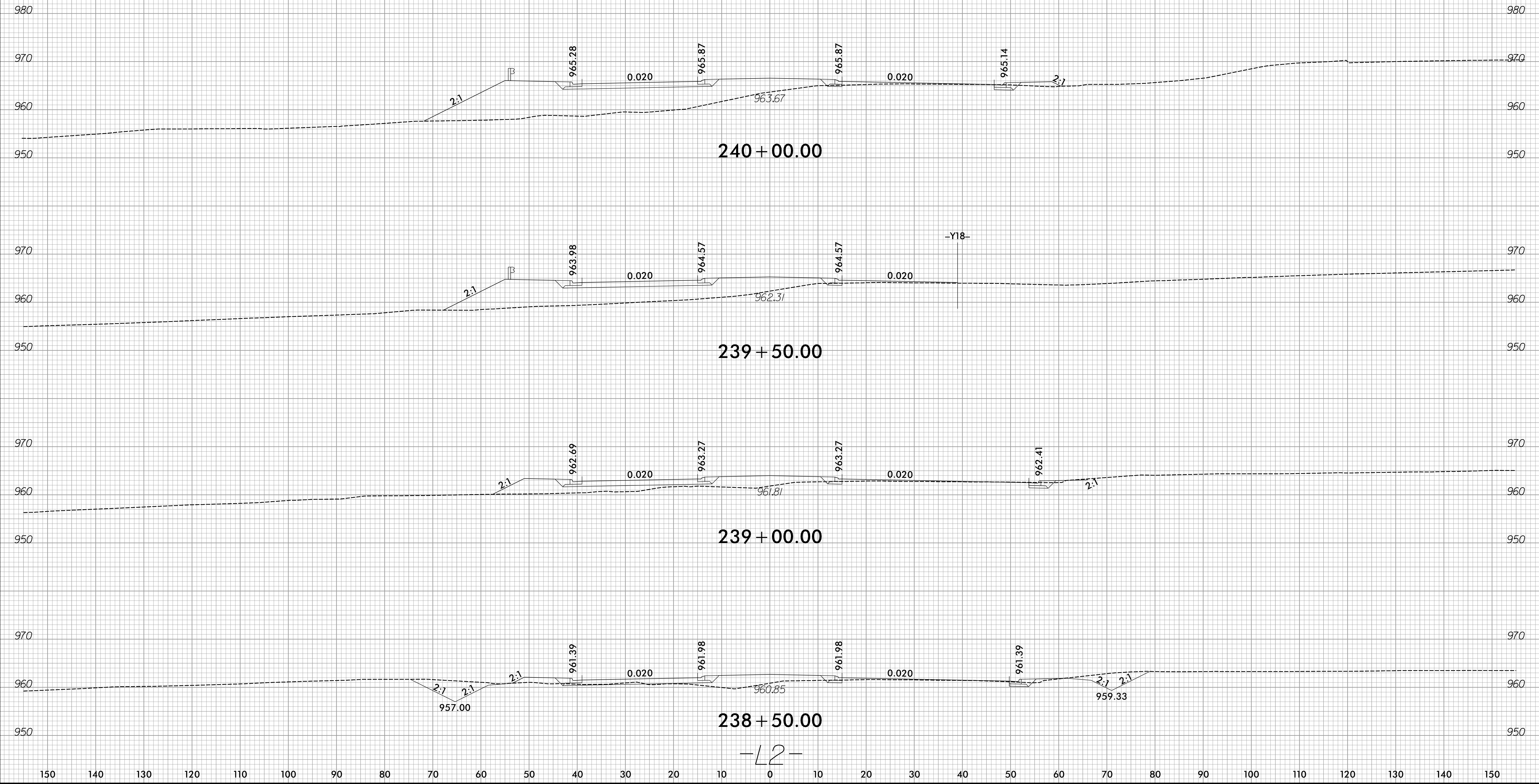

12/20/2023
R:\Roadway\XSC\R-2577A_RDY_xp1.L2.DGN
amcpherson



150 140 130 120 110 100 90 80 70 60 50 40 30 20 10 0 10 20 30 40 50 60 70 80 90 100 110 120 130 140 150

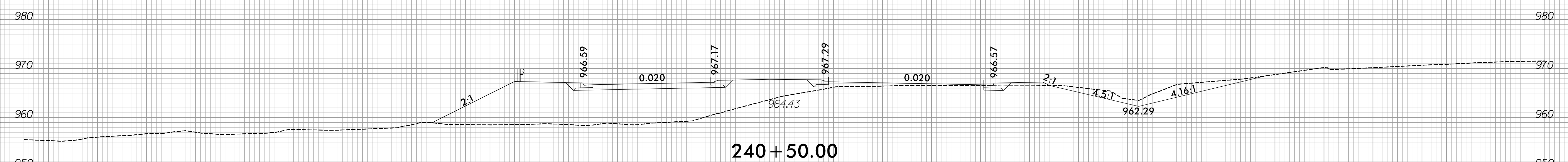
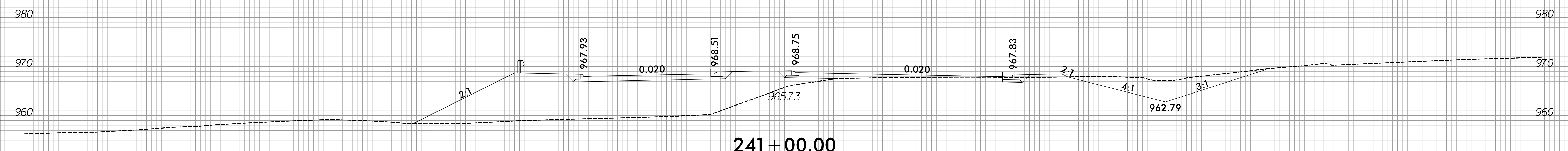
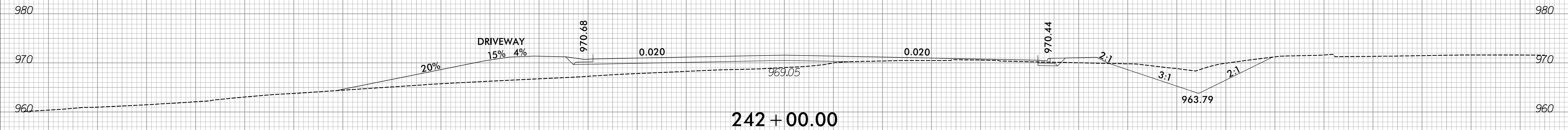

-L2-

150 140 130 120 110 100 90 80 70 60 50 40 30 20 10 0 10 20 30 40 50 60 70 80 90 100 110 120 130 140 150

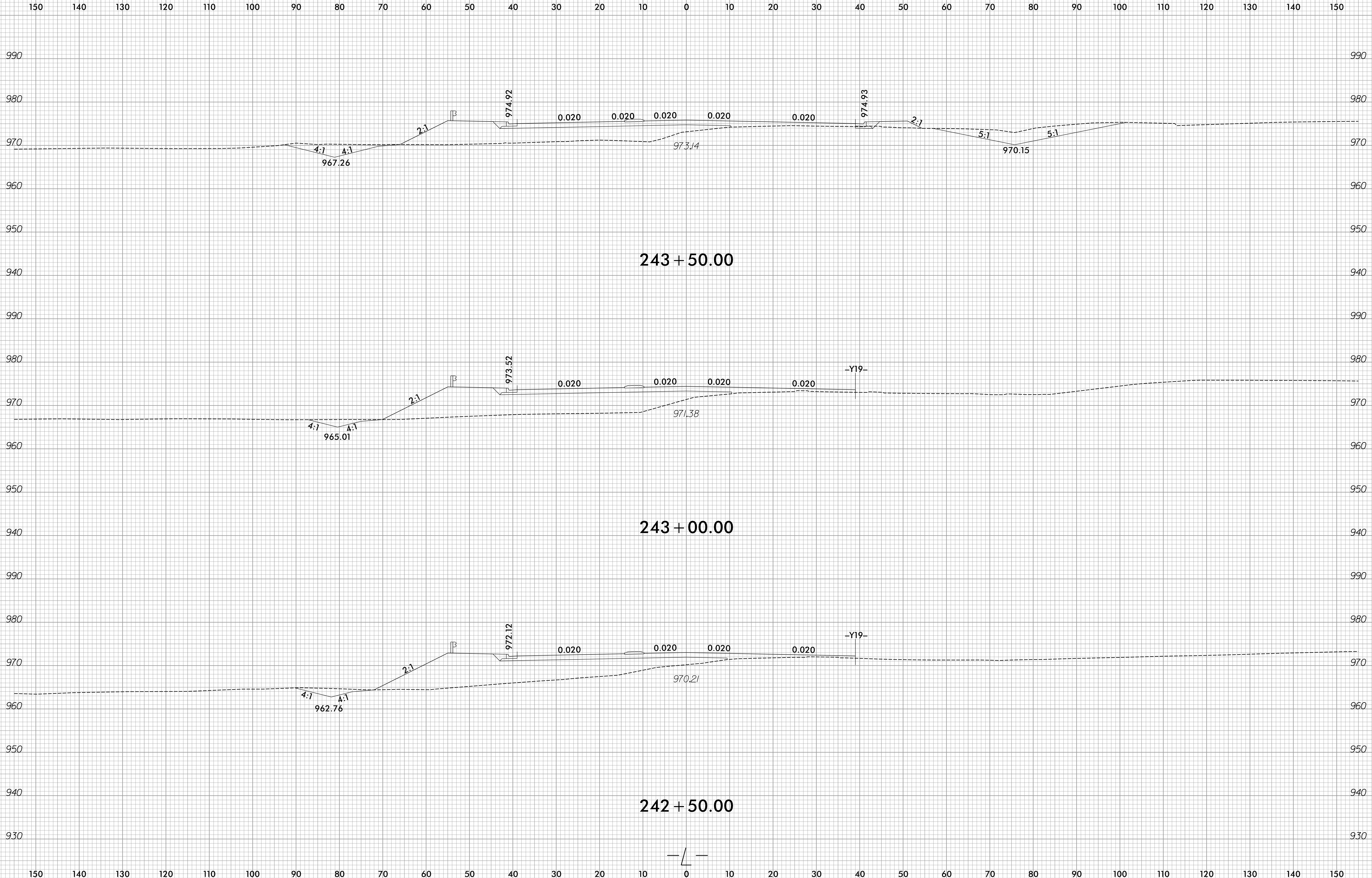

150 140 130 120 110 100 90 80 70 60 50 40 30 20 10 0 10 20 30 40 50 60 70 80 90 100 110 120 130 140 150

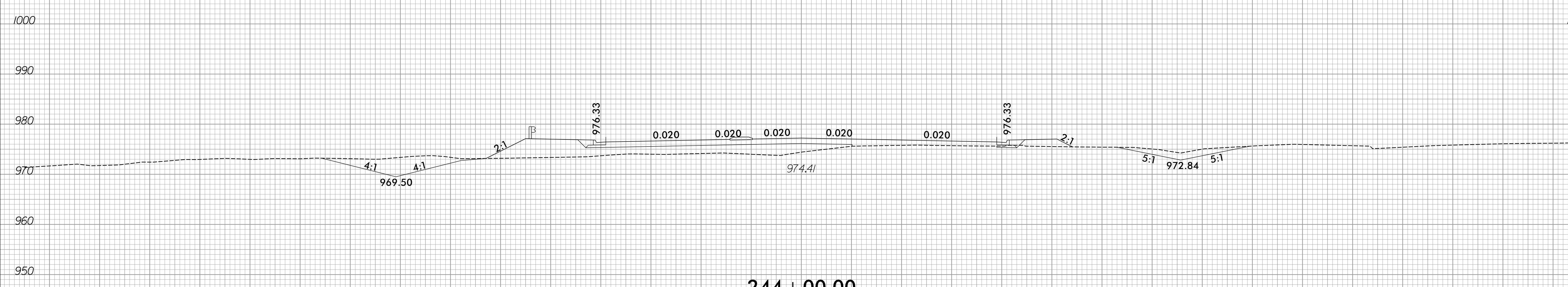
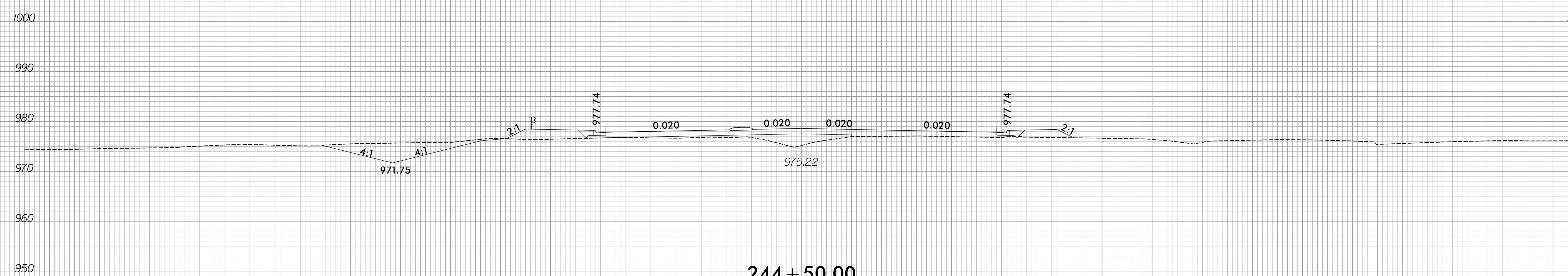
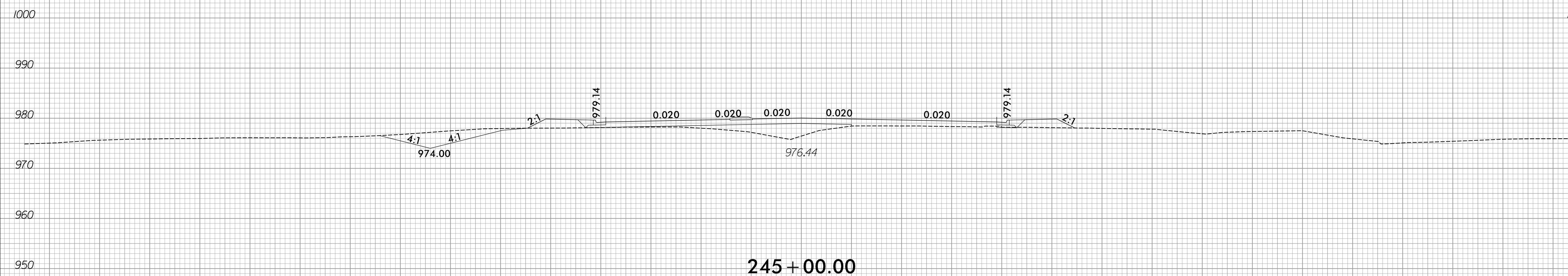

150 140 130 120 110 100 90 80 70 60 50 40 30 20 10 0 10 20 30 40 50 60 70 80 90 100 110 120 130 140 150

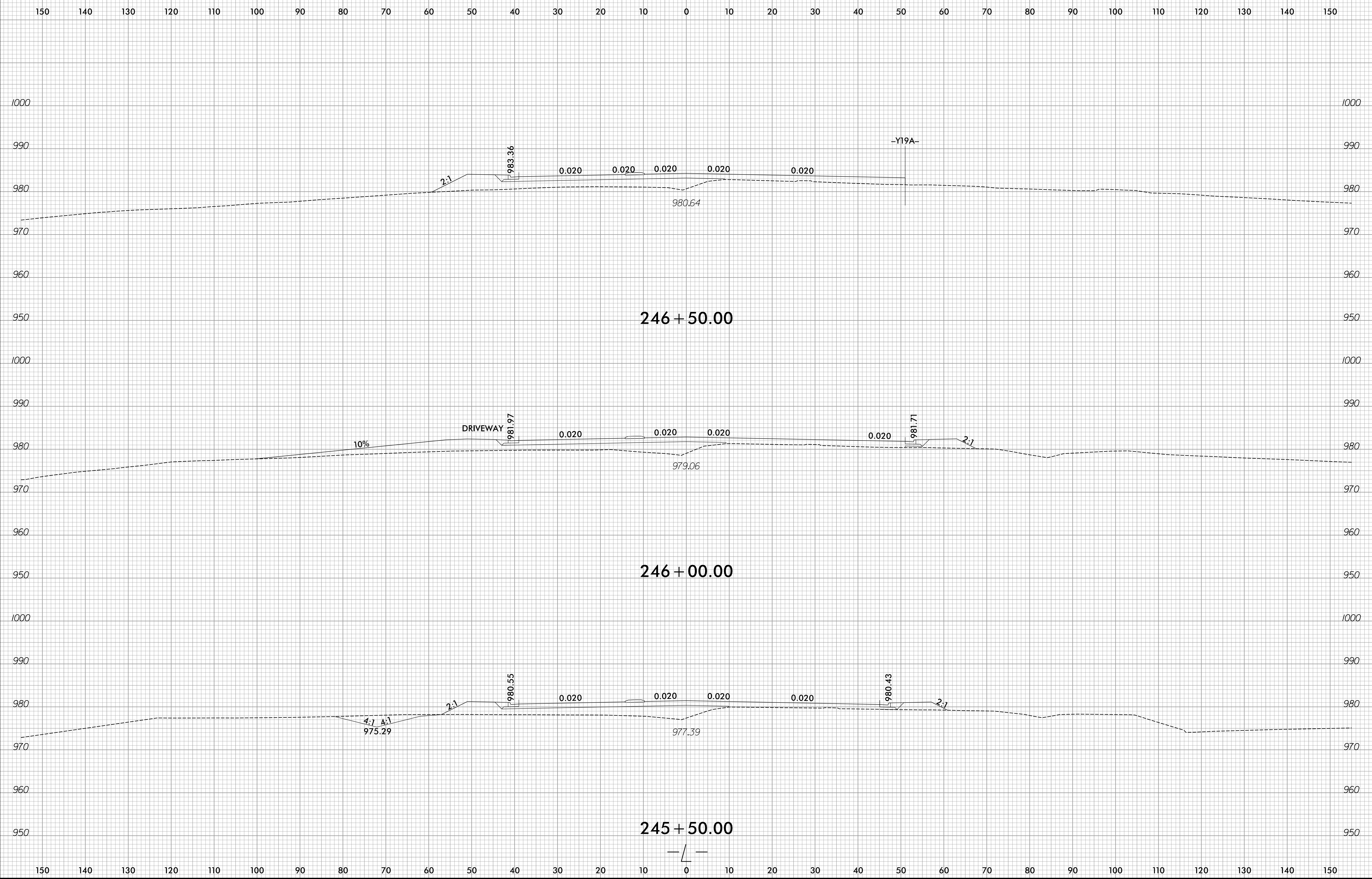

150 140 130 120 110 100 90 80 70 60 50 40 30 20 10 0 10 20 30 40 50 60 70 80 90 100 110 120 130 140 150

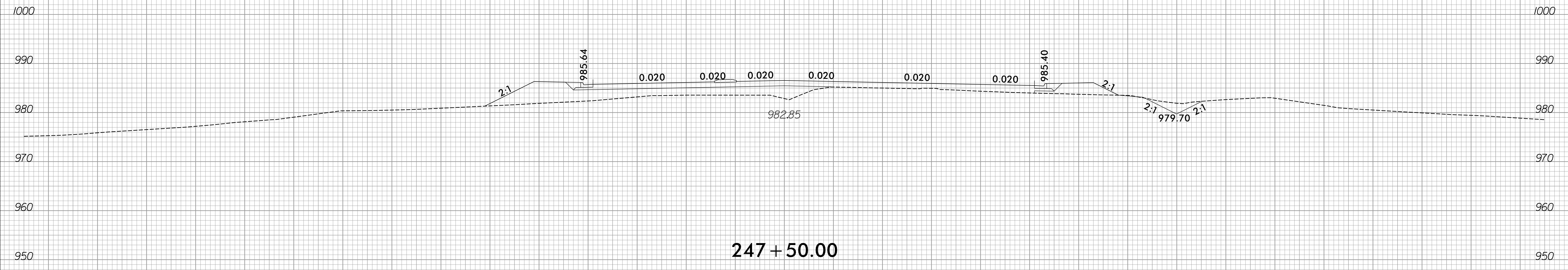

247 + 50.00

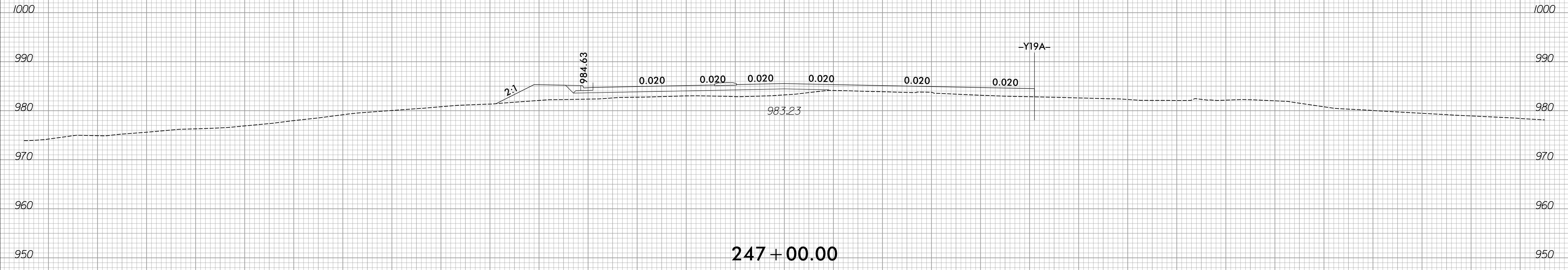

247 + 00.00

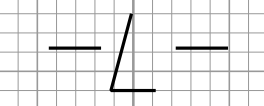

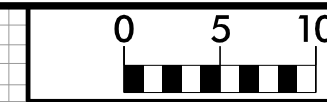

150 140 130 120 110 100 90 80 70 60 50 40 30 20 10 0 10 20 30 40 50 60 70 80 90 100 110 120 130 140 150

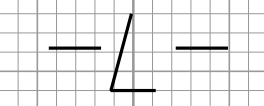
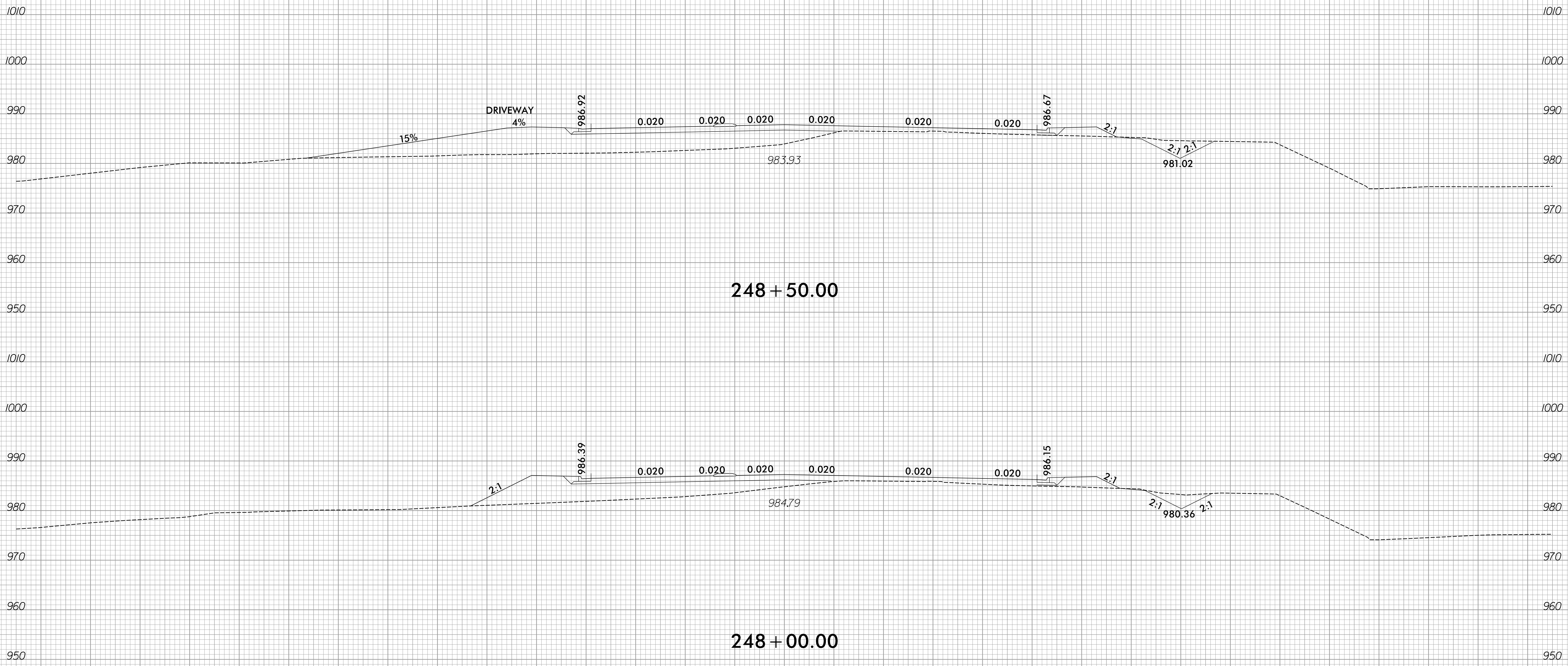

150 140 130 120 110 100 90 80 70 60 50 40 30 20 10 0 10 20 30 40 50 60 70 80 90 100 110 120 130 140 150

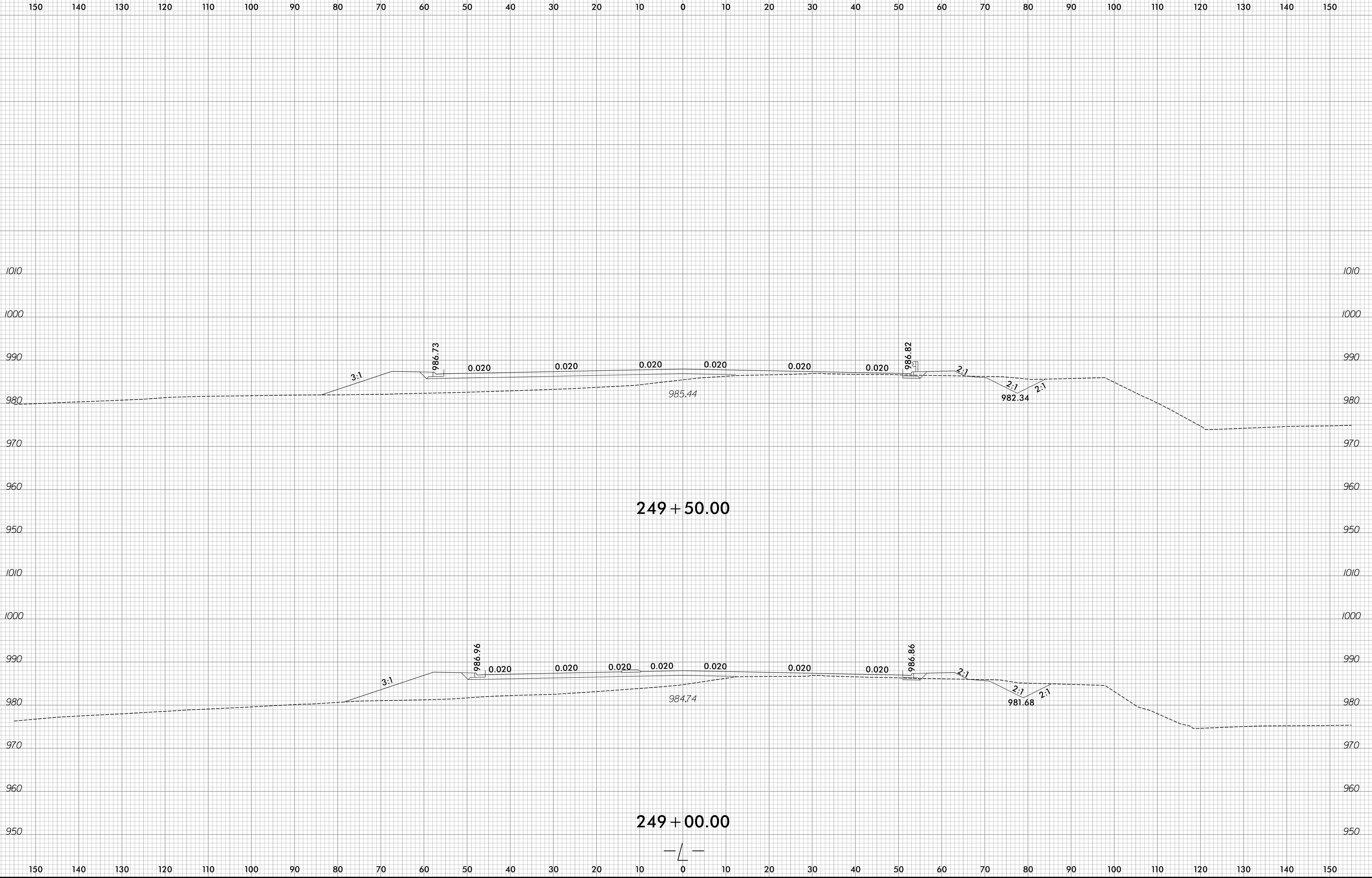

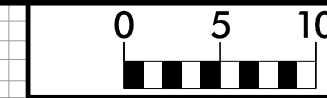

150 140 130 120 110 100 90 80 70 60 50 40 30 20 10 0 10 20 30 40 50 60 70 80 90 100 110 120 130 140 150

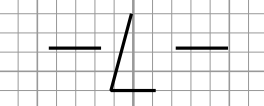
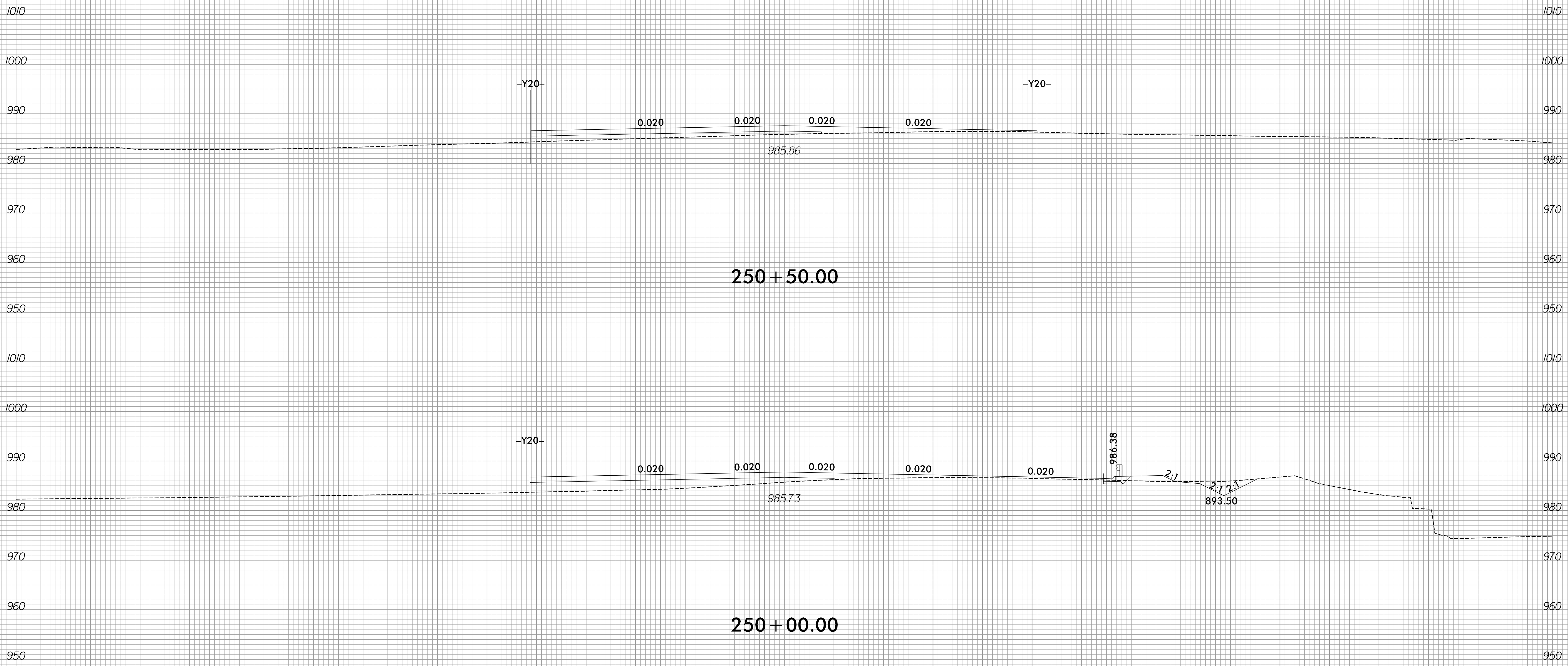

150 140 130 120 110 100 90 80 70 60 50 40 30 20 10 0 10 20 30 40 50 60 70 80 90 100 110 120 130 140 150



150 140 130 120 110 100 90 80 70 60 50 40 30 20 10 0 10 20 30 40 50 60 70 80 90 100 110 120 130 140 150

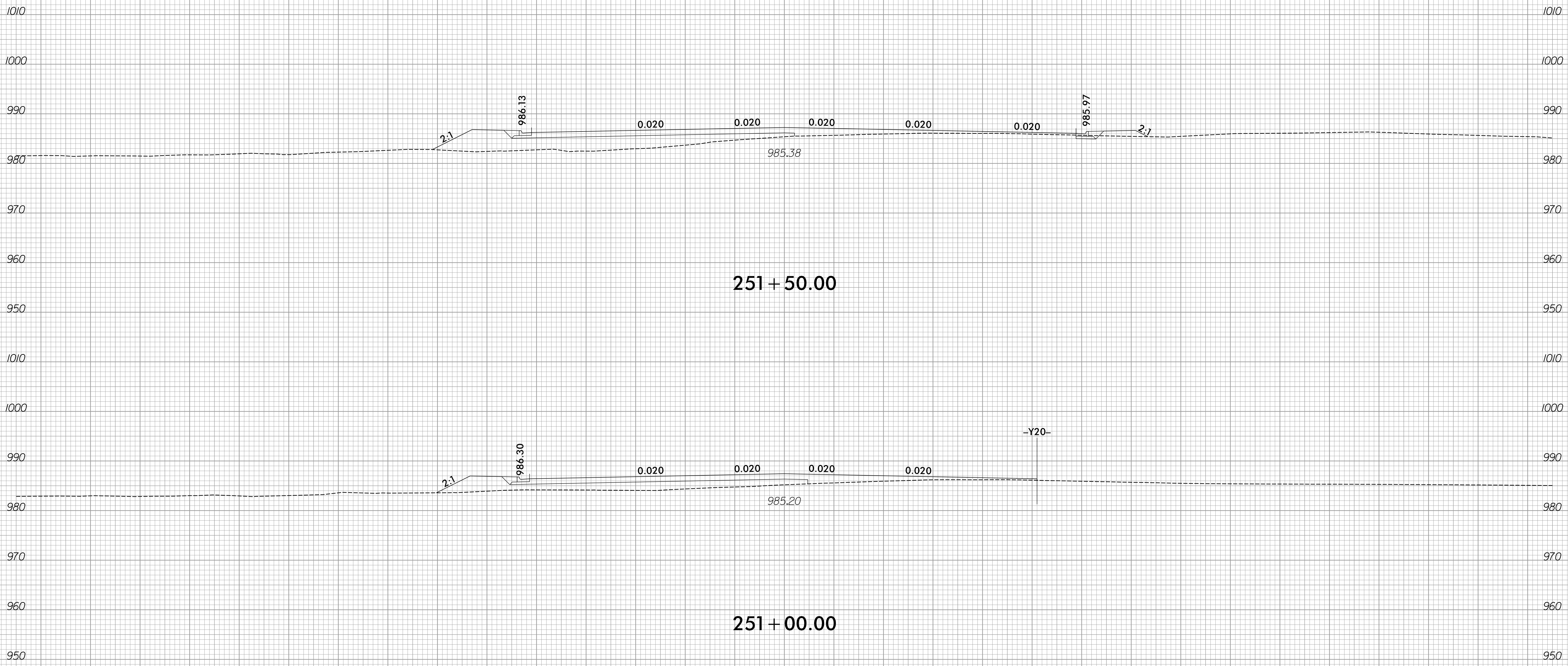

150 140 130 120 110 100 90 80 70 60 50 40 30 20 10 0 10 20 30 40 50 60 70 80 90 100 110 120 130 140 150

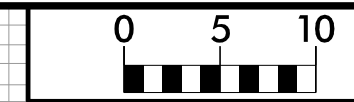

150 140 130 120 110 100 90 80 70 60 50 40 30 20 10 0 10 20 30 40 50 60 70 80 90 100 110 120 130 140 150

1010 1010

1000 1000

990 990

980 980

970 970

960 960

252 + 50.00

950 950

1010 1010

1000 1000

990 990

980 980

970 970

960 960

252 + 00.00

950 950

150 140 130 120 110 100 90 80 70 60 50 40 30 20 10 0 10 20 30 40 50 60 70 80 90 100 110 120 130 140 150

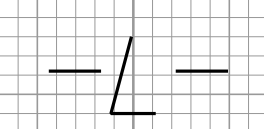



150 140 130 120 110 100 90 80 70 60 50 40 30 20 10 0 10 20 30 40 50 60 70 80 90 100 110 120 130 140 150

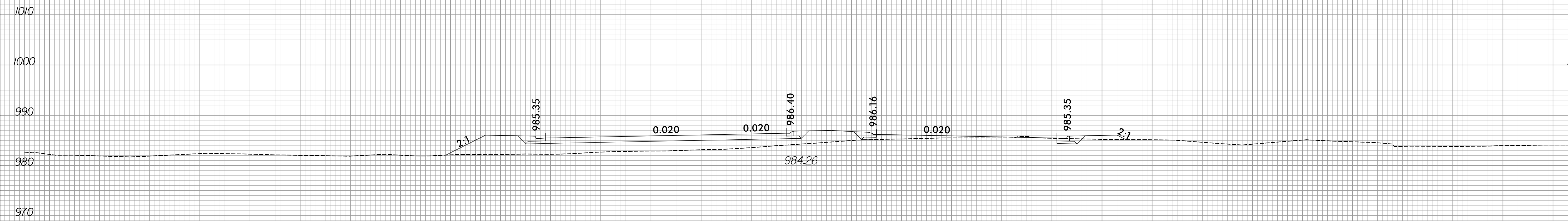

253 + 50.00

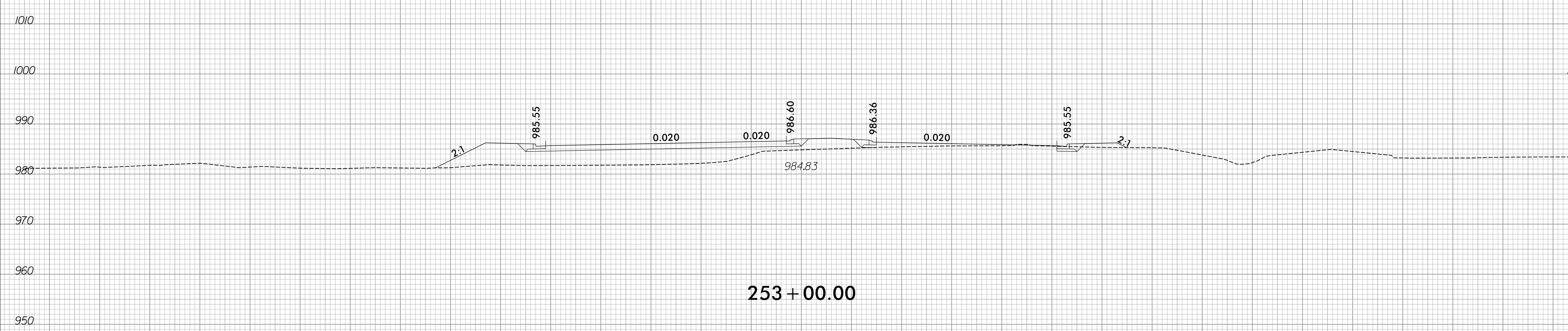

253 + 00.00

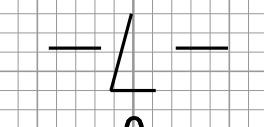

150 140 130 120 110 100 90 80 70 60 50 40 30 20 10 0 10 20 30 40 50 60 70 80 90 100 110 120 130 140 150

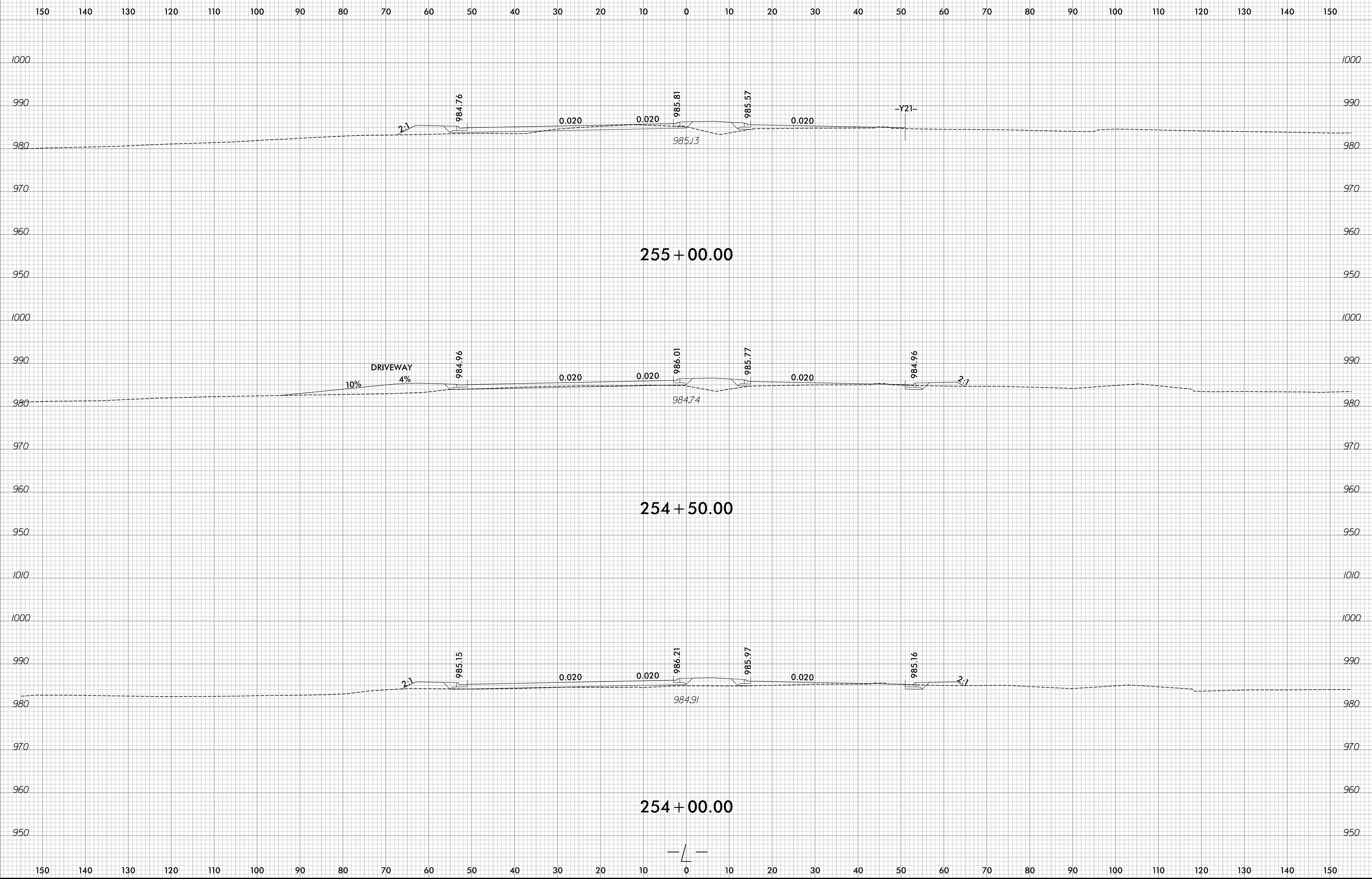

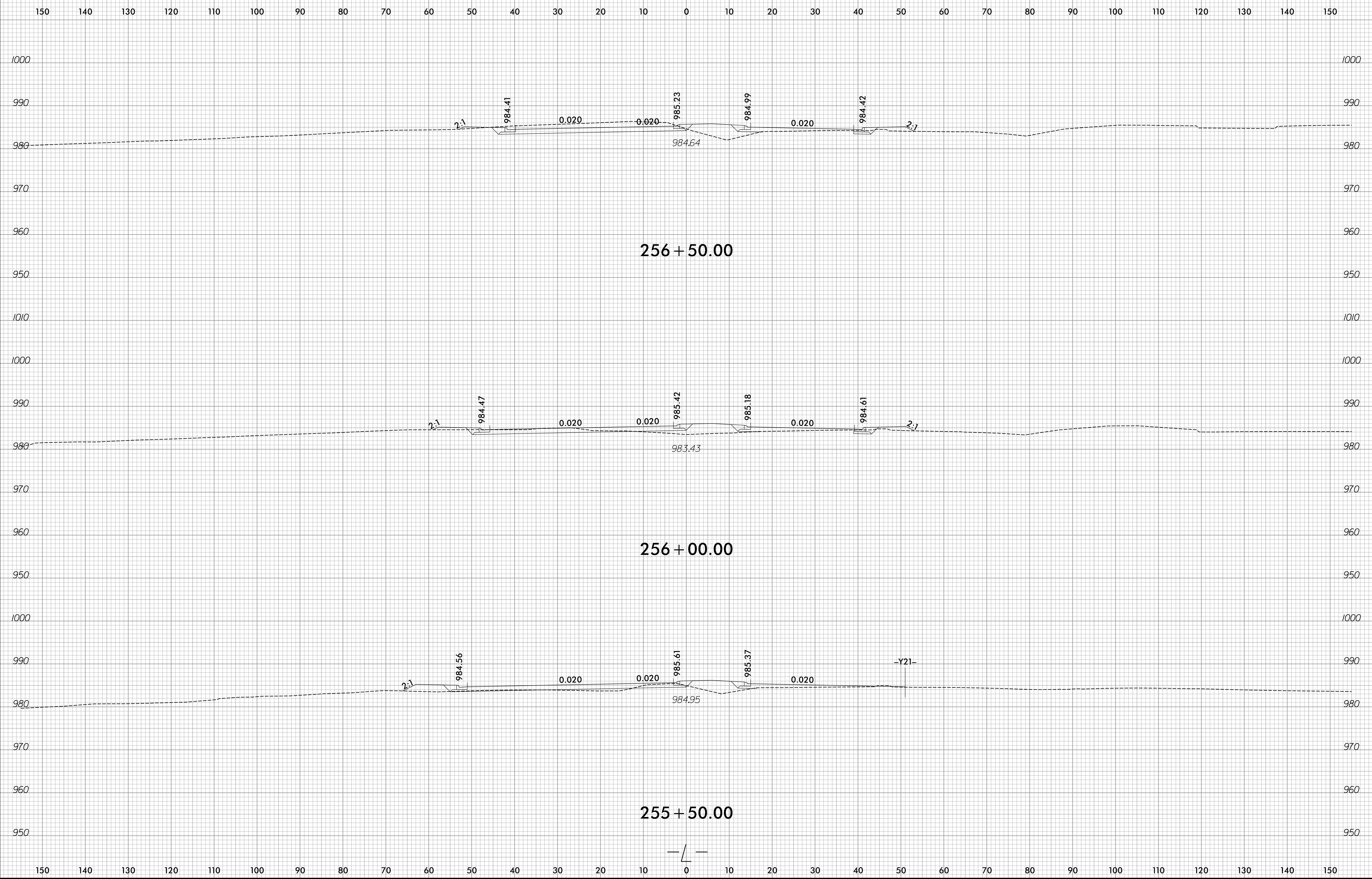
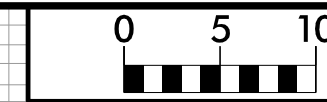

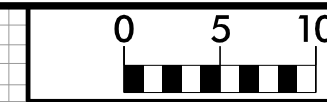

150 140 130 120 110 100 90 80 70 60 50 40 30 20 10 0 10 20 30 40 50 60 70 80 90 100 110 120 130 140 150

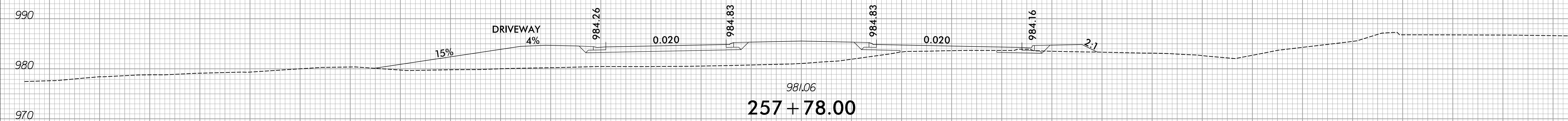

257 + 78.00

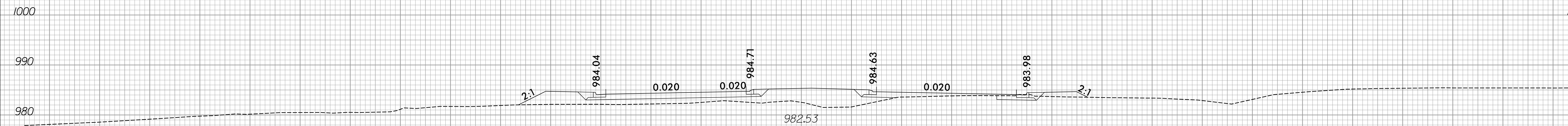

257 + 50.00

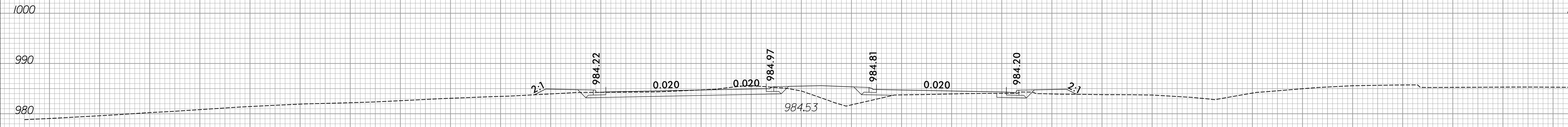

257 + 00.00

150 140 130 120 110 100 90 80 70 60 50 40 30 20 10 0 10 20 30 40 50 60 70 80 90 100 110 120 130 140 150

6/23/16

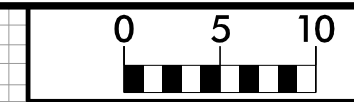

PROJ. REFERENCE NO.
R-2577A

SHEET NO.
X-216

150 140 130 120 110 100 90 80 70 60 50 40 30 20 10 0 10 20 30 40 50 60 70 80 90 100 110 120 130 140 150

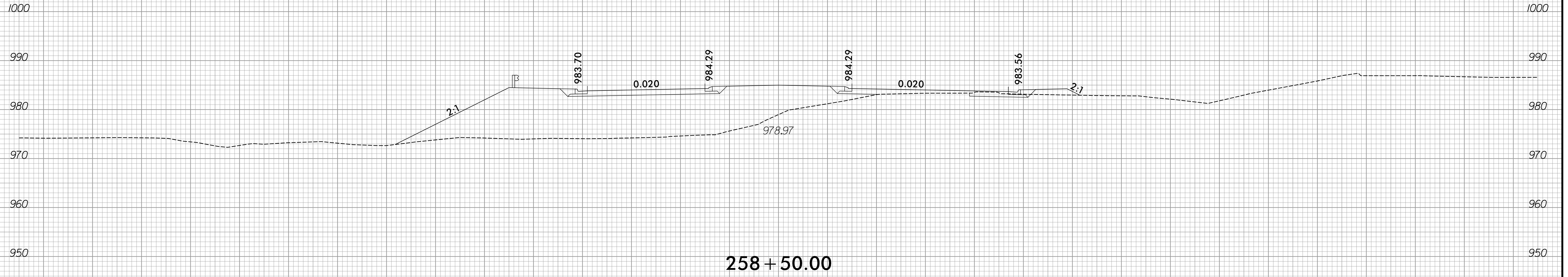

258 + 50.00

258 + 00.00

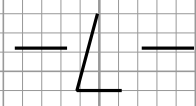

12/20/2023
R:\Roadway\XSC\R-2577A_Rdu_xp1.L_PART2.dgn
amcpherson



150 140 130 120 110 100 90 80 70 60 50 40 30 20 10 0 10 20 30 40 50 60 70 80 90 100 110 120 130 140 150

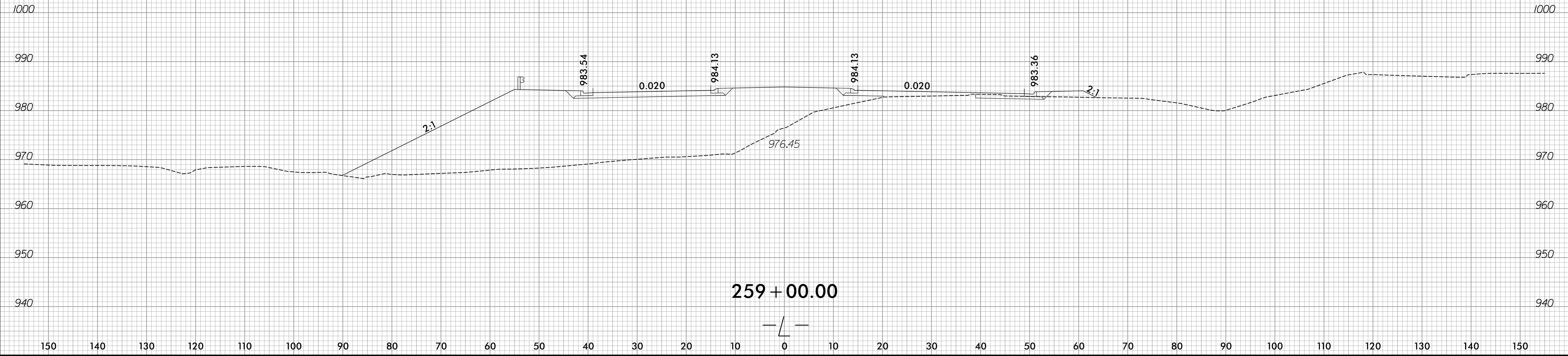
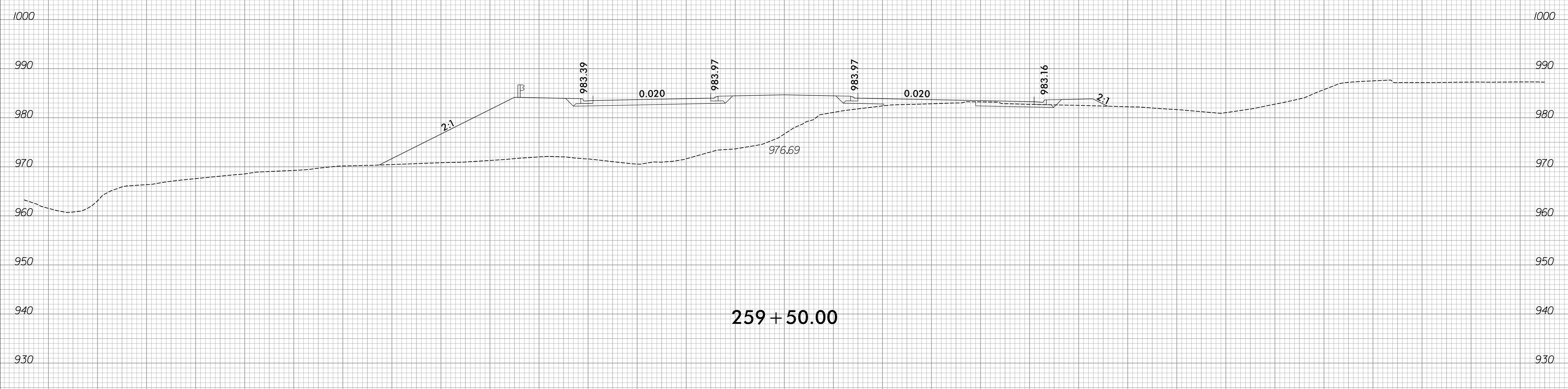

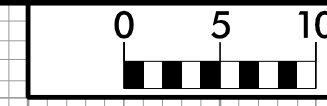

150 140 130 120 110 100 90 80 70 60 50 40 30 20 10 0 10 20 30 40 50 60 70 80 90 100 110 120 130 140 150

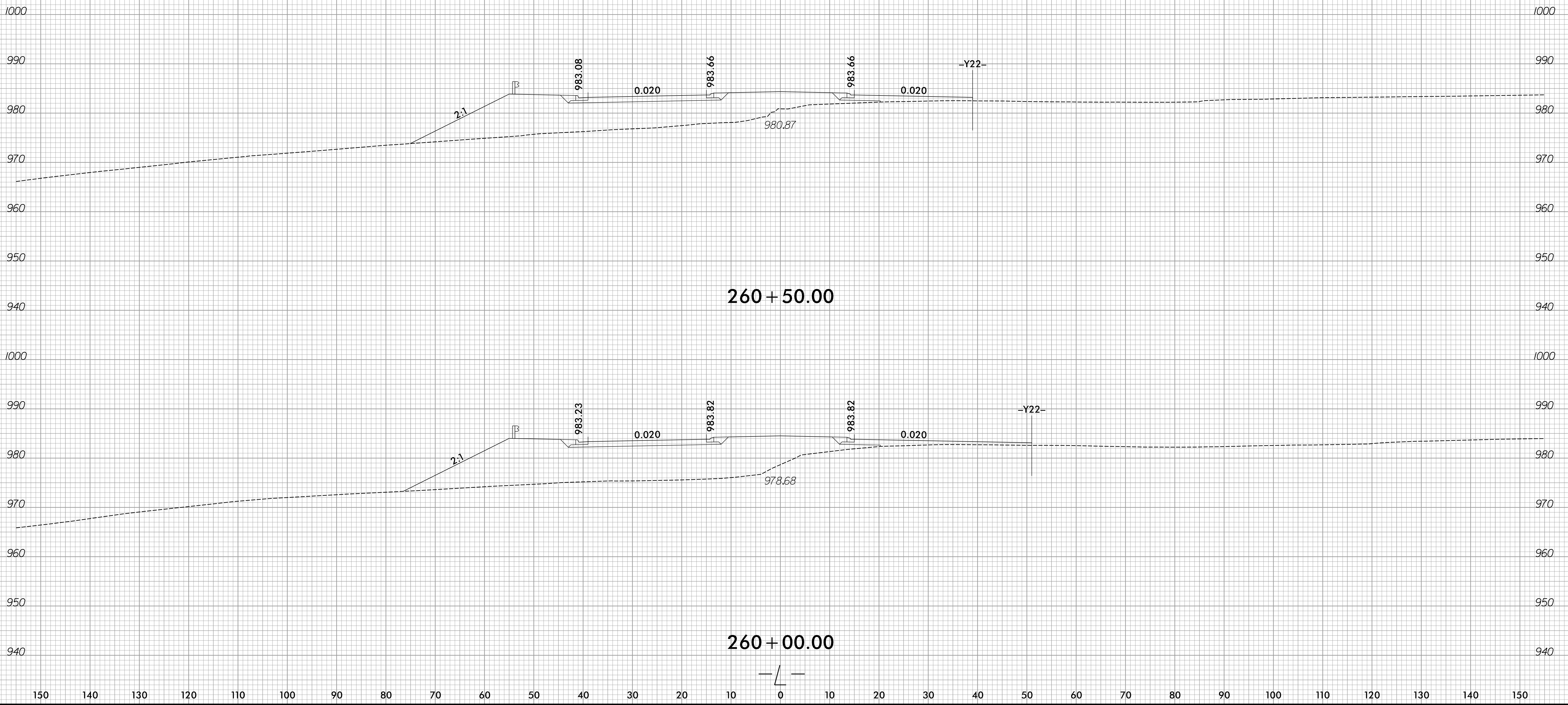

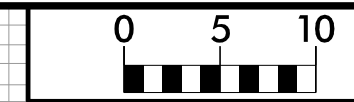

150 140 130 120 110 100 90 80 70 60 50 40 30 20 10 0 10 20 30 40 50 60 70 80 90 100 110 120 130 140 150

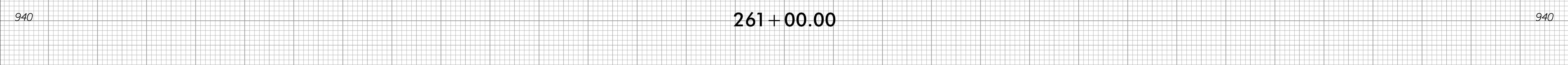
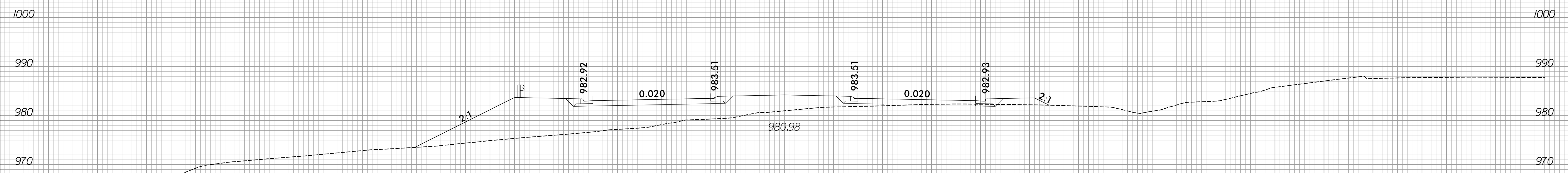
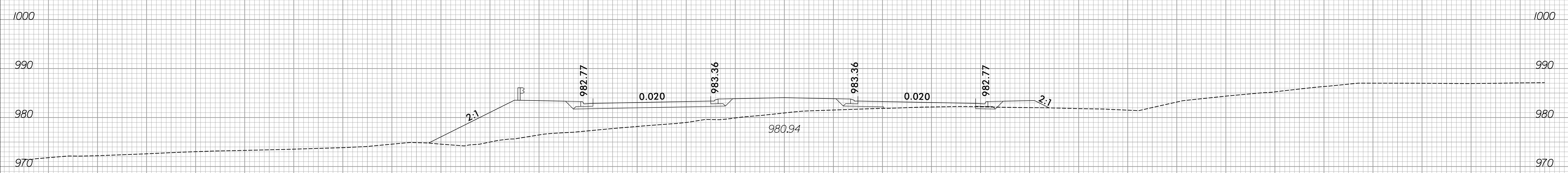

150 140 130 120 110 100 90 80 70 60 50 40 30 20 10 0 10 20 30 40 50 60 70 80 90 100 110 120 130 140 150

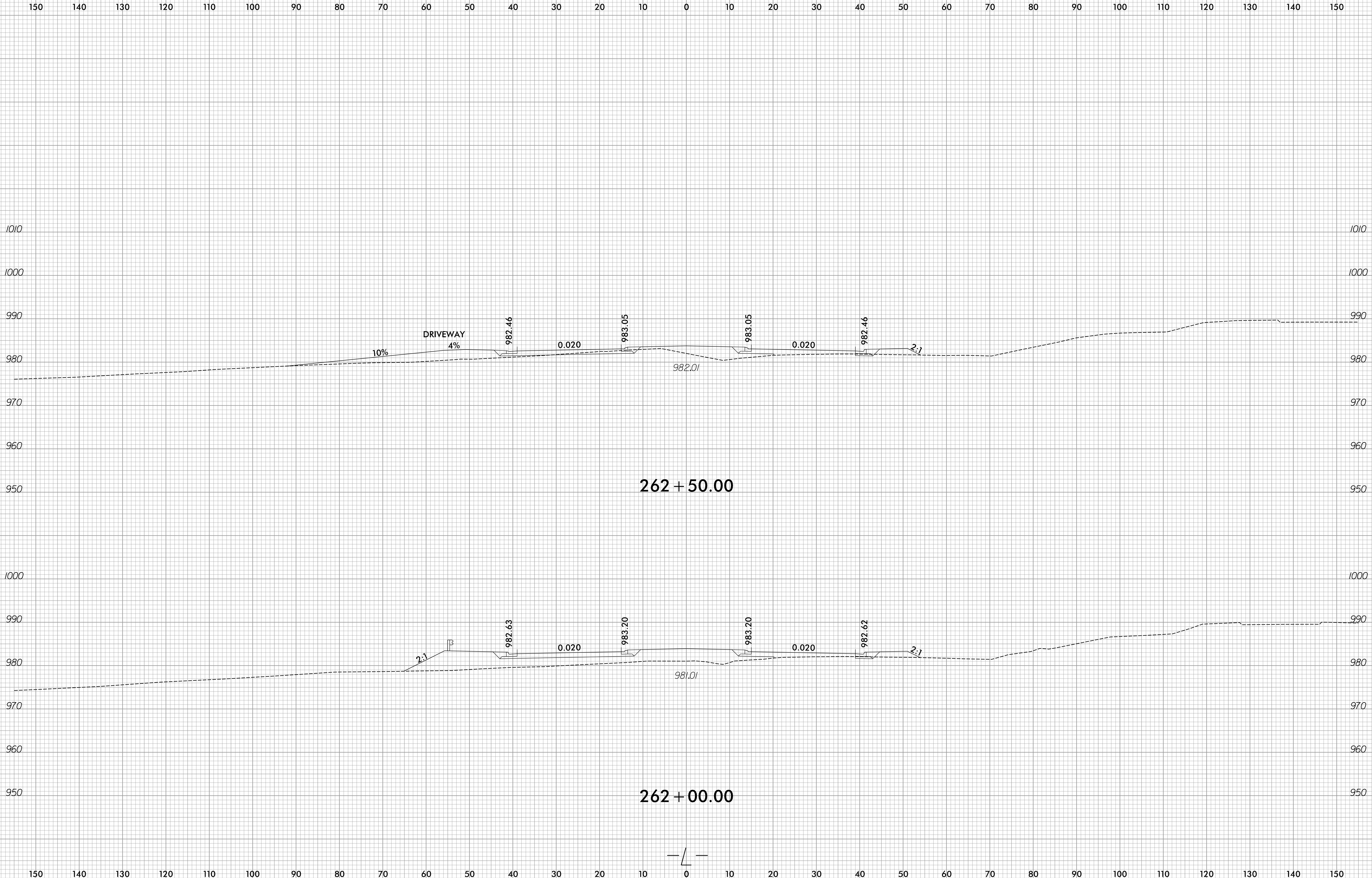



150 140 130 120 110 100 90 80 70 60 50 40 30 20 10 0 10 20 30 40 50 60 70 80 90 100 110 120 130 140 150

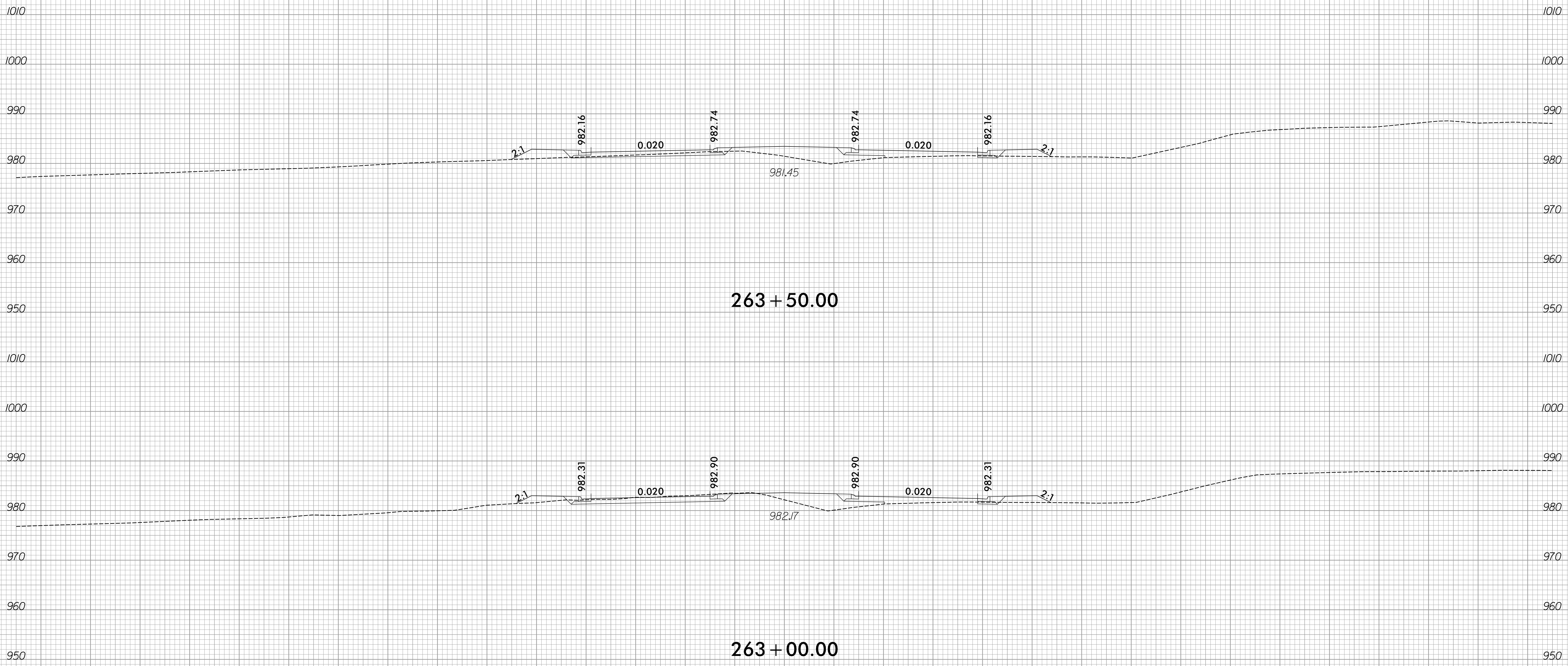

150 140 130 120 110 100 90 80 70 60 50 40 30 20 10 0 10 20 30 40 50 60 70 80 90 100 110 120 130 140 150

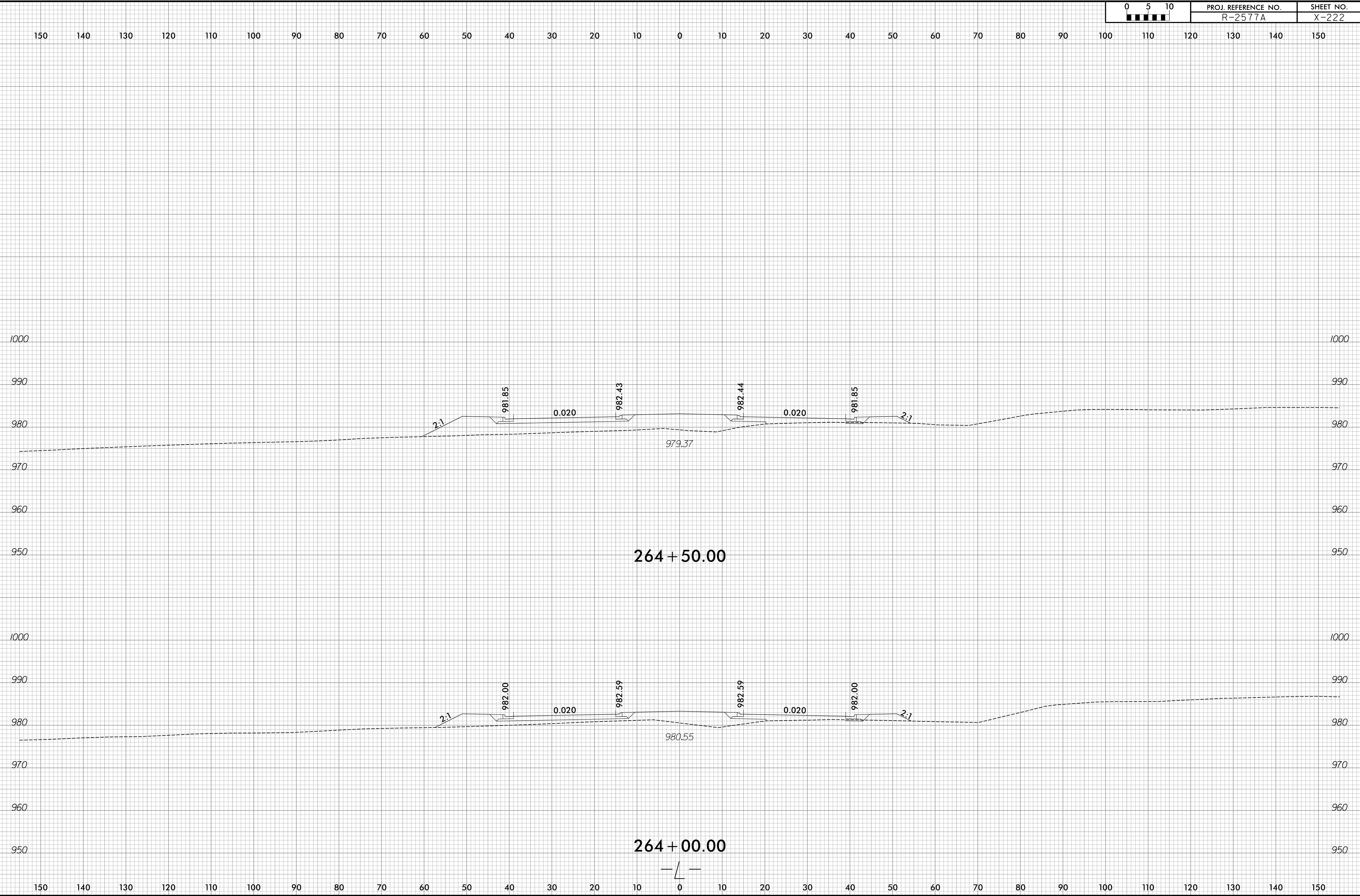

150 140 130 120 110 100 90 80 70 60 50 40 30 20 10 0 10 20 30 40 50 60 70 80 90 100 110 120 130 140 150

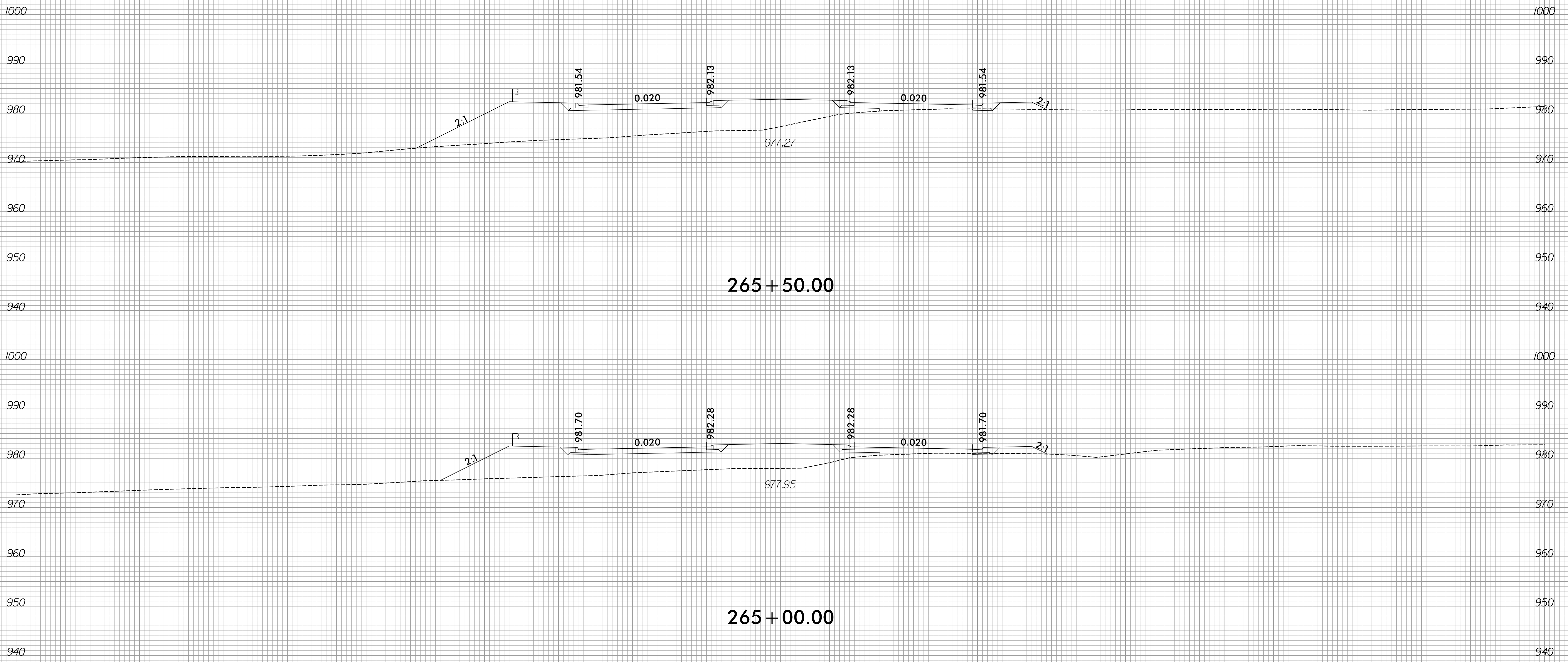

150 140 130 120 110 100 90 80 70 60 50 40 30 20 10 0 10 20 30 40 50 60 70 80 90 100 110 120 130 140 150

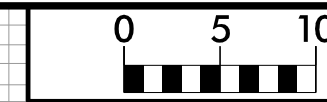

150 140 130 120 110 100 90 80 70 60 50 40 30 20 10 0 10 20 30 40 50 60 70 80 90 100 110 120 130 140 150

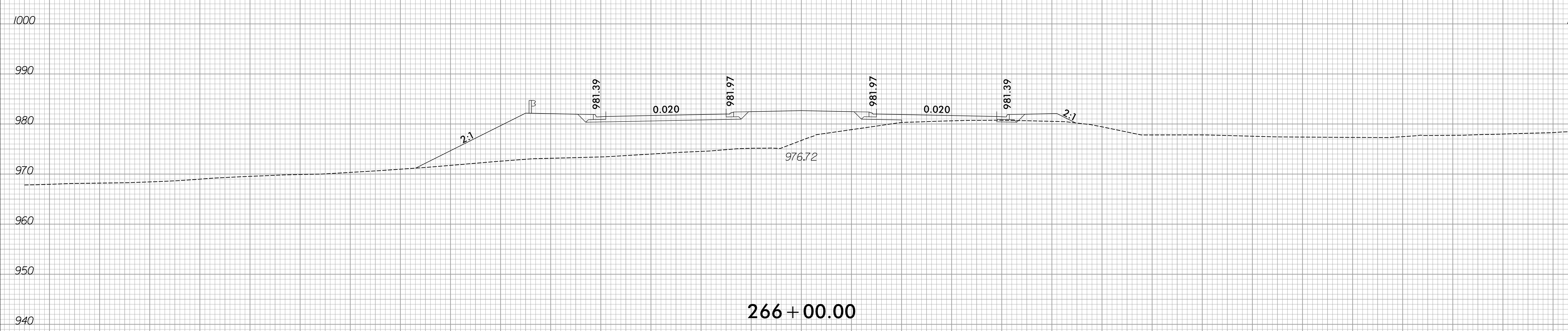
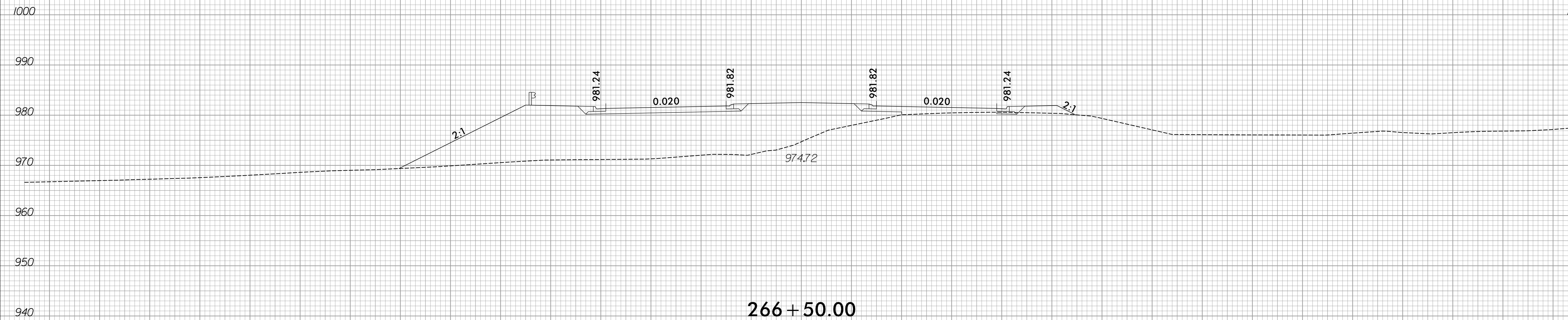

150 140 130 120 110 100 90 80 70 60 50 40 30 20 10 0 10 20 30 40 50 60 70 80 90 100 110 120 130 140 150



150 140 130 120 110 100 90 80 70 60 50 40 30 20 10 0 10 20 30 40 50 60 70 80 90 100 110 120 130 140 150

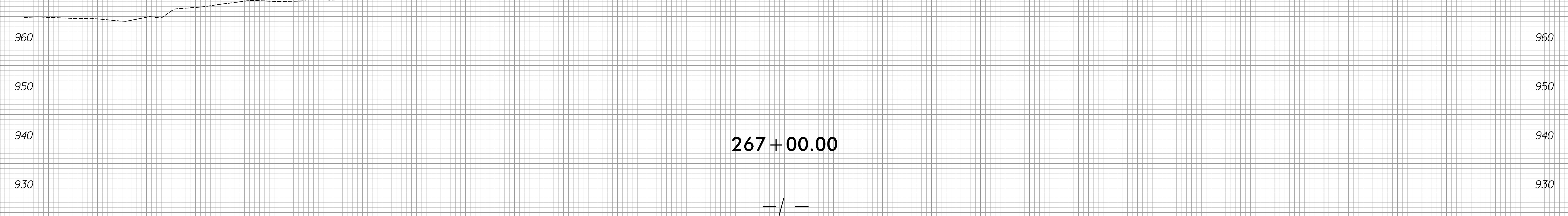
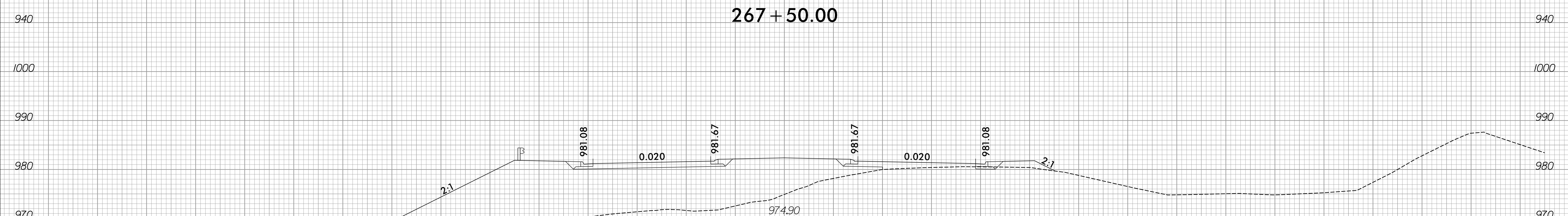

150 140 130 120 110 100 90 80 70 60 50 40 30 20 10 0 10 20 30 40 50 60 70 80 90 100 110 120 130 140 150



150 140 130 120 110 100 90 80 70 60 50 40 30 20 10 0 10 20 30 40 50 60 70 80 90 100 110 120 130 140 150

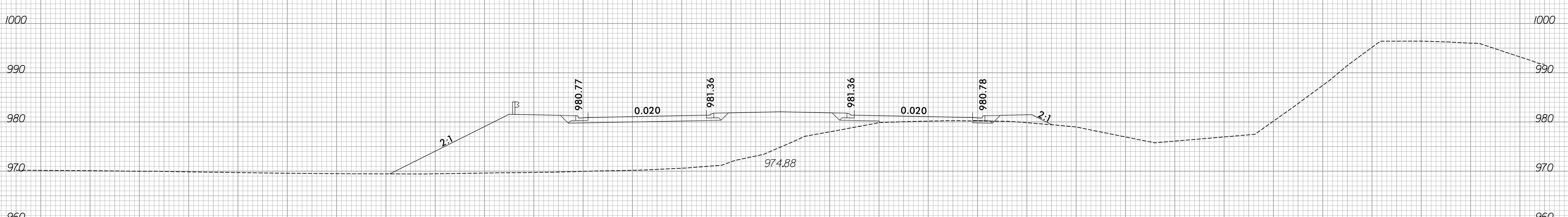

150 140 130 120 110 100 90 80 70 60 50 40 30 20 10 0 10 20 30 40 50 60 70 80 90 100 110 120 130 140 150

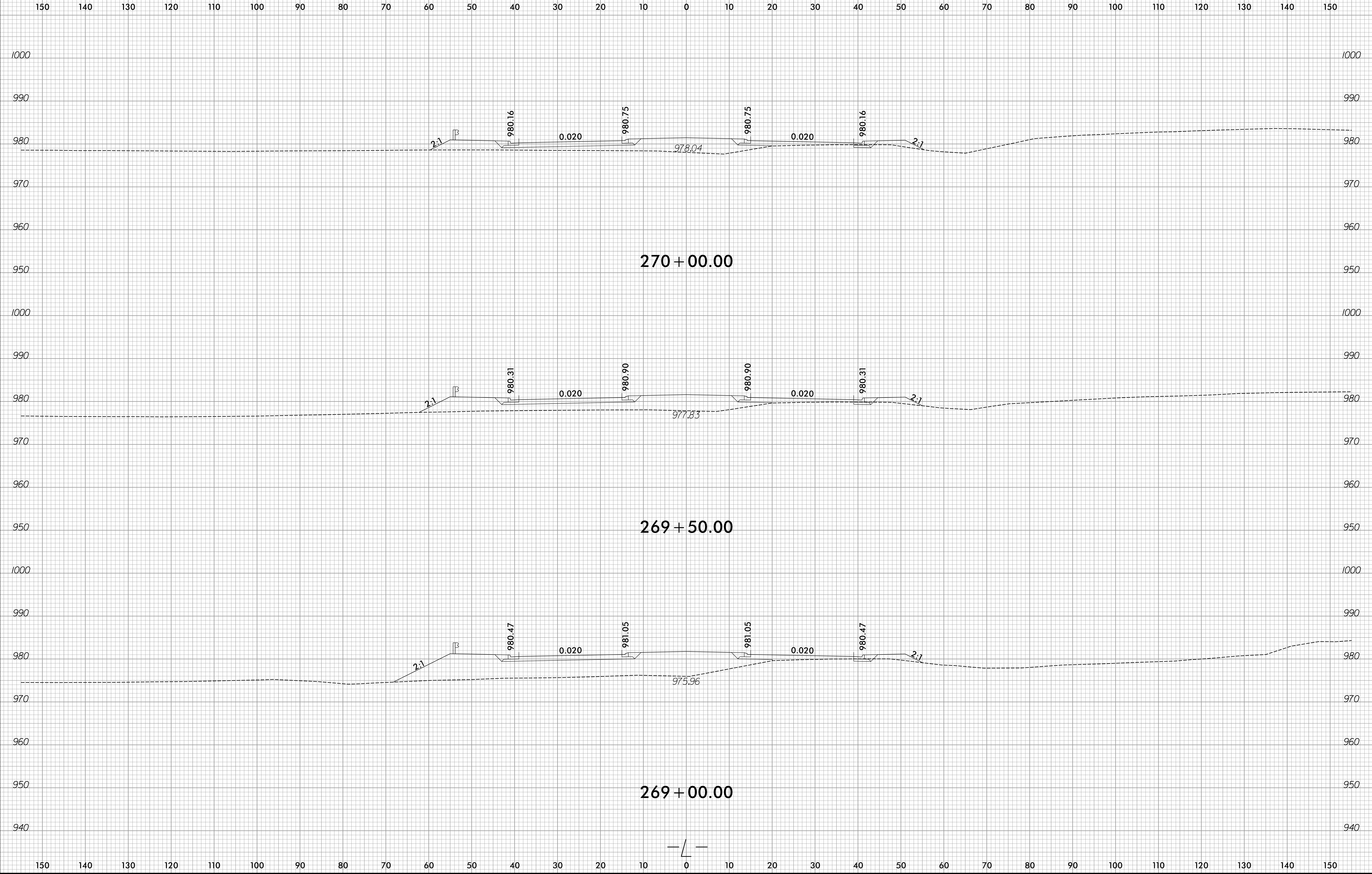



150 140 130 120 110 100 90 80 70 60 50 40 30 20 10 0 10 20 30 40 50 60 70 80 90 100 110 120 130 140 150

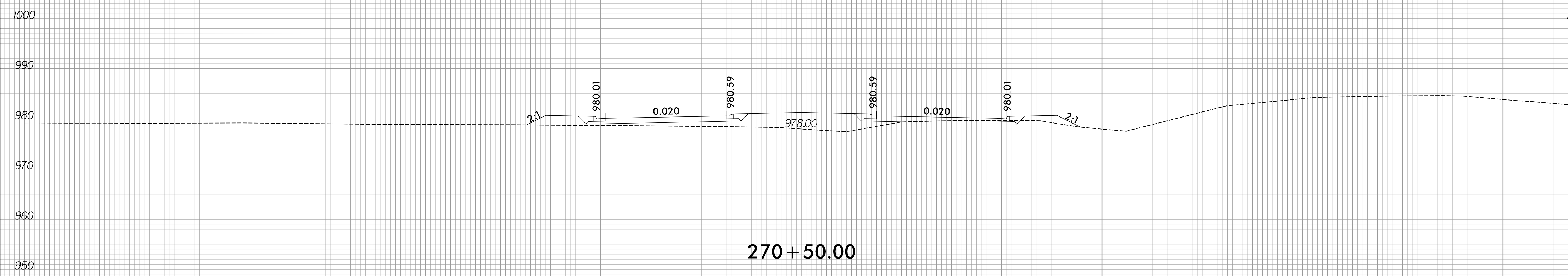
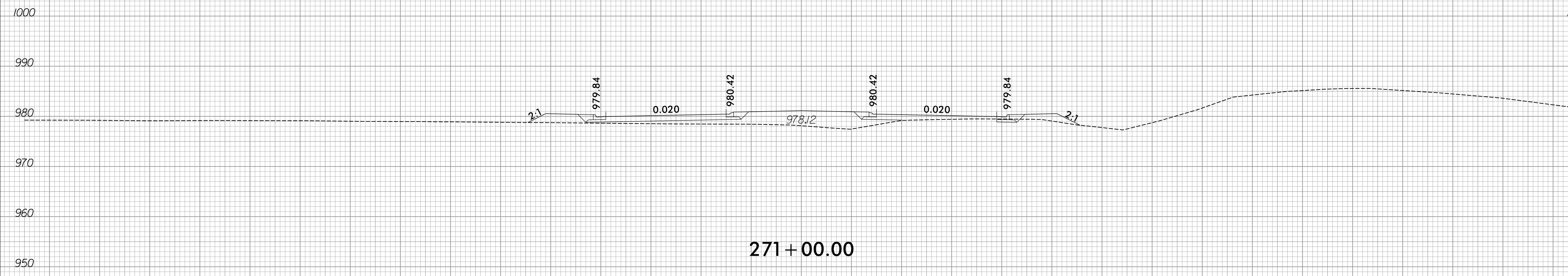
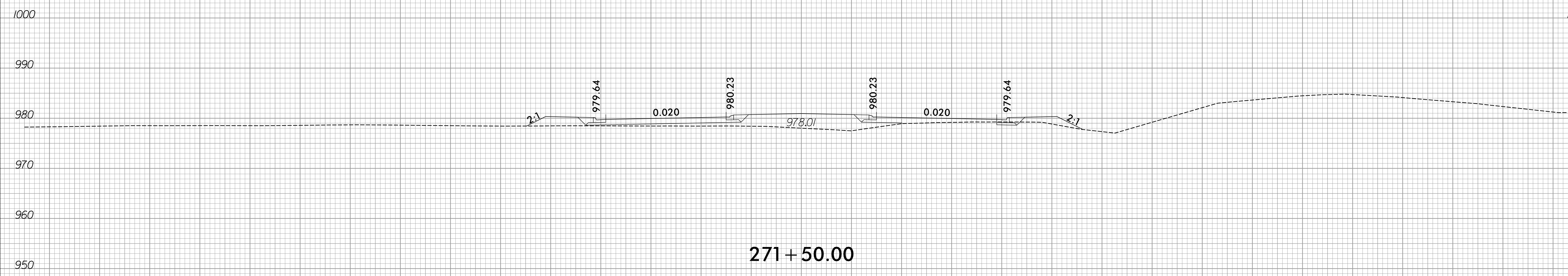

150 140 130 120 110 100 90 80 70 60 50 40 30 20 10 0 10 20 30 40 50 60 70 80 90 100 110 120 130 140 150



150 140 130 120 110 100 90 80 70 60 50 40 30 20 10 0 10 20 30 40 50 60 70 80 90 100 110 120 130 140 150

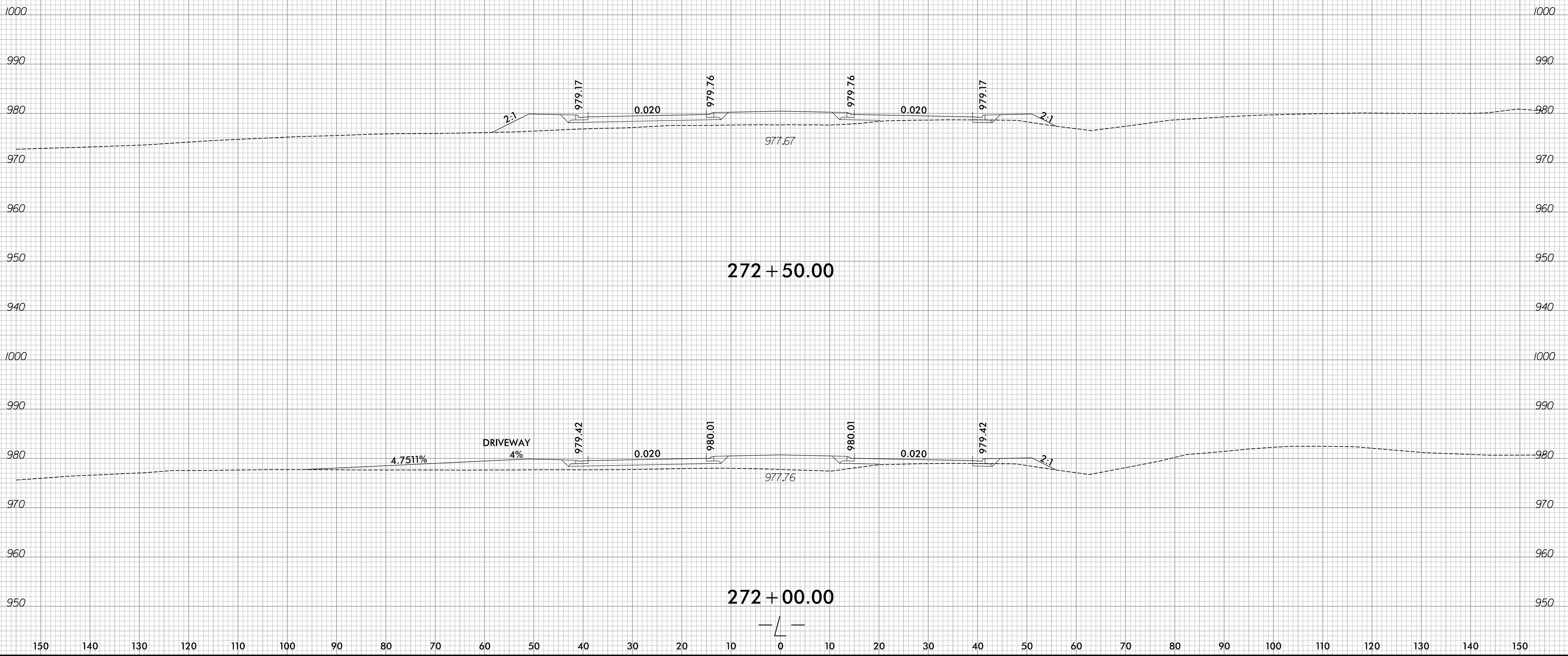

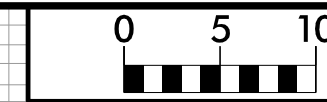

150 140 130 120 110 100 90 80 70 60 50 40 30 20 10 0 10 20 30 40 50 60 70 80 90 100 110 120 130 140 150

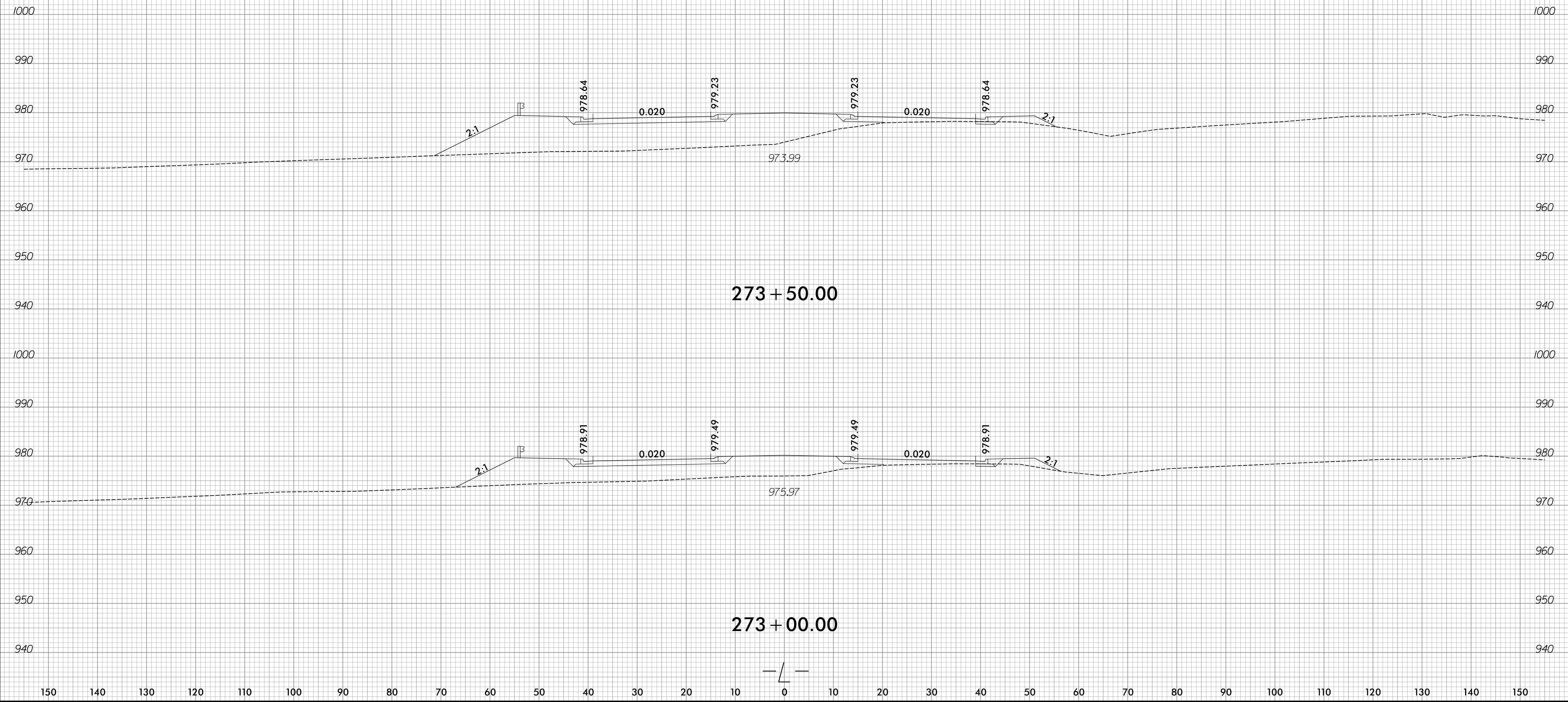

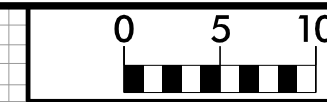

150 140 130 120 110 100 90 80 70 60 50 40 30 20 10 0 10 20 30 40 50 60 70 80 90 100 110 120 130 140 150

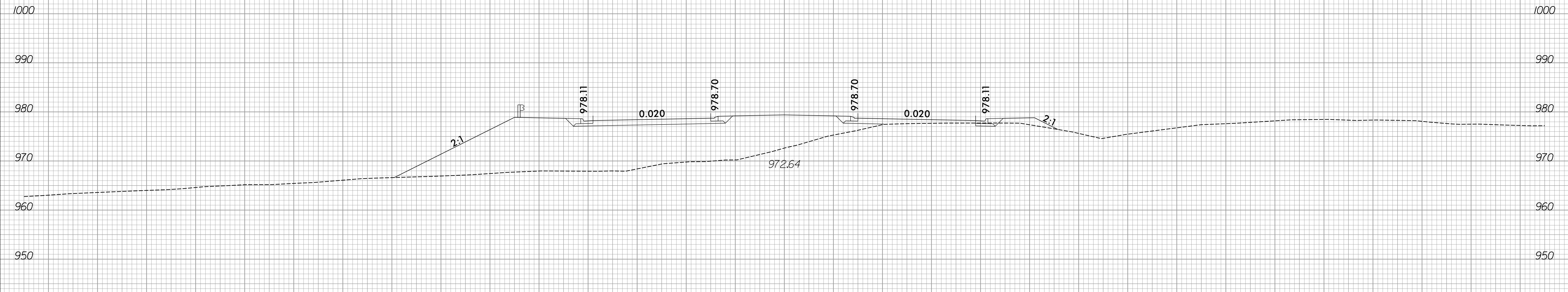

274 + 50.00



274 + 00.00



150 140 130 120 110 100 90 80 70 60 50 40 30 20 10 0 10 20 30 40 50 60 70 80 90 100 110 120 130 140 150

150 140 130 120 110 100 90 80 70 60 50 40 30 20 10 0 10 20 30 40 50 60 70 80 90 100 110 120 130 140 150

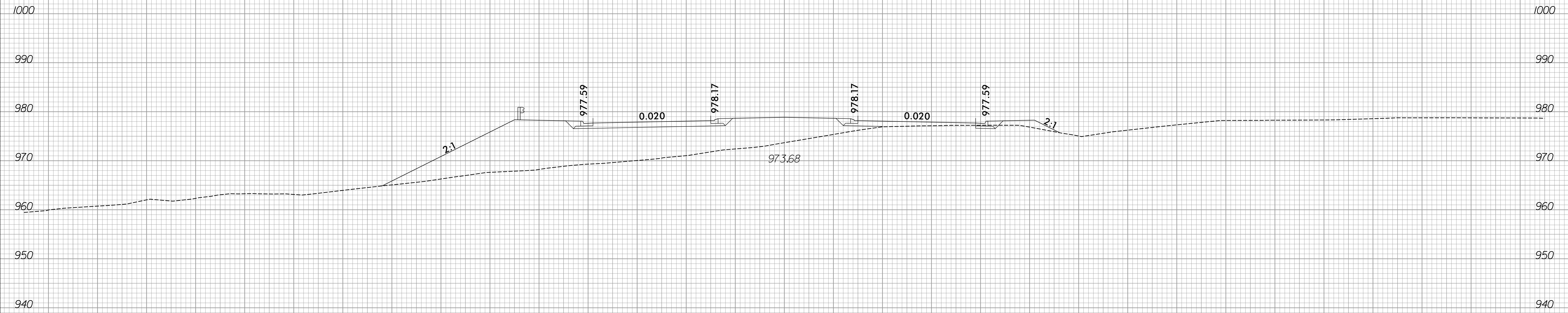

275 + 50.00

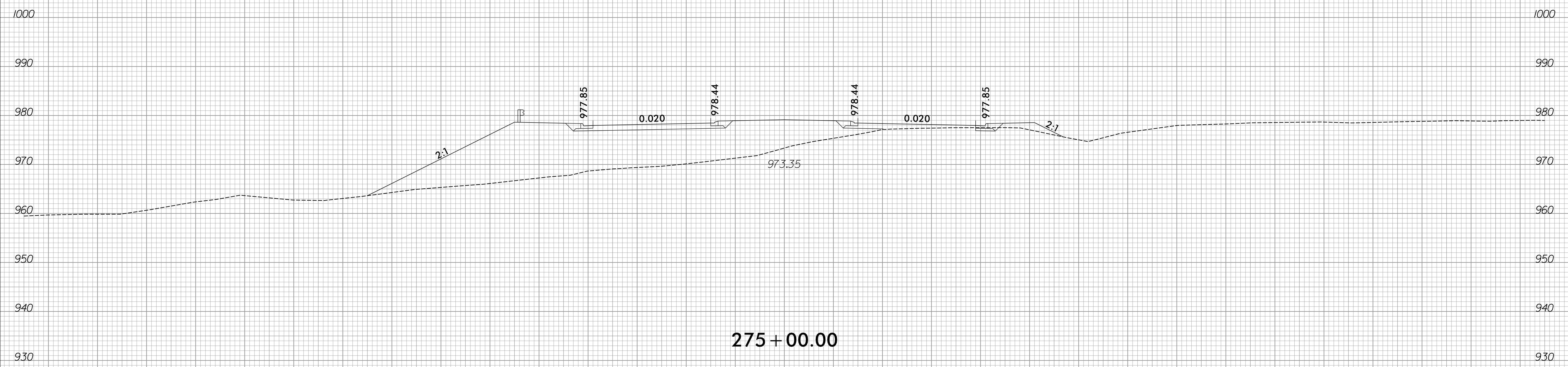

275 + 00.00

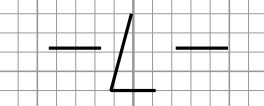

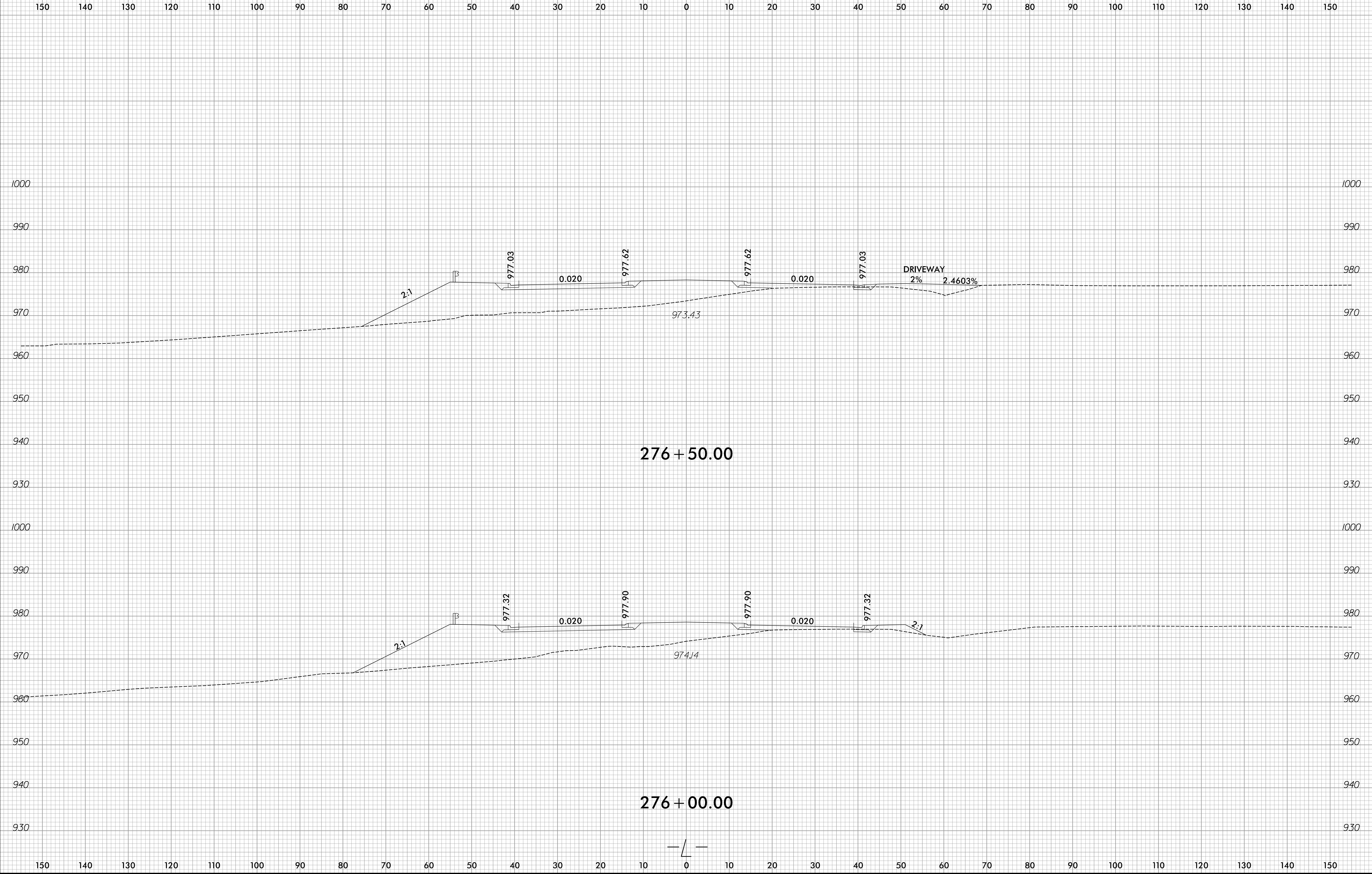



150 140 130 120 110 100 90 80 70 60 50 40 30 20 10 0 10 20 30 40 50 60 70 80 90 100 110 120 130 140 150

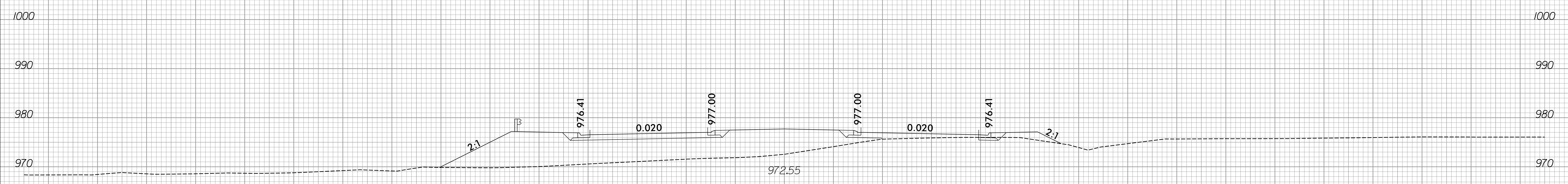

277 + 50.00

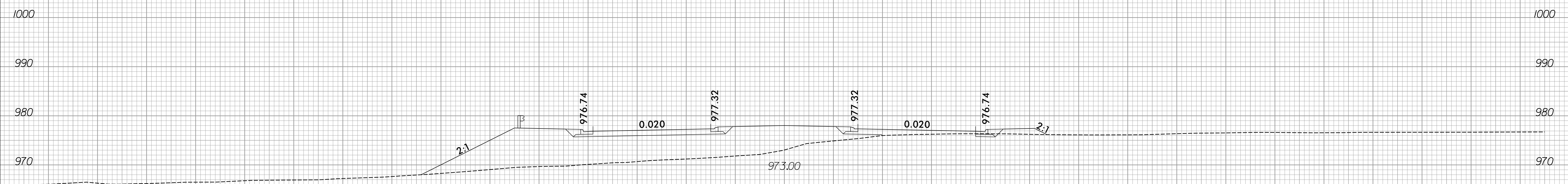

277 + 00.00



150 140 130 120 110 100 90 80 70 60 50 40 30 20 10 0 10 20 30 40 50 60 70 80 90 100 110 120 130 140 150

150 140 130 120 110 100 90 80 70 60 50 40 30 20 10 0 10 20 30 40 50 60 70 80 90 100 110 120 130 140 150

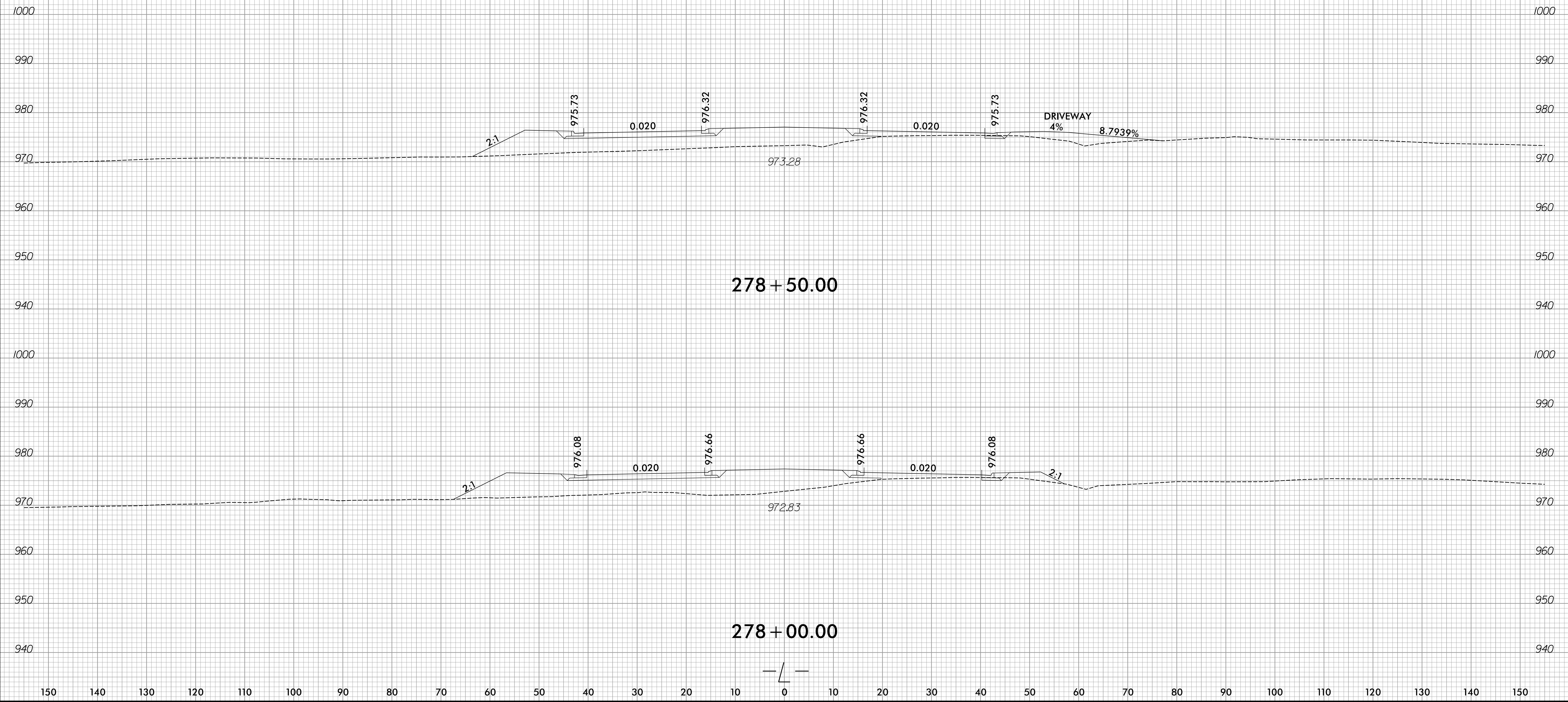

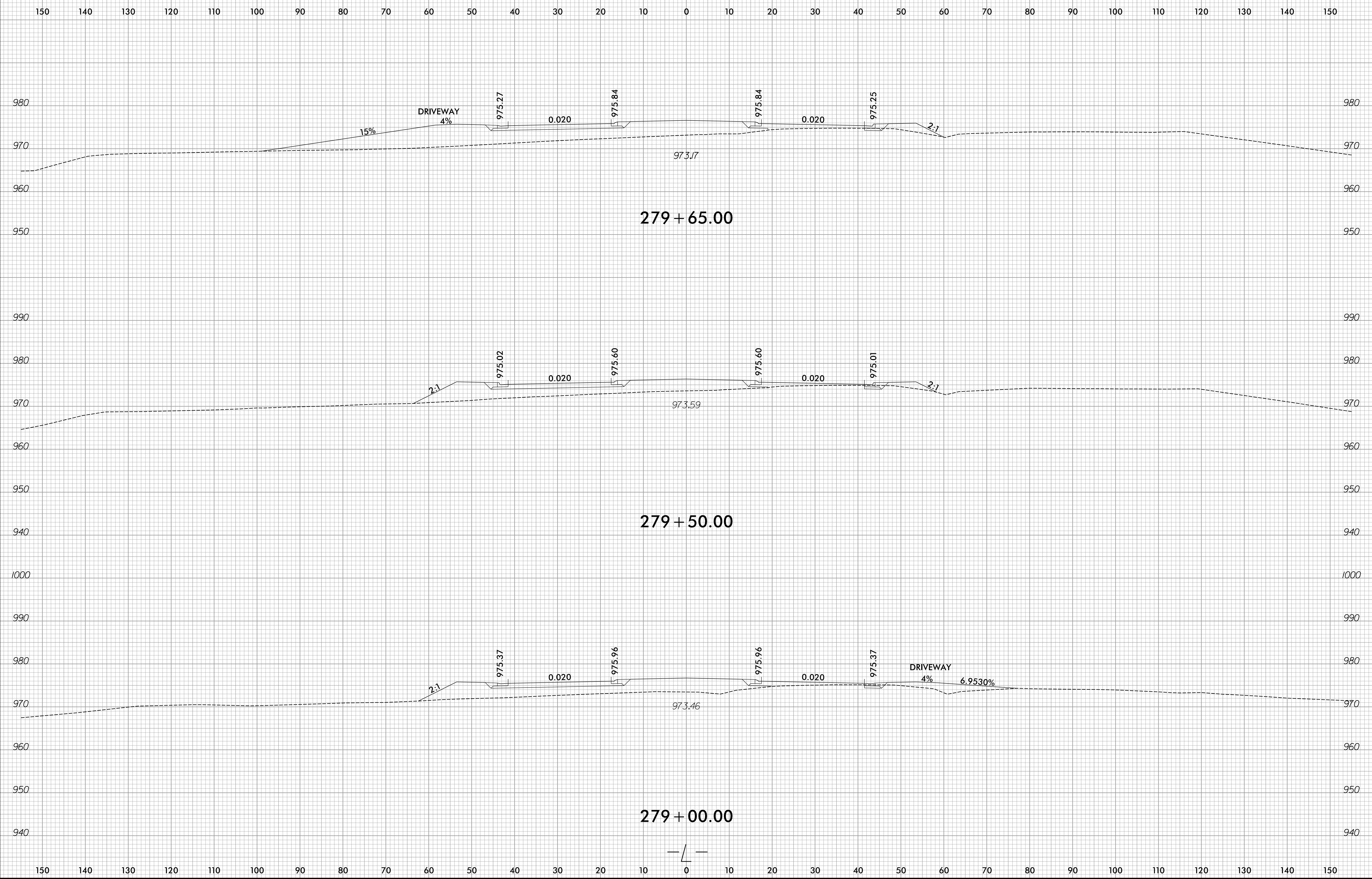



150 140 130 120 110 100 90 80 70 60 50 40 30 20 10 0 10 20 30 40 50 60 70 80 90 100 110 120 130 140 150

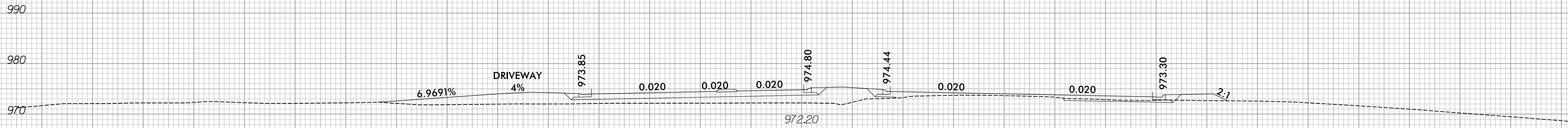

281 + 00.00

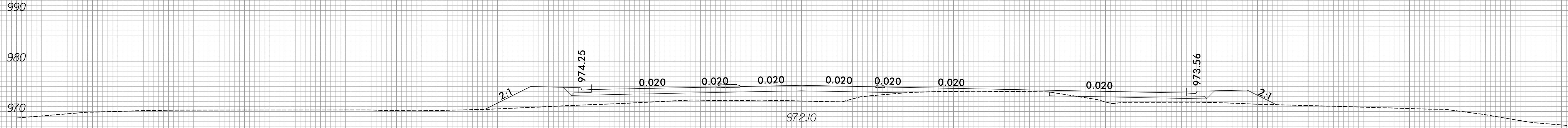

280 + 50.00



280 + 00.00

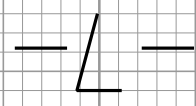

150 140 130 120 110 100 90 80 70 60 50 40 30 20 10 0 10 20 30 40 50 60 70 80 90 100 110 120 130 140 150

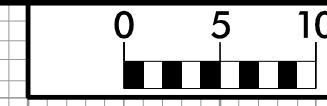

150 140 130 120 110 100 90 80 70 60 50 40 30 20 10 0 10 20 30 40 50 60 70 80 90 100 110 120 130 140 150

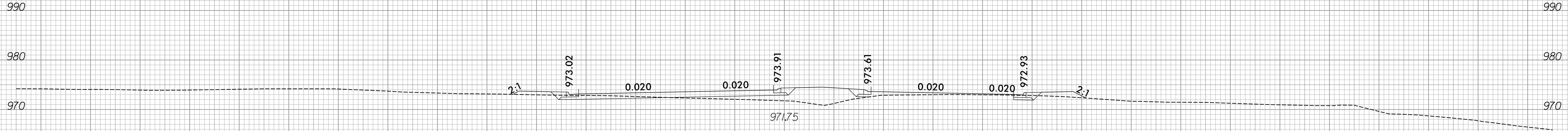

282 + 00.00

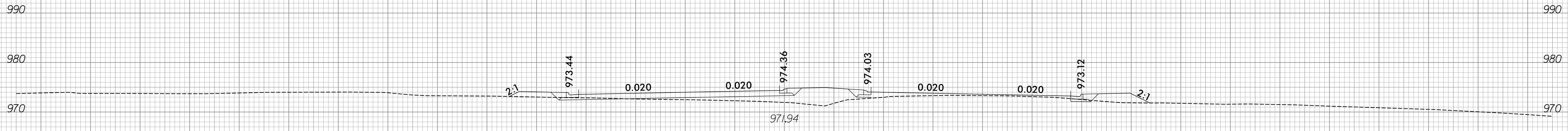

281 + 50.00

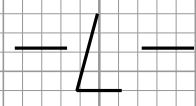

150 140 130 120 110 100 90 80 70 60 50 40 30 20 10 0 10 20 30 40 50 60 70 80 90 100 110 120 130 140 150

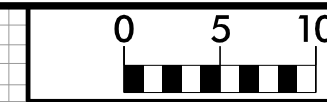

150 140 130 120 110 100 90 80 70 60 50 40 30 20 10 0 10 20 30 40 50 60 70 80 90 100 110 120 130 140 150

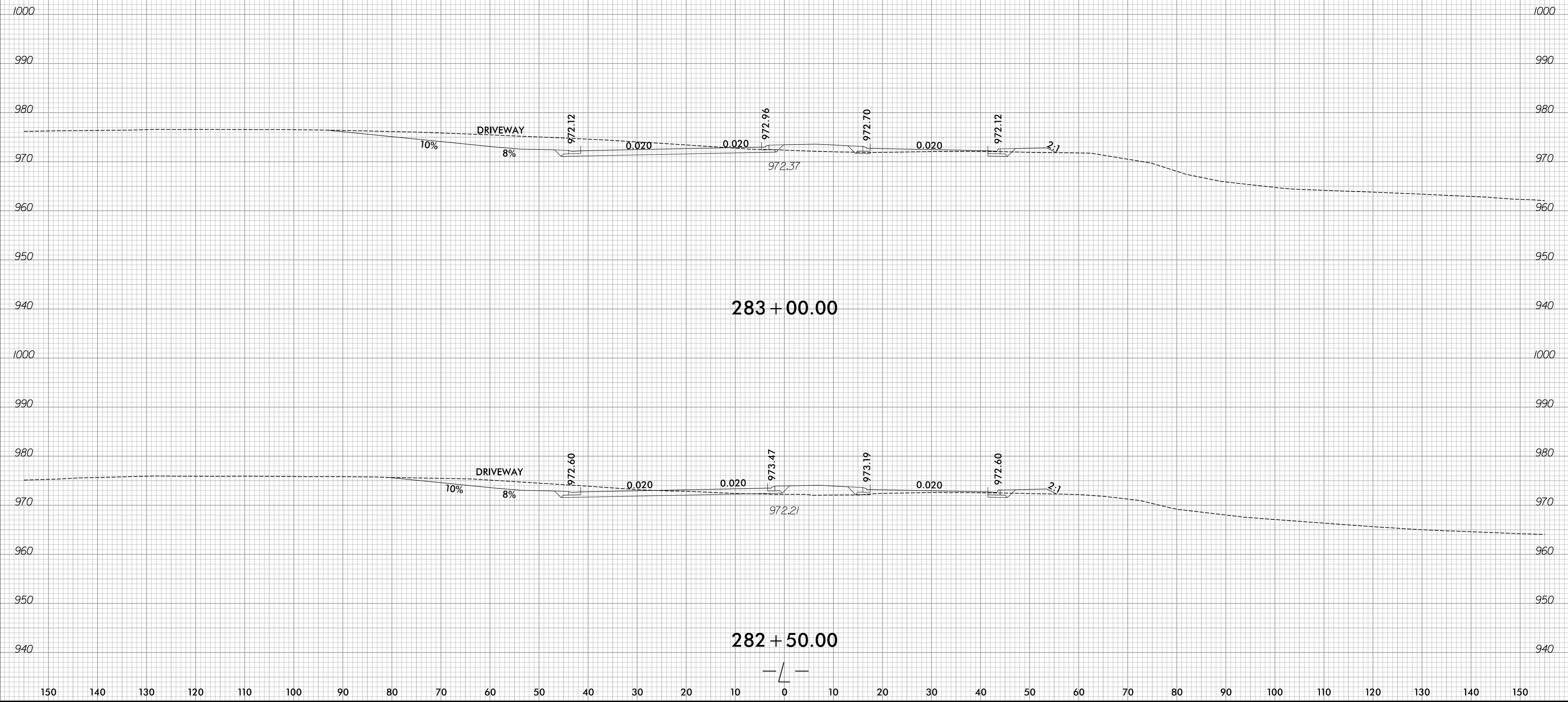

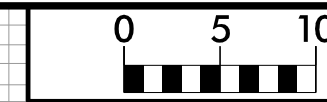

150 140 130 120 110 100 90 80 70 60 50 40 30 20 10 0 10 20 30 40 50 60 70 80 90 100 110 120 130 140 150

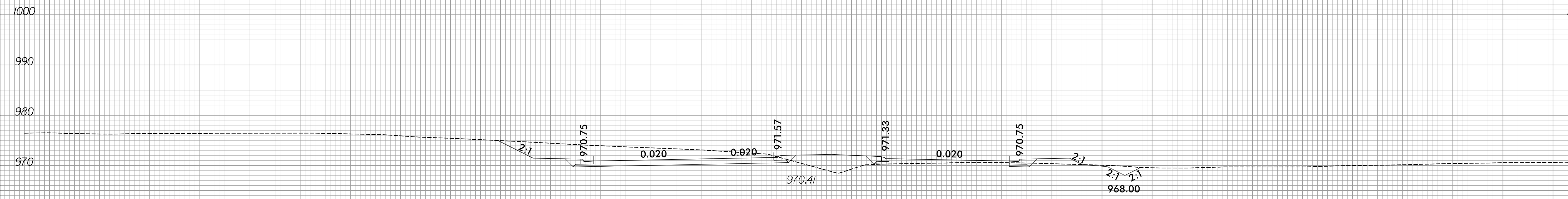

150 140 130 120 110 100 90 80 70 60 50 40 30 20 10 0 10 20 30 40 50 60 70 80 90 100 110 120 130 140 150

150 140 130 120 110 100 90 80 70 60 50 40 30 20 10 0 10 20 30 40 50 60 70 80 90 100 110 120 130 140 150

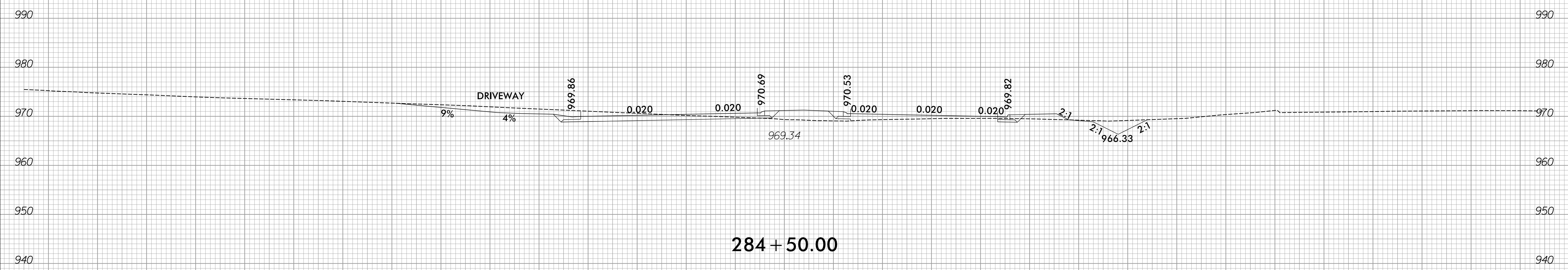
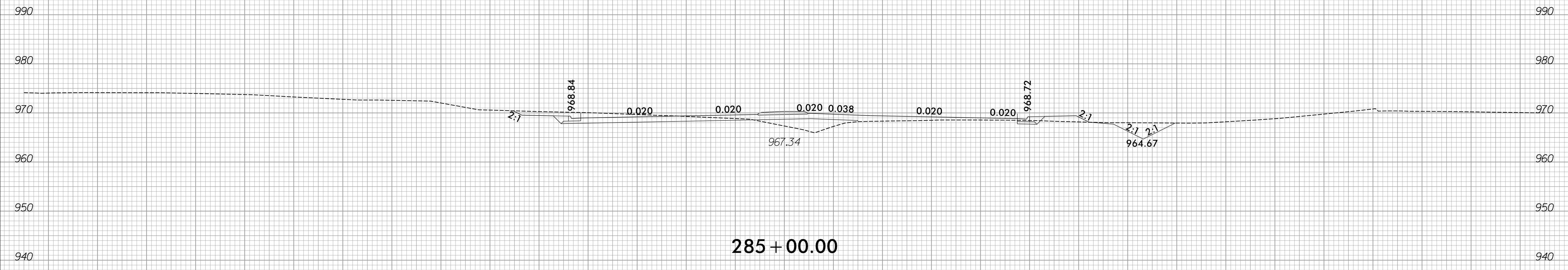

150 140 130 120 110 100 90 80 70 60 50 40 30 20 10 0 10 20 30 40 50 60 70 80 90 100 110 120 130 140 150



150 140 130 120 110 100 90 80 70 60 50 40 30 20 10 0 10 20 30 40 50 60 70 80 90 100 110 120 130 140 150

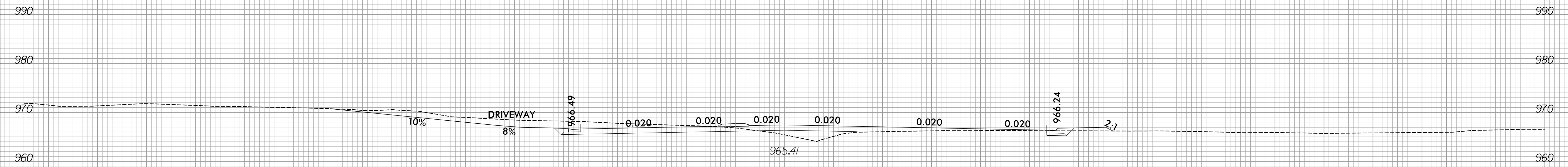

286 + 00.00

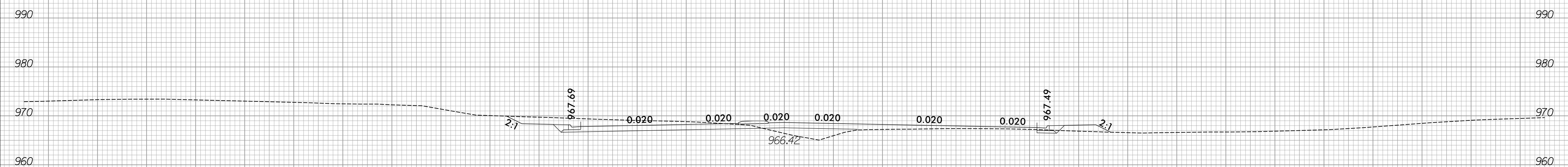

285 + 50.00

150 140 130 120 110 100 90 80 70 60 50 40 30 20 10 0 10 20 30 40 50 60 70 80 90 100 110 120 130 140 150

150 140 130 120 110 100 90 80 70 60 50 40 30 20 10 0 10 20 30 40 50 60 70 80 90 100 110 120 130 140 150

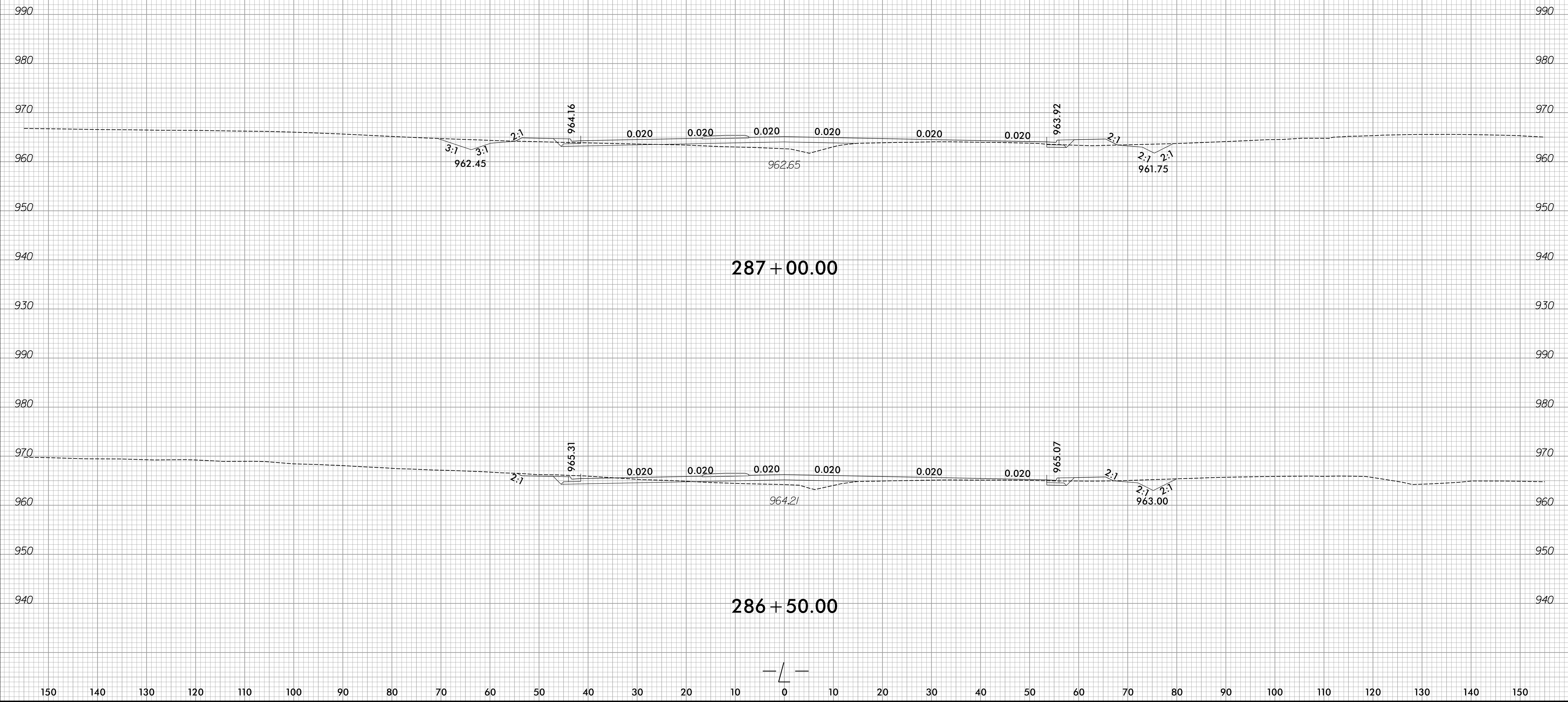

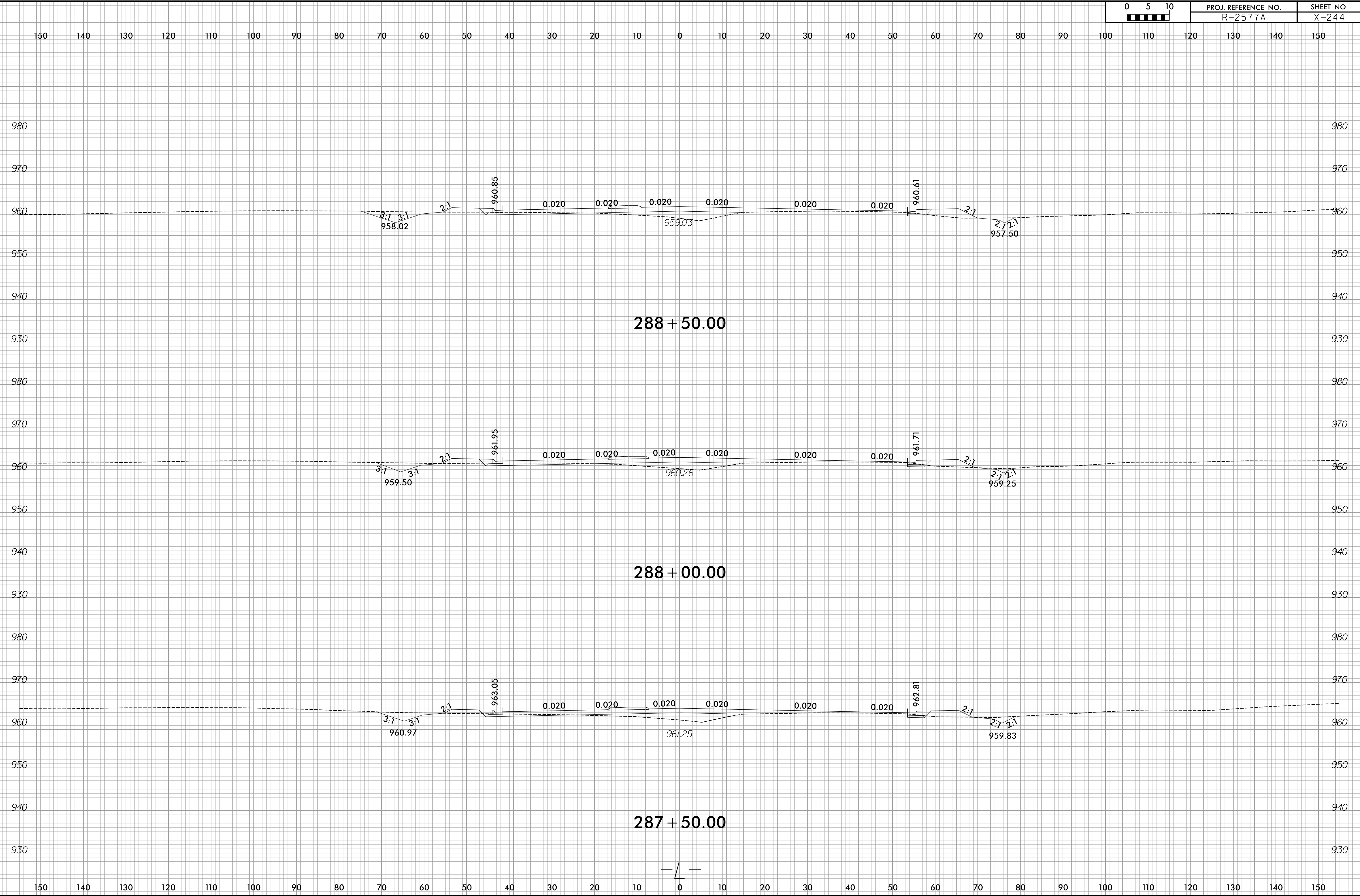

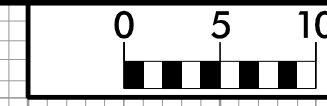

150 140 130 120 110 100 90 80 70 60 50 40 30 20 10 0 10 20 30 40 50 60 70 80 90 100 110 120 130 140 150

980 970 960 950 940 930 980 970 960 950 940 930

290 + 00.00

980 970 960 950 940 930 980 970 960 950 940 930

289 + 50.00

980 970 960 950 940 930 980 970 960 950 940 930

289 + 00.00

150 140 130 120 110 100 90 80 70 60 50 40 30 20 10 0 10 20 30 40 50 60 70 80 90 100 110 120 130 140 150

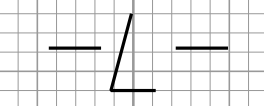
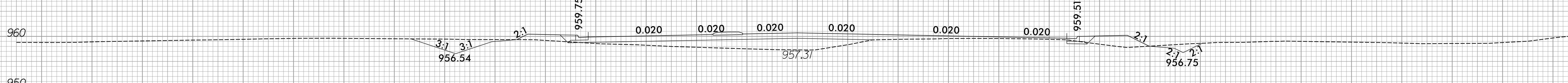
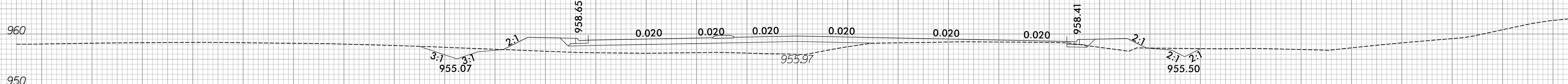
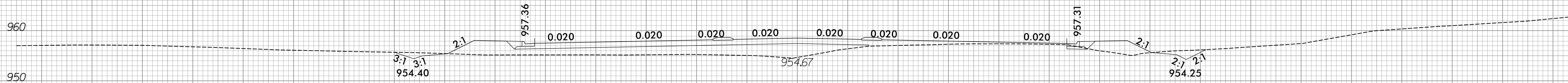

150 140 130 120 110 100 90 80 70 60 50 40 30 20 10 0 10 20 30 40 50 60 70 80 90 100 110 120 130 140 150

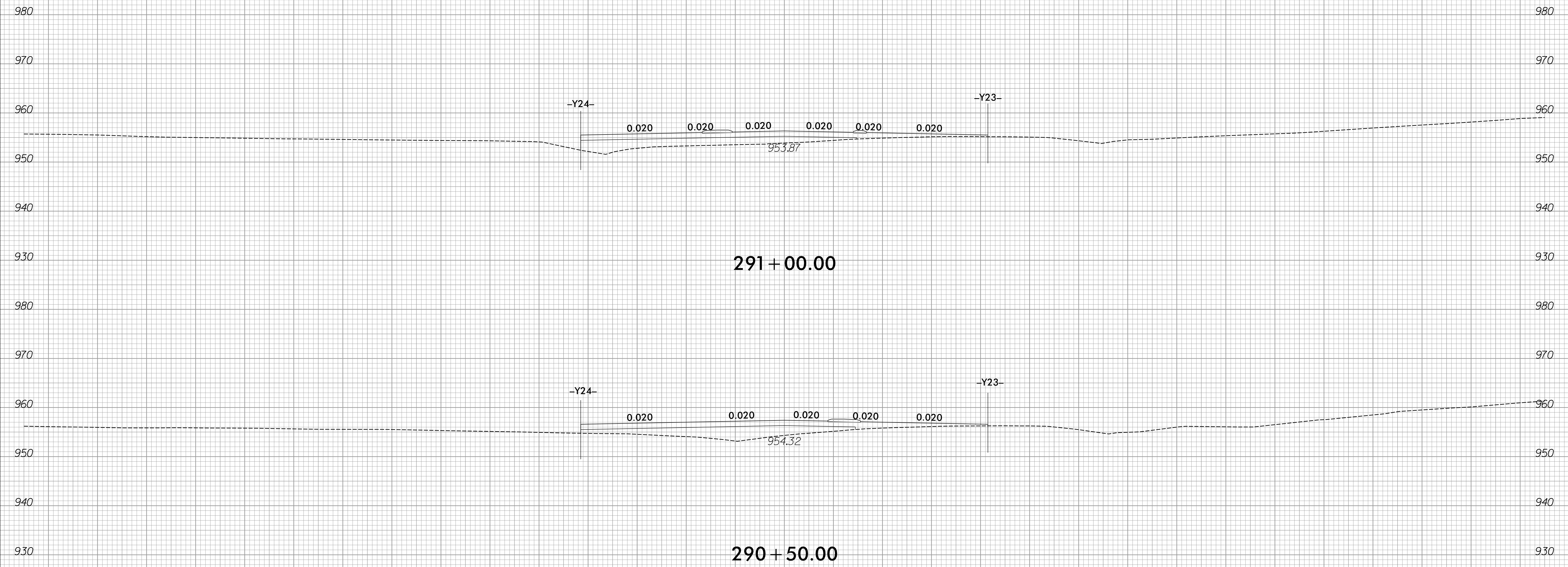

150 140 130 120 110 100 90 80 70 60 50 40 30 20 10 0 10 20 30 40 50 60 70 80 90 100 110 120 130 140 150

150 140 130 120 110 100 90 80 70 60 50 40 30 20 10 0 10 20 30 40 50 60 70 80 90 100 110 120 130 140 150

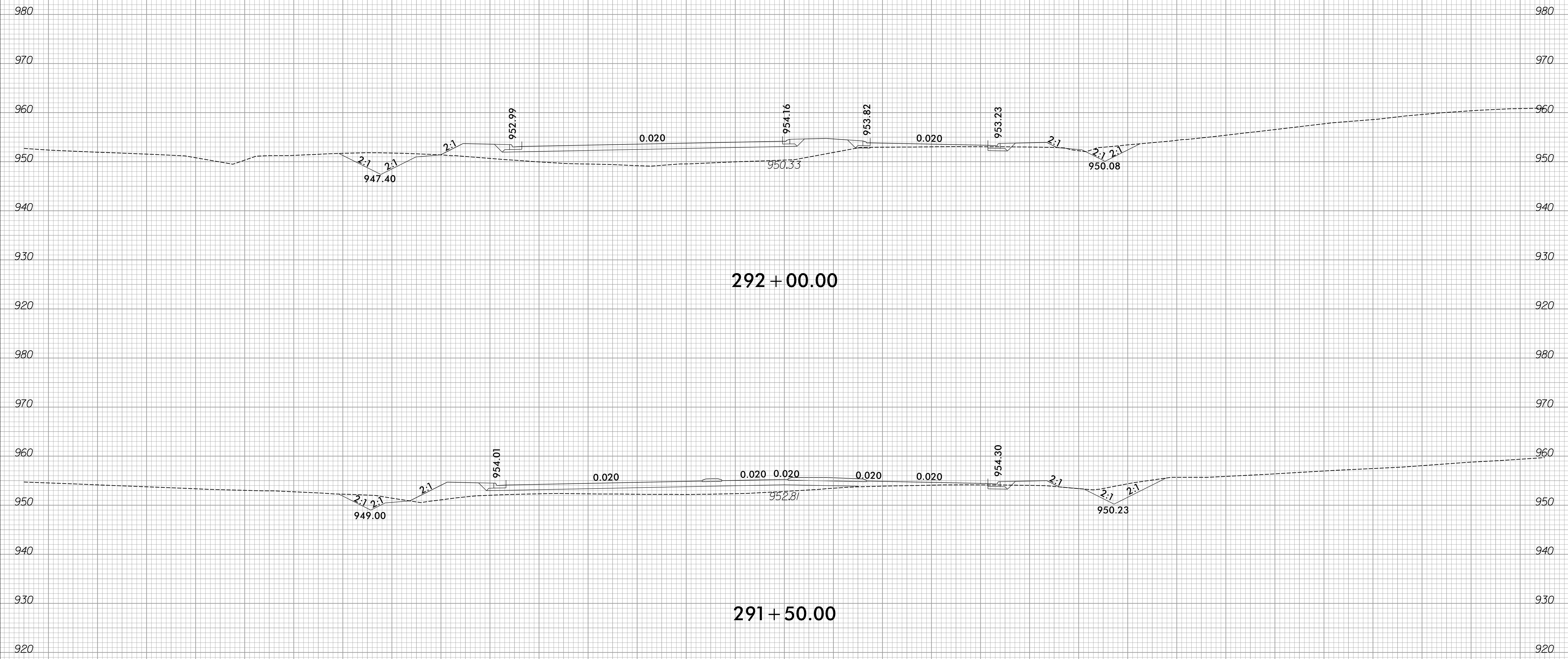

150 140 130 120 110 100 90 80 70 60 50 40 30 20 10 0 10 20 30 40 50 60 70 80 90 100 110 120 130 140 150

150 140 130 120 110 100 90 80 70 60 50 40 30 20 10 0 10 20 30 40 50 60 70 80 90 100 110 120 130 140 150

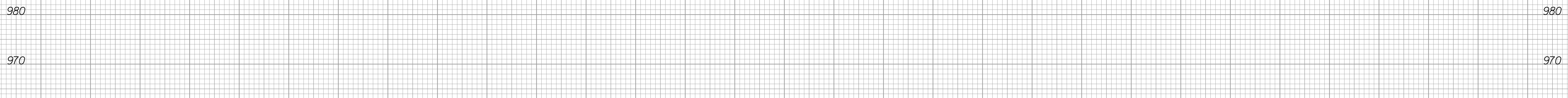

293 + 00.00

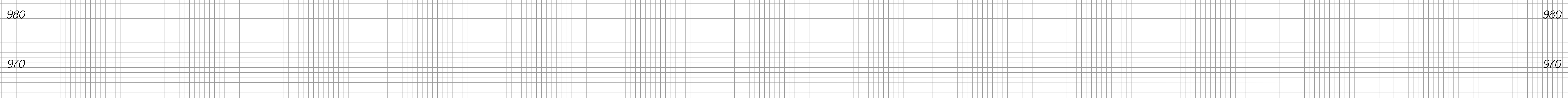

292 + 50.00

150 140 130 120 110 100 90 80 70 60 50 40 30 20 10 0 10 20 30 40 50 60 70 80 90 100 110 120 130 140 150

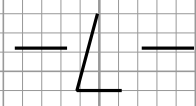

150 140 130 120 110 100 90 80 70 60 50 40 30 20 10 0 10 20 30 40 50 60 70 80 90 100 110 120 130 140 150

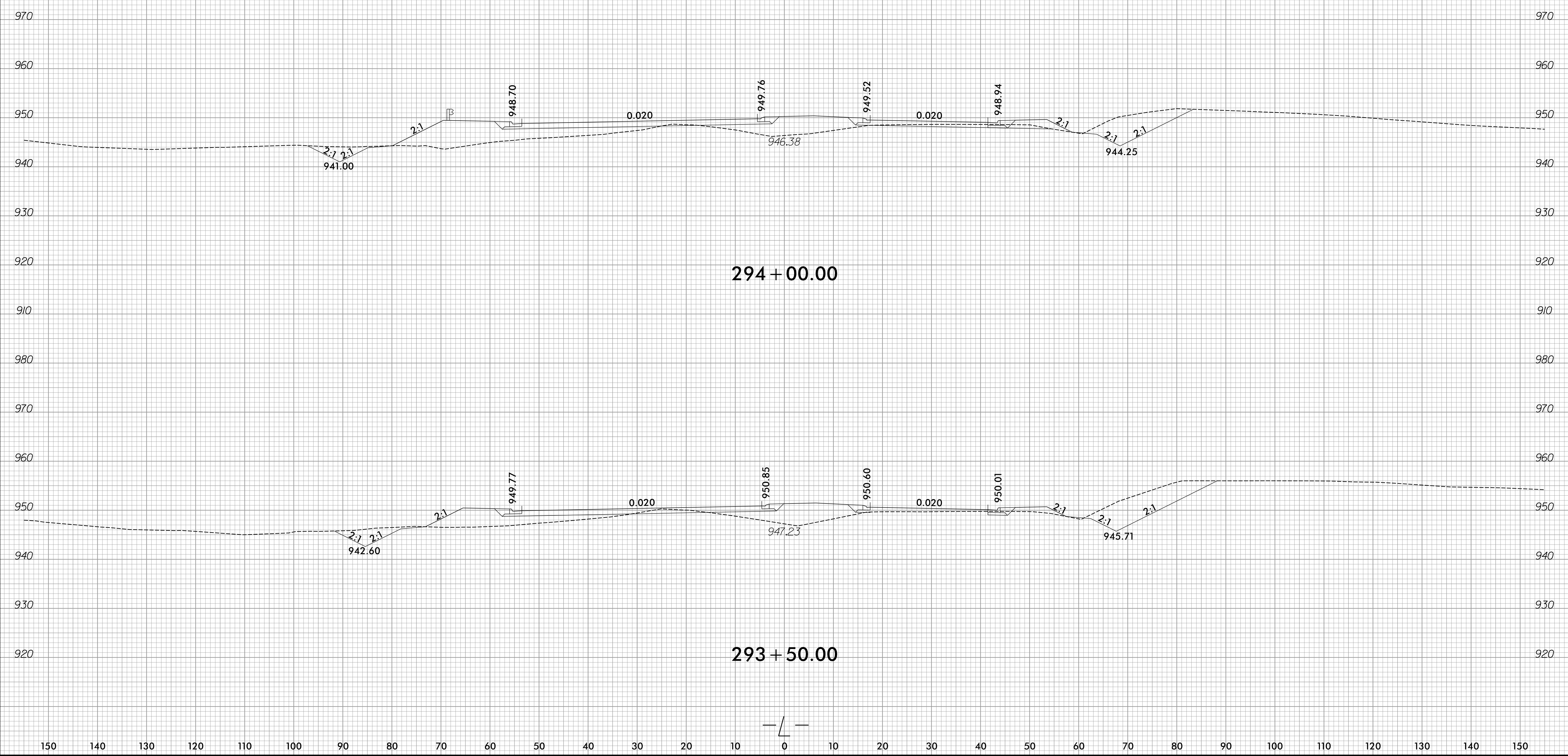

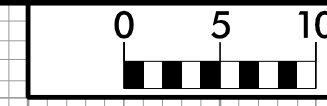

150 140 130 120 110 100 90 80 70 60 50 40 30 20 10 0 10 20 30 40 50 60 70 80 90 100 110 120 130 140 150

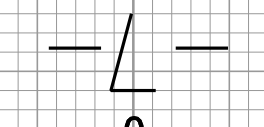
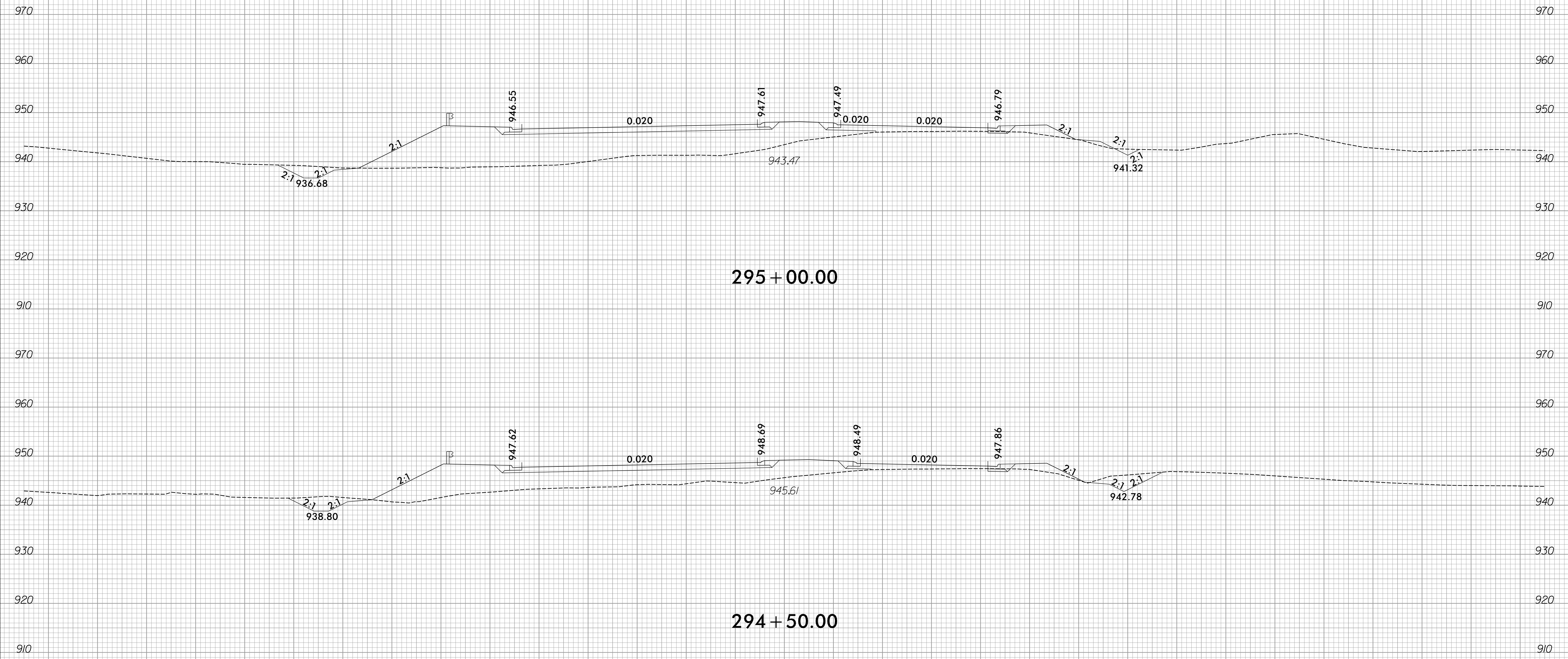

150 140 130 120 110 100 90 80 70 60 50 40 30 20 10 0 10 20 30 40 50 60 70 80 90 100 110 120 130 140 150

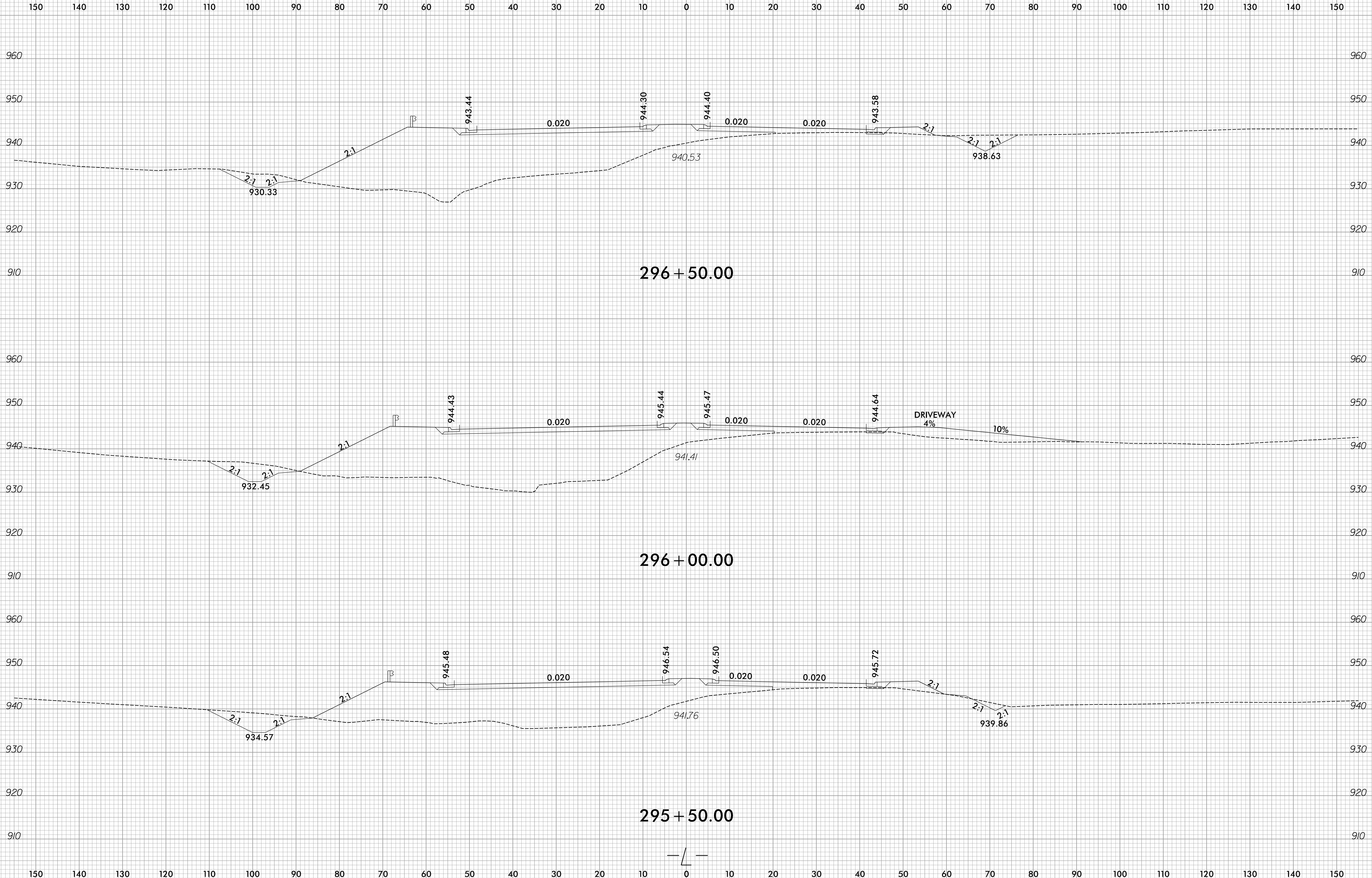

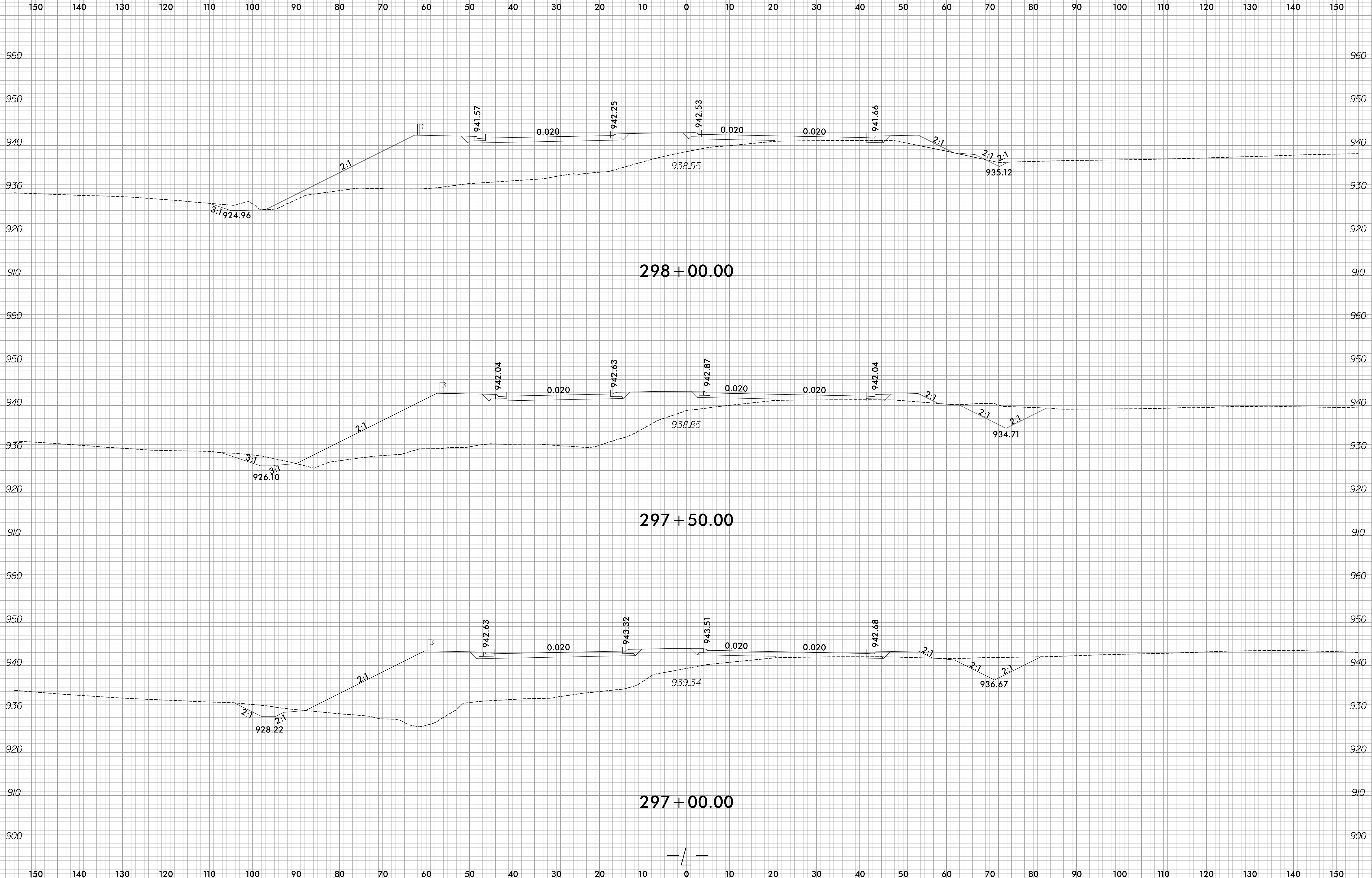

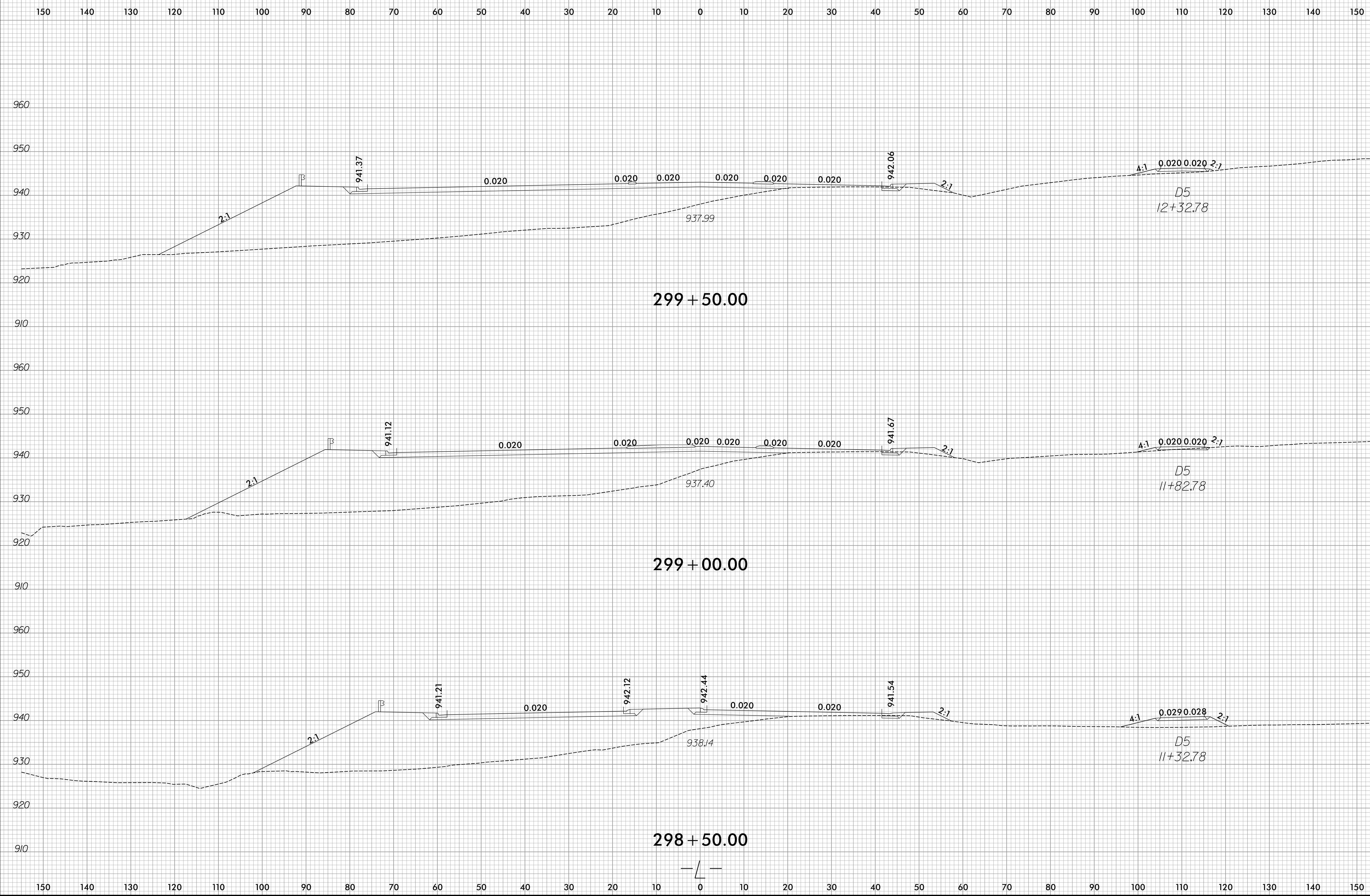

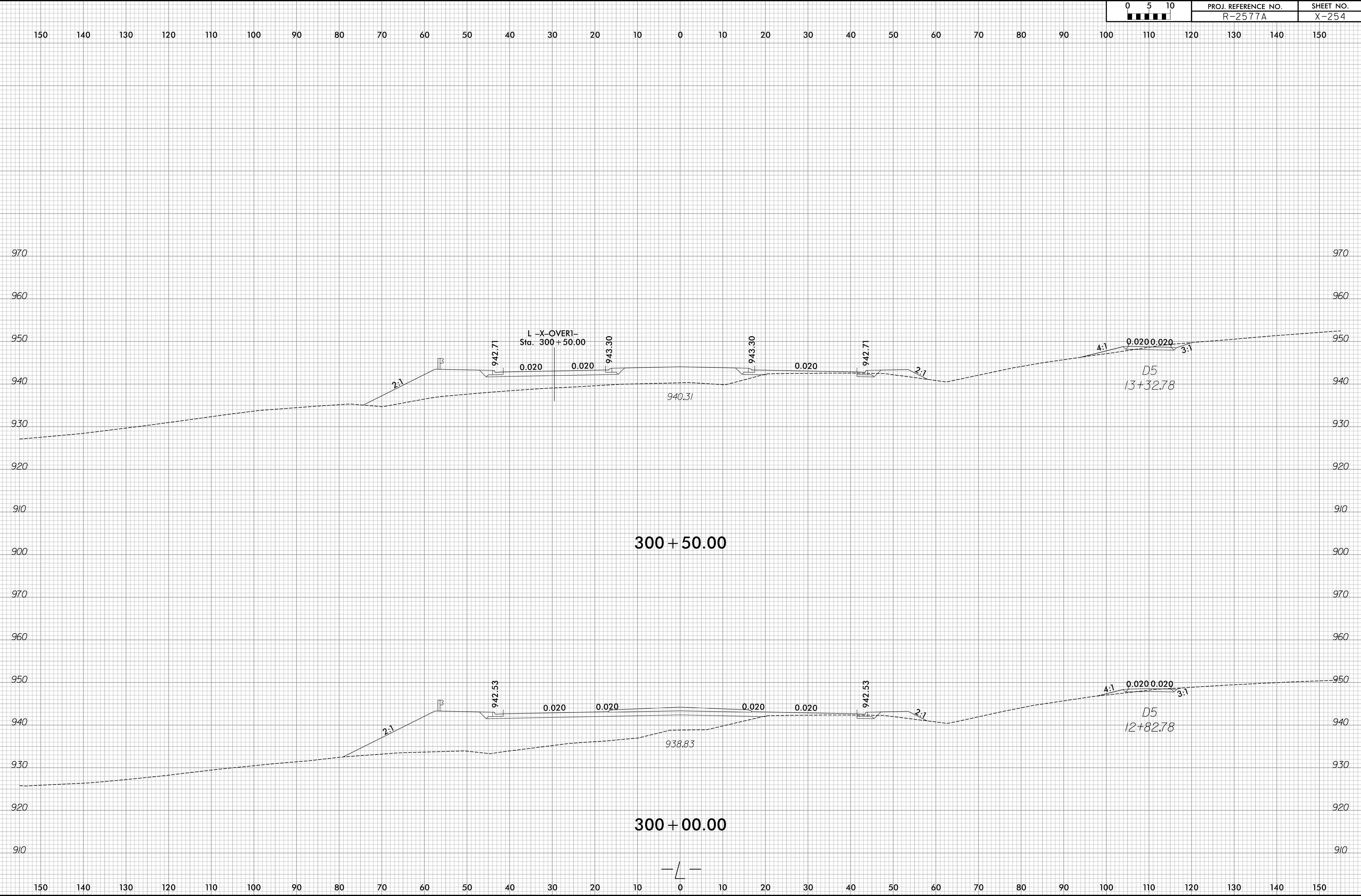

6/23/16

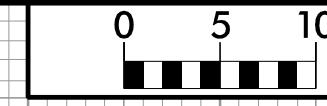

PROJ. REFERENCE NO.
R-2577A

SHEET NO.
X-255

150 140 130 120 110 100 90 80 70 60 50 40 30 20 10 0 10 20 30 40 50 60 70 80 90 100 110 120 130 140 150

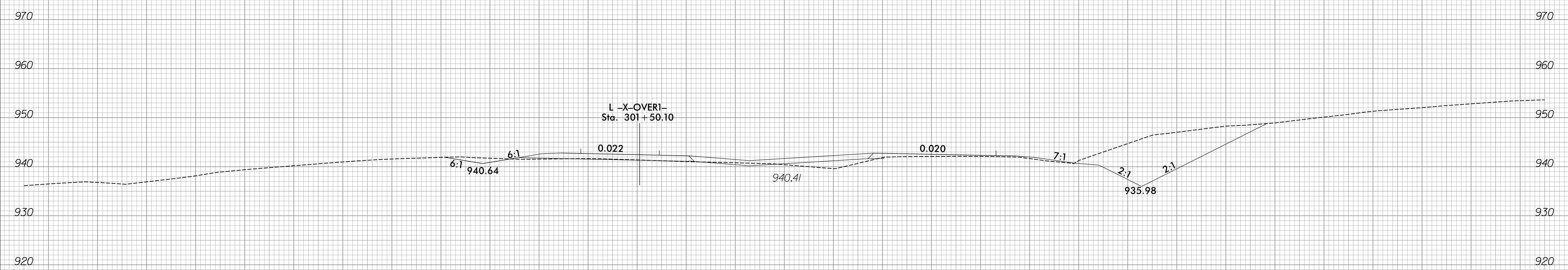

301 + 50.00

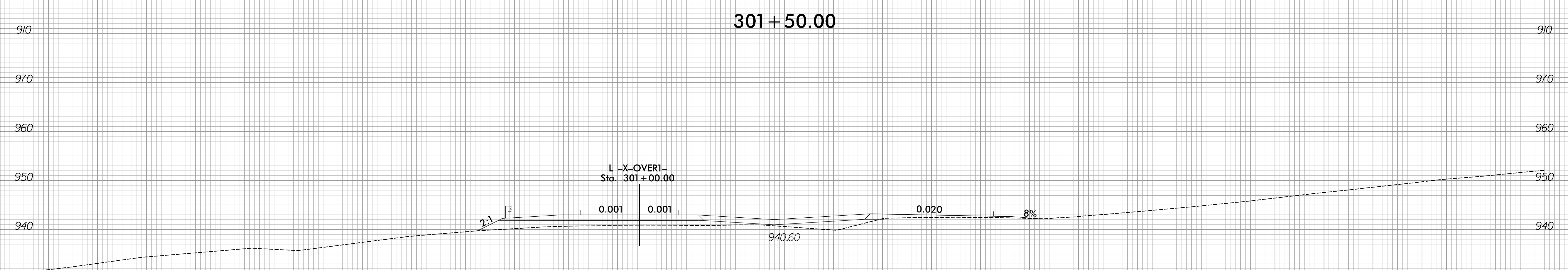

301 + 00.00

150 140 130 120 110 100 90 80 70 60 50 40 30 20 10 0 10 20 30 40 50 60 70 80 90 100 110 120 130 140 150

12/20/2023
R:\Roadway\XSC\R-2577A_Rdy_xp1.L_PART2.dgn
amc@pfs.com

6/23/16

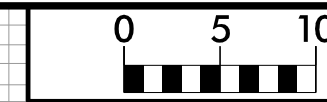

PROJ. REFERENCE NO.
R-2577A

SHEET NO.
X-256

150 140 130 120 110 100 90 80 70 60 50 40 30 20 10 0 10 20 30 40 50 60 70 80 90 100 110 120 130 140 150

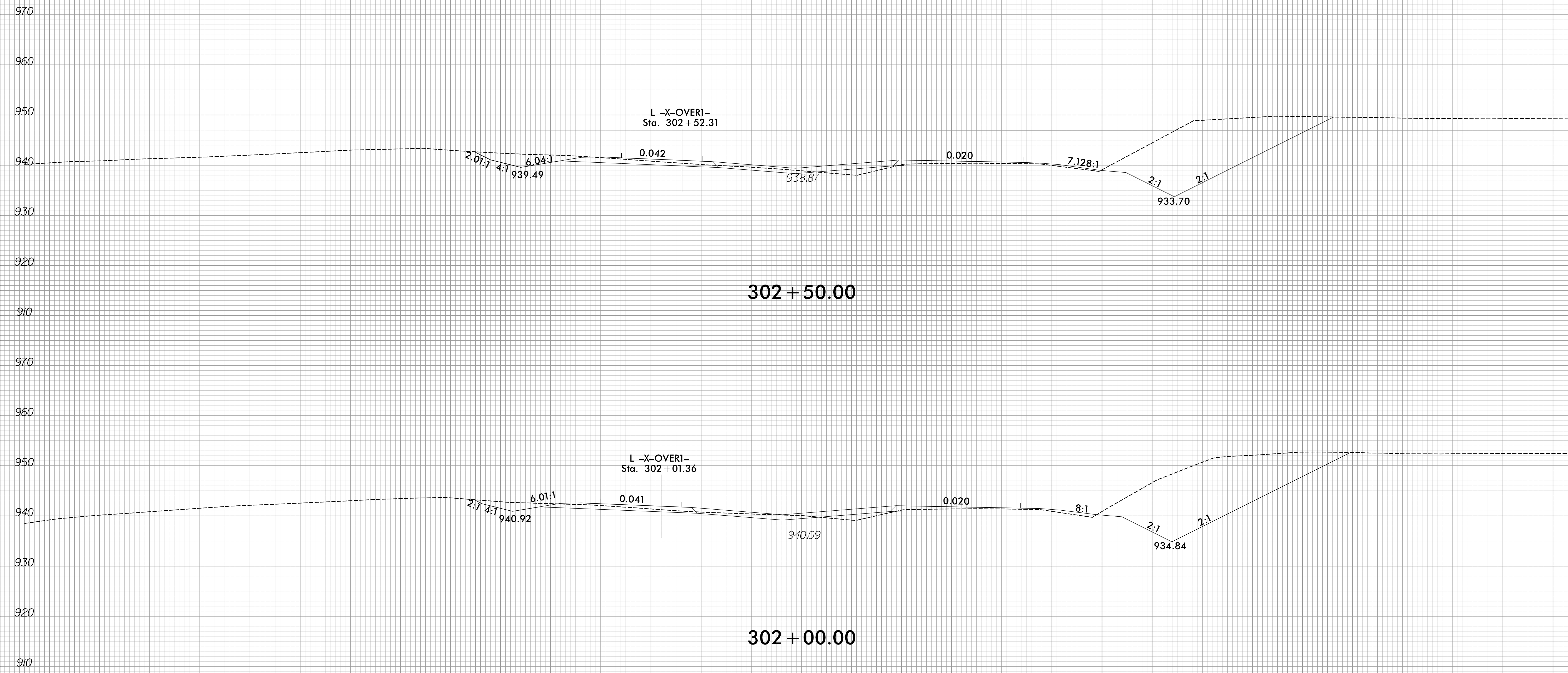

150 140 130 120 110 100 90 80 70 60 50 40 30 20 10 0 10 20 30 40 50 60 70 80 90 100 110 120 130 140 150

12/20/2023
R:\Roadway\XSC\R-2577A_Rdy_xp1.L_PART2.dgn
amcpherson



150 140 130 120 110 100 90 80 70 60 50 40 30 20 10 0 10 20 30 40 50 60 70 80 90 100 110 120 130 140 150

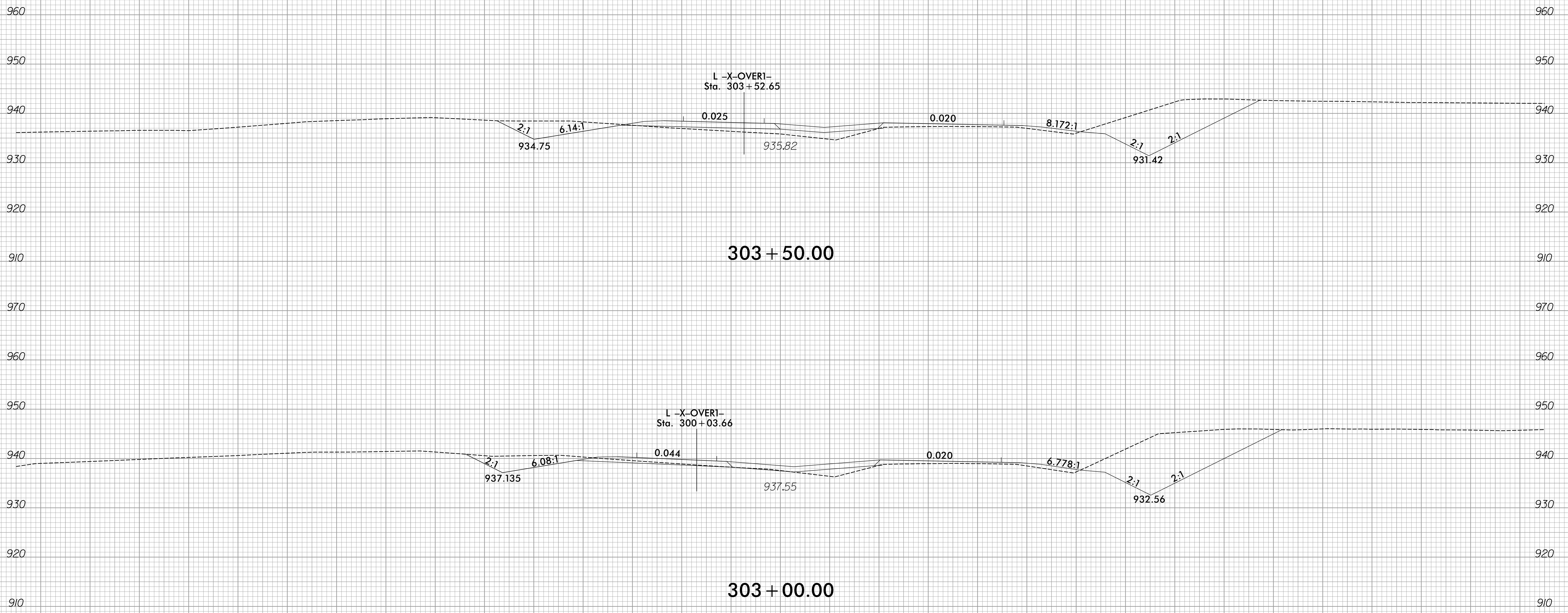

150 140 130 120 110 100 90 80 70 60 50 40 30 20 10 0 10 20 30 40 50 60 70 80 90 100 110 120 130 140 150

150 140 130 120 110 100 90 80 70 60 50 40 30 20 10 0 10 20 30 40 50 60 70 80 90 100 110 120 130 140 150

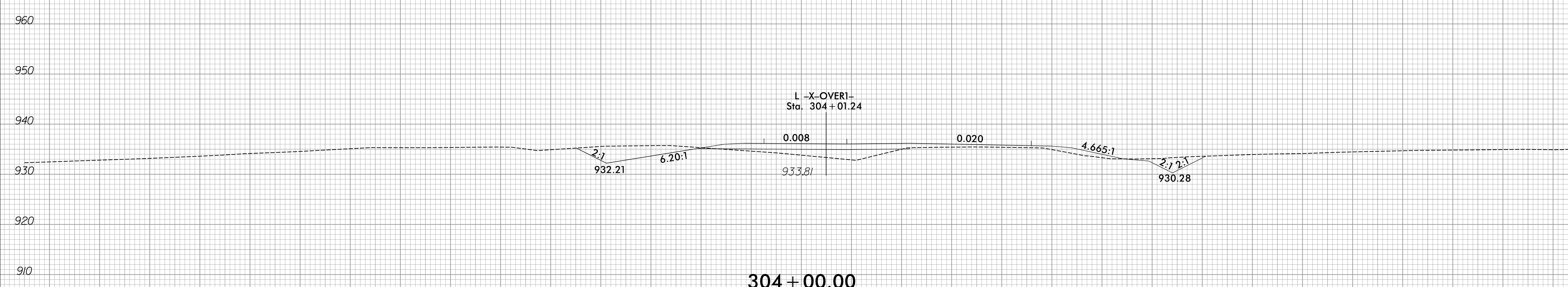
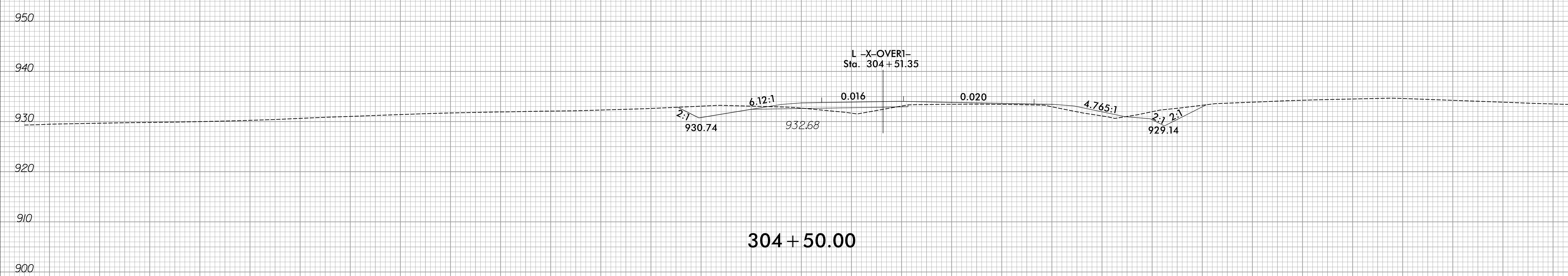
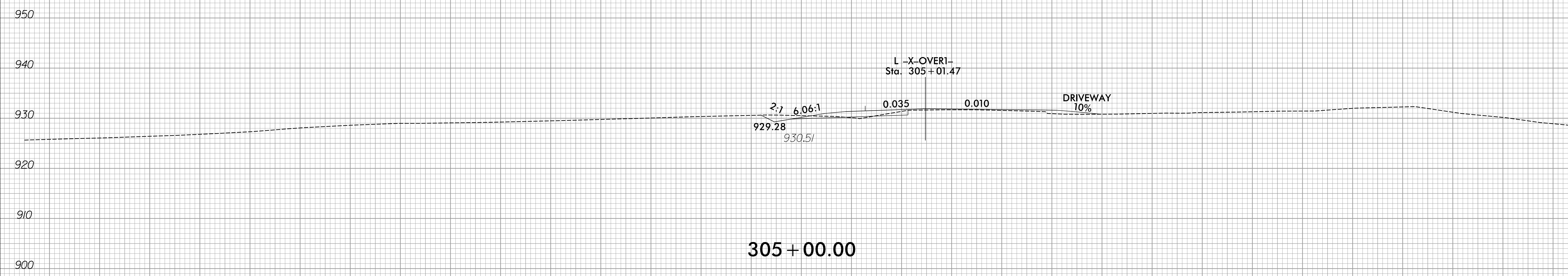

150 140 130 120 110 100 90 80 70 60 50 40 30 20 10 0 10 20 30 40 50 60 70 80 90 100 110 120 130 140 150

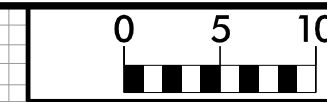

150 140 130 120 110 100 90 80 70 60 50 40 30 20 10 0 10 20 30 40 50 60 70 80 90 100 110 120 130 140 150

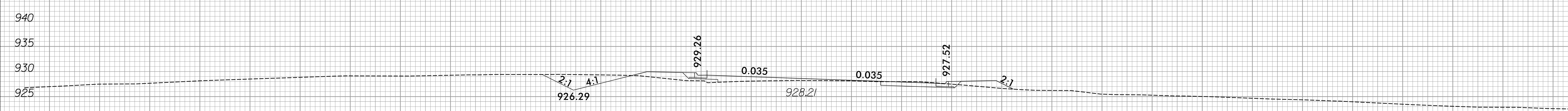

12 + 00.00

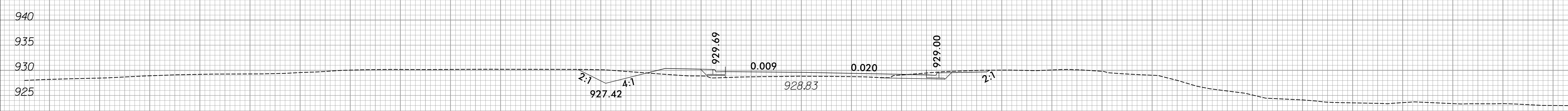

11 + 50.00

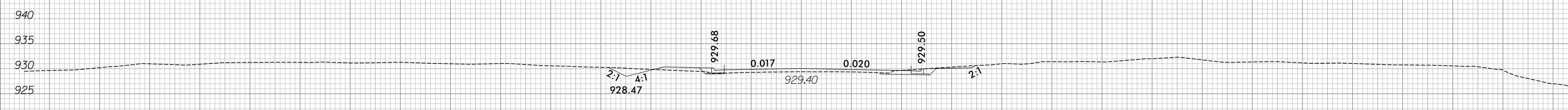

11 + 00.00

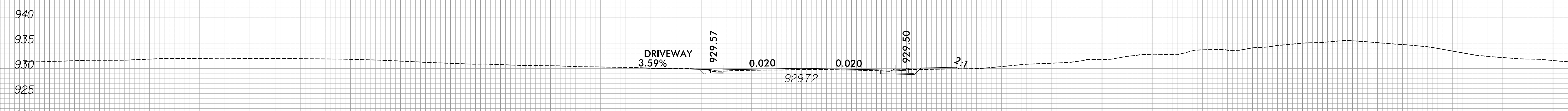

10 + 50.00

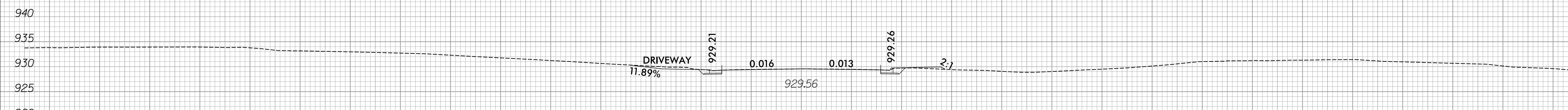

10 + 00.00

-Y/A-

150 140 130 120 110 100 90 80 70 60 50 40 30 20 10 0 10 20 30 40 50 60 70 80 90 100 110 120 130 140 150

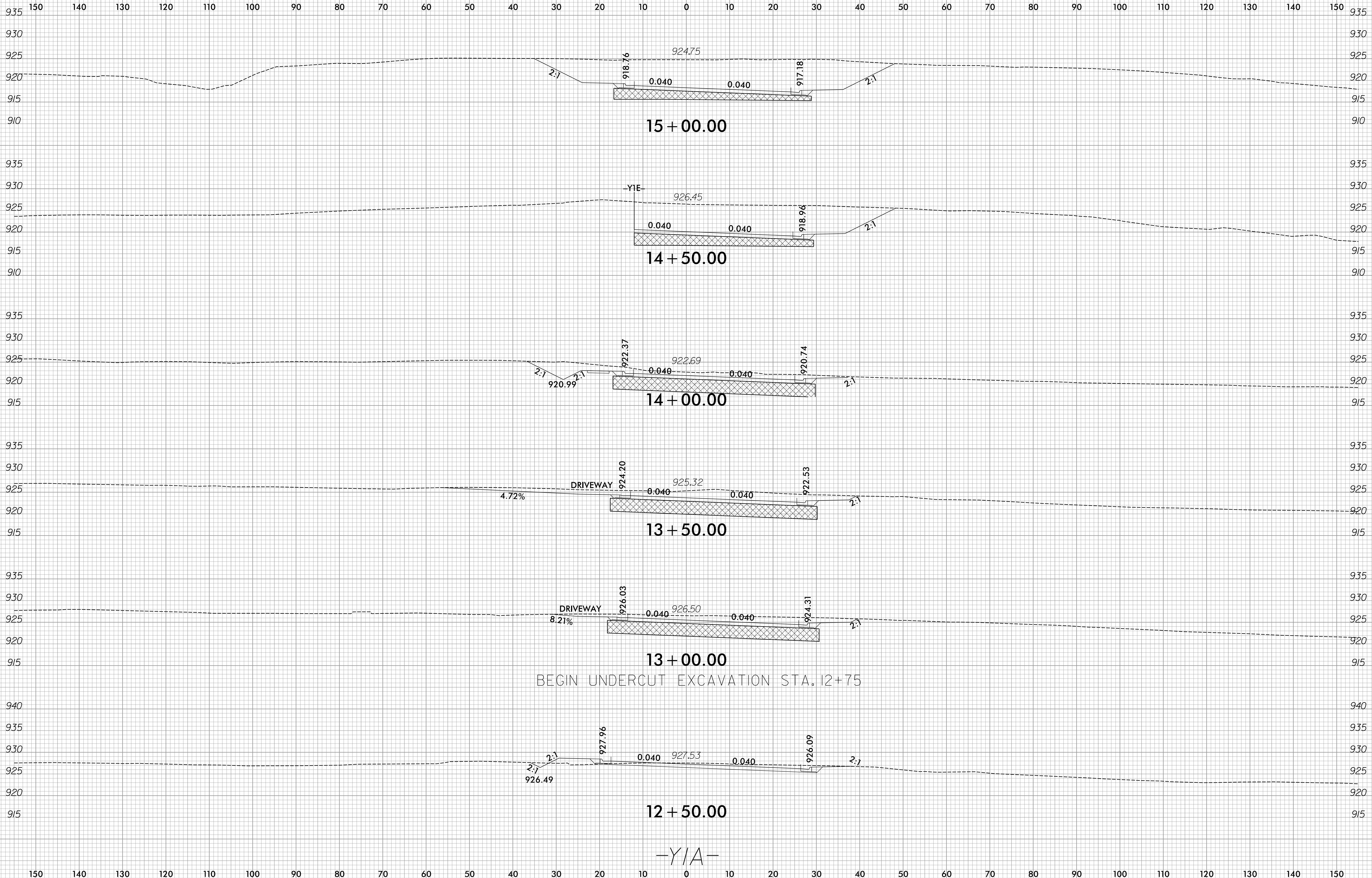



150 140 130 120 110 100 90 80 70 60 50 40 30 20 10 0 10 20 30 40 50 60 70 80 90 100 110 120 130 140 150

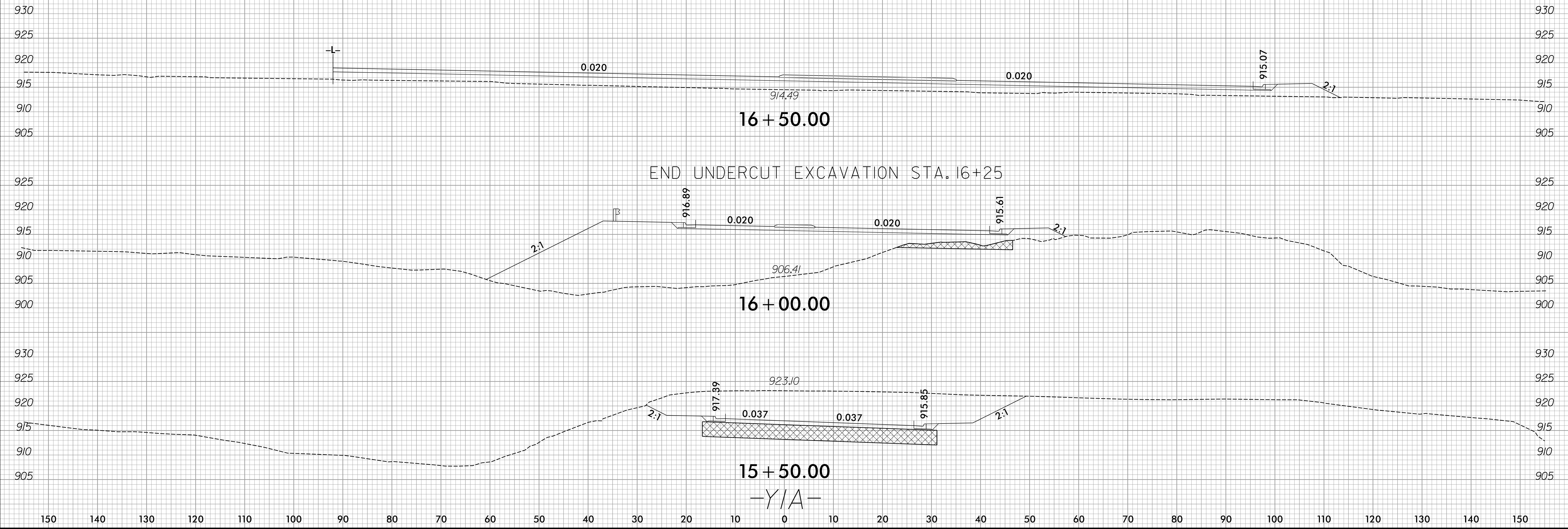

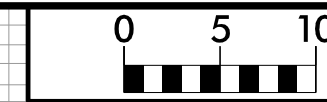

150 140 130 120 110 100 90 80 70 60 50 40 30 20 10 0 10 20 30 40 50 60 70 80 90 100 110 120 130 140 150

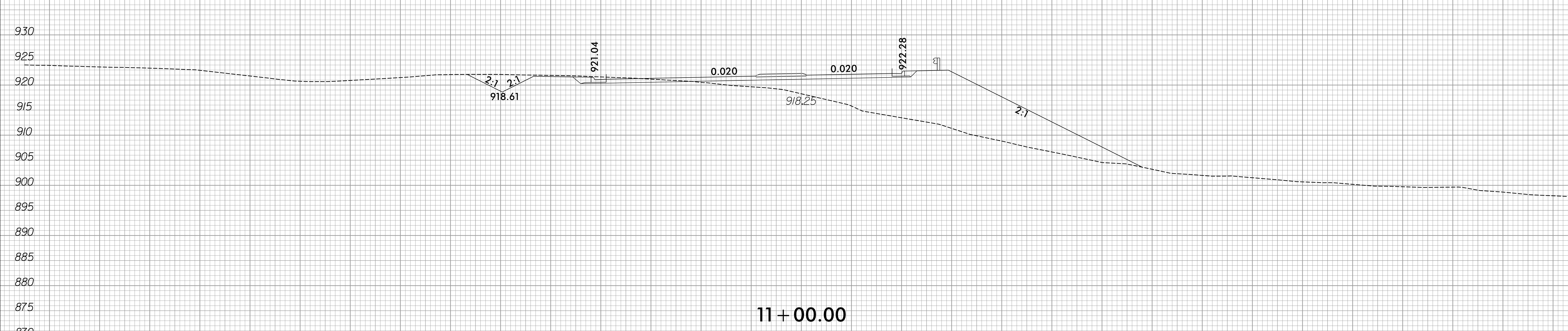
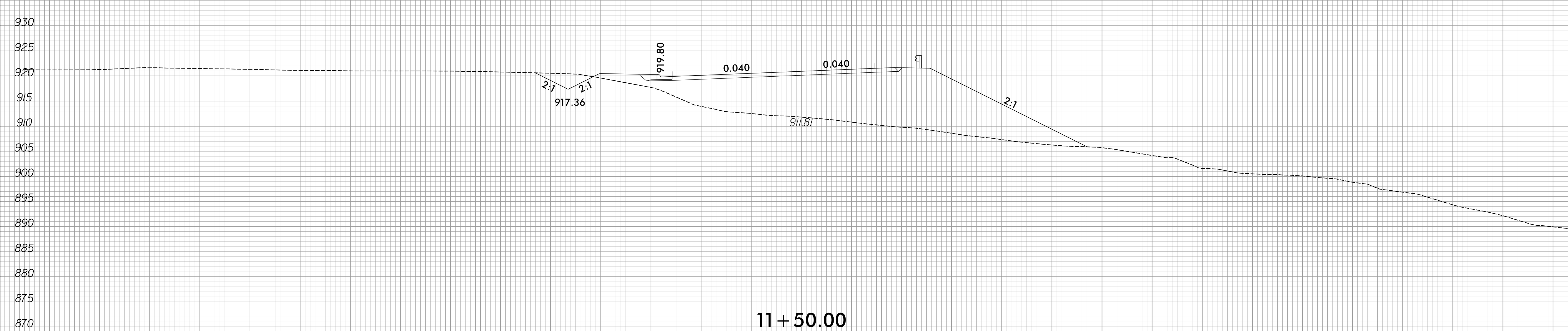
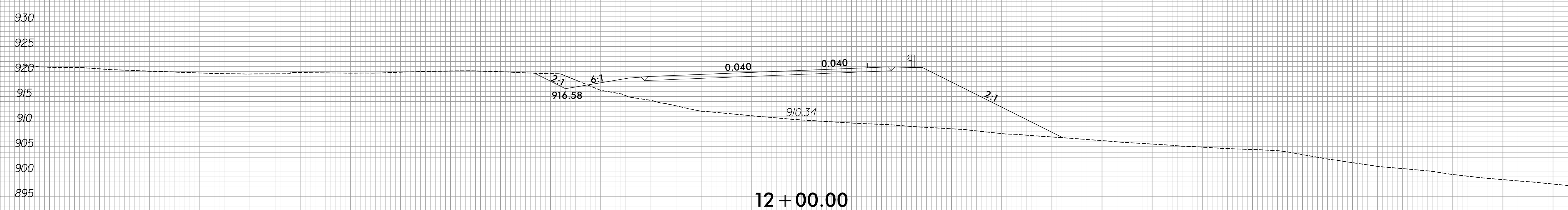

-YIB-

150 140 130 120 110 100 90 80 70 60 50 40 30 20 10 0 10 20 30 40 50 60 70 80 90 100 110 120 130 140 150

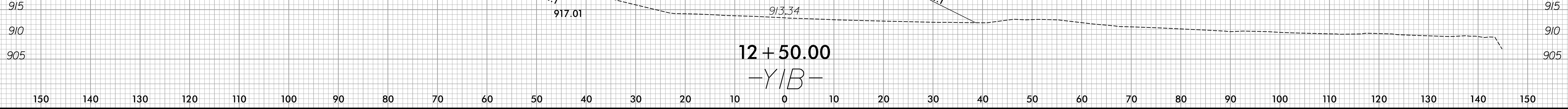
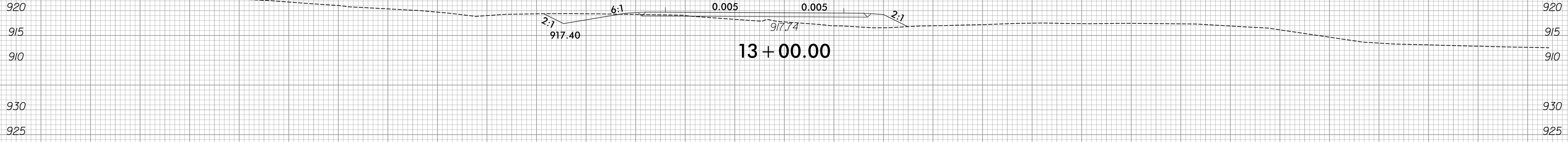
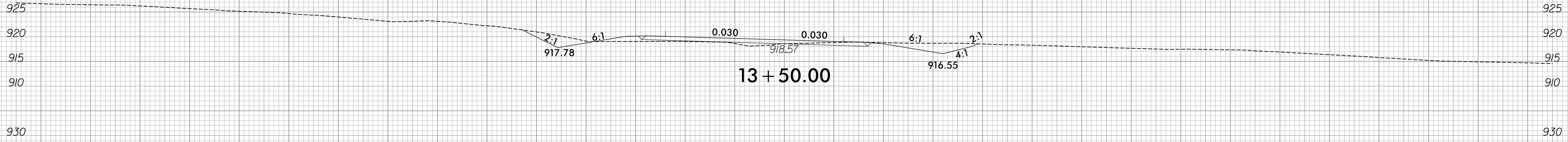
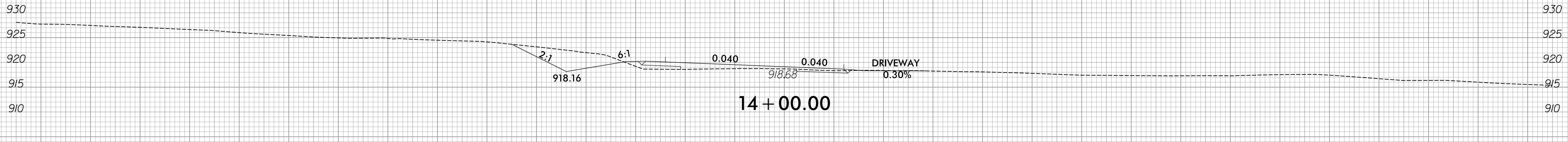
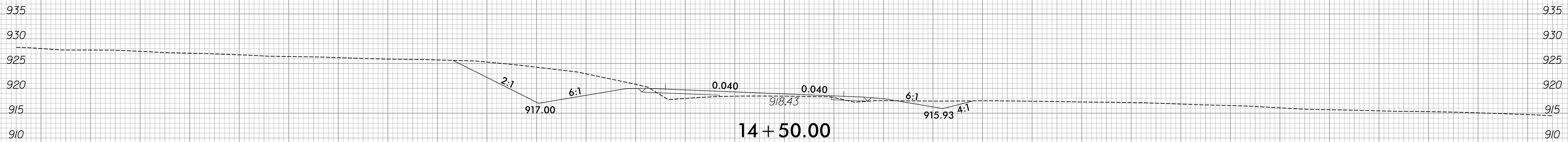
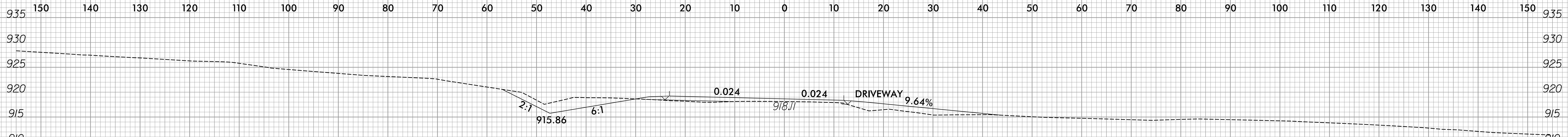

150 140 130 120 110 100 90 80 70 60 50 40 30 20 10 0 10 20 30 40 50 60 70 80 90 100 110 120 130 140 150

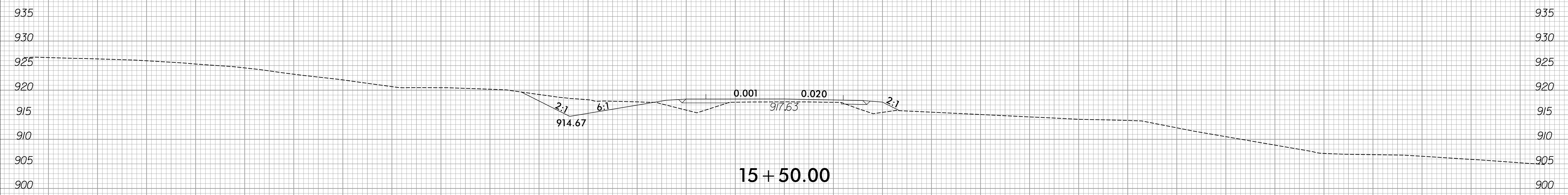
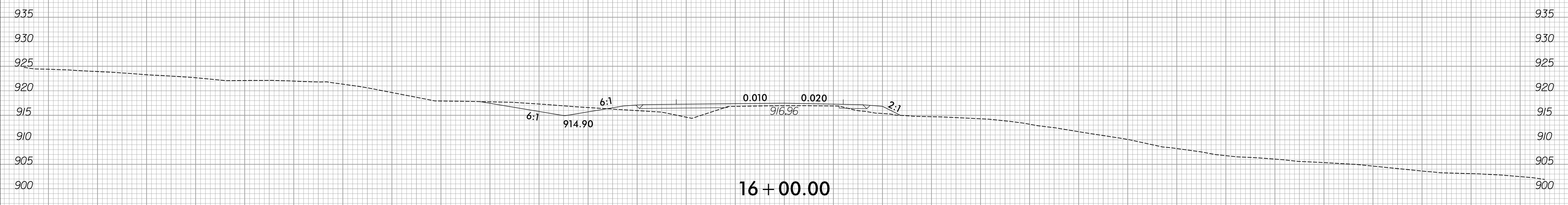
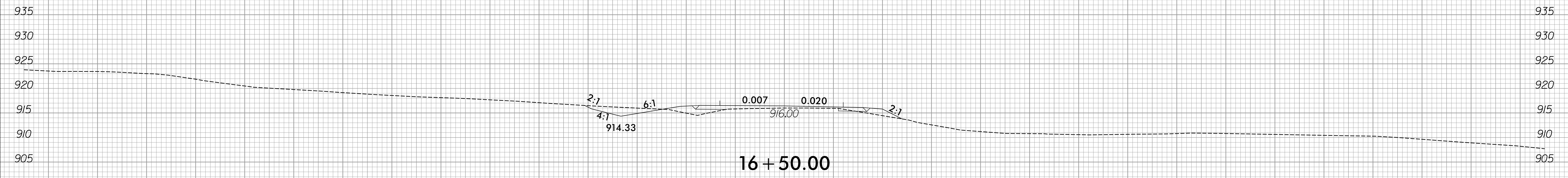
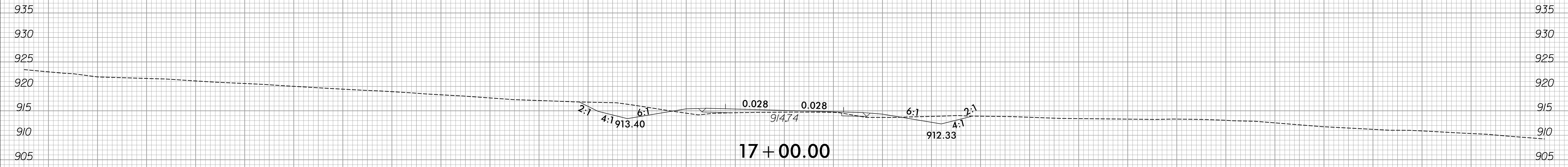

-YIB-

150 140 130 120 110 100 90 80 70 60 50 40 30 20 10 0 10 20 30 40 50 60 70 80 90 100 110 120 130 140 150



150 140 130 120 110 100 90 80 70 60 50 40 30 20 10 0 10 20 30 40 50 60 70 80 90 100 110 120 130 140 150

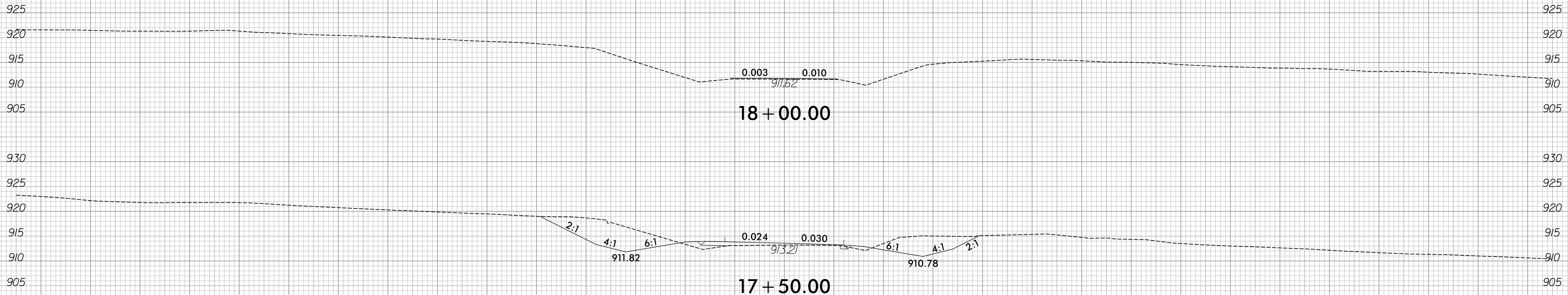

-YIB-

150 140 130 120 110 100 90 80 70 60 50 40 30 20 10 0 10 20 30 40 50 60 70 80 90 100 110 120 130 140 150

6/23/16

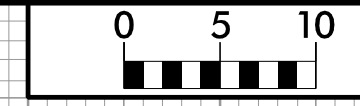

PROJ. REFERENCE NO.
R-2577A

SHEET NO.
X-266

150 140 130 120 110 100 90 80 70 60 50 40 30 20 10 0 10 20 30 40 50 60 70 80 90 100 110 120 130 140 150

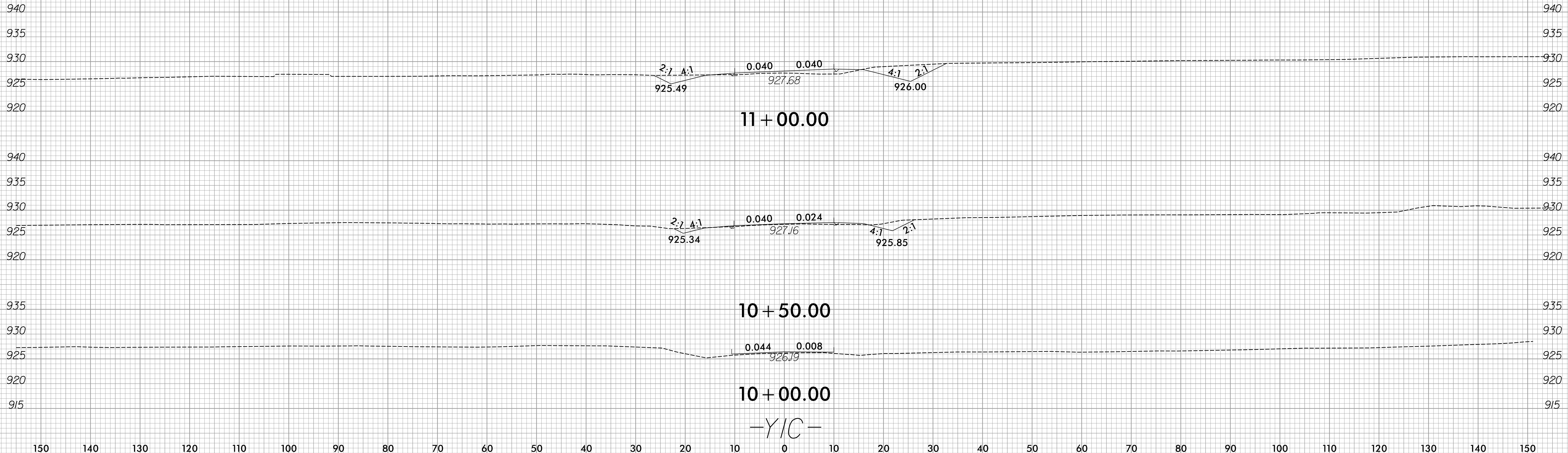

12/21/2023
R:\Roadway\XSC\R-2577A_Rdy_xpl_YIC.dgn
amcpherson

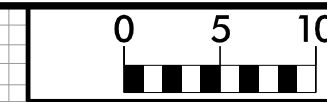

150 140 130 120 110 100 90 80 70 60 50 40 30 20 10 0 10 20 30 40 50 60 70 80 90 100 110 120 130 140 150

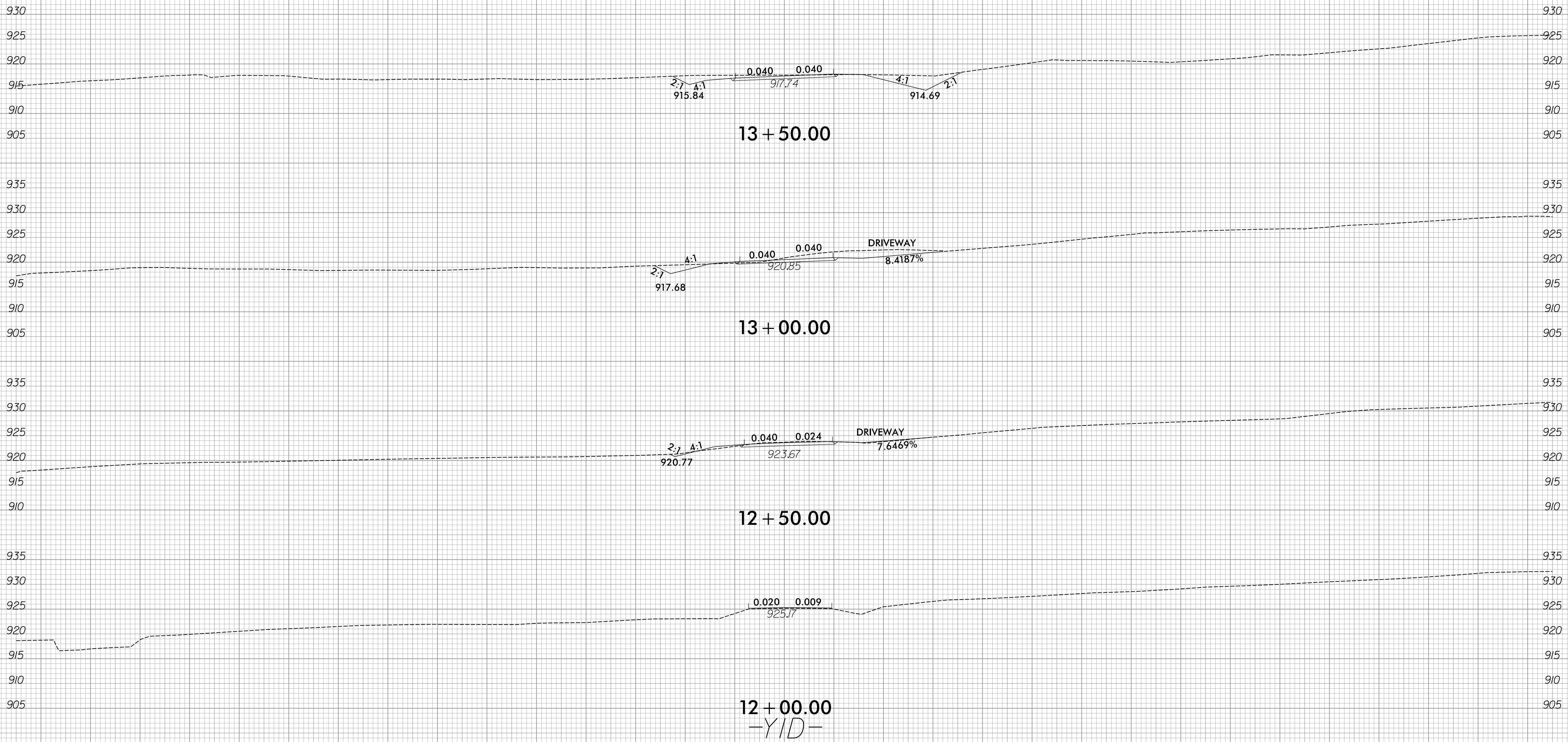

150 140 130 120 110 100 90 80 70 60 50 40 30 20 10 0 10 20 30 40 50 60 70 80 90 100 110 120 130 140 150



150 140 130 120 110 100 90 80 70 60 50 40 30 20 10 0 10 20 30 40 50 60 70 80 90 100 110 120 130 140 150

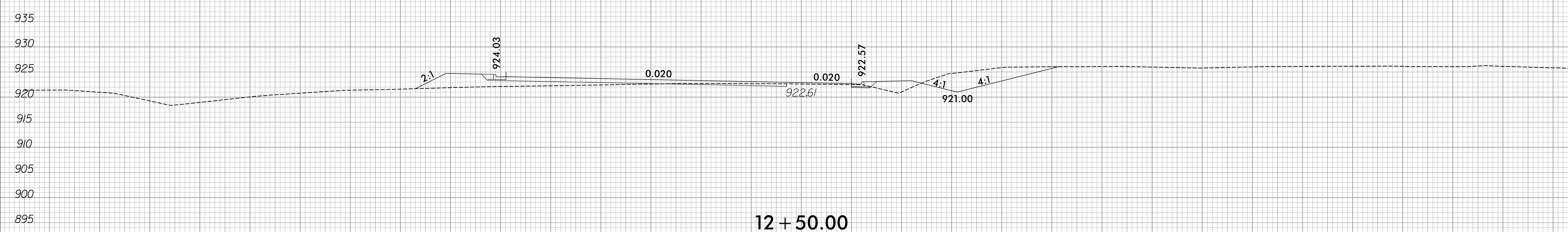
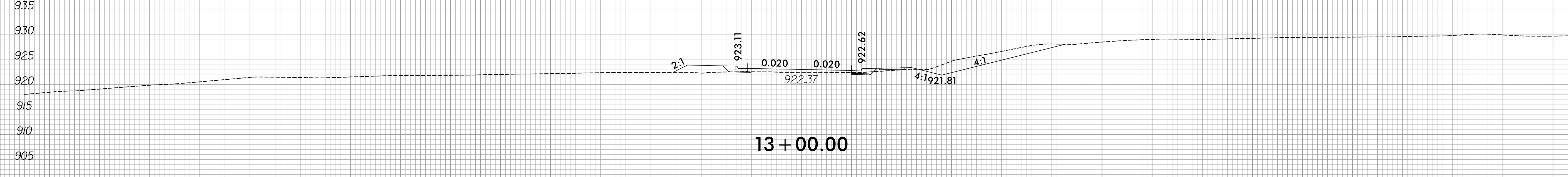
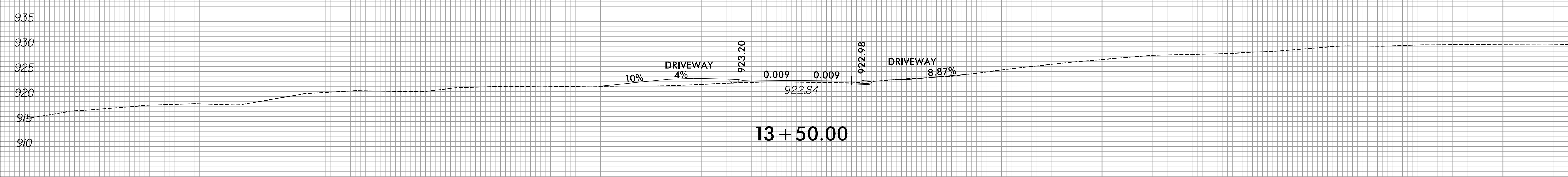
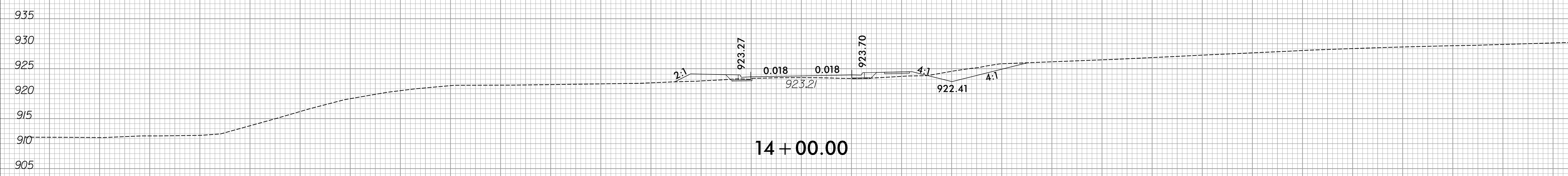

-Y/E-

150 140 130 120 110 100 90 80 70 60 50 40 30 20 10 0 10 20 30 40 50 60 70 80 90 100 110 120 130 140 150



150 140 130 120 110 100 90 80 70 60 50 40 30 20 10 0 10 20 30 40 50 60 70 80 90 100 110 120 130 140 150

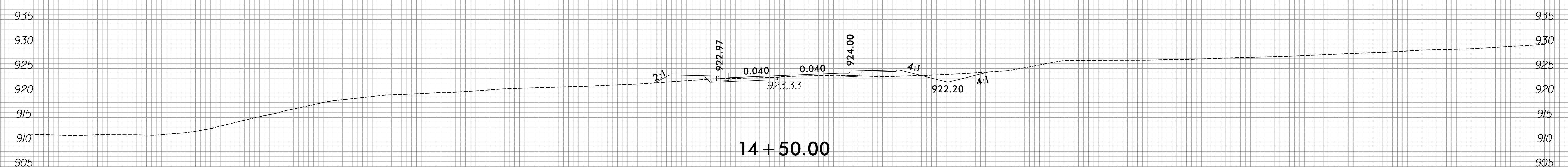
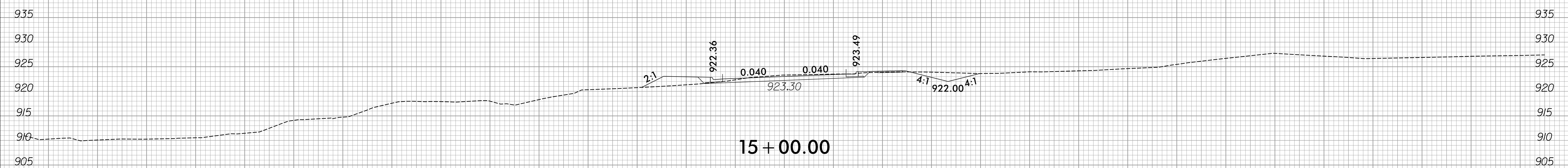
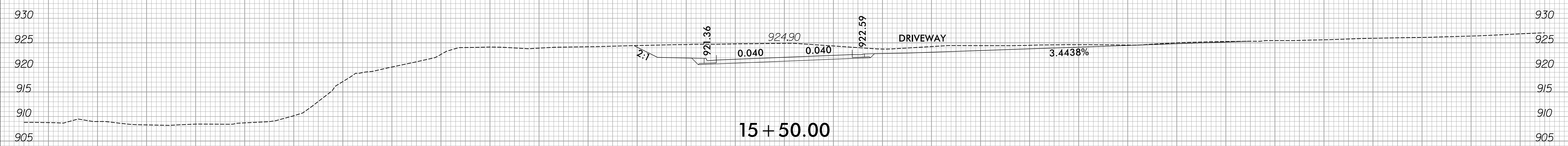
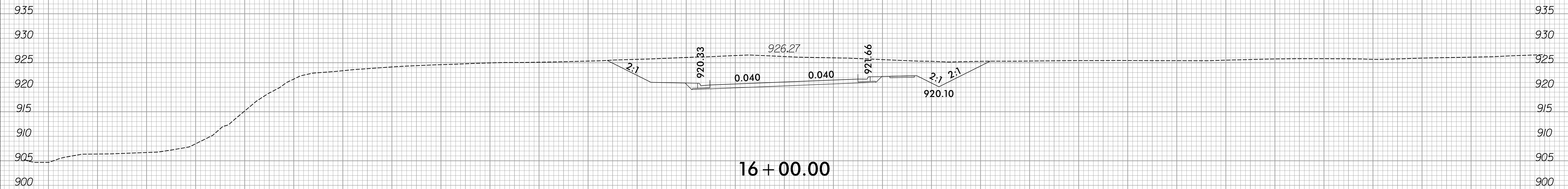

-Y/E-

150 140 130 120 110 100 90 80 70 60 50 40 30 20 10 0 10 20 30 40 50 60 70 80 90 100 110 120 130 140 150

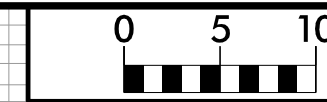

150 140 130 120 110 100 90 80 70 60 50 40 30 20 10 0 10 20 30 40 50 60 70 80 90 100 110 120 130 140 150

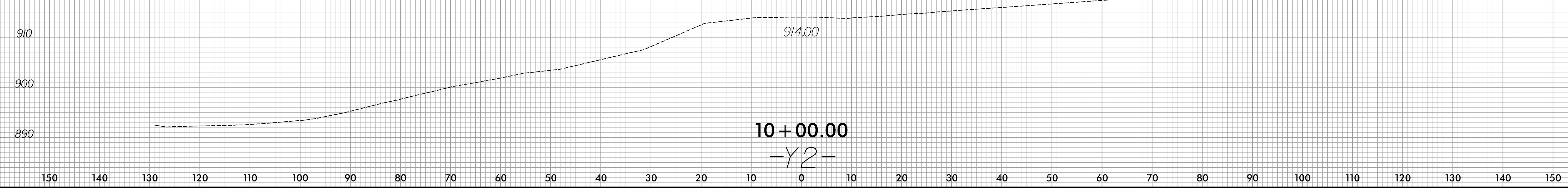
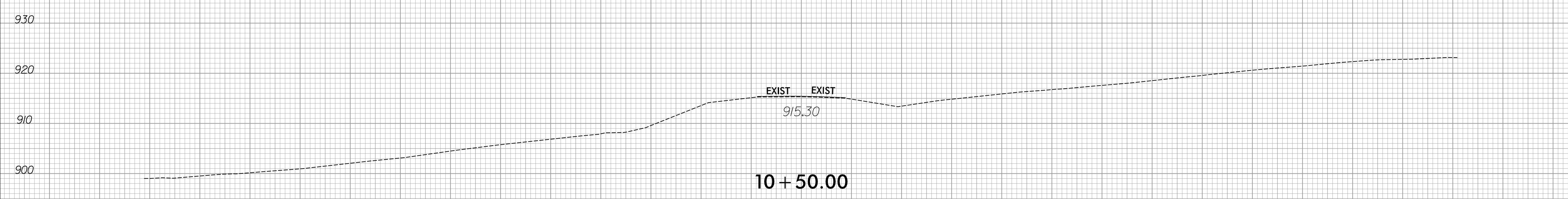
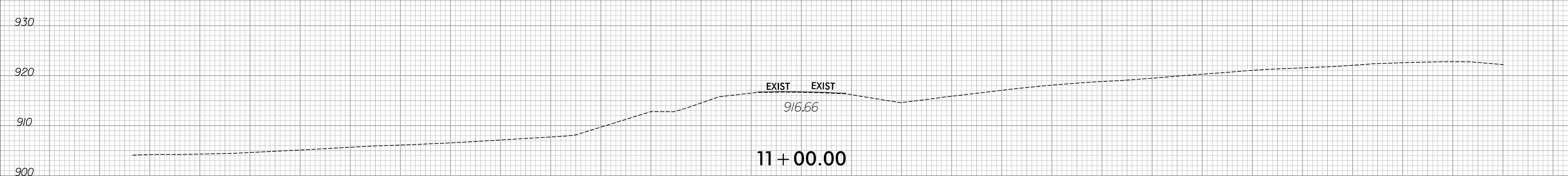
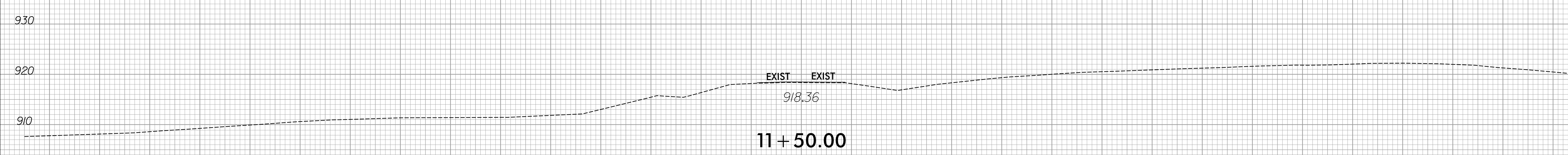

150 140 130 120 110 100 90 80 70 60 50 40 30 20 10 0 10 20 30 40 50 60 70 80 90 100 110 120 130 140 150

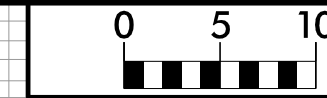

150 140 130 120 110 100 90 80 70 60 50 40 30 20 10 0 10 20 30 40 50 60 70 80 90 100 110 120 130 140 150

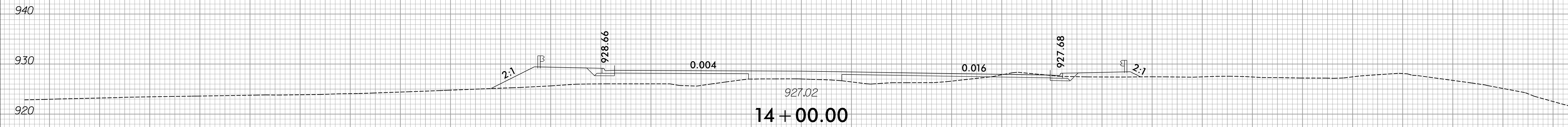

14 + 00.00

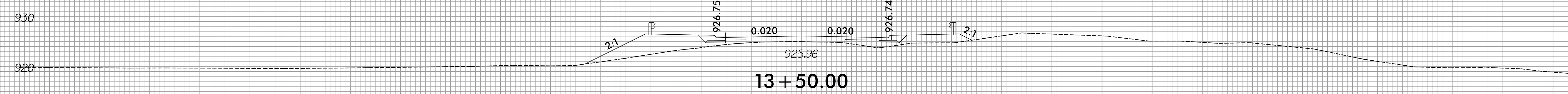

13 + 50.00

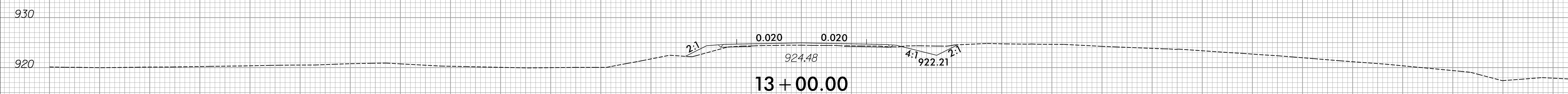

13 + 00.00

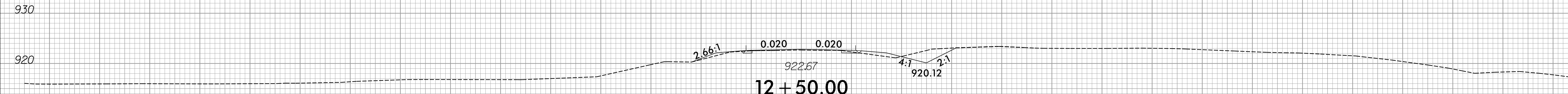

12 + 50.00

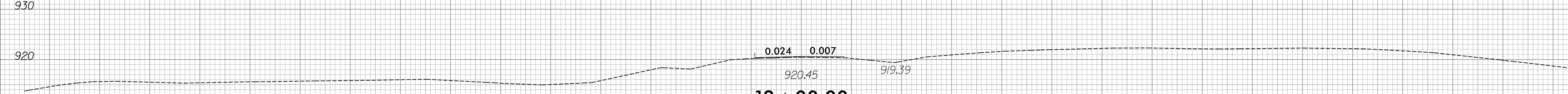

12 + 00.00

-Y2-

150 140 130 120 110 100 90 80 70 60 50 40 30 20 10 0 10 20 30 40 50 60 70 80 90 100 110 120 130 140 150

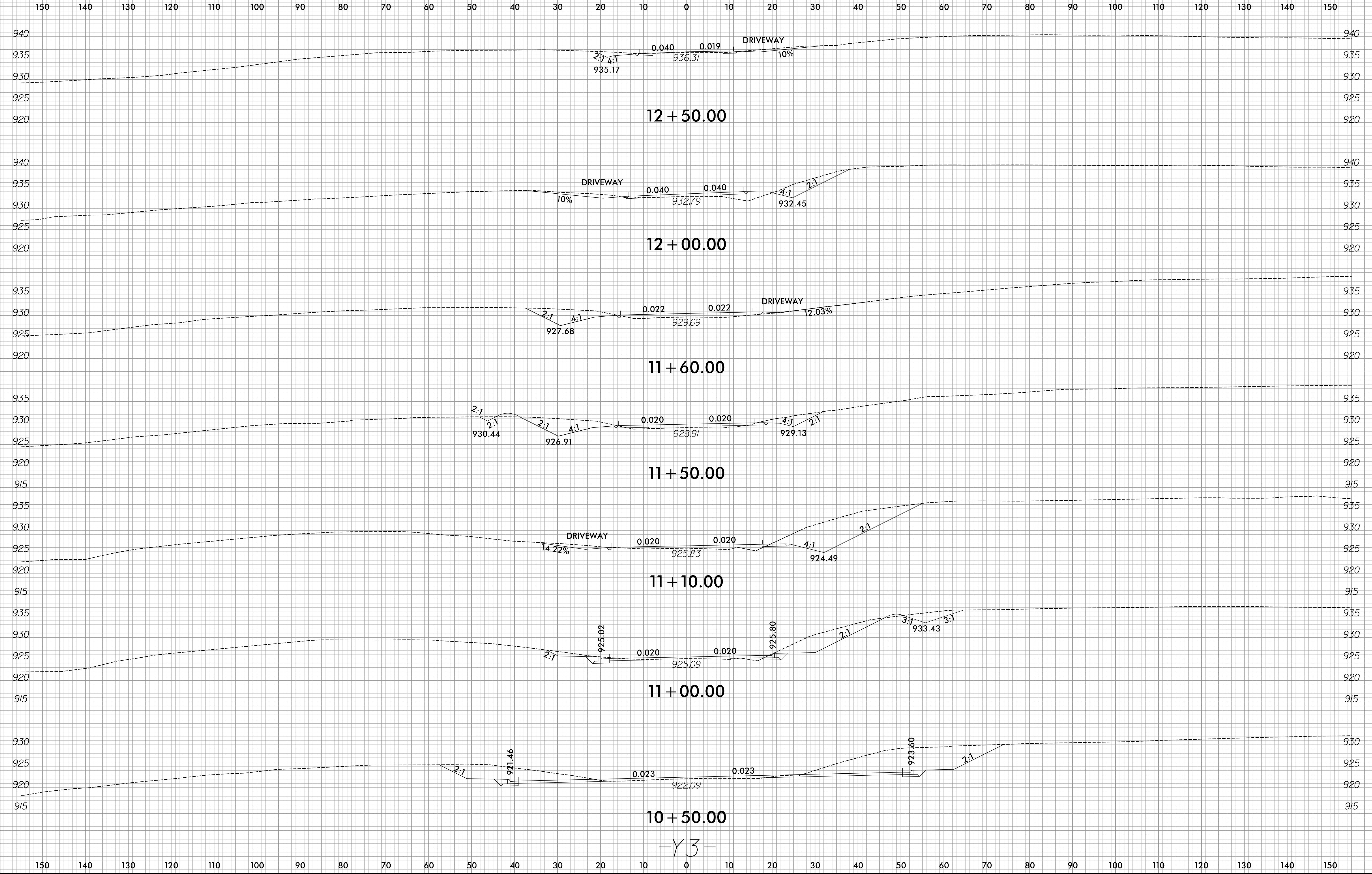

10 + 50.00

-Y3-



150 140 130 120 110 100 90 80 70 60 50 40 30 20 10 0 10 20 30 40 50 60 70 80 90 100 110 120 130 140 150

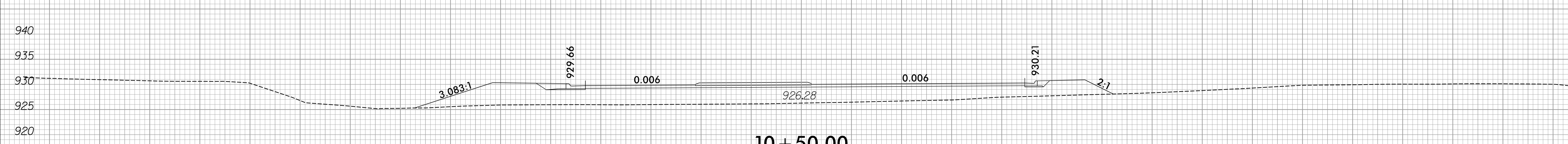
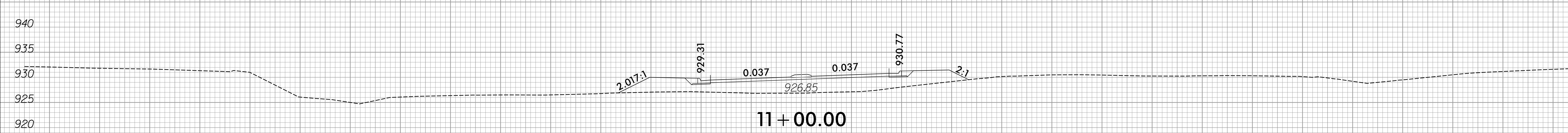
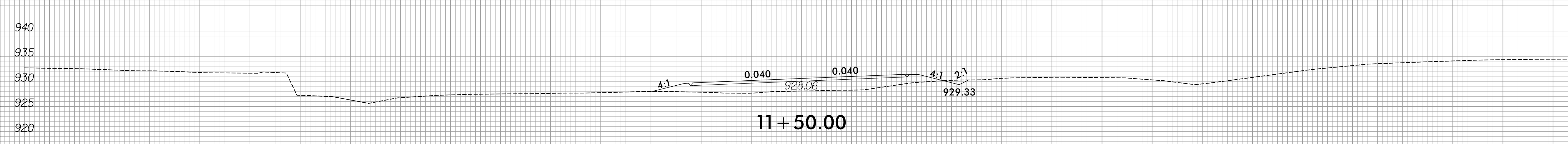
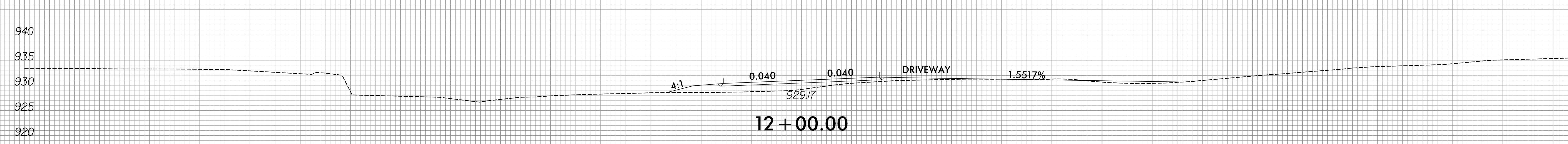
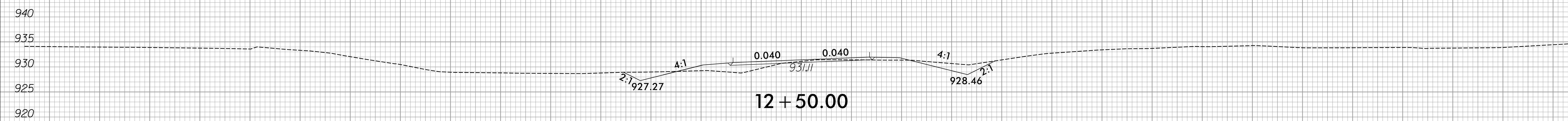
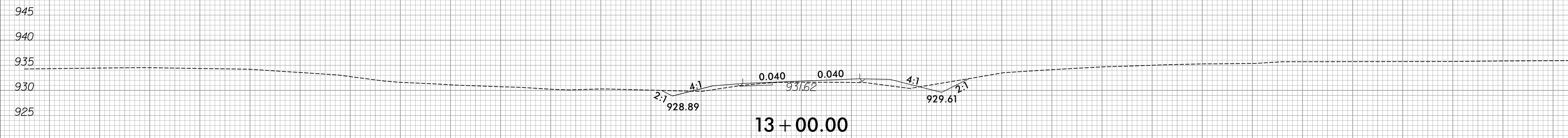

150 140 130 120 110 100 90 80 70 60 50 40 30 20 10 0 10 20 30 40 50 60 70 80 90 100 110 120 130 140 150

-Y4-



150 140 130 120 110 100 90 80 70 60 50 40 30 20 10 0 10 20 30 40 50 60 70 80 90 100 110 120 130 140 150

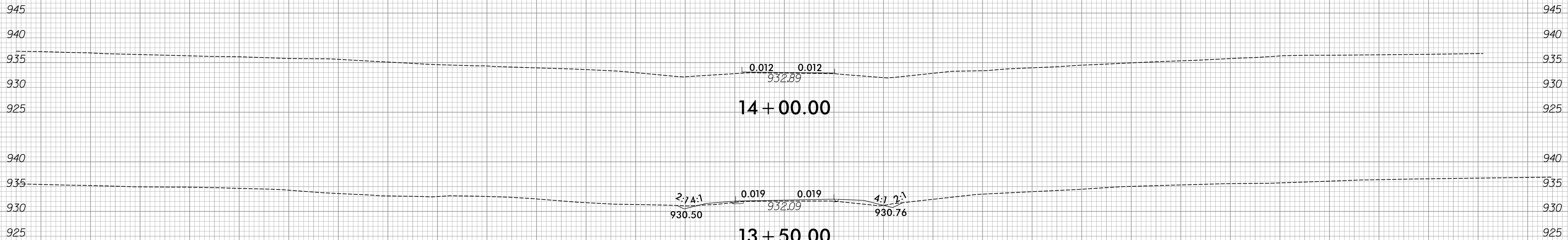

-Y4-

150 140 130 120 110 100 90 80 70 60 50 40 30 20 10 0 10 20 30 40 50 60 70 80 90 100 110 120 130 140 150

6/23/16

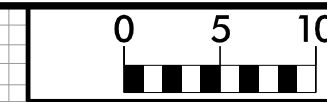

PROJ. REFERENCE NO.
R-2577A

SHEET NO.
X-274

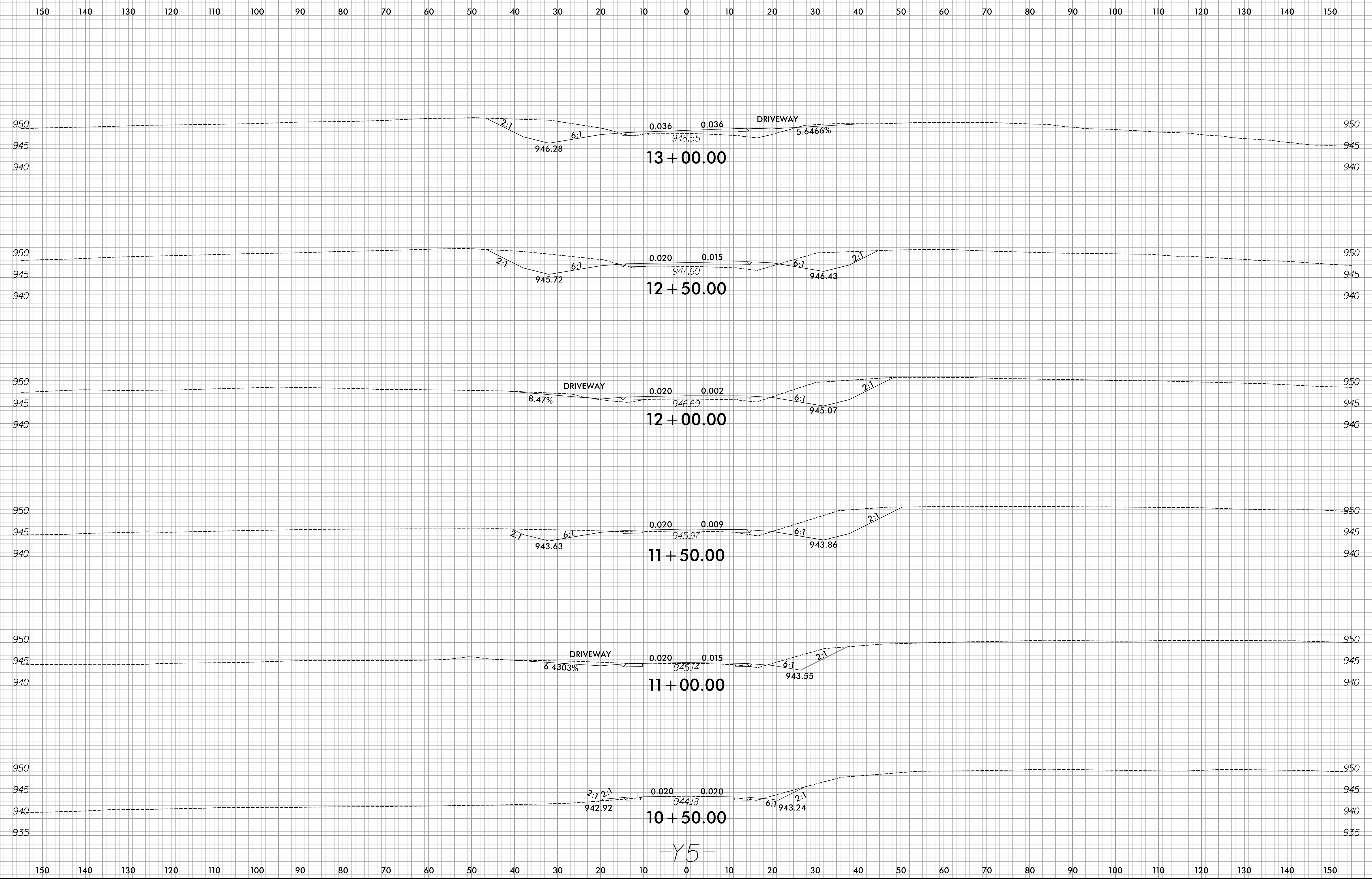

-Y5-

12/21/2023
R:\Roadway\XSC\R-2577A_Rdu_xp1_Y5.dgn
amcpherson

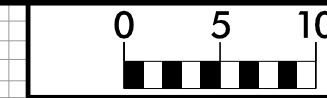

150 140 130 120 110 100 90 80 70 60 50 40 30 20 10 0 10 20 30 40 50 60 70 80 90 100 110 120 130 140 150

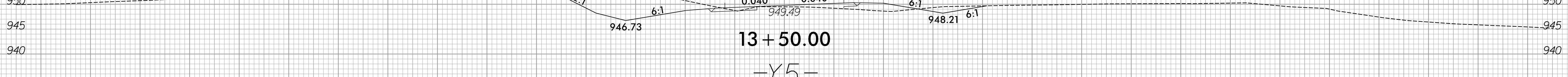
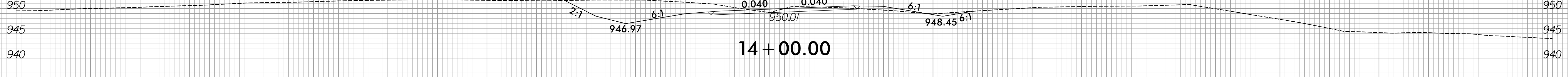
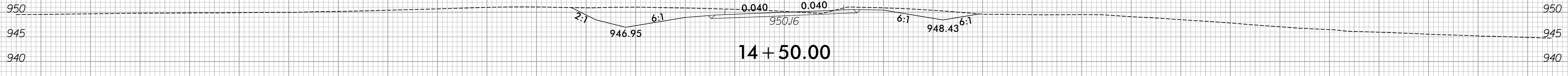
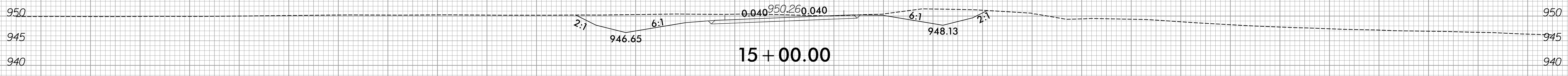
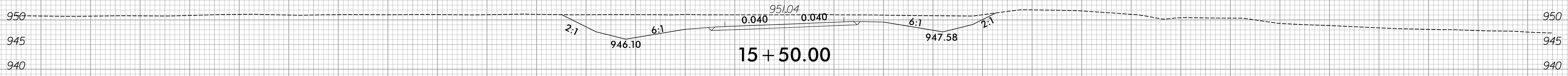
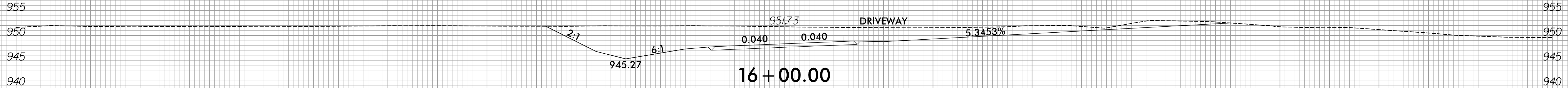

-Y5-

150 140 130 120 110 100 90 80 70 60 50 40 30 20 10 0 10 20 30 40 50 60 70 80 90 100 110 120 130 140 150

150 140 130 120 110 100 90 80 70 60 50 40 30 20 10 0 10 20 30 40 50 60 70 80 90 100 110 120 130 140 150

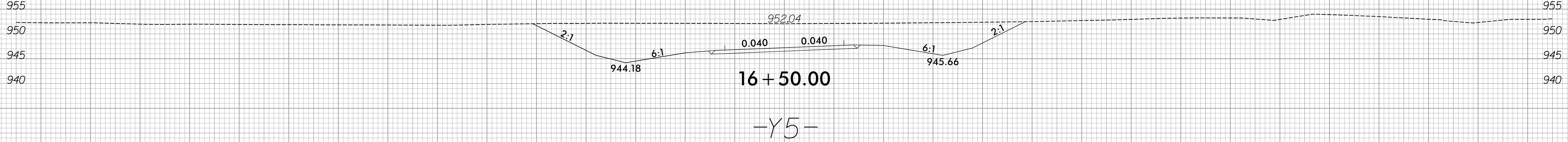
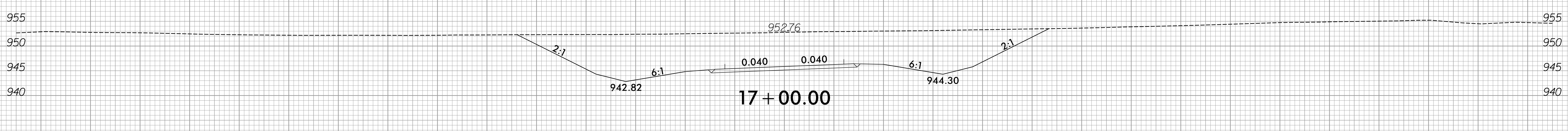
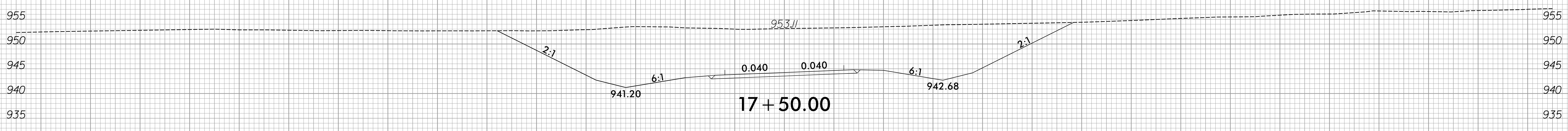
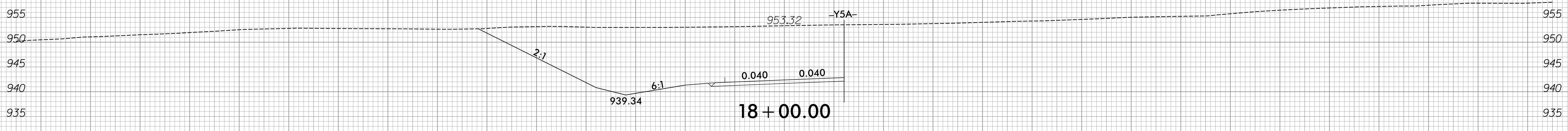
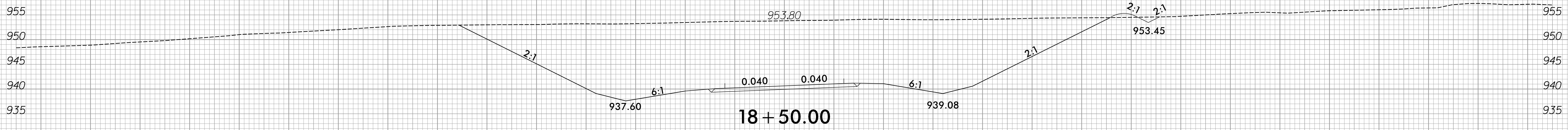

150 140 130 120 110 100 90 80 70 60 50 40 30 20 10 0 10 20 30 40 50 60 70 80 90 100 110 120 130 140 150

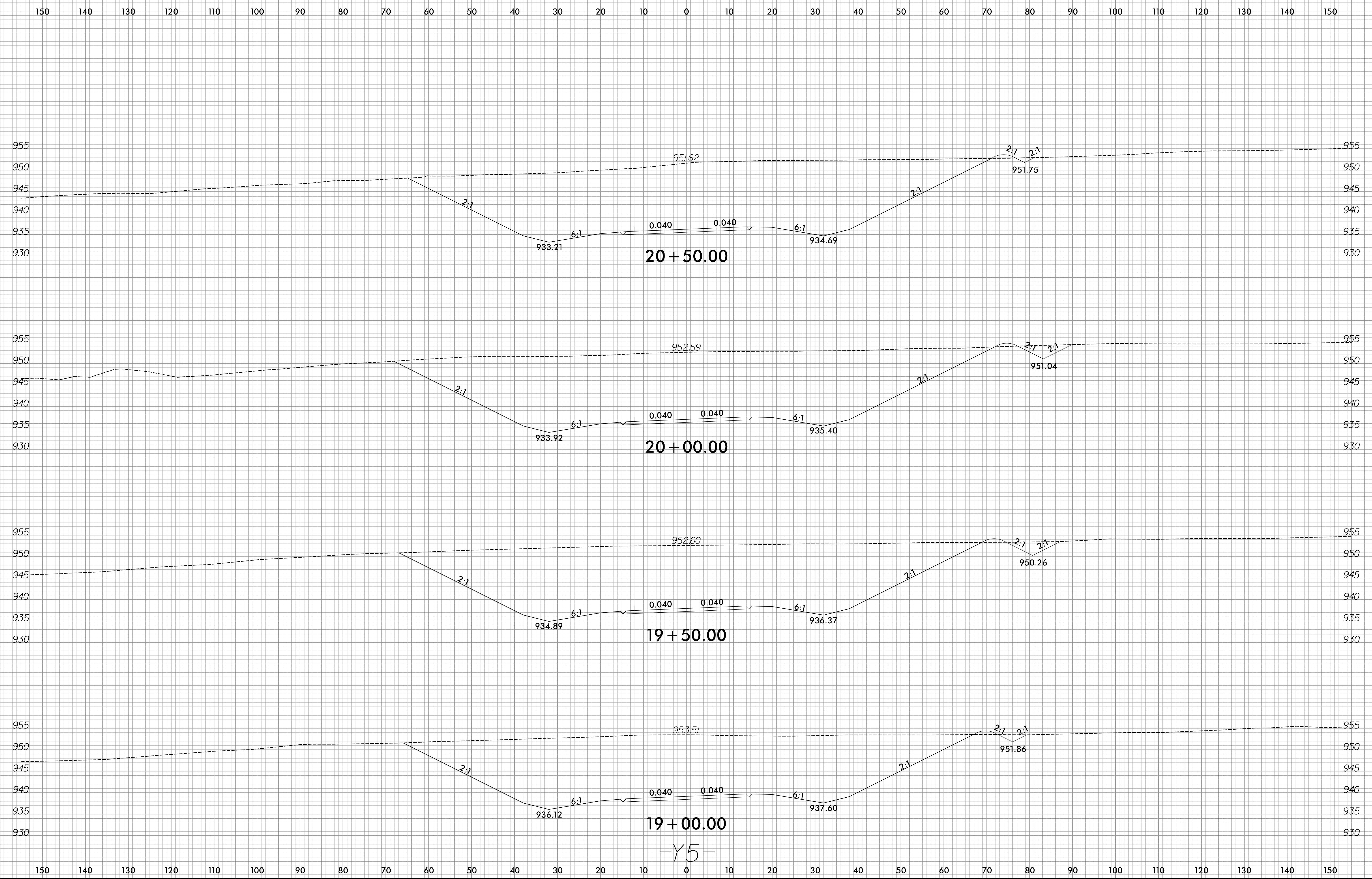
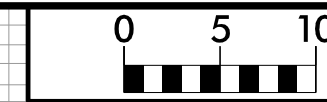

19 + 00.00
-Y5-

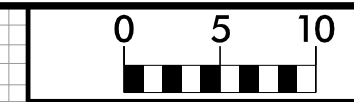

150 140 130 120 110 100 90 80 70 60 50 40 30 20 10 0 10 20 30 40 50 60 70 80 90 100 110 120 130 140 150

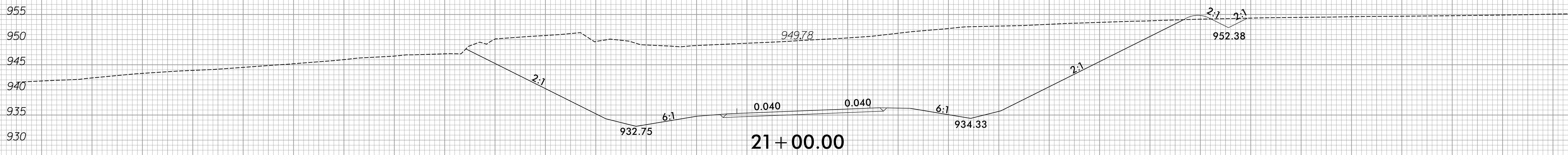
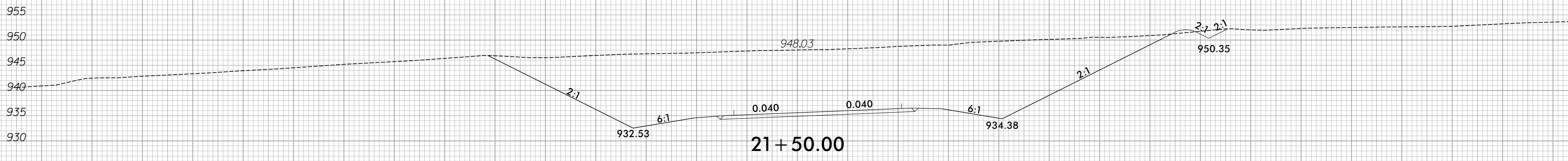
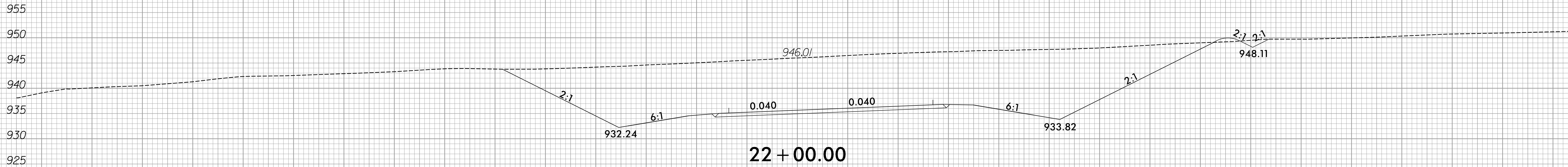
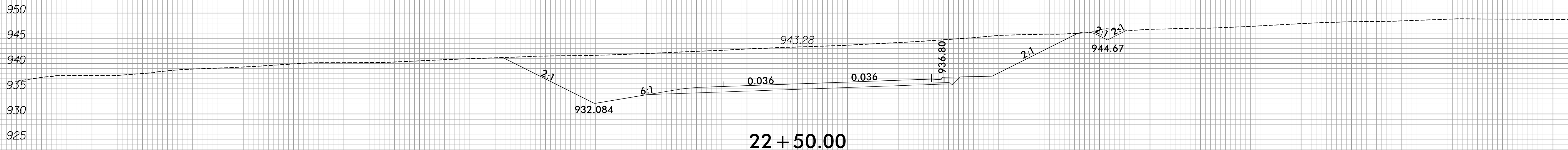

-Y5-

150 140 130 120 110 100 90 80 70 60 50 40 30 20 10 0 10 20 30 40 50 60 70 80 90 100 110 120 130 140 150

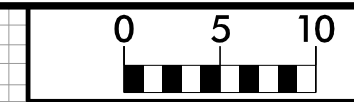

150 140 130 120 110 100 90 80 70 60 50 40 30 20 10 0 10 20 30 40 50 60 70 80 90 100 110 120 130 140 150

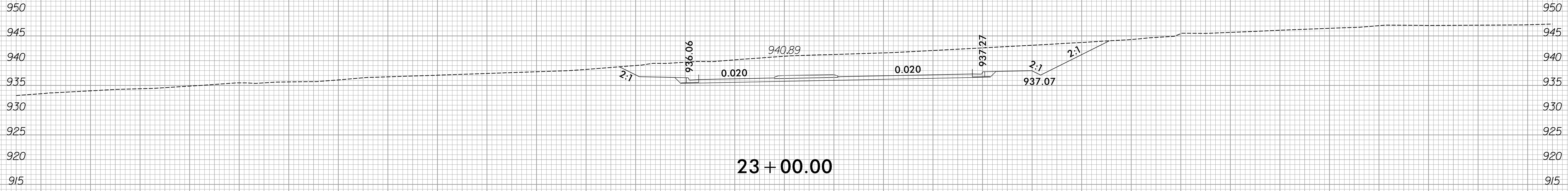
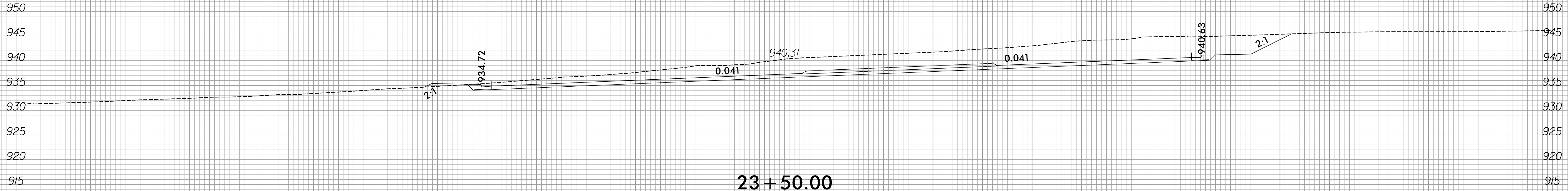

150 140 130 120 110 100 90 80 70 60 50 40 30 20 10 0 10 20 30 40 50 60 70 80 90 100 110 120 130 140 150

6/23/16



PROJ. REFERENCE NO. R-2577A	SHEET NO. X-280
--------------------------------	--------------------

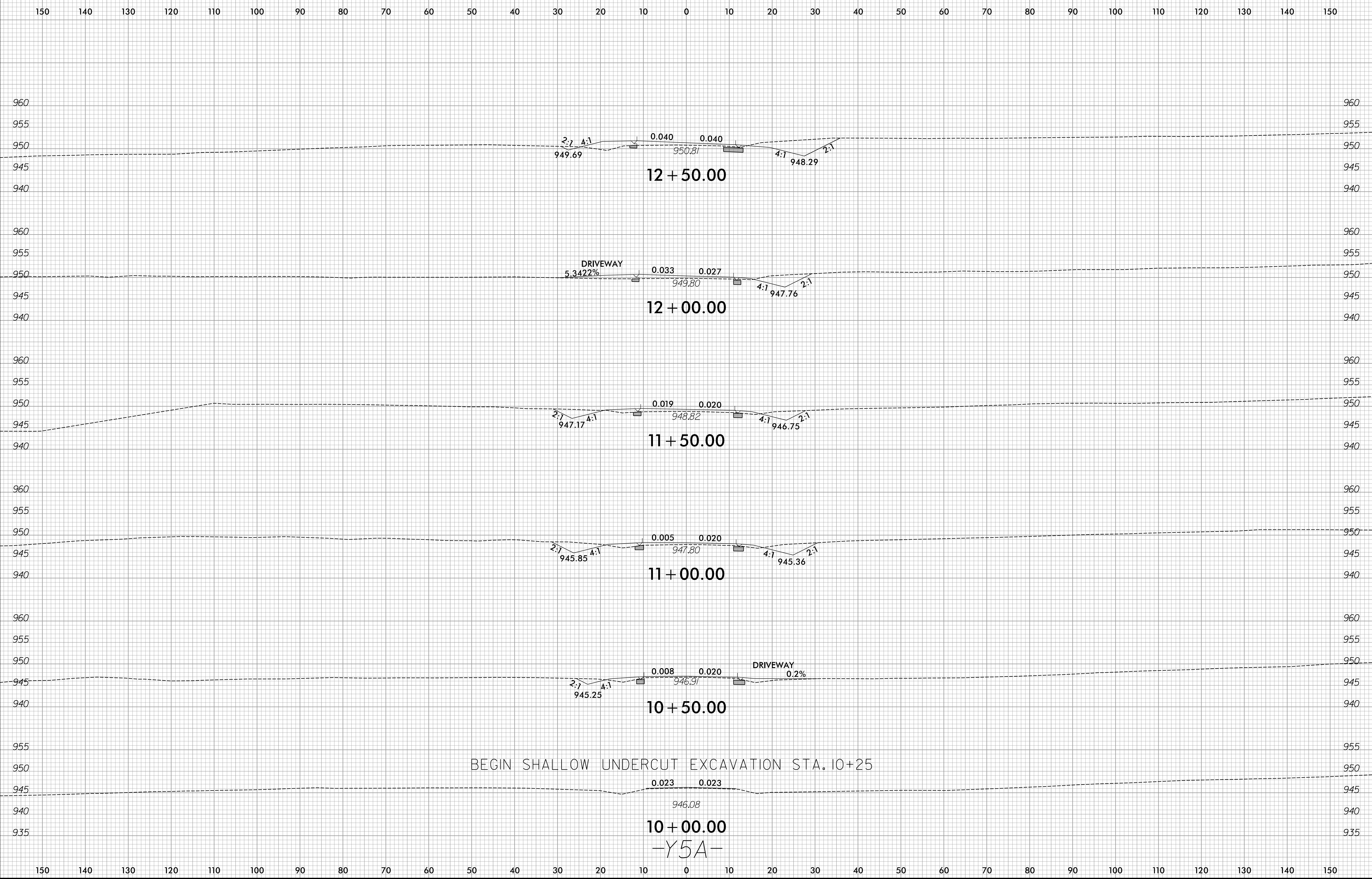

12/2/2023
R:\Roadway\XSC\R-2577A_RdY_xp1_Y5A.dgn
amcpherson

6/23/16

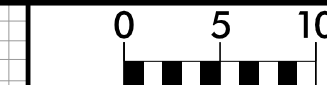

PROJ. REFERENCE NO.
R-2577A

SHEET NO.
X-281

150 140 130 120 110 100 90 80 70 60 50 40 30 20 10 0 10 20 30 40 50 60 70 80 90 100 110 120 130 140 150

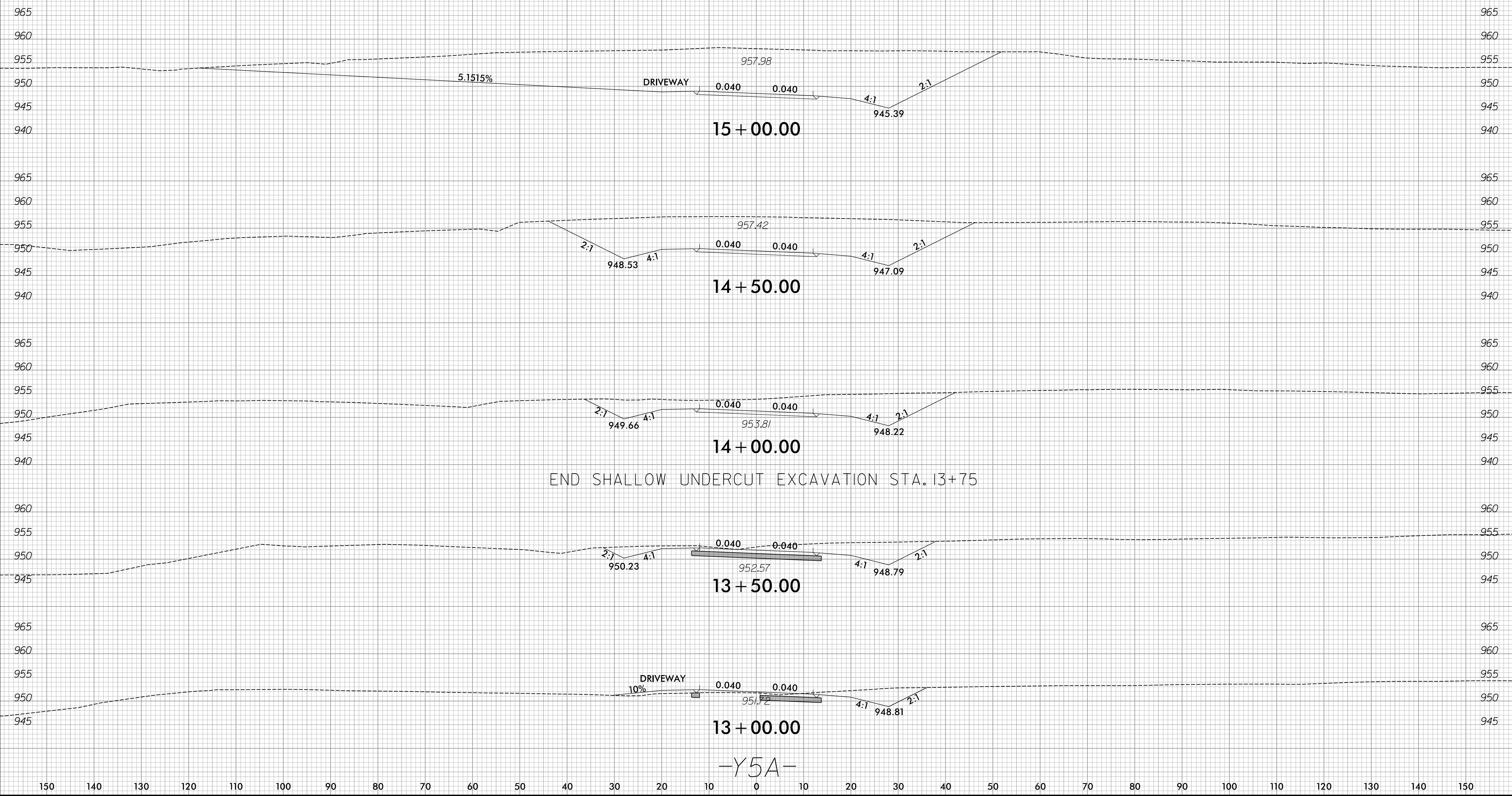

12/2/2023
R:\Roadway\XSC\R-2577A_RdLxp1_Y5A.dgn
amcpherson

150 140 130 120 110 100 90 80 70 60 50 40 30 20 10 0 10 20 30 40 50 60 70 80 90 100 110 120 130 140 150

6/23/16

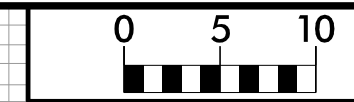

PROJ. REFERENCE NO.
R-2577A

SHEET NO.
X-282

150 140 130 120 110 100 90 80 70 60 50 40 30 20 10 0 10 20 30 40 50 60 70 80 90 100 110 120 130 140 150

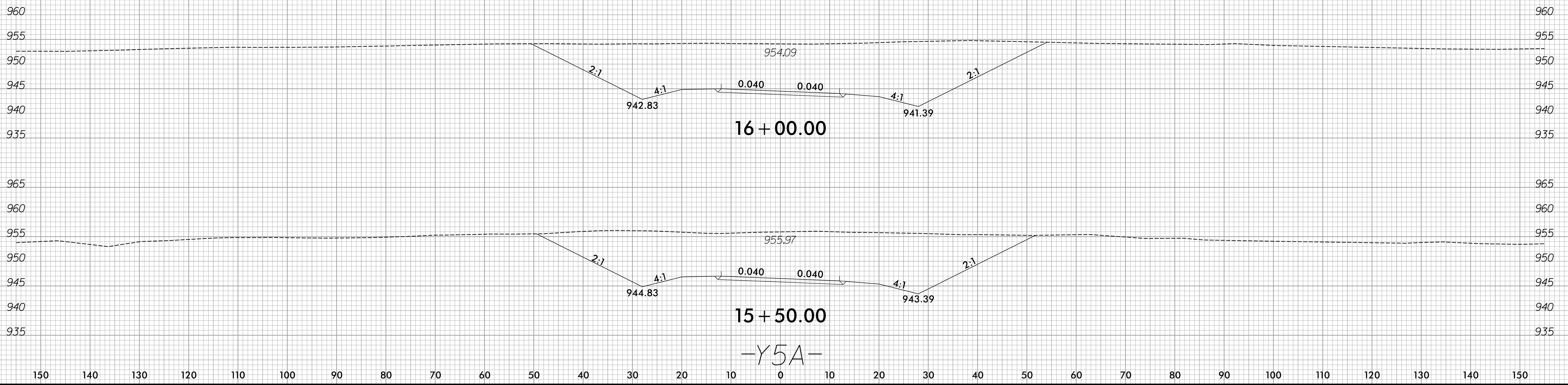

12/2/2023
R:\Roadway\XSC\R-2577A_RdY_xpl_Y5A.dgn
amcpherson

150 140 130 120 110 100 90 80 70 60 50 40 30 20 10 0 10 20 30 40 50 60 70 80 90 100 110 120 130 140 150

6/23/16

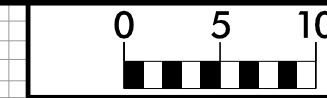

PROJ. REFERENCE NO.
R-2577A

SHEET NO.
X-283

150 140 130 120 110 100 90 80 70 60 50 40 30 20 10 0 10 20 30 40 50 60 70 80 90 100 110 120 130 140 150

950 950

940 940

930 930

12 + 00.00

960 960

950 950

940 940

11 + 50.00

930 930

960 960

950 950

940 940

11 + 00.00

930 930

960 960

950 950

940 940

10 + 50.00

930 930

-Y6-

150 140 130 120 110 100 90 80 70 60 50 40 30 20 10 0 10 20 30 40 50 60 70 80 90 100 110 120 130 140 150

12/2/2023
R:\Roadway\XSC\R-2577A_RdY_xp1_Y6.dgn
amcpherson



150 140 130 120 110 100 90 80 70 60 50 40 30 20 10 0 10 20 30 40 50 60 70 80 90 100 110 120 130 140 150

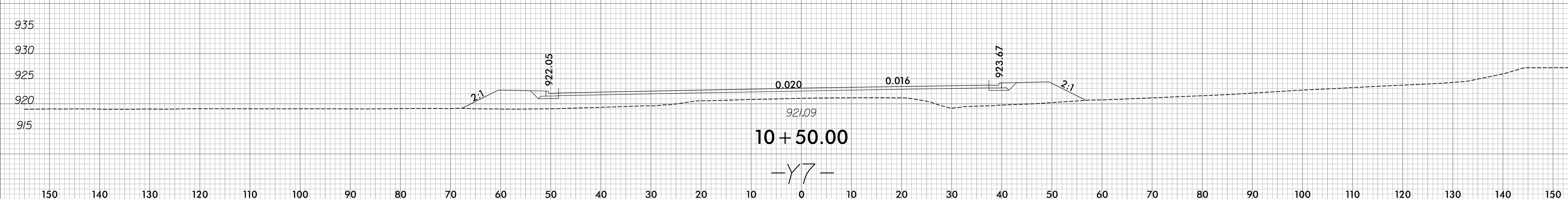
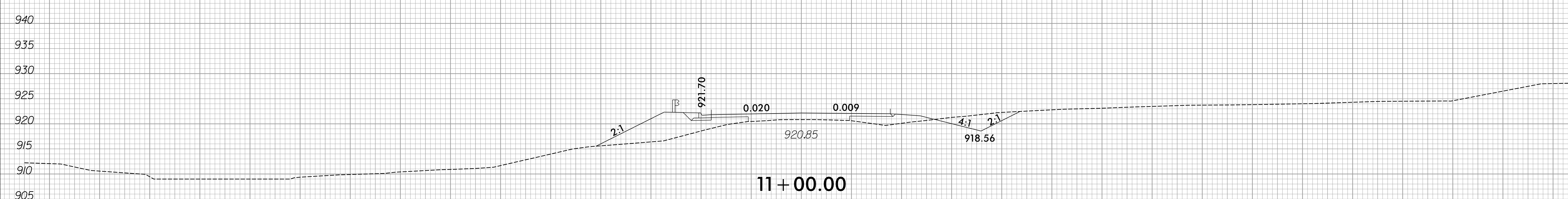
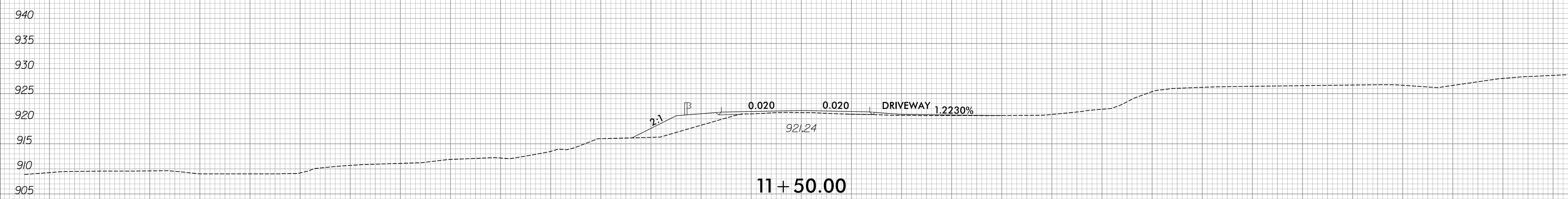
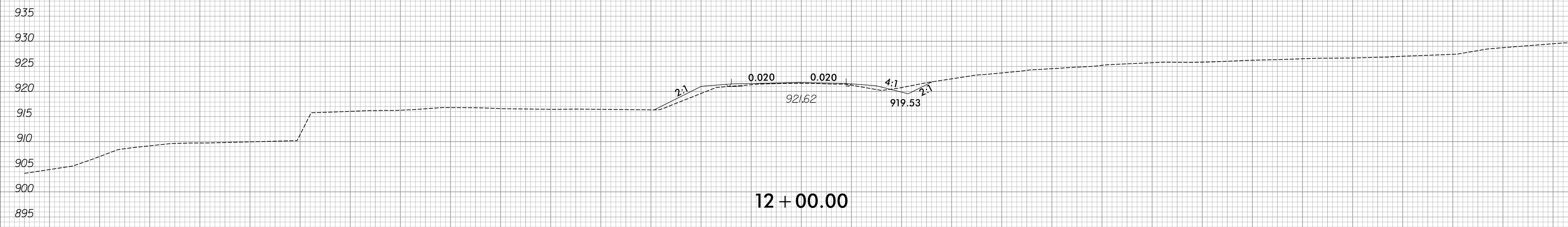

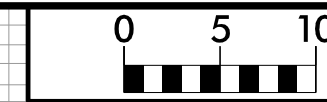

150 140 130 120 110 100 90 80 70 60 50 40 30 20 10 0 10 20 30 40 50 60 70 80 90 100 110 120 130 140 150

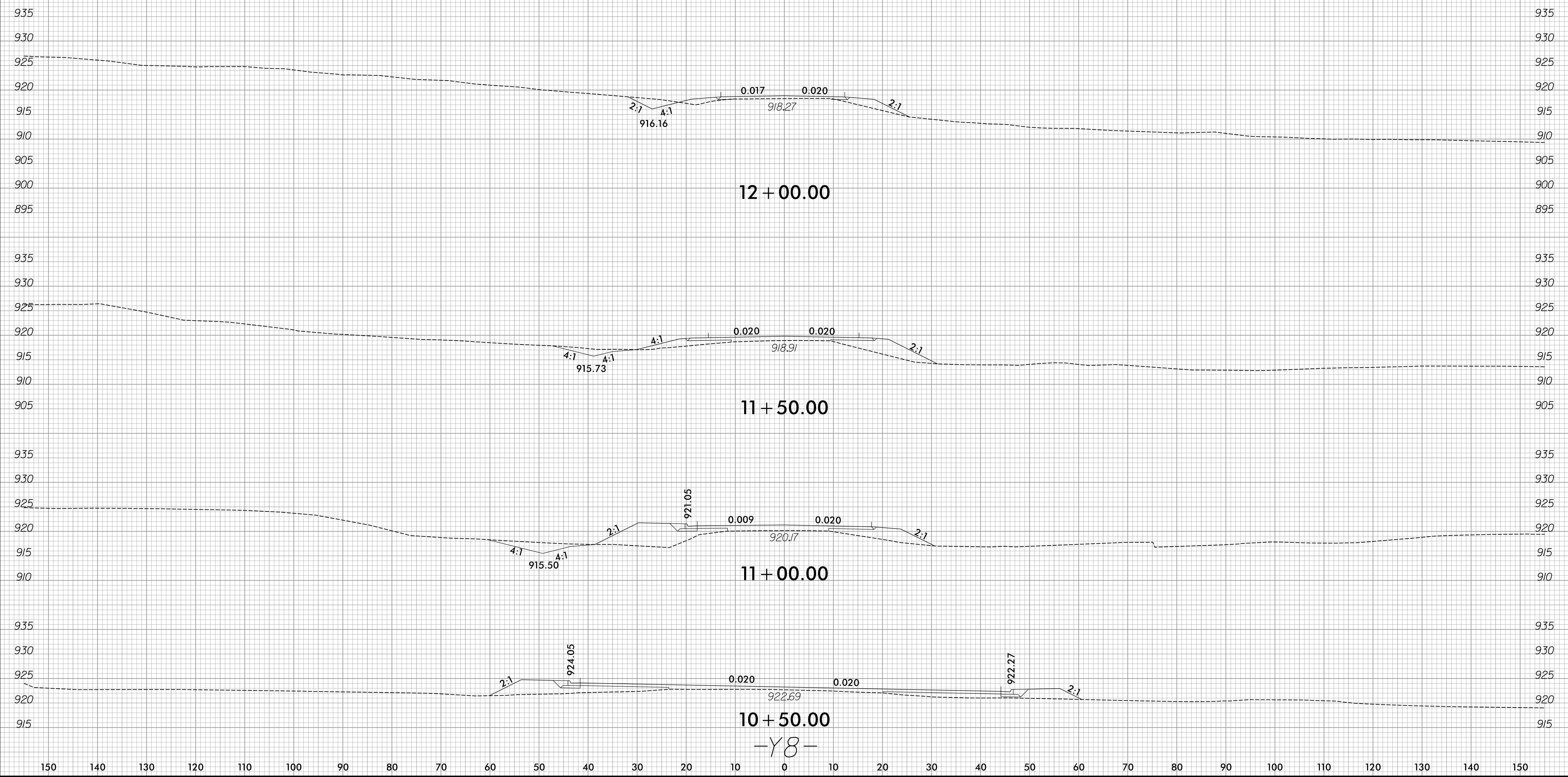

12 + 00.00

11 + 50.00

11 + 00.00

10 + 50.00

-Y8-

6/23/16

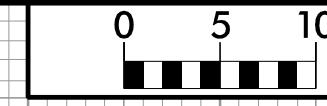

PROJ. REFERENCE NO. R-2577A	SHEET NO. X-286
--------------------------------	--------------------

150 140 130 120 110 100 90 80 70 60 50 40 30 20 10 0 10 20 30 40 50 60 70 80 90 100 110 120 130 140 150

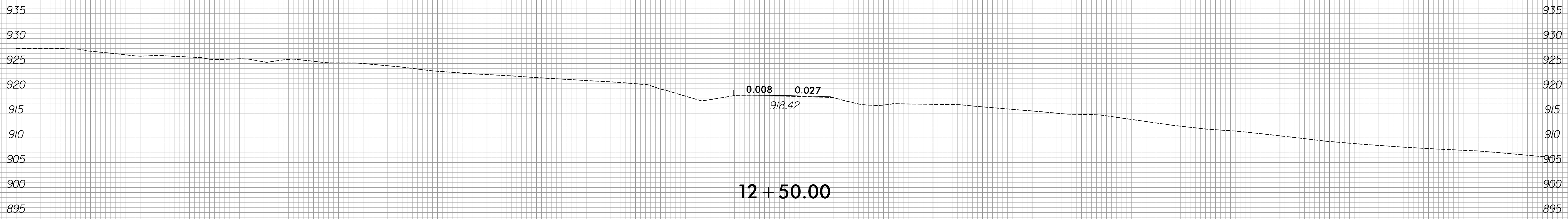

12 + 50.00

-Y8-

12/2/2023
R:\Roadway\XSC\R-2577A_Rdwy_xpl_Y8.dgn
amcpherson

150 140 130 120 110 100 90 80 70 60 50 40 30 20 10 0 10 20 30 40 50 60 70 80 90 100 110 120 130 140 150

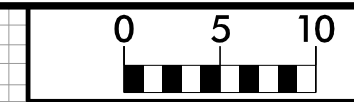

150 140 130 120 110 100 90 80 70 60 50 40 30 20 10 0 10 20 30 40 50 60 70 80 90 100 110 120 130 140 150

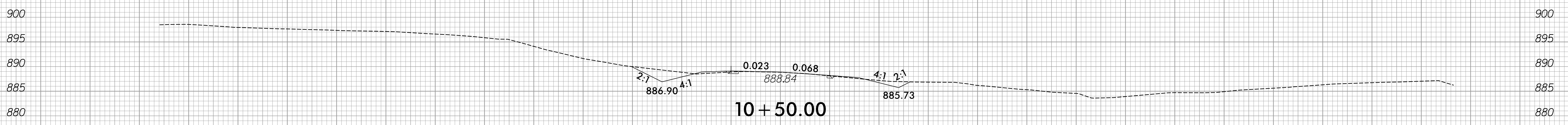
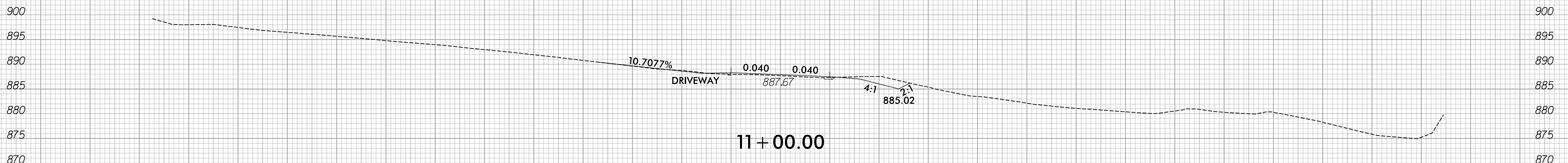
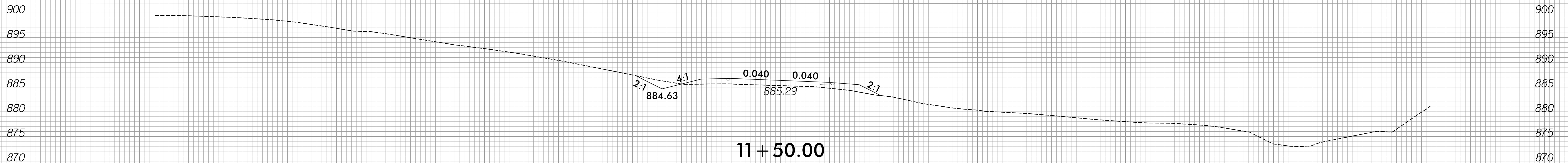
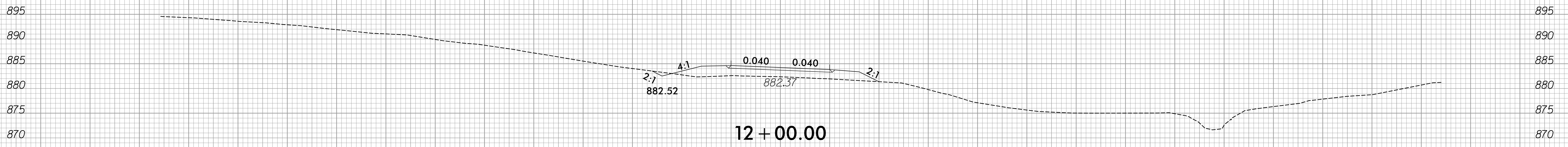
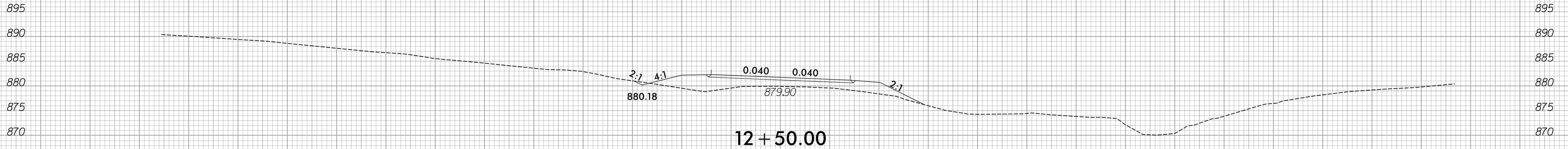

-Y9-

150 140 130 120 110 100 90 80 70 60 50 40 30 20 10 0 10 20 30 40 50 60 70 80 90 100 110 120 130 140 150



150 140 130 120 110 100 90 80 70 60 50 40 30 20 10 0 10 20 30 40 50 60 70 80 90 100 110 120 130 140 150

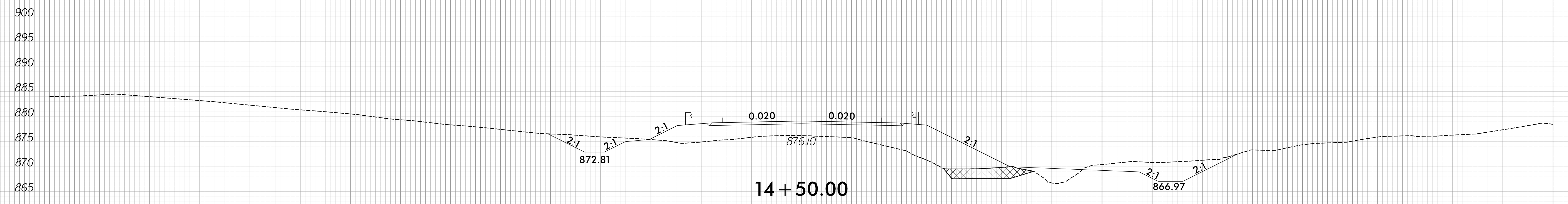

BEGIN UNDERCUT EXCAVATION STA. 14+25

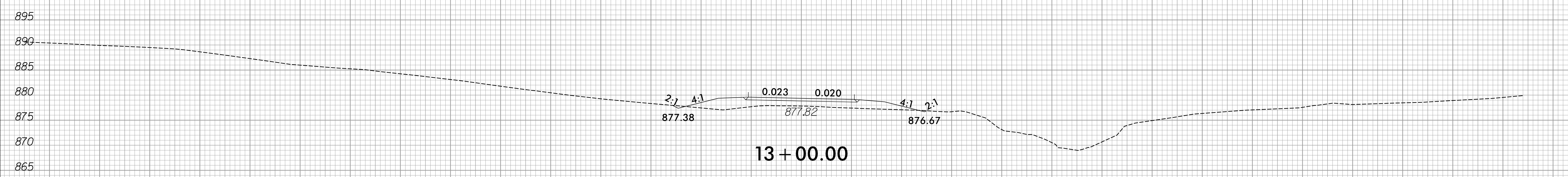
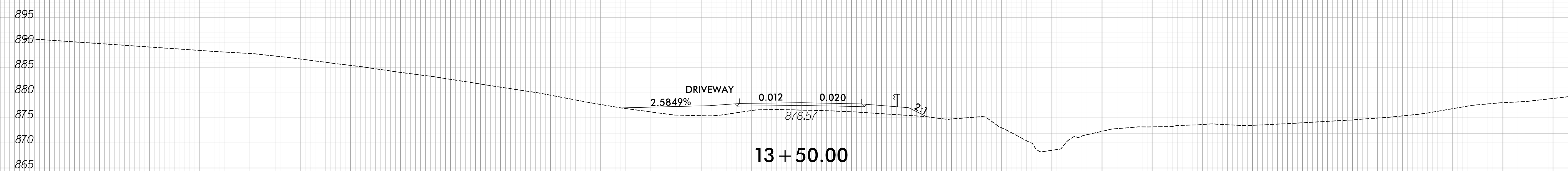
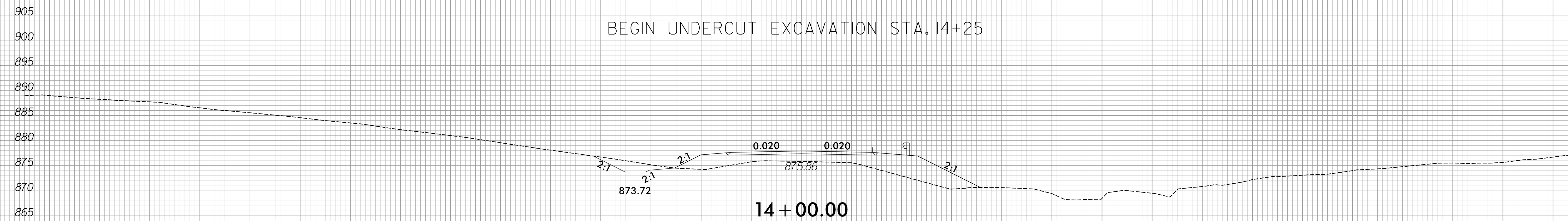

-Y9-

150 140 130 120 110 100 90 80 70 60 50 40 30 20 10 0 10 20 30 40 50 60 70 80 90 100 110 120 130 140 150



150 140 130 120 110 100 90 80 70 60 50 40 30 20 10 0 10 20 30 40 50 60 70 80 90 100 110 120 130 140 150

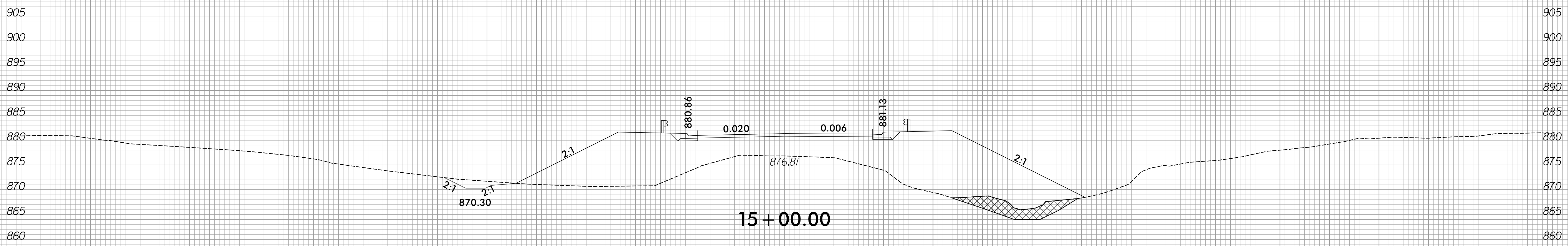
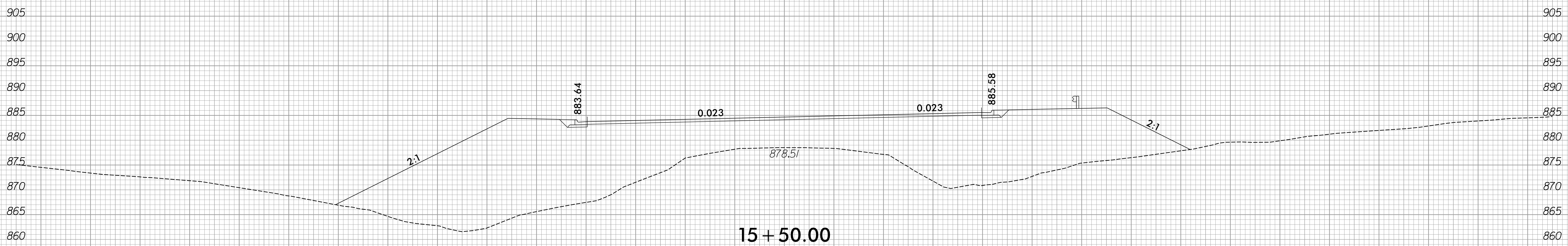

-Y9-

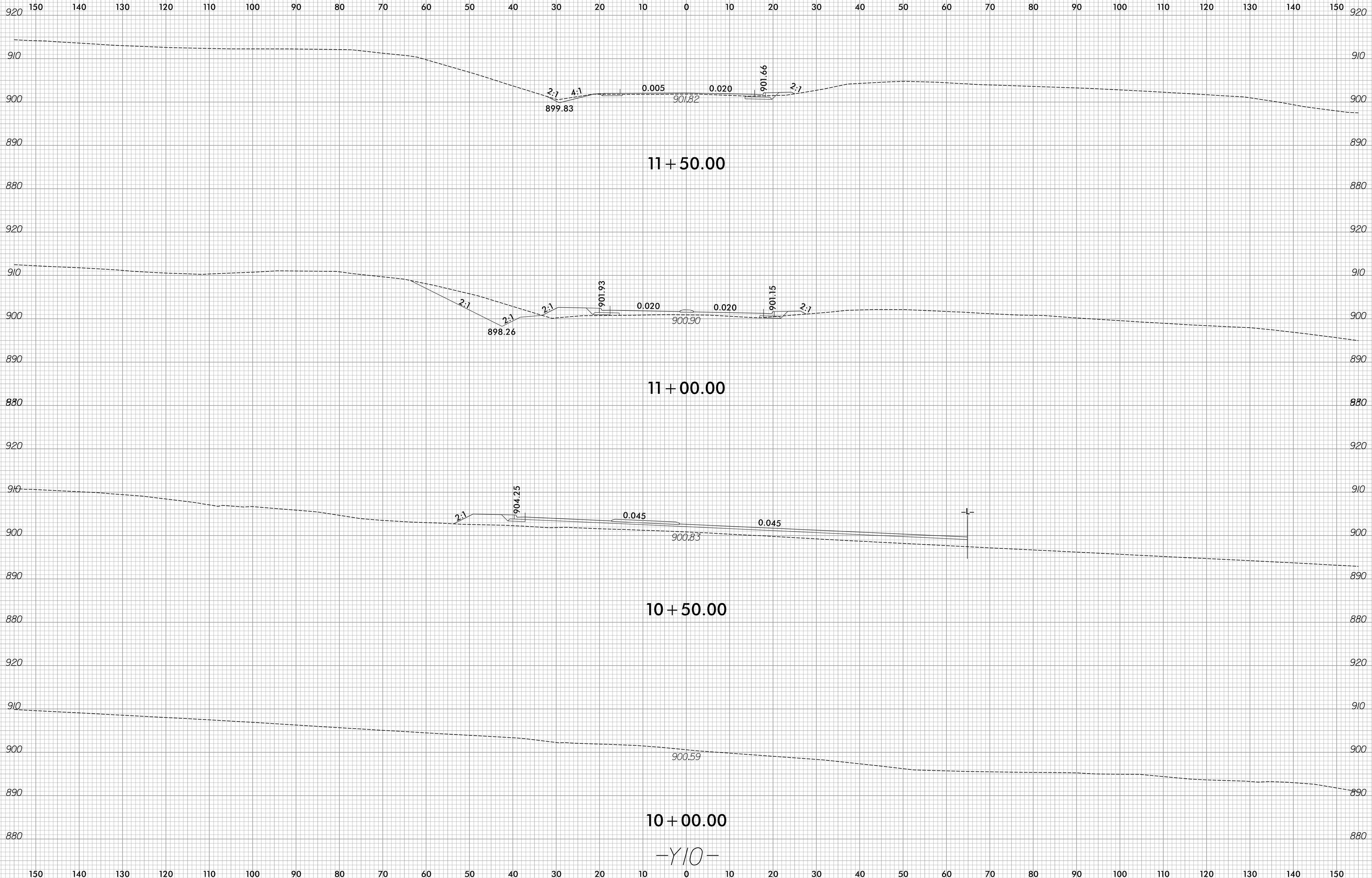

-Y10-