

NOTES:

- FIVE (5) DAYS PRIOR TO BEGINNING WORK ON THE SIGNAL SYSTEM/CCTV INSTALLATION, CONTACT THE WINSTON-SALEM TRAFFIC ENGINEER AT (336)747-6885 TO ARRANGE FOR THE CITY TO PROGRAM THE NEW FIELD ETHERNET SWITCHES FOR SIGNALS ON THE WINSTON-SALEM SIGNAL SYSTEM AND CONTACT THE DIVISION TRAFFIC ENGINEER AT (336)747-7800 TO ARRANGE FOR THE DIVISION TO PROGRAM THE NEW FIELD ETHERNET SWITCHES FOR SIGNALS AND ITS DEVICES ON THE D09-11 WINSTON-SALEM SYSTEM. EACH ETHERNET SWITCH WILL BE PROGRAMMED WITH THE NECESSARY NETWORK CONFIGURATION DATA, INCLUDING BUT NOT LIMITED TO: THE PROJECT IP ADDRESS, DEFAULT GATEWAY, SUBNET MASK AND VLAN ID INFORMATION. NOTIFY THE DIVISION TRAFFIC ENGINEER AFTER ALL WORK IS PERFORMED TO ENSURE THAT ALL FIBER CIRCUITS ARE FUNCTIONING PROPERLY. WORK IS NOT COMPLETE UNTIL THE SIGNAL SYSTEM IS BACK UP AND OPERATIONAL.

2/12/2024
 R:\Projects\2577A\Drawings\Signal\SCP_24.dgn
 WPT Jones

RK&K
 P: (919) 878-8560
 8801 Six Forks Road Suite 700 | Raleigh, North Carolina 27615-2965
 NC License No. F-0112
 www.rk.com
 Responsive People | Creative Solutions

Prepared for the Offices of:

 750 N. Greenfield Pkwy, Garner, NC 27529

Signal System D09-11 Winston-Salem Signal Communication Plans	
Division 09 Forsyth County	Winston-Salem/ Walkertown
PLAN DATE: February 2024	REVIEWED BY: Porter Erickson-Jones
PREPARED BY: Haylee Townsend	REVIEWED BY:
REVISIONS	INIT. DATE

DOCUMENT NOT CONSIDERED
FINAL UNLESS ALL
SIGNATURES COMPLETED

SEAL

 Porter Jones
 2/12/2024
 SIGNATURE DATE
 SIG. INVENTORY NO.

FIBER OPTIC CABLE

SPLICE ENCLOSURE
FOR SIGNAL INVENTORY #09-0980
SHEET SCP 2

COLOR CODE TIA/EIA 598-A		LEGEND	
(1) BLUE	(7) RED	C = CAP AND SEAL	
(2) ORANGE	(8) BLACK	X = FUSION SPLICE INDIVIDUAL FIBER	
(3) GREEN	(9) YELLOW	O = EXISTING SPLICE	
(4) BROWN	(10) VIOLET	BUFFER TUBE = EXPRESS ENTIRE BUFFER TUBE	
(5) SLATE	(11) ROSE	SPLICE = SPLICE ENTIRE BUFFER TUBE COLOR TO COLOR	
(6) WHITE	(12) AQUA		

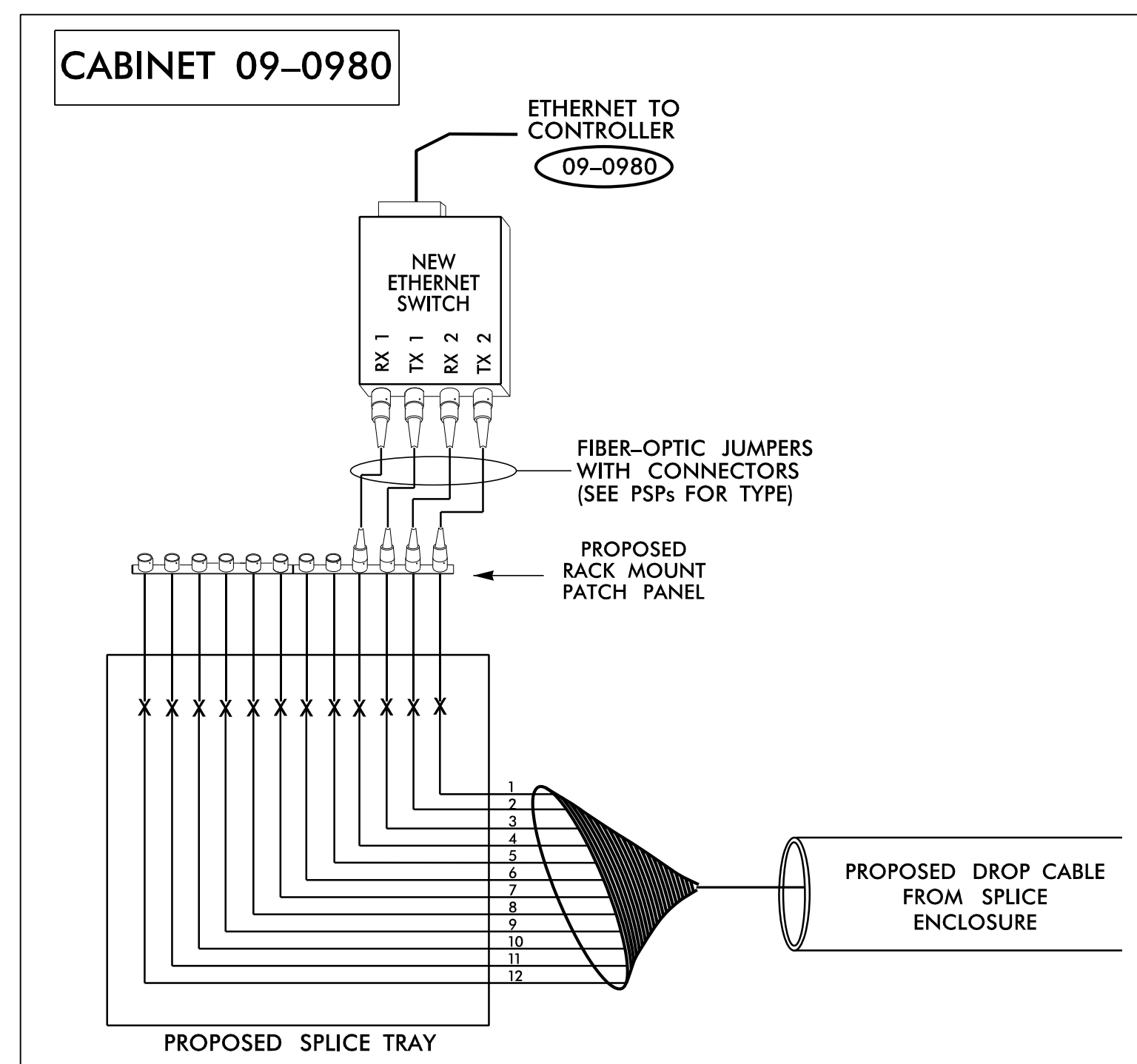
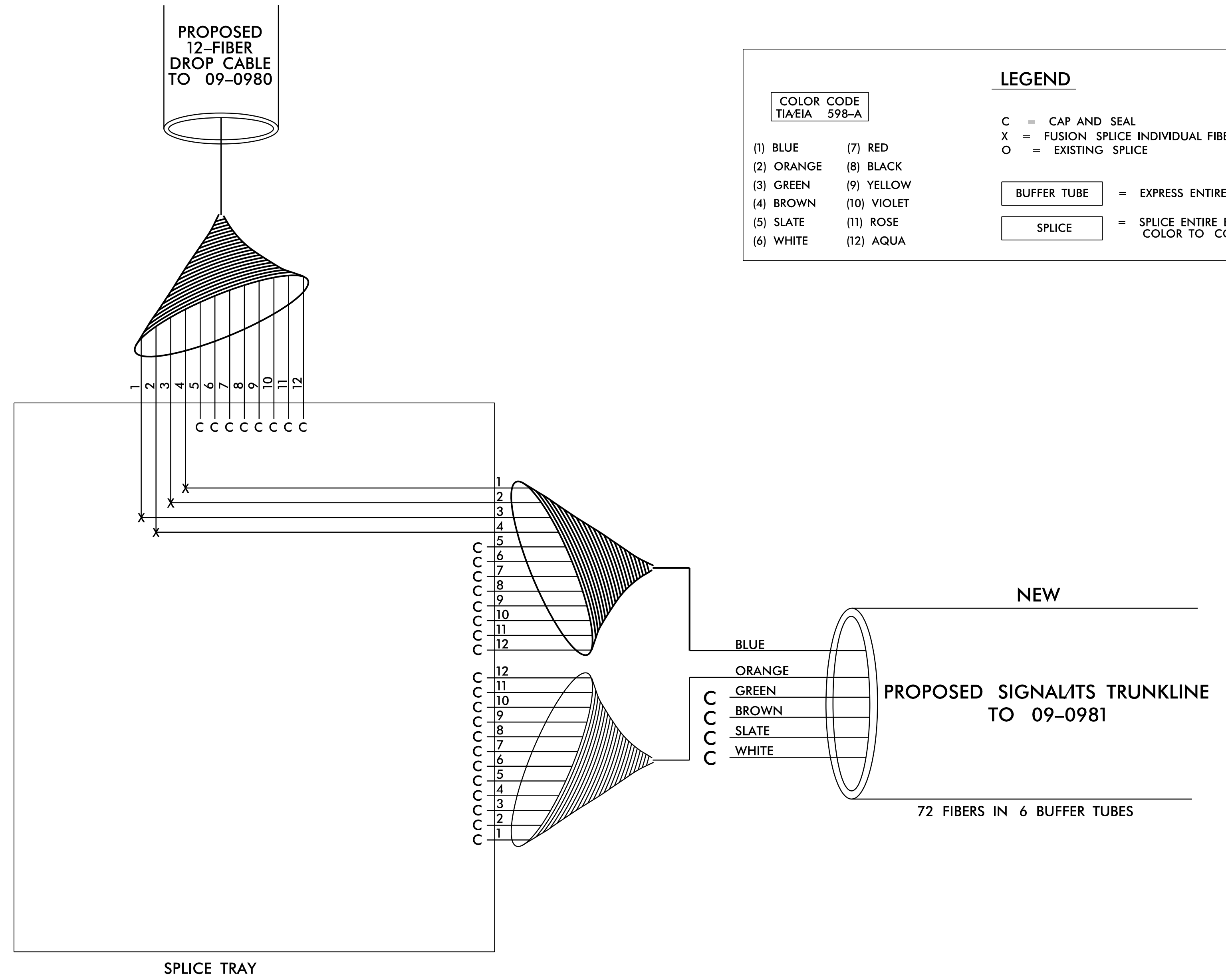

- NOTES:
- FIBER INTERCONNECT CENTER RACKS ARE SCHEMATIC ONLY, ACTUAL EQUIPMENT FORM MAY VARY.
 - UNUSED FIBERS LEFT COILED AND STORED IN SPLICE TRAY.
 - UNUSED BUFFER TUBES LEFT COILED AND STORED IN SPLICE TRAY.
 - ETHERNET SWITCH TERMINATION CONFIGURATIONS ARE GENERIC. CONTRACTOR IS RESPONSIBLE FOR DETERMINING /ENSURING PROPER TERMINATION.
 - INCLUDE ON THE COVER OF EACH SPLICE TRAY THE FOLLOWING:
 - SPLICE
 - DATE
 - COMPANY NAME
 - NAME OF INDIVIDUAL PERFORMING THE SPLICING
- PRIOR TO INSTALLING THE COVER ON THE SPLICE TRAY, TAKE A DIGITAL PHOTOGRAPH SHOWING THE SPLICE TRAY AND INFORMATION SHOWN ABOVE (1-4) AND SUBMIT PHOTOGRAPH ALONG WITH OTRD TEST RESULTS TO THE ENGINEER.

DOCUMENT NOT CONSIDERED FINAL UNLESS ALL SIGNATURES COMPLETED

RKK
P: (919) 878-9560
8801 Six Forks Road, Forum 1, Suite 700
Raleigh, North Carolina 27615-3960
NC License No. F-0112
www.rkk.com
Responsive People | Creative Solutions

Prepared for the Offices of: 		SEAL NORTH CAROLINA PROFESSIONAL ENGINEER W. PORTER JONES 056142 2/12/2024	
SCALE N/A		SPLICE DETAILS Division 09 Forsyth County Winston-Salem/Walkertown PLAN DATE: February 2024 REVIEWED BY: Porter Erickson-Jones PREPARED BY: Haylee Townsend REVIEWED BY:	
REVISIONS	INIT.	DATE	
DocuSigned by: Porter Jones 2/12/2024			DATE
CADD Filename:			

2/12/2024
 R:\Projects\cns\gn\09-0980\09-0980\09-0980\09-0980\SCP-2\SCP-2.dgn
 W:\Jones

**SPLICE ENCLOSURE
FOR SIGNAL INVENTORY #09-0981
AND DMS-1
SHEET SCP 3**

FIBER OPTIC CABLE

COLOR CODE
TIA/EIA 598-A

- (1) BLUE (7) RED
- (2) ORANGE (8) BLACK
- (3) GREEN (9) YELLOW
- (4) BROWN (10) VIOLET
- (5) SLATE (11) ROSE
- (6) WHITE (12) AQUA

LEGEND

- C = CAP AND SEAL
- X = FUSION SPLICE INDIVIDUAL FIBER
- O = EXISTING SPLICE

BUFFER TUBE = EXPRESS ENTIRE BUFFER TUBE

SPLICE = SPLICE ENTIRE BUFFER TUBE COLOR TO COLOR

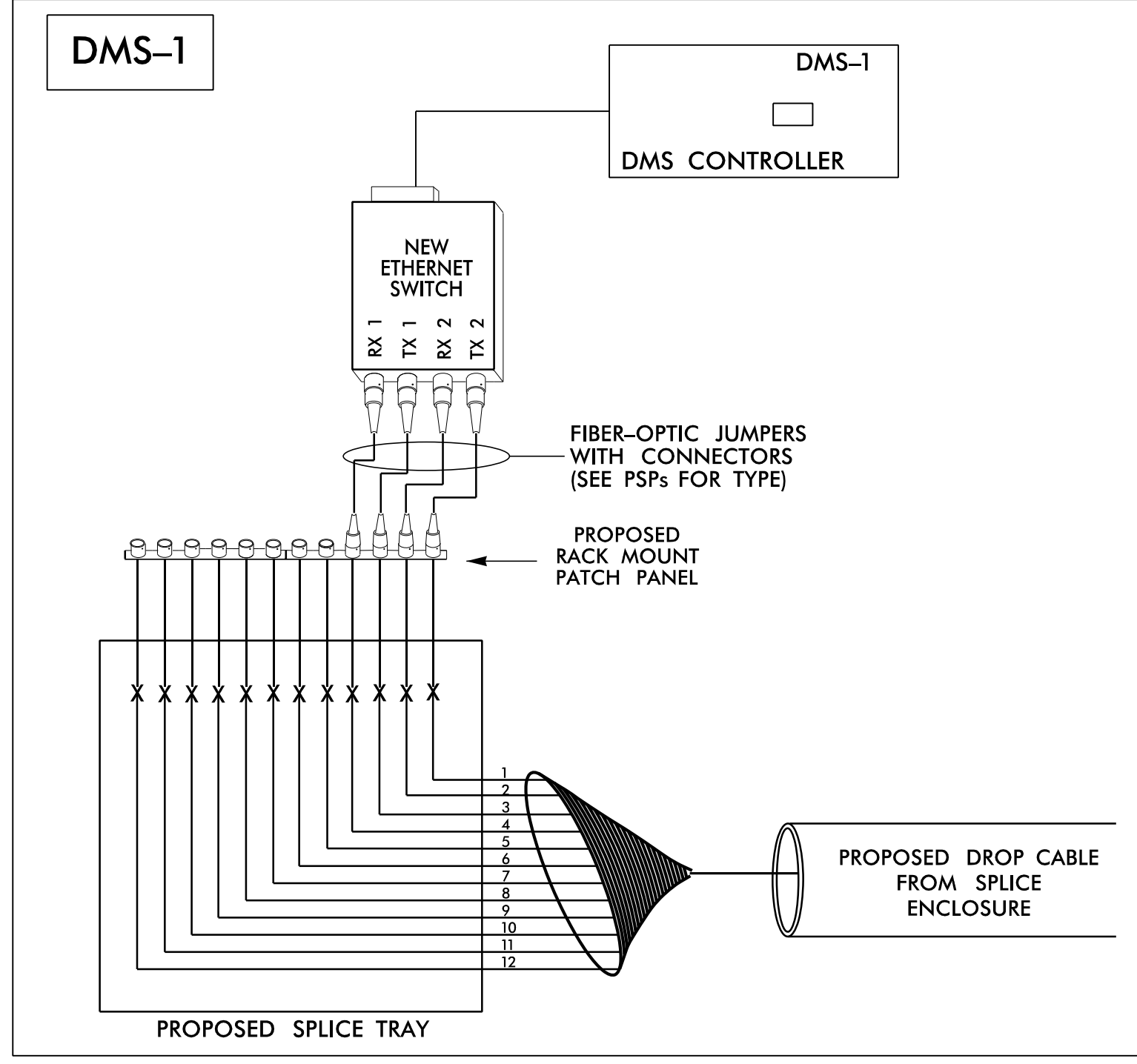
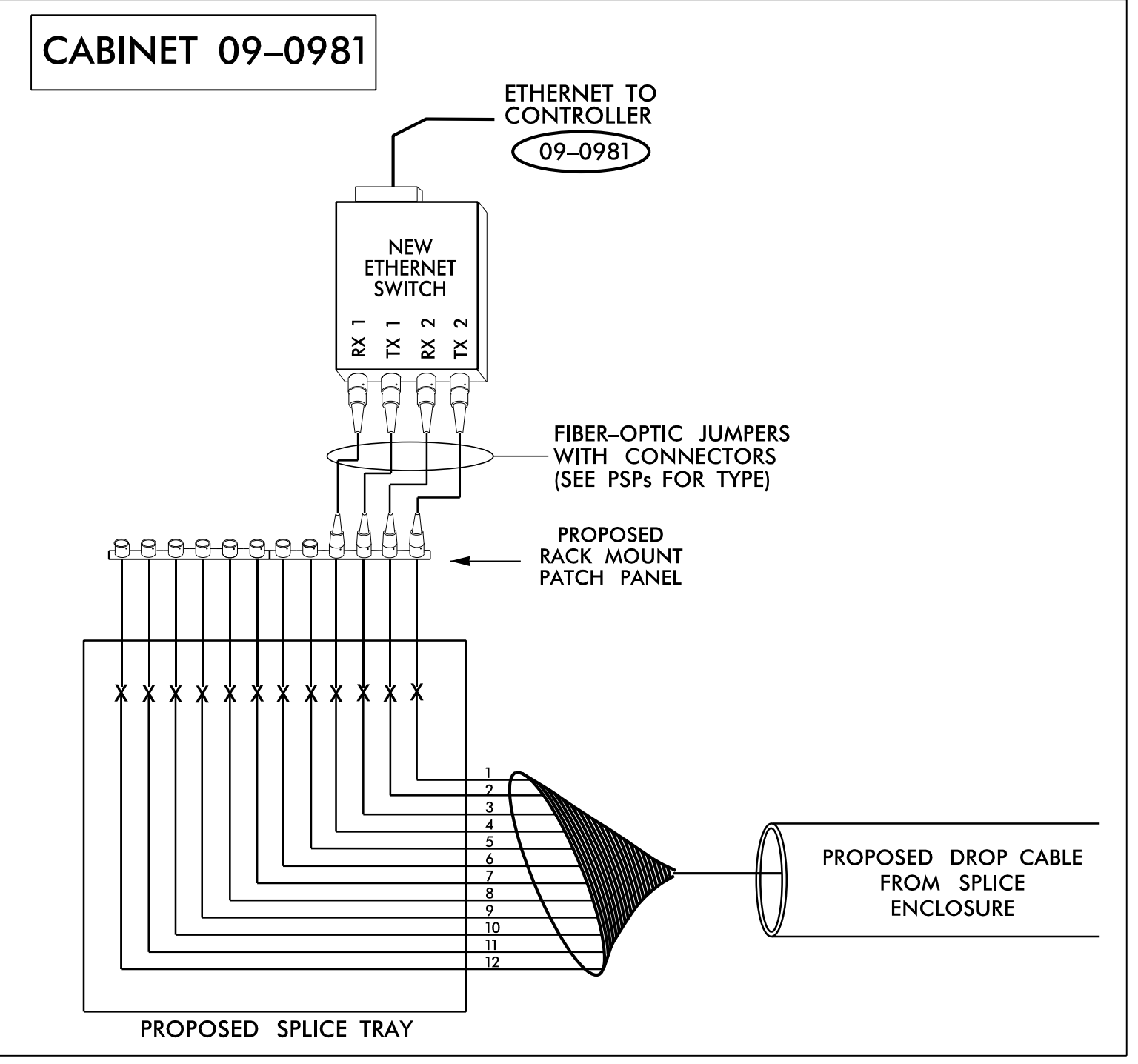
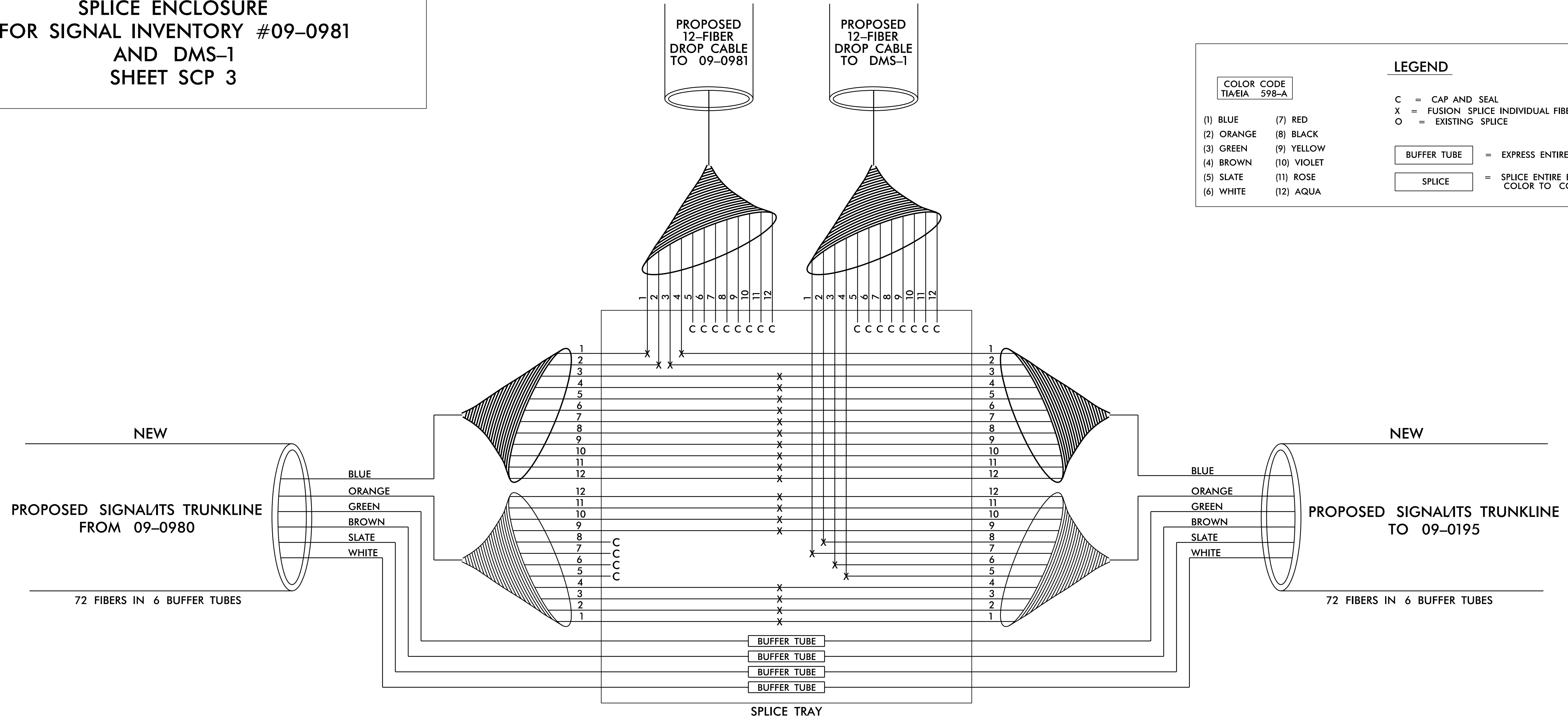

NOTES:

1. FIBER INTERCONNECT CENTER RACKS ARE SCHEMATIC ONLY, ACTUAL EQUIPMENT FORM MAY VARY.
 2. UNUSED FIBERS LEFT COILED AND STORED IN SPLICE TRAY.
 3. UNUSED BUFFER TUBES LEFT COILED AND STORED IN SPLICE TRAY.
 4. ETHERNET SWITCH TERMINATION CONFIGURATIONS ARE GENERIC. CONTRACTOR IS RESPONSIBLE FOR DETERMINING /ENSURING PROPER TERMINATION.
 5. INCLUDE ON THE COVER OF EACH SPLICE TRAY THE FOLLOWING:
 (1) SPLICE
 (2) DATE
 (3) COMPANY NAME
 (4) NAME OF INDIVIDUAL PERFORMING THE SPLICING
- PRIOR TO INSTALLING THE COVER ON THE SPLICE TRAY, TAKE A DIGITAL PHOTOGRAPH SHOWING THE SPLICE TRAY AND INFORMATION SHOWN ABOVE (1-4) AND SUBMIT PHOTOGRAPH ALONG WITH OTRD TEST RESULTS TO THE ENGINEER.

**DOCUMENT NOT CONSIDERED FINAL
UNLESS ALL SIGNATURES COMPLETED**

	SPLICE DETAILS	
	Division 09 Forsyth County PLAN DATE: February 2024 PREPARED BY: Haylee Townsend	Winston-Salem/ Walkertown REVIEWED BY: Porter Erickson-Jones REVIEWED BY:
SCALE N/A	REVISIONS _____	INIT. DATE _____
DocuSigned by Porter Jones 2/12/2024		DATE _____

RK&K
 P: (919) 878-9560
 8801 Six Forks Road, Forum 1, Suite 700
 Raleigh, North Carolina 27615-3960
 NC License No. F-0112
 Engineers | Construction Managers | Planners | Scientists
 www.rkk.com
 Responsive People | Creative Solutions

2/12/2024
 R:\Projects\09-0981\09-0981\09-0981\09-0981\SCP-3.dgn
 W:\Jones

**SPLICE ENCLOSURE
FOR SIGNAL INVENTORY #09-0195
AND CCTV-1
SHEET SCP 3**

FIBER OPTIC CABLE

COLOR CODE
TIA/EIA 598-A

- (1) BLUE (7) RED
- (2) ORANGE (8) BLACK
- (3) GREEN (9) YELLOW
- (4) BROWN (10) VIOLET
- (5) SLATE (11) ROSE
- (6) WHITE (12) AQUA

LEGEND

- C = CAP AND SEAL
- X = FUSION SPLICE INDIVIDUAL FIBER
- O = EXISTING SPLICE

BUFFER TUBE = EXPRESS ENTIRE BUFFER TUBE

SPLICE = SPLICE ENTIRE BUFFER TUBE COLOR TO COLOR

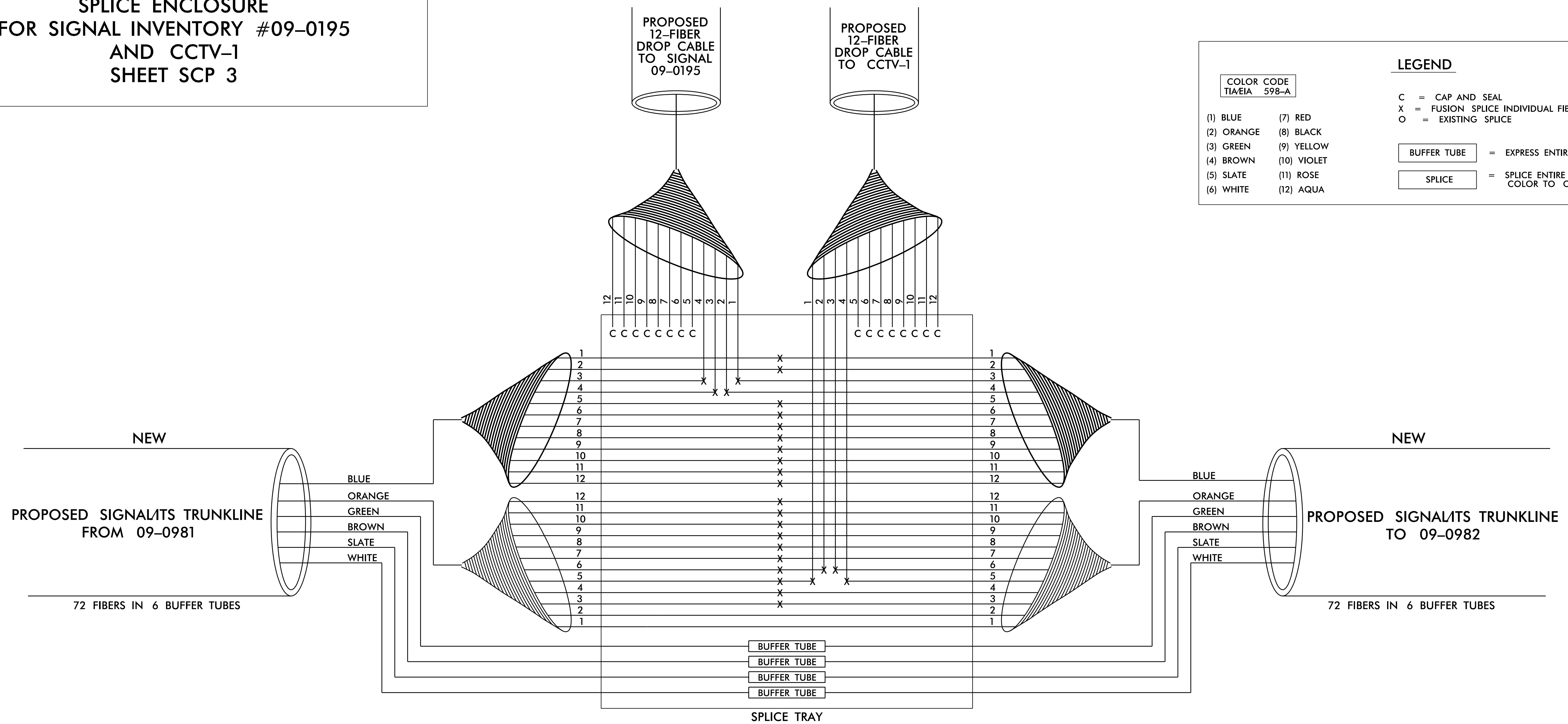

CABINET 09-0195

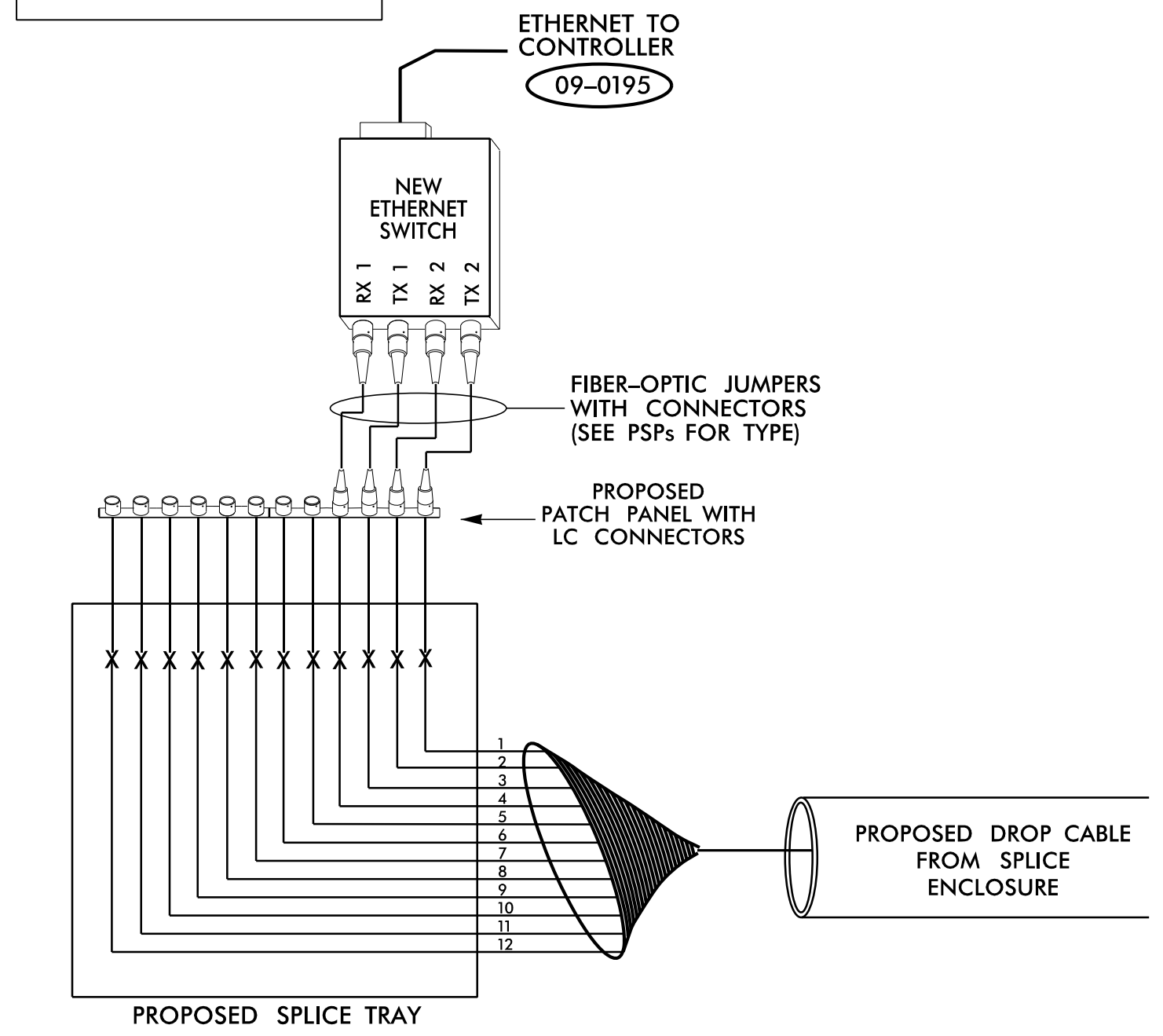

CCTV-1

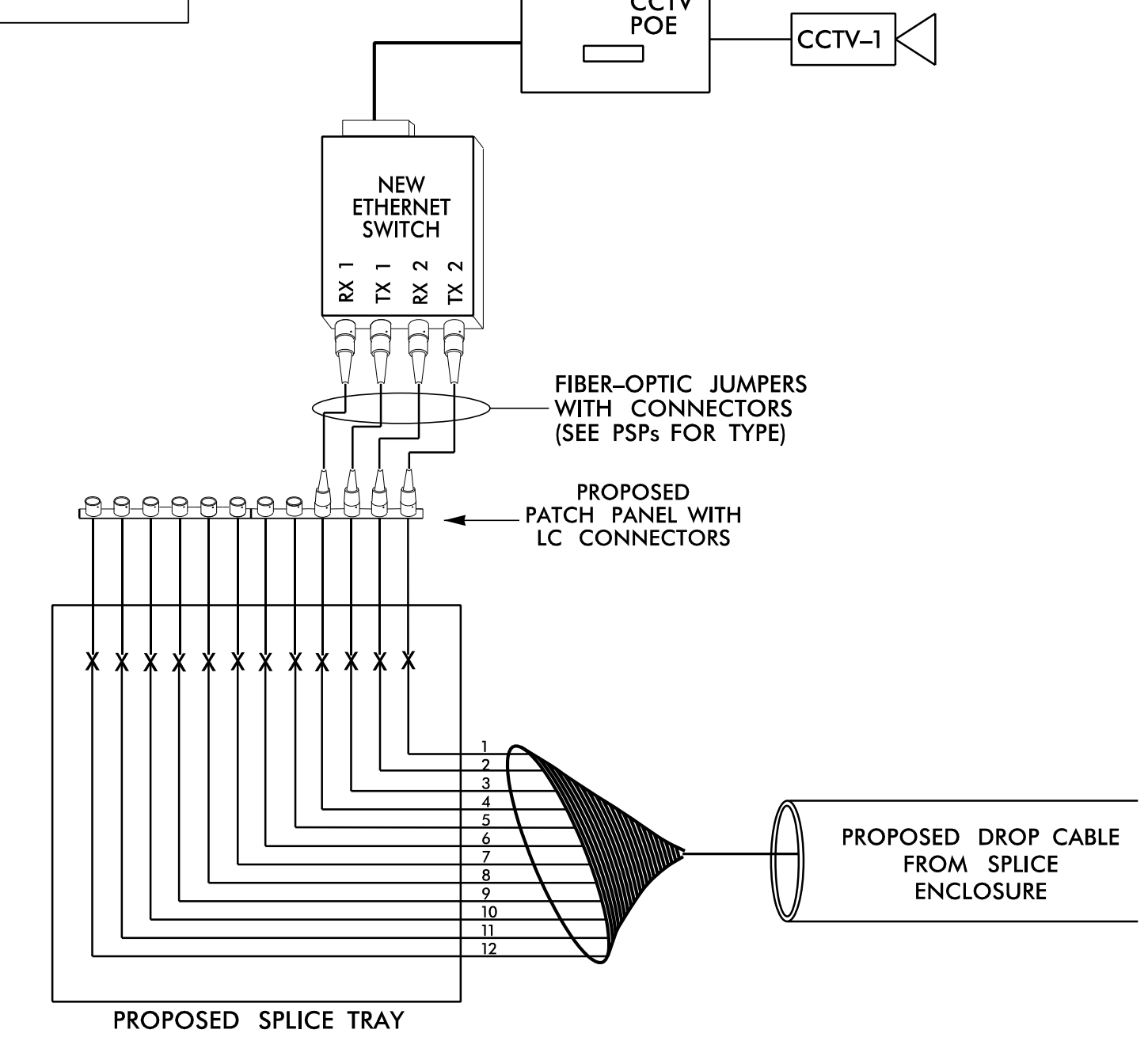

NOTES:

1. FIBER INTERCONNECT CENTER RACKS ARE SCHEMATIC ONLY, ACTUAL EQUIPMENT FORM MAY VARY.
 2. UNUSED FIBERS LEFT COILED AND STORED IN SPLICE TRAY.
 3. UNUSED BUFFER TUBES LEFT COILED AND STORED IN SPLICE TRAY.
 4. ETHERNET SWITCH TERMINATION CONFIGURATIONS ARE GENERIC. CONTRACTOR IS RESPONSIBLE FOR DETERMINING /ENSURING PROPER TERMINATION.
 5. INCLUDE ON THE COVER OF EACH SPLICE TRAY THE FOLLOWING:
(1) SPLICE
(2) DATE
(3) COMPANY NAME
(4) NAME OF INDIVIDUAL PERFORMING THE SPLICING
- PRIOR TO INSTALLING THE COVER ON THE SPLICE TRAY, TAKE A DIGITAL PHOTOGRAPH SHOWING THE SPLICE TRAY AND INFORMATION SHOWN ABOVE (1-4) AND SUBMIT PHOTOGRAPH ALONG WITH OTRD TEST RESULTS TO THE ENGINEER.

**DOCUMENT NOT CONSIDERED FINAL
UNLESS ALL SIGNATURES COMPLETED**

RK&K
P: (919) 878-9560
8801 Six Forks Road, Forum 1, Suite 700
Raleigh, North Carolina 27615-3960
NC License No. F-0112
www.rkk.com
Responsive People | Creative Solutions

Prepared for the Offices of:
ENGINEERING PROFESSIONALS
250 N. Greenfield Pkwy., Garner, NC 27529

SPLICE DETAILS

Division 09 Forsyth County Winston-Salem/
Walkertown
PLAN DATE: February 2024 REVIEWED BY: Porter Erickson-Jones
PREPARED BY: Haylee Townsend REVIEWED BY:



SCALE: N/A

REVISIONS	INIT.	DATE

SEAL
NORTH CAROLINA PROFESSIONAL SEAL 056142
PORTER JONES
Porter Jones
2/12/2024
CADD Filename:

SPLICE ENCLOSURE
FOR SIGNAL INVENTORY #09-0982
SHEET SCP 4

FIBER OPTIC CABLE

COLOR CODE TIA/EIA 598-A		LEGEND	
(1) BLUE	(7) RED	C = CAP AND SEAL	
(2) ORANGE	(8) BLACK	X = FUSION SPLICE INDIVIDUAL FIBER	
(3) GREEN	(9) YELLOW	O = EXISTING SPLICE	
(4) BROWN	(10) VIOLET	 = EXPRESS ENTIRE BUFFER TUBE	
(5) SLATE	(11) ROSE	 = SPLICE ENTIRE BUFFER TUBE COLOR TO COLOR	
(6) WHITE	(12) AQUA		

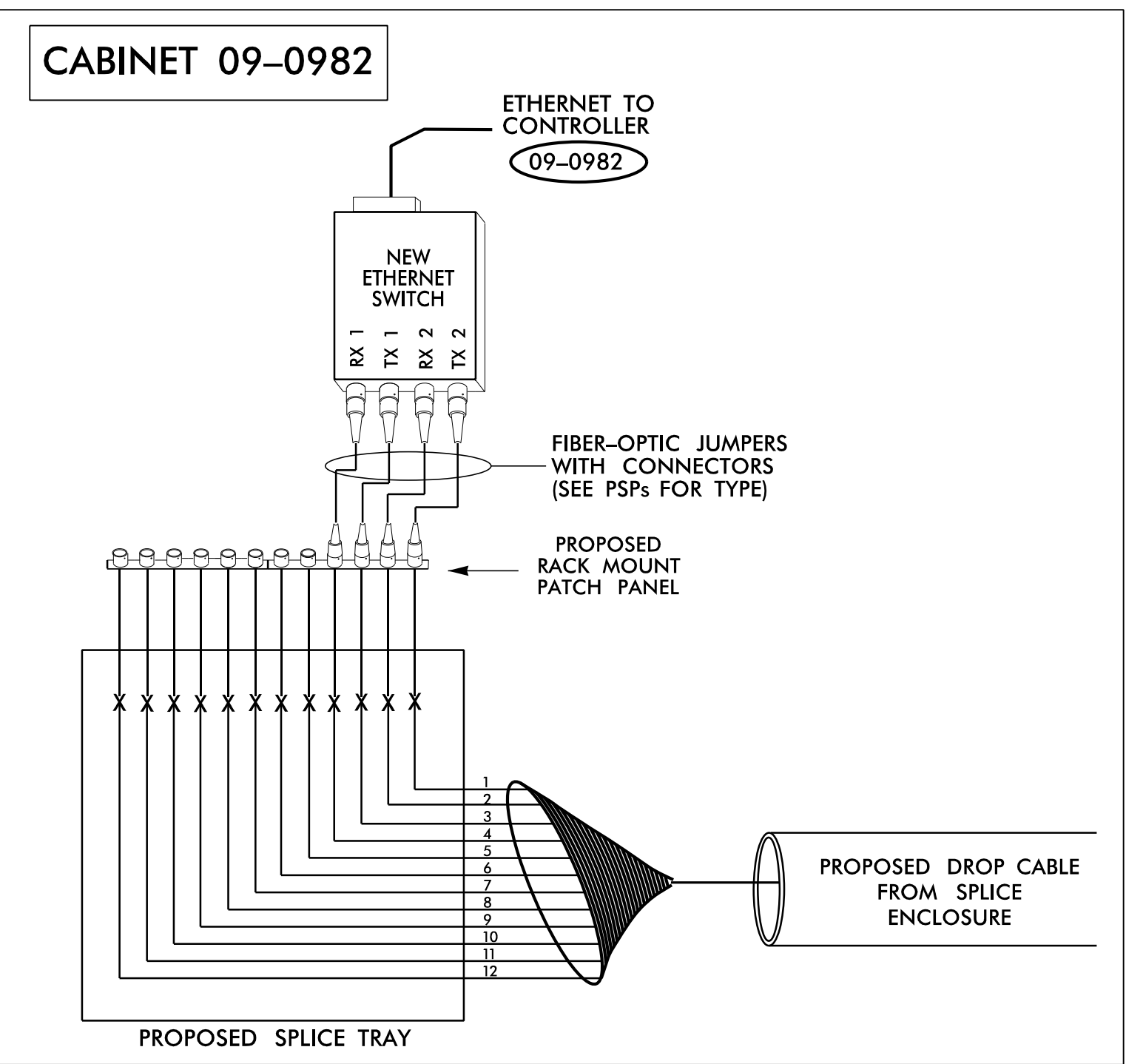
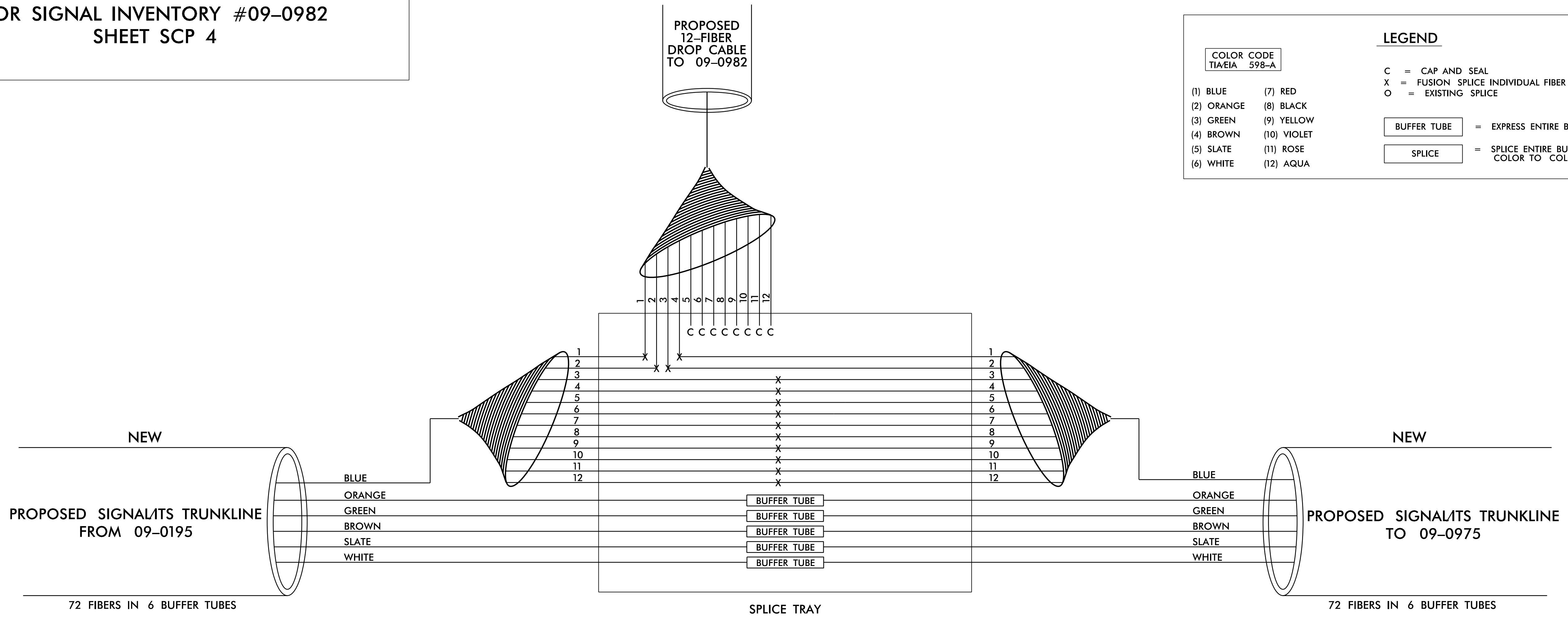

- NOTES:**
- FIBER INTERCONNECT CENTER RACKS ARE SCHEMATIC ONLY, ACTUAL EQUIPMENT FORM MAY VARY.
 - UNUSED FIBERS LEFT COILED AND STORED IN SPLICE TRAY.
 - UNUSED BUFFER TUBES LEFT COILED AND STORED IN SPLICE TRAY.
 - ETHERNET SWITCH TERMINATION CONFIGURATIONS ARE GENERIC. CONTRACTOR IS RESPONSIBLE FOR DETERMINING /ENSURING PROPER TERMINATION.
 - INCLUDE ON THE COVER OF EACH SPLICE TRAY THE FOLLOWING:
 - SPLICE
 - DATE
 - COMPANY NAME
 - NAME OF INDIVIDUAL PERFORMING THE SPLICING
- PRIOR TO INSTALLING THE COVER ON THE SPLICE TRAY, TAKE A DIGITAL PHOTOGRAPH SHOWING THE SPLICE TRAY AND INFORMATION SHOWN ABOVE (1-4) AND SUBMIT PHOTOGRAPH ALONG WITH OTDR TEST RESULTS TO THE ENGINEER.

**DOCUMENT NOT CONSIDERED FINAL
UNLESS ALL SIGNATURES COMPLETED**

RK&K
P: (919) 878-9560
8801 Six Forks Road, Forum 1, Suite 700
Raleigh, North Carolina 27615-3960
NC License No. F-0112
www.rkk.com
Responsive People | Creative Solutions

SPLICE DETAILS

Division 09 Forsyth County Winston-Salem/
Walkertown

PLAN DATE: February 2024 REVIEWED BY: Porter Erickson-Jones

PREPARED BY: Haylee Townsend REVIEWED BY:

REVISIONS	INIT.	DATE

SCALE: N/A

SEAL



Porter Jones
2/12/2024
SIGNATURE DATE
CADD Filename:

2/12/2024 R:\Projects\cns\gna\040as\gna\4545CP\W2577A_SCP_11ce_Detail.scdgn wplones

FIBER OPTIC CABLE

SPLICE ENCLOSURE
FOR SIGNAL INVENTORY #09-0975
SHEET SCP 8

COLOR CODE
TIA/EIA 598-A

(1) BLUE	(7) RED
(2) ORANGE	(8) BLACK
(3) GREEN	(9) YELLOW
(4) BROWN	(10) VIOLET
(5) SLATE	(11) ROSE
(6) WHITE	(12) AQUA

LEGEND

C = CAP AND SEAL
X = FUSION SPLICE INDIVIDUAL FIBER
O = EXISTING SPLICE

BUFFER TUBE = EXPRESS ENTIRE BUFFER TUBE

SPLICE = SPLICE ENTIRE BUFFER TUBE COLOR TO COLOR

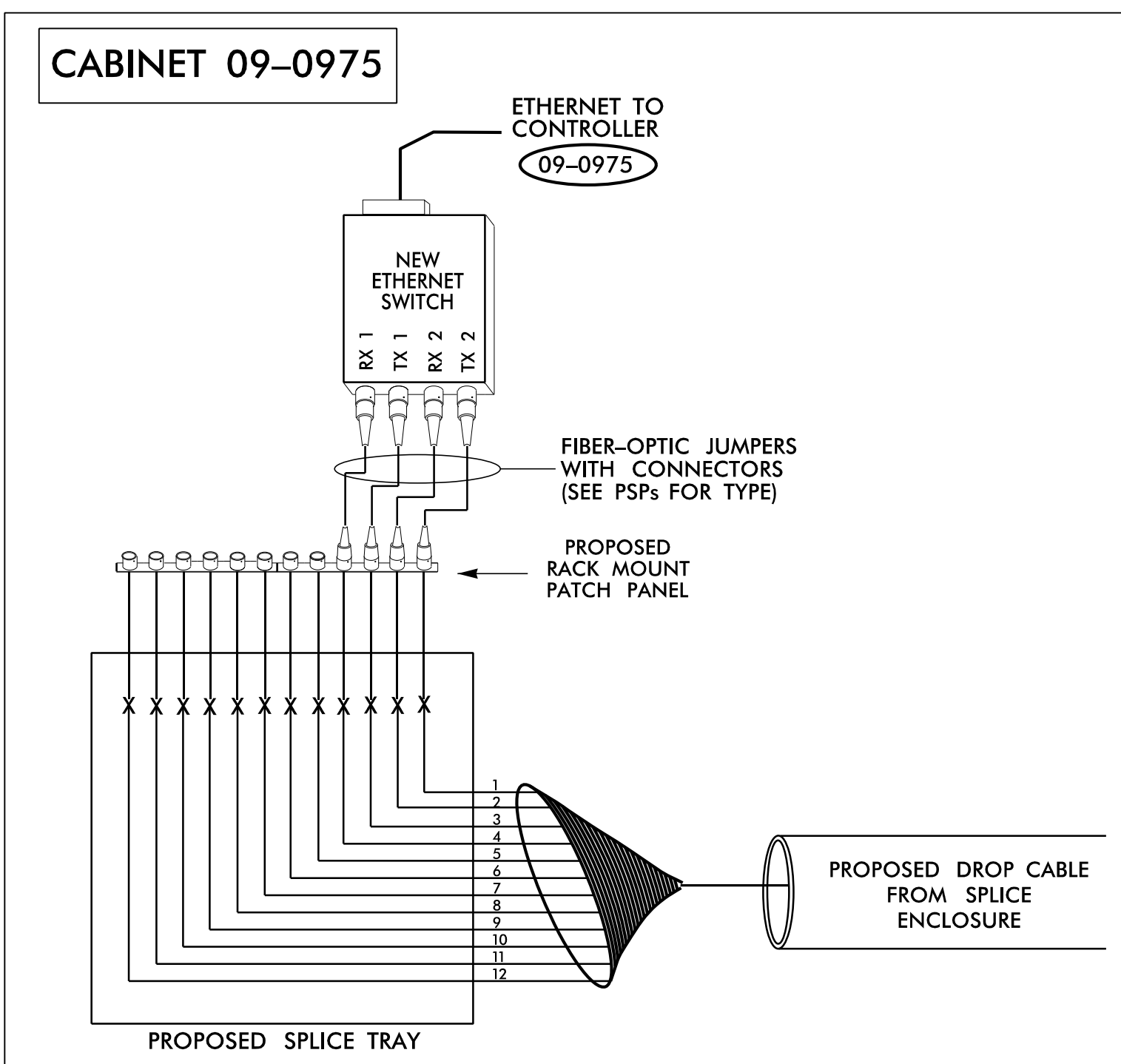
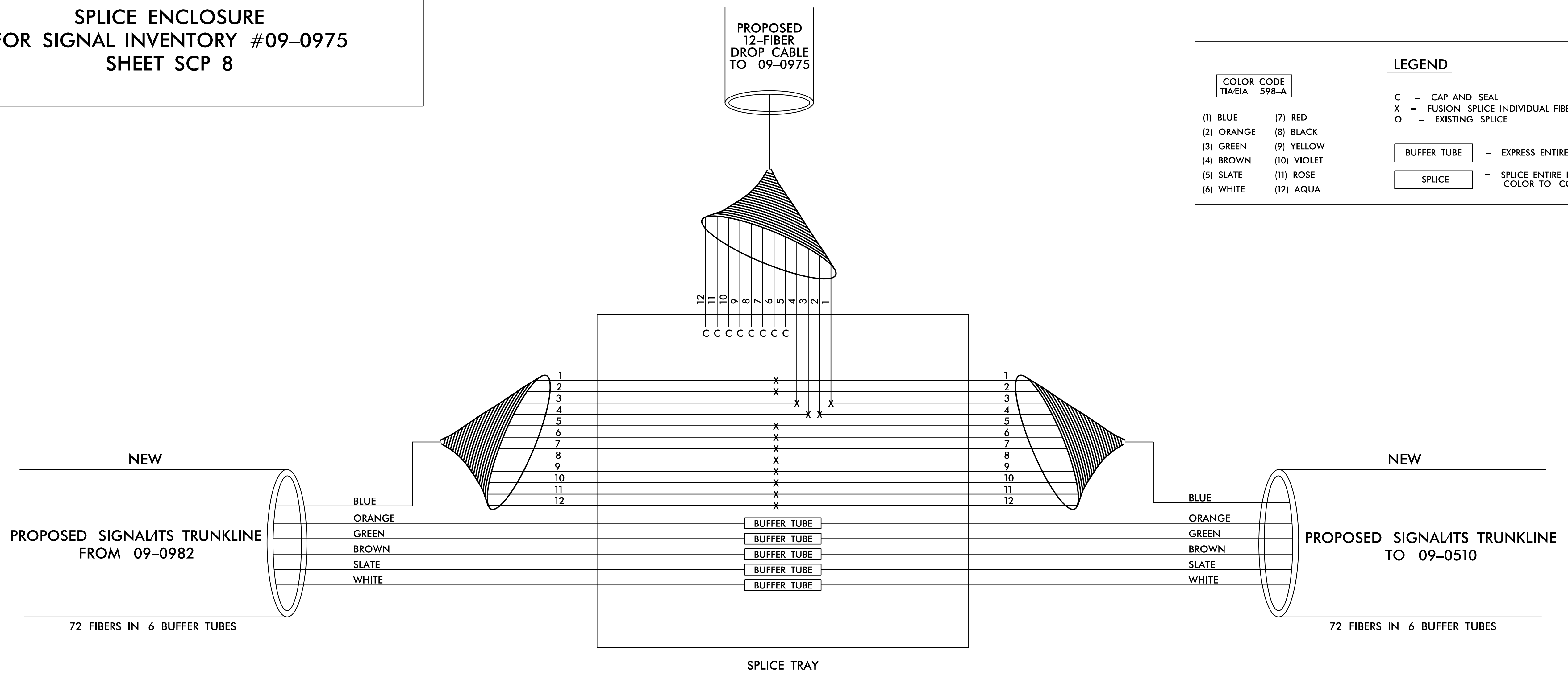

NOTES:

1. FIBER INTERCONNECT CENTER RACKS ARE SCHEMATIC ONLY, ACTUAL EQUIPMENT FORM MAY VARY.
2. UNUSED FIBERS LEFT COILED AND STORED IN SPLICE TRAY.
3. UNUSED BUFFER TUBES LEFT COILED AND STORED IN SPLICE TRAY.
4. ETHERNET SWITCH TERMINATION CONFIGURATIONS ARE GENERIC. CONTRACTOR IS RESPONSIBLE FOR DETERMINING /ENSURING PROPER TERMINATION.
5. INCLUDE ON THE COVER OF EACH SPLICE TRAY THE FOLLOWING:
(1) SPLICE
(2) DATE
(3) COMPANY NAME
(4) NAME OF INDIVIDUAL PERFORMING THE SPLICING

PRIOR TO INSTALLING THE COVER ON THE SPLICE TRAY, TAKE A DIGITAL PHOTOGRAPH SHOWING THE SPLICE TRAY AND INFORMATION SHOWN ABOVE (1-4) AND SUBMIT PHOTOGRAPH ALONG WITH OTRD TEST RESULTS TO THE ENGINEER.

DOCUMENT NOT CONSIDERED FINAL
UNLESS ALL SIGNATURES COMPLETED

RK&K
P: (919) 878-9560
8801 Six Forks Road, Forum 1, Suite 700
Raleigh, North Carolina 27615-3960
NC License No. F-0112
www.rkk.com
Responsive People | Creative Solutions

Prepared for the Offices of:
ENGINEERING CONSULTANTS & ARCHITECTS
750 N. Greenfield Pkwy., Garner, NC 27529

SPLICE DETAILS

Division 09 Forsyth County Winston-Salem/
Walkertown
PLAN DATE: February 2024 REVIEWED BY: Porter Erickson-Jones
PREPARED BY: Haylee Townsend REVIEWED BY:

REVISIONS	INIT.	DATE

SCALE: N/A

SEAL: PORTER JONES, PROFESSIONAL ENGINEER, SEAL 056142
DocuSigned by: Porter Jones, 2/12/2024
CADD Filename: _____

FIBER OPTIC CABLE

SPlice ENCLOSURE
FOR SIGNAL INVENTORY #09-0510
SHEET SCP 14

COLOR CODE TIA/EIA 598-A		LEGEND	
(1) BLUE	(7) RED	C = CAP AND SEAL	
(2) ORANGE	(8) BLACK	X = FUSION SPlice INDIVIDUAL FIBER	
(3) GREEN	(9) YELLOW	O = EXISTING SPlice	
(4) BROWN	(10) VIOLET	BUFFER TUBE = EXPRESS ENTIRE BUFFER TUBE	
(5) SLATE	(11) ROSE	SPlice = SPlice ENTIRE BUFFER TUBE COLOR TO COLOR	
(6) WHITE	(12) AQUA		

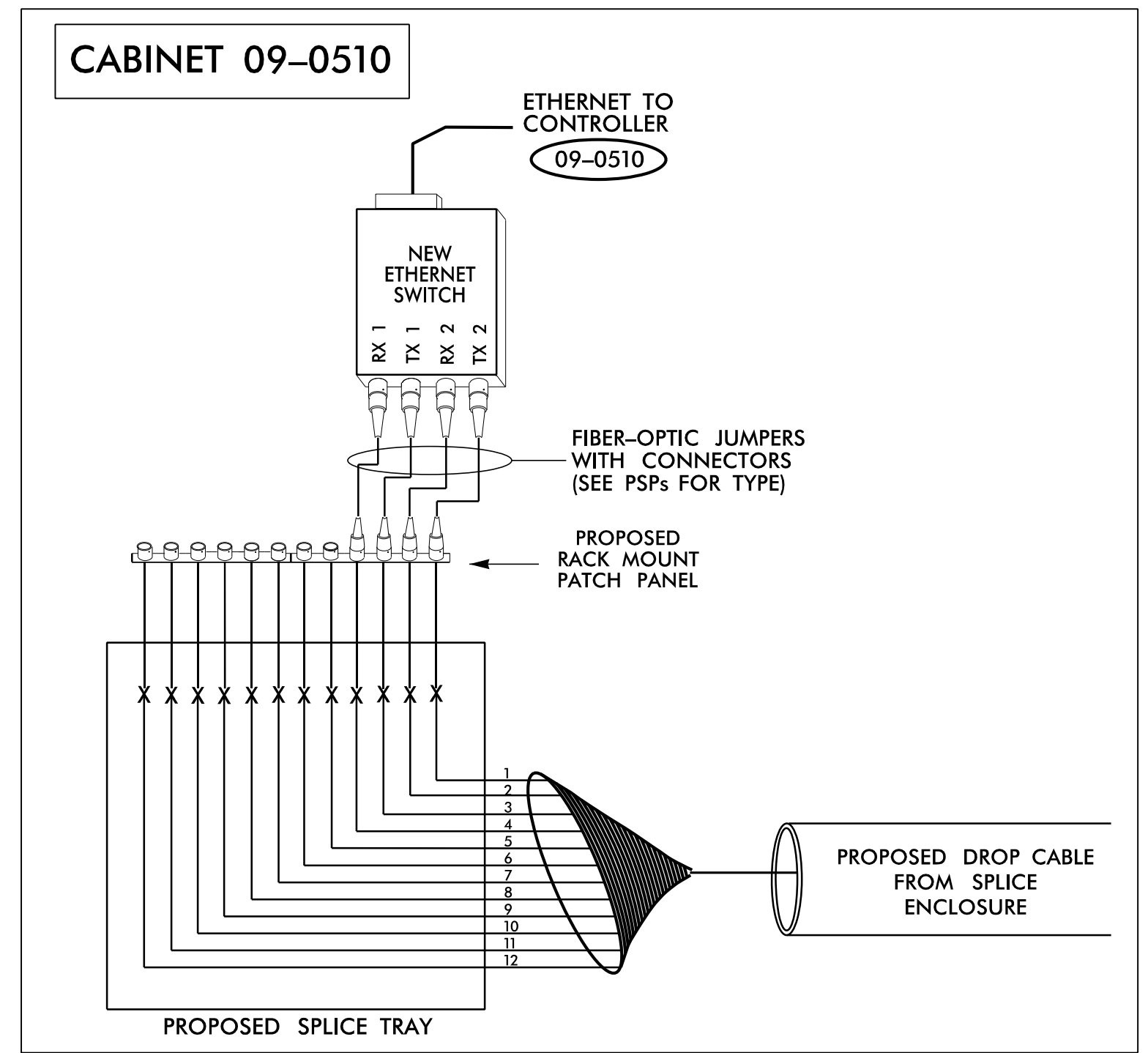
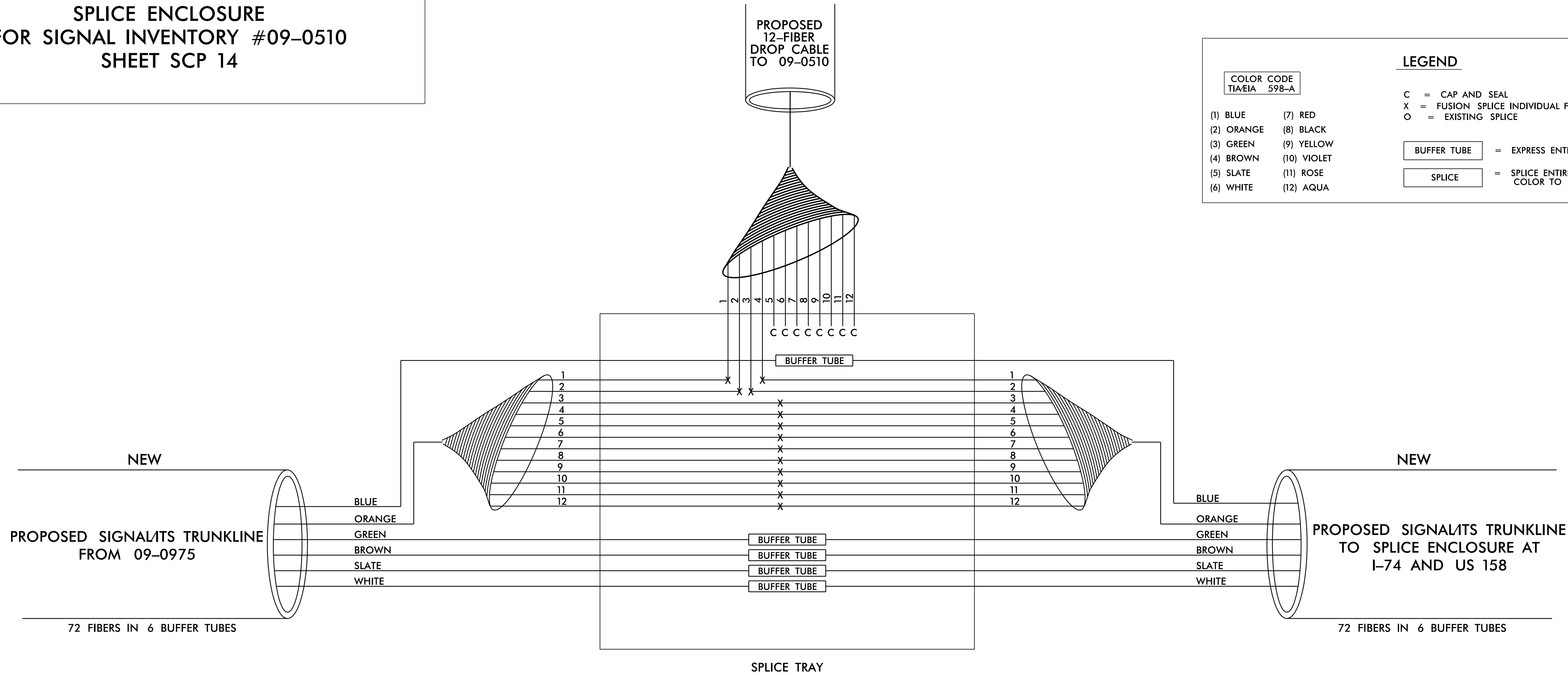

- NOTES:
- FIBER INTERCONNECT CENTER RACKS ARE SCHEMATIC ONLY, ACTUAL EQUIPMENT FORM MAY VARY.
 - UNUSED FIBERS LEFT COILED AND STORED IN SPlice TRAY.
 - UNUSED BUFFER TUBES LEFT COILED AND STORED IN SPlice TRAY.
 - ETHERNET SWITCH TERMINATION CONFIGURATIONS ARE GENERIC. CONTRACTOR IS RESPONSIBLE FOR DETERMINING /ENSURING PROPER TERMINATION.
 - INCLUDE ON THE COVER OF EACH SPlice TRAY THE FOLLOWING:
 - SPlice
 - DATE
 - COMPANY NAME
 - NAME OF INDIVIDUAL PERFORMING THE SPlicing
- PRIOR TO INSTALLING THE COVER ON THE SPlice TRAY, TAKE A DIGITAL PHOTOGRAPH SHOWING THE SPlice TRAY AND INFORMATION SHOWN ABOVE (1-4) AND SUBMIT PHOTOGRAPH ALONG WITH OTRD TEST RESULTS TO THE ENGINEER.

DOCUMENT NOT CONSIDERED FINAL
UNLESS ALL SIGNATURES COMPLETED

RK&K
P: (919) 878-9560
8801 Six Forks Road, Forum 1, Suite 700
Raleigh, North Carolina 27615-3960
NC License No. F-0112
www.rkk.com
Responsive People | Creative Solutions

Prepared for the Offices of: ENGINEERS ARCHITECTS PLANNERS 250 N. Greenfield Pkwy., Garner, NC 27529		<p>SEAL</p> <p>SPlice DETAILS</p> <p>Division 09 Forsyth County Winston-Salem/ Walkertown</p> <p>PLAN DATE: February 2024 REVIEWED BY: Porter Erickson-Jones</p> <p>PREPARED BY: Haylee Townsend REVIEWED BY:</p>		<p>SEAL</p> <p>PORTER ERICKSON-JONES PROFESSIONAL ENGINEER 056142</p> <p>Porter Jones 2/12/2024</p>
SCALE N/A	REVISIONS	INIT.	DATE	

2/12/2024
R:\Projects\cns\gn\09-0510\09-0510\09-0510\SCP-14.dgn
wplones

FIBER OPTIC CABLE

SPLICE ENCLOSURE
FOR TRUNKLINE TO I-74
SHEET SCP 14

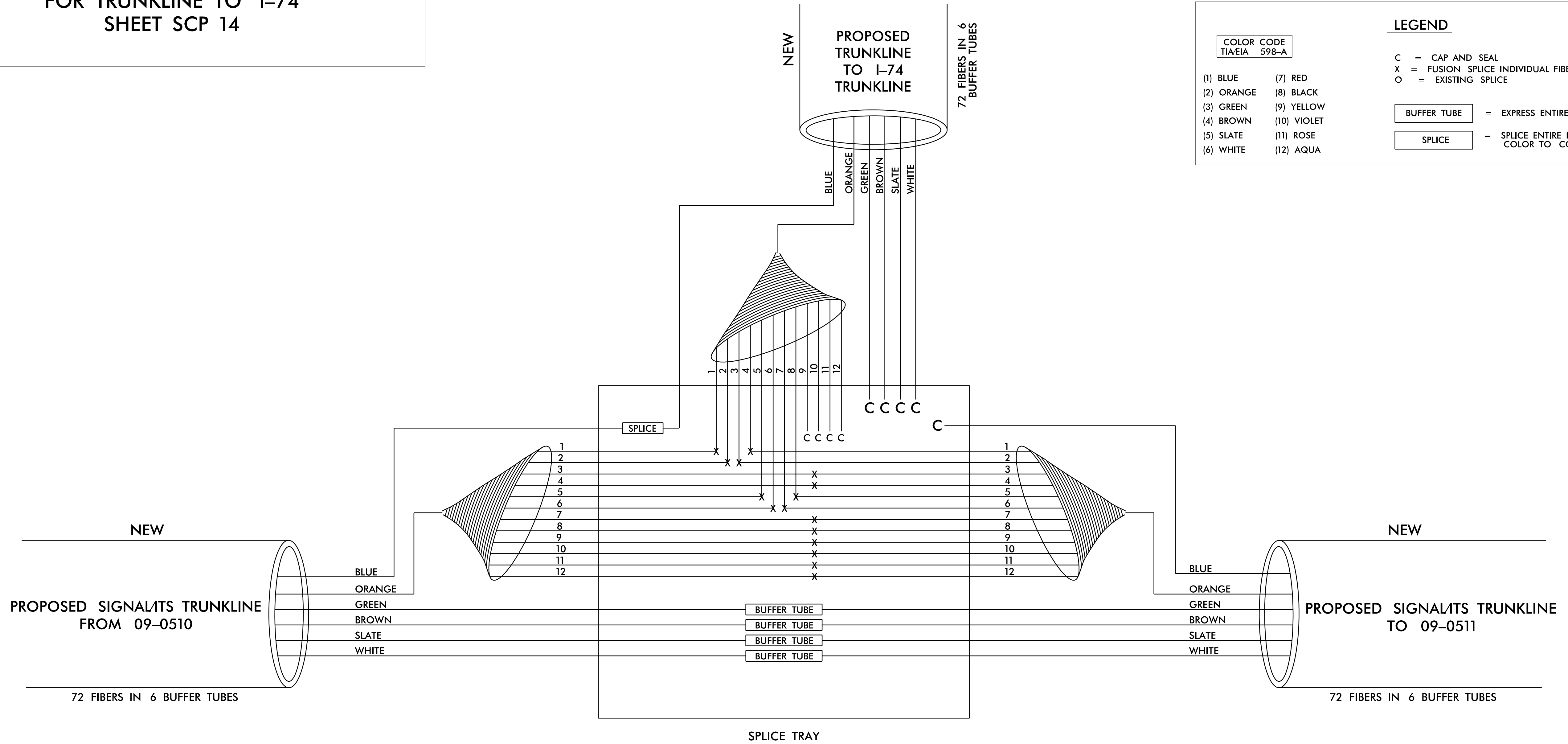

COLOR CODE
TIA/EIA 598-A

- (1) BLUE
- (2) ORANGE
- (3) GREEN
- (4) BROWN
- (5) SLATE
- (6) WHITE
- (7) RED
- (8) BLACK
- (9) YELLOW
- (10) VIOLET
- (11) ROSE
- (12) AQUA

LEGEND

- C = CAP AND SEAL
- X = FUSION SPLICE INDIVIDUAL FIBER
- O = EXISTING SPLICE
- BUFFER TUBE = EXPRESS ENTIRE BUFFER TUBE
- SPLICE = SPLICE ENTIRE BUFFER TUBE COLOR TO COLOR

NOTES:

1. FIBER INTERCONNECT CENTER RACKS ARE SCHEMATIC ONLY, ACTUAL EQUIPMENT FORM MAY VARY.
 2. UNUSED FIBERS LEFT COILED AND STORED IN SPLICE TRAY.
 3. UNUSED BUFFER TUBES LEFT COILED AND STORED IN SPLICE TRAY.
 4. ETHERNET SWITCH TERMINATION CONFIGURATIONS ARE GENERIC. CONTRACTOR IS RESPONSIBLE FOR DETERMINING /ENSURING PROPER TERMINATION.
 5. INCLUDE ON THE COVER OF EACH SPLICE TRAY THE FOLLOWING:
 - (1) SPLICE
 - (2) DATE
 - (3) COMPANY NAME
 - (4) NAME OF INDIVIDUAL PERFORMING THE SPLICING
- PRIOR TO INSTALLING THE COVER ON THE SPLICE TRAY, TAKE A DIGITAL PHOTOGRAPH SHOWING THE SPLICE TRAY AND INFORMATION SHOWN ABOVE (1-4) AND SUBMIT PHOTOGRAPH ALONG WITH OTDR TEST RESULTS TO THE ENGINEER.

**DOCUMENT NOT CONSIDERED FINAL
UNLESS ALL SIGNATURES COMPLETED**

2/12/2024
 R:\Projects\cns\gn\is\40as\gn\is\45CP\2577A_SCP_Sp1.tce Det\11.s.dgn
 wplones

RKK
 P: (919) 878-9560
 8801 Six Forks Road, Forum 1, Suite 700
 Raleigh, North Carolina 27615-3960
 NC License No. F-0112
 Engineers | Construction Managers | Planners | Scientists
 www.rkk.com
 Responsive People | Creative Solutions

Prepared for the Offices of: 750 N. Greenfield Pkwy., Garner, NC 27529		SPLICE DETAILS		SEAL 	
Division 09 Forsyth County Winston-Salem/ Walkertown		PLAN DATE: February 2024 REVIEWED BY: Porter Erickson-Jones		PREPARED BY: Haylee Townsend REVIEWED BY:	
SCALE		REVISIONS		INIT. DATE	
N/A					
		DocuSigned by: 2/12/2024		SIGNATURE DATE	
CADD Filename:					

FIBER OPTIC CABLE

SPlice ENCLOSURE
FOR SIGNAL INVENTORY #09-0511
SHEET SCP 15

COLOR CODE TIA/EIA 598-A		LEGEND	
(1) BLUE	(7) RED	C = CAP AND SEAL	
(2) ORANGE	(8) BLACK	X = FUSION SPLICE INDIVIDUAL FIBER	
(3) GREEN	(9) YELLOW	O = EXISTING SPLICE	
(4) BROWN	(10) VIOLET	BUFFER TUBE = EXPRESS ENTIRE BUFFER TUBE	
(5) SLATE	(11) ROSE	SPLICE = SPLICE ENTIRE BUFFER TUBE COLOR TO COLOR	
(6) WHITE	(12) AQUA		

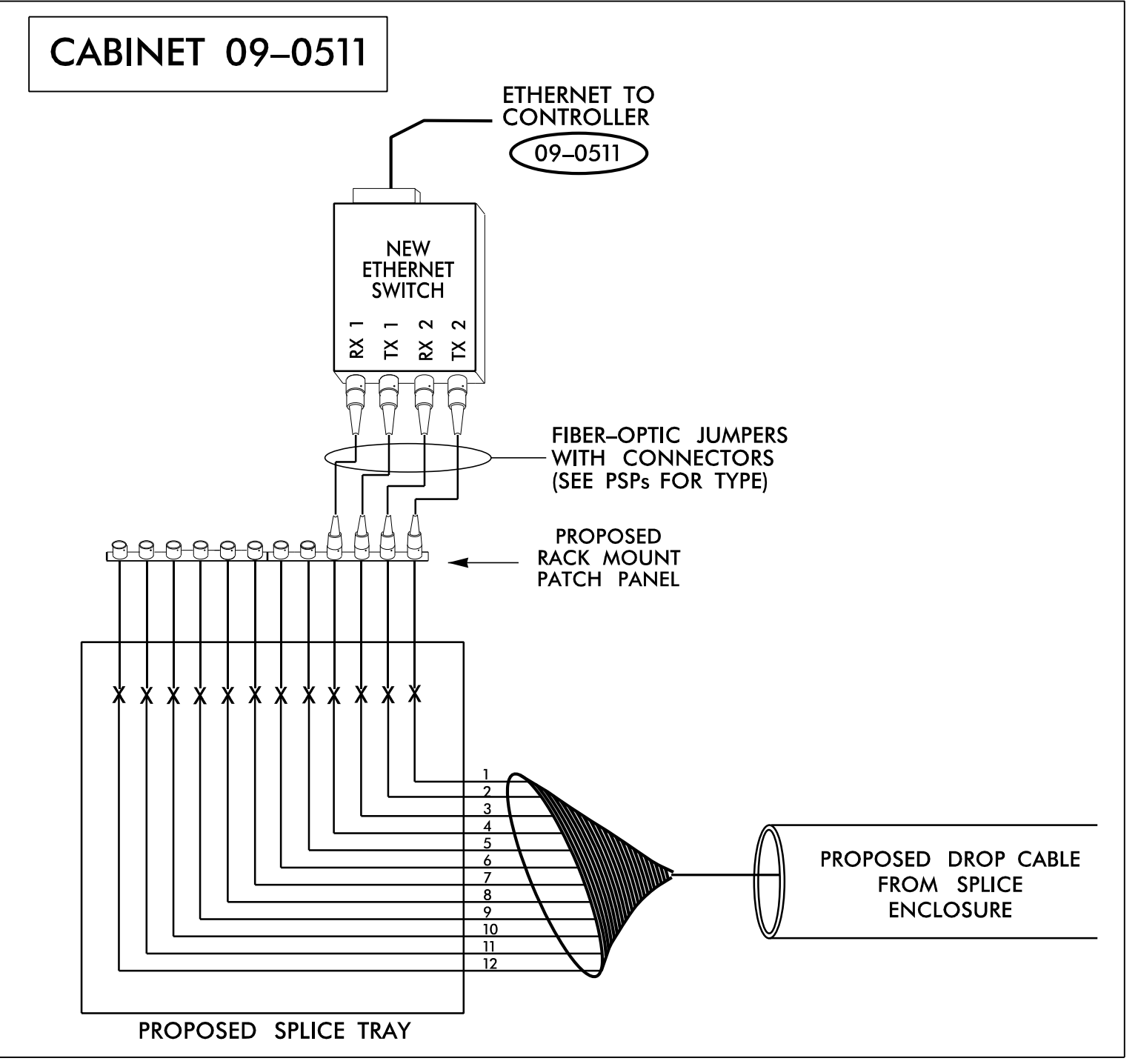
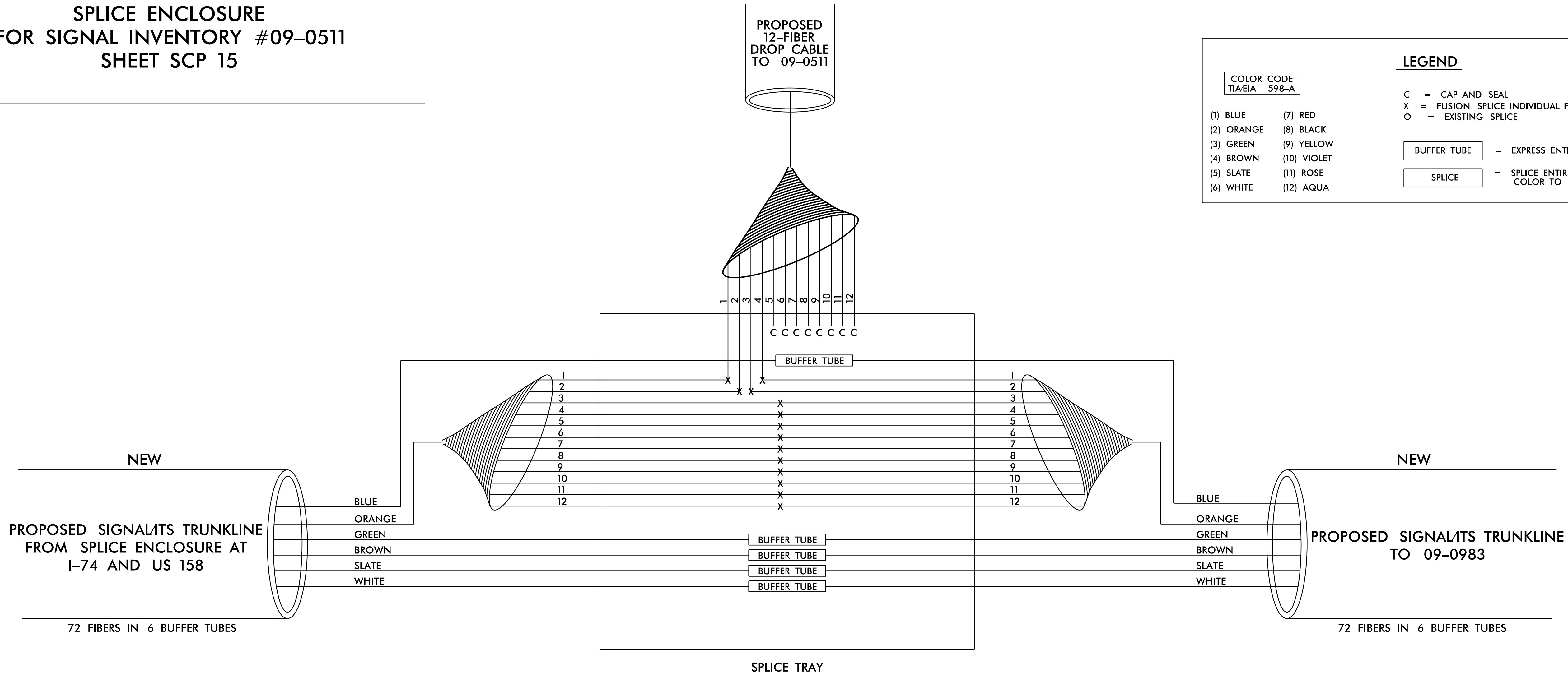

- NOTES:**
1. FIBER INTERCONNECT CENTER RACKS ARE SCHEMATIC ONLY, ACTUAL EQUIPMENT FORM MAY VARY.
 2. UNUSED FIBERS LEFT COILED AND STORED IN SPLICE TRAY.
 3. UNUSED BUFFER TUBES LEFT COILED AND STORED IN SPLICE TRAY.
 4. ETHERNET SWITCH TERMINATION CONFIGURATIONS ARE GENERIC. CONTRACTOR IS RESPONSIBLE FOR DETERMINING /ENSURING PROPER TERMINATION.
 5. INCLUDE ON THE COVER OF EACH SPLICE TRAY THE FOLLOWING:
 (1) SPLICE
 (2) DATE
 (3) COMPANY NAME
 (4) NAME OF INDIVIDUAL PERFORMING THE SPLICING
- PRIOR TO INSTALLING THE COVER ON THE SPLICE TRAY, TAKE A DIGITAL PHOTOGRAPH SHOWING THE SPLICE TRAY AND INFORMATION SHOWN ABOVE (1-4) AND SUBMIT PHOTOGRAPH ALONG WITH OTRD TEST RESULTS TO THE ENGINEER.

DOCUMENT NOT CONSIDERED FINAL
UNLESS ALL SIGNATURES COMPLETED



<p>Prepared for the Offices of:</p> <p>750 N. Greenfield Pkwy., Garner, NC 27529</p>	<h2>SPLICE DETAILS</h2>		<p>SEAL</p> <p>Porter Jones 2/12/2024</p>					
	<p>Division 09 Forsyth County Winston-Salem/ Walkertown</p> <p>PLAN DATE: February 2024 REVIEWED BY: Porter Erickson-Jones</p> <p>PREPARED BY: Haylee Townsend REVIEWED BY:</p>	<table border="1"> <thead> <tr> <th>REVISIONS</th> <th>INIT.</th> <th>DATE</th> </tr> </thead> <tbody> <tr> <td> </td> <td> </td> <td> </td> </tr> </tbody> </table>		REVISIONS	INIT.	DATE		
REVISIONS	INIT.	DATE						

RKK
 P: (919) 878-9560
 8801 Six Forks Road, Forum 1, Suite 700
 Raleigh, North Carolina 27615-3960
 NC License No. F-0112
 www.rkk.com
 Responsive People | Creative Solutions

2/12/2024
 R:\Projects\cns\190404as\gnms\gnms\190404as\450CP\W2577A_SCP_Sp11ce_Detail1.s.dgn
 wplones

FIBER OPTIC CABLE

SPLICE ENCLOSURE
FOR SIGNAL INVENTORY #09-0983
SHEET SCP 17

COLOR CODE TIA/EIA 598-A		LEGEND	
(1) BLUE	(7) RED	C = CAP AND SEAL	
(2) ORANGE	(8) BLACK	X = FUSION SPLICE INDIVIDUAL FIBER	
(3) GREEN	(9) YELLOW	O = EXISTING SPLICE	
(4) BROWN	(10) VIOLET	 = EXPRESS ENTIRE BUFFER TUBE	
(5) SLATE	(11) ROSE	 = SPLICE ENTIRE BUFFER TUBE COLOR TO COLOR	
(6) WHITE	(12) AQUA		

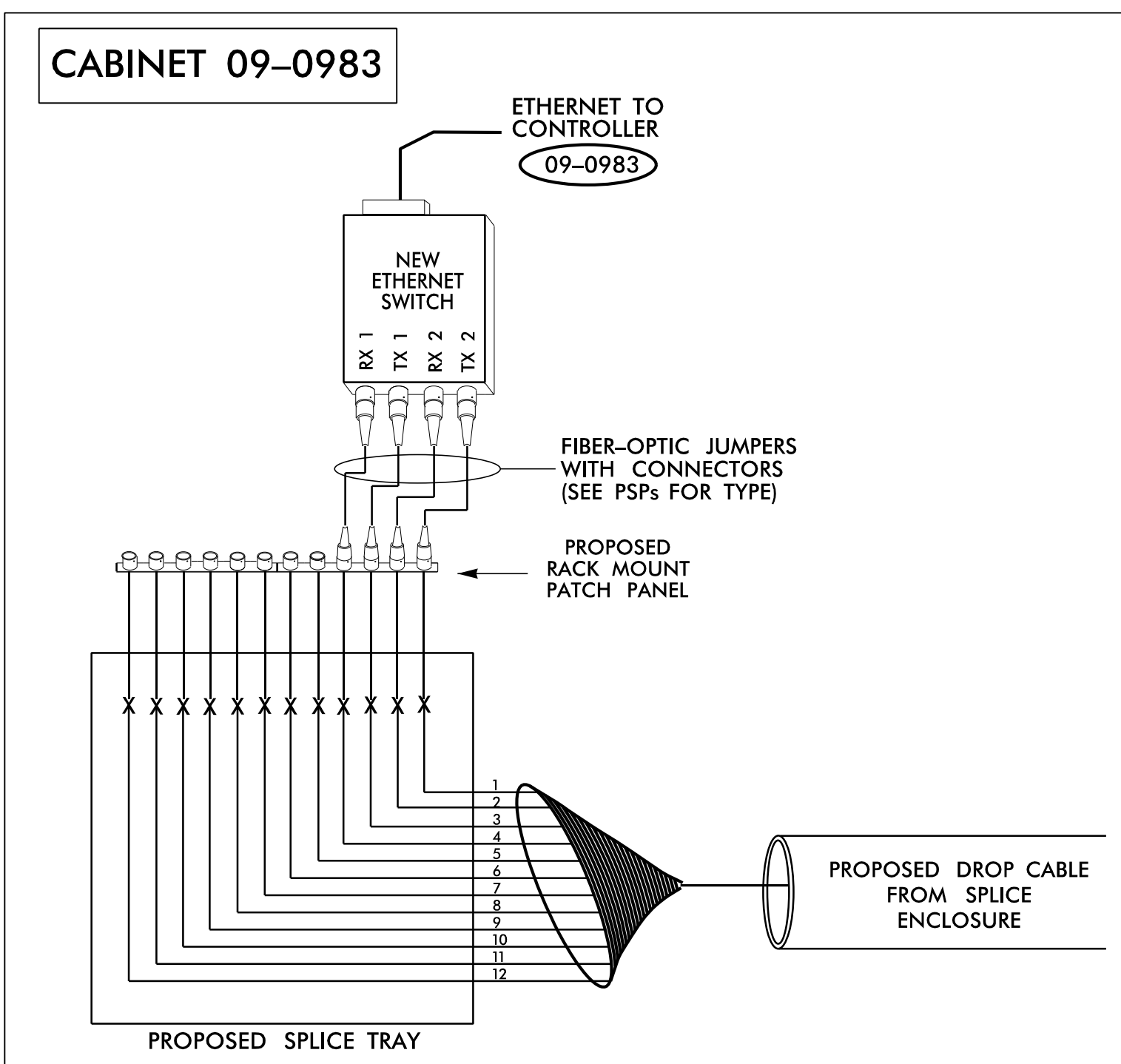
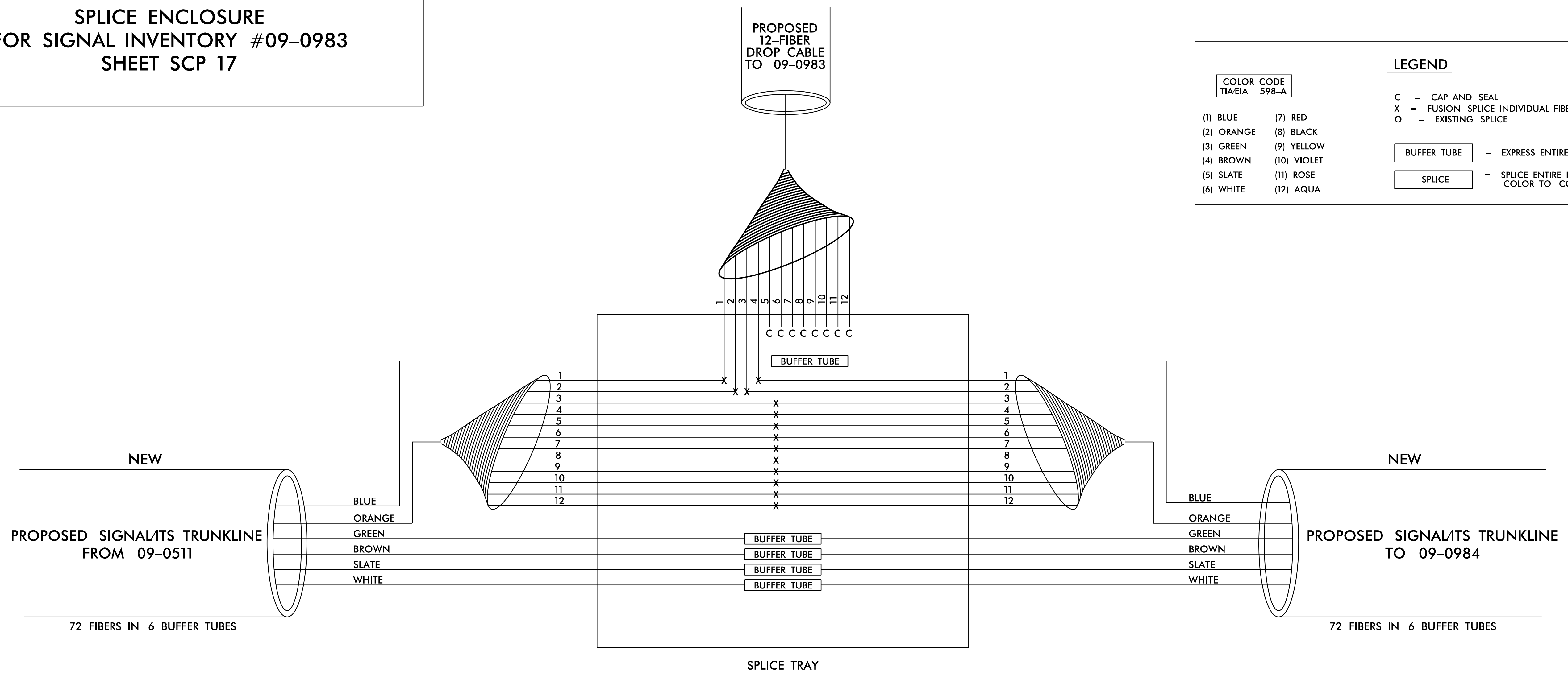

- NOTES:
1. FIBER INTERCONNECT CENTER RACKS ARE SCHEMATIC ONLY, ACTUAL EQUIPMENT FORM MAY VARY.
 2. UNUSED FIBERS LEFT COILED AND STORED IN SPLICE TRAY.
 3. UNUSED BUFFER TUBES LEFT COILED AND STORED IN SPLICE TRAY.
 4. ETHERNET SWITCH TERMINATION CONFIGURATIONS ARE GENERIC. CONTRACTOR IS RESPONSIBLE FOR DETERMINING /ENSURING PROPER TERMINATION.
 5. INCLUDE ON THE COVER OF EACH SPLICE TRAY THE FOLLOWING:
 - (1) SPLICE
 - (2) DATE
 - (3) COMPANY NAME
 - (4) NAME OF INDIVIDUAL PERFORMING THE SPLICING
- PRIOR TO INSTALLING THE COVER ON THE SPLICE TRAY, TAKE A DIGITAL PHOTOGRAPH SHOWING THE SPLICE TRAY AND INFORMATION SHOWN ABOVE (1-4) AND SUBMIT PHOTOGRAPH ALONG WITH OTRD TEST RESULTS TO THE ENGINEER.

DOCUMENT NOT CONSIDERED FINAL
UNLESS ALL SIGNATURES COMPLETED

RK&K
P: (919) 878-9560
8801 Six Forks Road, Forum 1, Suite 700
Raleigh, North Carolina 27615-3960
NC License No. F-0112
www.rkk.com
Responsive People | Creative Solutions

Prepared for the Offices of:

250 N. Greenfield Pkwy., Garner, NC 27529

SPLICE DETAILS
Division 09 Forsyth County Winston-Salem/
Walkertown
PLAN DATE: February 2024 REVIEWED BY: Porter Erickson-Jones
PREPARED BY: Haylee Townsend REVIEWED BY:

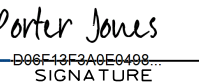

REVISIONS	INIT.	DATE

SCALE: N/A

DocuSigned by:

Porter Jones
2/12/2024
CADD Filename:

2/12/2024
R:\Projects\09-0983\09-0983\09-0983\09-0983_SCP_17.dgn
WJL

SPLICE ENCLOSURE FOR SIGNAL INVENTORY #09-0984 AND 09-0996 SHEET SCP 18

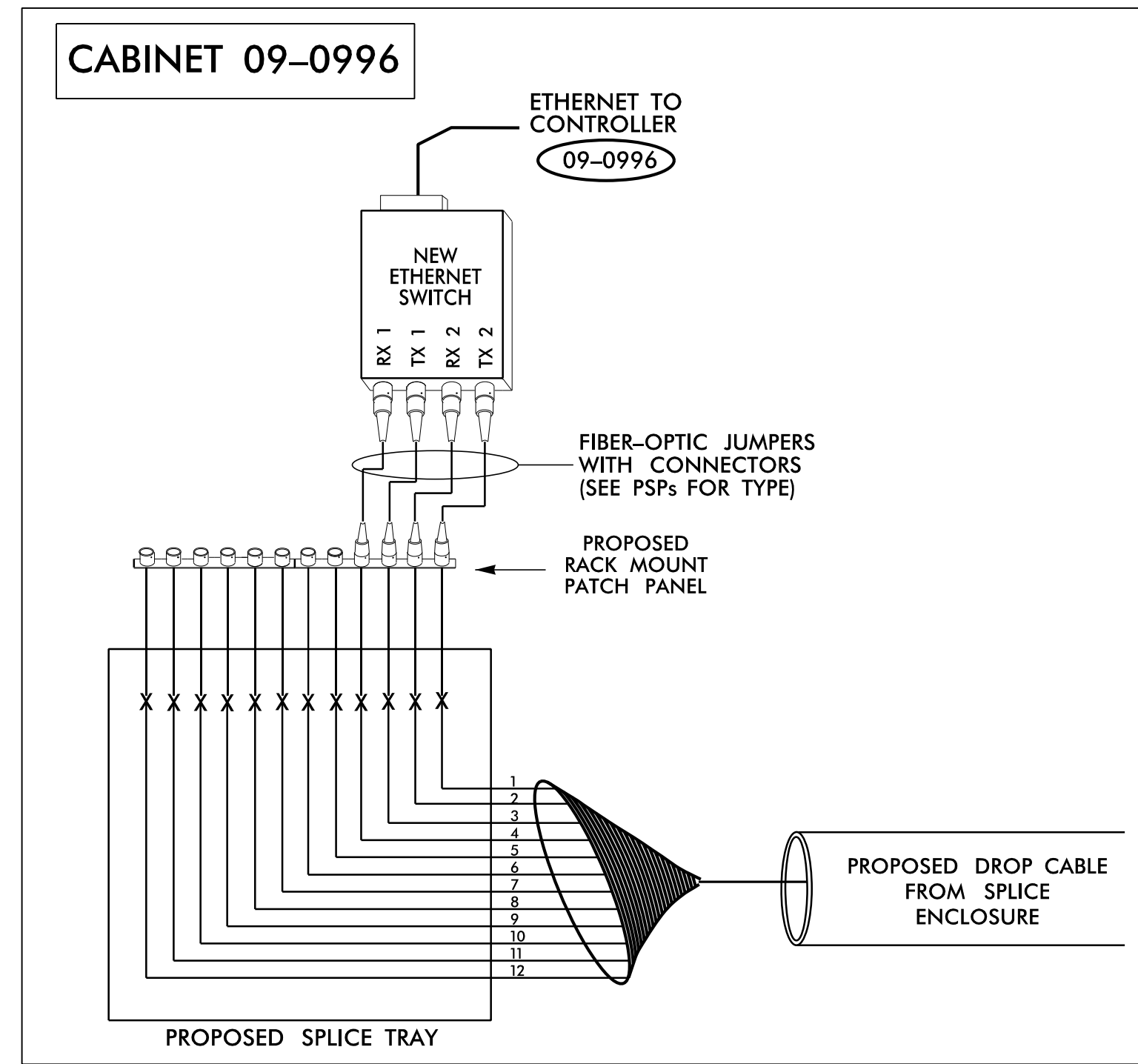
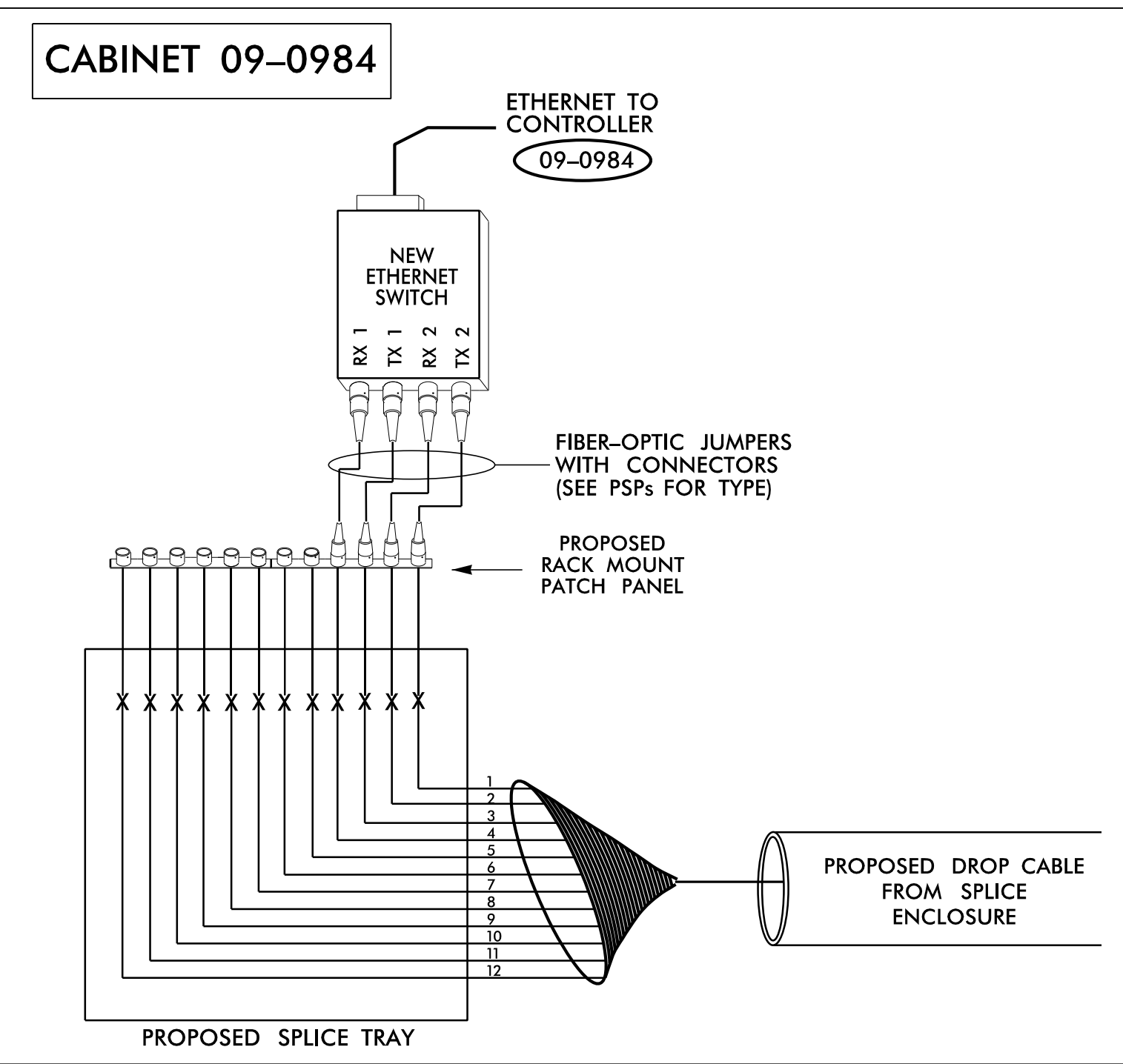
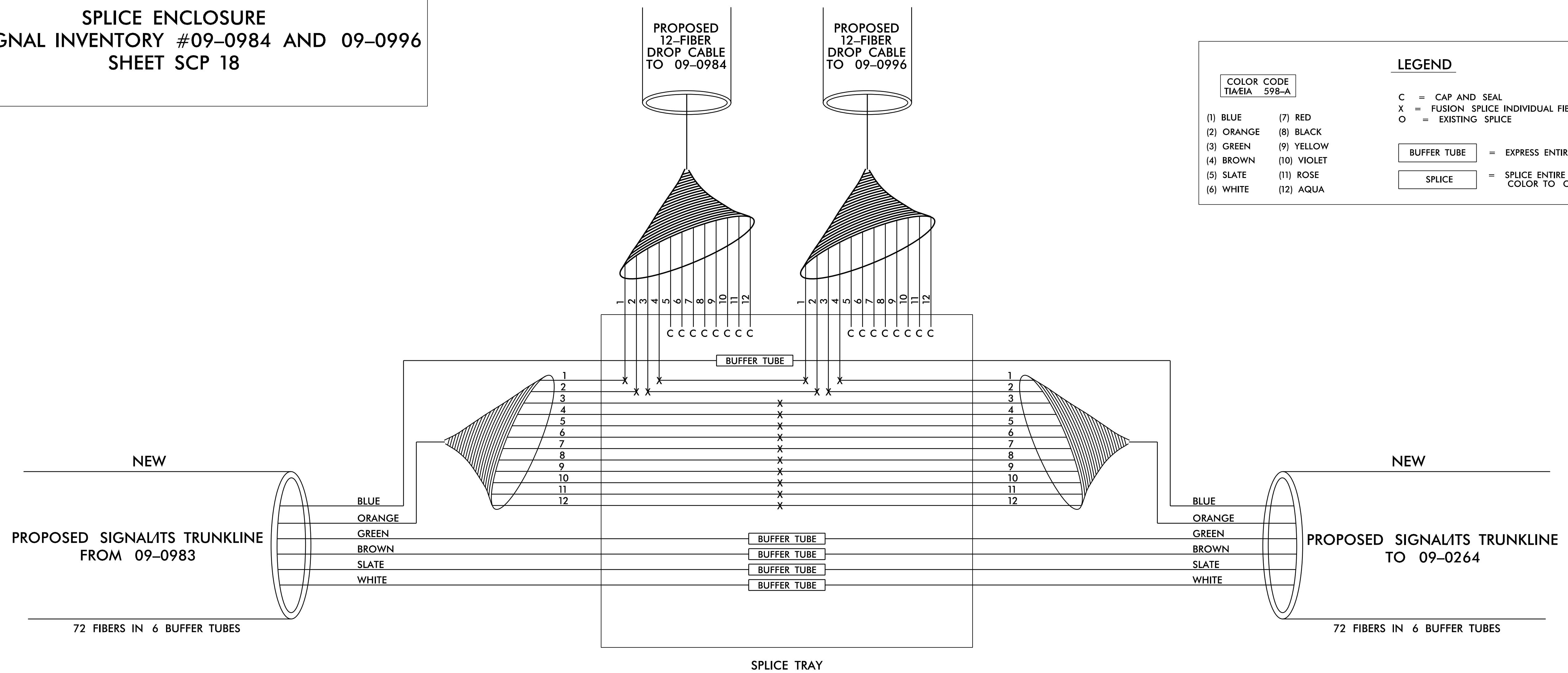
COLOR CODE TIA/EIA 598-A		LEGEND	
(1) BLUE	(7) RED	C = CAP AND SEAL	
(2) ORANGE	(8) BLACK	X = FUSION SPLICE INDIVIDUAL FIBER	
(3) GREEN	(9) YELLOW	O = EXISTING SPLICE	
(4) BROWN	(10) VIOLET	 = EXPRESS ENTIRE BUFFER TUBE	
(5) SLATE	(11) ROSE	 = SPLICE ENTIRE BUFFER TUBE COLOR TO COLOR	
(6) WHITE	(12) AQUA		



- NOTES:**
- FIBER INTERCONNECT CENTER RACKS ARE SCHEMATIC ONLY, ACTUAL EQUIPMENT FORM MAY VARY.
 - UNUSED FIBERS LEFT COILED AND STORED IN SPLICE TRAY.
 - UNUSED BUFFER TUBES LEFT COILED AND STORED IN SPLICE TRAY.
 - ETHERNET SWITCH TERMINATION CONFIGURATIONS ARE GENERIC. CONTRACTOR IS RESPONSIBLE FOR DETERMINING /ENSURING PROPER TERMINATION.
 - INCLUDE ON THE COVER OF EACH SPLICE TRAY THE FOLLOWING:
 - SPLICE
 - DATE
 - COMPANY NAME
 - NAME OF INDIVIDUAL PERFORMING THE SPLICING
- PRIOR TO INSTALLING THE COVER ON THE SPLICE TRAY, TAKE A DIGITAL PHOTOGRAPH SHOWING THE SPLICE TRAY AND INFORMATION SHOWN ABOVE (1-4) AND SUBMIT PHOTOGRAPH ALONG WITH OTDR TEST RESULTS TO THE ENGINEER.

DOCUMENT NOT CONSIDERED FINAL UNLESS ALL SIGNATURES COMPLETED

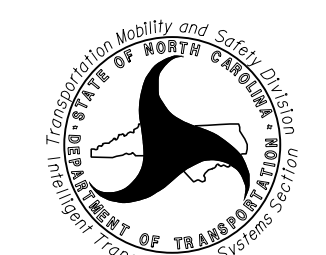
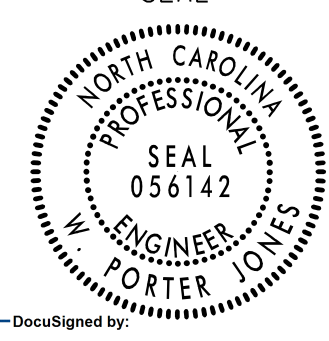
Prepared for the Offices of:  DIVISION OF TRANSPORTATION		SPLICE DETAILS		SEAL 	
750 N. Greenfield Pkwy., Garner, NC 27529		Division 09 Forsyth County Winston-Salem/Walkertown		PLANNED BY: Porter Erickson-Jones	
SCALE: N/A		PLAN DATE: February 2024		REVIEWED BY: Porter Erickson-Jones	
Engineers Construction Managers Planners Scientists www.rkk.com		PREPARED BY: Haylee Townsend		REVIEWED BY:	
Responsive People Creative Solutions		REVISIONS		INIT. DATE	
				Porter Jones 2/12/2024	
				CADD Filename:	

2/12/2024 R:\Projects\cws\gn\09-0984\09-0996\09-0984\09-0996\SCP-18_Sp11.dwg Detail: s.dgn wpl:ones

**SPLICE ENCLOSURE
FOR SIGNAL INVENTORY #09-0264 AND CCTV-2
SHEET SCP 21**

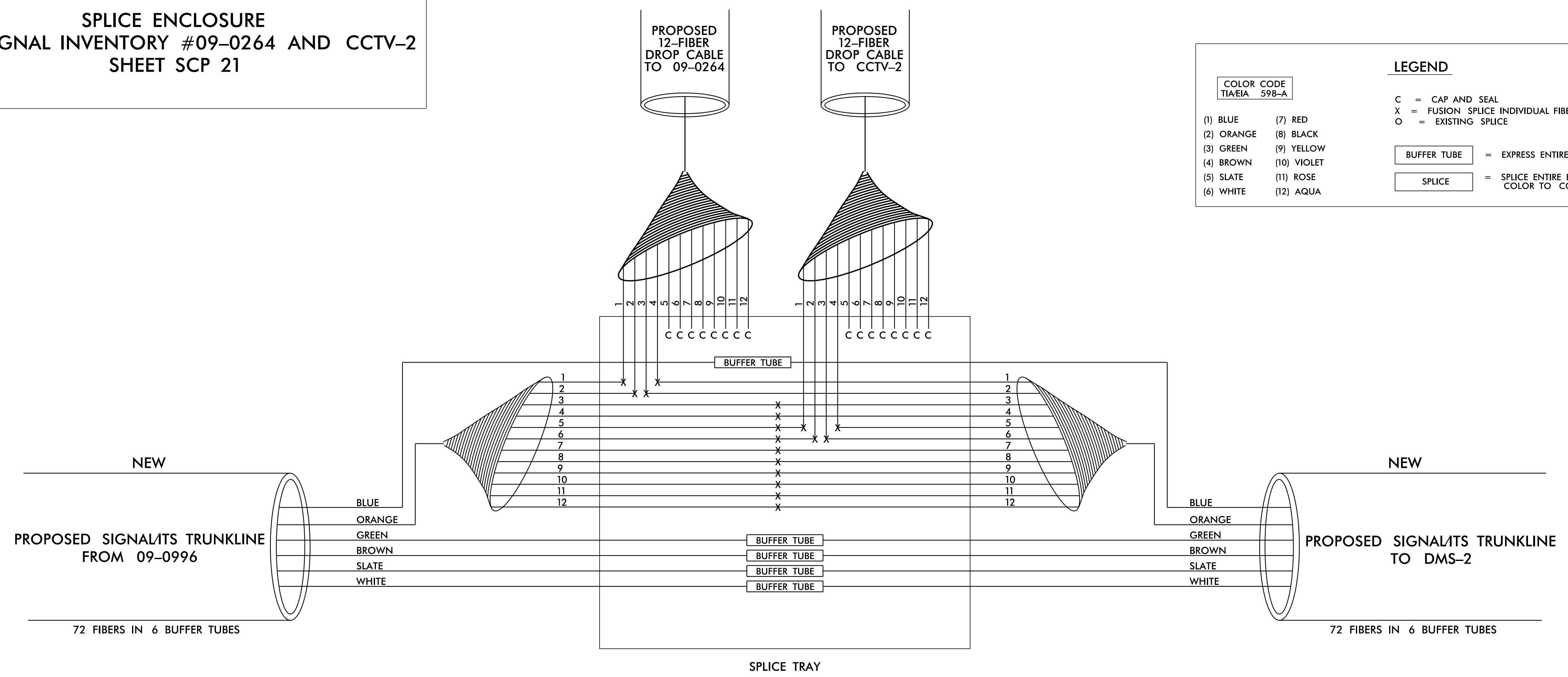

COLOR CODE
TIA/EIA 598-A

(1) BLUE	(7) RED
(2) ORANGE	(8) BLACK
(3) GREEN	(9) YELLOW
(4) BROWN	(10) VIOLET
(5) SLATE	(11) ROSE
(6) WHITE	(12) AQUA

LEGEND

C = CAP AND SEAL
X = FUSION SPLICE INDIVIDUAL FIBER
O = EXISTING SPLICE

BUFFER TUBE = EXPRESS ENTIRE BUFFER TUBE

SPLICE = SPLICE ENTIRE BUFFER TUBE COLOR TO COLOR

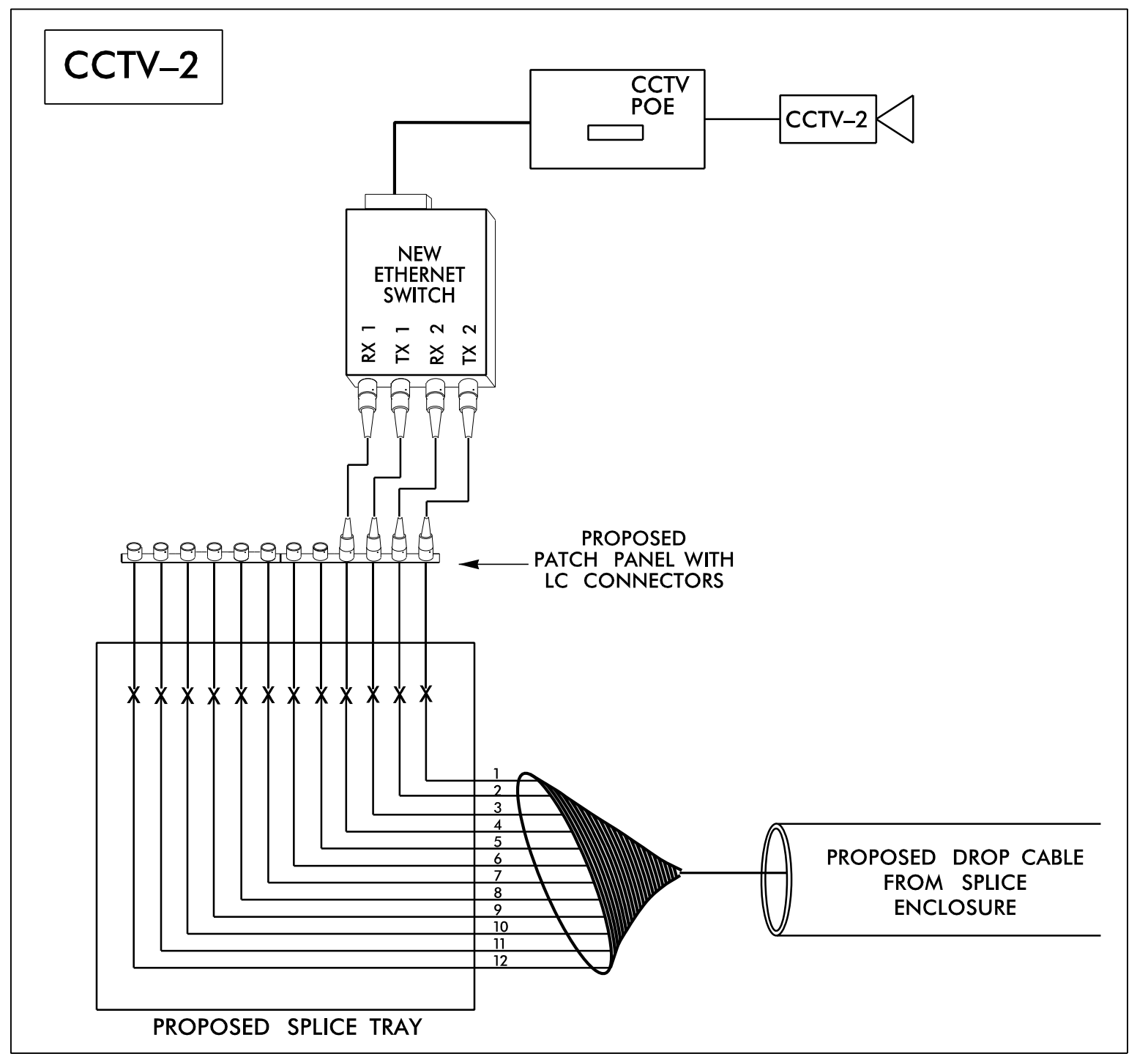
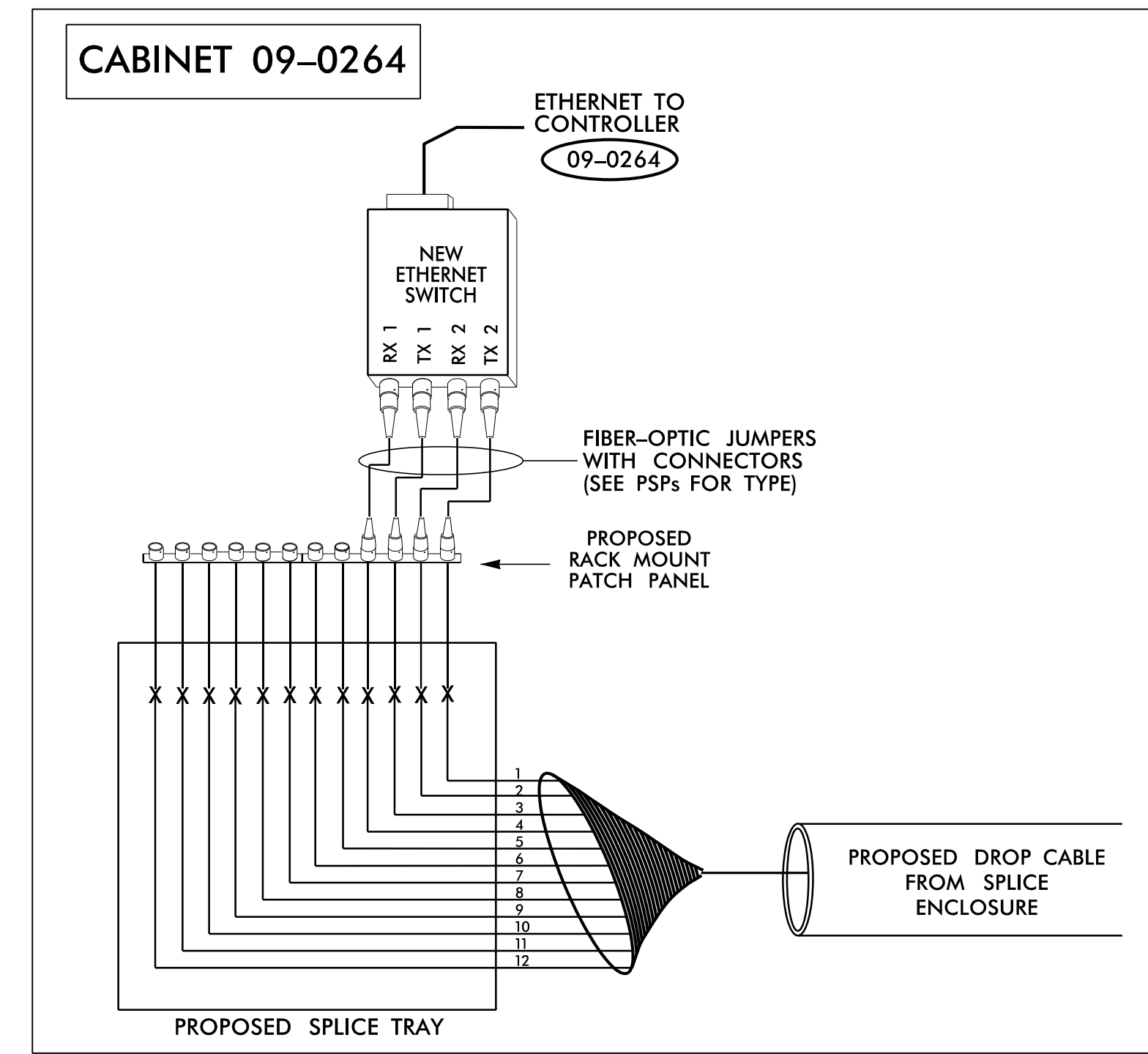

- NOTES:**
1. FIBER INTERCONNECT CENTER RACKS ARE SCHEMATIC ONLY, ACTUAL EQUIPMENT FORM MAY VARY.
 2. UNUSED FIBERS LEFT COILED AND STORED IN SPLICE TRAY.
 3. UNUSED BUFFER TUBES LEFT COILED AND STORED IN SPLICE TRAY.
 4. ETHERNET SWITCH TERMINATION CONFIGURATIONS ARE GENERIC. CONTRACTOR IS RESPONSIBLE FOR DETERMINING /ENSURING PROPER TERMINATION.
 5. INCLUDE ON THE COVER OF EACH SPLICE TRAY THE FOLLOWING:
(1) SPLICE
(2) DATE
(3) COMPANY NAME
(4) NAME OF INDIVIDUAL PERFORMING THE SPLICING
- PRIOR TO INSTALLING THE COVER ON THE SPLICE TRAY, TAKE A DIGITAL PHOTOGRAPH SHOWING THE SPLICE TRAY AND INFORMATION SHOWN ABOVE (1-4) AND SUBMIT PHOTOGRAPH ALONG WITH OTDR TEST RESULTS TO THE ENGINEER.

**DOCUMENT NOT CONSIDERED FINAL
UNLESS ALL SIGNATURES COMPLETED**

RK&K
P: (919) 878-9560
8801 Six Forks Road, Forum 1, Suite 700
Raleigh, North Carolina 27615-3960
NC License No. F-0112
www.rkk.com
Responsive People | Creative Solutions

Prepared for the Offices of:
ENGINEERING
750 N. Greenfield Pkwy., Garner, NC 27529

SPLICE DETAILS

Division 09 Forsyth County Winston-Salem/
Walkertown
PLAN DATE: February 2024 REVIEWED BY: Porter Erickson-Jones
PREPARED BY: Haylee Townsend REVIEWED BY:

SCALE: N/A

REVISIONS	INIT.	DATE

DocuSigned by:
Porter Jones
056142
2/12/2024

CADD Filename:

2/12/2024
R:\Projects\cns\gna\09-0264\09-0264-SCP-39.dwg
wplones

**SPLICE ENCLOSURE
FOR SIGNAL INVENTORY #09-0985, 09-1100,
CCTV-3 AND DMS-2
SHEET SCP 25**

FIBER OPTIC CABLE

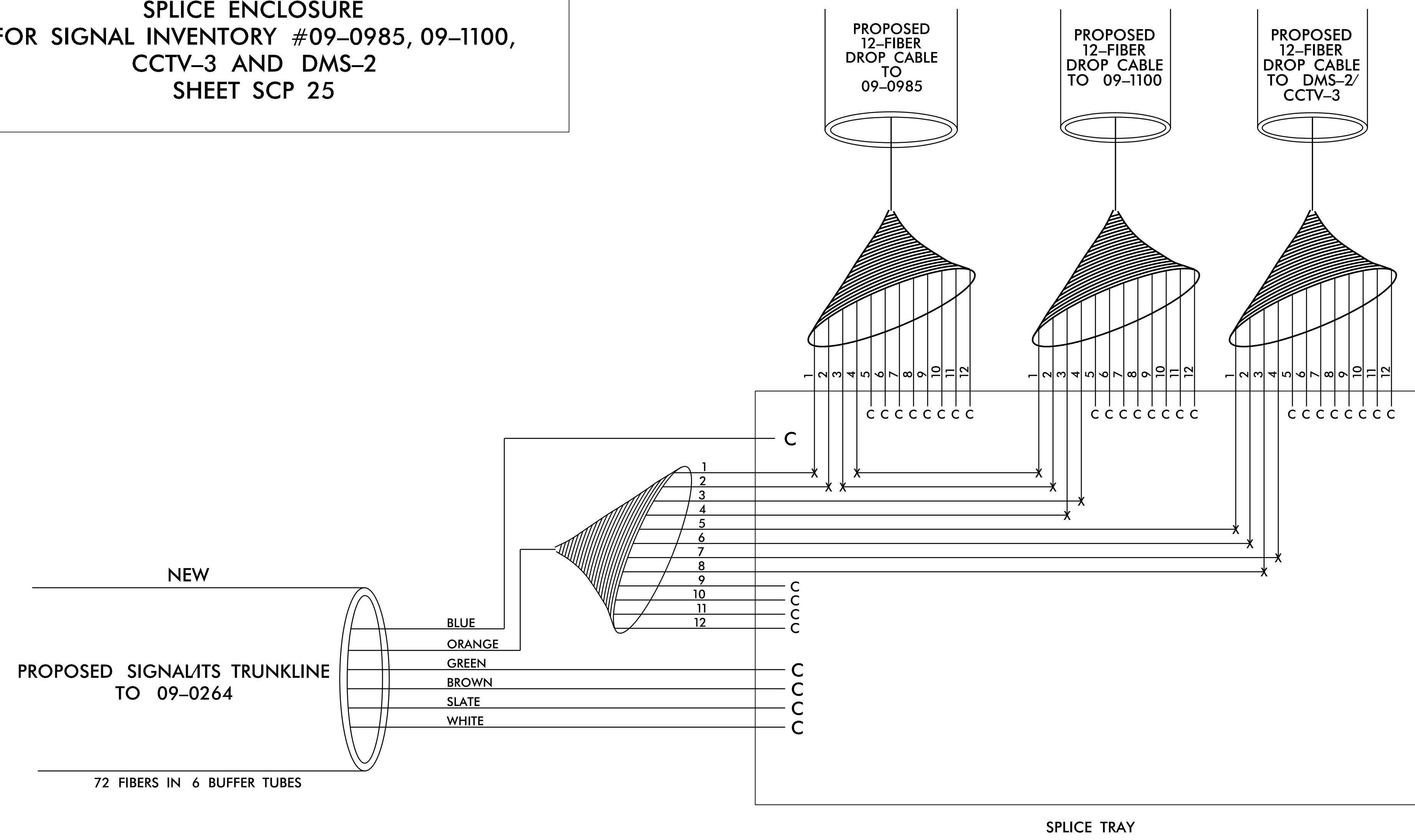

COLOR CODE
TIA/EIA 598-A

- (1) BLUE
- (2) ORANGE
- (3) GREEN
- (4) BROWN
- (5) SLATE
- (6) WHITE
- (7) RED
- (8) BLACK
- (9) YELLOW
- (10) VIOLET
- (11) ROSE
- (12) AQUA

LEGEND

- C = CAP AND SEAL
- X = FUSION SPLICE INDIVIDUAL FIBER
- O = EXISTING SPLICE
- BUFFER TUBE = EXPRESS ENTIRE BUFFER TUBE
- SPLICE = SPLICE ENTIRE BUFFER TUBE COLOR TO COLOR

NOTES:

1. FIBER INTERCONNECT CENTER RACKS ARE SCHEMATIC ONLY, ACTUAL EQUIPMENT FORM MAY VARY.
 2. UNUSED FIBERS LEFT COILED AND STORED IN SPLICE TRAY.
 3. UNUSED BUFFER TUBES LEFT COILED AND STORED IN SPLICE TRAY.
 4. ETHERNET SWITCH TERMINATION CONFIGURATIONS ARE GENERIC. CONTRACTOR IS RESPONSIBLE FOR DETERMINING /ENSURING PROPER TERMINATION.
 5. INCLUDE ON THE COVER OF EACH SPLICE TRAY THE FOLLOWING:
 - (1) SPLICE
 - (2) DATE
 - (3) COMPANY NAME
 - (4) NAME OF INDIVIDUAL PERFORMING THE SPLICING
- PRIOR TO INSTALLING THE COVER ON THE SPLICE TRAY, TAKE A DIGITAL PHOTOGRAPH SHOWING THE SPLICE TRAY AND INFORMATION SHOWN ABOVE (1-4) AND SUBMIT PHOTOGRAPH ALONG WITH OTDR TEST RESULTS TO THE ENGINEER.

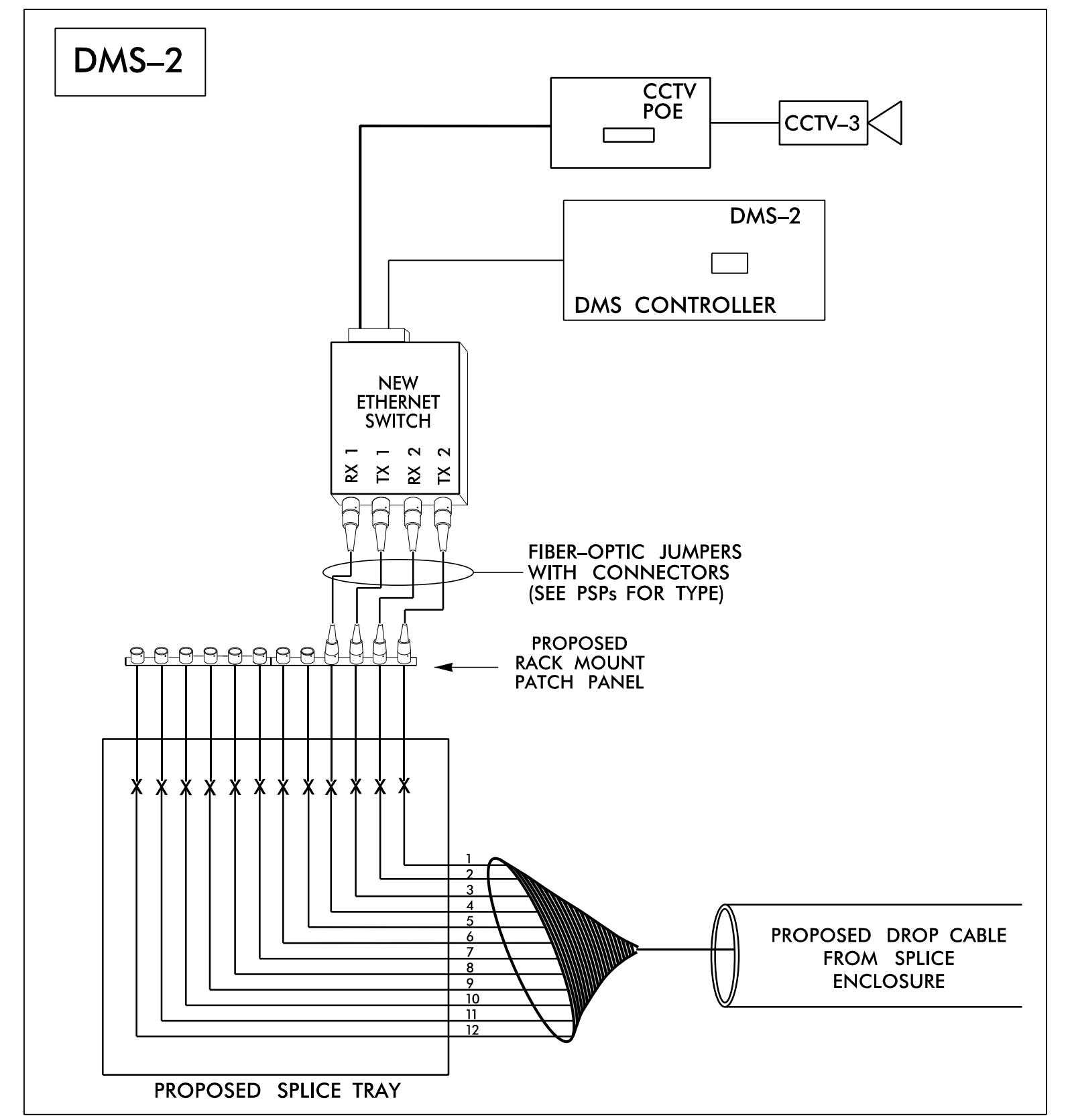
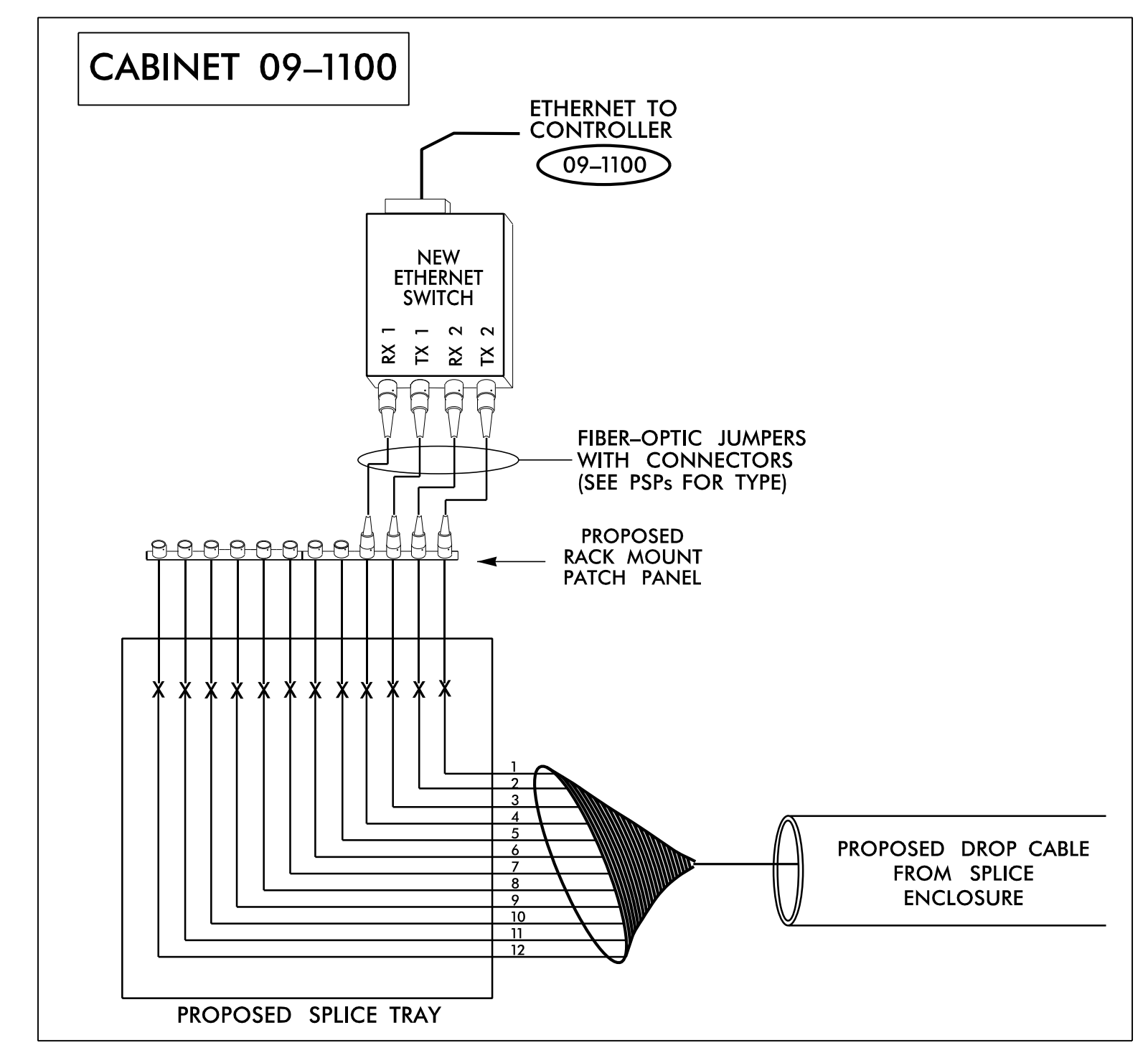
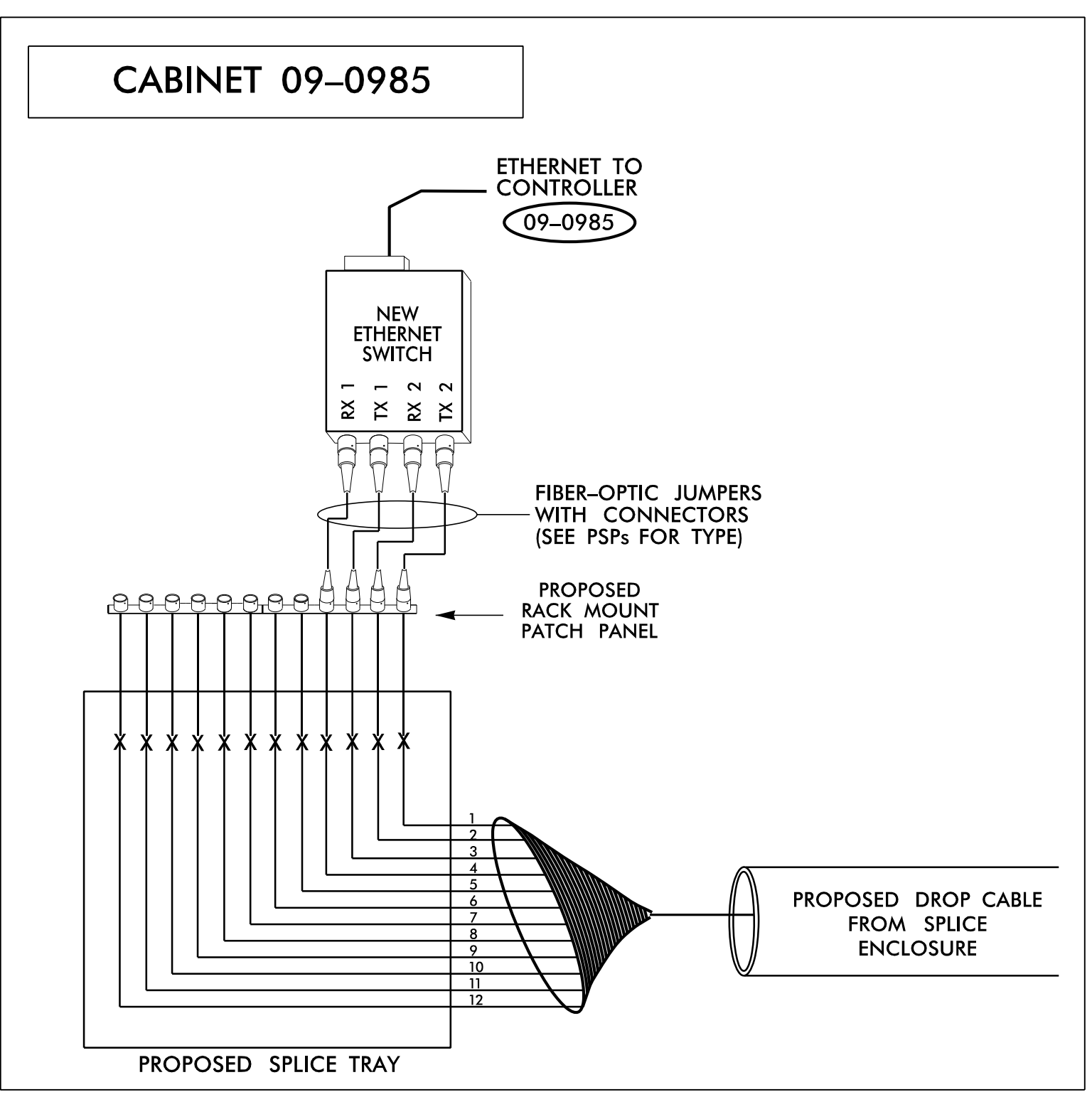

**DOCUMENT NOT CONSIDERED FINAL
UNLESS ALL SIGNATURES COMPLETED**

<p><i>Prepared for the Offices of:</i></p> <p>750 N. Greenfield Pkwy., Garner, NC 27529</p> <p>SCALE: N/A</p>	<h2>SPLICE DETAILS</h2>		<p>SEAL</p>									
	<p>Division 09 Forsyth County Winston-Salem/ Walkertown</p> <p>PLAN DATE: February 2024 REVIEWED BY: Porter Erickson-Jones</p> <p>PREPARED BY: Haylee Townsend REVIEWED BY:</p>		<p>DocuSigned by: Porter Jones 2/12/2024</p>									
	<table border="1" style="width: 100%; border-collapse: collapse;"> <thead> <tr> <th>REVISIONS</th> <th>INIT.</th> <th>DATE</th> </tr> </thead> <tbody> <tr> <td> </td> <td> </td> <td> </td> </tr> <tr> <td> </td> <td> </td> <td> </td> </tr> </tbody> </table>			REVISIONS	INIT.	DATE						
REVISIONS	INIT.	DATE										

P: (919) 878-9560
 8801 Six Forks Road, Forum 1, Suite 700
 Raleigh, North Carolina 27615-3960
 NC License No. F-0112
 Engineers | Construction Managers | Planners | Scientists
 www.rkk.com
 Responsive People | Creative Solutions

2/12/2024
 R:\Projects\09-0985\09-1100\09-0985\09-0985\09-0985_SCP-25.dgn
 WPL:ones

FIBER OPTIC CABLE

MODIFIED SPLICE ENCLOSURE
FOR EXISTING CCTV
SHEET SCP 26

COLOR CODE
TIA/EIA 598-A

(1) BLUE	(7) RED
(2) ORANGE	(8) BLACK
(3) GREEN	(9) YELLOW
(4) BROWN	(10) VIOLET
(5) SLATE	(11) ROSE
(6) WHITE	(12) AQUA

LEGEND

C = CAP AND SEAL
X = FUSION SPLICE INDIVIDUAL FIBER
O = EXISTING SPLICE

BUFFER TUBE = EXPRESS ENTIRE BUFFER TUBE

SPLICE = SPLICE ENTIRE BUFFER TUBE COLOR TO COLOR

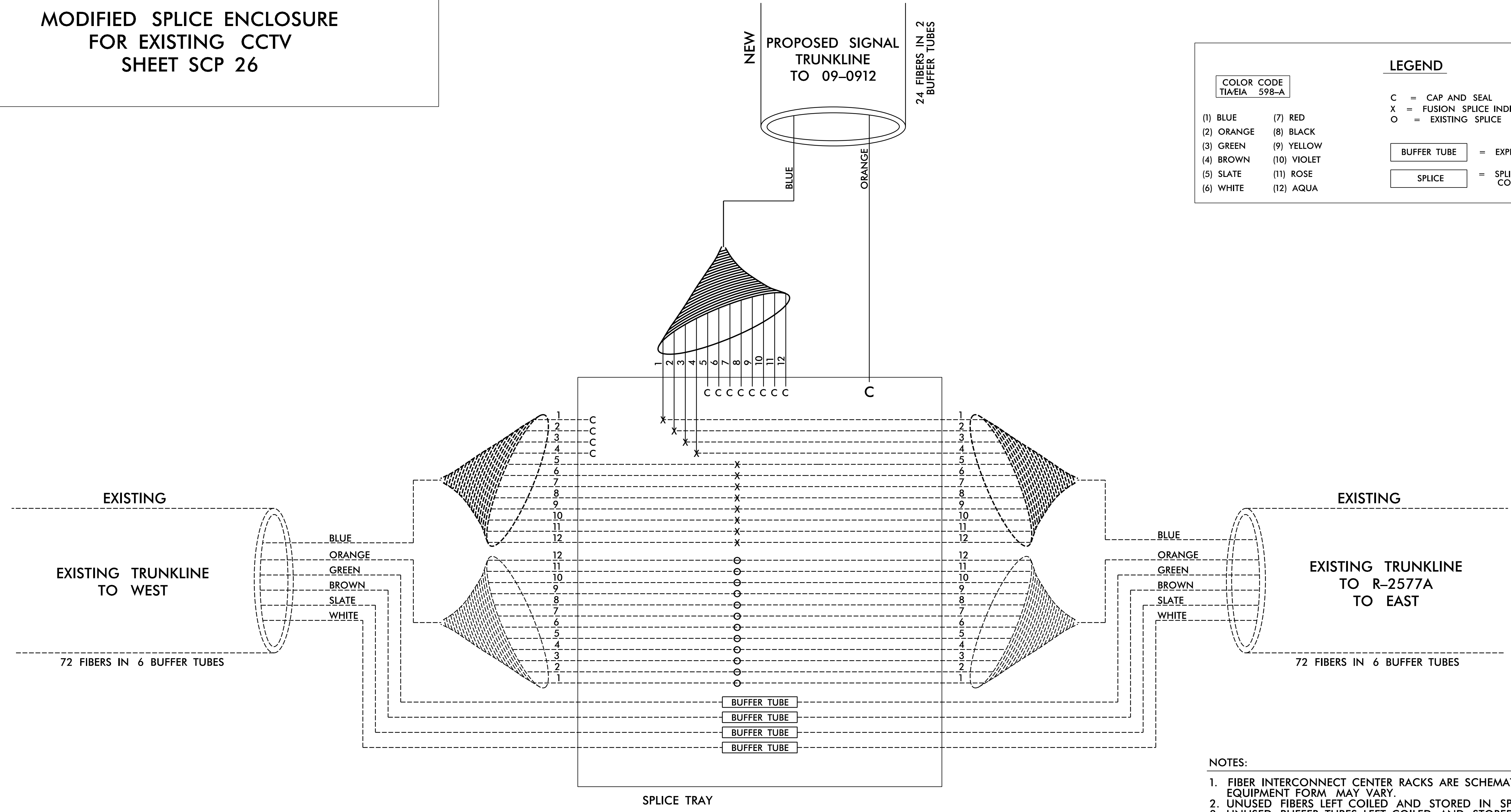

- NOTES:**
- FIBER INTERCONNECT CENTER RACKS ARE SCHEMATIC ONLY, ACTUAL EQUIPMENT FORM MAY VARY.
 - UNUSED FIBERS LEFT COILED AND STORED IN SPLICE TRAY.
 - UNUSED BUFFER TUBES LEFT COILED AND STORED IN SPLICE TRAY.
 - ETHERNET SWITCH TERMINATION CONFIGURATIONS ARE GENERIC. CONTRACTOR IS RESPONSIBLE FOR DETERMINING /ENSURING PROPER TERMINATION.
 - INCLUDE ON THE COVER OF EACH SPLICE TRAY THE FOLLOWING:
 - SPLICE
 - DATE
 - COMPANY NAME
 - NAME OF INDIVIDUAL PERFORMING THE SPLICING
- PRIOR TO INSTALLING THE COVER ON THE SPLICE TRAY, TAKE A DIGITAL PHOTOGRAPH SHOWING THE SPLICE TRAY AND INFORMATION SHOWN ABOVE (1-4) AND SUBMIT PHOTOGRAPH ALONG WITH OTDR TEST RESULTS TO THE ENGINEER.

**DOCUMENT NOT CONSIDERED FINAL
UNLESS ALL SIGNATURES COMPLETED**

Prepared for the Offices of:
THE STATE OF NORTH CAROLINA
DEPARTMENT OF TRANSPORTATION

SPLICE DETAILS

Division 09 Forsyth County Winston-Salem/
Walkertown

PLAN DATE: February 2024 REVIEWED BY: Porter Erickson-Jones

PREPARED BY: Haylee Townsend REVIEWED BY:

REVISIONS	INIT.	DATE

SCALE: N/A

750 N. Greenfield Pkwy., Garner, NC 27529

SEAL
NORTH CAROLINA
PROFESSIONAL
ENGINEER
SEAL
056142
W. PORTER JONES

DocuSigned by:
Porter Jones
2/12/2024

CADD Filename:

RK&K
P: (919) 878-9560
8801 Six Forks Road, Forum 1, Suite 700
Raleigh, North Carolina 27615-3960
NC License No. F-0112

Engineers | Construction Managers | Planners | Scientists
www.rkk.com

Responsive People | Creative Solutions

2/12/2024
R:\Projects\cns\gna\is\40as\gna\is\45CP\W2577A_SCP_11ce_Detail1.scdgn
wplones

FIBER OPTIC CABLE

MODIFIED SPLICE ENCLOSURE
FOR SIGNAL INVENTORY 09-0912
SHEET SCP 26

COLOR CODE
TIA/EIA 598-A

- (1) BLUE (7) RED
- (2) ORANGE (8) BLACK
- (3) GREEN (9) YELLOW
- (4) BROWN (10) VIOLET
- (5) SLATE (11) ROSE
- (6) WHITE (12) AQUA

LEGEND

- C = CAP AND SEAL
- X = FUSION SPLICE INDIVIDUAL FIBER
- O = EXISTING SPLICE

BUFFER TUBE = EXPRESS ENTIRE BUFFER TUBE

SPLICE = SPLICE ENTIRE BUFFER TUBE COLOR TO COLOR

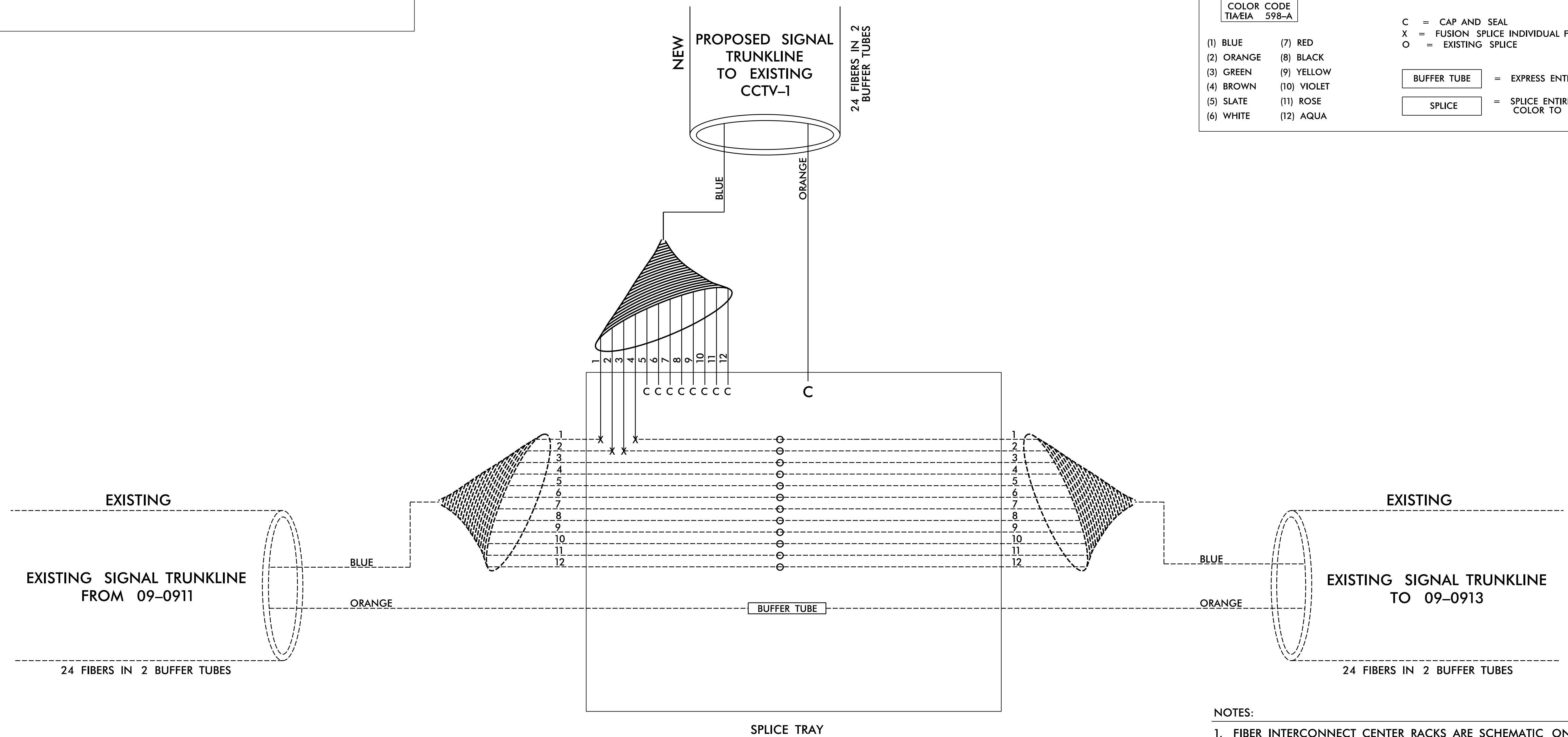

NOTES:

1. FIBER INTERCONNECT CENTER RACKS ARE SCHEMATIC ONLY, ACTUAL EQUIPMENT FORM MAY VARY.
2. UNUSED FIBERS LEFT COILED AND STORED IN SPLICE TRAY.
3. UNUSED BUFFER TUBES LEFT COILED AND STORED IN SPLICE TRAY.
4. ETHERNET SWITCH TERMINATION CONFIGURATIONS ARE GENERIC. CONTRACTOR IS RESPONSIBLE FOR DETERMINING /ENSURING PROPER TERMINATION.
5. INCLUDE ON THE COVER OF EACH SPLICE TRAY THE FOLLOWING:
 - (1) SPLICE
 - (2) DATE
 - (3) COMPANY NAME
 - (4) NAME OF INDIVIDUAL PERFORMING THE SPLICING

PRIOR TO INSTALLING THE COVER ON THE SPLICE TRAY, TAKE A DIGITAL PHOTOGRAPH SHOWING THE SPLICE TRAY AND INFORMATION SHOWN ABOVE (1-4) AND SUBMIT PHOTOGRAPH ALONG WITH OTDR TEST RESULTS TO THE ENGINEER.

**DOCUMENT NOT CONSIDERED FINAL
UNLESS ALL SIGNATURES COMPLETED**

RK&K
P: (919) 878-9560
8801 Six Forks Road, Forum 1, Suite 700
Raleigh, North Carolina 27615-3960
NC License No. F-0112
www.rkk.com
Responsive People | Creative Solutions

Prepared for the Offices of:
TRANSPORTATION
750 N. Greenfield Pkwy., Garner, NC 27529

SPLICE DETAILS
Division 09 Forsyth County Winston-Salem/
Walkertown
PLAN DATE: February 2024 REVIEWED BY: Porter Erickson-Jones
PREPARED BY: Haylee Townsend REVIEWED BY:

REVISIONS	INIT.	DATE

SCALE: N/A

SEAL
NORTH CAROLINA
PROFESSIONAL
ENGINEER
PORTER
JONES
2/12/2024
DATE
CADD Filename:

2/12/2024 R:\Projects\cns\gna\is\40as\gna\is\40cp\2577A_SCP_Spl1.cdw Detail1.s.dgn wplones

MODIFIED HUB CABINET AT NC 74 AND US 421/40 BUS SHEET SCP 27

EXISTING HUB CABINET

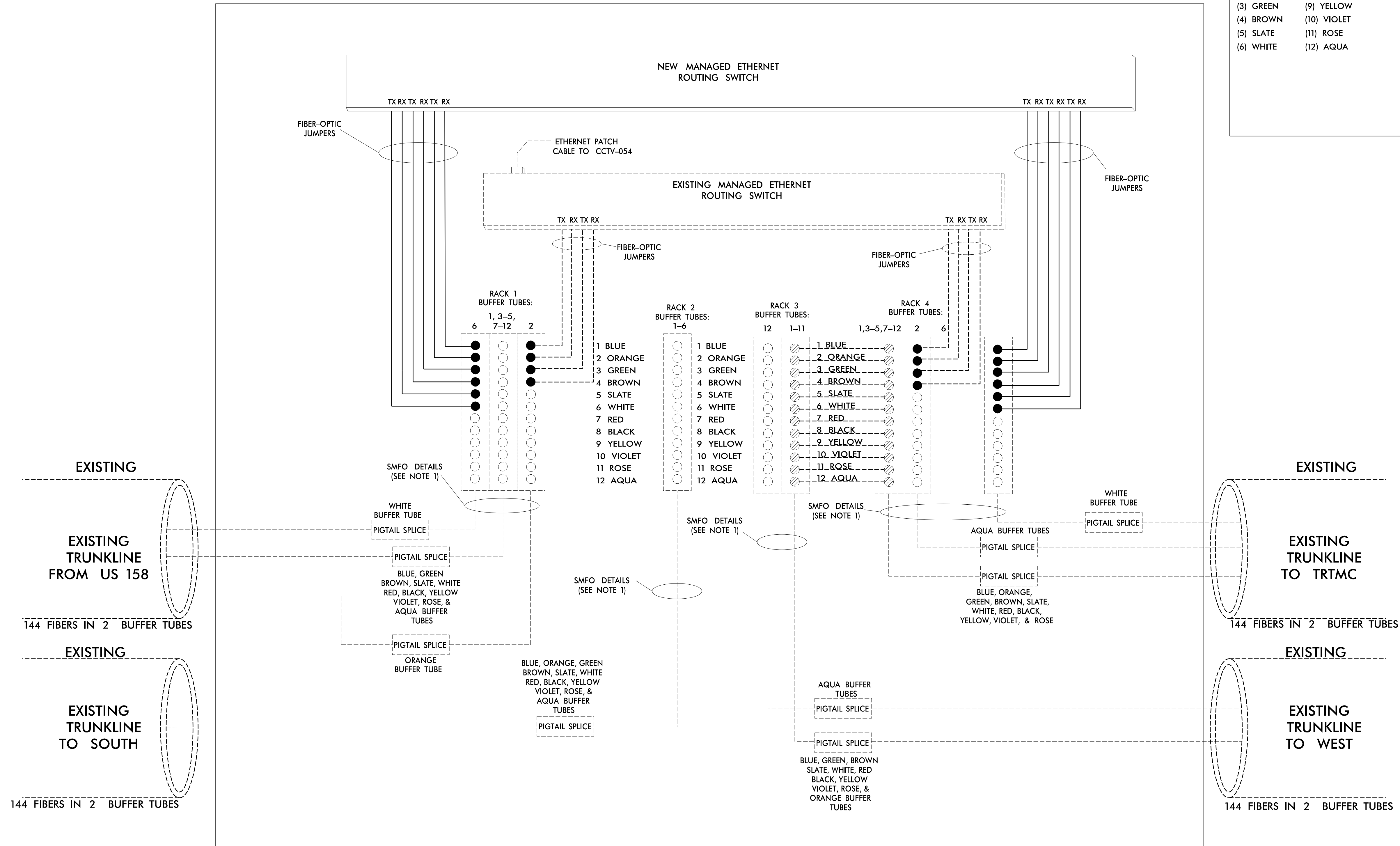

COLOR CODE
TIA/EIA 598-A

(1) BLUE	(7) RED
(2) ORANGE	(8) BLACK
(3) GREEN	(9) YELLOW
(4) BROWN	(10) VIOLET
(5) SLATE	(11) ROSE
(6) WHITE	(12) AQUA

LEGEND

- C = CAP AND SEAL
- X = FUSION SPLICE INDIVIDUAL FIBER
- O = EXISTING SPLICE
- = FIBERS IN USE
- = FIBERS NOT IN USE
- ⊗ = FIBERS USE UNKNOWN

BUFFER TUBE = EXPRESS ENTIRE BUFFER TUBE
SPLICE = SPLICE ENTIRE BUFFER TUBE COLOR TO COLOR

NOTES:

1. FIBER INTERCONNECT CENTER RACKS ARE SCHEMATIC ONLY, ACTUAL EQUIPMENT FORM MAY VARY.
2. UNUSED FIBERS LEFT COILED AND STORED IN SPLICE TRAY.
3. UNUSED BUFFER TUBES LEFT COILED AND STORED IN SPLICE TRAY.
4. ETHERNET SWITCH TERMINATION CONFIGURATIONS ARE GENERIC. CONTRACTOR IS RESPONSIBLE FOR DETERMINING /ENSURING PROPER TERMINATION.

DOCUMENT NOT CONSIDERED FINAL UNLESS ALL SIGNATURES COMPLETED

Prepared for the Offices of:

250 N. Greenfield Pkwy., Garner, NC 27529

SCALE: N/A

SPLICE DETAILS

Division 09 Forsyth County Winston-Salem/Walkertown

PLAN DATE: February 2024 REVIEWED BY: Porter Erickson-Jones

PREPARED BY: Haylee Townsend REVIEWED BY:

REVISIONS	INIT.	DATE

SEAL

DocuSigned by:
Porter Jones
2/12/2024

CADD Filename:

RKK
P: (919) 878-9560
8801 Six Forks Road, Forum 1, Suite 700
Raleigh, North Carolina 27615-3960
NC License No. F-0112

Engineers | Construction Managers | Planners | Scientists
www.rkk.com

Responsive People | Creative Solutions

2/12/2024 R:\Projects\cns\gn\40as\gn\40as\40SCP\2577A_SCP_1.dwg Detail s.dgn wpl Jones