



SECTION 0-0

3/7/2024  
 R-2577A\_tmp\_psh34B.dgn  
 Kolsby

APPROVED:  DATE: 3/7/2024 SEAL 		<p style="text-align: center;">PHASE I - STEP 4</p>
<p style="text-align: center;"><b>DOCUMENT NOT CONSIDERED FINAL UNLESS ALL SIGNATURES COMPLETED</b></p>		

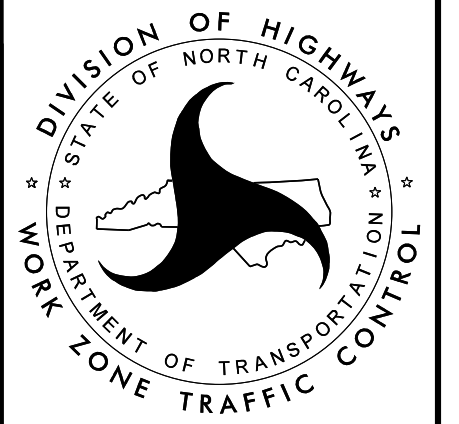
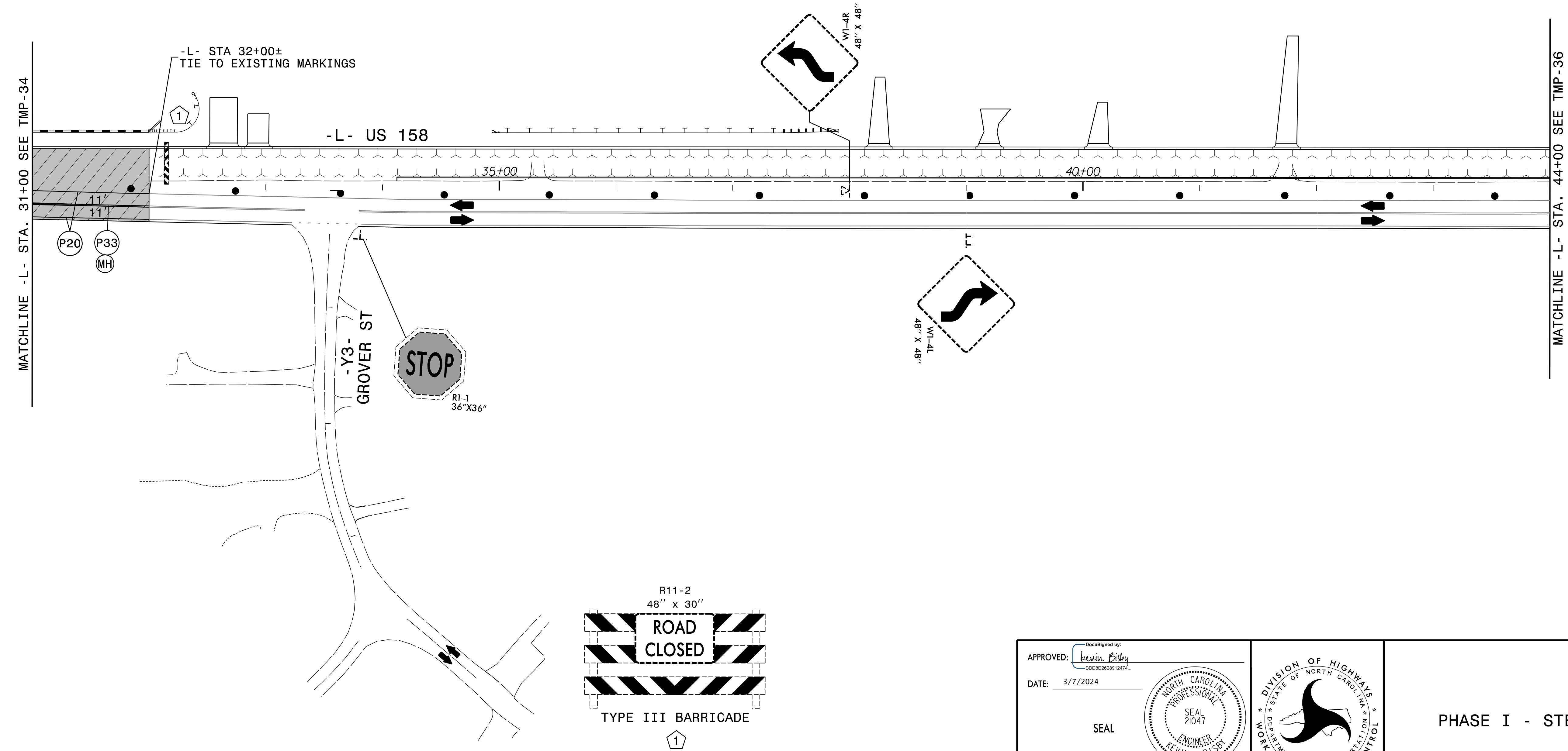
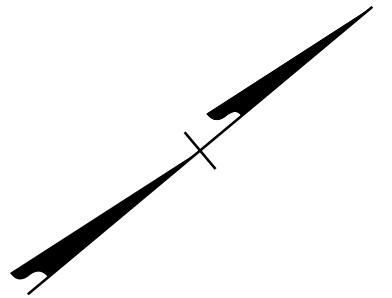

3/7/2024  
 R-2577A\_tmp\_psh35.dgn  
 K. Bishby

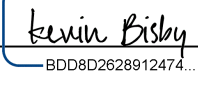
APPROVED:   
 DATE: 3/7/2024

SEAL

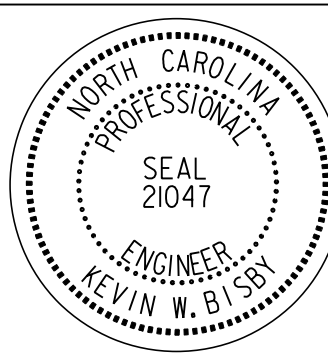
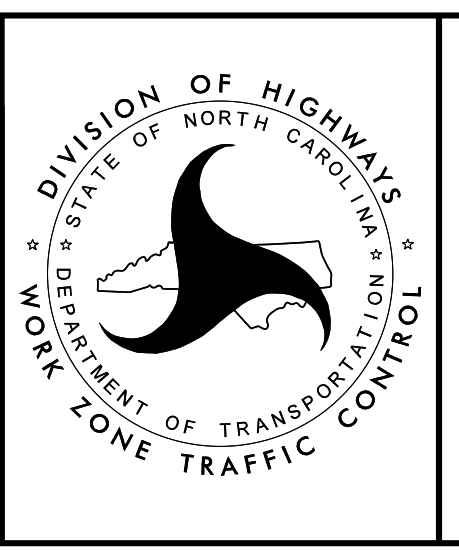
PHASE I - STEP 4

DOCUMENT NOT CONSIDERED FINAL  
 UNLESS ALL SIGNATURES COMPLETED

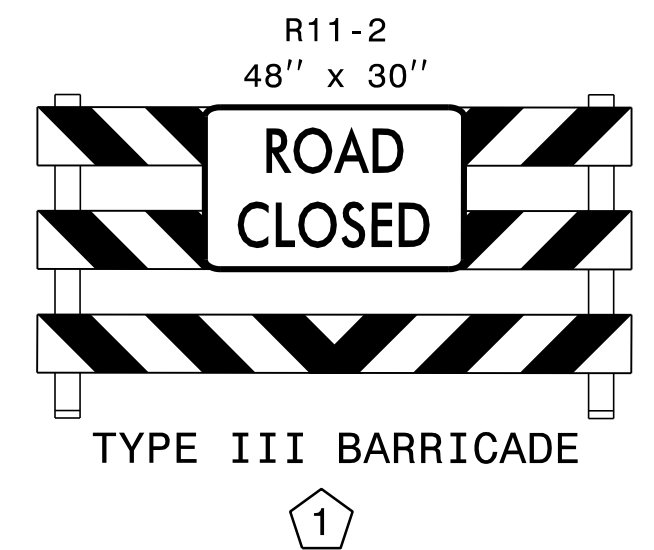
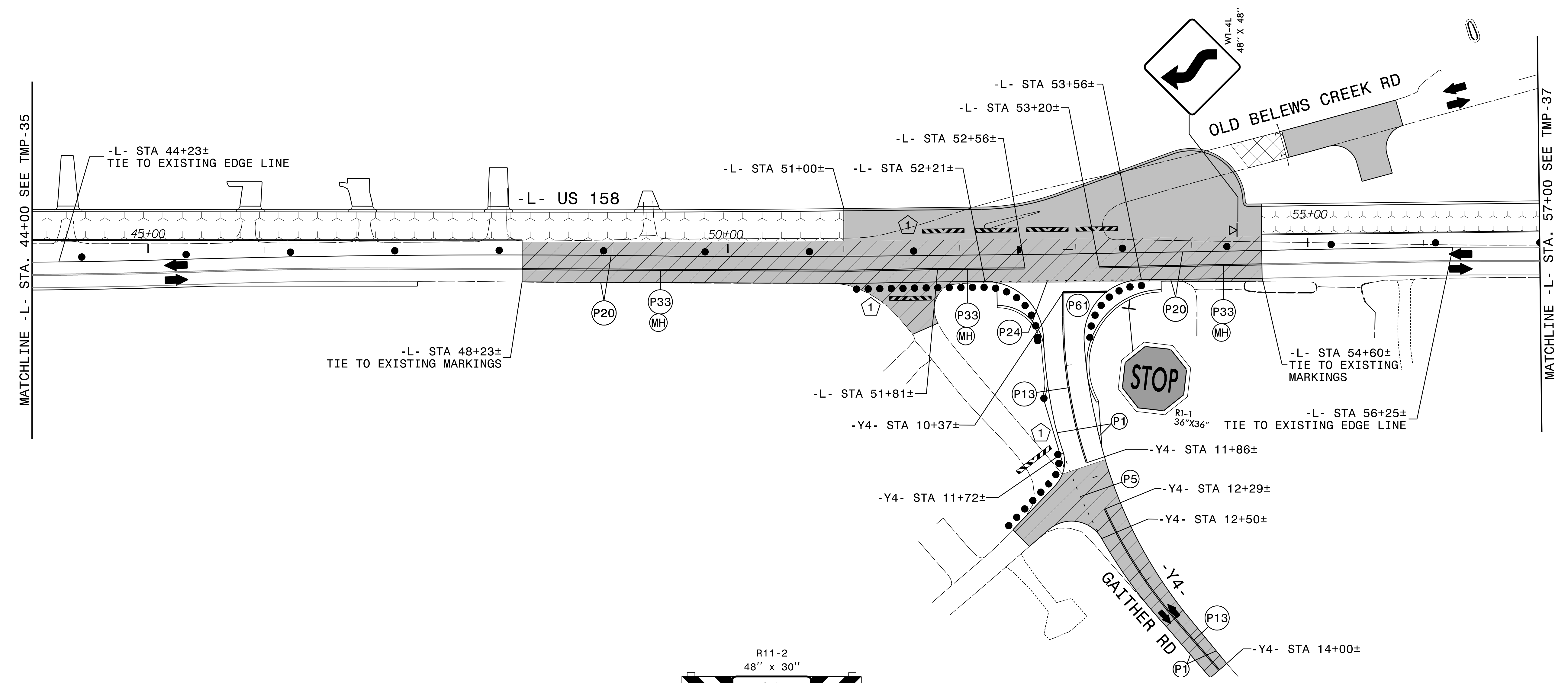
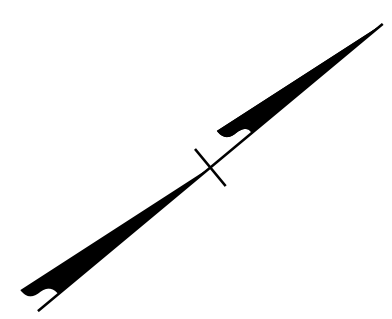

11' LANES

APPROVED: *Kevin Bishy*  
 DATE: 3/7/2024

SEAL

**DOCUMENT NOT CONSIDERED FINAL  
 UNLESS ALL SIGNATURES COMPLETED**

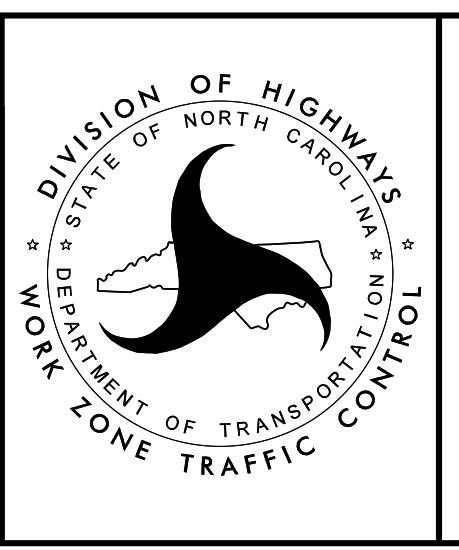

PHASE I - STEP 4

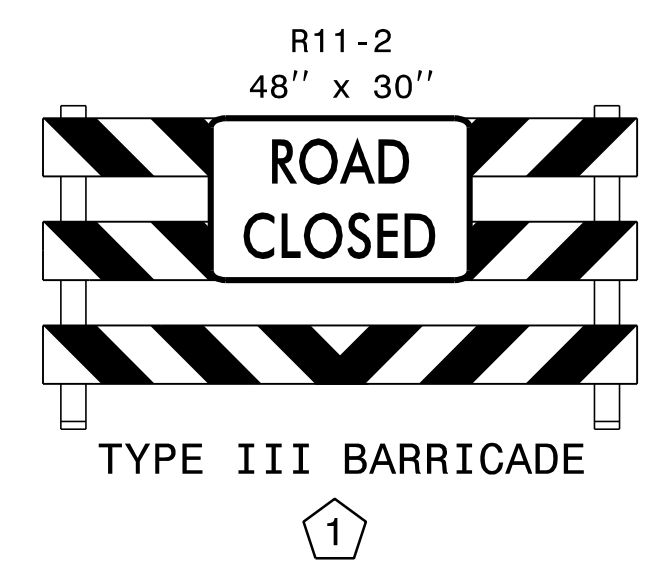
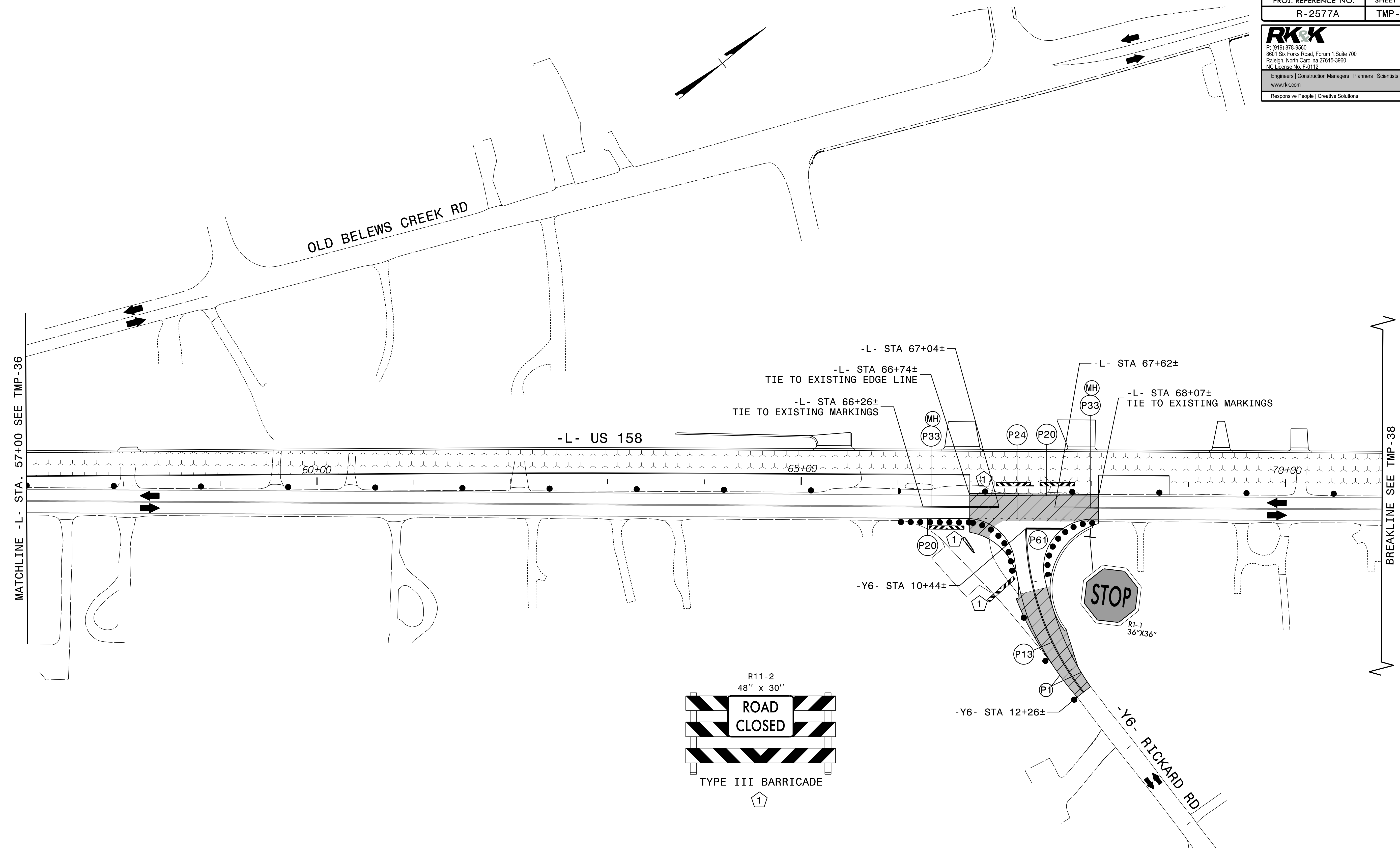

3/7/2024  
 R-2577A\_tmp\_psh37.dgn  
 KRobby

APPROVED: *Kevin Bishy*  
 DATE: 3/7/2024

SEAL

DOCUMENT NOT CONSIDERED FINAL  
 UNLESS ALL SIGNATURES COMPLETED

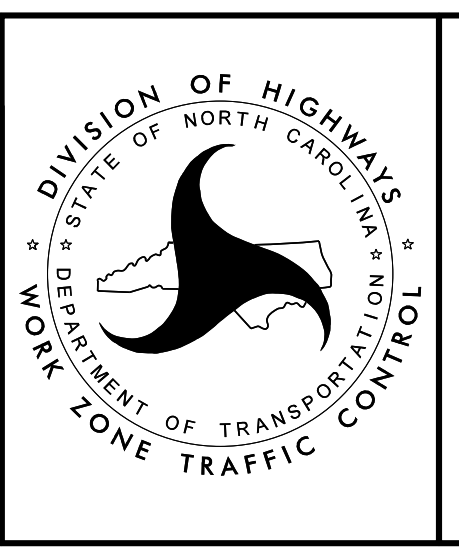

DIVISION OF HIGHWAYS  
 STATE OF NORTH CAROLINA  
 DEPARTMENT OF TRANSPORTATION  
 WORK ZONE TRAFFIC CONTROL

PHASE I - STEP 4

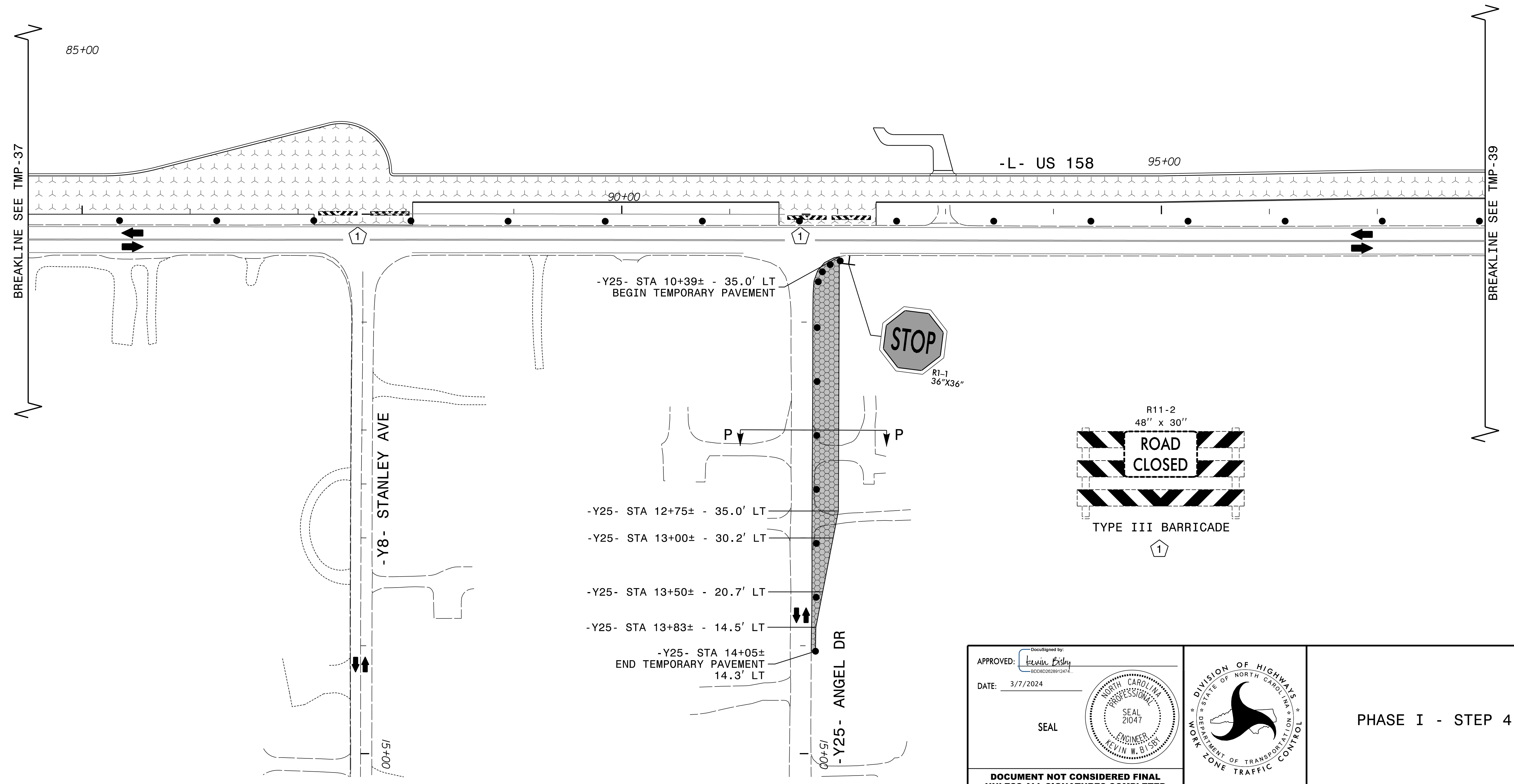
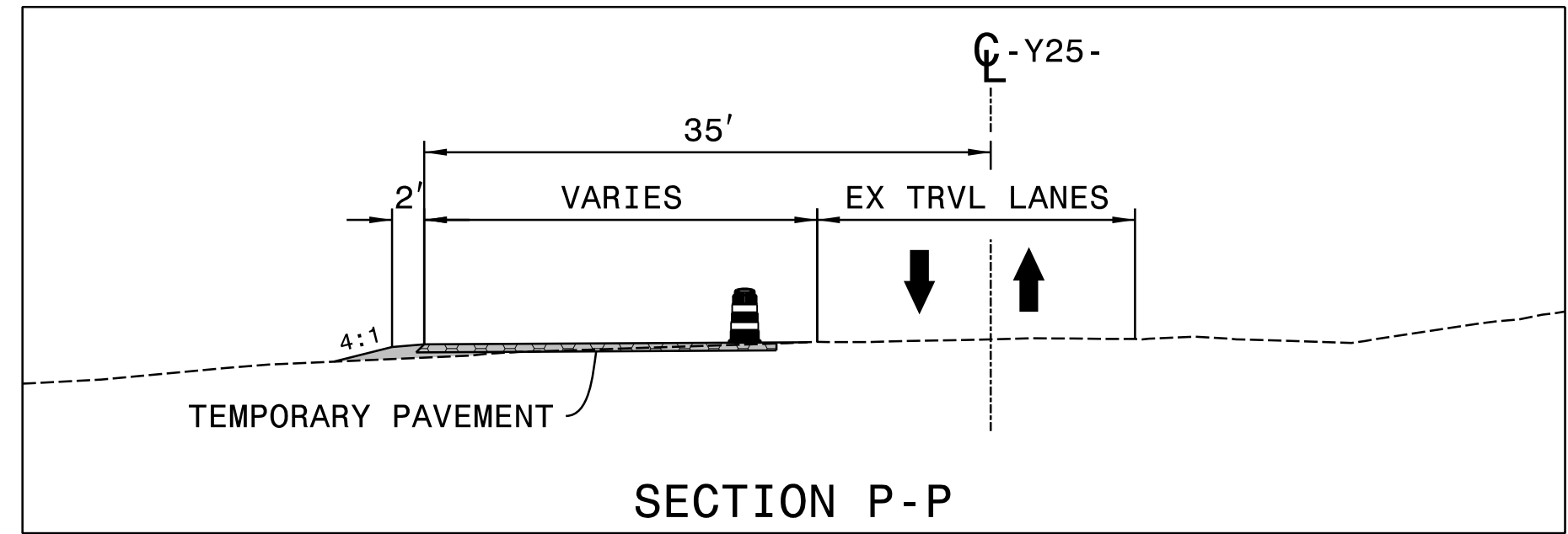
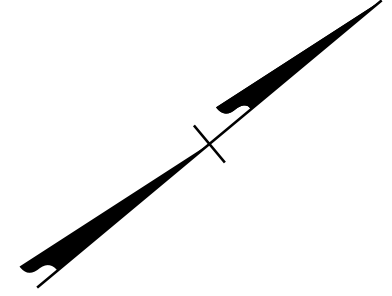

3/7/2024  
 R-2577A\_tmp\_psh38.dgn  
 KRobby

APPROVED: *Kevin Bisby*  
 DATE: 3/7/2024

SEAL

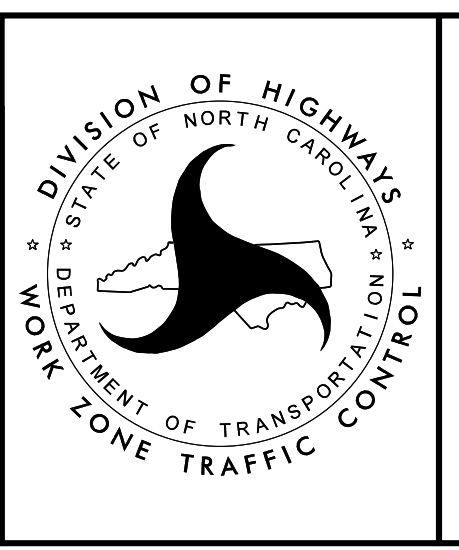

PHASE I - STEP 4

DOCUMENT NOT CONSIDERED FINAL  
 UNLESS ALL SIGNATURES COMPLETED

PROJ. REFERENCE NO.	SHEET NO.
R-2577A	TMP-39

**RKK**  
 P: (919) 878-8560  
 8601 Six Forks Road, Forum 1, Suite 700  
 Raleigh, North Carolina 27615-3960  
 NC License No. F-0112  
 Engineers | Construction Managers | Planners | Scientists  
 www.rkk.com  
 Responsive People | Creative Solutions

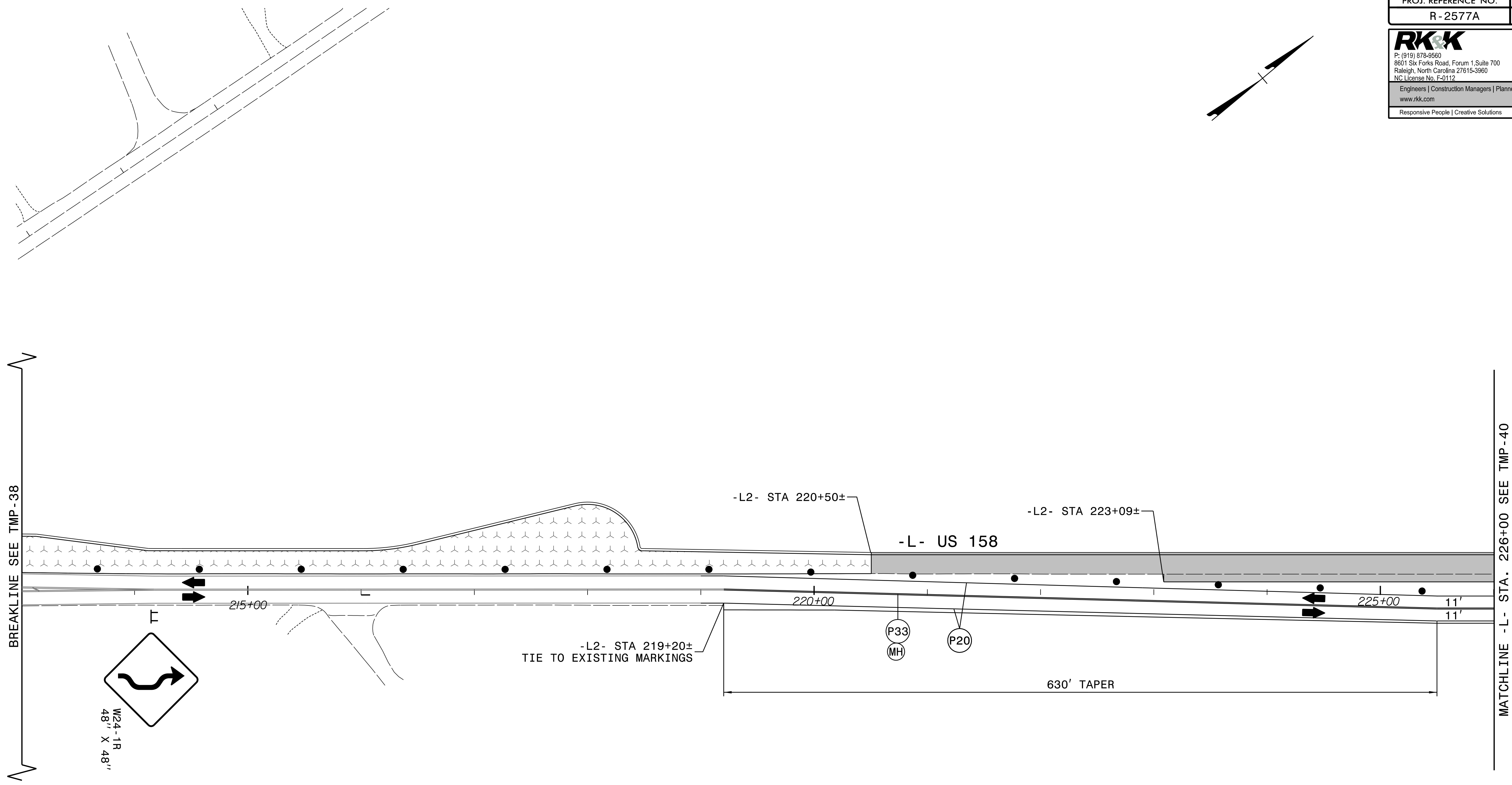
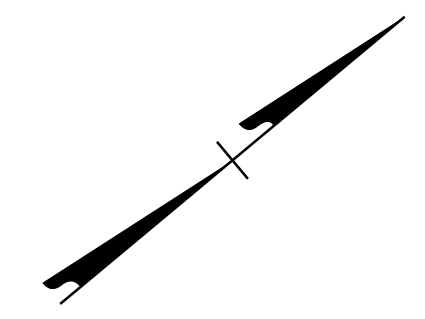

3/7/2024  
 R-2577A\_tmp\_psh39.dgn  
 KRobby

APPROVED: *Kevin Bisby*  
DocuSigned by: Kevin Bisby  
 B0C802628912472

DATE: 3/7/2024

SEAL

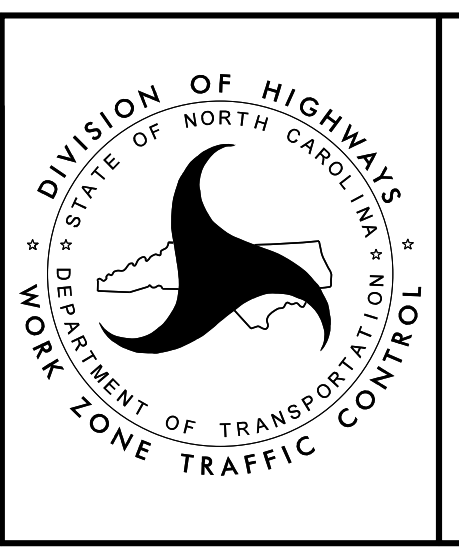

PHASE I - STEP 4

DOCUMENT NOT CONSIDERED FINAL  
 UNLESS ALL SIGNATURES COMPLETED

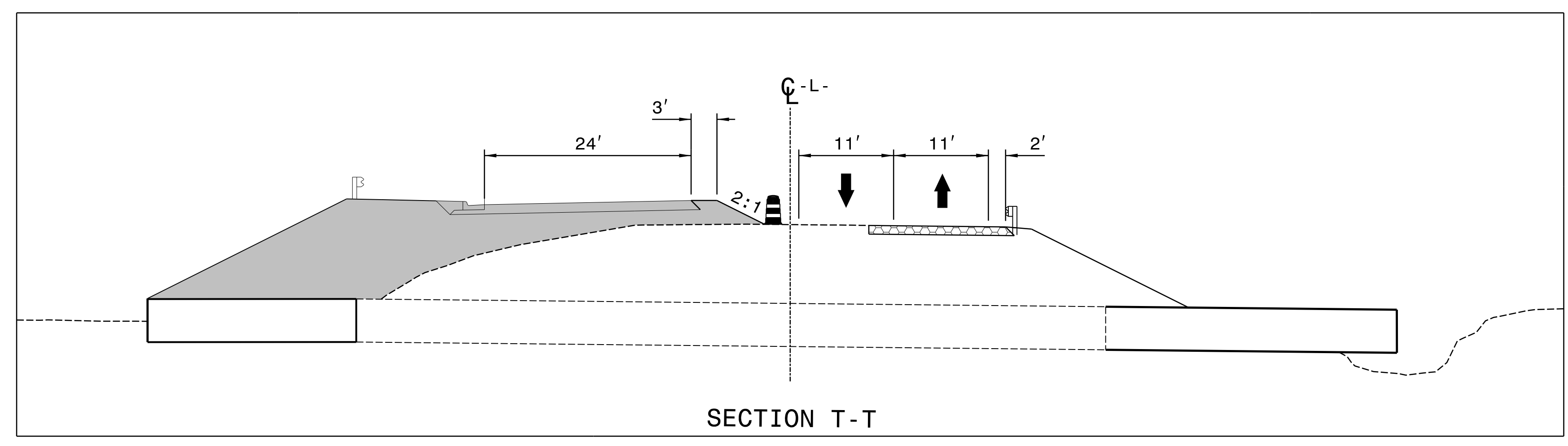
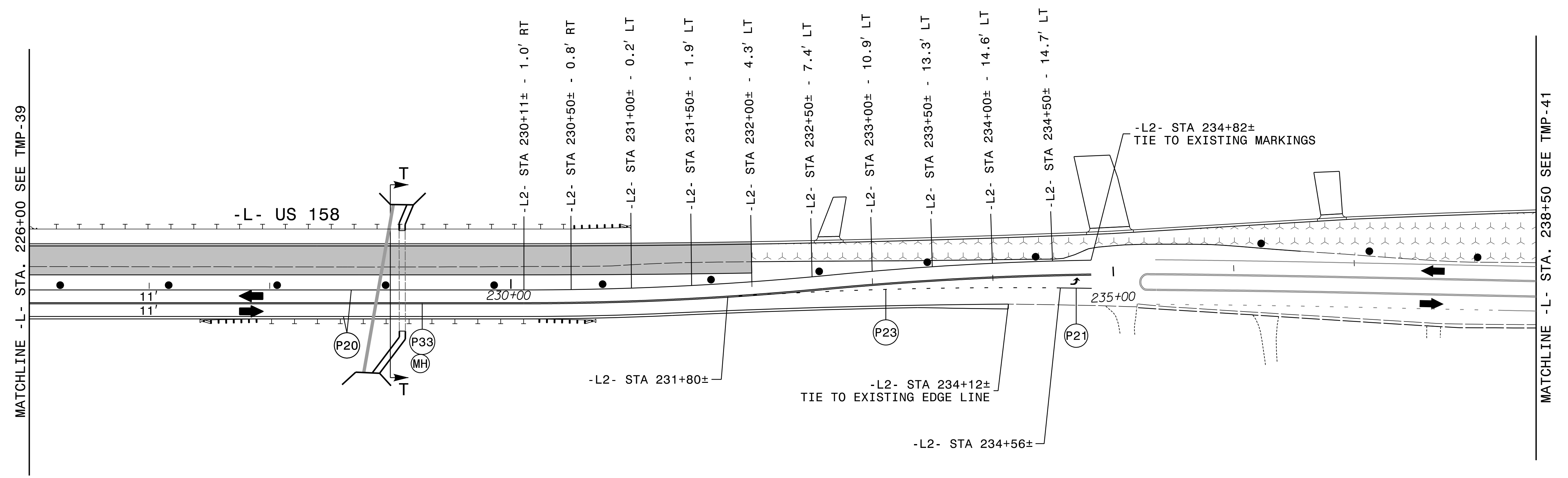
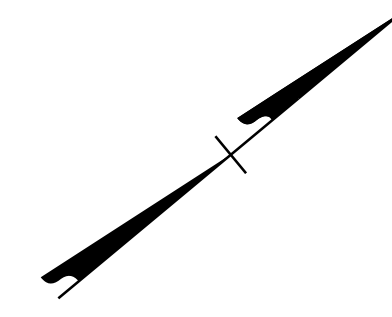

SECTION T-T

APPROVED: *Kevin Bisby*  
 DATE: 3/7/2024

SEAL

NORTH CAROLINA PROFESSIONAL ENGINEER KEVIN W. BISBY SEAL 21047

DOCUMENT NOT CONSIDERED FINAL UNLESS ALL SIGNATURES COMPLETED

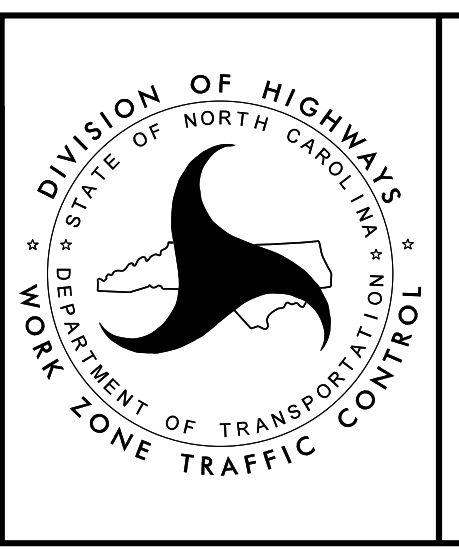

PHASE I - STEP 4

3/7/2024  
 R-2577A\_tmp\_psh40.dgn  
 K.Bisby

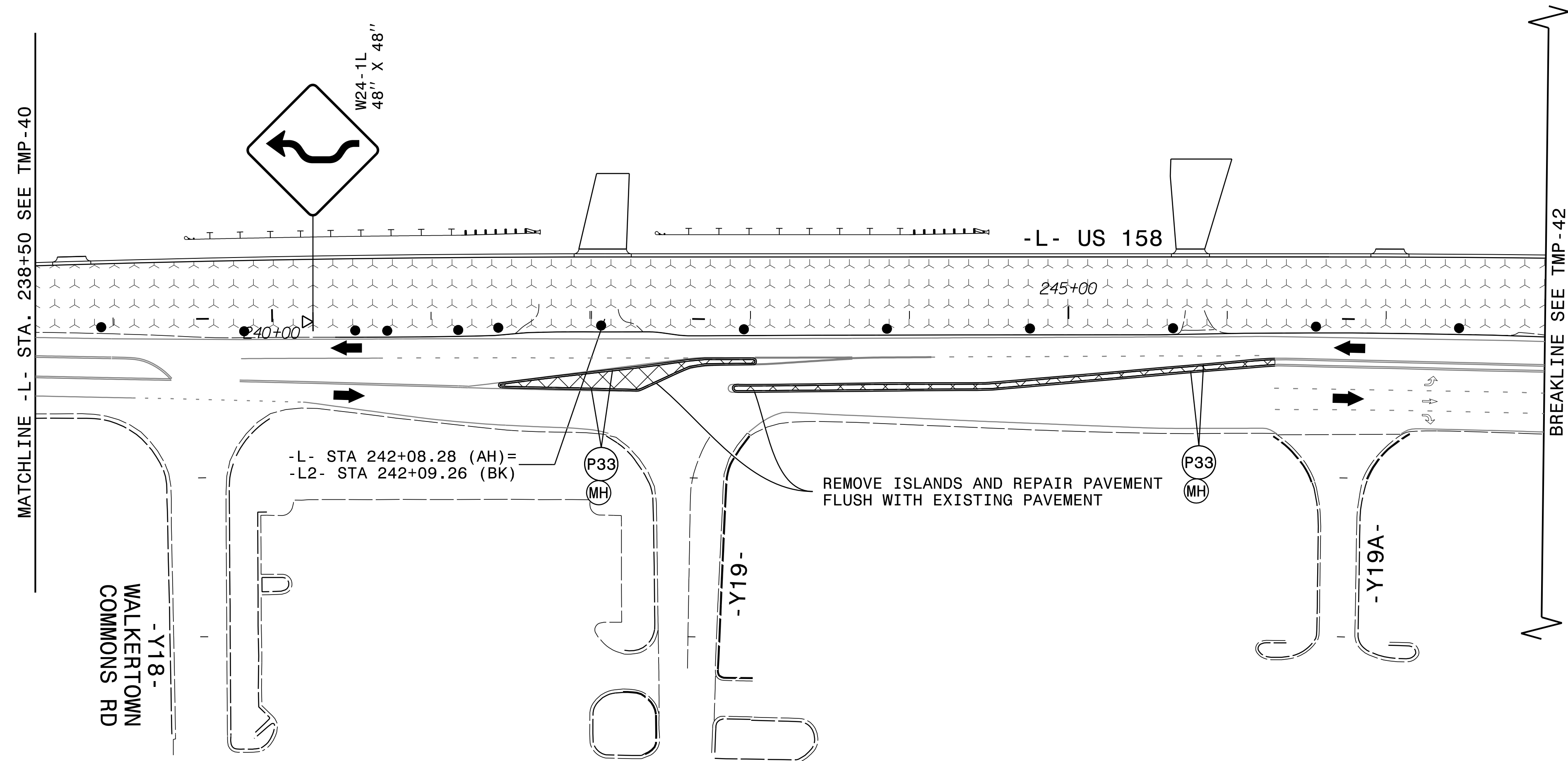
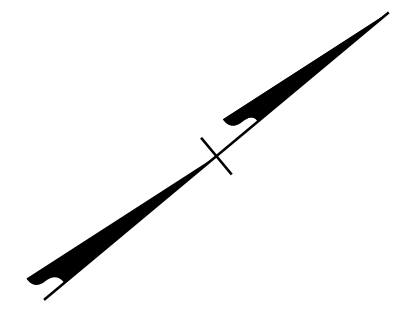

3/7/2024  
 R-2577A\_tmp\_psh41.dgn  
 Kolsby

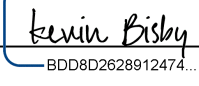
APPROVED:   
DocuSigned by: Kevin W. Bisby  
 B0C80262891247

DATE: 3/7/2024

SEAL

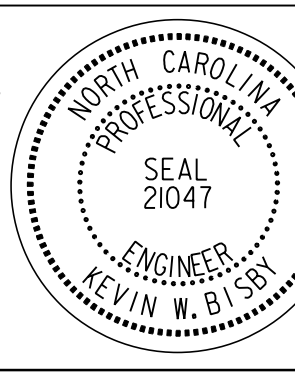
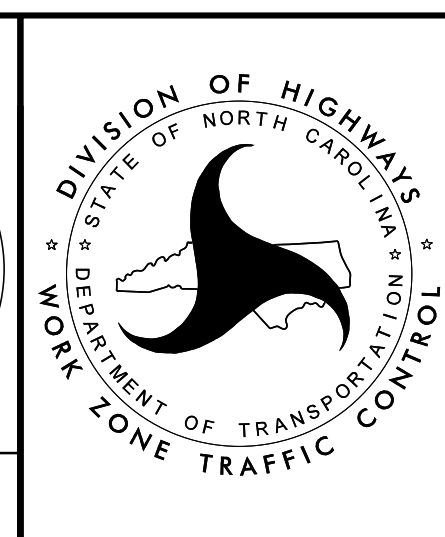
PHASE I - STEP 4

**DOCUMENT NOT CONSIDERED FINAL  
 UNLESS ALL SIGNATURES COMPLETED**



PROJ. REFERENCE NO.	SHEET NO.
R-2577A	TMP-42

**RKK**  
 P: (919) 878-8560  
 8601 Six Forks Road, Forum 1, Suite 700  
 Raleigh, North Carolina 27615-3960  
 NC License No. F-0112  
 Engineers | Construction Managers | Planners | Scientists  
 www.rkk.com  
 Responsive People | Creative Solutions

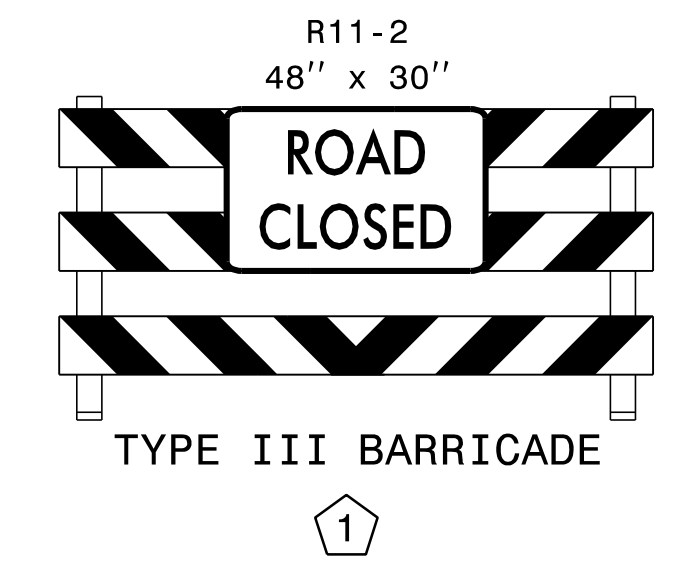
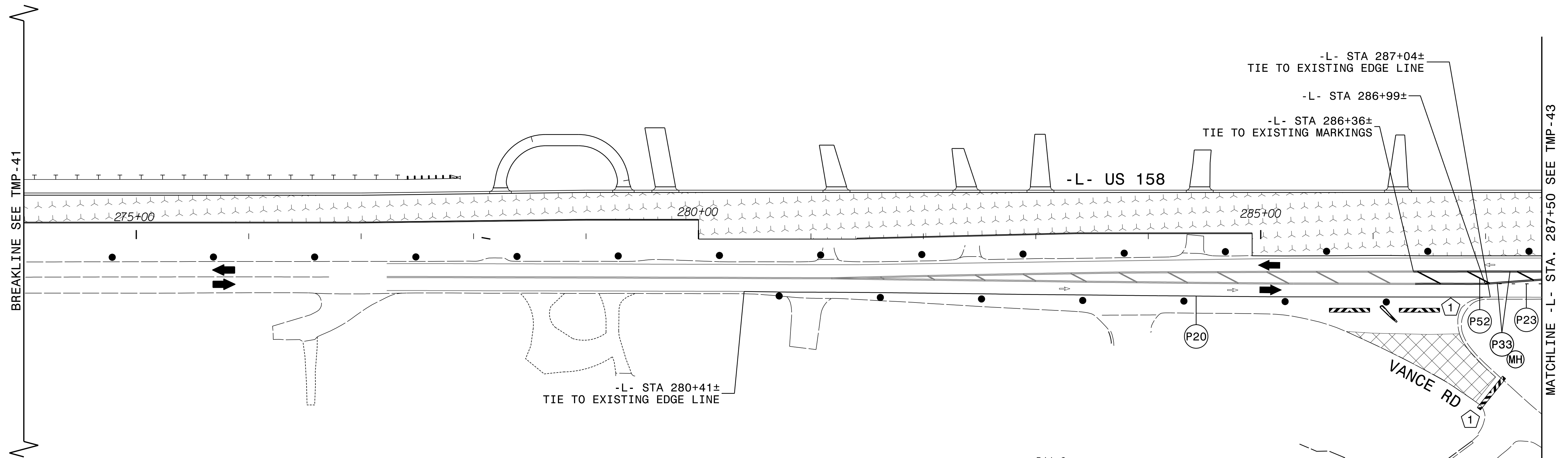
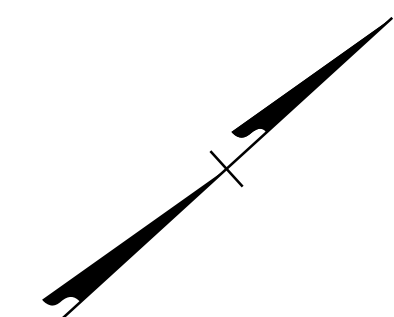

3/7/2024  
 R-2577A\_tmp\_psh42.dgn  
 KRobby

APPROVED: *Kevin Bisby*  
DocuSigned by: Kevin Bisby  
 B0C8D2628912472

DATE: 3/7/2024

SEAL

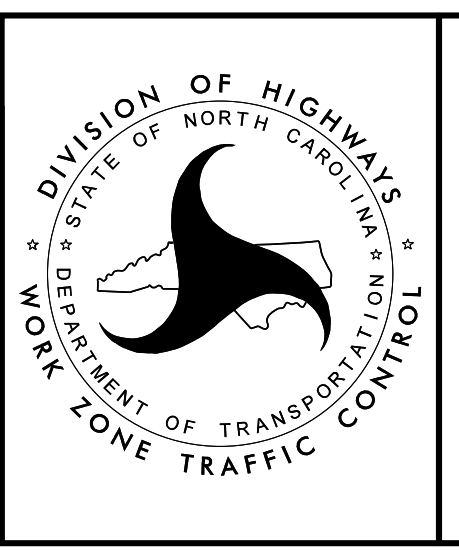

PHASE I - STEP 4

DOCUMENT NOT CONSIDERED FINAL  
 UNLESS ALL SIGNATURES COMPLETED

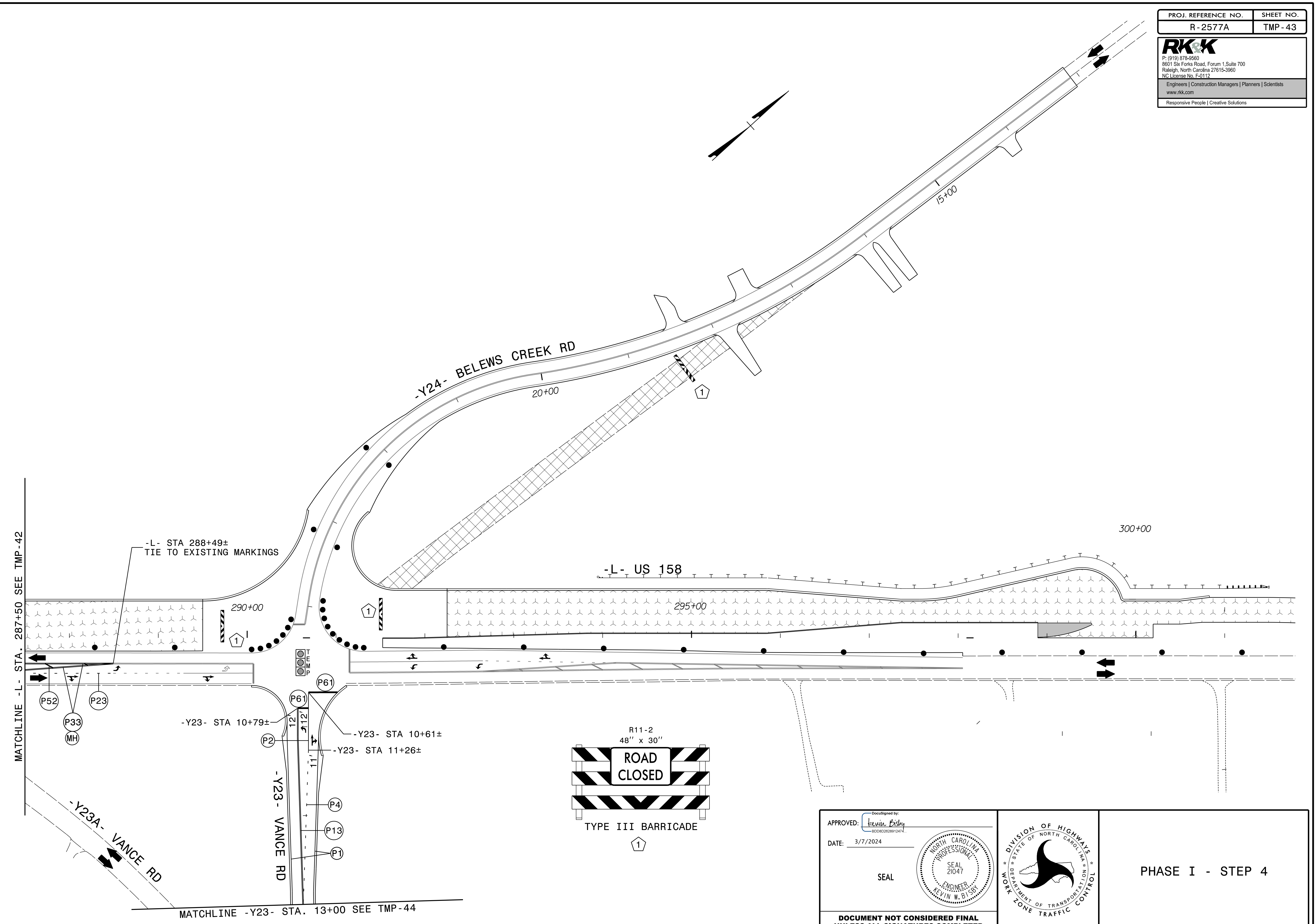

3/7/2024  
 R-2577A\_tmp\_psh43.dgn  
 R015by

<p>APPROVED: <i>Kevin Bisby</i>        DATE: 3/7/2024</p> <p>SEAL</p> <p><b>DOCUMENT NOT CONSIDERED FINAL        UNLESS ALL SIGNATURES COMPLETED</b></p>		<p><b>PHASE I - STEP 4</b></p>
--	--	--------------------------------

PROJ. REFERENCE NO.	SHEET NO.
R - 2577A	TMP - 44

**RKK**  
 P: (919) 878-8560  
 8601 Six Forks Road, Forum 1, Suite 700  
 Raleigh, North Carolina 27615-3960  
 NC License No. F-0112  
 Engineers | Construction Managers | Planners | Scientists  
 www.rkk.com  
 Responsive People | Creative Solutions

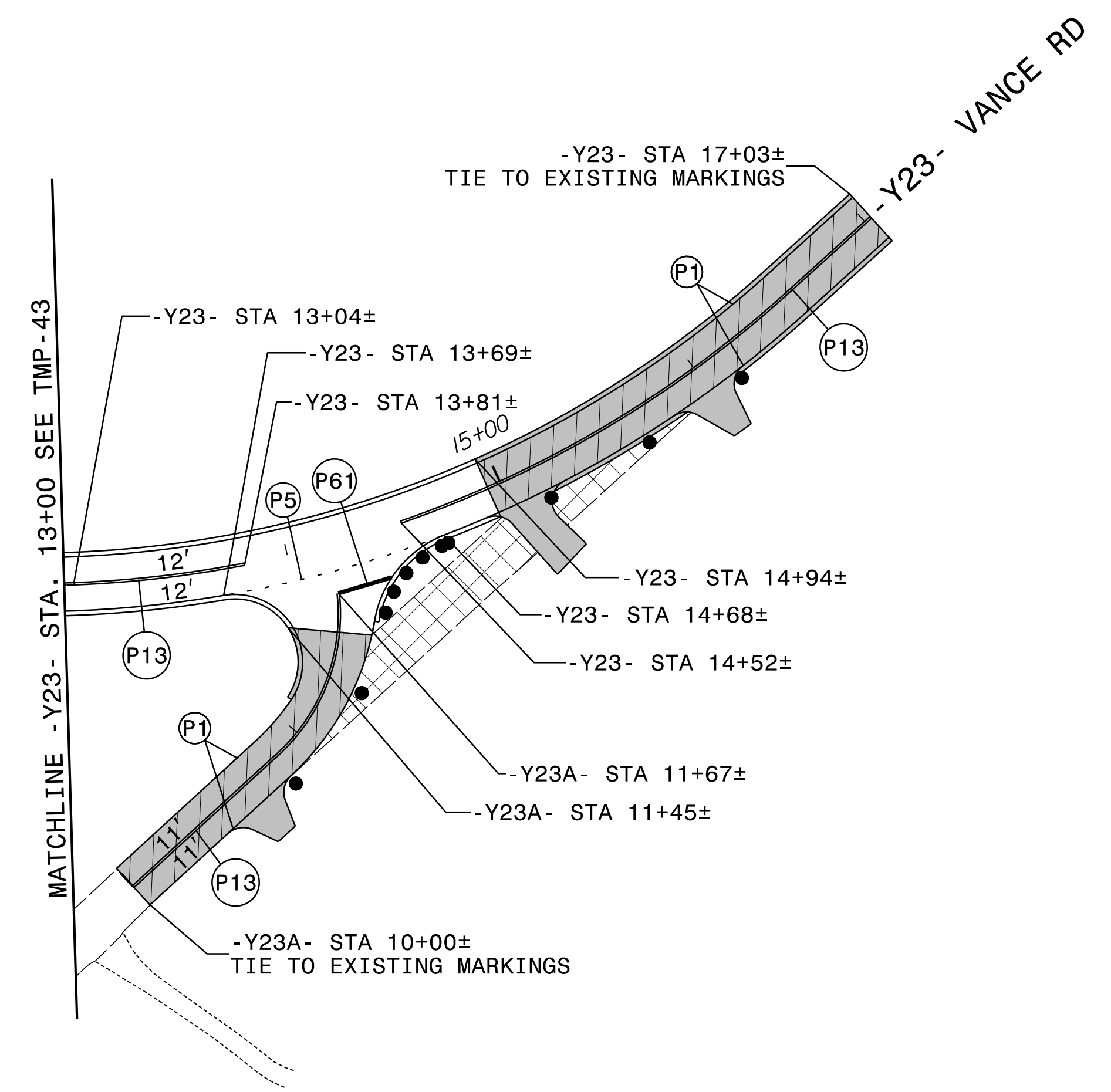
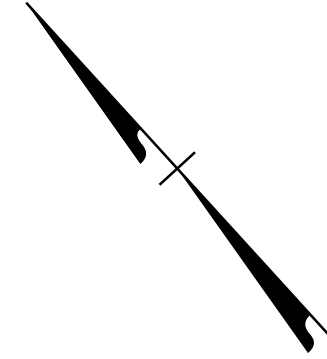

3/7/2024  
 R-2577A\_tmp\_psh44.dgn  
 Rolsby

APPROVED: *Kevin Bishy*  
DocuSigned by: Kevin Bishy  
 B0C8D2628912477

DATE: 3/7/2024

SEAL

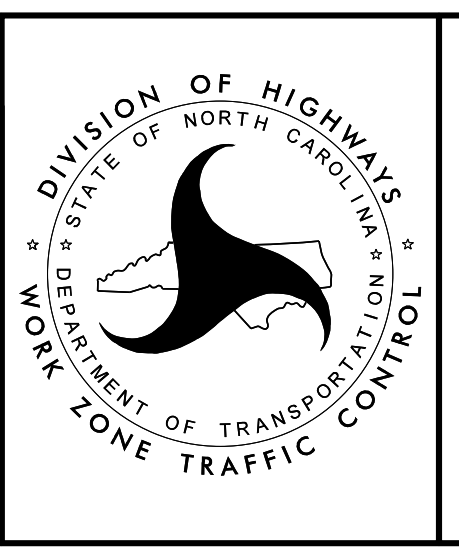

PHASE I - STEP 4

DOCUMENT NOT CONSIDERED FINAL  
 UNLESS ALL SIGNATURES COMPLETED

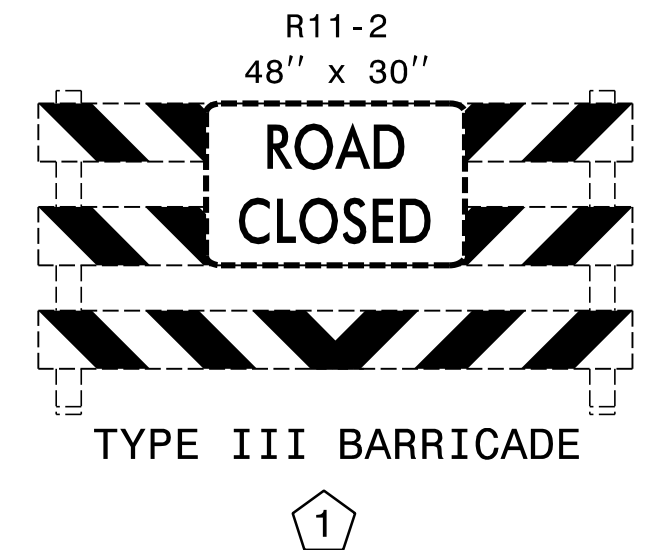
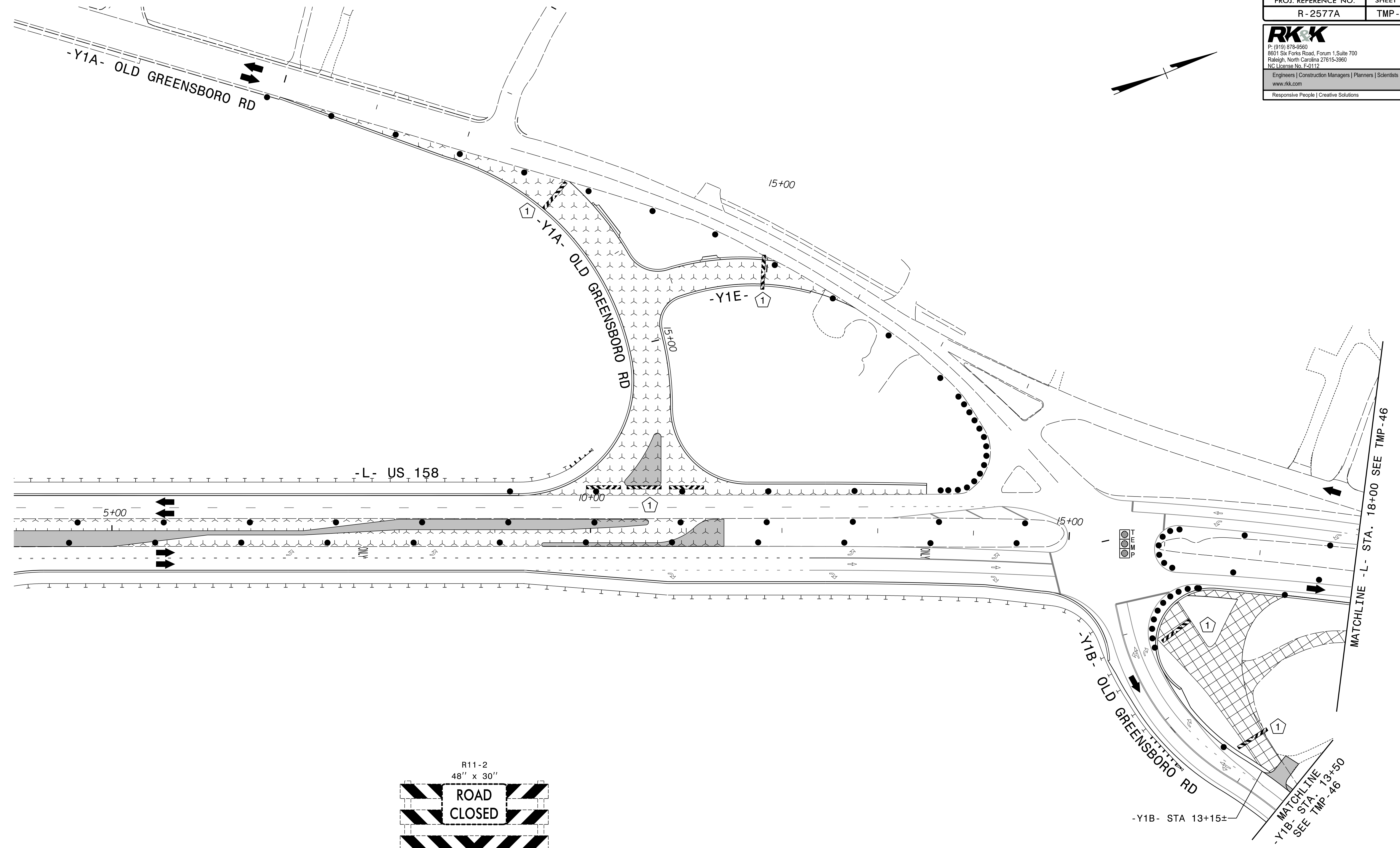
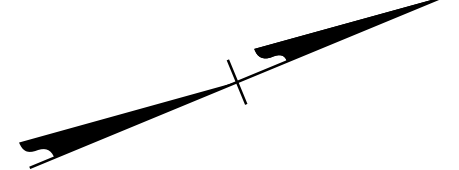

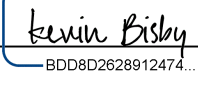
APPROVED:   
 DATE: 3/7/2024

SEAL

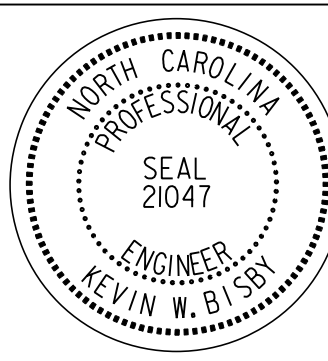

**DOCUMENT NOT CONSIDERED FINAL  
UNLESS ALL SIGNATURES COMPLETED**

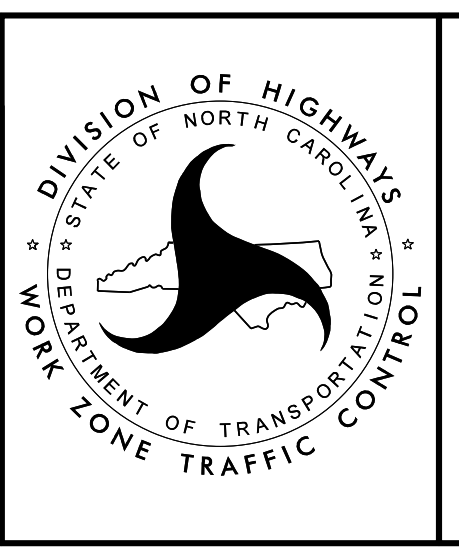

PHASE I - STEP 5

3/7/2024  
 R-2577A\_tmp\_psh45.dgn  
 KRobby

PROJ. REFERENCE NO.	SHEET NO.
R - 2577A	TMP - 46

**RKK**  
 P: (919) 878-8560  
 8601 Six Forks Road, Forum 1, Suite 700  
 Raleigh, North Carolina 27615-3960  
 NC License No. F-0112  
 Engineers | Construction Managers | Planners | Scientists  
 www.rkk.com  
 Responsive People | Creative Solutions

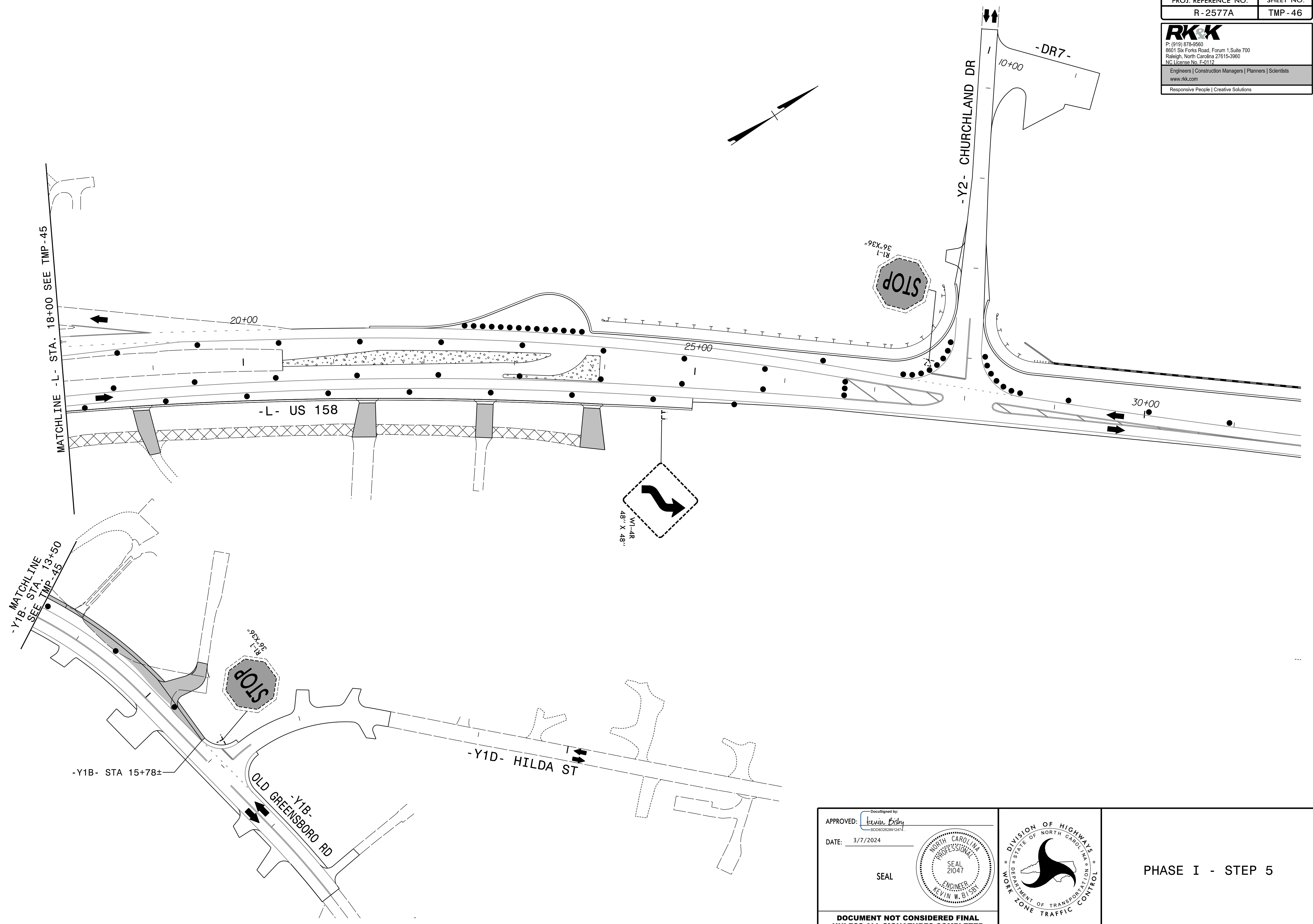

3/7/2024  
 R-2577A\_tmp\_psh46.dgn  
 KRobby

APPROVED: *Kevin Bisby*  
 DATE: 3/7/2024  
 SEAL  
 NORTH CAROLINA PROFESSIONAL ENGINEER  
 SEAL 21047  
 KEVIN W. BISBY

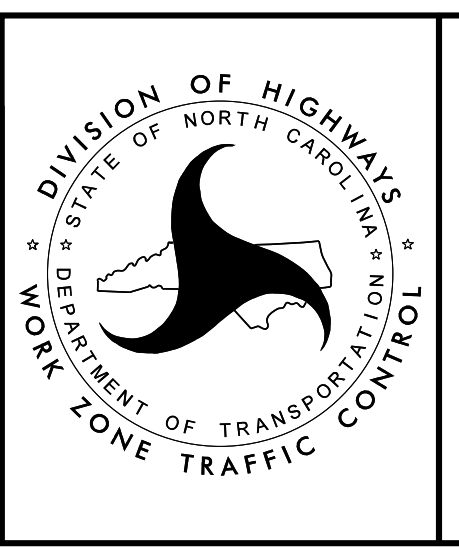

PHASE I - STEP 5

DOCUMENT NOT CONSIDERED FINAL  
 UNLESS ALL SIGNATURES COMPLETED

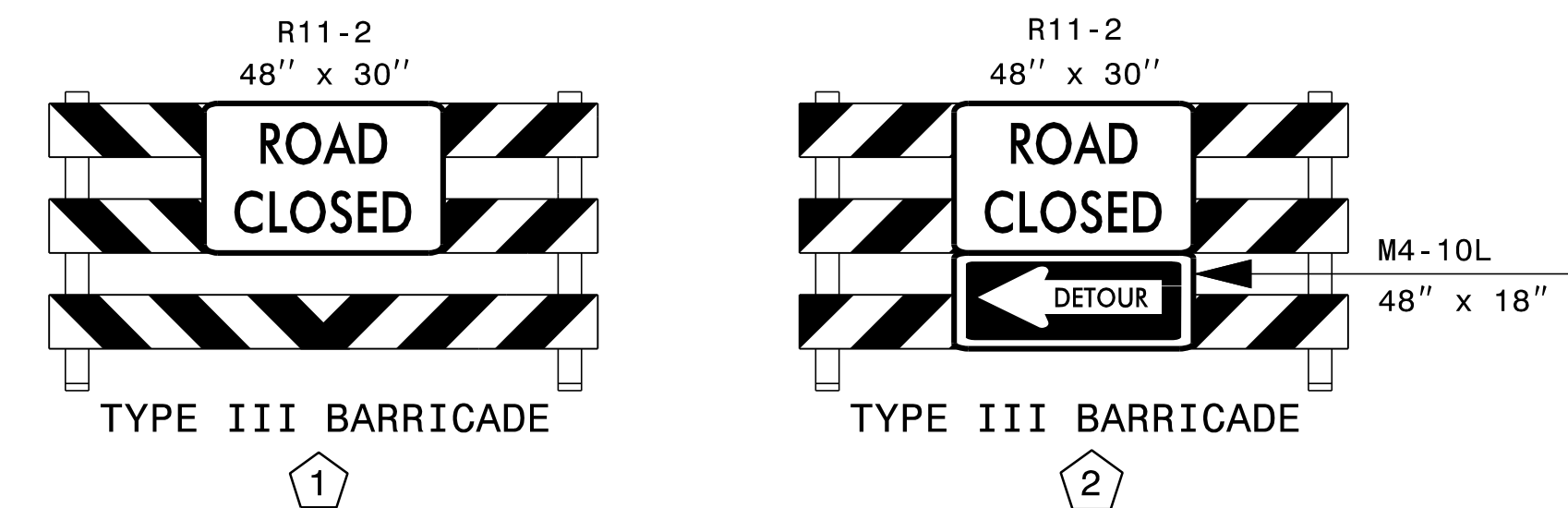
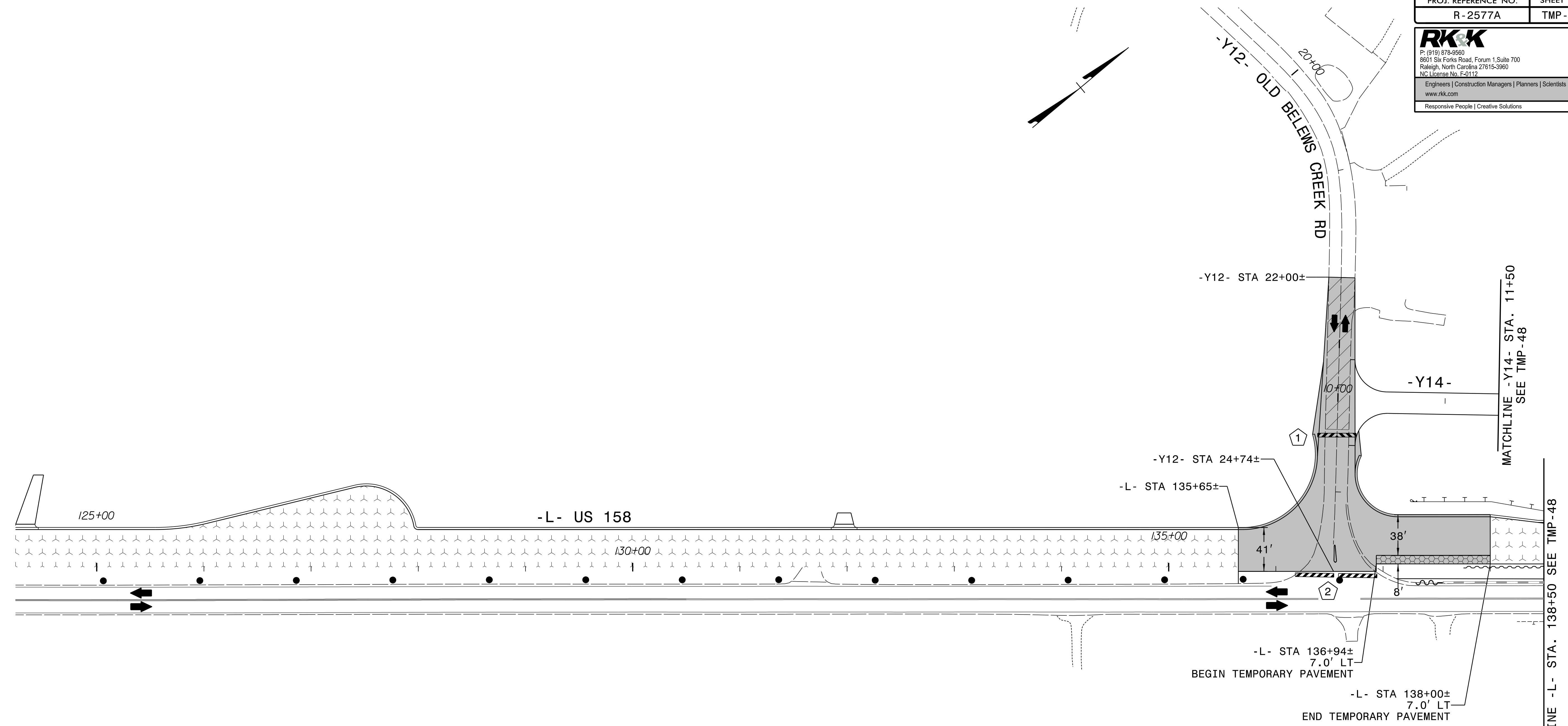

SEE TMP-2FA FOR OLD BELEWS CREEK RD OFFSITE DETOUR DETAIL

APPROVED: *Kevin Bishy*  
 DATE: 3/7/2024

SEAL

**NORTH CAROLINA PROFESSIONAL ENGINEER**  
 SEAL 21047  
 KEVIN W. BISHY

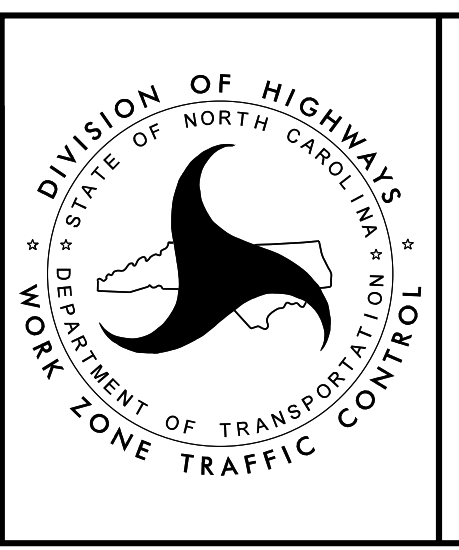

PHASE I - STEP 6

3/7/2024  
 R-2577A\_tmp\_psh47.dgn  
 KRobby

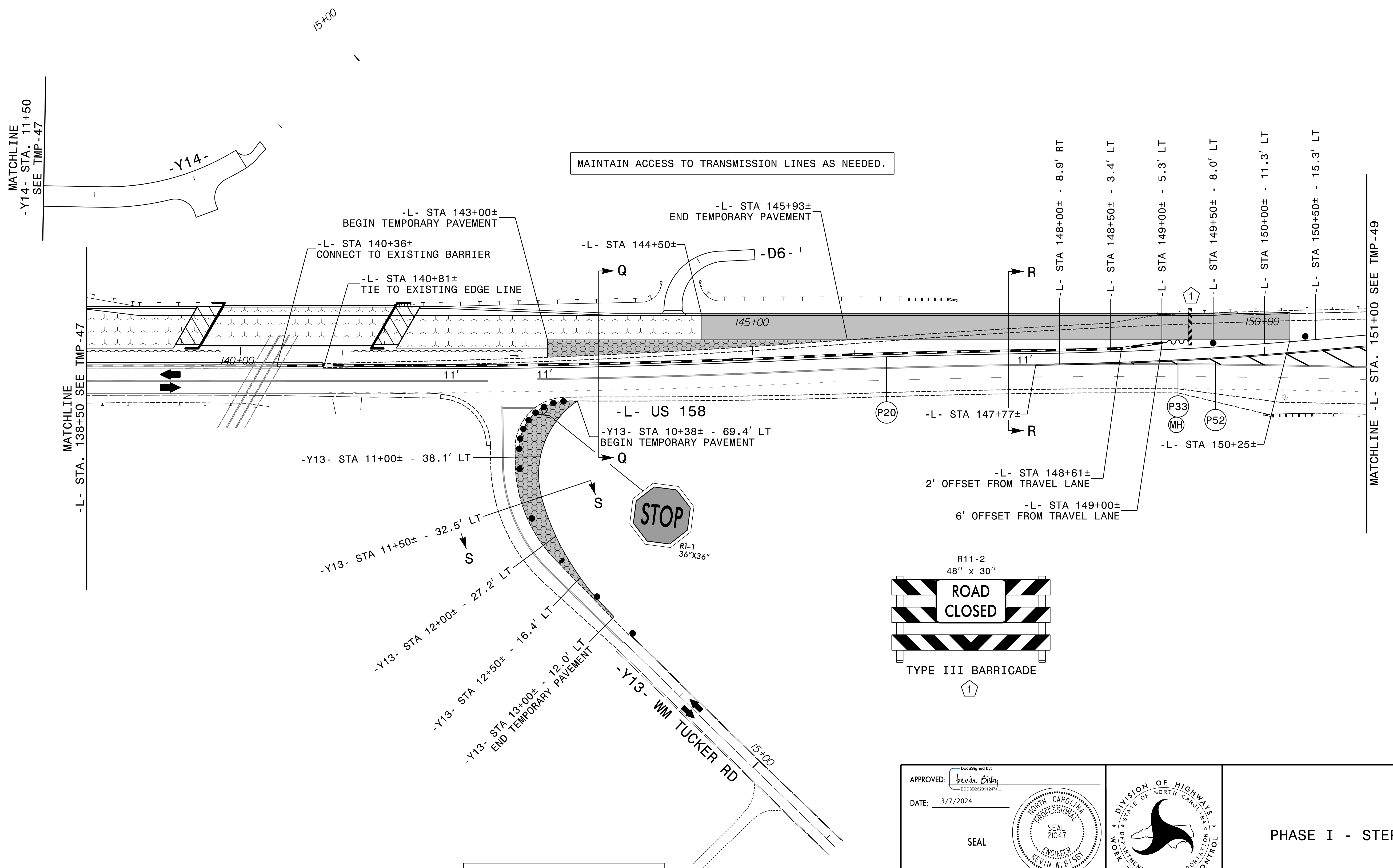
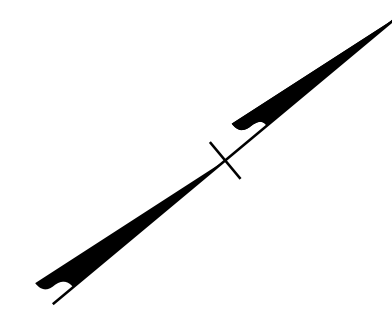

SEE TMP-48A FOR SECTION VIEWS

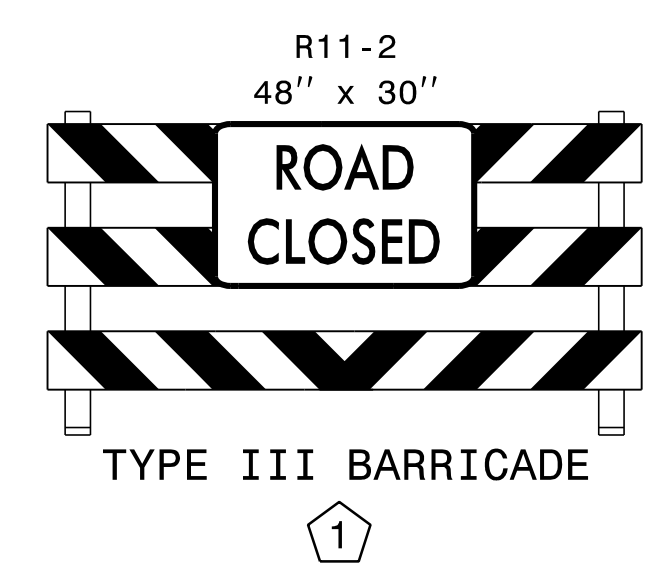

APPROVED: *Kevin Bishy*  
 DATE: 3/7/2024  
 SEAL  
 NORTH CAROLINA PROFESSIONAL ENGINEER  
 KEVIN W. BISHY  
 SEAL 21047

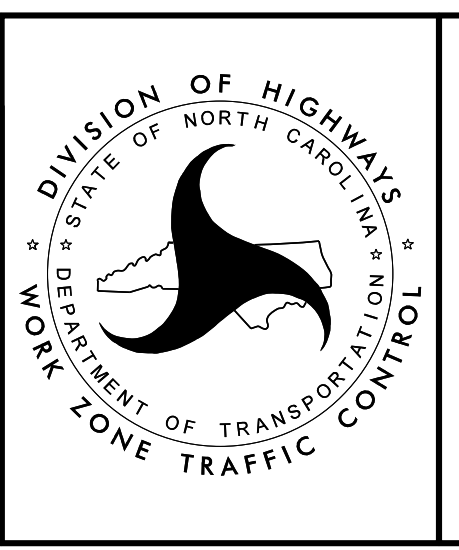

PHASE I - STEP 6

3/7/2024  
 R-2577A\_tmp\_psh48.dgn  
 KRobby

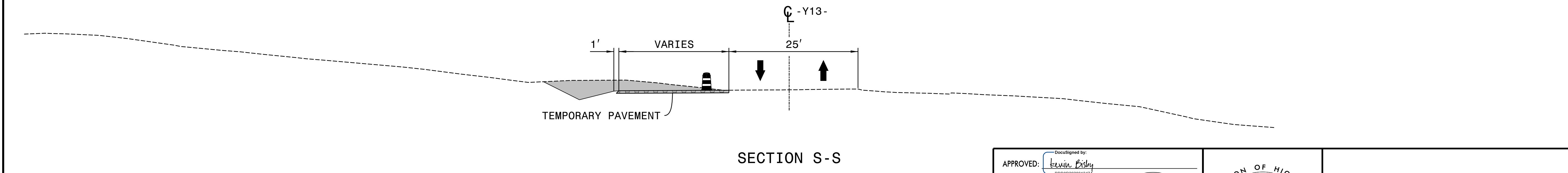
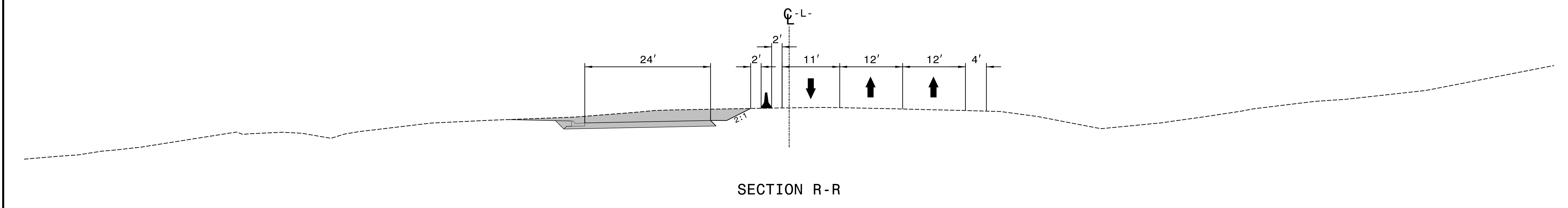
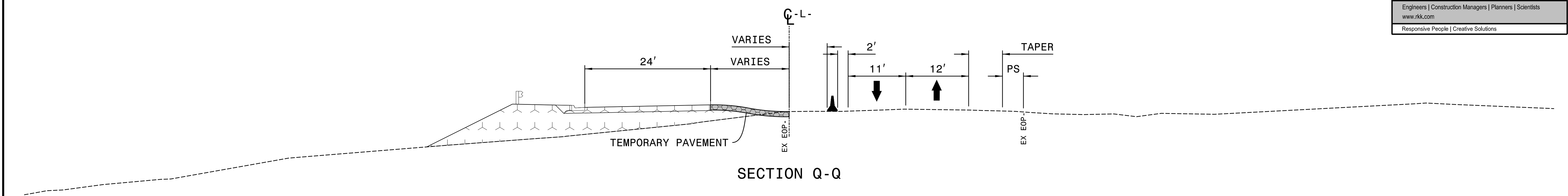

3/7/2024  
 R-2577A\_tmp\_psh48A.dgn  
 KJlsby

APPROVED: *Kevin Bisby*  
 DATE: 3/7/2024

SEAL

**DOCUMENT NOT CONSIDERED FINAL  
 UNLESS ALL SIGNATURES COMPLETED**

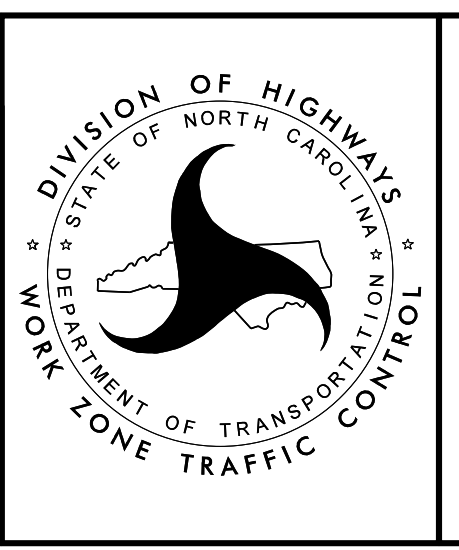

PHASE I - STEP 6



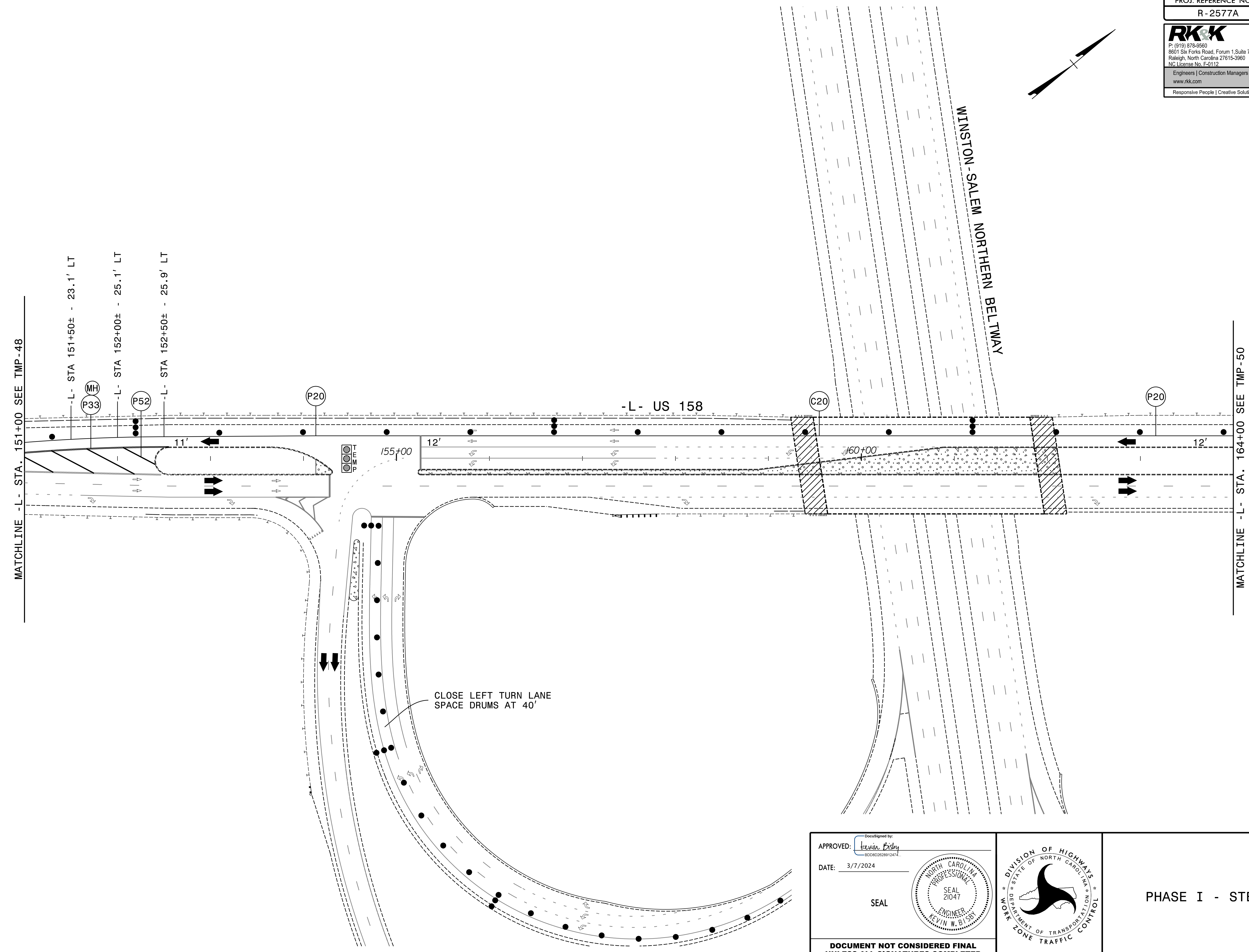
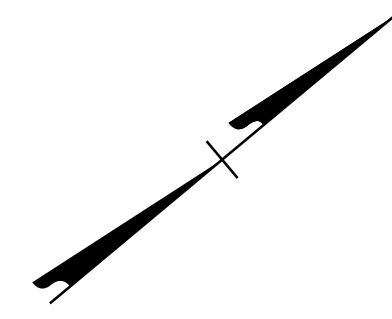

3/7/2024  
 R-2577A\_tmp\_psh49.dgn  
 Rolsby

APPROVED: *Kevin Bishop*  
DocuSigned by:  
Kevin Bishop  
800802628012472

DATE: 3/7/2024

SEAL

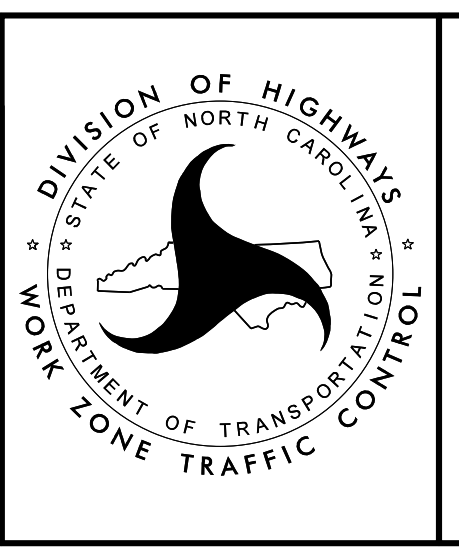

PHASE I - STEP 6

DOCUMENT NOT CONSIDERED FINAL  
 UNLESS ALL SIGNATURES COMPLETED

PROJ. REFERENCE NO.	SHEET NO.
R-2577A	TMP-50

**RKK**  
 P: (919) 878-8560  
 8601 Six Forks Road, Forum 1, Suite 700  
 Raleigh, North Carolina 27615-3960  
 NC License No. F-0112  
 Engineers | Construction Managers | Planners | Scientists  
 www.rkk.com  
 Responsive People | Creative Solutions

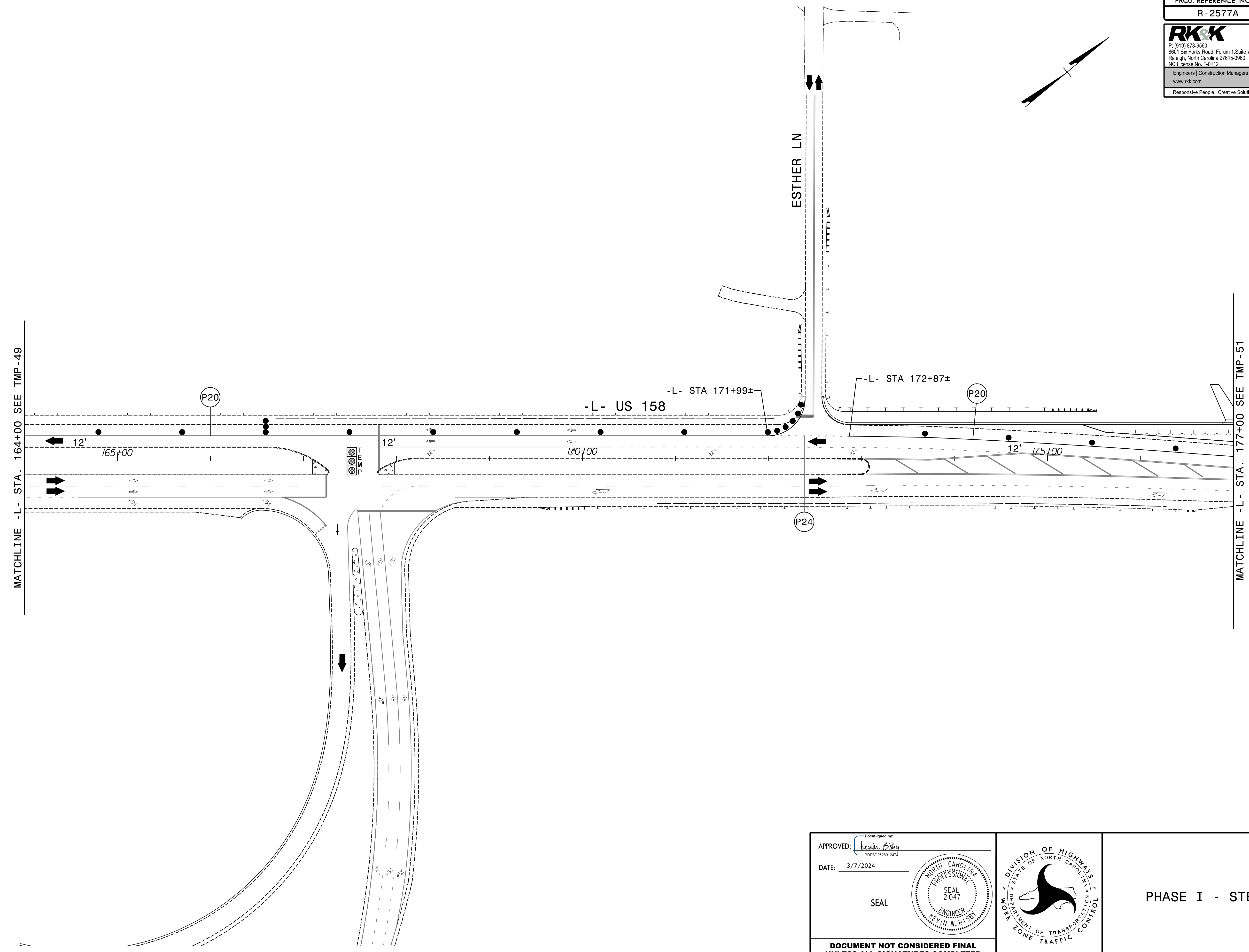
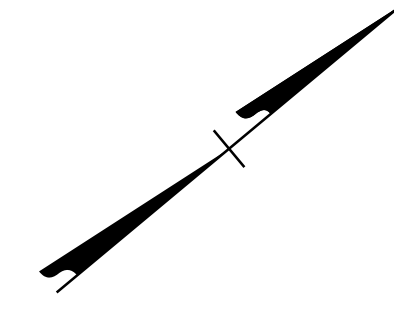

3/7/2024  
 R-2577A\_tmp\_psh50.dgn  
 KRobby

APPROVED:   
 DATE: 3/7/2024

SEAL

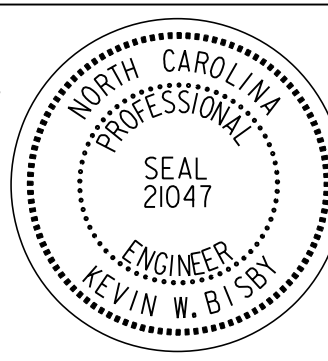

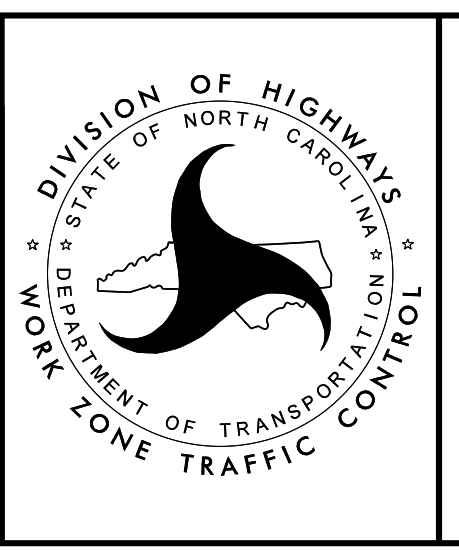

**DOCUMENT NOT CONSIDERED FINAL  
 UNLESS ALL SIGNATURES COMPLETED**

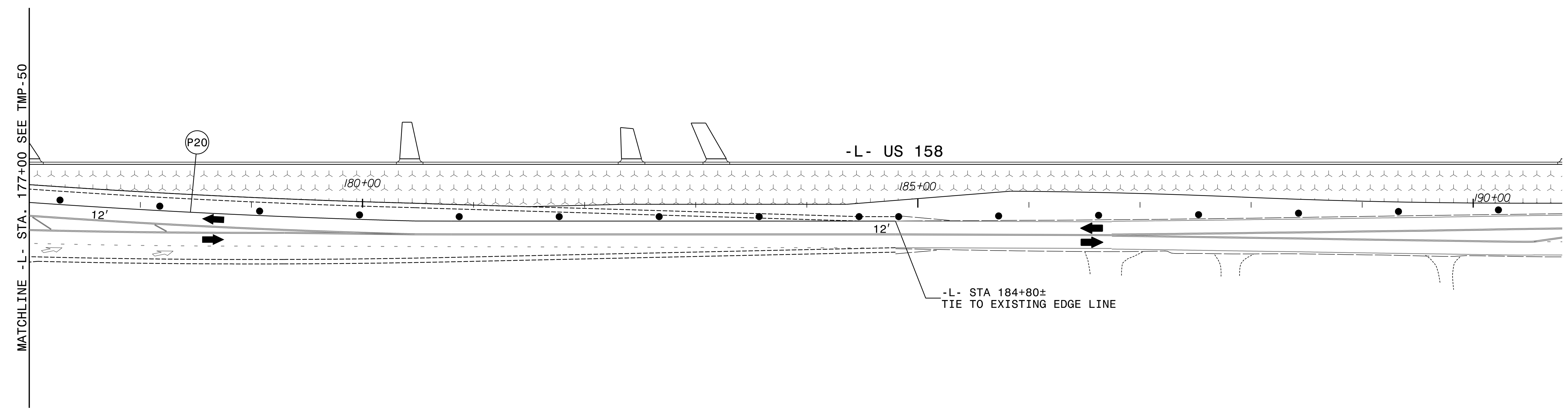
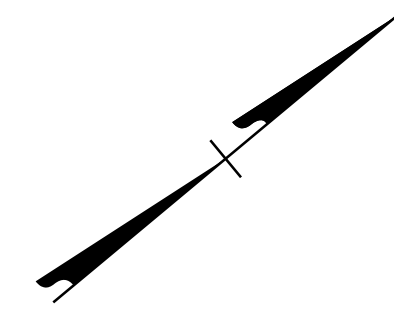

PHASE I - STEP 6



3/7/2024  
 R-2577A\_tmp\_psh51.dgn  
 KRobby

APPROVED:  DATE: 3/7/2024 SEAL 		<p>PHASE I - STEP 6</p>
<p><b>DOCUMENT NOT CONSIDERED FINAL          UNLESS ALL SIGNATURES COMPLETED</b></p>		

PROJ. REFERENCE NO.	SHEET NO.
R-2577A	TMP-52

**RKK**  
 P: (919) 878-8560  
 8601 Six Forks Road, Forum 1, Suite 700  
 Raleigh, North Carolina 27615-3960  
 NC License No. F-0112  
 Engineers | Construction Managers | Planners | Scientists  
 www.rkk.com  
 Responsive People | Creative Solutions

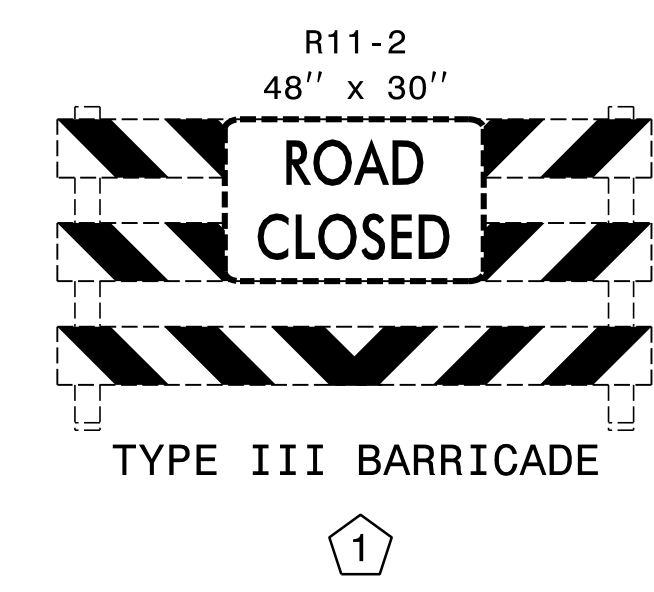
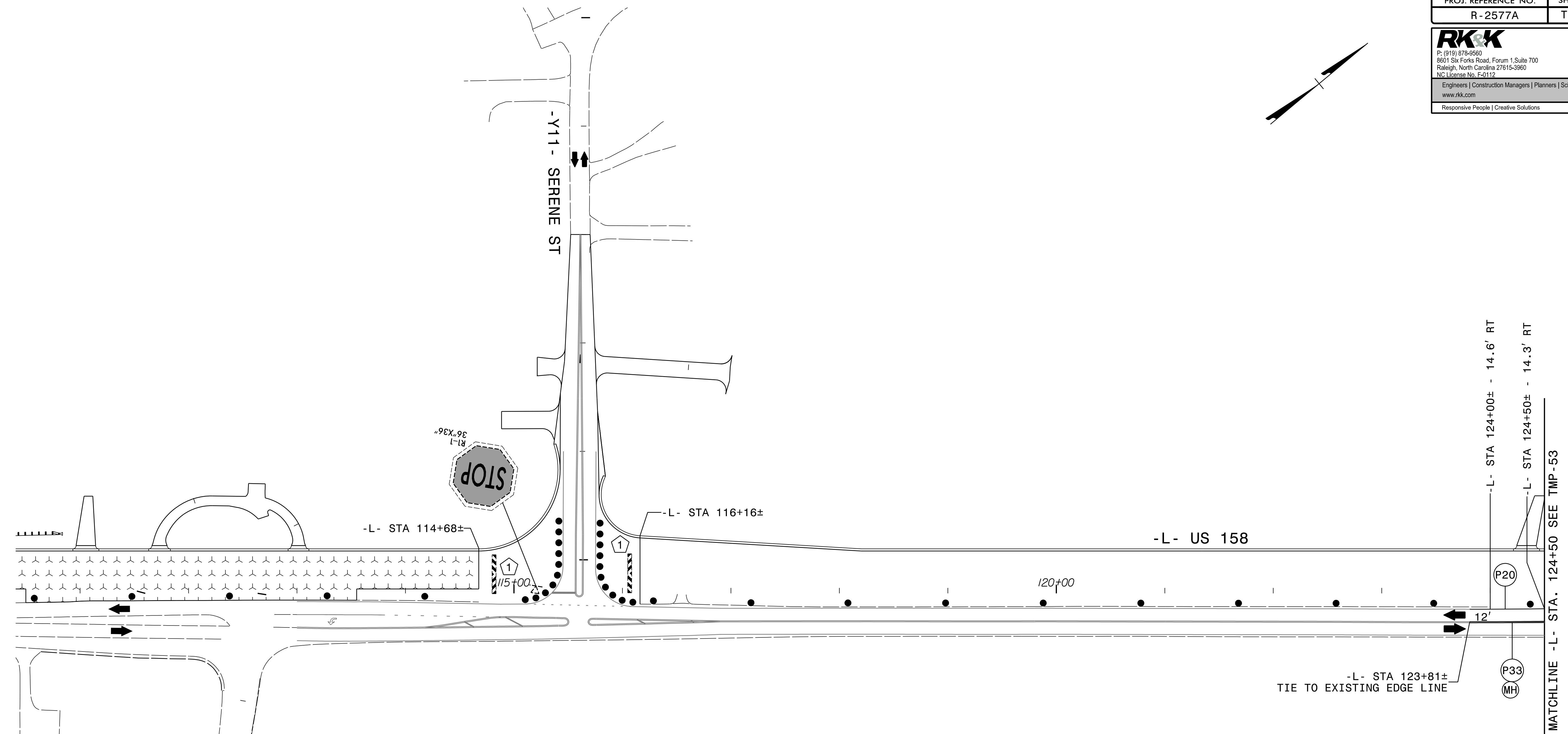
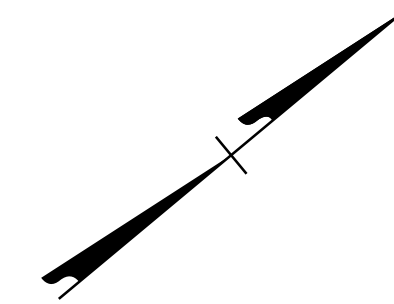

3/7/2024  
 R-2577A\_tmp\_psh52.dgn  
 Kolsby

-Y10- STANLEY PARK RD

APPROVED: *Kevin Bisby*  
 DATE: 3/7/2024

SEAL

**DOCUMENT NOT CONSIDERED FINAL  
 UNLESS ALL SIGNATURES COMPLETED**

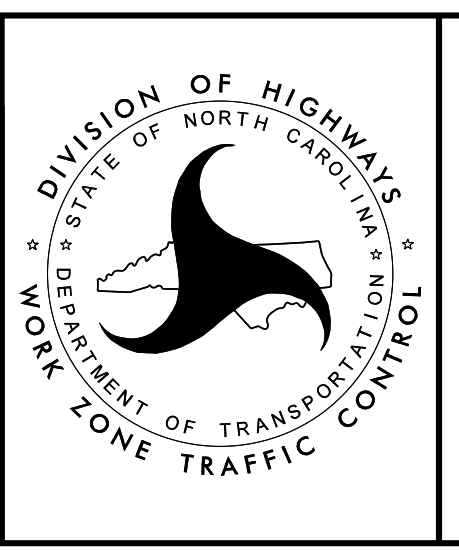

PHASE I - STEP 6

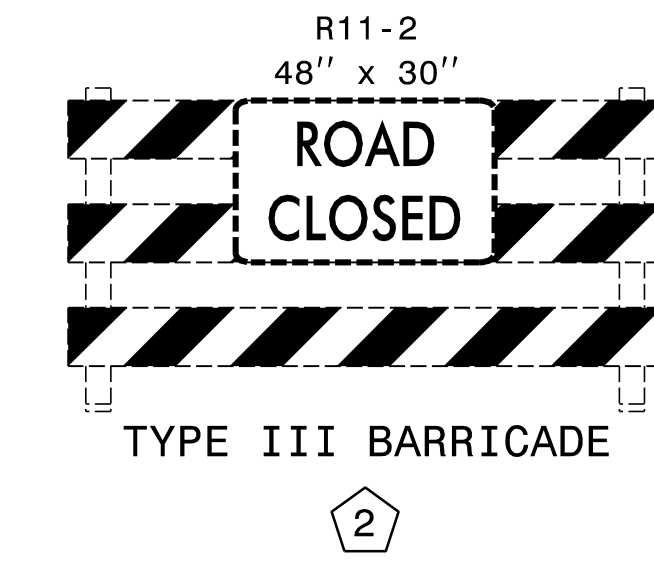
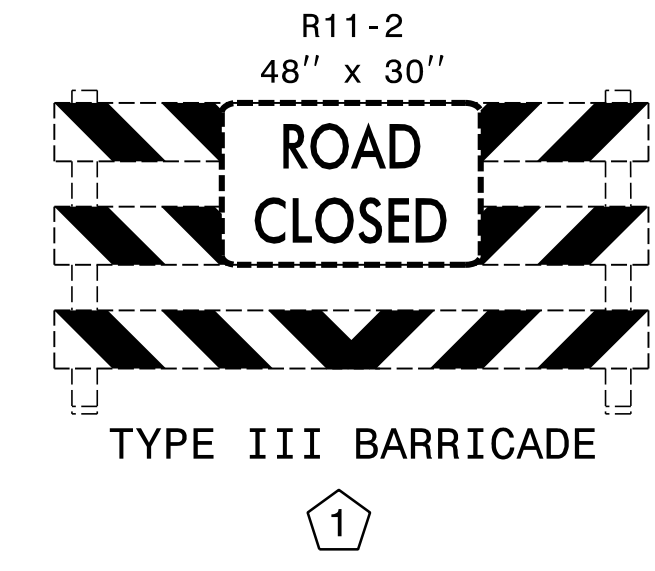
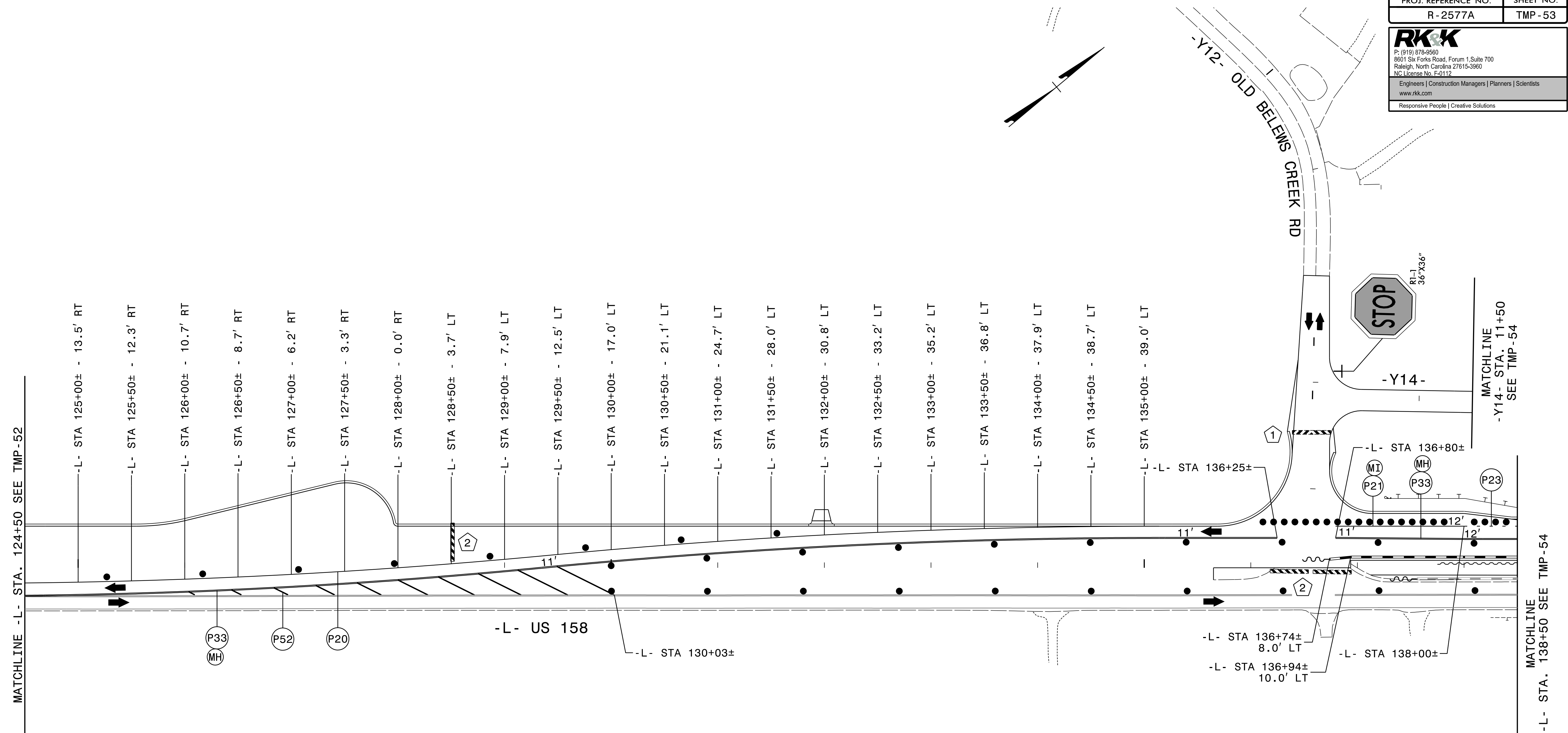

APPROVED: *Kevin Bishy*  
DocuSigned by:  
Kevin Bishy  
800802628912472

DATE: 3/7/2024

SEAL

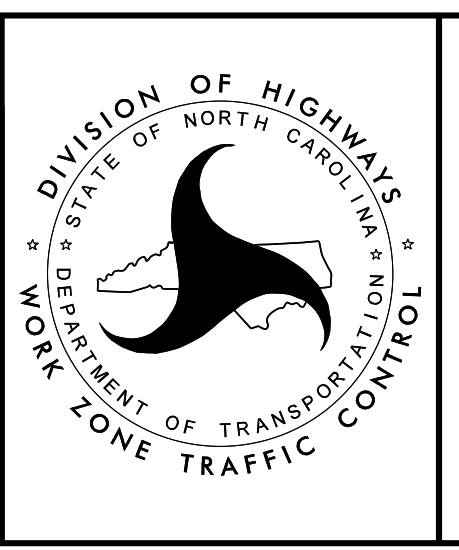

PHASE I - STEP 6

DOCUMENT NOT CONSIDERED FINAL  
UNLESS ALL SIGNATURES COMPLETED

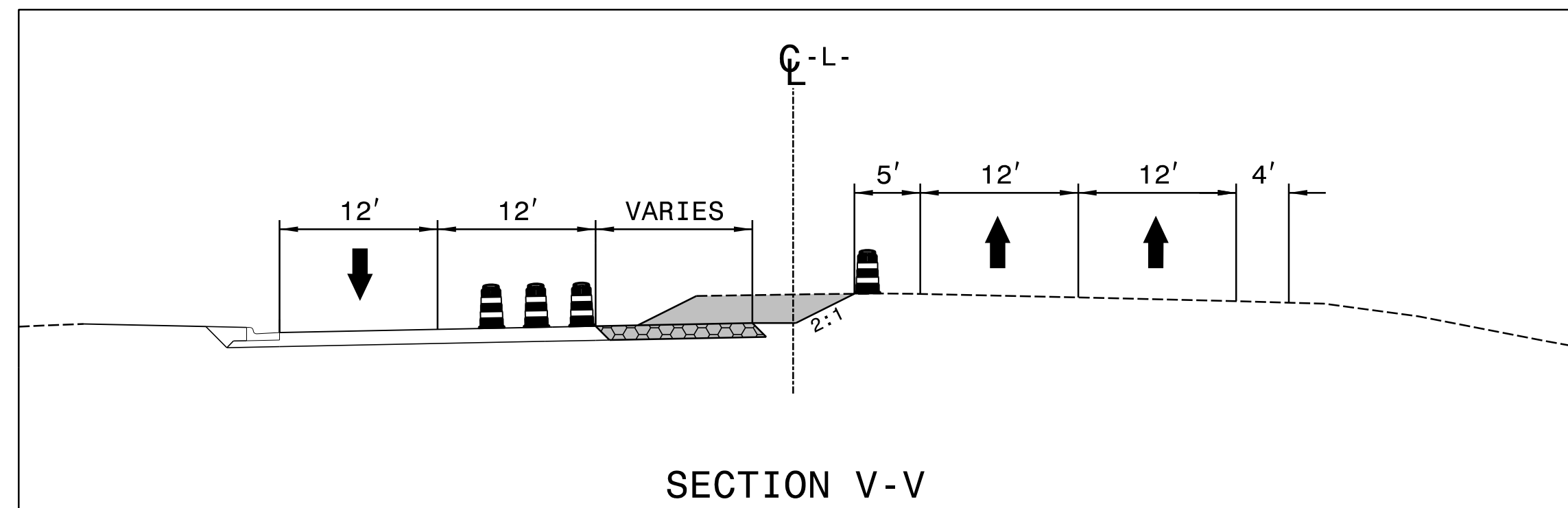
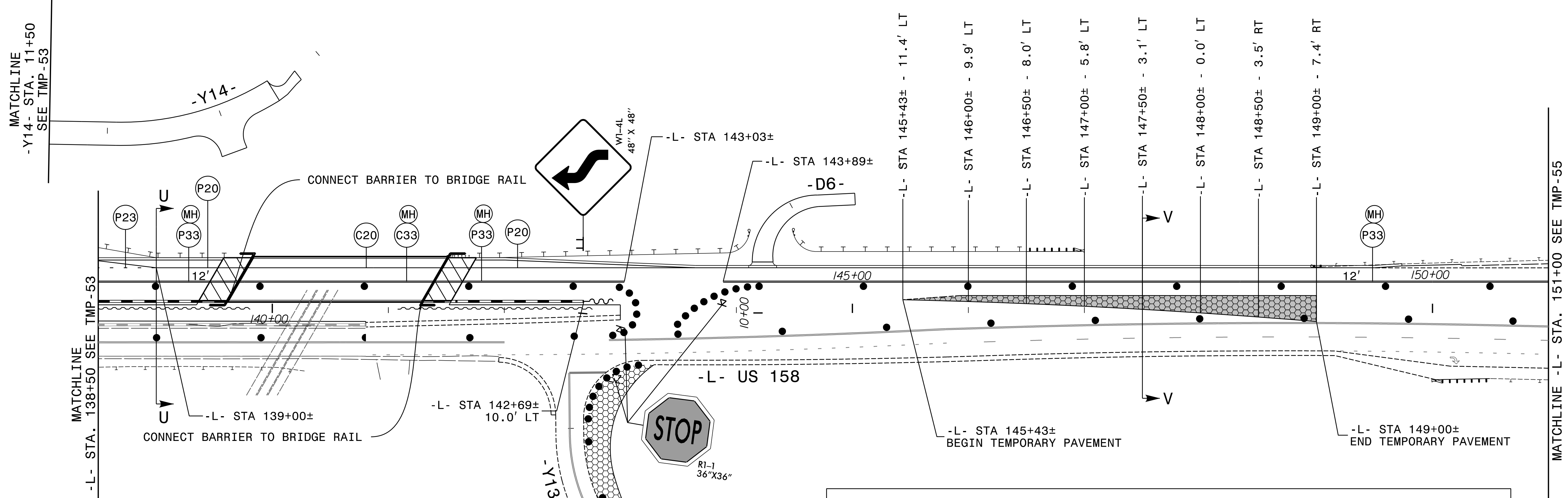
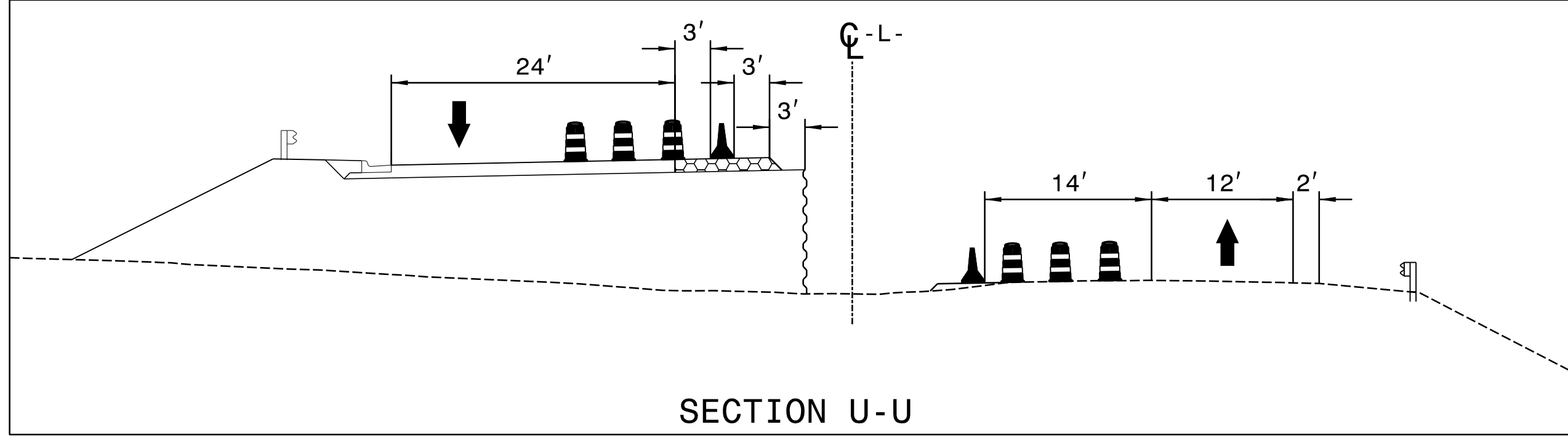
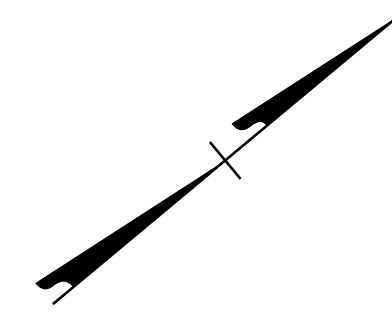

APPROVED: *Kevin Bishy*  
 DATE: 3/7/2024

SEAL

**DOCUMENT NOT CONSIDERED FINAL  
UNLESS ALL SIGNATURES COMPLETED**

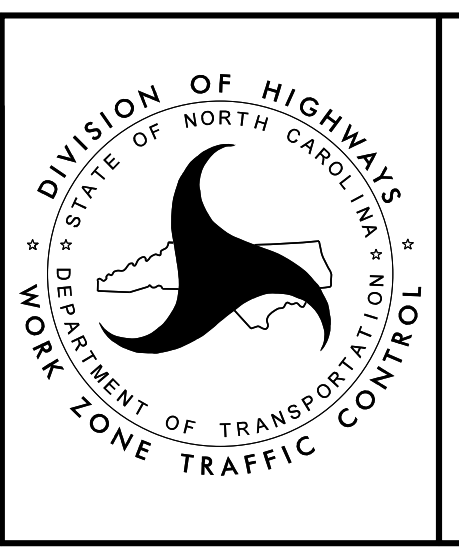

PHASE I - STEP 6

3/7/2024  
 R-2577A\_tmp\_psh54.dgn  
 KRobby

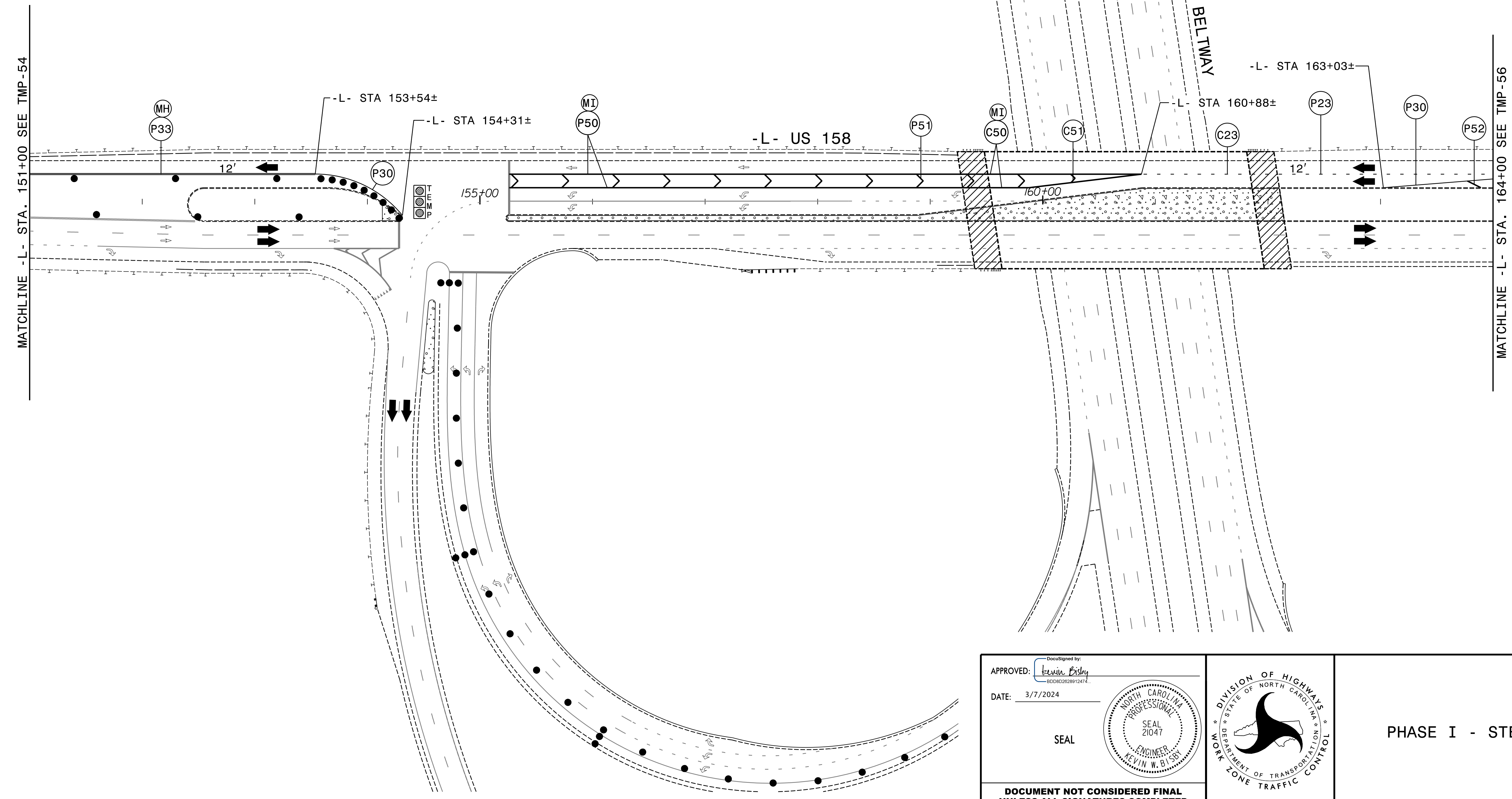
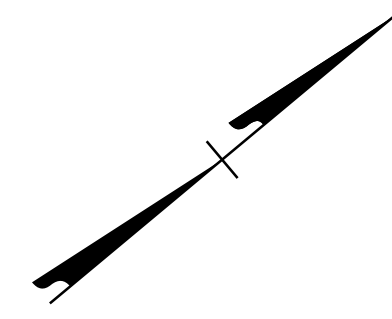

3/7/2024  
 R-2577A\_tmp\_psh55.dgn  
 R01sby

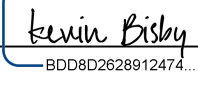
APPROVED:   
DocuSigned by: Kevin W. D. Isby  
 B0C802628912477

DATE: 3/7/2024

SEAL

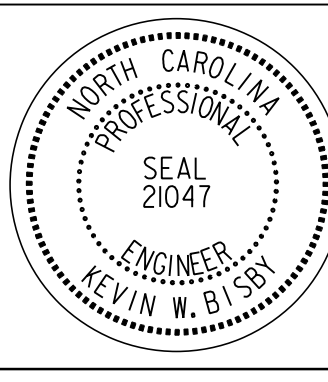
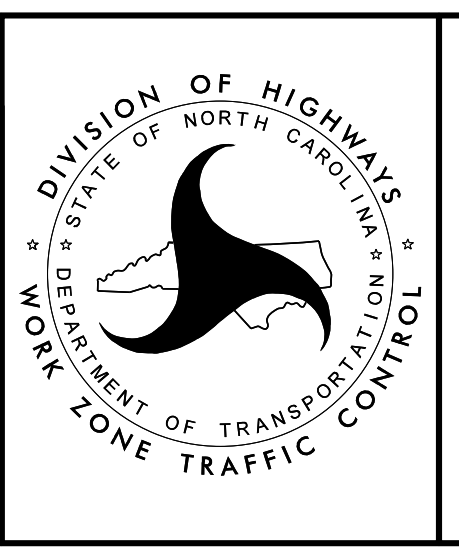
PHASE I - STEP 6

DOCUMENT NOT CONSIDERED FINAL  
 UNLESS ALL SIGNATURES COMPLETED

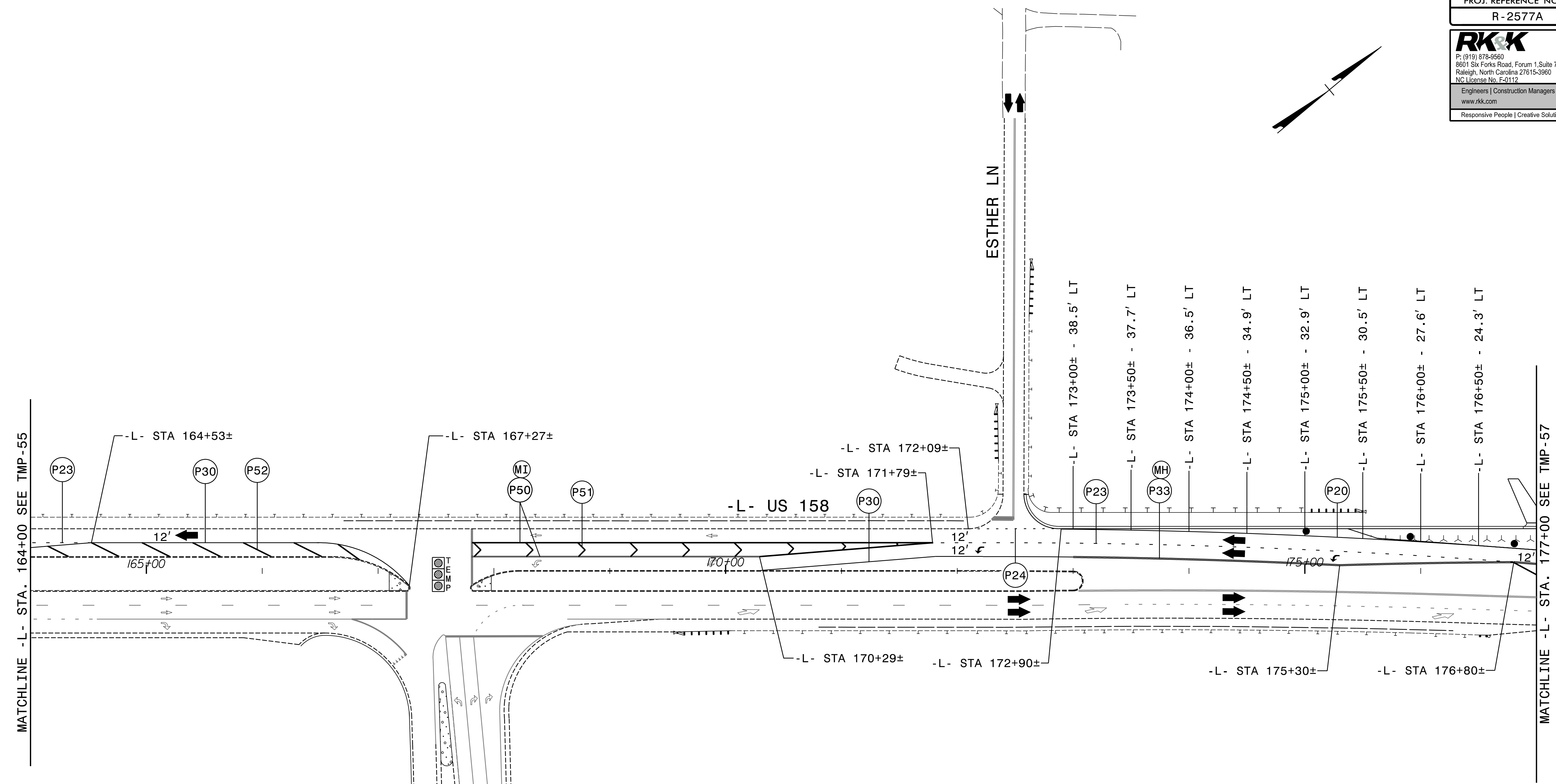
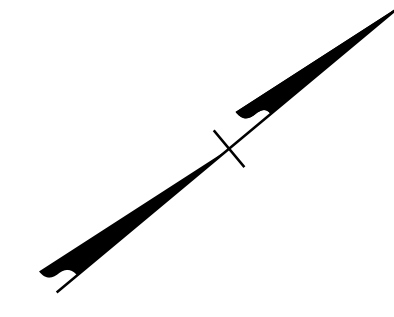

3/7/2024  
 R-2577A\_tmp\_psh56.dgn  
 KRobby

APPROVED: *Kevin Bisby*  
DocuSigned by: Kevin Bisby  
 B0C8D2628912477

DATE: 3/7/2024

SEAL

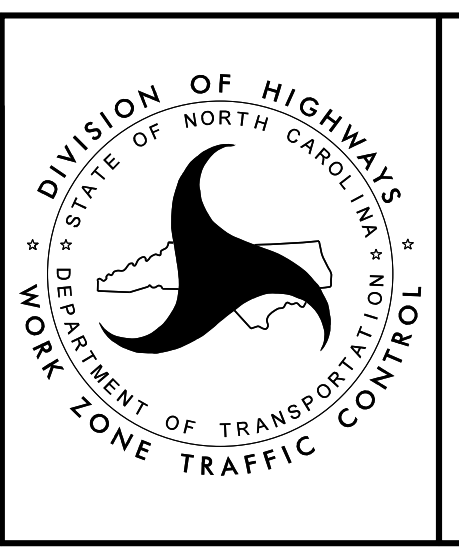

PHASE I - STEP 6

**DOCUMENT NOT CONSIDERED FINAL  
 UNLESS ALL SIGNATURES COMPLETED**



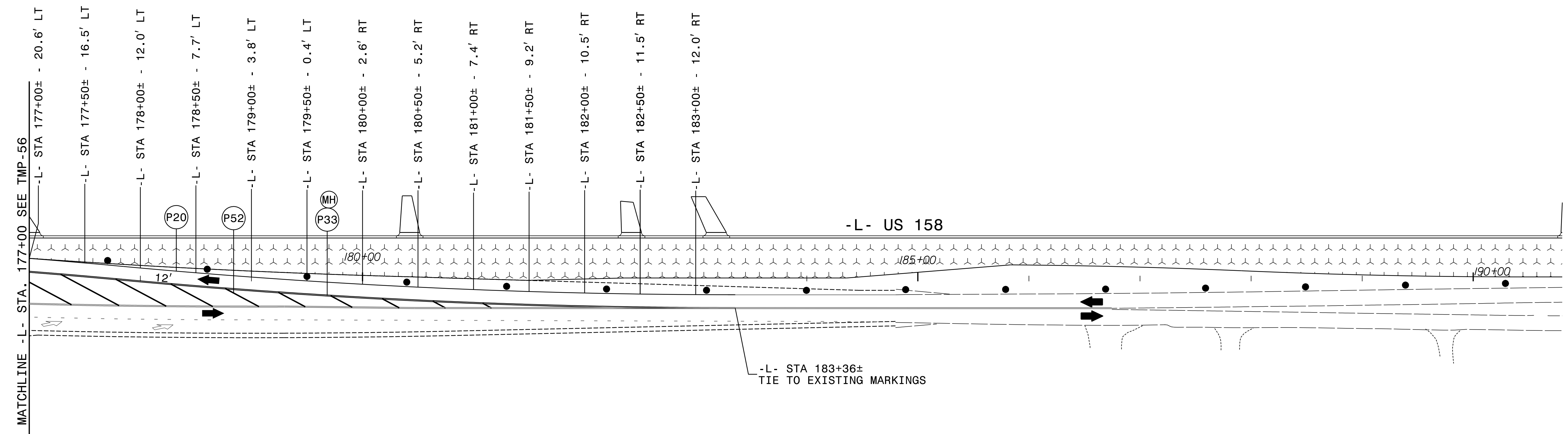
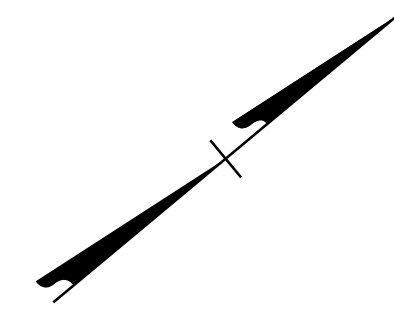

3/7/2024  
 R-2577A\_tmp\_psh57.dgn  
 KRobby

APPROVED:   
 DATE: 3/7/2024

SEAL

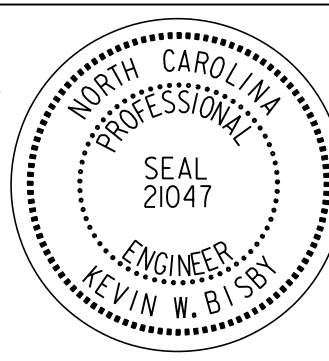

**DOCUMENT NOT CONSIDERED FINAL  
 UNLESS ALL SIGNATURES COMPLETED**

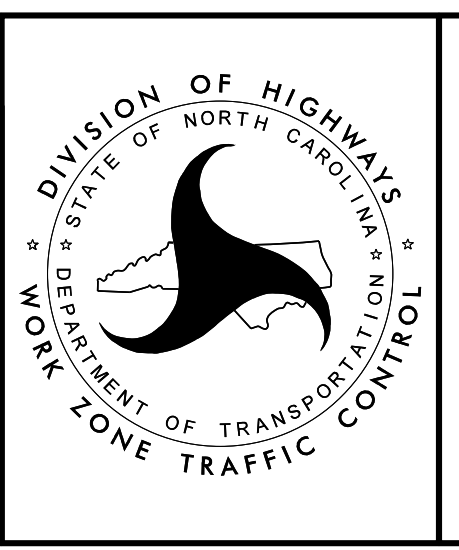

PHASE I - STEP 6

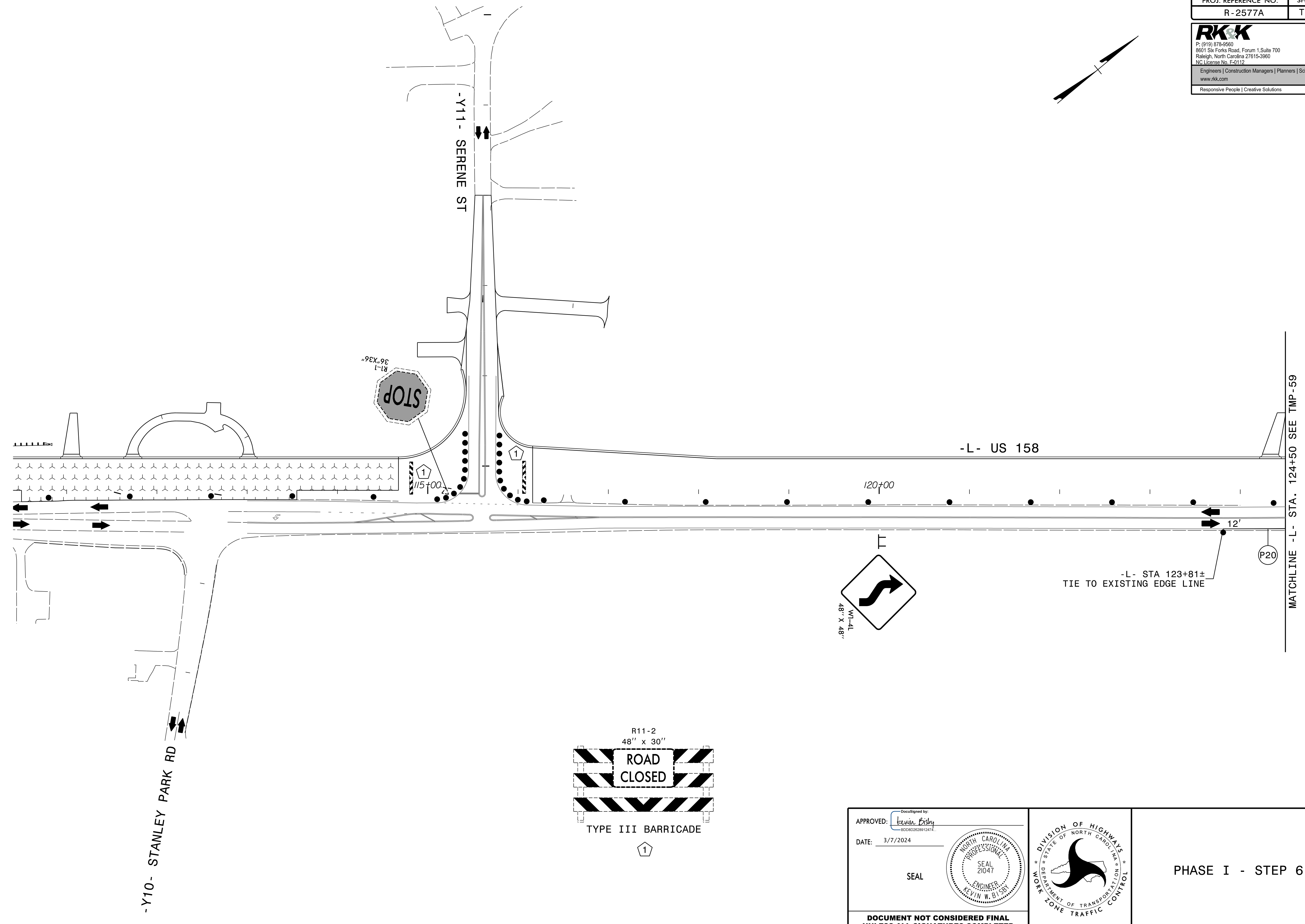
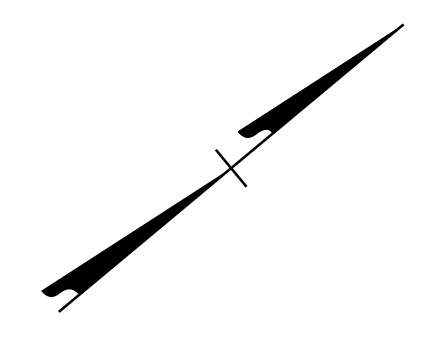

3/7/2024  
 R-2577A\_tmp\_pst58.dgn  
 Kolsby

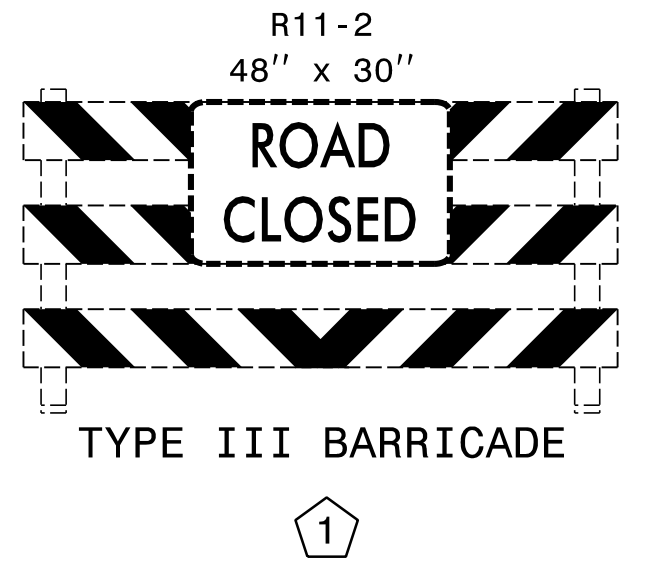

APPROVED: *Kevin Bishop*  
 DATE: 3/7/2024  
 SEAL  
 NORTH CAROLINA PROFESSIONAL ENGINEER  
 SEAL 21047  
 KEVIN W. BISHOP

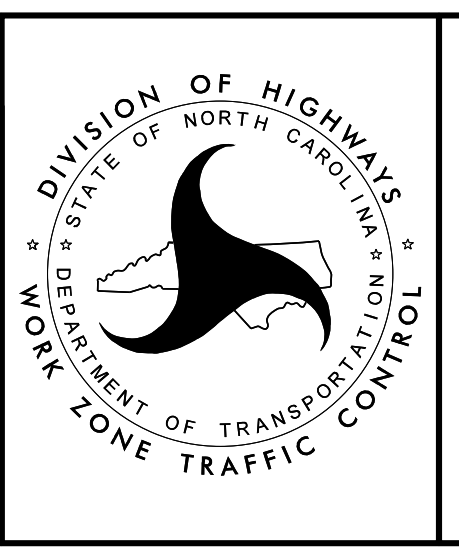

PHASE I - STEP 6

DOCUMENT NOT CONSIDERED FINAL  
UNLESS ALL SIGNATURES COMPLETED

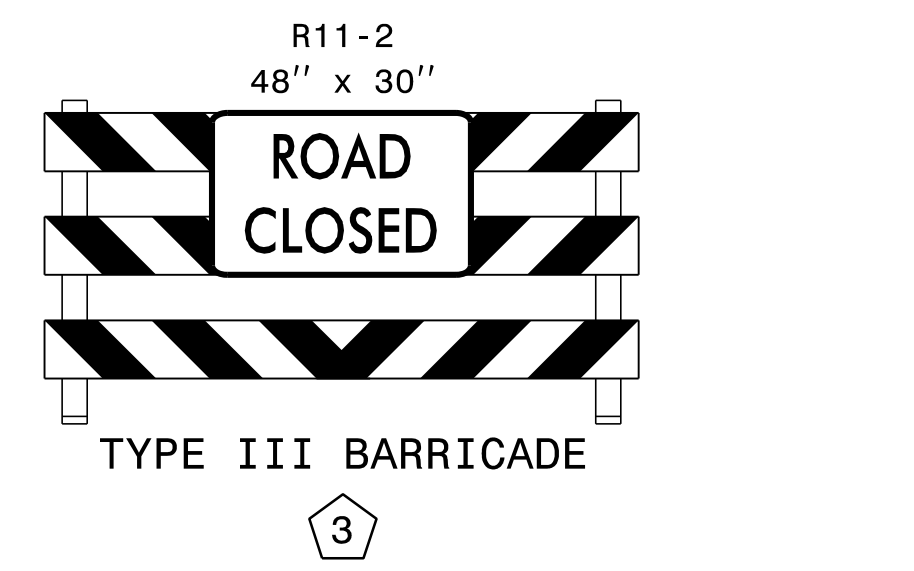
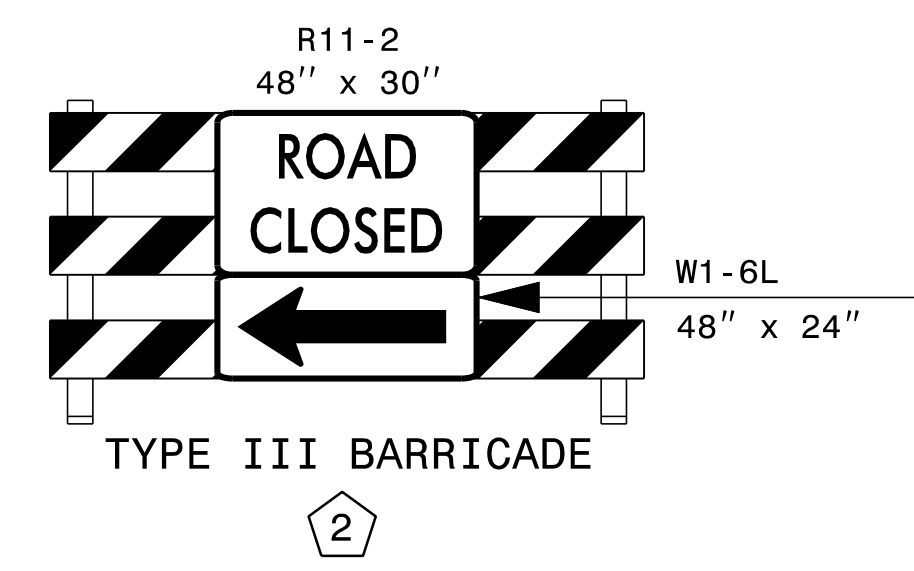
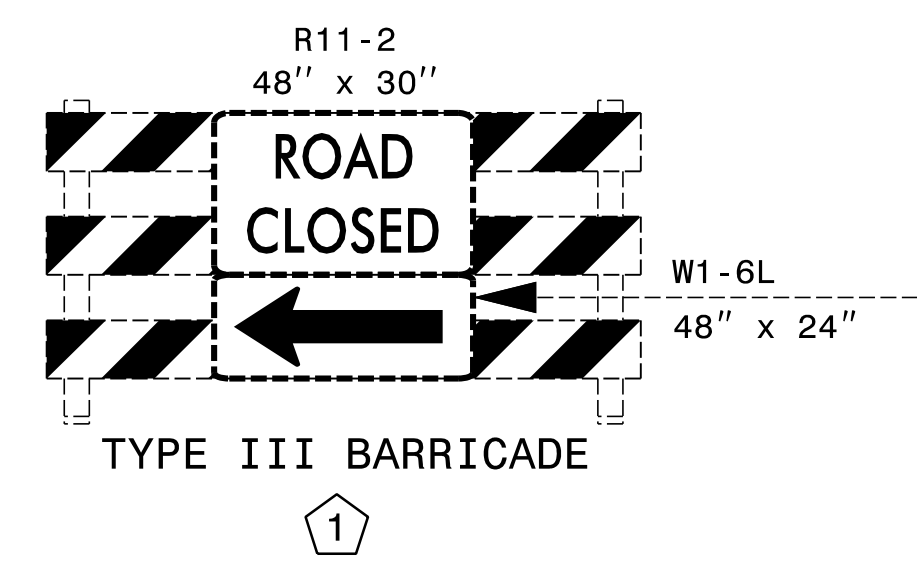
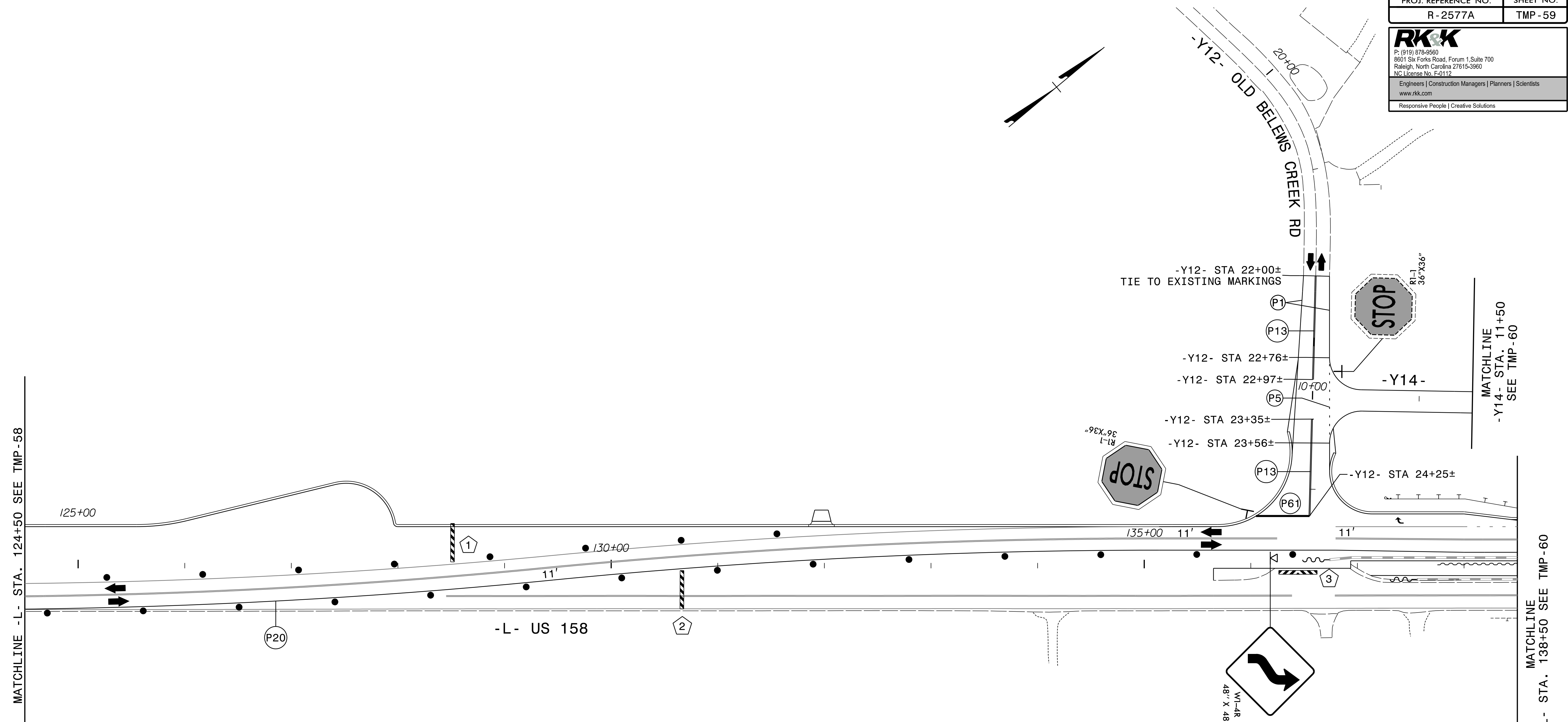

APPROVED: *Kevin Bishy*  
DocuSigned by:  
Kevin Bishy  
800802628912477

DATE: 3/7/2024

SEAL

**SEAL**  
 NORTH CAROLINA  
 PROFESSIONAL  
 ENGINEER  
 KEVIN W. BISHY  
 21047

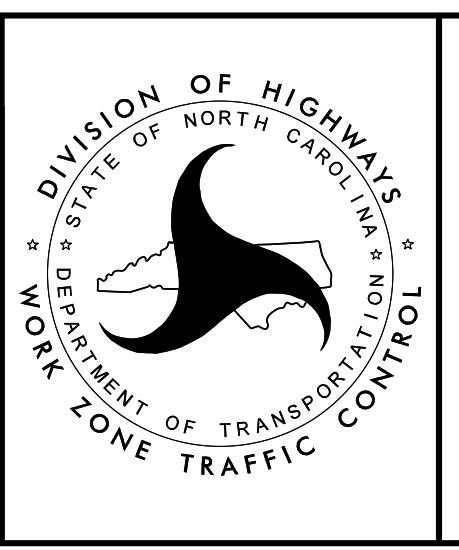

PHASE I - STEP 6

DOCUMENT NOT CONSIDERED FINAL  
 UNLESS ALL SIGNATURES COMPLETED

3/7/2024  
 R-2577A\_Tmp\_pst59.dgn  
 KRobby

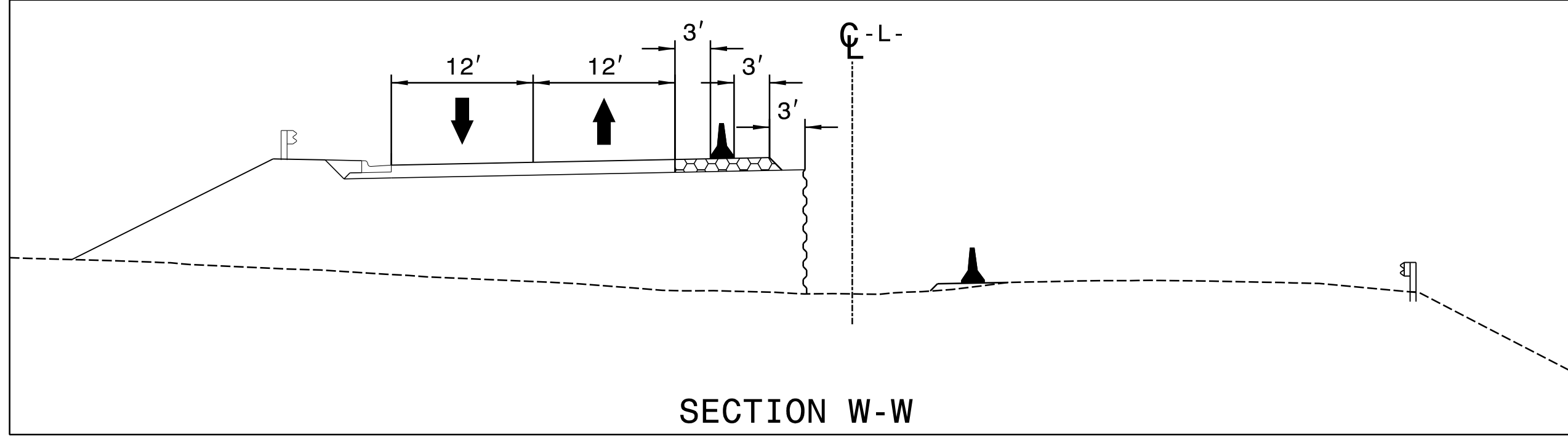
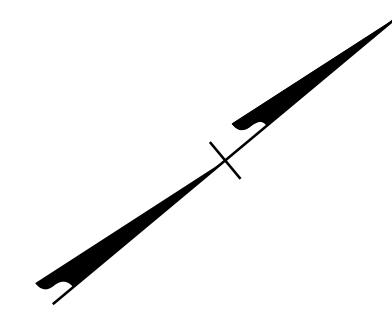

MATCHLINE  
-Y14- STA. 11+50  
SEE TMP-59

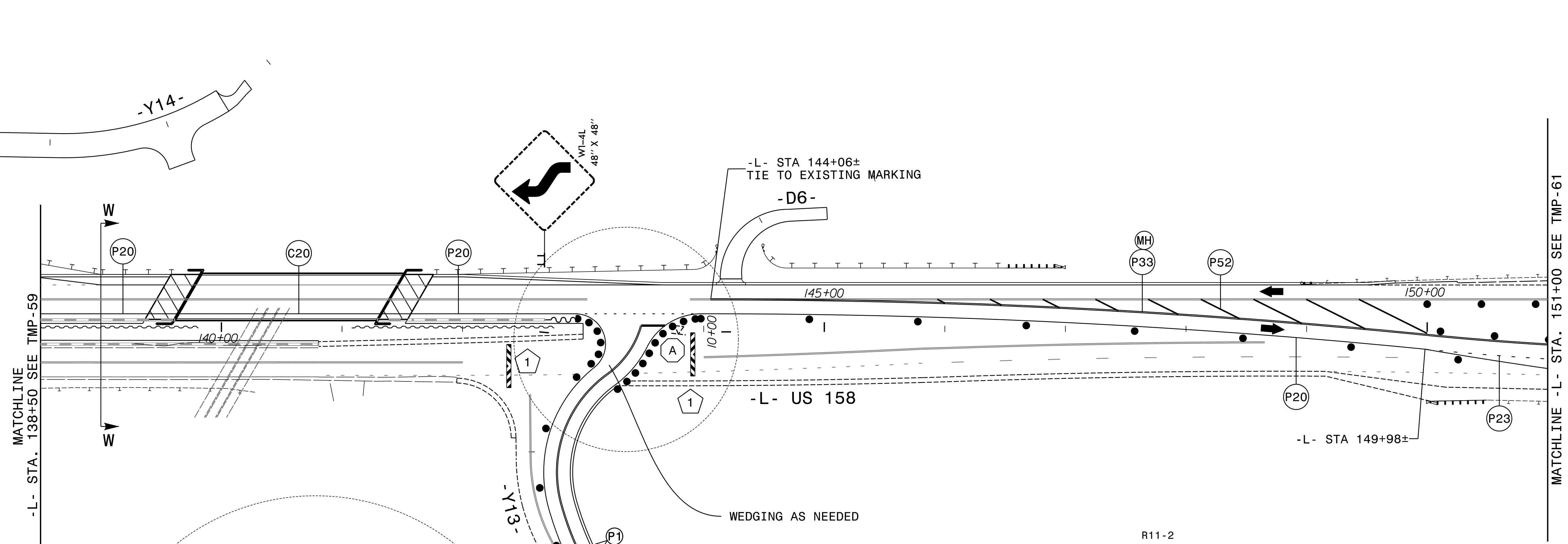

MATCHLINE  
-L- STA. 138+50 SEE TMP-59

MATCHLINE -L- STA. 151+00 SEE TMP-61

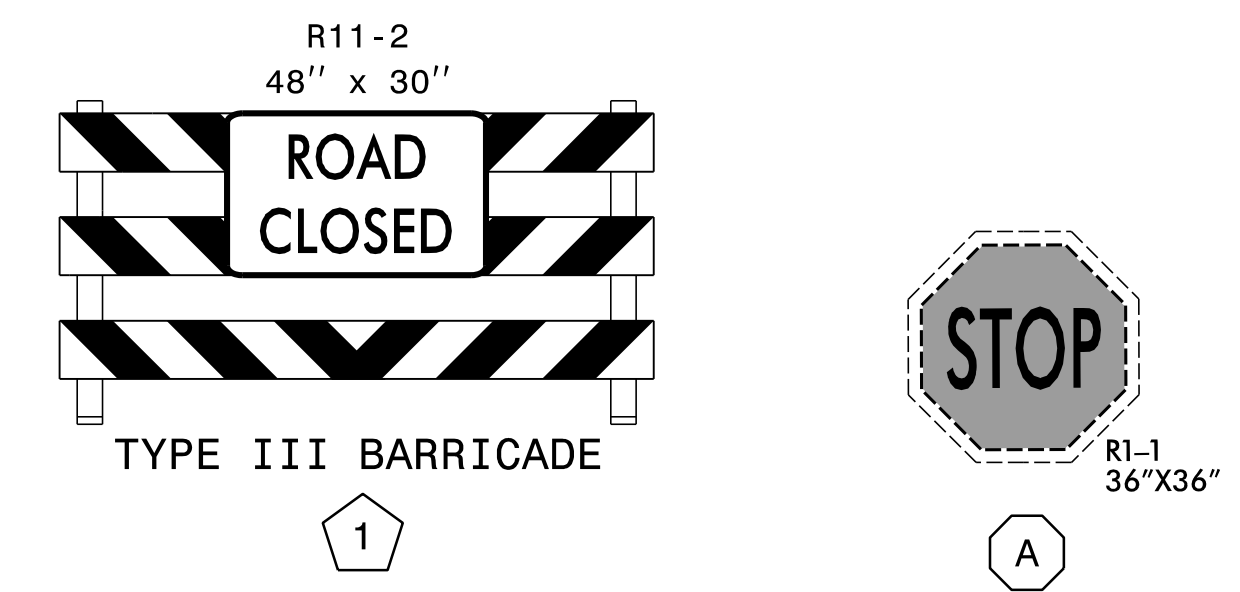
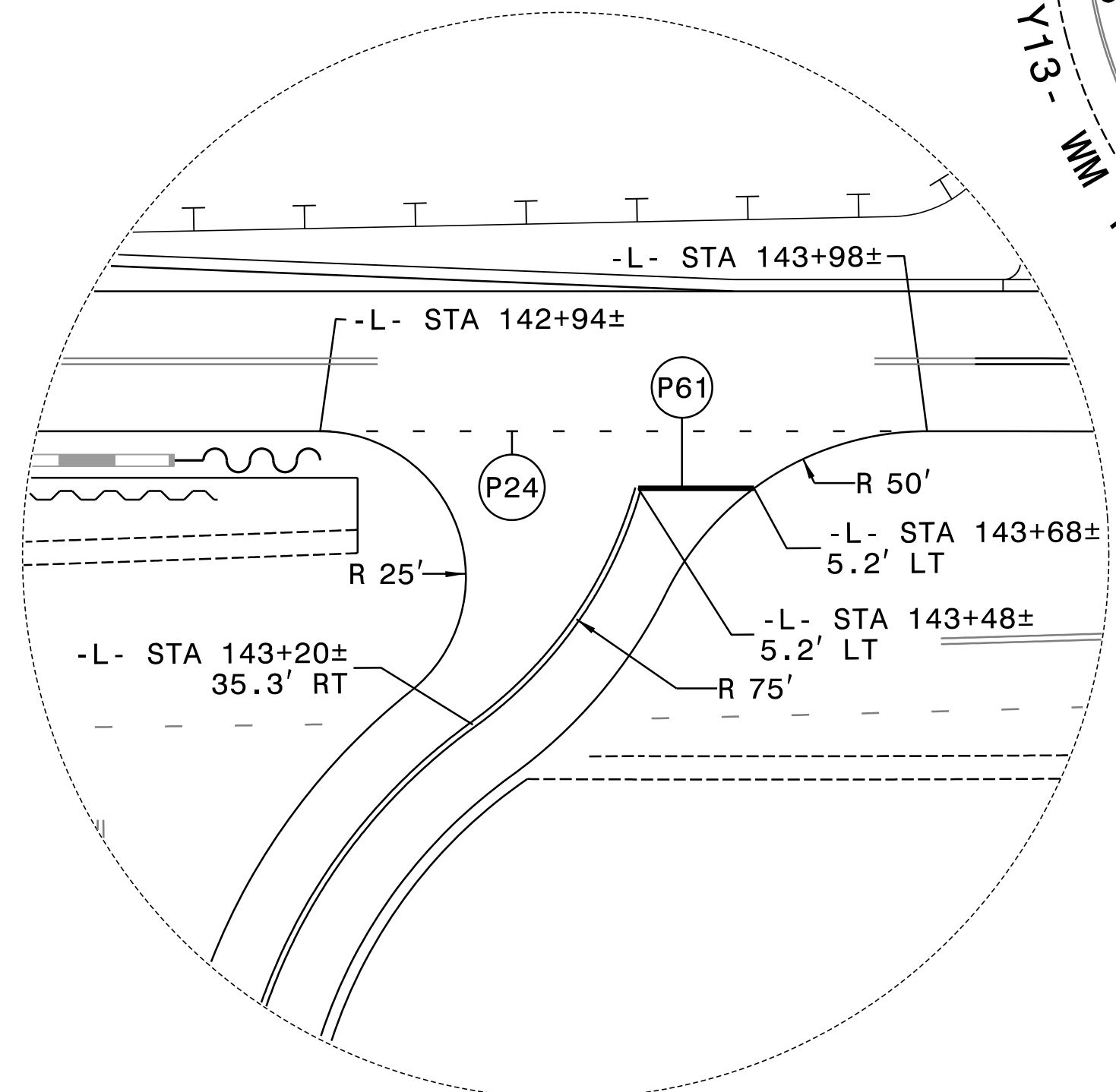

SEE TMP-60A FOR PAVEMENT MARKING ALIGNMENT

APPROVED: *Kevin Bishy*  
 DATE: 3/7/2024

SEAL

PHASE I - STEP 6

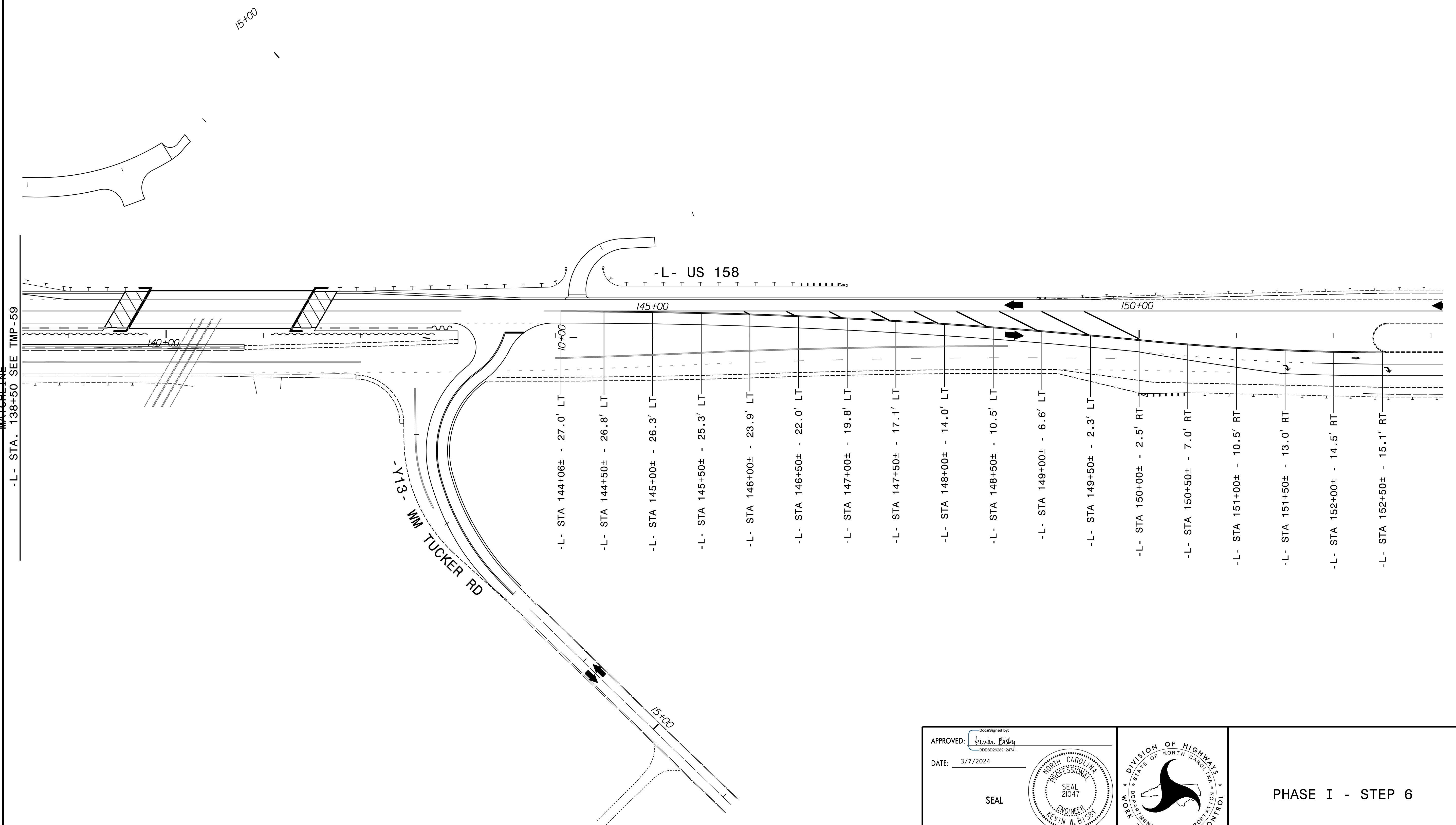
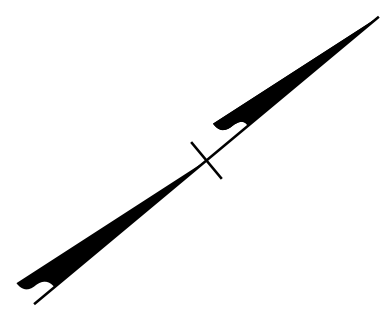

3/7/2024  
 R-2577A\_tmp\_psh60A.dgn  
 K01sby

APPROVED: *Kevin Bisby*  
DocuSigned by: Kevin Bisby  
 B0C802628912472

DATE: 3/7/2024

SEAL

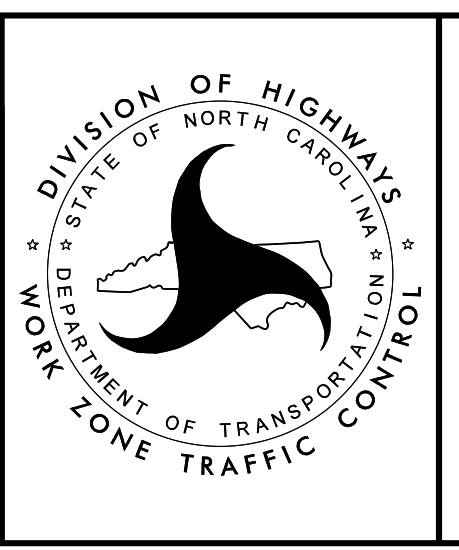

PHASE I - STEP 6

**DOCUMENT NOT CONSIDERED FINAL  
 UNLESS ALL SIGNATURES COMPLETED**

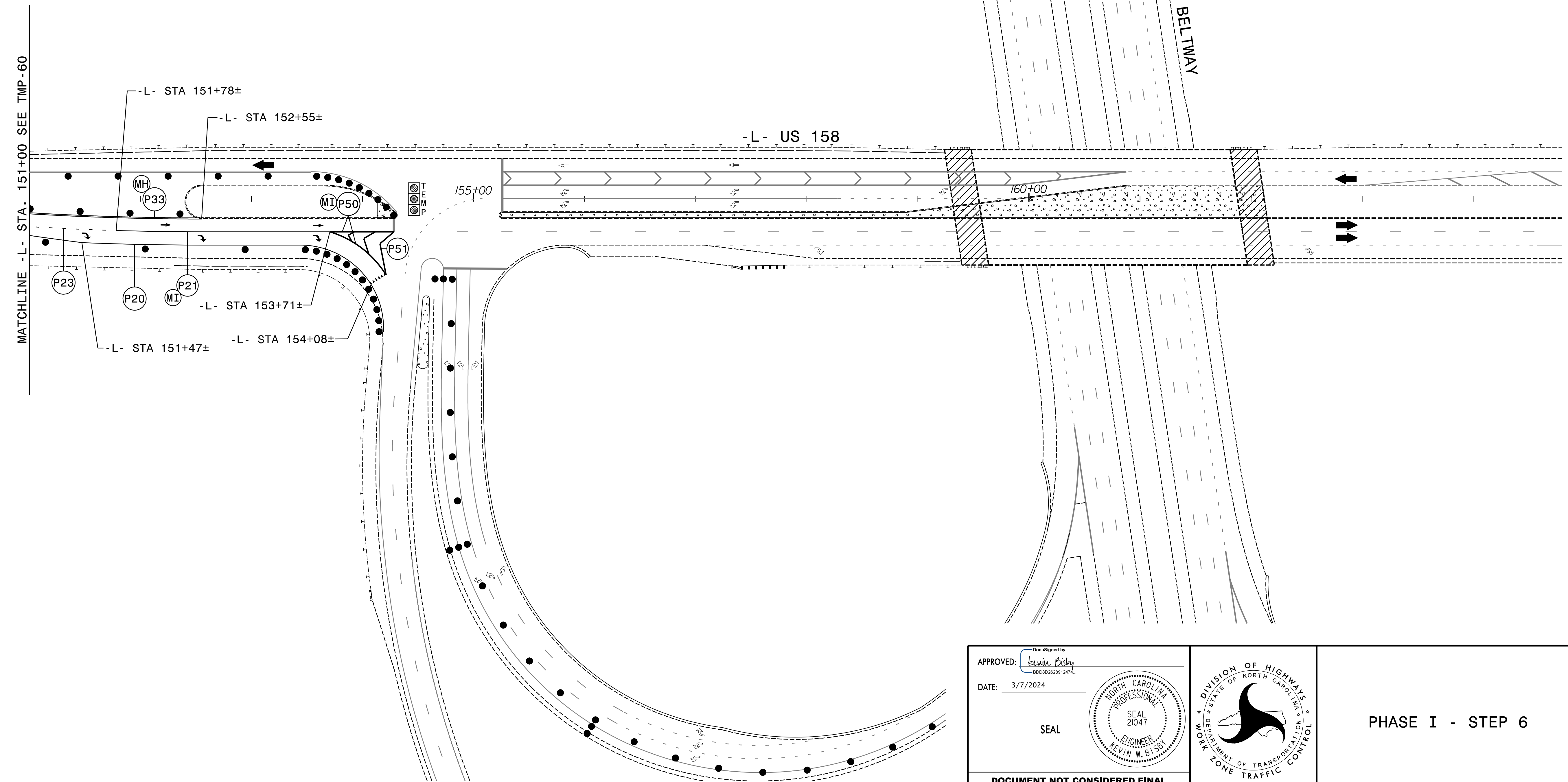
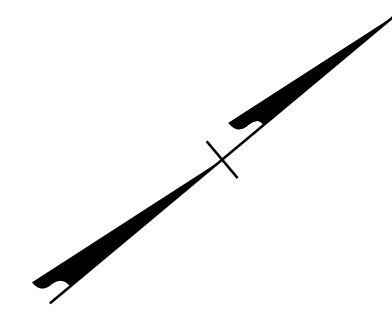

3/7/2024  
 R-2577A\_tmp\_psh61.dgn  
 KRobby

APPROVED: *Kevin Bishop*  
DocuSigned by: Kevin Bishop  
 8D0802628912472

DATE: 3/7/2024

SEAL

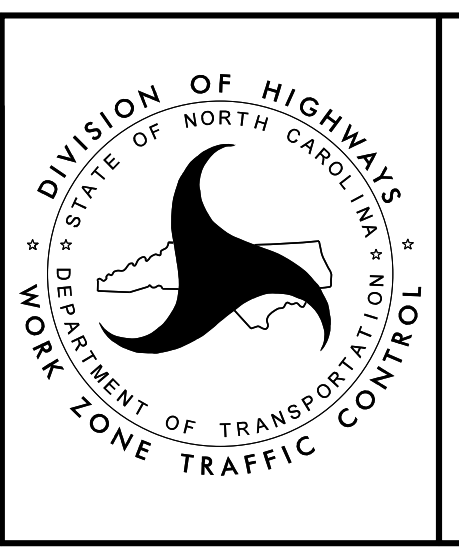

PHASE I - STEP 6

DOCUMENT NOT CONSIDERED FINAL  
 UNLESS ALL SIGNATURES COMPLETED

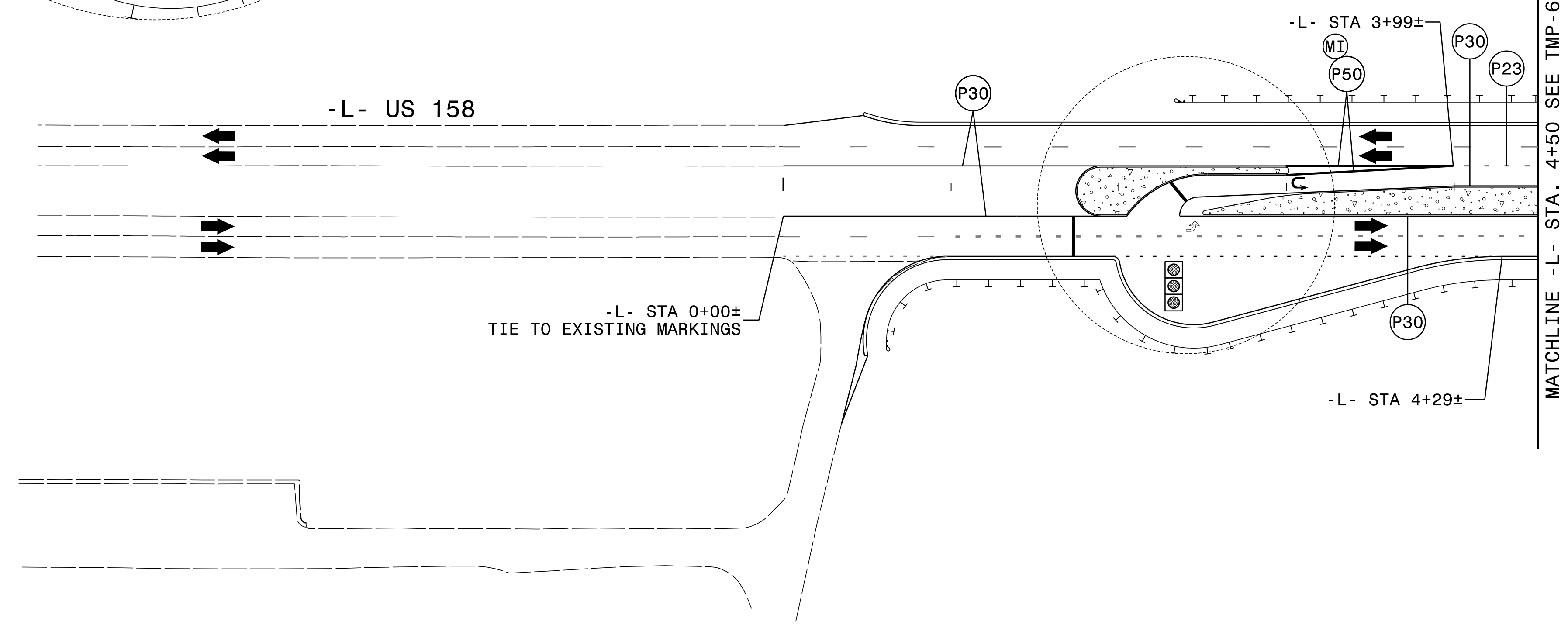
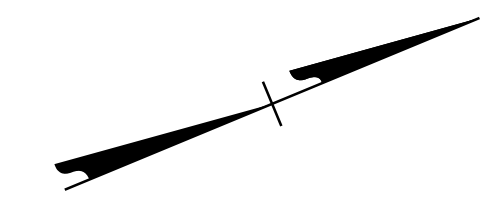
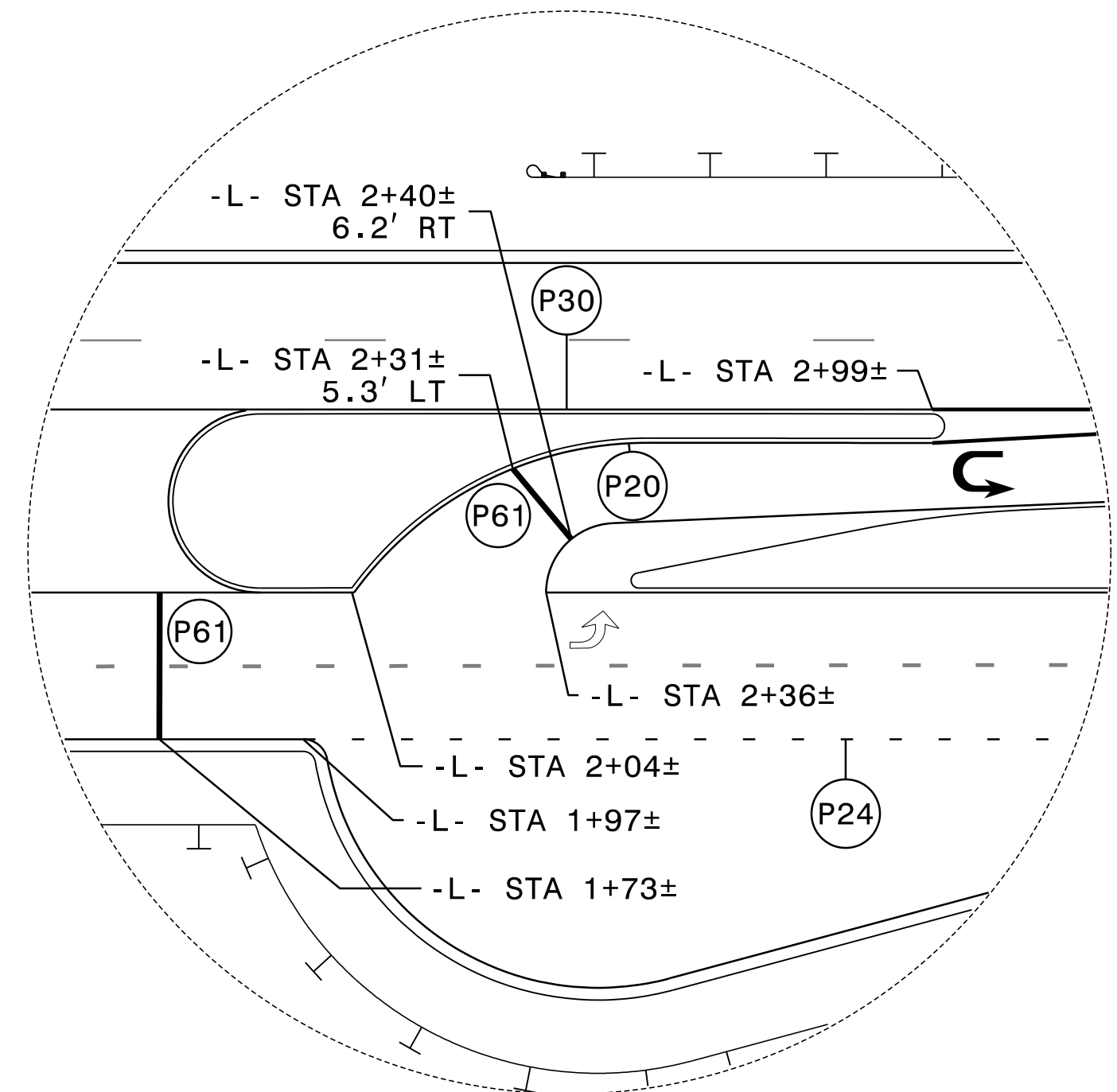

3/7/2024  
 R-2577A\_tmp\_psh62.dgn  
 Kolsby

ERECT PROPOSED SIGNS AS APPLICABLE

APPROVED: *Kevin Bishy*  
DocuSigned by: Kevin Bishy  
 B0C8D2628912477

DATE: 3/7/2024

SEAL

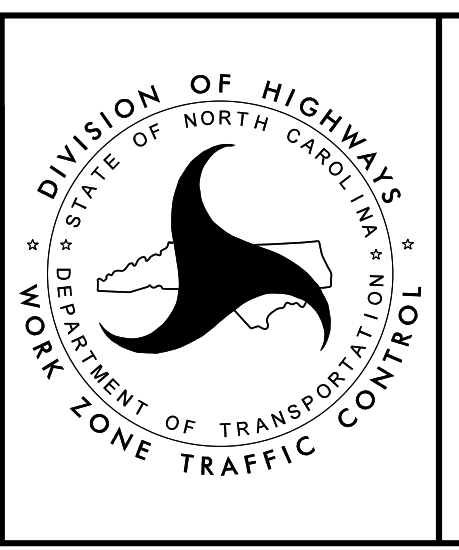

PHASE II - STEP 1

DOCUMENT NOT CONSIDERED FINAL  
 UNLESS ALL SIGNATURES COMPLETED

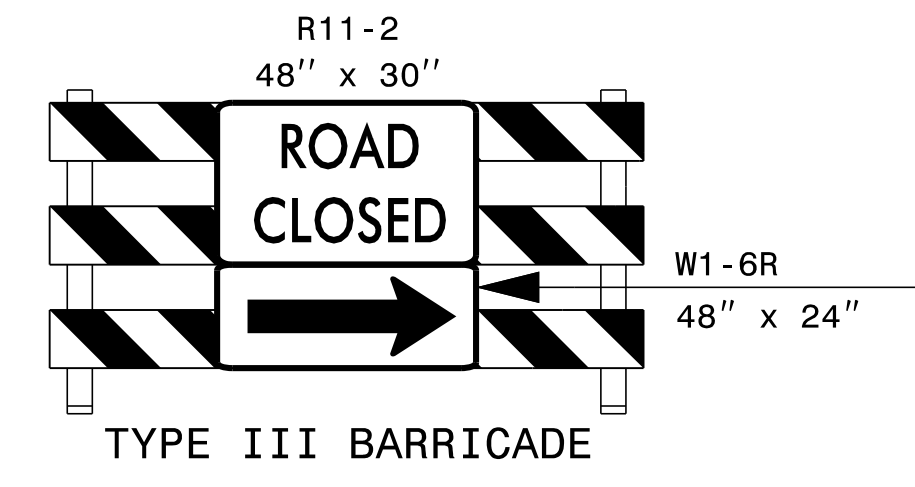
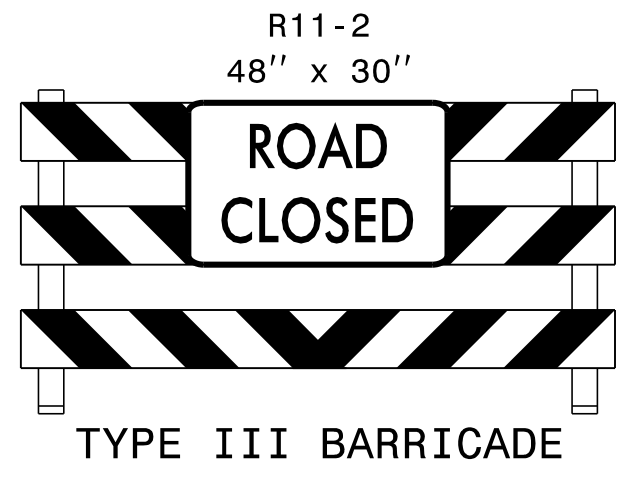
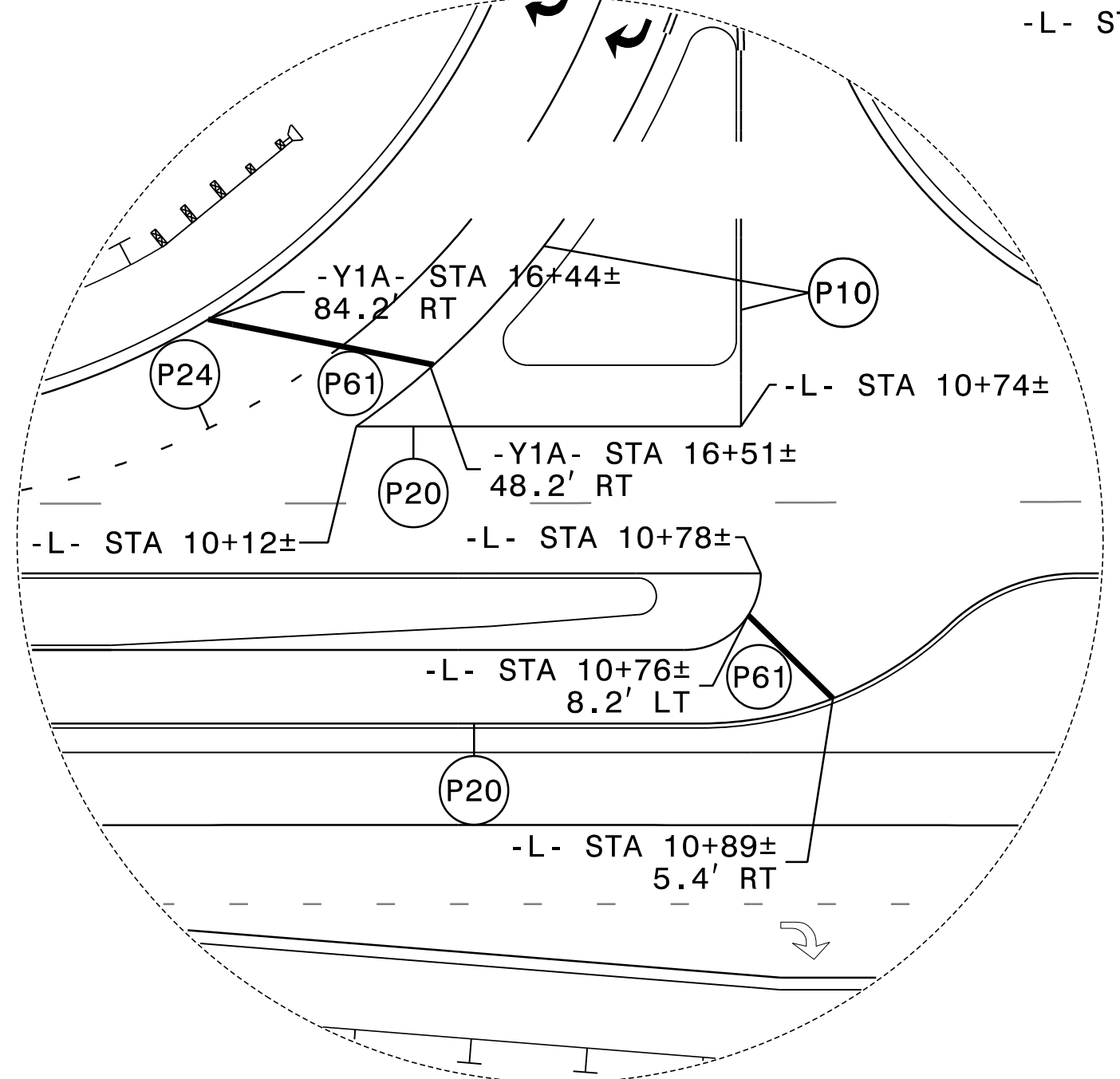
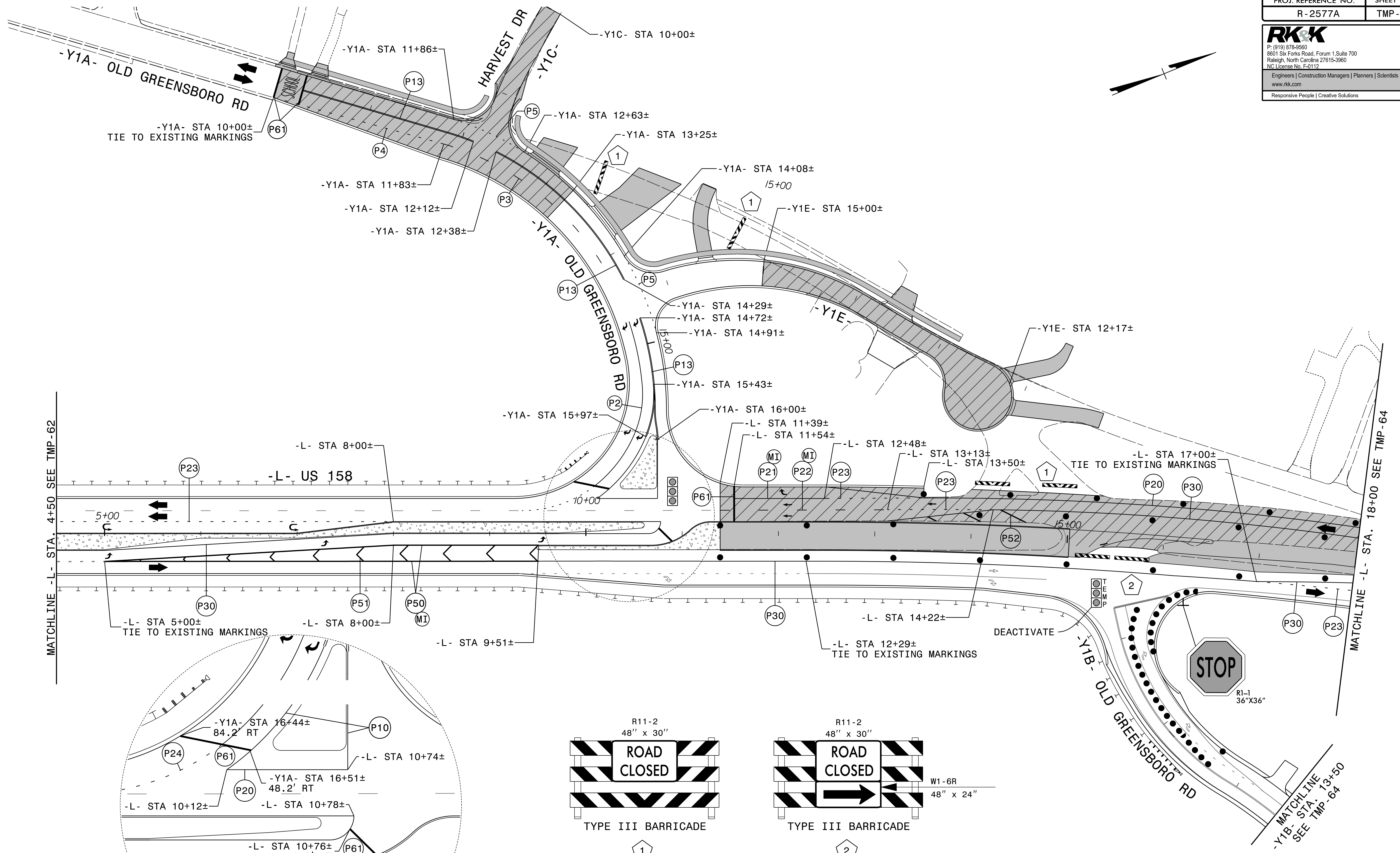
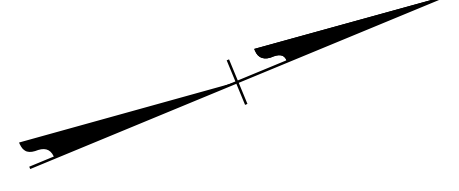

SEE TMP-63A FOR PAVEMENT MARKING LAYOUT  
 ERECT PROPOSED SIGNS AS APPLICABLE

APPROVED: *Kevin Bishy*  
 DATE: 3/7/2024

SEAL

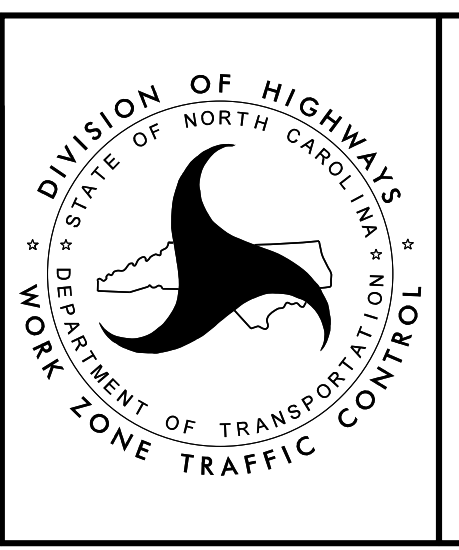

PHASE II - STEP 1 AND 2

3/7/2024  
 R-2577A\_tmp\_psh63.dgn  
 Robby



PROJ. REFERENCE NO.	SHEET NO.
R-2577A	TMP-63A

**RKK**  
 P: (919) 878-8560  
 8601 Six Forks Road, Forum 1, Suite 700  
 Raleigh, North Carolina 27615-3960  
 NC License No. F-0112  
 Engineers | Construction Managers | Planners | Scientists  
 www.rkk.com  
 Responsive People | Creative Solutions

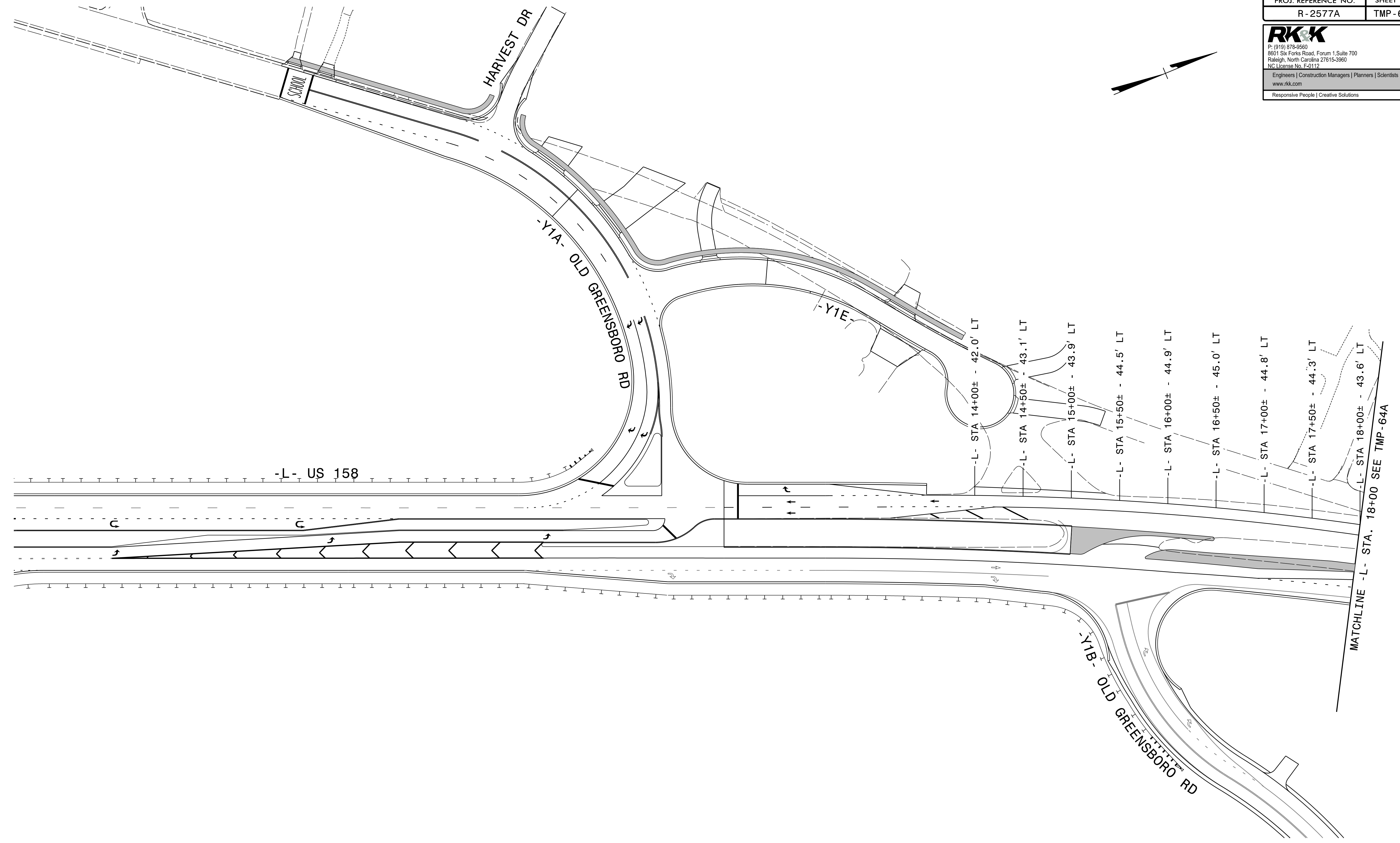
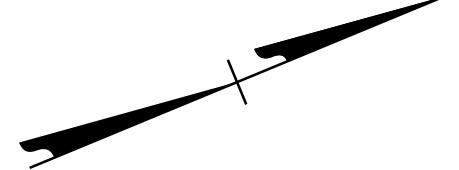

3/7/2024  
 R-2577A\_tmp\_psh63A.dgn  
 KRobby

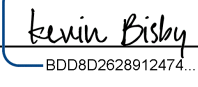
APPROVED:   
DocuSigned by: Kevin Bishop  
 B0C80262891247

DATE: 3/7/2024

SEAL

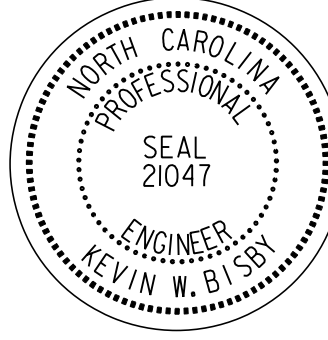
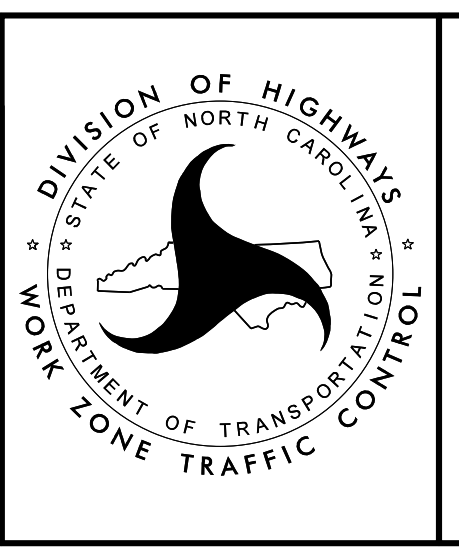
PHASE II - STEP 1 AND 2

DOCUMENT NOT CONSIDERED FINAL  
 UNLESS ALL SIGNATURES COMPLETED

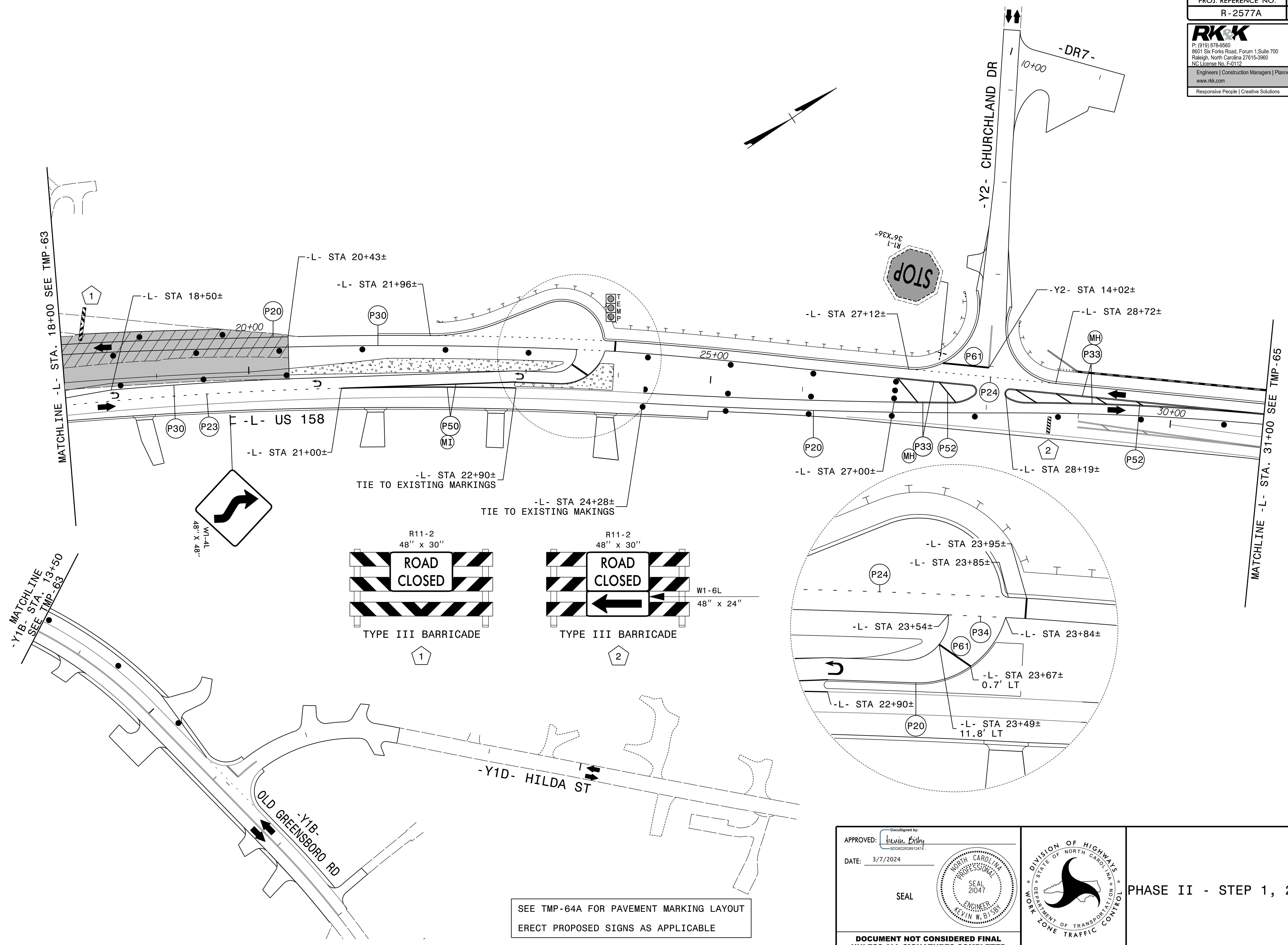

3/7/2024  
 R-2577A\_tmp\_psh64.dgn  
 Rolsby

SEE TMP-64A FOR PAVEMENT MARKING LAYOUT  
 ERECT PROPOSED SIGNS AS APPLICABLE

APPROVED: *Kevin Bishy*  
 DATE: 3/7/2024

SEAL

DOCUMENT NOT CONSIDERED FINAL  
 UNLESS ALL SIGNATURES COMPLETED

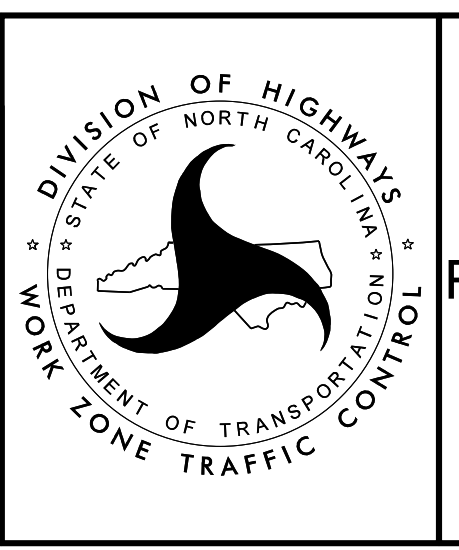

DIVISION OF HIGHWAYS  
 NORTH CAROLINA  
 DEPARTMENT OF TRANSPORTATION  
 WORK ZONE TRAFFIC CONTROL

PHASE II - STEP 1, 2 AND 3

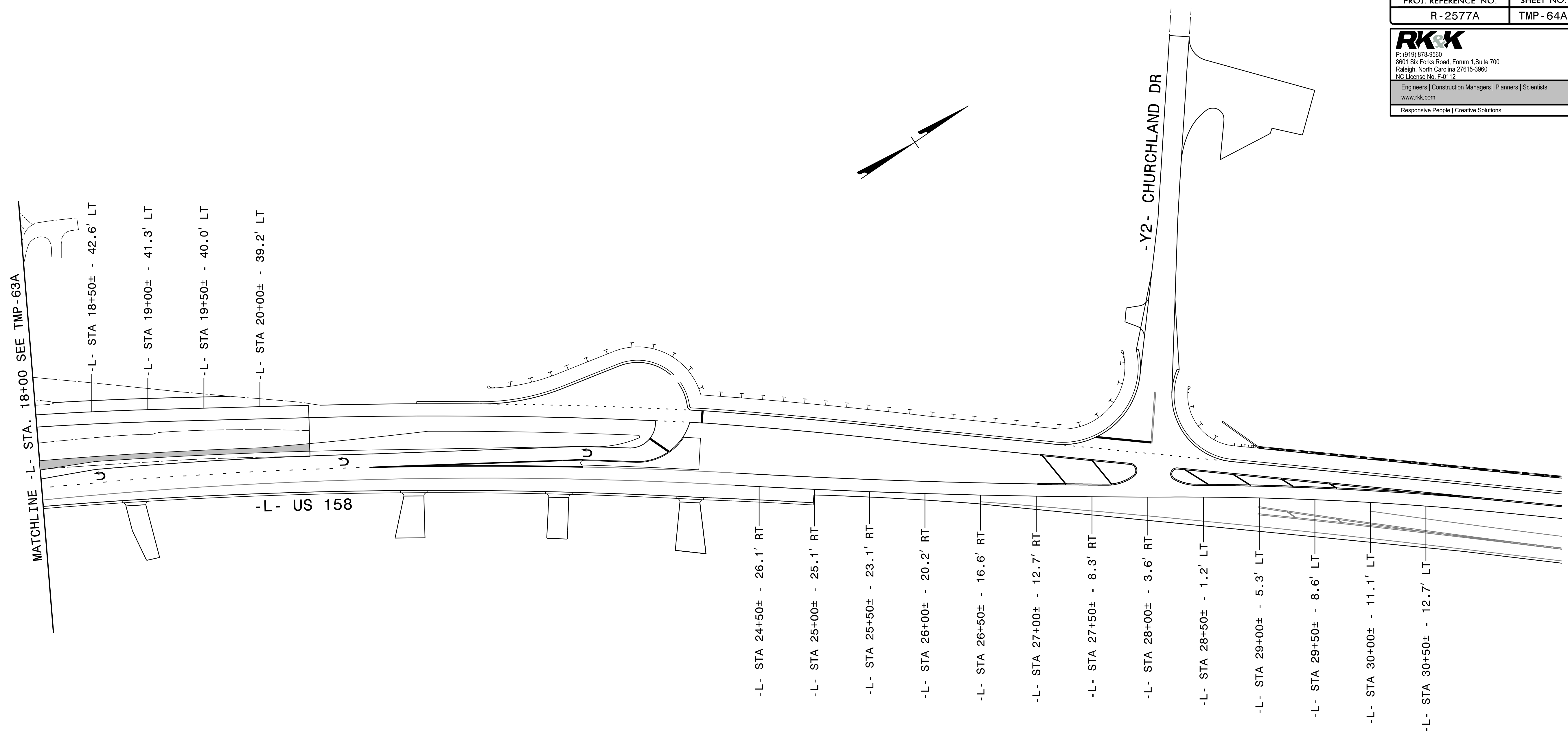

3/7/2024  
 R-2577A\_tmp\_psh64a.dgn  
 KRobby

APPROVED:   
DocuSigned by: Kevin Bishop  
B0C802628912472

DATE: 3/7/2024

SEAL

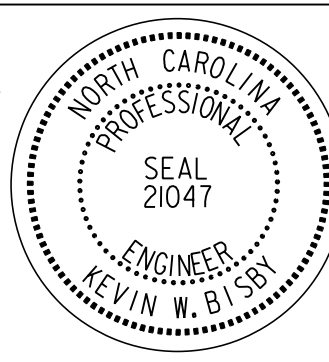
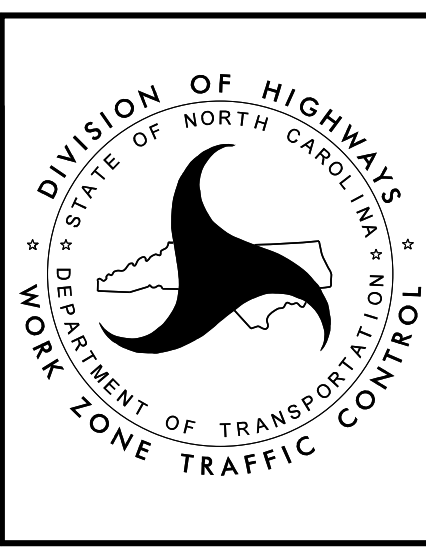
PHASE II - STEP 1, 2 AND 3

**DOCUMENT NOT CONSIDERED FINAL  
 UNLESS ALL SIGNATURES COMPLETED**

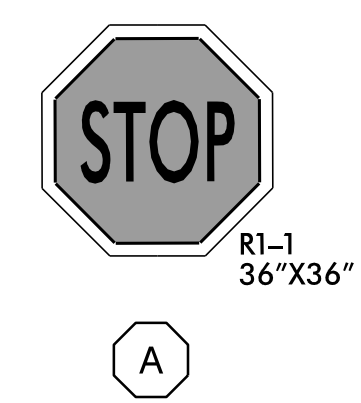
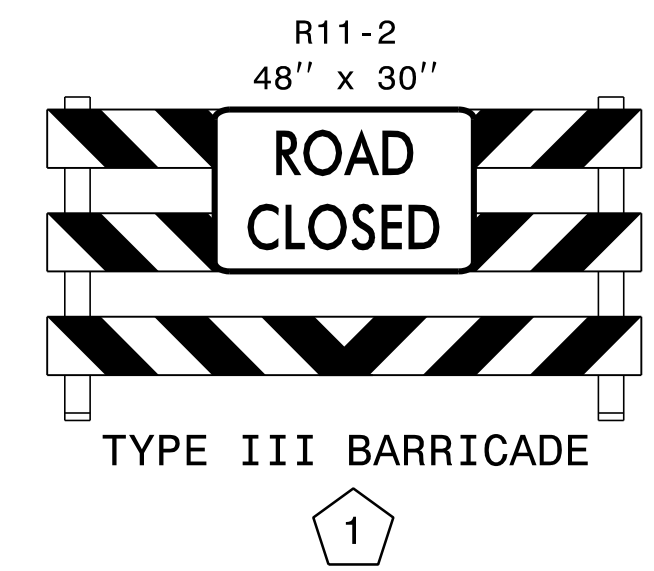
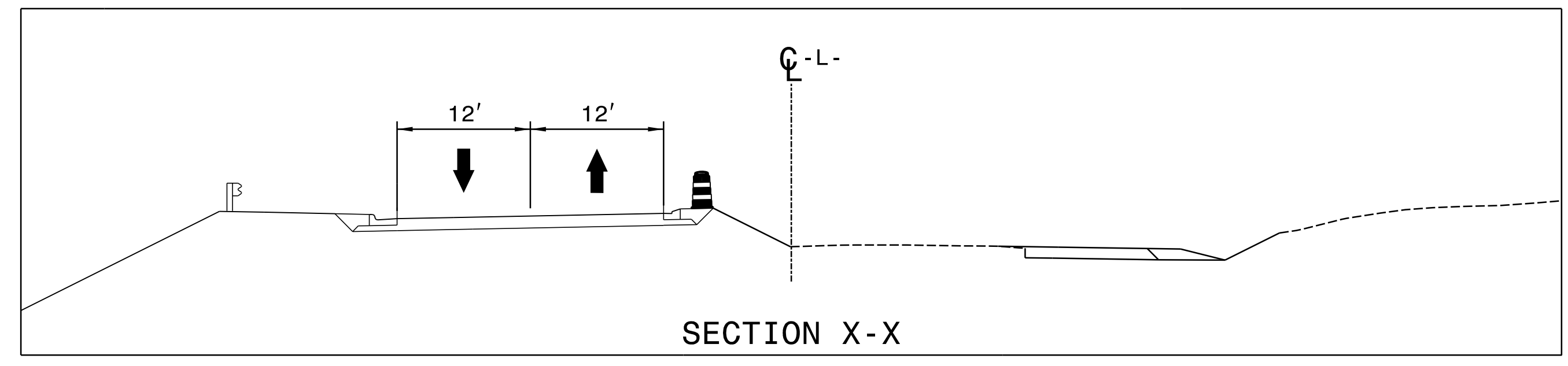
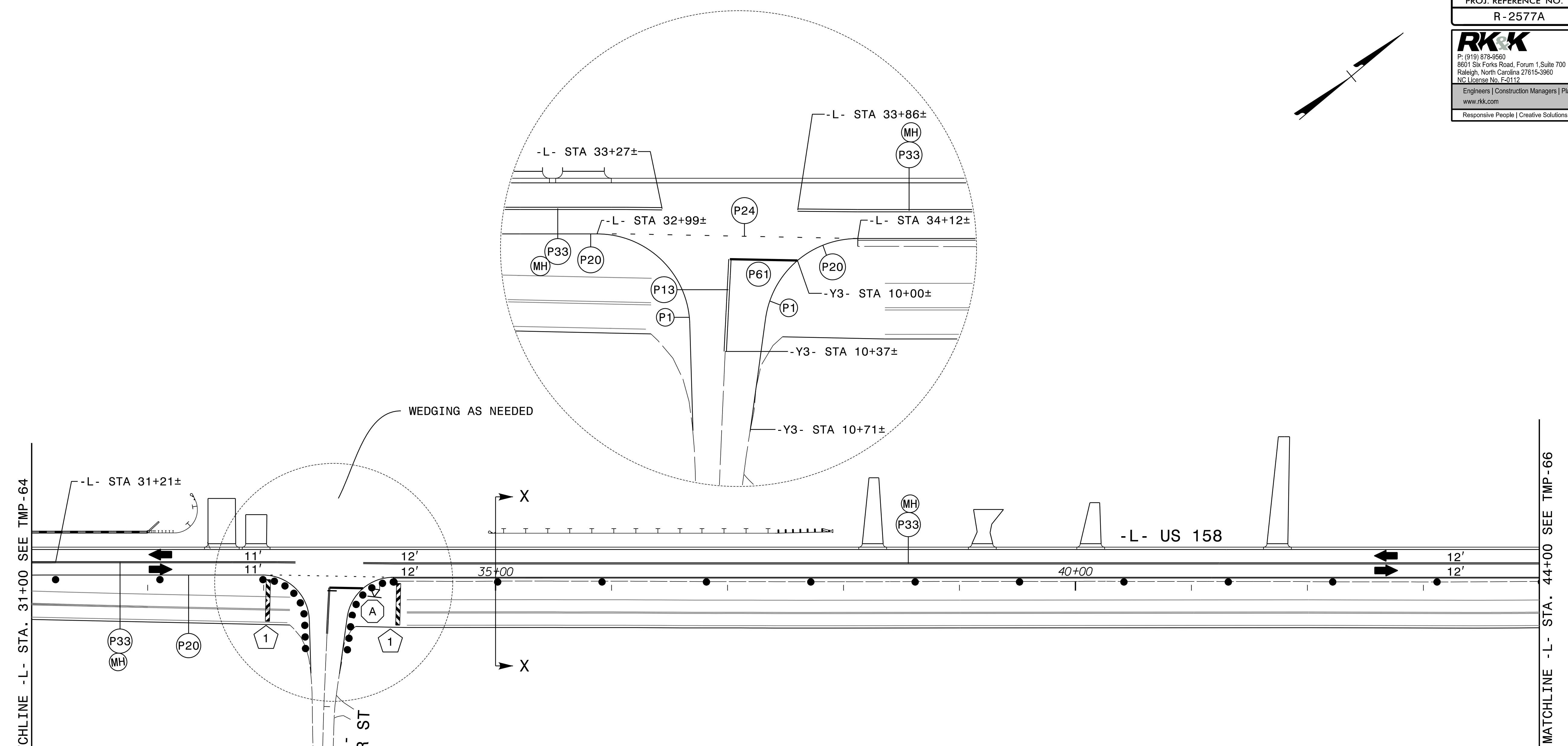
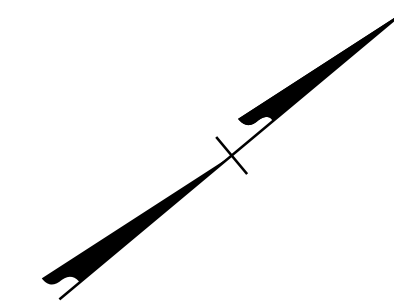

APPROVED: *Kevin Bisby*  
 DATE: 3/7/2024

SEAL

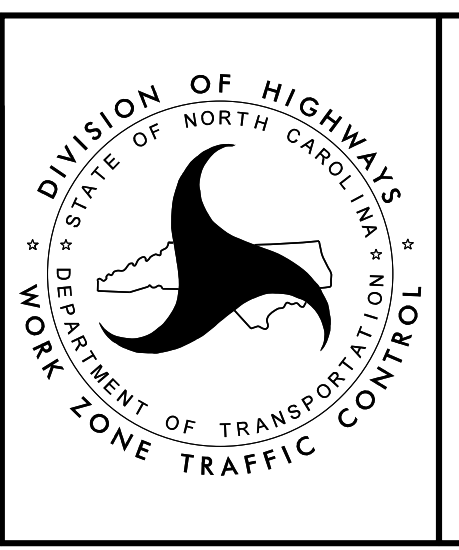

PHASE II - STEP 3

3/7/2024  
 R-2577A\_tmp\_psh65.dgn  
 K.Bisby

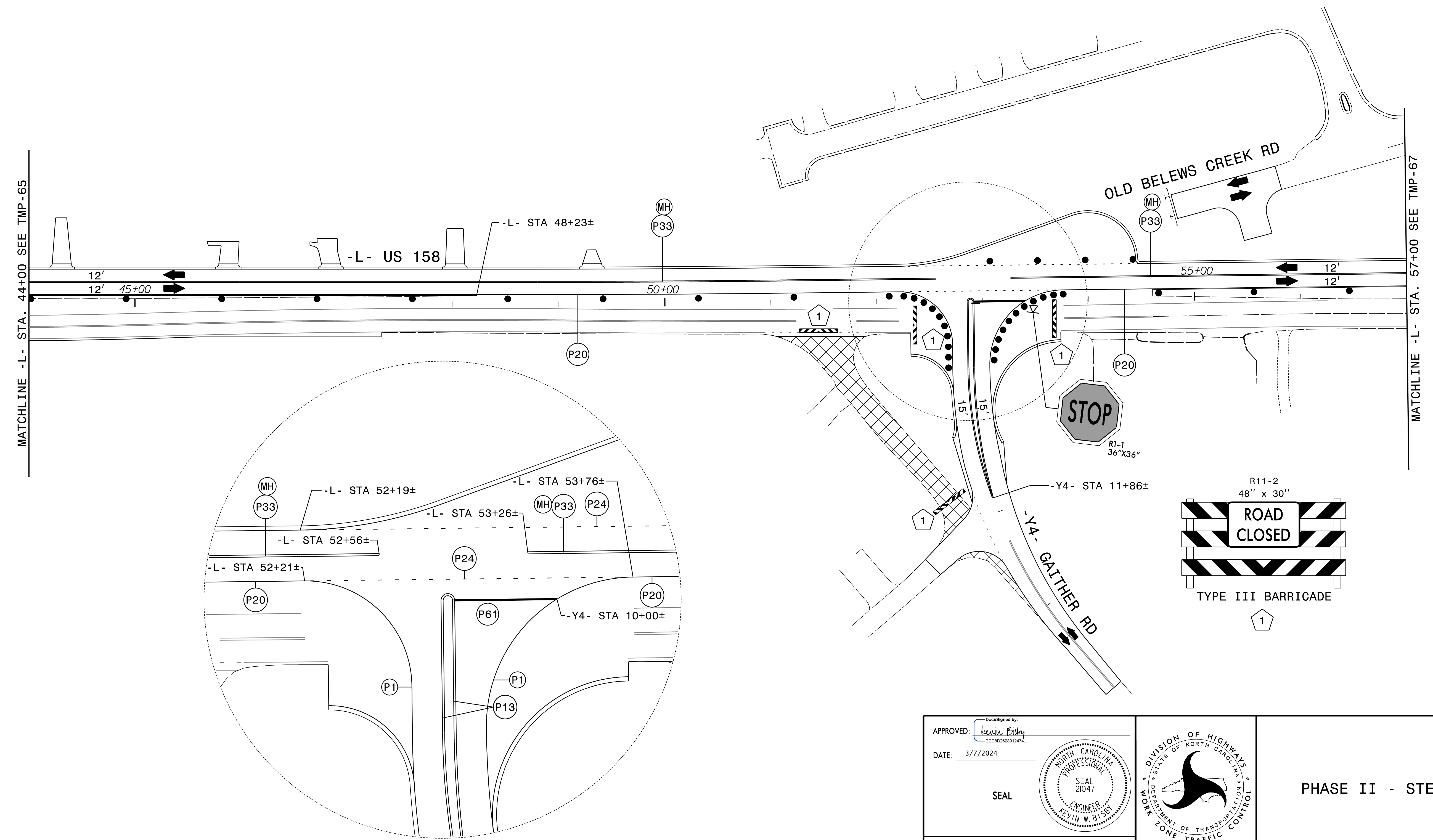
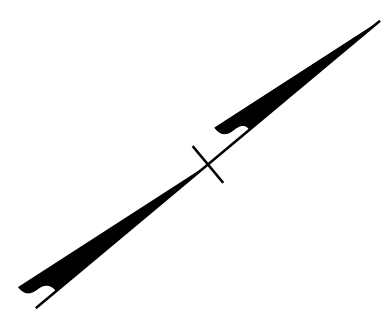

3/7/2024  
 R-2577A\_tmp\_psh66.dgn  
 KRobby

APPROVED: *Kevin Bishy*  
DocuSigned by: Kevin Bishy  
 B0C802628912472

DATE: 3/7/2024

SEAL

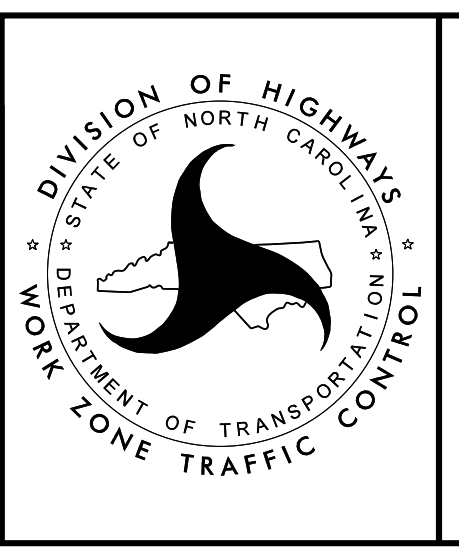

PHASE II - STEP 3

**DOCUMENT NOT CONSIDERED FINAL  
 UNLESS ALL SIGNATURES COMPLETED**

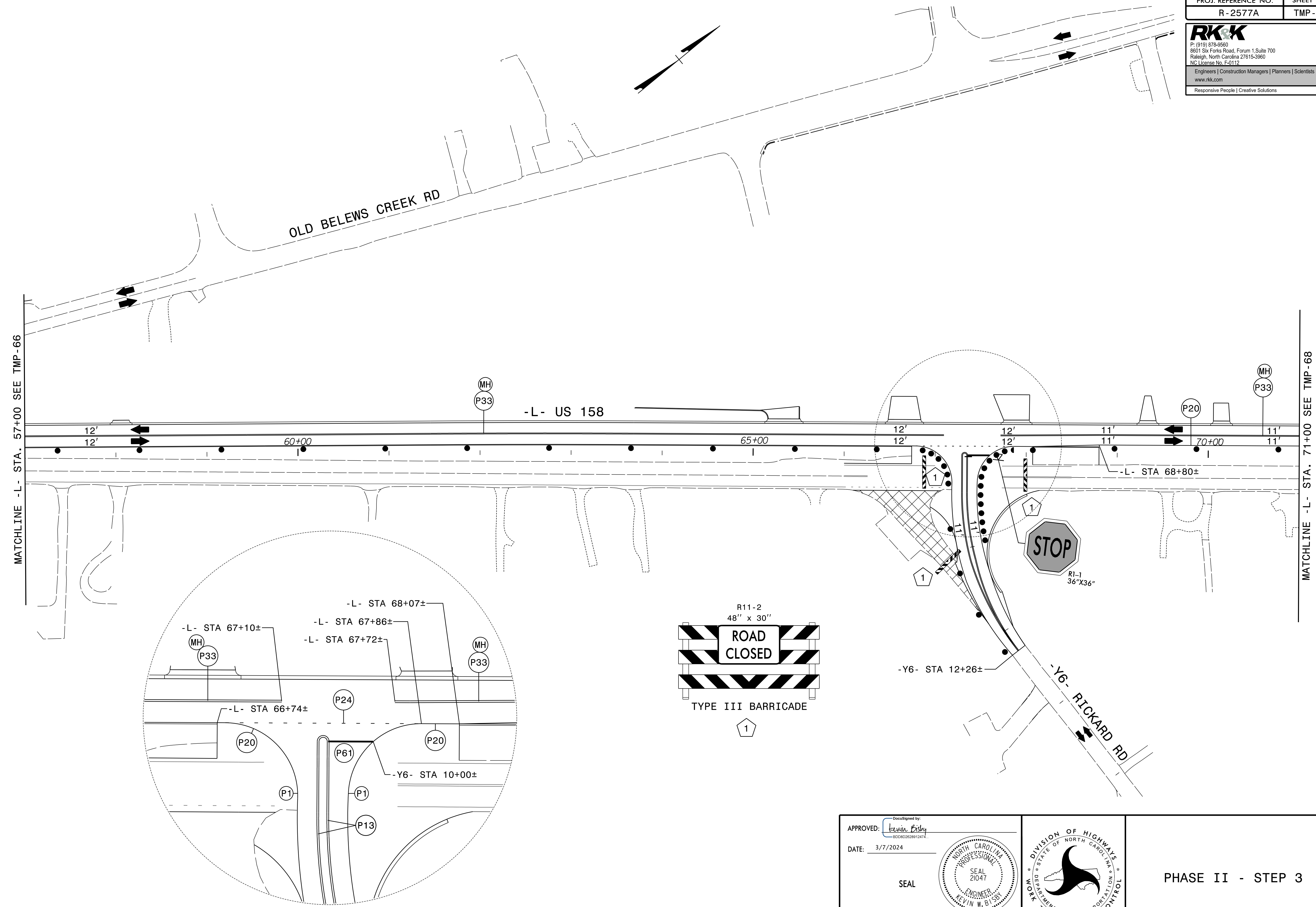

3/7/2024  
 R-2577A\_tmp\_psh67.dgn  
 Kolsby

APPROVED: *Kevin Bishy*  
 DATE: 3/7/2024

SEAL

**PROFESSIONAL ENGINEER**  
 KEVIN W. BISHY  
 SEAL 21047  
 ENGINEER

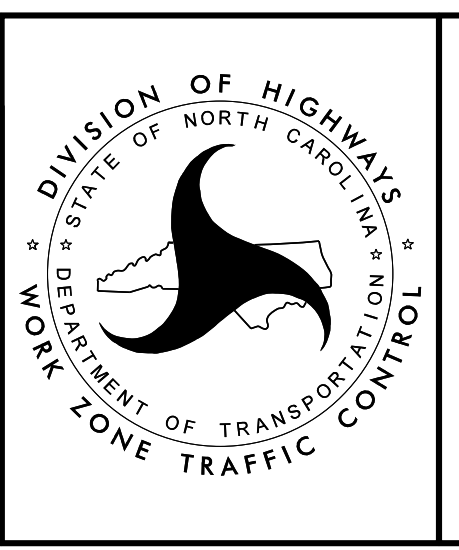

PHASE II - STEP 3

DOCUMENT NOT CONSIDERED FINAL  
 UNLESS ALL SIGNATURES COMPLETED

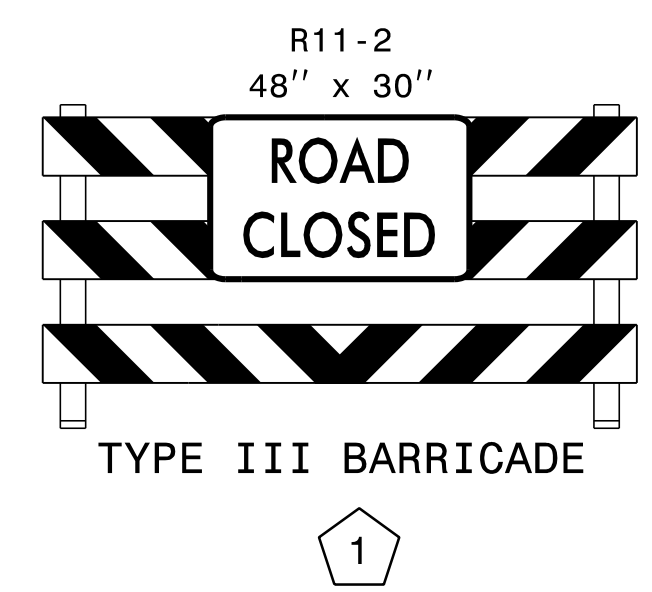
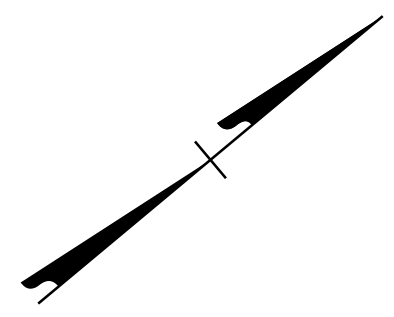
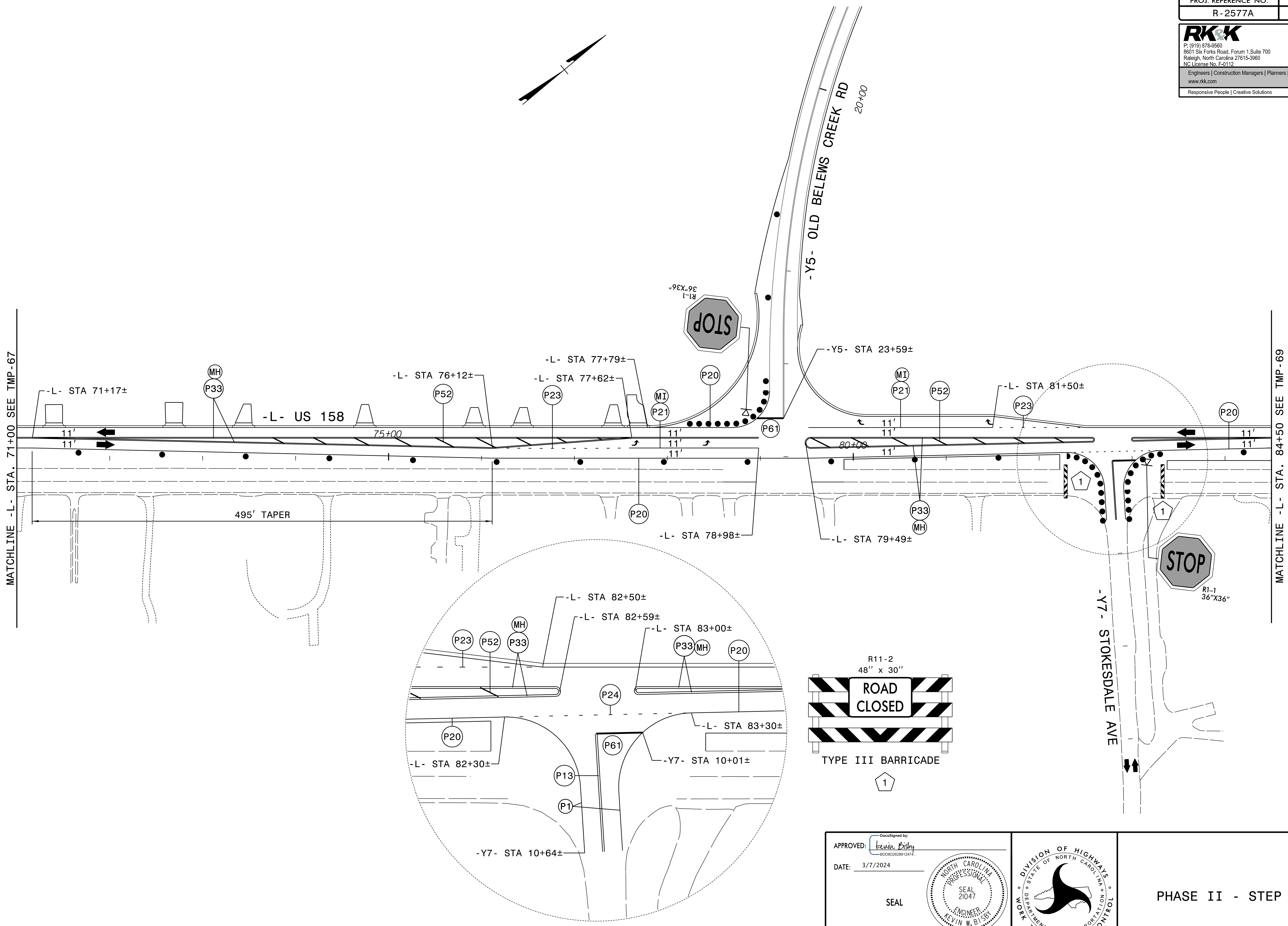

APPROVED: *Kevin Bisby*  
 DATE: 3/7/2024  
 SEAL  
 NORTH CAROLINA PROFESSIONAL ENGINEER  
 KEVIN W. BISBY  
 21047

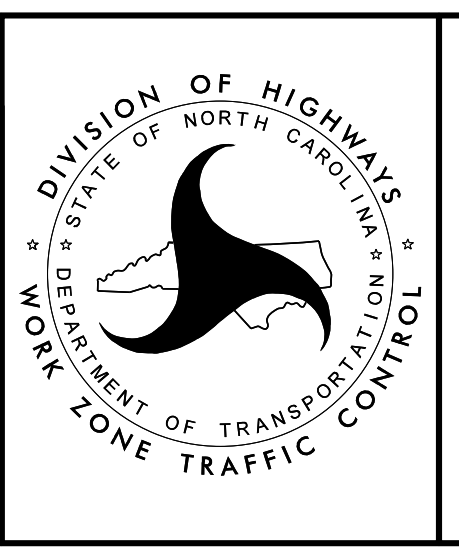

PHASE II - STEP 3

3/7/2024  
 R-2577A\_tmp\_psh68.dgn  
 K.Bisby

DOCUMENT NOT CONSIDERED FINAL  
 UNLESS ALL SIGNATURES COMPLETED

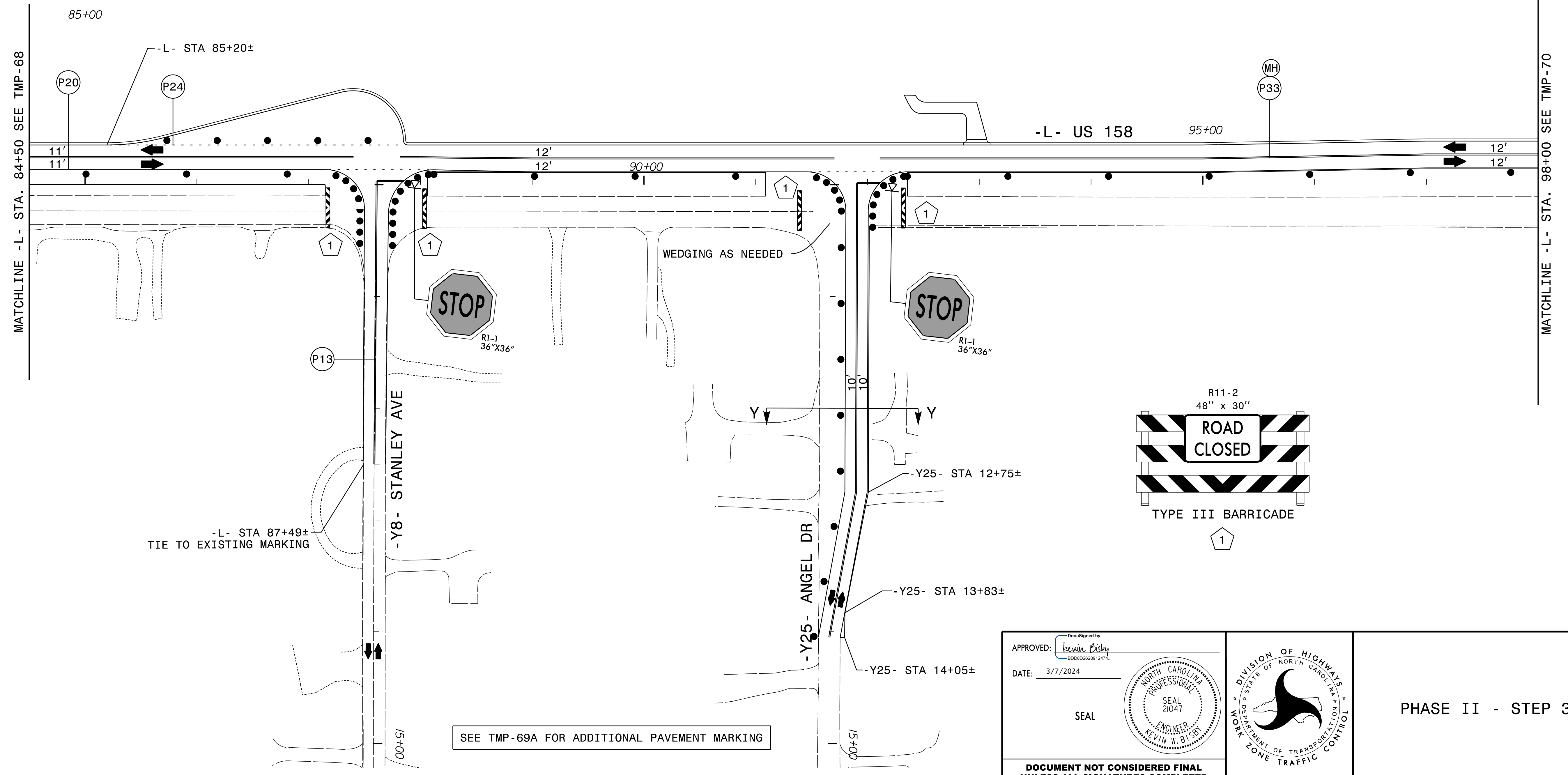
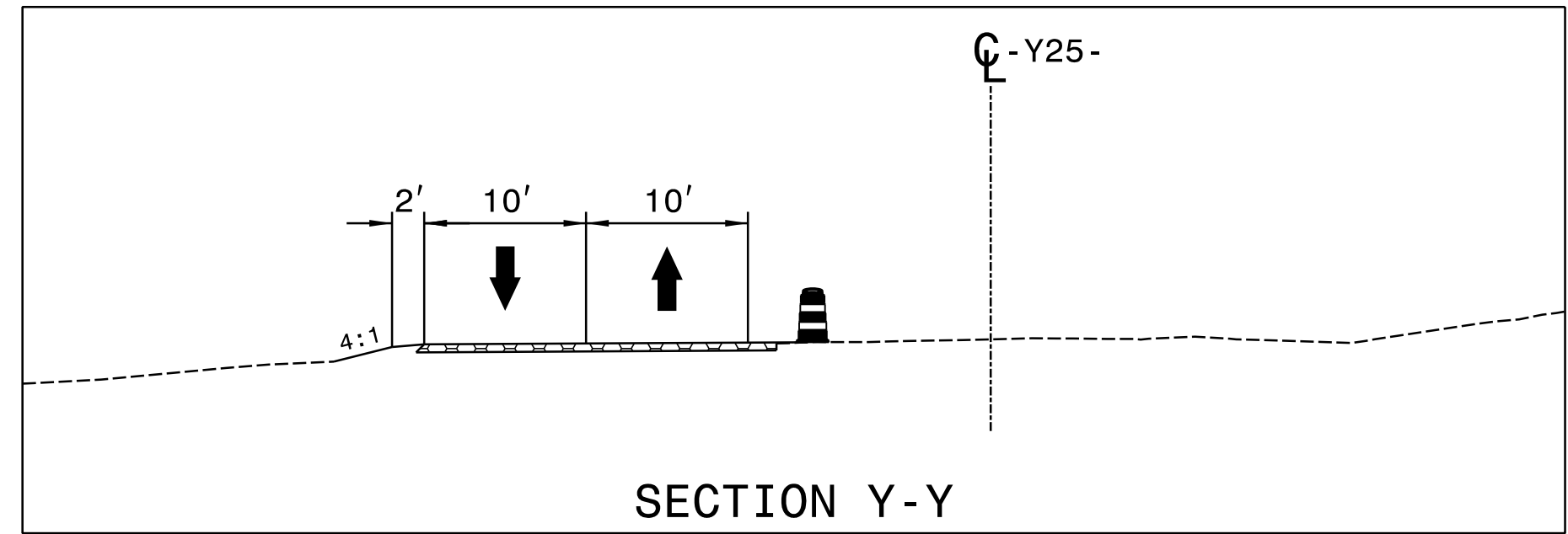
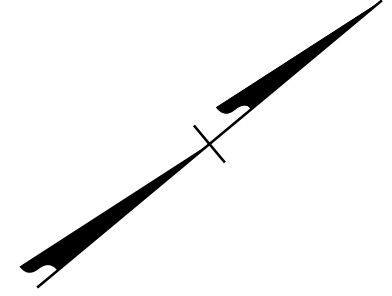

3/7/2024  
 R-2577A\_tmp\_psh69.dgn  
 KRobby

APPROVED: *Kevin Bishy*  
 DATE: 3/7/2024

SEAL

**DOCUMENT NOT CONSIDERED FINAL  
 UNLESS ALL SIGNATURES COMPLETED**

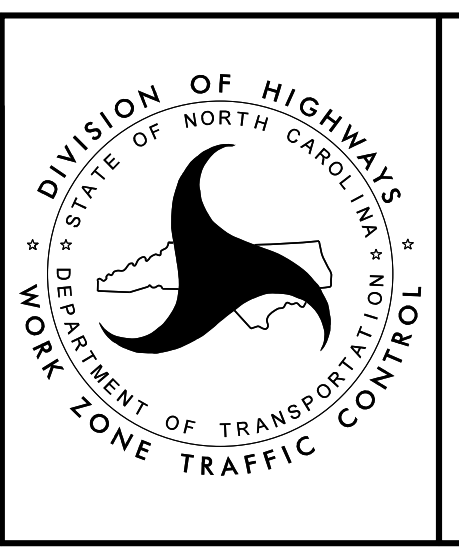

PHASE II - STEP 3



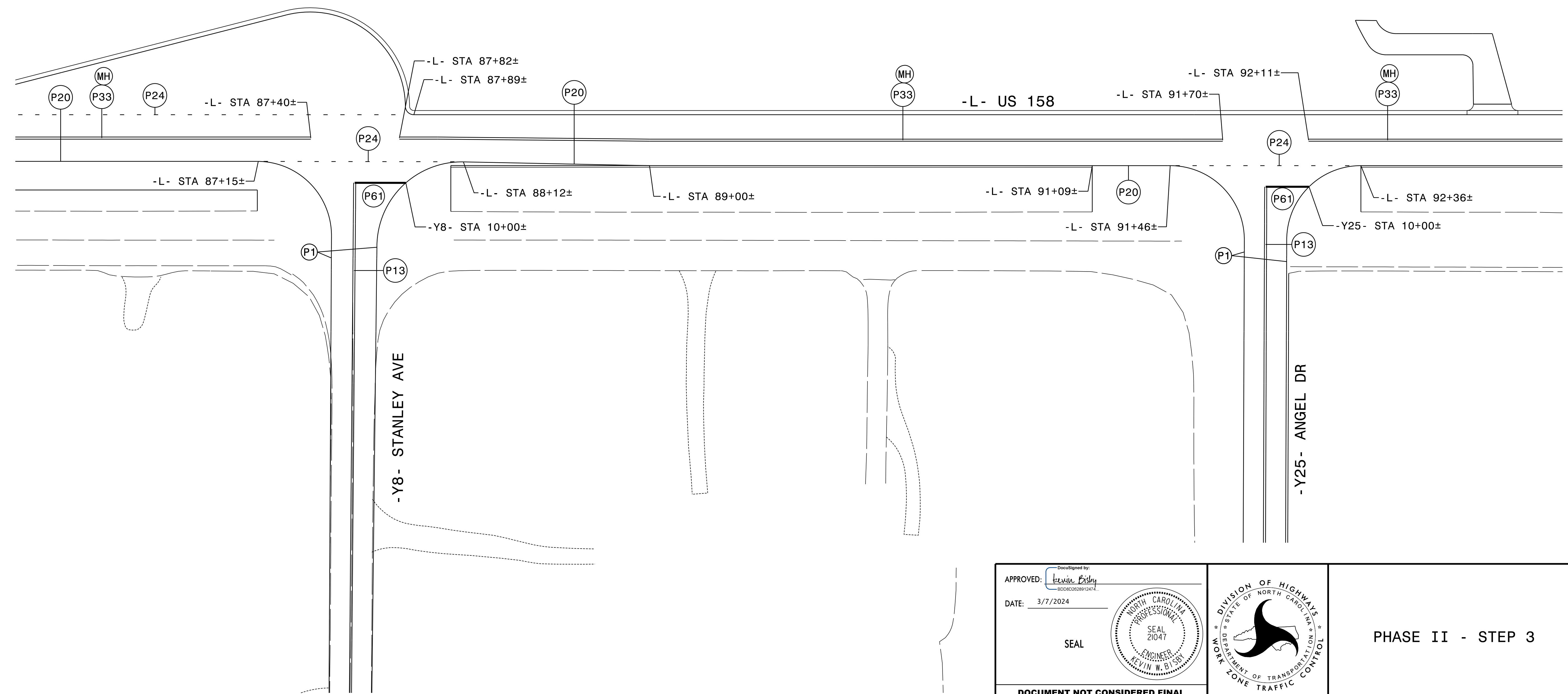
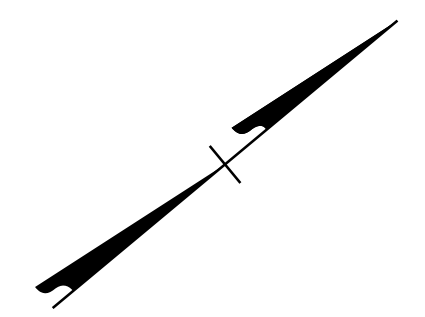

3/7/2024  
R-2577A\_tmp\_psh69A.dgn  
Rolsby

APPROVED: *Kevin Bishy*  
DocuSigned by: Kevin Bishy  
800802628912477

DATE: 3/7/2024

SEAL

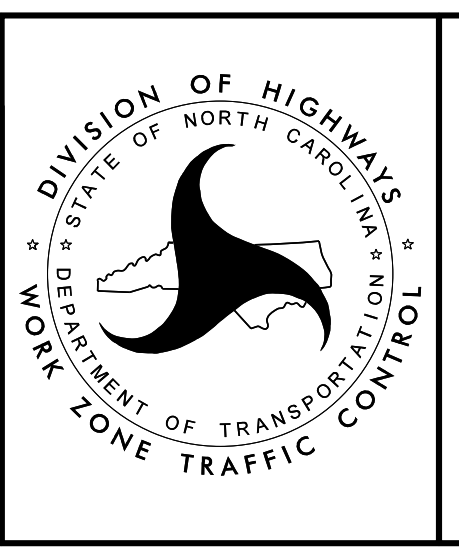

PHASE II - STEP 3

DOCUMENT NOT CONSIDERED FINAL  
UNLESS ALL SIGNATURES COMPLETED

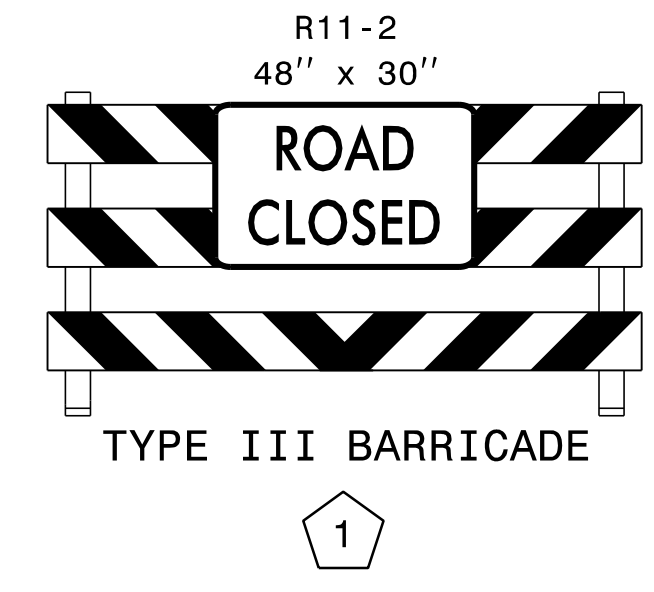
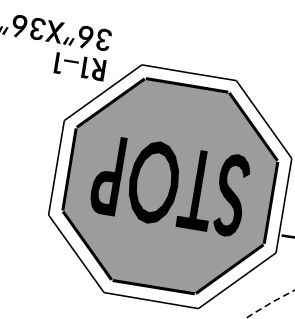
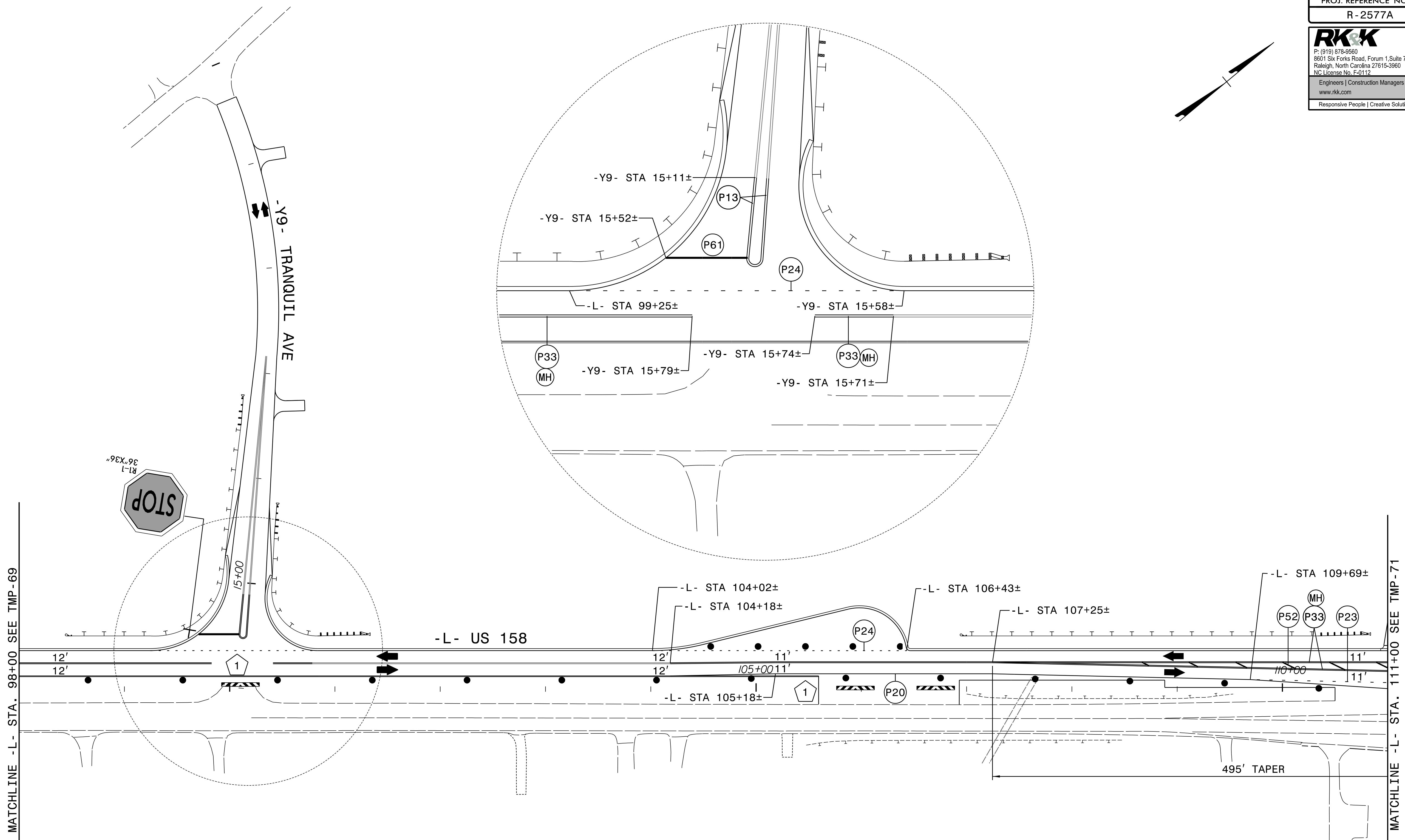
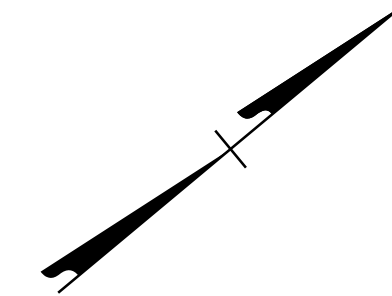

MATCHLINE -L- STA. 98+00 SEE TMP-69

MATCHLINE -L- STA. 111+00 SEE TMP-71

3/7/2024  
 R-2577A\_tmp\_psh70.dgn  
 Rolsby

APPROVED:   
 DATE: 3/7/2024

SEAL

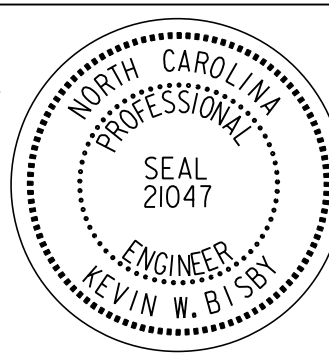

**DOCUMENT NOT CONSIDERED FINAL  
 UNLESS ALL SIGNATURES COMPLETED**

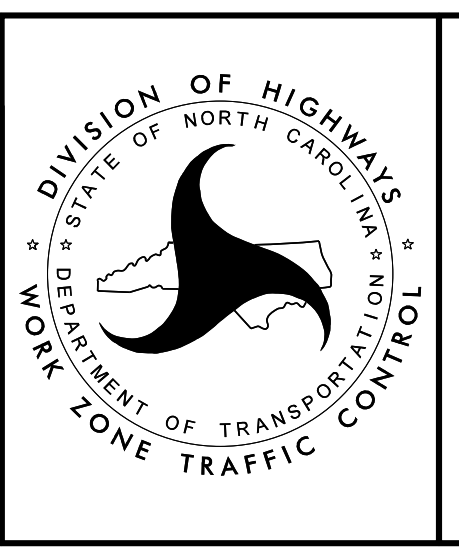

PHASE II - STEP 3

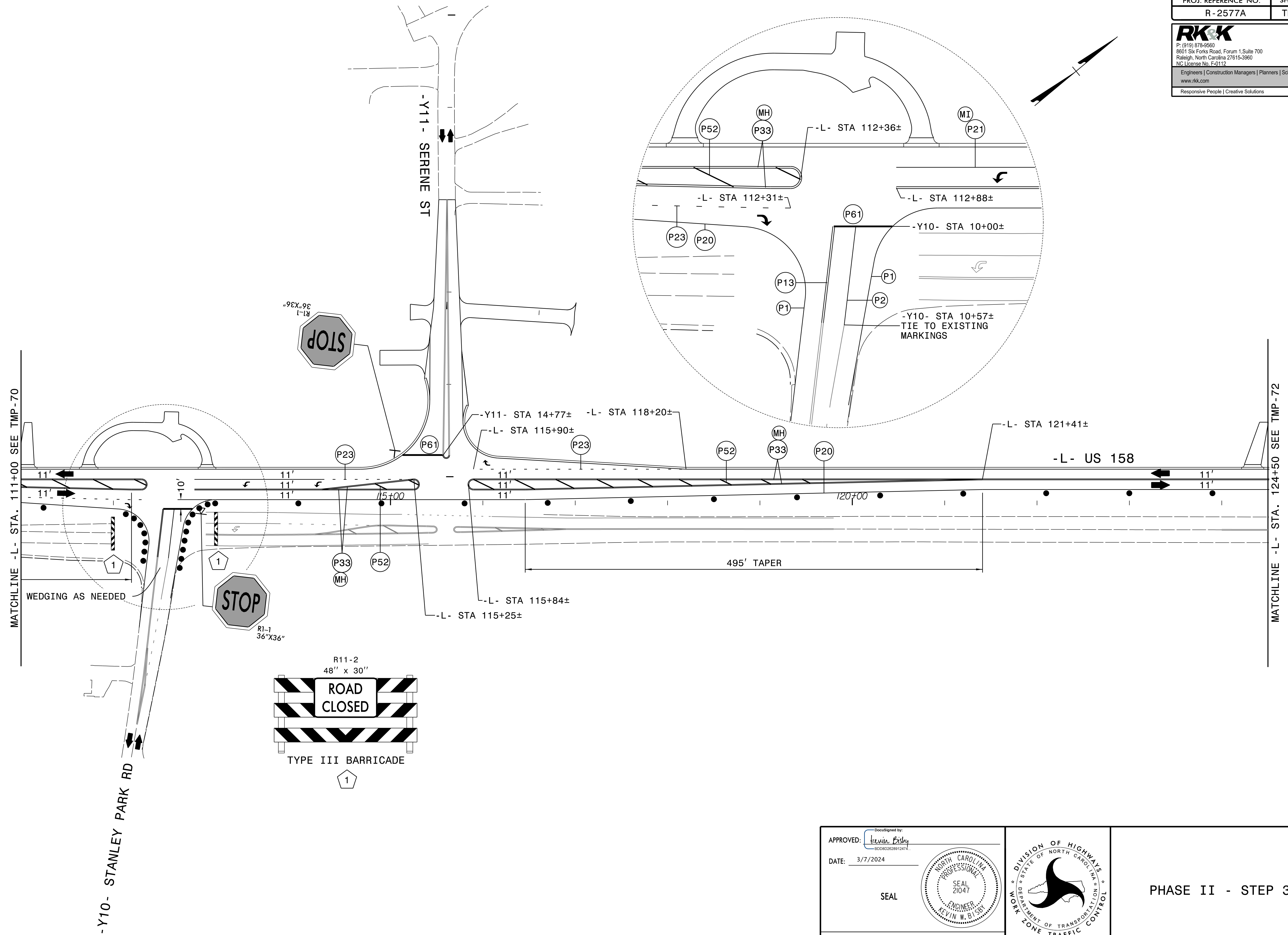

3/7/2024  
 R-2577A\_tmp\_psh71.dgn  
 KJlsby

APPROVED: *Kevin Bisby*  
 DATE: 3/7/2024

SEAL

**SEAL**  
 NORTH CAROLINA  
 PROFESSIONAL  
 ENGINEER  
 KEVIN W. BISBY  
 21047

**DOCUMENT NOT CONSIDERED FINAL  
 UNLESS ALL SIGNATURES COMPLETED**

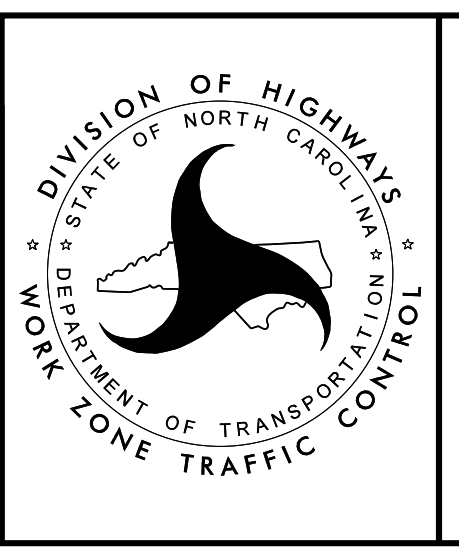

PHASE II - STEP 3

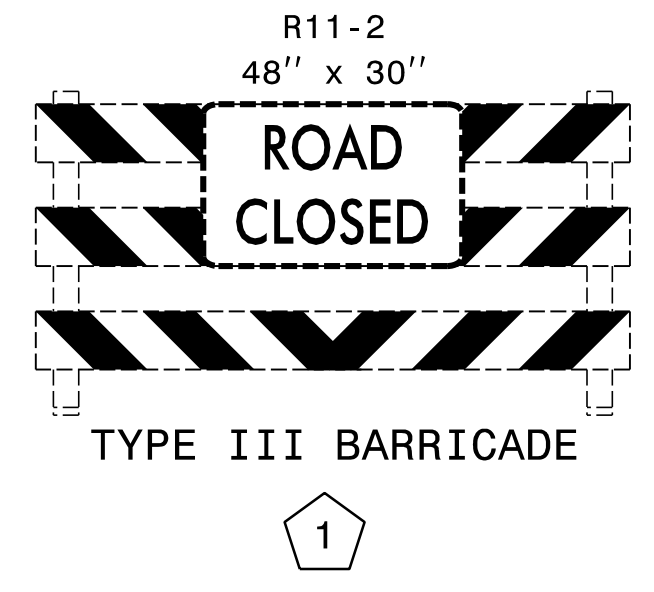
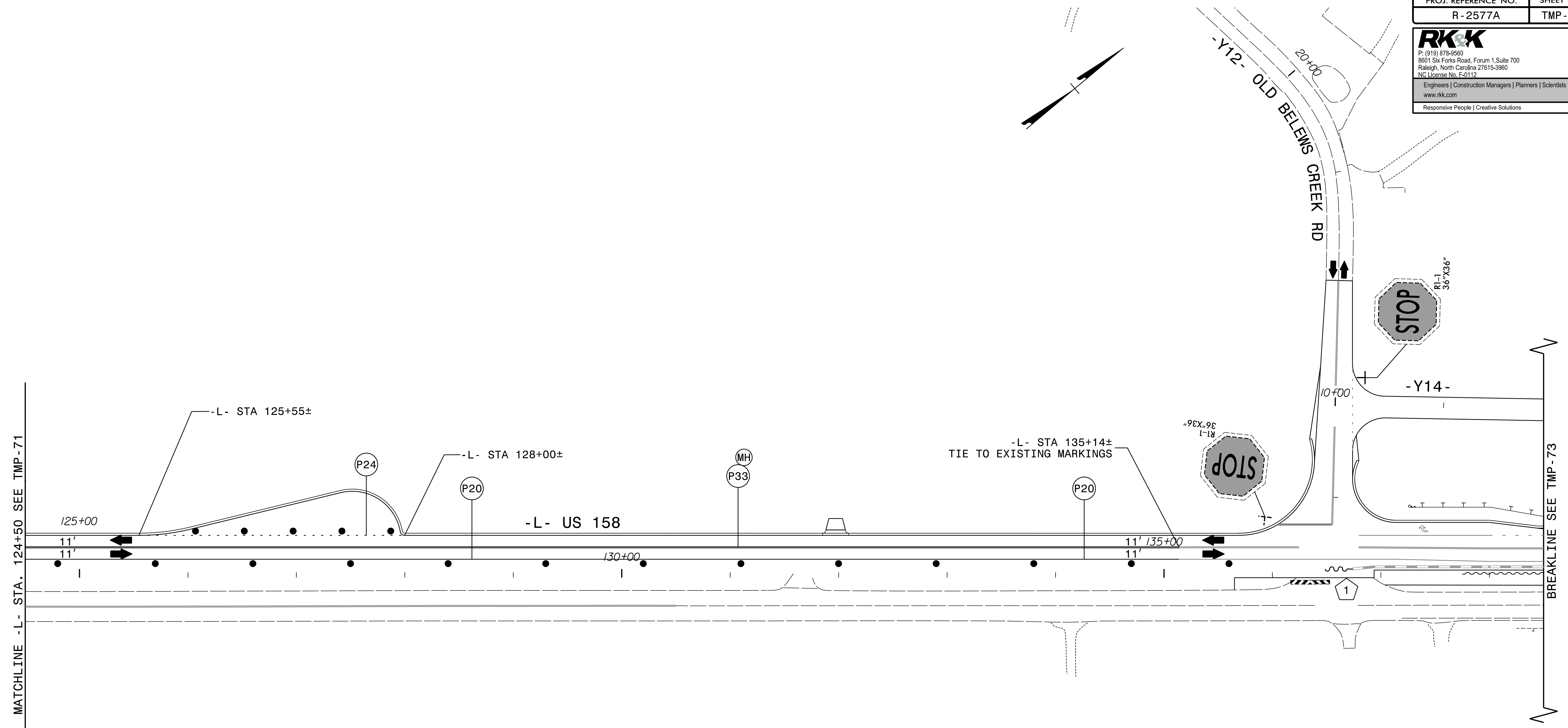

3/7/2024  
 R-2577A\_tmp\_psh72.dgn  
 KRobby

APPROVED: *Kevin Bisby*  
DocuSigned by: Kevin Bisby  
B0C802628912472

DATE: 3/7/2024

SEAL

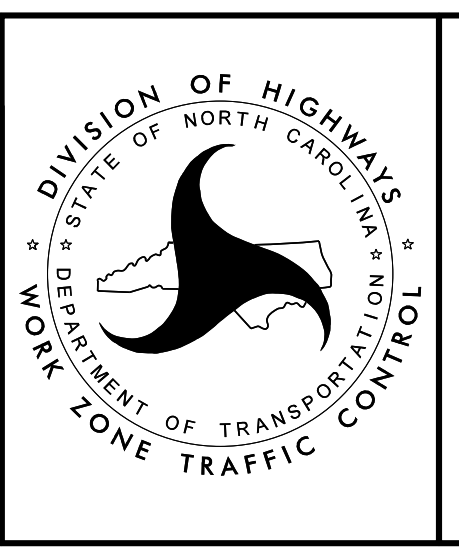

PHASE II - STEP 3

DOCUMENT NOT CONSIDERED FINAL  
UNLESS ALL SIGNATURES COMPLETED

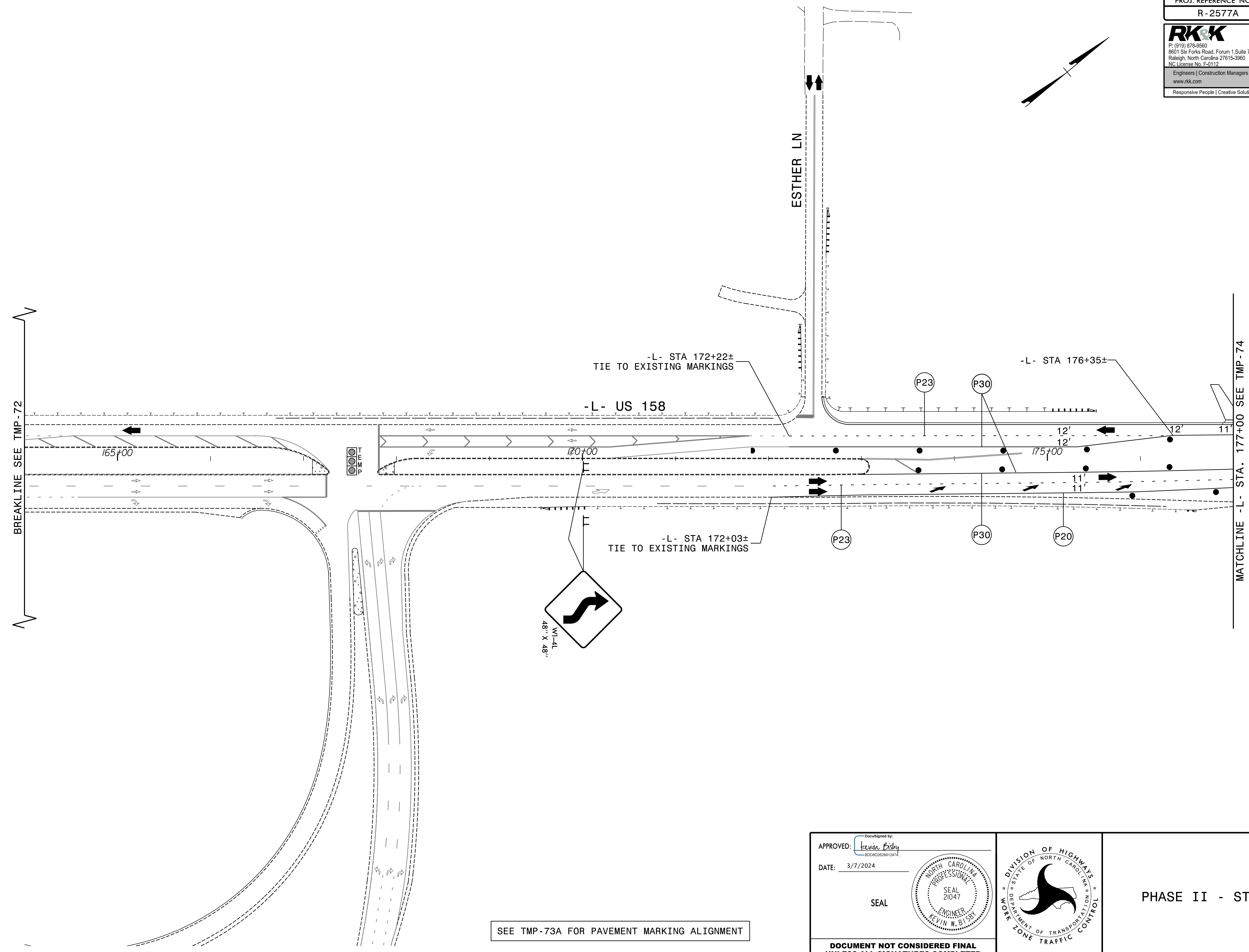
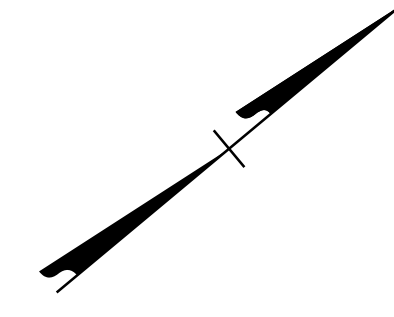

SEE TMP-73A FOR PAVEMENT MARKING ALIGNMENT

3/7/2024  
 R-2577A\_tmp\_psh73.dgn  
 Rolsby

APPROVED: *Kevin Bishy*  
 DATE: 3/7/2024

SEAL

**DOCUMENT NOT CONSIDERED FINAL  
 UNLESS ALL SIGNATURES COMPLETED**

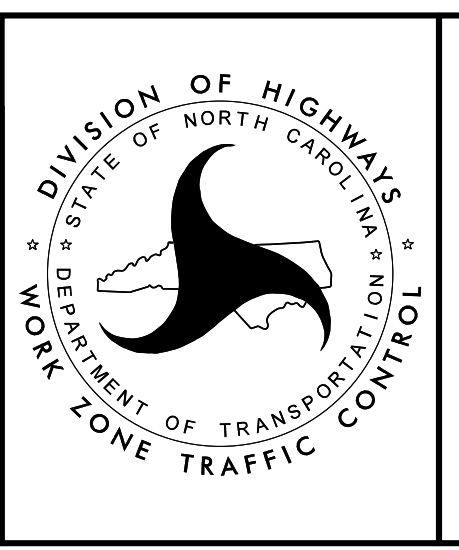

PHASE II - STEP 3

PROJ. REFERENCE NO.	SHEET NO.
R-2577A	TMP-73A

**RKK**  
 P: (919) 878-8560  
 8601 Six Forks Road, Forum 1, Suite 700  
 Raleigh, North Carolina 27615-3960  
 NC License No. F-0112  
 Engineers | Construction Managers | Planners | Scientists  
 www.rkk.com  
 Responsive People | Creative Solutions

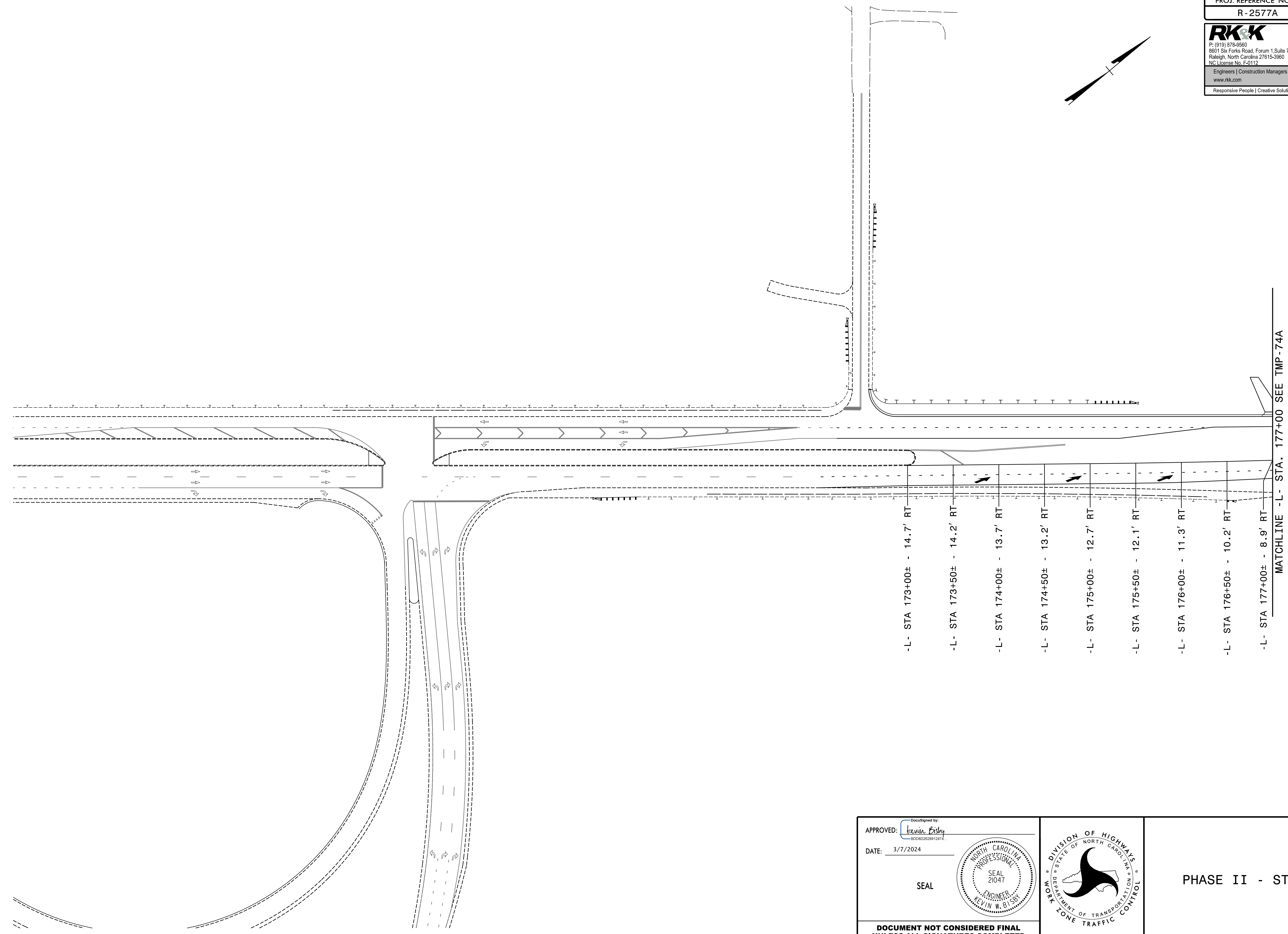
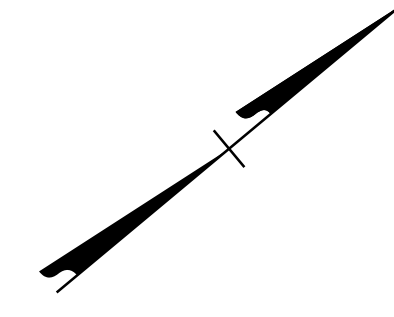

- L- STA 173+00± - 14.7' RT
- L- STA 173+50± - 14.2' RT
- L- STA 174+00± - 13.7' RT
- L- STA 174+50± - 13.2' RT
- L- STA 175+00± - 12.7' RT
- L- STA 175+50± - 12.1' RT
- L- STA 176+00± - 11.3' RT
- L- STA 176+50± - 10.2' RT
- L- STA 177+00± - 8.9' RT

MATCHLINE -L- STA. 177+00 SEE TMP-74A

3/7/2024  
 R-2577A\_tmp\_psh73A.dgn  
 R01587

APPROVED:   
 DATE: 3/7/2024

SEAL

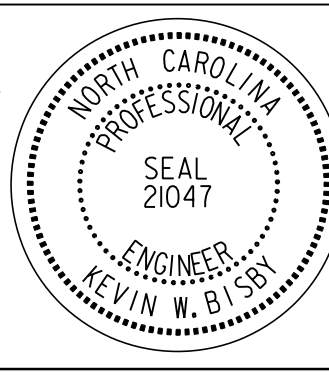
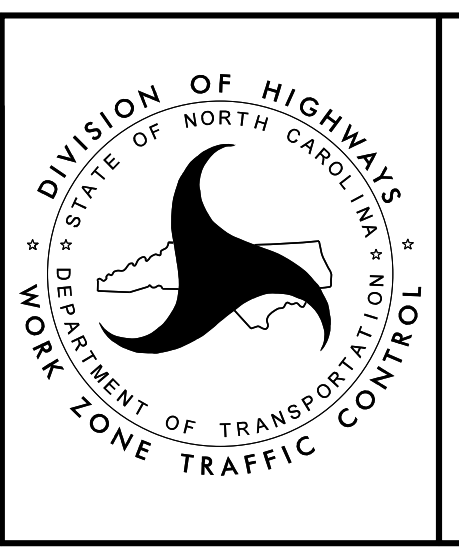

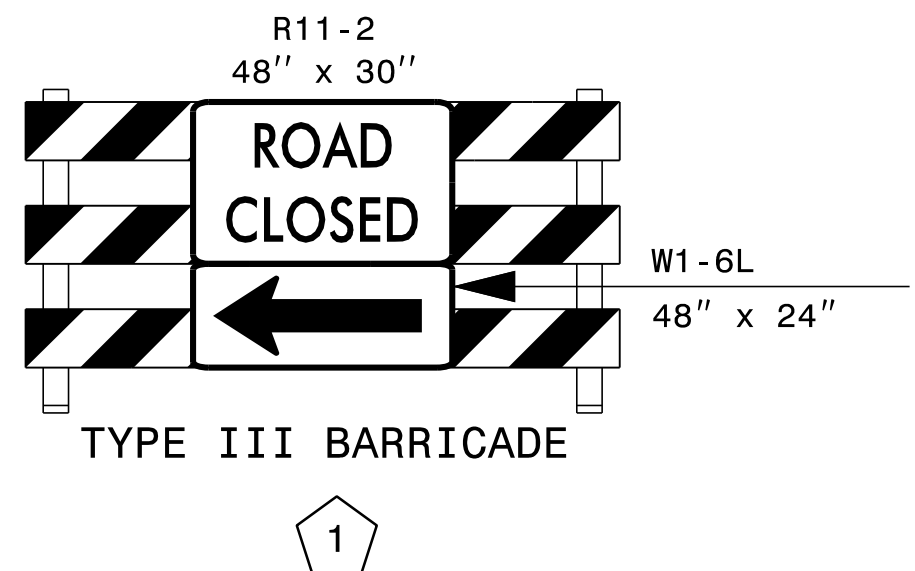
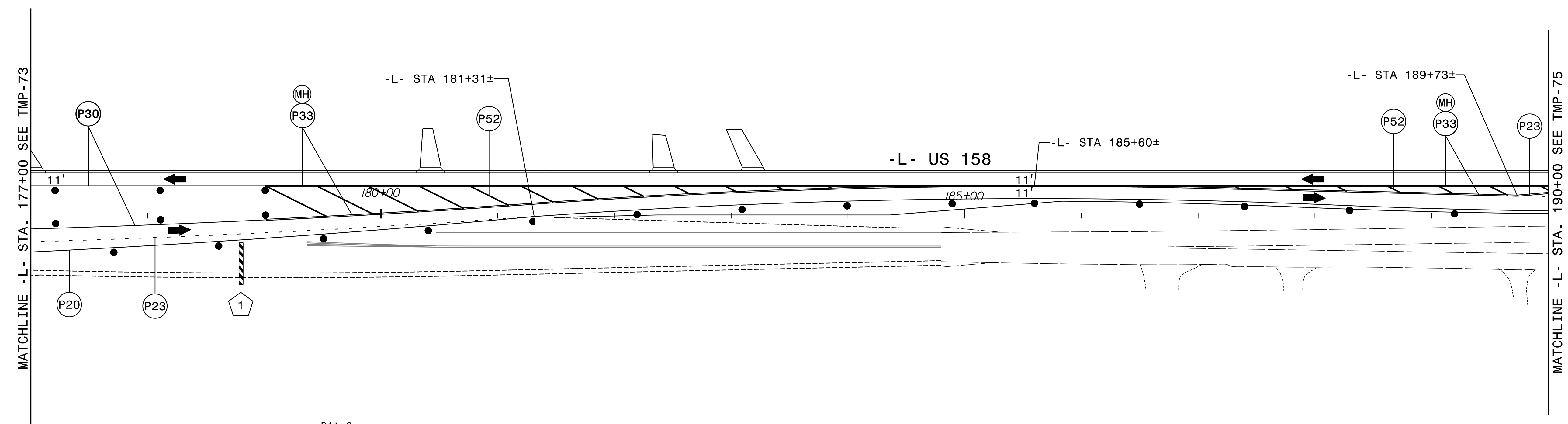
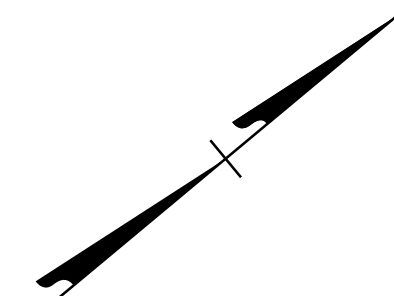

PHASE II - STEP 3

DOCUMENT NOT CONSIDERED FINAL  
 UNLESS ALL SIGNATURES COMPLETED

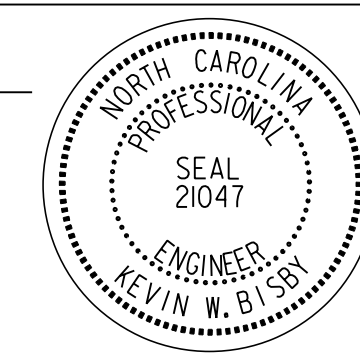

SEE TMP-74A FOR PAVEMENT MARKING ALIGNMENT

APPROVED: *Kevin Bishy*  
DocuSigned by:  
Kevin Bishy  
8D0802628912477  
 DATE: 3/7/2024  
 SEAL  

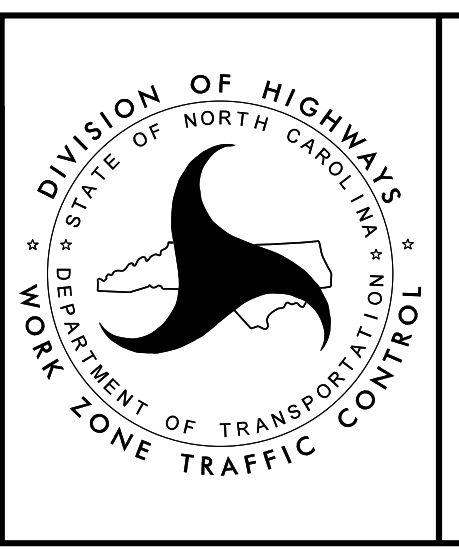

PHASE II - STEP 3

DOCUMENT NOT CONSIDERED FINAL  
UNLESS ALL SIGNATURES COMPLETED

3/7/2024  
 R-2577A\_tmp\_psh74.dgn  
 K.Bishy

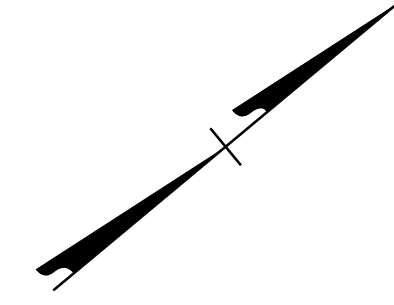

MATCHLINE - L- STA. 177+00 SEE TMP - 73A

- L- STA 177+50± - 7.4' RT
- L- STA 178+00± - 5.6' RT
- L- STA 178+50± - 3.5' RT
- L- STA 179+00± - 1.2' RT
- L- STA 179+50± - 1.3' LT
- L- STA 180+00± - 4.1' LT
- L- STA 180+50± - 7.2' LT
- L- STA 181+00± - 10.5' LT
- L- STA 181+50± - 14.0' LT
- L- STA 182+00± - 17.2' LT
- L- STA 182+50± - 20.0' LT
- L- STA 183+00± - 22.4' LT
- L- STA 183+50± - 24.3' LT
- L- STA 184+00± - 25.9' LT
- L- STA 184+50± - 27.0' LT
- L- STA 185+00± - 27.7' LT

3/7/2024  
 R-2577A\_tmp\_psh74A.dgn  
 K015by

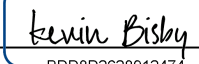
APPROVED:   
DocuSigned by: Kevin W. Bisby  
B0C802628912474

DATE: 3/7/2024

SEAL

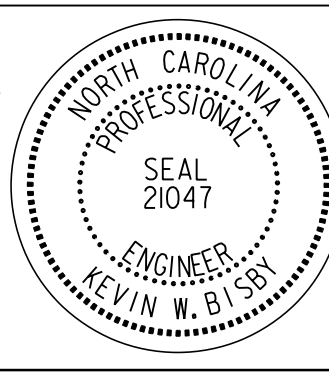

**DOCUMENT NOT CONSIDERED FINAL  
UNLESS ALL SIGNATURES COMPLETED**

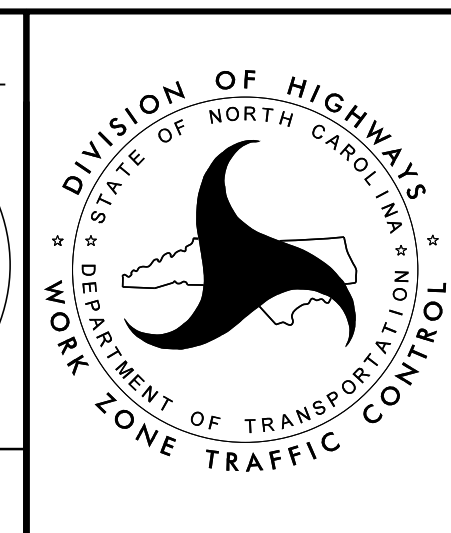

PHASE II - STEP 3



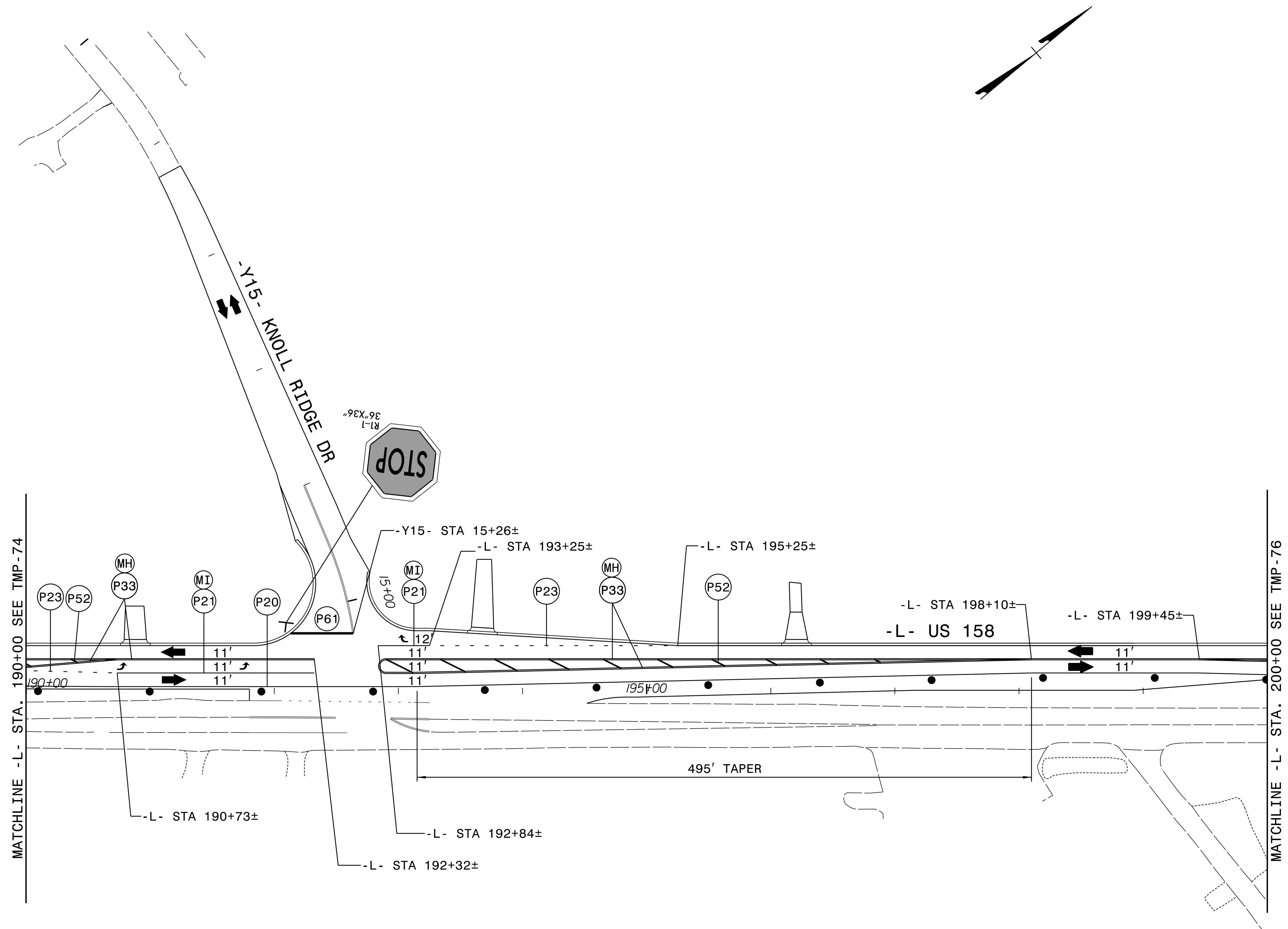

3/7/2024  
 R-2577A\_tmp\_psh75.dgn  
 Kolsby

APPROVED:   
 DATE: 3/7/2024

SEAL

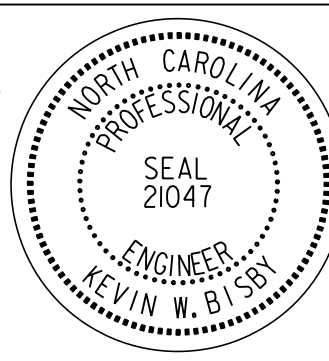

**DOCUMENT NOT CONSIDERED FINAL  
 UNLESS ALL SIGNATURES COMPLETED**

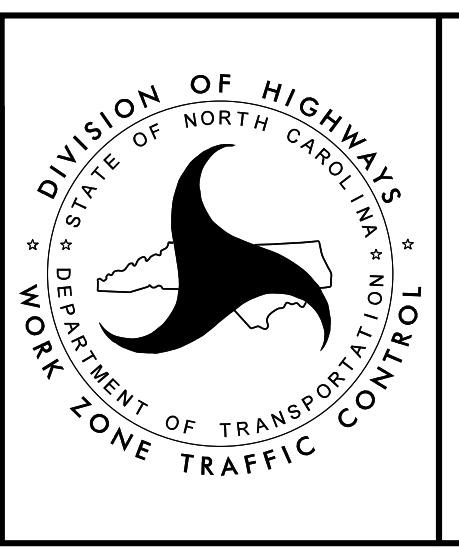

PHASE II - STEP 3

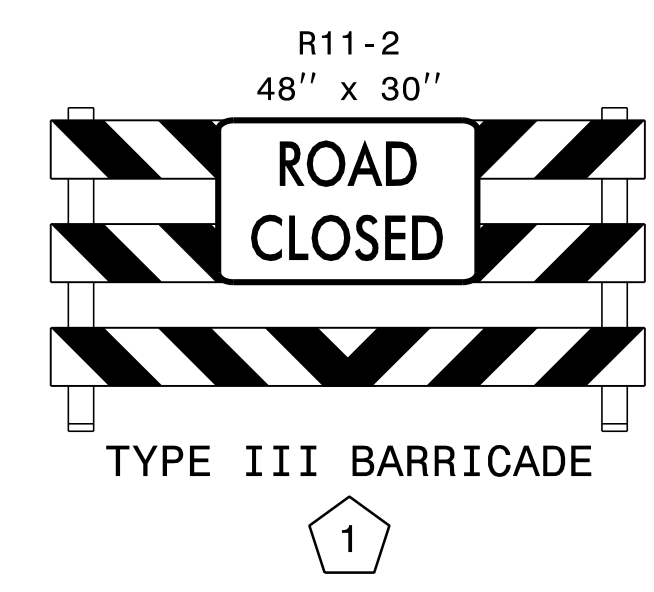
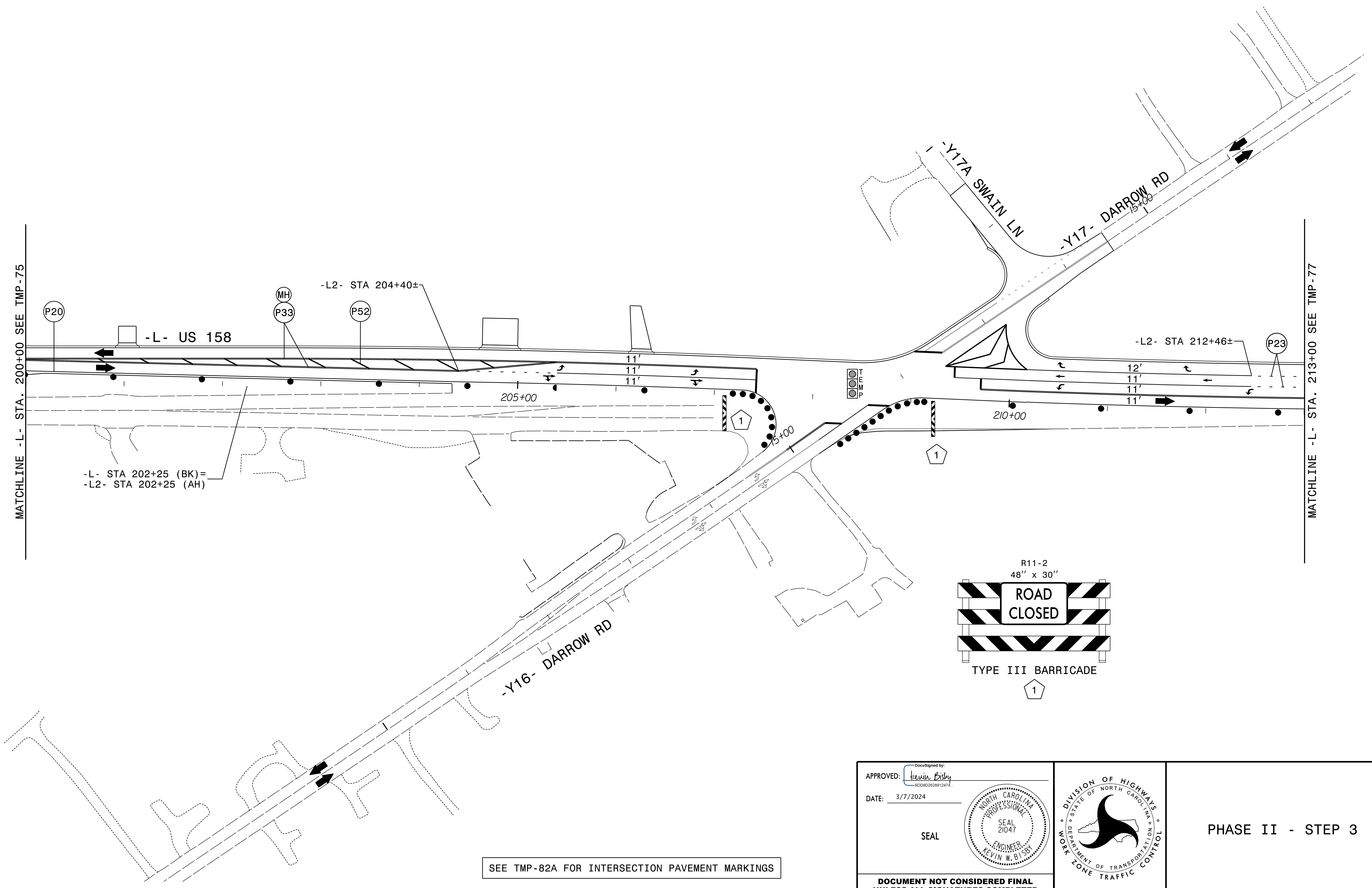
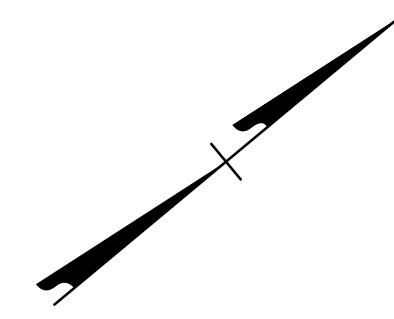

SEE TMP-82A FOR INTERSECTION PAVEMENT MARKINGS

3/7/2024  
 R-2577A\_tmp\_psh76.dgn  
 R. Robby

APPROVED:   
 DATE: 3/7/2024

SEAL

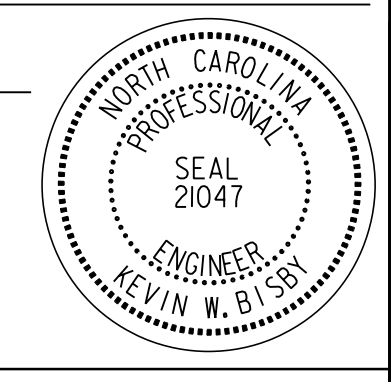
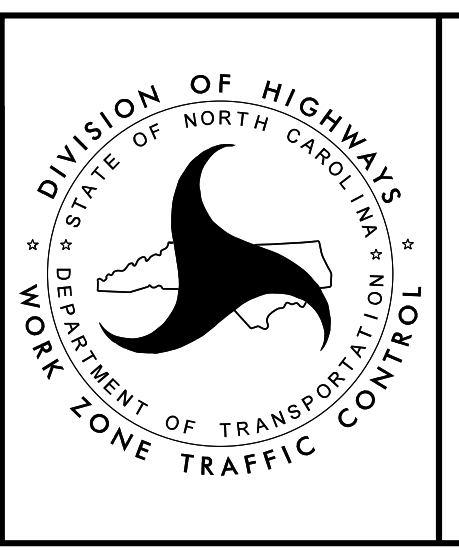



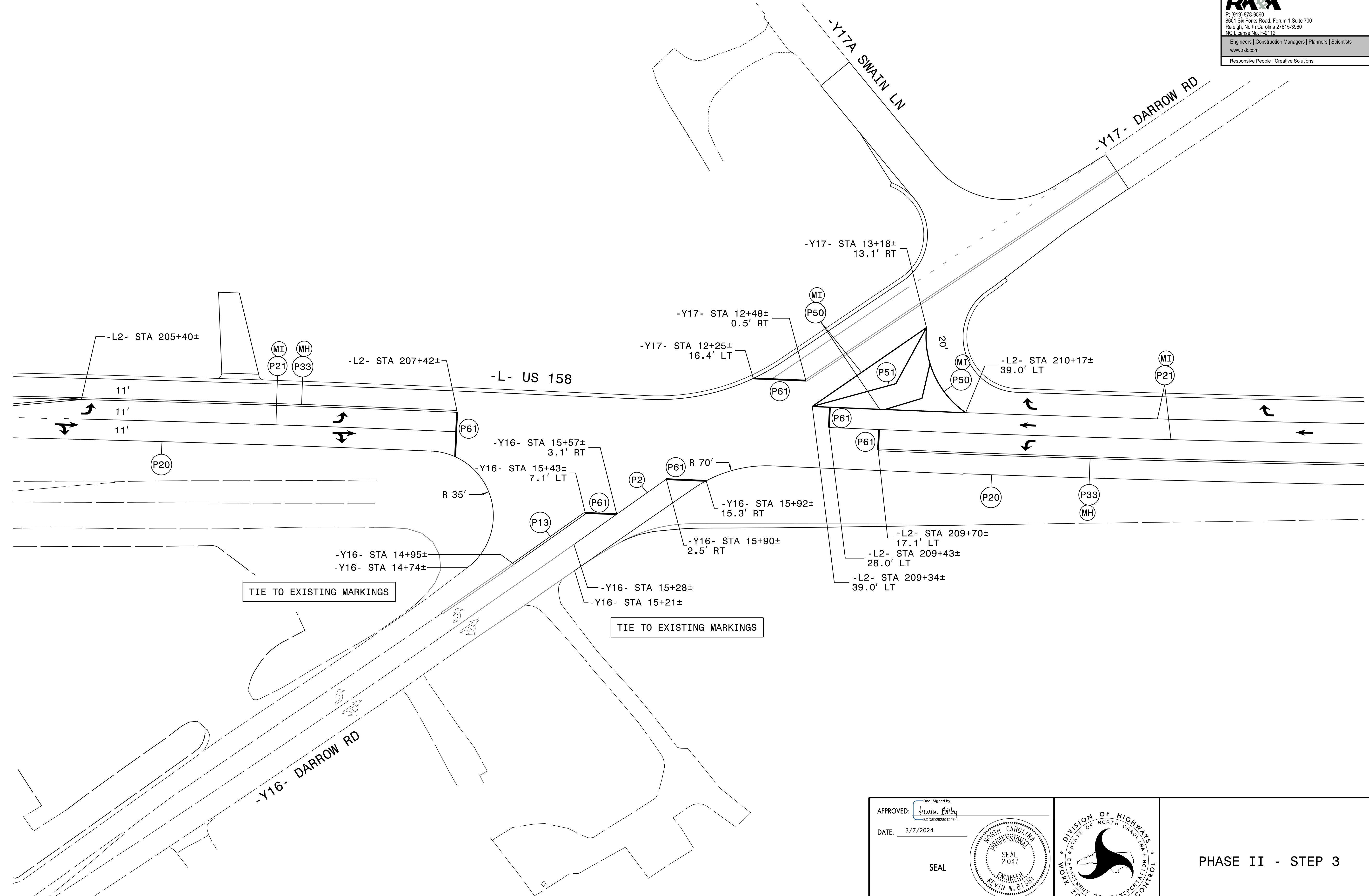

PHASE II - STEP 3

**DOCUMENT NOT CONSIDERED FINAL  
 UNLESS ALL SIGNATURES COMPLETED**

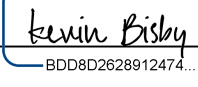

3/7/2024  
R-2577A\_tmp\_psh76A.dgn  
R015by



APPROVED:  DATE: 3/7/2024  		<p style="text-align: center; font-weight: bold;">PHASE II - STEP 3</p>
DOCUMENT NOT CONSIDERED FINAL UNLESS ALL SIGNATURES COMPLETED		

PROJ. REFERENCE NO.	SHEET NO.
R - 2577A	TMP - 77

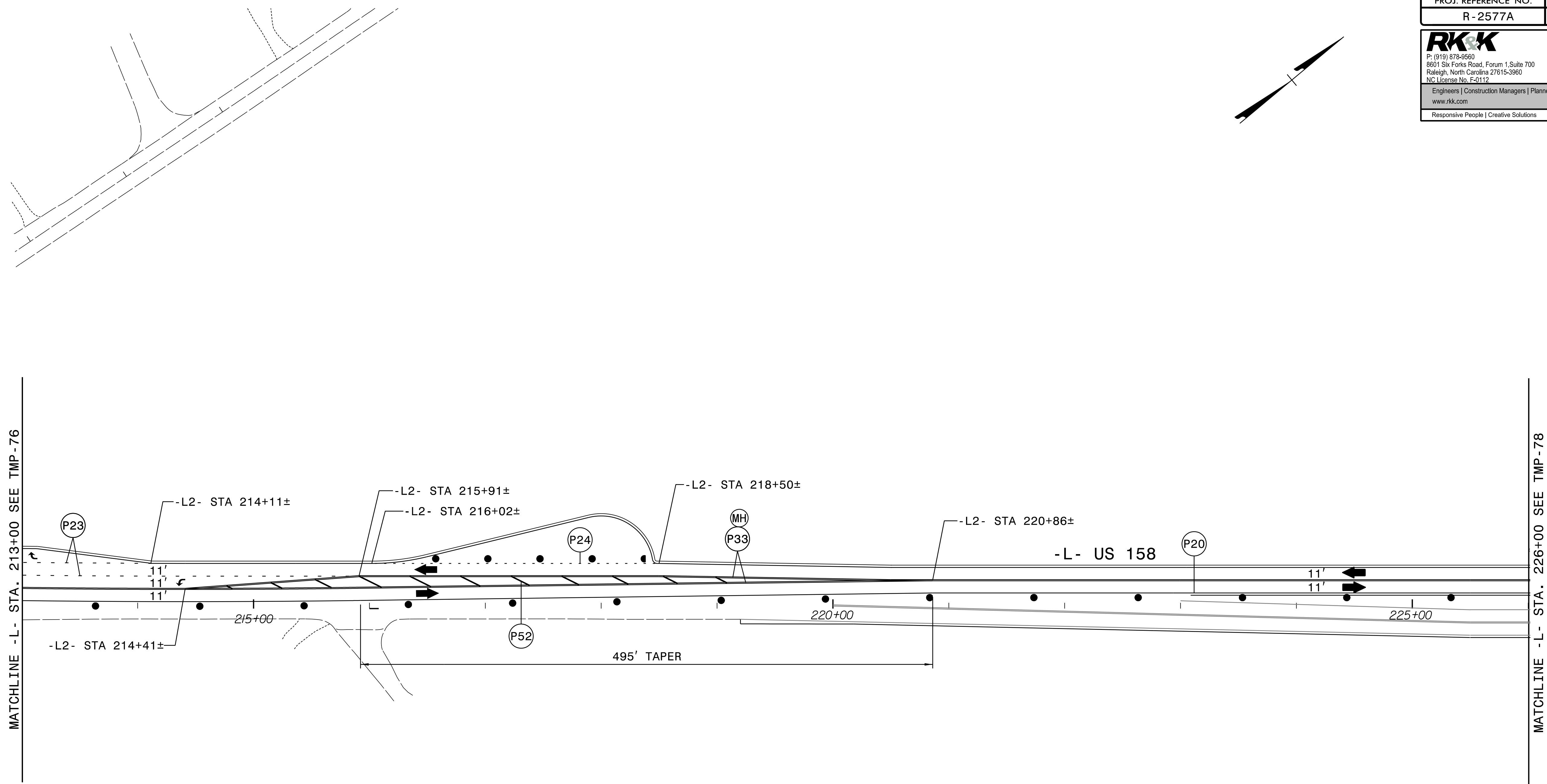
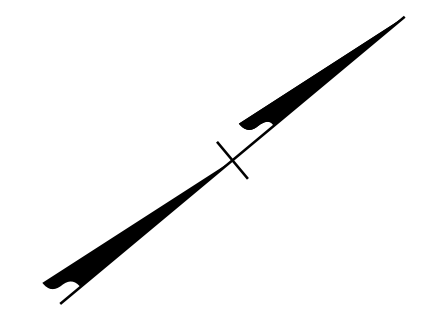
**RKK**  
 P: (919) 578-8560  
 8601 Six Forks Road, Forum 1, Suite 700  
 Raleigh, North Carolina 27615-3960  
 NC License No. F-0112  
 Engineers | Construction Managers | Planners | Scientists  
 www.rkk.com  
 Responsive People | Creative Solutions



3/7/2024  
 R-2577A\_tmp\_psh77.dgn  
 KRobby

APPROVED:  DATE: 3/7/2024 SEAL			PHASE II - STEP 3
DOCUMENT NOT CONSIDERED FINAL UNLESS ALL SIGNATURES COMPLETED			

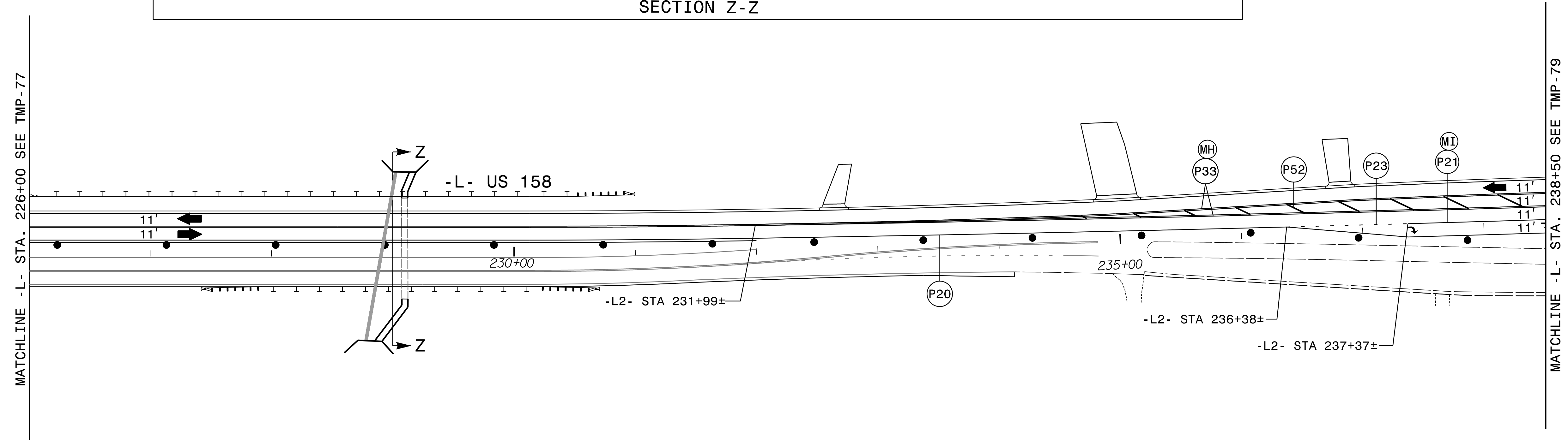
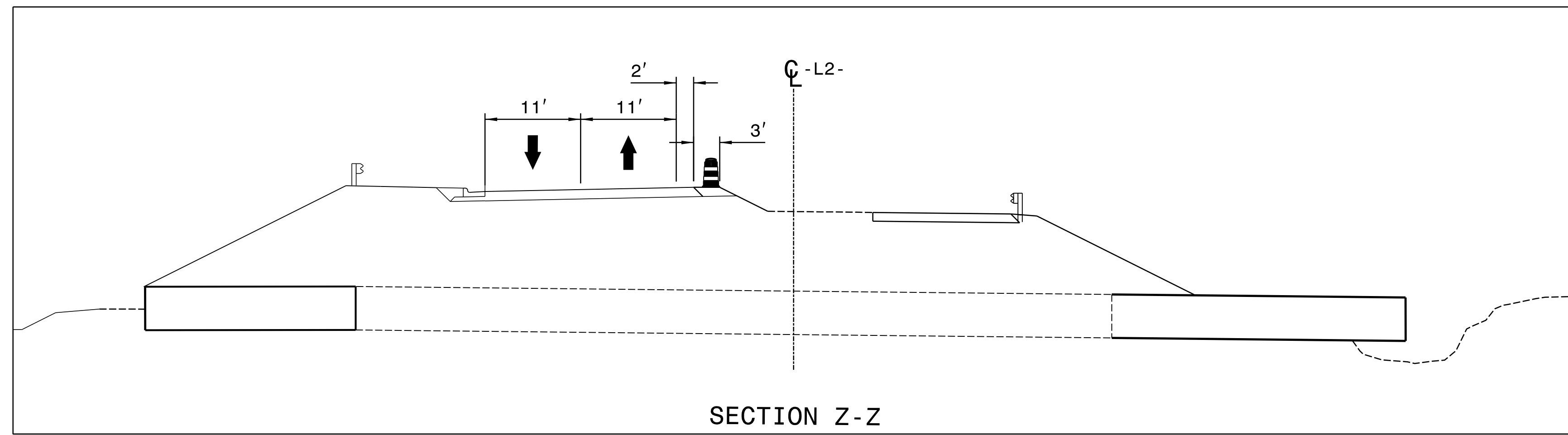
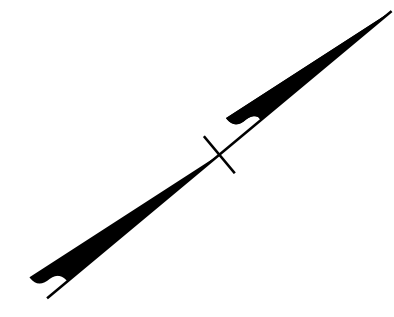

SEE TMP-78A FOR PAVEMENT MARKING ALIGNMENT

APPROVED: *Kevin Bishy*  
DocuSigned by:  
 Kevin Bishy  
 B0C802628912472

DATE: 3/7/2024

SEAL

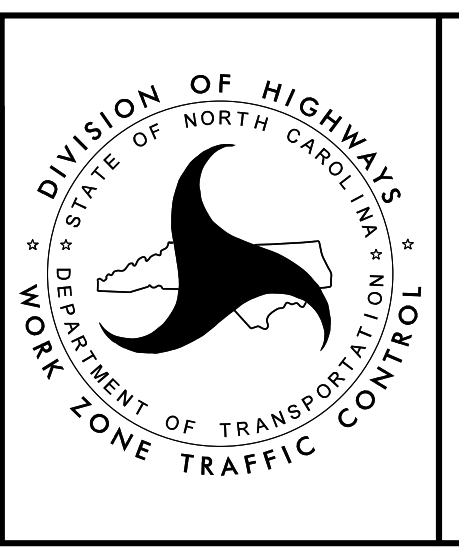

PHASE II - STEP 3

DOCUMENT NOT CONSIDERED FINAL  
 UNLESS ALL SIGNATURES COMPLETED

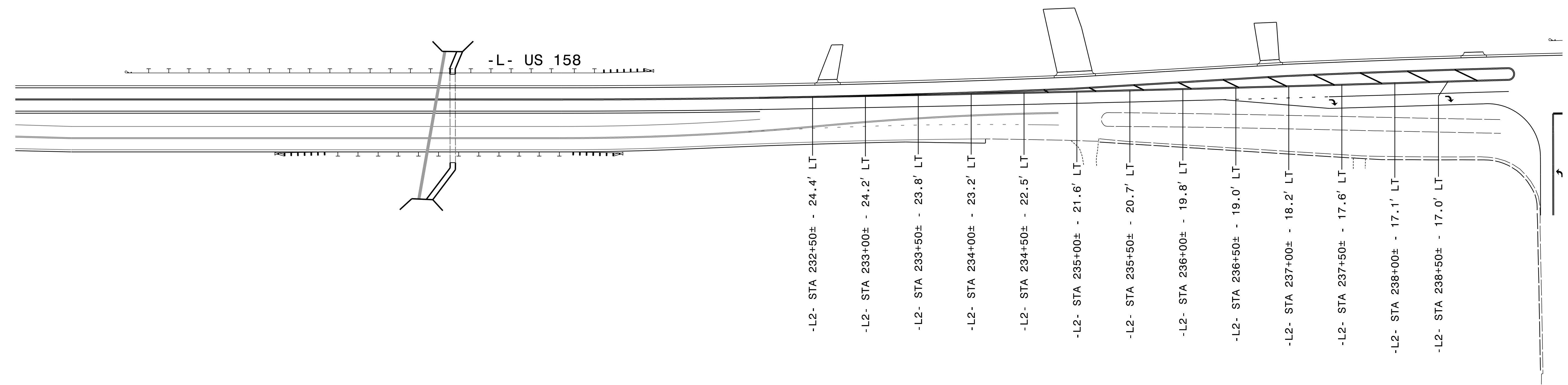
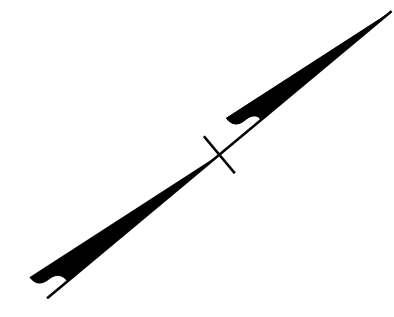

3/7/2024  
 R-2577A\_tmp\_psh78A.dgn  
 KRobby

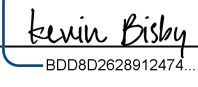
APPROVED:   
DocuSigned by: Kevin W. Bisby  
B0C802628912472

DATE: 3/7/2024

SEAL



**DOCUMENT NOT CONSIDERED FINAL  
UNLESS ALL SIGNATURES COMPLETED**

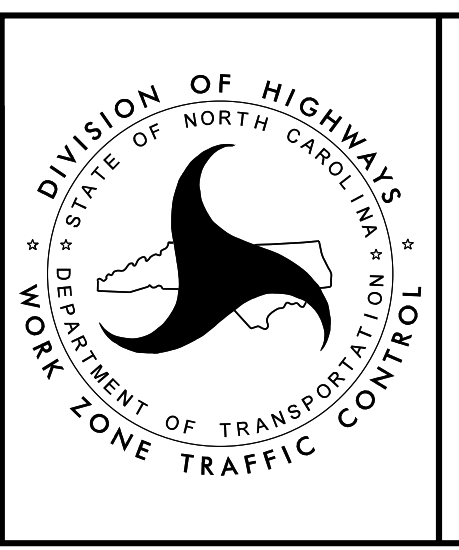

PHASE II - STEP 3

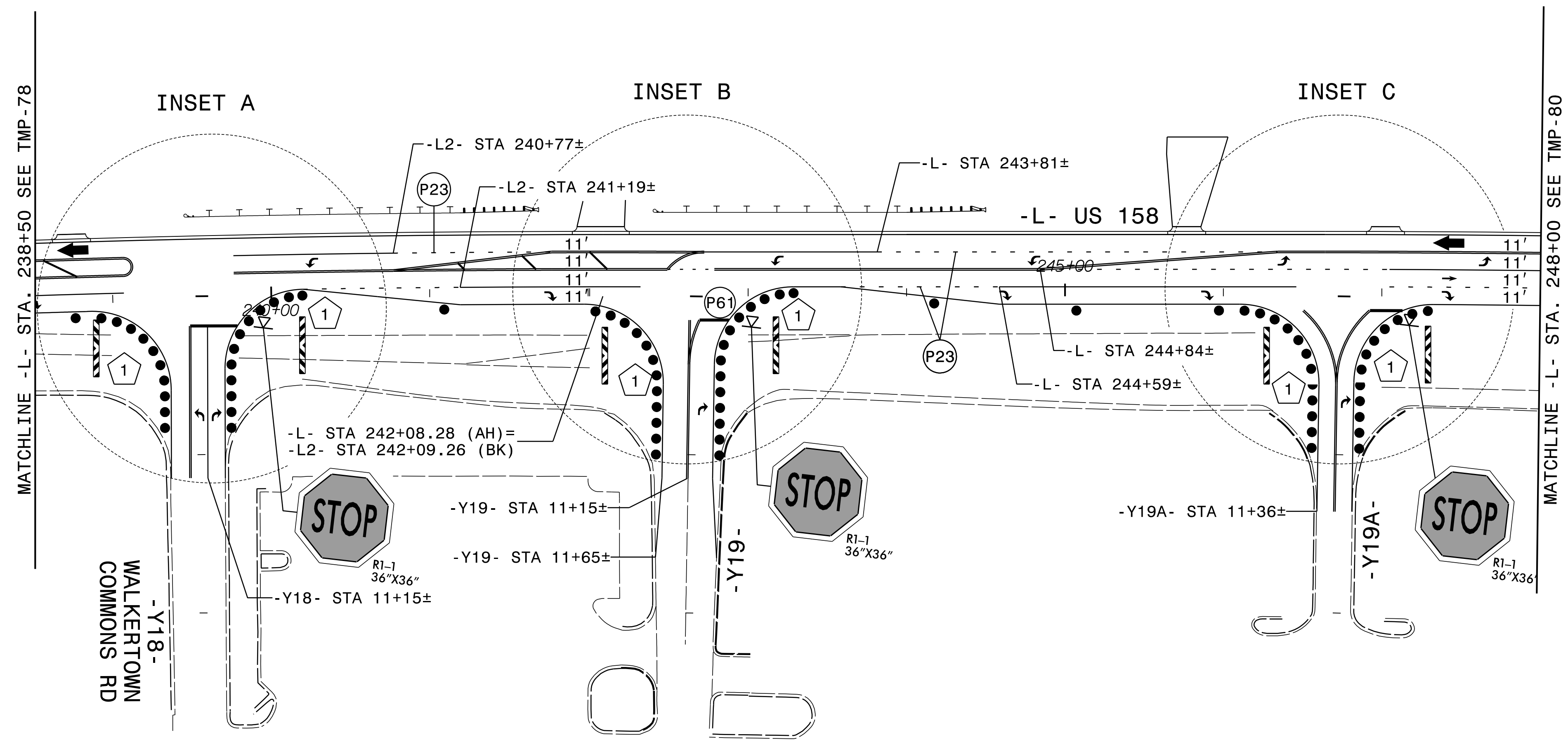
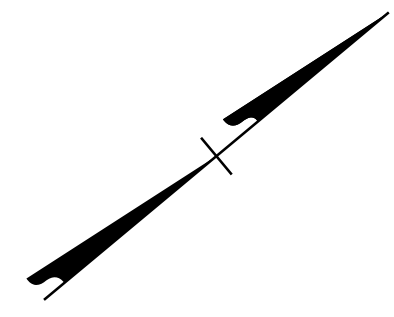

MATCHLINE - L- STA. 238+50 SEE TMP-78

MATCHLINE - L- STA. 248+00 SEE TMP-80

-Y18-  
WALKERTOWN  
COMMONS RD

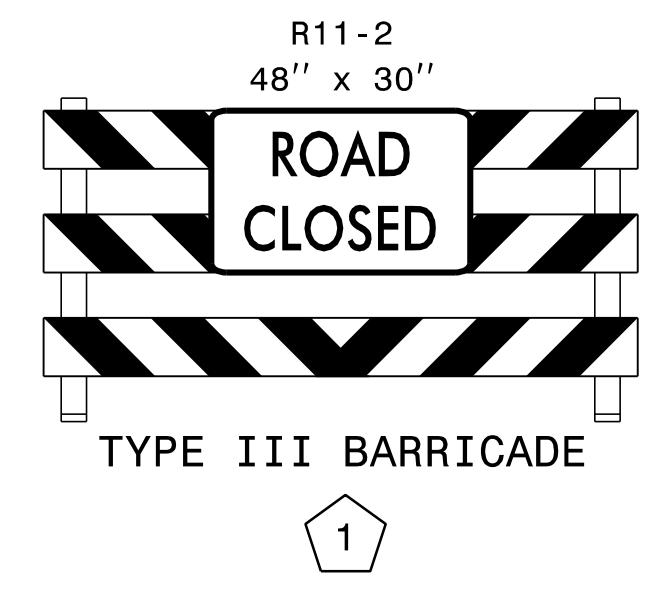

SEE TMP-79A FOR INTERSECTION PAVEMENT MARKINGS

APPROVED: *Kevin Bishop*  
 DATE: 3/7/2024

SEAL

DOCUMENT NOT CONSIDERED FINAL  
UNLESS ALL SIGNATURES COMPLETED

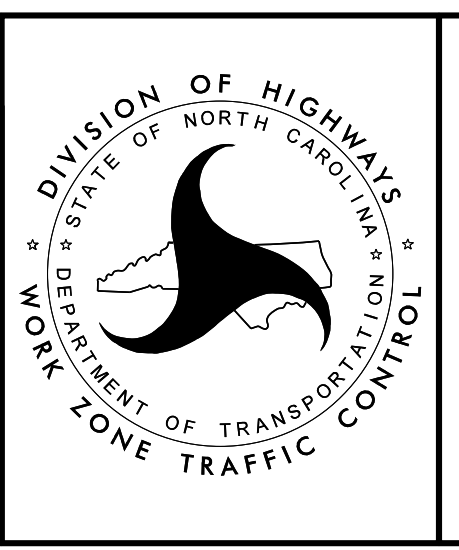

PHASE II - STEP 3

INSET A

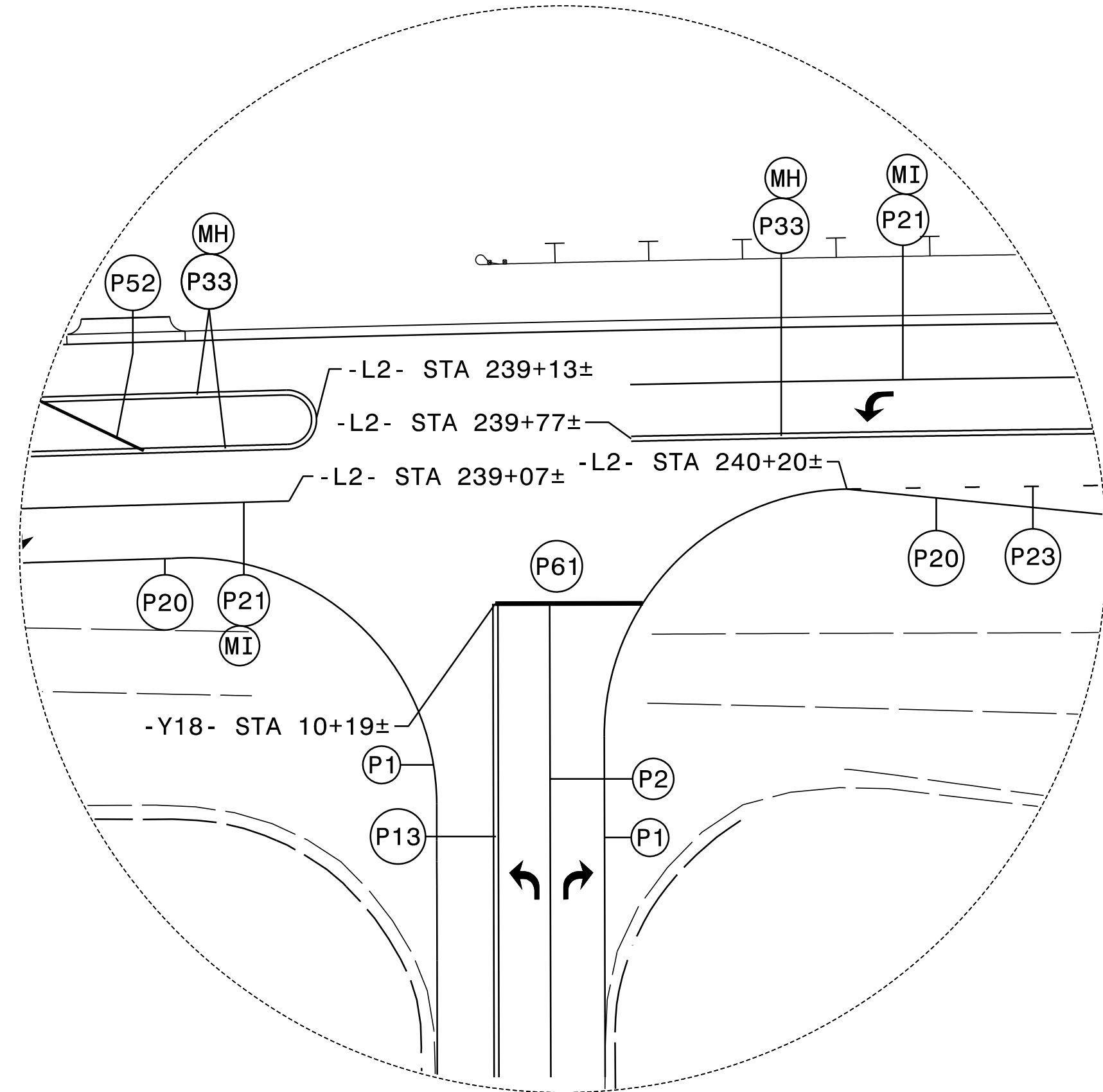

INSET B

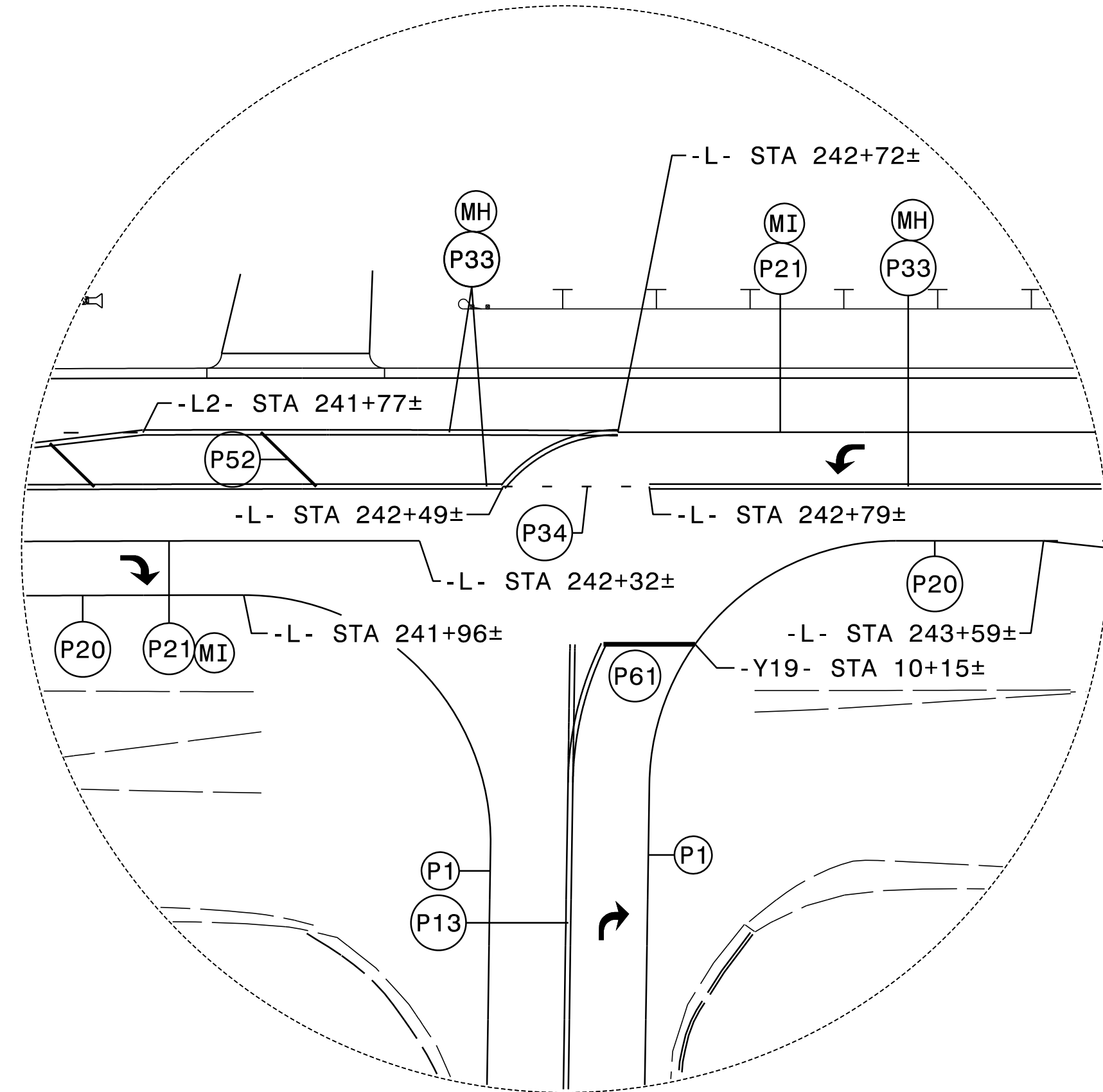

INSET C

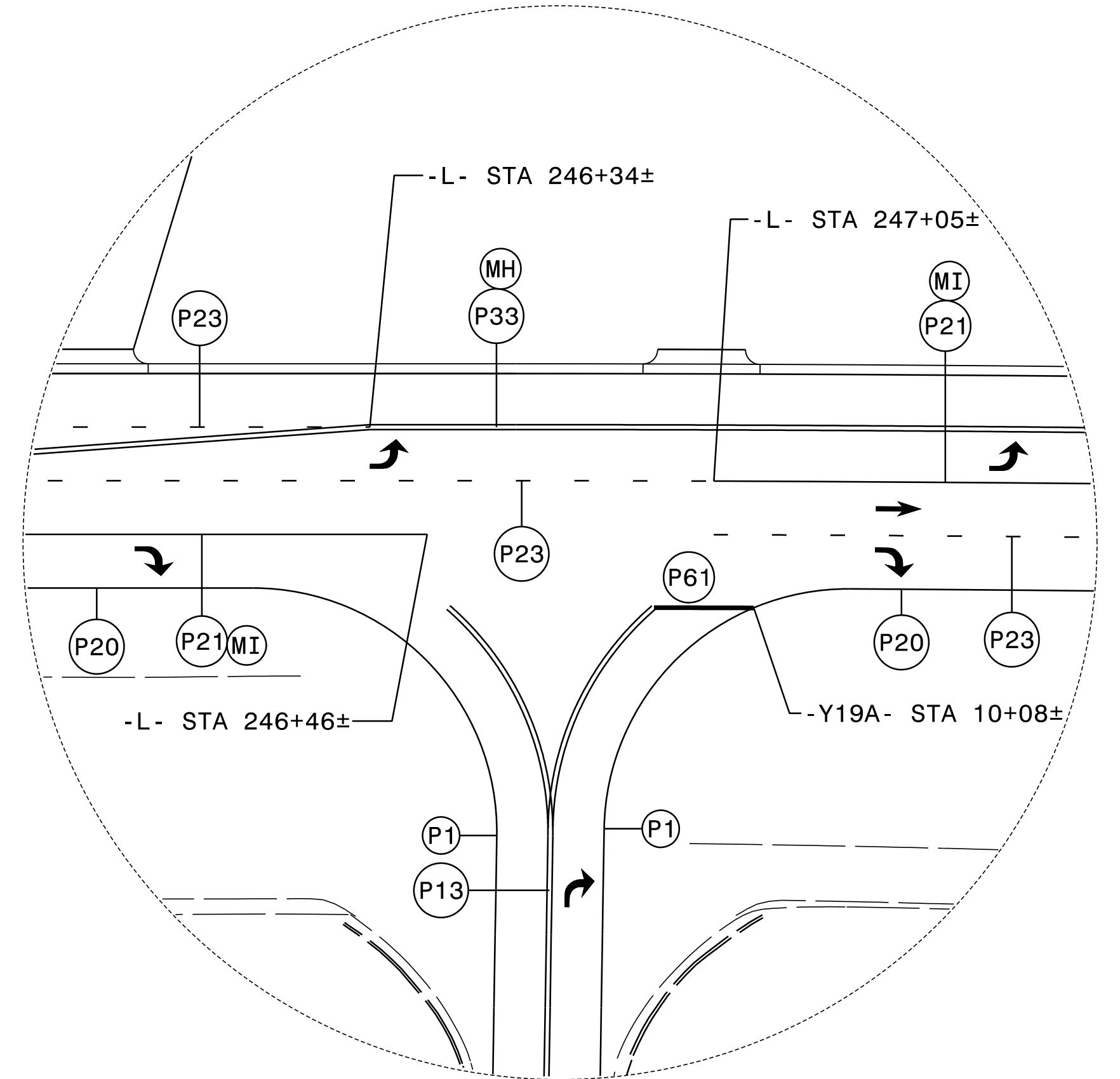

3/7/2024  
 R-2577A\_tmp\_psh79A.dgn  
 KRobby

APPROVED: *Kevin Bishy*  
 DATE: 3/7/2024  
 SEAL  
 NORTH CAROLINA PROFESSIONAL ENGINEER  
 SEAL 21047  
 KEVIN W. BISHY

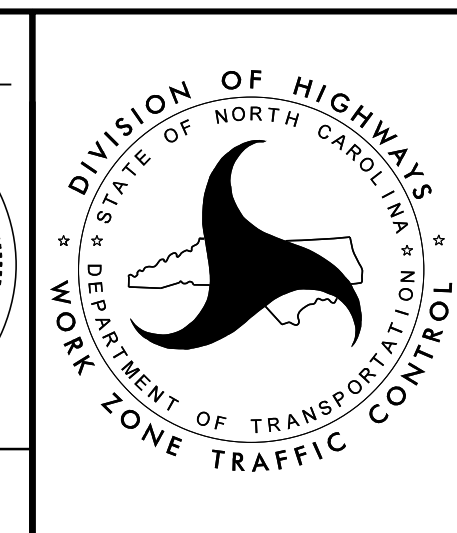

PHASE II - STEP 3

DOCUMENT NOT CONSIDERED FINAL  
 UNLESS ALL SIGNATURES COMPLETED



**RKK**  
 P: (919) 878-8560  
 8601 Six Forks Road, Forum 1, Suite 700  
 Raleigh, North Carolina 27615-3960  
 NC License No. F-0112  
 Engineers | Construction Managers | Planners | Scientists  
 www.rkk.com  
 Responsive People | Creative Solutions

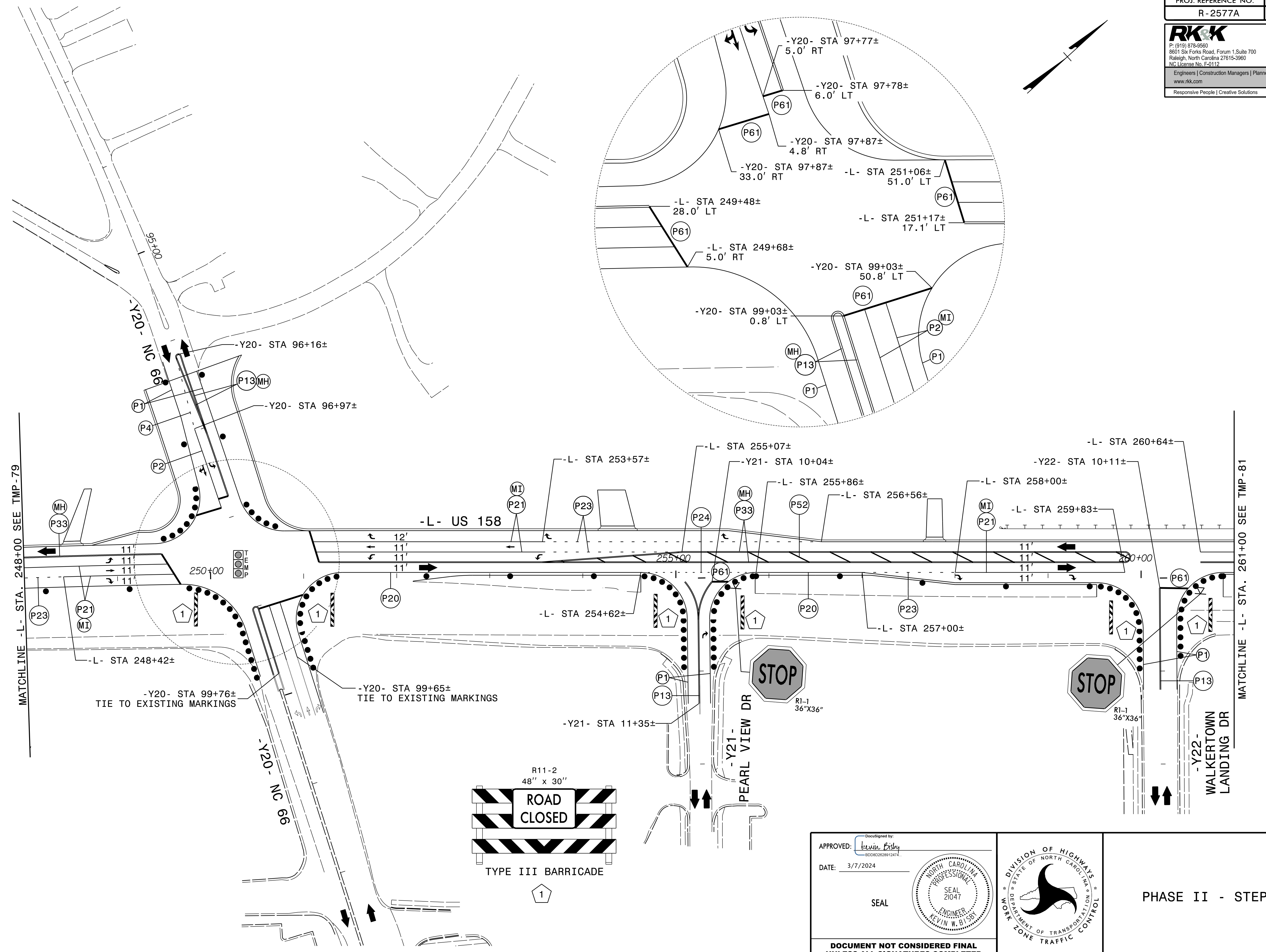

3/7/2024  
 P-2577A\_tmp\_psh80.dgn  
 R01sby

APPROVED: *Kevin Bishy*  
 DATE: 3/7/2024

SEAL

**SEAL 21047**  
 ENGINEER  
 KEVIN W. BISHY

**DOCUMENT NOT CONSIDERED FINAL  
 UNLESS ALL SIGNATURES COMPLETED**

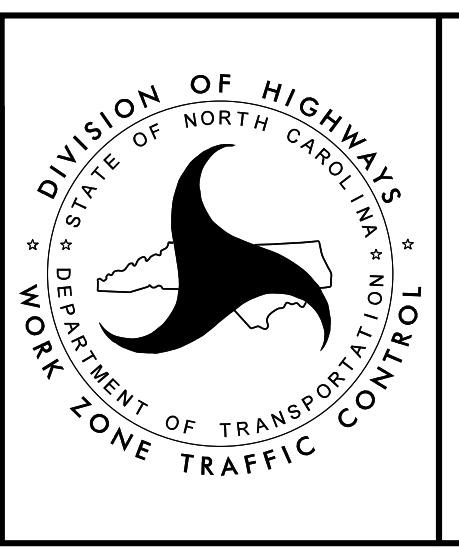

**PHASE II - STEP 3**

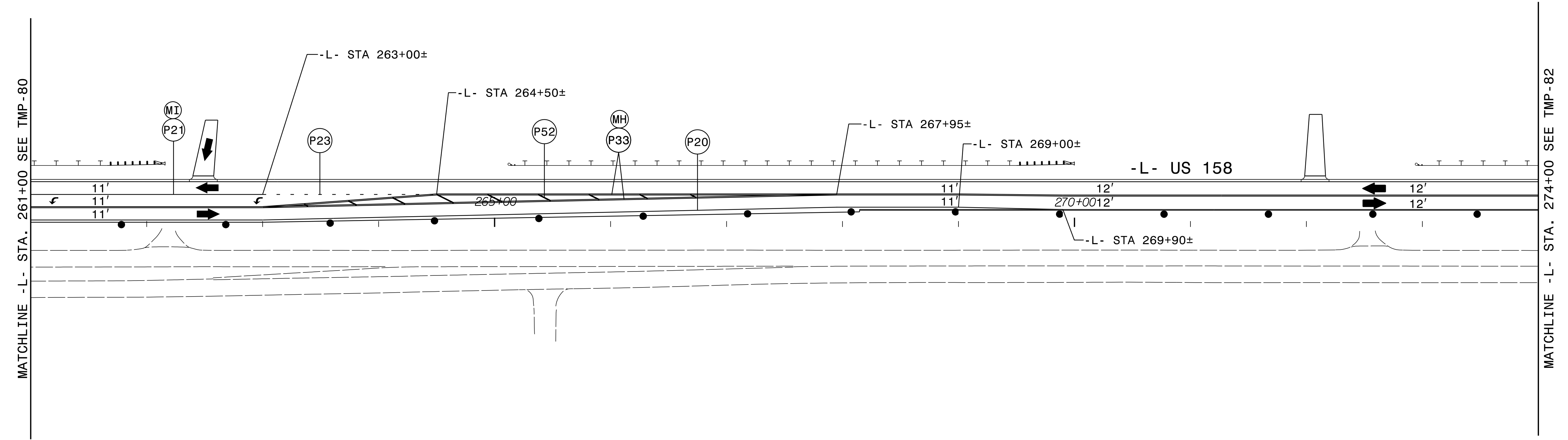
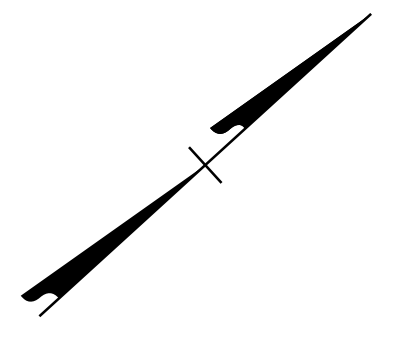

3/7/2024  
 R-2577A\_tmp\_psh81.dgn  
 KRobby

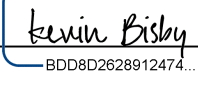
APPROVED:   
DocuSigned by: Kevin Bisby  
B0C8D2628912474

DATE: 3/7/2024

SEAL

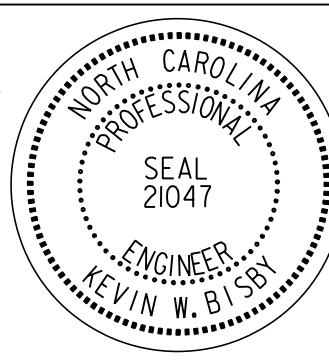
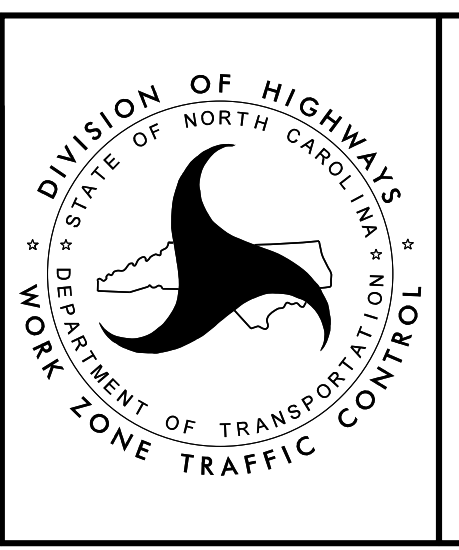
PHASE II - STEP 3

**DOCUMENT NOT CONSIDERED FINAL  
 UNLESS ALL SIGNATURES COMPLETED**

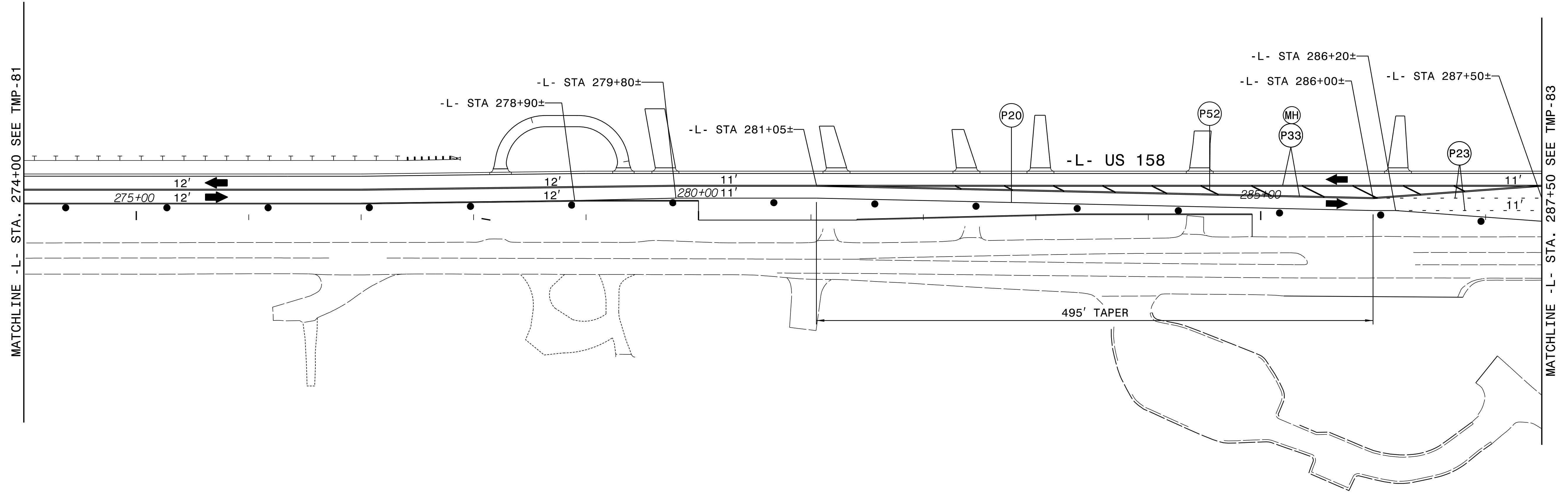
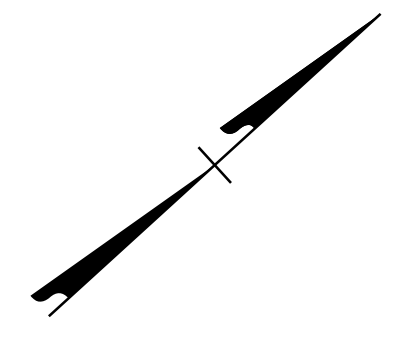

3/7/2024  
 R-2577A\_tmp\_psh82.dgn  
 Kolsby

APPROVED: *Kevin Bishy*  
DocuSigned by: Kevin Bishy  
 BDC0802628912477

DATE: 3/7/2024

SEAL

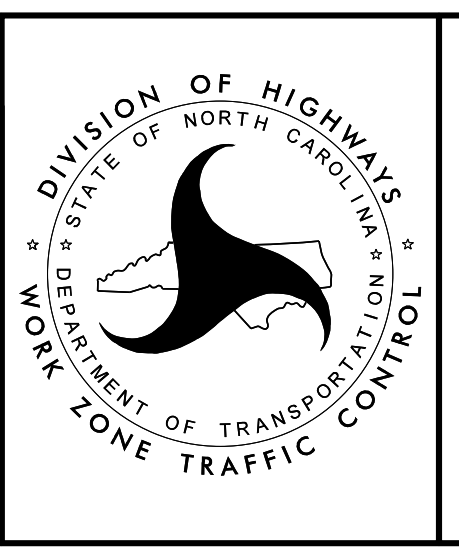

PHASE II - STEP 3

DOCUMENT NOT CONSIDERED FINAL  
 UNLESS ALL SIGNATURES COMPLETED

**RKK**  
 P: (919) 878-8560  
 8601 Six Forks Road, Forum 1, Suite 700  
 Raleigh, North Carolina 27615-3960  
 NC License No. F-0112  
 Engineers | Construction Managers | Planners | Scientists  
 www.rkk.com  
 Responsive People | Creative Solutions

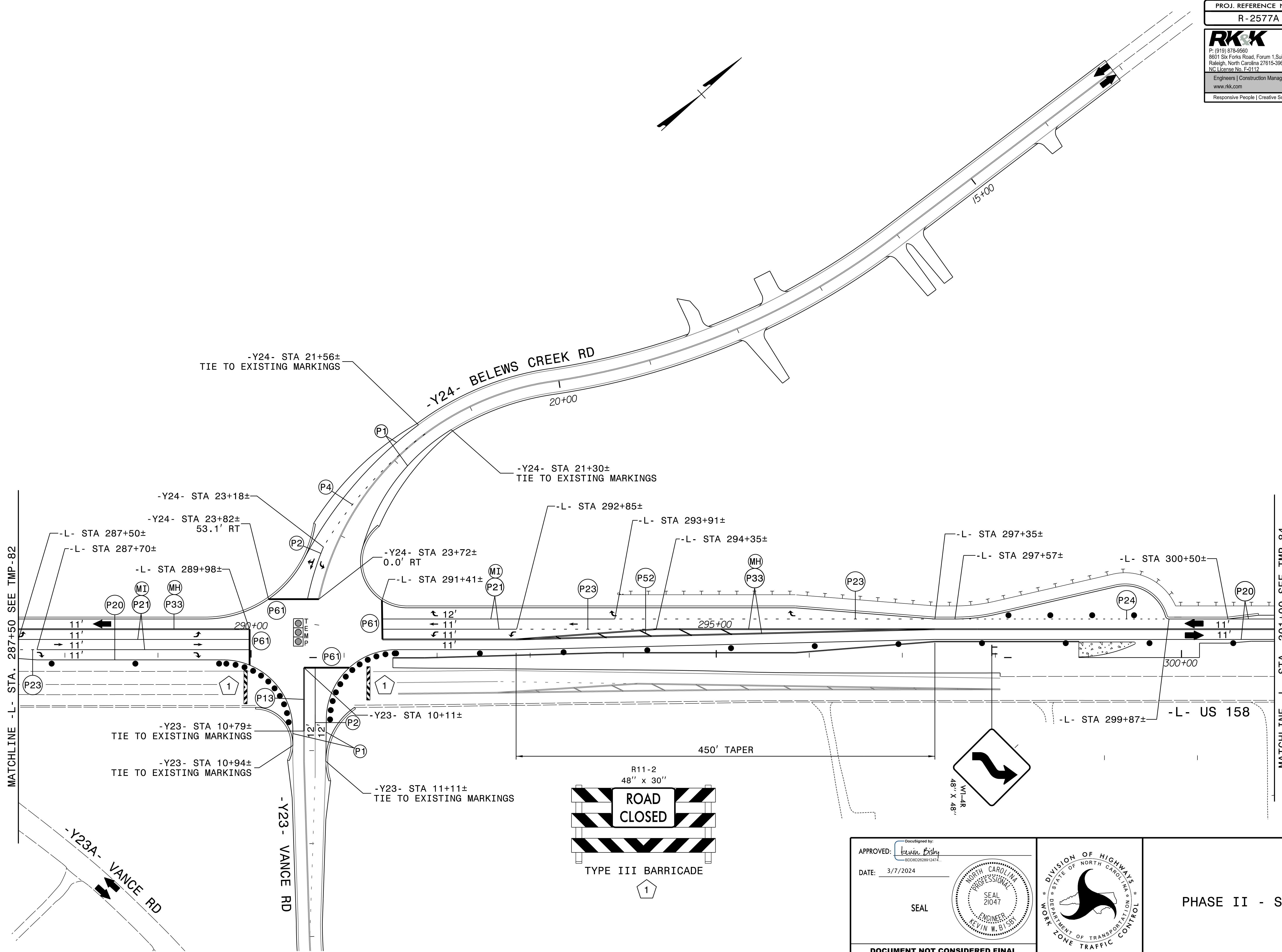
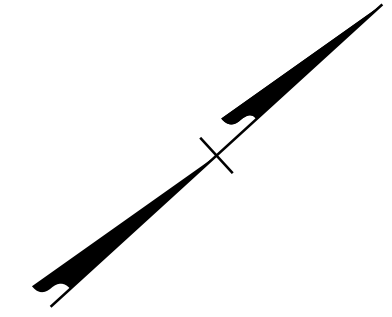

3/7/2024  
 R-2577A\_tmp\_psh83.dgn  
 Rolsby

APPROVED: *Kevin Bishy*  
 DATE: 3/7/2024

SEAL

DOCUMENT NOT CONSIDERED FINAL  
 UNLESS ALL SIGNATURES COMPLETED

NORTH CAROLINA  
 PROFESSIONAL  
 SEAL  
 21047  
 ENGINEER  
 KEVIN W. BISHY

DIVISION OF HIGHWAYS  
 STATE OF NORTH CAROLINA  
 DEPARTMENT OF TRANSPORTATION  
 WORK ZONE TRAFFIC CONTROL

PHASE II - STEP 3

PROJ. REFERENCE NO.	SHEET NO.
R - 2577A	TMP - 84

**RKK**  
 P: (919) 878-8560  
 8601 Six Forks Road, Forum 1, Suite 700  
 Raleigh, North Carolina 27615-3960  
 NC License No. F-0112  
 Engineers | Construction Managers | Planners | Scientists  
 www.rkk.com  
 Responsive People | Creative Solutions

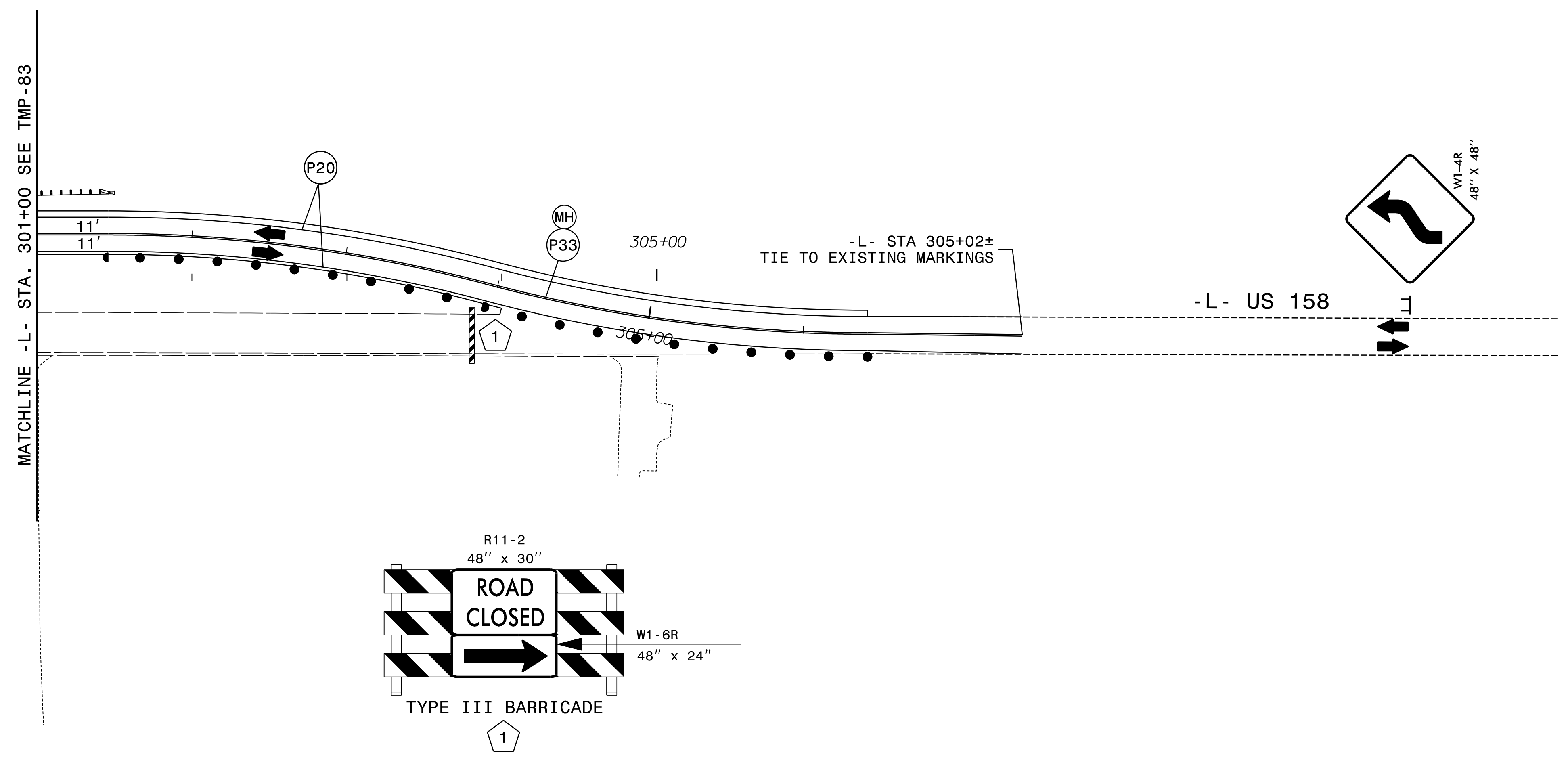
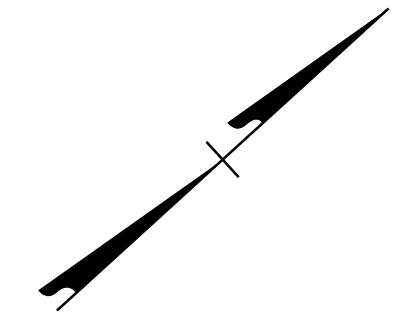

3/7/2024  
 R-2577A\_tmp\_psh84.dgn  
 Kolsby

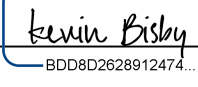
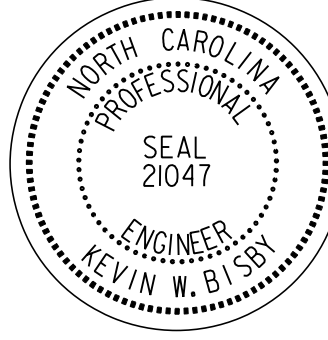
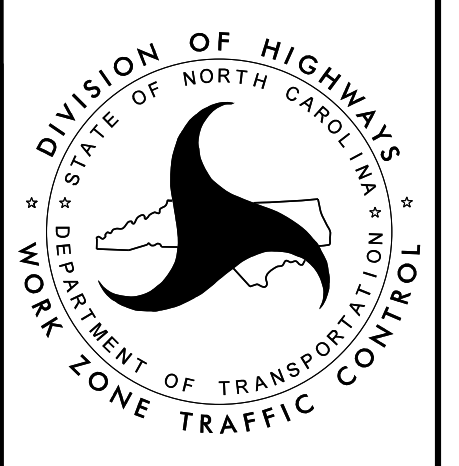
APPROVED:  DATE: 3/7/2024 SEAL 		PHASE II - STEP 3
<b>DOCUMENT NOT CONSIDERED FINAL          UNLESS ALL SIGNATURES COMPLETED</b>		

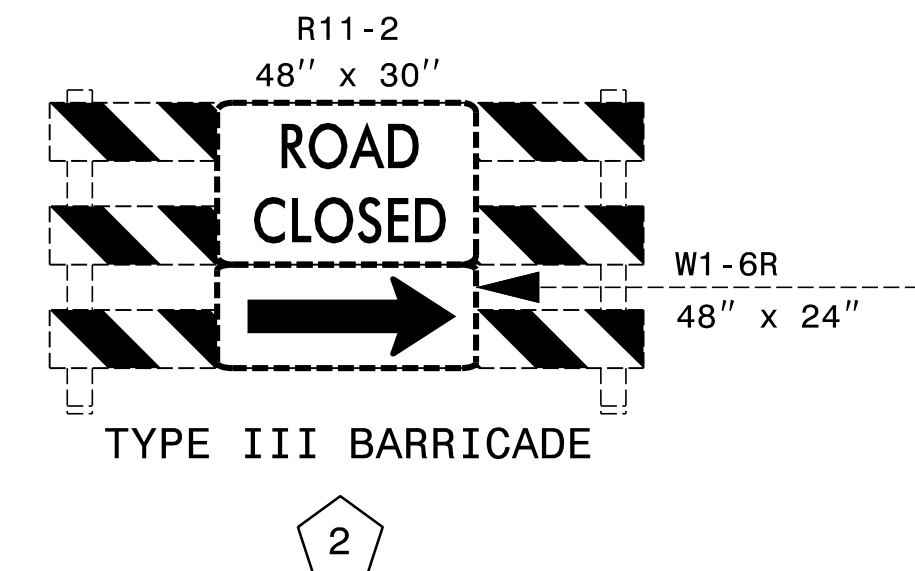
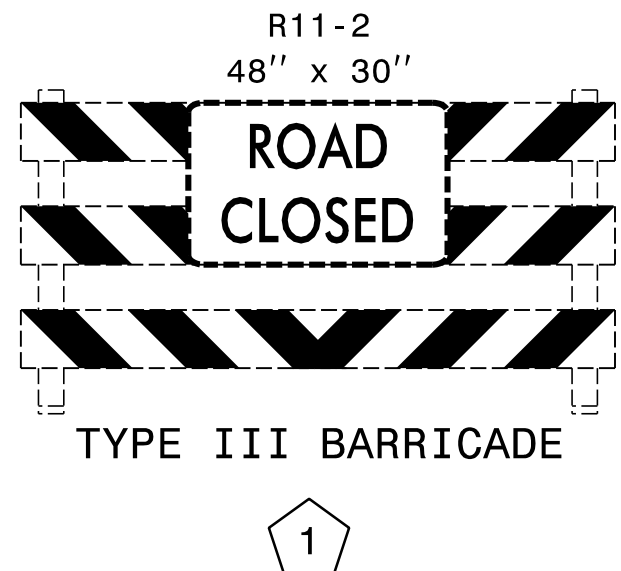
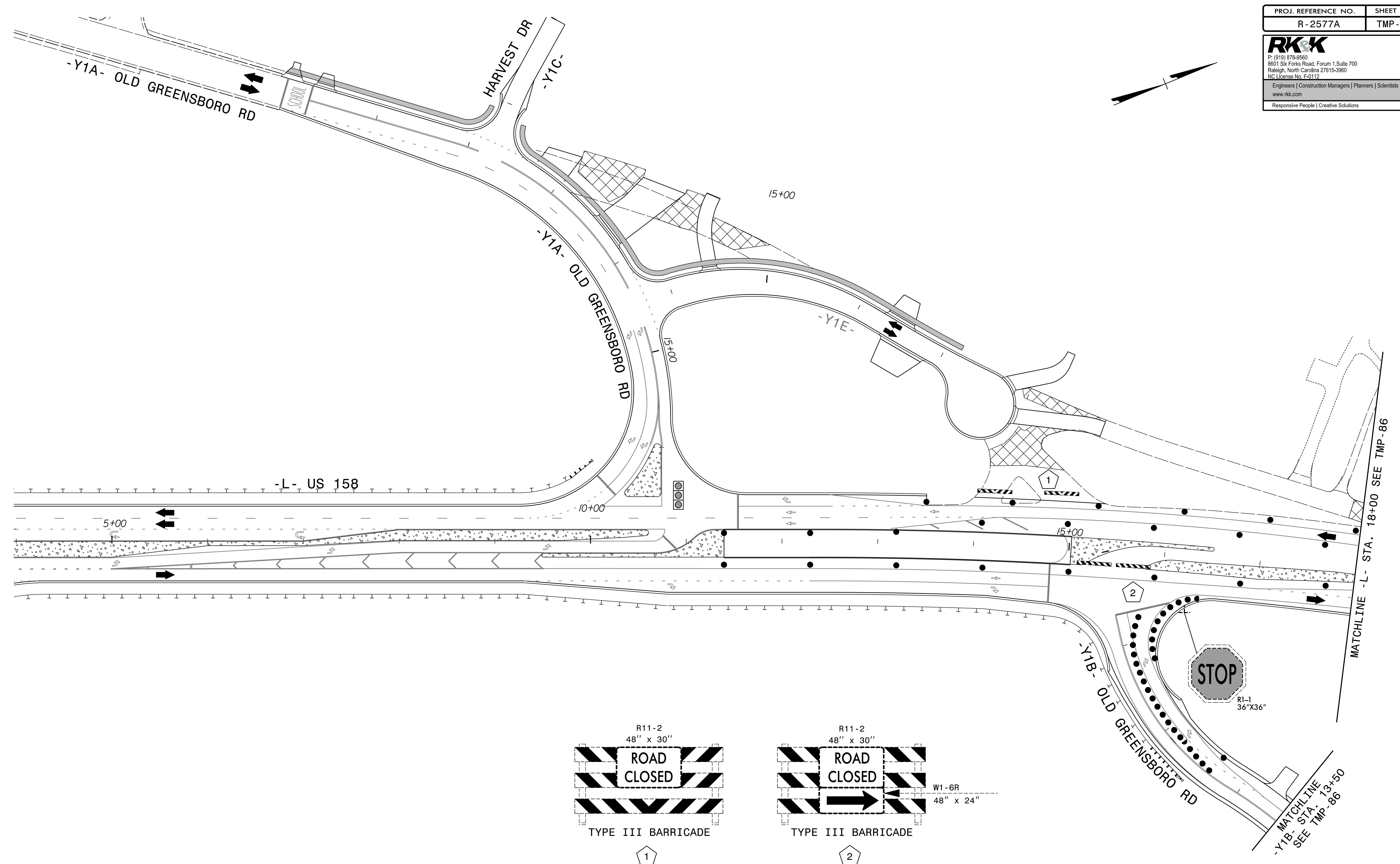
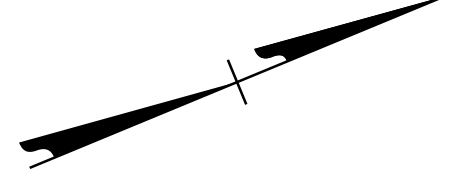

APPROVED: *Kevin Bisby*  
 DATE: 3/7/2024

SEAL

**DOCUMENT NOT CONSIDERED FINAL  
 UNLESS ALL SIGNATURES COMPLETED**

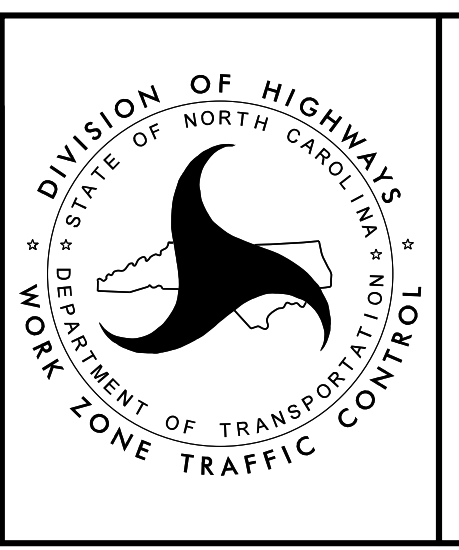

PHASE II - STEP 4

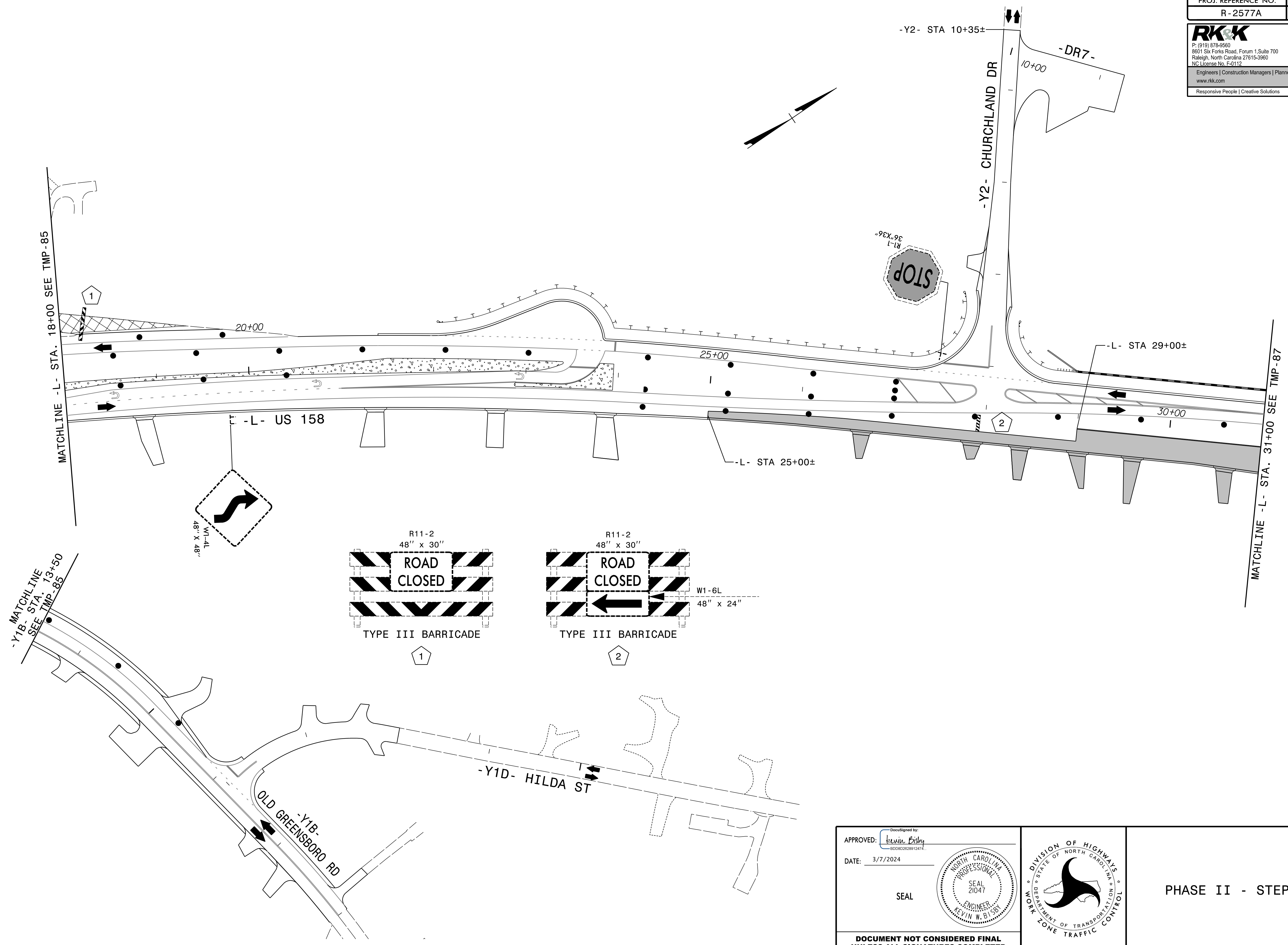

3/7/2024  
 R-2577A\_tmp\_psh86.dgn  
 KRobby

APPROVED: *Kevin Bisby*  
 DATE: 3/7/2024

SEAL

**DOCUMENT NOT CONSIDERED FINAL  
 UNLESS ALL SIGNATURES COMPLETED**

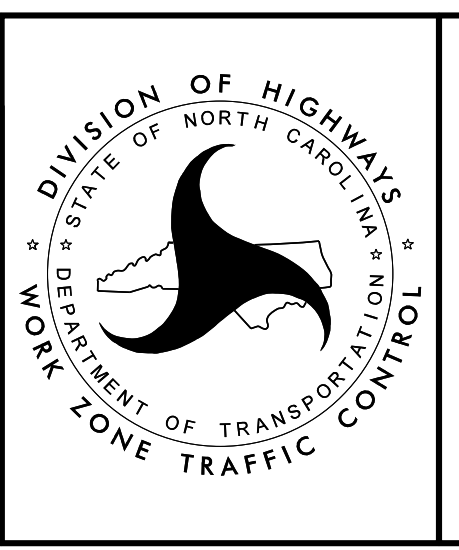

**DIVISION OF HIGHWAYS**  
 NORTH CAROLINA  
 DEPARTMENT OF TRANSPORTATION  
 WORK ZONE TRAFFIC CONTROL

**PHASE II - STEP 4**

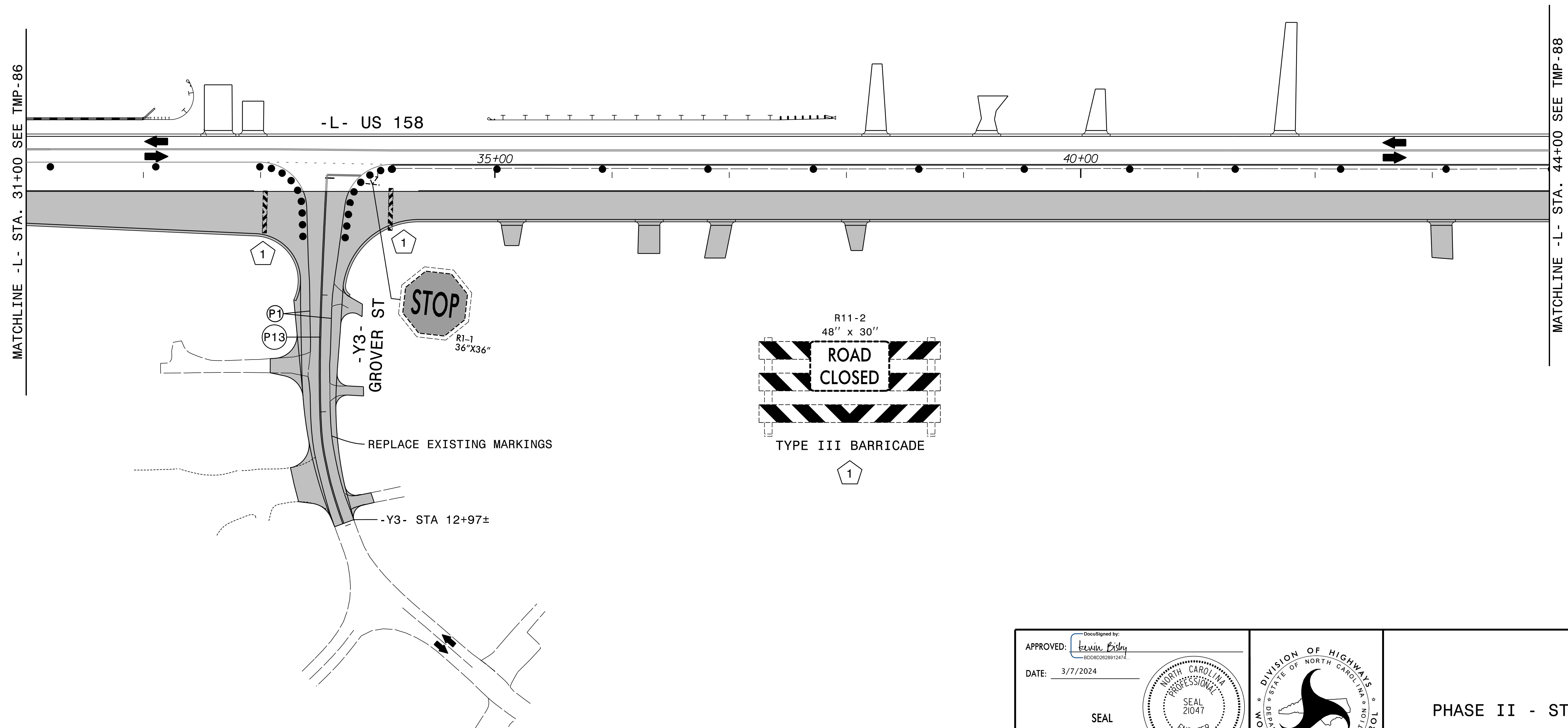
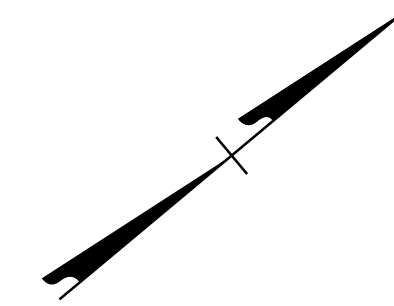

3/7/2024  
 R-2577A\_tmp\_psh87.dgn  
 Kolsby

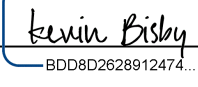
APPROVED:   
 DATE: 3/7/2024

SEAL

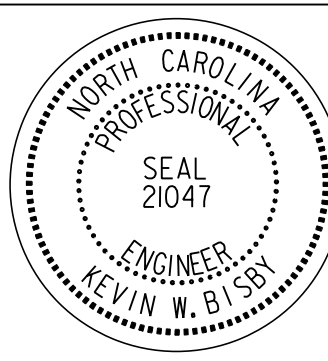
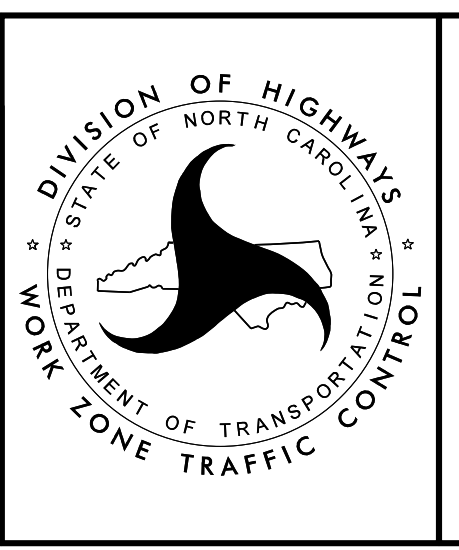
PHASE II - STEP 4

**DOCUMENT NOT CONSIDERED FINAL  
 UNLESS ALL SIGNATURES COMPLETED**



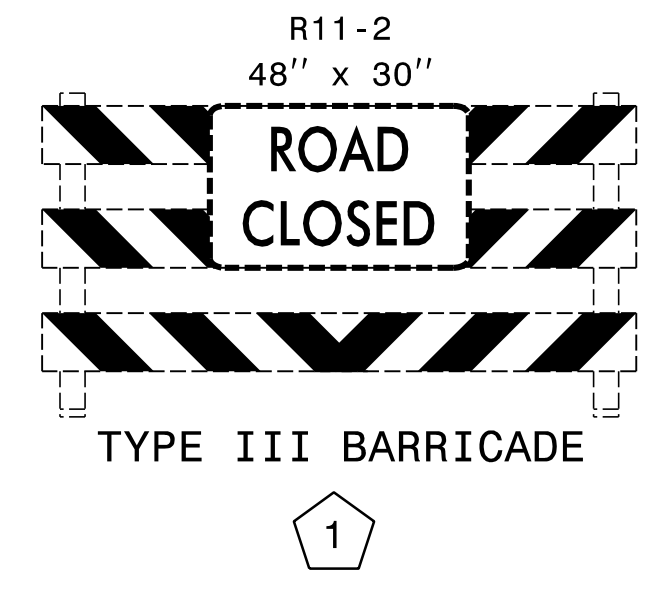
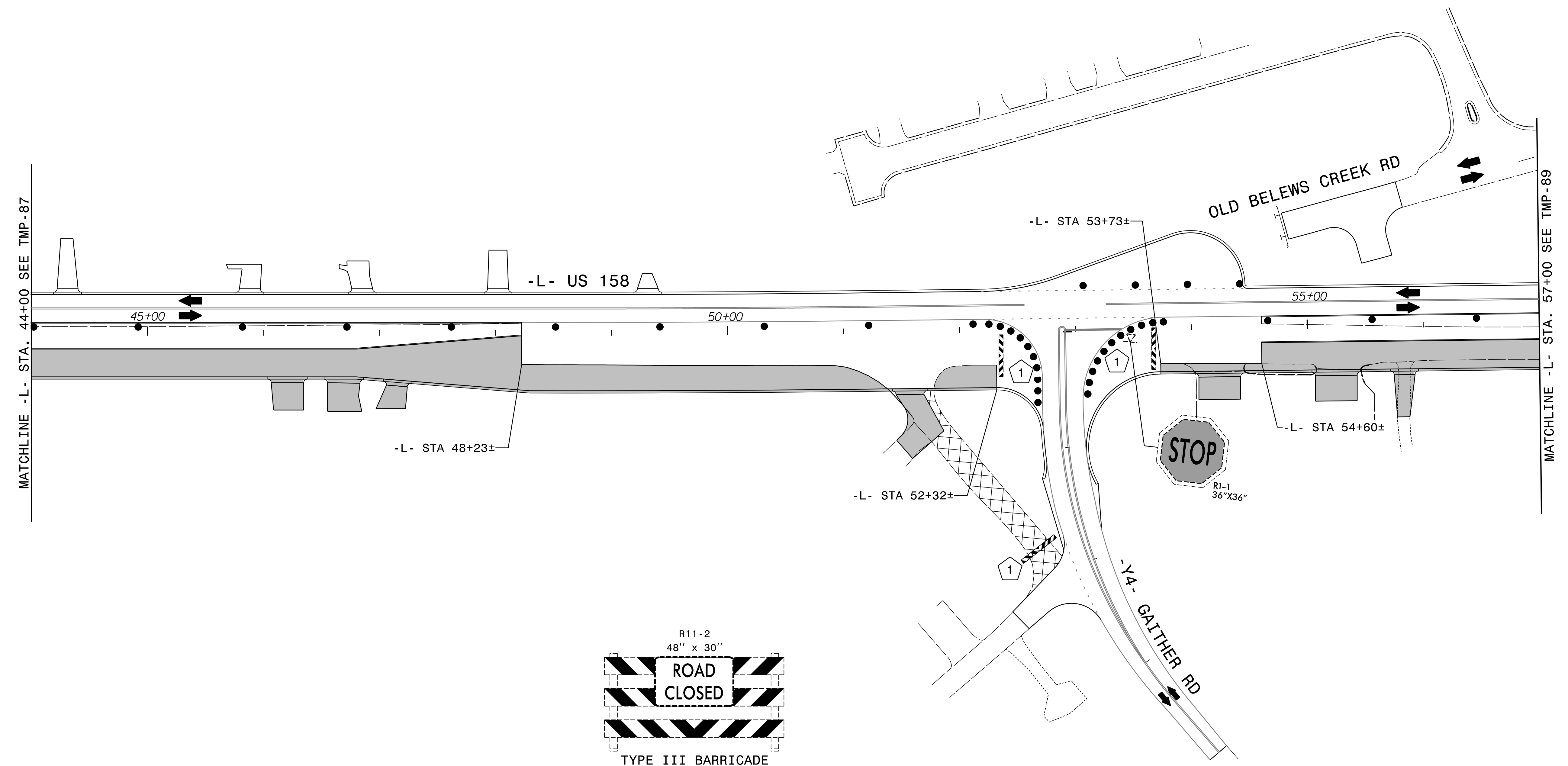
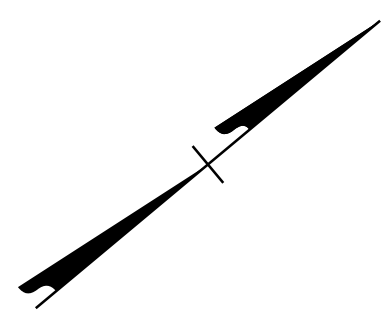

APPROVED: *Kevin Bishy*  
DocuSigned by: Kevin Bishy  
 B0C802628912477

DATE: 3/7/2024

SEAL

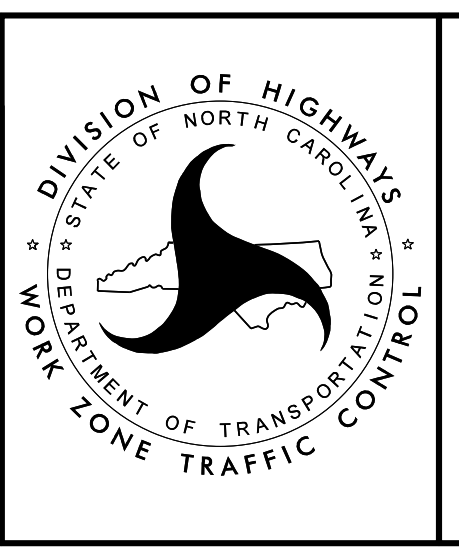

PHASE II - STEP 4

DOCUMENT NOT CONSIDERED FINAL  
 UNLESS ALL SIGNATURES COMPLETED

3/7/2024  
 R-2577A\_tmp\_psh88.dgn  
 Kolsby

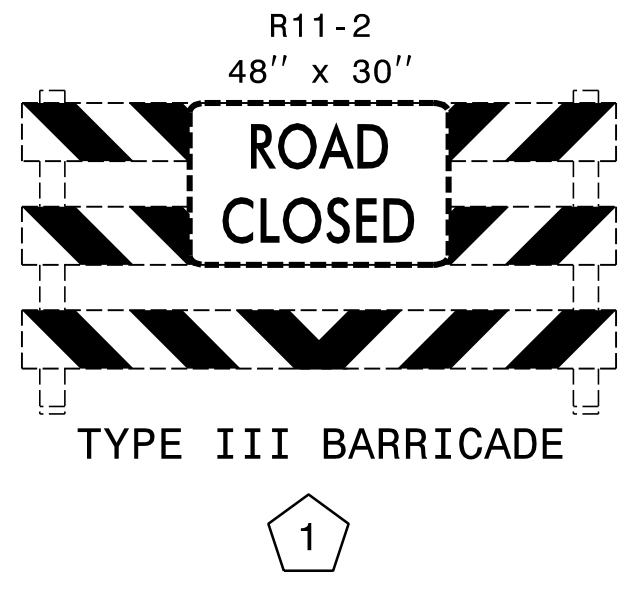
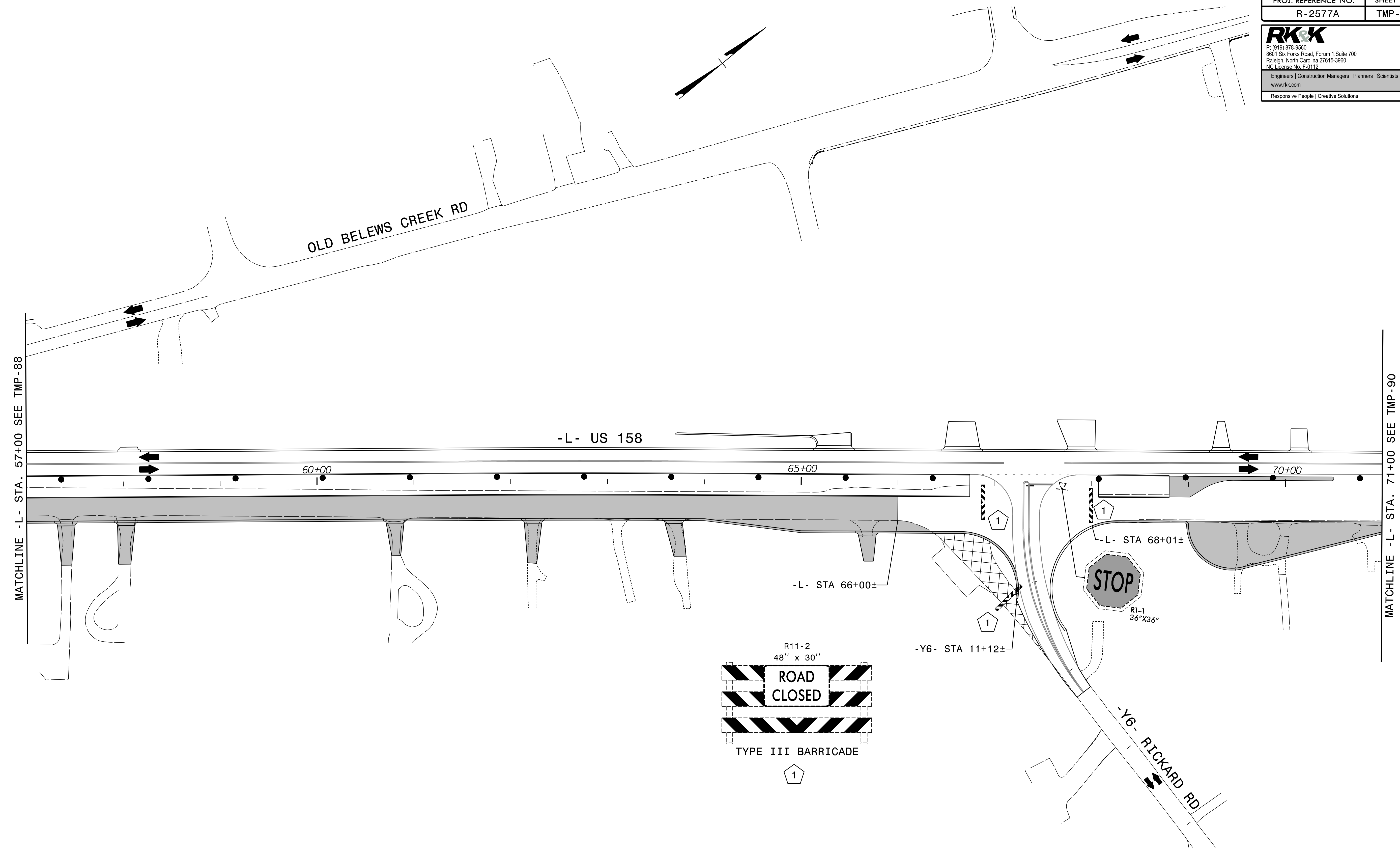

APPROVED: *Kevin Bishy*  
 DATE: 3/7/2024  
 SEAL

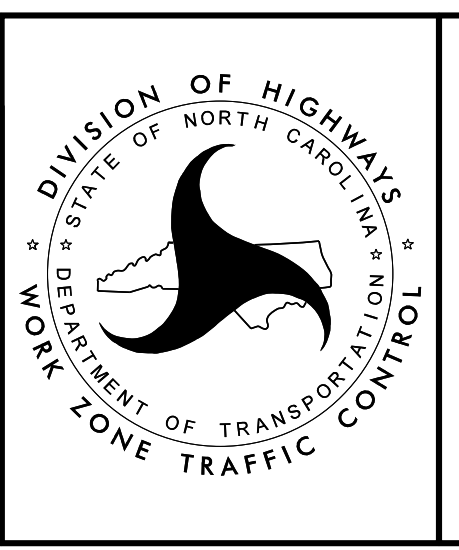

DIVISION OF HIGHWAYS  
 STATE OF NORTH CAROLINA  
 DEPARTMENT OF TRANSPORTATION  
 WORK ZONE TRAFFIC CONTROL

PHASE II - STEP 4

DOCUMENT NOT CONSIDERED FINAL  
 UNLESS ALL SIGNATURES COMPLETED

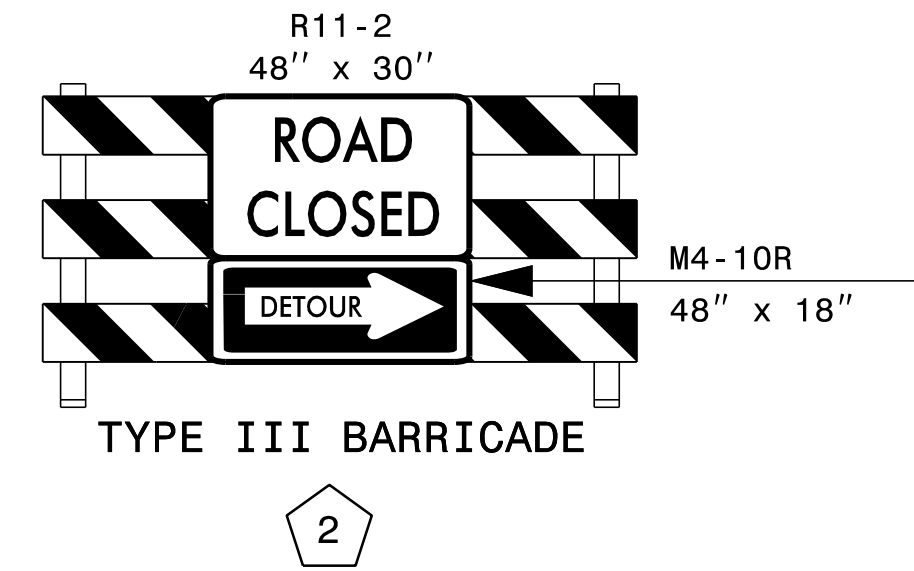
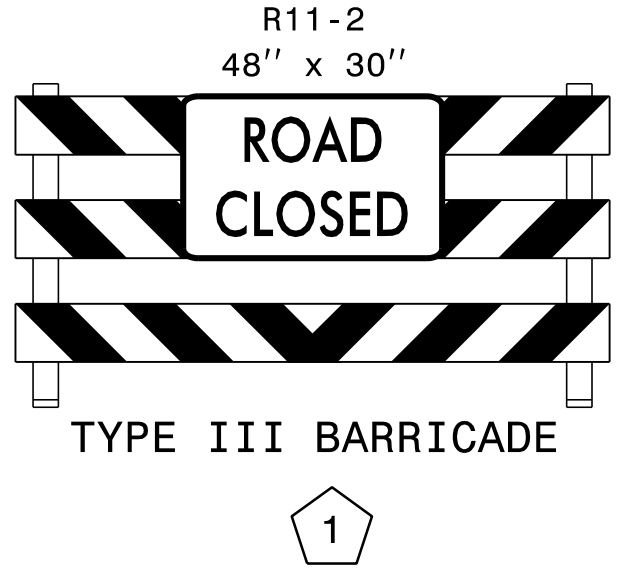
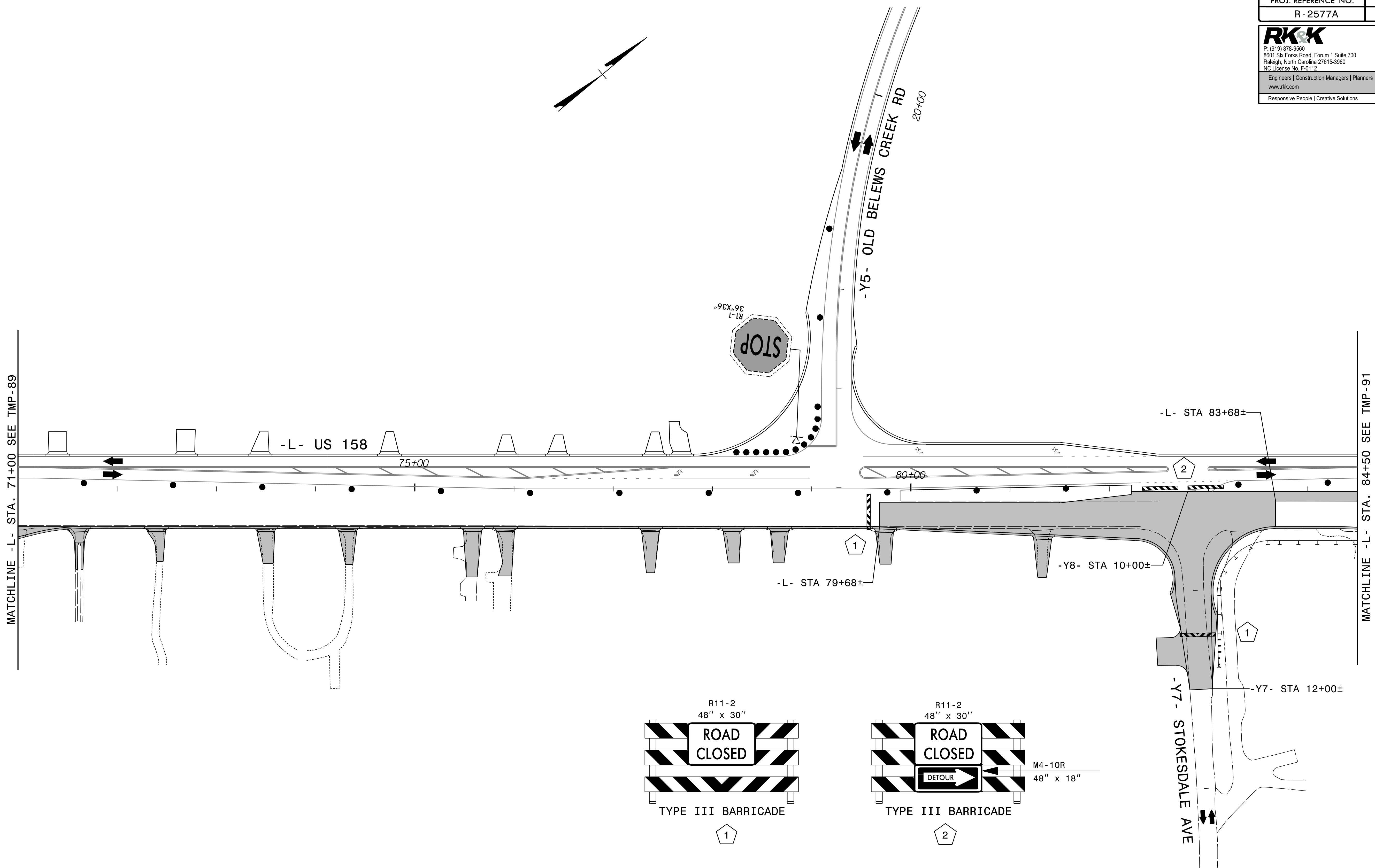

SEE TMP-2I FOR STOKESDALE AVE OFFSITE DETOUR DETAIL

APPROVED: *Kevin E. Bixby*  
 DATE: 3/7/2024

SEAL

DOCUMENT NOT CONSIDERED FINAL  
UNLESS ALL SIGNATURES COMPLETED

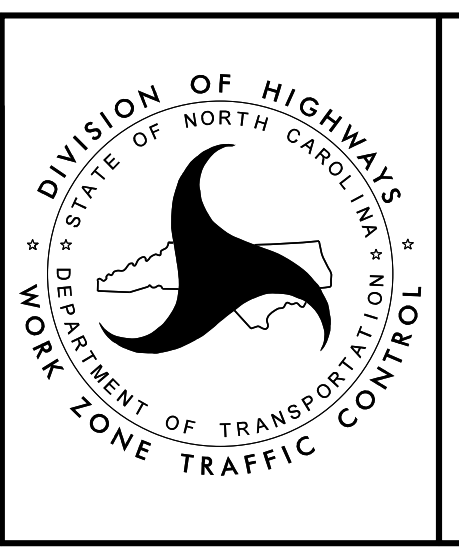

PHASE II - STEP 4

3/7/2024  
 R-2577A\_tmp\_psh90.dgn  
 KRobby

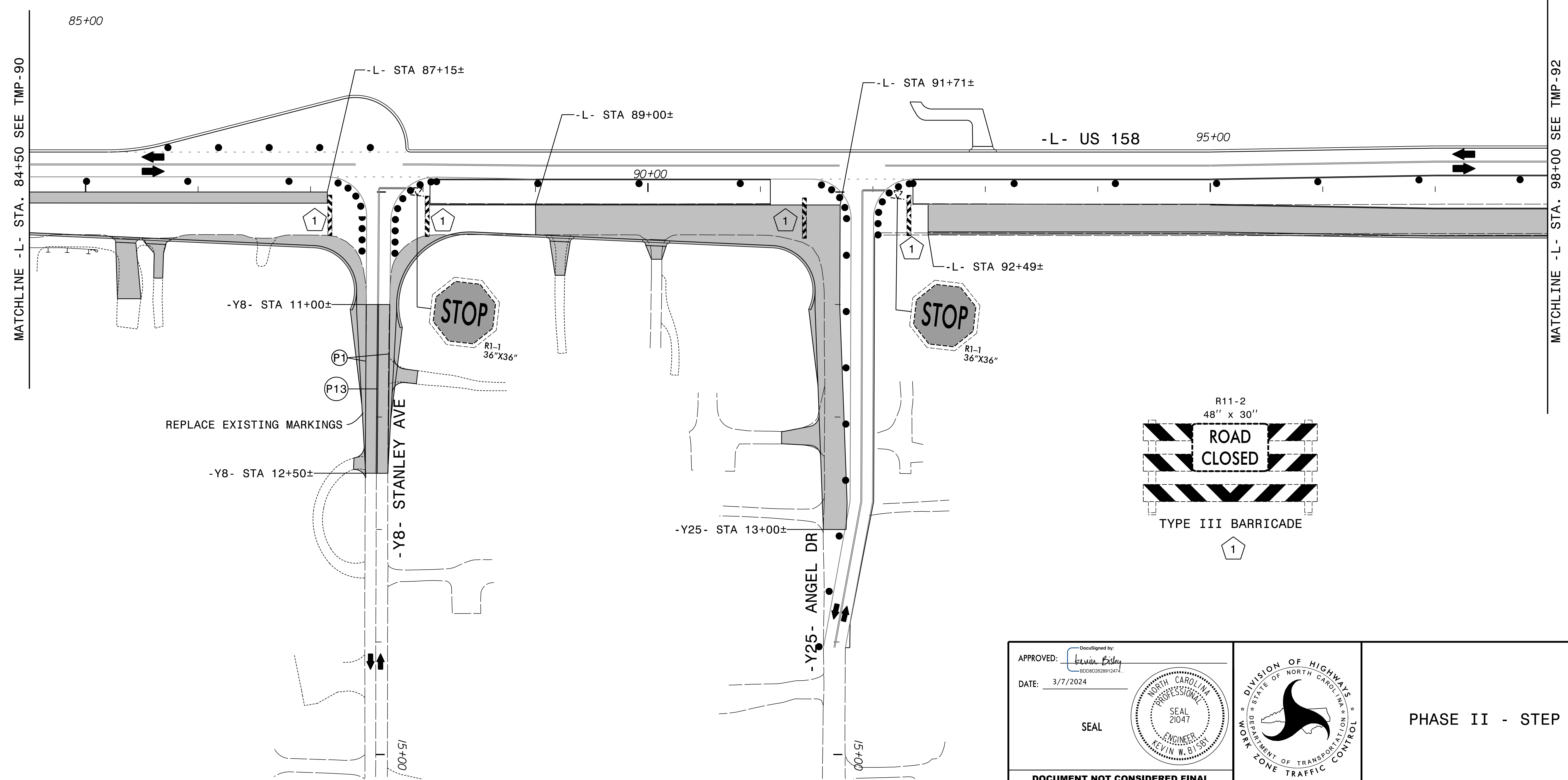
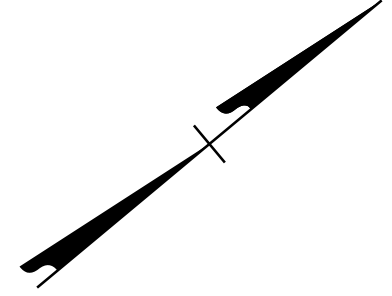

3/7/2024  
 R-2577A\_tmp\_psh91.dgn  
 Rolsby

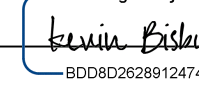
APPROVED:   
 DATE: 3/7/2024

SEAL

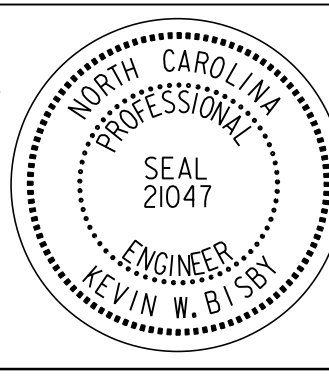
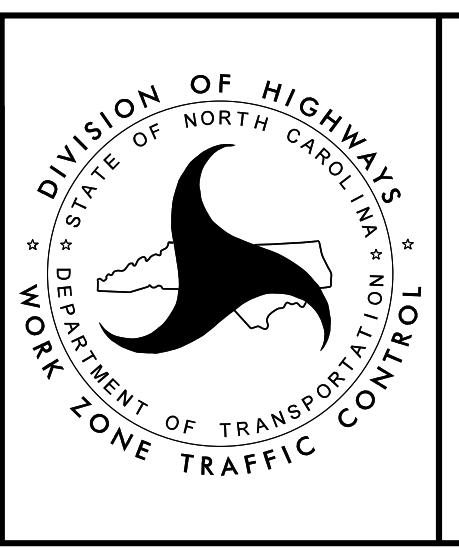



PHASE II - STEP 4

DOCUMENT NOT CONSIDERED FINAL  
UNLESS ALL SIGNATURES COMPLETED

PROJ. REFERENCE NO.	SHEET NO.
R - 2577A	TMP - 92

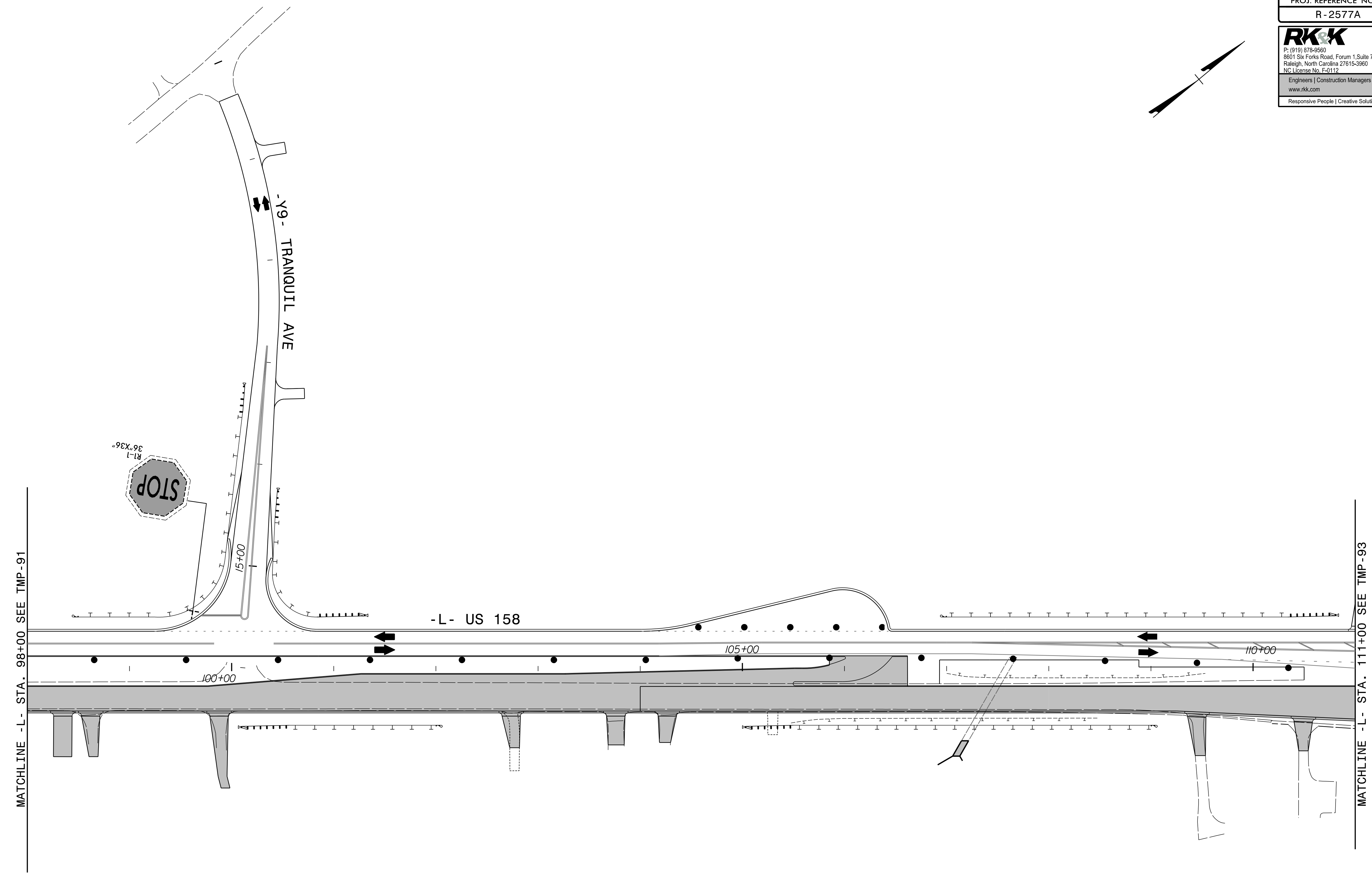
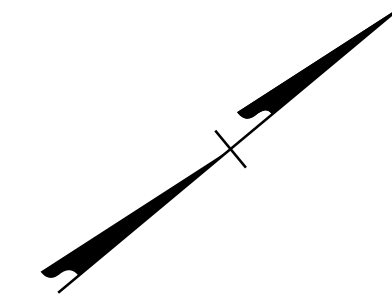
**RKK**  
 P: (919) 878-8560  
 8601 Six Forks Road, Forum 1, Suite 700  
 Raleigh, North Carolina 27615-3960  
 NC License No. F-0112  
 Engineers | Construction Managers | Planners | Scientists  
 www.rkk.com  
 Responsive People | Creative Solutions

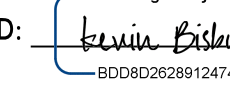

3/7/2024  
 R-2577A\_tmp\_psh92.dgn  
 Rolsby

APPROVED:   
 DATE: 3/7/2024

SEAL

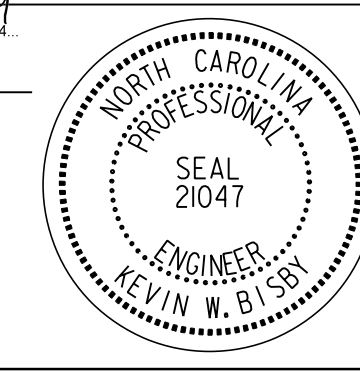
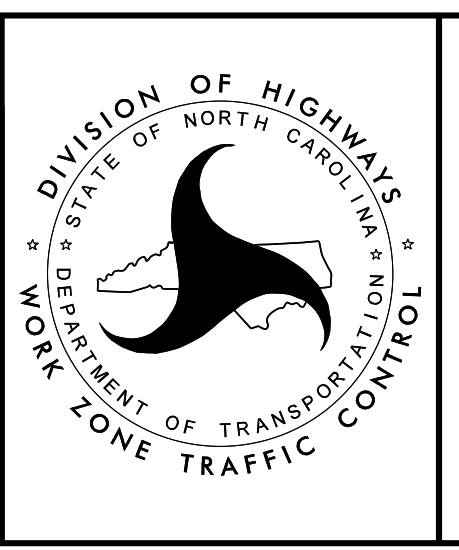

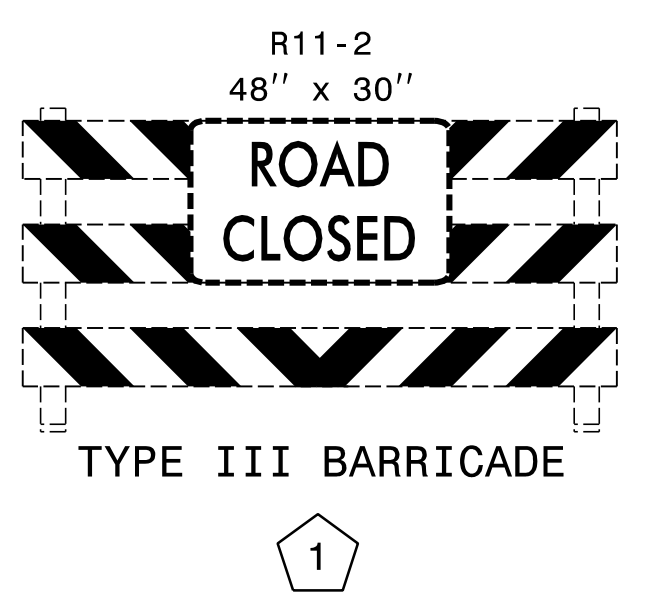
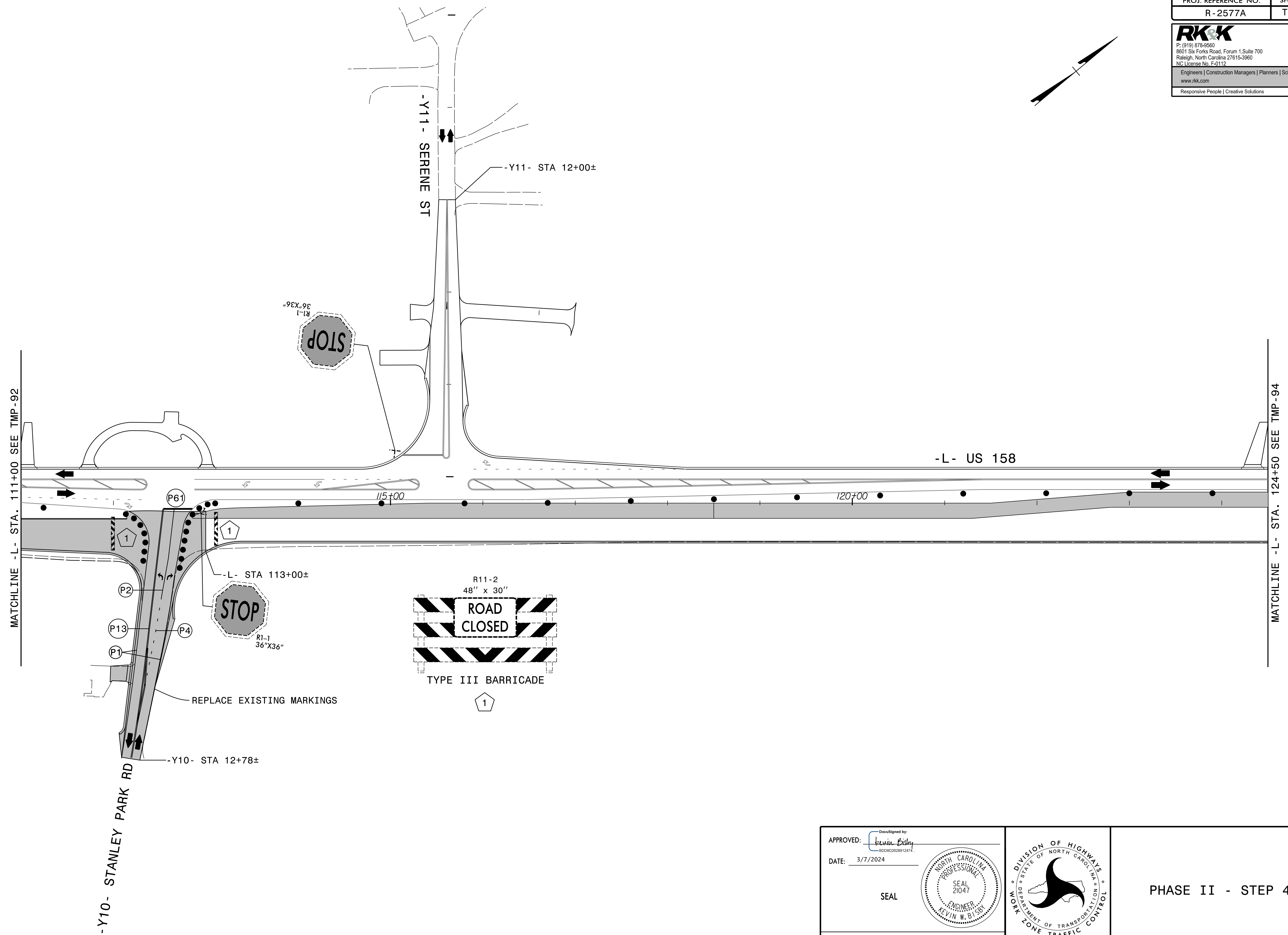
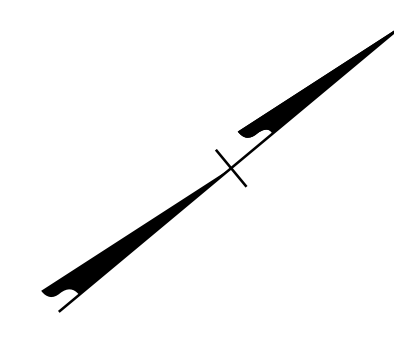

PHASE II - STEP 4

DOCUMENT NOT CONSIDERED FINAL  
 UNLESS ALL SIGNATURES COMPLETED

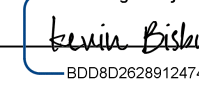

3/7/2024  
 R-2577A\_tmp\_psh93.dgn  
 R015by

APPROVED:   
 DATE: 3/7/2024

SEAL

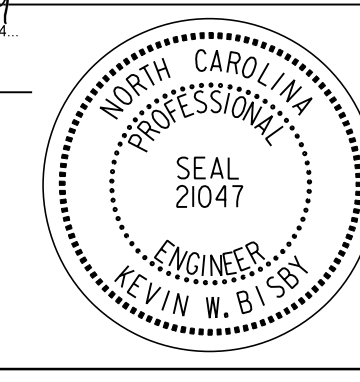
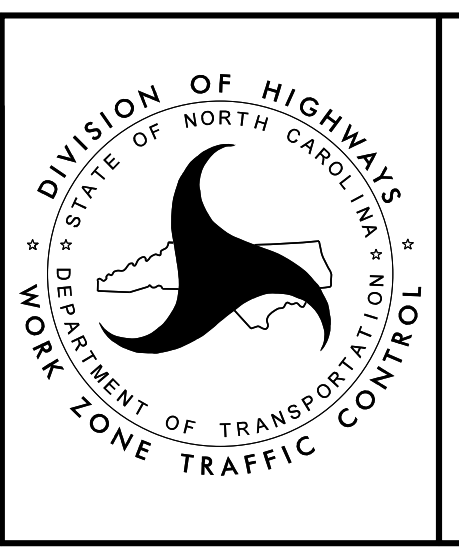



PHASE II - STEP 4

**DOCUMENT NOT CONSIDERED FINAL  
 UNLESS ALL SIGNATURES COMPLETED**

PROJ. REFERENCE NO.	SHEET NO.
R - 2577A	TMP - 94

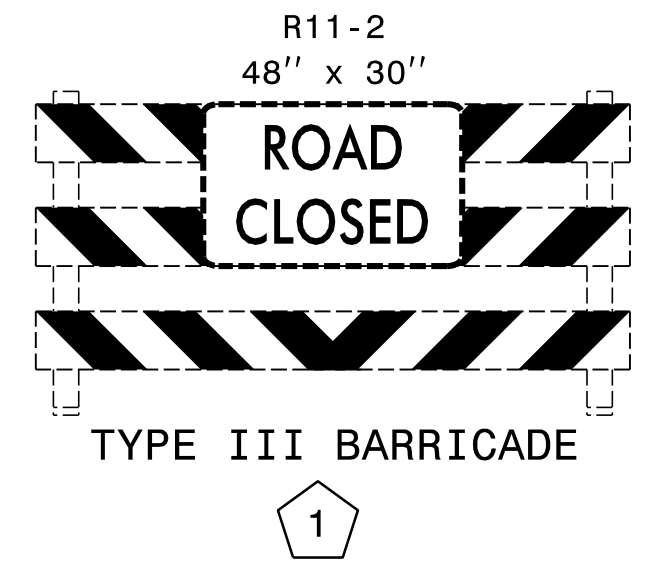
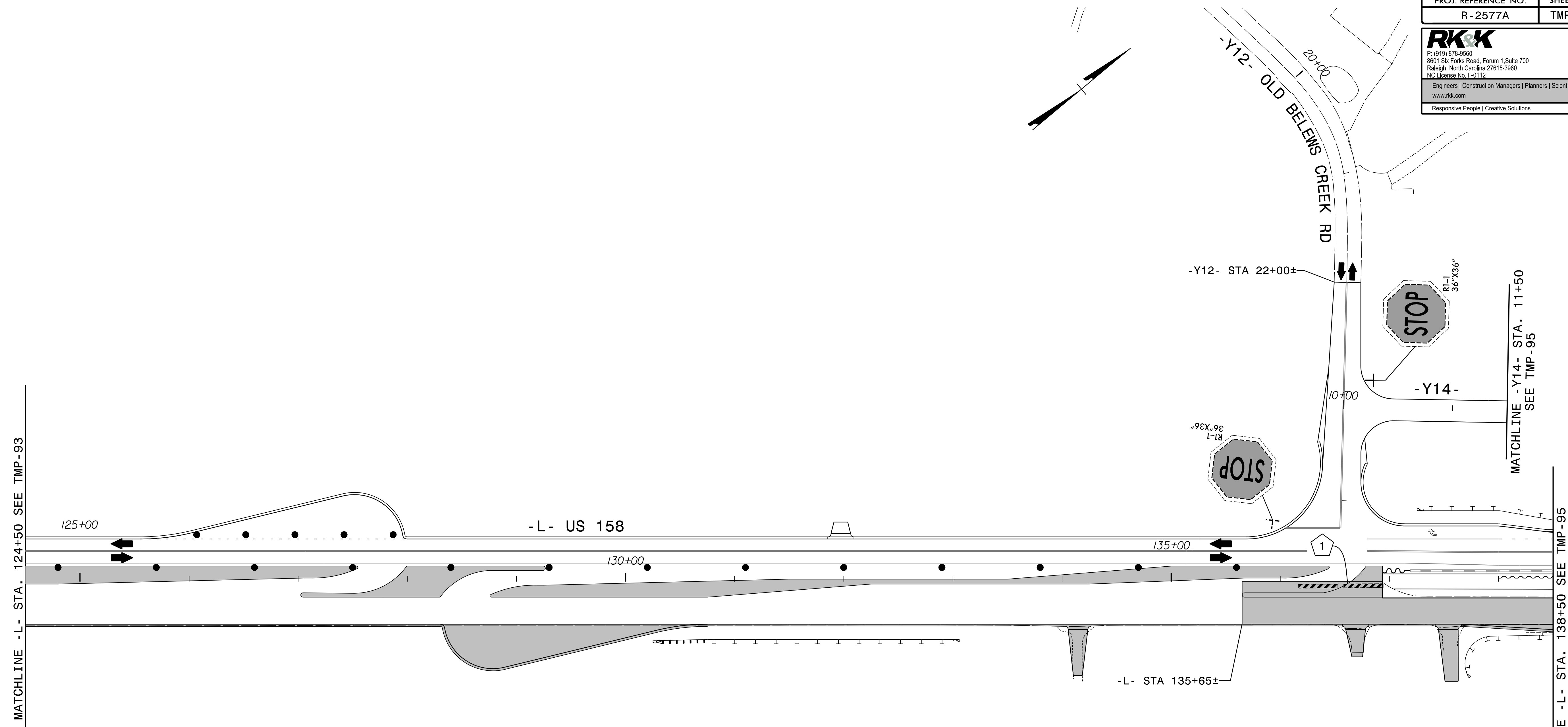
**RKK**  
 P: (919) 878-8560  
 8601 Six Forks Road, Forum 1, Suite 700  
 Raleigh, North Carolina 27615-3960  
 NC License No. F-0112  
 Engineers | Construction Managers | Planners | Scientists  
 www.rkk.com  
 Responsive People | Creative Solutions



3/7/2024  
 R-2577A\_tmp\_psh94.dgn  
 Kolsby

APPROVED: *Kevin W. D'Isby*  
 DATE: 3/7/2024

SEAL

**DOCUMENT NOT CONSIDERED FINAL  
 UNLESS ALL SIGNATURES COMPLETED**

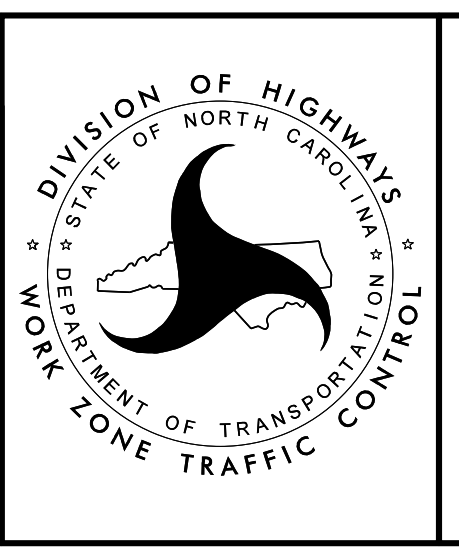

PHASE II - STEP 4

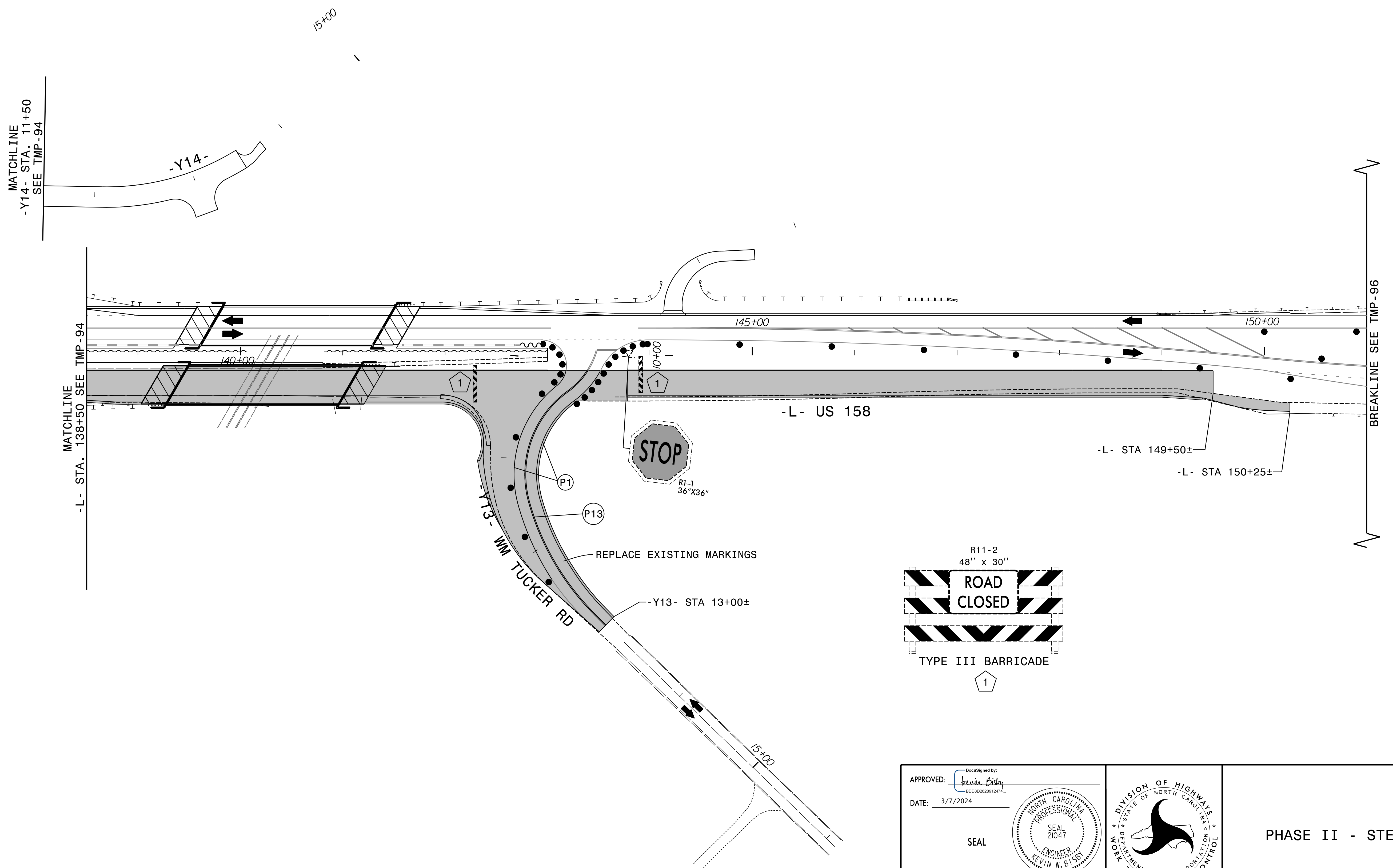
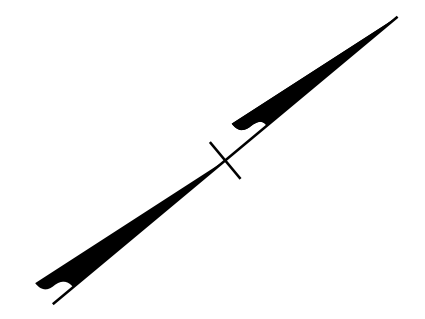

3/7/2024  
 R-2577A\_tmp\_psh95.dgn  
 Robby

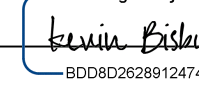
APPROVED:   
 DATE: 3/7/2024

SEAL

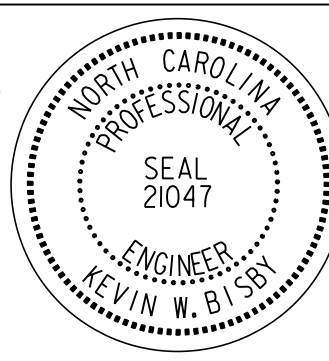
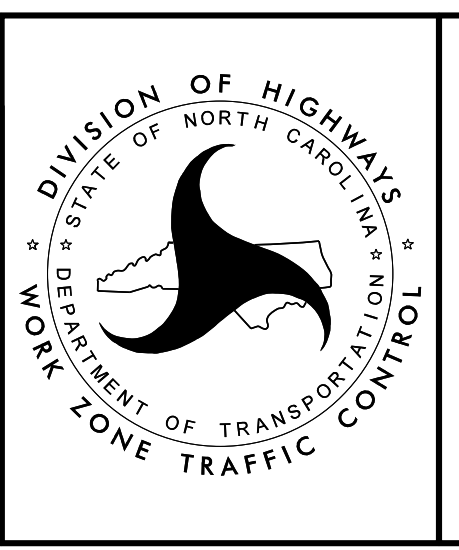
PHASE II - STEP 4

**DOCUMENT NOT CONSIDERED FINAL  
UNLESS ALL SIGNATURES COMPLETED**



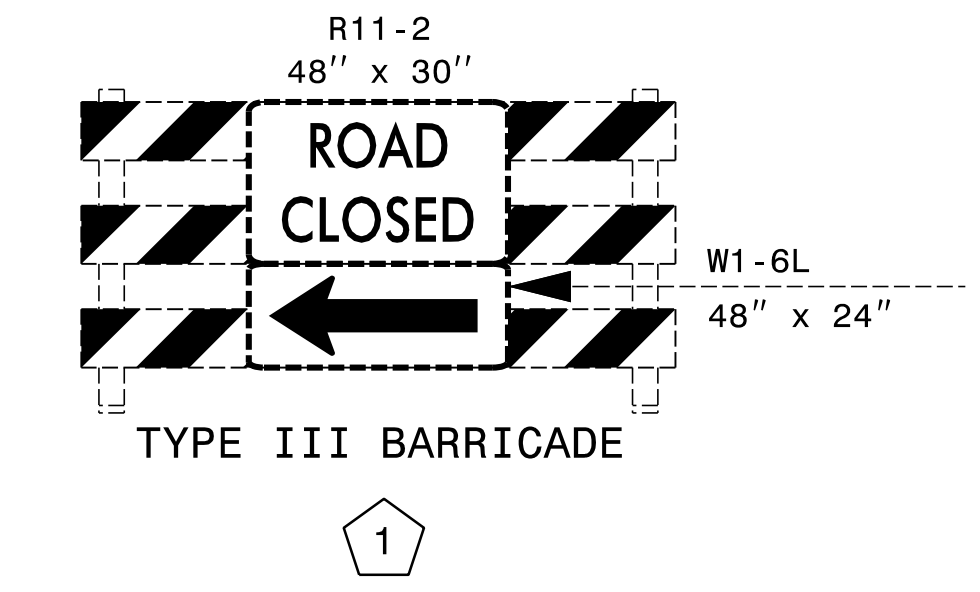
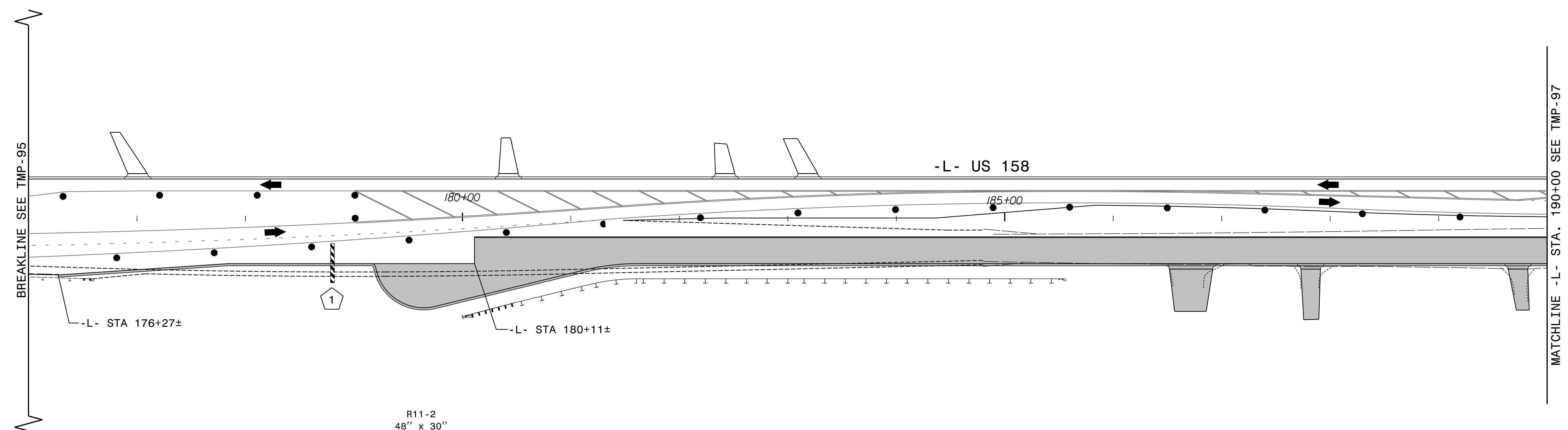
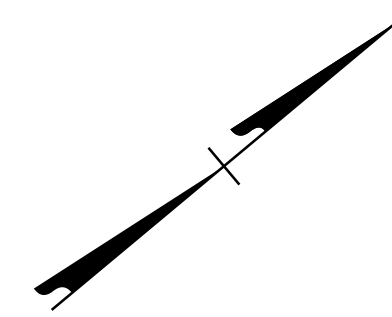

3/7/2024  
 R-2577A\_tmp\_psh96.dgn  
 Rolsby

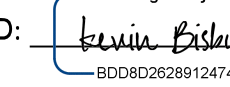
APPROVED:   
 DATE: 3/7/2024

SEAL

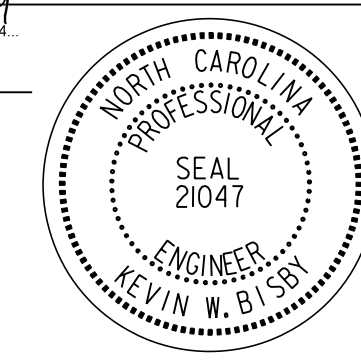
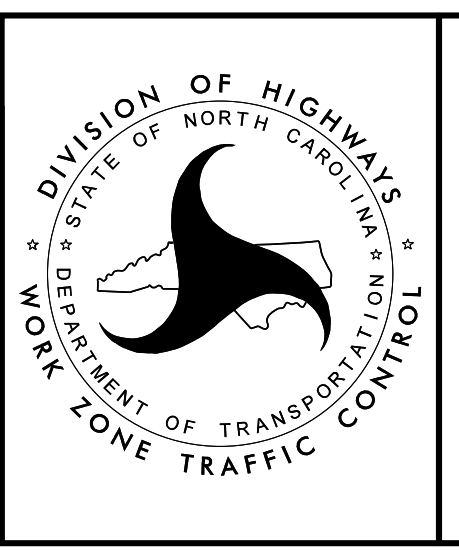



PHASE II - STEP 4

**DOCUMENT NOT CONSIDERED FINAL  
 UNLESS ALL SIGNATURES COMPLETED**

PROJ. REFERENCE NO.	SHEET NO.
R - 2577A	TMP - 97

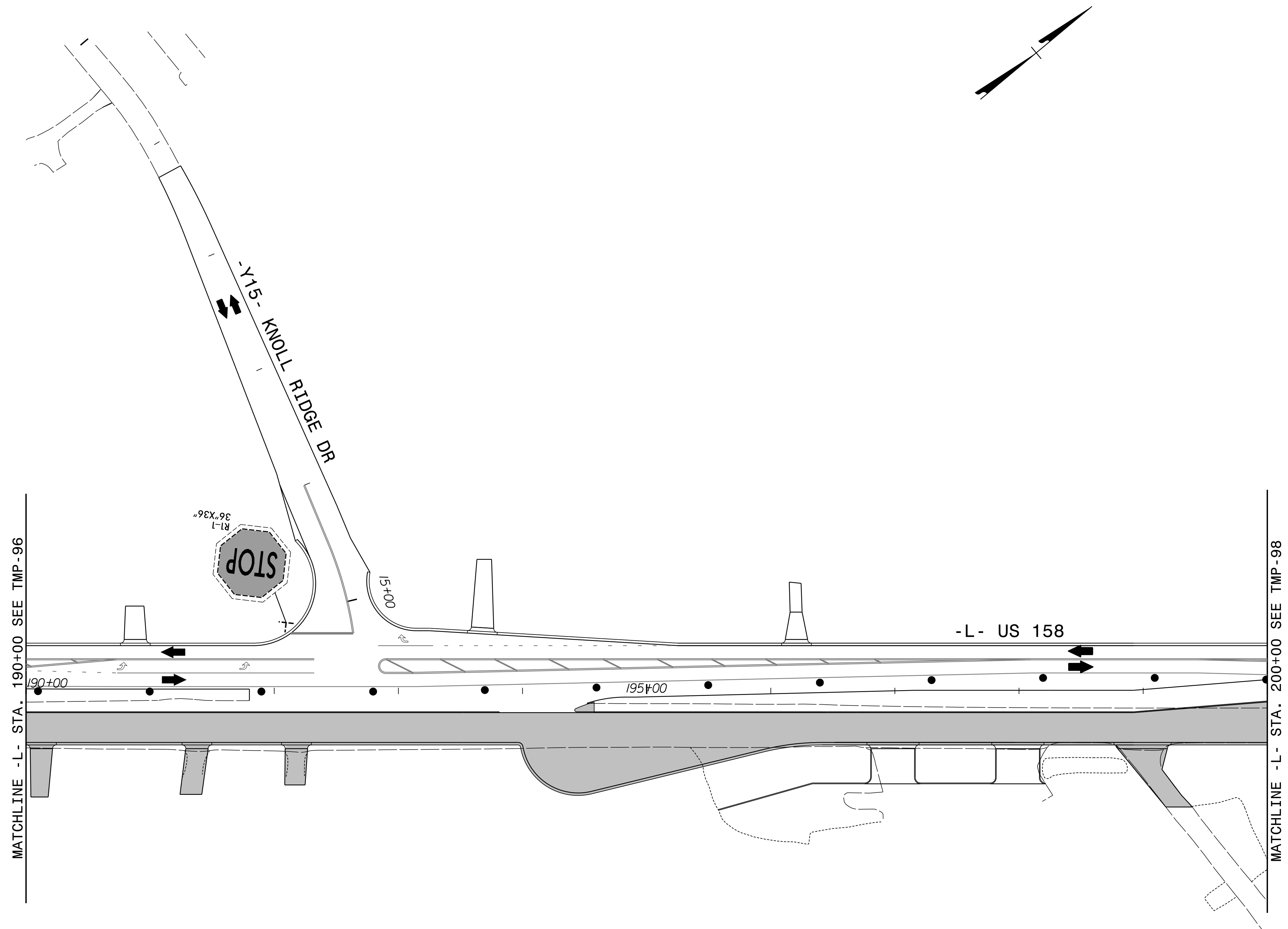
**RKK**  
 P: (919) 878-8560  
 8601 Six Forks Road, Forum 1, Suite 700  
 Raleigh, North Carolina 27615-3960  
 NC License No. F-0112  
 Engineers | Construction Managers | Planners | Scientists  
 www.rkk.com  
 Responsive People | Creative Solutions

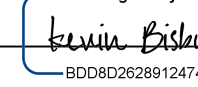

3/7/2024  
 R-2577A\_tmp\_psh97.dgn  
 Kolsby

APPROVED:   
DocuSigned by: Kevin W. D'Isby  
 8D0C82028912474

DATE: 3/7/2024

SEAL

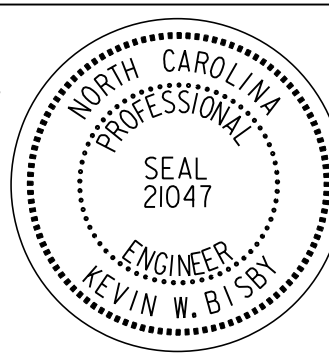
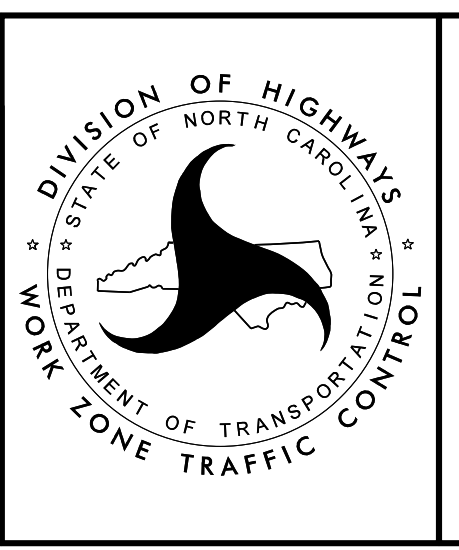

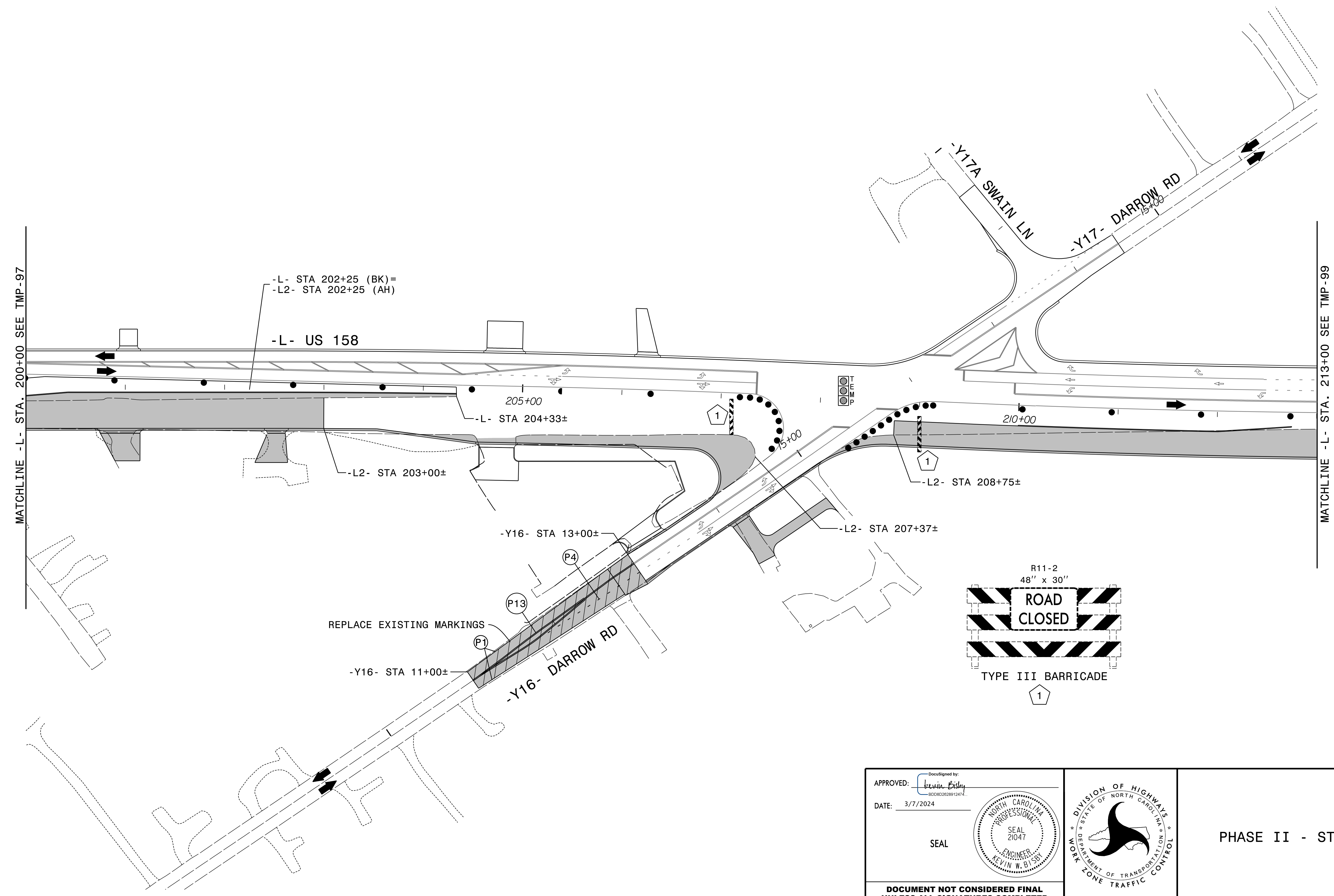
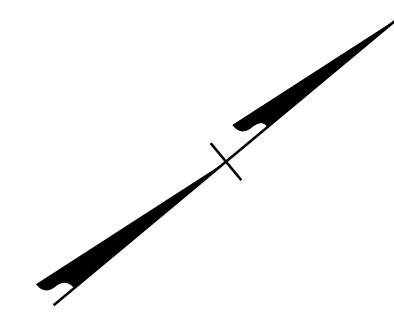

PHASE II - STEP 4

**DOCUMENT NOT CONSIDERED FINAL  
 UNLESS ALL SIGNATURES COMPLETED**

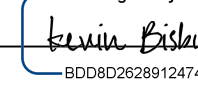

3/7/2024  
 R-2577A\_tmp\_psh98.dgn  
 Robby

APPROVED:   
 DATE: 3/7/2024

SEAL

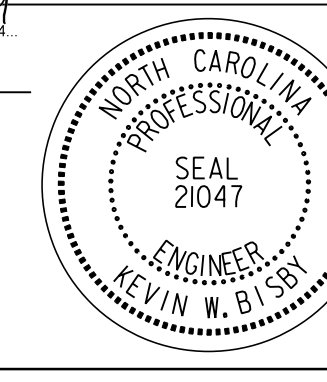
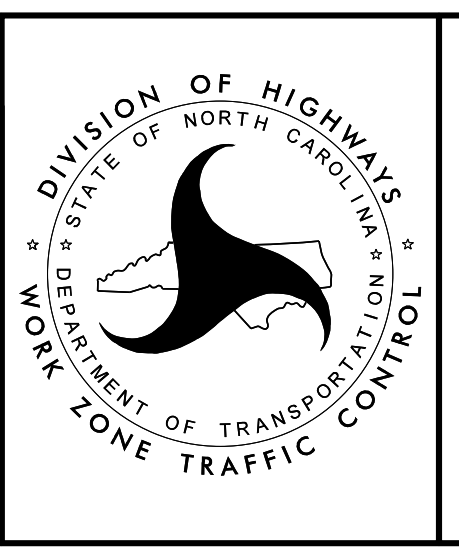



PHASE II - STEP 4

**DOCUMENT NOT CONSIDERED FINAL  
 UNLESS ALL SIGNATURES COMPLETED**

PROJ. REFERENCE NO.	SHEET NO.
R - 2577A	TMP - 99

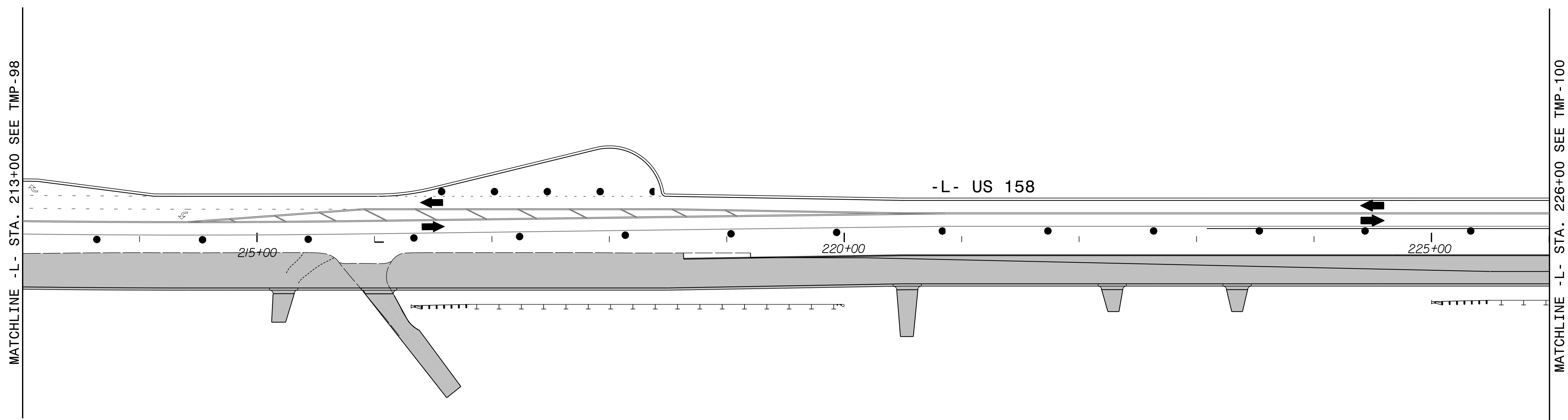
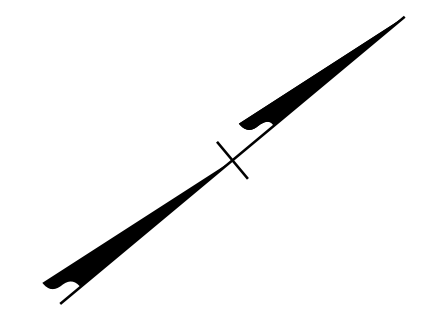
**RKK**  
 P: (919) 878-8560  
 8601 Six Forks Road, Forum 1, Suite 700  
 Raleigh, North Carolina 27615-3960  
 NC License No. F-0112  
 Engineers | Construction Managers | Planners | Scientists  
 www.rkk.com  
 Responsive People | Creative Solutions

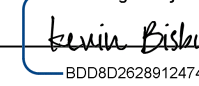

3/7/2024  
 R-2577A\_tmp\_psh99.dgn  
 KRobby

APPROVED:   
DocuSigned by: Kevin W. Dobby  
 BDC982028912474

DATE: 3/7/2024

SEAL

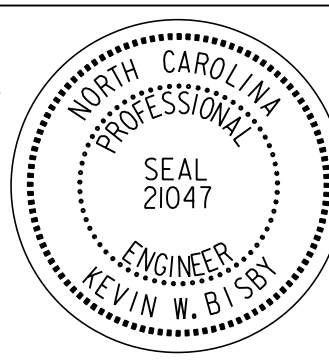
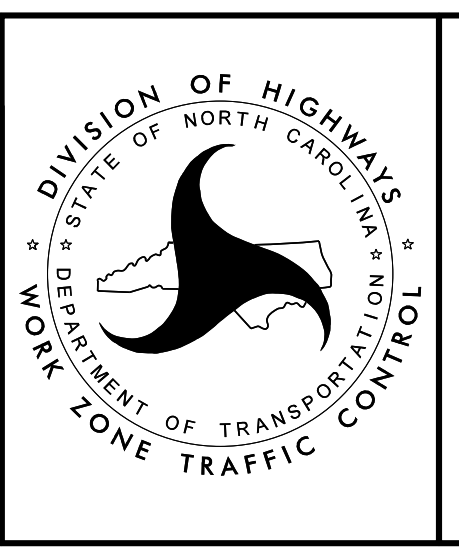

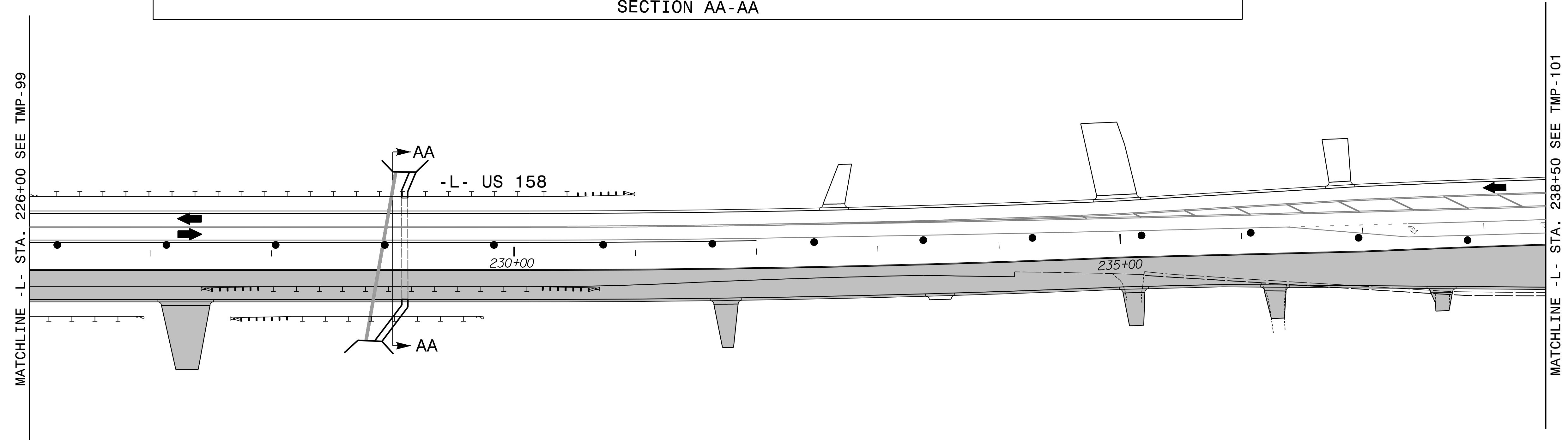
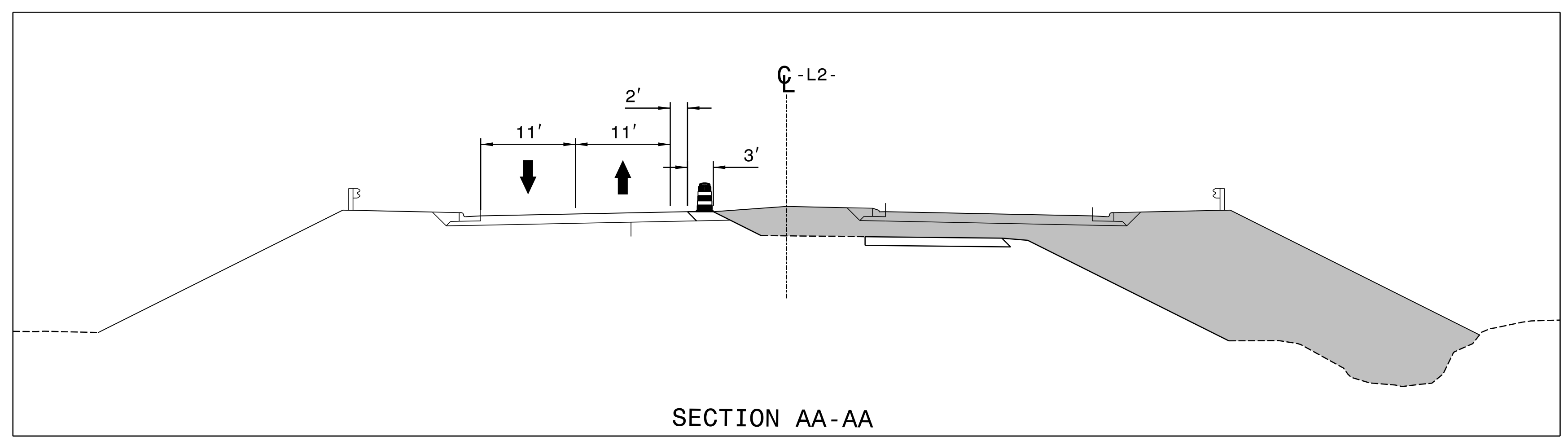
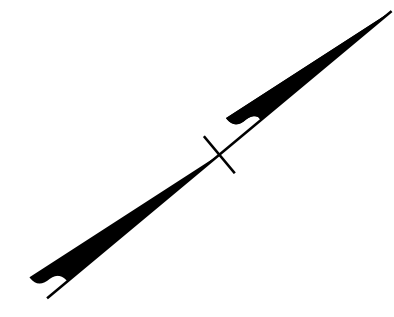

PHASE II - STEP 4

**DOCUMENT NOT CONSIDERED FINAL  
 UNLESS ALL SIGNATURES COMPLETED**

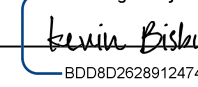

3/7/2024  
 R-2577A\_tmp\_psh100.dgn  
 Kolsby

APPROVED:   
DocuSigned by: Kevin W. Bissby  
 8D0682028912474

DATE: 3/7/2024

SEAL

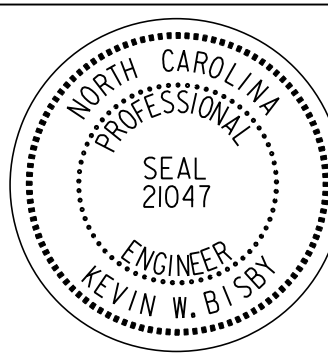
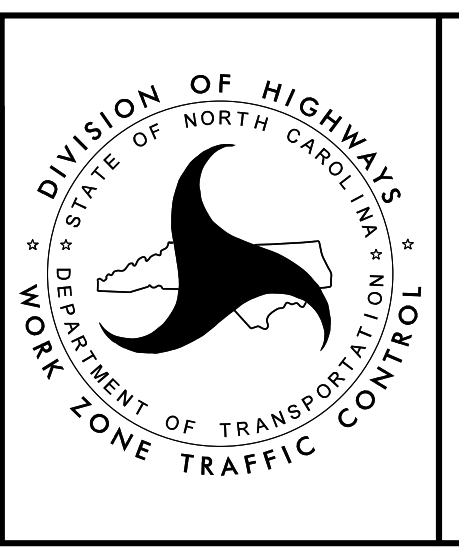
PHASE II - STEP 4

**DOCUMENT NOT CONSIDERED FINAL  
 UNLESS ALL SIGNATURES COMPLETED**

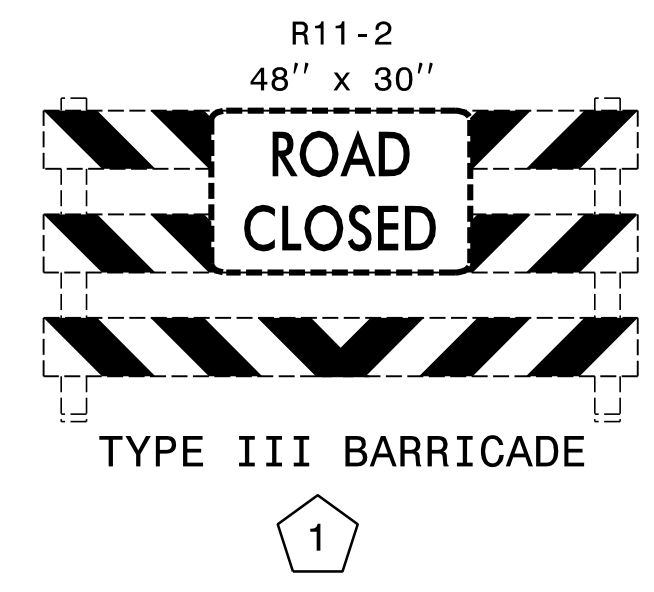
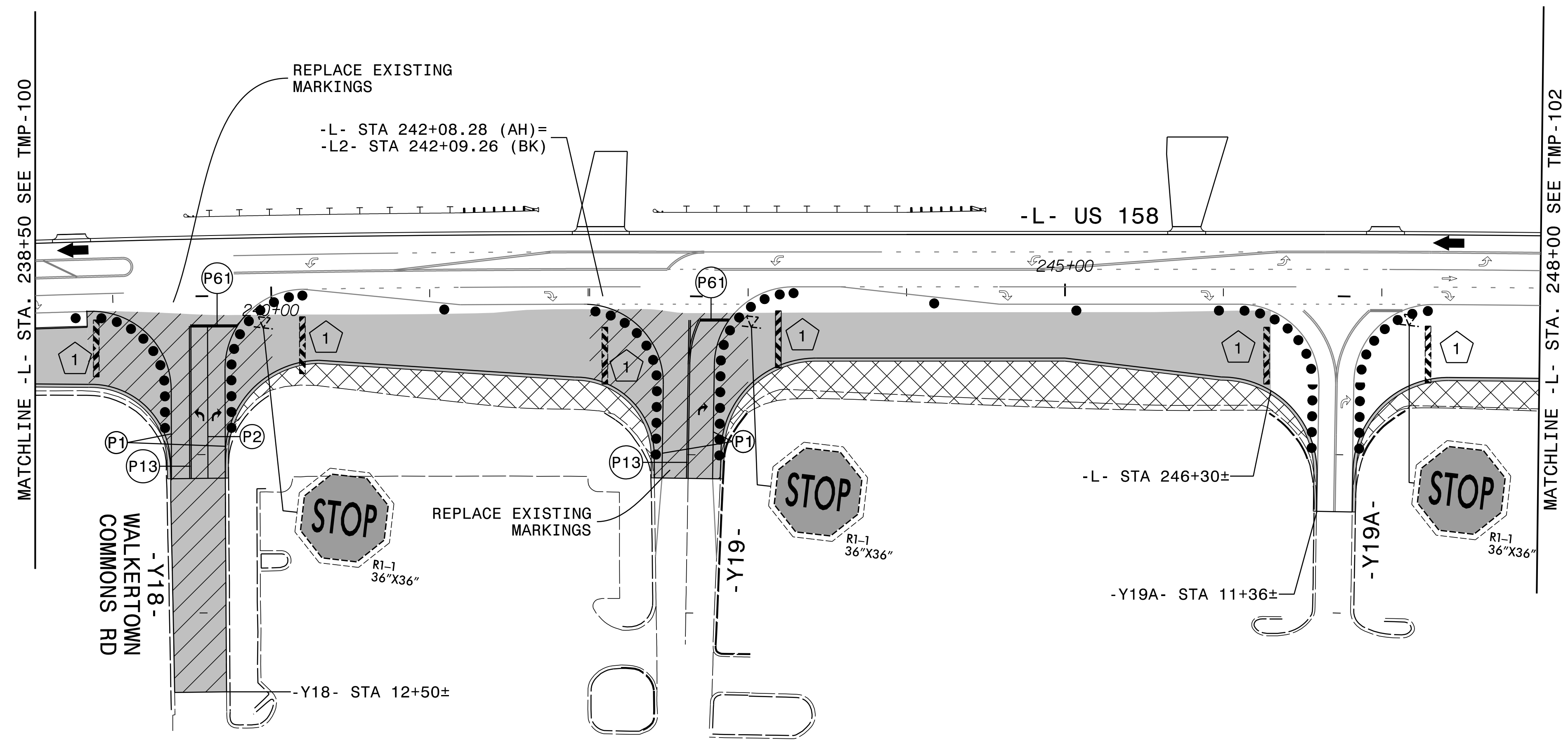
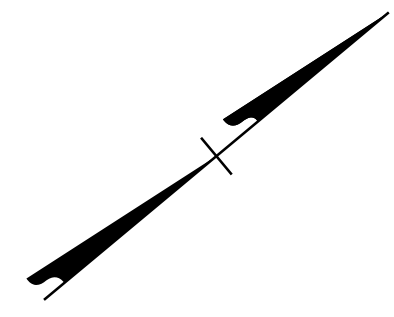

APPROVED: *Kevin B. Bly*  
 DATE: 3/7/2024

SEAL

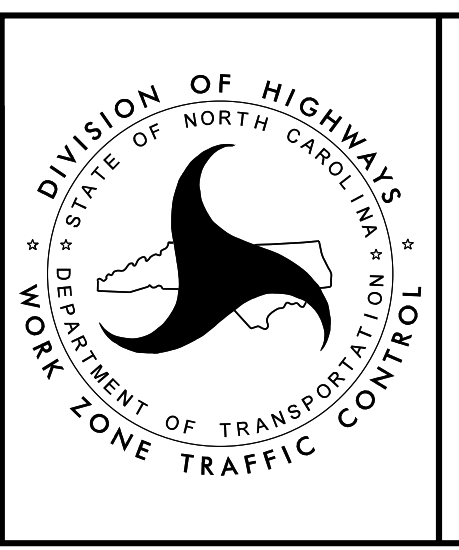

PHASE II - STEP 4

3/7/2024  
 R-2577A\_tmp\_psh101.dgn  
 R01sby

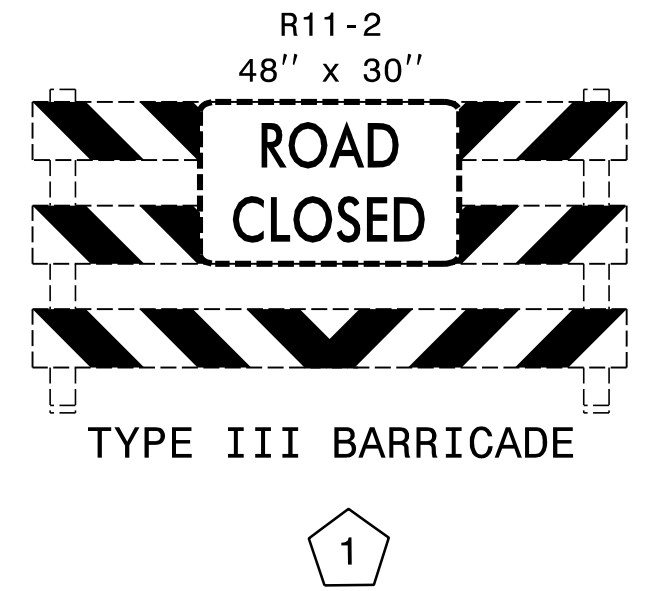
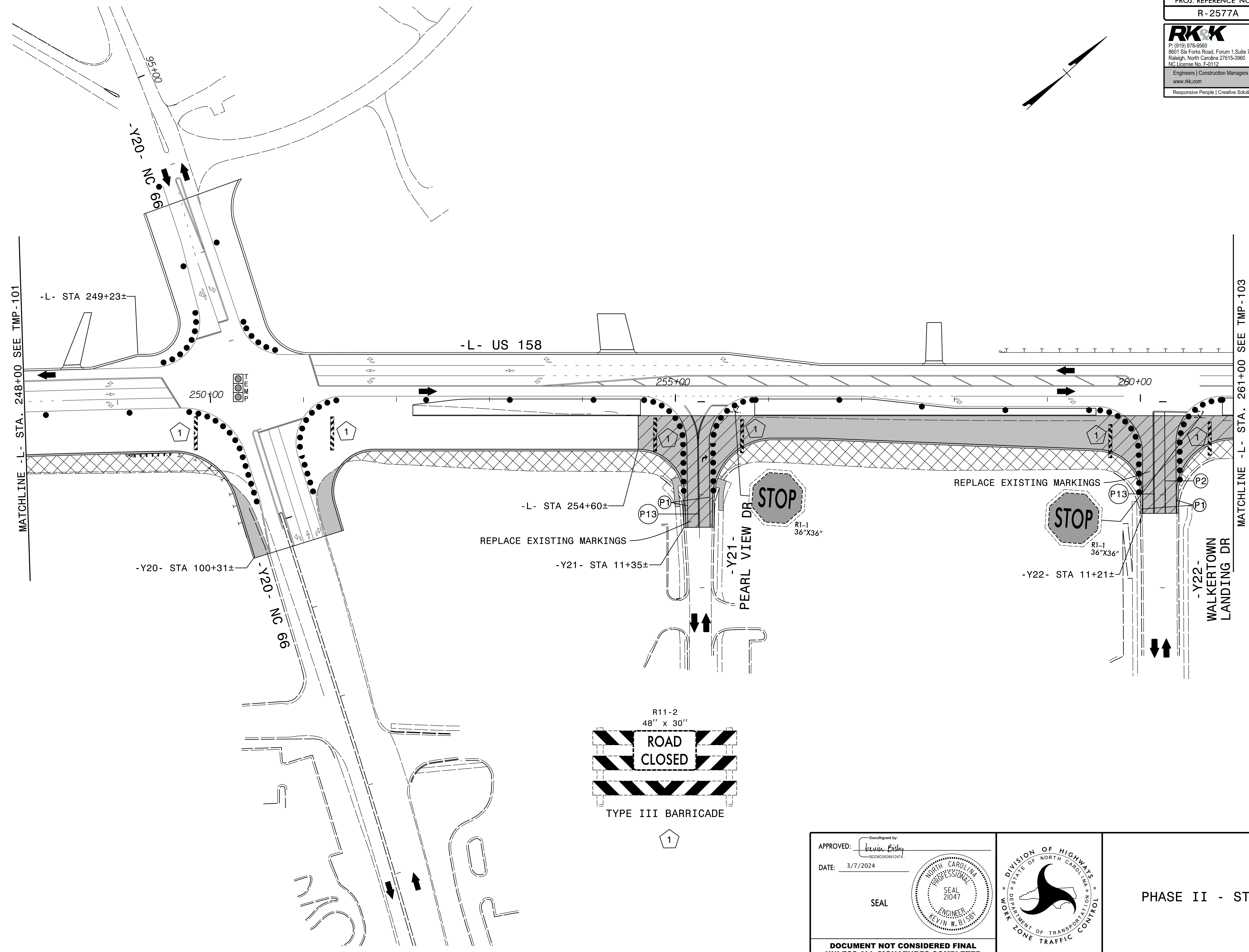
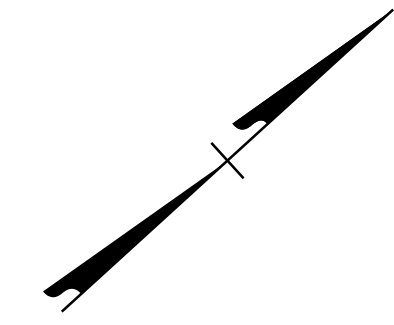

3/7/2024  
 R-2577A\_tmp\_psh102.dgn  
 Rolsby

APPROVED: *Kevin B. Bly*  
 DATE: 3/7/2024

SEAL

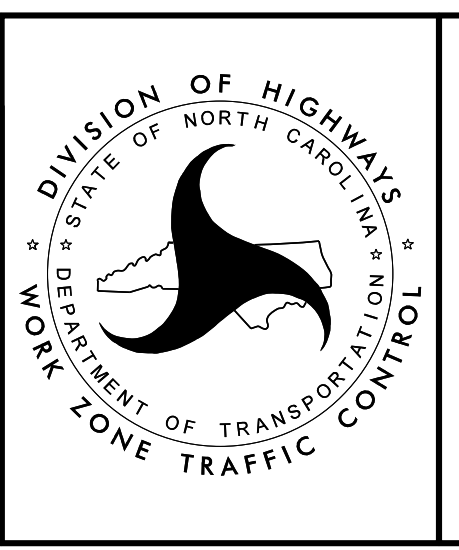

PHASE II - STEP 4

DOCUMENT NOT CONSIDERED FINAL  
UNLESS ALL SIGNATURES COMPLETED

PROJ. REFERENCE NO.	SHEET NO.
R - 2577A	TMP - 103

**RKK**  
 P: (919) 878-8560  
 8601 Six Forks Road, Forum 1, Suite 700  
 Raleigh, North Carolina 27615-3960  
 NC License No. F-0112  
 Engineers | Construction Managers | Planners | Scientists  
 www.rkk.com  
 Responsive People | Creative Solutions

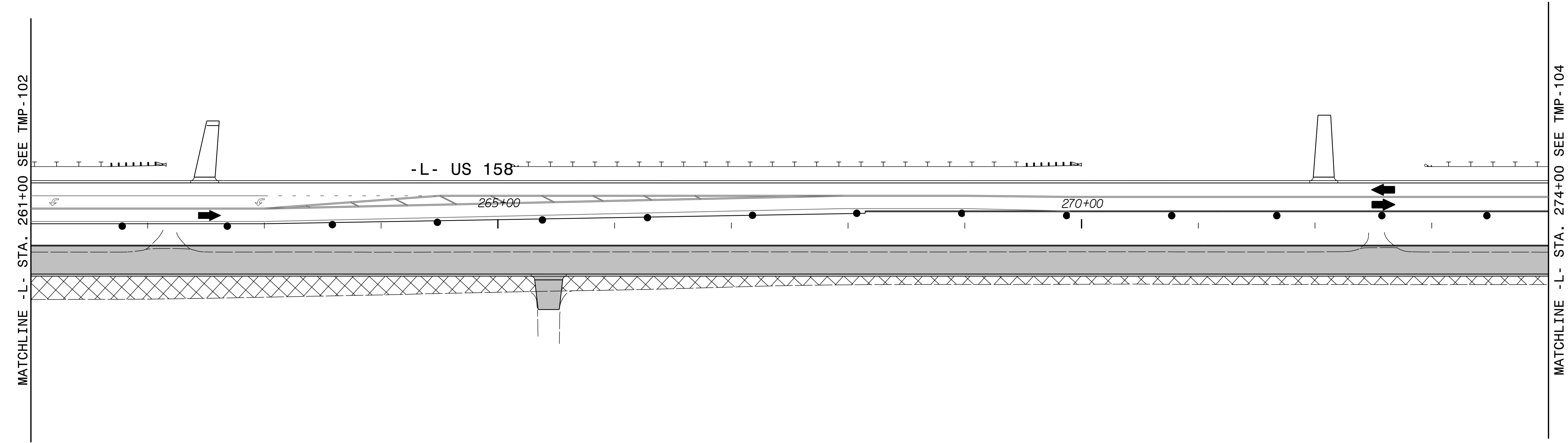
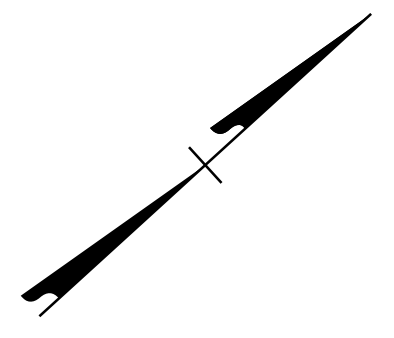

3/7/2024  
 R-2577A\_tmp\_psh03.dgn  
 Rolsby

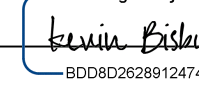
APPROVED:   
DocuSigned by: Kevin B. Bissby  
 8D0682028912474

DATE: 3/7/2024

SEAL

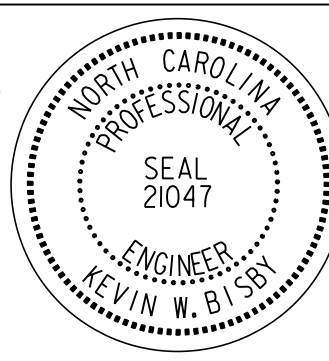
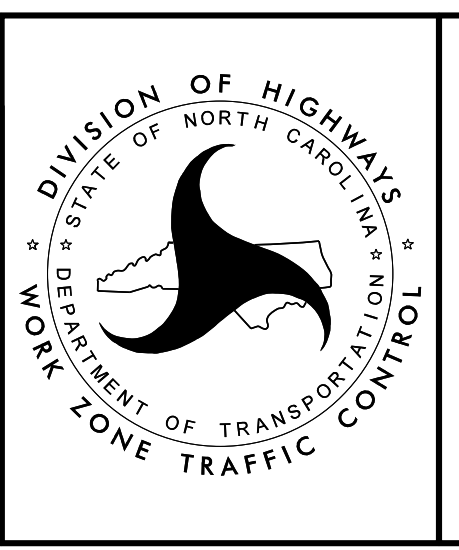
PHASE II - STEP 4

**DOCUMENT NOT CONSIDERED FINAL  
 UNLESS ALL SIGNATURES COMPLETED**



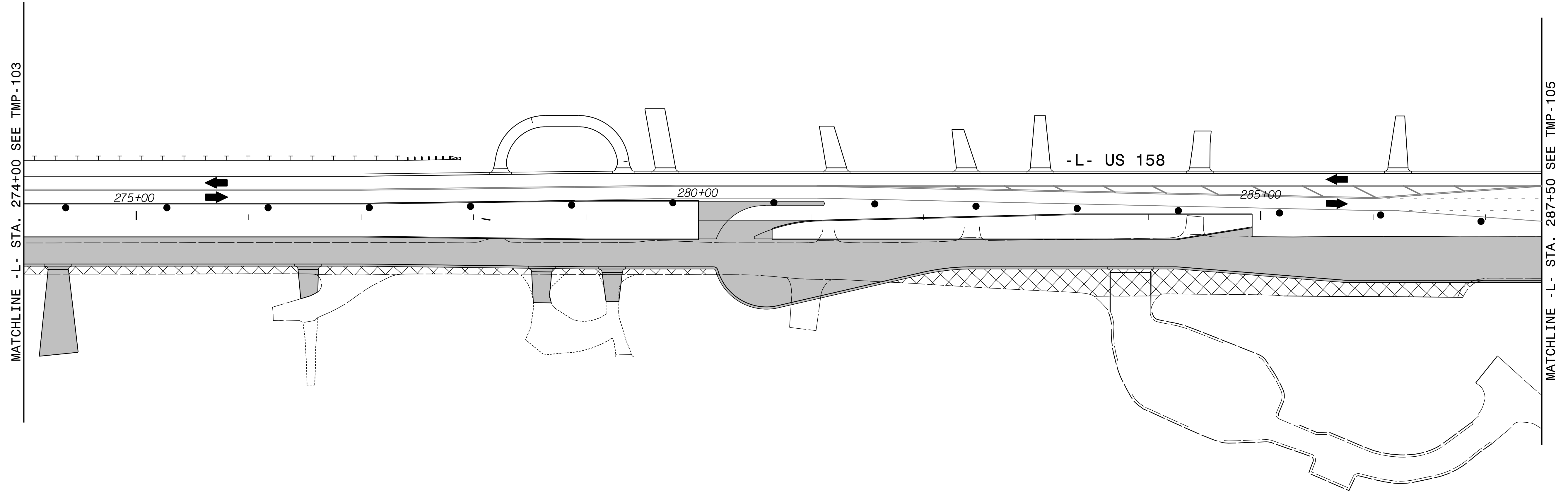
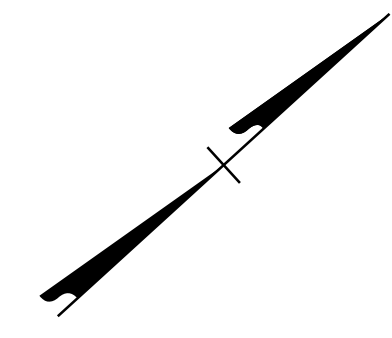

3/7/2024  
 R-2577A\_tmp\_psh104.dgn  
 KRobby

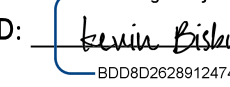
APPROVED:   
DocuSigned by: Kevin W. Dobby  
 BDC982028912474

DATE: 3/7/2024

SEAL

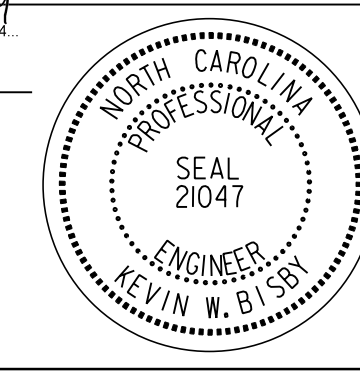
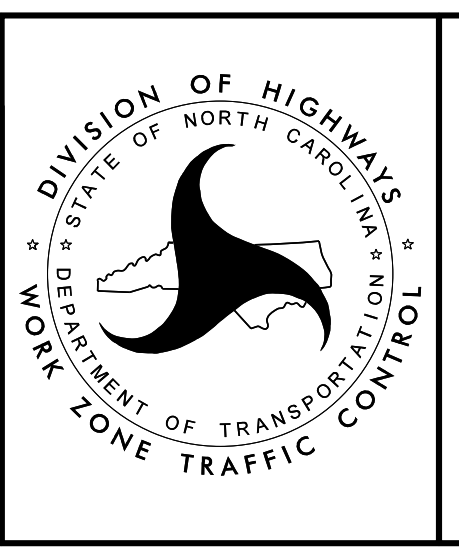



PHASE II - STEP 4

DOCUMENT NOT CONSIDERED FINAL  
 UNLESS ALL SIGNATURES COMPLETED

PROJ. REFERENCE NO.	SHEET NO.
R-2577A	TMP-105

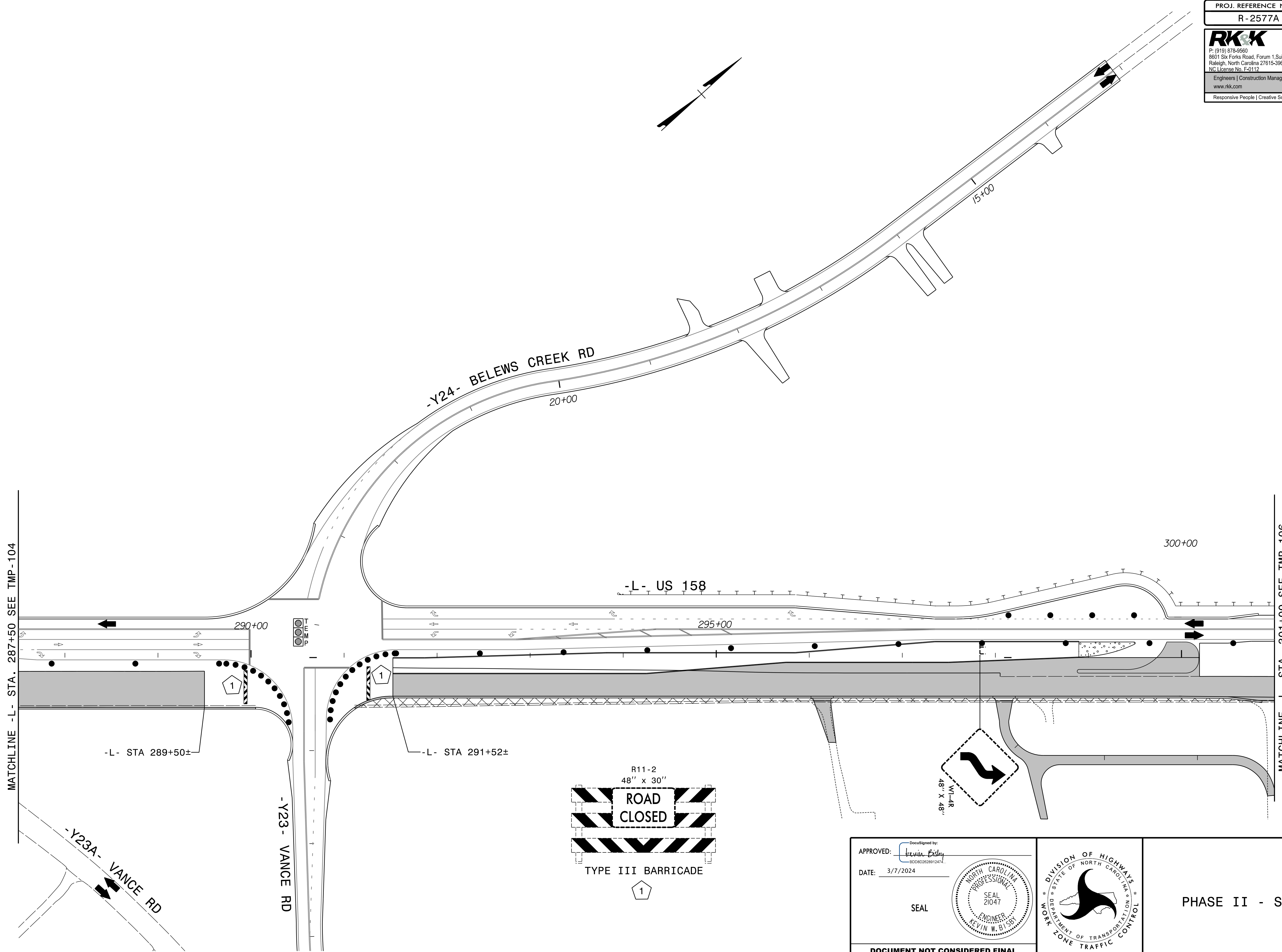
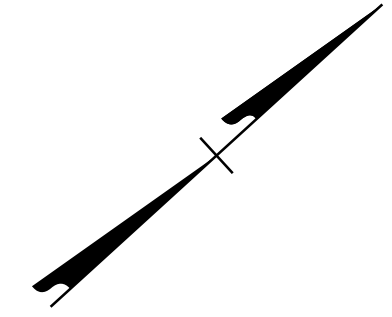
**RKK**  
 P: (919) 878-8560  
 8601 Six Forks Road, Forum 1, Suite 700  
 Raleigh, North Carolina 27615-3960  
 NC License No. F-0112  
 Engineers | Construction Managers | Planners | Scientists  
 www.rkk.com  
 Responsive People | Creative Solutions



MATCHLINE -L- STA. 287+50 SEE TMP-104

MATCHLINE -L- STA. 301+00 SEE TMP-106

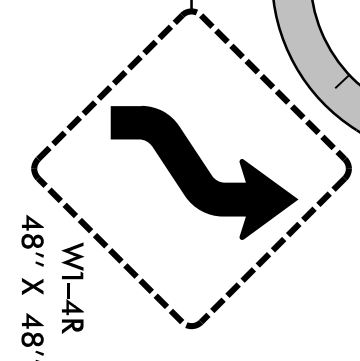
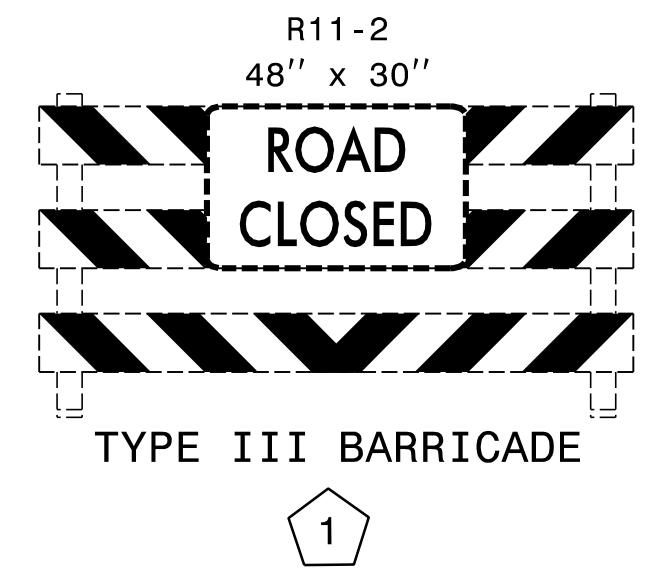

APPROVED: *Kevin E. Eddy*  
 DATE: 3/7/2024

SEAL

**DOCUMENT NOT CONSIDERED FINAL  
UNLESS ALL SIGNATURES COMPLETED**

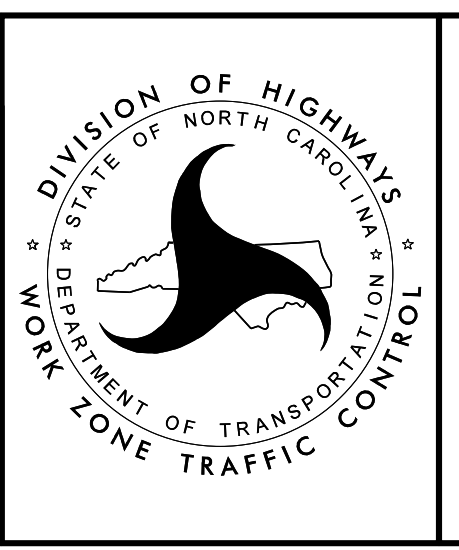

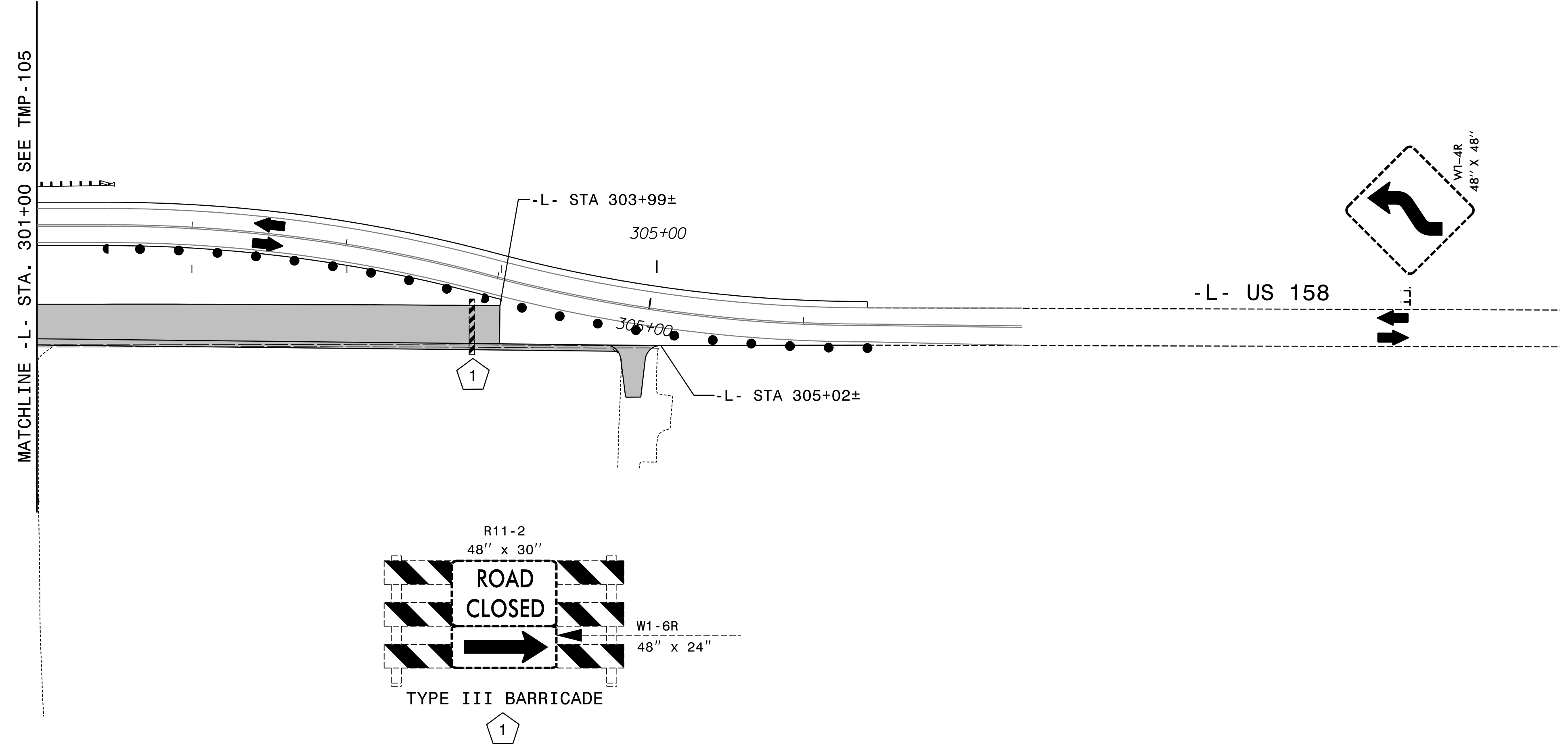
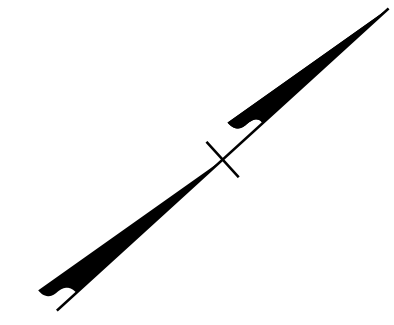

**PHASE II - STEP 4**

3/7/2024  
 R-2577A\_tmp\_psh105.dgn  
 Rolsby

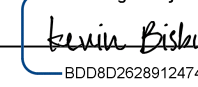
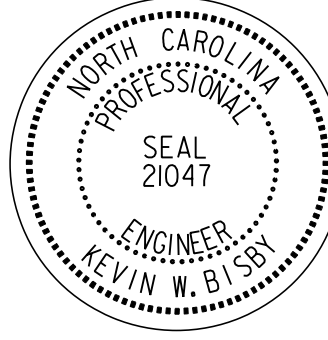

3/7/2024  
 R-2577A\_tmp\_psh106.dgn  
 Kolsby

APPROVED:  DATE: 3/7/2024 SEAL 		PHASE II - STEP 4
<b>DOCUMENT NOT CONSIDERED FINAL          UNLESS ALL SIGNATURES COMPLETED</b>		

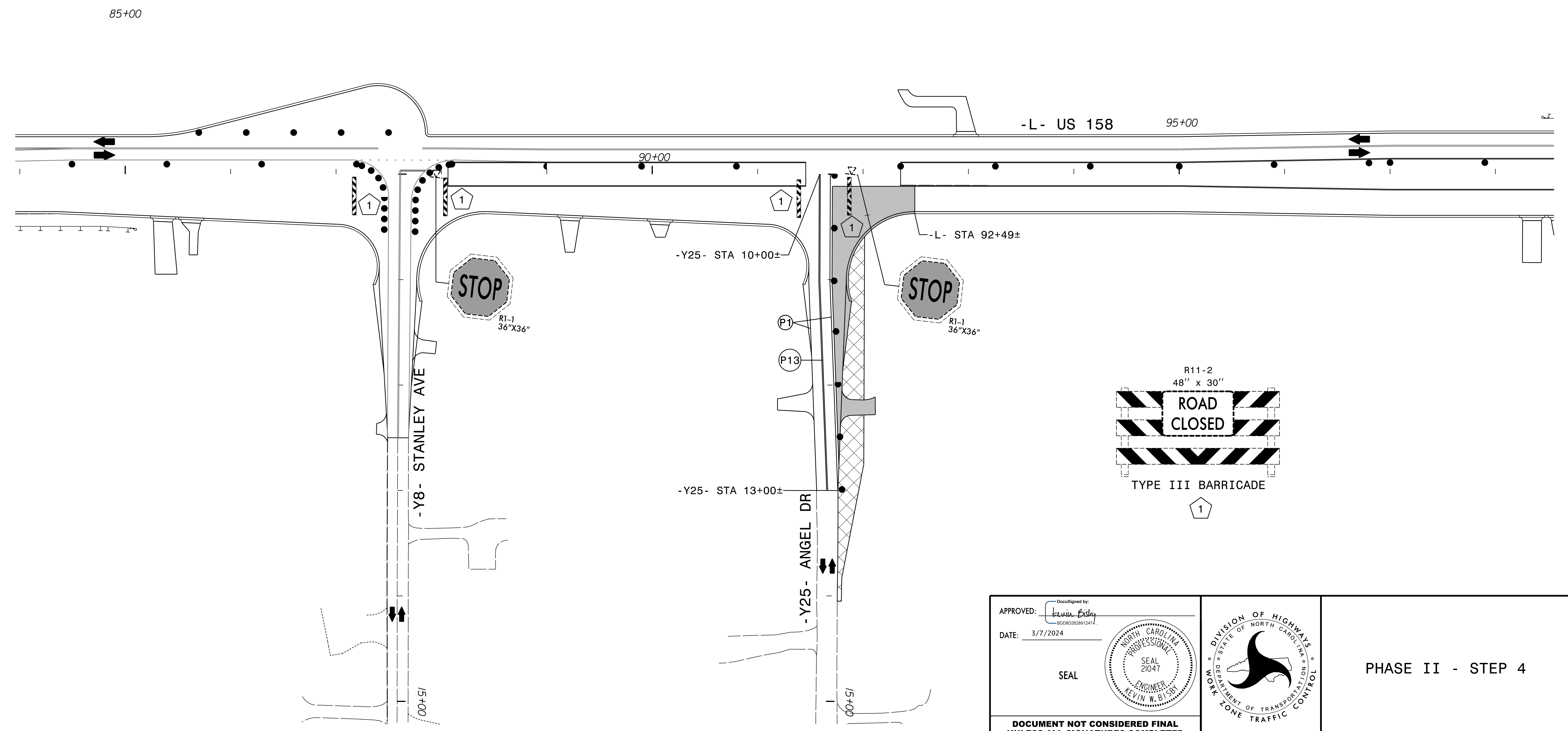
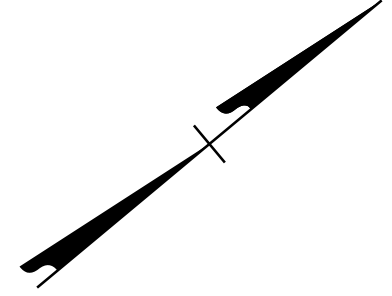

3/7/2024  
 R-2577A\_tmp\_psh107.dgn  
 Robby

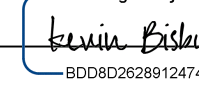
APPROVED:   
DocuSigned by: Kevin W. Blisby  
 BDC982028912474

DATE: 3/7/2024

SEAL

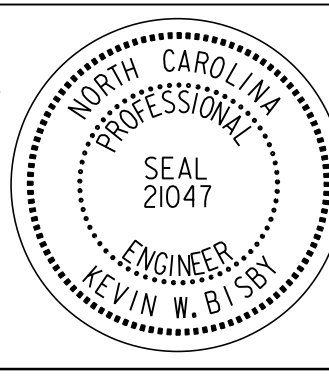
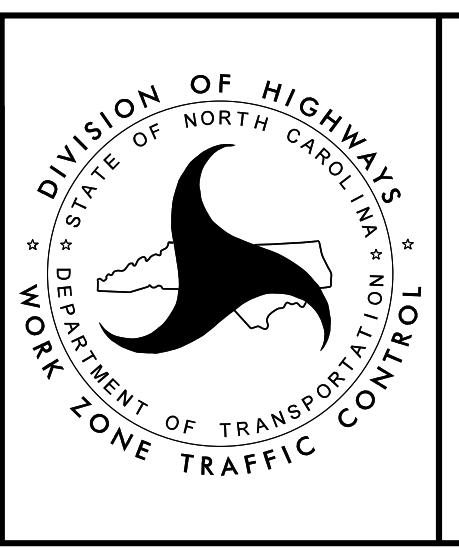

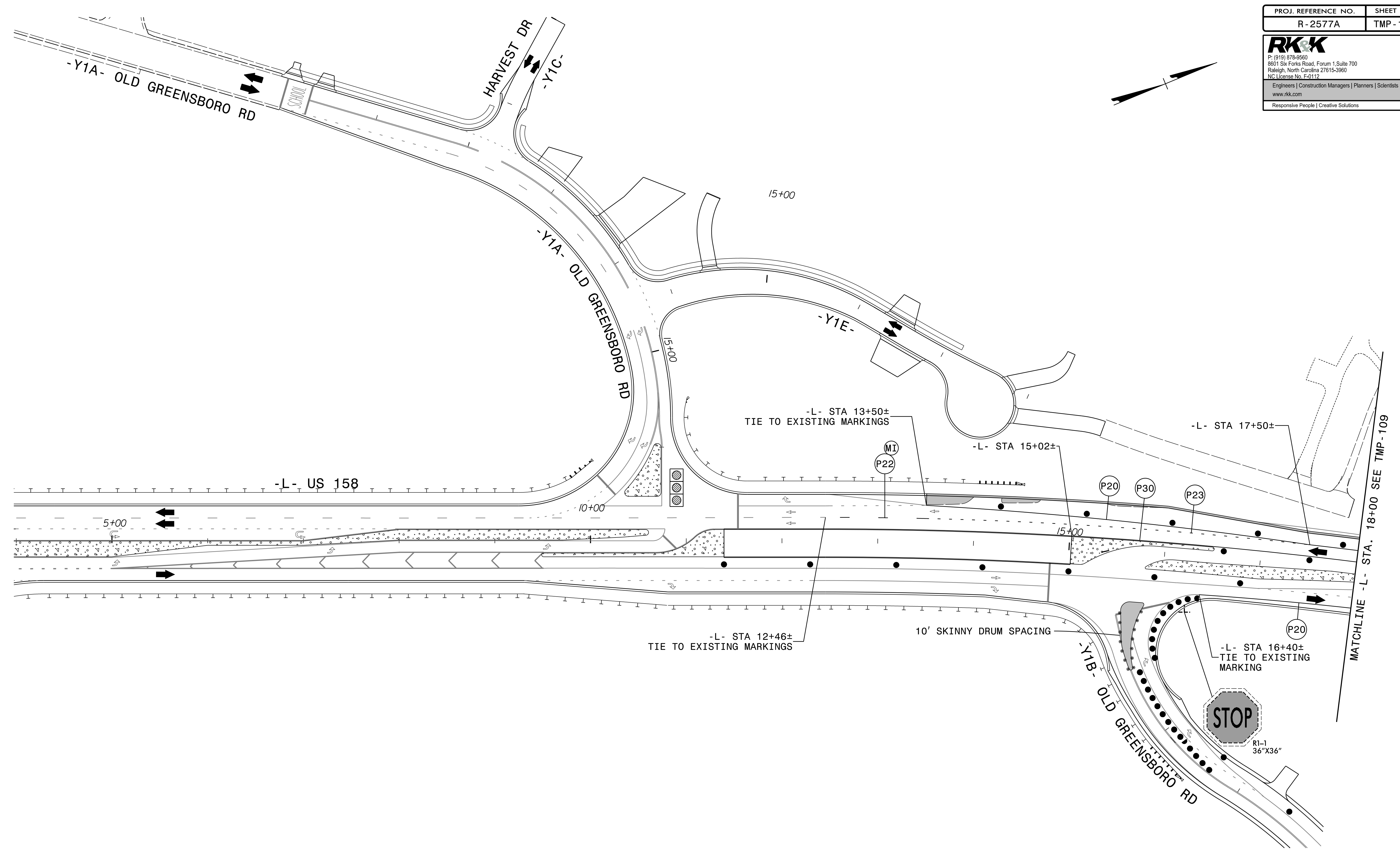
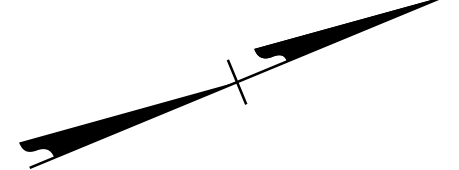

PHASE II - STEP 4

**DOCUMENT NOT CONSIDERED FINAL  
 UNLESS ALL SIGNATURES COMPLETED**

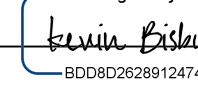

ERECT PROPOSED SIGNS AS APPLICABLE  
 12' LANES UNLESS OTHERWISE INDICATED.  
 SEE TMP-116A FOR PAVEMENT MARKING ALIGNMENT

APPROVED:   
 DATE: 3/7/2024

SEAL

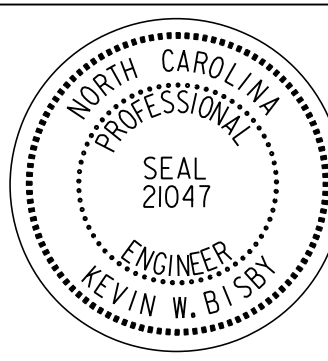
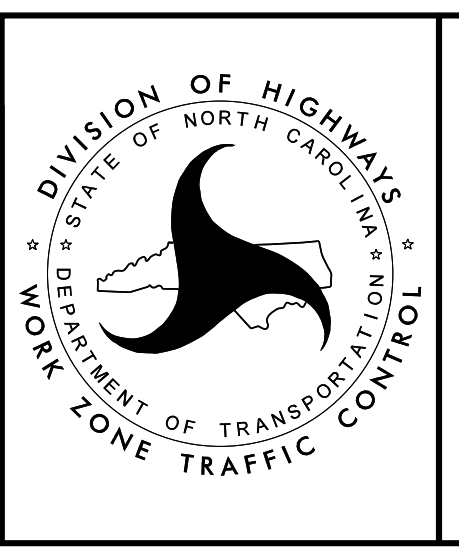
PHASE III - STEP 1 AND 2

3/7/2024  
 R-2577A\_tmp\_psh108.dgn  
 KRobby