

TIP PROJECT: I-5941

CONTRACT: C204885

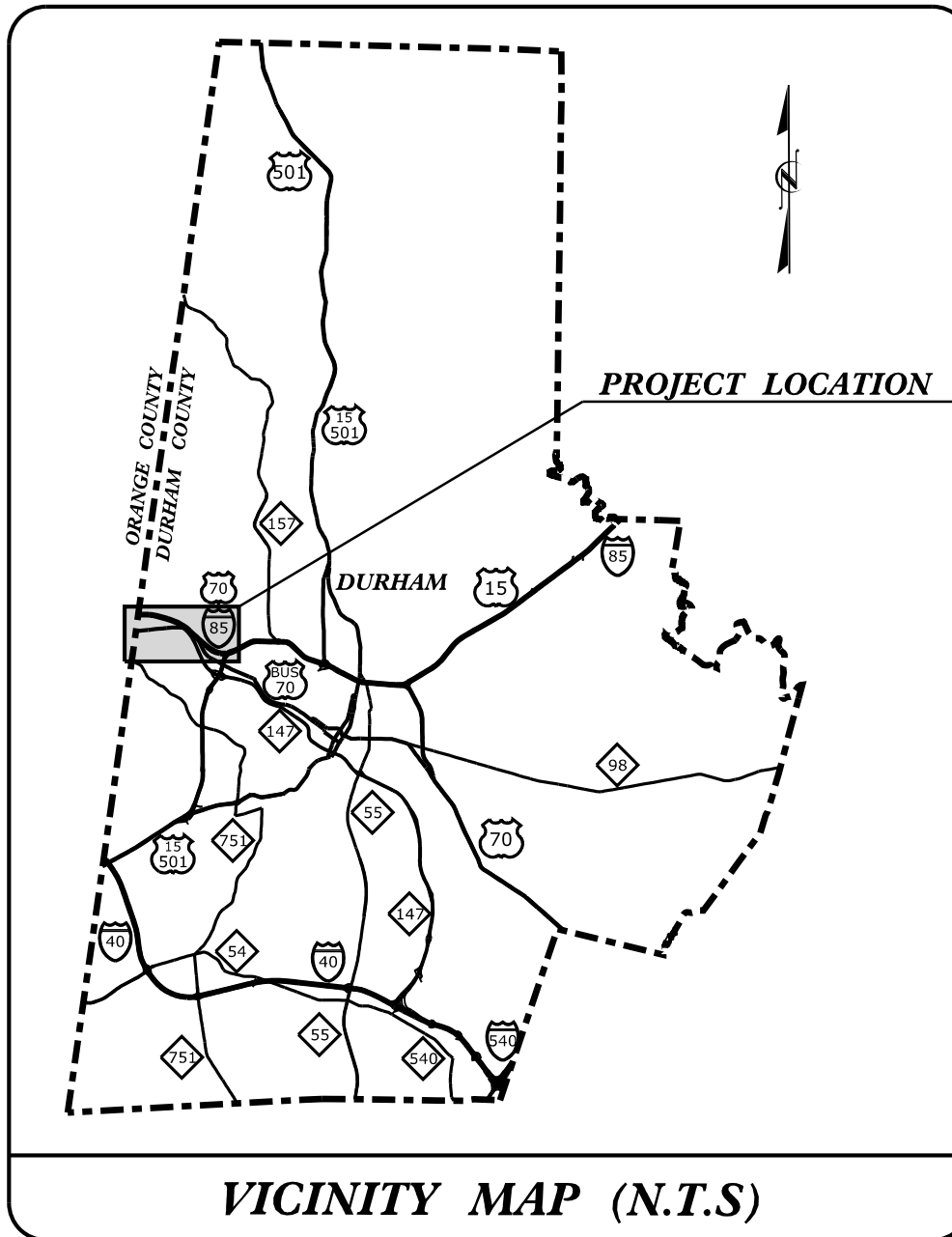

STATE OF NORTH CAROLINA
 DIVISION OF HIGHWAYS
 PLAN FOR PROPOSED
 HIGHWAY EROSION CONTROL
DURHAM COUNTY

LOCATION: I-85 FROM THE ORANGE COUNTY LINE TO US 15/US 501
TYPE OF WORK: PAVEMENT REHABILITATION, BRIDGE PRESERVATION, SIGNING, AND SIGNALS

BEGIN TIP PROJECT I-5941
 -I85NBL- STA. 102+50 (MAP 1)
 -I85SBL- STA. 302+50 (MAP 2)

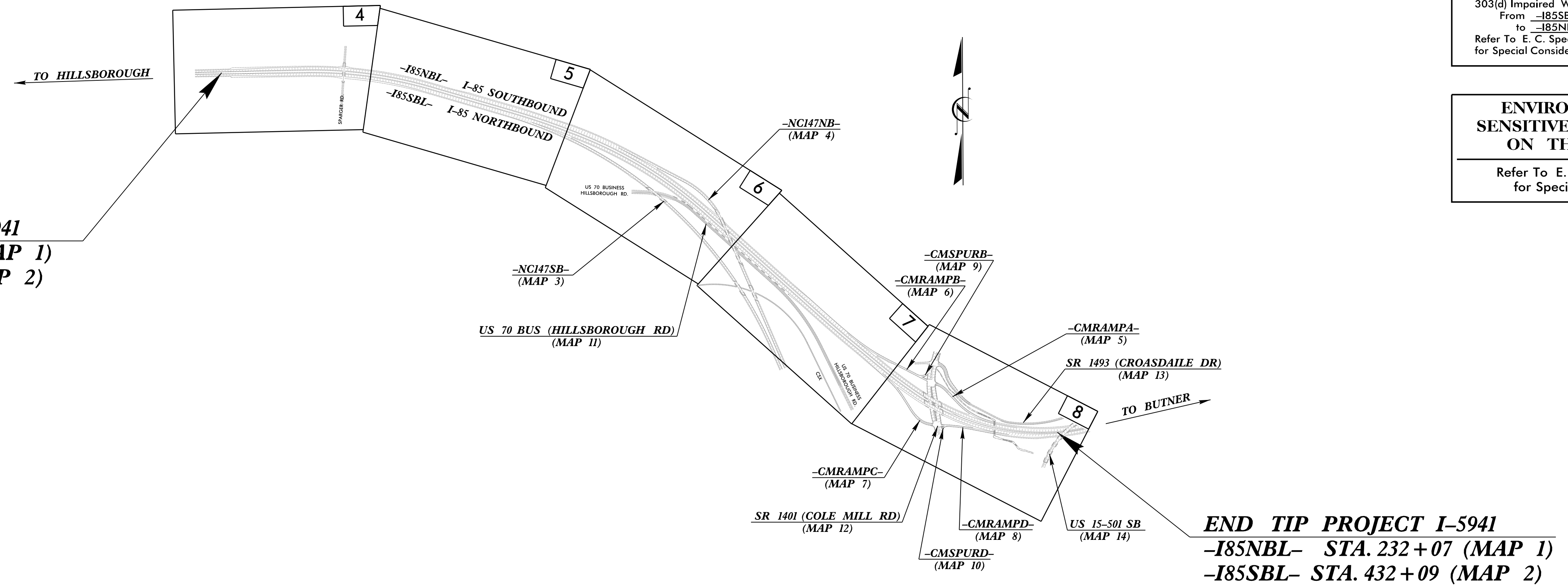

END TIP PROJECT I-5941
 -I85NBL- STA. 232+07 (MAP 1)
 -I85SBL- STA. 432+09 (MAP 2)

STATE	STATE PROJECT REFERENCE NO.	SHEET NO.	TOTAL SHEETS
N.C.	I-5941	EC-1	
STATE PROJ. NO.	F.A. PROJ. NO.	DESCRIPTION	
45884.1.1	N/A	P.E.	
45884.3.1	4588401	CONST.	

THIS PROJECT HAS BEEN DESIGNED TO SENSITIVE WATERSHED STANDARDS.

303(d) IMPAIRED WATER(S) EXIST ON THIS PROJECT
 303(d) Impaired Water Zone(s) Exist From -I85SBL- Sta. 410+00 (LT) to -I85NBL- Sta. 232+00 (RT). Refer To E. C. Special Provisions for Special Considerations.

ENVIRONMENTALLY SENSITIVE AREA(S) EXIST ON THIS PROJECT
 Refer To E. C. Special Provisions for Special Considerations.

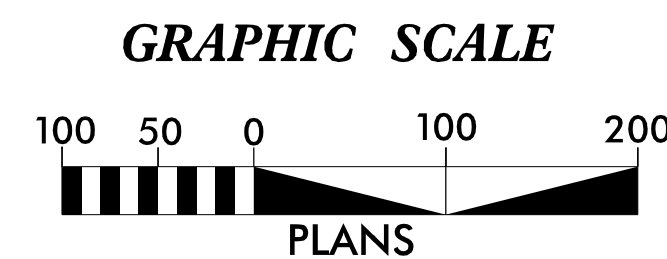

THESE EROSION AND SEDIMENT CONTROL PLANS COMPLY WITH THE APPLICABLE REGULATIONS SET FORTH BY THE NCG-010000 GENERAL CONSTRUCTION PERMIT EFFECTIVE APRIL 1, 2019 AND ISSUED BY THE NORTH CAROLINA DEPARTMENT OF ENVIRONMENTAL QUALITY DIVISION OF WATER RESOURCES.



Prepared in the Office of:
VHB ENGINEERING NC, P.C.
 940 MAIN CAMPUS DRIVE, SUITE 500
 RALEIGH, NORTH CAROLINA 27606
 NC LICENSE NO. C-3705

FOR NORTH CAROLINA DEPARTMENT OF TRANSPORTATION
 2024 STANDARD SPECIFICATIONS

Designed by:

BRANDON BARHAM, PE 3368
 NAME LEVEL III CERTIFICATION NO.

Roadway Standard Drawings

The "Roadway Standard Drawings"- Roadway Design Unit - N. C. Department of Transportation - Raleigh, N. C., dated January 2024 and the latest revision thereto are applicable to this project and by reference hereby are considered a part of these plans.

NOTES: Less than 5' - 10' undisturbed buffer from ROW, ditchline, water feature, or drainage inlet, add BMP.

EROSION CONTROL DETAIL

BMP Options: Wattle, Silt Fence or Hardened Aggregate.

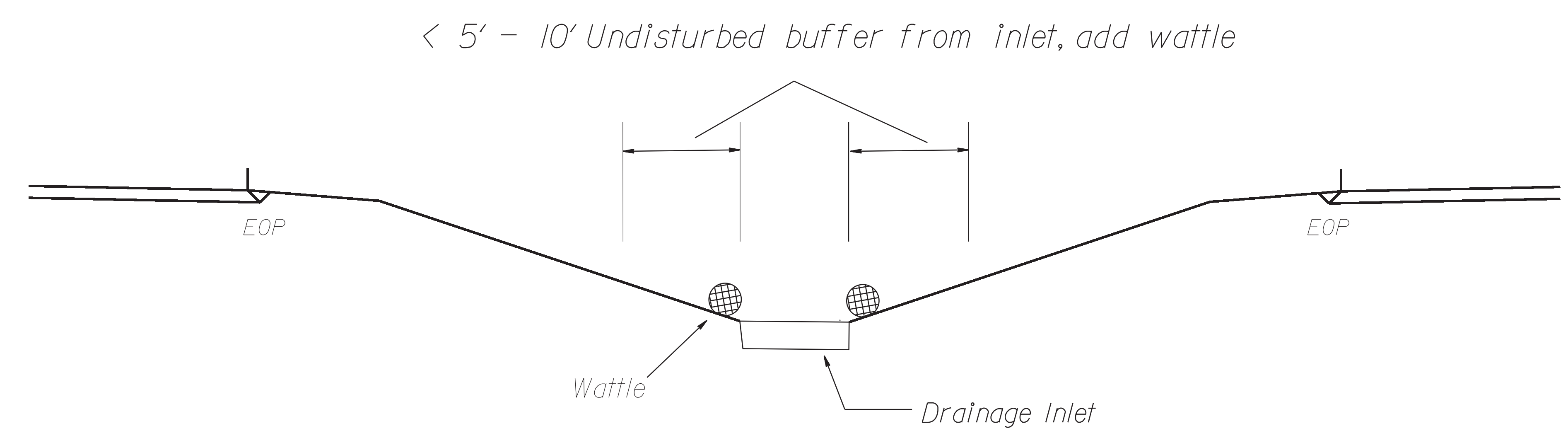
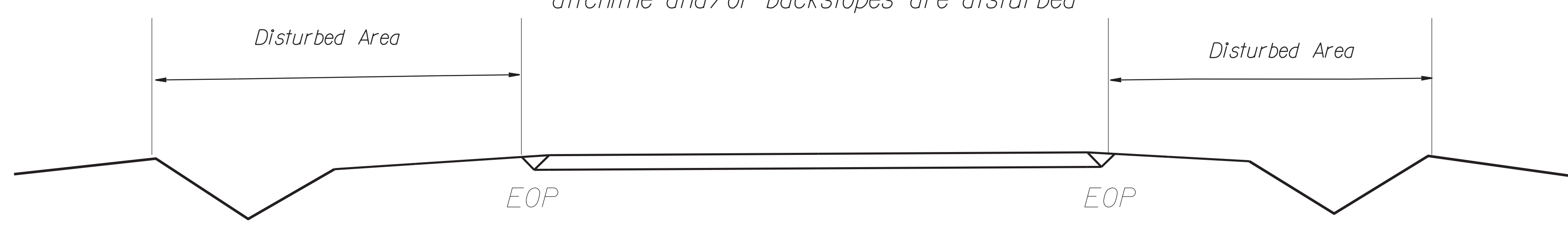
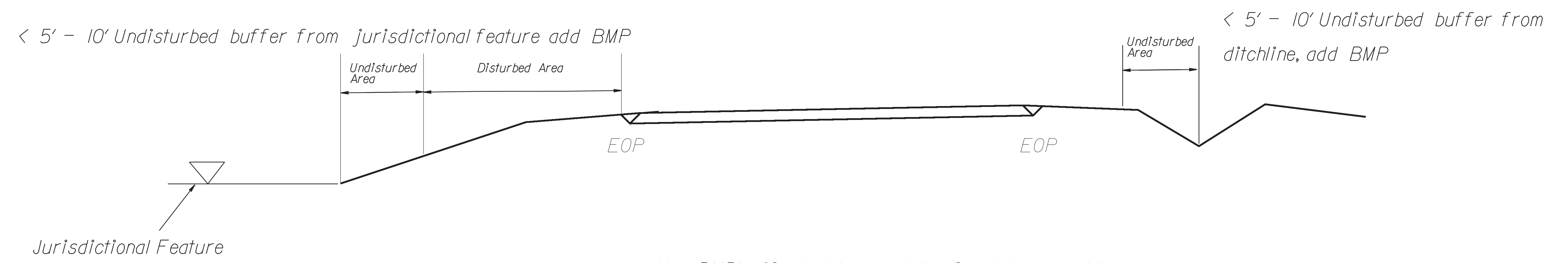
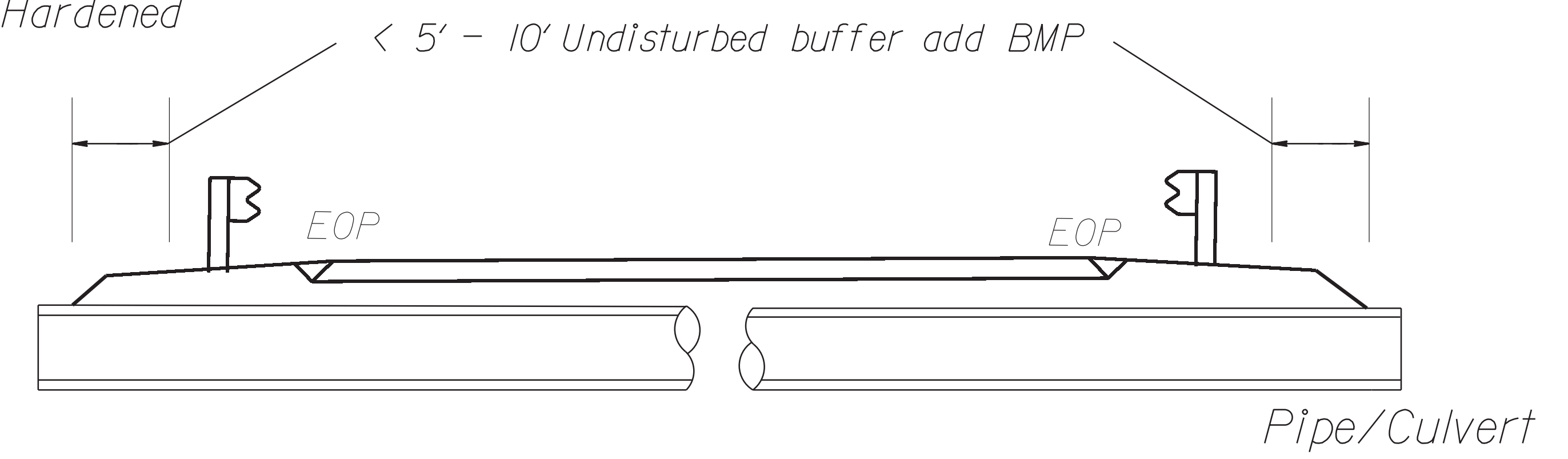

NOT TO SCALE

WATTLE BARRIER DETAIL

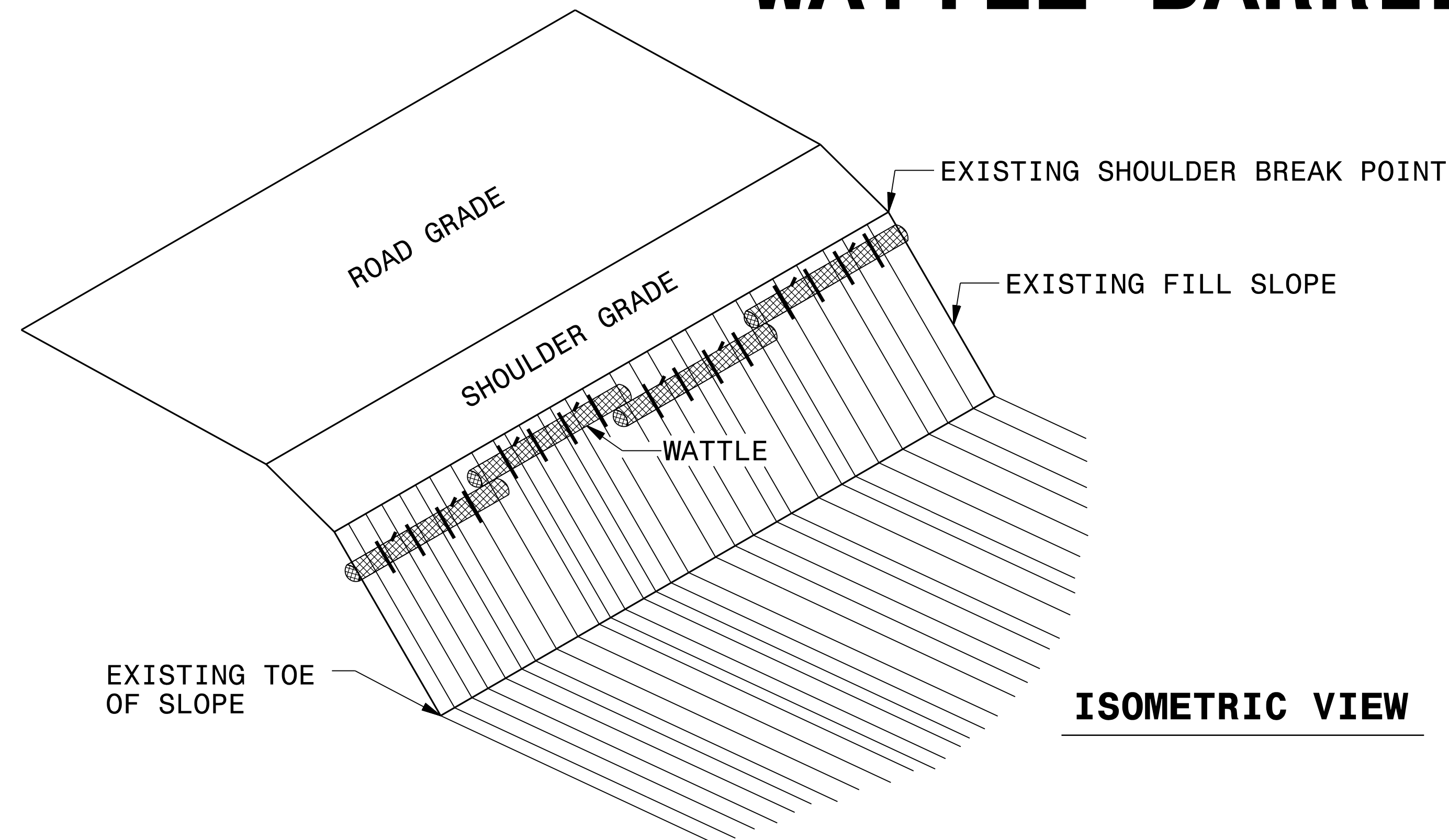

ISOMETRIC VIEW

NOTES

USE MINIMUM 18 IN. NOMINAL DIAMETER EXCELSIOR WATTLE AND LENGTH OF 10 FT.

WHEN WATTLE BARRIERS ARE USED ON SLOPES TO REDUCE RUNOFF VELOCITY, 9" DIAMETER WATTLES MAY BE USED.

EXCAVATE A 2 TO 3 INCH TRENCH FOR WATTLE TO BE PLACED.

DO NOT PLACE WATTLES ABOVE SHOULDER BREAK POINT OR ON TOE OF SLOPE.

USE 2 FT. WOODEN STAKES WITH A 2 IN. BY 2 IN. NOMINAL CROSS SECTION.

INSTALL A MINIMUM OF 2 UPSLOPE STAKES AND 4 DOWNSLOPE STAKES AT AN ANGLE TO WEDGE WATTLE TO GROUND.

PROVIDE STAPLES MADE OF 11 GAUGE STEEL WIRE FORMED INTO A U SHAPE NOT LESS THAN 6" IN LENGTH.

INSTALL STAPLES APPROXIMATELY EVERY 1 LINEAR FOOT ON BOTH SIDES OF WATTLE AND AT EACH END TO SECURE IT TO THE SOIL.

FOR BREAKS ALONG LARGE SLOPES, USE MAXIMUM SPACING OF 25 FT.

REMOVE WATTLE BARRIERS WHEN ADEQUATE GROUND COVER VEGETATION HAS BEEN ESTABLISHED AS DIRECTED BY THE ENGINEER.

WATTLE BARRIER LOCATIONS

INSTALL WATTLE BARRIERS WHERE CLEARING VEGETATION OR SHOULDER GRADING OCCUR ON OR ADJACENT TO FILL SLOPES, AND AS DIRECTED BY THE ENGINEER.

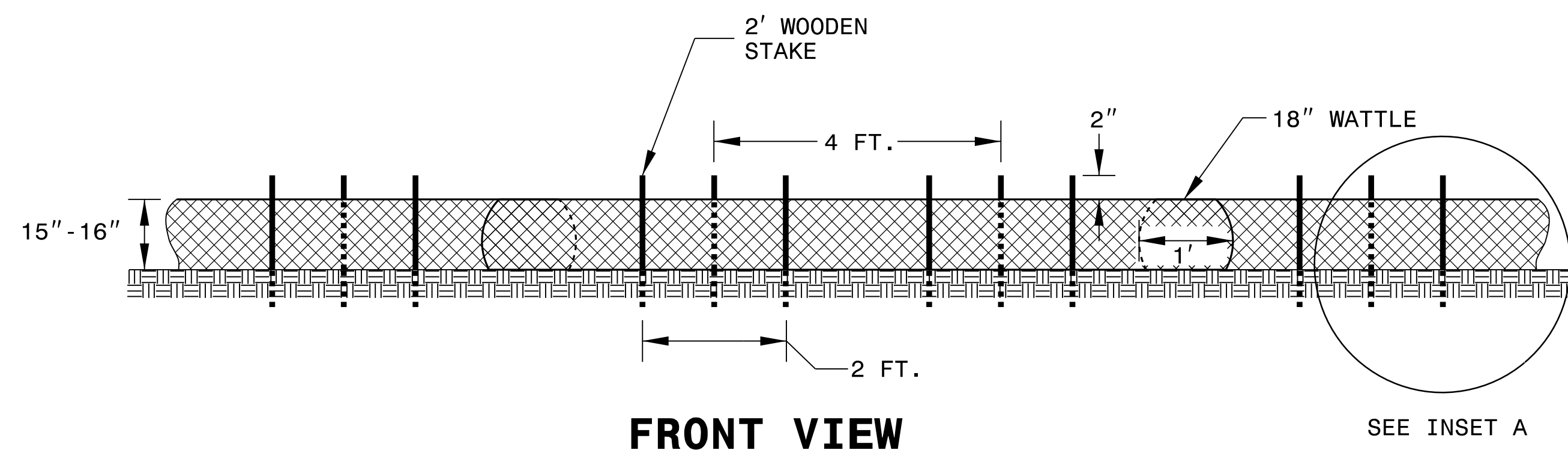

FRONT VIEW

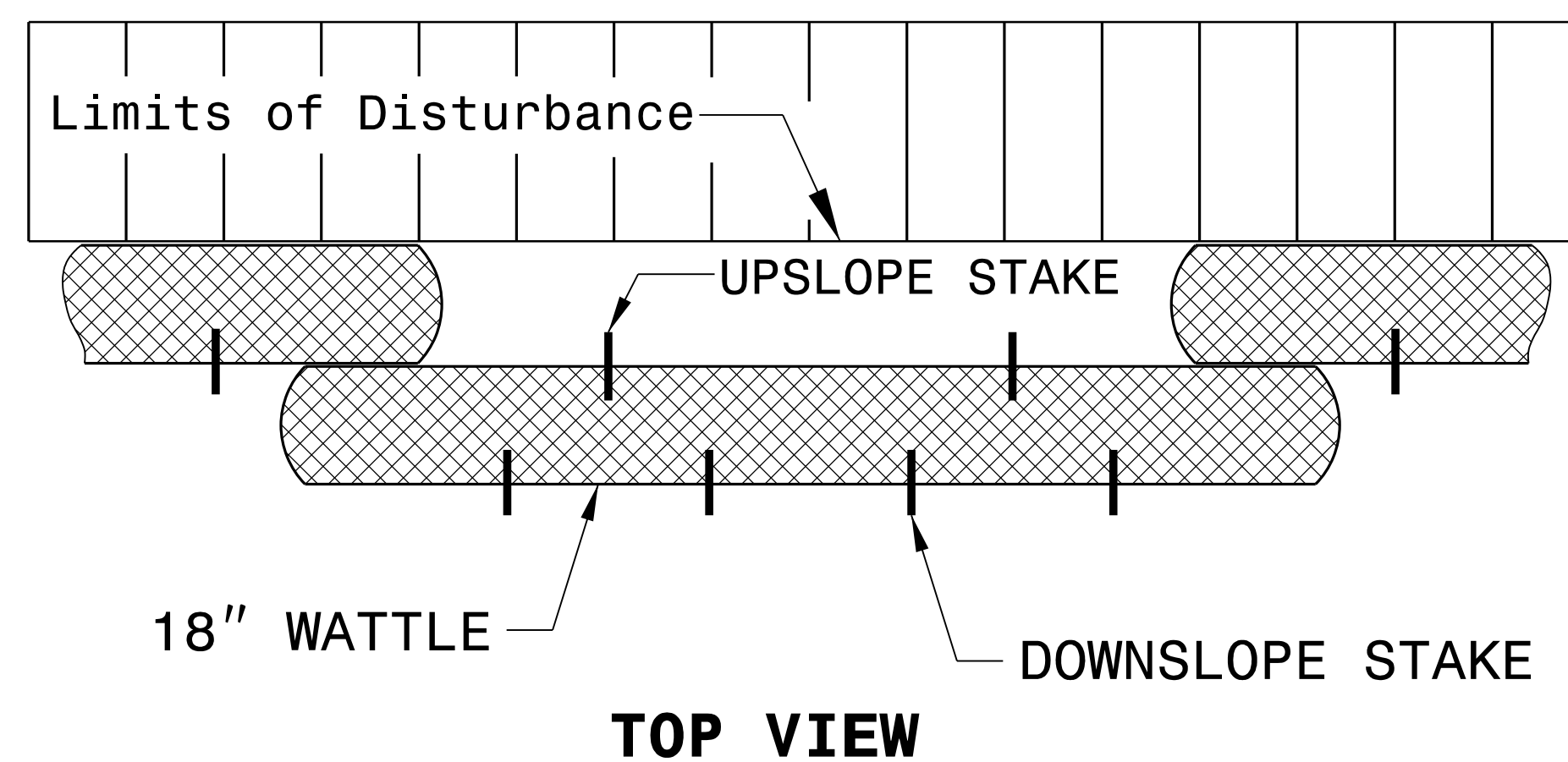

TOP VIEW

PLACE TOP OF WATTLE BARRIERS BELOW SHOULDER BREAK POINT ELEVATION

EXISTING SHOULDER BREAK POINT

SHOULDER GRADE

EXISTING SLOPE

INSET A

2" - 3" TRENCH

ONSITE CONCRETE WASHOUT STRUCTURE WITH LINER

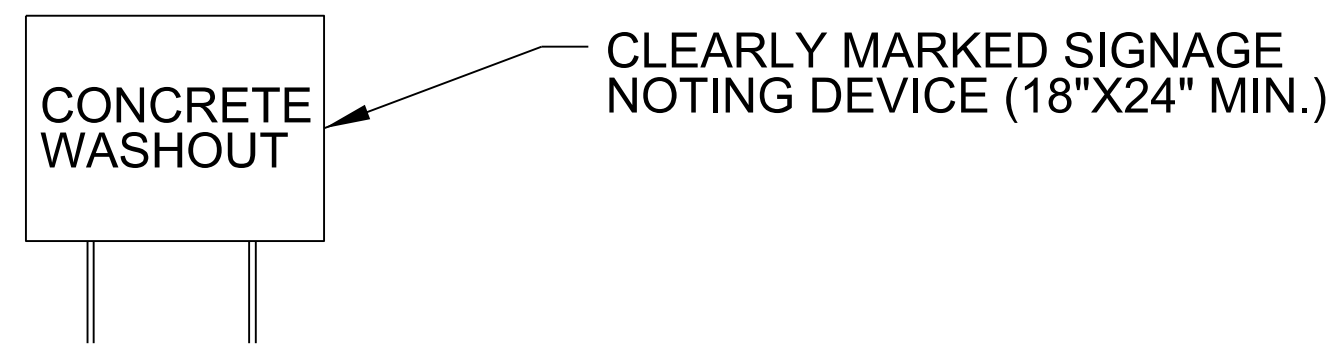
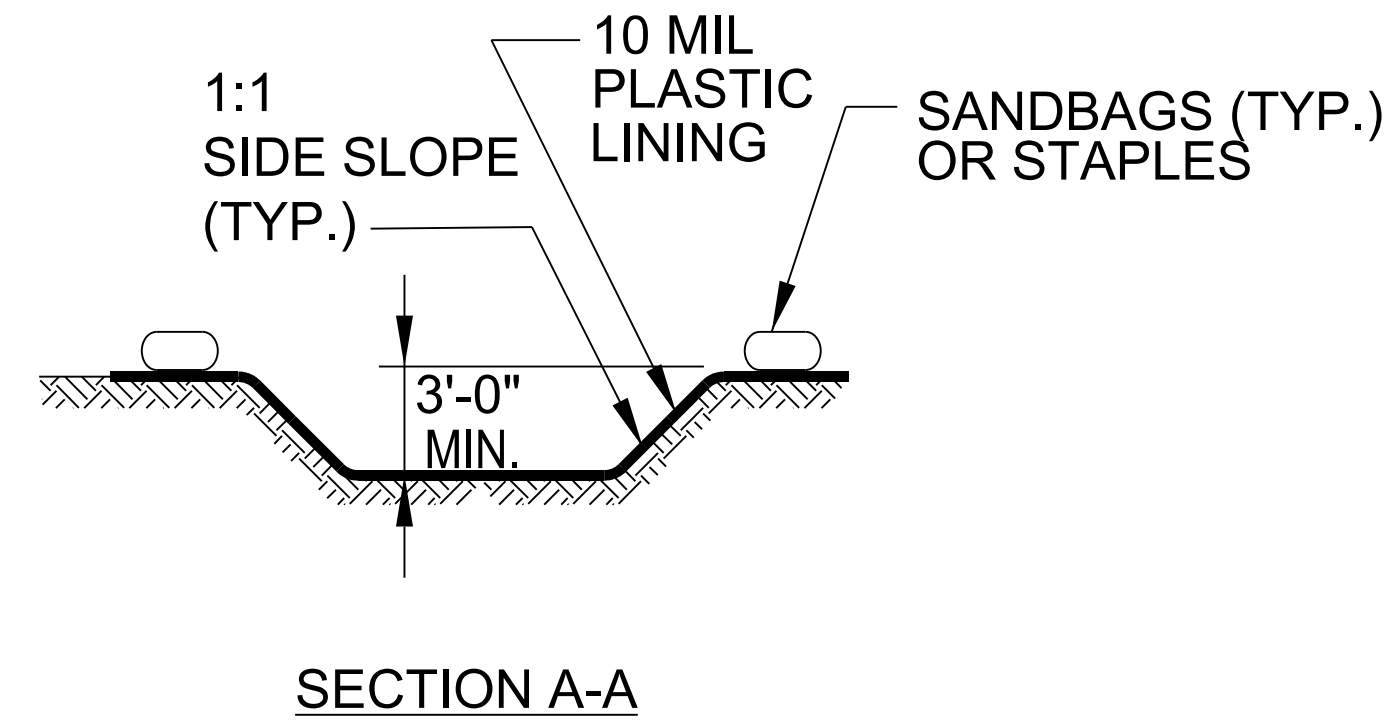
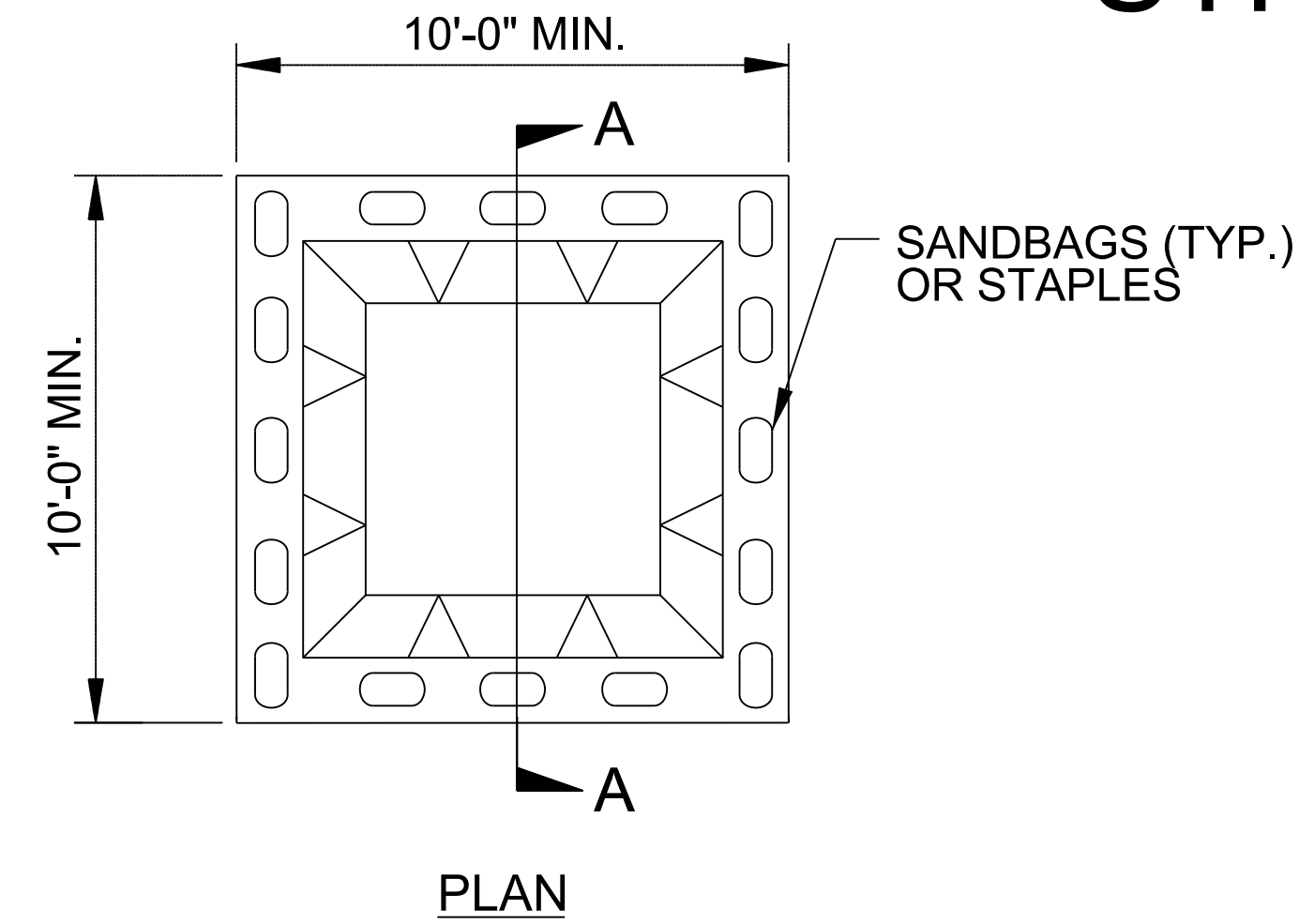

BELOW GRADE WASHOUT STRUCTURE
NOT TO SCALE

- NOTES:
1. ACTUAL LOCATION DETERMINED IN FIELD
 2. THE CONCRETE WASHOUT STRUCTURES SHALL BE MAINTAINED WHEN THE LIQUID AND/OR SOLID REACHES 75% OF THE STRUCTURES CAPACITY TO PROVIDE ADEQUATE HOLDING CAPACITY WITH A MINIMUM 12 INCHES OF FREEBOARD.
 3. CONCRETE WASHOUT STRUCTURE NEEDS TO BE CLEARLY MARKED WITH SIGNAGE NOTING DEVICE.

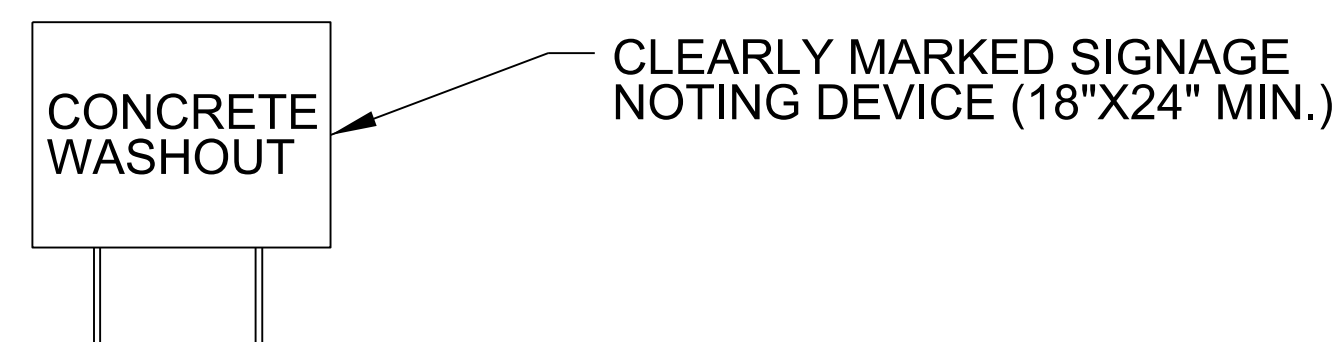
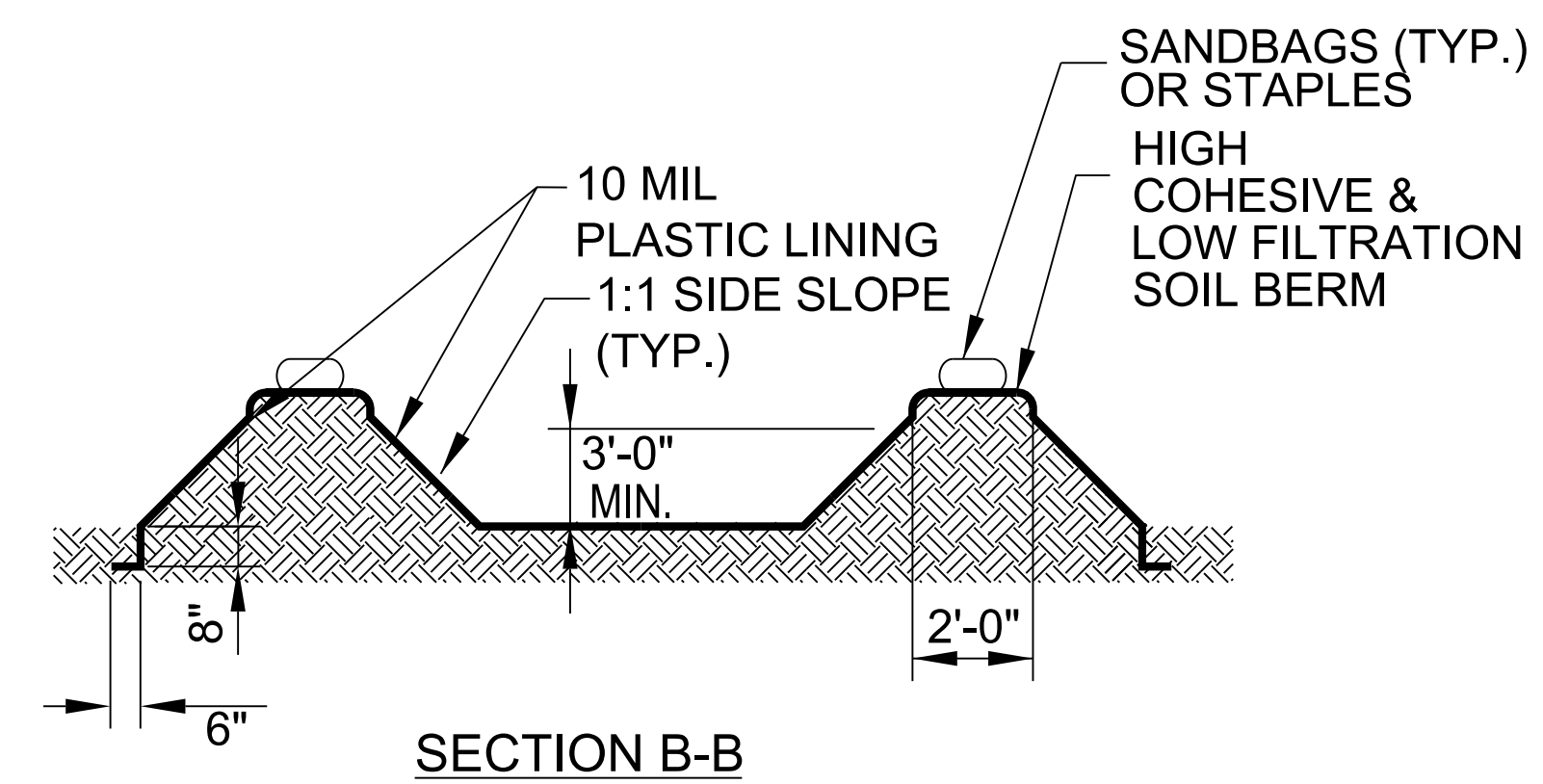
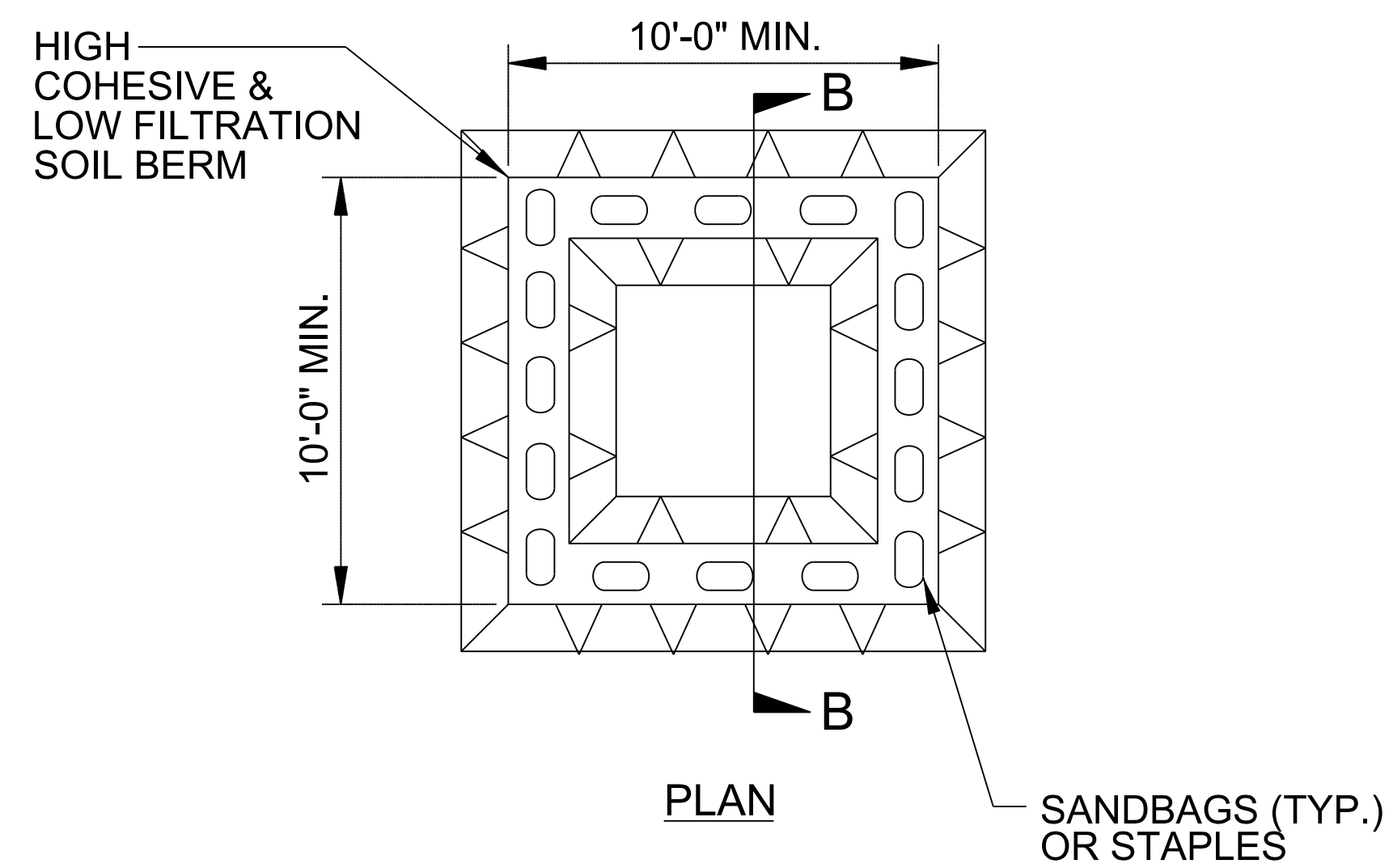

ABOVE GRADE WASHOUT STRUCTURE
NOT TO SCALE

- NOTES:
1. ACTUAL LOCATION DETERMINED IN FIELD
 2. THE CONCRETE WASHOUT STRUCTURES SHALL BE MAINTAINED WHEN THE LIQUID AND/OR SOLID REACHES 75% OF THE STRUCTURES CAPACITY TO PROVIDE ADEQUATE HOLDING CAPACITY WITH A MINIMUM 12 INCHES OF FREEBOARD.
 3. CONCRETE WASHOUT STRUCTURE NEEDS TO BE CLEARLY MARKED WITH SIGNAGE NOTING DEVICE.

DIVISION OF HIGHWAYS
STATE OF NORTH CAROLINA

SOIL STABILIZATION SUMMARY
MATTING FOR EROSION CONTROL

SHEET NO.	LINE	FROM STATION	TO STATION	SIDE	ESTIMATE (SY)
EC-4	-185NØL-	113+27	114+11	RT	195
EC-8	-185ØØL-	415+47	415+89	LT	6,175
EC-8	-185ØØL-	423+50	435+00	LT	480
				SUBTOTAL	6,850
	MISCELLANEOUS MATTING TO BE INSTALLED AS DIRECTED BY THE ENGINEER				11,400
				TOTAL	18,250
				SAY	18,250

SOIL STABILIZATION TIMEFRAMES

SITE DESCRIPTION	STABILIZATION TIME	TIMEFRAME EXCEPTIONS
PERIMETER DIKES, SWALES, DITCHES AND SLOPES	7 DAYS	NONE
HIGH QUALITY WATER (HQW) ZONES	7 DAYS	NONE
SLOPES STEEPER THAN 3:1	7 DAYS	IF SLOPES ARE 10' OR LESS IN LENGTH AND ARE NOT STEEPER THAN 2:1, 14 DAYS ARE ALLOWED.
SLOPES 3:1 OR FLATTER	14 DAYS	7 DAYS FOR SLOPES GREATER THAN 50' IN LENGTH.
ALL OTHER AREAS WITH SLOPES FLATTER THAN 4:1	14 DAYS	NONE, EXCEPT FOR PERIMETERS AND HQW ZONES.

NOTES:

1. NO LOCATION SURVEY HAS BEEN PERFORMED ON THIS PROJECT. BASE MAPPING AND CONTOUR ELEVATIONS SHOWN ARE FROM NCDOT GIS SOURCES AND ARE CONSIDERED TO BE APPROXIMATE.
2. ALIGNMENTS SHOWN ARE INTENDED TO PROVIDE APPROXIMATE LENGTHS AND LOCATIONS ONLY. PLAN STATIONS ARE APPROXIMATE AND MAY REQUIRE FIELD ADJUSTMENT AS DETERMINED BY THE ENGINEER.
3. INSTALL FABRIC INSERT INLET PROTECTION DEVICE IN LIEU OF ROCK INLET SEDIMENT TRAP TYPE 'C' AS DIRECTED TO AVOID PONDING OF RUNOFF IN ROADWAY OPEN TO PUBLIC TRAFFIC.

BEGIN TIP PROJECT I-5941
 BEGIN MILLING AND RESURFACING
 MATCH EXIST. AT CONST. JOINT
 -I85NBL- STA. 102+50
 -I85SBL- STA. 302+50

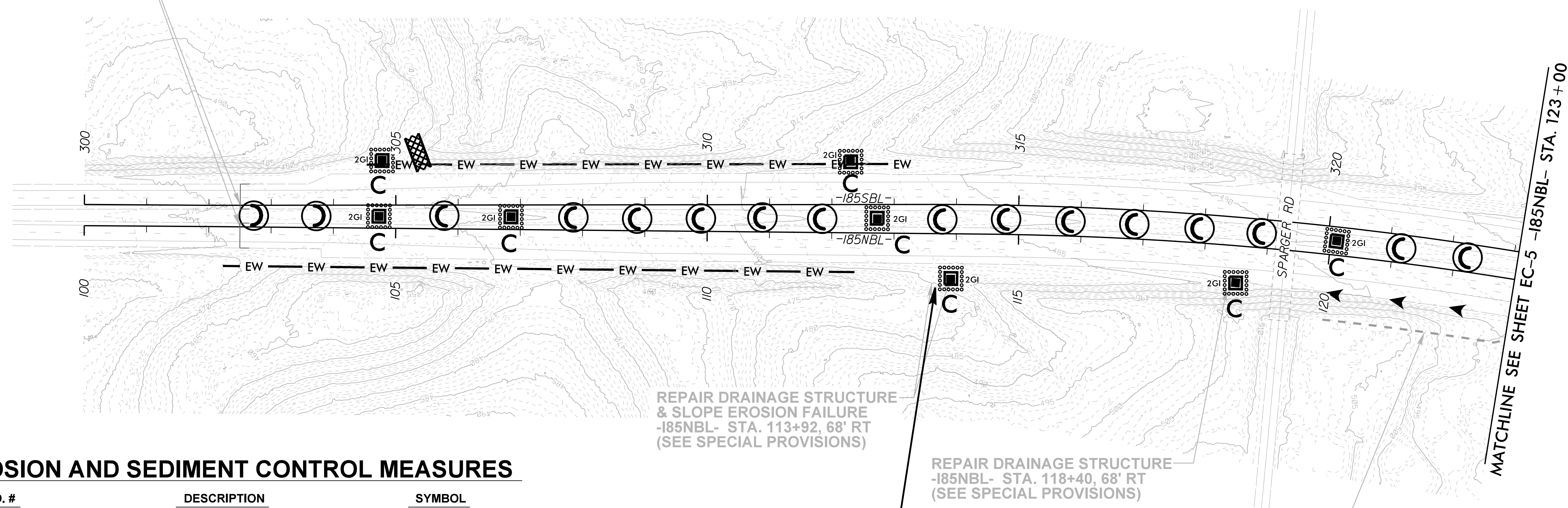

REPAIR DRAINAGE STRUCTURE & SLOPE EROSION FAILURE
 -I85NBL- STA. 113+92, 68' RT
 (SEE SPECIAL PROVISIONS)

REPAIR DRAINAGE STRUCTURE
 -I85NBL- STA. 118+40, 68' RT
 (SEE SPECIAL PROVISIONS)

REMOVE VEGETATION AT NOISE WALL
 (SEE SHEET 2B-1 FOR DETAILS)

Place Matting for Erosion Control on Slope
 for Erosion Repair as Work Allows.
 -I85NBL- Sta. 113+27 to Sta. 114+11 RT

EROSION AND SEDIMENT CONTROL MEASURES

STD. #	DESCRIPTION	SYMBOL
1632.03	ROCK INLET SEDIMENT TRAP TYPE C	C
1633.01	TEMPORARY ROCK SILT CHECK TYPE A	
1633.02	TEMPORARY ROCK SILT CHECK TYPE B	
1636.01	EXCELSIOR WATTLE CHECK WITH FLOCCULANT	
SEE SHEET EC-2B	EXCELSIOR WATTLE BARRIER	— EW —

MATCHLINE SEE SHEET EC-5 -I85NBL- STA. 123+00

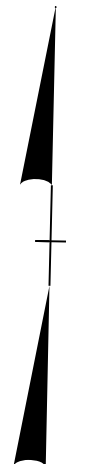

8/17/99
 4958012-2003
 J:\Roadway\I-5941\I-5941_EC_esh04.dgn
 15:22

NOTES:

1. NO LOCATION SURVEY HAS BEEN PERFORMED ON THIS PROJECT. BASE MAPPING AND CONTOUR ELEVATIONS SHOWN ARE FROM NCDOT GIS SOURCES AND ARE CONSIDERED TO BE APPROXIMATE.
2. ALIGNMENTS SHOWN ARE INTENDED TO PROVIDE APPROXIMATE LENGTHS AND LOCATIONS ONLY. PLAN STATIONS ARE APPROXIMATE AND MAY REQUIRE FIELD ADJUSTMENT AS DETERMINED BY THE ENGINEER.
3. INSTALL FABRIC INSERT INLET PROTECTION DEVICE IN LIEU OF ROCK INLET SEDIMENT TRAP TYPE 'C' AS DIRECTED TO AVOID PONDING OF RUNOFF IN ROADWAY OPEN TO PUBLIC TRAFFIC.

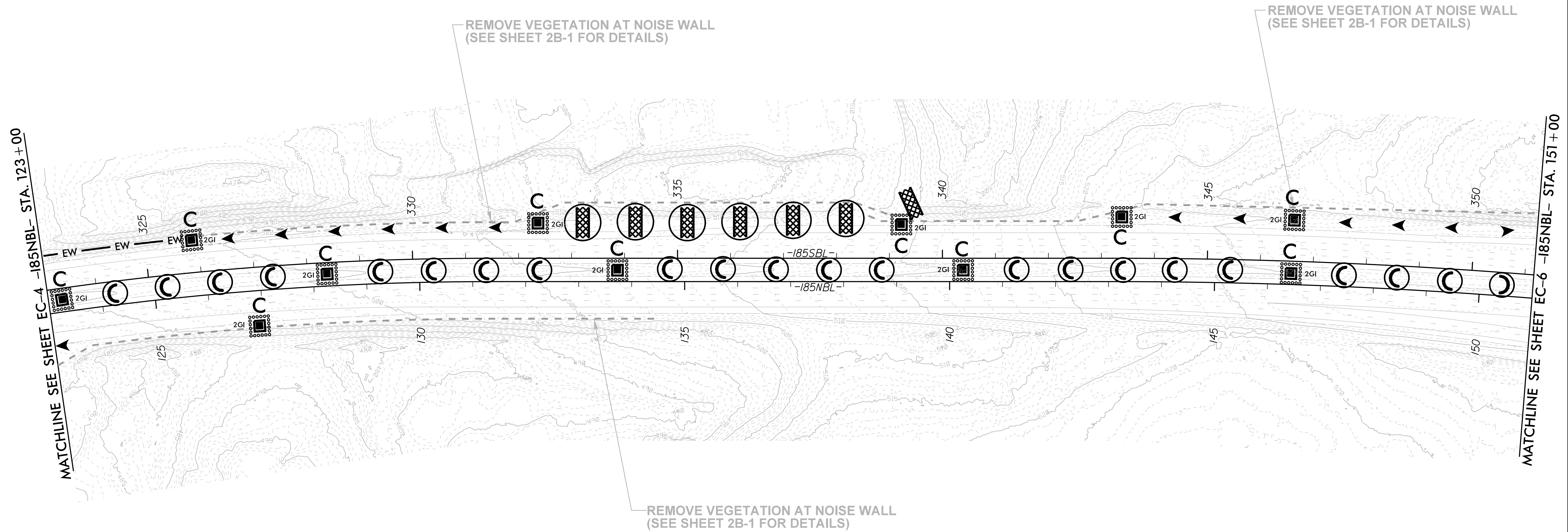
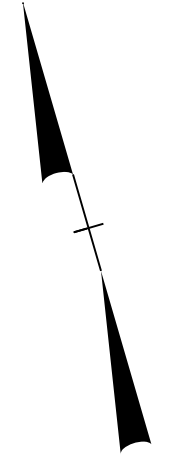

EROSION AND SEDIMENT CONTROL MEASURES

STD. #	DESCRIPTION	SYMBOL
1632.03	ROCK INLET SEDIMENT TRAP TYPE C	C
1633.01	TEMPORARY ROCK SILT CHECK TYPE A	
1633.01	TEMPORARY ROCK SILT CHECK TYPE A WITH FLOCCULANT	
1633.02	TEMPORARY ROCK SILT CHECK TYPE B	
1636.01	EXCELSIOR WATTLE CHECK WITH FLOCCULANT	
SEE SHEET EC-2B	EXCELSIOR WATTLE BARRIER	

NOTES:

1. NO LOCATION SURVEY HAS BEEN PERFORMED ON THIS PROJECT. BASE MAPPING AND CONTOUR ELEVATIONS SHOWN ARE FROM NCDOT GIS SOURCES AND ARE CONSIDERED TO BE APPROXIMATE.
2. ALIGNMENTS SHOWN ARE INTENDED TO PROVIDE APPROXIMATE LENGTHS AND LOCATIONS ONLY. PLAN STATIONS ARE APPROXIMATE AND MAY REQUIRE FIELD ADJUSTMENT AS DETERMINED BY THE ENGINEER.
3. INSTALL FABRIC INSERT INLET PROTECTION DEVICE IN LIEU OF ROCK INLET SEDIMENT TRAP TYPE 'C' AS DIRECTED TO AVOID PONDING OF RUNOFF IN ROADWAY OPEN TO PUBLIC TRAFFIC.

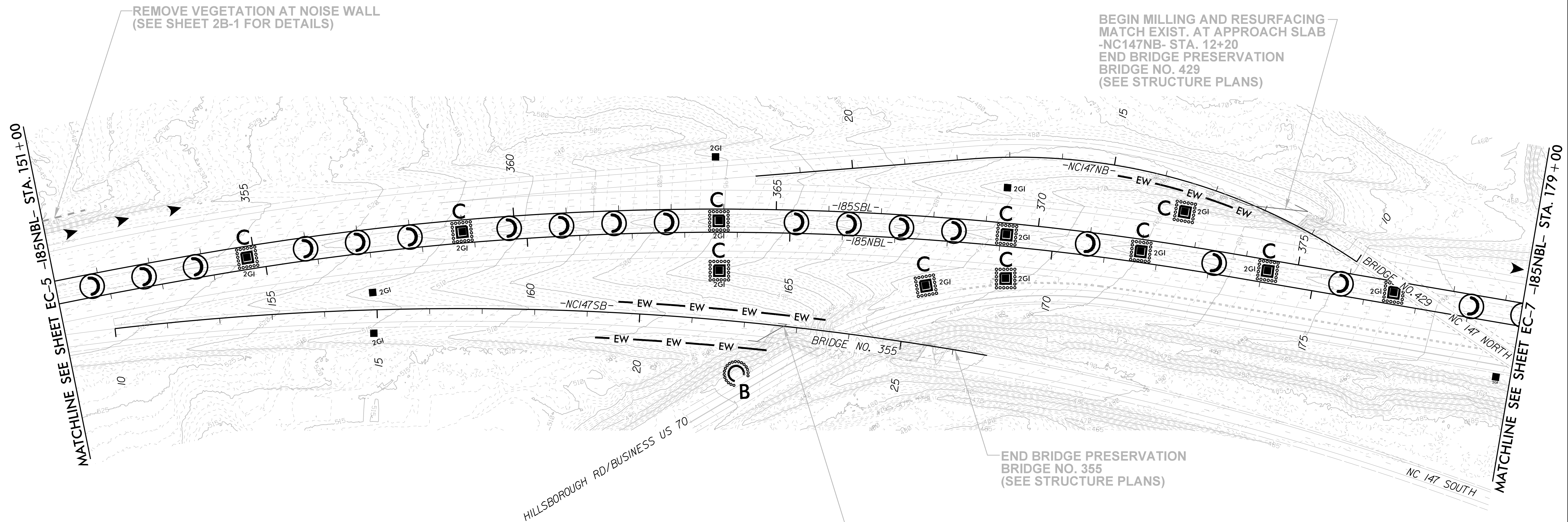
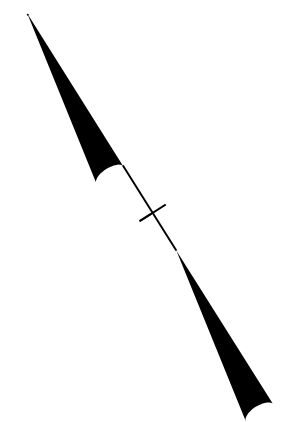

EROSION AND SEDIMENT CONTROL MEASURES

STD. #	DESCRIPTION	SYMBOL
1632.03	ROCK INLET SEDIMENT TRAP TYPE C	C
1633.01	TEMPORARY ROCK SILT CHECK TYPE A	
1633.01	TEMPORARY ROCK SILT CHECK TYPE A WITH FLOCCULANT	
1633.02	TEMPORARY ROCK SILT CHECK TYPE B	
1635.02	ROCK PIPE INLET SEDIMENT TRAP TYPE B	B
1636.01	EXCELSIOR WATTLE CHECK WITH FLOCCULANT	C
SEE SHEET EC-2B	EXCELSIOR WATTLE BARRIER	EW





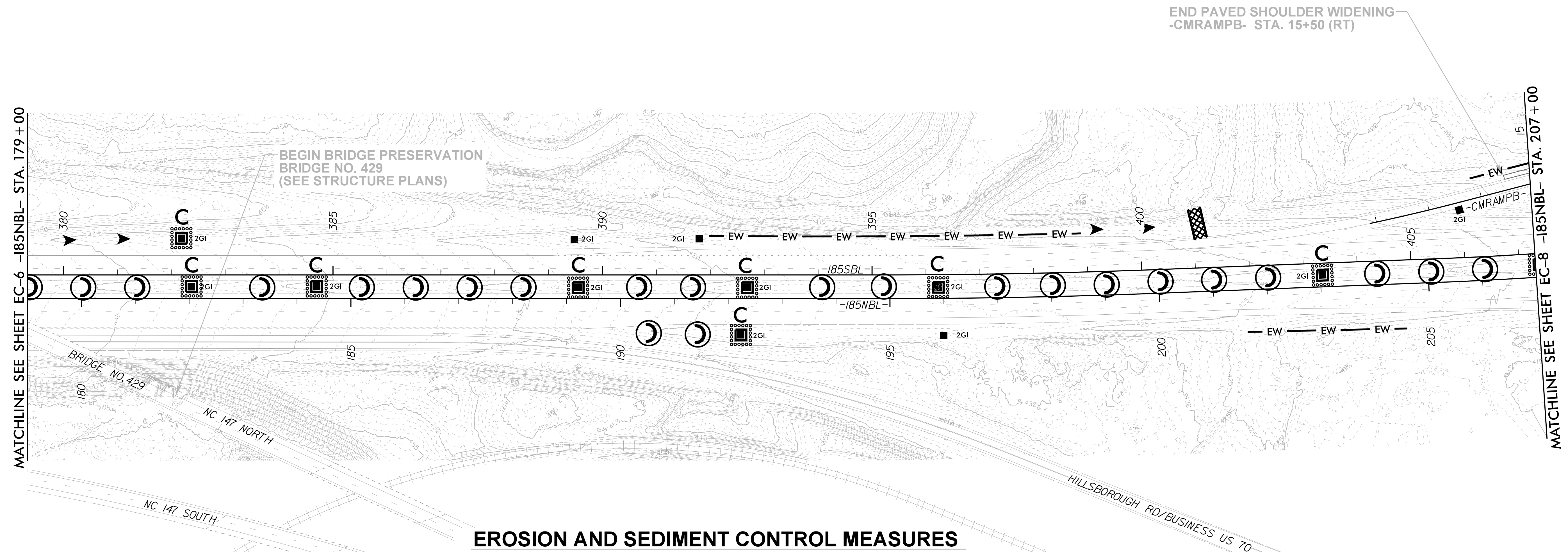
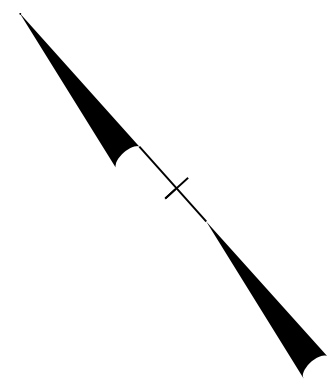

8/17/99
 27 NOV 2007 15:22
 I:\Road\EC\1-5941-EC-6\1-5941-EC-6.dgn
 lason.breda

NOTES:

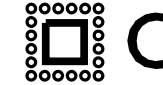
1. NO LOCATION SURVEY HAS BEEN PERFORMED ON THIS PROJECT. BASE MAPPING AND CONTOUR ELEVATIONS SHOWN ARE FROM NCDOT GIS SOURCES AND ARE CONSIDERED TO BE APPROXIMATE.
2. ALIGNMENTS SHOWN ARE INTENDED TO PROVIDE APPROXIMATE LENGTHS AND LOCATIONS ONLY. PLAN STATIONS ARE APPROXIMATE AND MAY REQUIRE FIELD ADJUSTMENT AS DETERMINED BY THE ENGINEER.
3. INSTALL FABRIC INSERT INLET PROTECTION DEVICE IN LIEU OF ROCK INLET SEDIMENT TRAP TYPE 'C' AS DIRECTED TO AVOID PONDING OF RUNOFF IN ROADWAY OPEN TO PUBLIC TRAFFIC.



EROSION AND SEDIMENT CONTROL MEASURES

STD. #	DESCRIPTION	SYMBOL
1632.03	ROCK INLET SEDIMENT TRAP TYPE C	 C
1633.01	TEMPORARY ROCK SILT CHECK TYPE A	
1633.01	TEMPORARY ROCK SILT CHECK TYPE A WITH FLOCCULANT	
1633.02	TEMPORARY ROCK SILT CHECK TYPE B	
1635.02	ROCK PIPE INLET SEDIMENT TRAP TYPE B	 B
1636.01	EXCELSIOR WATTLE CHECK WITH FLOCCULANT	
SEE SHEET EC-2B	EXCELSIOR WATTLE BARRIER	 EW

8/17/99
 49580107.dwg
 J:\Roadway\Projects\1-5941_EC_esh07.dwg
 15:25

NOTES:

- NO LOCATION SURVEY HAS BEEN PERFORMED ON THIS PROJECT. BASE MAPPING AND CONTOUR ELEVATIONS SHOWN ARE FROM NCDOT GIS SOURCES AND ARE CONSIDERED TO BE APPROXIMATE.
- ALIGNMENTS SHOWN ARE INTENDED TO PROVIDE APPROXIMATE LENGTHS AND LOCATIONS ONLY. PLAN STATIONS ARE APPROXIMATE AND MAY REQUIRE FIELD ADJUSTMENT AS DETERMINED BY THE ENGINEER.
- INSTALL FABRIC INSERT INLET PROTECTION DEVICE IN LIEU OF ROCK INLET SEDIMENT TRAP TYPE 'C' AS DIRECTED TO AVOID PONDING OF RUNOFF IN ROADWAY OPEN TO PUBLIC TRAFFIC.

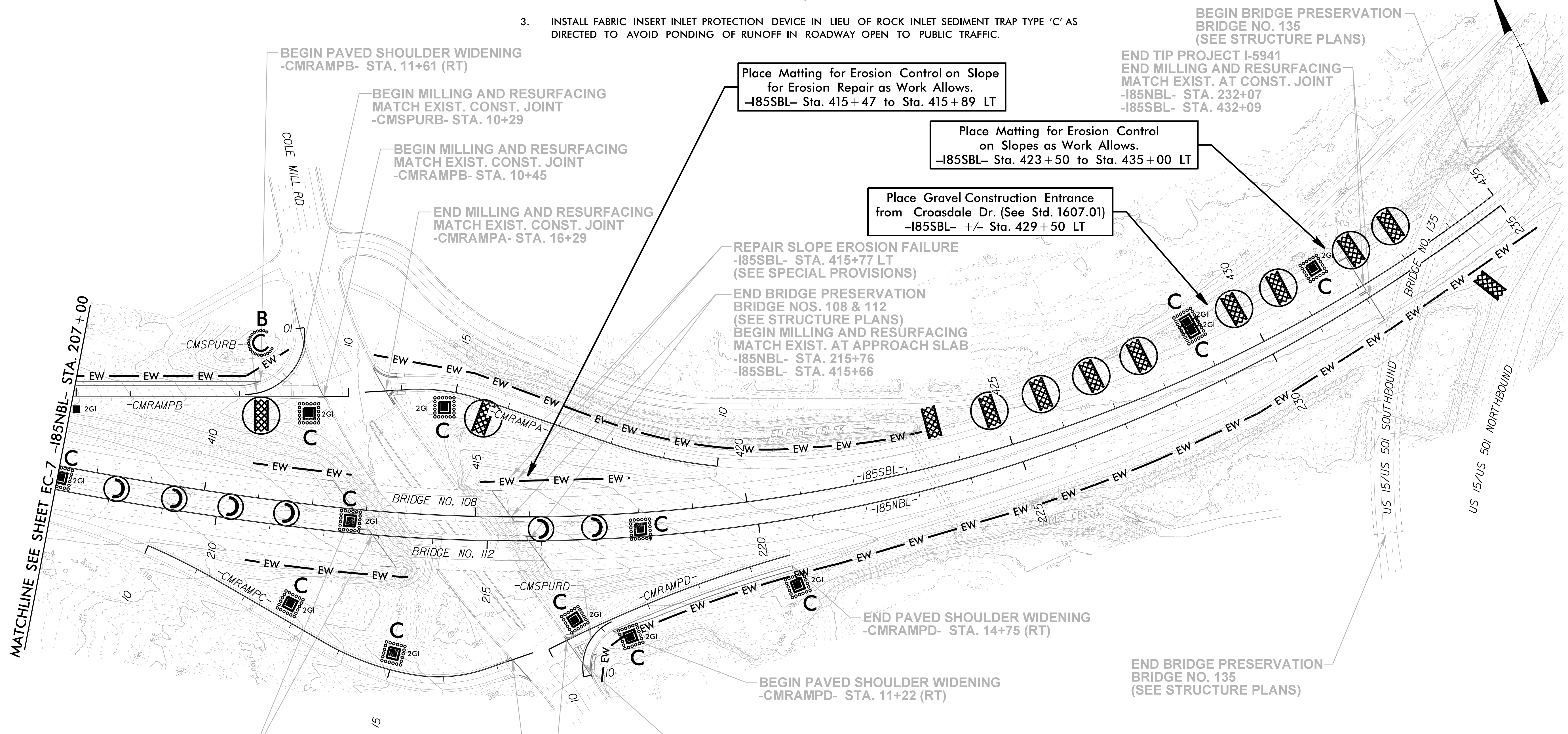

BEGIN BRIDGE PRESERVATION
BRIDGE NOS. 108 & 112
(SEE STRUCTURE PLANS)
END MILLING AND RESURFACING
MATCH EXIST. AT APPROACH SLAB
-I85NBL- STA. 212+89
-I85SBL- STA. 412+77

END MILLING AND RESURFACING
MATCH EXIST. CONST. JOINT
-CMRAMPC- STA. 17+31

BEGIN MILLING AND RESURFACING
MATCH EXIST. CONST. JOINT
-CMRAMPD- STA. 10+36

BEGIN MILLING AND RESURFACING
MATCH EXIST. CONST. JOINT
-CMSPURD- STA. 10+00

EROSION AND SEDIMENT CONTROL MEASURES

STD. #	DESCRIPTION	SYMBOL
1632.03	ROCK INLET SEDIMENT TRAP TYPE C	
1633.01	TEMPORARY ROCK SILT CHECK TYPE A	
1633.01	TEMPORARY ROCK SILT CHECK TYPE A WITH FLOCCULANT	
1633.02	TEMPORARY ROCK SILT CHECK TYPE B	
1635.02	ROCK PIPE INLET SEDIMENT TRAP TYPE B	
1636.01	EXCELSIOR WATTLE CHECK WITH FLOCCULANT	
SEE SHEET EC-2B	EXCELSIOR WATTLE BARRIER	

8/17/99

 49580127093 1526
 J:\Roadway\I-5941\EC-8\const\B.dwg