

9/8/2023 K:\CHL\PR\01036360\_U-5907\_Potts-Sloan-Ex'traffic\Signing\CADD\Pavement Marking Plans\U-5907\_pmp\_1.tsdgn

**T.I.P.: U-5907**

**CONTRACT: C204431**

**STATE OF NORTH CAROLINA  
DEPARTMENT OF TRANSPORTATION**

**PAVEMENT MARKING PLAN  
MECKLENBURG COUNTY**

**LOCATION: POTTS-SLOAN-BEATY CONNECTOR**

|  |                    |
|--|--------------------|
| TIP NO.<br>U-5907  | SHEET NO.<br>PMP-1 |
| APPROVED:  |                    |
| DATE: 10/25/2023   |                    |
|  |                    |
| DOCUMENT NOT CONSIDERED FINAL<br>UNLESS ALL SIGNATURES COMPLETED |                    |

**INDEX**

| SHEET NO.        | DESCRIPTION                                    |
|------------------|--|
| PMP-1            | PAVEMENT MARKING PLAN TITLE AND SCHEDULE SHEET |
| PMP-2 THRU PMP-9 | PAVEMENT MARKING DETAIL                        |

**ROADWAY STANDARD DRAWING**

THE FOLLOWING ROADWAY STANDARDS AS APPEAR IN "ROADWAY STANDARD DRAWINGS" - PROJECT SERVICES UNIT - N.C. DEPARTMENT OF TRANSPORTATION - RALEIGH, N.C., DATED JANUARY 2018 ARE APPLICABLE TO THIS PROJECT AND BY REFERENCE HEREBY ARE CONSIDERED A PART OF THESE PLANS:

| STD. NO. | TITLE   |
|----------|---|
| 1205.01  | PAVEMENT MARKINGS - LINE TYPES AND OFFSETS          |
| 1205.02  | PAVEMENT MARKINGS - TWO-LANE AND MULTILANE ROADWAYS |
| 1205.04  | PAVEMENT MARKINGS - INTERSECTIONS                   |
| 1205.05  | PAVEMENT MARKINGS - TURN LANES                      |
| 1205.07  | PAVEMENT MARKINGS - PEDESTRIAN CROSSWALKS           |
| 1205.08  | PAVEMENT MARKINGS - SYMBOLS AND WORD MESSAGES       |
| 1205.09  | PAVEMENT MARKINGS - PAINTED ISLANDS                 |
| 1205.14  | PAVEMENT MARKINGS - ROUNDABOUTS                     |

**PAVEMENT MARKING SCHEDULE**

| SYMBOL   | DESCRIPTION  |
|--|--|
| FINAL PAVEMENT MARKINGS                          |  |
| THERMOPLASTIC (4", 90 MILS)                      |  |
| T1   | WHITE EDGELINE                                       |
| T2   | WHITE SOLID LANE LINE                                |
| T4   | 3 FT. - 9 FT. / SP WHITE MINISKIP                    |
| T10  | YELLOW EDGELINE                                      |
| T13  | YELLOW DOUBLE CENTER                                 |
| THERMOPLASTIC (8", 90 MILS)                      |  |
| T40  | WHITE GORELINE                                       |
| T42  | YELLOW DIAGONAL                                      |
| T45  | 3 FT. - 3 FT. / SP WHITE MINISKIP (ROUNDABOUTS ONLY) |
| T46  | WHITE CROSSWALK LINE                                 |
| THERMOPLASTIC (24", 90 MILS)                     |  |
| T61  | WHITE STOP BAR                                       |
| T62  | WHITE CROSSWALK LINE                                 |
| THERMOPLASTIC PAVEMENT MARKING SYMBOLS (90 MILS) |  |
| T70  | LEFT TURN ARROW                                      |
| T72  | STRAIGHT ARROW                                       |
| T73  | COMBO. LEFT/STRAIGHT ARROW                           |
| T75  | COMBO. LEFT/RIGHT ARROW                              |
| T90  | BICYCLE SYMBOL, HEATED-IN-PLACE                      |
| T91  | BICYCLE STRAIGHT ARROW, HEATED-IN-PLACE              |
| T100   | ALPHANUMERIC CHAR.                                   |
| T103   | 24" YIELD LINE TRIANGLE                              |
| T112   | FISH-HOOK RIGHT/STRAIGHT ARROW                       |
| T114   | FISH-HOOK LEFT/RIGHT/STRAIGHT ARROW                  |
| T116   | FISH-HOOK W/ CIRCLE LEFT ARROW                       |
| T117   | FISH-HOOK W/ CIRCLE LEFT/STRAIGHT ARROW              |

**GENERAL NOTES**

THE FOLLOWING GENERAL NOTES APPLY AT ALL TIMES FOR THE DURATION OF THE CONSTRUCTION PROJECT, EXCEPT WHEN OTHERWISE NOTED IN THE PLAN, OR DIRECTED BY THE ENGINEER.

- A) INSTALL PAVEMENT MARKINGS ON THE FINAL SURFACE AS FOLLOWS:
 

|                  |                |
|------------------|----------------|
| <u>ROAD NAME</u> | <u>MARKING</u> |
| ALL              | THERMOPLASTIC  |
- B) TIE PROPOSED PAVEMENT MARKING LINES TO EXISTING PAVEMENT MARKING LINES.
- C) REMOVE/REPLACE ANY CONFLICTING/DAMAGED PAVEMENT MARKINGS AND MARKERS.
- D) STOP BAR LOCATION AT NON-SIGNALIZED INTERSECTIONS MAY BE ADJUSTED AS DIRECTED BY THE ENGINEER.
- E) PASSING ZONES WILL BE DETERMINED IN THE FIELD AND MUST BE APPROVED BY THE ENGINEER.
- F) UNLESS OTHERWISE SPECIFIED, HEATED-IN-PLACE THERMOPLASTIC MAY BE USED IN LIEU OF EXTRUDED THERMOPLASTIC FOR ARROWS, STOP BARS, SYMBOLS, CHARACTERS AND DIAGONALS. IF HEATED-IN-PLACE IS USED, IT SHALL BE PAID FOR USING THE EXTRUDED THERMOPLASTIC PAY ITEM.
- G) SEE ROADWAY PLANS FOR ALTERNATE CURB RAMP DESIGNS WHEN INDICATED ON PAVEMENT MARKING DETAIL SHEETS.

**PLAN REVIEWED BY: N.C.D.O.T. SIGNING AND DELINEATION UNIT**

\_\_\_\_\_  
SIGNING & DELINEATION REGIONAL ENGINEER

\_\_\_\_\_  
SIGNING & DELINEATION PROJECT DESIGN ENGINEER



**PLAN PREPARED BY: Kimley-Horn and Associates**

FRANK MASTERSON, P.E. PROJECT DESIGN ENGINEER

ANDREW WEEKS, E.I. DESIGNER



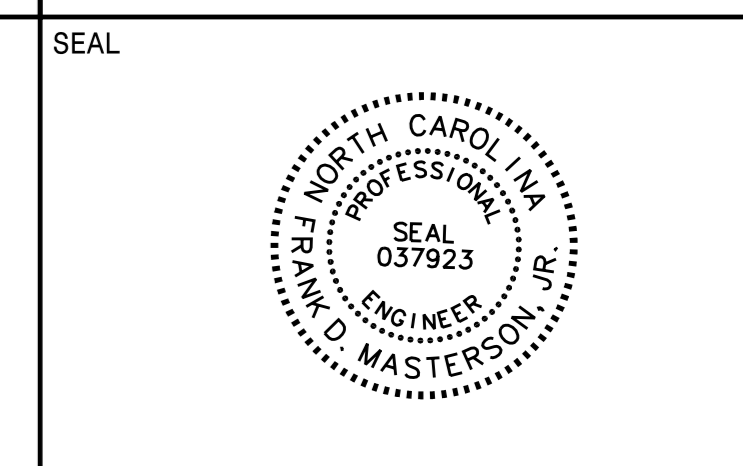
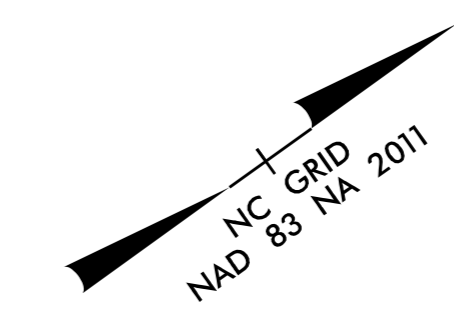

**DOCUMENT NOT CONSIDERED FINAL  
 UNLESS ALL SIGNATURES COMPLETED**

K:\CHL\_PR\01036360\_U-5907\_Potts-Sloan\_ExtTrafficSigning\CADD\Pavement Marking Plans\U-5907\_rdy\_pmp\_3.dgn

9/7/2023

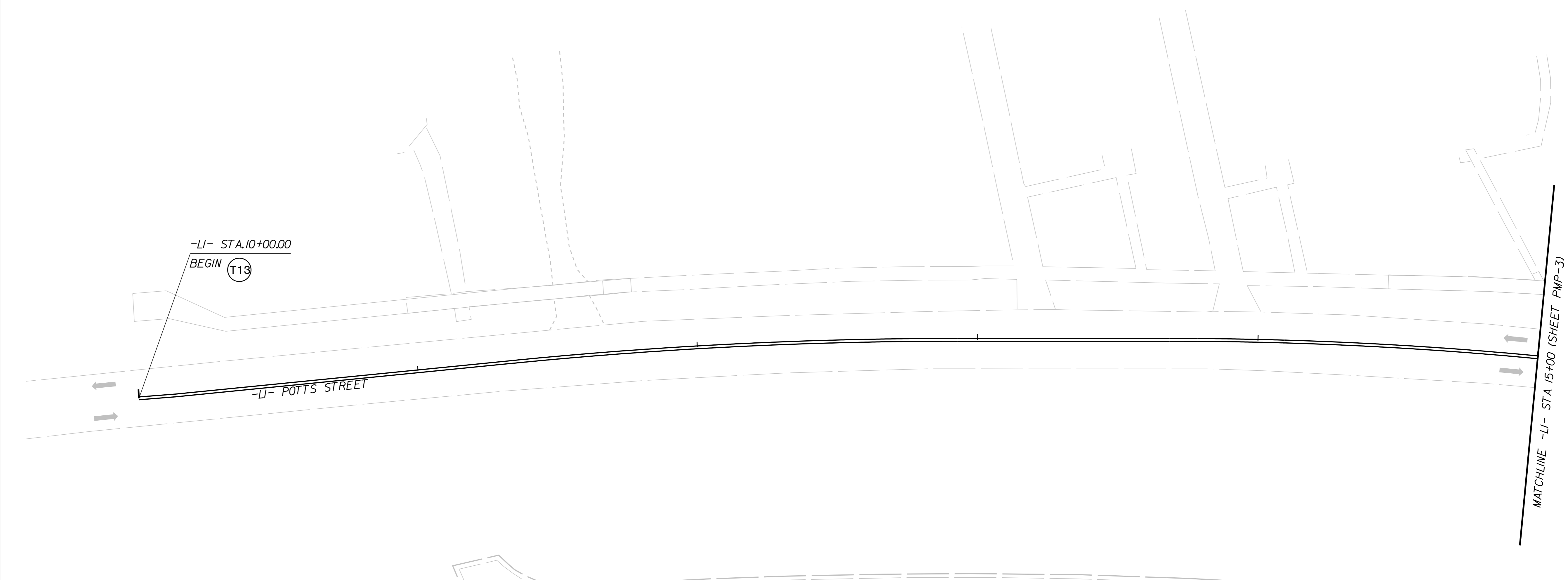

| THERMOPLASTIC PAVEMENT MARKING LINES |                                 |
|--------------------------------------|---------------------------------|
| T1 - THERMOPLASTIC (4", 90 MILS)     | WHITE EDGELINE                  |
| T2 - THERMOPLASTIC (4", 90 MILS)     | WHITE SOLID LANE LINE           |
| T4 - THERMOPLASTIC (4", 90 MILS)     | 3 FT. - 9 FT./SP WHITE MINISKIP |
| T10 - THERMOPLASTIC (4", 90 MIL)     | YELLOW EDGELINE                 |
| T13 - THERMOPLASTIC (4", 90 MILS)    | YELLOW DOUBLE CENTER LINE       |
| T40 - THERMOPLASTIC (8", 90 MILS)    | WHITE GORELINE                  |
| T41 - THERMOPLASTIC (8", 90 MILS)    | WHITE DIAGONAL                  |
| T42 - THERMOPLASTIC (8", 90 MILS)    | YELLOW DIAGONAL                 |
| T45 - THERMOPLASTIC (8", 90 MILS)    | 3 FT. - 3 FT./SP WHITE MINISKIP |
| T61 - THERMOPLASTIC (24", 90 MILS)   | WHITE STOPBAR                   |
| T62 - THERMOPLASTIC (24" 90 MILS)    | WHITE CROSSWALK LINE            |

| THERMOPLASTIC PAVEMENT MARKING SYMBOLS |  |
|--|--|
| T70 - THERMOPLASTIC (90 MILS)          | LEFT TURN ARROW                        |
| T72 - THERMOPLASTIC (90 MILS)          | STRAIGHT ARROW                         |
| T73 - THERMOPLASTIC (90 MILS)          | COMBO. LEFT/STRAIGHT ARROW             |
| T90 - THERMOPLASTIC (90 MILS)          | BICYCLE SYMBOL                         |
| T91 - THERMOPLASTIC (90 MILS)          | BICYCLE STRAIGHT ARROW                 |
| T100 - THERMOPLASTIC (90 MILS)         | ALPHANUMERIC CHAR.                     |
| T103 - THERMOPLASTIC (90 MILS)         | 24" YIELD LINE TRIANGLE                |
| T112 - THERMOPLASTIC (90 MILS)         | FISH-HOOK RIGHT/STRAIGHT ARROW         |
| T114 - THERMOPLASTIC (90 MILS)         | FISH-HOOK LEFT/RIGHT/STRAIGHT ARROW    |
| T116 - THERMOPLASTIC (90 MILS)         | FISH-HOOK W/CIRCLE LEFT ARROW          |
| T117 - THERMOPLASTIC (90 MILS)         | FISH-HOOK W/CIRCLE LEFT/STRAIGHT ARROW |

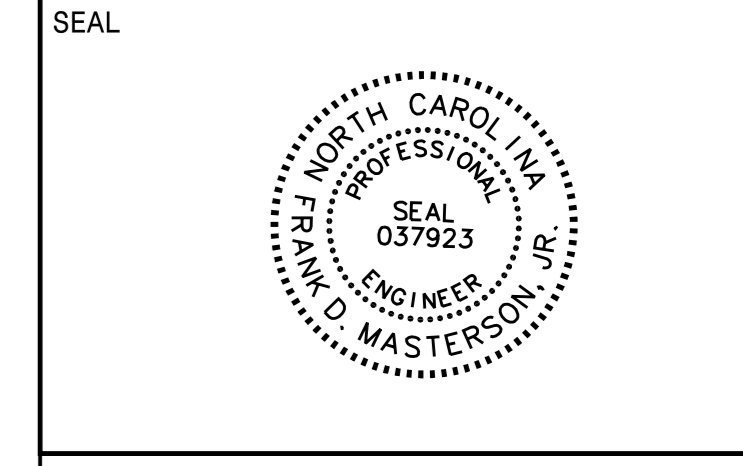

**DOCUMENT NOT CONSIDERED FINAL  
 UNLESS ALL SIGNATURES COMPLETED**

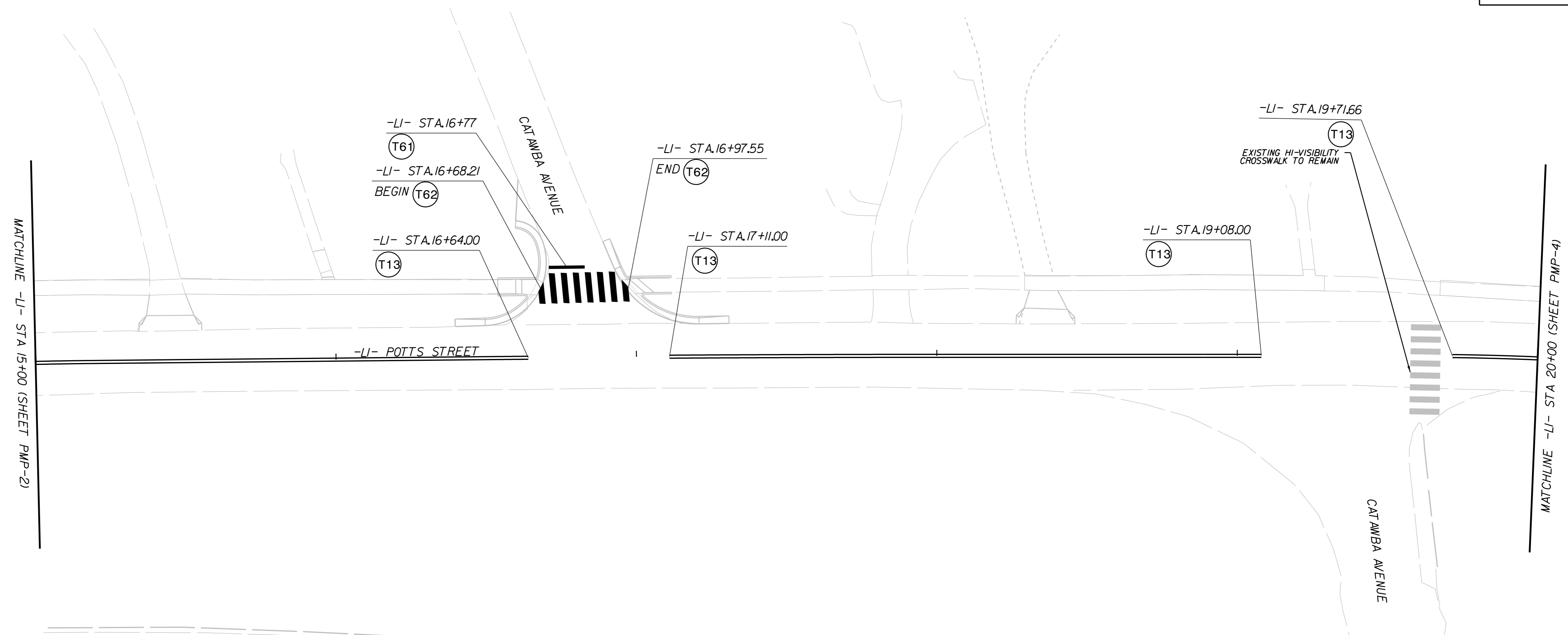
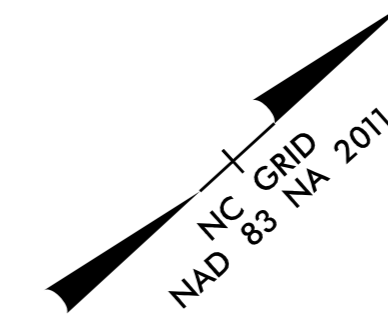

### THERMOPLASTIC PAVEMENT MARKING LINES

|                                    |                                 |
|------------------------------------|---------------------------------|
| T1 - THERMOPLASTIC (4", 90 MILS)   | WHITE EDGELINE                  |
| T2 - THERMOPLASTIC (4", 90 MILS)   | WHITE SOLID LANE LINE           |
| T4 - THERMOPLASTIC (4", 90 MILS)   | 3 FT. - 9 FT./SP WHITE MINISKIP |
| T10 - THERMOPLASTIC (4", 90 MIL)   | YELLOW EDGELINE                 |
| T13 - THERMOPLASTIC (4", 90 MILS)  | YELLOW DOUBLE CENTER LINE       |
| T40 - THERMOPLASTIC (8", 90 MILS)  | WHITE GORELINE                  |
| T41 - THERMOPLASTIC (8", 90 MILS)  | WHITE DIAGONAL                  |
| T42 - THERMOPLASTIC (8", 90 MILS)  | YELLOW DIAGONAL                 |
| T45 - THERMOPLASTIC (8", 90 MILS)  | 3 FT. - 3 FT./SP WHITE MINISKIP |
| T61 - THERMOPLASTIC (24", 90 MILS) | WHITE STOPBAR                   |
| T62 - THERMOPLASTIC (24" 90 MILS)  | WHITE CROSSWALK LINE            |

### THERMOPLASTIC PAVEMENT MARKING SYMBOLS

|                                |  |
|--------------------------------|--|
| T70 - THERMOPLASTIC (90 MILS)  | LEFT TURN ARROW                        |
| T72 - THERMOPLASTIC (90 MILS)  | STRAIGHT ARROW                         |
| T73 - THERMOPLASTIC (90 MILS)  | COMBO. LEFT/STRAIGHT ARROW             |
| T90 - THERMOPLASTIC (90 MILS)  | BICYCLE SYMBOL                         |
| T91 - THERMOPLASTIC (90 MILS)  | BICYCLE STRAIGHT ARROW                 |
| T100 - THERMOPLASTIC (90 MILS) | ALPHANUMERIC CHAR.                     |
| T103 - THERMOPLASTIC (90 MILS) | 24" YIELD LINE TRIANGLE                |
| T112 - THERMOPLASTIC (90 MILS) | FISH-HOOK RIGHT/STRAIGHT ARROW         |
| T114 - THERMOPLASTIC (90 MILS) | FISH-HOOK LEFT/RIGHT/STRAIGHT ARROW    |
| T116 - THERMOPLASTIC (90 MILS) | FISH-HOOK W/CIRCLE LEFT ARROW          |
| T117 - THERMOPLASTIC (90 MILS) | FISH-HOOK W/CIRCLE LEFT/STRAIGHT ARROW |

K:\CHL\_PRJ\01036360\_U-5907\_Potts-Sloan\_ExtTrafficSigning\CADD\Pavement Marking Plans\U-5907\_rdy\_pmp\_4.dgn

9/7/2023



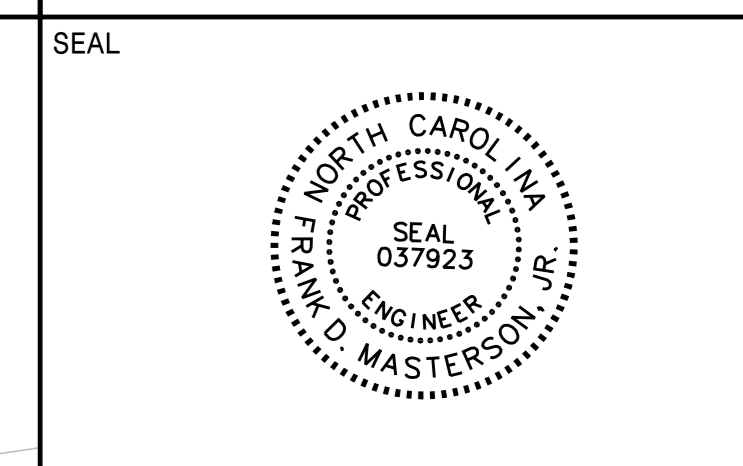

**DOCUMENT NOT CONSIDERED FINAL  
 UNLESS ALL SIGNATURES COMPLETED**

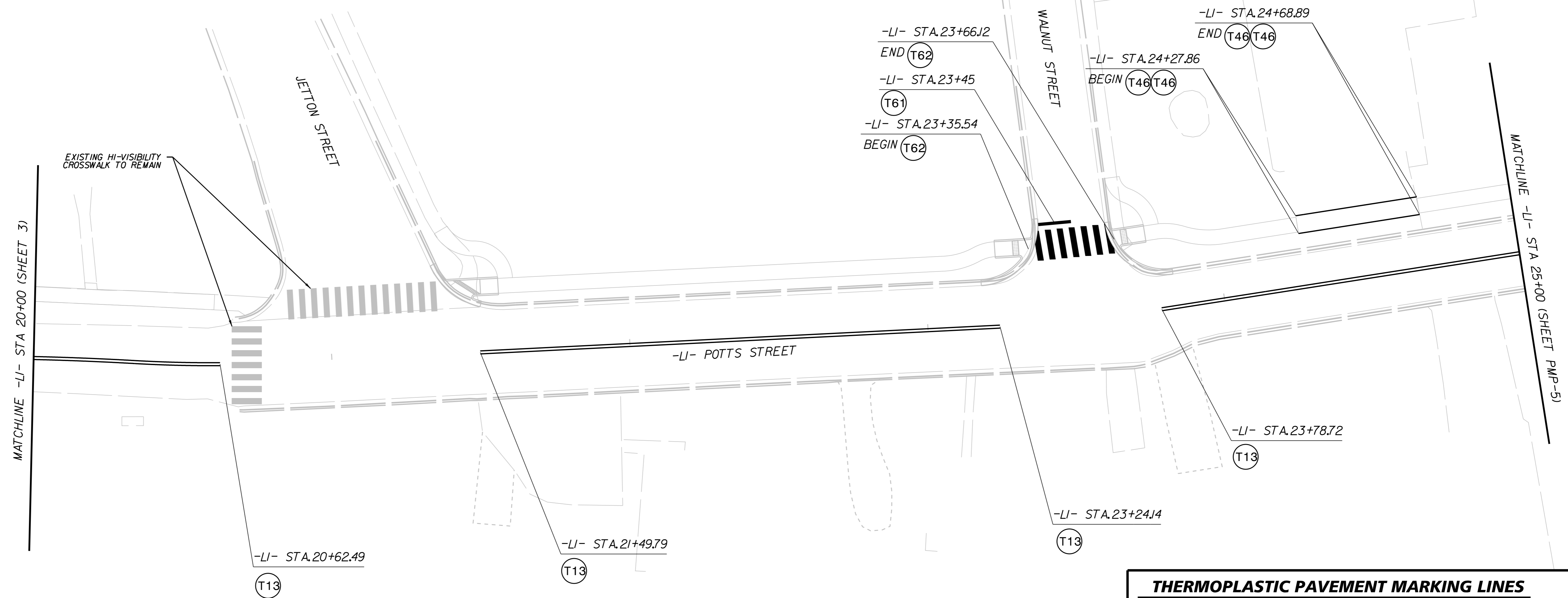
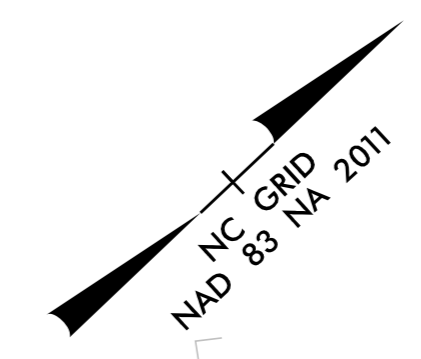

| THERMOPLASTIC PAVEMENT MARKING LINES |                                 |
|--------------------------------------|---------------------------------|
| T1 - THERMOPLASTIC (4", 90 MILS)     | WHITE EDGELINE                  |
| T2 - THERMOPLASTIC (4", 90 MILS)     | WHITE SOLID LANE LINE           |
| T4 - THERMOPLASTIC (4", 90 MILS)     | 3 FT. - 9 FT./SP WHITE MINISKIP |
| T10 - THERMOPLASTIC (4", 90 MIL)     | YELLOW EDGELINE                 |
| T13 - THERMOPLASTIC (4", 90 MILS)    | YELLOW DOUBLE CENTER LINE       |
| T40 - THERMOPLASTIC (8", 90 MILS)    | WHITE GORELINE                  |
| T41 - THERMOPLASTIC (8", 90 MILS)    | WHITE DIAGONAL                  |
| T42 - THERMOPLASTIC (8", 90 MILS)    | YELLOW DIAGONAL                 |
| T45 - THERMOPLASTIC (8", 90 MILS)    | 3 FT. - 3 FT./SP WHITE MINISKIP |
| T61 - THERMOPLASTIC (24", 90 MILS)   | WHITE STOPBAR                   |
| T62 - THERMOPLASTIC (24" 90 MILS)    | WHITE CROSSWALK LINE            |

  

| THERMOPLASTIC PAVEMENT MARKING SYMBOLS |  |
|--|--|
| T70 - THERMOPLASTIC (90 MILS)          | LEFT TURN ARROW                        |
| T72 - THERMOPLASTIC (90 MILS)          | STRAIGHT ARROW                         |
| T73 - THERMOPLASTIC (90 MILS)          | COMBO. LEFT/STRAIGHT ARROW             |
| T90 - THERMOPLASTIC (90 MILS)          | BICYCLE SYMBOL                         |
| T91 - THERMOPLASTIC (90 MILS)          | BICYCLE STRAIGHT ARROW                 |
| T100 - THERMOPLASTIC (90 MILS)         | ALPHANUMERIC CHAR.                     |
| T103 - THERMOPLASTIC (90 MILS)         | 24" YIELD LINE TRIANGLE                |
| T112 - THERMOPLASTIC (90 MILS)         | FISH-HOOK RIGHT/STRAIGHT ARROW         |
| T114 - THERMOPLASTIC (90 MILS)         | FISH-HOOK LEFT/RIGHT/STRAIGHT ARROW    |
| T116 - THERMOPLASTIC (90 MILS)         | FISH-HOOK W/CIRCLE LEFT ARROW          |
| T117 - THERMOPLASTIC (90 MILS)         | FISH-HOOK W/CIRCLE LEFT/STRAIGHT ARROW |

K:\CHL\_PRJ\01036360\_U-5907\_Potts-Sloan\_ExtTrafficSigning\CADD\Pavement Marking Plans\U-5907\_rdy\_pmp\_5.dgn  
 9/7/2023



**DOCUMENT NOT CONSIDERED FINAL  
UNLESS ALL SIGNATURES COMPLETED**

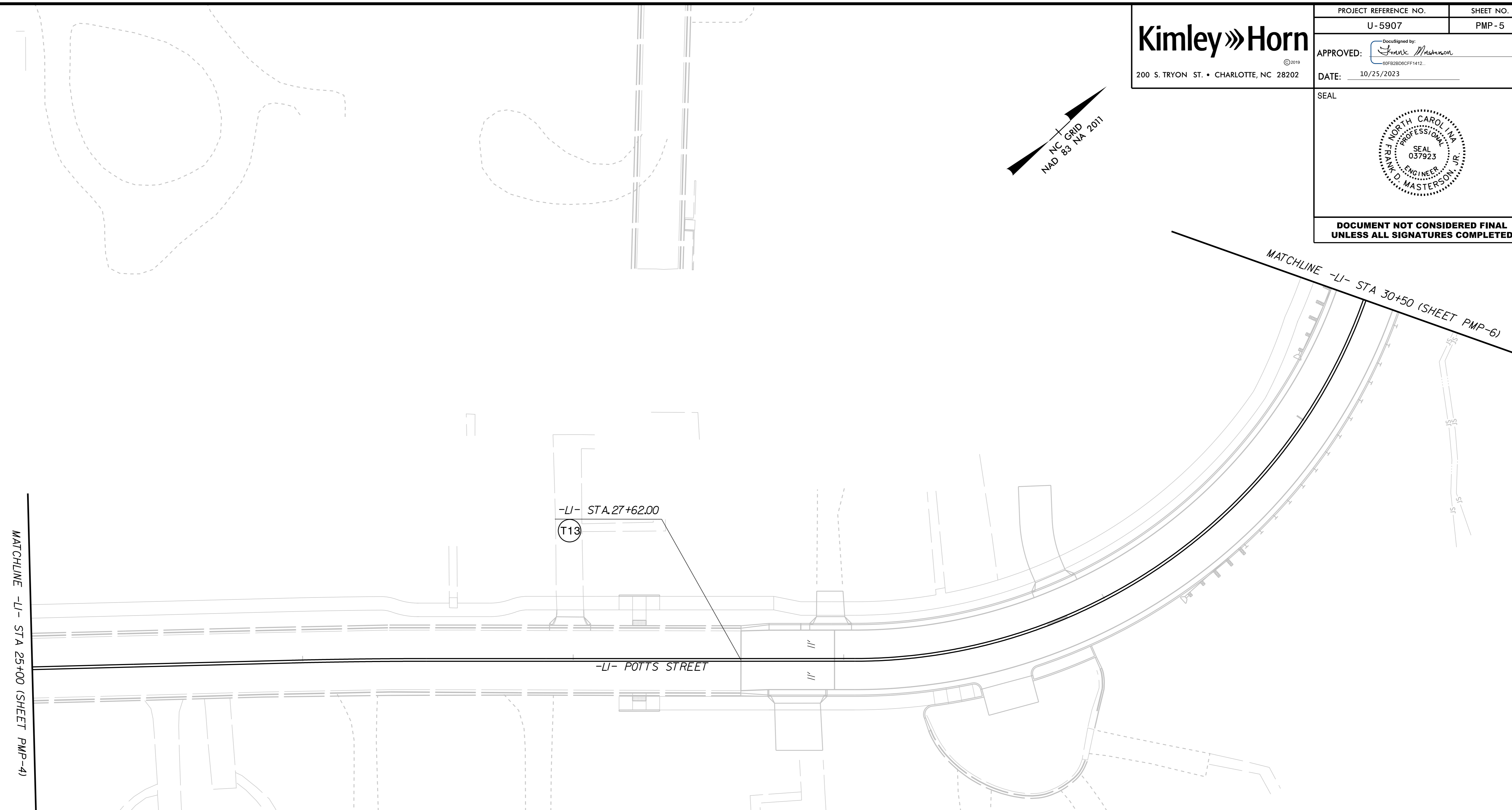
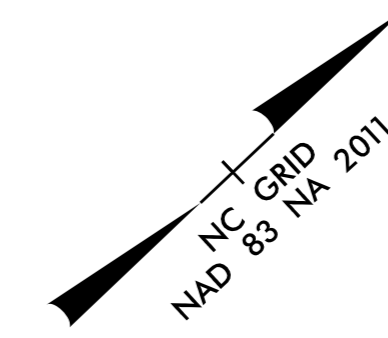

**THERMOPLASTIC PAVEMENT MARKING LINES**

|                                    |                                 |
|------------------------------------|---------------------------------|
| T1 - THERMOPLASTIC (4", 90 MILS)   | WHITE EDGELINE                  |
| T2 - THERMOPLASTIC (4", 90 MILS)   | WHITE SOLID LANE LINE           |
| T4 - THERMOPLASTIC (4", 90 MILS)   | 3 FT. - 9 FT./SP WHITE MINISKIP |
| T10 - THERMOPLASTIC (4", 90 MIL)   | YELLOW EDGELINE                 |
| T13 - THERMOPLASTIC (4", 90 MILS)  | YELLOW DOUBLE CENTER LINE       |
| T40 - THERMOPLASTIC (8", 90 MILS)  | WHITE GORELINE                  |
| T41 - THERMOPLASTIC (8", 90 MILS)  | WHITE DIAGONAL                  |
| T42 - THERMOPLASTIC (8", 90 MILS)  | YELLOW DIAGONAL                 |
| T45 - THERMOPLASTIC (8", 90 MILS)  | 3 FT. - 3 FT./SP WHITE MINISKIP |
| T61 - THERMOPLASTIC (24", 90 MILS) | WHITE STOPBAR                   |
| T62 - THERMOPLASTIC (24" 90 MILS)  | WHITE CROSSWALK LINE            |

**THERMOPLASTIC PAVEMENT MARKING SYMBOLS**

|                                |  |
|--------------------------------|--|
| T70 - THERMOPLASTIC (90 MILS)  | LEFT TURN ARROW                        |
| T72 - THERMOPLASTIC (90 MILS)  | STRAIGHT ARROW                         |
| T73 - THERMOPLASTIC (90 MILS)  | COMBO. LEFT/STRAIGHT ARROW             |
| T90 - THERMOPLASTIC (90 MILS)  | BICYCLE SYMBOL                         |
| T91 - THERMOPLASTIC (90 MILS)  | BICYCLE STRAIGHT ARROW                 |
| T100 - THERMOPLASTIC (90 MILS) | ALPHANUMERIC CHAR.                     |
| T103 - THERMOPLASTIC (90 MILS) | 24" YIELD LINE TRIANGLE                |
| T112 - THERMOPLASTIC (90 MILS) | FISH-HOOK RIGHT/STRAIGHT ARROW         |
| T114 - THERMOPLASTIC (90 MILS) | FISH-HOOK LEFT/RIGHT/STRAIGHT ARROW    |
| T116 - THERMOPLASTIC (90 MILS) | FISH-HOOK W/CIRCLE LEFT ARROW          |
| T117 - THERMOPLASTIC (90 MILS) | FISH-HOOK W/CIRCLE LEFT/STRAIGHT ARROW |

K:\CHL\_PRJ\01036360\_U-5907\_Potts-Sloan\_ExtTrafficSigning\CADD\Pavement Marking Plans\U-5907\_rdy\_pmp\_6.dgn

9/7/2023





**DOCUMENT NOT CONSIDERED FINAL  
UNLESS ALL SIGNATURES COMPLETED**

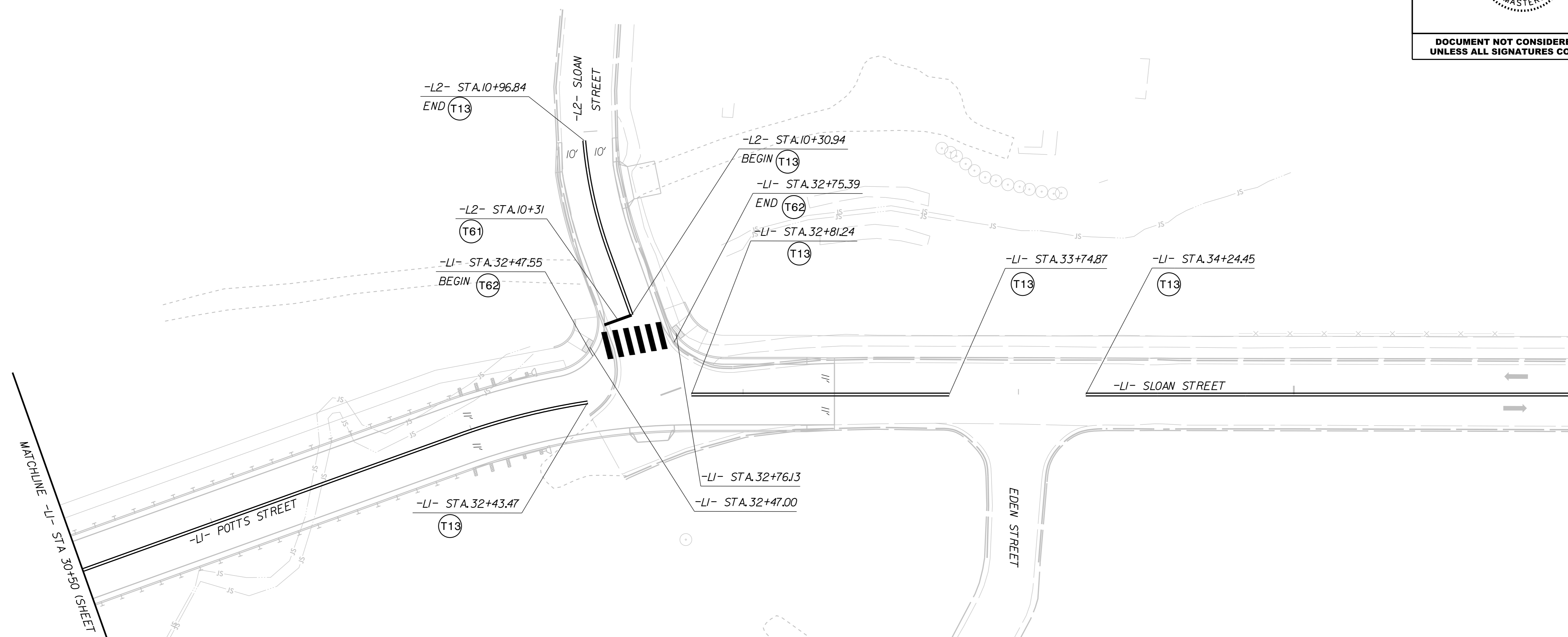
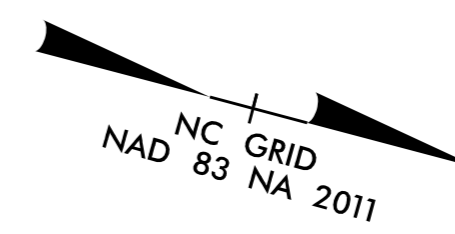

**THERMOPLASTIC PAVEMENT MARKING LINES**

|                                    |                                 |
|------------------------------------|---------------------------------|
| T1 - THERMOPLASTIC (4", 90 MILS)   | WHITE EDGELINE                  |
| T2 - THERMOPLASTIC (4", 90 MILS)   | WHITE SOLID LANE LINE           |
| T4 - THERMOPLASTIC (4", 90 MILS)   | 3 FT. - 9 FT./SP WHITE MINISKIP |
| T10 - THERMOPLASTIC (4", 90 MIL)   | YELLOW EDGELINE                 |
| T13 - THERMOPLASTIC (4", 90 MILS)  | YELLOW DOUBLE CENTER LINE       |
| T40 - THERMOPLASTIC (8", 90 MILS)  | WHITE GORELINE                  |
| T41 - THERMOPLASTIC (8", 90 MILS)  | WHITE DIAGONAL                  |
| T42 - THERMOPLASTIC (8", 90 MILS)  | YELLOW DIAGONAL                 |
| T45 - THERMOPLASTIC (8", 90 MILS)  | 3 FT. - 3 FT./SP WHITE MINISKIP |
| T61 - THERMOPLASTIC (24", 90 MILS) | WHITE STOPBAR                   |
| T62 - THERMOPLASTIC (24" 90 MILS)  | WHITE CROSSWALK LINE            |

**THERMOPLASTIC PAVEMENT MARKING SYMBOLS**

|                                |  |
|--------------------------------|--|
| T70 - THERMOPLASTIC (90 MILS)  | LEFT TURN ARROW                        |
| T72 - THERMOPLASTIC (90 MILS)  | STRAIGHT ARROW                         |
| T73 - THERMOPLASTIC (90 MILS)  | COMBO. LEFT/STRAIGHT ARROW             |
| T90 - THERMOPLASTIC (90 MILS)  | BICYCLE SYMBOL                         |
| T91 - THERMOPLASTIC (90 MILS)  | BICYCLE STRAIGHT ARROW                 |
| T100 - THERMOPLASTIC (90 MILS) | ALPHANUMERIC CHAR.                     |
| T103 - THERMOPLASTIC (90 MILS) | 24" YIELD LINE TRIANGLE                |
| T112 - THERMOPLASTIC (90 MILS) | FISH-HOOK RIGHT/STRAIGHT ARROW         |
| T114 - THERMOPLASTIC (90 MILS) | FISH-HOOK LEFT/RIGHT/STRAIGHT ARROW    |
| T116 - THERMOPLASTIC (90 MILS) | FISH-HOOK W/CIRCLE LEFT ARROW          |
| T117 - THERMOPLASTIC (90 MILS) | FISH-HOOK W/CIRCLE LEFT/STRAIGHT ARROW |

K:\CHL\_PRJ\01036360\_U-5907\_Potts-Sloan\_ExtTrafficSigning\CADD\Pavement Marking Plans\U-5907\_rdy\_pmp\_7.dgn

9/7/2023

MATCHLINE -LI- STA 30+50 (SHEET PMP-5)

MATCHLINE -LI- STA 36+00 (SHEET PMP-7)



**DOCUMENT NOT CONSIDERED FINAL  
 UNLESS ALL SIGNATURES COMPLETED**

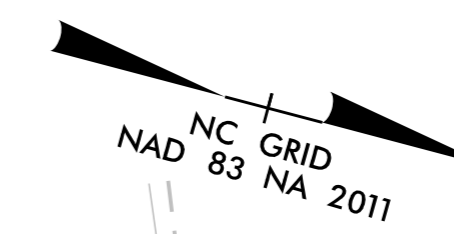

NC GRID  
 NAD 83 NA 2011

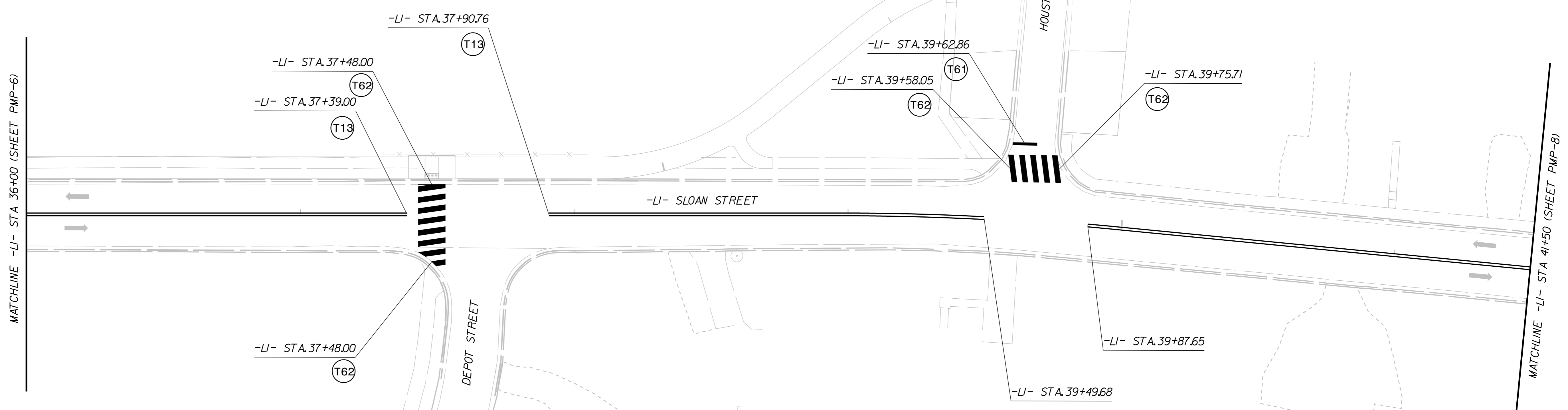

| THERMOPLASTIC PAVEMENT MARKING LINES |                                 |
|--------------------------------------|---------------------------------|
| T1 - THERMOPLASTIC (4", 90 MILS)     | WHITE EDGELINE                  |
| T2 - THERMOPLASTIC (4", 90 MILS)     | WHITE SOLID LANE LINE           |
| T4 - THERMOPLASTIC (4", 90 MILS)     | 3 FT. - 9 FT./SP WHITE MINISKIP |
| T10 - THERMOPLASTIC (4", 90 MIL)     | YELLOW EDGELINE                 |
| T13 - THERMOPLASTIC (4", 90 MILS)    | YELLOW DOUBLE CENTER LINE       |
| T40 - THERMOPLASTIC (8", 90 MILS)    | WHITE GORELINE                  |
| T41 - THERMOPLASTIC (8", 90 MILS)    | WHITE DIAGONAL                  |
| T42 - THERMOPLASTIC (8", 90 MILS)    | YELLOW DIAGONAL                 |
| T45 - THERMOPLASTIC (8", 90 MILS)    | 3 FT. - 3 FT./SP WHITE MINISKIP |
| T61 - THERMOPLASTIC (24", 90 MILS)   | WHITE STOPBAR                   |
| T62 - THERMOPLASTIC (24" 90 MILS)    | WHITE CROSSWALK LINE            |

| THERMOPLASTIC PAVEMENT MARKING SYMBOLS |  |
|--|--|
| T70 - THERMOPLASTIC (90 MILS)          | LEFT TURN ARROW                        |
| T72 - THERMOPLASTIC (90 MILS)          | STRAIGHT ARROW                         |
| T73 - THERMOPLASTIC (90 MILS)          | COMBO. LEFT/STRAIGHT ARROW             |
| T90 - THERMOPLASTIC (90 MILS)          | BICYCLE SYMBOL                         |
| T91 - THERMOPLASTIC (90 MILS)          | BICYCLE STRAIGHT ARROW                 |
| T100 - THERMOPLASTIC (90 MILS)         | ALPHANUMERIC CHAR.                     |
| T103 - THERMOPLASTIC (90 MILS)         | 24" YIELD LINE TRIANGLE                |
| T112 - THERMOPLASTIC (90 MILS)         | FISH-HOOK RIGHT/STRAIGHT ARROW         |
| T114 - THERMOPLASTIC (90 MILS)         | FISH-HOOK LEFT/RIGHT/STRAIGHT ARROW    |
| T116 - THERMOPLASTIC (90 MILS)         | FISH-HOOK W/CIRCLE LEFT ARROW          |
| T117 - THERMOPLASTIC (90 MILS)         | FISH-HOOK W/CIRCLE LEFT/STRAIGHT ARROW |

K:\CHL\_PRJ\01036360\_U-5907\_Potts-Sloan\_ExtTrafficSigning\CADD\Pavement Marking Plans\U-5907\_rdy\_pmp\_8.dgn  
 9/7/2023







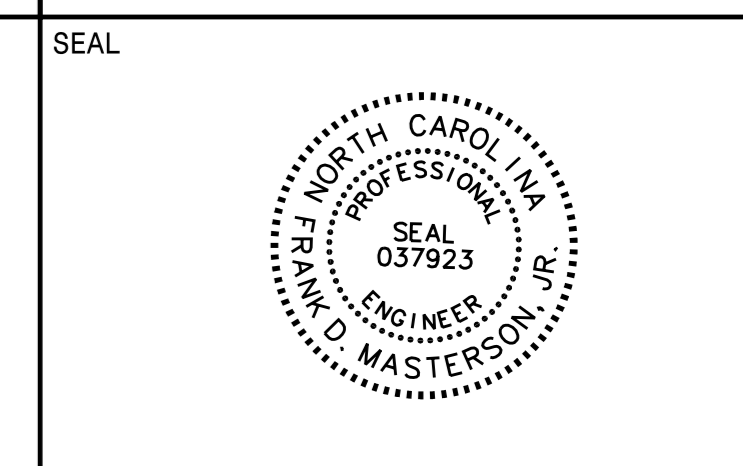
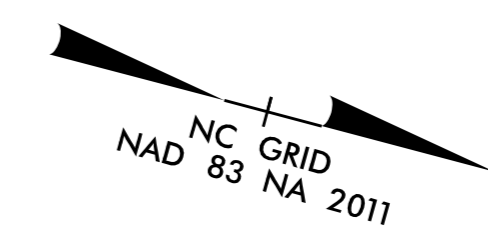

**DOCUMENT NOT CONSIDERED FINAL  
UNLESS ALL SIGNATURES COMPLETED**

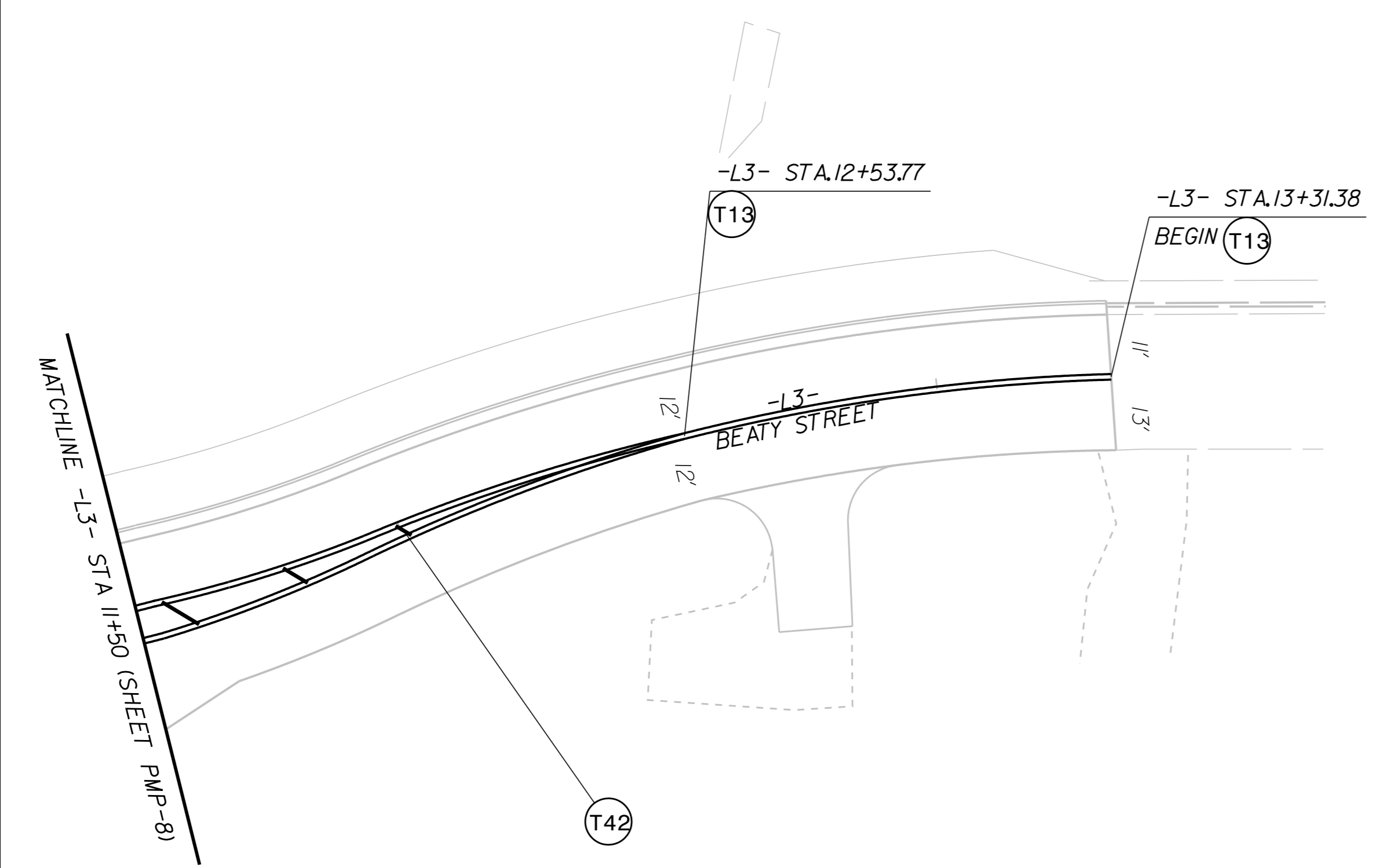

K:\CHL\_PRJ\01036360\_U-5907\_Potts-Sloan\_ExtTrafficSigning\CADD\Pavement Marking Plans\U-5907\_rdy\_pmp\_10.dgn

9/7/2023

**THERMOPLASTIC PAVEMENT MARKING LINES**

|                                    |                                 |
|------------------------------------|---------------------------------|
| T1 - THERMOPLASTIC (4", 90 MILS)   | WHITE EDGELINE                  |
| T2 - THERMOPLASTIC (4", 90 MILS)   | WHITE SOLID LANE LINE           |
| T4 - THERMOPLASTIC (4", 90 MILS)   | 3 FT. - 9 FT./SP WHITE MINISKIP |
| T10 - THERMOPLASTIC (4", 90 MIL)   | YELLOW EDGELINE                 |
| T13 - THERMOPLASTIC (4", 90 MILS)  | YELLOW DOUBLE CENTER LINE       |
| T40 - THERMOPLASTIC (8", 90 MILS)  | WHITE GORELINE                  |
| T41 - THERMOPLASTIC (8", 90 MILS)  | WHITE DIAGONAL                  |
| T42 - THERMOPLASTIC (8", 90 MILS)  | YELLOW DIAGONAL                 |
| T45 - THERMOPLASTIC (8", 90 MILS)  | 3 FT. - 3 FT./SP WHITE MINISKIP |
| T61 - THERMOPLASTIC (24", 90 MILS) | WHITE STOPBAR                   |
| T62 - THERMOPLASTIC (24" 90 MILS)  | WHITE CROSSWALK LINE            |

**THERMOPLASTIC PAVEMENT MARKING SYMBOLS**

|                                |  |
|--------------------------------|--|
| T70 - THERMOPLASTIC (90 MILS)  | LEFT TURN ARROW                        |
| T72 - THERMOPLASTIC (90 MILS)  | STRAIGHT ARROW                         |
| T73 - THERMOPLASTIC (90 MILS)  | COMBO. LEFT/STRAIGHT ARROW             |
| T90 - THERMOPLASTIC (90 MILS)  | BICYCLE SYMBOL                         |
| T91 - THERMOPLASTIC (90 MILS)  | BICYCLE STRAIGHT ARROW                 |
| T100 - THERMOPLASTIC (90 MILS) | ALPHANUMERIC CHAR.                     |
| T103 - THERMOPLASTIC (90 MILS) | 24" YIELD LINE TRIANGLE                |
| T112 - THERMOPLASTIC (90 MILS) | FISH-HOOK RIGHT/STRAIGHT ARROW         |
| T114 - THERMOPLASTIC (90 MILS) | FISH-HOOK LEFT/RIGHT/STRAIGHT ARROW    |
| T116 - THERMOPLASTIC (90 MILS) | FISH-HOOK W/CIRCLE LEFT ARROW          |
| T117 - THERMOPLASTIC (90 MILS) | FISH-HOOK W/CIRCLE LEFT/STRAIGHT ARROW |

K:\CHL\_PRJ\01036360\_U-5907\_Potts-Sloan\_ExtTrafficSigning\CADD\Pavement Marking Plans\U-5907\_rdy\_pmp\_11dgn

9/7/2023

# Kimley»Horn

200 S. TRYON ST. • CHARLOTTE, NC 28202

|                       |           |
|-----------------------|-----------|
| PROJECT REFERENCE NO. | SHEET NO. |
| U-5907                | PMP-10    |

APPROVED:    
DESIGNED BY: Frank Masterson  
60F82B06CFF1412  
 DATE: 10/25/2023

SEAL



**DOCUMENT NOT CONSIDERED FINAL  
UNLESS ALL SIGNATURES COMPLETED**

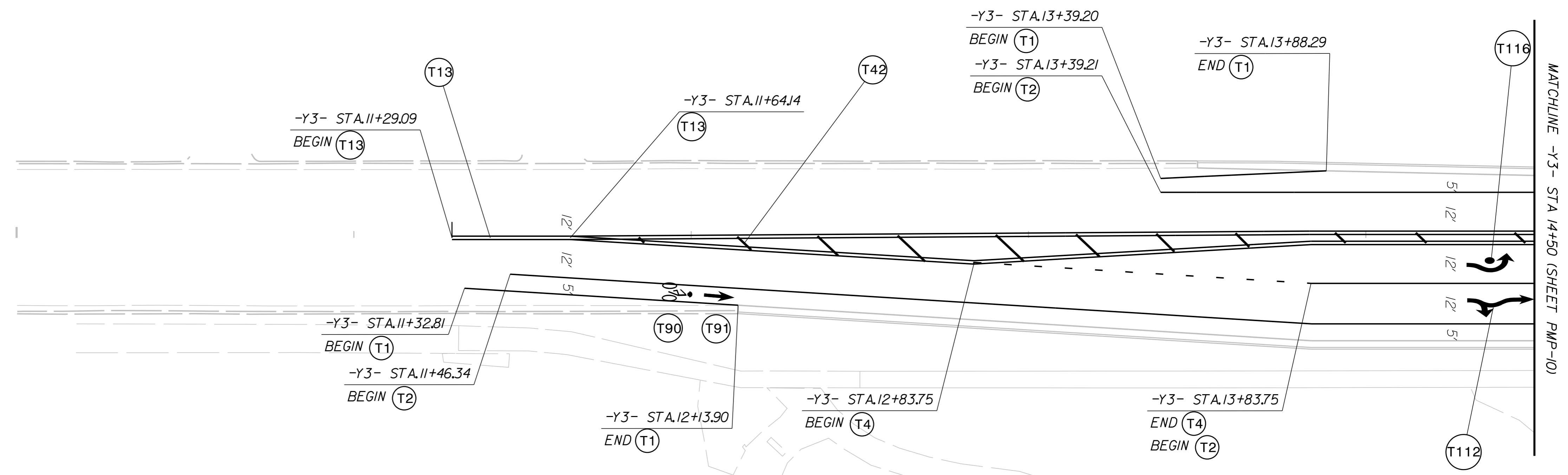
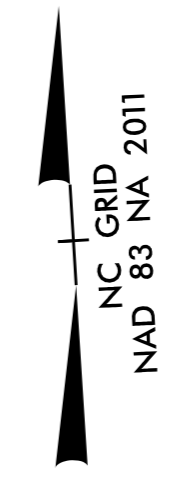

| THERMOPLASTIC PAVEMENT MARKING LINES |                                 |
|--------------------------------------|---------------------------------|
| T1 - THERMOPLASTIC (4", 90 MILS)     | WHITE EDGELINE                  |
| T2 - THERMOPLASTIC (4", 90 MILS)     | WHITE SOLID LANE LINE           |
| T4 - THERMOPLASTIC (4", 90 MILS)     | 3 FT. - 9 FT./SP WHITE MINISKIP |
| T10 - THERMOPLASTIC (4", 90 MIL)     | YELLOW EDGELINE                 |
| T13 - THERMOPLASTIC (4", 90 MILS)    | YELLOW DOUBLE CENTER LINE       |
| T40 - THERMOPLASTIC (8", 90 MILS)    | WHITE GORELINE                  |
| T41 - THERMOPLASTIC (8", 90 MILS)    | WHITE DIAGONAL                  |
| T42 - THERMOPLASTIC (8", 90 MILS)    | YELLOW DIAGONAL                 |
| T45 - THERMOPLASTIC (8", 90 MILS)    | 3 FT. - 3 FT./SP WHITE MINISKIP |
| T61 - THERMOPLASTIC (24", 90 MILS)   | WHITE STOPBAR                   |
| T62 - THERMOPLASTIC (24" 90 MILS)    | WHITE CROSSWALK LINE            |

  

| THERMOPLASTIC PAVEMENT MARKING SYMBOLS |  |
|--|--|
| T70 - THERMOPLASTIC (90 MILS)          | LEFT TURN ARROW                        |
| T72 - THERMOPLASTIC (90 MILS)          | STRAIGHT ARROW                         |
| T73 - THERMOPLASTIC (90 MILS)          | COMBO. LEFT/STRAIGHT ARROW             |
| T90 - THERMOPLASTIC (90 MILS)          | BICYCLE SYMBOL                         |
| T91 - THERMOPLASTIC (90 MILS)          | BICYCLE STRAIGHT ARROW                 |
| T100 - THERMOPLASTIC (90 MILS)         | ALPHANUMERIC CHAR.                     |
| T103 - THERMOPLASTIC (90 MILS)         | 24" YIELD LINE TRIANGLE                |
| T112 - THERMOPLASTIC (90 MILS)         | FISH-HOOK RIGHT/STRAIGHT ARROW         |
| T114 - THERMOPLASTIC (90 MILS)         | FISH-HOOK LEFT/RIGHT/STRAIGHT ARROW    |
| T116 - THERMOPLASTIC (90 MILS)         | FISH-HOOK W/CIRCLE LEFT ARROW          |
| T117 - THERMOPLASTIC (90 MILS)         | FISH-HOOK W/CIRCLE LEFT/STRAIGHT ARROW |



K:\CHL\_PRJ\01036360\_U-5907\_Potts-Sloan\_ExtTrafficSigning\CADD\Pavement Marking Plans\U-5907\_rdy\_pmp\_12.dgn

9/7/2023

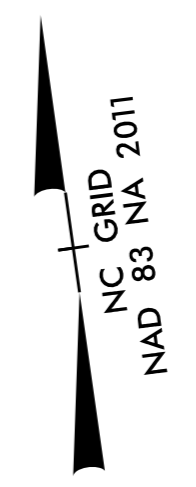

|  |                                 |                       |
|--|---------------------------------|-----------------------|
| <b>Kimley»Horn</b><br>©2019<br>200 S. TRYON ST. • CHARLOTTE, NC 28202    | PROJECT REFERENCE NO.<br>U-5907 | SHEET NO.<br>PMP - 11 |
| APPROVED:<br>DocuSigned by:<br>Frank Masterson<br>09F82B0CFF1412         |                                 | DATE: 10/25/2023      |
|  |                                 |                       |
| <b>DOCUMENT NOT CONSIDERED FINAL<br/>UNLESS ALL SIGNATURES COMPLETED</b> |                                 |                       |

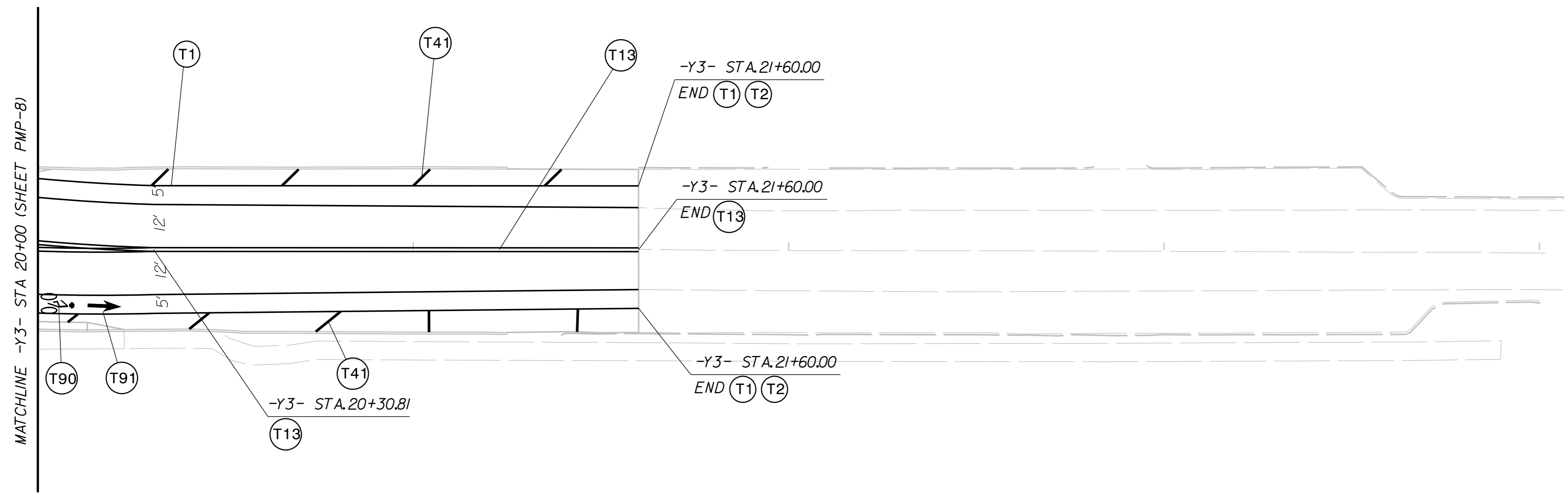

| <b>THERMOPLASTIC PAVEMENT MARKING LINES</b> |                                 |
|---|---------------------------------|
| T1 - THERMOPLASTIC (4", 90 MILS)            | WHITE EDGELINE                  |
| T2 - THERMOPLASTIC (4", 90 MILS)            | WHITE SOLID LANE LINE           |
| T4 - THERMOPLASTIC (4", 90 MILS)            | 3 FT. - 9 FT./SP WHITE MINISKIP |
| T10 - THERMOPLASTIC (4", 90 MIL)            | YELLOW EDGELINE                 |
| T13 - THERMOPLASTIC (4", 90 MILS)           | YELLOW DOUBLE CENTER LINE       |
| T40 - THERMOPLASTIC (8", 90 MILS)           | WHITE GORELINE                  |
| T41 - THERMOPLASTIC (8", 90 MILS)           | WHITE DIAGONAL                  |
| T42 - THERMOPLASTIC (8", 90 MILS)           | YELLOW DIAGONAL                 |
| T45 - THERMOPLASTIC (8", 90 MILS)           | 3 FT. - 3 FT./SP WHITE MINISKIP |
| T61 - THERMOPLASTIC (24", 90 MILS)          | WHITE STOPBAR                   |
| T62 - THERMOPLASTIC (24" 90 MILS)           | WHITE CROSSWALK LINE            |

| <b>THERMOPLASTIC PAVEMENT MARKING SYMBOLS</b> |  |
|---|--|
| T70 - THERMOPLASTIC (90 MILS)                 | LEFT TURN ARROW                        |
| T72 - THERMOPLASTIC (90 MILS)                 | STRAIGHT ARROW                         |
| T73 - THERMOPLASTIC (90 MILS)                 | COMBO. LEFT/STRAIGHT ARROW             |
| T90 - THERMOPLASTIC (90 MILS)                 | BICYCLE SYMBOL                         |
| T91 - THERMOPLASTIC (90 MILS)                 | BICYCLE STRAIGHT ARROW                 |
| T100 - THERMOPLASTIC (90 MILS)                | ALPHANUMERIC CHAR.                     |
| T103 - THERMOPLASTIC (90 MILS)                | 24" YIELD LINE TRIANGLE                |
| T112 - THERMOPLASTIC (90 MILS)                | FISH-HOOK RIGHT/STRAIGHT ARROW         |
| T114 - THERMOPLASTIC (90 MILS)                | FISH-HOOK LEFT/RIGHT/STRAIGHT ARROW    |
| T116 - THERMOPLASTIC (90 MILS)                | FISH-HOOK W/CIRCLE LEFT ARROW          |
| T117 - THERMOPLASTIC (90 MILS)                | FISH-HOOK W/CIRCLE LEFT/STRAIGHT ARROW |