

18 CHANNEL IP CONFLICT MONITOR PROGRAMMING DETAIL

(remove jumpers and set switches as shown)

REMOVE DIODE JUMPERS 1-5, 1-6, 1-7, 1-8, 1-10, 1-11, 1-12, 2-5, 2-6, 2-7, 2-8, 2-9, 2-10, 2-11, 2-12, 3-7, 3-8, 3-9, 3-12, 4-10, 4-11, 5-7, 5-8, 5-9, 5-11, 5-12, 6-9, 6-10, 6-11, 6-12, 7-8, 7-9, 7-11, 7-12, 8-9, 8-11, 8-12, 9-10, 9-11, 9-12, 10-11, 10-12 AND 11-12.

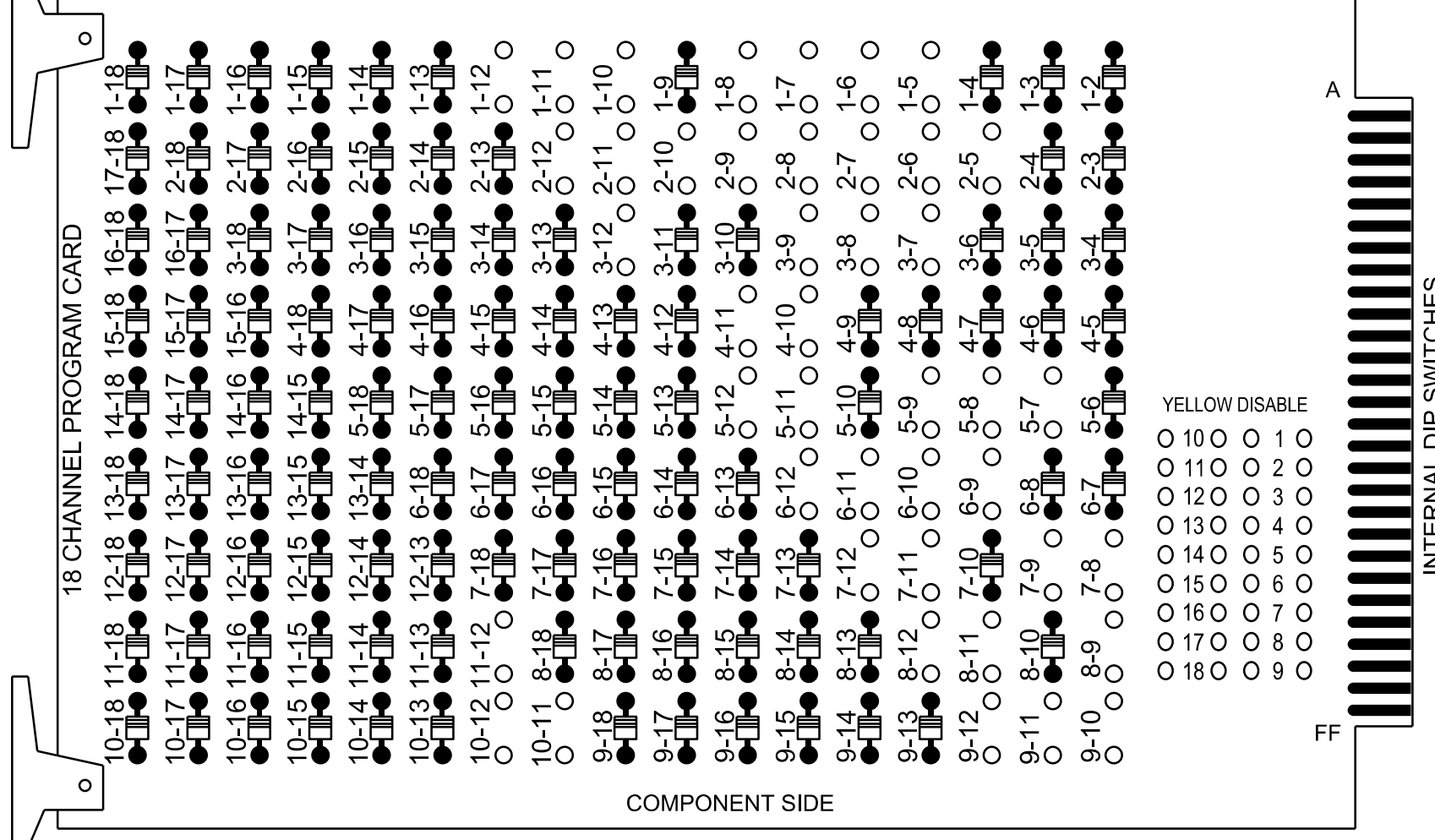

REMOVE JUMPERS AS SHOWN

NOTES:

- Card is provided with all diode jumpers in place. Removal of any jumper allows its channels to run concurrently.
- Ensure jumpers SEL2-SEL5 and SEL9 are present on the monitor board.
- Ensure that the Red Enable is active at all times during normal operation.
- Integrate monitor with Ethernet network in cabinet.

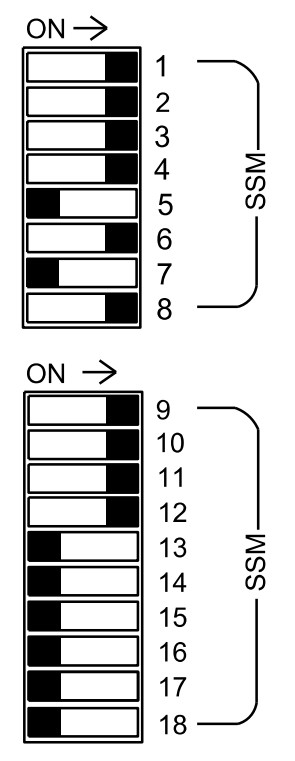
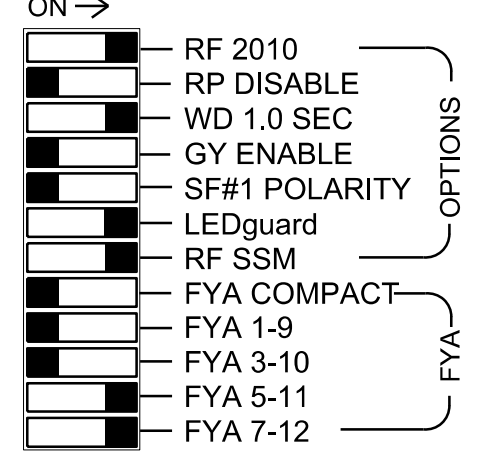
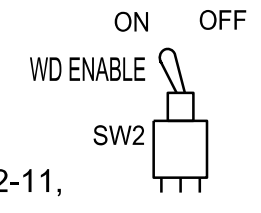

■ = DENOTES POSITION OF SWITCH

NOTES

- To prevent "flash-conflict" problems, insert red flash program blocks for all unused vehicle load switches in the output file. The installer shall verify that signal heads flash in accordance with the signal plan.
- Program controller to start up in phase 2 Green No Walk and 6 Green No Walk.
- If this signal will be managed by an ATMS software, enable controller and detector logging for all detectors used at this location.
- The cabinet and controller are part of the D14-12 Waynesville Signal System.

EQUIPMENT INFORMATION

Controller.....2070LX
 Cabinet.....332 w/ Aux
 Software.....Q-Free MAXTIME
 Cabinet Mount.....Base
 Output File Positions.....18 With Aux. Output File
 Load Switches Used.....S1, S2, S4, S5, S7, S8, S10, S11, AUX S1, AUX S2, AUX S4, AUX S5
 Phases Used.....1, 2, 3, 4, 5, 6
 Overlap "1".....*
 Overlap "2".....*
 Overlap "3".....*
 Overlap "4".....*
 Overlap "7".....*
 Overlap "8".....*

*See overlap programming detail on sheet 2

SIGNAL HEAD HOOK-UP CHART

LOAD SWITCH NO.	S1	S2	S3	S4	S5	S6	S7	S8	S9	S10	S11	S12	AUX S1	AUX S2	AUX S3	AUX S4	AUX S5	AUX S6	
CMU CHANNEL NO.	1	2	13	3	4	14	5	6	15	7	8	16	9	10	17	11	12	18	
PHASE	1	2	2 PED	3	4	4 PED	5	6	6 PED	OL7	OL8	8 PED	OL1	OL2	SPARE	OL3	OL4	SPARE	
SIGNAL HEAD NO.	11	21,22	NU	31	41,42,43,44,45	NU	51	61,62	NU	52	32,33	NU	23,24	63,64	NU	51	52	NU	
RED		128			101			134			107		A121	A124					
YELLOW		129			102		*	135		*			A122	A125					
GREEN		130			103			136					A123	A126					
RED ARROW	125			116														A114	A101
YELLOW ARROW	126			117							108							A115	A102
FLASHING YELLOW ARROW																		A116	A103
GREEN ARROW	127			118			133			124	109								

NU = Not Used
 * Denotes install load resistor. See load resistor installation detail this sheet.
 * See pictorial of head wiring in detail this sheet.

INPUT FILE POSITION LAYOUT

(front view)

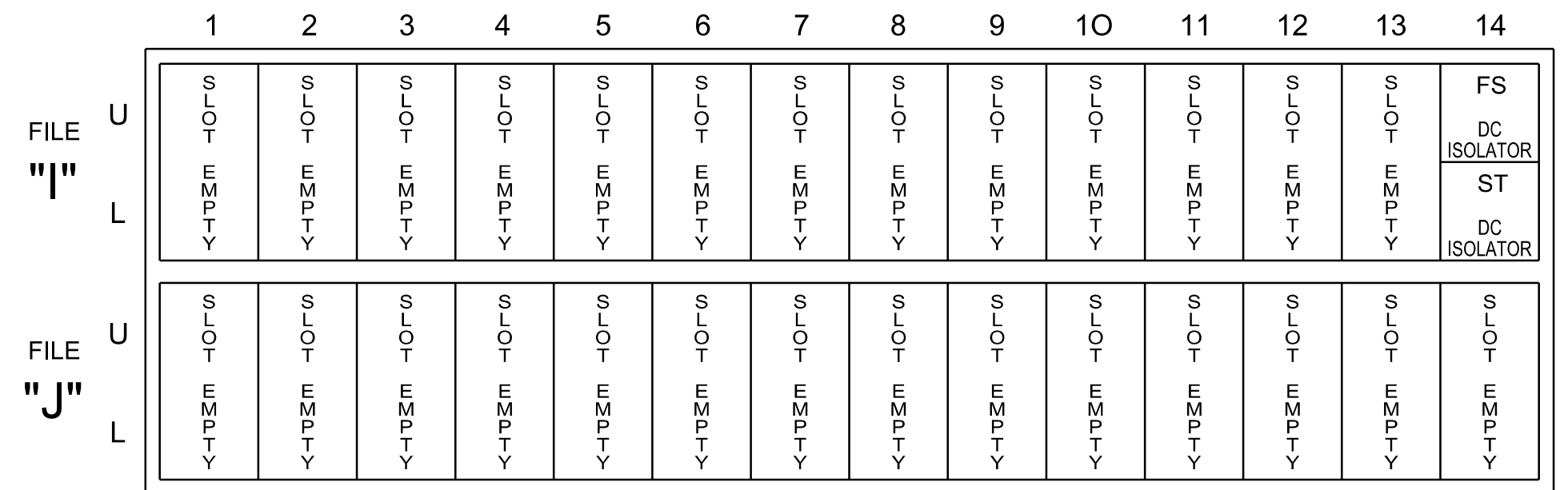

EX.: 1A, 2A, ETC. = LOOP NO.'S

FS = FLASH SENSE
 ST = STOP TIME

SPECIAL DETECTOR NOTE

Install a multizone microwave detection system for vehicle detection. Perform installation according to manufacturer's directions and NCDOT engineer-approved mounting locations to accomplish the detection schemes shown on the Signal Design Plans.

FYA SIGNAL WIRING DETAIL

(wire signal heads as shown)

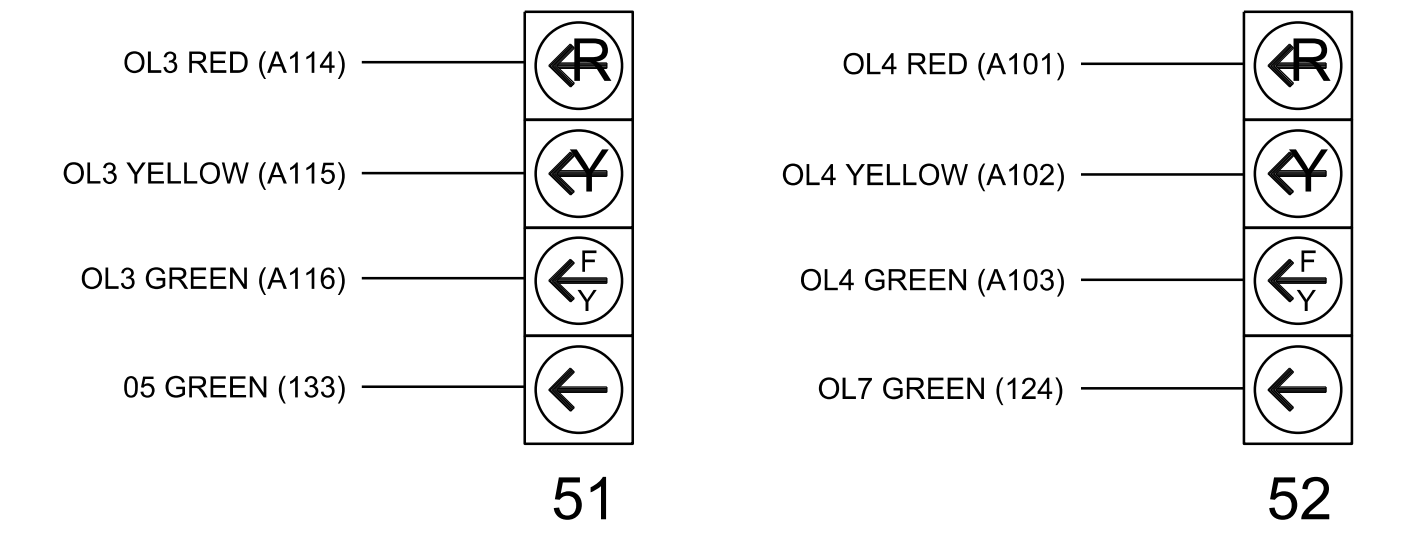

LOAD RESISTOR INSTALLATION DETAIL

(install resistors as shown)

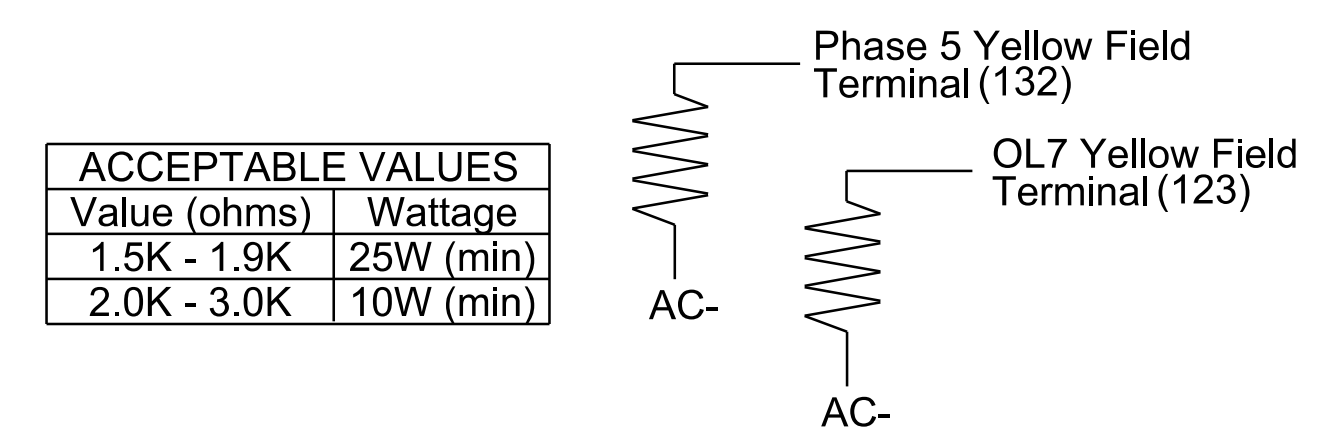

ACCEPTABLE VALUES	
Value (ohms)	Wattage
1.5K - 1.9K	25W (min)
2.0K - 3.0K	10W (min)

Electrical Detail - Sheet 1 of 2
 Temporary Design 2 - (TMP Phase I, Step 2)

Infrastructure Consulting Services, Inc.
RKA
 RAMEY KEMP ASSOCIATES
8210 University Executive Park Drive Suite 220 Charlotte, North Carolina 28223
 Phone: 704-548-4200 | www.rameykemp.com | NC License No. F-1489

US 276 (Russ Avenue)
 at
 US 23-74 WB Ramps

Division 14 Haywood County Waynesville

PLAN DATE: April 2023 REVIEWED BY: WJ Hamilton
 PREPARED BY: TS Popelka RKA PROJ. NO: 16085 (040)

SEAL
 NORTH CAROLINA PROFESSIONAL ENGINEER
 SEAL 32396
 WILLIAM J. HAMILTON
 DATE: 04/11/2023
 SIGNATURE: _____
 DATE: _____
 SIG. INVENTORY NO. 14-0974T2