

DEBONDING LEGEND

- FULLY BONDED STRANDS
- STRANDS DEBONDED FOR 4'-0" FROM END OF GIRDER
- STRANDS DEBONDED FOR 8'-0" FROM END OF GIRDER
- STRANDS DEBONDED FOR 12'-0" FROM END OF GIRDER

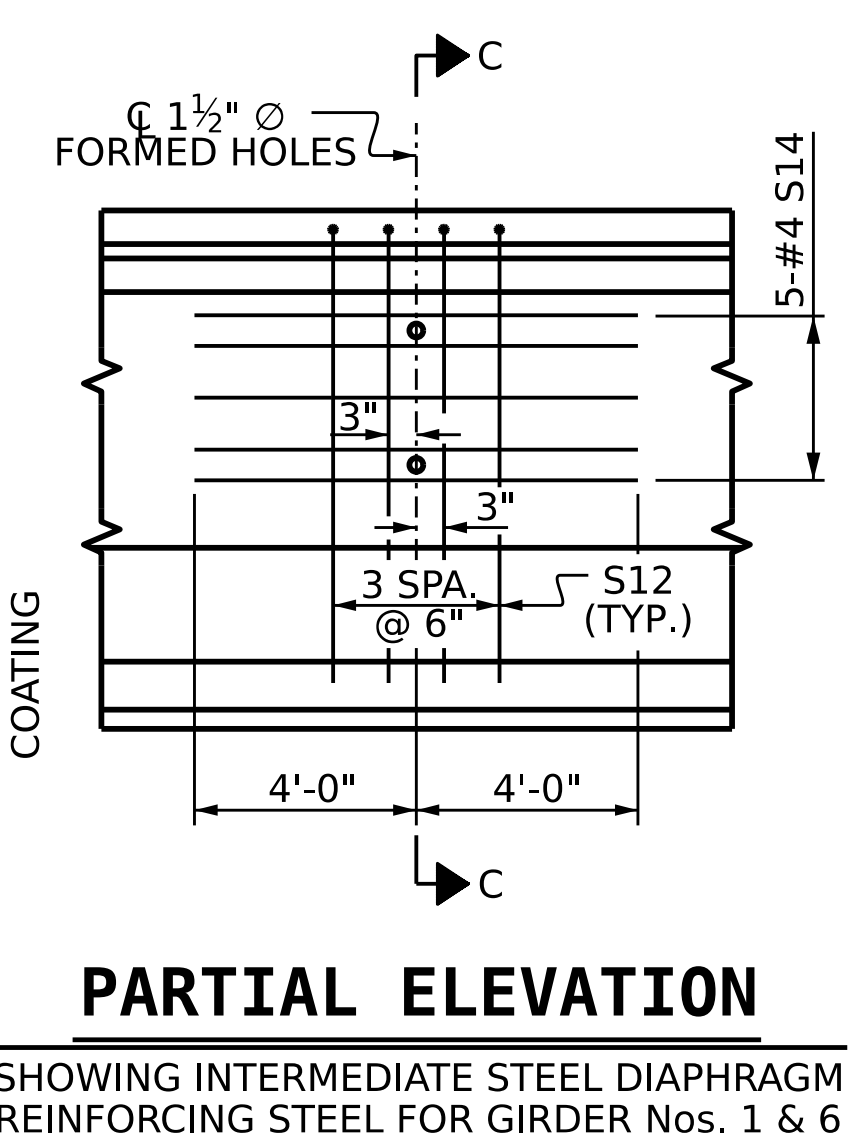
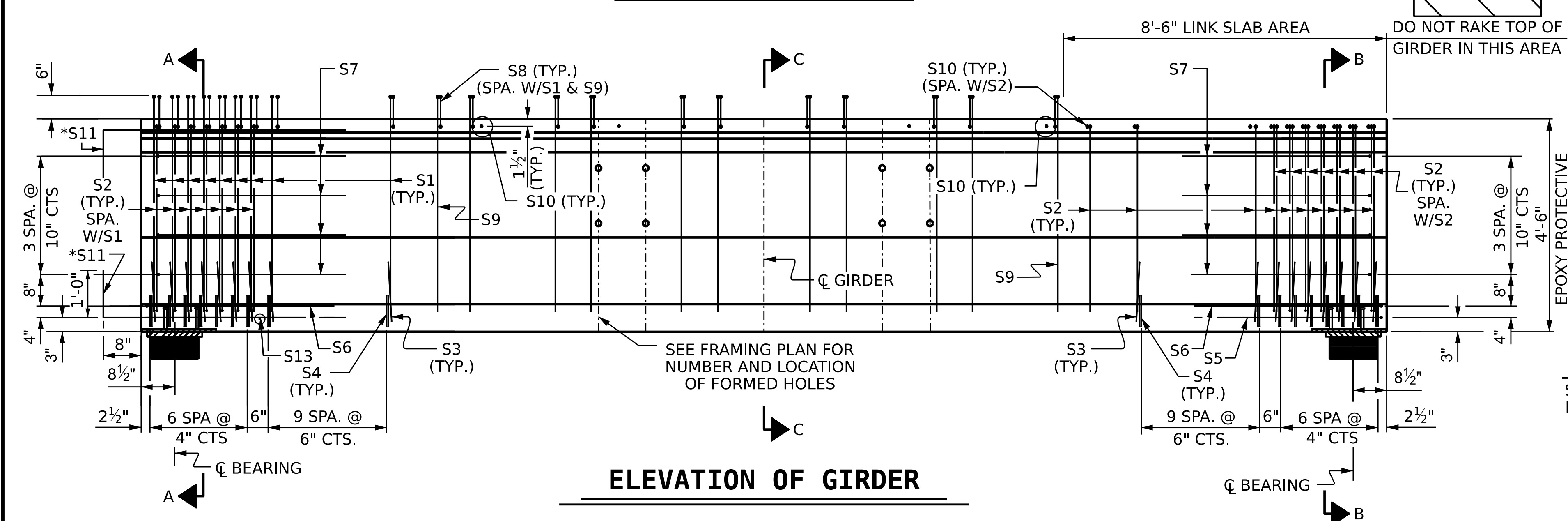
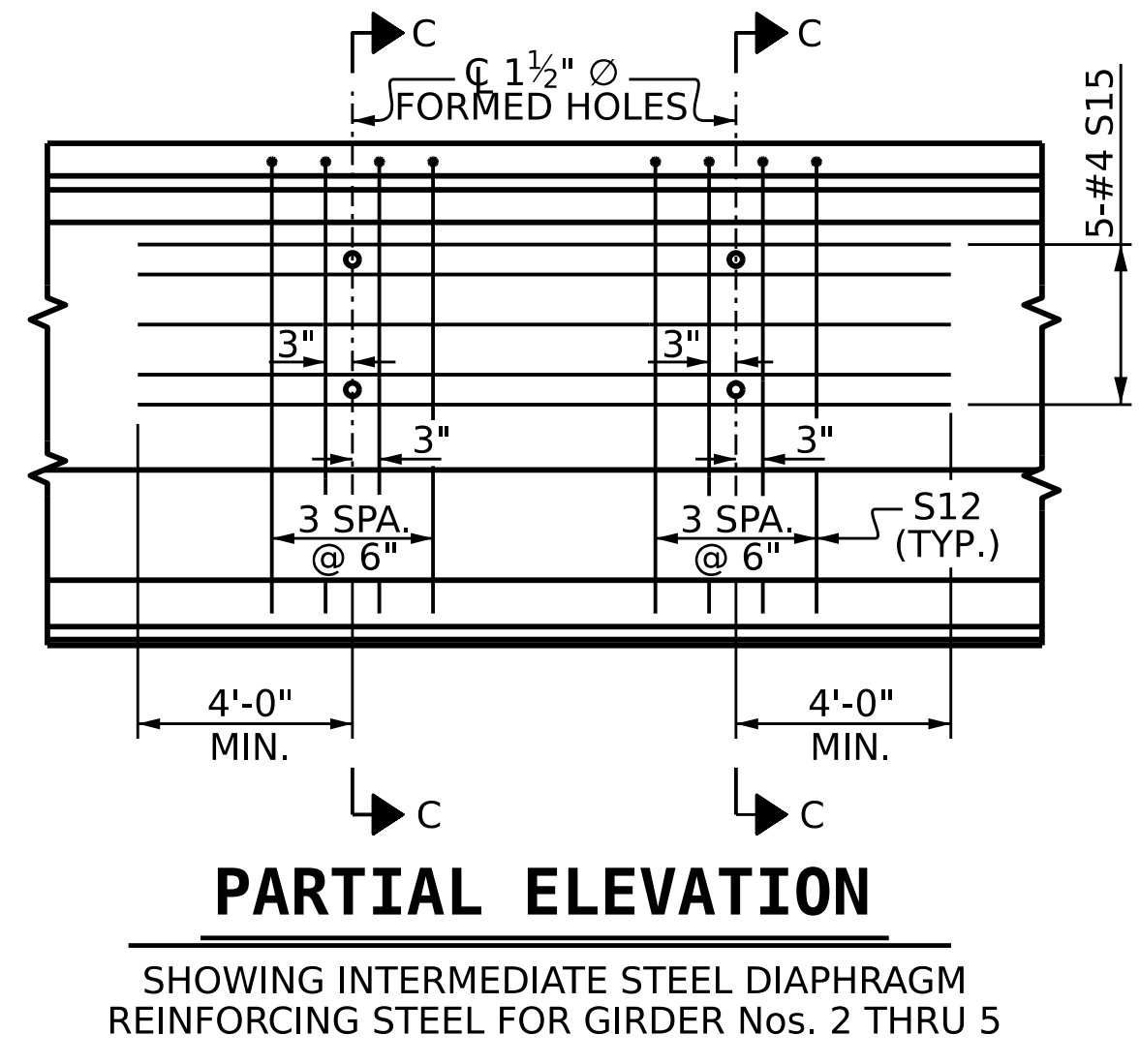
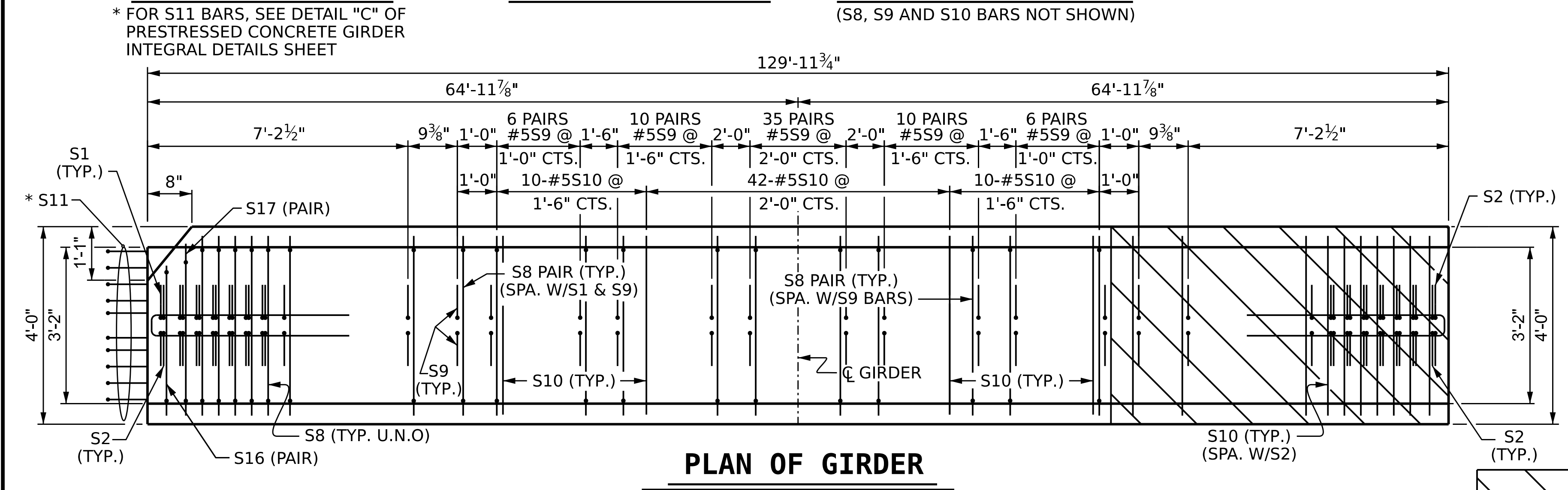
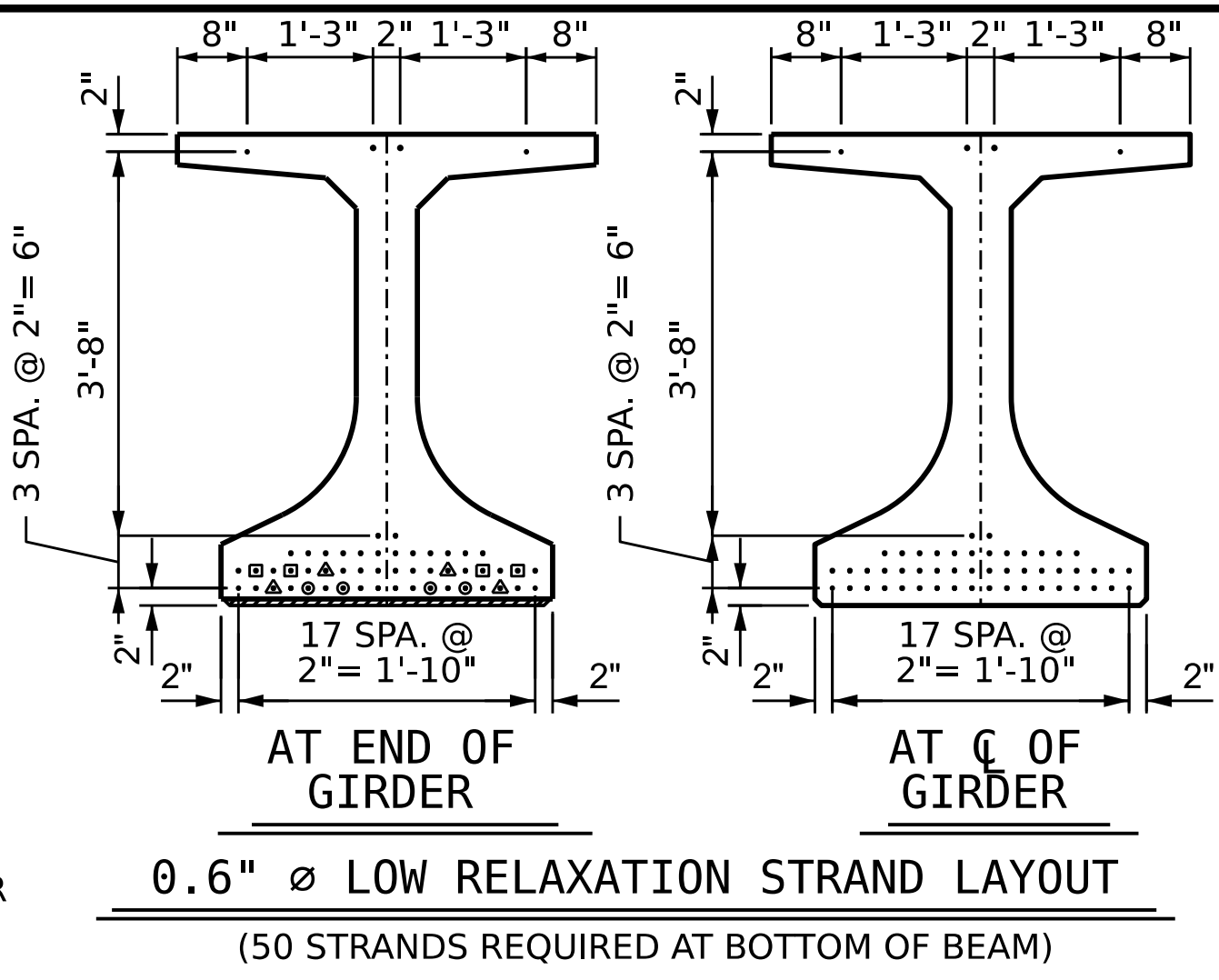

0.6" Ø L. R. GRADE 270 STRANDS		
AREA (SQ. INCHES)	ULTIMATE STRENGTH (LBS. PER STRAND)	APPLIED PRESTRESS (LBS. PER STRAND)
0.217	58,600	43,950

REINFORCING STEEL FOR ONE GDR						
BAR	NUMBER	SIZE	TYPE	LENGTH	WEIGHT	
S1	34	#5	5	5'-4"	189	
S2	64	#5	4	5'-4"	356	
S3	34	#3	2	3'-4"	43	
S4	68	#3	1	4'-3"	109	
S5	1	#5	3	10'-9"	11	
S6	2	#5	3	9'-9"	20	
S7	8	#4	3	8'-5"	45	
S8	166	#5	7	4'-8"	809	
S9	136	#5	5	5'-4"	756	
S10	80	#5	STR	3'-8"	306	
*S11	20	#6	5	5'-8"	170	
EXTERIOR GDR.	S12	8	#5	6	8'-6"	71
INTERIOR GDR.	S12	16	#5	6	8'-6"	142
	S13	1	#4	STR	2'-10"	2
EXTERIOR GDR.	S14	10	#4	STR	8'-0"	53
INTERIOR GDR.	S15	10	#4	STR	12'-1"	81
	S16	2	#5	7	4'-2"	9
	S17	2	#5	7	4'-5"	9

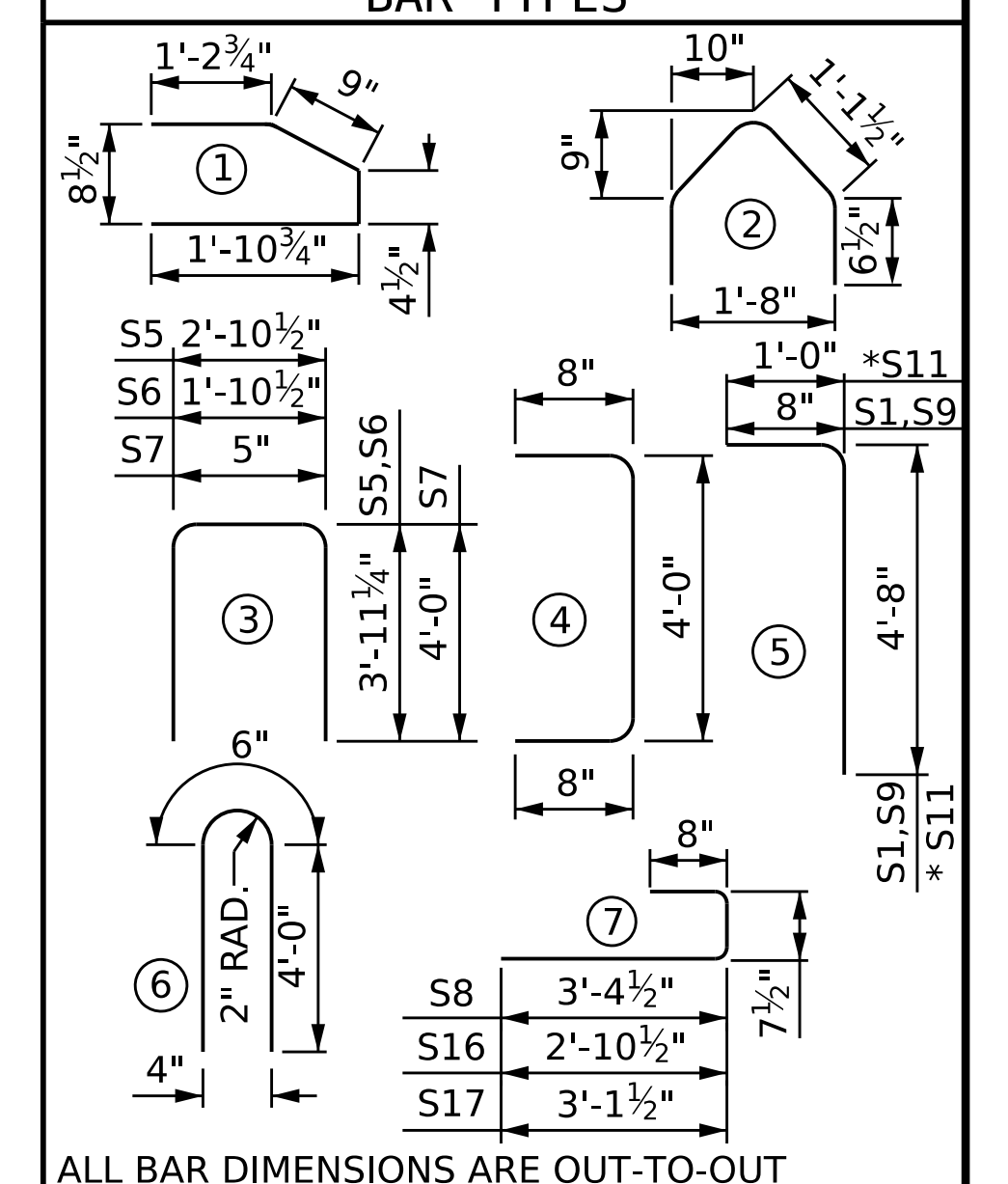

QUANTITIES FOR ONE GIRDER		
REINFORCING STEEL	8,000 PSI CONCRETE	0.6" Ø L.R. STRANDS
LB.	C.Y.	No.
EXTERIOR GDR. 2,958	31.2	54
INTERIOR GDR. 3,057	31.2	54

GIRDERS REQUIRED		
NUMBER	LENGTH	TOTAL LENGTH
6	129'-11 3/4"	779'-10 1/2"

PROJECT NO. **B-3186 / B-5898**
HAYWOOD COUNTY
 STATION: **24+42.26 -L_RT-**
 SHEET 1 OF 4

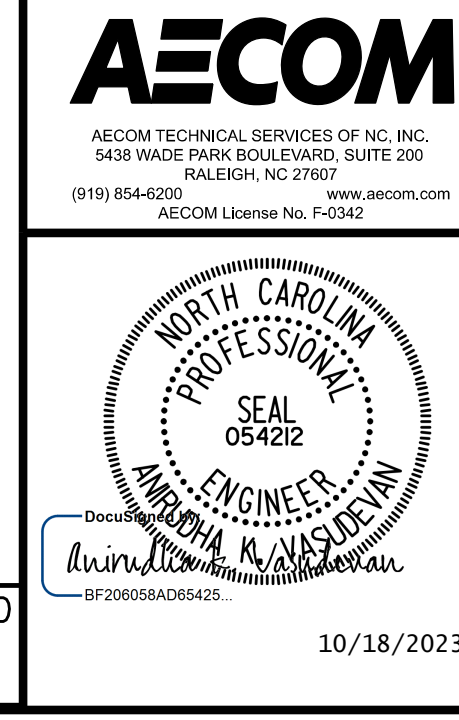

STATE OF NORTH CAROLINA DEPARTMENT OF TRANSPORTATION RALEIGH					
54" FLORIDA I-BEAM (FIB)					
PRESTRESSED CONCRETE GIRDER					
SPAN A					
REVISIONS					SHEET NO.
NO.	BY:	DATE:	NO.	BY:	DATE:
1			3		
2			4		

10/18/2023

ASSEMBLED BY : A.R. VAN VUREN DATE : 03/2023
 CHECKED BY : J.C. MORRISON DATE : 04/2023
 DRAWN BY : BNB 09/21
 CHECKED BY : AAI 09/22

* NOTE:
 S11 BARS SHALL BE BENT BEFORE SHIPMENT. HEAT BENDING SHALL NOT BE ALLOWED.
 SEE DETAIL "C" ON SHEET 3 OF 4

DOCUMENT NOT CONSIDERED FINAL UNLESS ALL SIGNATURES COMPLETED