

10/18/2023
 R5861.Lc_Tmp31.dgn
 kbisby

RK&K
 P: (919) 878-9560
 8601 Six Forks Road, Forum 1, Suite 700
 Raleigh, North Carolina 27615-3960
 NC License No. F-0112
 Engineers | Construction Managers | Planners | Scientists
 www.rkk.com
 Responsive People | Creative Solutions

APPROVED: 
800802628912472
 DATE: 10/18/2023
 SEAL

**DOCUMENT NOT CONSIDERED FINAL
 UNLESS ALL SIGNATURES COMPLETED**

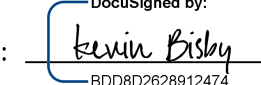
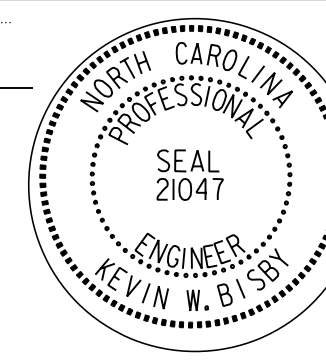
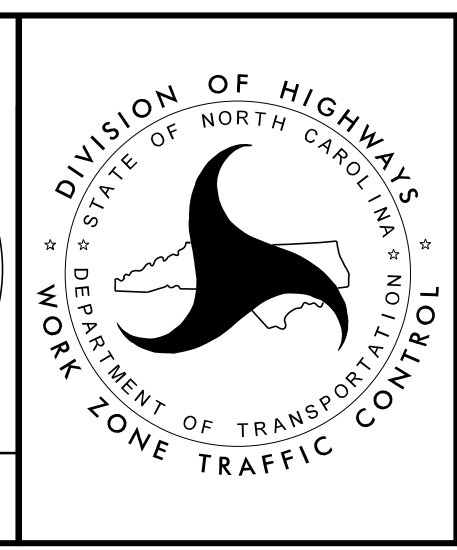

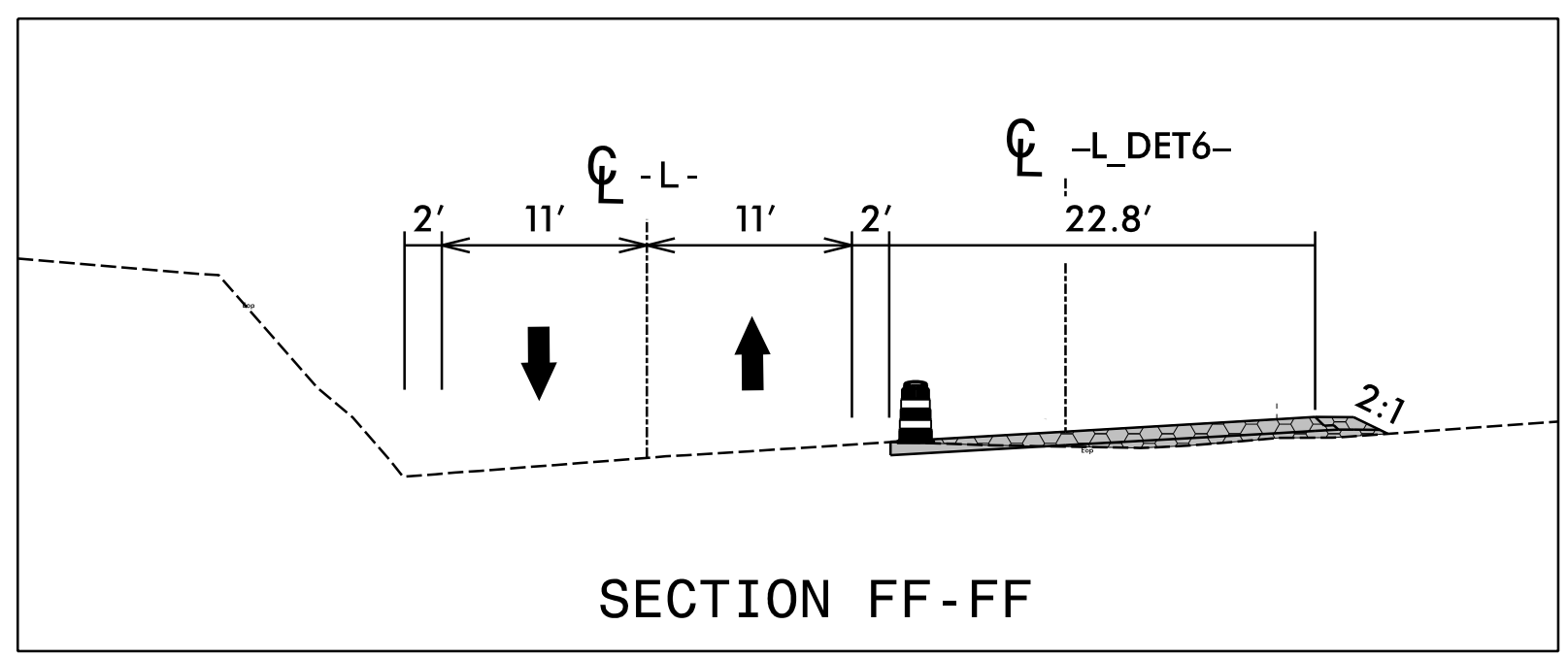
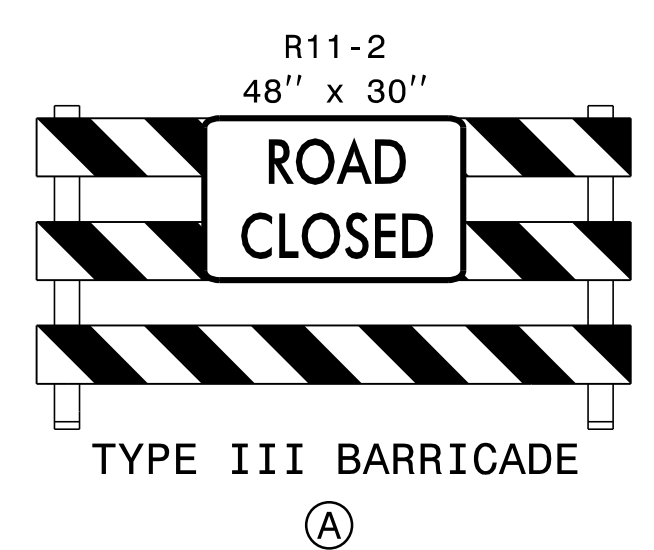
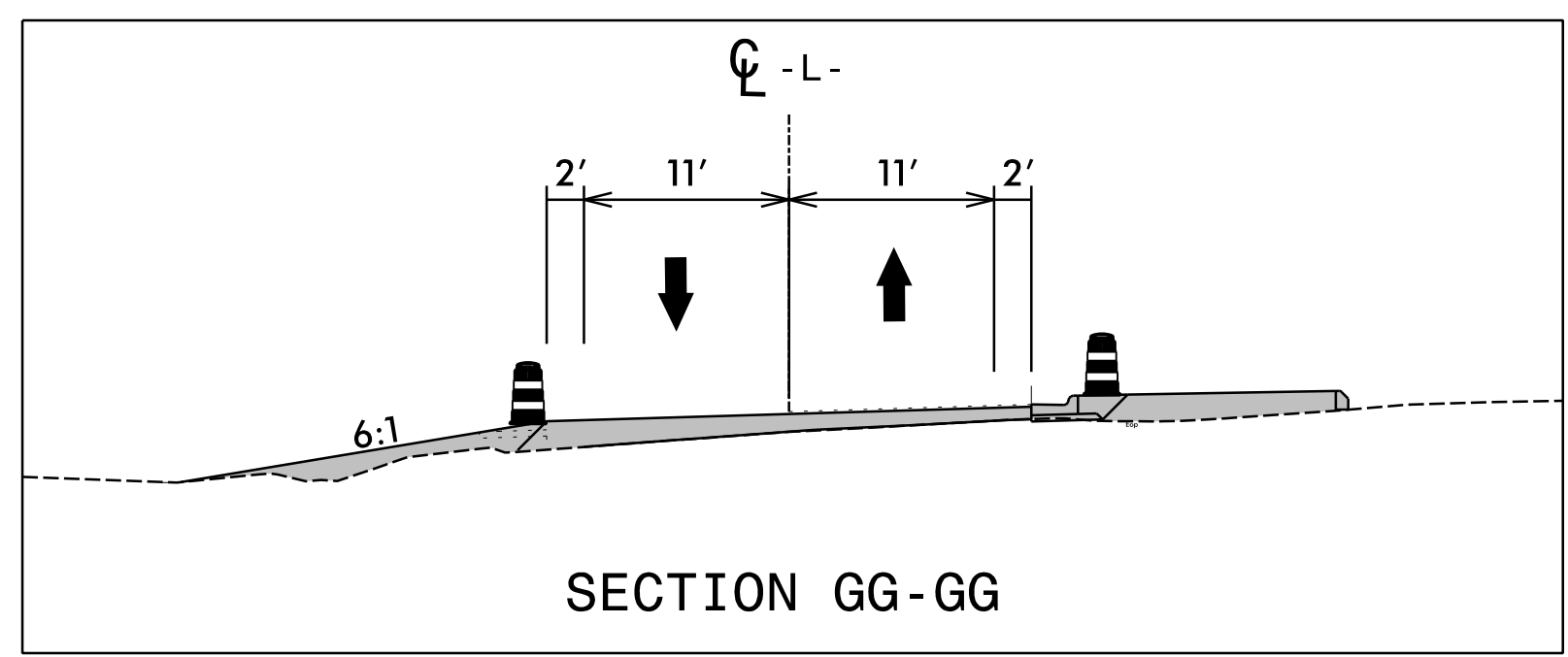
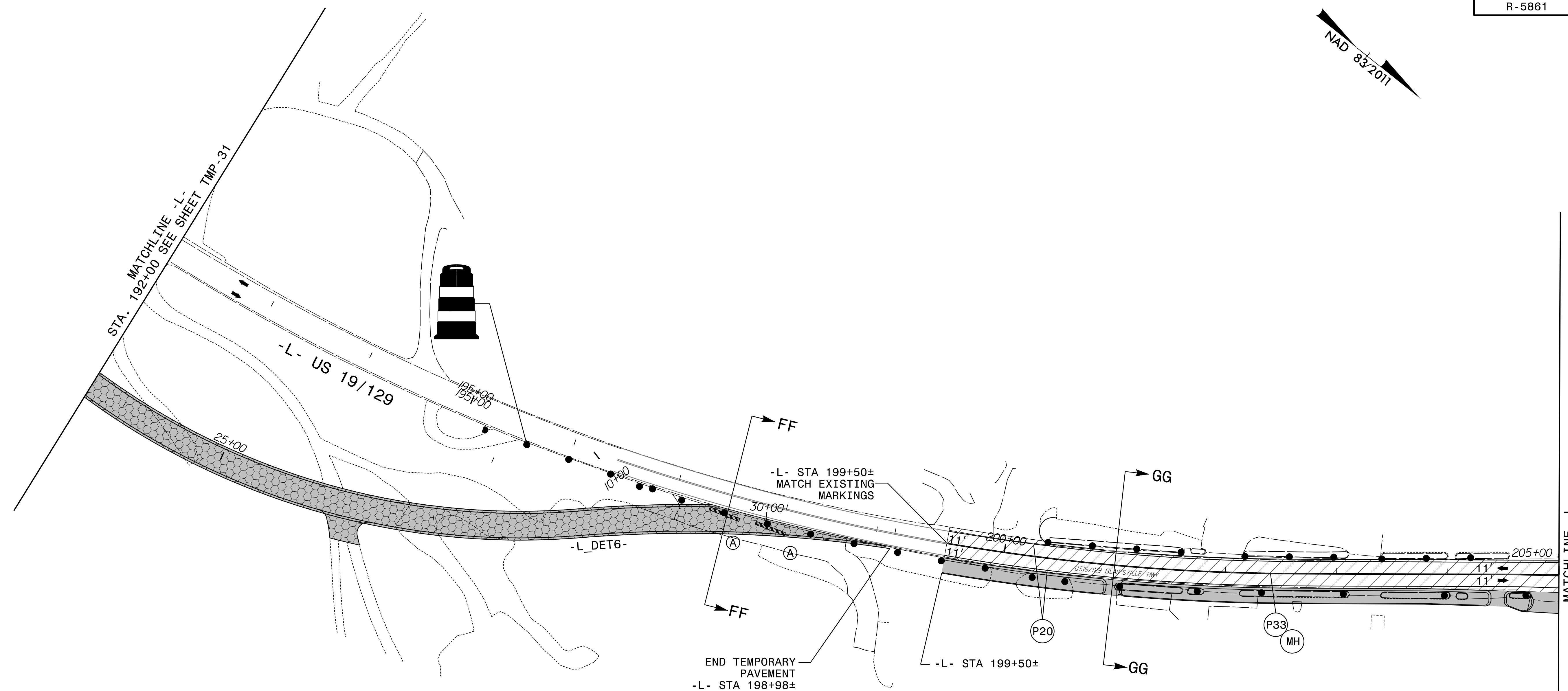
PHASE II - STEP 2



10/18/2023
R5861.Lc_Tmp32.dgn
KBlisby

RK&K
 P: (919) 878-9560
 8601 Six Forks Road, Forum 1, Suite 700
 Raleigh, North Carolina 27615-3960
 NC License No. F-0112
 Engineers | Construction Managers | Planners | Scientists
 www.rkk.com
 Responsive People | Creative Solutions

APPROVED: *Kevin Blisby*
800802628912472
 DATE: 10/18/2023
 SEAL
 NORTH CAROLINA
 PROFESSIONAL
 SEAL
 21047
 ENGINEER
 KEVIN W. BLISBY



PHASE II - STEP 2

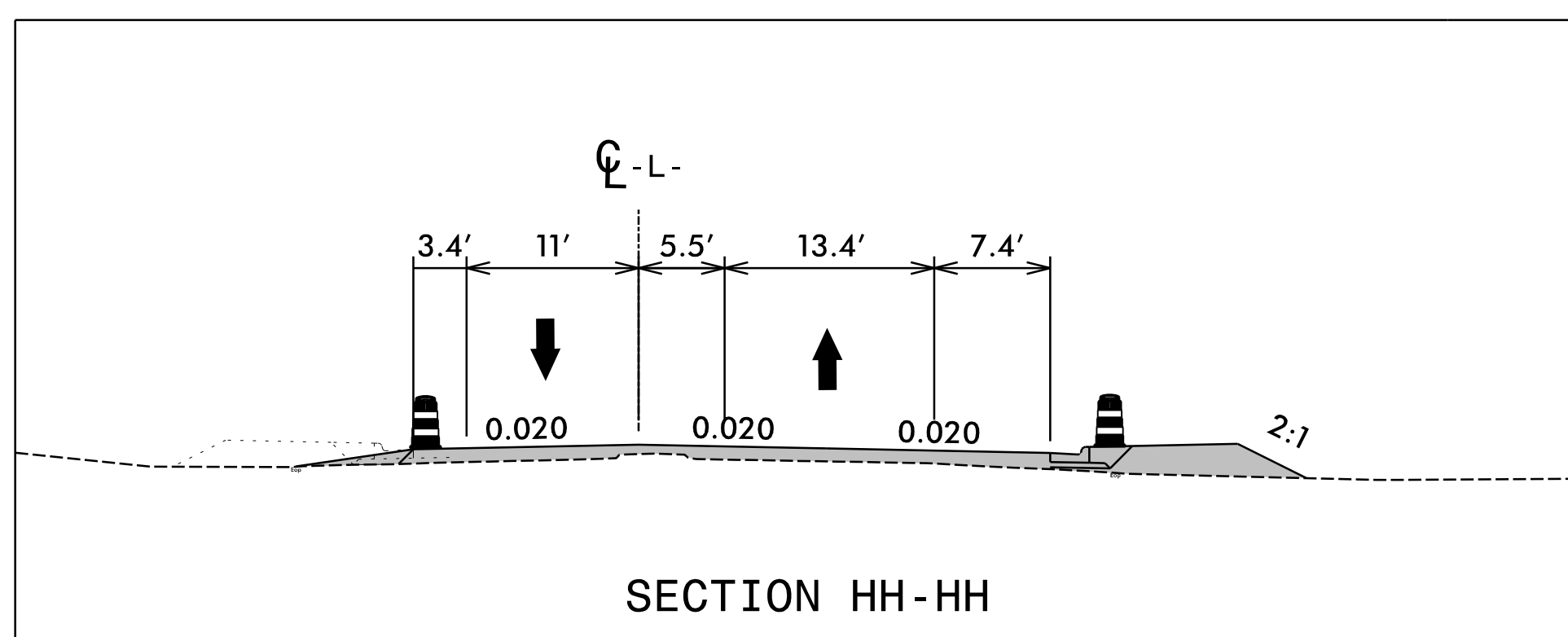
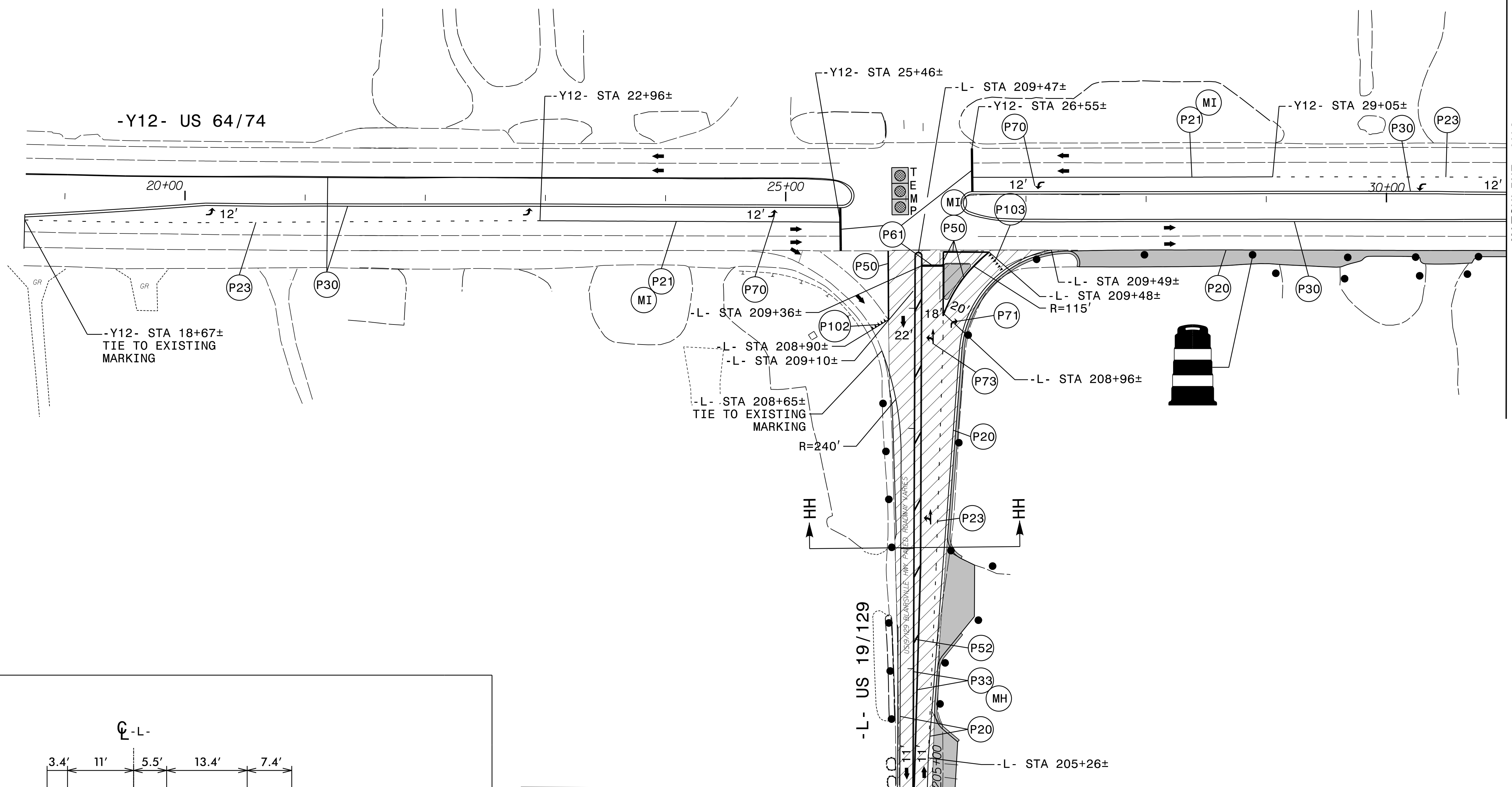
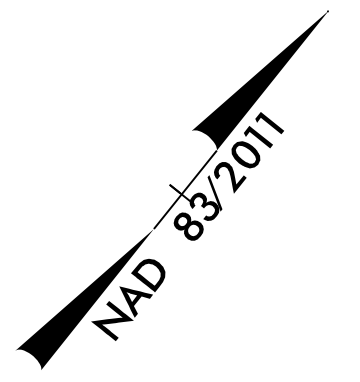

MATCHLINE -L-
STA. 205+00 SEE SHEET TMP-32

MATCHLINE -Y12-
STA. 31+00 SEE SHEET TMP-34

10/18/2023
R5861.Lc_Tmp33.dgn
Kbisby



P: (919) 878-9560
8601 Six Forks Road, Forum 1, Suite 700
Raleigh, North Carolina 27615-3960
NC License No. F-0112

Engineers | Construction Managers | Planners | Scientists
www.rkk.com
Responsive People | Creative Solutions

APPROVED: 
DATE: 10/18/2023

SEAL

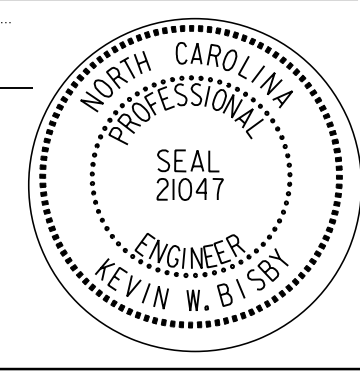

**DOCUMENT NOT CONSIDERED FINAL
UNLESS ALL SIGNATURES COMPLETED**

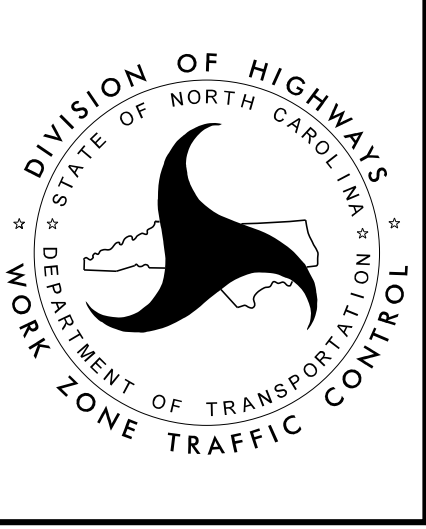

PHASE II - STEP 2

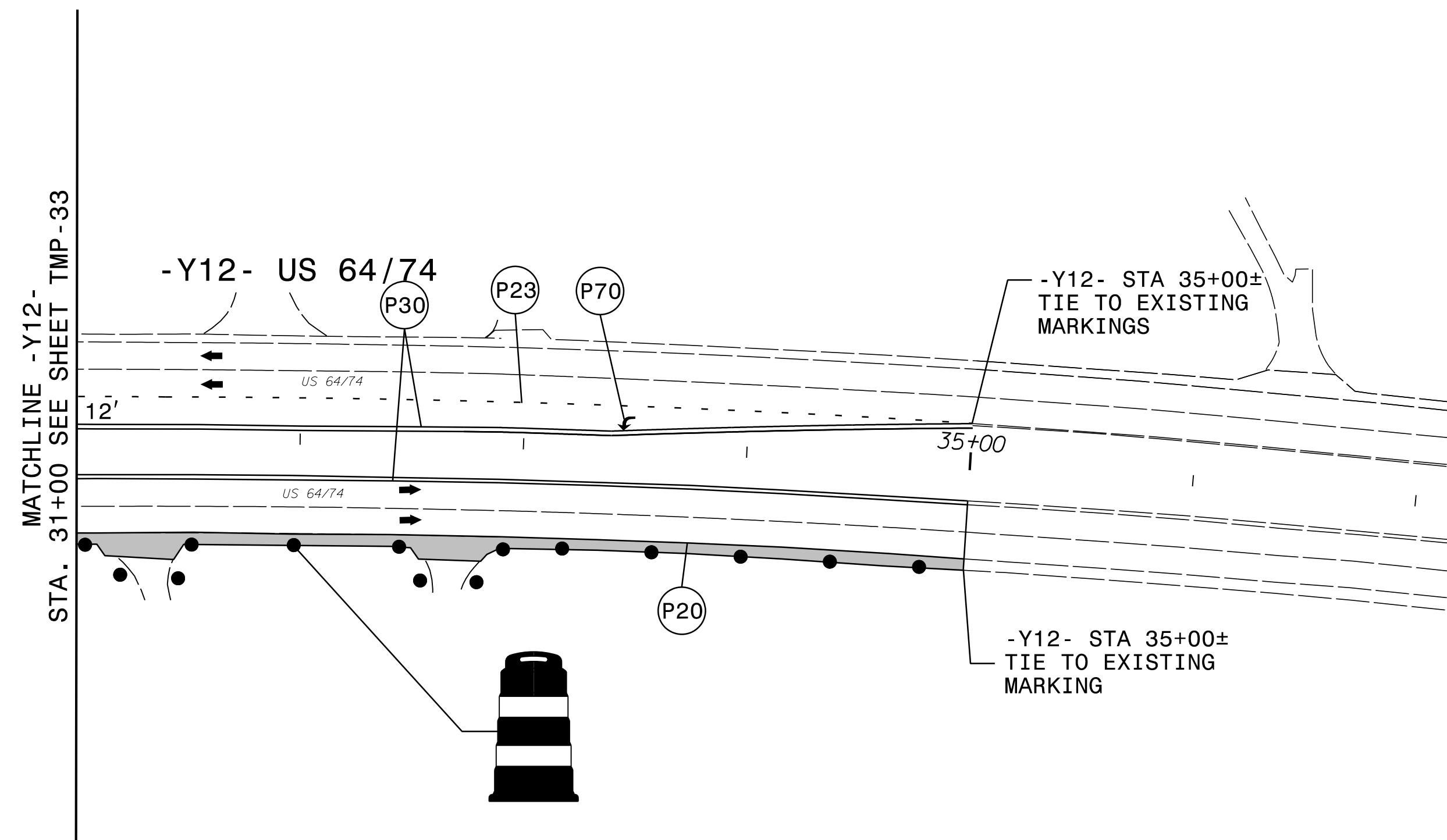
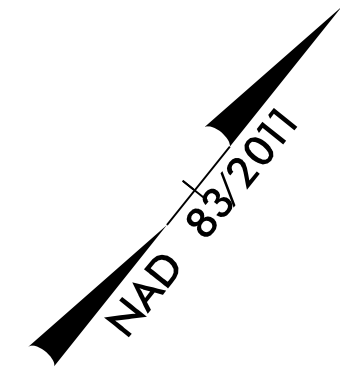

10/18/2023
 R5861.Tc_Tmp34.dgn
 kbisby

RK&K
 P: (919) 878-9560
 8601 Six Forks Road, Forum 1, Suite 700
 Raleigh, North Carolina 27615-3960
 NC License No. F-0112

Engineers | Construction Managers | Planners | Scientists
 www.rkk.com

Responsive People | Creative Solutions

APPROVED: 
DocuSigned by: Kevin Blisby
8D0802E28912472

DATE: 10/18/2023

SEAL

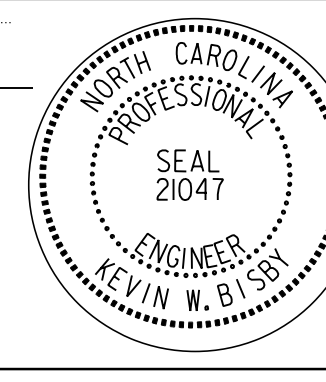

**DOCUMENT NOT CONSIDERED FINAL
 UNLESS ALL SIGNATURES COMPLETED**

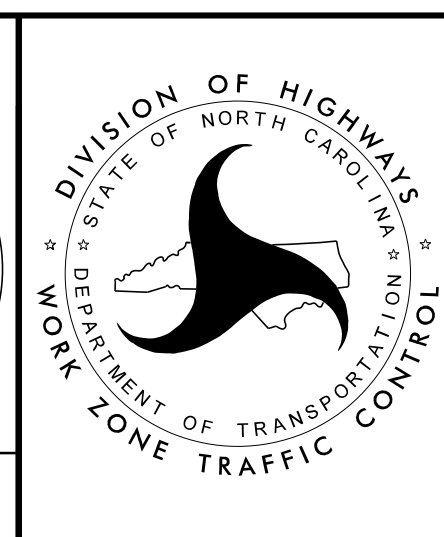

PHASE II - STEP 2

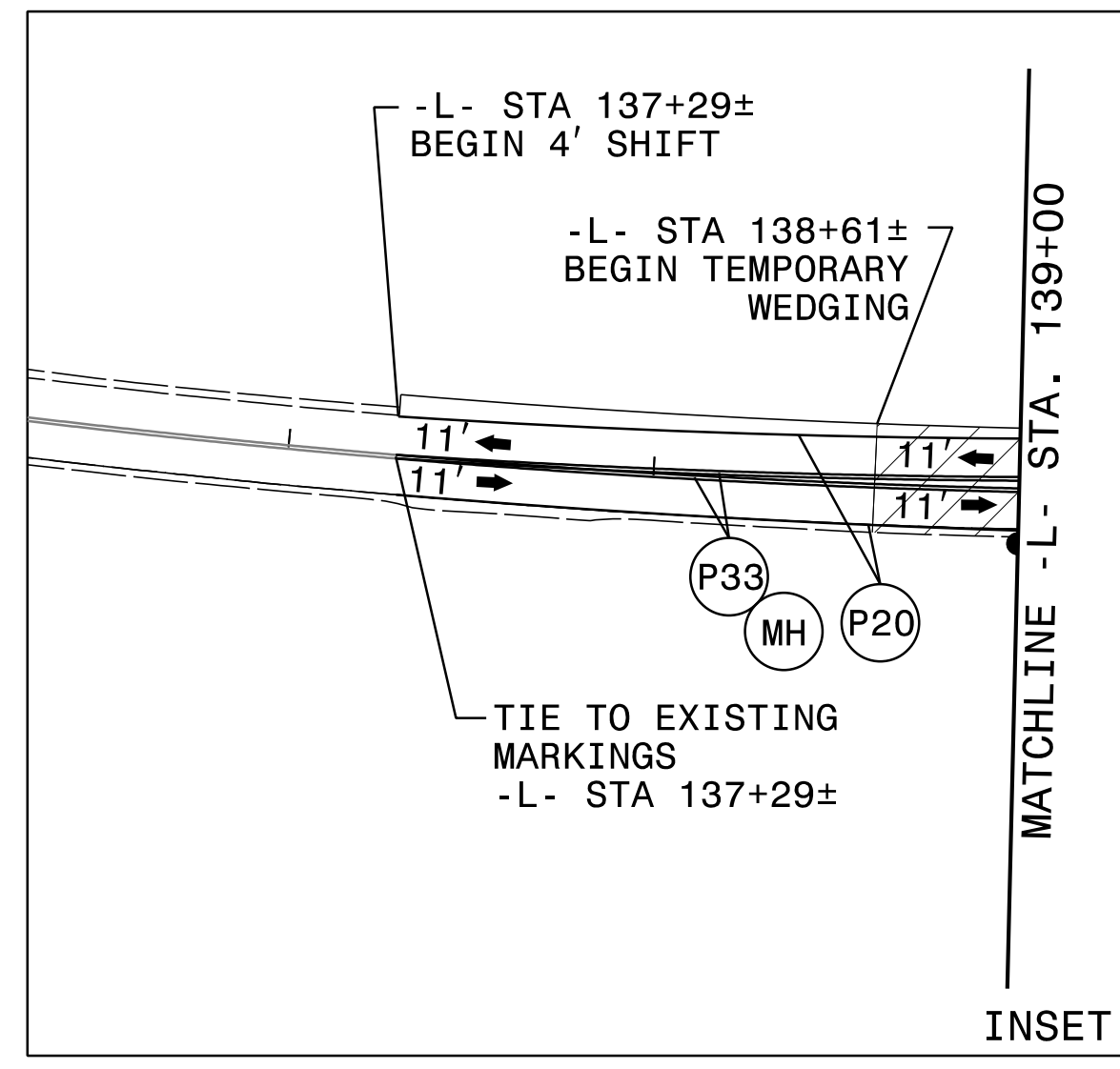
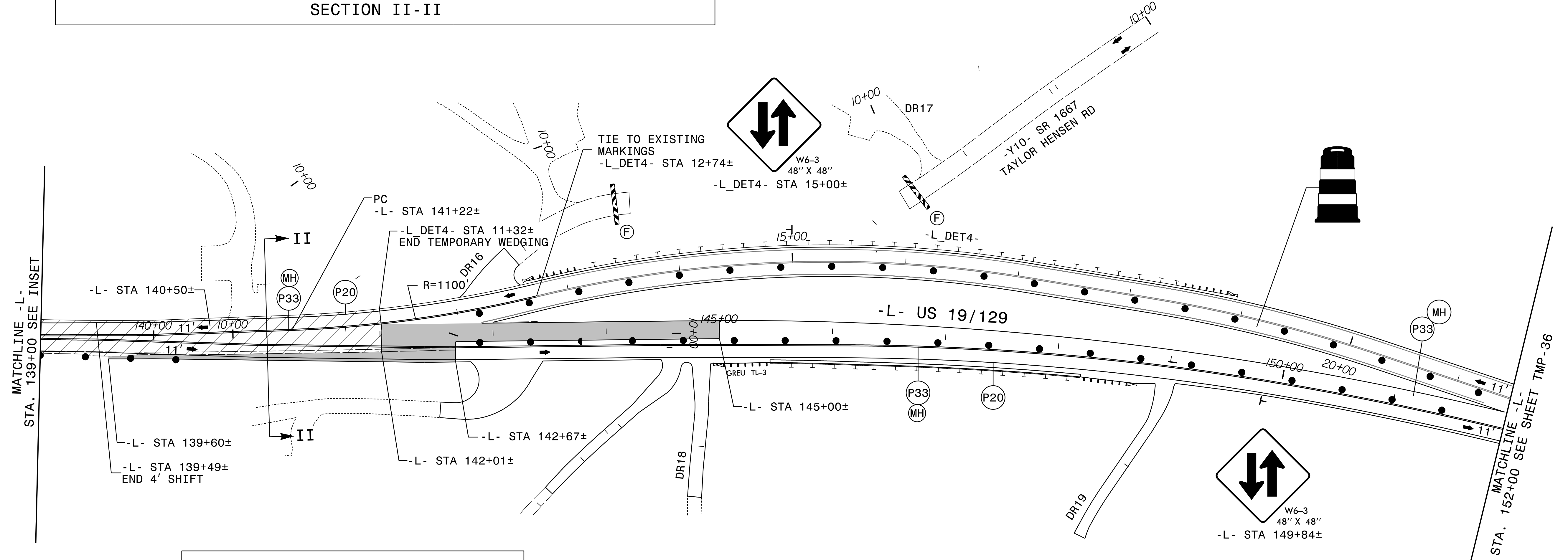
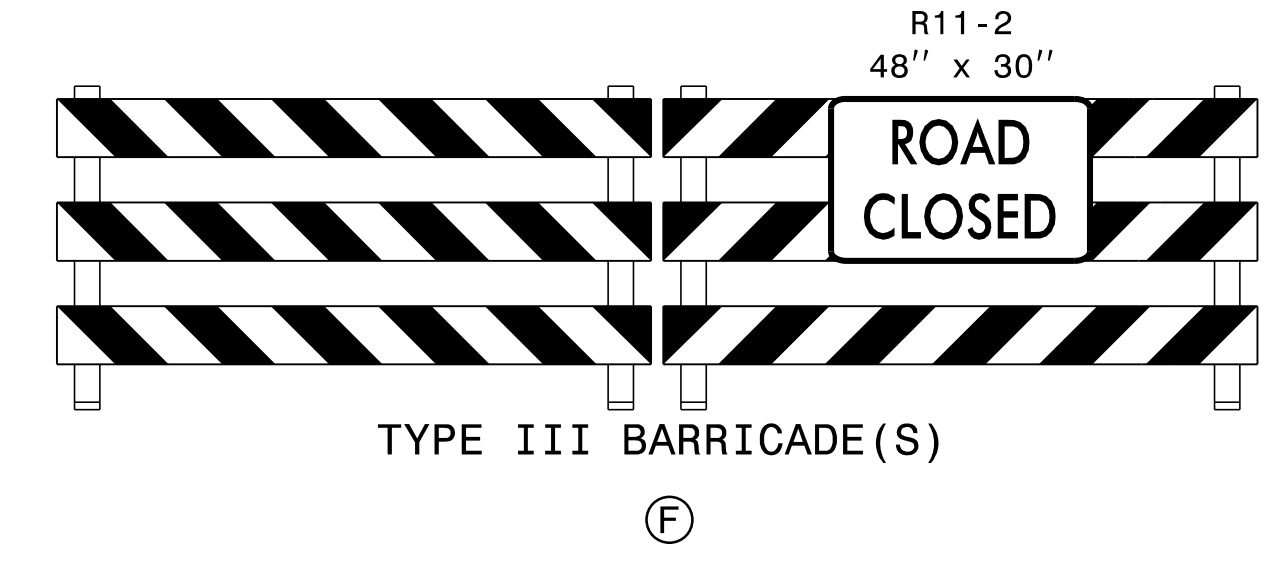
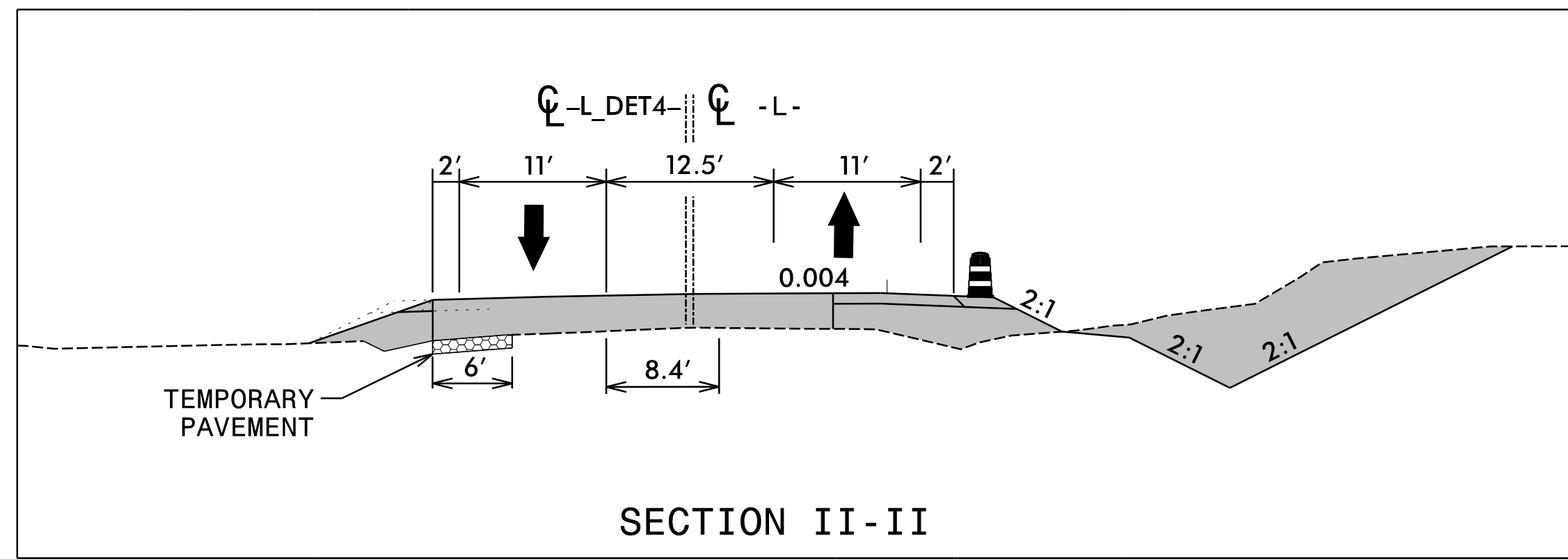

10/18/2023
 R5861.Lc_Tmp35.dgn
 kbisby

RK&K
 P: (919) 878-9560
 8601 Six Forks Road, Forum 1, Suite 700
 Raleigh, North Carolina 27615-3960
 NC License No. F-0112
 Engineers | Construction Managers | Planners | Scientists
 www.rkk.com
 Responsive People | Creative Solutions

APPROVED: *Kevin Bisby*
BD0802628912472
 DATE: 10/18/2023
 SEAL
 NORTH CAROLINA PROFESSIONAL ENGINEER
 KEVIN W. BISBY



PHASE II
STEPS 3 THROUGH 6

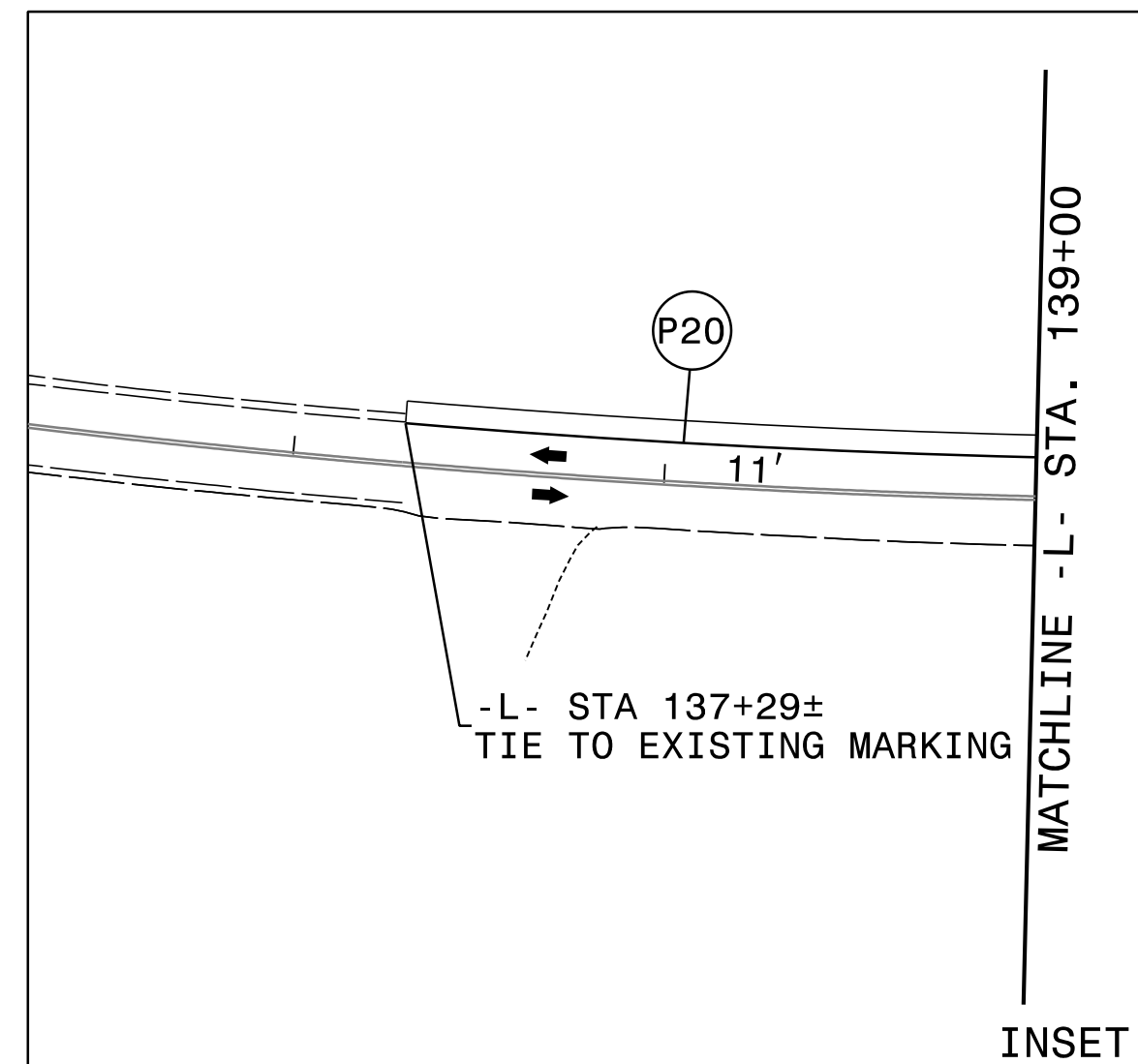
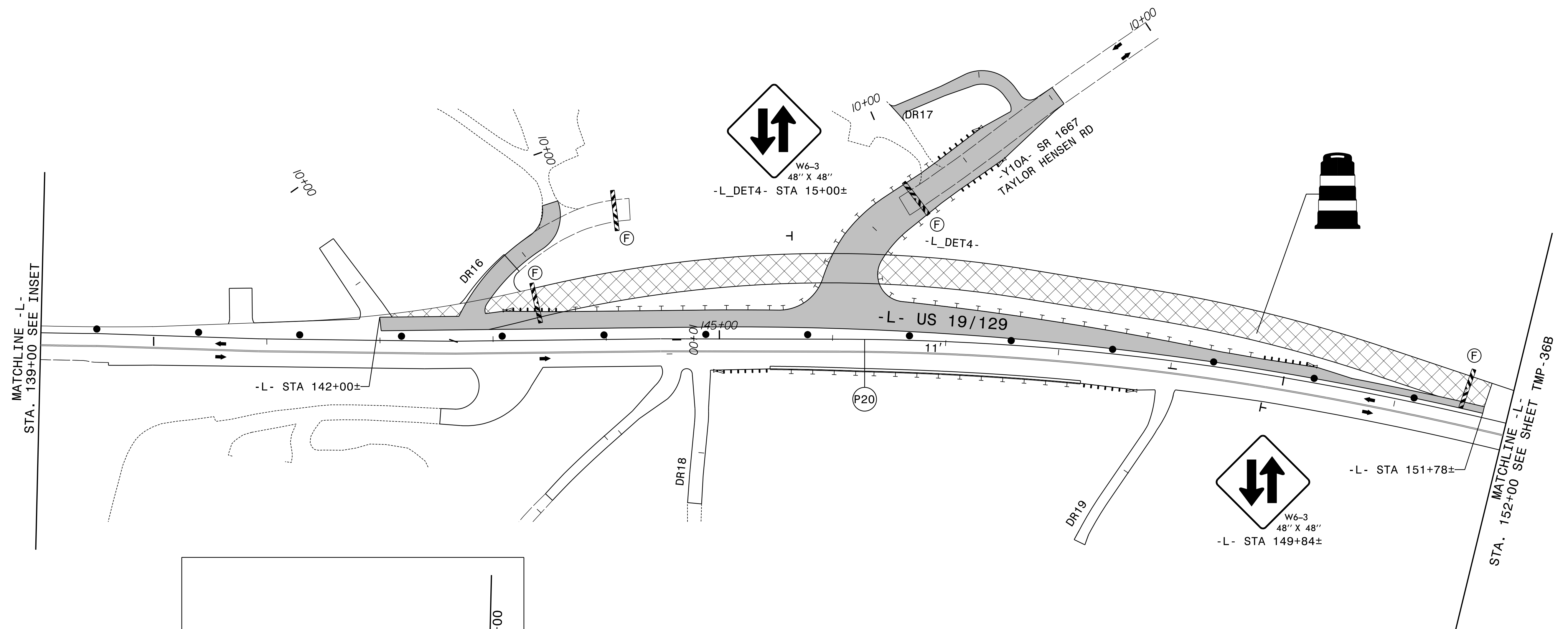
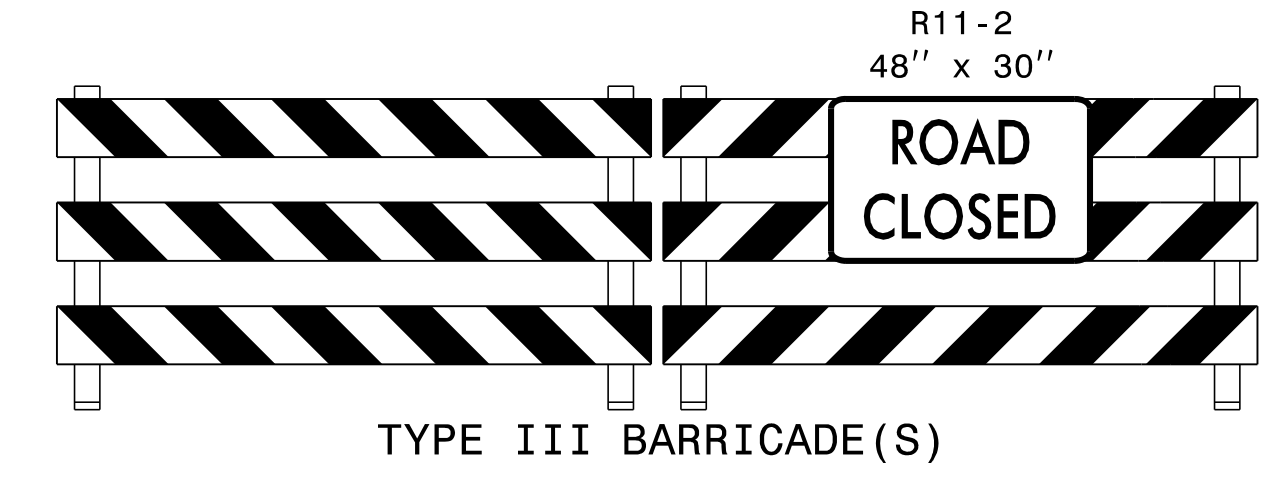

10/18/2023
 R5861.LTC_Tmp36A.dgn
 kbisby

RK&K
 P: (919) 878-9560
 8601 Six Forks Road, Forum 1, Suite 700
 Raleigh, North Carolina 27615-3960
 NC License No. F-0112
 Engineers | Construction Managers | Planners | Scientists
 www.rkk.com
 Responsive People | Creative Solutions

APPROVED: *Kevin Bisby*
800802628912472
 DATE: 10/18/2023
 SEAL



PHASE II - STEPS 7 AND 8

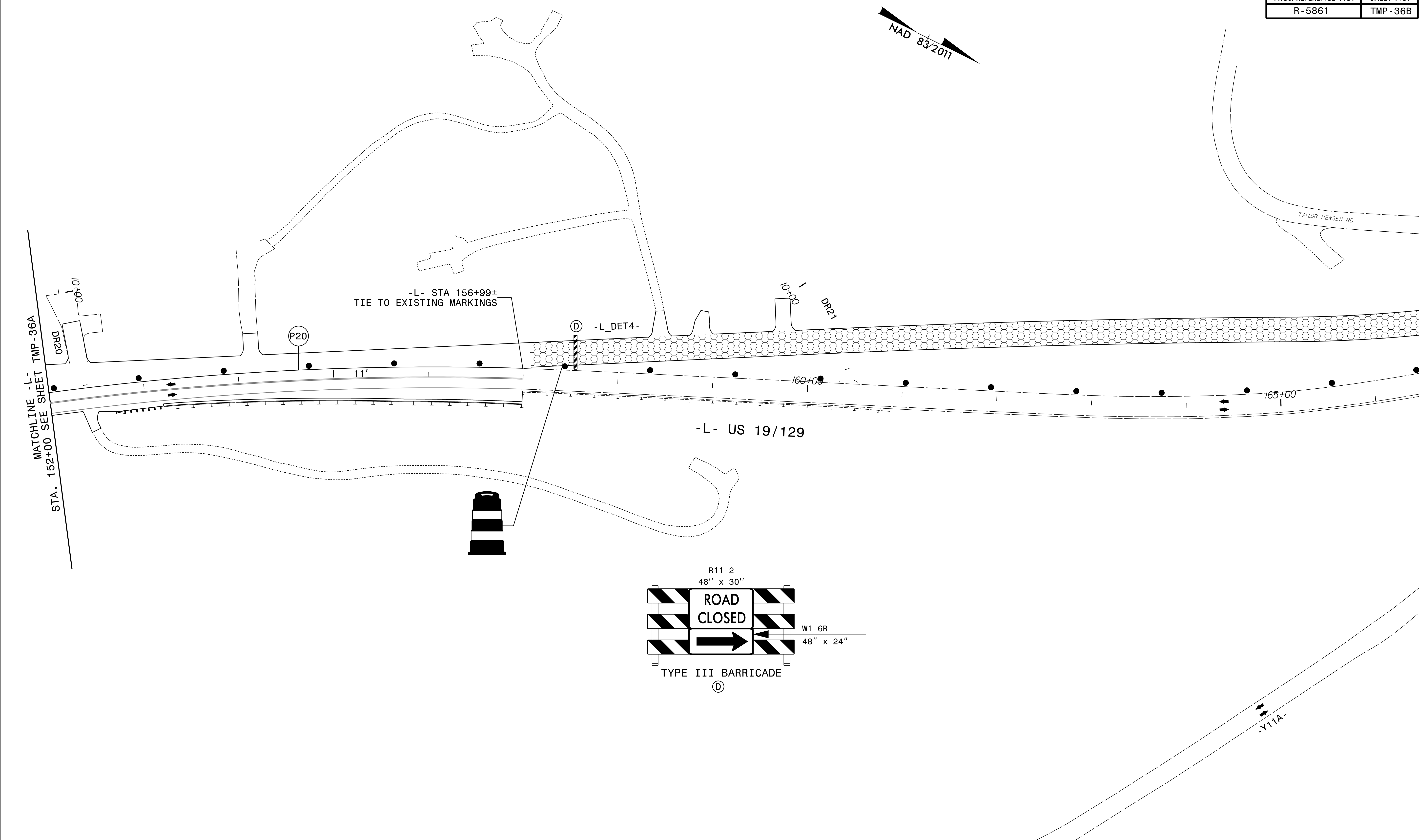
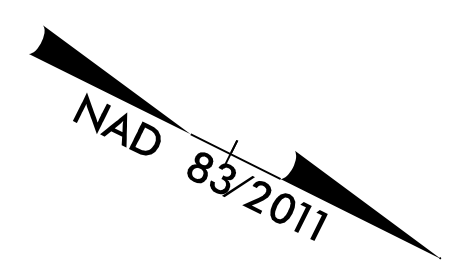

10/18/2023
 R5861.Lt_c_Tmp36B.dgn
 kbisby

RK&K
 P: (919) 878-9560
 8601 Six Forks Road, Forum 1, Suite 700
 Raleigh, North Carolina 27615-3960
 NC License No. F-0112
 Engineers | Construction Managers | Planners | Scientists
 www.rkk.com
 Responsive People | Creative Solutions

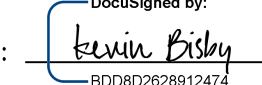
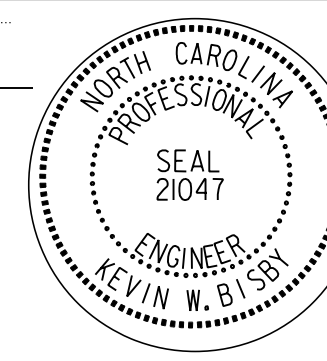
APPROVED: 
800802628912472
 DATE: 10/18/2023
 SEAL

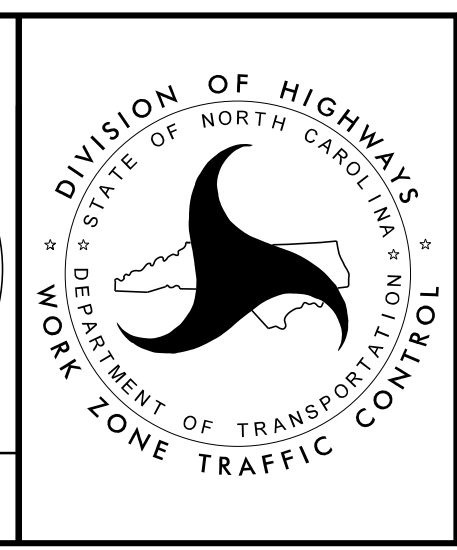
**DOCUMENT NOT CONSIDERED FINAL
 UNLESS ALL SIGNATURES COMPLETED**

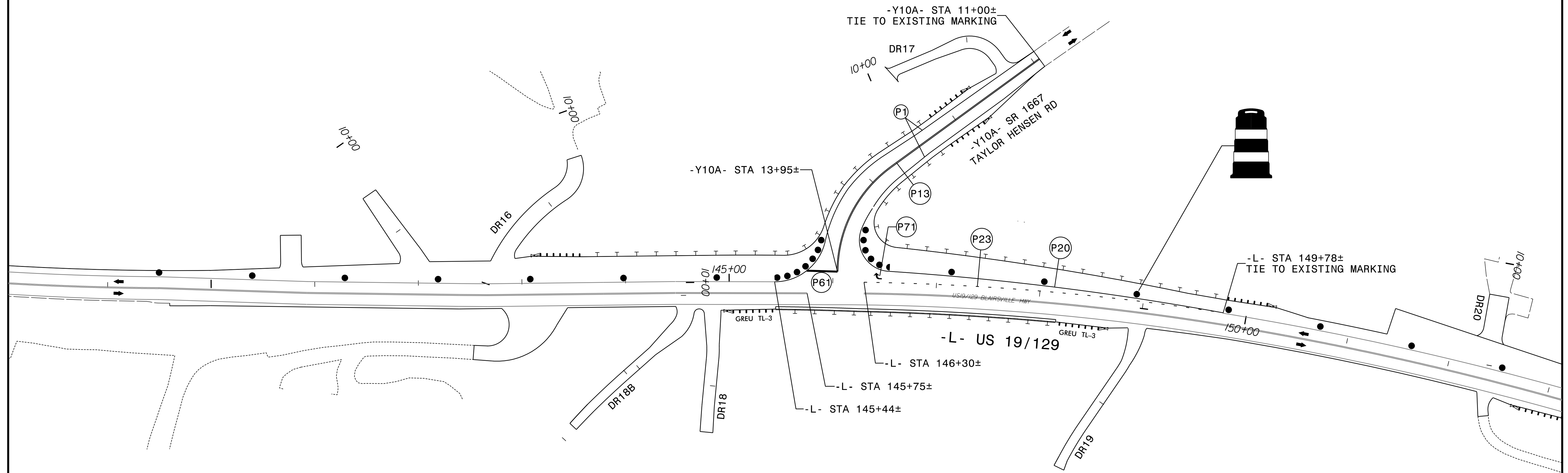

PHASE II - STEP 7



RK&K
 P: (919) 878-9560
 8601 Six Forks Road, Forum 1, Suite 700
 Raleigh, North Carolina 27615-3960
 NC License No. F-0112

Engineers | Construction Managers | Planners | Scientists
 www.rkk.com

Responsive People | Creative Solutions

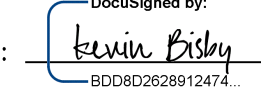
APPROVED: 
800802628912472

DATE: 10/18/2023

SEAL

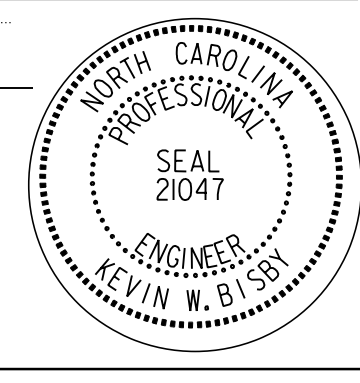

**DOCUMENT NOT CONSIDERED FINAL
 UNLESS ALL SIGNATURES COMPLETED**



PHASE II - STEP 8

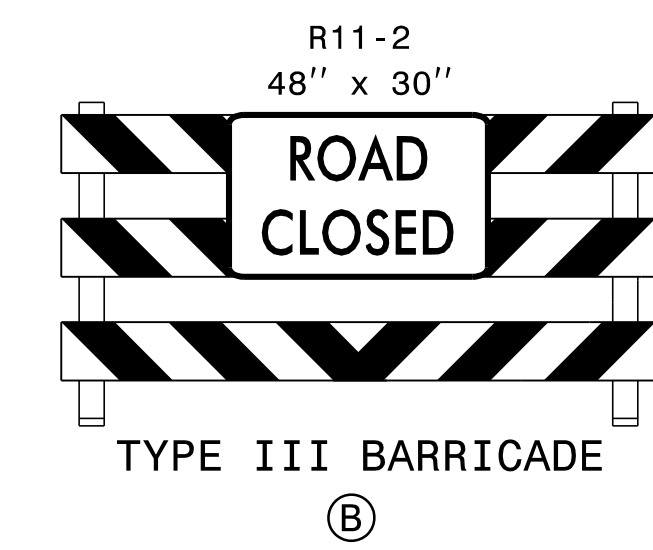
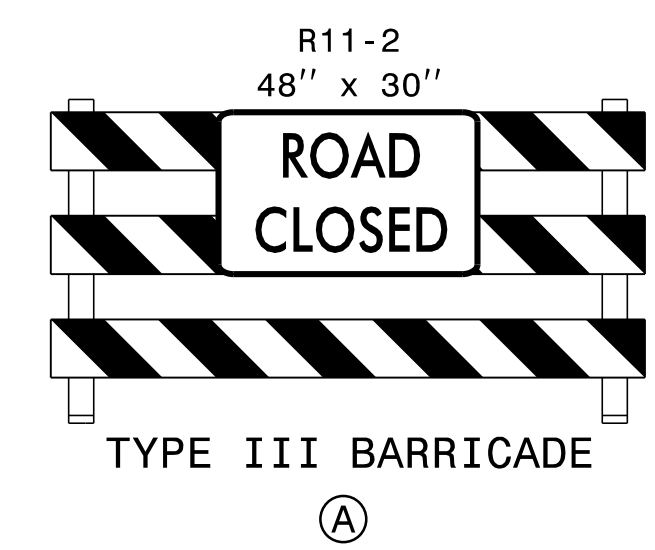
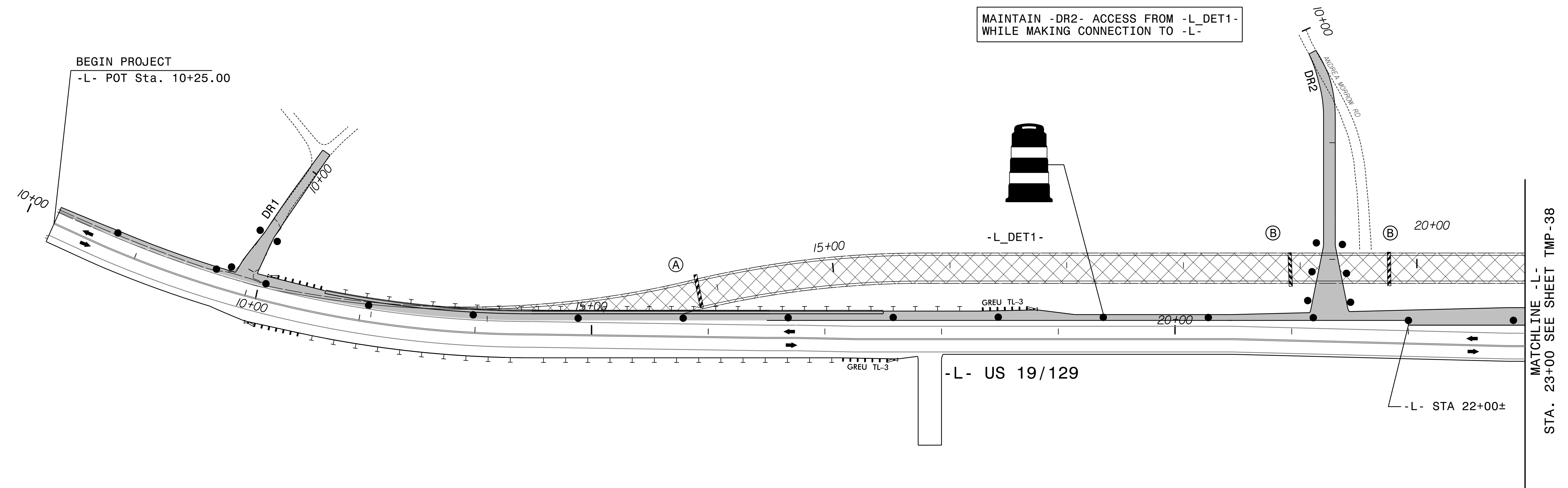
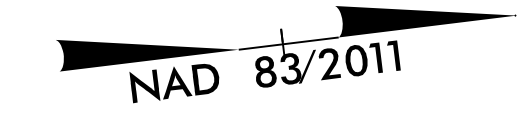

10/18/2023
 R5861.Tc_Tmp37.dgn
 kbisby

RK&K
 P: (919) 878-9560
 8601 Six Forks Road, Forum 1, Suite 700
 Raleigh, North Carolina 27615-3960
 NC License No. F-0112

Engineers | Construction Managers | Planners | Scientists
 www.rkk.com

Responsive People | Creative Solutions

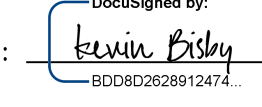
APPROVED: 
800802628912472

DATE: 10/18/2023

SEAL

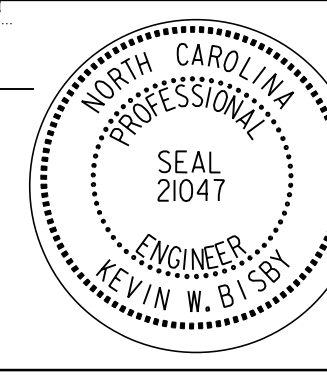

**DOCUMENT NOT CONSIDERED FINAL
 UNLESS ALL SIGNATURES COMPLETED**

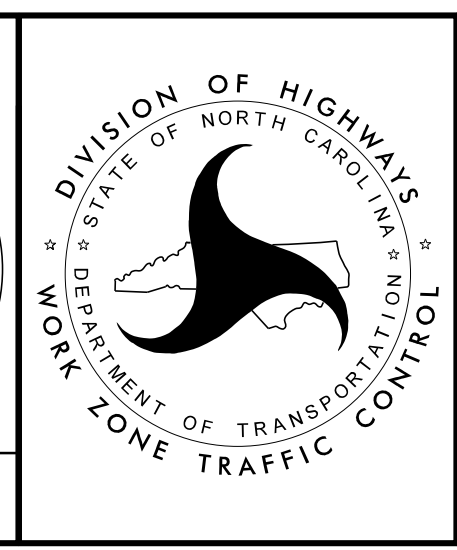

PHASE I - STEP 4
 PAVEMENT MARKINGS

PHASE III - STEP 4

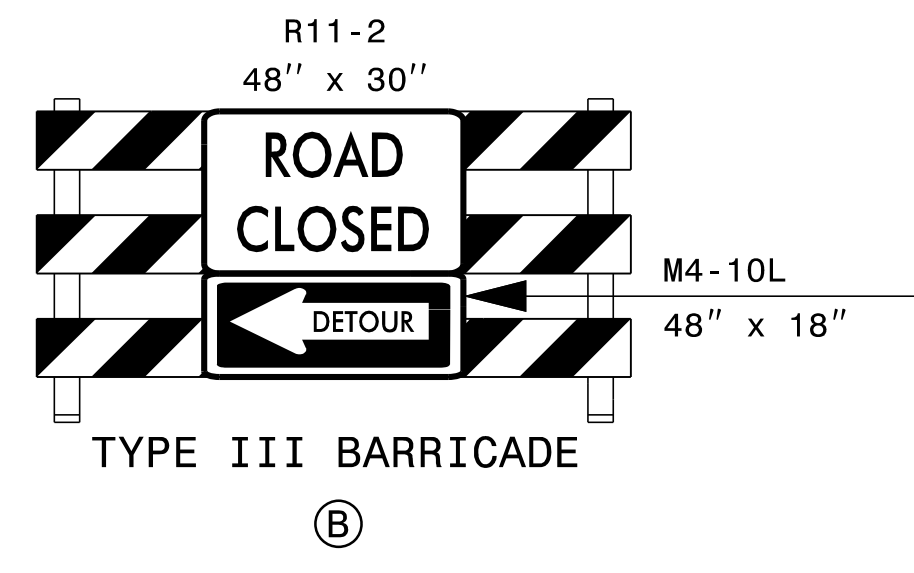
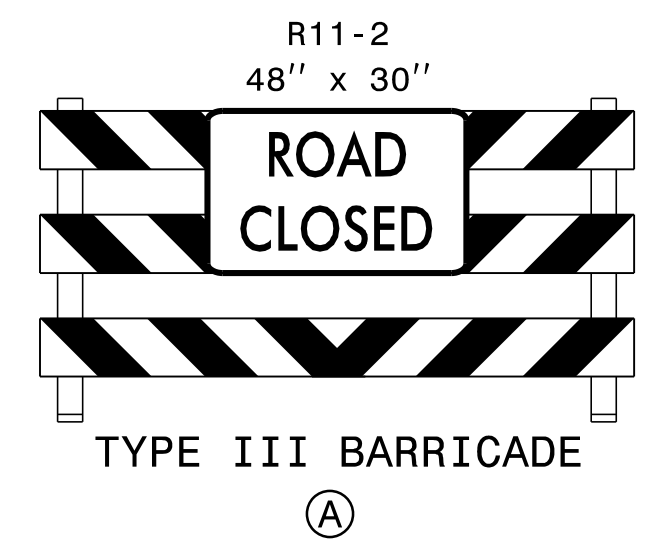
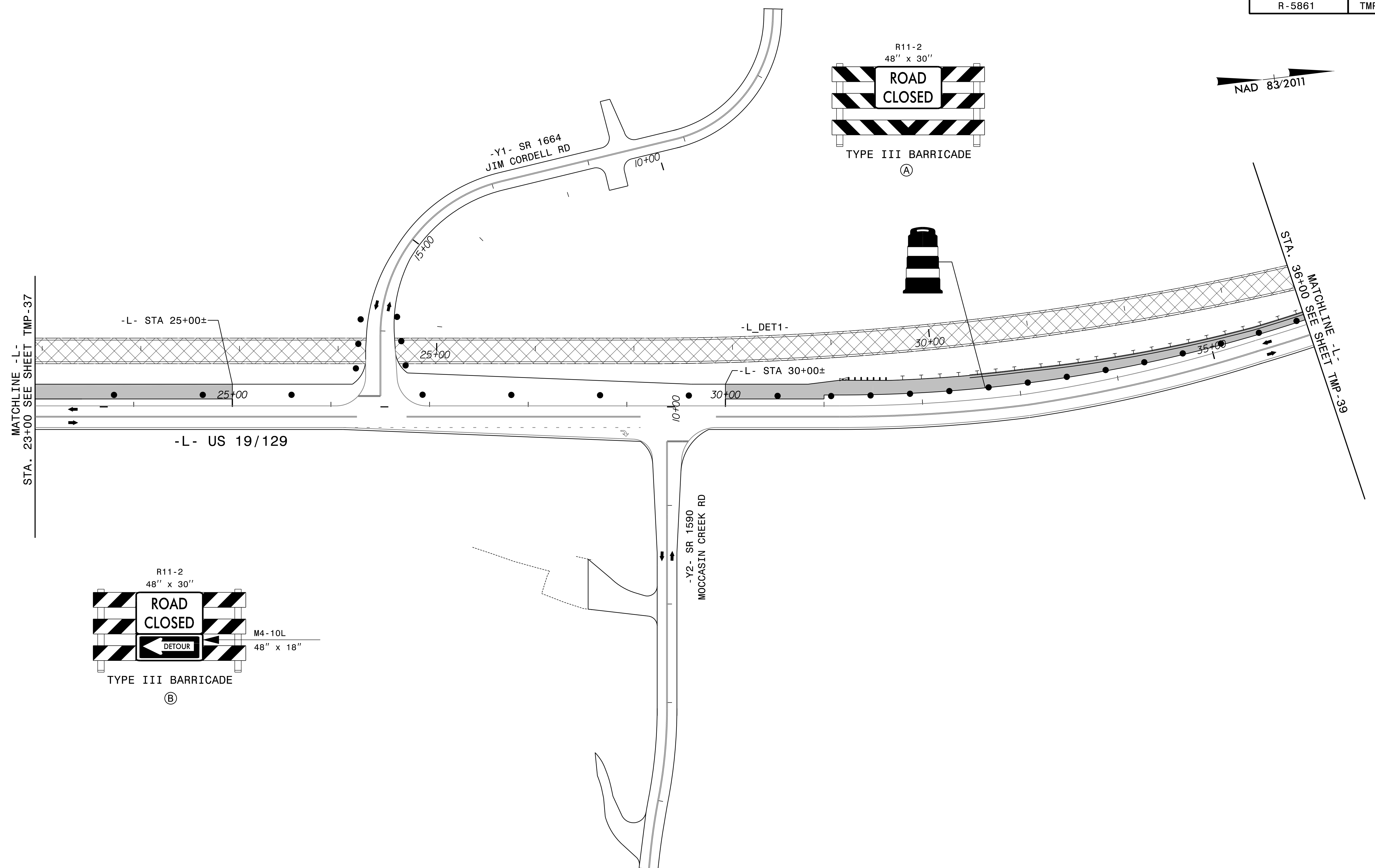
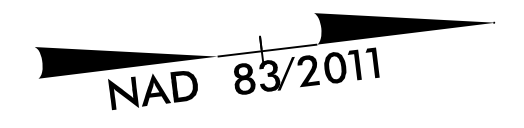

10/18/2023
 R5861.LTC_Tmp38.dgn
 kbisby

RK&K
 P: (919) 878-9560
 8601 Six Forks Road, Forum 1, Suite 700
 Raleigh, North Carolina 27615-3960
 NC License No. F-0112
 Engineers | Construction Managers | Planners | Scientists
 www.rkk.com
 Responsive People | Creative Solutions

APPROVED: *Kevin W. Blisby*
800802628912472
 DATE: 10/18/2023
 SEAL
 DOCUMENT NOT CONSIDERED FINAL
 UNLESS ALL SIGNATURES COMPLETED



PHASE III - STEP 4

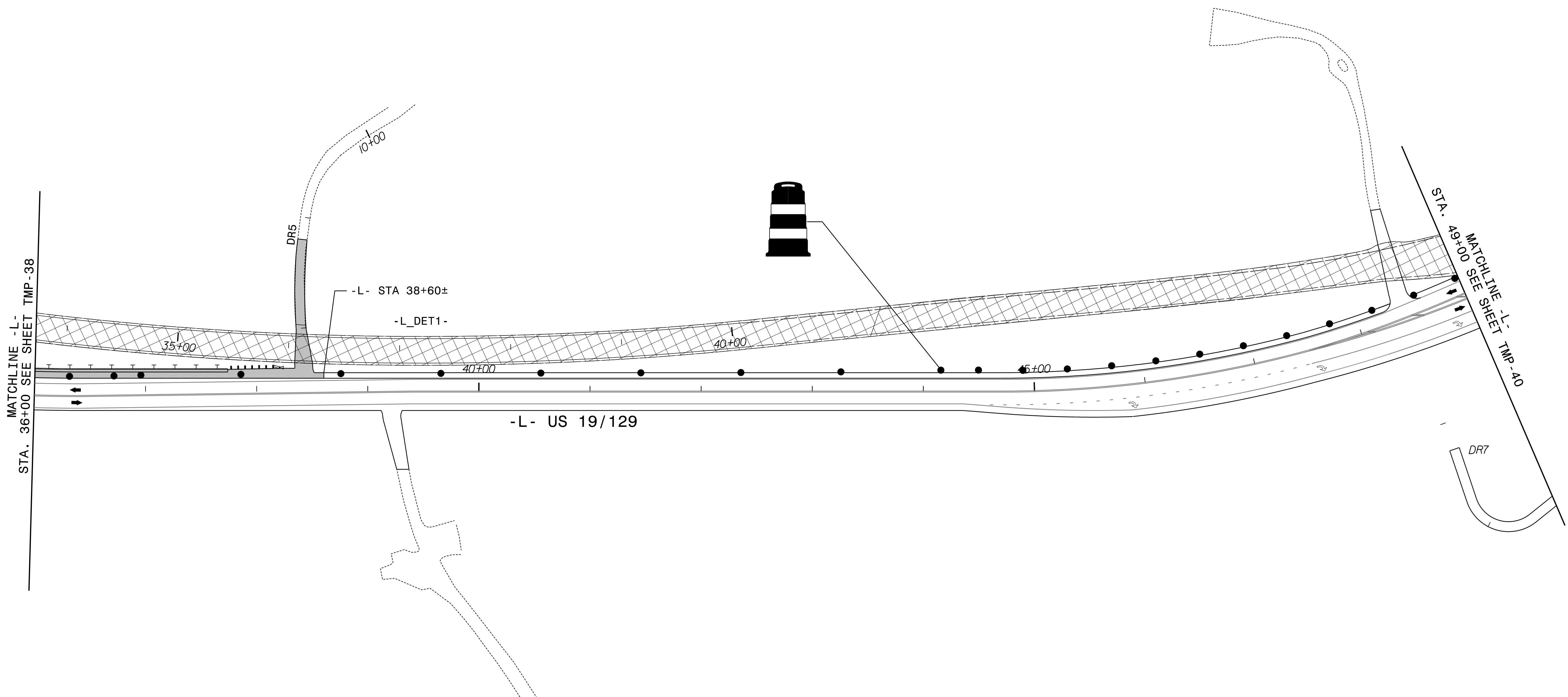
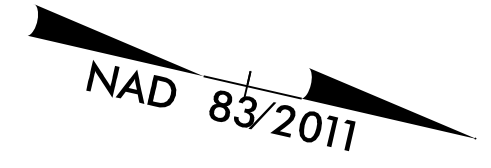

10/18/2023
 R5861.LTC_Tmp39.dgn
 kbisby

RK&K
 P: (919) 878-9560
 8601 Six Forks Road, Forum 1, Suite 700
 Raleigh, North Carolina 27615-3960
 NC License No. F-0112

Engineers | Construction Managers | Planners | Scientists
 www.rkk.com

Responsive People | Creative Solutions

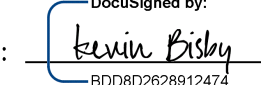
APPROVED: 
DocuSigned by:
Kevin Blisby
8D0802E28912472

DATE: 10/18/2023

SEAL

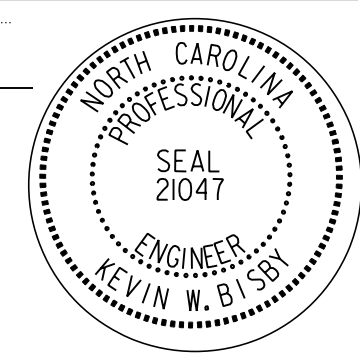

**DOCUMENT NOT CONSIDERED FINAL
UNLESS ALL SIGNATURES COMPLETED**



PHASE III - STEP 4

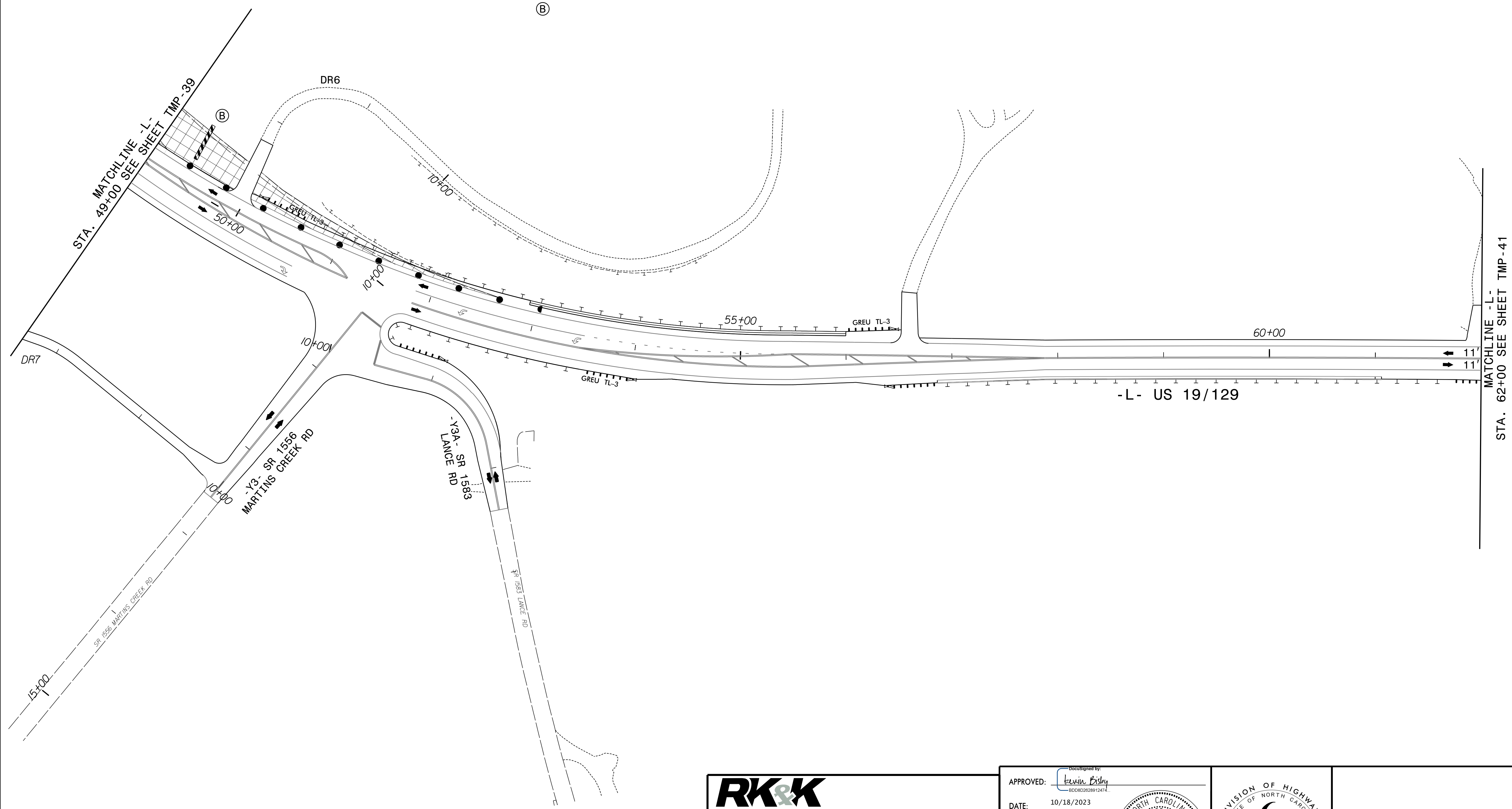
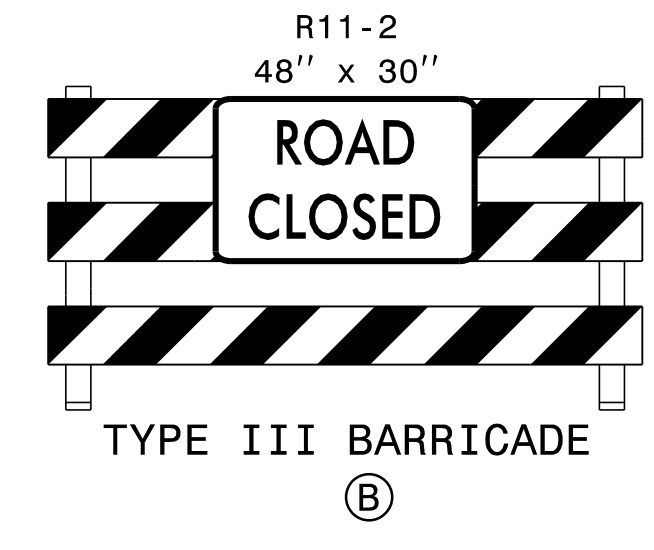
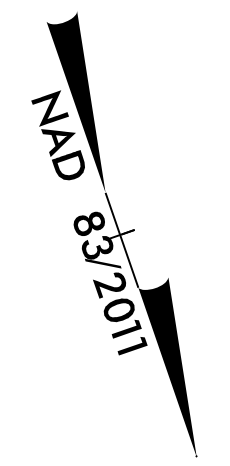

10/18/2023
 R5861.Lc_Tmp40.dgn
 kbisby

RK&K
 P: (919) 878-9560
 8601 Six Forks Road, Forum 1, Suite 700
 Raleigh, North Carolina 27615-3960
 NC License No. F-0112

Engineers | Construction Managers | Planners | Scientists
 www.rkk.com
 Responsive People | Creative Solutions

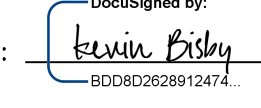
APPROVED: 
DocuSigned by:
Kevin Bisby
8DDB02E26912472

DATE: 10/18/2023

SEAL

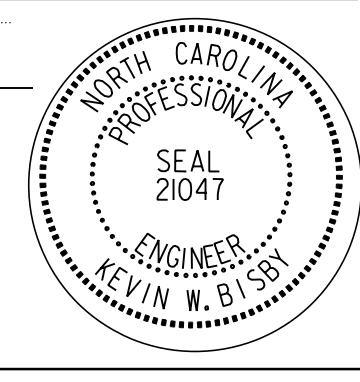

**DOCUMENT NOT CONSIDERED FINAL
UNLESS ALL SIGNATURES COMPLETED**



FOR INFORMATION ONLY

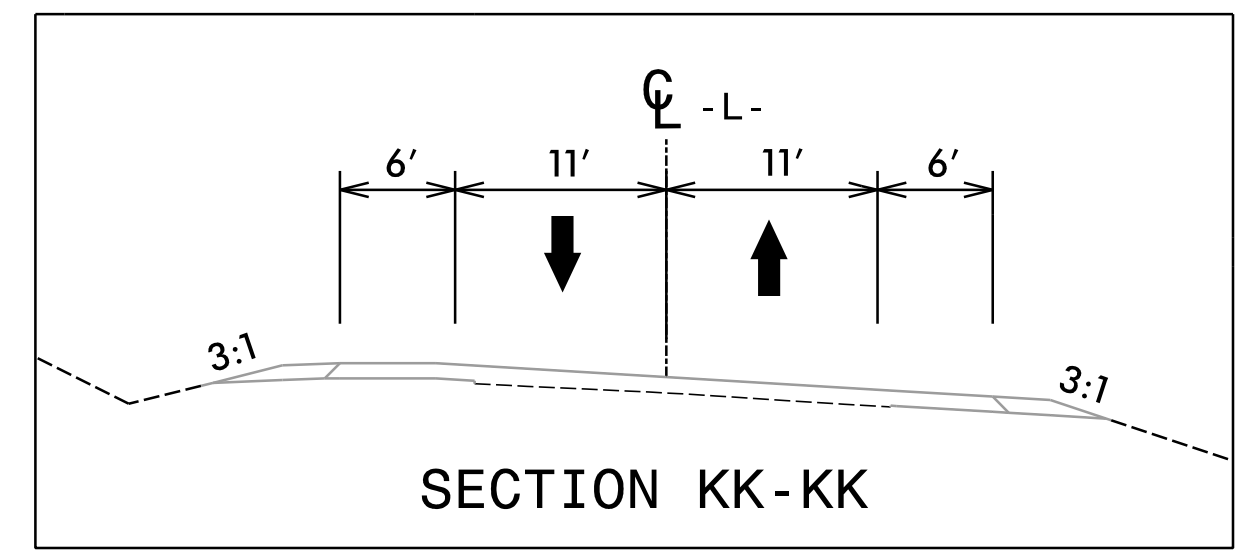
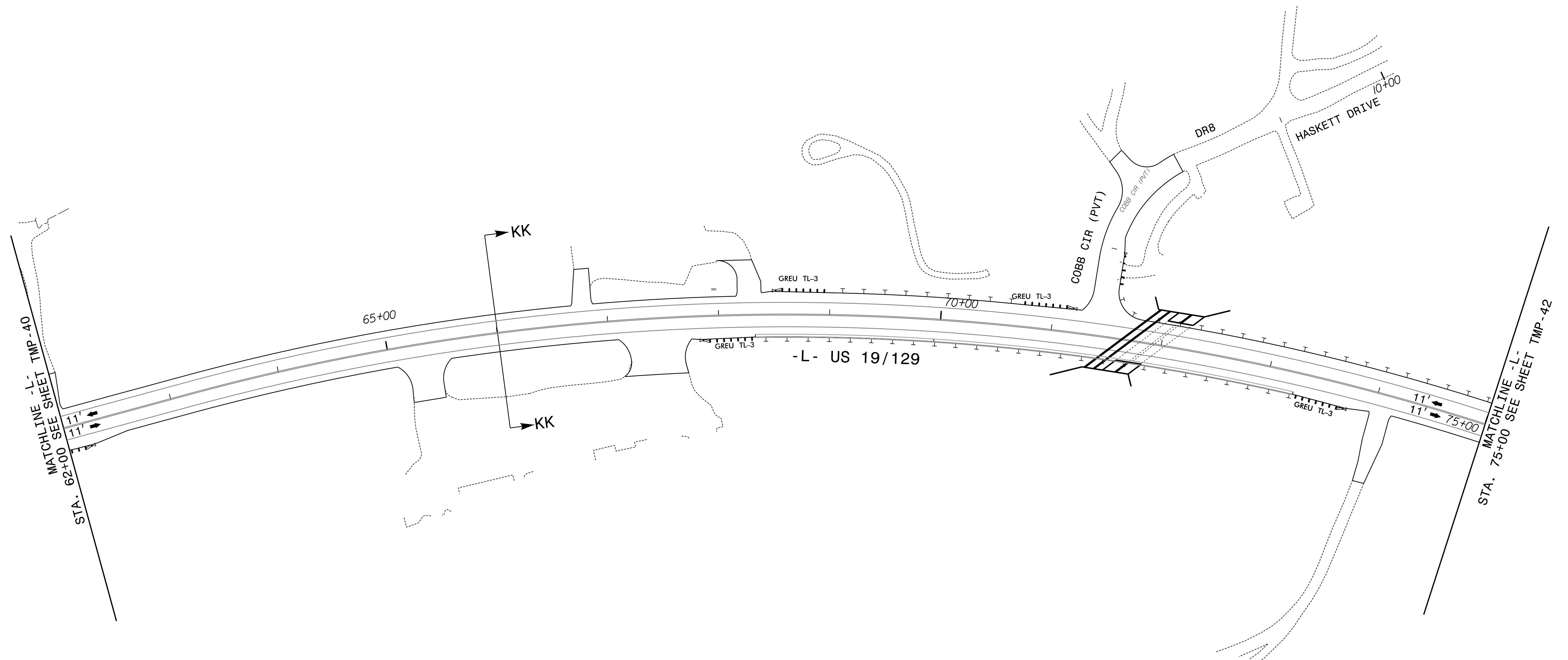
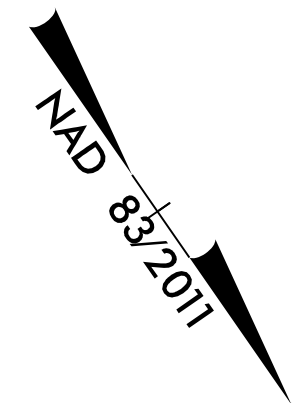

10/18/2023
 R5861.Lc_Tmp41.dgn
 kbisby

RK&K
 P: (919) 878-9560
 8601 Six Forks Road, Forum 1, Suite 700
 Raleigh, North Carolina 27615-3960
 NC License No. F-0112

Engineers | Construction Managers | Planners | Scientists
 www.rkk.com

Responsive People | Creative Solutions

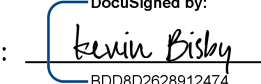
APPROVED: 
800802628912472

DATE: 10/18/2023

SEAL

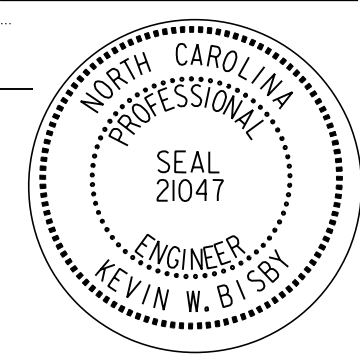

**DOCUMENT NOT CONSIDERED FINAL
 UNLESS ALL SIGNATURES COMPLETED**



FOR INFORMATION ONLY

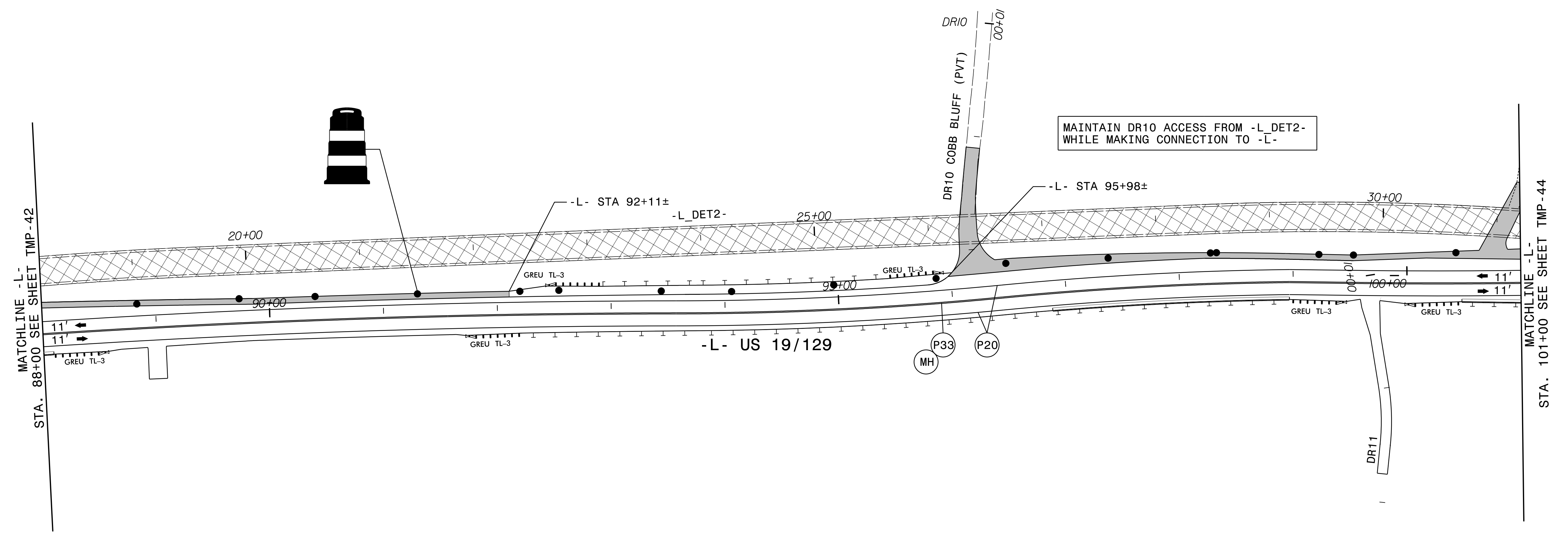
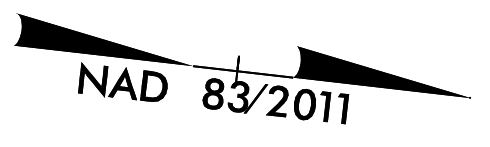

10/18/2023
 R5861.Lc_Tmp43.dgn
 kbisby

RK&K
 P: (919) 878-9560
 8601 Six Forks Road, Forum 1, Suite 700
 Raleigh, North Carolina 27615-3960
 NC License No. F-0112
 Engineers | Construction Managers | Planners | Scientists
 www.rkk.com
 Responsive People | Creative Solutions

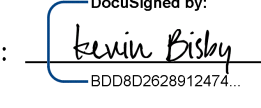
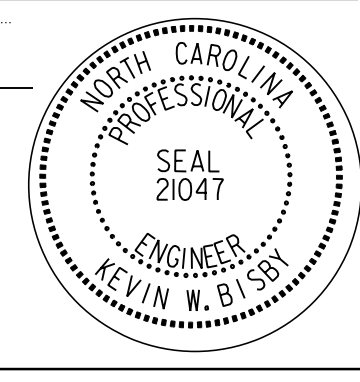
APPROVED: 
DocuSigned by: Kevin Blisby
BDD082628912472
 DATE: 10/18/2023
 SEAL

**DOCUMENT NOT CONSIDERED FINAL
 UNLESS ALL SIGNATURES COMPLETED**

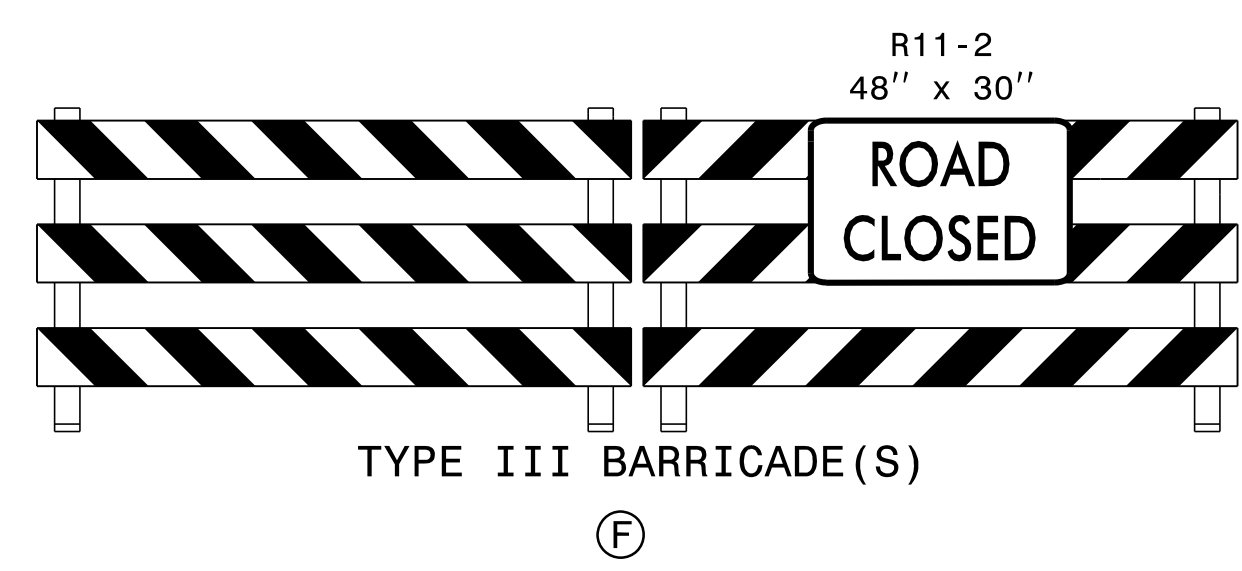
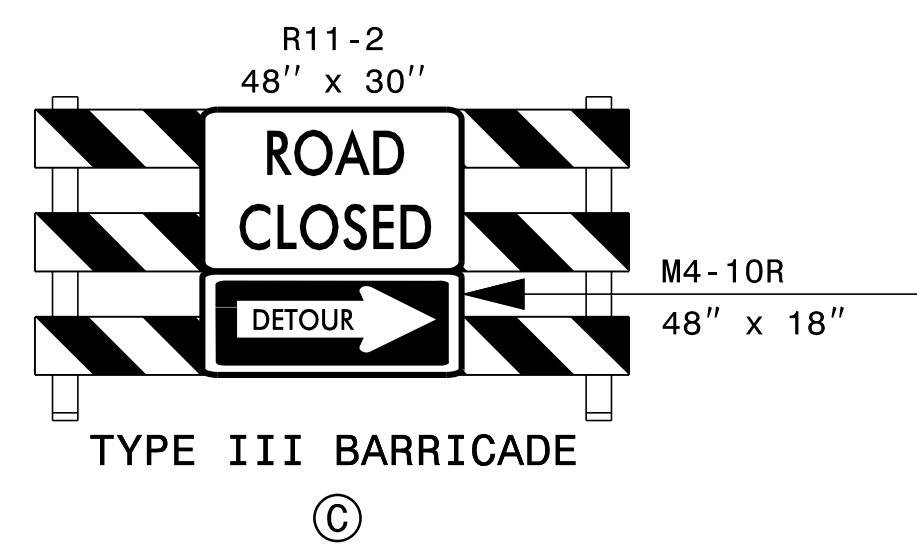
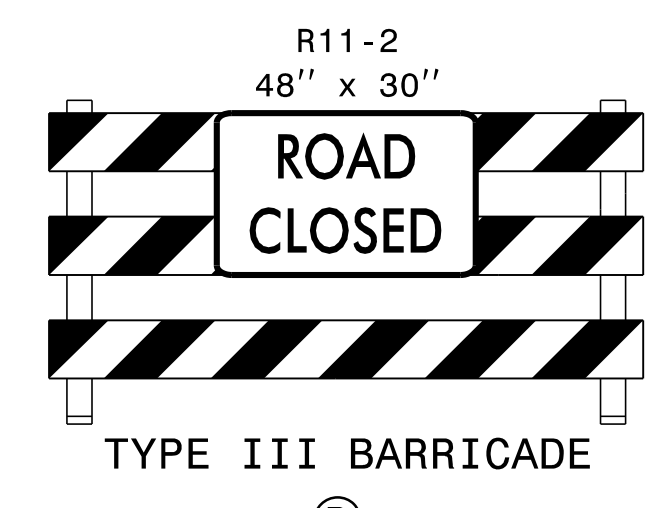
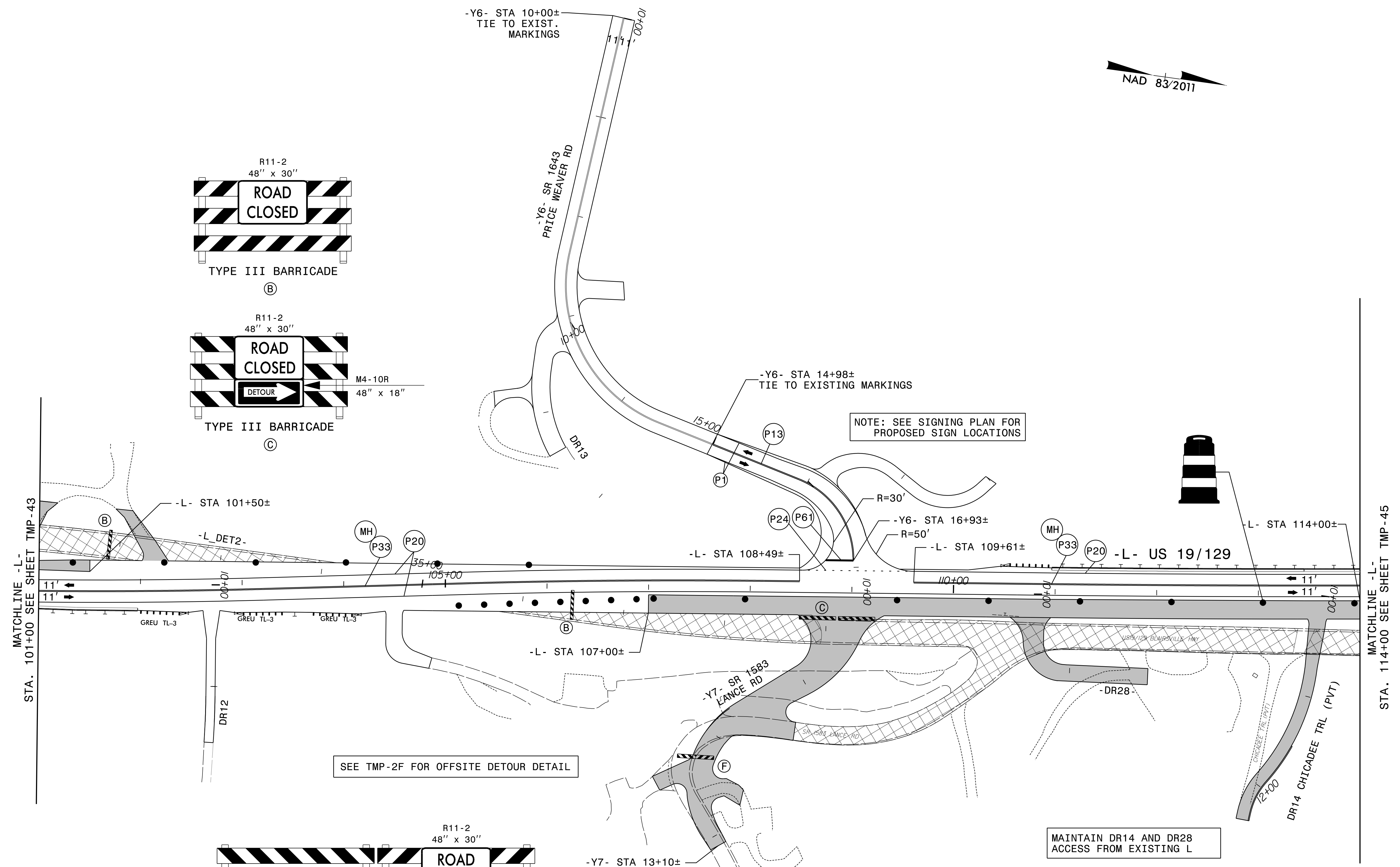
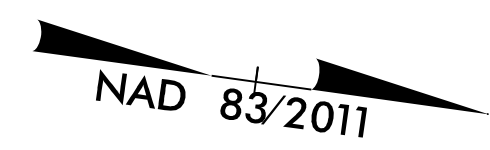

PHASE III - STEPS 1 AND 4



RK&K
 P: (919) 878-9560
 8601 Six Forks Road, Forum 1, Suite 700
 Raleigh, North Carolina 27615-3960
 NC License No. F-0112
 Engineers | Construction Managers | Planners | Scientists
 www.rkk.com
 Responsive People | Creative Solutions

APPROVED: *Kevin B. Bly*
 DATE: 10/18/2023
 SEAL
 DOCUMENT NOT CONSIDERED FINAL
 UNLESS ALL SIGNATURES COMPLETED



PHASE III - STEPS 1 AND 4

10/18/2023
 R5861.LTC_Tmp44.dgn
 kbisby

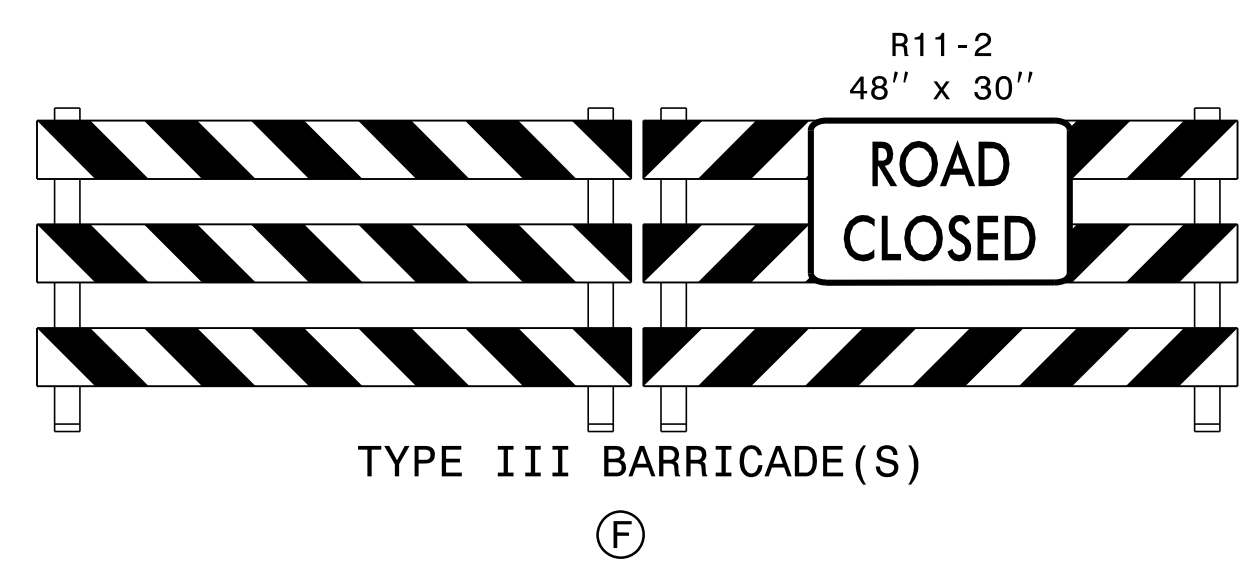
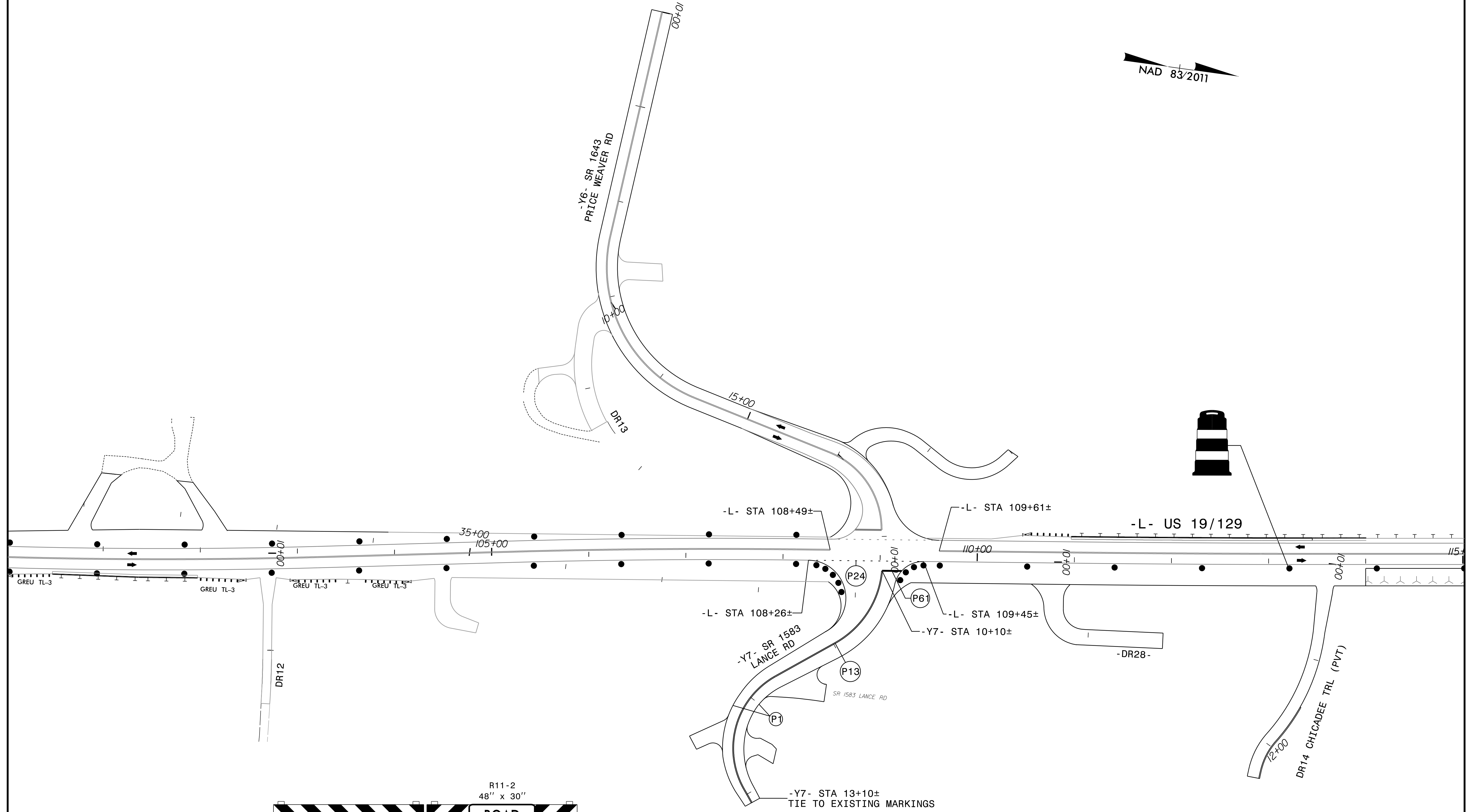
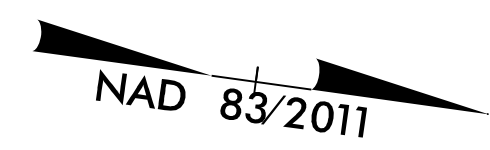

10/18/2023
 R5861.LTC_Tmp44A.dgn
 kbisby

RK&K
 P: (919) 878-9560
 8601 Six Forks Road, Forum 1, Suite 700
 Raleigh, North Carolina 27615-3960
 NC License No. F-0112
 Engineers | Construction Managers | Planners | Scientists
 www.rkk.com
 Responsive People | Creative Solutions

APPROVED: *Kevin Blisby*
800802628912472
 DATE: 10/18/2023
 SEAL

**DOCUMENT NOT CONSIDERED FINAL
 UNLESS ALL SIGNATURES COMPLETED**



**PHASE III - STEP 1
 PAVEMENT MARKINGS**

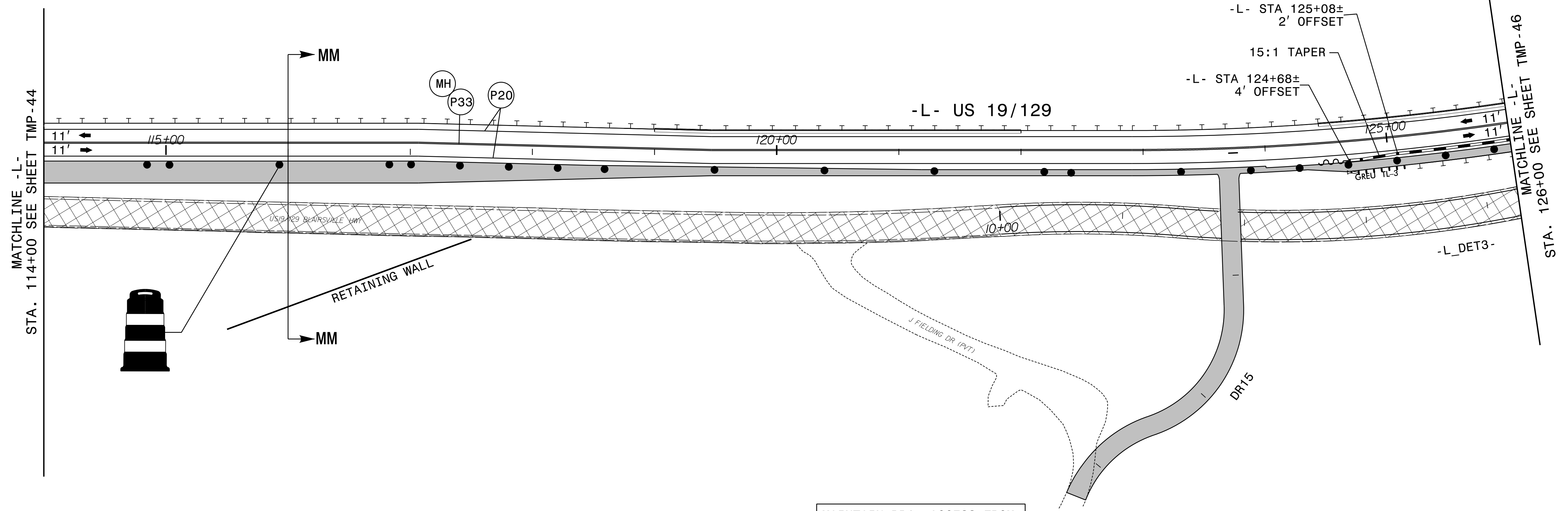
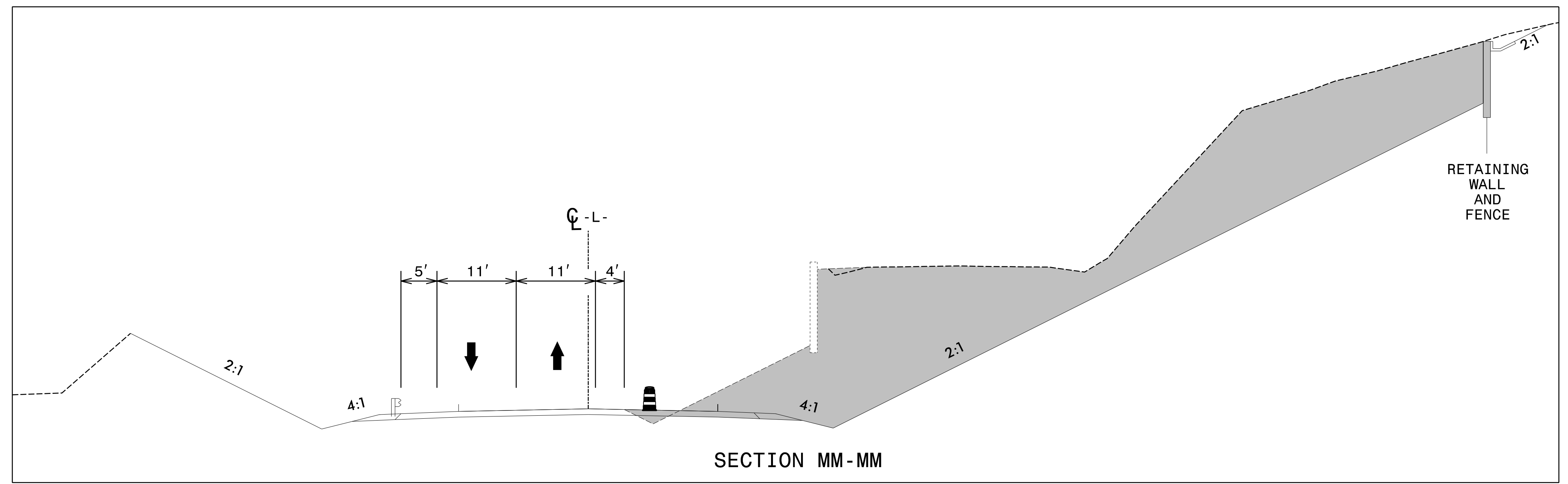

10/18/2023
 R5861.Lc_Tmp45.dgn
 kbisby

RK&K
 P: (919) 878-9560
 8601 Six Forks Road, Forum 1, Suite 700
 Raleigh, North Carolina 27615-3960
 NC License No. F-0112
 Engineers | Construction Managers | Planners | Scientists
 www.rkk.com
 Responsive People | Creative Solutions

APPROVED: *Kevin Bisy*
800802628912472
 DATE: 10/18/2023
 SEAL
 NORTH CAROLINA PROFESSIONAL ENGINEER
 KEVIN W. BISBY
 21047



PHASE III - STEPS 1 AND 4

**DOCUMENT NOT CONSIDERED FINAL
 UNLESS ALL SIGNATURES COMPLETED**

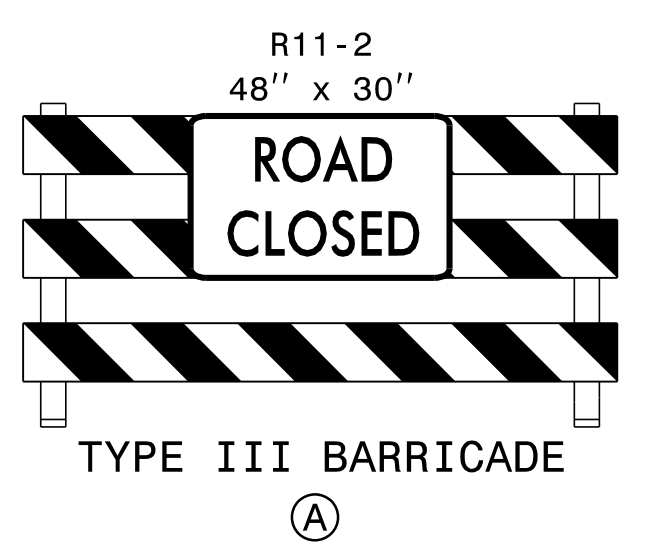
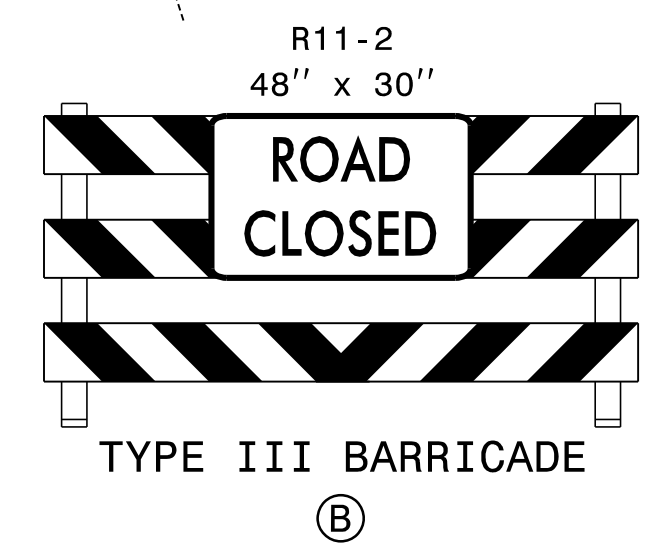
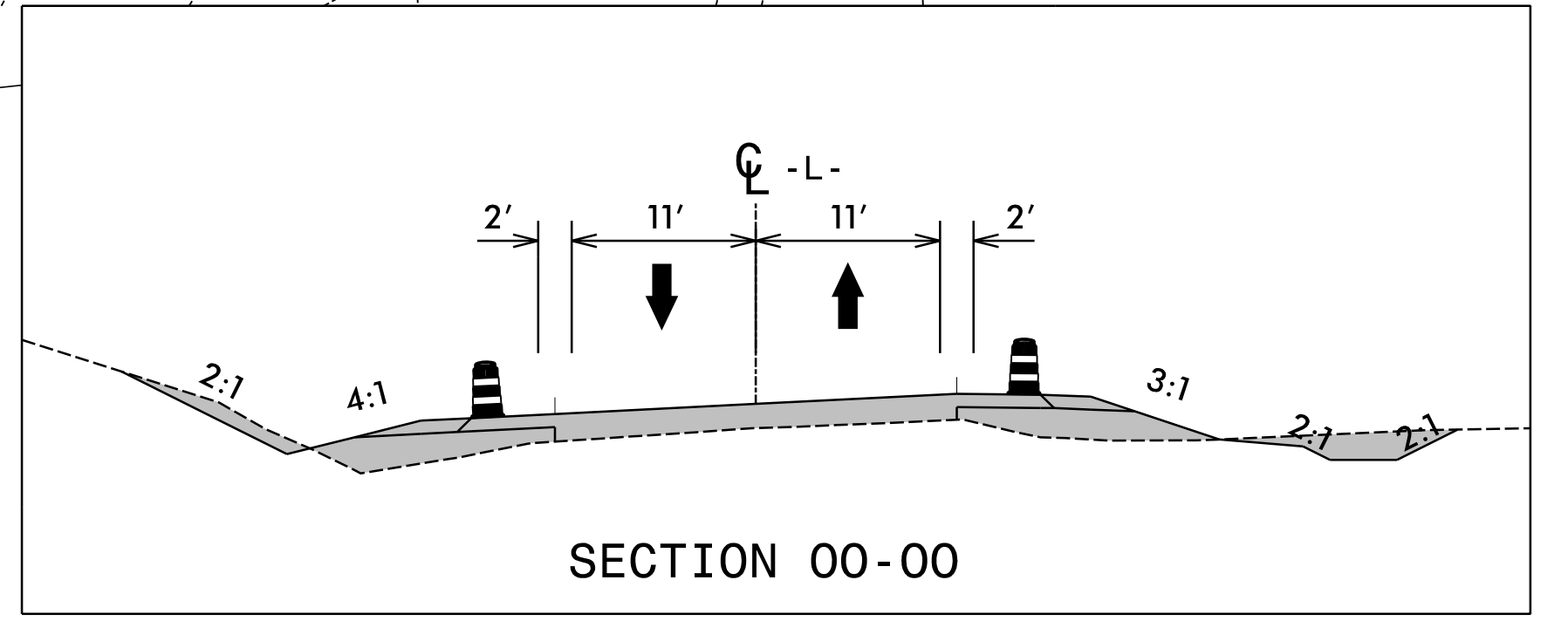
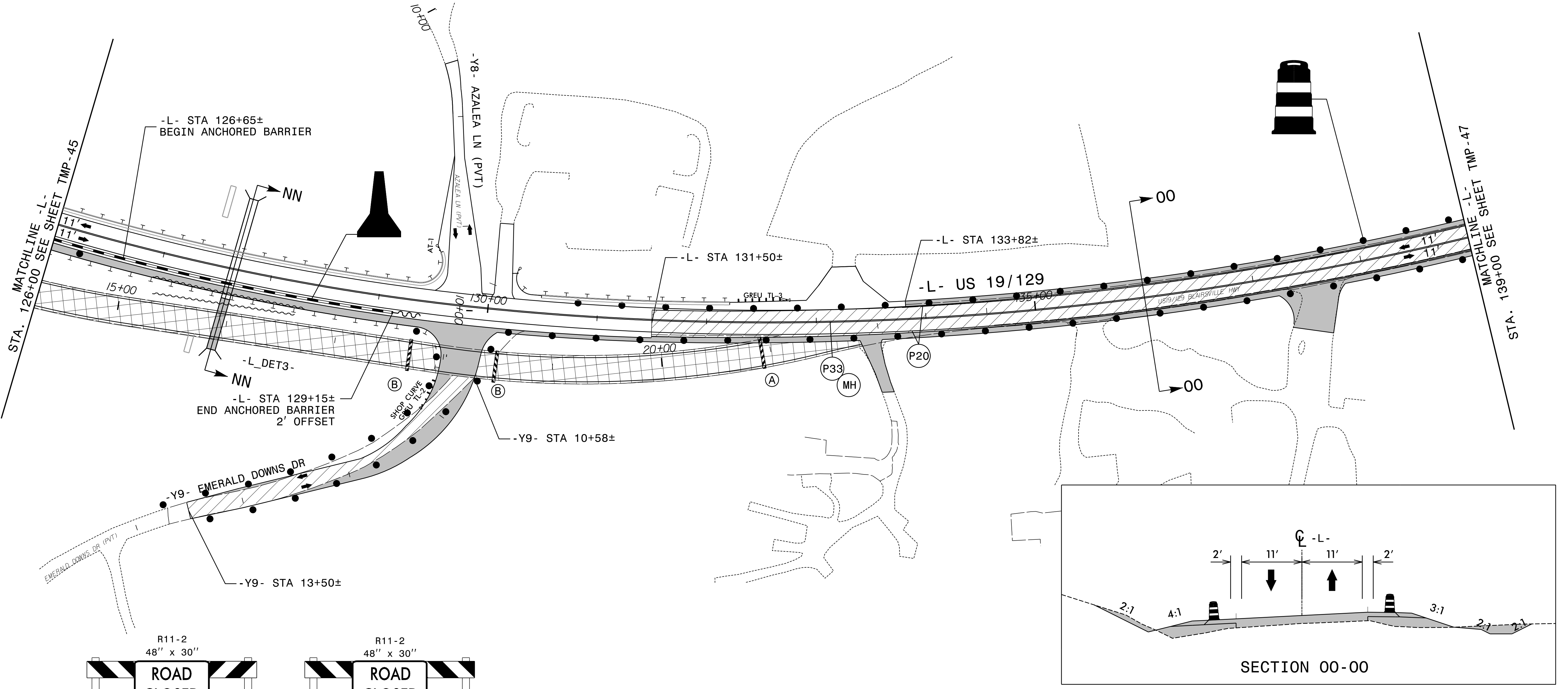
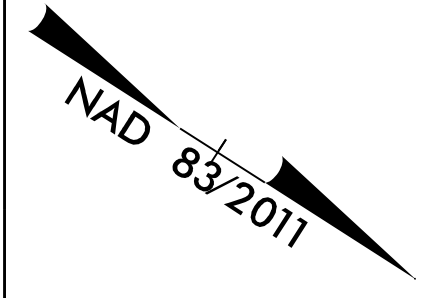
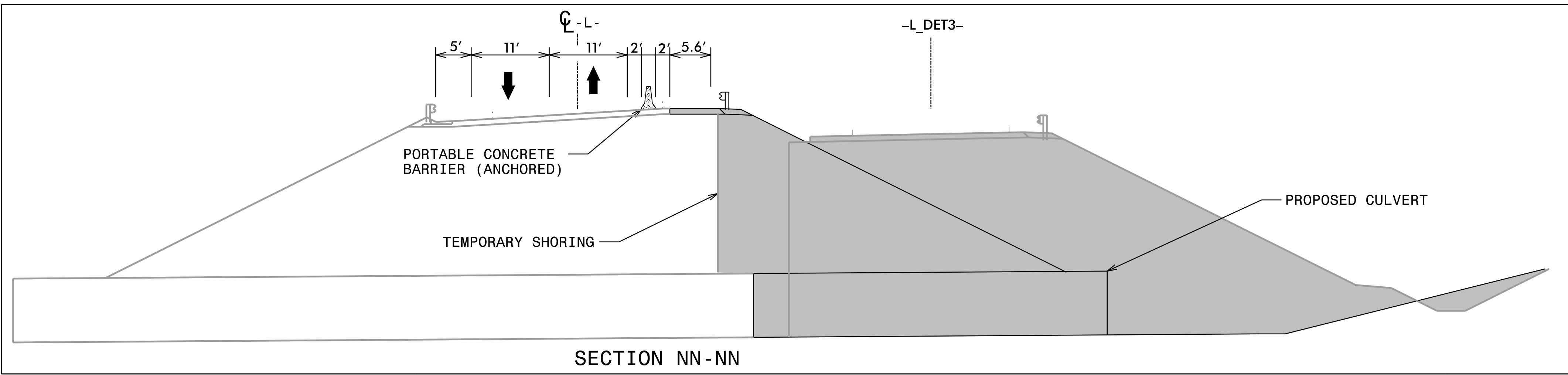

RK&K
 P: (919) 878-9560
 8601 Six Forks Road, Forum 1, Suite 700
 Raleigh, North Carolina 27615-3960
 NC License No. F-0112
 Engineers | Construction Managers | Planners | Scientists
 www.rkk.com
 Responsive People | Creative Solutions

APPROVED: *Kevin Bishy*
 DATE: 10/18/2023
 SEAL
 NORTH CAROLINA PROFESSIONAL ENGINEER
 KEVIN W. BISHY
 21047



PHASE III - STEPS 1 AND 4

10/18/2023
 R5861.LTC_Tmp46.dgn
 kbisby

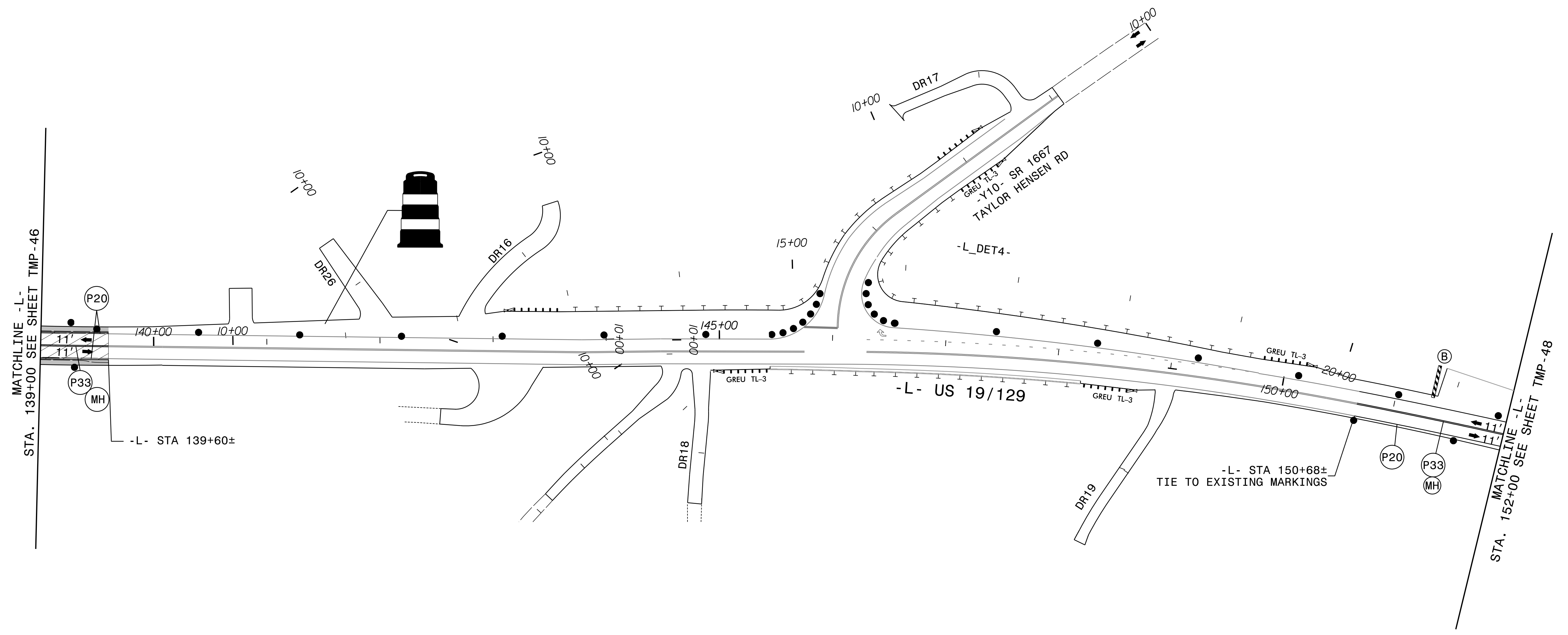
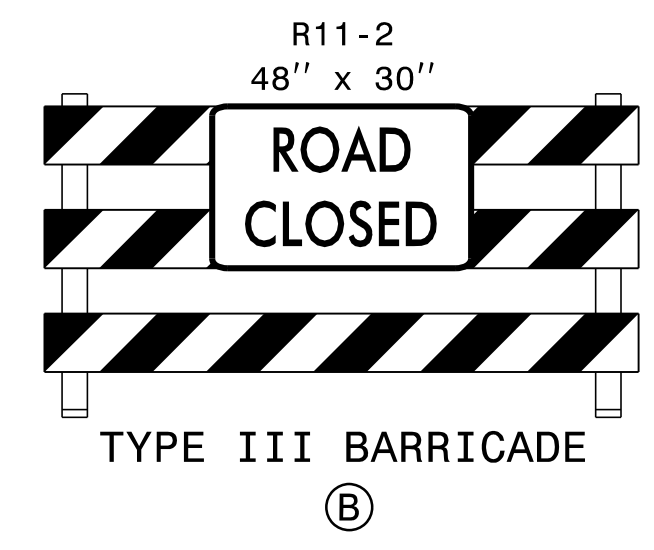
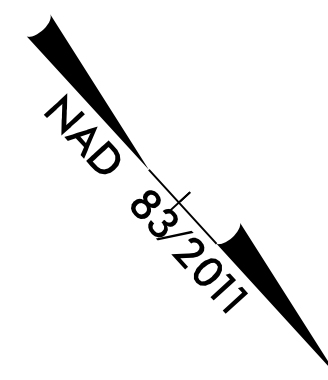

10/18/2023
 R5861.LTC_Tmp47.dgn
 kbisby

RK&K
 P: (919) 878-9560
 8601 Six Forks Road, Forum 1, Suite 700
 Raleigh, North Carolina 27615-3960
 NC License No. F-0112
 Engineers | Construction Managers | Planners | Scientists
 www.rkk.com
 Responsive People | Creative Solutions

APPROVED: *Kevin W. Blisby*
800802628912472
 DATE: 10/18/2023

SEAL

**DOCUMENT NOT CONSIDERED FINAL
 UNLESS ALL SIGNATURES COMPLETED**



PHASE III - STEPS 1 AND 2

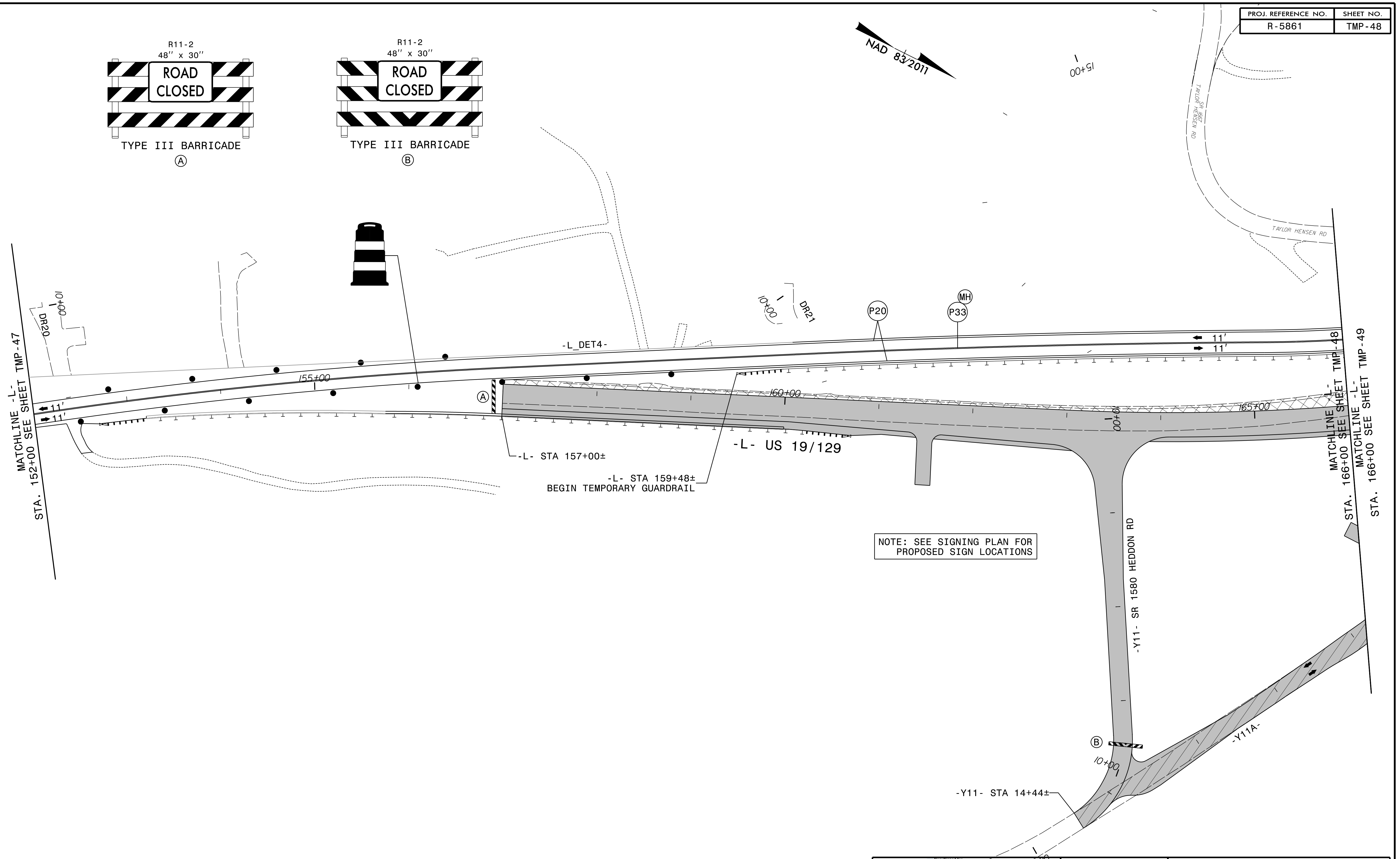
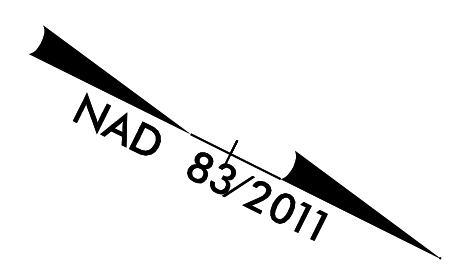
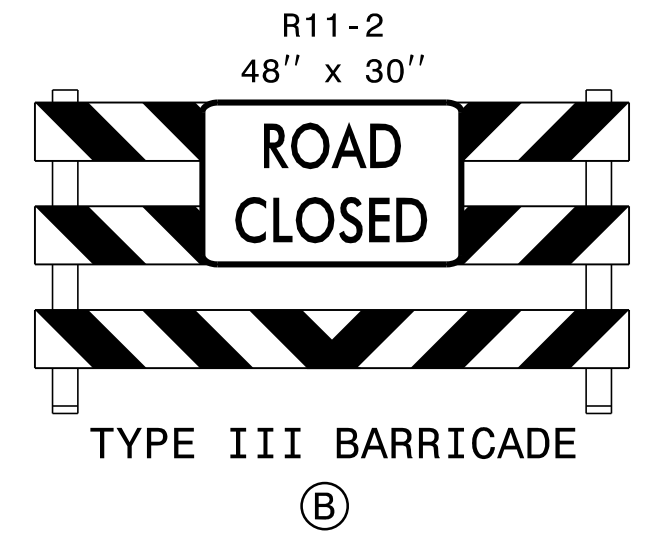
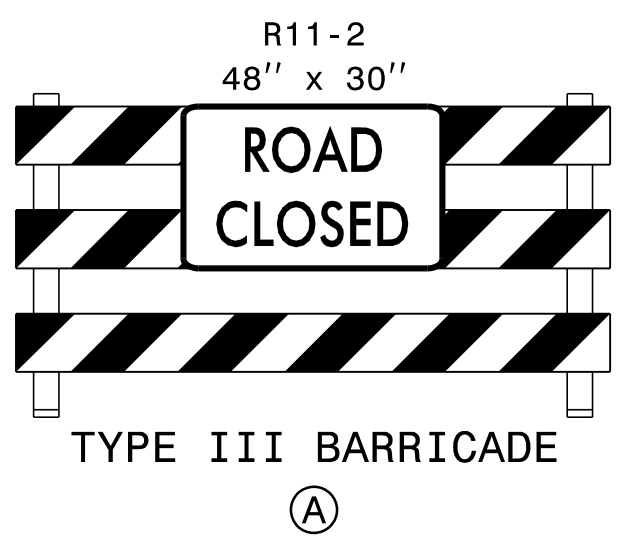

NOTE: SEE SIGNING PLAN FOR PROPOSED SIGN LOCATIONS

10/18/2023
R5861.LTC_Tmp48.dgn
KB/sby

RK&K
P: (919) 878-9560
8601 Six Forks Road, Forum 1, Suite 700
Raleigh, North Carolina 27615-3960
NC License No. F-0112
Engineers | Construction Managers | Planners | Scientists
www.rkk.com
Responsive People | Creative Solutions

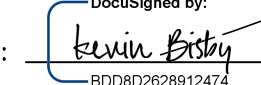
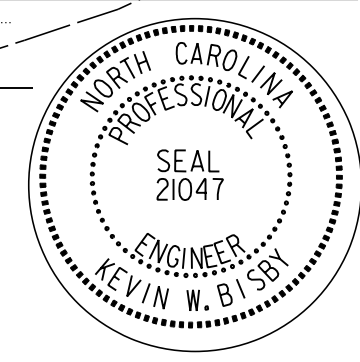
APPROVED: 
DATE: 10/18/2023
SEAL

DOCUMENT NOT CONSIDERED FINAL
UNLESS ALL SIGNATURES COMPLETED

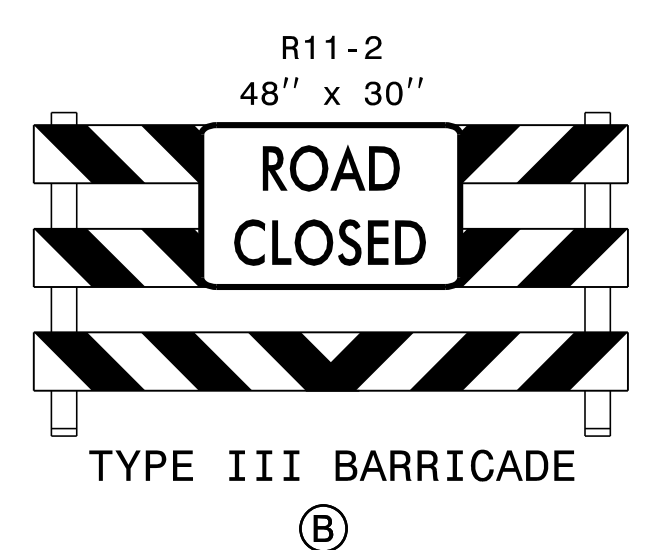
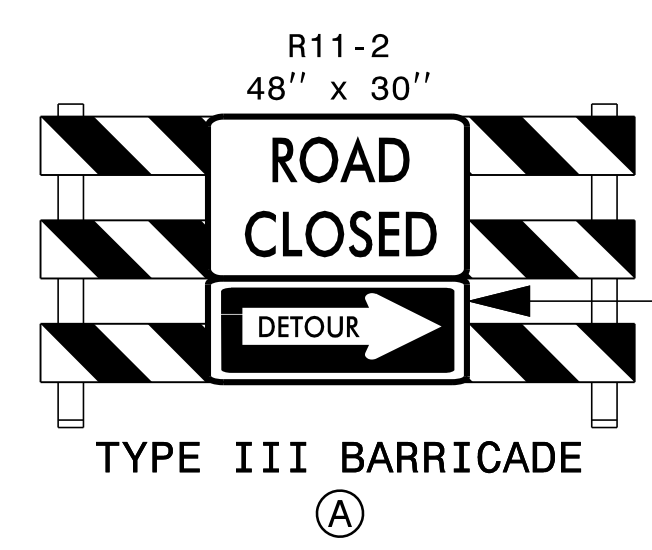
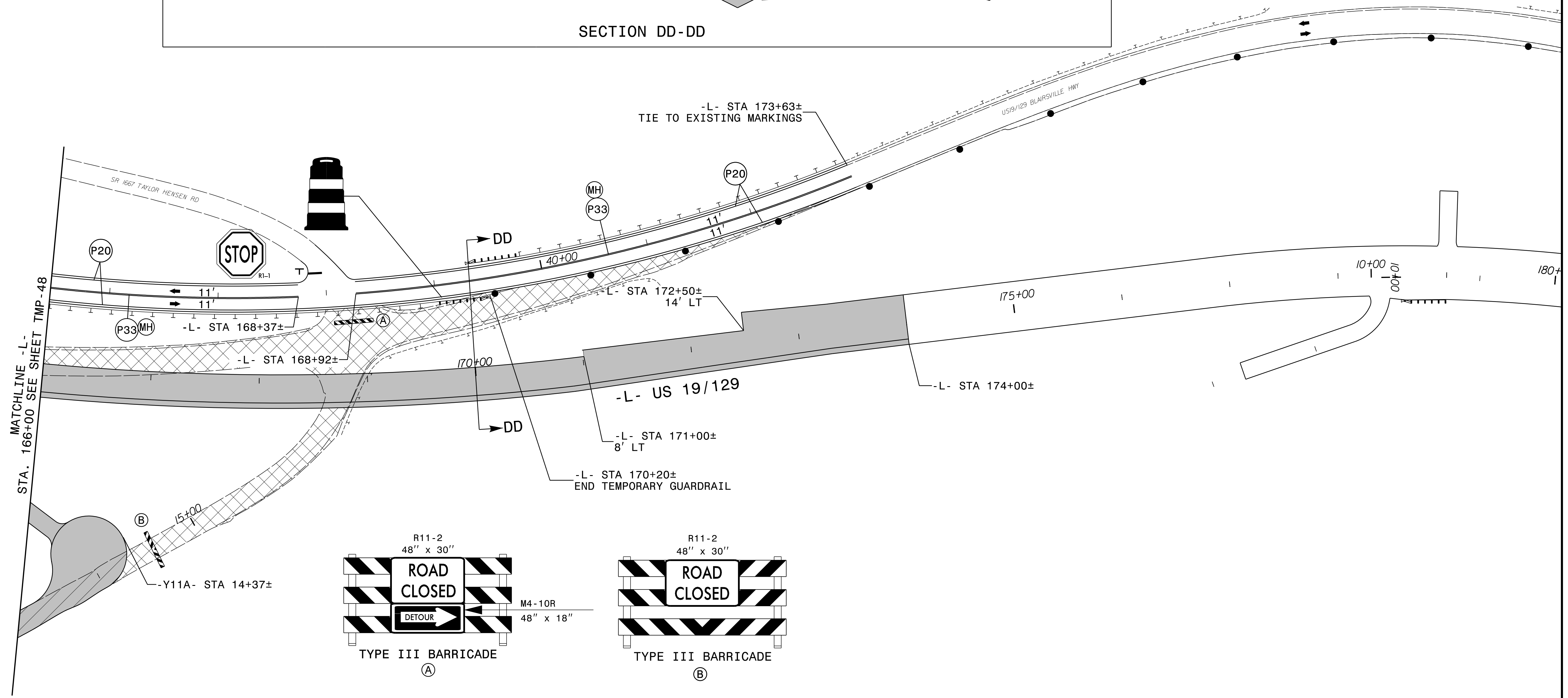
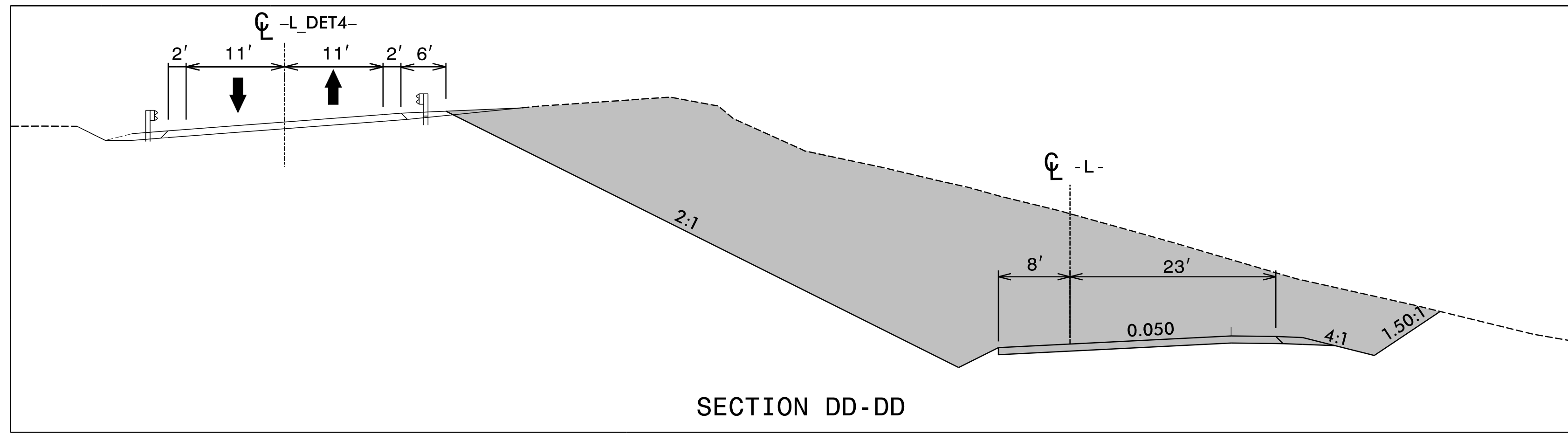

PHASE III - STEPS 2 AND 3



10/18/2023
 R5861.LTC_Tmp49.dgn
 kbisby

RK&K
 P: (919) 878-9560
 8601 Six Forks Road, Forum 1, Suite 700
 Raleigh, North Carolina 27615-3960
 NC License No. F-0112
 Engineers | Construction Managers | Planners | Scientists
 www.rkk.com
 Responsive People | Creative Solutions

APPROVED: *Kevin B. Bly*
BD080262891247
 DATE: 10/18/2023
 SEAL
 NORTH CAROLINA PROFESSIONAL ENGINEER
 KEVIN W. BLY
 SEAL 21047



PHASE III - STEPS 2 AND 3

**DOCUMENT NOT CONSIDERED FINAL
 UNLESS ALL SIGNATURES COMPLETED**

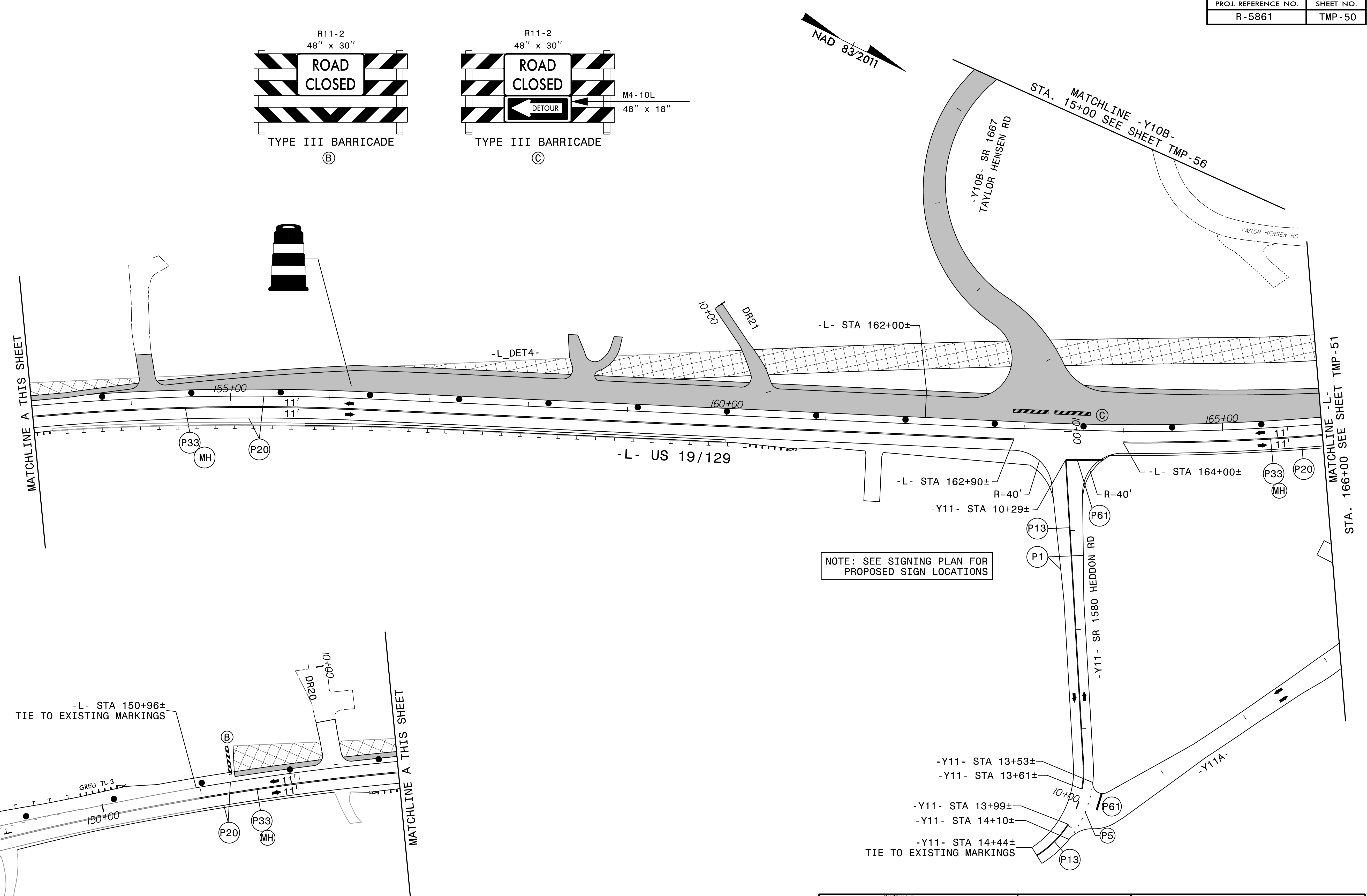
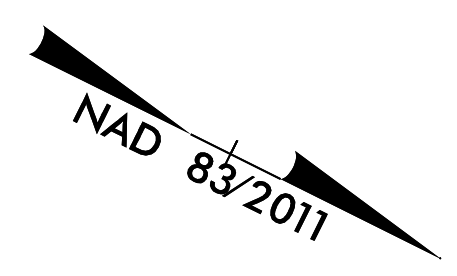
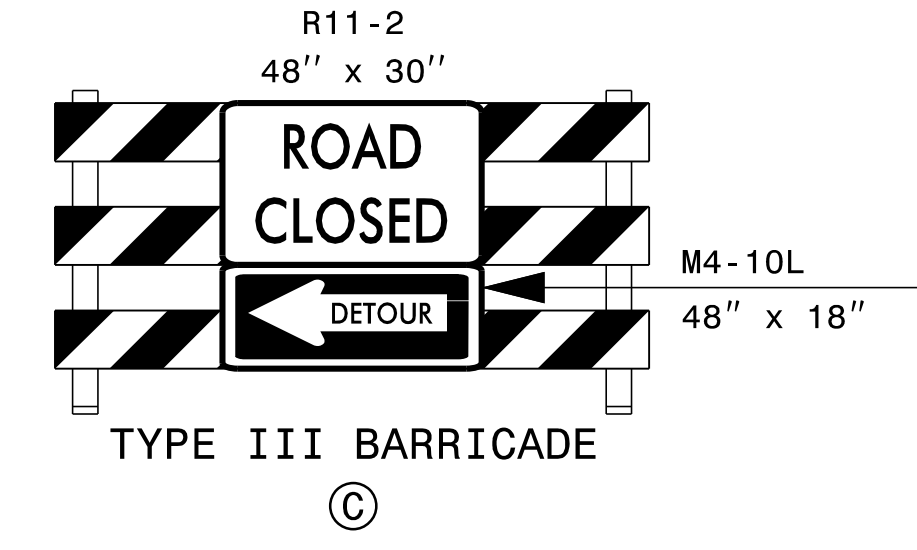
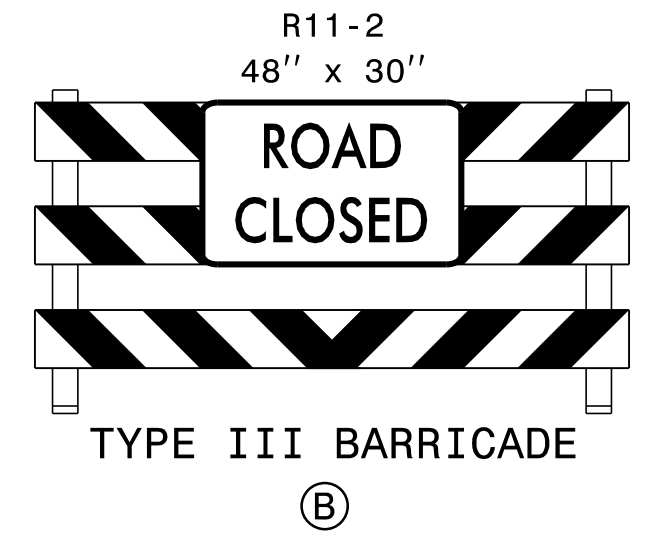

NOTE: SEE SIGNING PLAN FOR PROPOSED SIGN LOCATIONS

10/18/2023
R5861.Tc_Tmp50.dgn
Kb1sby

RK&K
 P: (919) 878-9560
 8601 Six Forks Road, Forum 1, Suite 700
 Raleigh, North Carolina 27615-3960
 NC License No. F-0112
 Engineers | Construction Managers | Planners | Scientists
 www.rkk.com
 Responsive People | Creative Solutions

APPROVED: *Kevin Bisy*
80080262891247
 DATE: 10/18/2023
 SEAL
 DOCUMENT NOT CONSIDERED FINAL
 UNLESS ALL SIGNATURES COMPLETED

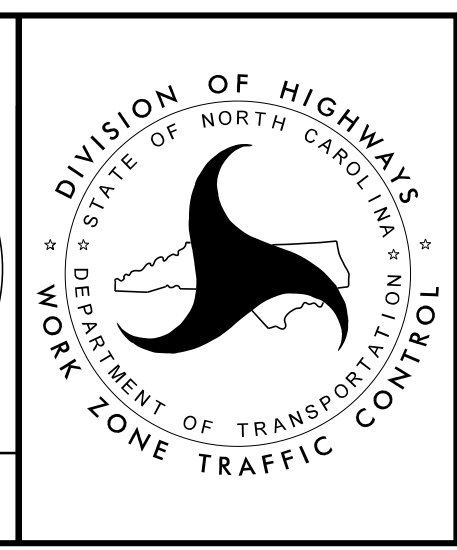

PHASE III - STEPS 3 AND 4

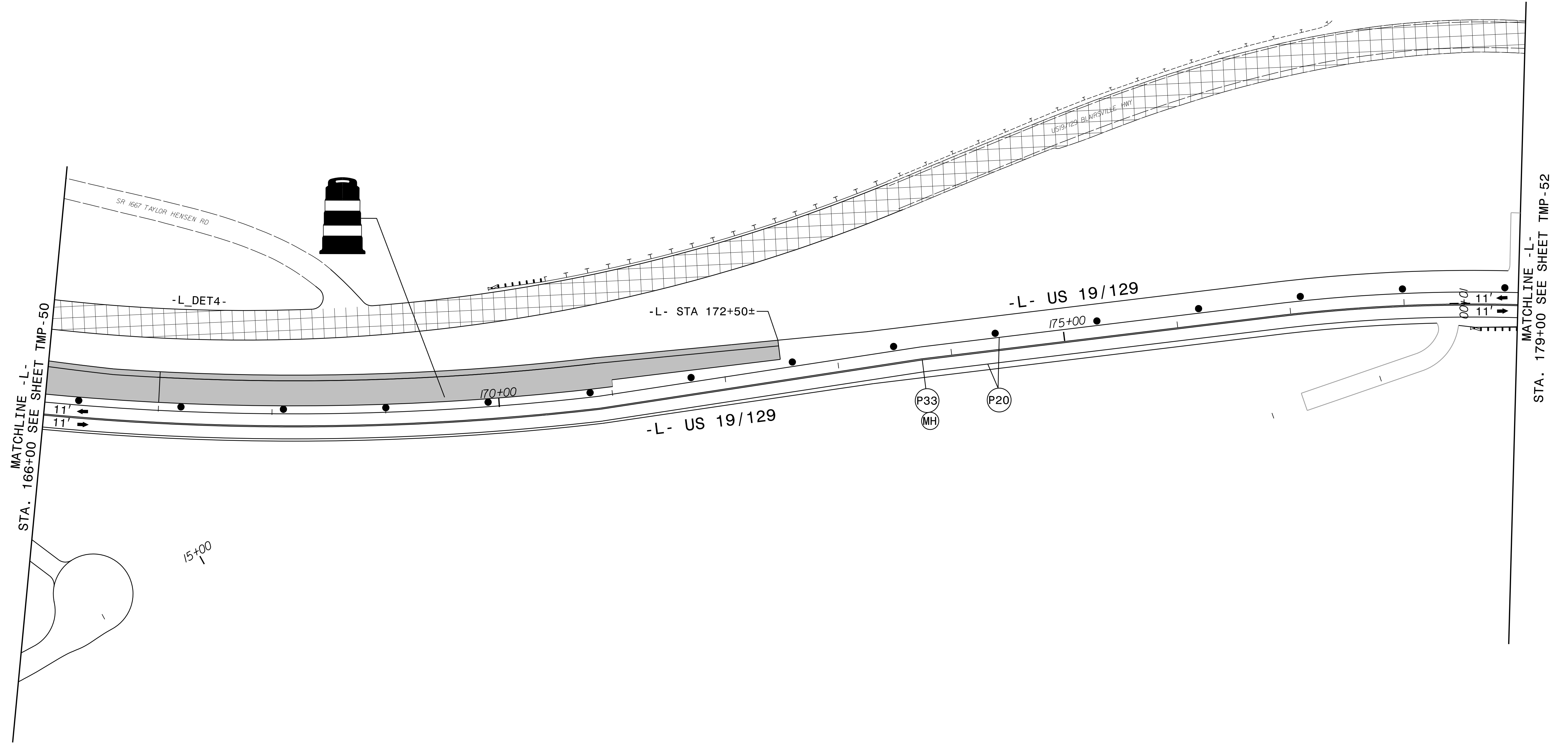

10/18/2023
 R5861.Lc_Tmp51.dgn
 kbisby

RK&K
 P: (919) 878-9560
 8601 Six Forks Road, Forum 1, Suite 700
 Raleigh, North Carolina 27615-3960
 NC License No. F-0112

Engineers | Construction Managers | Planners | Scientists
 www.rkk.com

Responsive People | Creative Solutions

APPROVED: *Kevin W. Blisby*
800802628912472

DATE: 10/18/2023

SEAL

**DOCUMENT NOT CONSIDERED FINAL
 UNLESS ALL SIGNATURES COMPLETED**



PHASE III - STEPS 3 AND 4

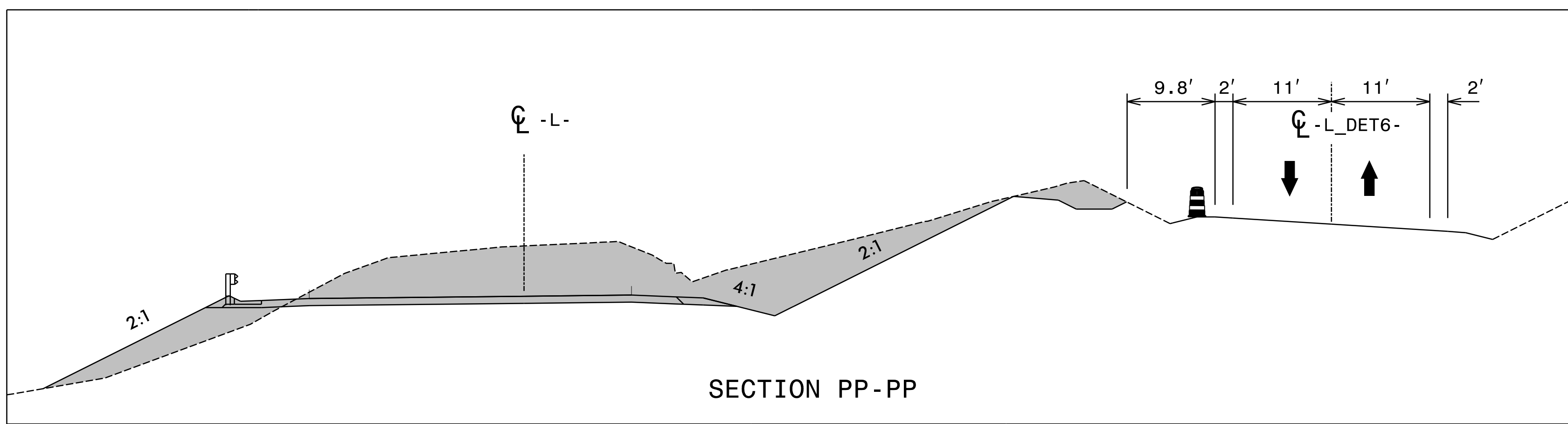
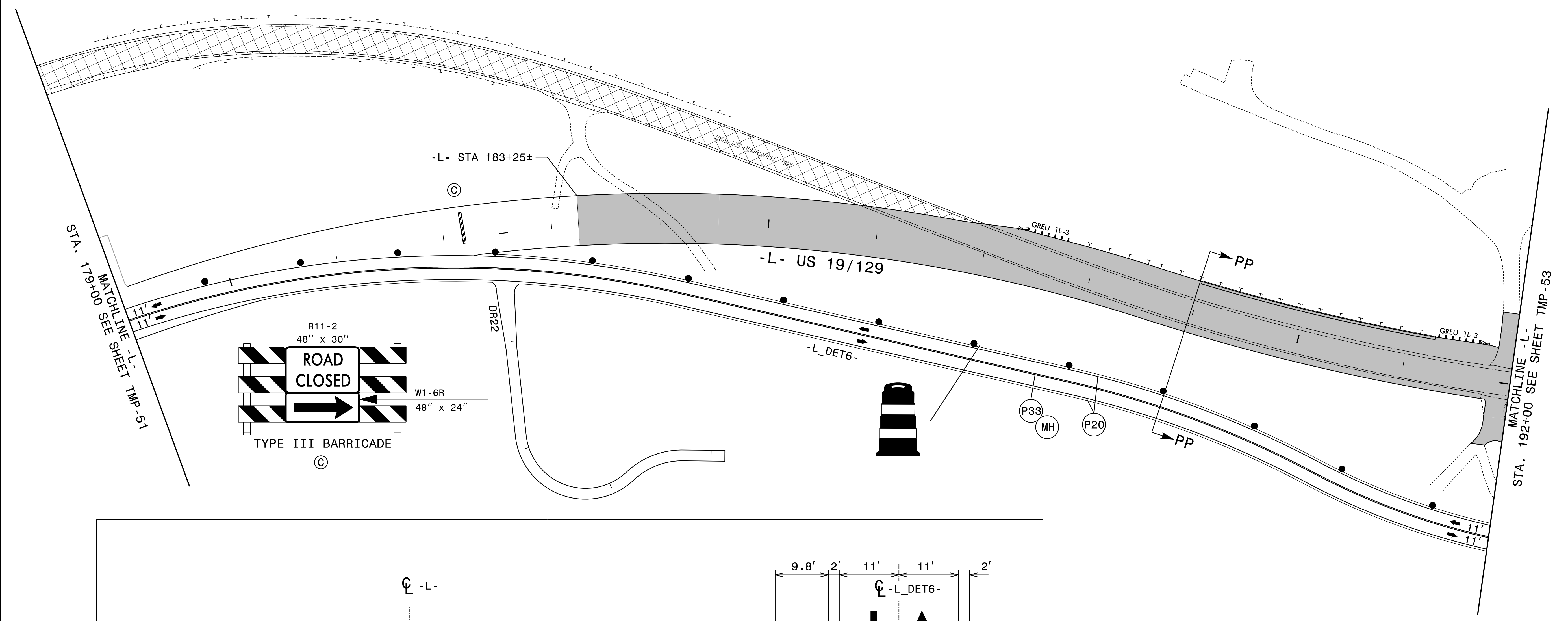

10/18/2023
 R5861.Lc_Tmp52.dgn
 kbisby

RK&K
 P: (919) 878-9560
 8601 Six Forks Road, Forum 1, Suite 700
 Raleigh, North Carolina 27615-3960
 NC License No. F-0112
 Engineers | Construction Managers | Planners | Scientists
 www.rkk.com
 Responsive People | Creative Solutions

APPROVED: *Kevin W. Blisby*
 DATE: 10/18/2023
 SEAL
 NORTH CAROLINA PROFESSIONAL ENGINEER
 SEAL 21047
 KEVIN W. BLISBY



PHASE III - STEPS 3 AND 4

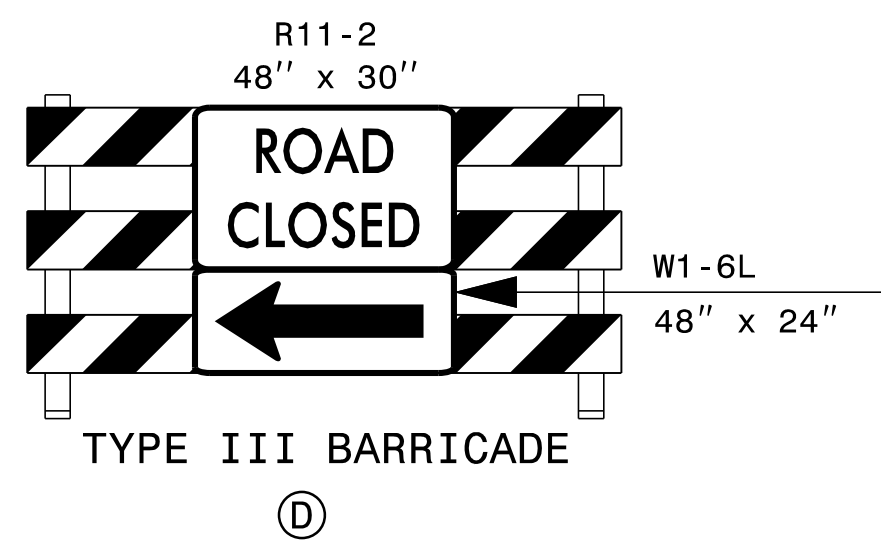
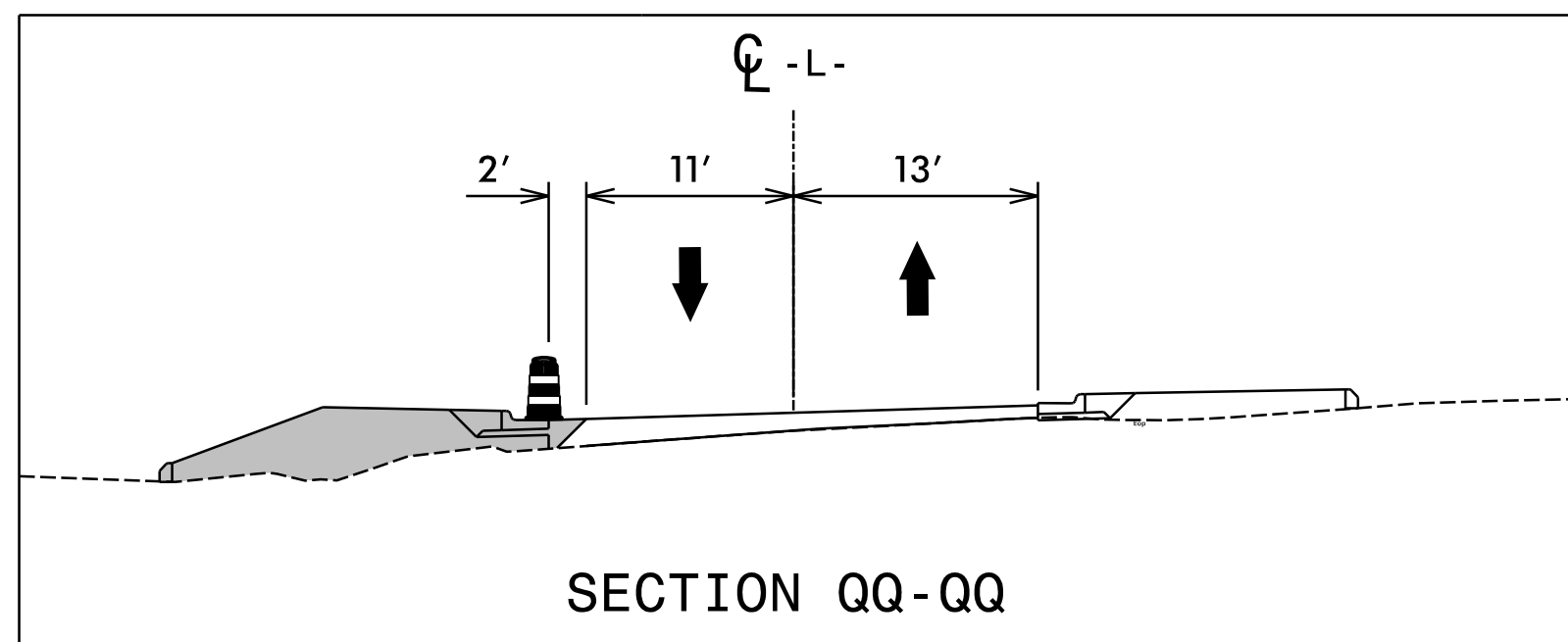
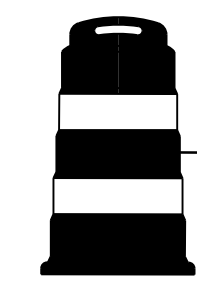
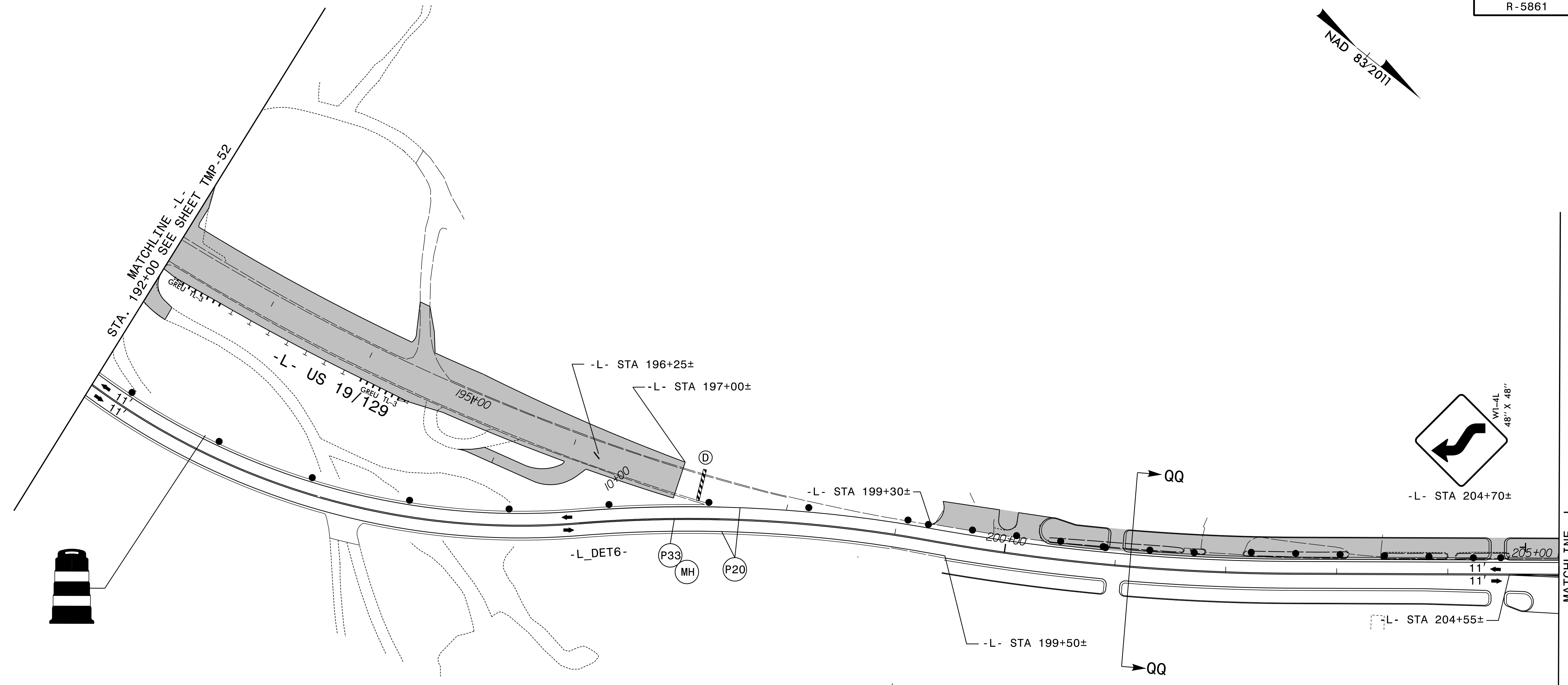

10/18/2023
 R5861.LTC_Tmp53.dgn
 kbisby

RK&K
 P: (919) 878-9560
 8601 Six Forks Road, Forum 1, Suite 700
 Raleigh, North Carolina 27615-3960
 NC License No. F-0112
 Engineers | Construction Managers | Planners | Scientists
 www.rkk.com
 Responsive People | Creative Solutions

APPROVED: *Kevin Bisy*
800802628912472
 DATE: 10/18/2023
 SEAL
 NORTH CAROLINA PROFESSIONAL ENGINEER
 KEVIN W. BISSY
 21047

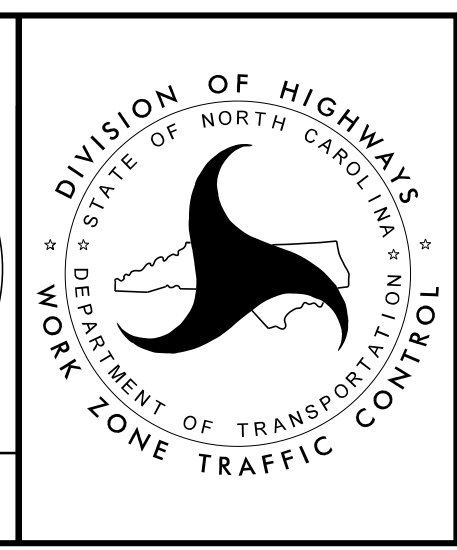

PHASE III - STEP 3

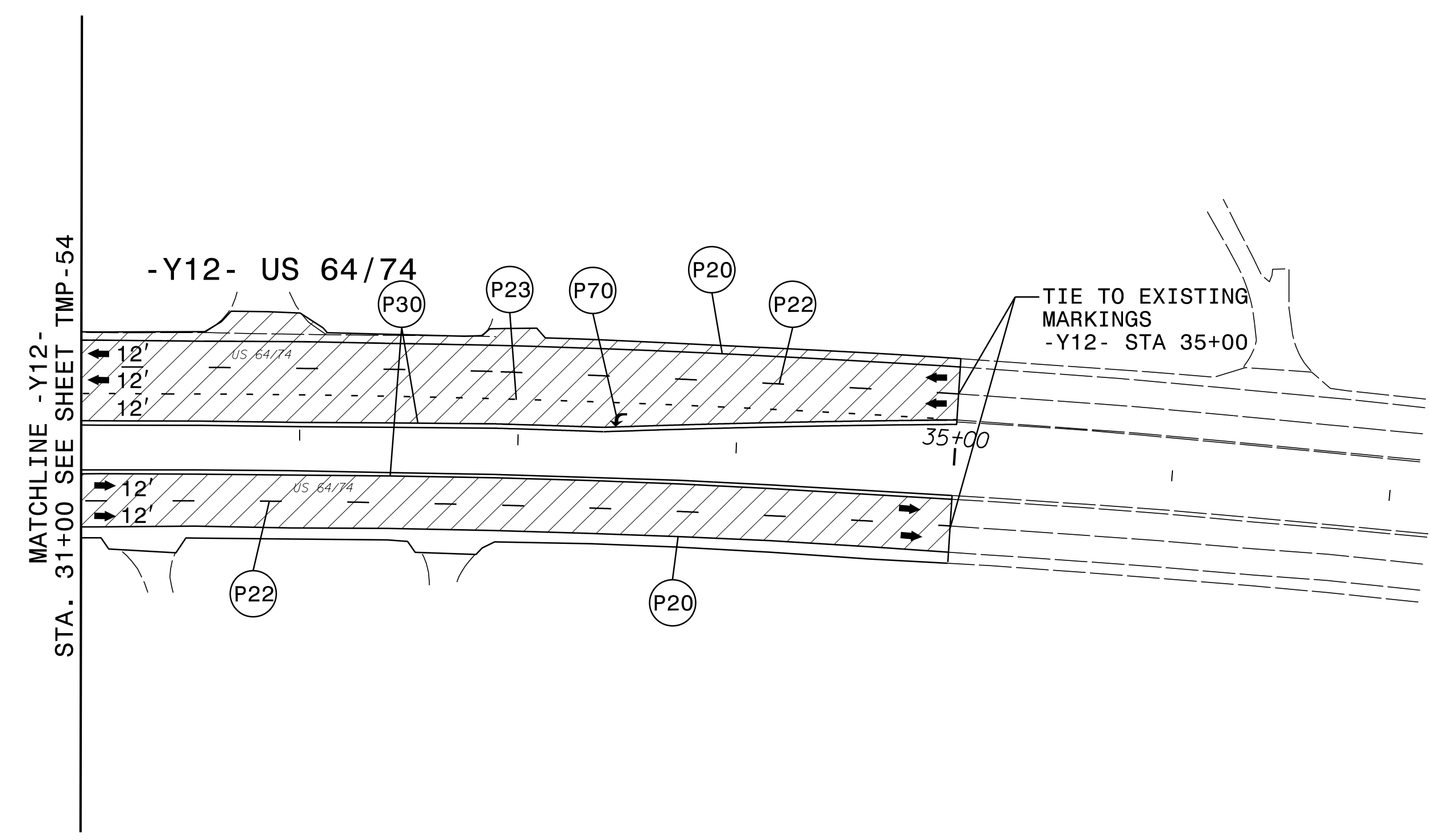

10/18/2023
 R5861.Ltc_Tmp55.dgn
 kbisby

RK&K
 P: (919) 878-9560
 8601 Six Forks Road, Forum 1, Suite 700
 Raleigh, North Carolina 27615-3960
 NC License No. F-0112

Engineers | Construction Managers | Planners | Scientists
 www.rkk.com

Responsive People | Creative Solutions

APPROVED: *Kevin Blisby*
800802628912472

DATE: 10/18/2023

SEAL

**DOCUMENT NOT CONSIDERED FINAL
 UNLESS ALL SIGNATURES COMPLETED**



PHASE III - STEP 4

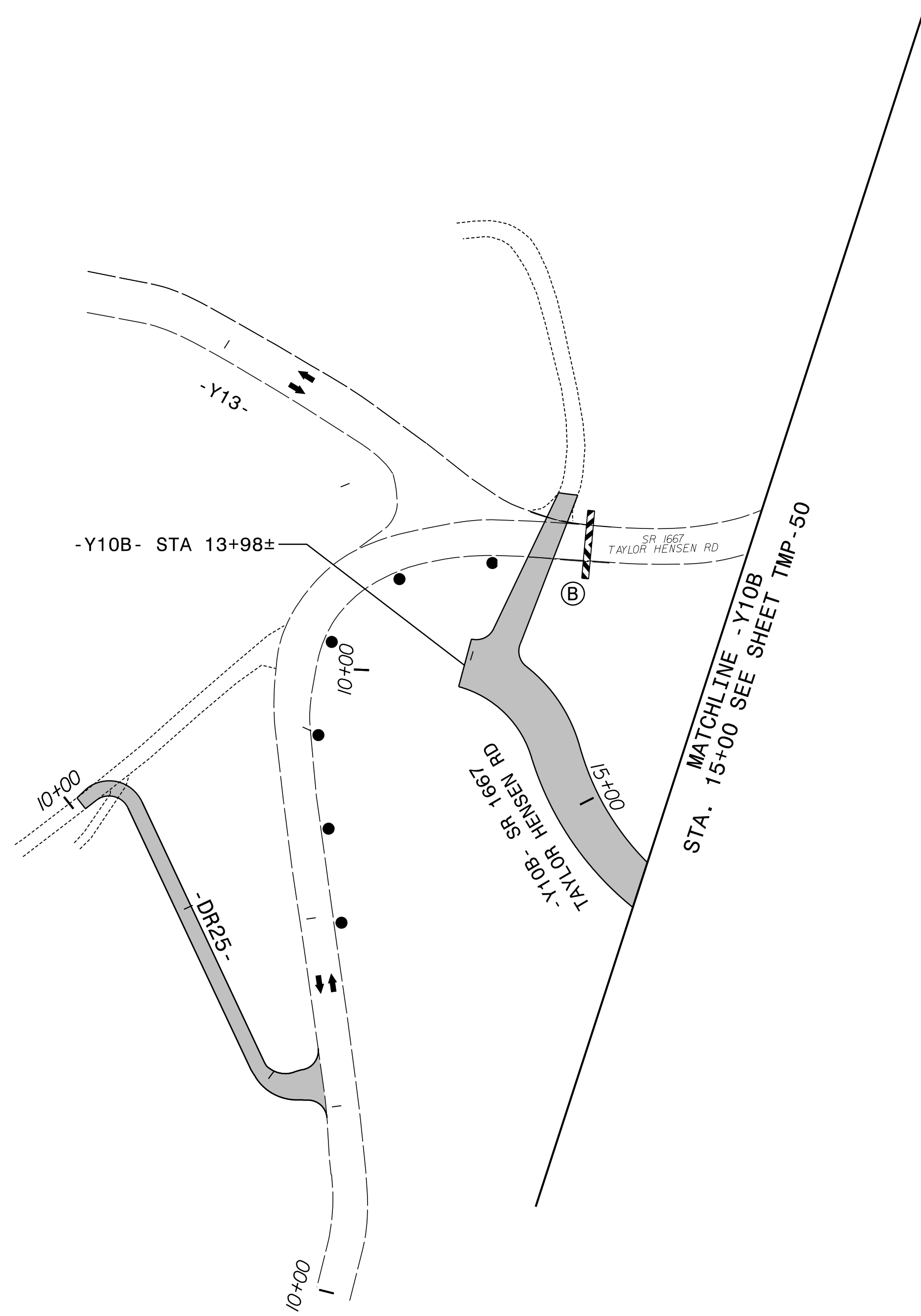
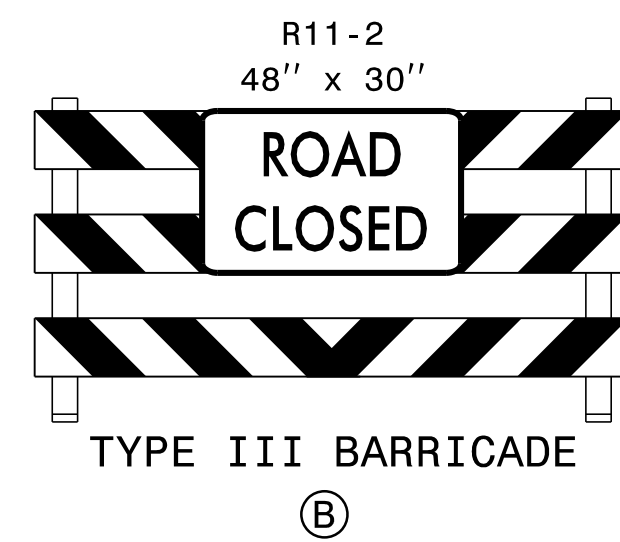
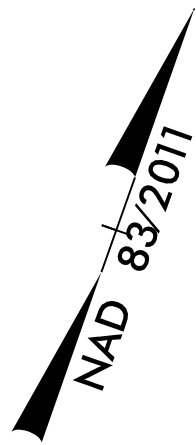

10/18/2023
 R5861.Ltc_Tmp56.dgn
 kbisby

RK&K
 P: (919) 878-9560
 8601 Six Forks Road, Forum 1, Suite 700
 Raleigh, North Carolina 27615-3960
 NC License No. F-0112
 Engineers | Construction Managers | Planners | Scientists
 www.rkk.com
 Responsive People | Creative Solutions

APPROVED: *Kevin Bisby*
B00802628912472
 DATE: 10/18/2023
 SEAL
**DOCUMENT NOT CONSIDERED FINAL
 UNLESS ALL SIGNATURES COMPLETED**

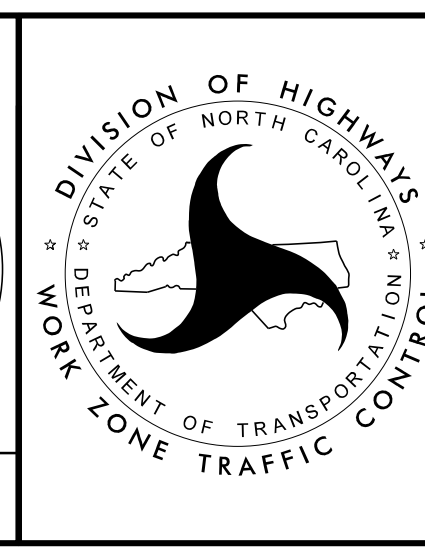

PHASE III - STEPS 3 AND 4

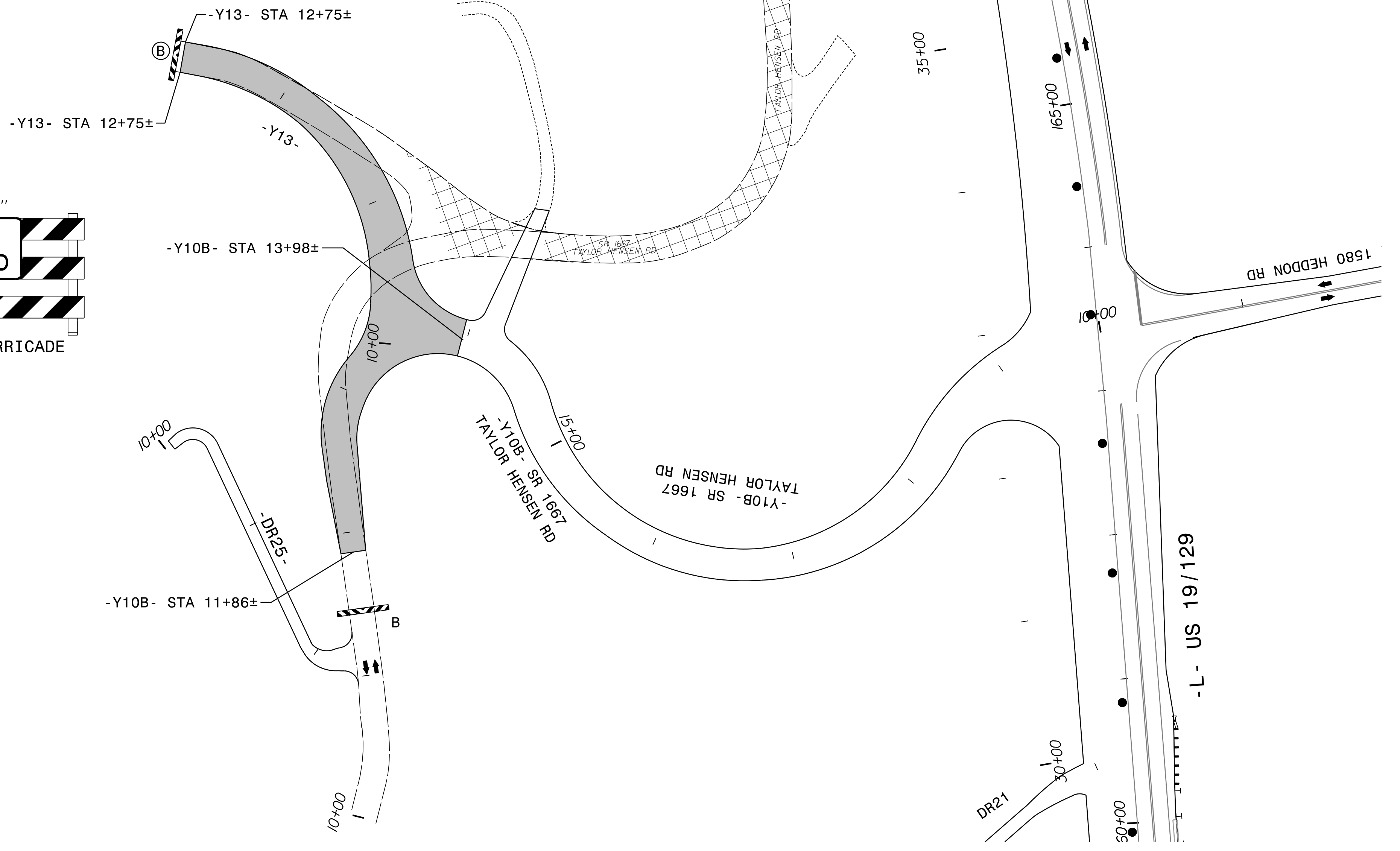
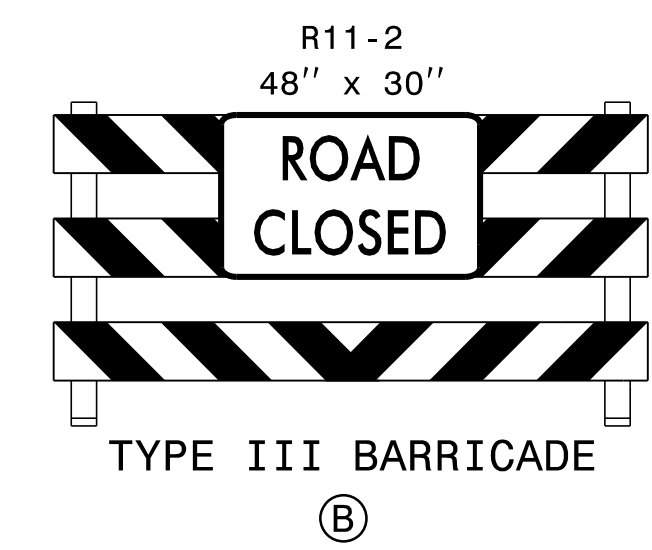
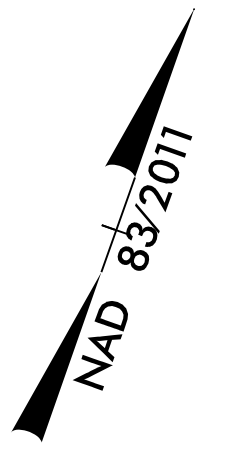

10/18/2023
 R5861.LTC_Tmp57.dgn
 kbisby

RK&K
 P: (919) 878-9560
 8601 Six Forks Road, Forum 1, Suite 700
 Raleigh, North Carolina 27615-3960
 NC License No. F-0112
 Engineers | Construction Managers | Planners | Scientists
 www.rkk.com
 Responsive People | Creative Solutions

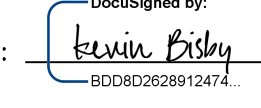
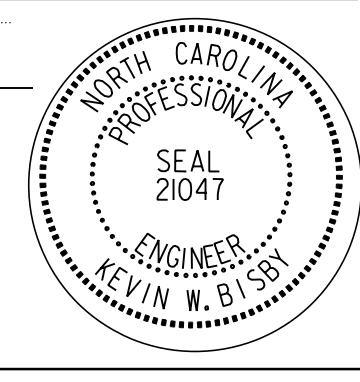
APPROVED: 
800802628912472
 DATE: 10/18/2023
 SEAL

**DOCUMENT NOT CONSIDERED FINAL
 UNLESS ALL SIGNATURES COMPLETED**

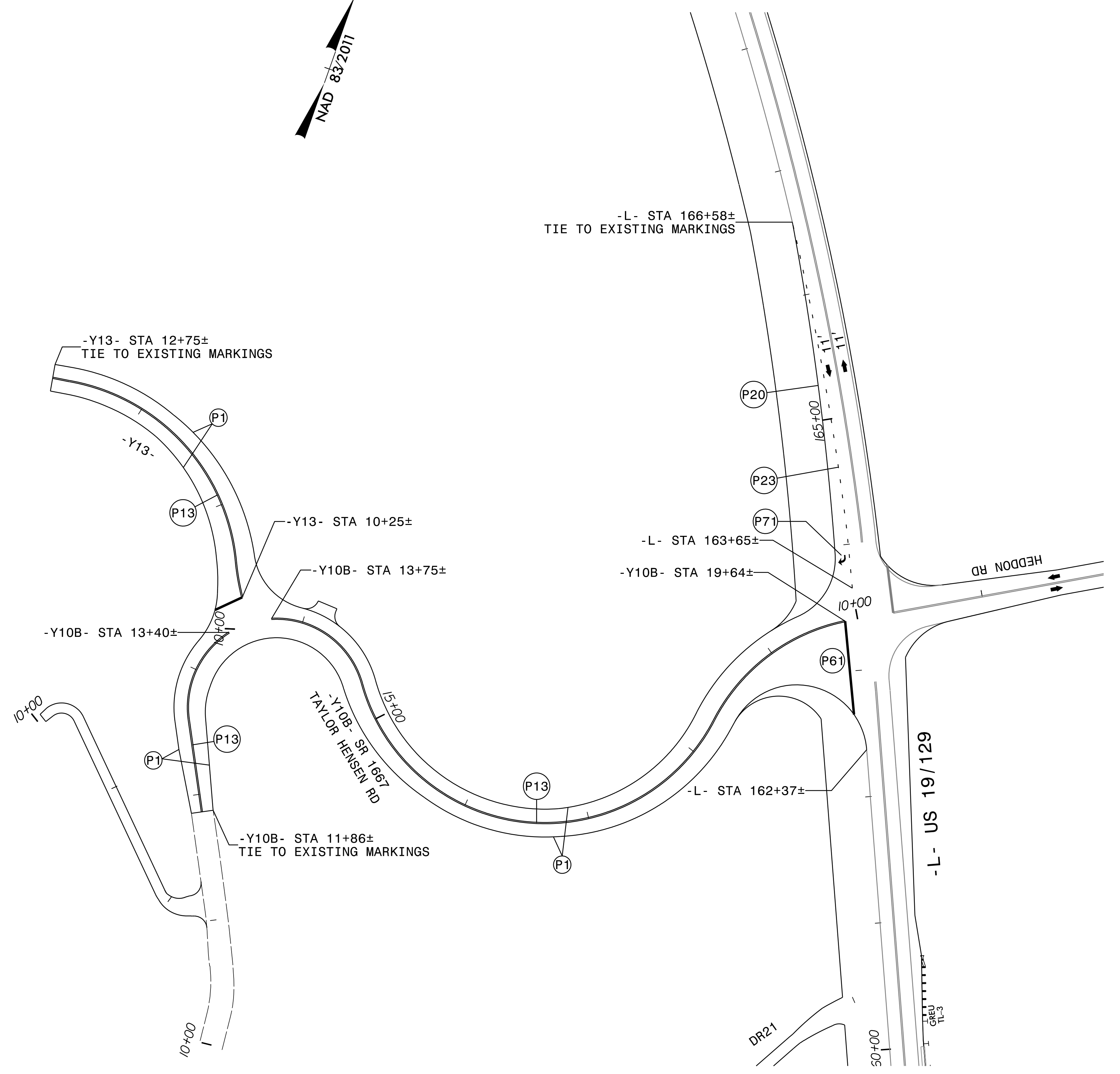
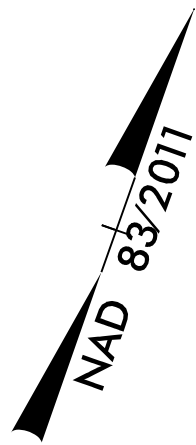

PHASE III - STEP 5



10/18/2023
 R5861.LTC_Tmp57A.dgn
 kbisby

RK&K
 P: (919) 878-9560
 8601 Six Forks Road, Forum 1, Suite 700
 Raleigh, North Carolina 27615-3960
 NC License No. F-0112

Engineers | Construction Managers | Planners | Scientists
 www.rkk.com

Responsive People | Creative Solutions

APPROVED: *Kevin Bisby*
800802628912472

DATE: 10/18/2023

SEAL

**DOCUMENT NOT CONSIDERED FINAL
 UNLESS ALL SIGNATURES COMPLETED**

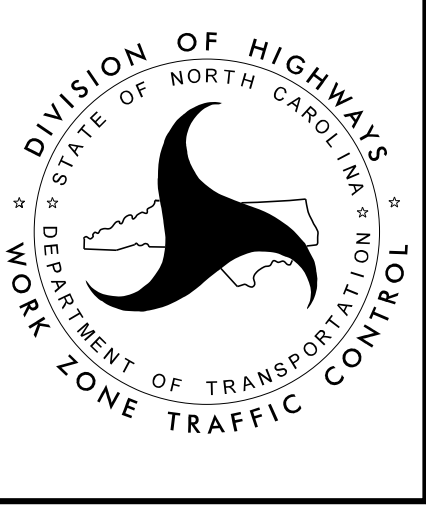

PHASE III - STEP 5

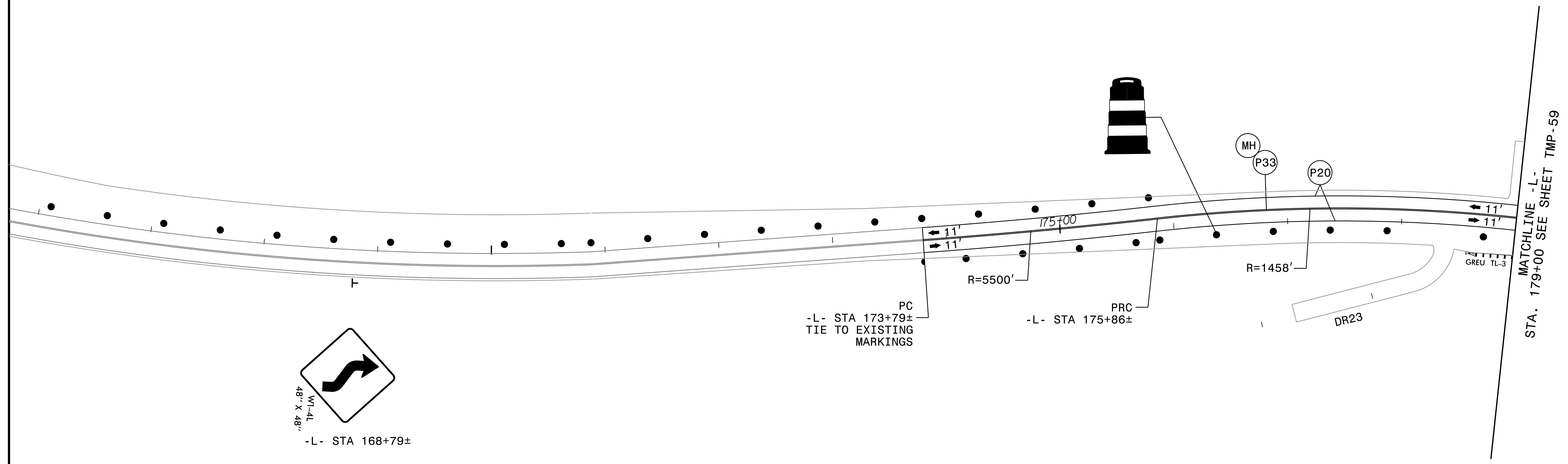

10/18/2023
 R5861.LTC_Tmp58.dgn
 kbisby

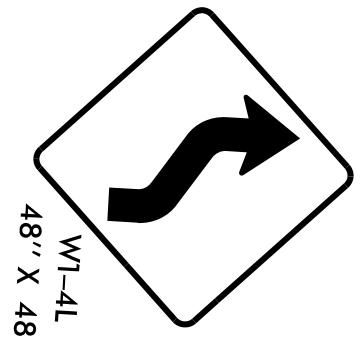

 W1-4L
 48' X 48'
 -L- STA 168+79±

PC
 -L- STA 173+79±
 TIE TO EXISTING
 MARKINGS

PRC
 -L- STA 175+86±

MATCHLINE - L -
 STA. 179+00 SEE SHEET TMP-59

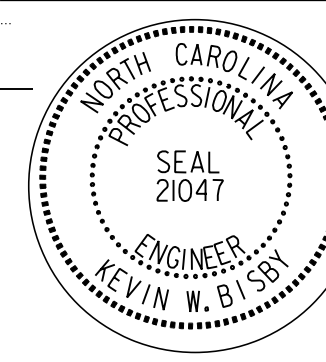
RK&K
 P: (919) 878-9560
 8601 Six Forks Road, Forum 1, Suite 700
 Raleigh, North Carolina 27615-3960
 NC License No. F-0112
 Engineers | Construction Managers | Planners | Scientists
 www.rkk.com
 Responsive People | Creative Solutions

APPROVED: 
800802628912472
 DATE: 10/18/2023
 SEAL

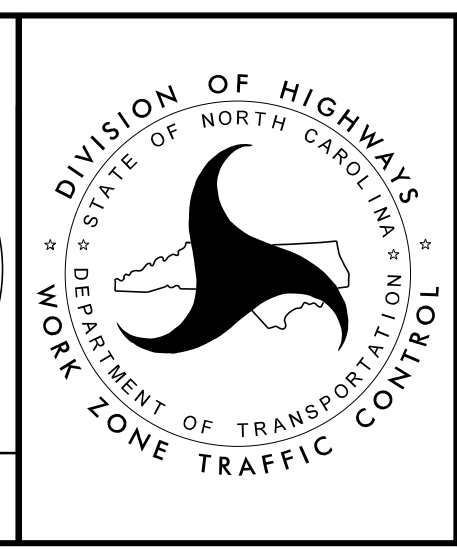

PHASE III - STEP 6

**DOCUMENT NOT CONSIDERED FINAL
 UNLESS ALL SIGNATURES COMPLETED**

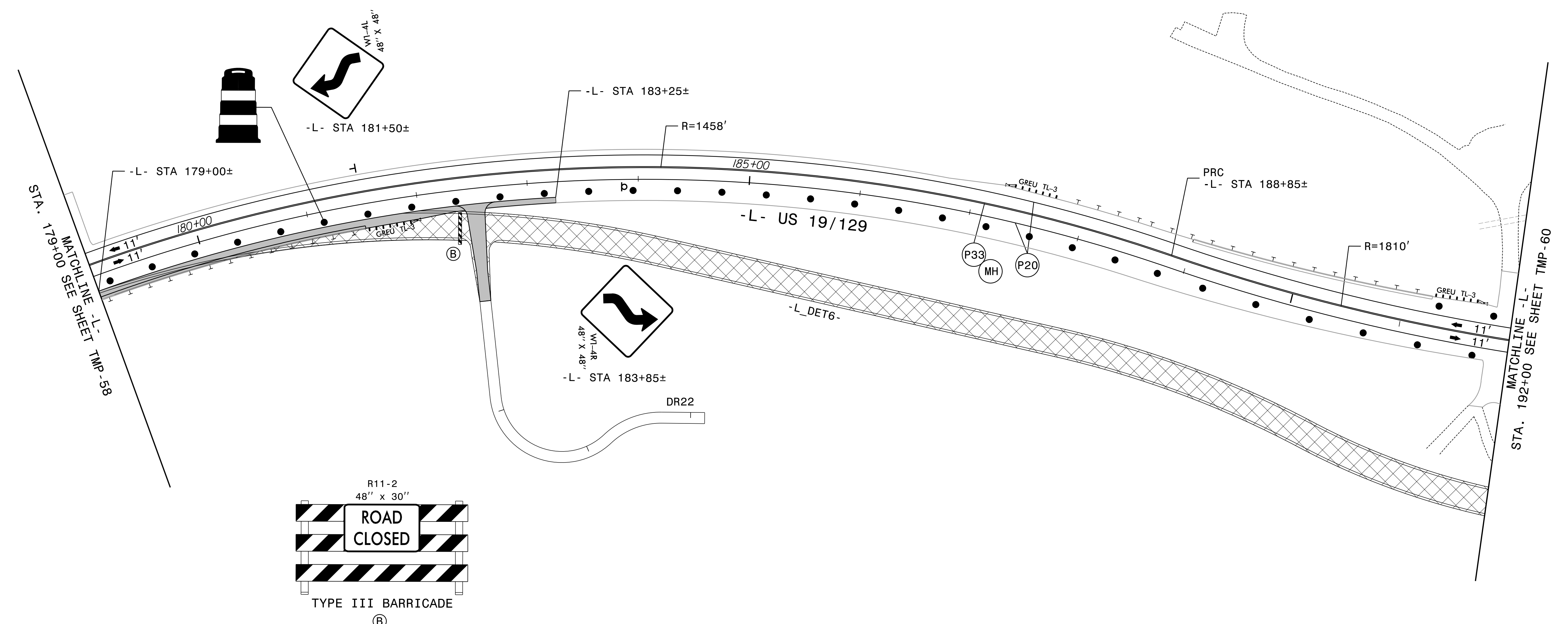

10/18/2023
 R5861.Lc_Tmp59.dgn
 kbisby

RK&K
 P: (919) 878-9560
 8601 Six Forks Road, Forum 1, Suite 700
 Raleigh, North Carolina 27615-3960
 NC License No. F-0112
 Engineers | Construction Managers | Planners | Scientists
 www.rkk.com
 Responsive People | Creative Solutions

APPROVED: *Kevin W. Blisby*
800802628912472
 DATE: 10/18/2023
 SEAL
 NORTH CAROLINA PROFESSIONAL ENGINEER
 SEAL 21047
 KEVIN W. BLISBY



PHASE III - STEP 6

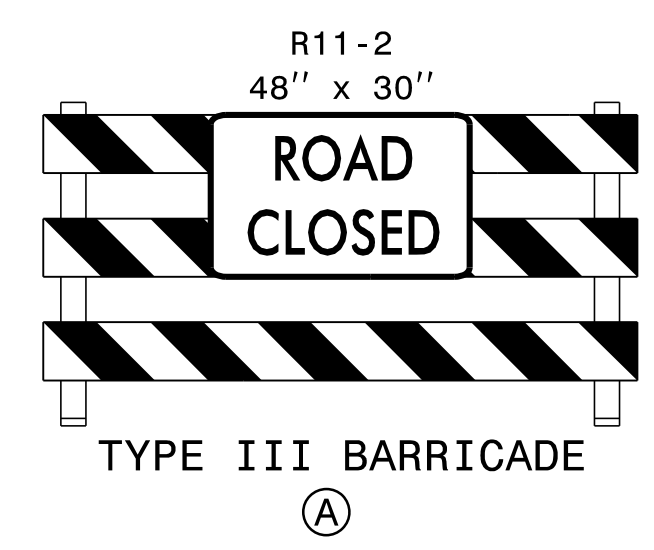
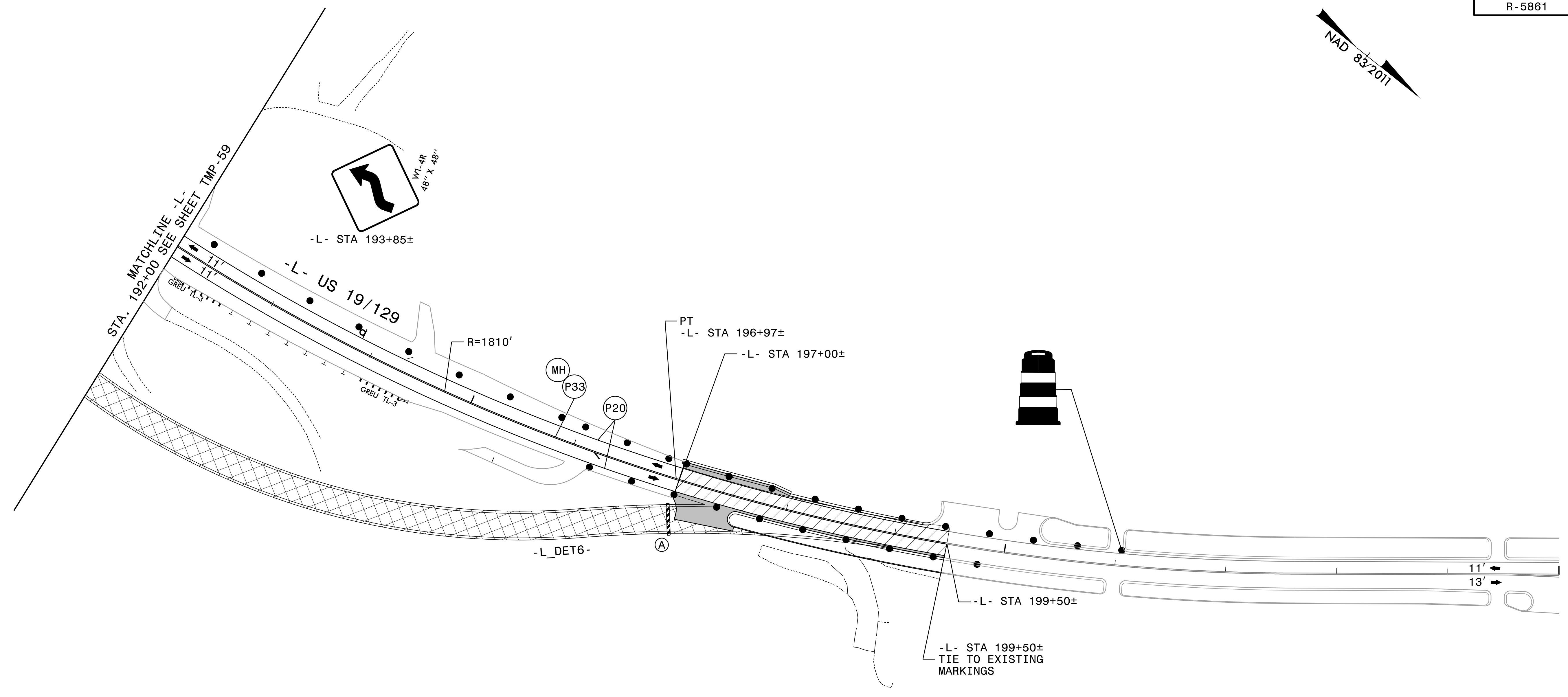

10/18/2023
 R5861.Ltc_Tmp60.dgn
 kbisby

RK&K
 P: (919) 878-9560
 8601 Six Forks Road, Forum 1, Suite 700
 Raleigh, North Carolina 27615-3960
 NC License No. F-0112
 Engineers | Construction Managers | Planners | Scientists
 www.rkk.com
 Responsive People | Creative Solutions

APPROVED: *Kevin Blisby*
800802628912472
 DATE: 10/18/2023
 SEAL
 NORTH CAROLINA PROFESSIONAL ENGINEER
 SEAL 21047
 KEVIN W. BLISBY



PHASE III - STEPS 6 AND 7

**DOCUMENT NOT CONSIDERED FINAL
 UNLESS ALL SIGNATURES COMPLETED**