

**T.I.P.: R-3833C**

**CONTRACT NO.: C204852**

**STATE OF NORTH CAROLINA  
DEPARTMENT OF TRANSPORTATION**

**PAVEMENT MARKING PLAN  
IREDELL COUNTY**

**LOCATION: SR 1100 (BRAWLEY SCHOOL RD) FROM  
SR 1116 (TALBERT RD) TO 1000 FT EAST OF US 21**

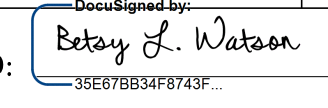
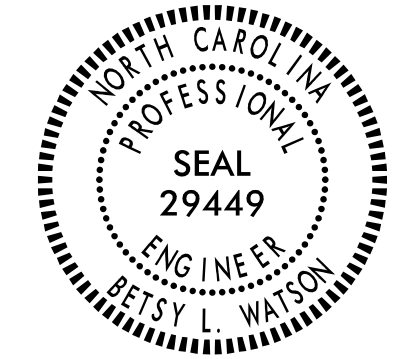
TIP NO. <b>R-3833C</b>	SHEET NO. <b>PMP - 1</b>
APPROVED:  <small>DocuSigned by: Betsy L. Watson 35E6F0B34F9743F</small>	
DATE: 4/28/2023	
	
<b>DOCUMENT NOT CONSIDERED FINAL UNLESS ALL SIGNATURES COMPLETED</b>	

**ROADWAY STANDARD DRAWINGS**

THE FOLLOWING ROADWAY STANDARDS AS APPEAR IN "ROADWAY STANDARD DRAWINGS" - PROJECT SERVICES UNIT - N.C. DEPARTMENT OF TRANSPORTATION - RALEIGH, N.C., DATED JANUARY 2018 ARE APPLICABLE TO THIS PROJECT AND BY REFERENCE HEREBY ARE CONSIDERED A PART OF THESE PLANS:

STD. NO.	TITLE
1205.01	PAVEMENT MARKINGS - LINE TYPES & OFFSETS
1205.02	PAVEMENT MARKINGS - 2 LANE & MULTILANE ROADWAYS
1205.04	PAVEMENT MARKINGS - INTERSECTIONS (SEE SHEET 1A FOR SHEET 2 OF 2)
1205.05	PAVEMENT MARKINGS - TURN LANES
1205.06	PAVEMENT MARKINGS - LANE DROP
1205.07	PAVEMENT MARKINGS - PEDESTRIAN CROSSWALKS
1205.08	PAVEMENT MARKINGS - SYMBOLS & WORD MESSAGES
1205.09	PAVEMENT MARKINGS - PAINTED ISLANDS
1205.13	PAVEMENT MARKINGS - LANE REDUCTIONS
1205.15	PAVEMENT MARKINGS - SUPERSTREETS
1250.01	RAISED PAVEMENT MARKERS - INSTALLATION SPACING
1253.01	RAISED PAVEMENT MARKERS - SNOWPLOWABLE
1261.01	GUARDRAIL & BARRIER DELINEATORS - INSTALLATION SPACING
1261.02	GUARDRAIL & BARRIER DELINEATORS - TYPES & MOUNTING
1262.01	GUARDRAIL END DELINEATION

**GENERAL NOTES**

THE FOLLOWING GENERAL NOTES APPLY AT ALL TIMES FOR THE DURATION OF THE CONSTRUCTION PROJECT, EXCEPT WHEN OTHERWISE NOTED IN THE PLAN, OR DIRECTED BY THE ENGINEER.

- A) INSTALL PAVEMENT MARKINGS AND PAVEMENT MARKERS ON THE FINAL SURFACE AS FOLLOWS:
 

ROAD NAME	MARKING	MARKER
ALL ROADS	POLYUREA	SNOWPLOWABLE
- B) TIE PROPOSED PAVEMENT MARKING LINES TO EXISTING PAVEMENT MARKING LINES.
- C) REMOVE/REPLACE ANY CONFLICTING/DAMAGED PAVEMENT MARKINGS AND MARKERS.
- D) PASSING ZONES WILL BE DETERMINED IN THE FIELD AND MUST BE APPROVED BY THE ENGINEER.
- E) STOP BAR LOCATION AT NON-SIGNALIZED INTERSECTIONS MAY BE ADJUSTED AS DIRECTED BY THE ENGINEER.
- F) UNLESS OTHERWISE SPECIFIED, HEATED-IN-PLACE THERMOPLASTIC MAY BE USED IN LIEU OF EXTRUDED THERMOPLASTIC FOR STOP BARS, SYMBOLS, CHARACTERS AND DIAGONALS.
- G) ALL BICYCLE LANE SYMBOLS SHALL BE HEATED-IN-PLACE THERMOPLASTIC. SYMBOLS SHALL BE PAID FOR USING THE HEATED-IN-PLACE PAY ITEM.
- H) SEE ROADWAY PLANS FOR ALTERNATE CURB RAMP DESIGNS WHEN INDICATED ON PAVEMENT MARKING DETAIL SHEETS.

**FINAL PAVEMENT MARKING SCHEDULE**

SYMBOL	DESCRIPTION	PAY ITEM
T41	WHITE DIAGONAL	(8", 90 MILS) THERMOPLASTIC
T42	YELLOW DIAGONAL	(8", 90 MILS) THERMOPLASTIC
T46	WHITE CROSSWALK LINE	(8", 90 MILS) THERMOPLASTIC
T51	WHITE DIAGONAL	(12", 90 MILS) THERMOPLASTIC
T52	YELLOW DIAGONAL	(12", 90 MILS) THERMOPLASTIC
T61	WHITE STOPBAR	(24", 90 MILS) THERMOPLASTIC
T62	WHITE CROSSWALK LINE	(24", 90 MILS) THERMOPLASTIC
T70	LEFT TURN ARROW	(90 MILS) THERMOPLASTIC
T71	RIGHT TURN ARROW	(90 MILS) THERMOPLASTIC
T72	STRAIGHT ARROW	(90 MILS) THERMOPLASTIC
T74	COMBO STRAIGHT/RIGHT	(90 MILS) THERMOPLASTIC
T77	U-TURN ARROW	(90 MILS) THERMOPLASTIC
T78	COMBO LEFT/U-TURN	(90 MILS) THERMOPLASTIC
T79	MERGE ARROW	(90 MILS) THERMOPLASTIC
T90	BICYCLE SYMBOL, HEATED-IN-PLACE	(90 MILS) THERMOPLASTIC
T91	BICYCLE STRAIGHT ARROW, HEATED-IN-PLACE	(90 MILS) THERMOPLASTIC
T93	BICYCLE CHARACTER, HEATED-IN-PLACE	(120 MILS) THERMOPLASTIC
T100	ALPHANUMERIC CHAR	(90 MILS) THERMOPLASTIC
T104	ROUTE SHIELD ON DARK PAVEMENT 6 FT X 15 FT	(90 MILS) THERMOPLASTIC
V1	WHITE EDGELINE	(4", 20 MILS) POLYUREA
V2	WHITE SOLID LANE LINE	(4", 20 MILS) POLYUREA
V3	10 FT WHITE SKIP	(4", 20 MILS) POLYUREA
V4	3 FT-9 FT/SP WHITE MINISKIP	(4", 20 MILS) POLYUREA
V5	2 FT-6FT/SP WHITE MINISKIP	(4", 20 MILS) POLYUREA
V10	YELLOW EDGELINE	(4", 20 MILS) POLYUREA
V13	YELLOW DOUBLE CENTER	(4", 20 MILS) POLYUREA
V14	2 FT-6FT/SP YELLOW MINISKIP	(4", 20 MILS) POLYUREA
V40	WHITE GORELINE	(8", 20 MILS) POLYUREA
V43	WHITE SOLID LANE LINE	(8", 20 MILS) POLYUREA
V44	3 FT-9 FT/SP WHITE MINISKIP	(8", 20 MILS) POLYUREA

**INDEX**

SHEET NO.	DESCRIPTION
PMP - 1	PAVEMENT MARKING PLAN TITLE AND SCHEDULE SHEET
PMP - 1A	REVISED ROADWAY STANDARD DRAWING
PMP - 2 - 9	PAVEMENT MARKING DETAIL

<b>PLAN PREPARED BY:</b>	 <small>Stantec Consulting Services Inc. 801 Jones Franklin Road Suite 300 Raleigh, NC 27606 Tel. (919) 851-6866 Fax. (919) 851-7024 www.stantec.com License No. F-0672</small>
<b>BETSY L. WATSON, P.E.</b> SENIOR TRANSPORTATION ENGINEER	
<b>ROSI R. HENNEIN</b> TRANSPORTATION DESIGNER	



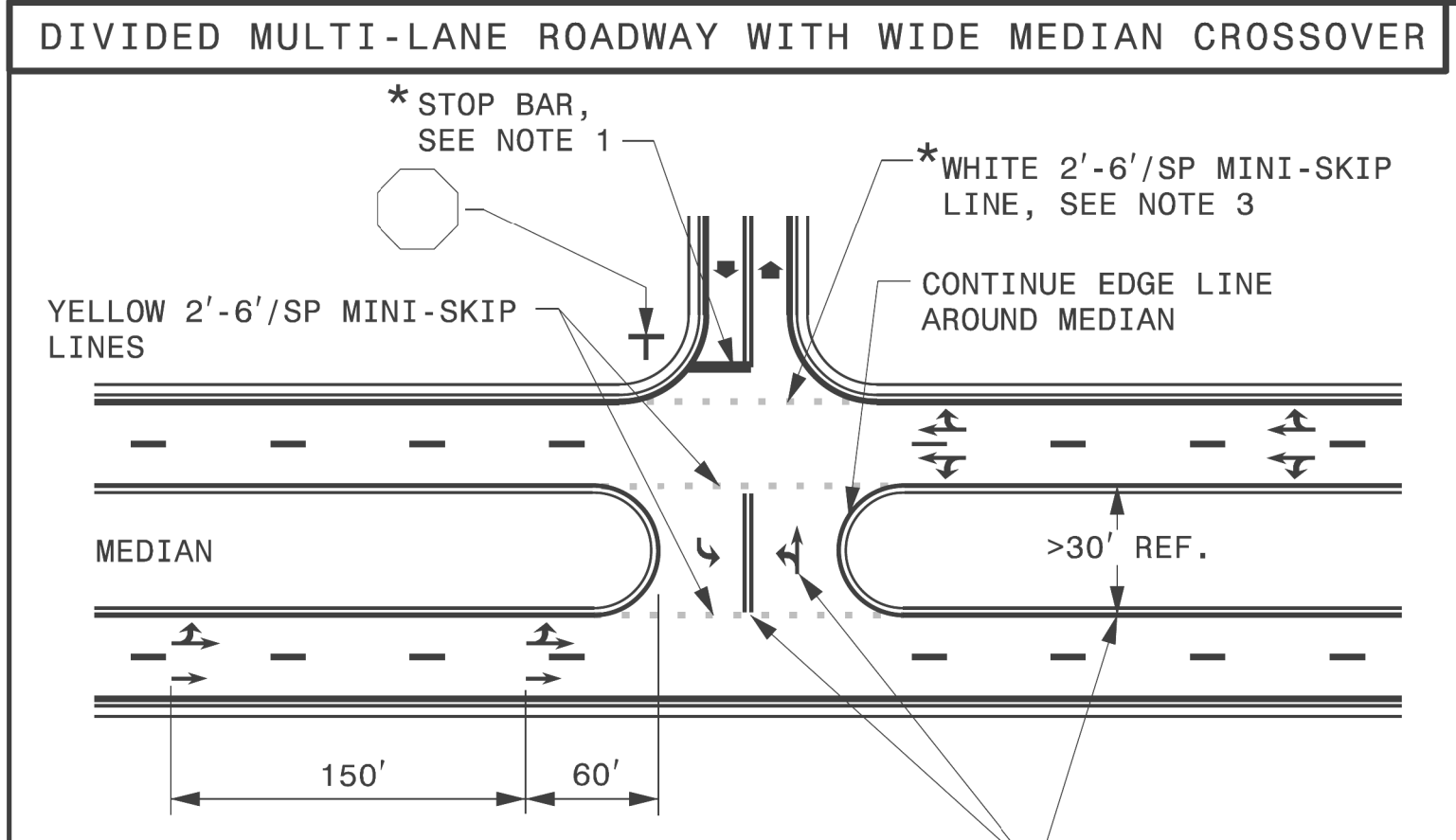
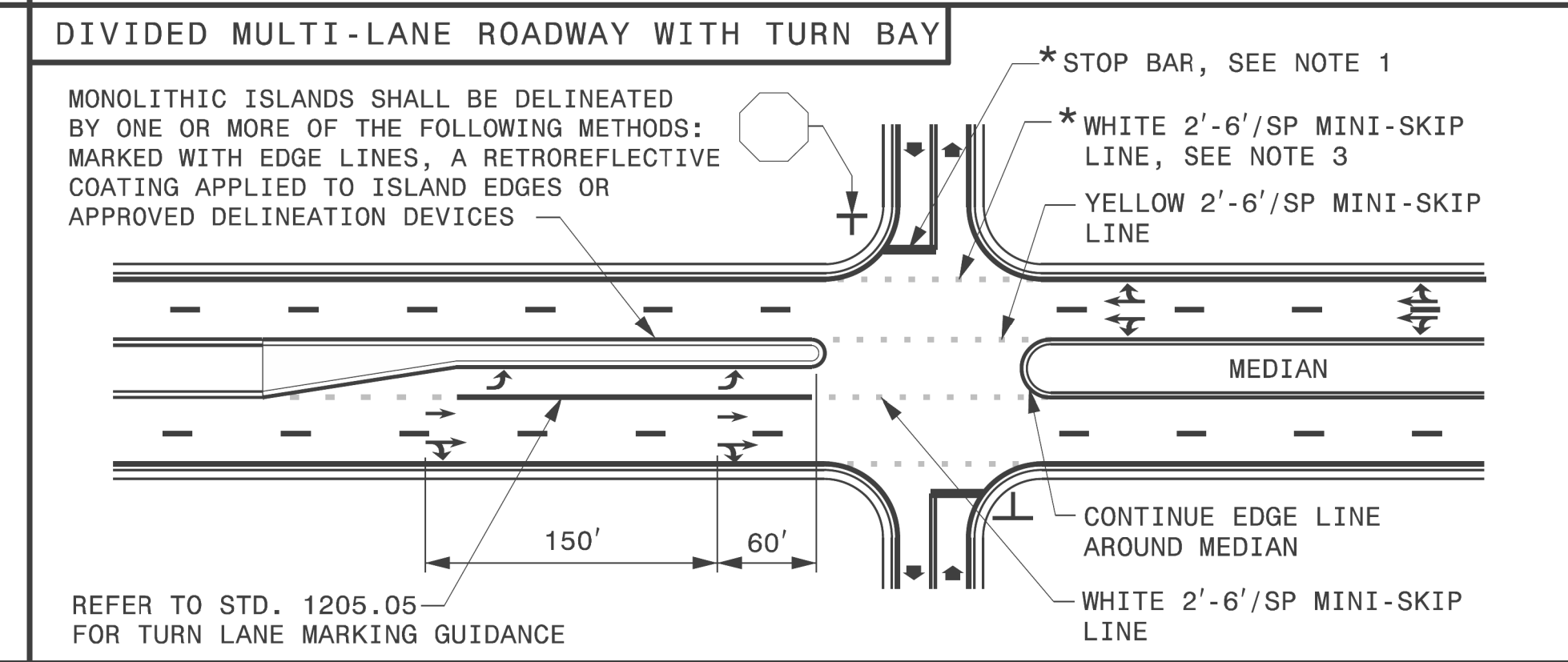
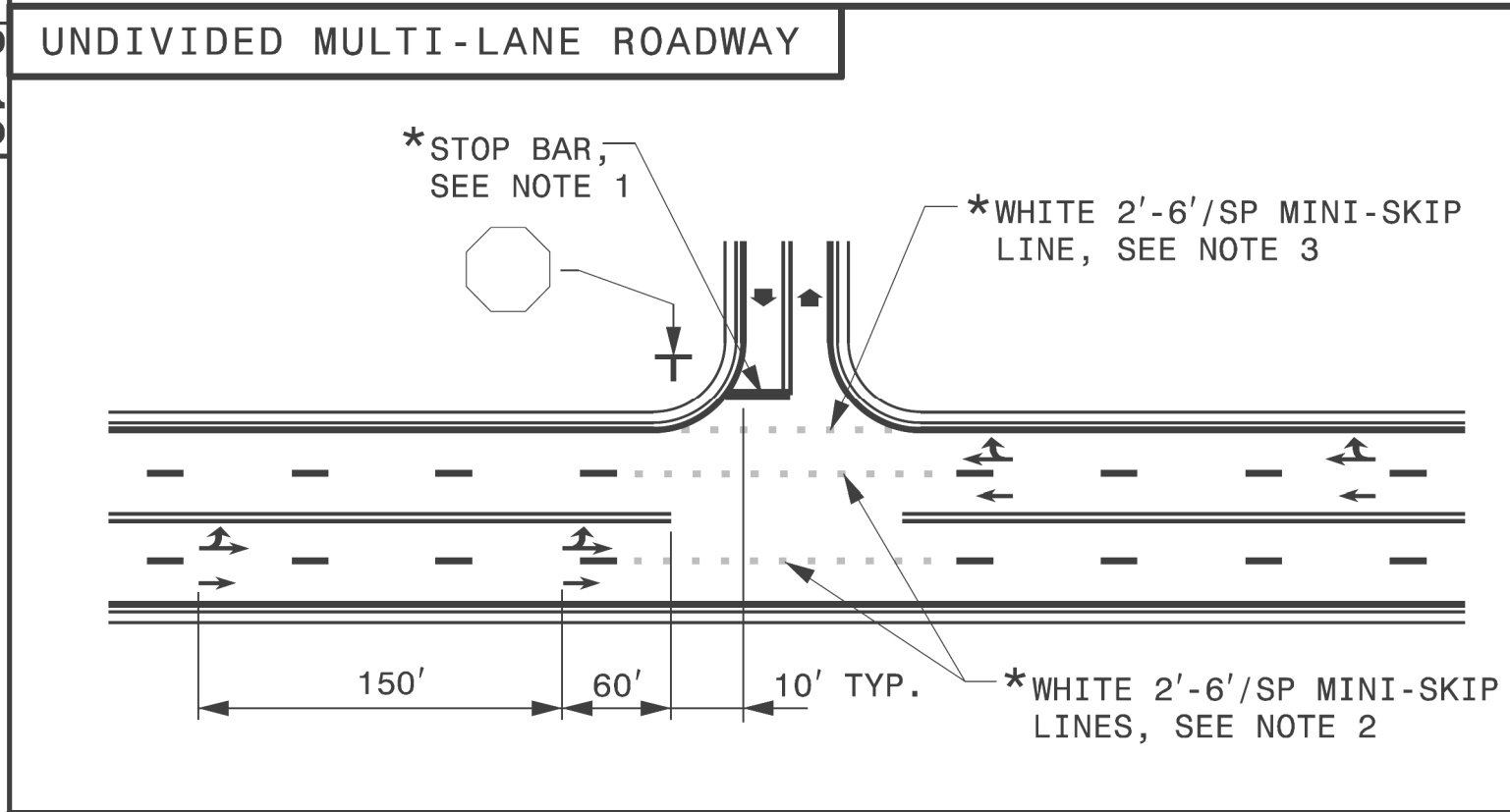
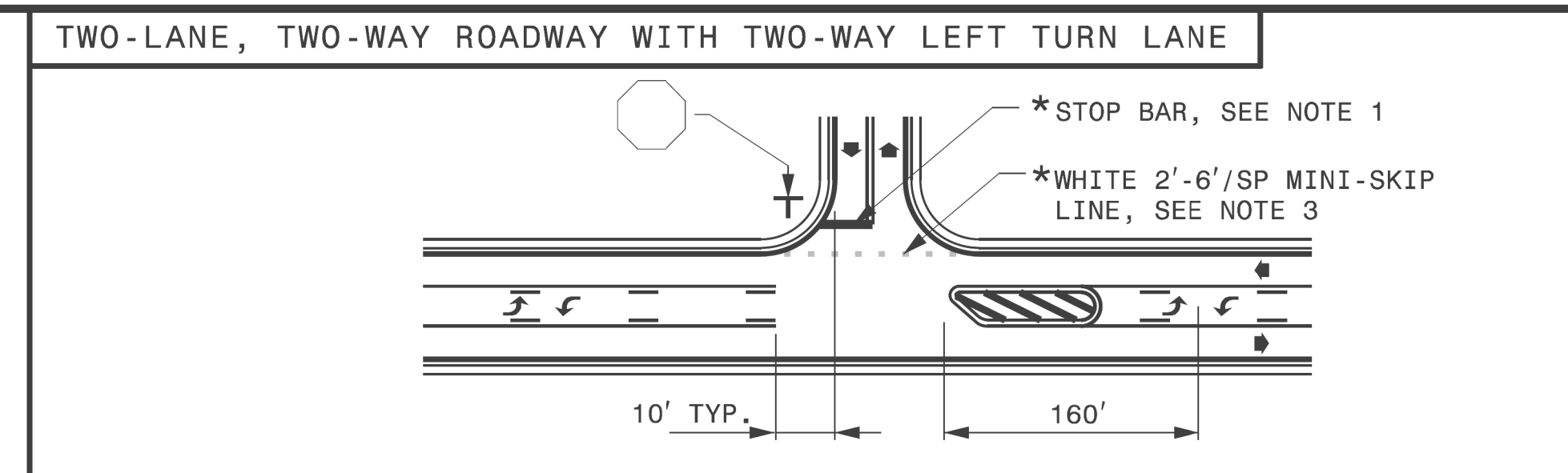
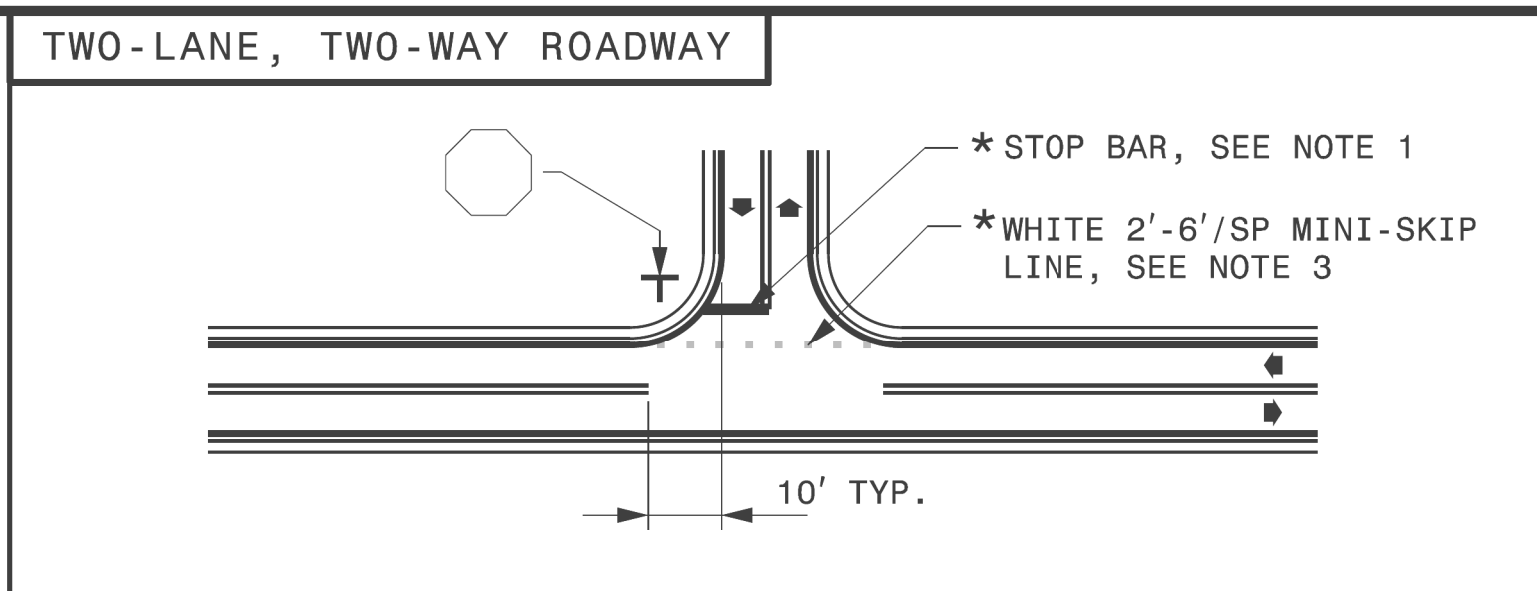

TIP NO.	SHEET NO.
DocuSigned by:	
<i>Matthew V. Springer</i>	
APPROVED:	8/13/2019
DATE:	8/13/2019 8:58:44 AM
SEAL	
	

STATE OF NORTH CAROLINA  
DEPT. OF TRANSPORTATION  
DIVISION OF HIGHWAYS  
RALEIGH, N.C.

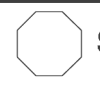

- GENERAL NOTES:**
- 1- PLACEMENT OF STOP BARS AT NON-SIGNALIZED INTERSECTIONS IS OPTIONAL AND USED WHERE IT IS IMPORTANT TO INDICATE THE POINT WHICH VEHICLES ARE REQUIRED TO STOP. PLACE STOP BARS NO LESS THAN 4 FEET AND NO MORE THAN 30 FEET FROM THE NEAREST EDGE OF THE INTERSECTING ROADWAY. USE 10 FEET AS THE TYPICAL SETBACK DISTANCE OR AS DIRECTED BY THE ENGINEER.
  - 2- MINI-SKIP LANE LINE EXTENSIONS SHOULD BE USED AT INTERSECTIONS THAT HAVE REDUCED VISIBILITY CONDITIONS SUCH AS OFFSET, SKEWED, OR CURVED ROADWAYS.
  - 3- MINI-SKIP EDGE LINE EXTENSIONS MAY BE PLACED THROUGH INTERSECTIONS AND MAJOR DRIVEWAYS.
  - 4- REFER TO ROADWAY STANDARD DRAWINGS 1205.01, 1205.02, 1205.05, 1205.08 AND 1205.09 FOR ADDITIONAL PAVEMENT MARKING GUIDANCE.

**LEGEND**

 STOP SIGN	 STATIONARY SIGN
 DIRECTION OF TRAFFIC FLOW	 PAVEMENT MARKING SYMBOLS
* OPTIONAL	

USE DOUBLE YELLOW CENTER LINE AND ARROW SYMBOLS IN MEDIAN CROSSOVER WHEN WIDTH OF MEDIAN EXCEEDS 30 FT, OTHERWISE THEY ARE NOT REQUIRED.

SHEET 2 OF 2  
**1205D04**

STATE OF NORTH CAROLINA  
DEPT. OF TRANSPORTATION  
DIVISION OF HIGHWAYS  
RALEIGH, N.C.

ENGLISH DETAIL DRAWING FOR  
**PAVEMENT MARKINGS**  
INTERSECTIONS

SHEET 2 OF 2  
**1205D04**

**REVISED PAVEMENT MARKING  
ROADWAY STANDARD DRAWING**

REVISED ROADWAY STANDARD DRAWING  
1205.04 SHEET 2 OF 2

\$\$\$\$\$SYTIME\$\$\$\$\$  
\$\$\$\$\$DGN\$\$\$\$\$  
\$\$\$\$\$USERNAME\$\$\$\$\$

C:\Users\jstokes\Documents\Drawings\Standards and Drawings\Standards and Drawings\2018 Standard Dwg\Division 12 Final\1205D04\_08-13-19.dgn  
User:rstokes



	CURB RAMP STATIONS	CURB RAMP TYPE
①	-Y1- STA 14+23+/-	TYPE 6
②	-Y1- STA 14+18+/-	TYPE 3 MODIFIED
③	-Y2- STA 13+50+/-	TYPE 3 MODIFIED
④	-Y2- STA 13+53+/-	TYPE 3 MODIFIED
⑤	-DRWY1- STA 10+69+/-	TYPE 3 MODIFIED
⑥	-DRWY1- STA 10+60+/-	TYPE 2A MODIFIED
⑦	-Y1- STA 15+45+/-	TYPE 1 MODIFIED
⑧	-Y1- STA 15+40+/-	STANDARD

TIP NO. R-3833C SHEET NO. PMP-2

APPROVED: *Betsy L. Watson*  
REGISTERED PROFESSIONAL ENGINEER

DATE: 4/28/2023

SEAL

**DOCUMENT NOT CONSIDERED FINAL  
UNLESS ALL SIGNATURES COMPLETED**

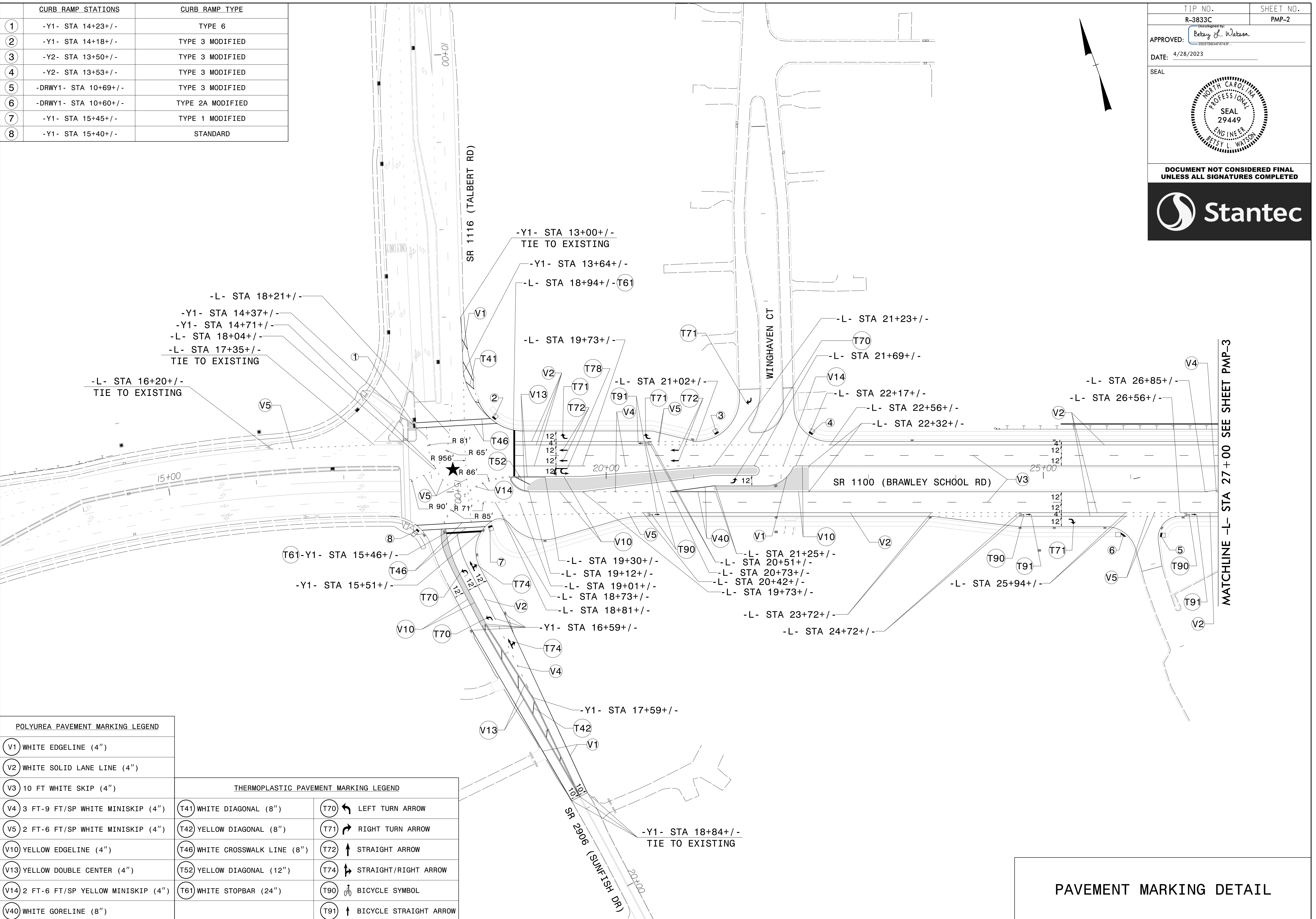

POLYUREA PAVEMENT MARKING LEGEND

V1	WHITE EDGELINE (4")
V2	WHITE SOLID LANE LINE (4")
V3	10 FT WHITE SKIP (4")
V4	3 FT-9 FT/SP WHITE MINISKIP (4")
V5	2 FT-6 FT/SP WHITE MINISKIP (4")
V10	YELLOW EDGELINE (4")
V13	YELLOW DOUBLE CENTER (4")
V14	2 FT-6 FT/SP YELLOW MINISKIP (4")
V40	WHITE GORELINE (8")

THERMOPLASTIC PAVEMENT MARKING LEGEND

T41	WHITE DIAGONAL (8")	T70	LEFT TURN ARROW
T42	YELLOW DIAGONAL (8")	T71	RIGHT TURN ARROW
T46	WHITE CROSSWALK LINE (8")	T72	STRAIGHT ARROW
T52	YELLOW DIAGONAL (12")	T74	STRAIGHT/RIGHT ARROW
T61	WHITE STOPBAR (24")	T90	BICYCLE SYMBOL
		T91	BICYCLE STRAIGHT ARROW

\$\$\$\$\$SYTIME\$\$\$\$\$  
 \$\$\$DDGN\$\$\$\$\$  
 \$\$\$USERNAME\$\$\$\$\$

MATCHLINE -L- STA 27+00 SEE SHEET PMP-3

**PAVEMENT MARKING DETAIL**

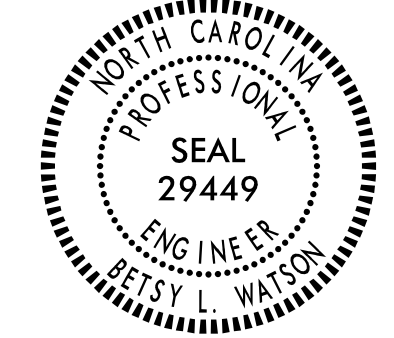

	CURB RAMP STATIONS	CURB RAMP TYPE
①	-DRWY2- STA 10+54+/-	TYPE 3 MODIFIED
②	-DRWY2- STA 10+53+/-	TYPE 7
③	-DRWY2- STA 10+53+/-	TYPE 7
④	-DRWY2- STA 10+54+/-	TYPE 2A MODIFIED

TIP NO. R-3833C	SHEET NO. PMP-3
APPROVED: <i>Betsy L. Watson</i> <small>35E97B834F8743F</small>	
DATE: 4/28/2023	
SEAL	
	
DOCUMENT NOT CONSIDERED FINAL UNLESS ALL SIGNATURES COMPLETED	

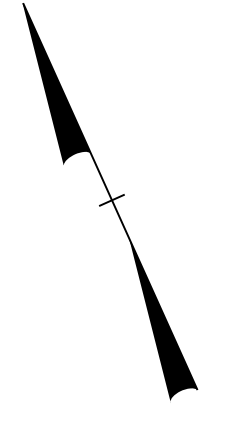

MATCHLINE -L- STA 27+00 SEE SHEET PMP-2

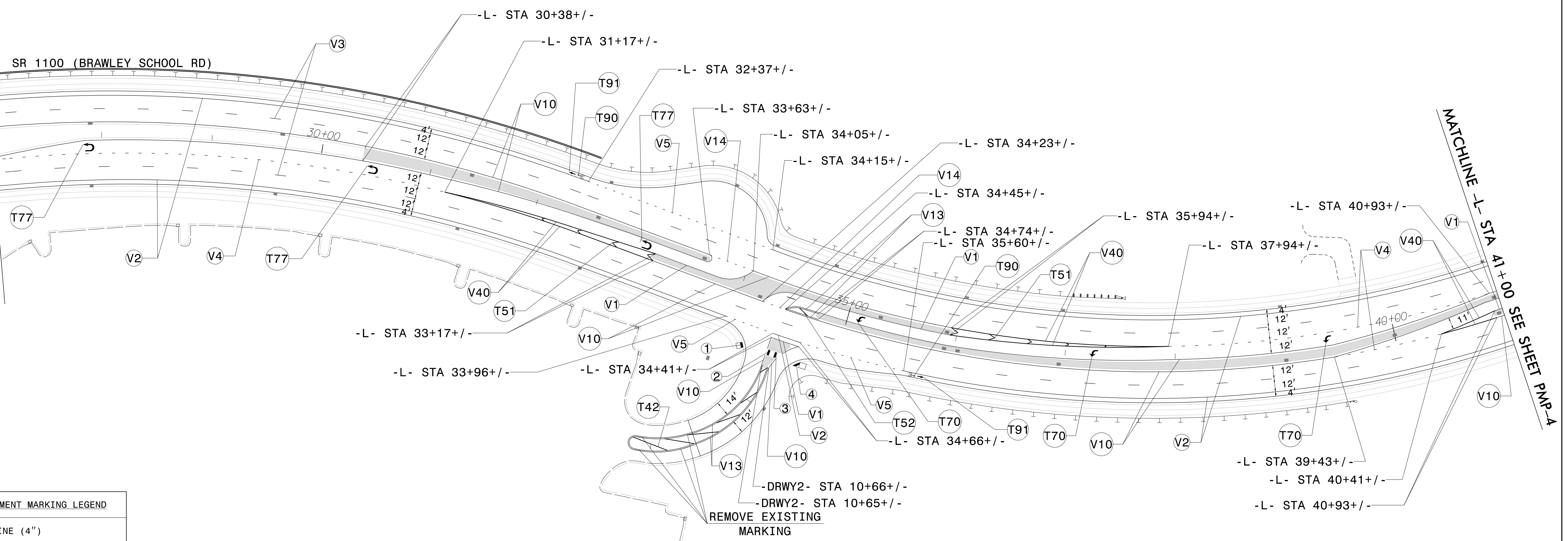

MATCHLINE -L- STA 41+00 SEE SHEET PMP-4

POLYUREA PAVEMENT MARKING LEGEND

V1	WHITE EDGELINE (4")
V2	WHITE SOLID LANE LINE (4")
V3	10 FT WHITE SKIP (4")
V4	3 FT-9 FT/SP WHITE MINISKIP (4")
V5	2 FT-6 FT/SP WHITE MINISKIP (4")
V10	YELLOW EDGELINE (4")
V13	YELLOW DOUBLE CENTER (4")
V14	2 FT-6 FT/SP YELLOW MINISKIP (4")
V40	WHITE GORELINE (8")

THERMOPLASTIC PAVEMENT MARKING LEGEND

T42	YELLOW DIAGONAL (8")	T70	← LEFT TURN ARROW
T51	WHITE DIAGONAL (12")	T77	↻ U-TURN ARROW
T52	YELLOW DIAGONAL (12")	T90	🚲 BICYCLE SYMBOL
		T91	↑ BICYCLE STRAIGHT ARROW

REMOVE EXISTING MARKING

PAVEMENT MARKING DETAIL

\$\$\$\$\$SYTIME\$\$\$\$\$  
\$\$\$\$\$DGN\$\$\$\$\$  
\$\$\$\$\$USERNAME\$\$\$\$\$



TIP NO. R-3833C	SHEET NO. PMP-4
APPROVED: <i>Betsy L. Watson</i>	
DATE: 4/28/2023	
SEAL	
<b>DOCUMENT NOT CONSIDERED FINAL UNLESS ALL SIGNATURES COMPLETED</b>	



CURB RAMP STATIONS	CURB RAMP TYPE	CURB RAMP STATIONS	CURB RAMP TYPE
① -Y3- STA 12+93+/-	TYPE 3 MODIFIED	⑨ -Y7- STA 10+57+/-	TYPE 1 MODIFIED
② -Y3- STA 12+89+/-	TYPE 7	⑩ -Y7- STA 10+45+/-	TYPE 1 MODIFIED
③ -Y3- STA 12+87+/-	TYPE 7	⑪ -Y5- STA 10+63+/-	TYPE 1 MODIFIED
④ -Y3- STA 12+79+/-	TYPE 3 MODIFIED	⑫ -Y5- STA 10+63+/-	TYPE 3 MODIFIED
⑤ -Y6- STA 12+39+/-	TYPE 3 MODIFIED	⑬ -Y4- STA 10+57+/-	TYPE 3 MODIFIED
⑥ -Y6- STA 12+39+/-	TYPE 7	⑭ -Y4- STA 10+54+/-	TYPE 7
⑦ -Y6- STA 12+39+/-	TYPE 7	⑮ -Y4- STA 10+53+/-	TYPE 7
⑧ -Y6- STA 12+39+/-	TYPE 3 MODIFIED	⑯ -Y4- STA 10+52+/-	TYPE 3 MODIFIED

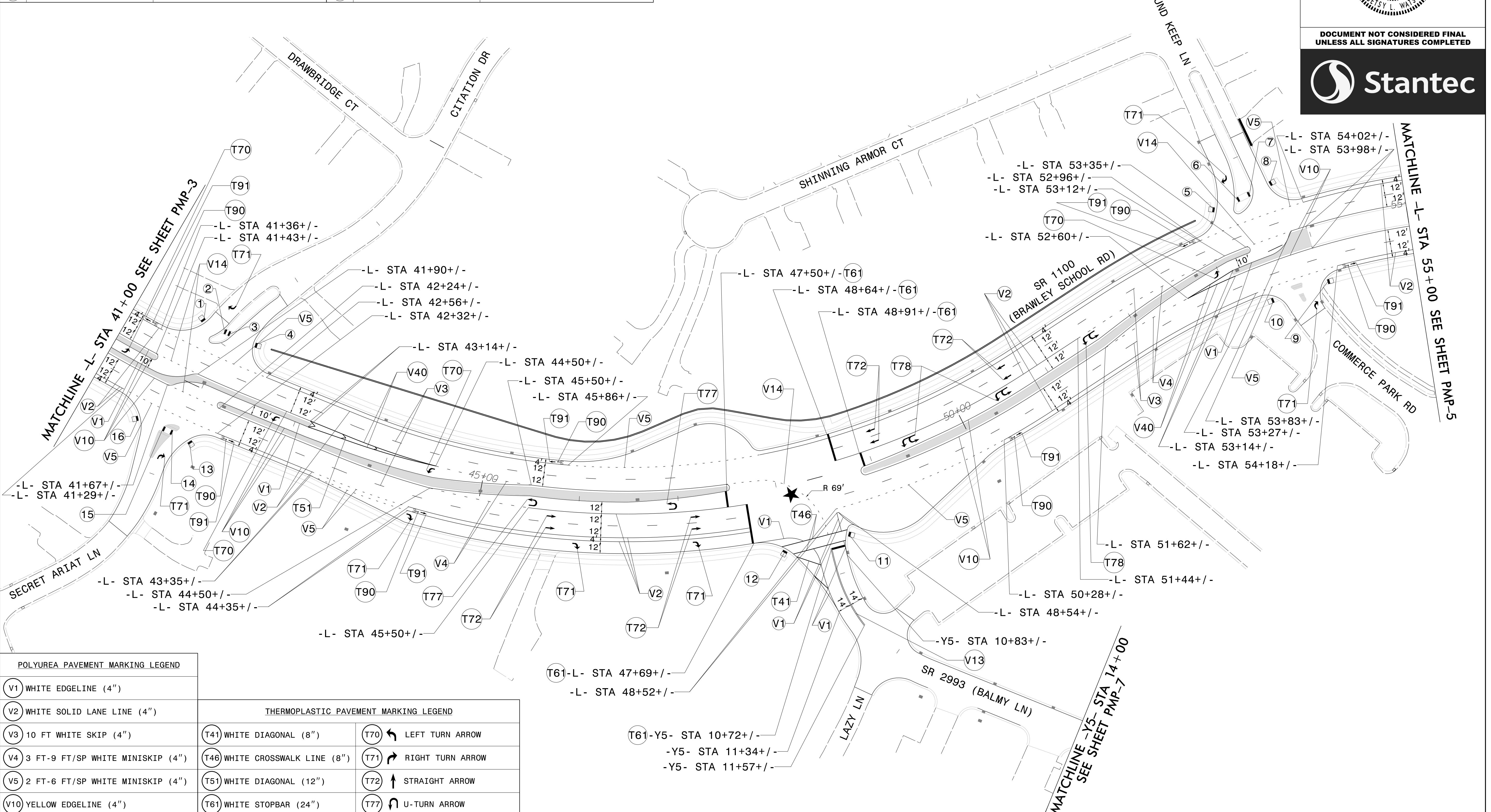

POLYUREA PAVEMENT MARKING LEGEND		THERMOPLASTIC PAVEMENT MARKING LEGEND	
V1	WHITE EDGLINE (4")	T41	WHITE DIAGONAL (8")
V2	WHITE SOLID LANE LINE (4")	T46	WHITE CROSSWALK LINE (8")
V3	10 FT WHITE SKIP (4")	T70	LEFT TURN ARROW
V4	3 FT-9 FT/SP WHITE MINISKIP (4")	T71	RIGHT TURN ARROW
V5	2 FT-6 FT/SP WHITE MINISKIP (4")	T72	STRAIGHT ARROW
V10	YELLOW EDGLINE (4")	T77	U-TURN ARROW
V13	YELLOW DOUBLE CENTER (4")	T78	LEFT/U-TURN ARROW
V14	2 FT-6 FT/SP YELLOW MINISKIP (4")	T90	BICYCLE SYMBOL
V40	WHITE GORELINE (8")	T91	BICYCLE STRAIGHT ARROW

\$\$\$SYTIME\$\$\$  
 \$\$\$DGN\$\$\$  
 \$\$\$USERNAME\$\$\$

**PAVEMENT MARKING DETAIL**



TIP NO. R-3833C	SHEET NO. PMP-5
APPROVED: <i>Betsy L. Watson</i> 356778348743F	
DATE: 4/28/2023	
SEAL	
DOCUMENT NOT CONSIDERED FINAL UNLESS ALL SIGNATURES COMPLETED	



CURB RAMP STATIONS	CURB RAMP TYPE	CURB RAMP STATIONS	CURB RAMP TYPE
1 -L- STA 55+46+/-	TYPE 1 MODIFIED	13 -Y- STA 37+78+/-	TYPE 7
2 -L- STA 55+85+/-	TYPE 2A MODIFIED	14 -Y- STA 37+77+/-	TYPE 3
3 -L- STA 58+19+/-	TYPE 2A MODIFIED	15 -L- STA 63+14+/-	TYPE 3 MODIFIED
4 -L- STA 58+75+/-	TYPE 2A MODIFIED	16 -L- STA 63+14+/-	TYPE 7
5 -L- STA 61+38+/-	TYPE 3 MODIFIED	17 -L- STA 63+14+/-	TYPE 7
6 -L- STA 61+39+/-	TYPE 7	18 -L- STA 63+14+/-	TYPE 3 MODIFIED
7 -L- STA 61+27+/-	TYPE 7	19 -DRWY3- STA 10+91+/-	TYPE 1 MODIFIED
8 -L- STA 61+27+/-	TYPE 6	20 -DRWY6- STA 11+10+/-	TYPE 2A MODIFIED
9 -L- STA 61+19+/-	TYPE 6	21 -DRWY6- STA 10+55+/-	TYPE 1 MODIFIED
10 -L- STA 60+87+/-	TYPE 3 MODIFIED	22 -DRWY6- STA 10+55+/-	TYPE 2A MODIFIED
11 -Y- STA 37+78+/-	TYPE 6	23 -DRWY7- STA 11+41+/-	TYPE 3 MODIFIED
12 -Y- STA 37+77+/-	TYPE 7	24 -DRWY7- STA 11+41+/-	TYPE 3 MODIFIED

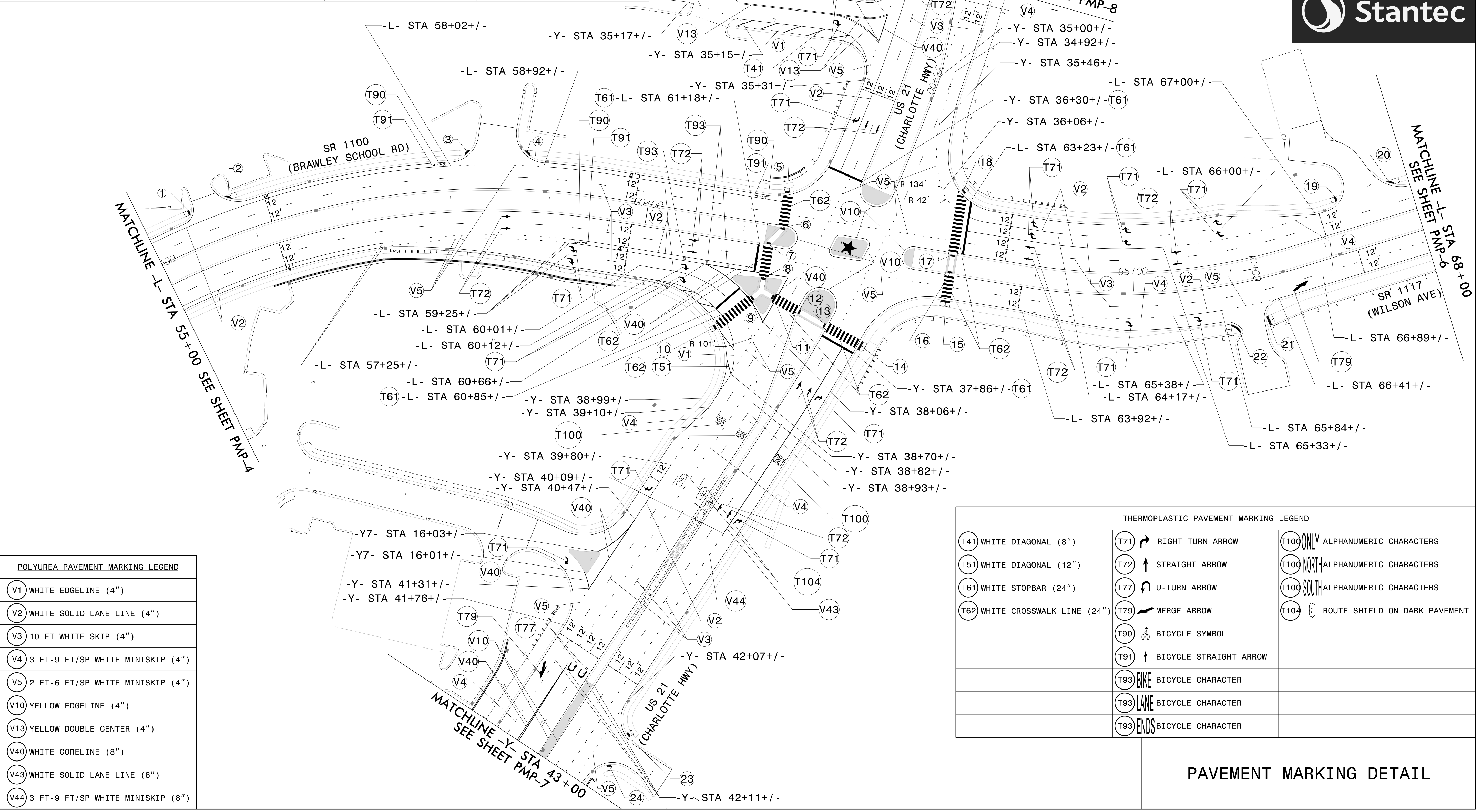

POLYUREA PAVEMENT MARKING LEGEND	
V1	WHITE EDGELINE (4")
V2	WHITE SOLID LANE LINE (4")
V3	10 FT WHITE SKIP (4")
V4	3 FT-9 FT/SP WHITE MINISKIP (4")
V5	2 FT-6 FT/SP WHITE MINISKIP (4")
V10	YELLOW EDGELINE (4")
V13	YELLOW DOUBLE CENTER (4")
V40	WHITE GORELINE (8")
V43	WHITE SOLID LANE LINE (8")
V44	3 FT-9 FT/SP WHITE MINISKIP (8")



THERMOPLASTIC PAVEMENT MARKING LEGEND					
T41	WHITE DIAGONAL (8")	T71	RIGHT TURN ARROW	T100 ONLY	ALPHANUMERIC CHARACTERS
T51	WHITE DIAGONAL (12")	T72	STRAIGHT ARROW	T100 NORTH	ALPHANUMERIC CHARACTERS
T61	WHITE STOPBAR (24")	T77	U-TURN ARROW	T100 SOUTH	ALPHANUMERIC CHARACTERS
T62	WHITE CROSSWALK LINE (24")	T79	MERGE ARROW	T104	ROUTE SHIELD ON DARK PAVEMENT
		T90	BICYCLE SYMBOL		
		T91	BICYCLE STRAIGHT ARROW		
		T93 BIKE	BICYCLE CHARACTER		
		T93 LANE	BICYCLE CHARACTER		
		T93 ENDS	BICYCLE CHARACTER		

PAVEMENT MARKING DETAIL

\$\$\$\$\$SYTIME\$\$\$\$\$  
\$\$\$\$\$DGN\$\$\$\$\$  
\$\$\$\$\$USERNAME\$\$\$\$\$

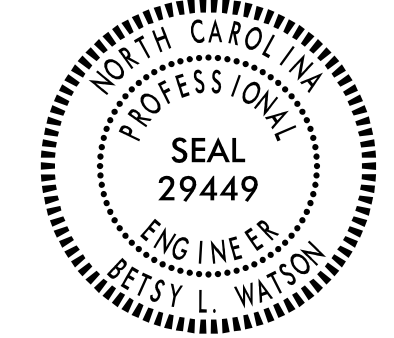

	CURB RAMP STATIONS	CURB RAMP TYPE
①	-DRWY4- STA 11+07+/-	TYPE 3 MODIFIED
②	-DRWY4- STA 11+08+/-	TYPE 3 MODIFIED

TIP NO. R-3833C	SHEET NO. PMP-6
APPROVED: <i>Betsy L. Watson</i> 35E97B34F8743F	
DATE: 4/28/2023	
SEAL	
	
<b>DOCUMENT NOT CONSIDERED FINAL UNLESS ALL SIGNATURES COMPLETED</b>	
	

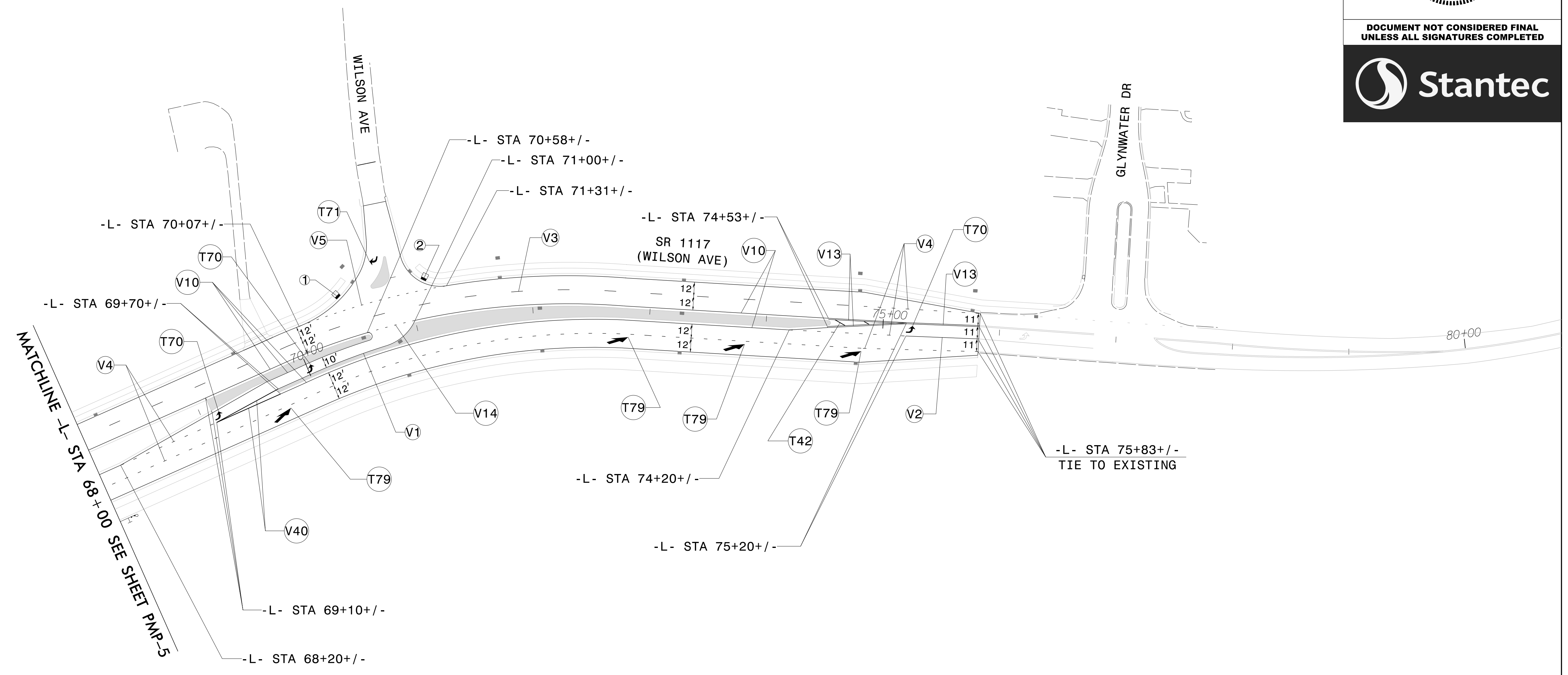
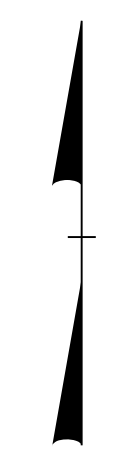



POLYUREA PAVEMENT MARKING LEGEND	
Ⓟ V1	WHITE EDGELINE (4")
Ⓟ V2	WHITE SOLID LANE LINE (4")
Ⓟ V3	10 FT WHITE SKIP (4")
Ⓟ V4	3 FT-9 FT/SP WHITE MINISKIP (4")
Ⓟ V5	2 FT-6 FT/SP WHITE MINISKIP (4")
Ⓟ V10	YELLOW EDGELINE (4")
Ⓟ V13	YELLOW DOUBLE CENTER (4")
Ⓟ V14	2 FT-6 FT/SP YELLOW MINISKIP (4")
Ⓟ V40	WHITE GORELINE (8")

THERMOPLASTIC PAVEMENT MARKING LEGEND	
Ⓟ T42	YELLOW DIAGONAL (8")
Ⓟ T70	LEFT TURN ARROW
Ⓟ T71	RIGHT TURN ARROW
Ⓟ T79	MERGE ARROW

\$\$\$\$\$SYTIME\$\$\$\$\$  
 \$\$\$DDGN\$\$\$\$\$  
 \$\$\$USERNAM\$\$\$\$\$

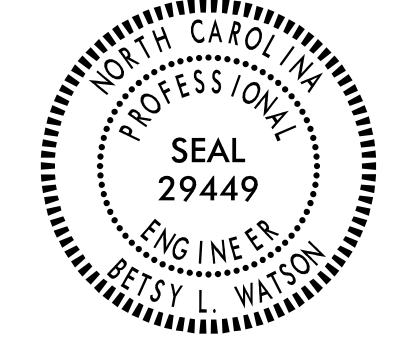
PAVEMENT MARKING DETAIL

TIP NO. R-3833C	SHEET NO. PMP-7
APPROVED: <i>Betsy L. Watson</i> 356978348743F	
DATE: 4/28/2023	
SEAL	
	
<p><b>DOCUMENT NOT CONSIDERED FINAL UNLESS ALL SIGNATURES COMPLETED</b></p> 	

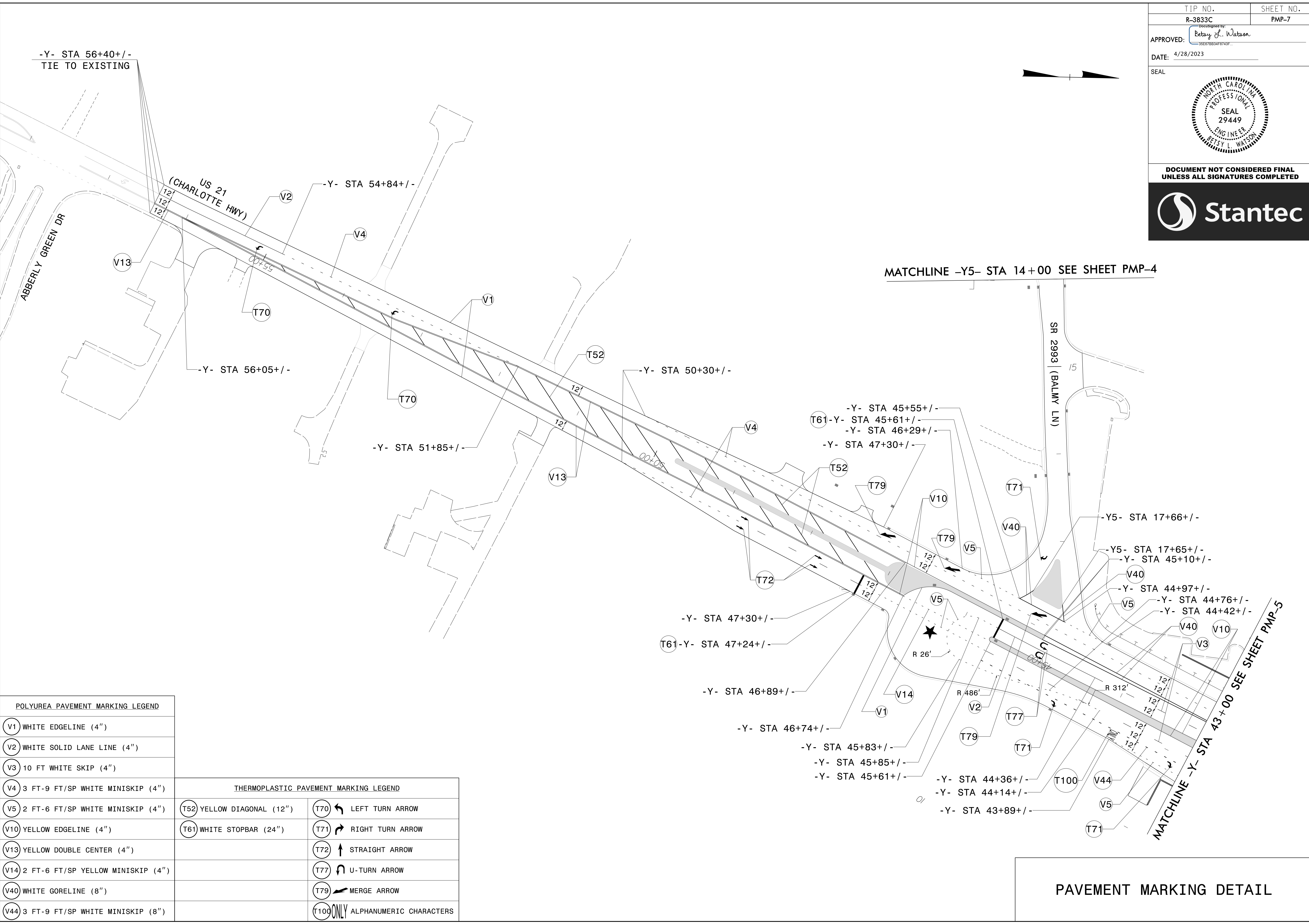

POLYUREA PAVEMENT MARKING LEGEND	
V1	WHITE EDGELINE (4")
V2	WHITE SOLID LANE LINE (4")
V3	10 FT WHITE SKIP (4")
V4	3 FT-9 FT/SP WHITE MINISKIP (4")
V5	2 FT-6 FT/SP WHITE MINISKIP (4")
V10	YELLOW EDGELINE (4")
V13	YELLOW DOUBLE CENTER (4")
V14	2 FT-6 FT/SP YELLOW MINISKIP (4")
V40	WHITE GORELINE (8")
V44	3 FT-9 FT/SP WHITE MINISKIP (8")

THERMOPLASTIC PAVEMENT MARKING LEGEND			
T52	YELLOW DIAGONAL (12")	T70	LEFT TURN ARROW
T61	WHITE STOPBAR (24")	T71	RIGHT TURN ARROW
		T72	STRAIGHT ARROW
		T77	U-TURN ARROW
		T79	MERGE ARROW
		T100	ONLY ALPHANUMERIC CHARACTERS

\$\$\$\$\$SYTIME\$\$\$\$\$  
 \$\$\$DDGN\$\$\$\$\$  
 \$\$\$USERNAME\$\$\$\$\$

**PAVEMENT MARKING DETAIL**





**DOCUMENT NOT CONSIDERED FINAL  
UNLESS ALL SIGNATURES COMPLETED**

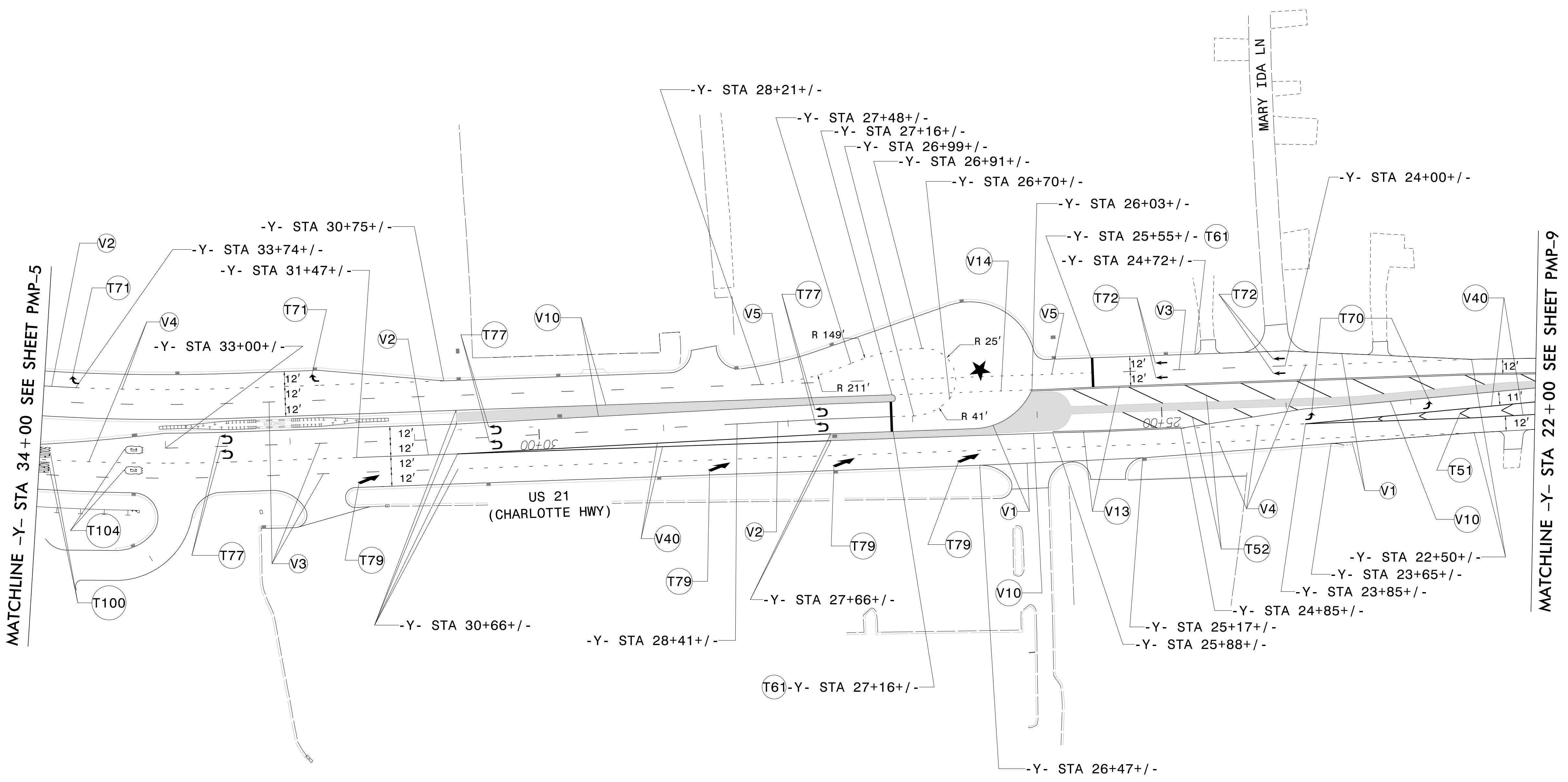
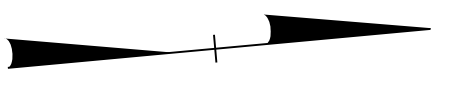



POLYUREA PAVEMENT MARKING LEGEND		THERMOPLASTIC PAVEMENT MARKING LEGEND	
V1	WHITE EDGLINE (4")	T51	WHITE DIAGONAL (12")
V2	WHITE SOLID LANE LINE (4")	T52	YELLOW DIAGONAL (12")
V3	10 FT WHITE SKIP (4")	T61	WHITE STOPBAR (24")
V4	3 FT-9 FT/SP WHITE MINISKIP (4")	T70	LEFT TURN ARROW
V5	2 FT-6 FT/SP WHITE MINISKIP (4")	T71	RIGHT TURN ARROW
V10	YELLOW EDGLINE (4")	T72	STRAIGHT ARROW
V13	YELLOW DOUBLE CENTER (4")	T77	U-TURN ARROW
V14	2 FT-6 FT/SP YELLOW MINISKIP (4")	T79	MERGE ARROW
V40	WHITE GORELINE (8")	T100 NORTH	ALPHANUMERIC CHARACTERS
		T100 SOUTH	ALPHANUMERIC CHARACTERS
		T104	ROUTE SHIELD ON DARK PAVEMENT

\$\$\$\$\$SYTIME\$\$\$\$\$  
 \$\$\$DDGN\$\$\$\$\$  
 \$\$\$USERNAM\$\$\$\$\$

**PAVEMENT MARKING DETAIL**

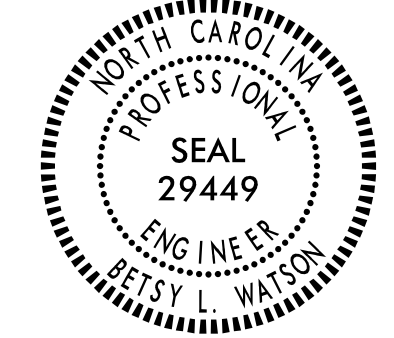

TIP NO. R-3833C	SHEET NO. PMP-9
APPROVED: <i>Betsy L. Watson</i> 35E97B34F8743F	
DATE: 4/28/2023	
SEAL	
	
<b>DOCUMENT NOT CONSIDERED FINAL UNLESS ALL SIGNATURES COMPLETED</b>	
	

MATCHLINE -Y- STA 22 + 00 SEE SHEET PMP-8

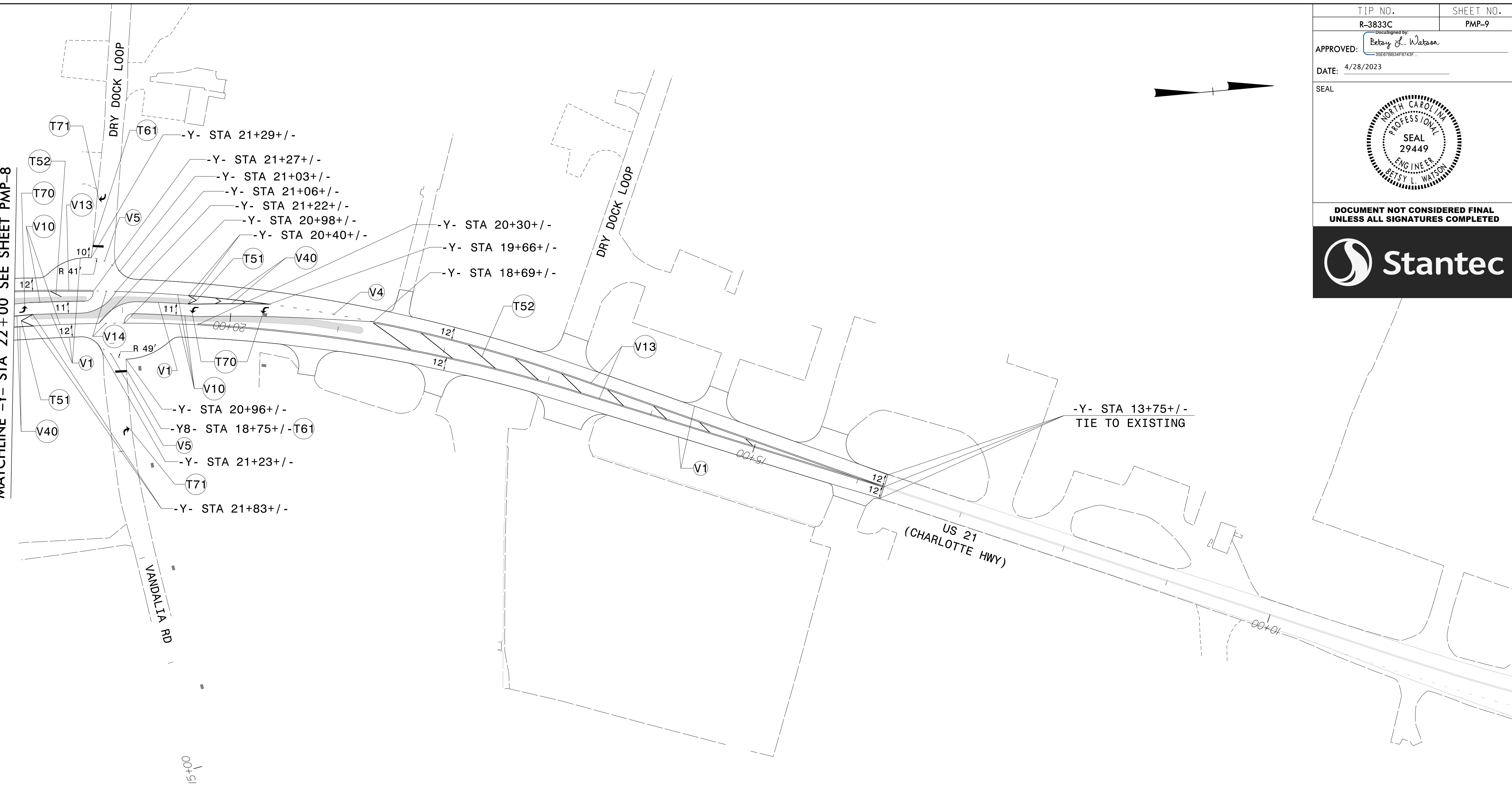

POLYUREA PAVEMENT MARKING LEGEND	
(V1)	WHITE EDGELINE (4")
(V4)	3 FT-9 FT/SP WHITE MINISKIP (4")
(V5)	2 FT-6 FT/SP WHITE MINISKIP (4")
(V10)	YELLOW EDGELINE (4")
(V13)	YELLOW DOUBLE CENTER (4")
(V14)	2 FT-6 FT/SP YELLOW MINISKIP (4")
(V40)	WHITE GORELINE (8")

THERMOPLASTIC PAVEMENT MARKING LEGEND	
(T51)	WHITE DIAGONAL (12")
(T52)	YELLOW DIAGONAL (12")
(T61)	WHITE STOPBAR (24")
(T70)	LEFT TURN ARROW
(T71)	RIGHT TURN ARROW

\$\$\$\$\$SYTIME\$\$\$\$\$  
\$\$\$\$\$DGN\$\$\$\$\$  
\$\$\$\$\$USERNAM\$\$\$\$\$

PAVEMENT MARKING DETAIL