

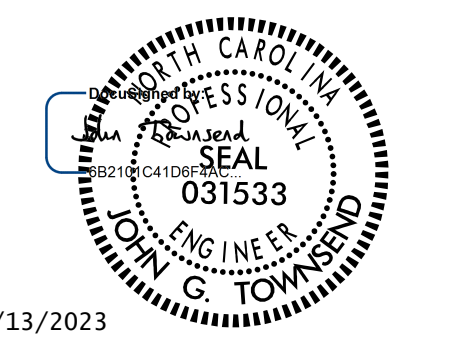

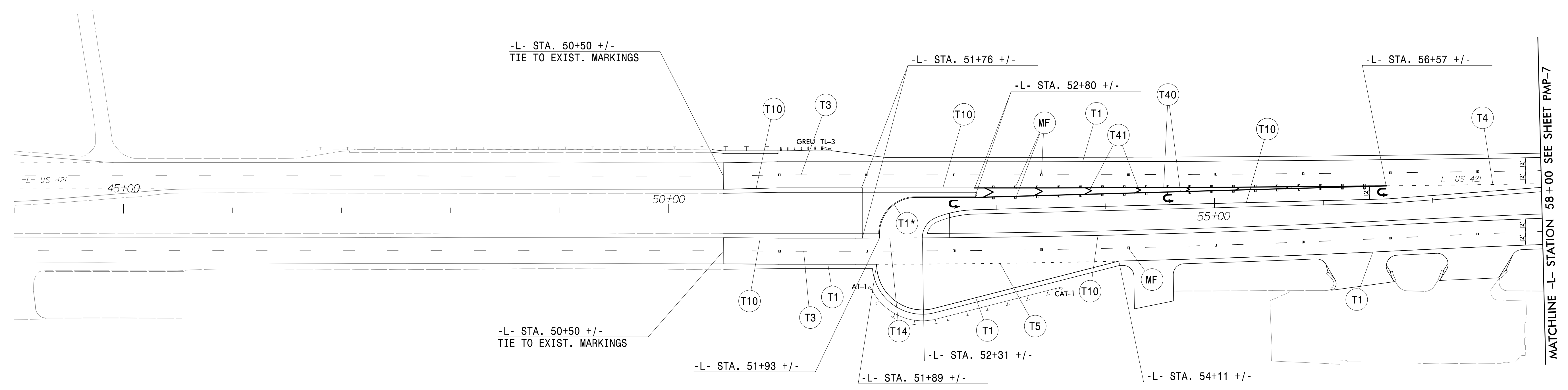

TIP NO. U-5312	SHEET NO. PMP-6
APPROVED: _____	
DATE: _____	
SEAL	
	
7/13/2023	
DOCUMENT NOT CONSIDERED FINAL UNLESS ALL SIGNATURES COMPLETED	



940 Main Campus Drive, Suite 500 Raleigh, NC 27606
NC License No. C-3705

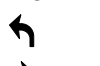

PAVEMENT MARKING SCHEDULE

SYMBOL	DESCRIPTION
T1	WHITE EDGELINE (4", 90 MIL)
T2	WHITE SOLID LANE LINE (4", 90 MIL)
T3	10 FT. WHITE SKIP (4", 90 MIL)
T4	3 FT.-9 FT./SP WHITE MINISKIP (4", 90 MIL)
T5	2 FT.-6 FT./SP WHITE MINISKIP (4", 90 MIL)
T10	YELLOW EDGELINE (4", 90 MIL)
T11	YELLOW SINGLE CENTER (4", 90 MIL)
T12	10 FT. YELLOW SKIP (4", 90 MIL)
T13	YELLOW DOUBLE CENTER (4", 90 MIL)
T14	2 FT.-6 FT./SP YELLOW MINISKIP (4", 90 MIL)
T40	WHITE GORELINE (8", 90 MIL)
T41	WHITE DIAGONAL (8", 90 MIL)
T42	YELLOW DIAGONAL (8", 90 MIL)
T46	WHITE CROSSWALK LINE (8", 90 MIL)
T61	WHITE STOPBAR (24", 90 MIL)
	LEFT TURN ARROW (90 MIL)
	RIGHT TURN ARROW (90 MIL)
	STRAIGHT ARROW (90 MIL)
	COMBO. STRAIGHT/RIGHT (90 MIL)
	U-TURN ARROW (90 MIL)
ME	SNOWPLOWABLE MARKER (YELLOW & YELLOW)
MF	SNOWPLOWABLE MARKER (CRYSTAL & RED)

* EDGELINE OFFSET 0.75' FROM FACE OF CURB/ISLAND

PAVEMENT MARKING DETAIL

3/10/2023
 R:\Traffic\PavementMarking\U5312_pm_psh06.dgn
 User:jtownsend

MATCHLINE -L- STATION 58+00 SEE SHEET PMP-7