

202 + 70.00

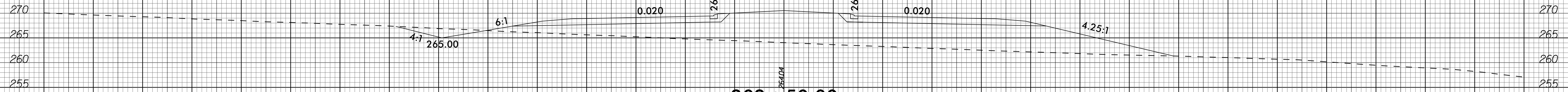

202 + 50.00

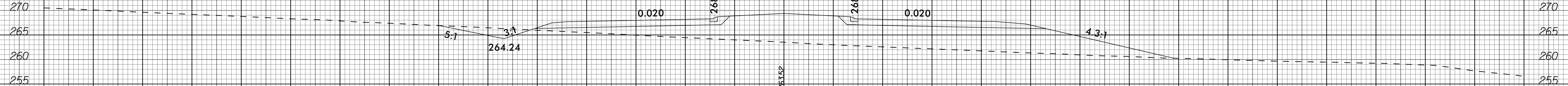

202 + 00.00

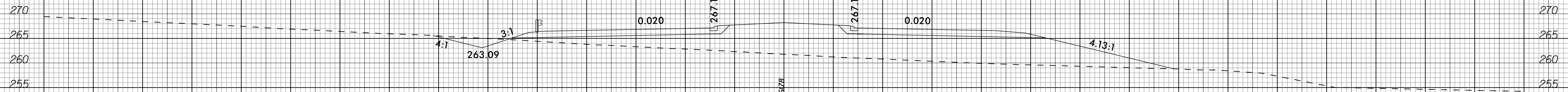

201 + 50.00

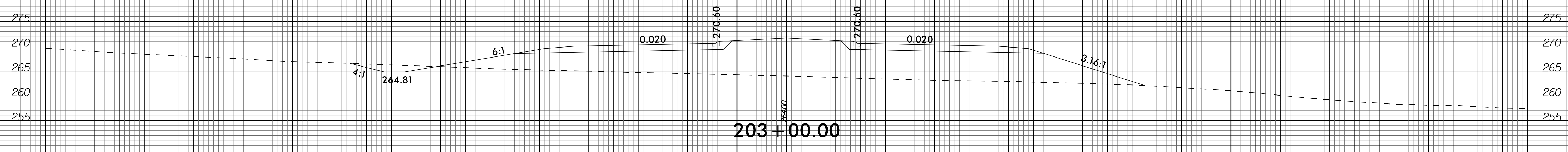
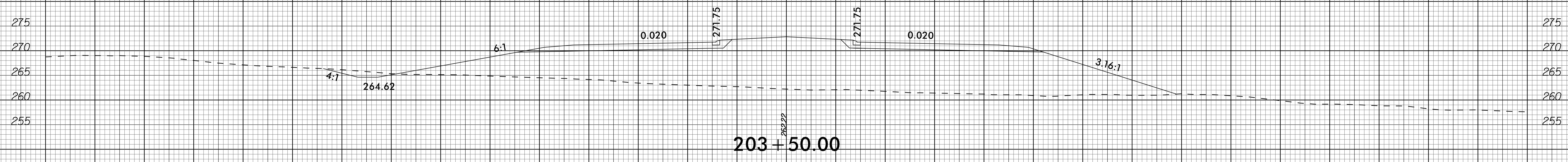
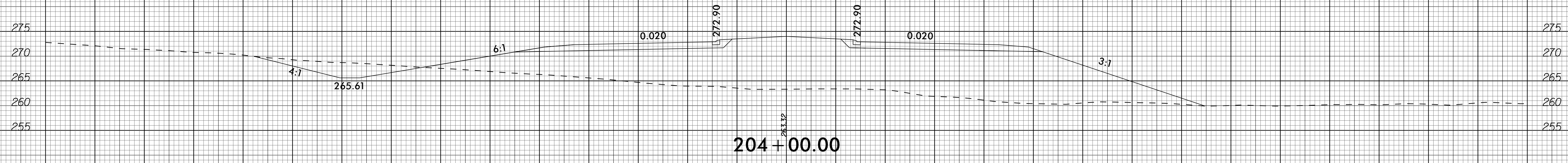
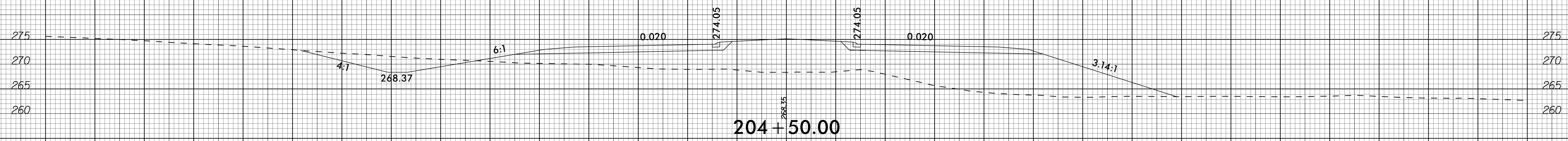

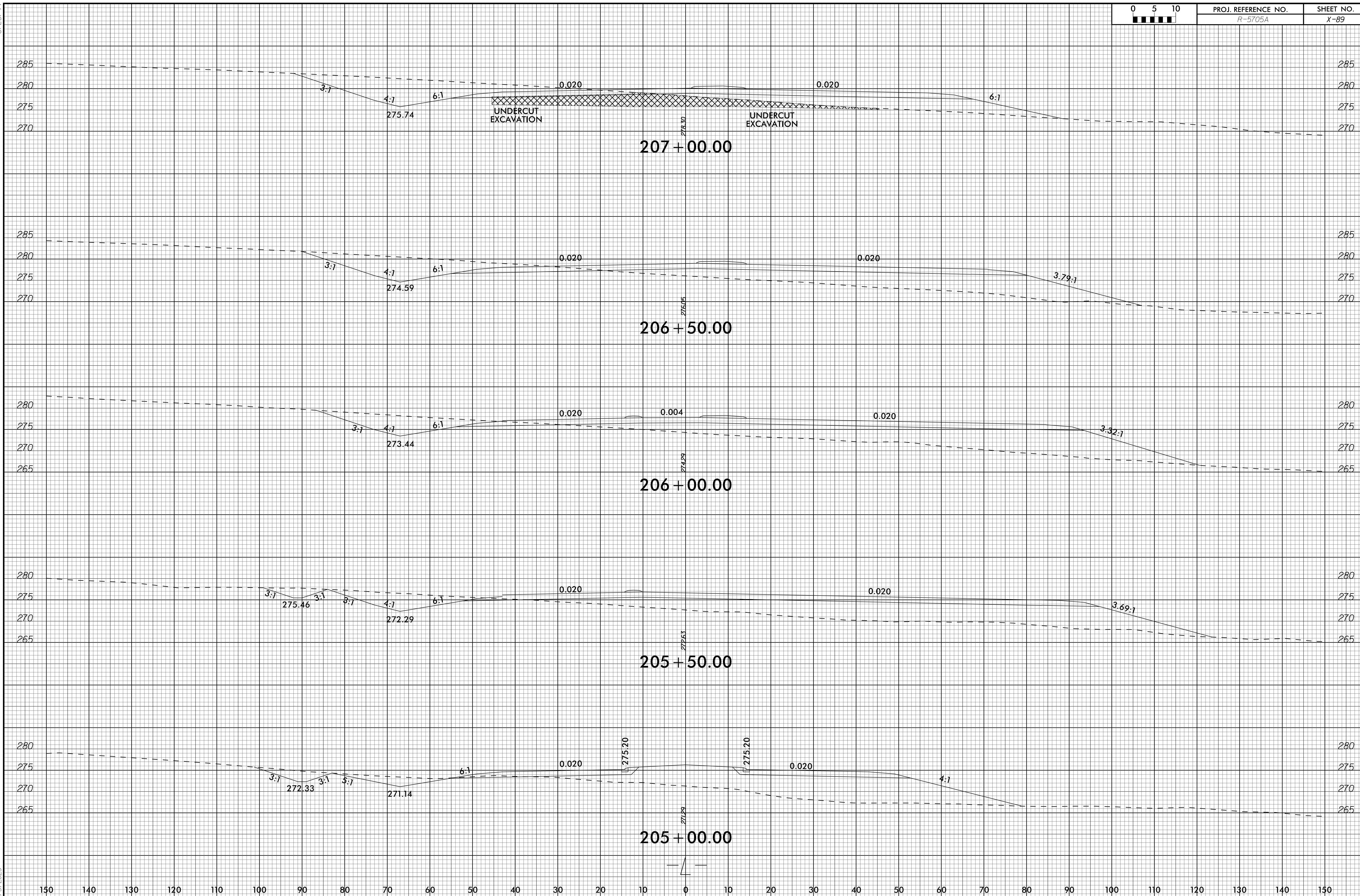

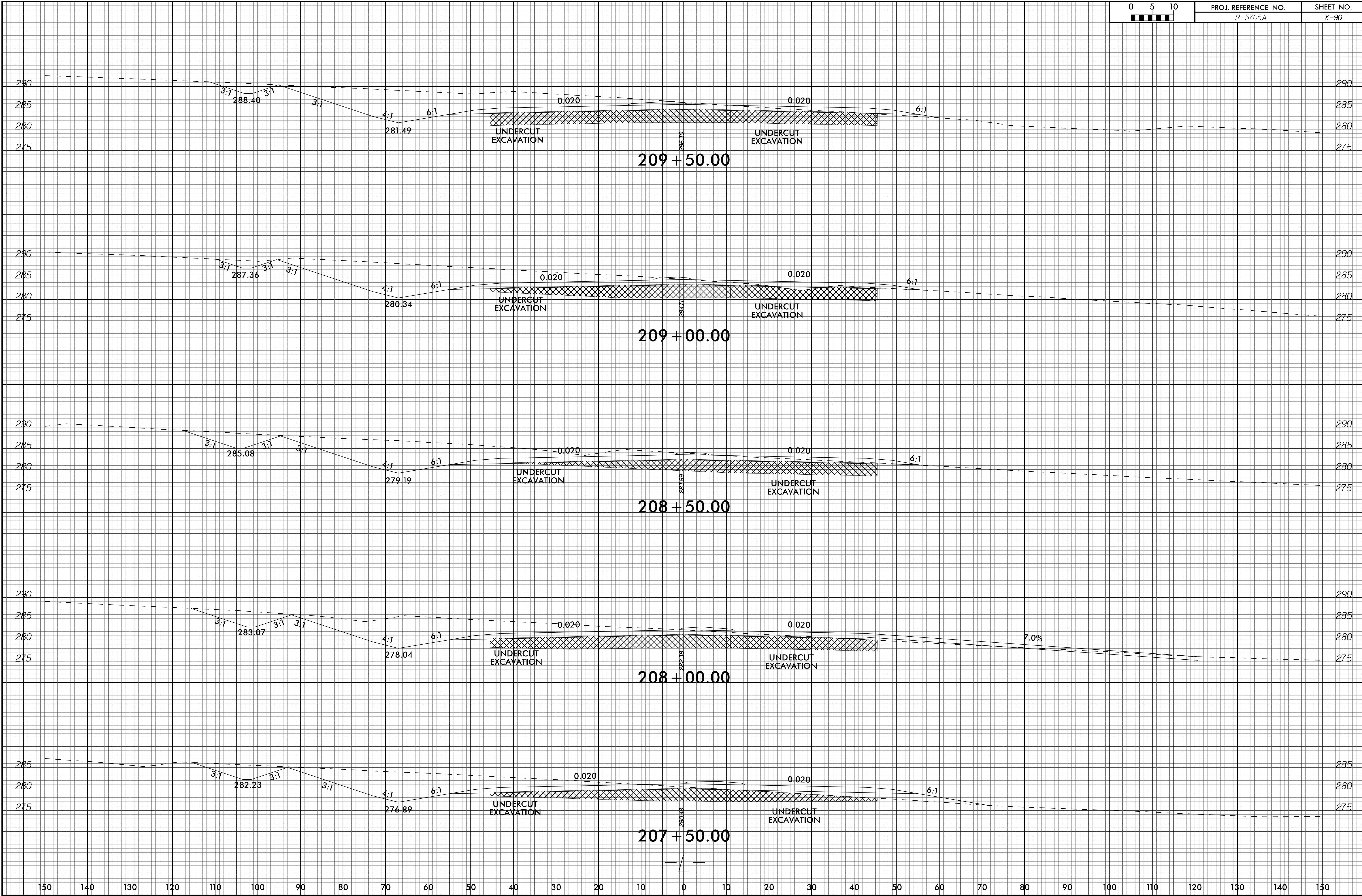

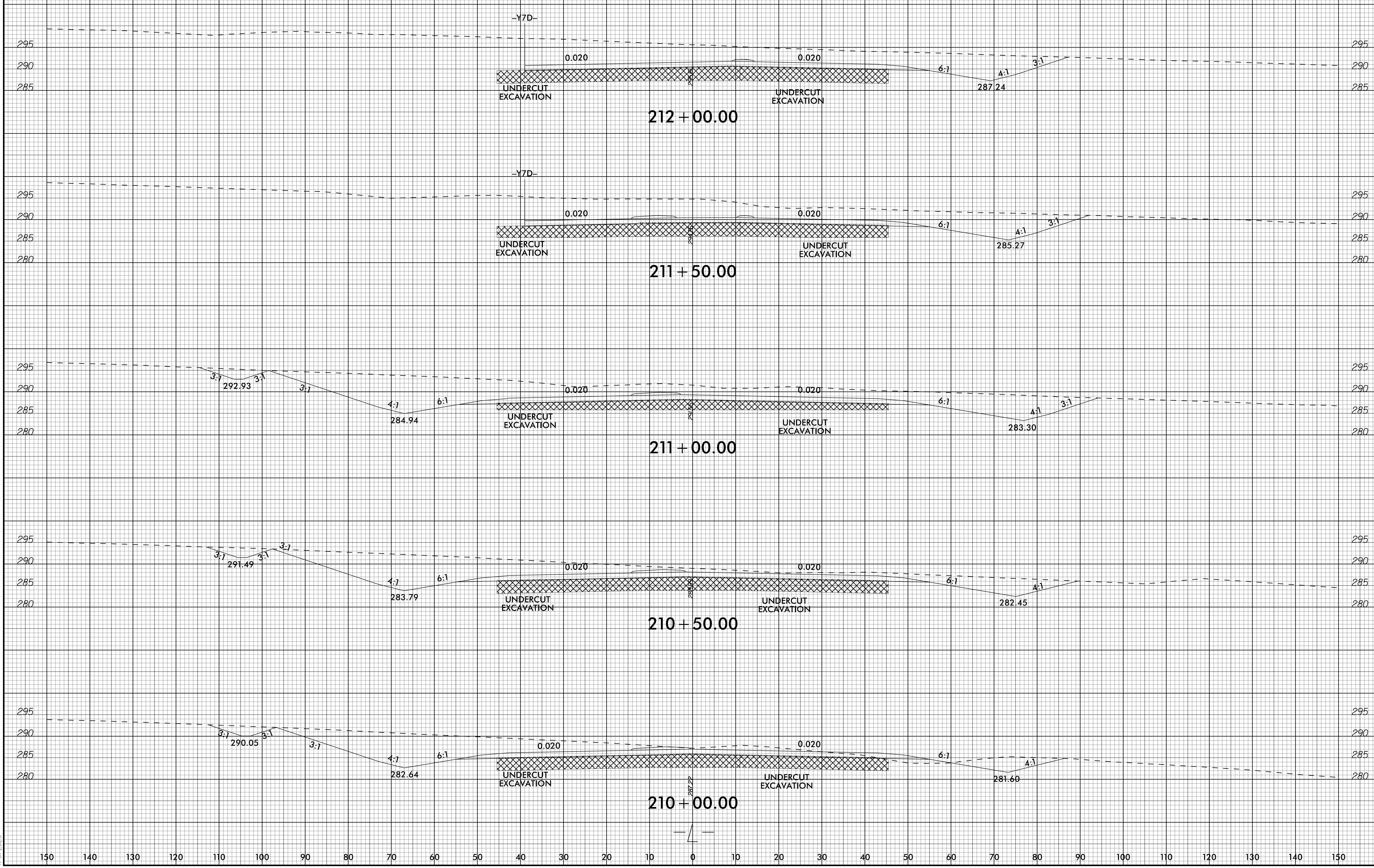



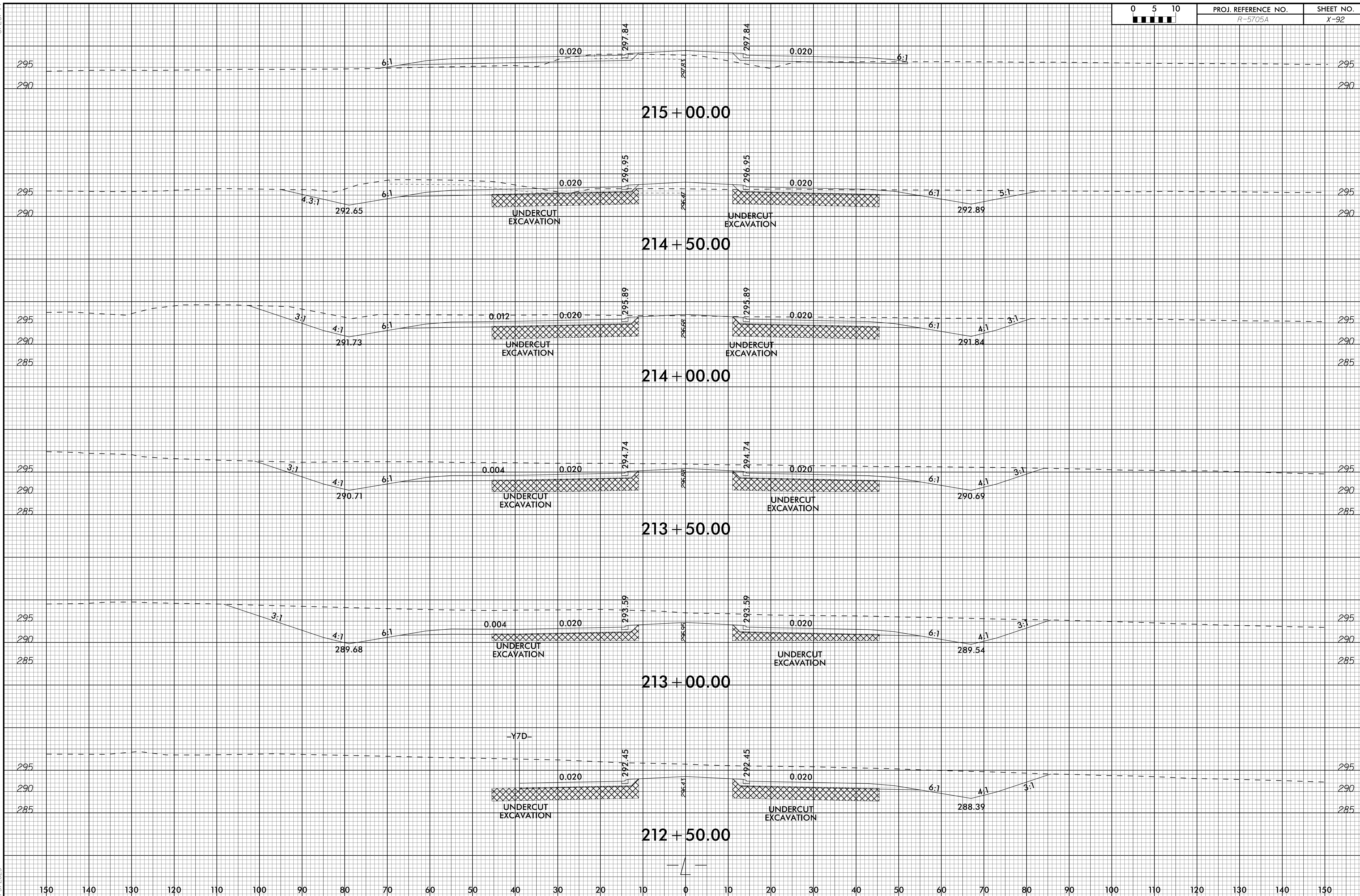

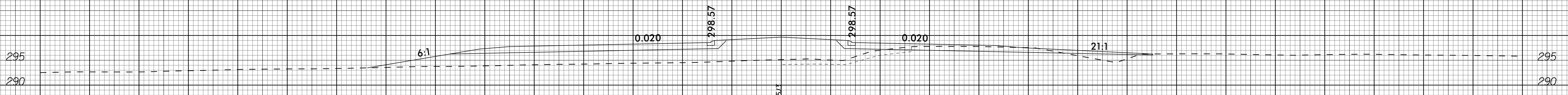
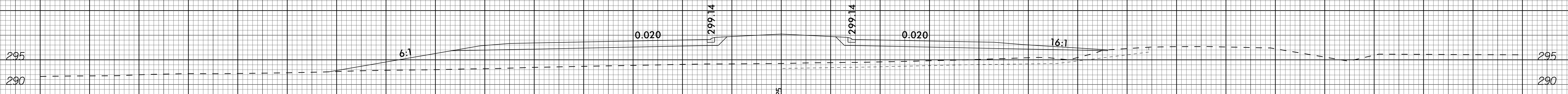
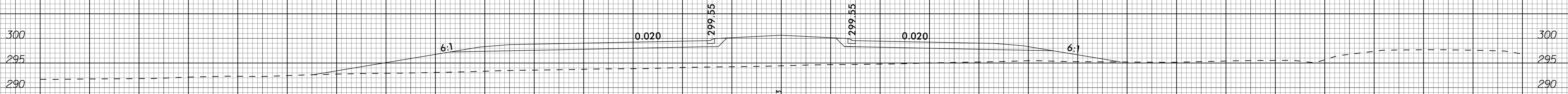
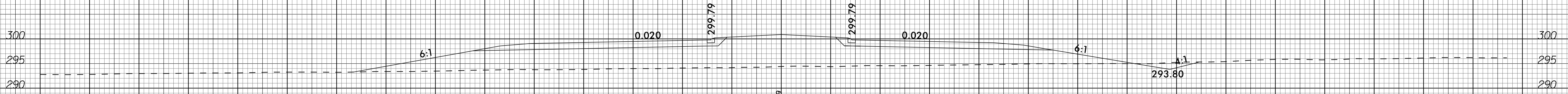
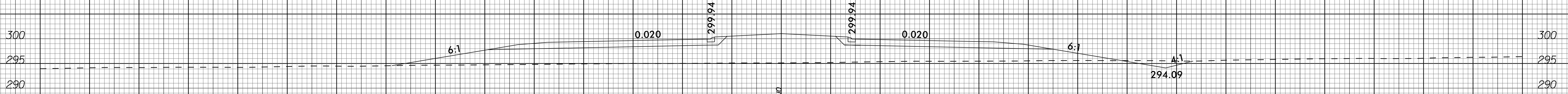

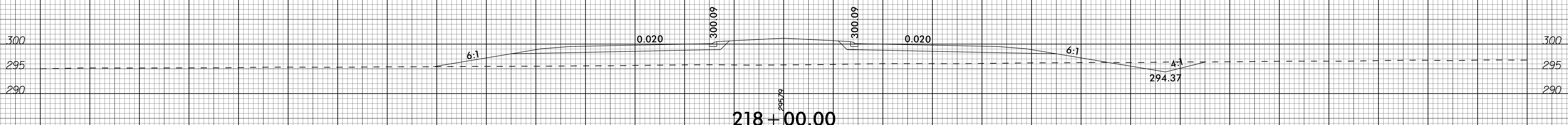
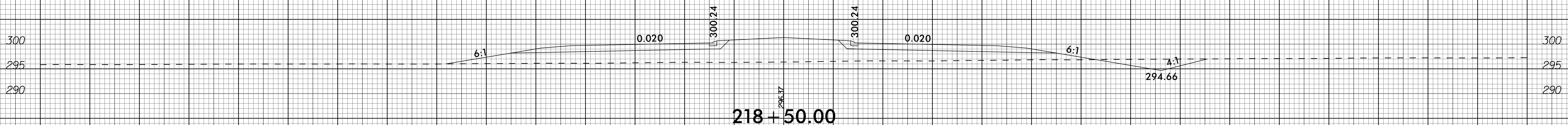
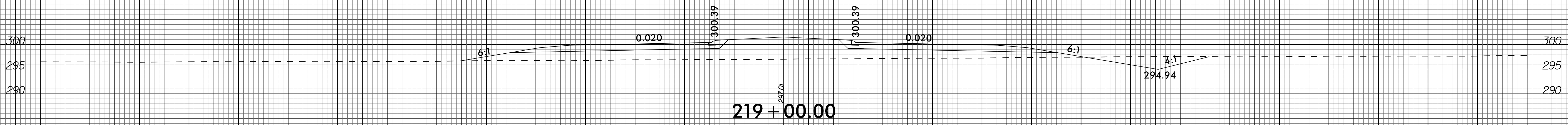
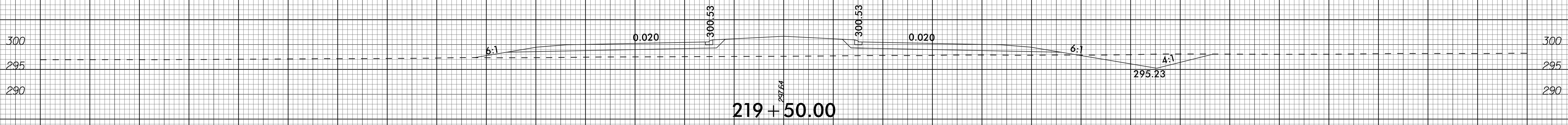
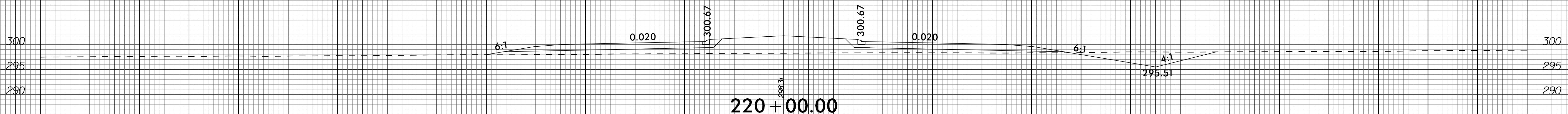

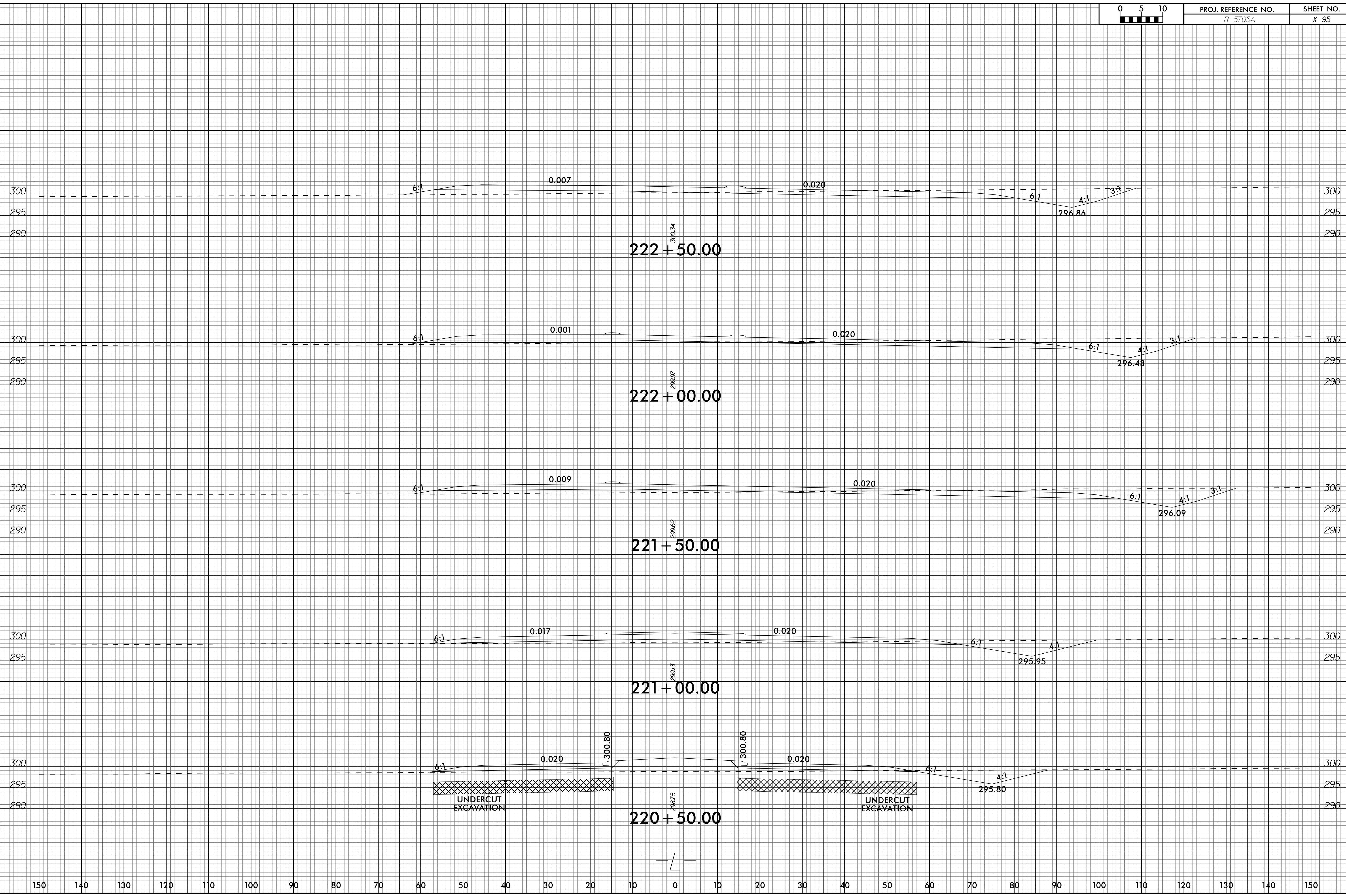

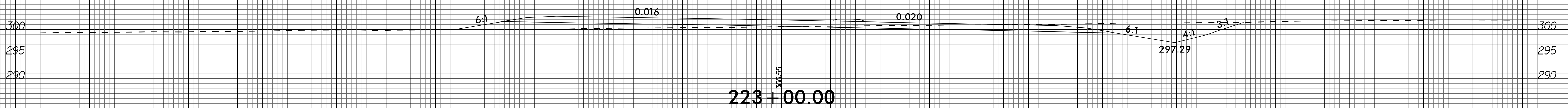
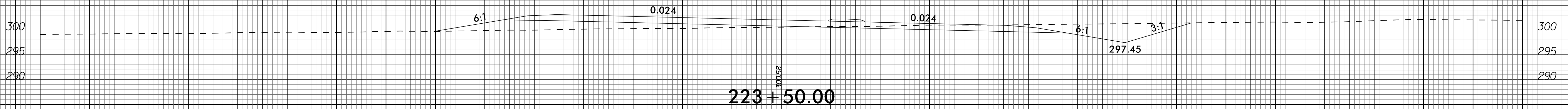
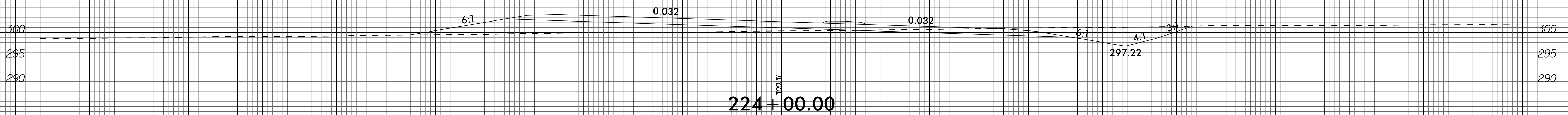
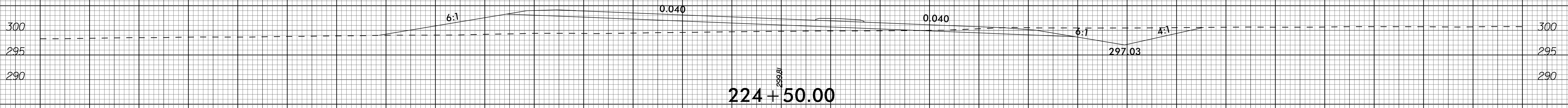
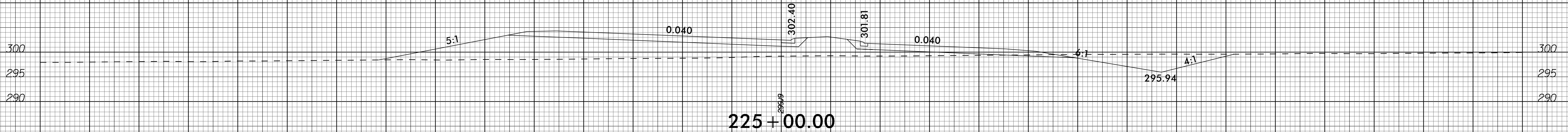

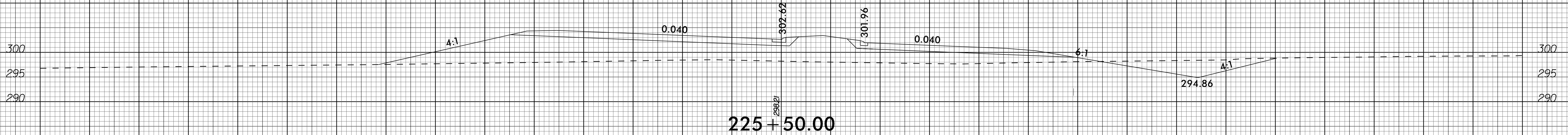
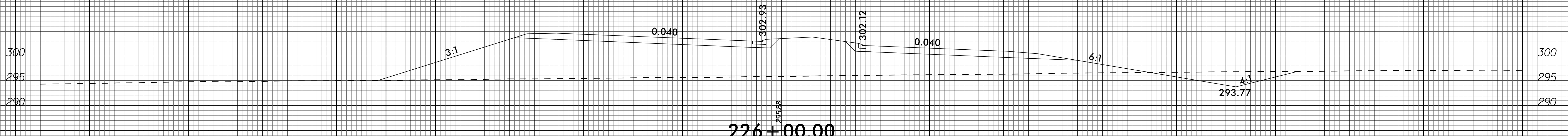
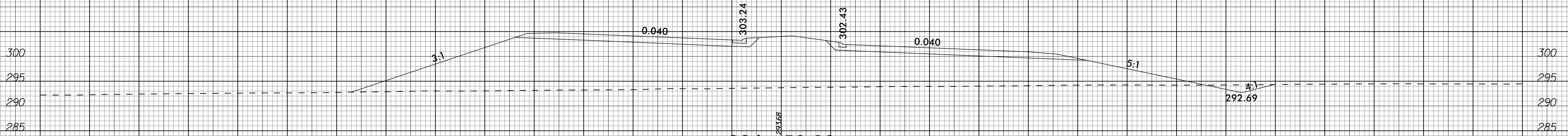
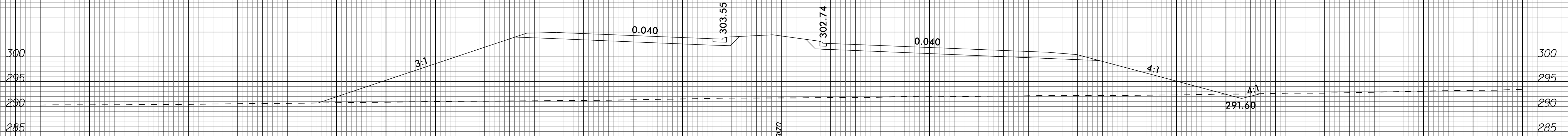
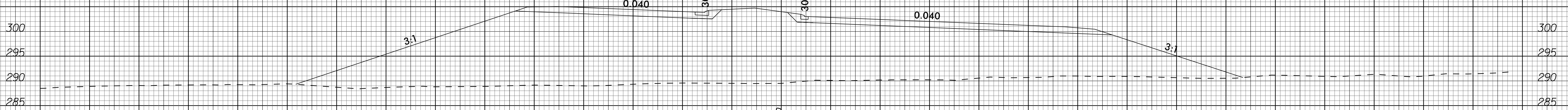

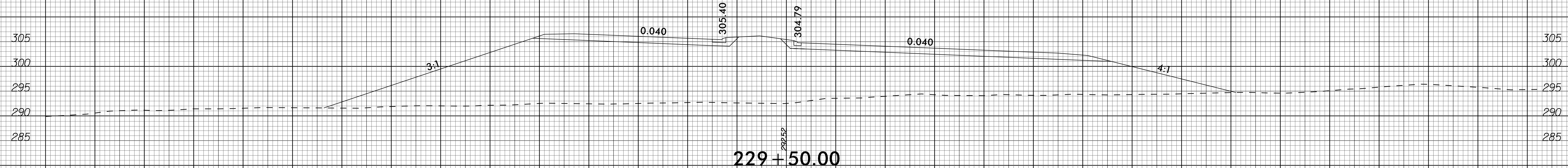

229 + 50.00

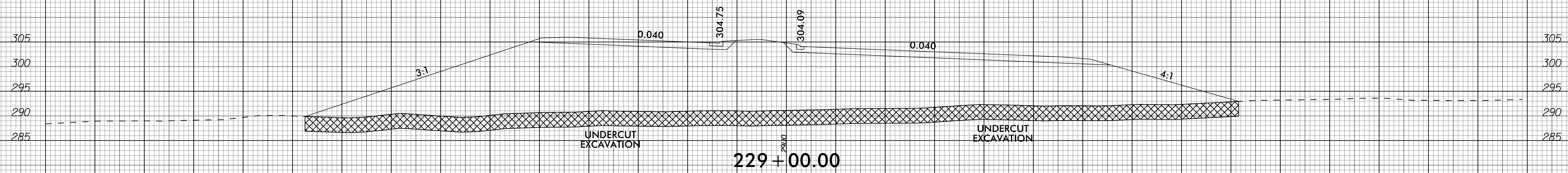

229 + 00.00

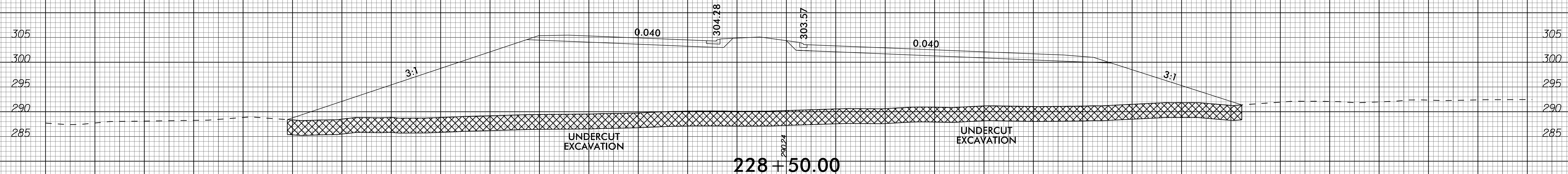

228 + 50.00

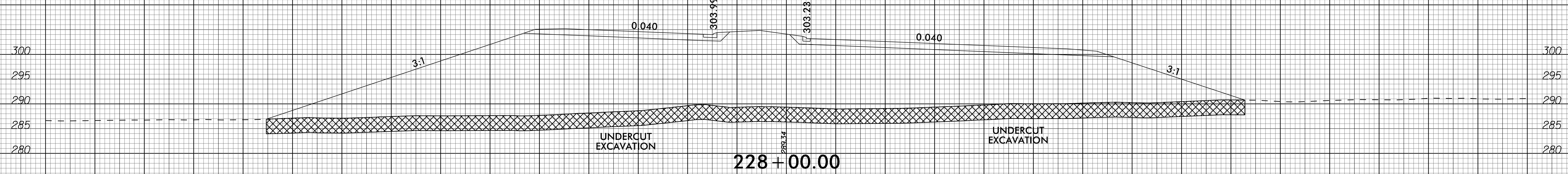

228 + 00.00

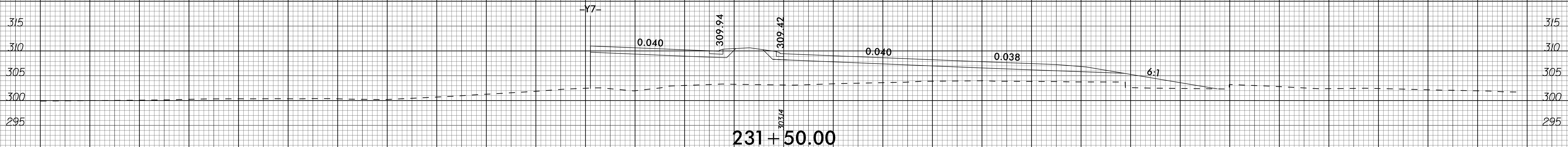

231+50.00

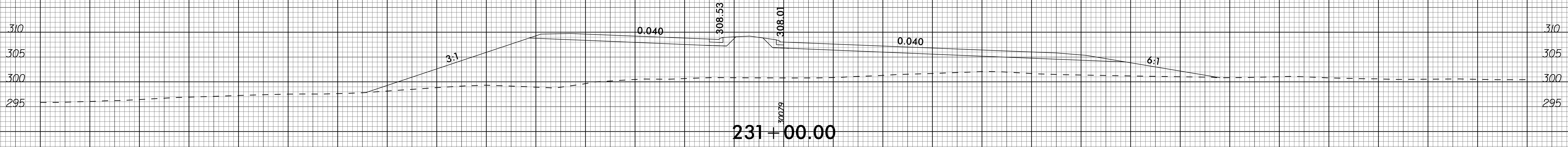

231+00.00

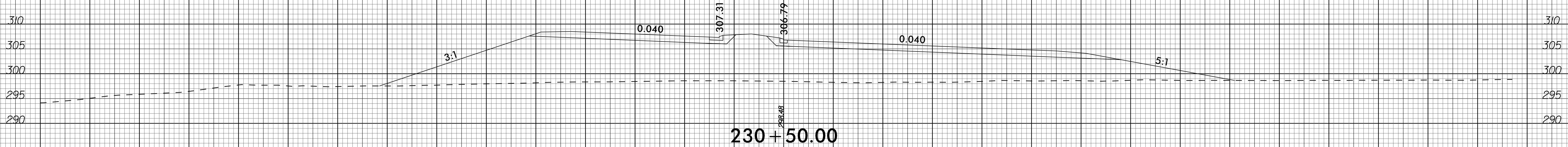

230+50.00

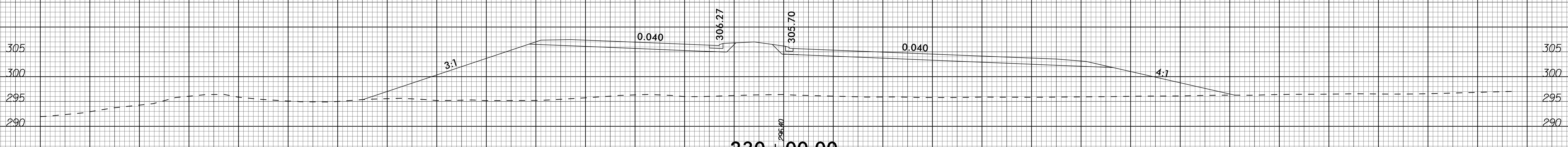

230+00.00



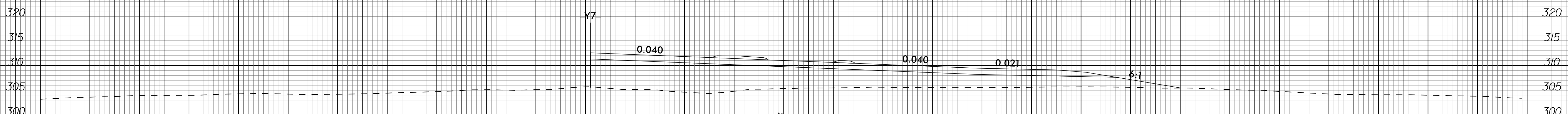
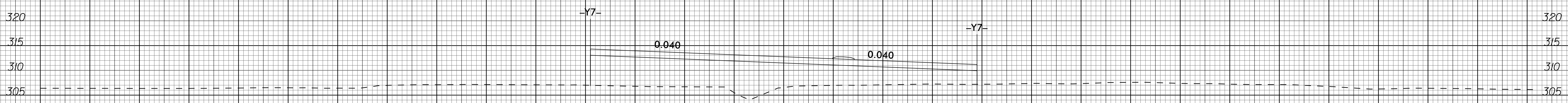
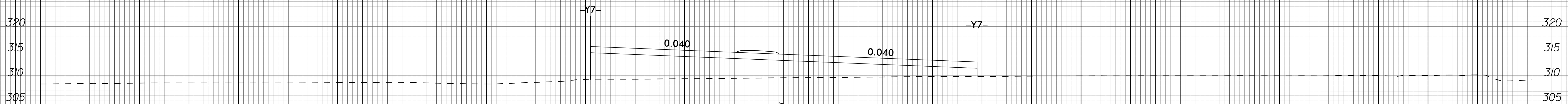

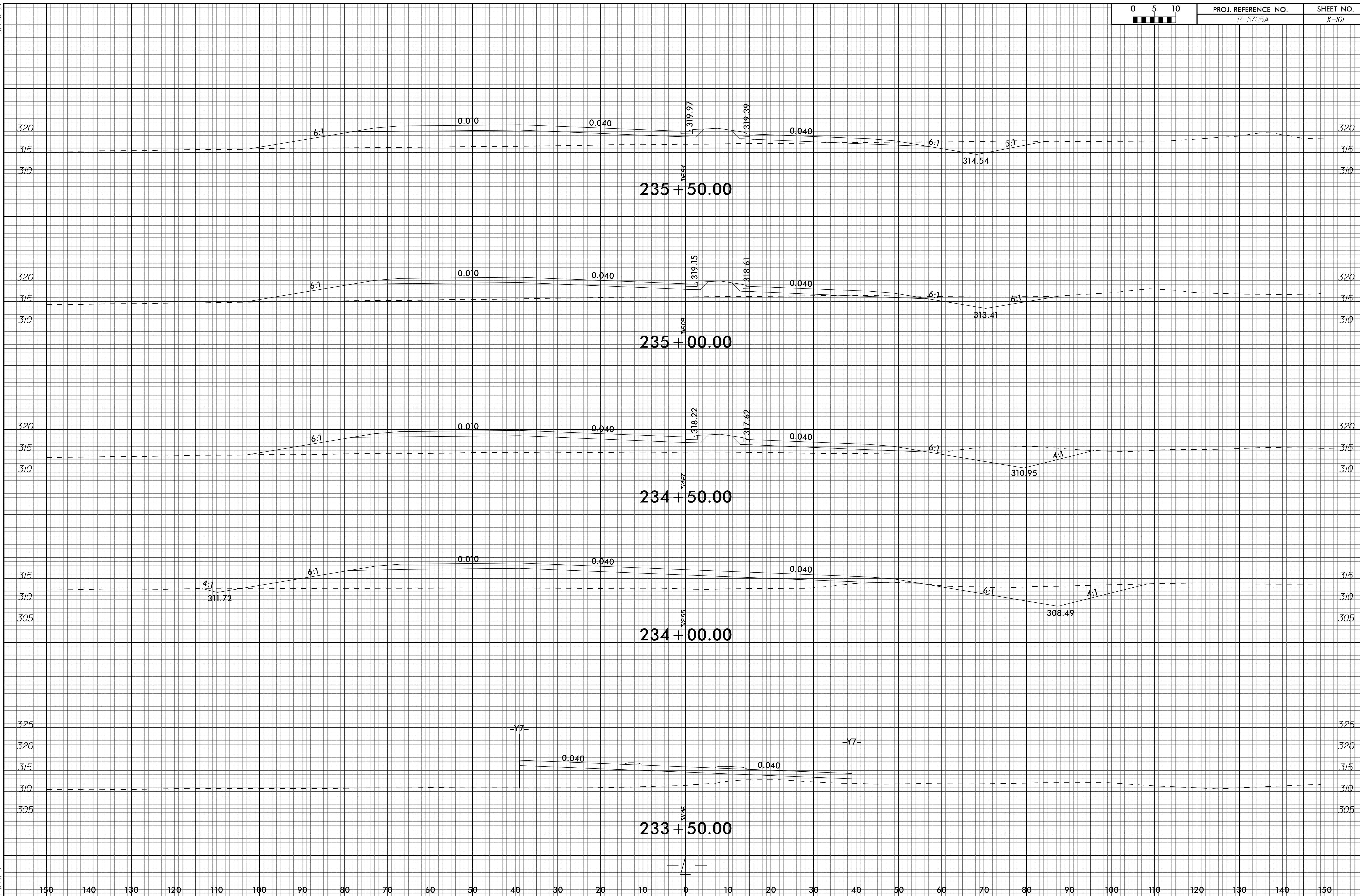



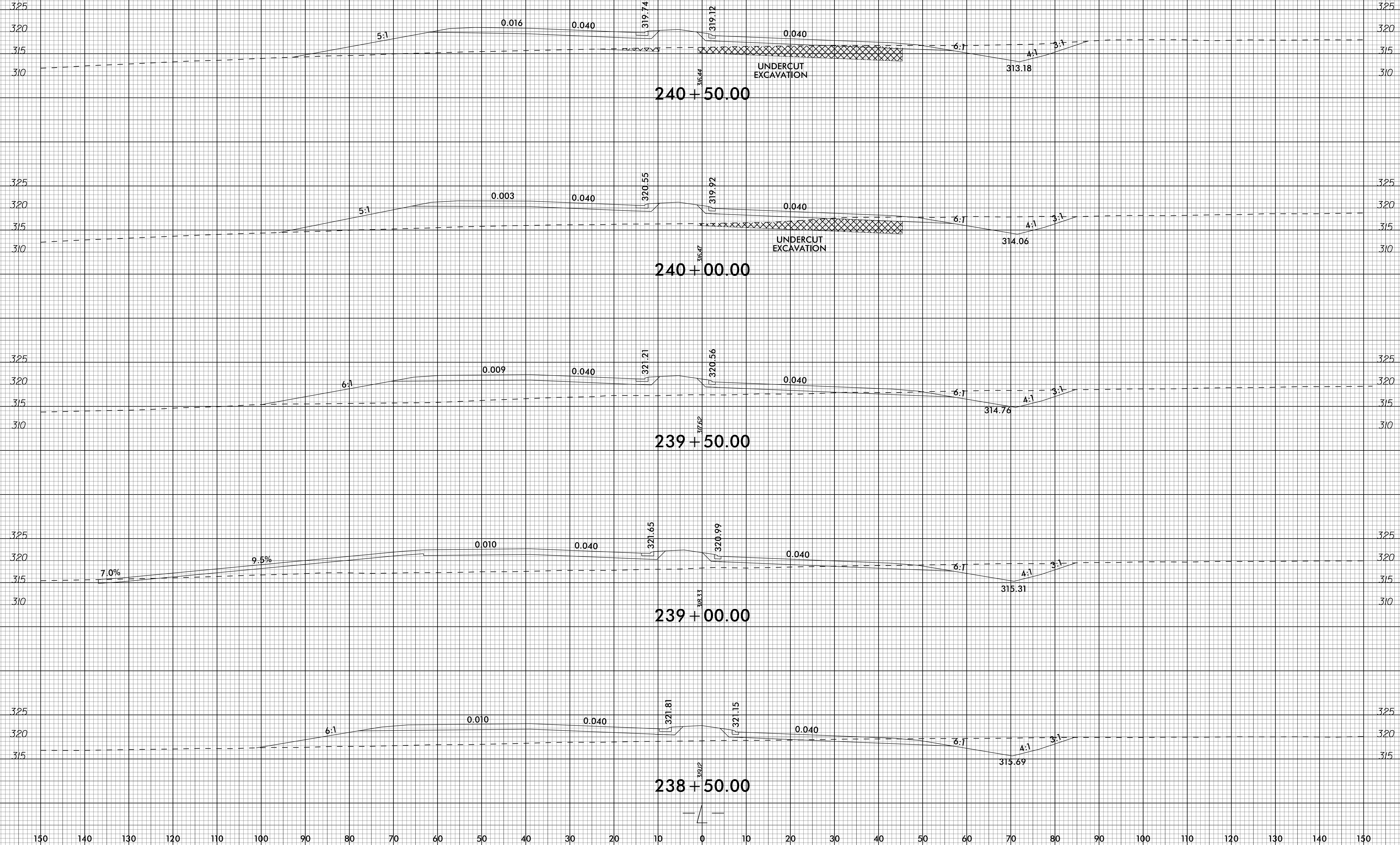

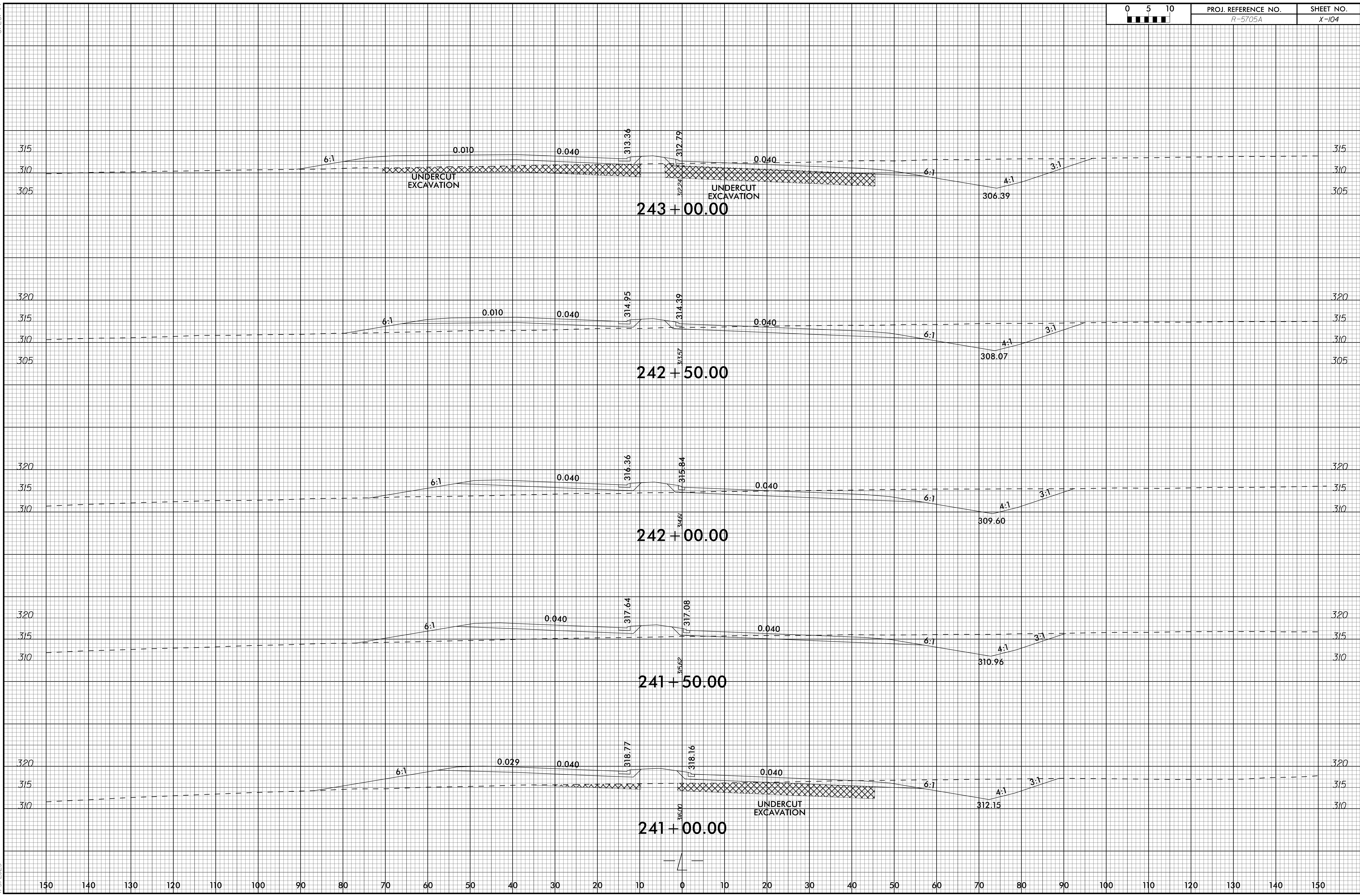
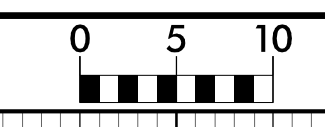

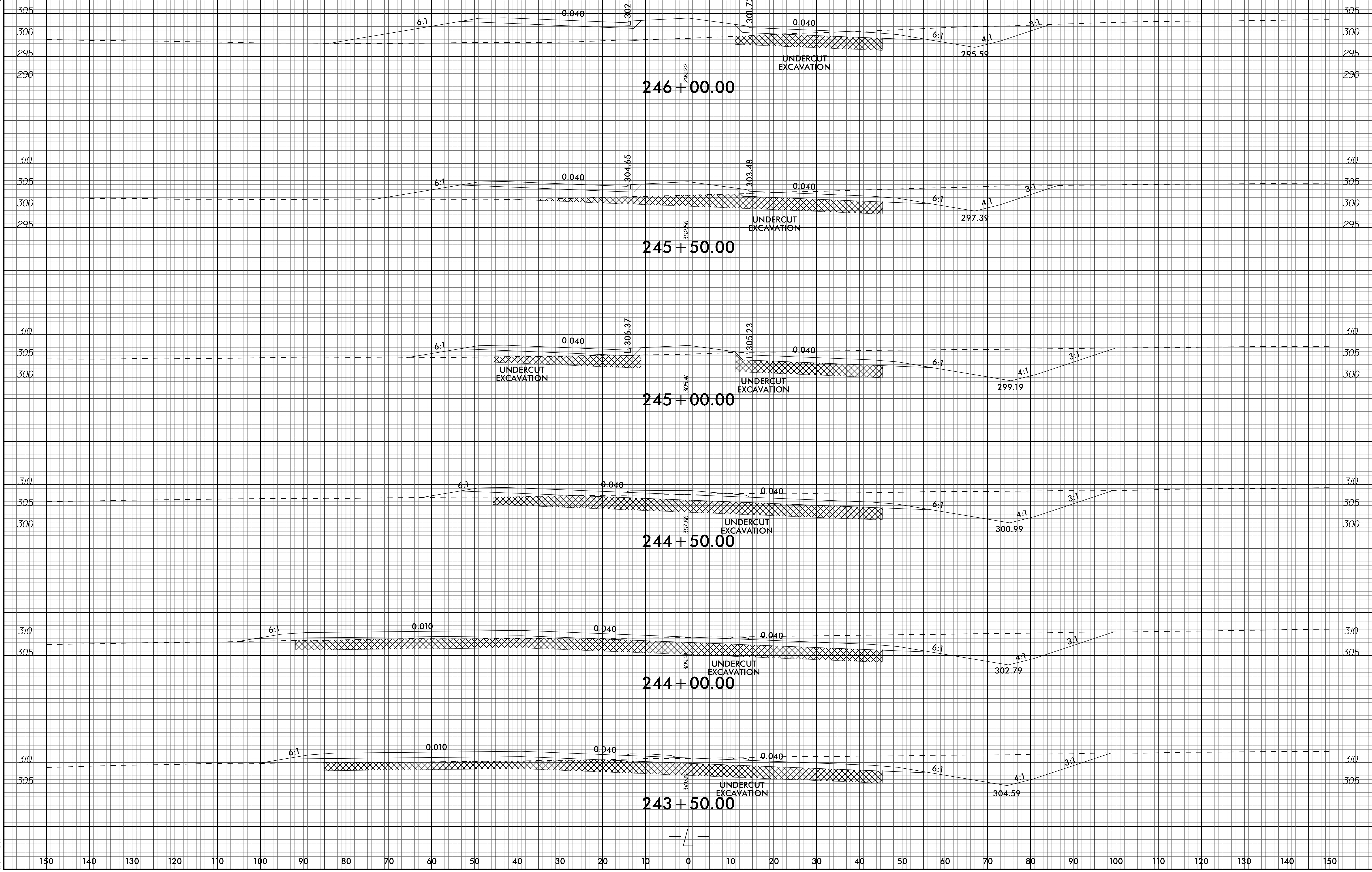
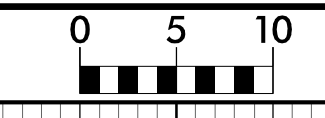

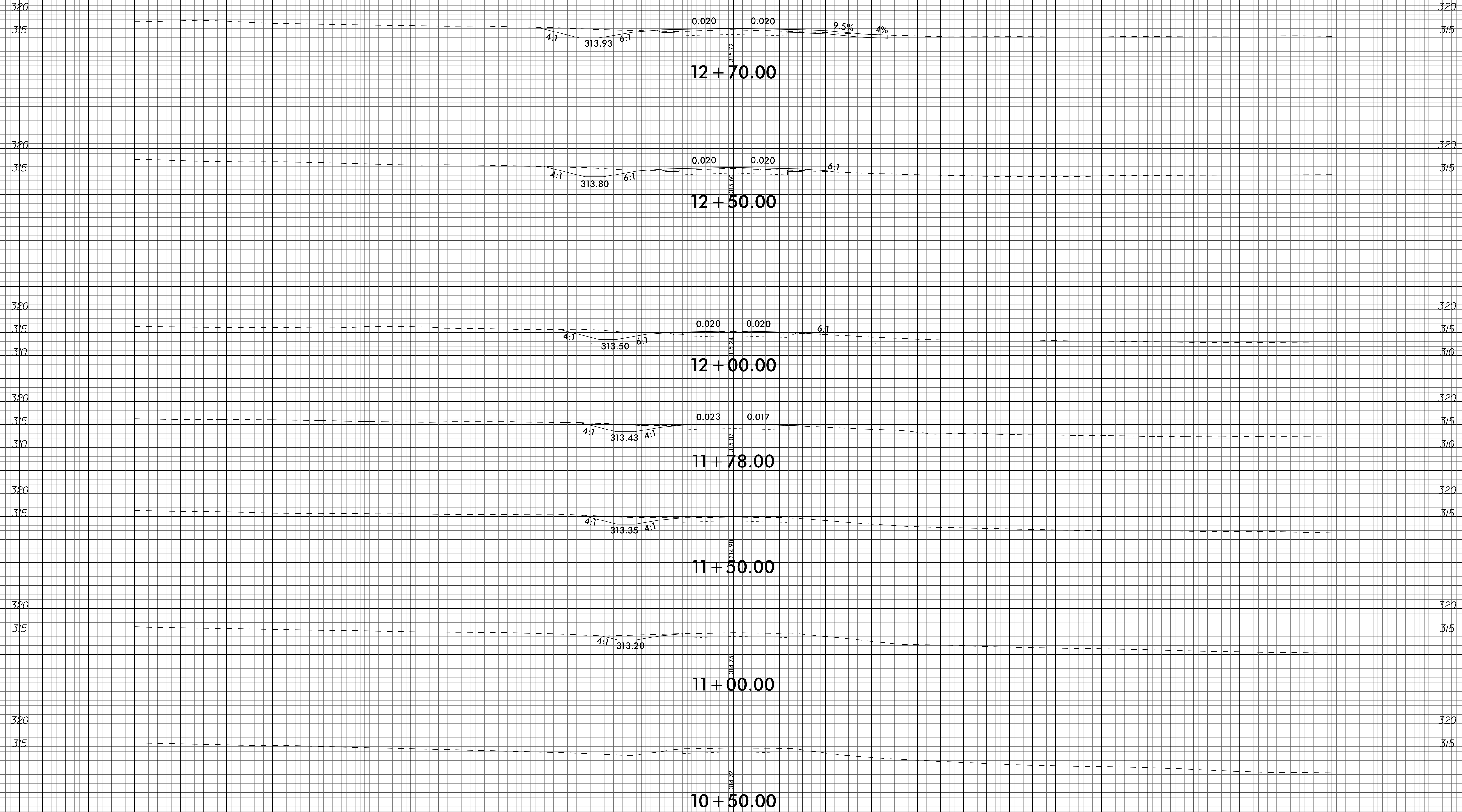

-Y/-

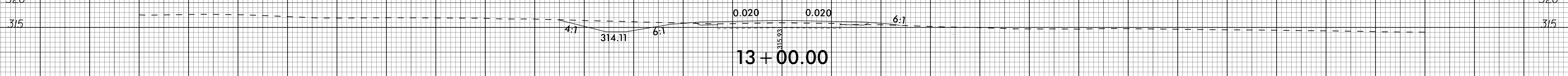
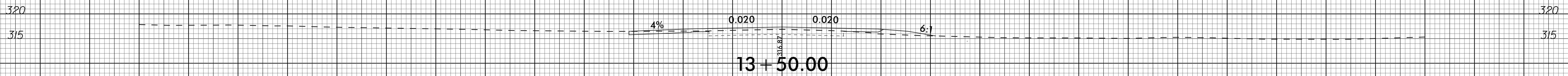
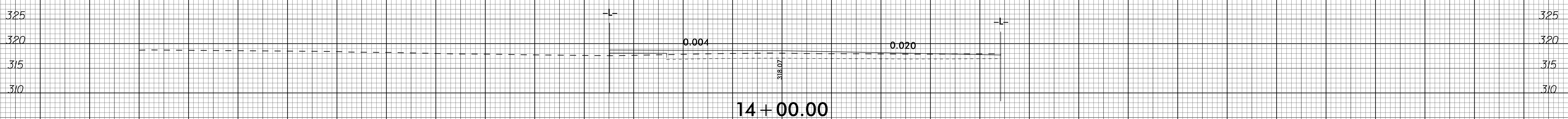
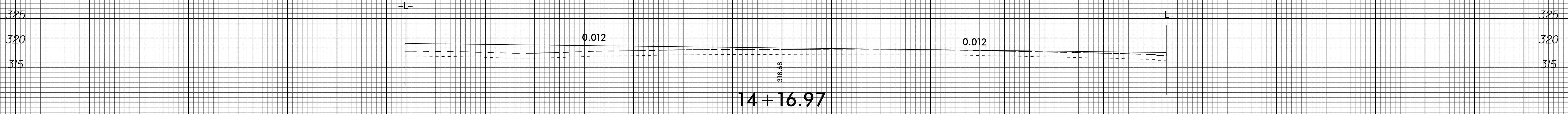

-Y/-



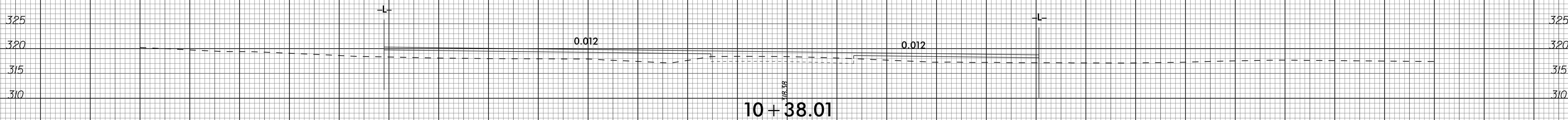
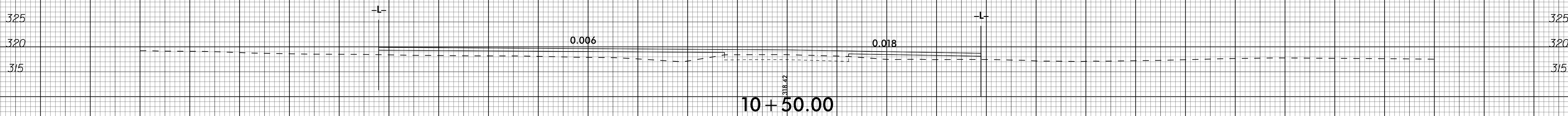
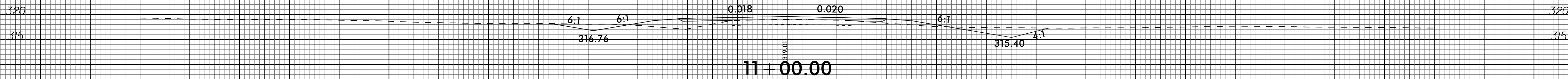
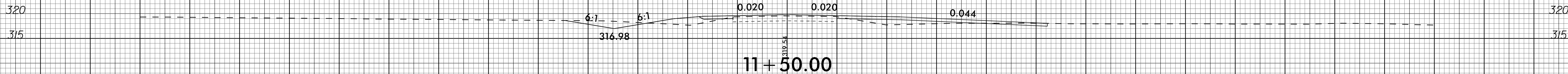

-Y2-

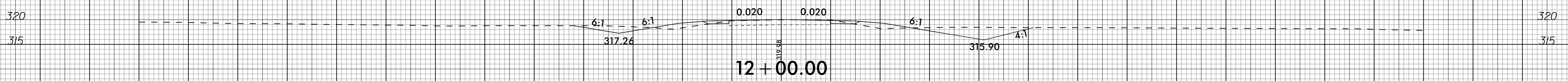
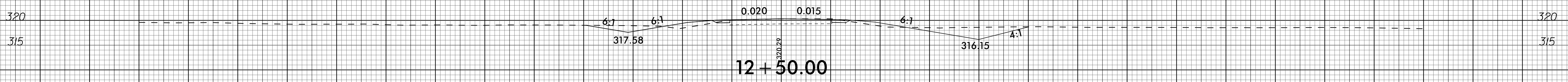
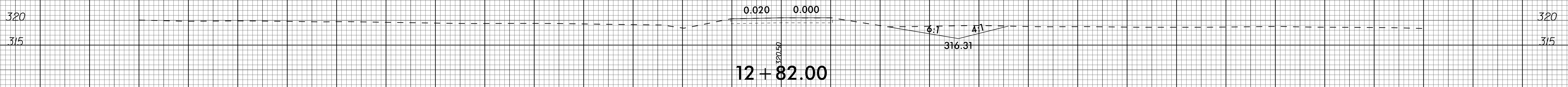
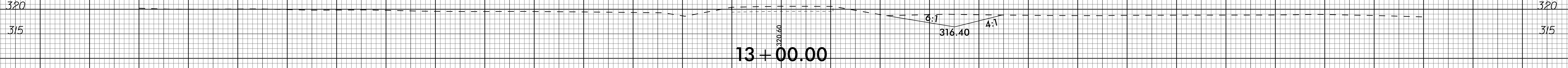

-Y2-

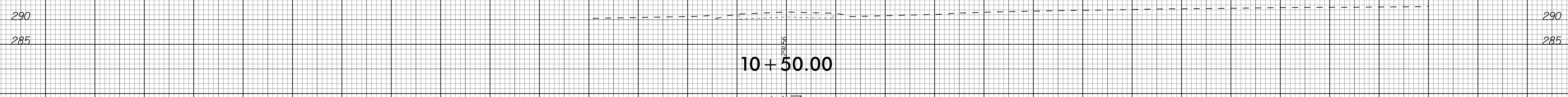
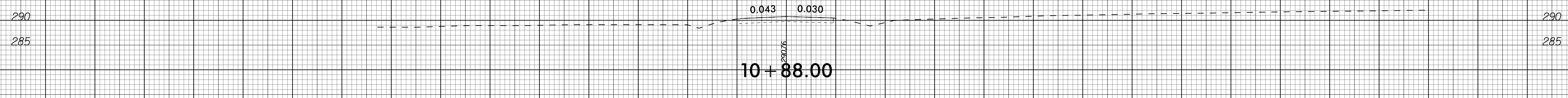
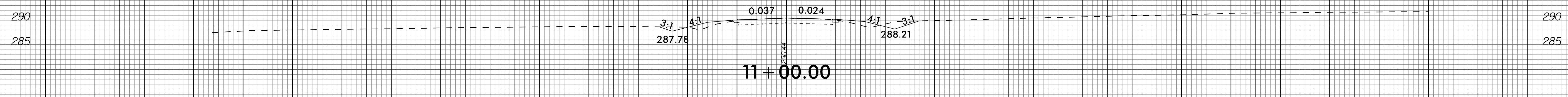
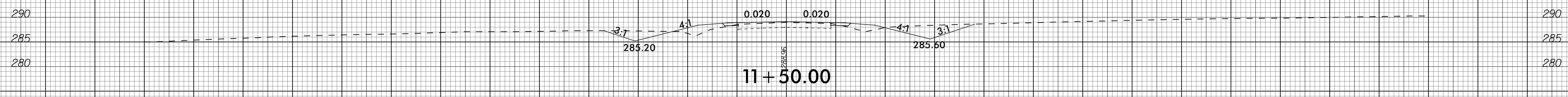
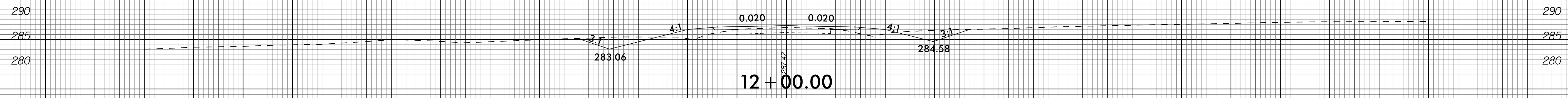

-Y3-

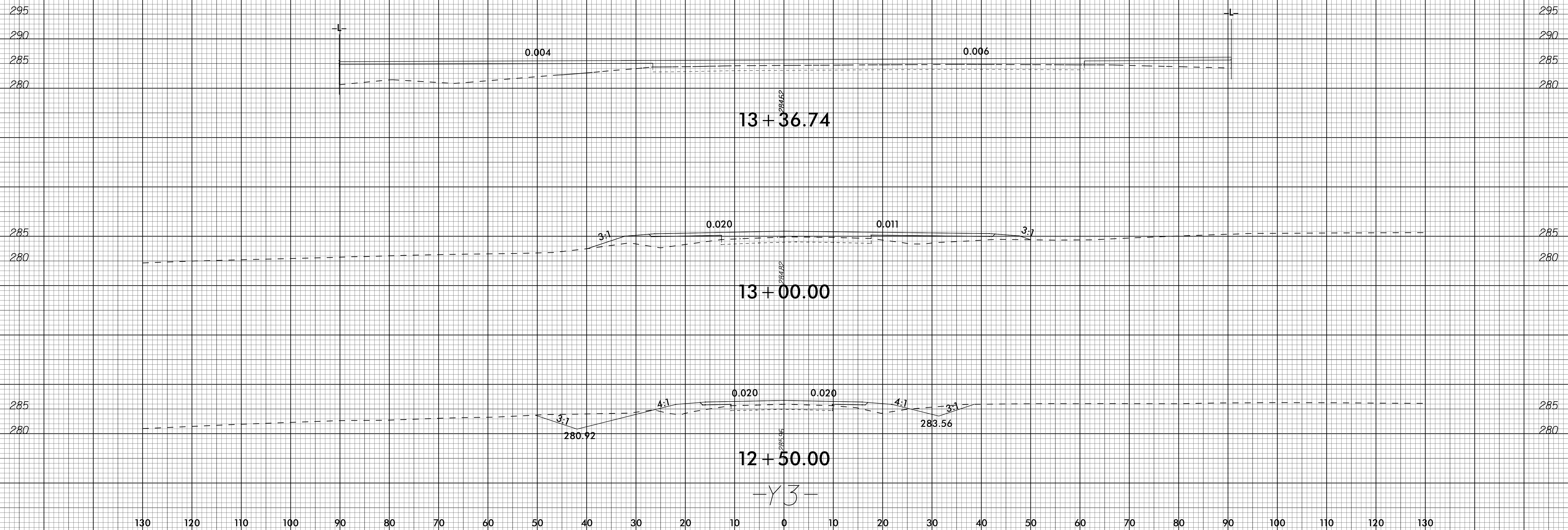

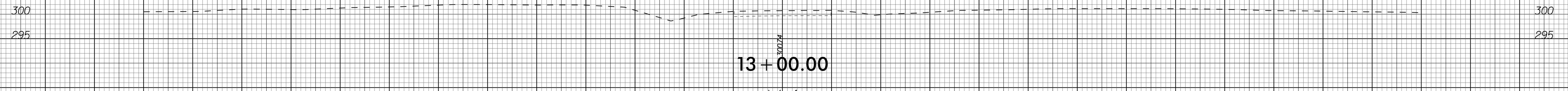
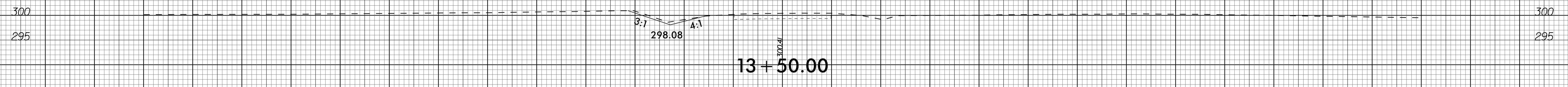
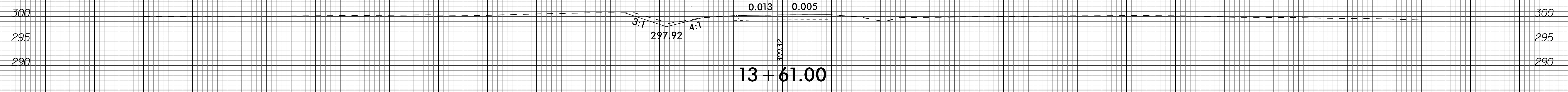
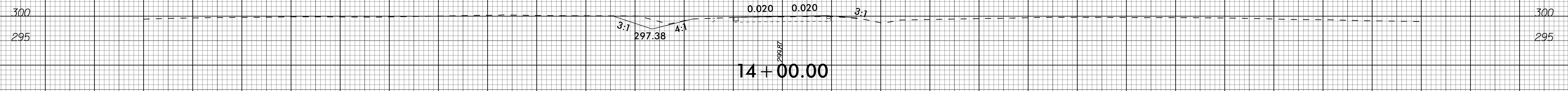
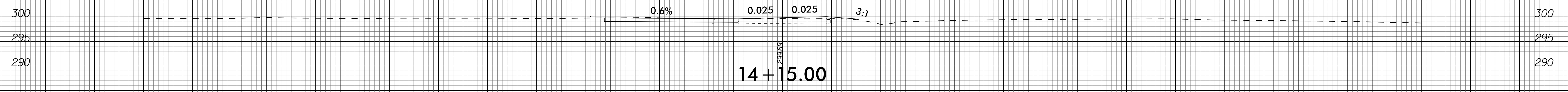
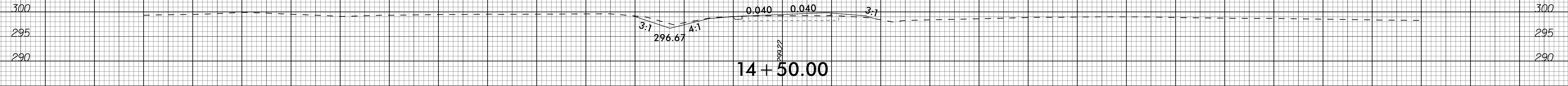
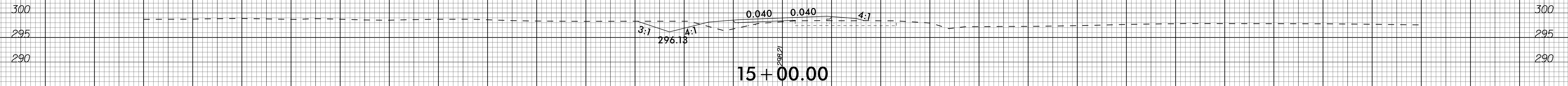

-Y4-

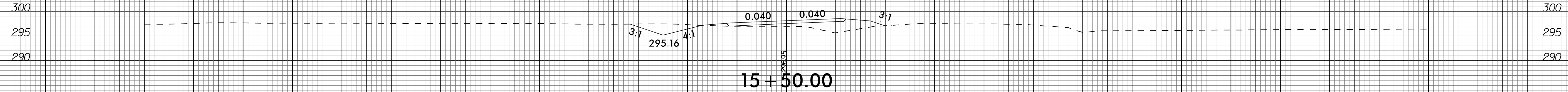
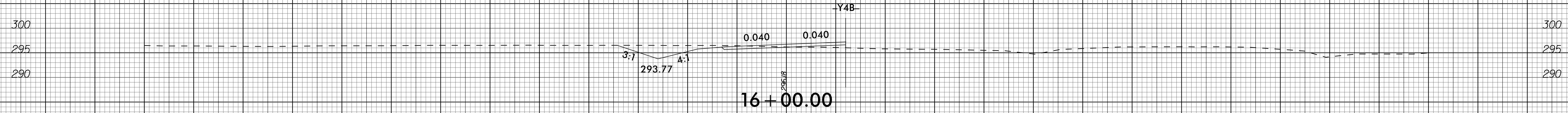
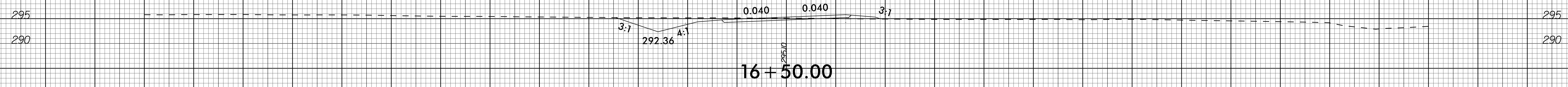
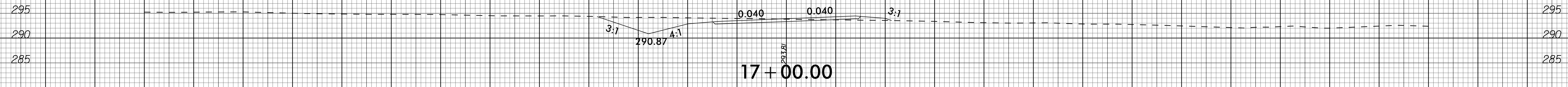
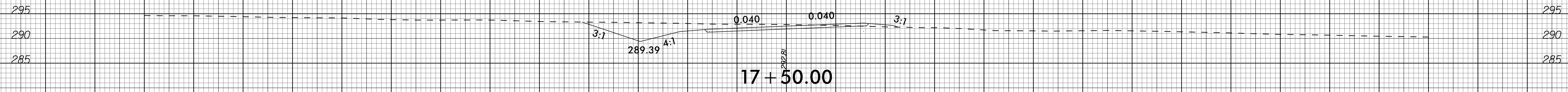
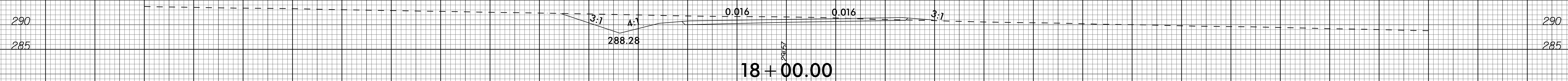

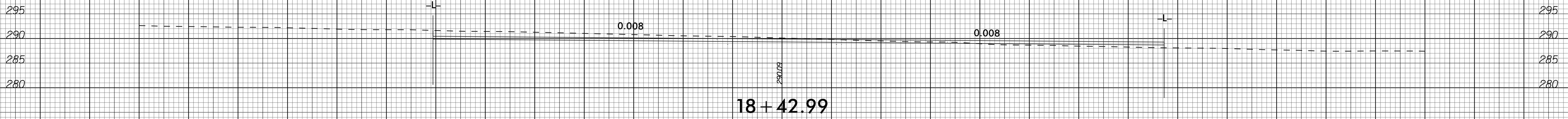
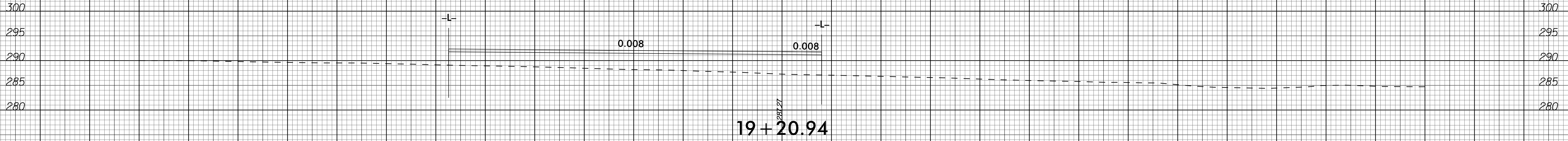
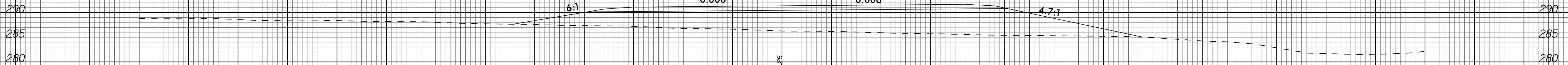

-Y4-

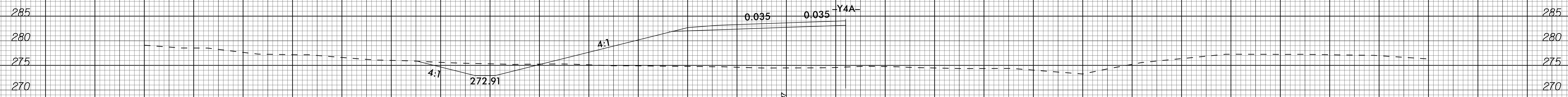

22 + 00.00

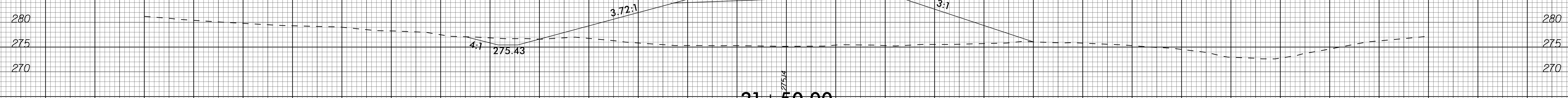

21 + 50.00

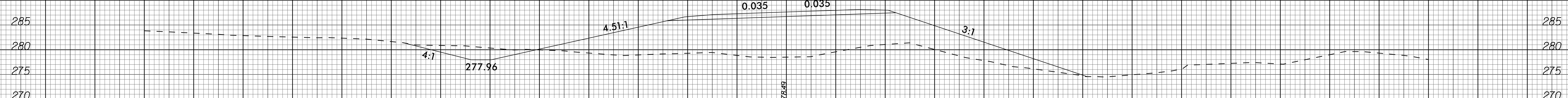

21 + 00.00

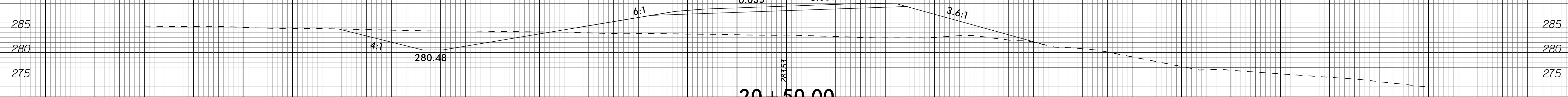

20 + 50.00

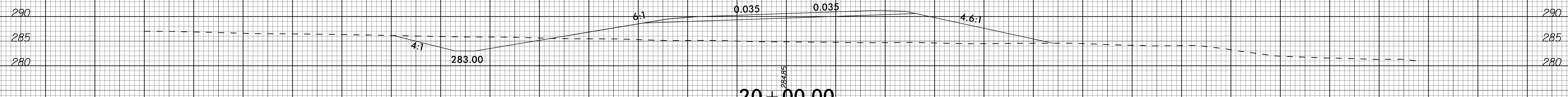

20 + 00.00

-Y4-



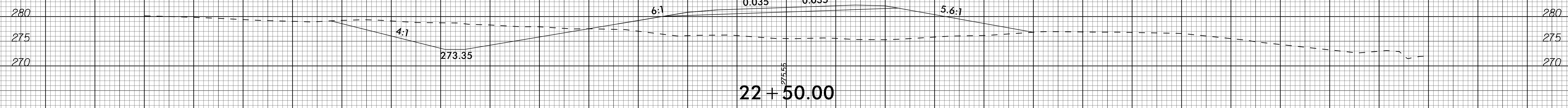
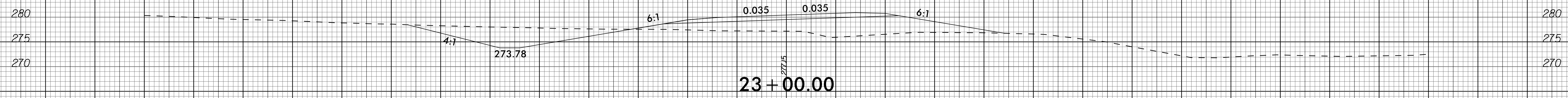
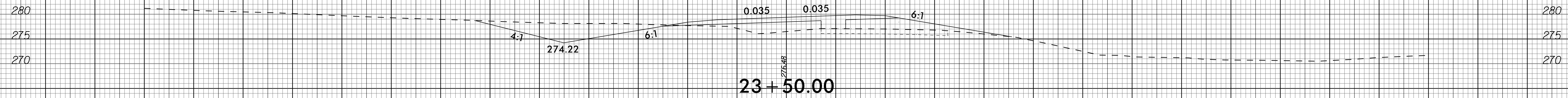
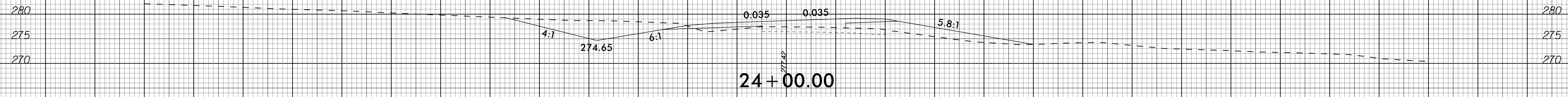
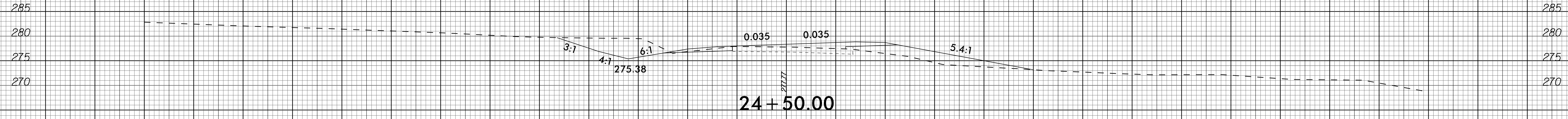

-Y4-

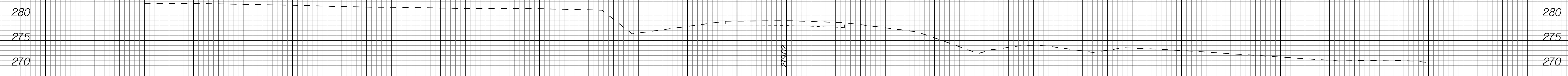

26 + 00.00

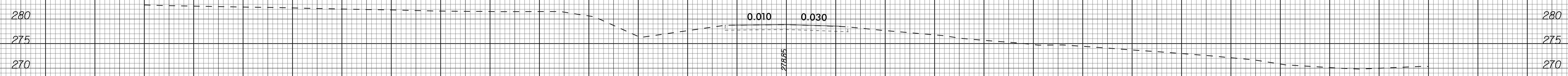

25 + 77.00

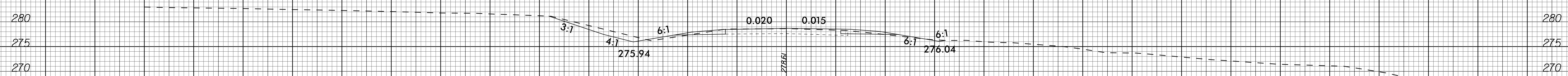

25 + 50.00

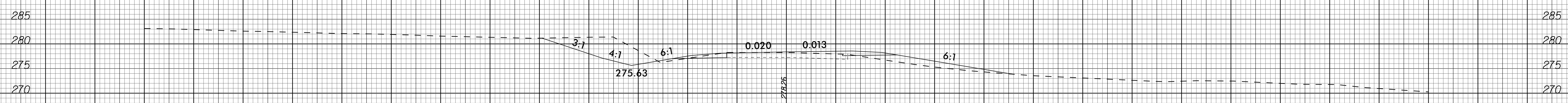

25 + 00.00

-Y4-

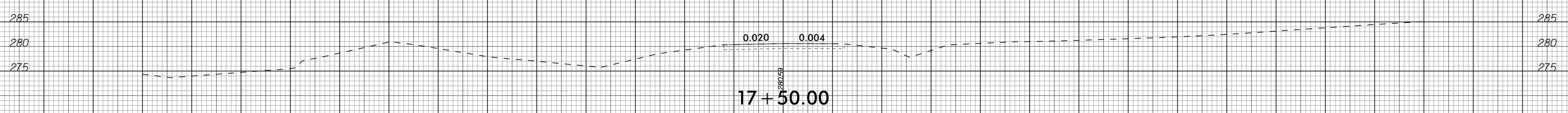
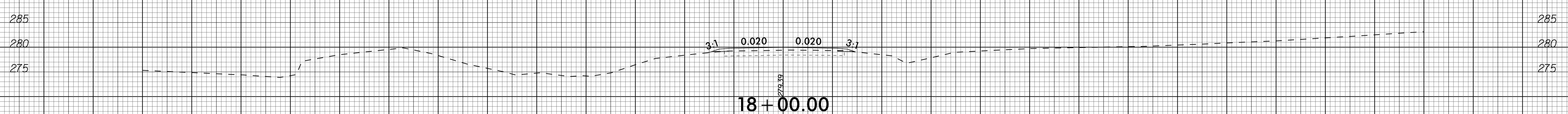
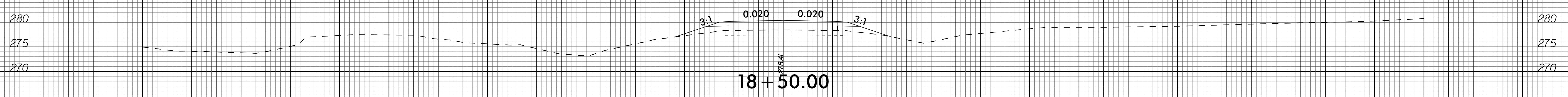
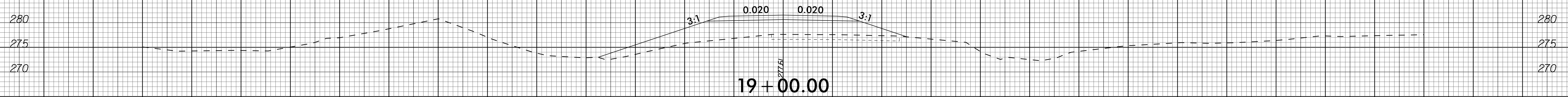
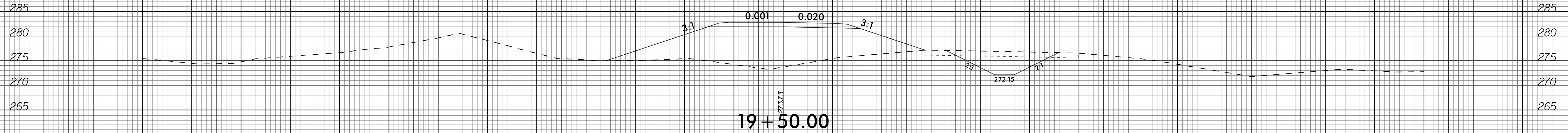

-Y4A-

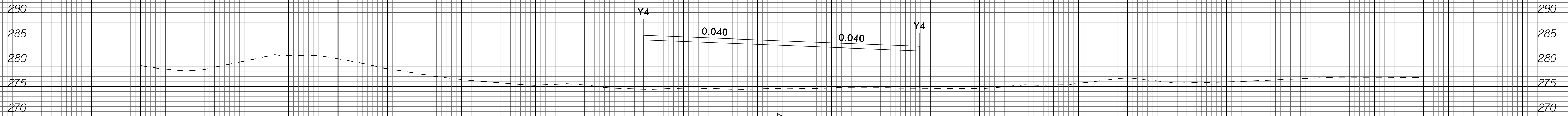

20+08.00

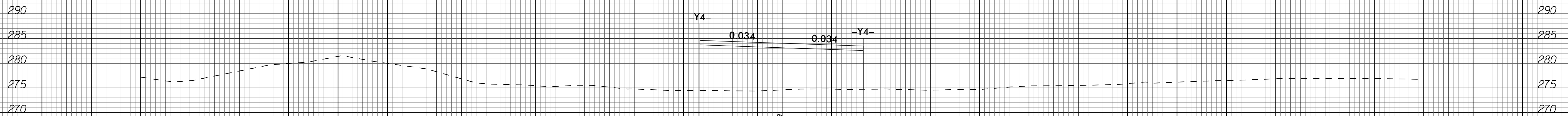

20+00.00

-Y4A-

130 120 110 100 90 80 70 60 50 40 30 20 10 0 10 20 30 40 50 60 70 80 90 100 110 120 130

290  
285

290  
285

EXIST EXIST  
291.47  
12 + 90.74

290  
285

290  
285

0.030 0.015 EXIST EXIST  
292.06  
12 + 45.00

295  
290  
285

295  
290  
285

EXIST EXIST  
291.27  
11 + 40.00

-Y4A- TURNAROUND

130 120 110 100 90 80 70 60 50 40 30 20 10 0 10 20 30 40 50 60 70 80 90 100 110 120 130

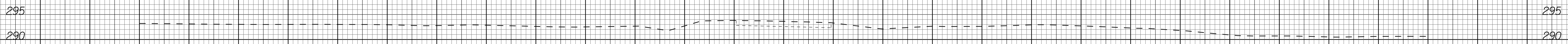
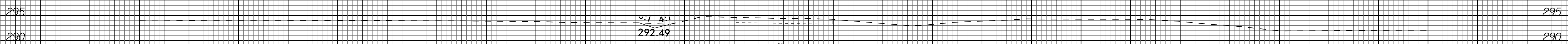
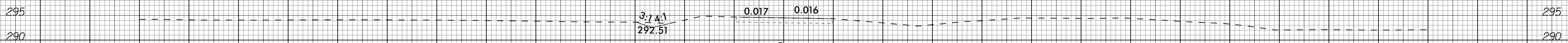
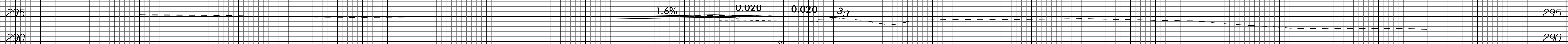
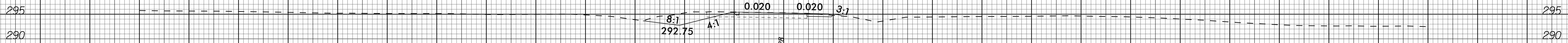
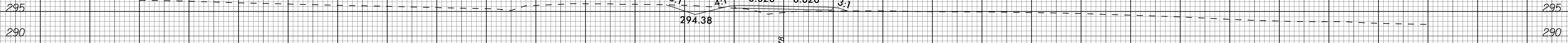

-Y4B-

8/23/99

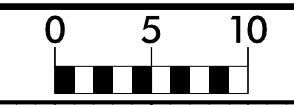

PROJ. REFERENCE NO.  
R-5705A

SHEET NO.  
X-122

305  
300  
295  
290

-Y4-

-Y4-

0.028

0.028

17+00.00

295.54

295  
290

3.1

0.020

0.020

3.1

16+78.49

295.53

-Y4B-

130 120 110 100 90 80 70 60 50 40 30 20 10 0 10 20 30 40 50 60 70 80 90 100 110 120 130

1/31/2023

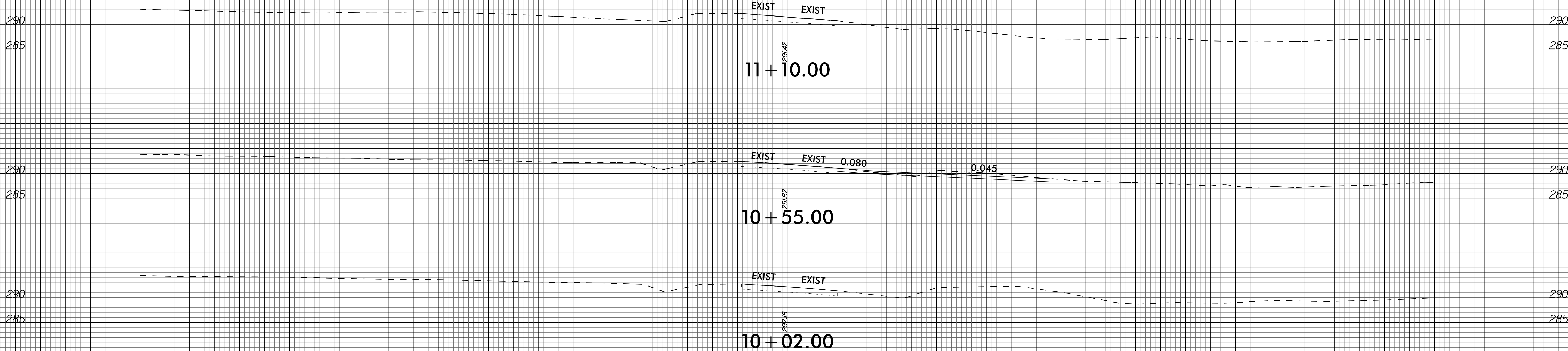

-Y4B- TURNAROUND



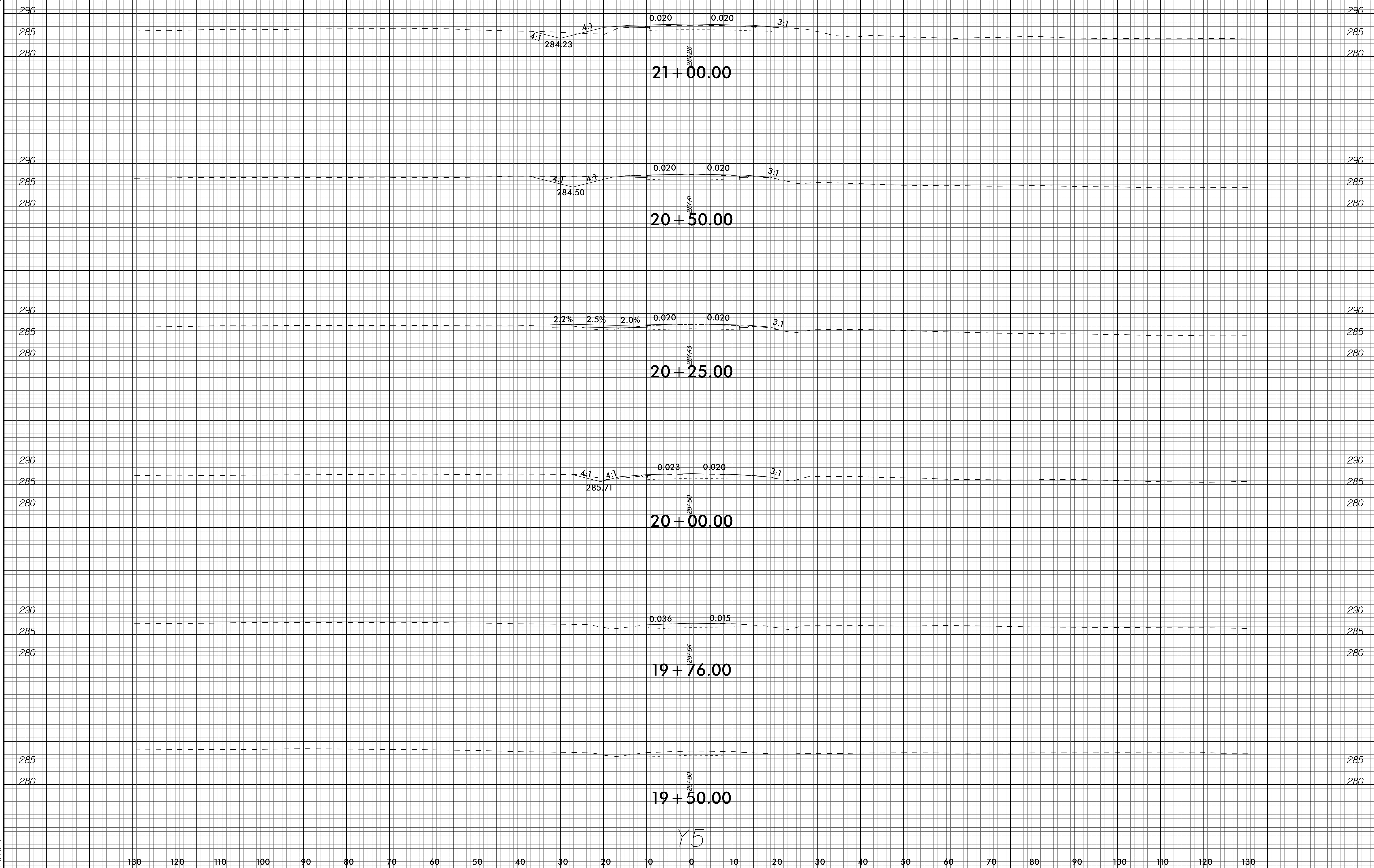

-Y5-

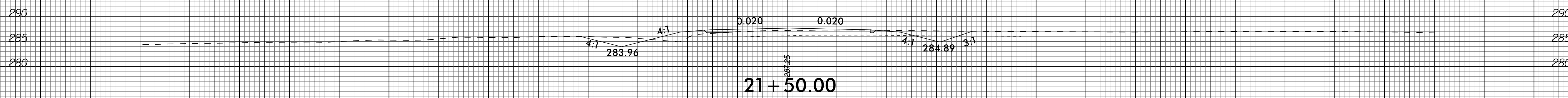
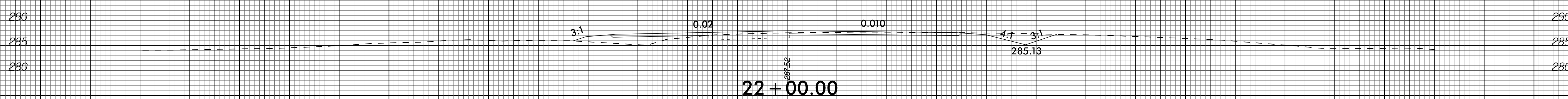
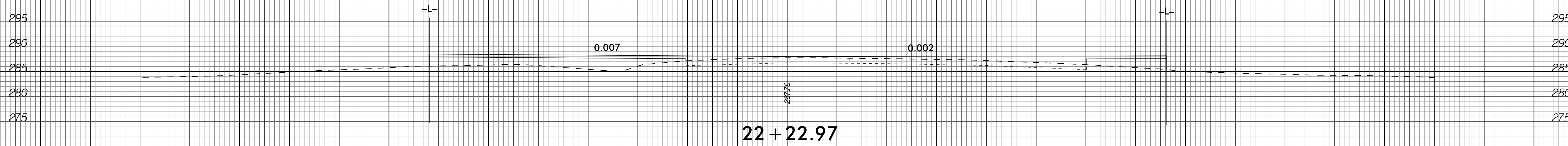
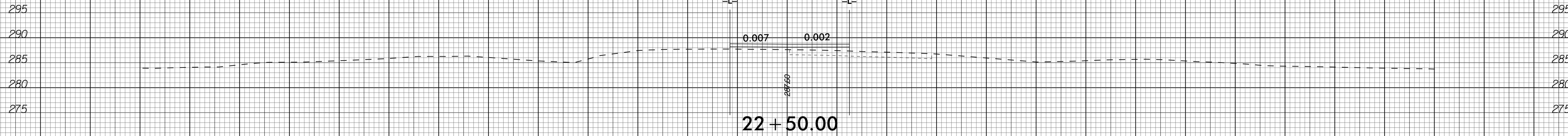

-Y5-

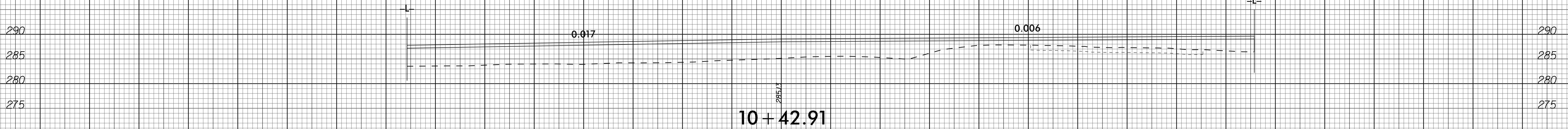
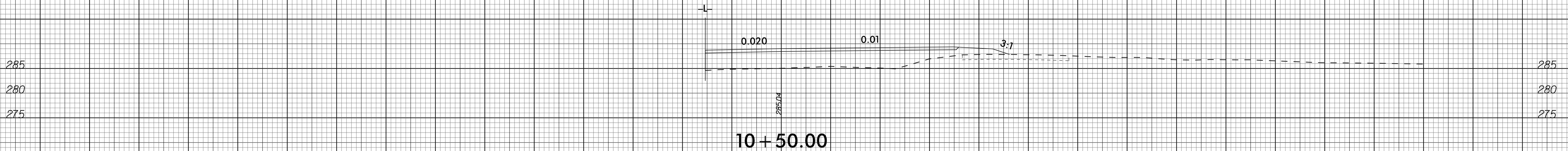
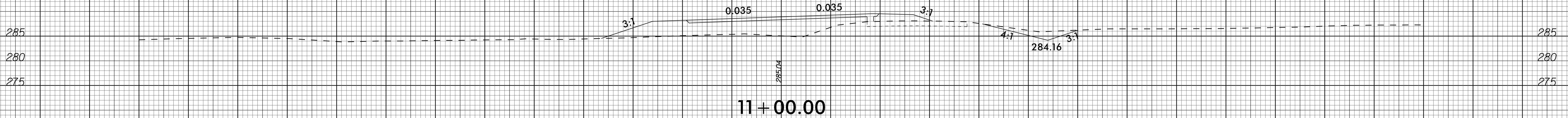
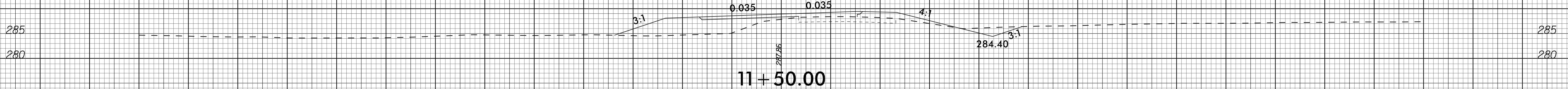

-Y5A-

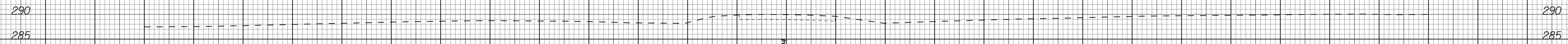

14 + 00.00

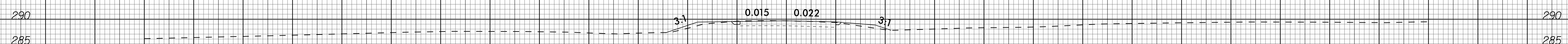

13 + 50.00

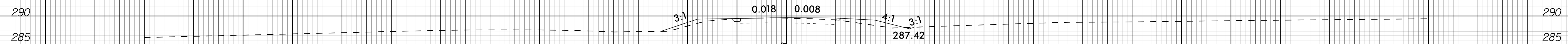

13 + 30.00

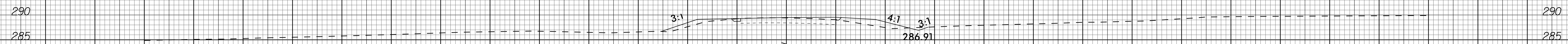

13 + 00.00

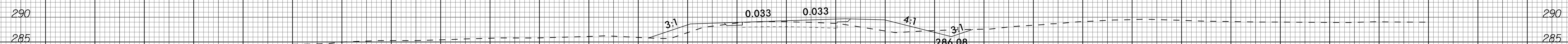

12 + 50.00

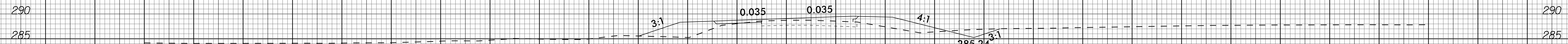

12 + 00.00

-Y5A-

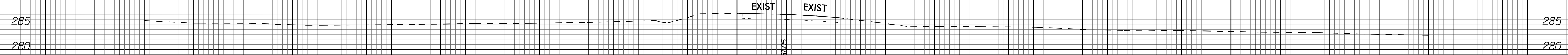

13 + 19.00

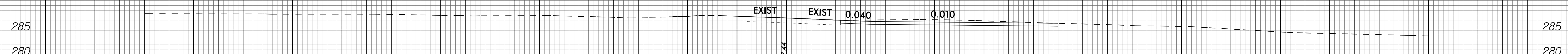

12 + 50.00

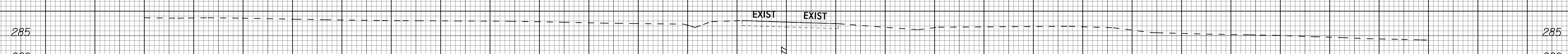

12 + 15.00

-Y5B- TURNAROUND

130 120 110 100 90 80 70 60 50 40 30 20 10 0 10 20 30 40 50 60 70 80 90 100 110 120 130

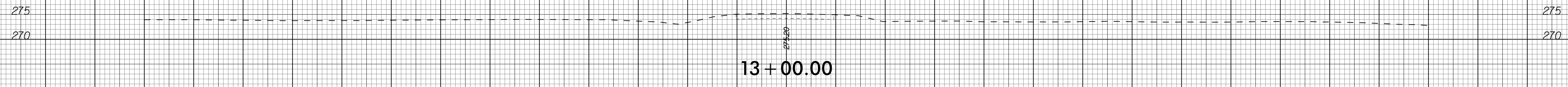
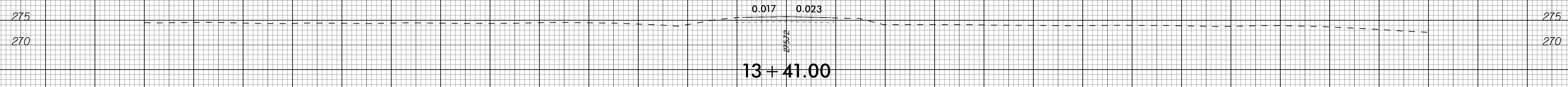
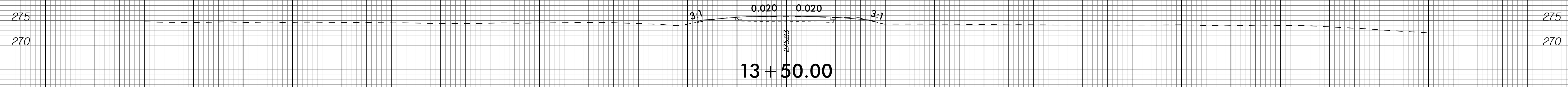
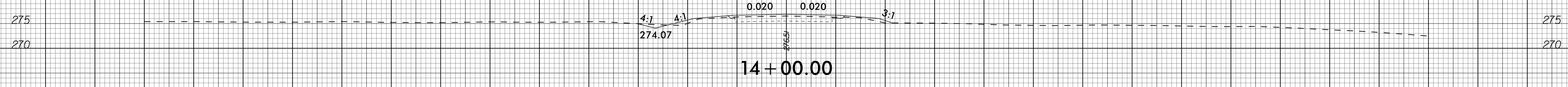
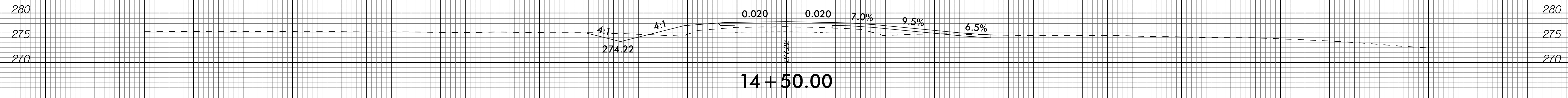
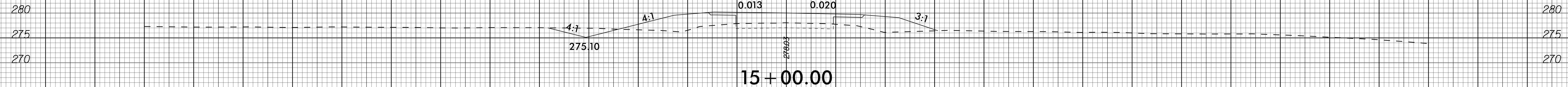

-Y6-

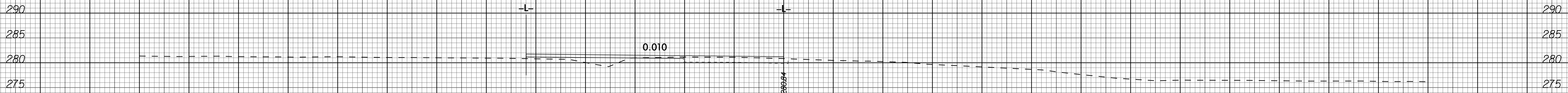

16+95.86

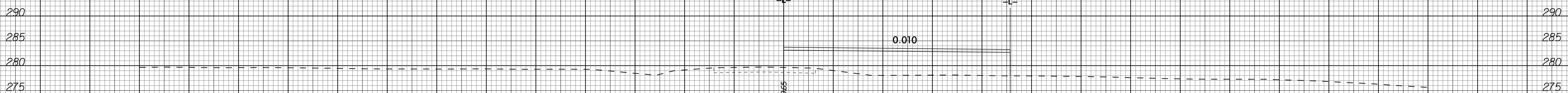

16+16.60

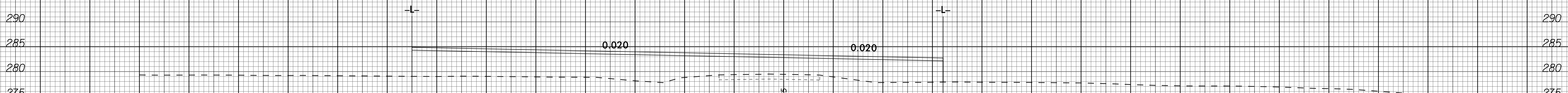

16+00.00

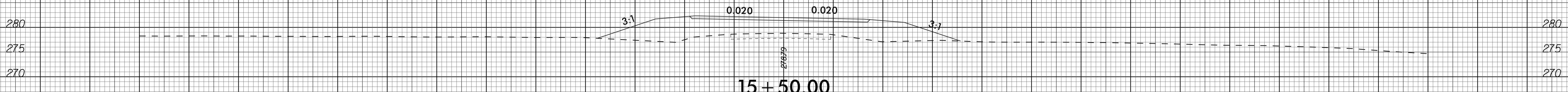

15+50.00

-Y6-

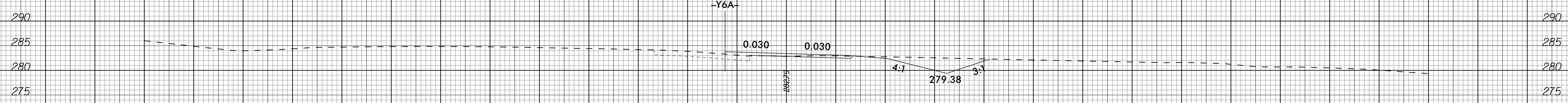

18 + 90.00

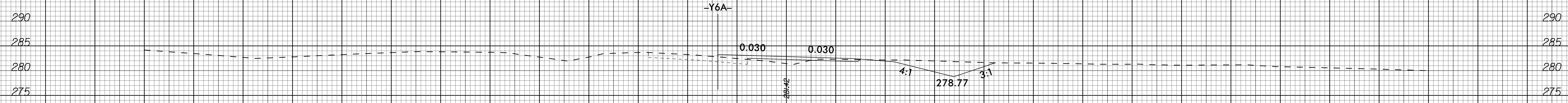

18 + 50.00

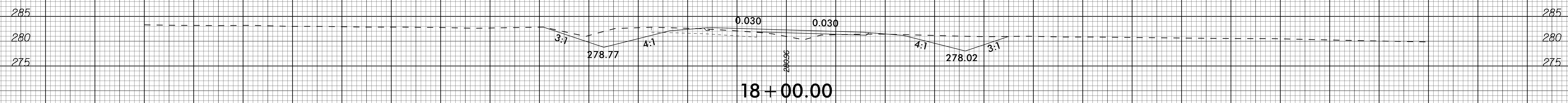

18 + 00.00

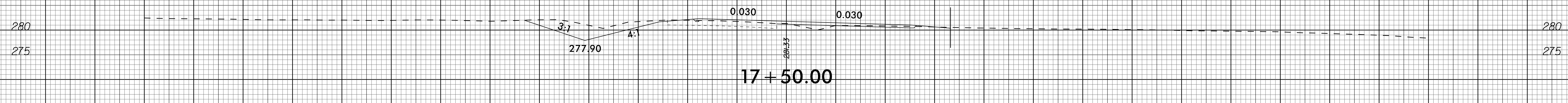

17 + 50.00

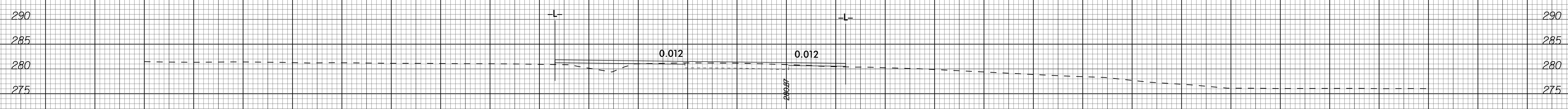

17 + 00.00

-Y6-



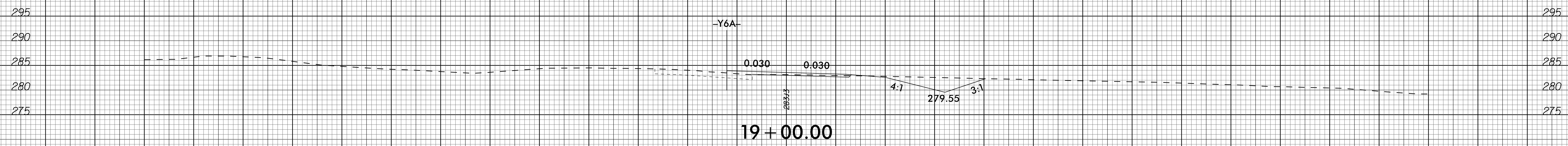
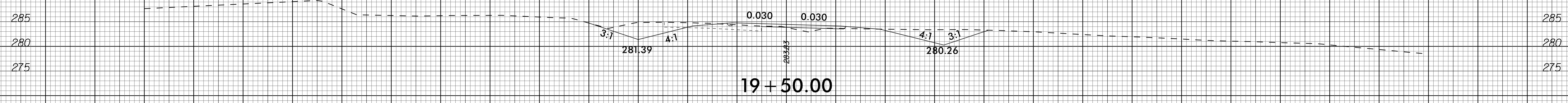
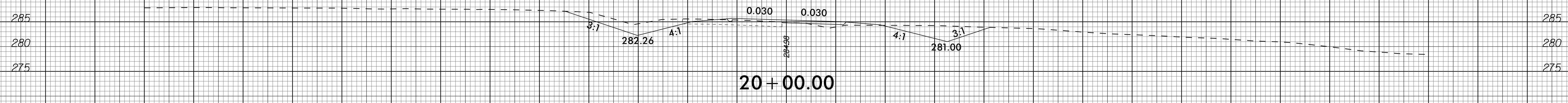
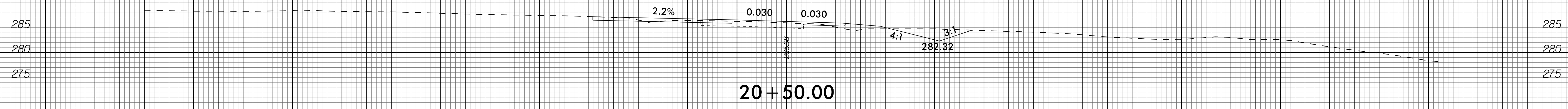
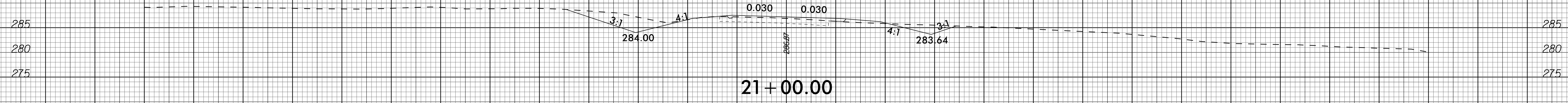

-Y6-

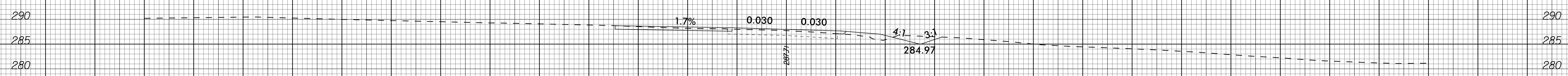
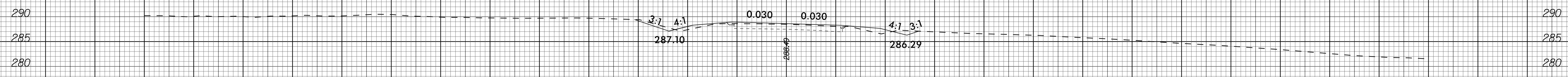
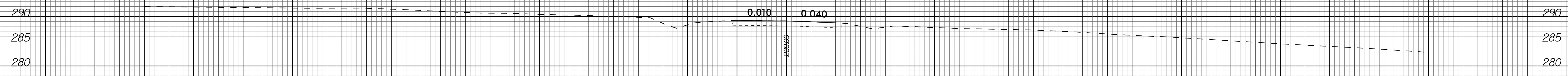
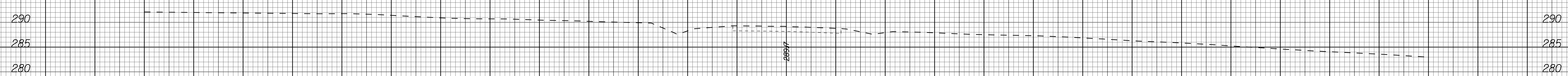

21+50.00

-Y6-

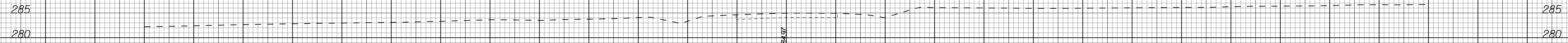

11+50.00

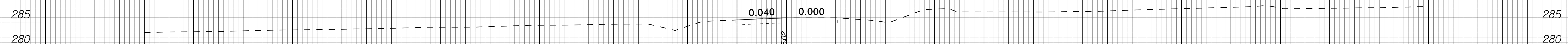

11+17.00

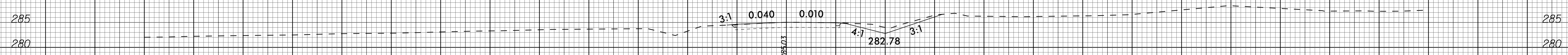

11+00.00

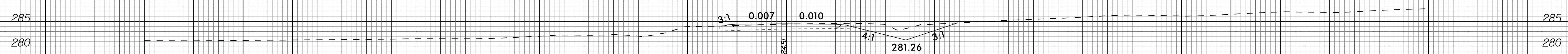

10+50.00

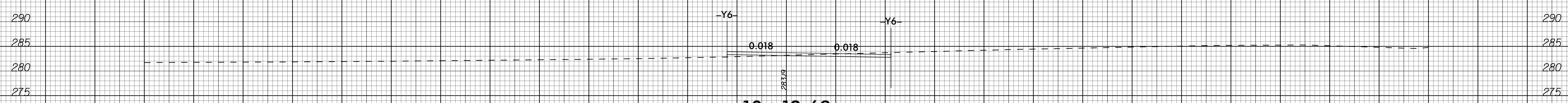

10+12.69

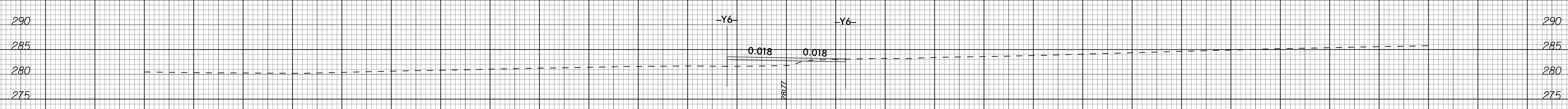

10+00.00

-Y6A-

130 120 110 100 90 80 70 60 50 40 30 20 10 0 10 20 30 40 50 60 70 80 90 100 110 120 130

275

270

275

270

280

275

270

275

270

275

270

280

275

270

EXIST

EXIST

18 + 19.00

275.79

EXIST

EXIST

0.016

17 + 25.00

276.87

EXIST

EXIST

16 + 66.00

277.77

-Y6A- TURNAROUND

130 120 110 100 90 80 70 60 50 40 30 20 10 0 10 20 30 40 50 60 70 80 90 100 110 120 130

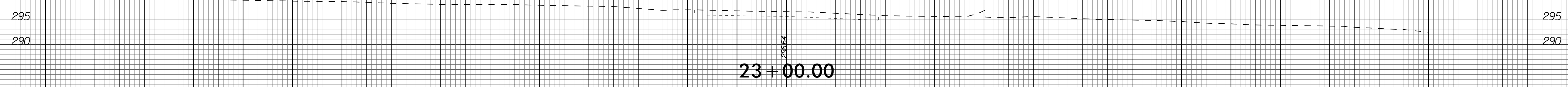
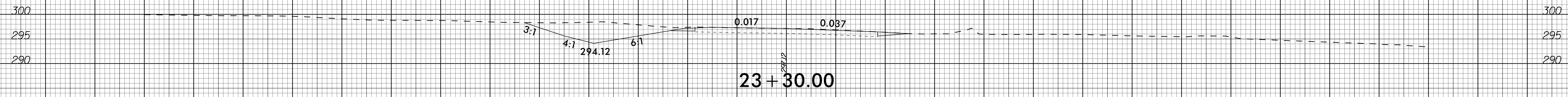
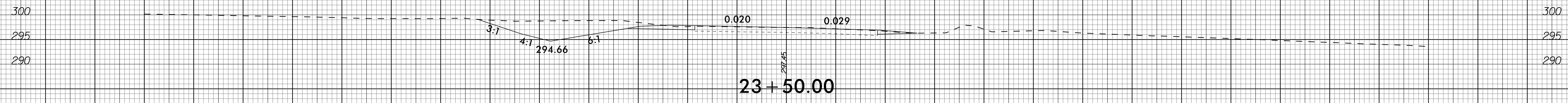
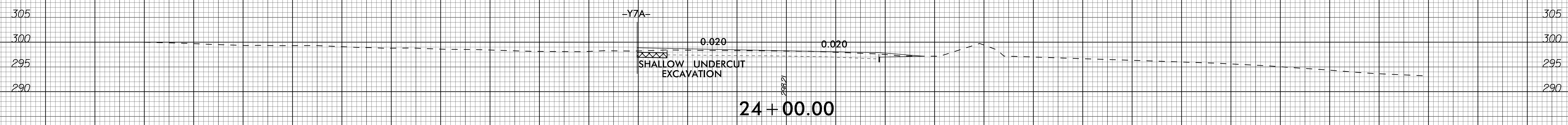
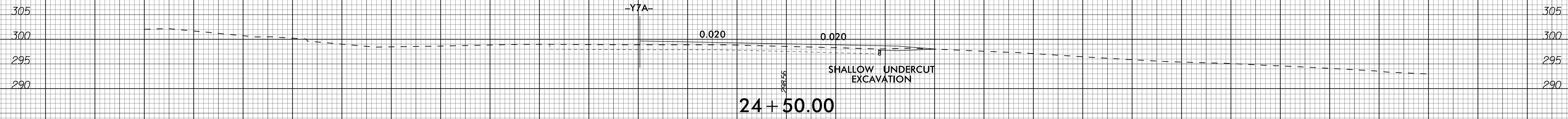

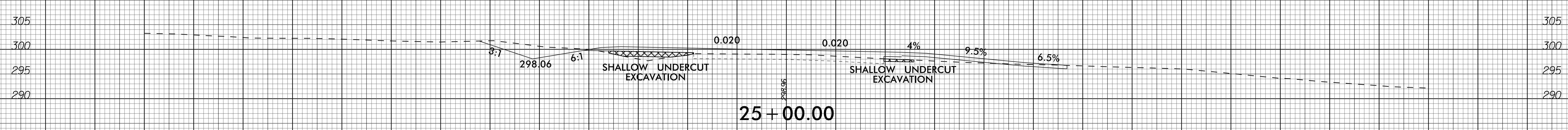
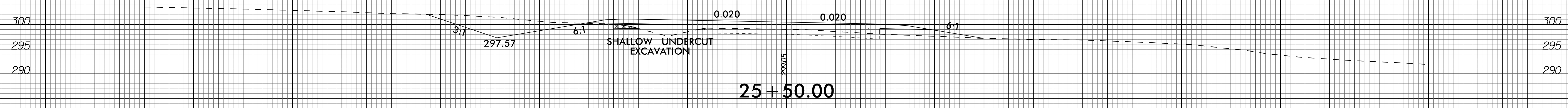
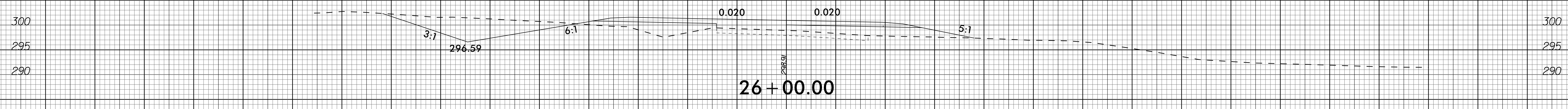
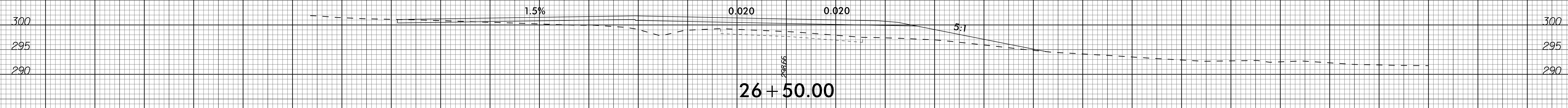
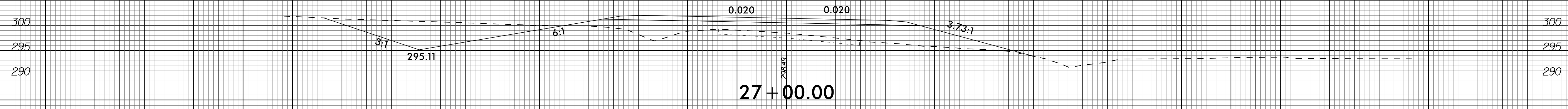

-Y7-

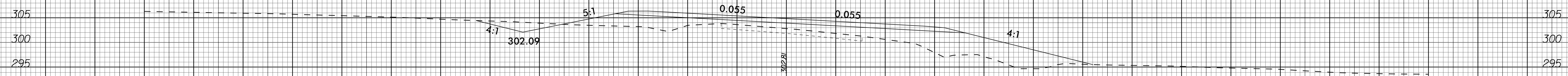

29 + 50.00

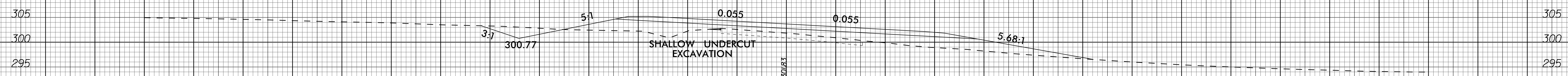

29 + 00.00

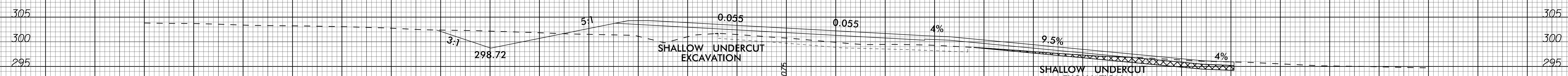

28 + 50.00

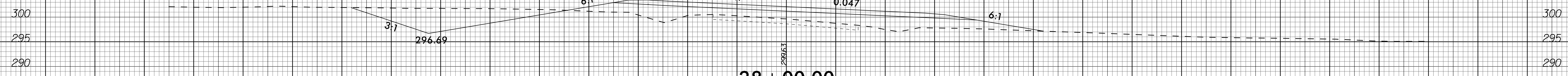

28 + 00.00

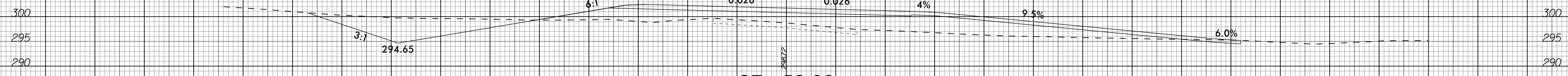

27 + 50.00

-Y7-

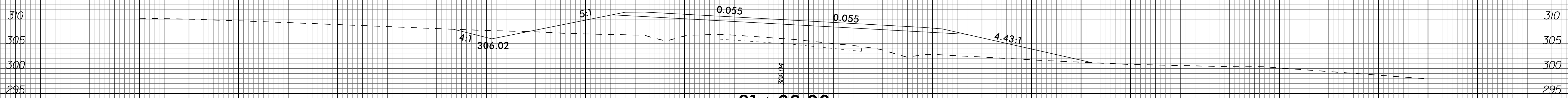
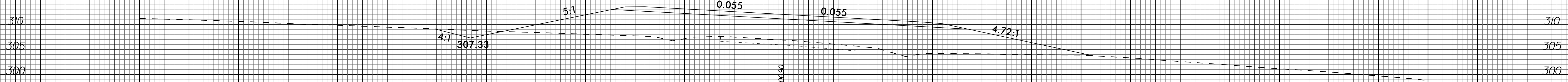



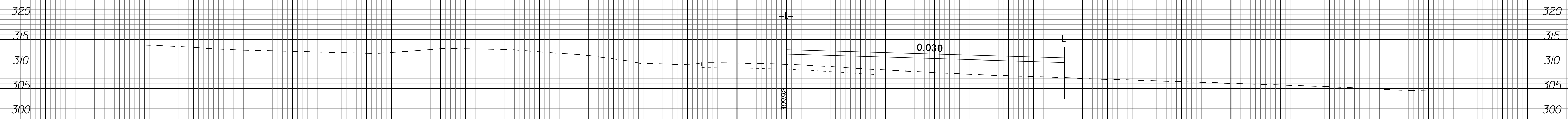

33 + 40.63

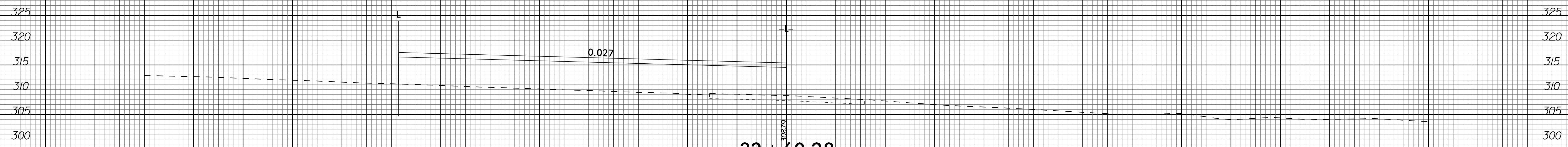

32 + 60.28

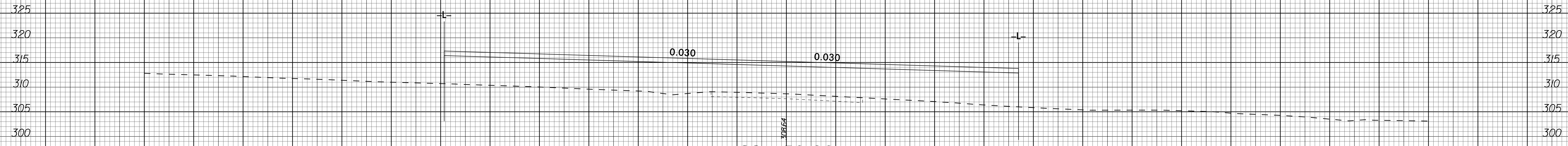

32 + 50.00

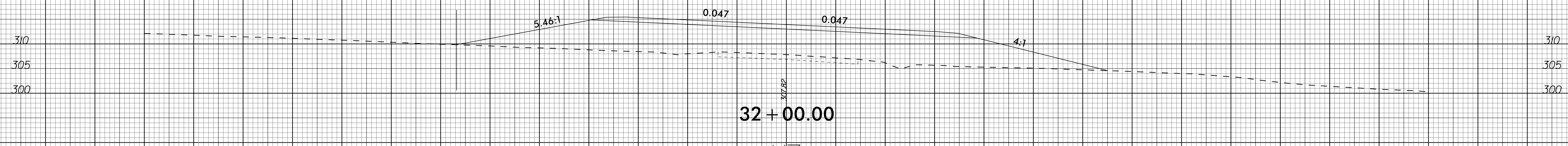

32 + 00.00

-Y7-

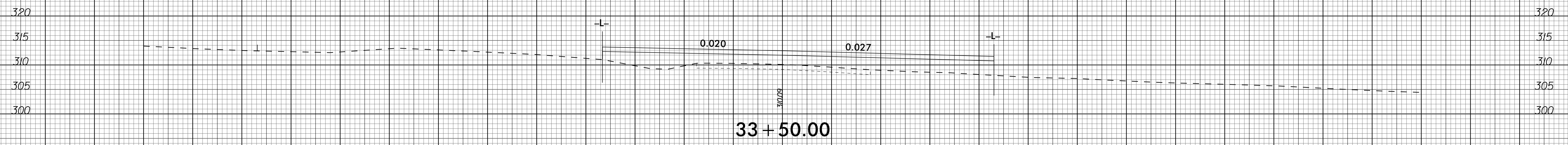
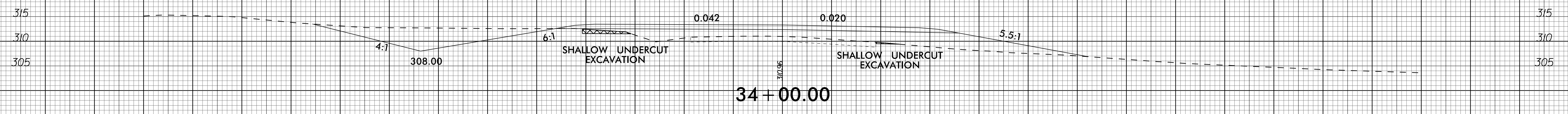
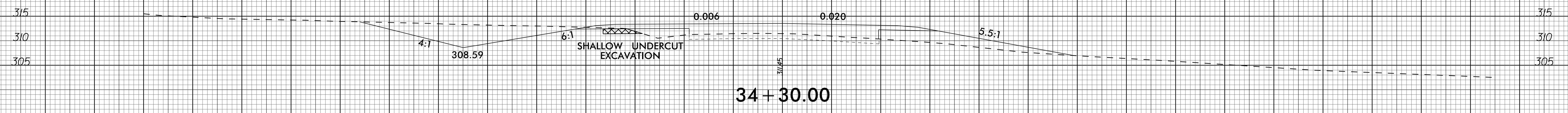
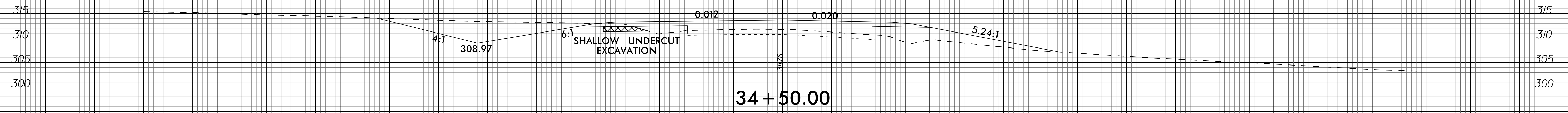
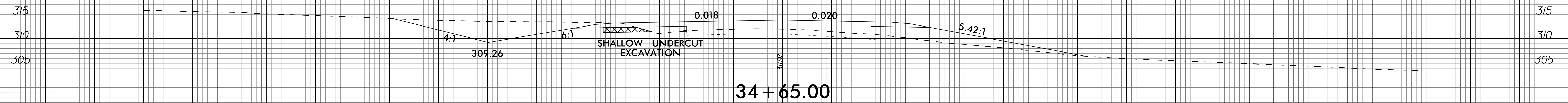
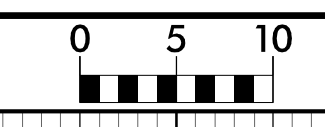

-Y7-

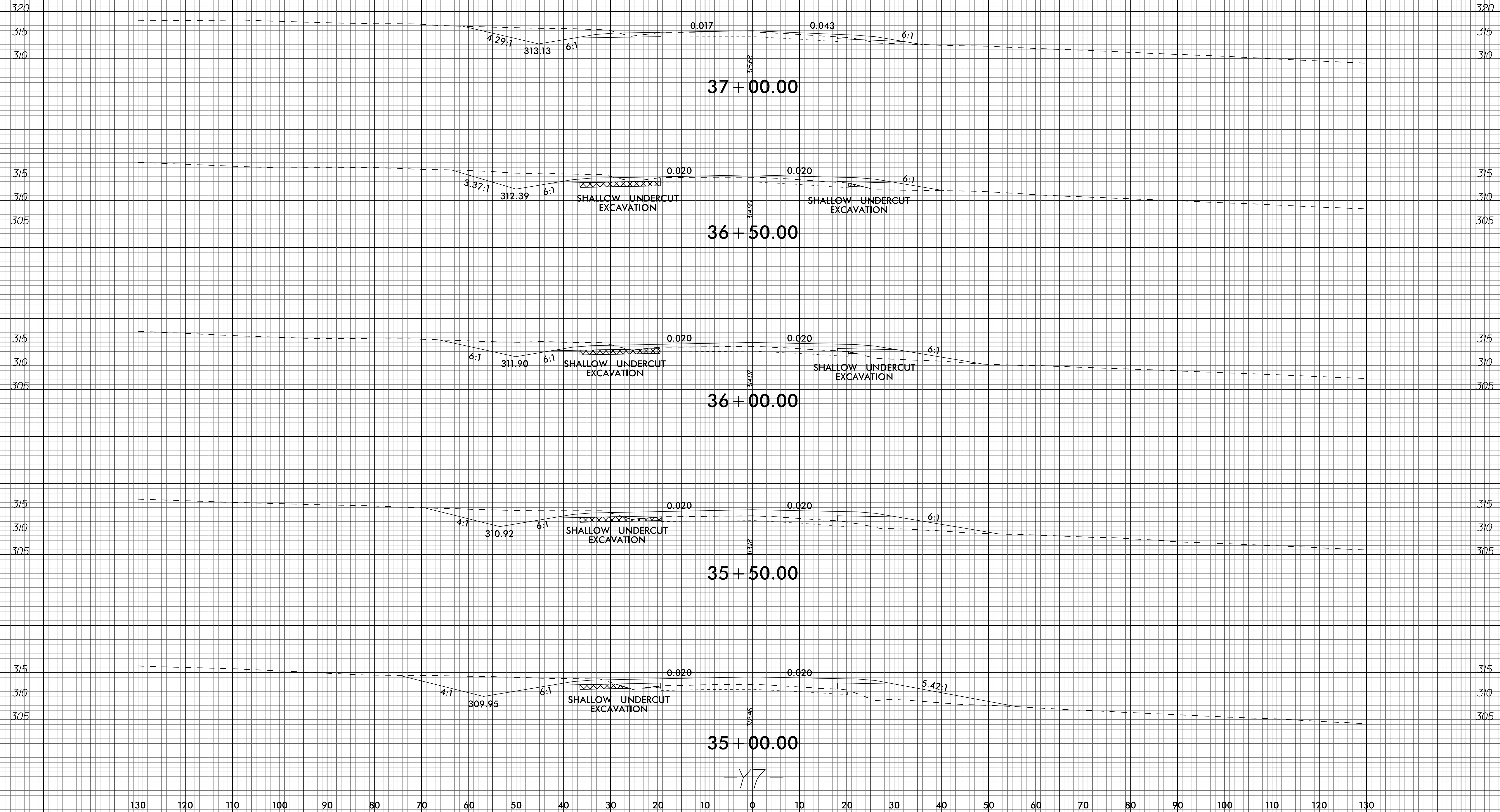

-Y7-

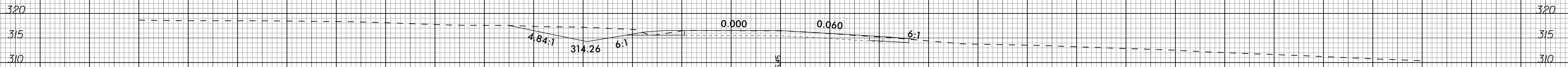
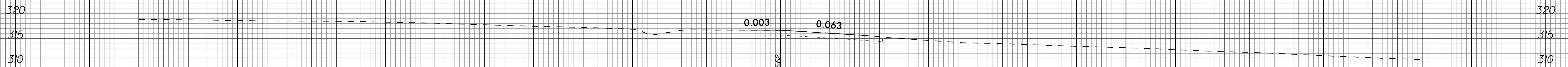
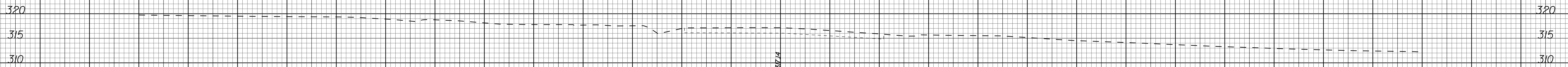

-Y7-

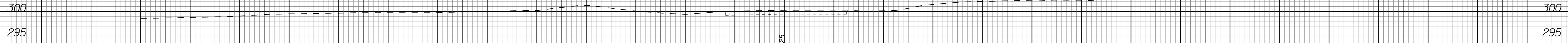

48 + 00.00

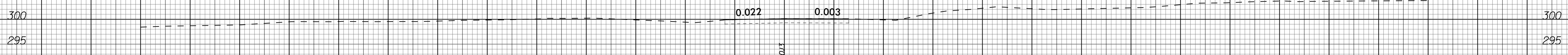

47 + 90.00

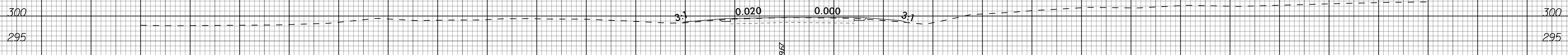

47 + 50.00

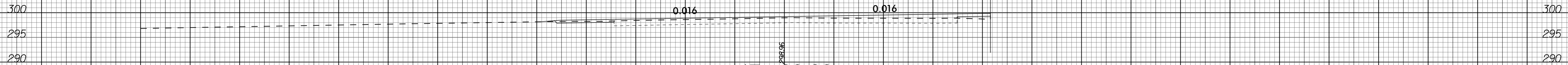

47 + 00.00

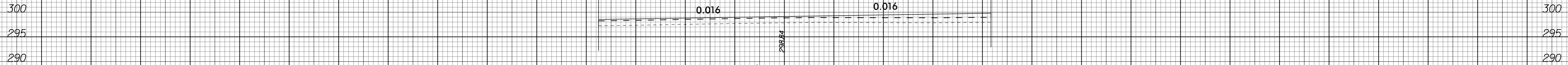

46 + 91.77

-Y7A-

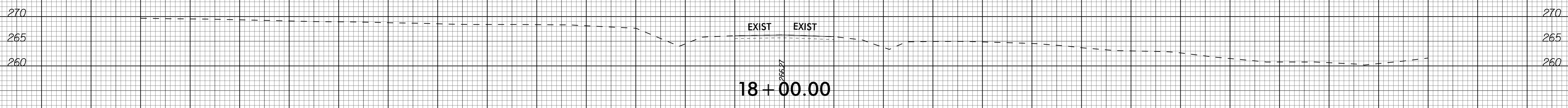
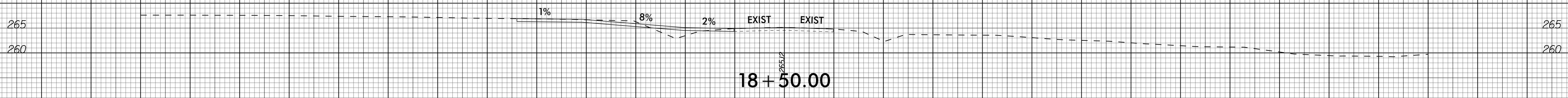
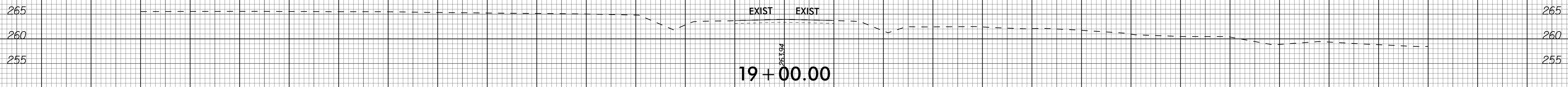

-Y7B- TURNAROUND

8/23/99

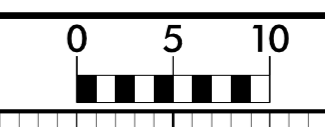

PROJ. REFERENCE NO.  
R-5705A

SHEET NO.  
X-146

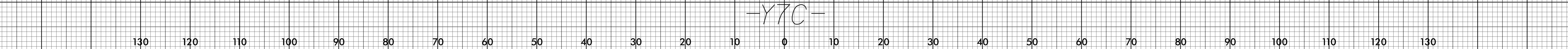
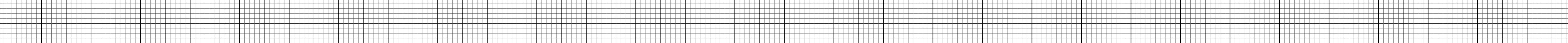
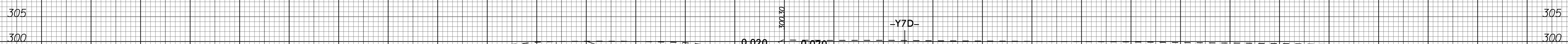
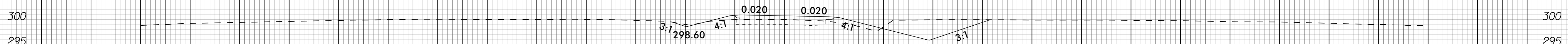
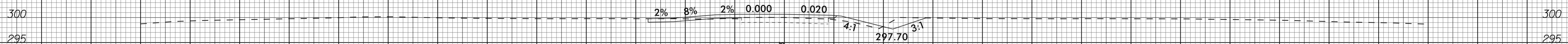
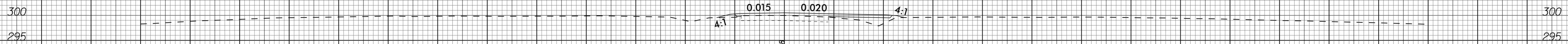
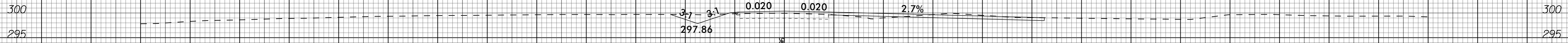

130 120 110 100 90 80 70 60 50 40 30 20 10 0 10 20 30 40 50 60 70 80 90 100 110 120 130

1/31/2003

8/23/99

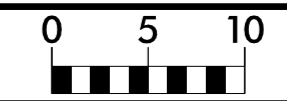

PROJ. REFERENCE NO.  
R-5705A

SHEET NO.  
X-147

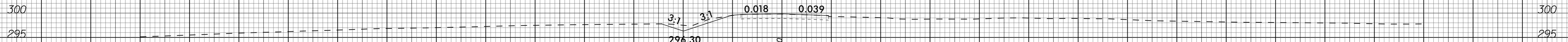

16 + 00.00

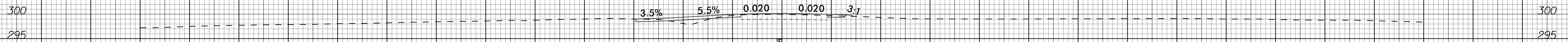

15 + 50.00

-Y7C-

1/31/2023



8/23/99

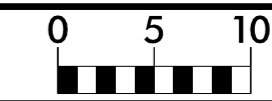

PROJ. REFERENCE NO.  
R-5705A

SHEET NO.  
X-148

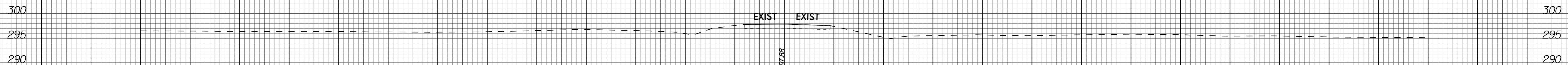

20 + 84.00

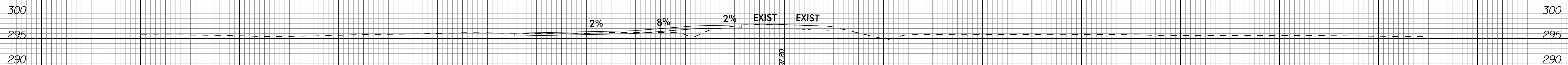

20 + 34.00

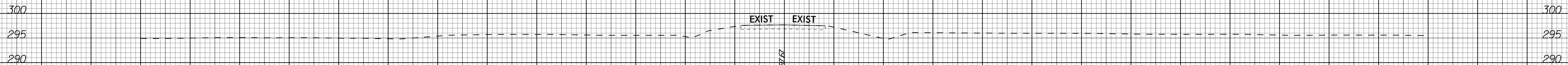

19 + 84.00

-Y7C- TURNAROUND

130 120 110 100 90 80 70 60 50 40 30 20 10 0 10 20 30 40 50 60 70 80 90 100 110 120 130

1/31/2003

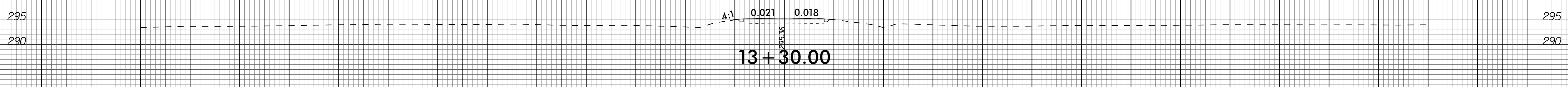
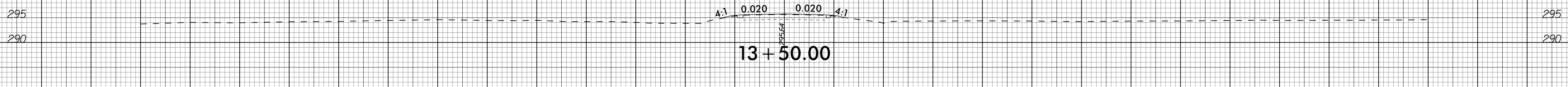
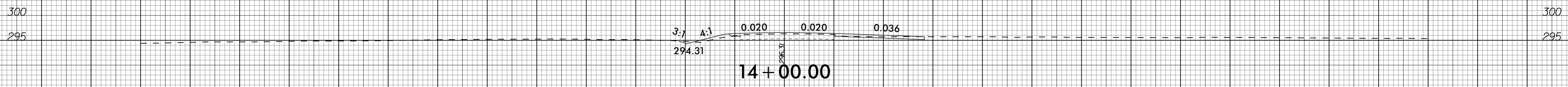
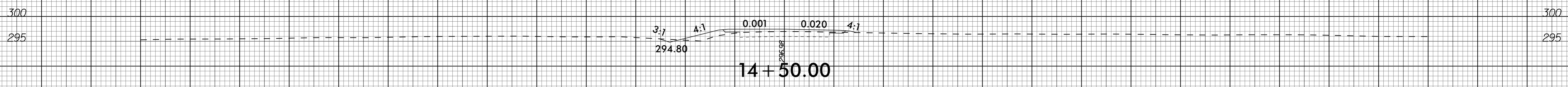
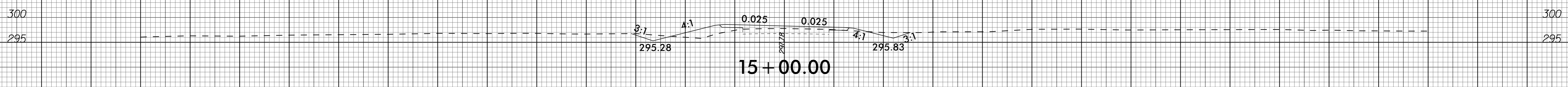
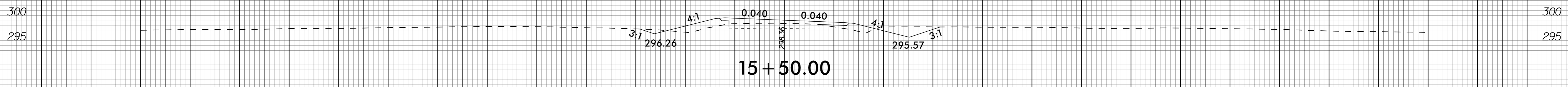
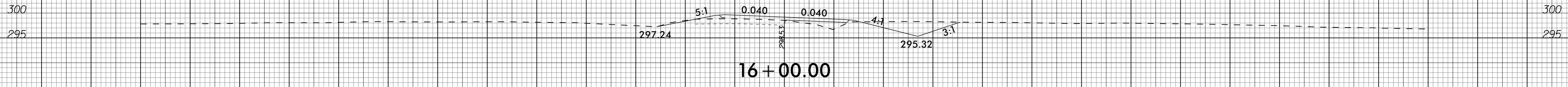

-YTD-



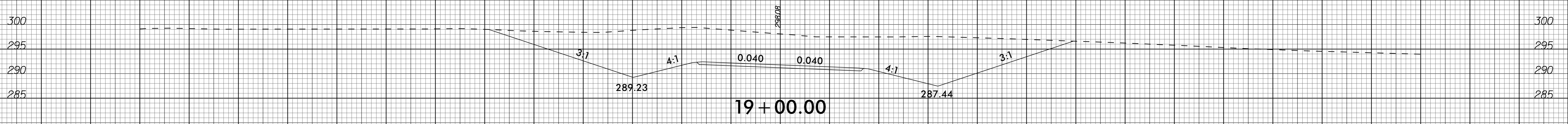
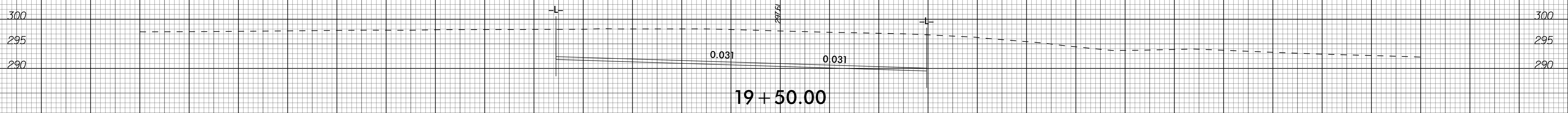
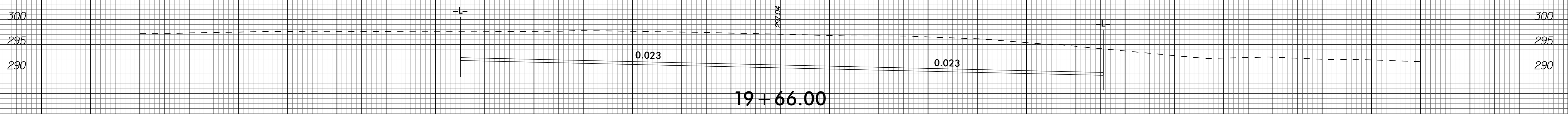

-YTD-

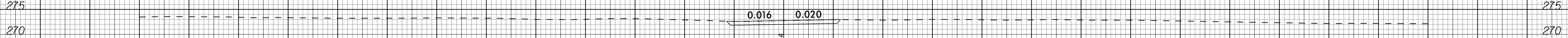

12+00.00

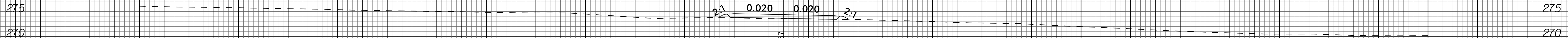

11+50.00

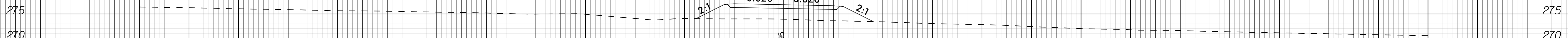

11+00.00

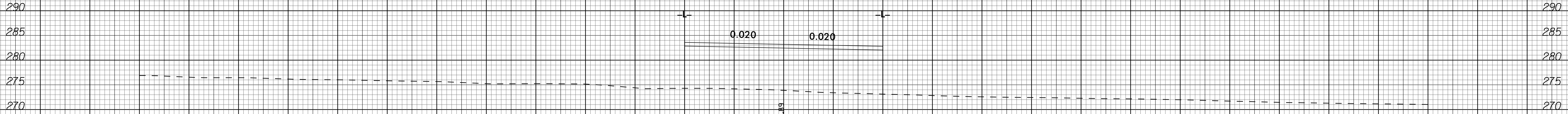

10+43.00

-DRW2-

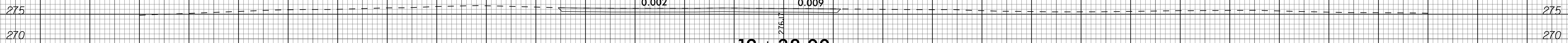

12 + 38.00

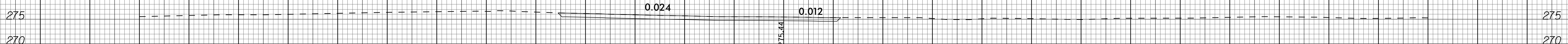

12 + 00.00

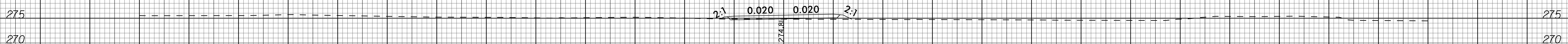

11 + 50.00

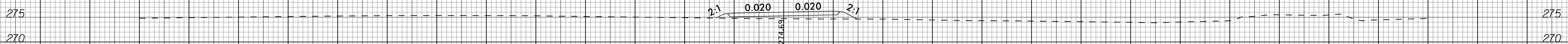

11 + 00.00

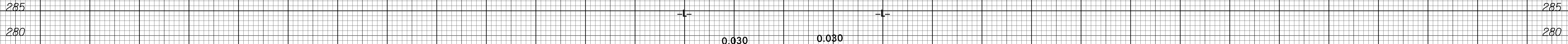

10 + 43.00

-DRW3-

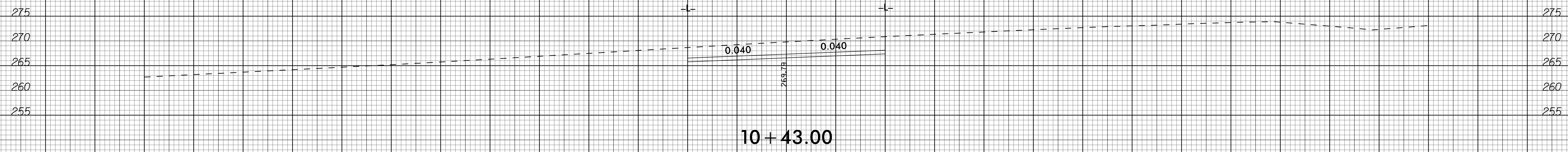
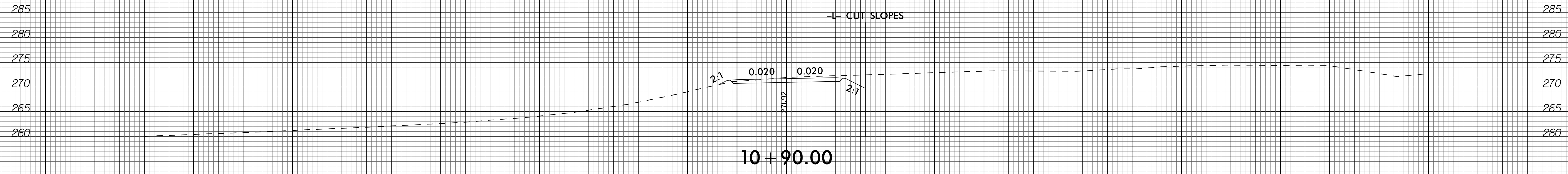
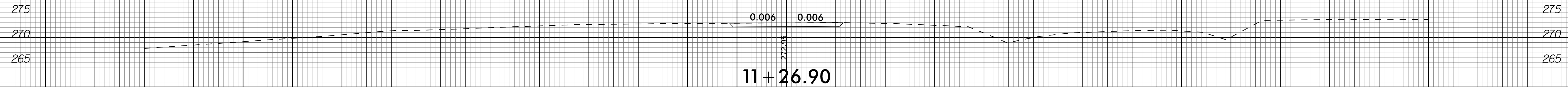

-DRW4-

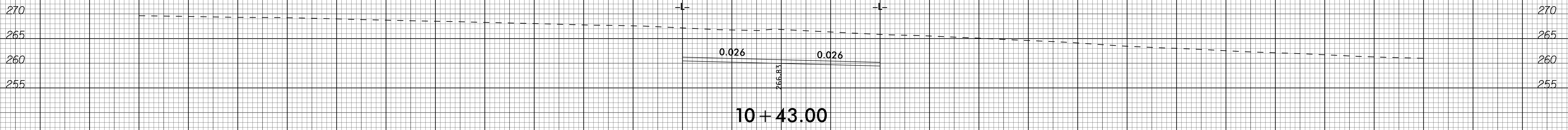
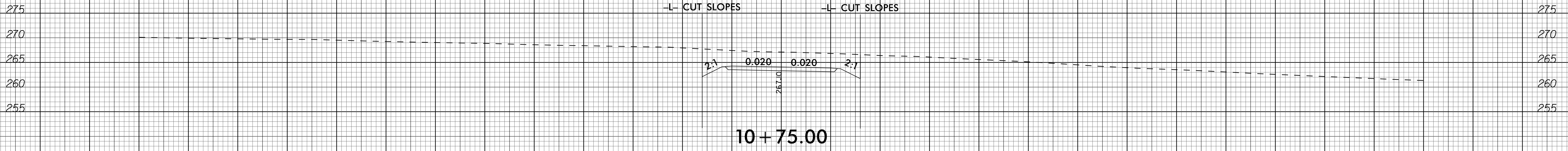
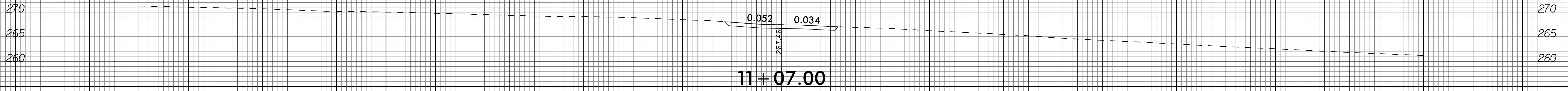

-DRW5-



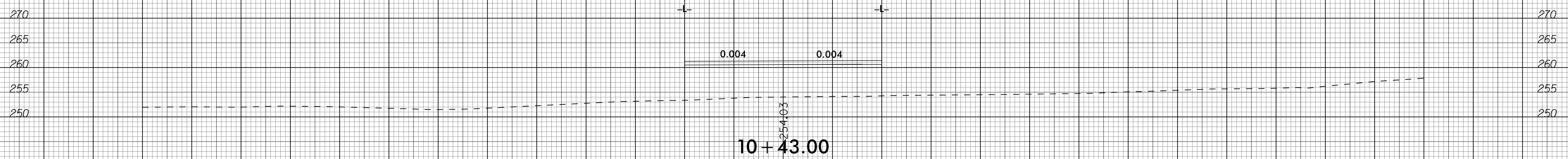
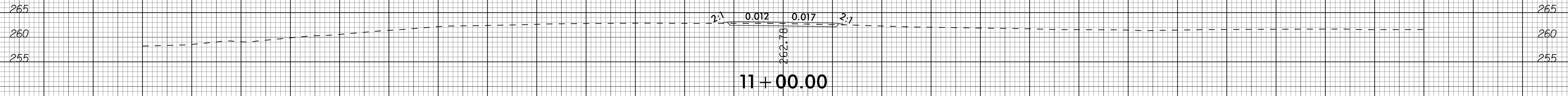
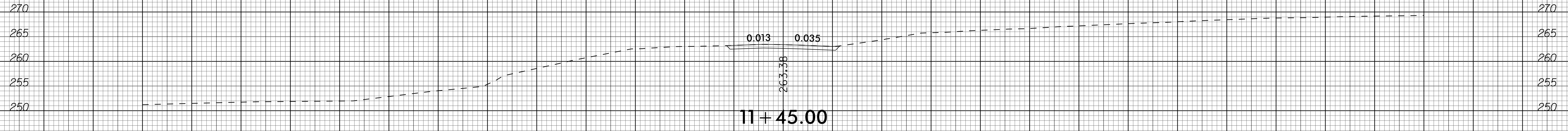

-DRAWN-

8/23/99

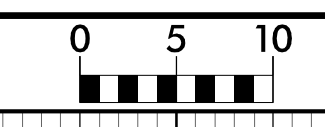

PROJ. REFERENCE NO.  
R-5705A

SHEET NO.  
X-157

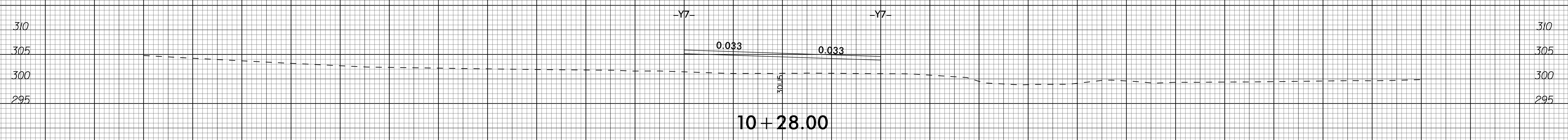
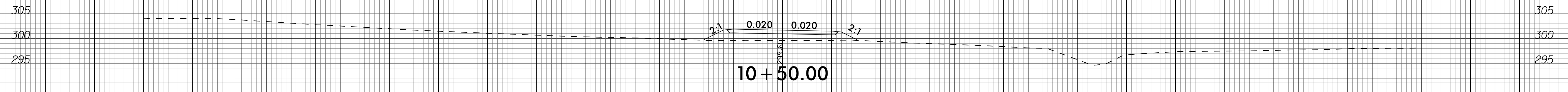
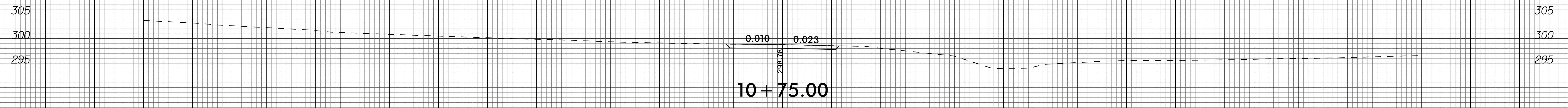

-DRW8-

1/31/2023

130 120 110 100 90 80 70 60 50 40 30 20 10 0 10 20 30 40 50 60 70 80 90 100 110 120 130

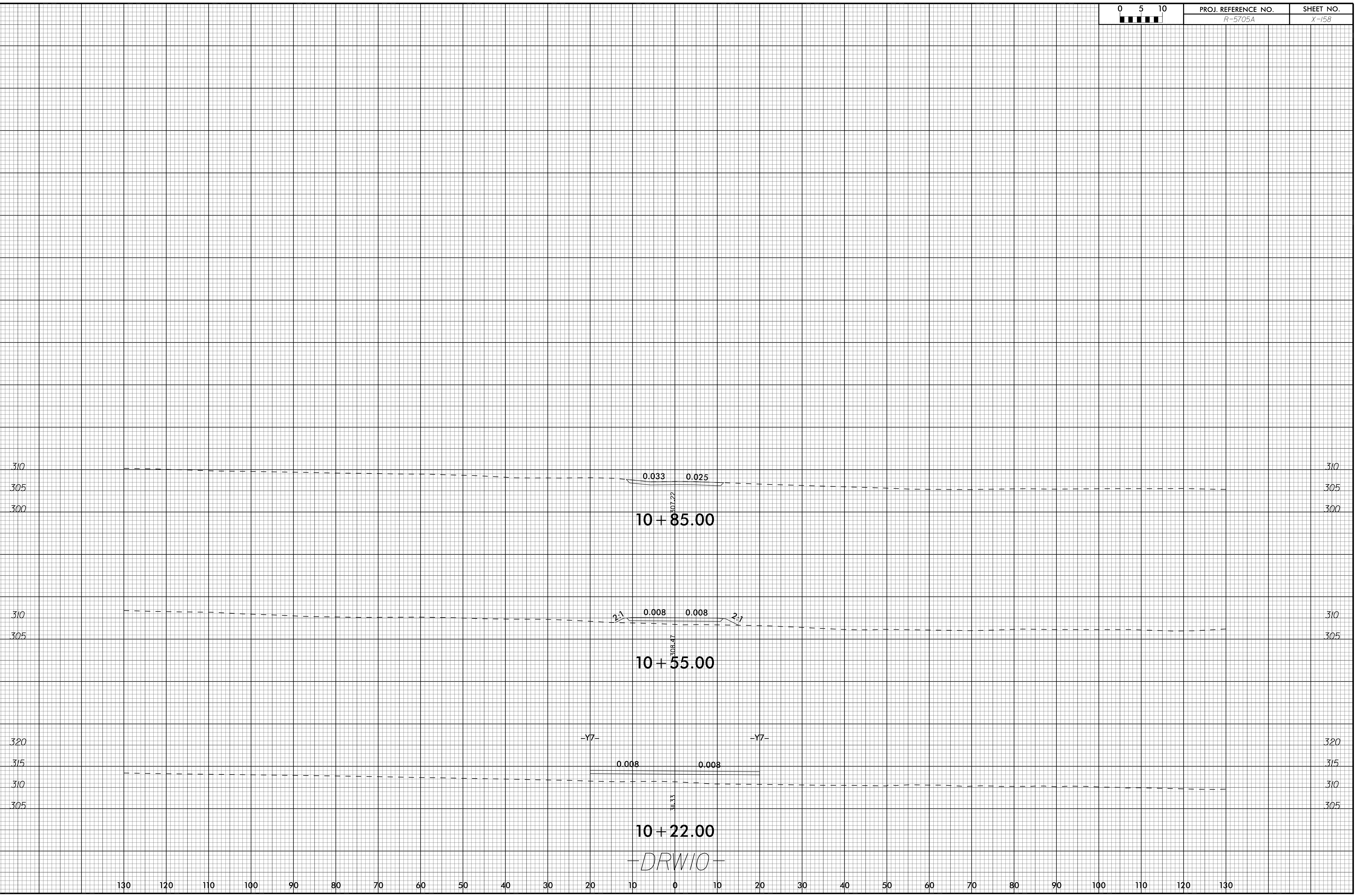

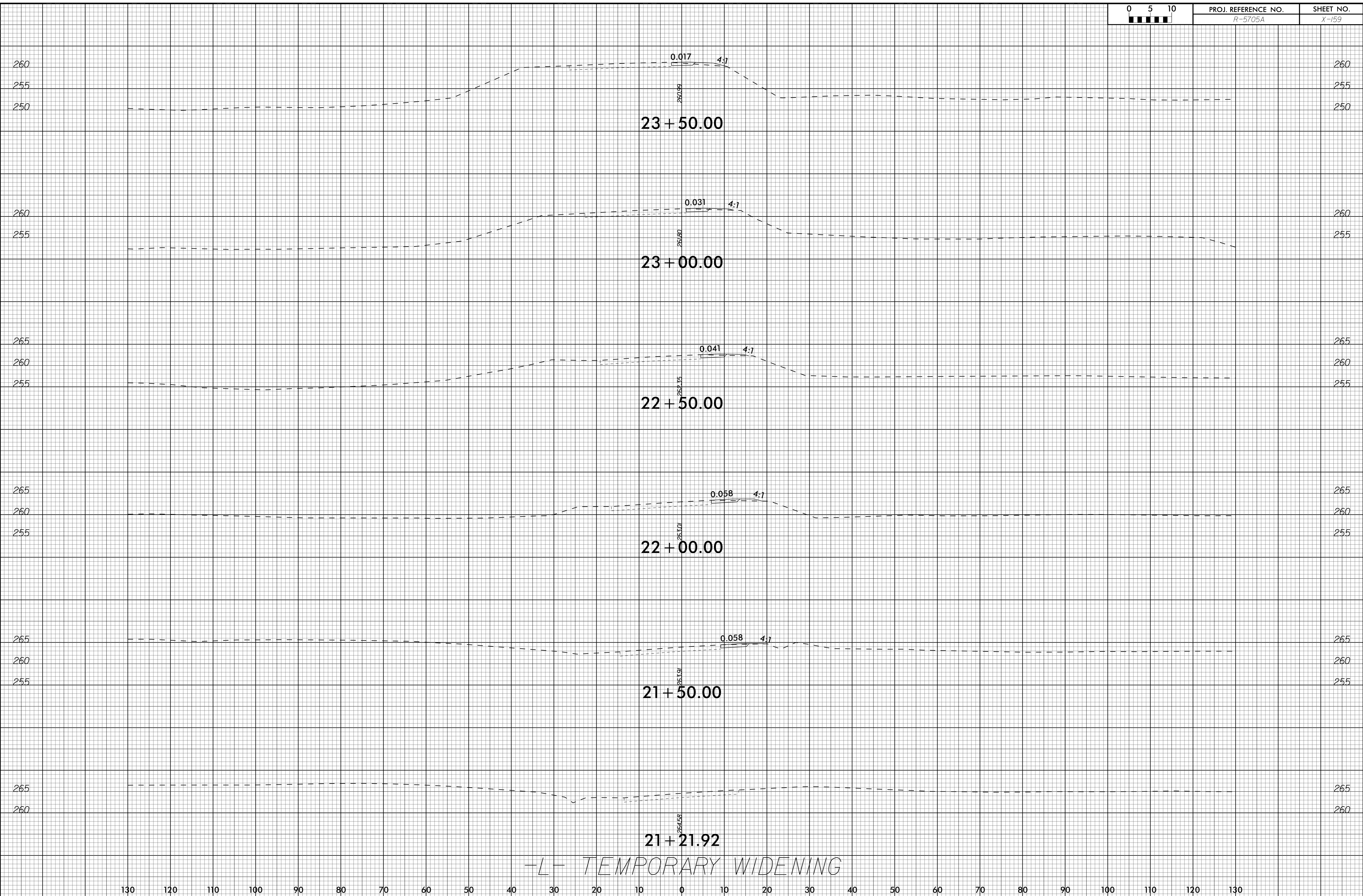

-L- TEMPORARY WIDENING

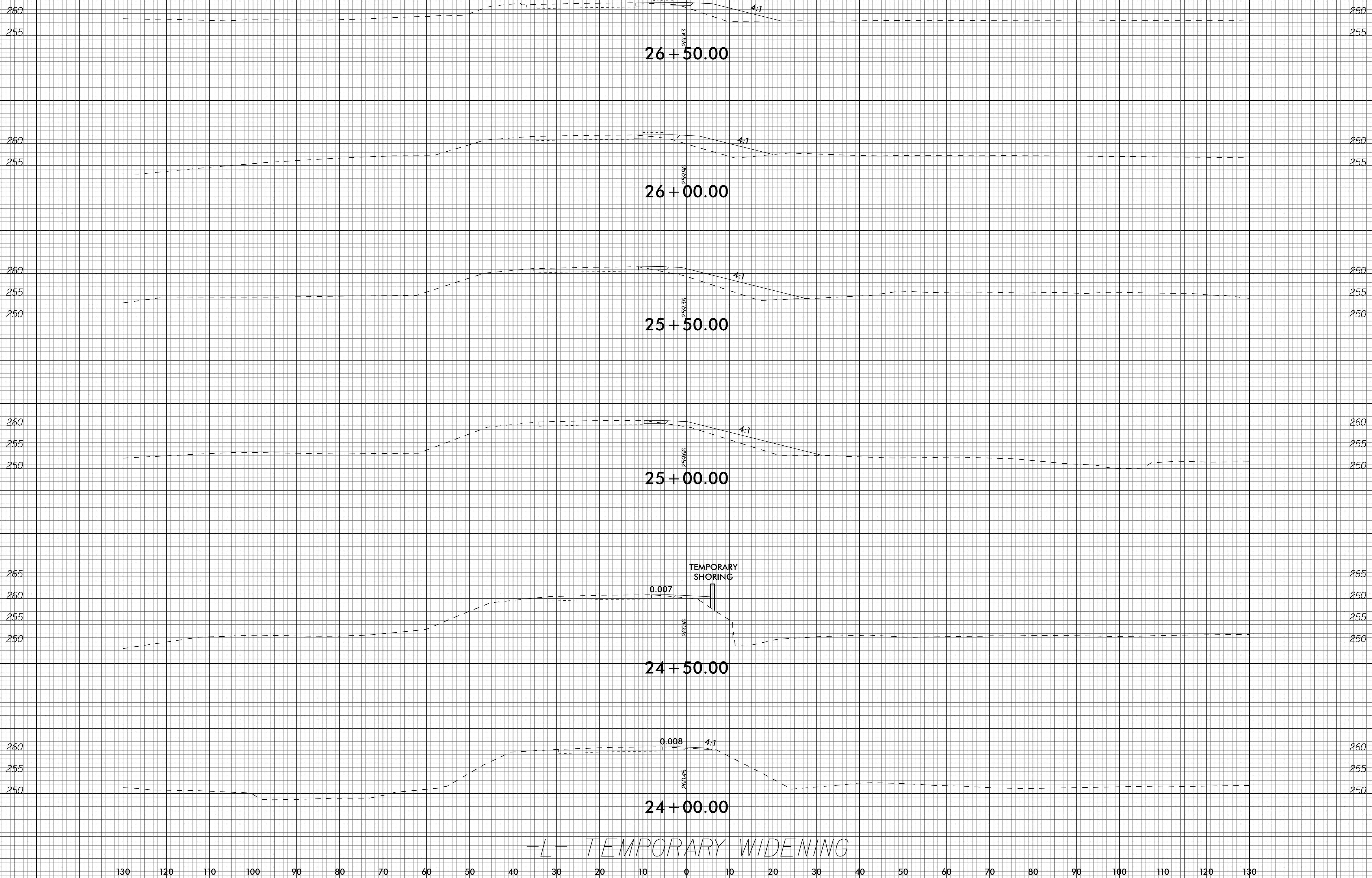

-L- TEMPORARY WIDENING

8/23/99

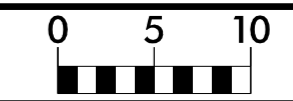

PROJ. REFERENCE NO.  
R-5705A

SHEET NO.  
X-161

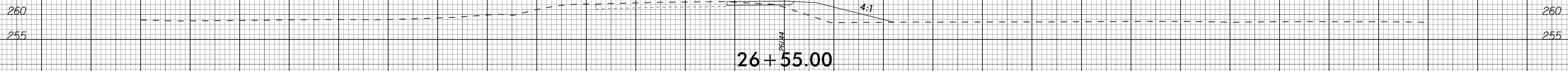

-L- TEMPORARY WIDENING

1/31/2003

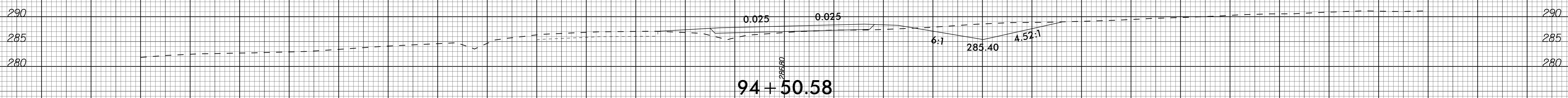
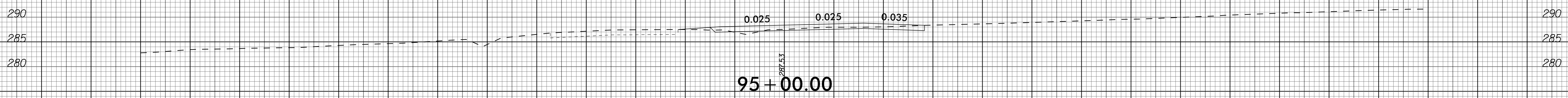
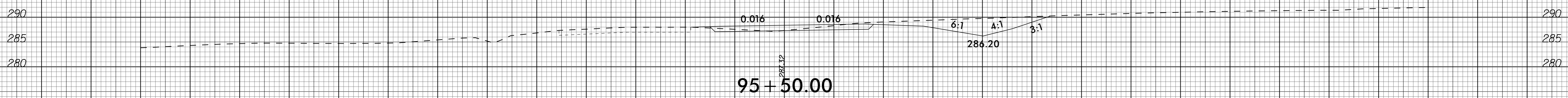
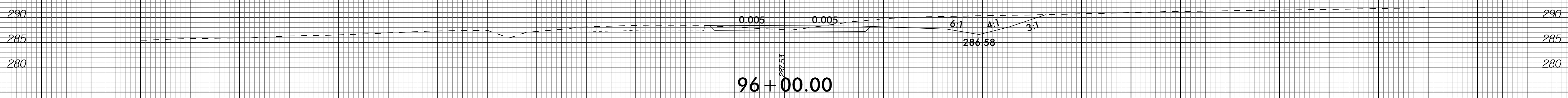
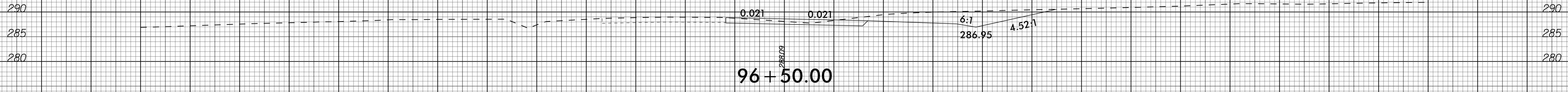

-LDET-

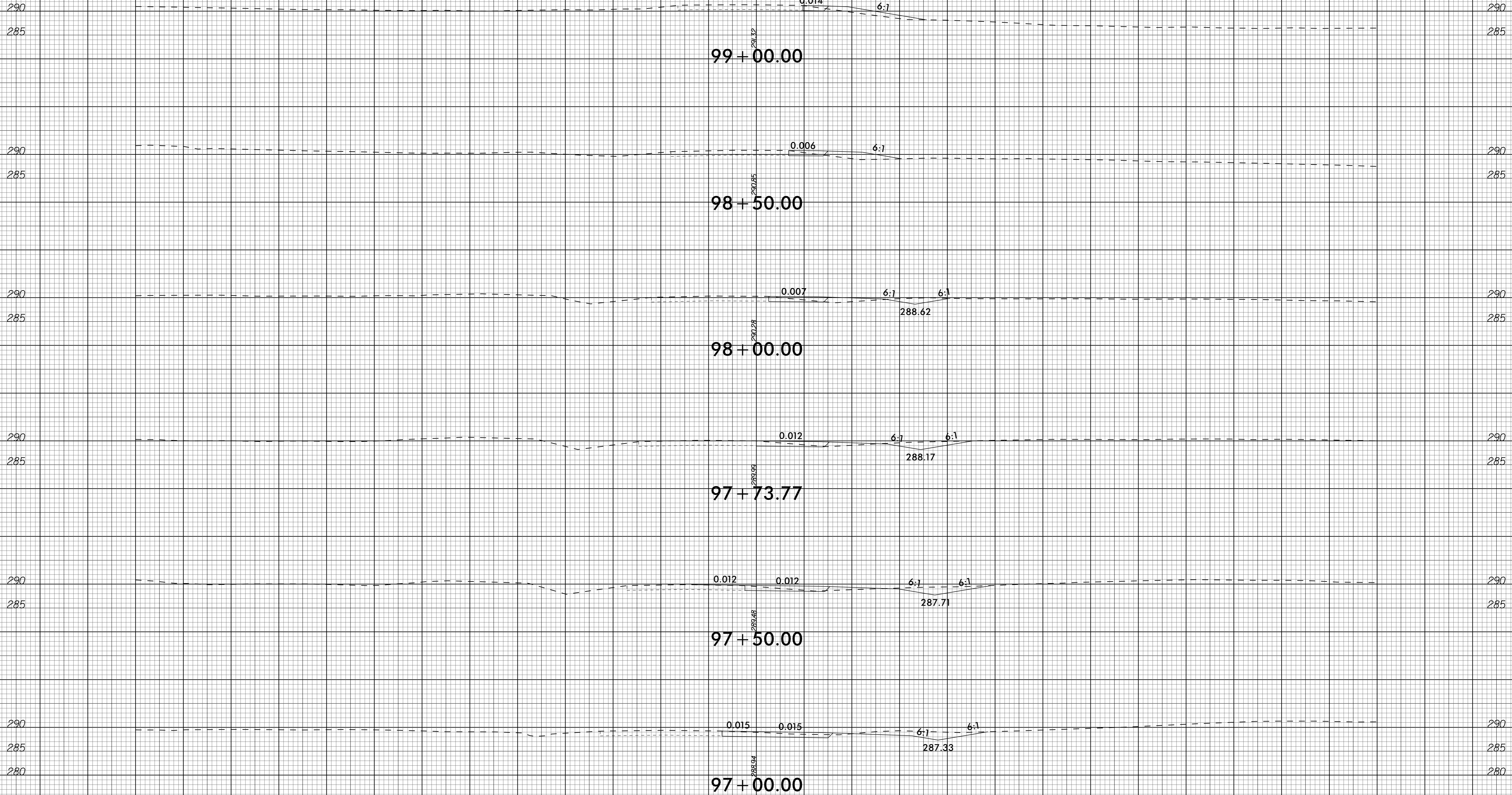

-LDET-



8/23/99

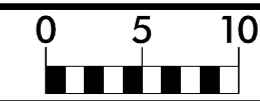

PROJ. REFERENCE NO.  
R-5705A

SHEET NO.  
X-164

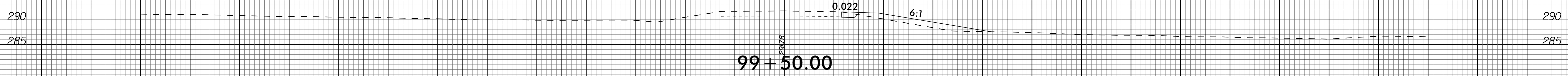
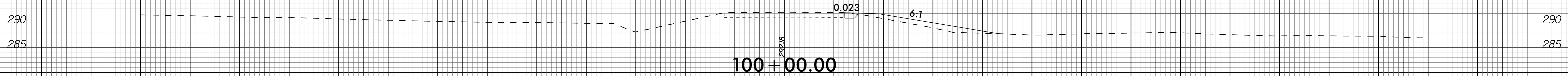
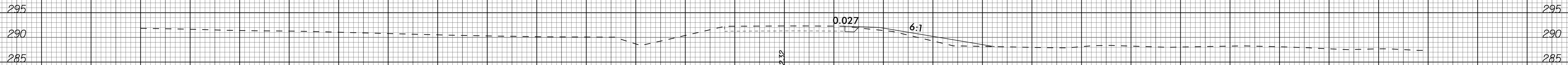

-LDET-

130 120 110 100 90 80 70 60 50 40 30 20 10 0 10 20 30 40 50 60 70 80 90 100 110 120 130

1/31/2023

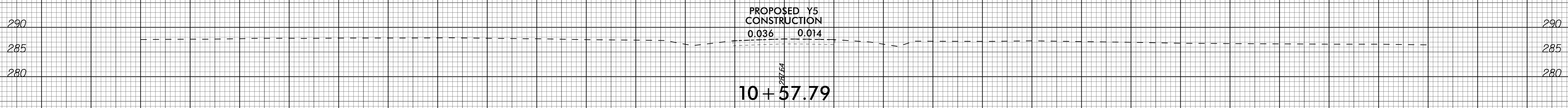
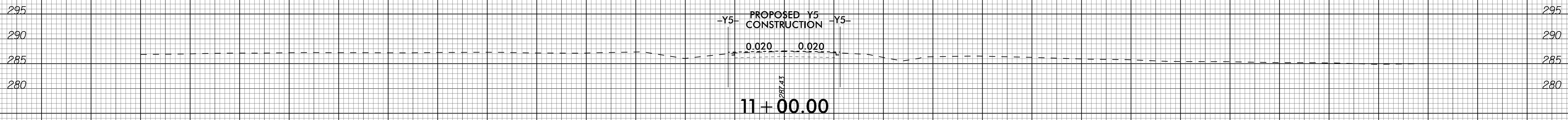
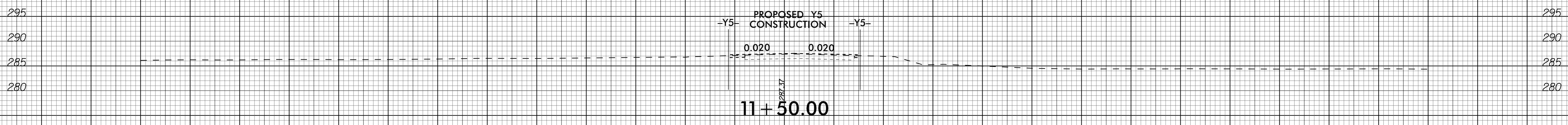
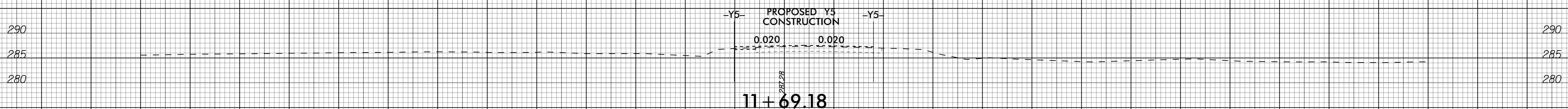
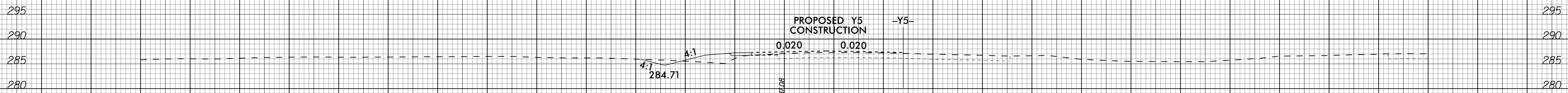

-Y5DET-

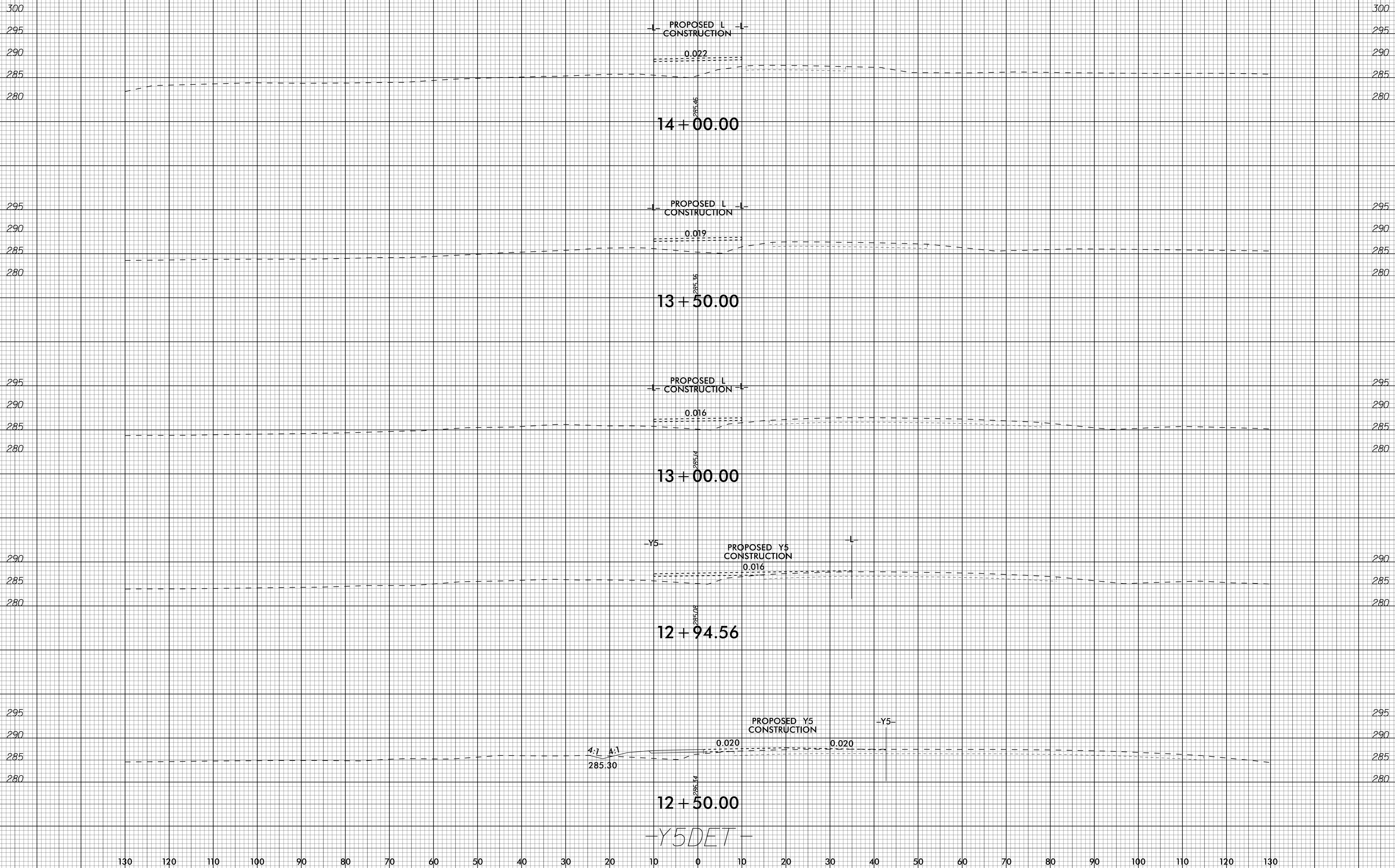

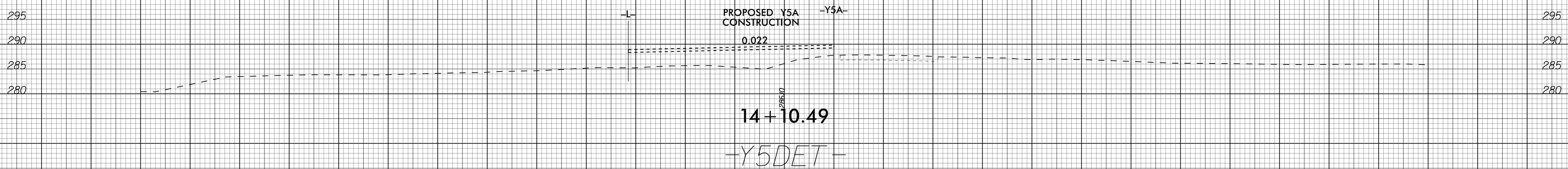
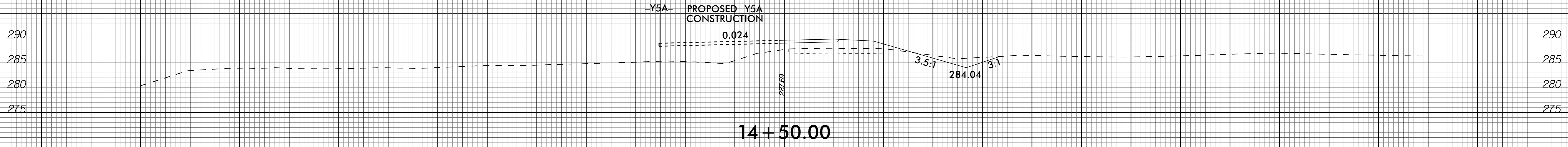
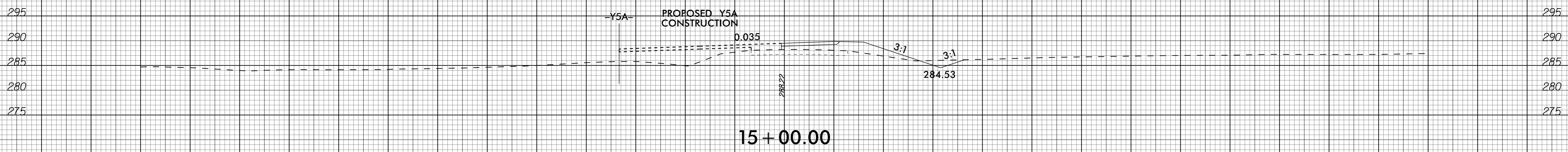
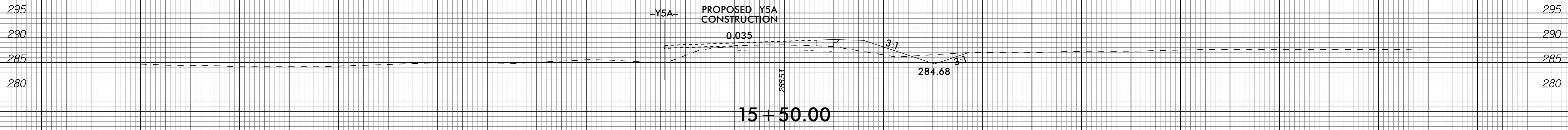
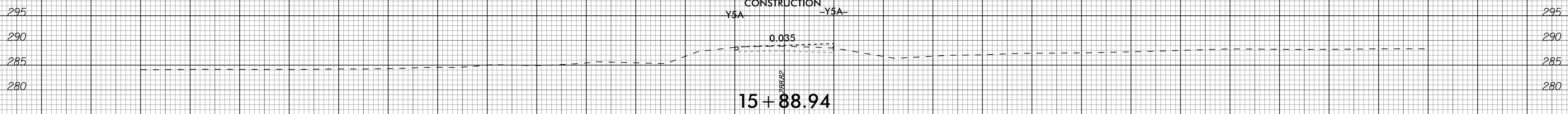

130 120 110 100 90 80 70 60 50 40 30 20 10 0 10 20 30 40 50 60 70 80 90 100 110 120 130

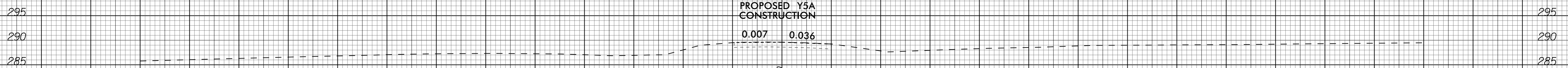

17+15.00

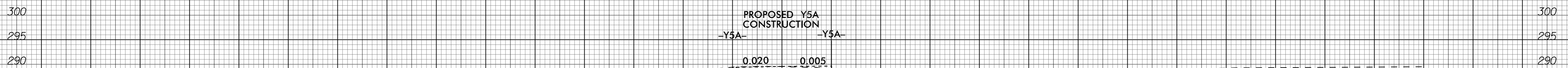

17+00.00

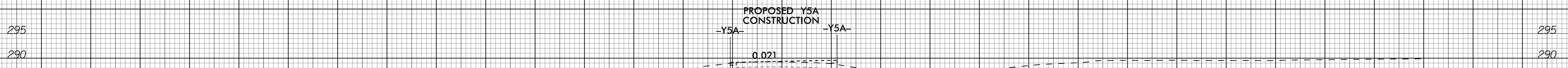

16+50.00

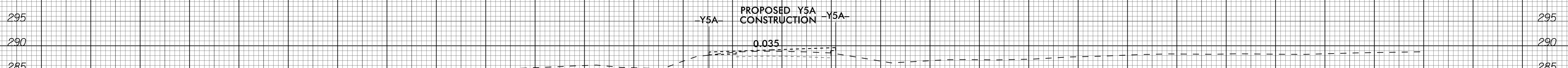

16+00.00

-Y5DET-

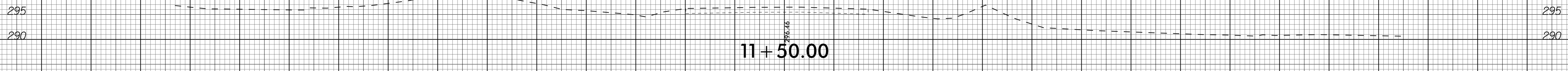
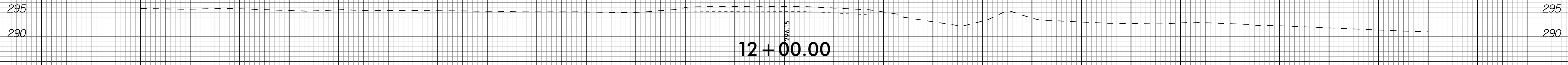
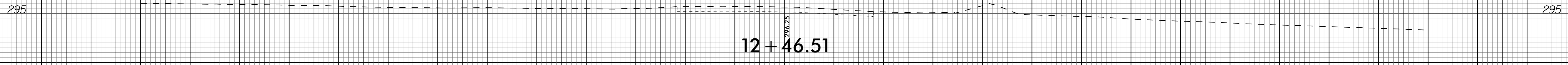
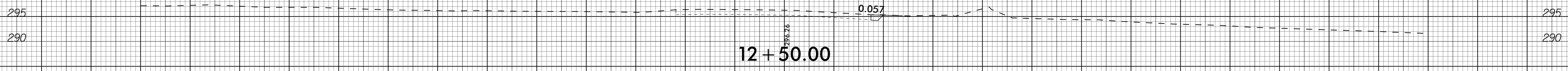
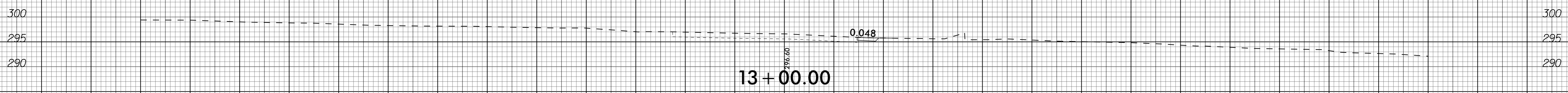
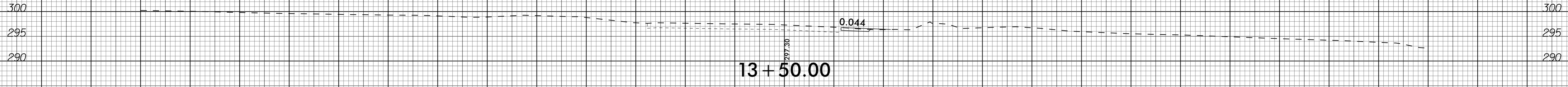
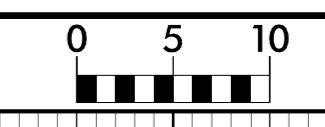

-Y7DETI-

130 120 110 100 90 80 70 60 50 40 30 20 10 0 10 20 30 40 50 60 70 80 90 100 110 120 130

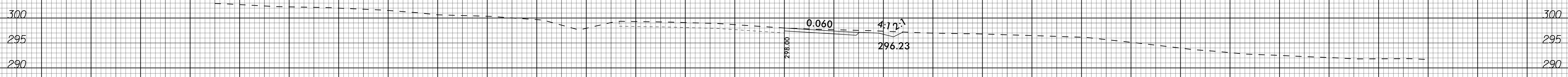
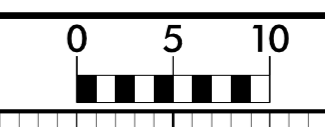

15 + 61.19

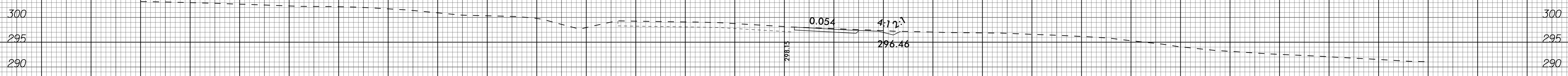

15 + 50.00

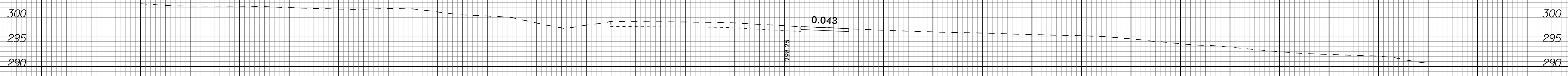

15 + 00.00

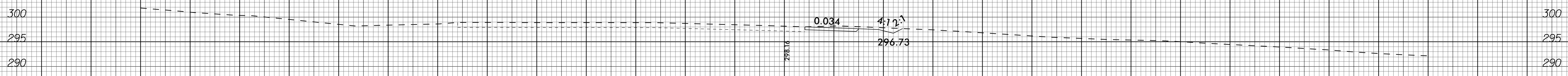

14 + 50.00

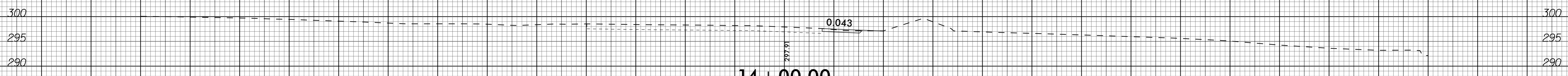

14 + 00.00

-Y7DETI-

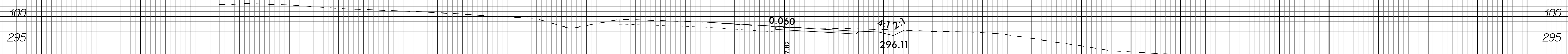
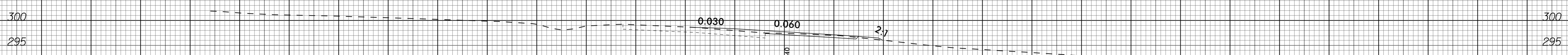
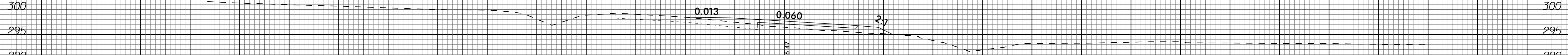
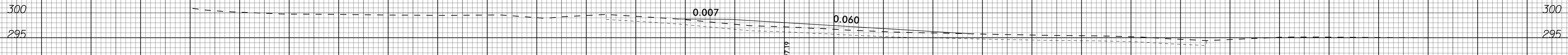
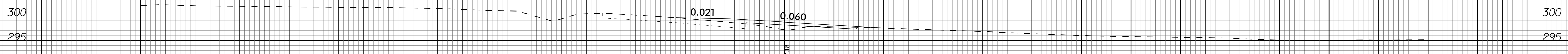
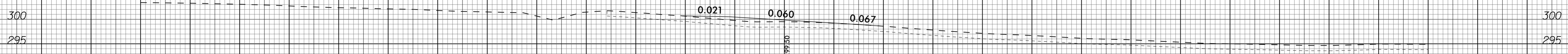
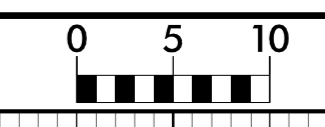

-Y7DETI-



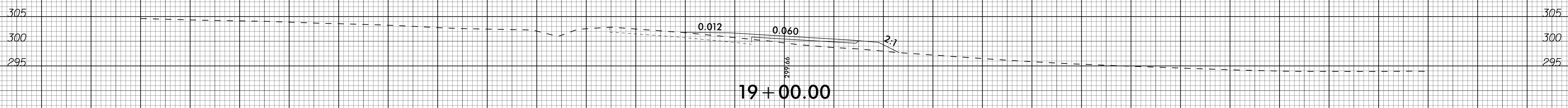
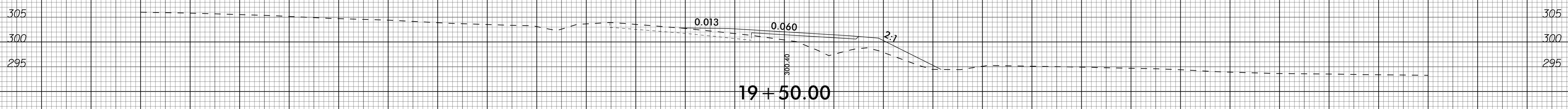
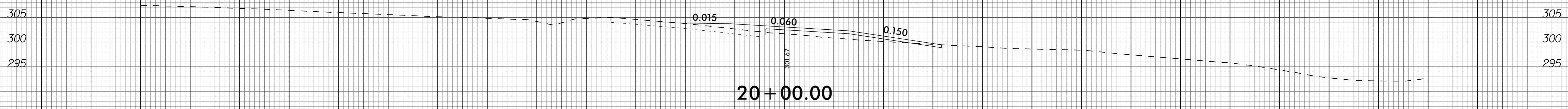
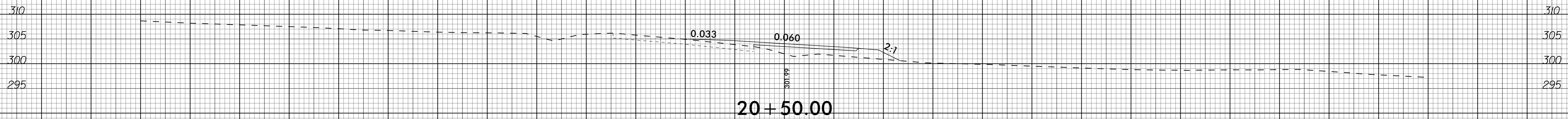
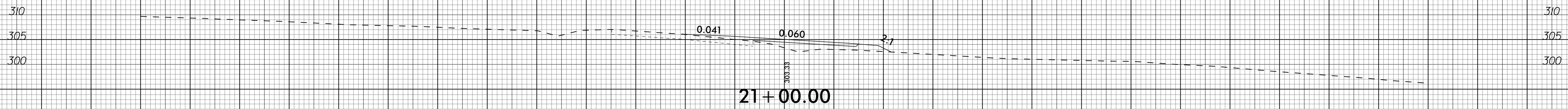
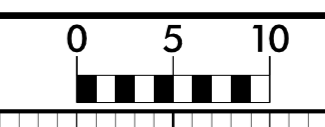

-Y7DETI-

8/23/99

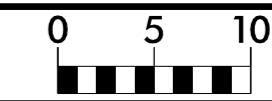

PROJ. REFERENCE NO.  
R-5705A

SHEET NO.  
X-173

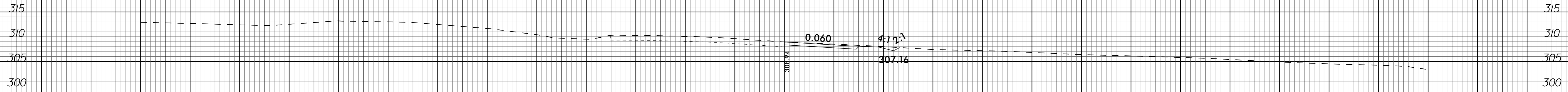

**23 + 37.98**

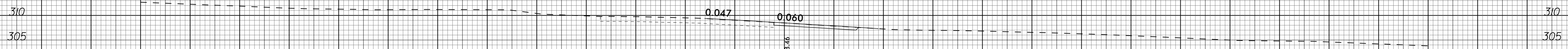

**23 + 00.00**

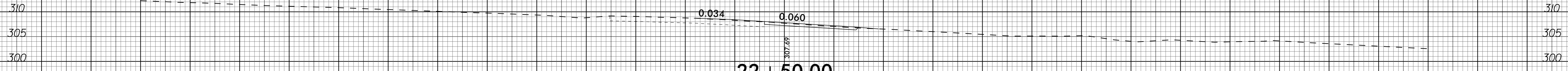

**22 + 50.00**

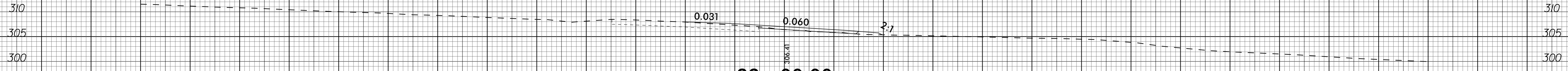

**22 + 00.00**

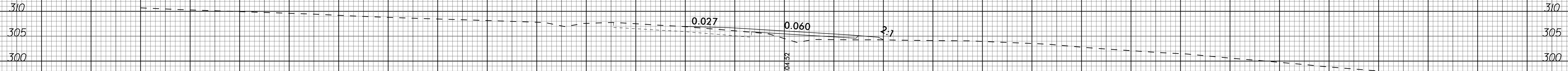

**21 + 50.00**

-Y7DETI-

130 120 110 100 90 80 70 60 50 40 30 20 10 0 10 20 30 40 50 60 70 80 90 100 110 120 130

1/31/2003

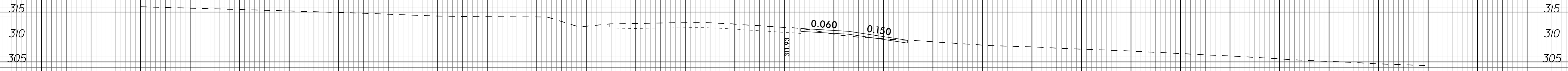

25 + 20.00

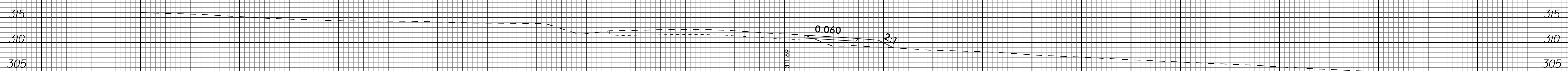

25 + 00.00

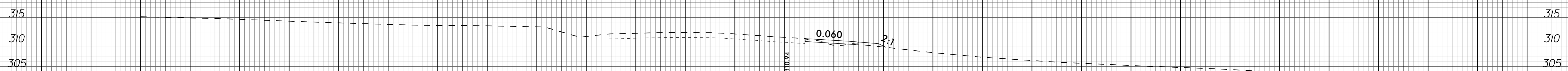

24 + 50.00

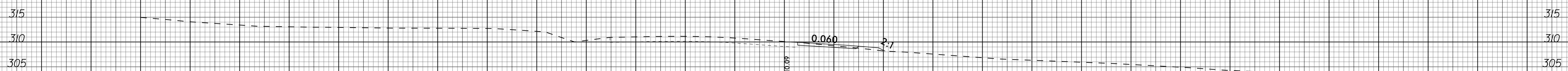

24 + 00.00

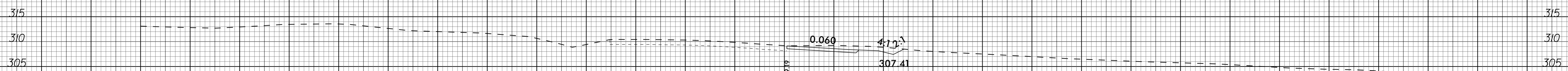

23 + 50.00

-Y7DETI-

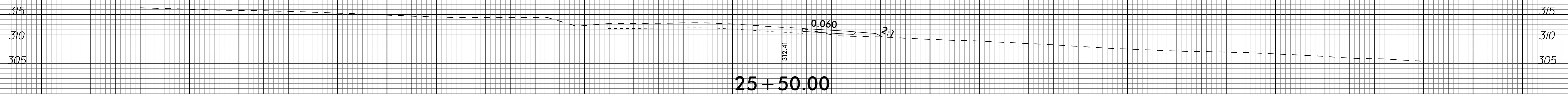
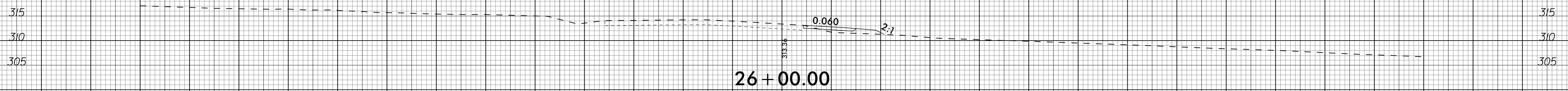
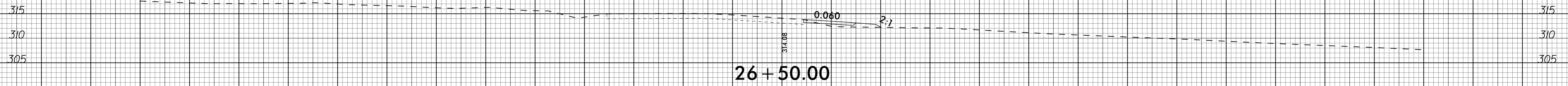
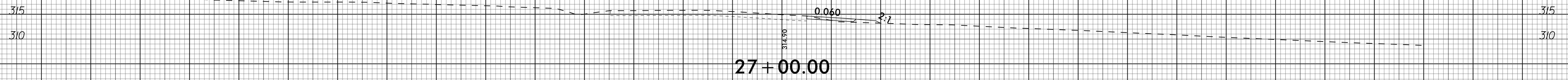
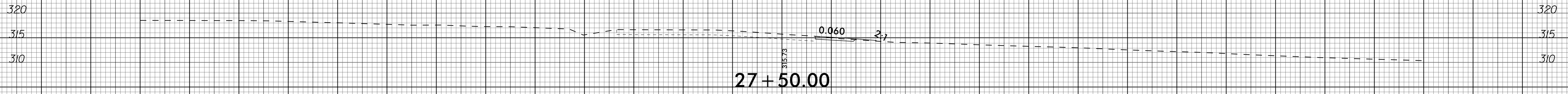
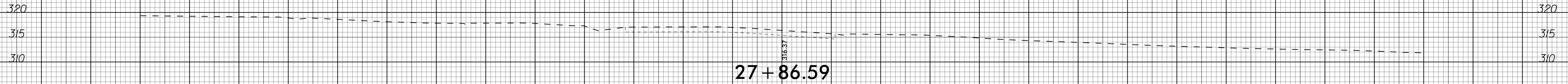

-Y7DETI-

8/23/99

0 5 10  
[Scale bar]

PROJ. REFERENCE NO.  
R-5705A

SHEET NO.  
X-176

320  
315  
310

320  
315  
310

28 + 00.00

-Y7DETI-

130 120 110 100 90 80 70 60 50 40 30 20 10 0 10 20 30 40 50 60 70 80 90 100 110 120 130

1/31/2023

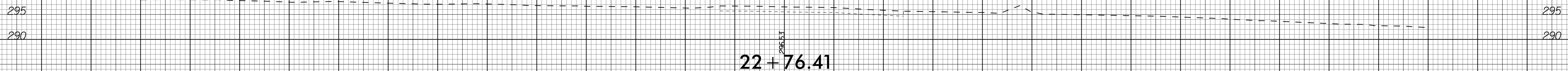
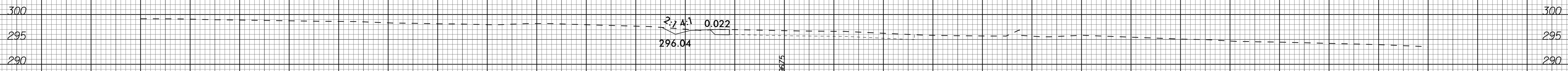
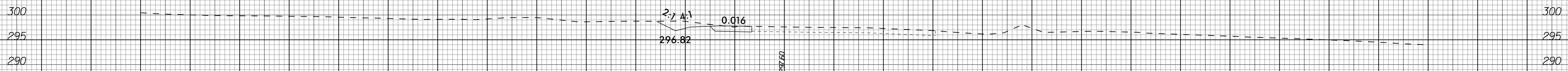
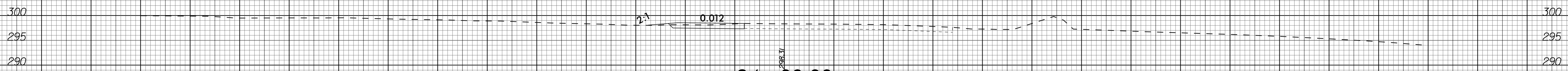
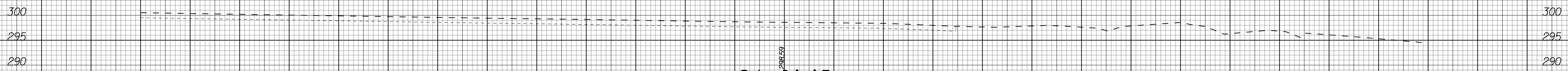

-Y7DET2-