

TIP NO. U-5748  
CROSS SECTION INDEX

LOCATION	STATION TO STATION	SHEET NO.
-L-	15 + 50.00 TO 86 + 00.00	X-1 TO X-34
-Y1-	10 + 71.00 TO 19 + 50.00	X-35 TO X-38
-Y2-	11 + 50.00 TO 33 + 00.00	X-39 TO X-46
-Y3-	10 + 50.00 TO 14 + 93.84	X-47 TO X-48
-Y4-	10 + 50.00 TO 16 + 00.00	X-49 TO X-50
-Y5-	10 + 83.00 TO 12 + 85.27	X-51 TO X-52
-DRIVE1-	11 + 00.00 TO 12 + 37.08	X-53
-DRIVE2-	10 + 83.00 TO 11 + 50.00	X-54
-DRIVE3-	10 + 69.21 TO 12 + 00.00	X-55
-DRIVE4-	10 + 24.54 TO 11 + 25.00	X-56
-L1-	18 + 50.00 TO 73 + 73.50	X-57 TO X-78
-Y6-	14 + 00.00 TO 20 + 50.00	X-79 TO X-81
-Y7-	11 + 00.00 TO 14 + 50.00	X-82 TO X-83
-Y8-	11 + 00.00 TO 11 + 50.00	X-84
-Y10-	11 + 50.00 TO 12 + 00.00	X-85
-DET 1-	10 + 00.00 TO 20 + 20.00	X-86 TO X-90

 SHALLOW UNDERCUT

# STATE OF NORTH CAROLINA DIVISION OF HIGHWAYS

<b>PROJ. REFERENCE NO.</b>	<b>SHEET NO.</b>
U-5748	X-1A

Approximate quantities only.

NOTE: EMBANKMENT COLUMN DOES NOT INCLUDE BACKFILL FOR UNDERCUT

## CROSS-SECTION SUMMARY

Station	Uncl. Exc.	Embt	Station	Uncl. Exc.	Embt	Station	Uncl. Exc.	Embt	Station	Uncl. Exc.	Embt	Station	Uncl. Exc.	Embt	Station	Uncl. Exc.	Embt
L_LT	(cu. yd.)	(cu. yd.)	L_LT	(cu. yd.)	(cu. yd.)	L_LT	(cu. yd.)	(cu. yd.)	L_RT	(cu. yd.)	(cu. yd.)	L_RT	(cu. yd.)	(cu. yd.)	L_RT	(cu. yd.)	(cu. yd.)
15+50.00	0	0	40+00.00	638	0	62+50.00	15	107	19+50.00	30	201	44+00.00	8	601	66+50.00	0	217
16+00.00	0	0	40+50.00	612	1	63+00.00	14	103	20+00.00	38	208	44+50.00	15	535	67+00.00	0	180
16+50.00	0	0	41+00.00	446	3	63+50.00	8	104	20+50.00	38	161	45+00.00	21	424	67+50.00	5	144
17+00.00	6	2	41+50.00	297	6	64+00.00	5	112	21+00.00	39	161	45+50.00	20	352	68+00.00	7	133
17+50.00	14	3	42+00.00	150	18	64+50.00	1	130	21+50.00	44	139	46+00.00	19	236	68+50.00	6	129
18+00.00	19	1	42+50.00	41	113	65+00.00	0	144	22+00.00	46	106	46+50.00	15	185	69+00.00	6	132
18+50.00	25	0	43+00.00	18	188	65+50.00	0	154	22+50.00	44	72	47+00.00	31	205	69+50.00	12	133
19+00.00	26	1	43+50.00	89	105	66+00.00	0	160	23+00.00	50	46	47+50.00	52	153	70+00.00	19	126
19+50.00	28	4	44+00.00	229	32	66+50.00	0	156	23+38.00	42	27	48+00.00	58	147	70+50.00	19	122
20+00.00	32	6	44+50.00	369	29	67+00.00	0	134	Station	Uncl. Exc.	Embt	48+50.00	51	138	71+00.00	19	124
20+50.00	33	12	45+00.00	443	25	67+50.00	5	115	L_RT	(cu. yd.)	(cu. yd.)	49+00.00	30	118	71+50.00	22	120
21+00.00	34	33	45+50.00	403	19	68+00.00	7	107	L_RT	(cu. yd.)	(cu. yd.)	49+50.00	19	131	72+00.00	21	114
21+50.00	40	58	46+00.00	305	11	68+50.00	6	102	26+37.00	0	0	50+00.00	14	130	72+50.00	19	105
22+00.00	46	78	46+50.00	217	32	69+00.00	15	105	26+50.00	0	0	50+50.00	13	115	73+00.00	19	94
22+50.00	49	93	47+00.00	102	77	69+50.00	31	106	27+00.00	105	525	Station	Uncl. Exc.	Embt	73+50.00	16	87
23+00.00	51	88	47+50.00	13	214	70+00.00	31	101	27+50.00	63	678	L_RT	(cu. yd.)	(cu. yd.)	74+00.00	12	85
23+38.00	45	59	48+00.00	0	464	70+50.00	19	99	28+00.00	57	947	L_RT	(cu. yd.)	(cu. yd.)	74+50.00	57	81
Station	Uncl. Exc.	Embt	48+50.00	0	580	71+00.00	308	66	28+50.00	54	1007	50+50.00	13	115	75+00.00	80	47
L_LT	(cu. yd.)	(cu. yd.)	49+00.00	0	489	71+50.00	606	26	29+00.00	52	856	51+00.00	17	104	75+50.00	42	16
26+37.00	0	0	49+50.00	0	271	72+00.00	627	22	29+50.00	50	506	51+50.00	15	99	76+00.00	88	17
26+50.00	0	0	50+00.00	2	95	72+50.00	664	21	30+00.00	120	159	52+00.00	19	106	76+50.00	179	14
27+00.00	69	368	50+50.00	11	56	73+00.00	650	26	30+50.00	372	31	52+50.00	14	138	77+00.00	219	6
27+50.00	72	430	Station	Uncl. Exc.	Embt	73+50.00	595	26	31+00.00	1002	35	53+00.00	0	431	77+50.00	232	5
28+00.00	67	454	L_LT	(cu. yd.)	(cu. yd.)	74+00.00	554	23	31+50.00	1469	34	53+50.00	1	1140	78+00.00	217	4
28+50.00	63	490	50+50.00	11	56	74+50.00	550	24	32+00.00	1809	32	54+00.00	2	1388	78+50.00	123	4
29+00.00	64	460	50+50.00	11	56	75+00.00	531	22	32+50.00	1071	50	54+50.00	2	995	79+00.00	37	47
29+50.00	64	460	51+00.00	119	39	75+50.00	389	20	33+00.00	10	44	55+00.00	2	613	79+50.00	23	128
30+00.00	63	323	51+50.00	280	30	76+00.00	236	18	33+50.00	6	10	55+50.00	3	304	80+00.00	23	183
30+50.00	58	235	52+00.00	339	26	76+50.00	184	16	33+68.82	0	0	56+00.00	5	151	80+50.00	18	189
31+00.00	54	106	52+50.00	312	26	77+00.00	171	13	Station	Uncl. Exc.	Embt	56+50.00	5	127	81+00.00	10	166
31+50.00	115	29	53+00.00	178	42	77+50.00	129	15	L_RT	(cu. yd.)	(cu. yd.)	57+00.00	3	135	81+50.00	9	166
32+00.00	220	16	53+50.00	51	279	78+00.00	64	24	L_RT	(cu. yd.)	(cu. yd.)	57+50.00	4	128	82+00.00	12	169
32+50.00	227	14	54+00.00	32	767	78+50.00	27	56	33+68.82	0	0	58+00.00	9	106	82+50.00	16	151
33+00.00	155	40	54+50.00	35	1244	79+00.00	20	60	34+00.00	0	0	58+50.00	13	54	83+00.00	14	133
33+50.00	59	33	55+00.00	35	1069	79+50.00	16	44	34+50.00	396	38	Station	Uncl. Exc.	Embt	83+50.00	10	127
33+68.82	0	0	55+50.00	33	468	80+00.00	39	26	35+00.00	401	61	L_RT	(cu. yd.)	(cu. yd.)	84+00.00	26	370
Station	Uncl. Exc.	Embt	56+00.00	31	253	80+50.00	77	10	35+50.00	17	68	L_RT	(cu. yd.)	(cu. yd.)	84+50.00	13	176
L_LT	(cu. yd.)	(cu. yd.)	56+50.00	29	169	81+00.00	86	23	36+00.00	24	137	58+50.00	12	54	85+00.00	10	67
34+00.00	0	0	57+00.00	40	75	81+50.00	116	34	36+50.00	28	242	59+00.00	31	49	85+50.00	68	41
34+50.00	6	22	57+50.00	46	66	82+00.00	175	30	37+00.00	92	602	59+50.00	36	44			
35+00.00	10	45	58+00.00	36	91	82+50.00	240	15	37+50.00	87	540	60+00.00	24	99			
35+50.00	17	68	58+50.00	22	62	83+00.00	279	8	38+00.00	94	819	60+50.00	21	97			
36+00.00	22	131	Station	Uncl. Exc.	Embt	83+50.00	240	8	38+50.00	121	1671	61+00.00	15	99			
36+50.00	25	232	L_LT	(cu. yd.)	(cu. yd.)	84+00.00	159	17	39+00.00	56	1805	61+50.00	8	122			
37+00.00	26	274	58+50.00	50	72	84+50.00	81	24	39+50.00	46	1529	62+00.00	8	132			
37+50.00	23	216	58+50.00	50	72	85+00.00	45	14	40+00.00	60	1019	62+50.00	12	128			
38+00.00	22	127	59+00.00	170	56	85+50.00	97	6	40+50.00	62	517	63+00.00	11	124			
38+50.00	97	53	59+50.00	147	61	Station	Uncl. Exc.	Embt	41+00.00	56	340	63+50.00	8	128			
39+00.00	252	14	60+00.00	24	63	L_RT	(cu. yd.)	(cu. yd.)	41+50.00	49	540	64+00.00	5	142			
39+50.00	454	1	60+50.00	21	73	42+00.00	38	659	42+50.00	38	659	64+50.00	1	166			
			61+00.00	15	72	18+10.00	0	0	42+50.00	19	565	65+00.00	0	186			
			61+50.00	8	95	18+50.00	0	0	43+00.00	5	576	65+50.00	0	204			
			62+00.00	8	109	19+00.00	19	96	43+50.00	5	617	66+00.00	0	218			

# STATE OF NORTH CAROLINA DIVISION OF HIGHWAYS

<b>PROJ. REFERENCE NO.</b>	<b>SHEET NO.</b>
U-5748	X-1B

Approximate quantities only.

## CROSS-SECTION SUMMARY

NOTE: EMBANKMENT COLUMN DOES NOT INCLUDE BACKFILL FOR UNDERCUT

Station	Uncl. Exc.	Embt	Station	Uncl. Exc.	Embt	Station	Uncl. Exc.	Embt	Station	Uncl. Exc.	Embt	Station	Uncl. Exc.	Embt	Station	Uncl. Exc.	Embt
Y1	(cu. yd.)	(cu. yd.)	Y2	(cu. yd.)	(cu. yd.)	Drive2	(cu. yd.)	(cu. yd.)	L1_med	(cu. yd.)	(cu. yd.)	L1_med	(cu. yd.)	(cu. yd.)	DET_1	(cu. yd.)	(cu. yd.)
10+71.00	0	0	33+45.68	93	428	11+40.00	30	3	26+50.00	33	0	55+00.00	36	0	19+00.00	10	0
11+00.00	15	1	<b>Station</b>	<b>Uncl. Exc.</b>	<b>Embt</b>	11+50.00	7	1	27+00.00	9	0	55+50.00	23	0	19+50.00	14	0
11+50.00	674	7	<b>Y3</b>	<b>(cu. yd.)</b>	<b>(cu. yd.)</b>	<b>Station</b>	<b>Uncl. Exc.</b>	<b>Embt</b>	27+50.00	15	0	56+00.00	22	0	20+00.00	15	0
12+00.00	885	6				<b>Drive3</b>	<b>(cu. yd.)</b>	<b>(cu. yd.)</b>	28+00.00	40	0	56+50.00	22	0	20+28.42	4	0
12+50.00	395	17	11+00.00	0	0				28+50.00	50	0	57+00.00	34	0			
13+00.00	247	26	11+50.00	2	0	10+69.21	0	0	29+00.00	48	0	57+50.00	19	1			
13+20.00	66	6	12+00.00	4	1	11+00.00	70	7	29+50.00	44	0	58+00.00	13	1			
<b>Station</b>	<b>Uncl. Exc.</b>	<b>Embt</b>	12+50.00	6	14	11+50.00	76	17	30+00.00	41	0	58+50.00	11	0			
<b>Y2</b>	<b>(cu. yd.)</b>	<b>(cu. yd.)</b>	13+00.00	9	20	11+80.00	41	5	30+50.00	36	0	59+00.00	11	0			
			13+50.00	26	15	12+00.00	15	1	31+00.00	33	0	59+50.00	11	0			
12+00.00	0	0	14+00.00	161	8	<b>Station</b>	<b>Uncl. Exc.</b>	<b>Embt</b>	31+50.00	31	0	60+00.00	11	0			
12+50.00	50	21	14+50.00	549	1				32+00.00	28	0	60+50.00	10	0			
13+00.00	81	49	14+93.84	881	0	<b>Drive4</b>	<b>(cu. yd.)</b>	<b>(cu. yd.)</b>	32+50.00	25	0	61+00.00	10	0			
13+50.00	94	77	<b>Station</b>	<b>Uncl. Exc.</b>	<b>Embt</b>	10+24.54	0	0	33+00.00	24	0	61+60.00	7	0			
14+00.00	243	90				10+50.00	16	36	33+50.00	25	0	<b>Station</b>	<b>Uncl. Exc.</b>	<b>Embt</b>			
14+50.00	352	80	<b>Y4</b>	<b>(cu. yd.)</b>	<b>(cu. yd.)</b>	11+00.00	6	70	34+00.00	26	0						
15+00.00	276	83	11+50.00	0	0	11+25.00	2	0	34+50.00	27	0	<b>L1_RT</b>	<b>(cu. yd.)</b>	<b>(cu. yd.)</b>			
15+50.00	134	100	12+00.00	0	0	<b>Station</b>	<b>Uncl. Exc.</b>	<b>Embt</b>	35+00.00	27	0	26+01.98	0	0			
16+00.00	44	128	12+50.00	35	4				35+50.00	25	0	26+50.00	85	22			
16+50.00	21	127	13+00.00	43	3	<b>L1_LT</b>	<b>(cu. yd.)</b>	<b>(cu. yd.)</b>	36+00.00	26	0	27+00.00	111	83			
17+00.00	46	96	13+50.00	37	1	23+42.00	0	0	36+50.00	0	0	27+50.00	37	85			
17+50.00	327	43	14+00.00	44	0	24+00.00	16	20	37+00.00	10	0	28+00.00	31	35			
18+00.00	740	0	14+50.00	44	1	24+50.00	31	74	37+50.00	19	0	28+50.00	19	11			
18+50.00	1260	0	15+00.00	44	4	25+00.00	31	176	38+00.00	19	0	28+62.23	1	0			
19+00.00	1633	0	15+50.00	54	5	25+50.00	31	264	38+50.00	19	0	<b>Station</b>	<b>Uncl. Exc.</b>	<b>Embt</b>			
19+50.00	1713	0	16+00.00	31	16	26+02.72	18	151	39+00.00	19	0						
20+00.00	2062	0	16+22.36	1	12	<b>Station</b>	<b>Uncl. Exc.</b>	<b>Embt</b>	39+50.00	19	0	<b>L1_RT</b>	<b>(cu. yd.)</b>	<b>(cu. yd.)</b>			
20+50.00	2216	0	<b>Station</b>	<b>Uncl. Exc.</b>	<b>Embt</b>				40+00.00	19	0	72+00.00	0	0			
21+00.00	1944	0				<b>L1_LT</b>	<b>(cu. yd.)</b>	<b>(cu. yd.)</b>	40+50.00	9	0	72+50.00	0	1			
21+50.00	1756	0	<b>Y5</b>	<b>(cu. yd.)</b>	<b>(cu. yd.)</b>	47+54.84	0	0	<b>Station</b>	<b>Uncl. Exc.</b>	<b>Embt</b>	73+00.00	0	1			
22+00.00	1631	0	10+83.00	0	0	48+00.00	11	3				73+50.00	0	2			
22+50.00	1636	0	11+00.00	7	12	48+50.00	26	156	<b>L1_med</b>	<b>(cu. yd.)</b>	<b>(cu. yd.)</b>	73+73.50	0	1			
23+00.00	1479	0	11+50.00	25	23	49+00.00	27	482	44+90.06	0	0	<b>Station</b>	<b>Uncl. Exc.</b>	<b>Embt</b>			
23+50.00	728	0	12+00.00	7	14	49+50.00	27	708	45+00.00	1	0						
24+00.00	106	625	12+50.00	6	10	50+00.00	14	379	45+50.00	13	1	<b>DET_1</b>	<b>(cu. yd.)</b>	<b>(cu. yd.)</b>			
24+50.00	0	1844	12+85.27	3	4	50+40.22	1	0	46+00.00	21	1	10+00.00	0	0			
25+00.00	0	2681	<b>Station</b>	<b>Uncl. Exc.</b>	<b>Embt</b>	<b>Station</b>	<b>Uncl. Exc.</b>	<b>Embt</b>	46+50.00	36	0	10+50.00	6	30			
25+50.00	209	1831							47+00.00	51	0	11+00.00	6	27			
26+00.00	756	369	<b>Y10</b>	<b>(cu. yd.)</b>	<b>(cu. yd.)</b>	<b>L1_med</b>	<b>(cu. yd.)</b>	<b>(cu. yd.)</b>	47+50.00	62	0	11+50.00	5	30			
26+50.00	1608	0	11+08.06	0	0	19+50.00	0	0	48+00.00	67	0	12+00.00	5	31			
27+00.00	2515	0	11+50.00	0	0	20+00.00	8	0	48+50.00	67	0	12+50.00	4	30			
27+50.00	3358	0	11+80.00	0	0	20+50.00	22	0	49+00.00	77	0	13+00.00	2	32			
28+00.00	4286	0	<b>Station</b>	<b>Uncl. Exc.</b>	<b>Embt</b>	21+00.00	34	0	49+50.00	85	0	13+50.00	2	32			
28+50.00	4988	0				21+50.00	39	0	50+00.00	82	0	14+00.00	1	23			
29+00.00	4866	0	<b>Drive1</b>	<b>(cu. yd.)</b>	<b>(cu. yd.)</b>	22+00.00	31	0	50+50.00	45	0	14+50.00	1	11			
29+50.00	4056	0	11+50.00	0	0	22+50.00	23	0	51+00.00	9	1	15+00.00	2	13			
30+00.00	3261	0	12+00.00	61	4	23+00.00	22	0	51+50.00	10	1	15+50.00	0	9			
30+50.00	2770	0	12+37.08	64	5	23+50.00	24	0	52+00.00	11	0	16+00.00	0	79			
31+00.00	2520	0	<b>Station</b>	<b>Uncl. Exc.</b>	<b>Embt</b>	24+00.00	37	0	52+50.00	11	0	16+50.00	0	158			
31+50.00	2342	0				24+50.00	49	0	53+00.00	13	0	17+00.00	0	148			
32+00.00	1852	0	<b>Drive2</b>	<b>(cu. yd.)</b>	<b>(cu. yd.)</b>	25+00.00	48	0	53+50.00	16	0	17+50.00	2	85			
32+50.00	841	45	10+83.00	0	0	25+50.00	47	0	54+00.00	19	0	18+00.00	5	28			
33+00.00	169	280	11+00.00	0	0	26+00.00	47	0	54+50.00	23	0	18+50.00	7	7			

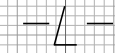
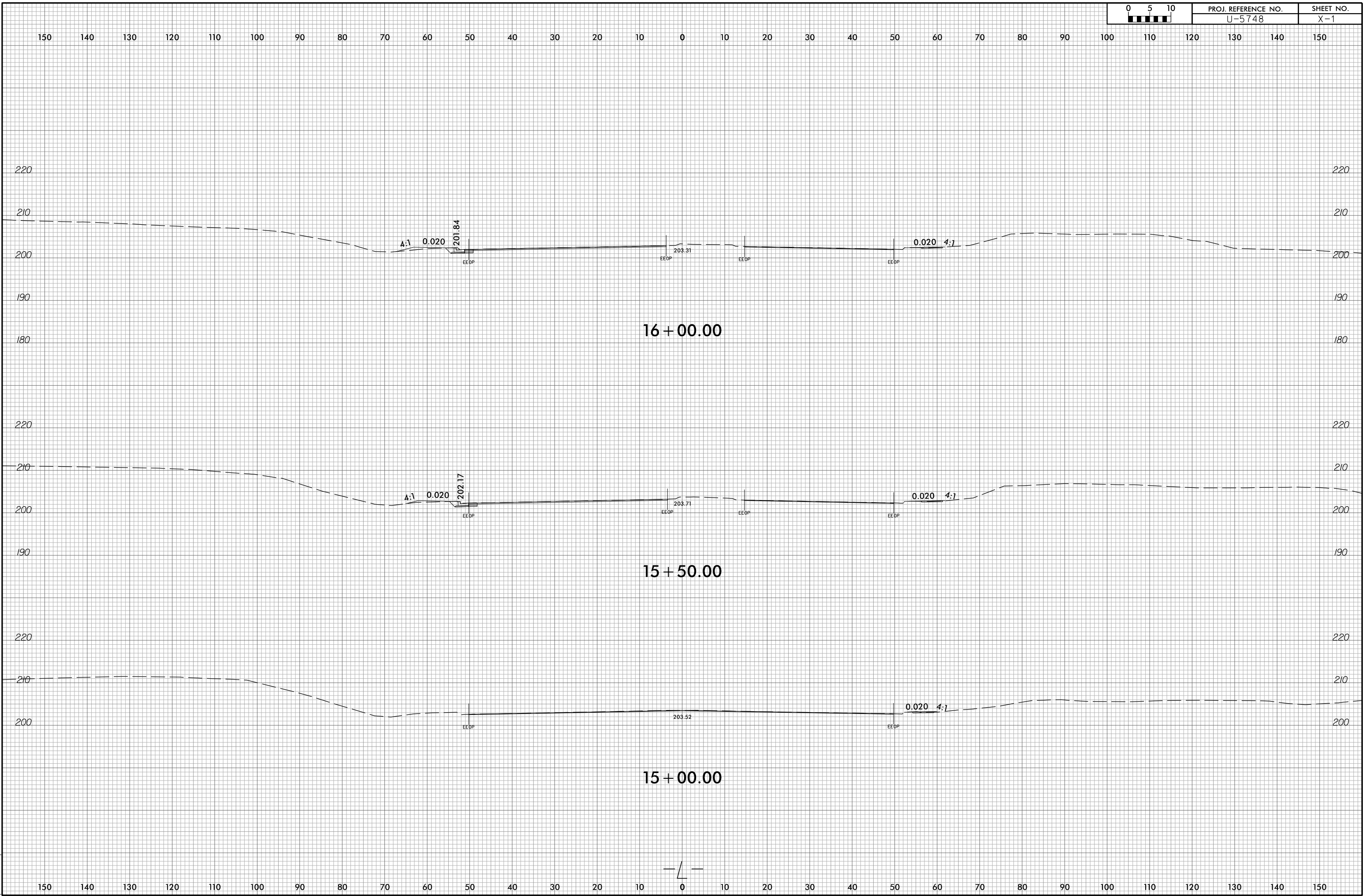

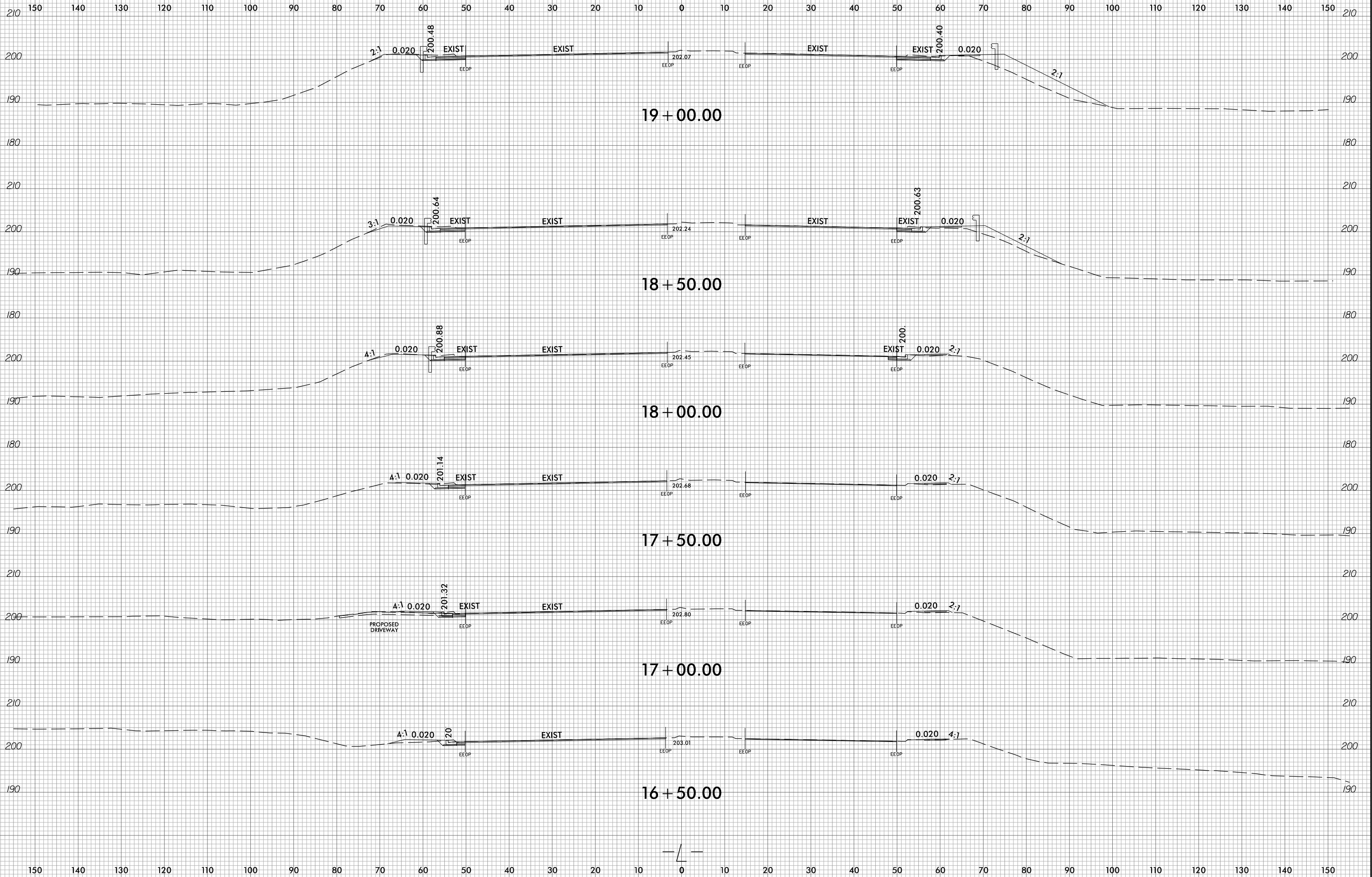

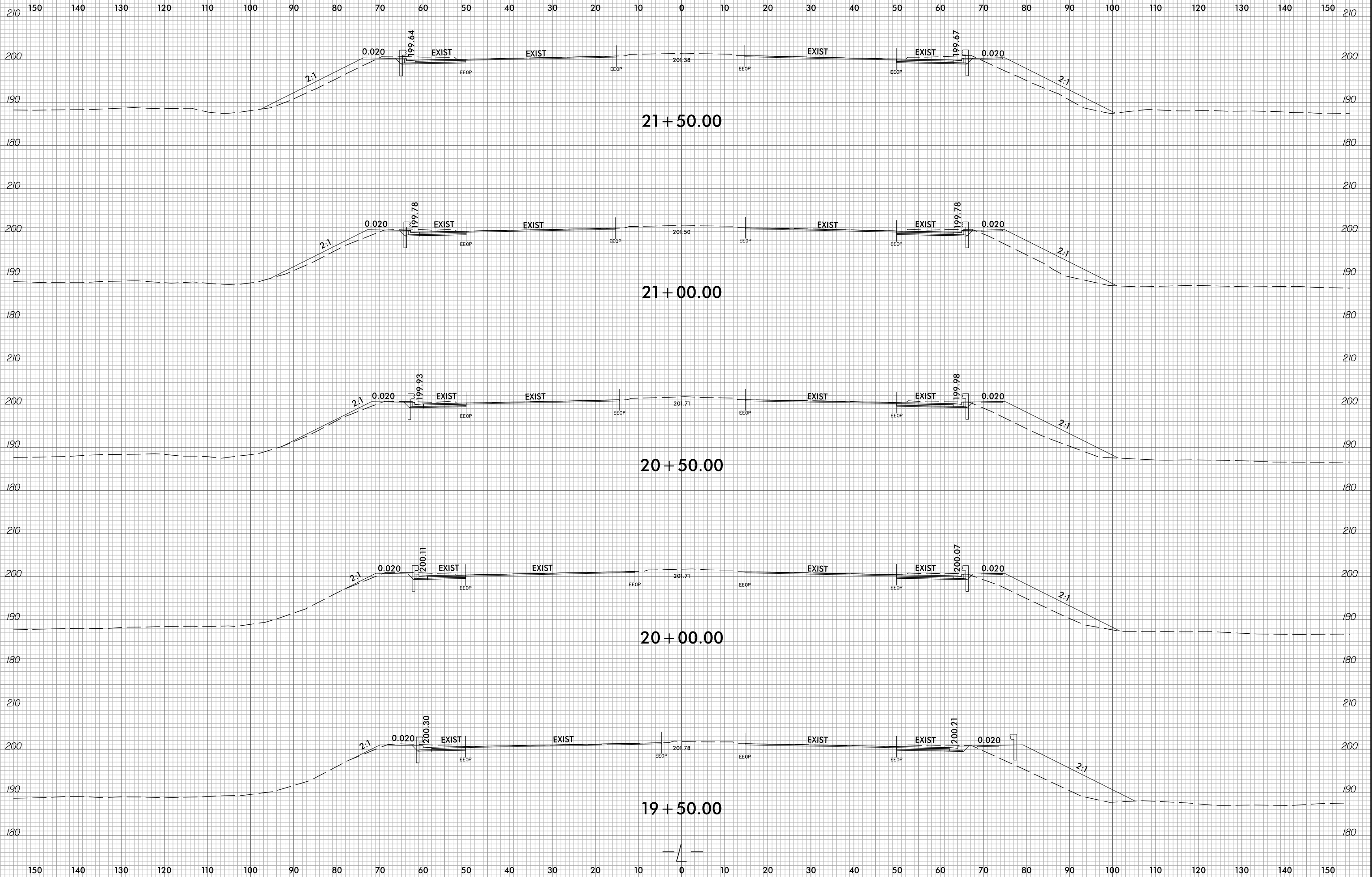

6/23/16

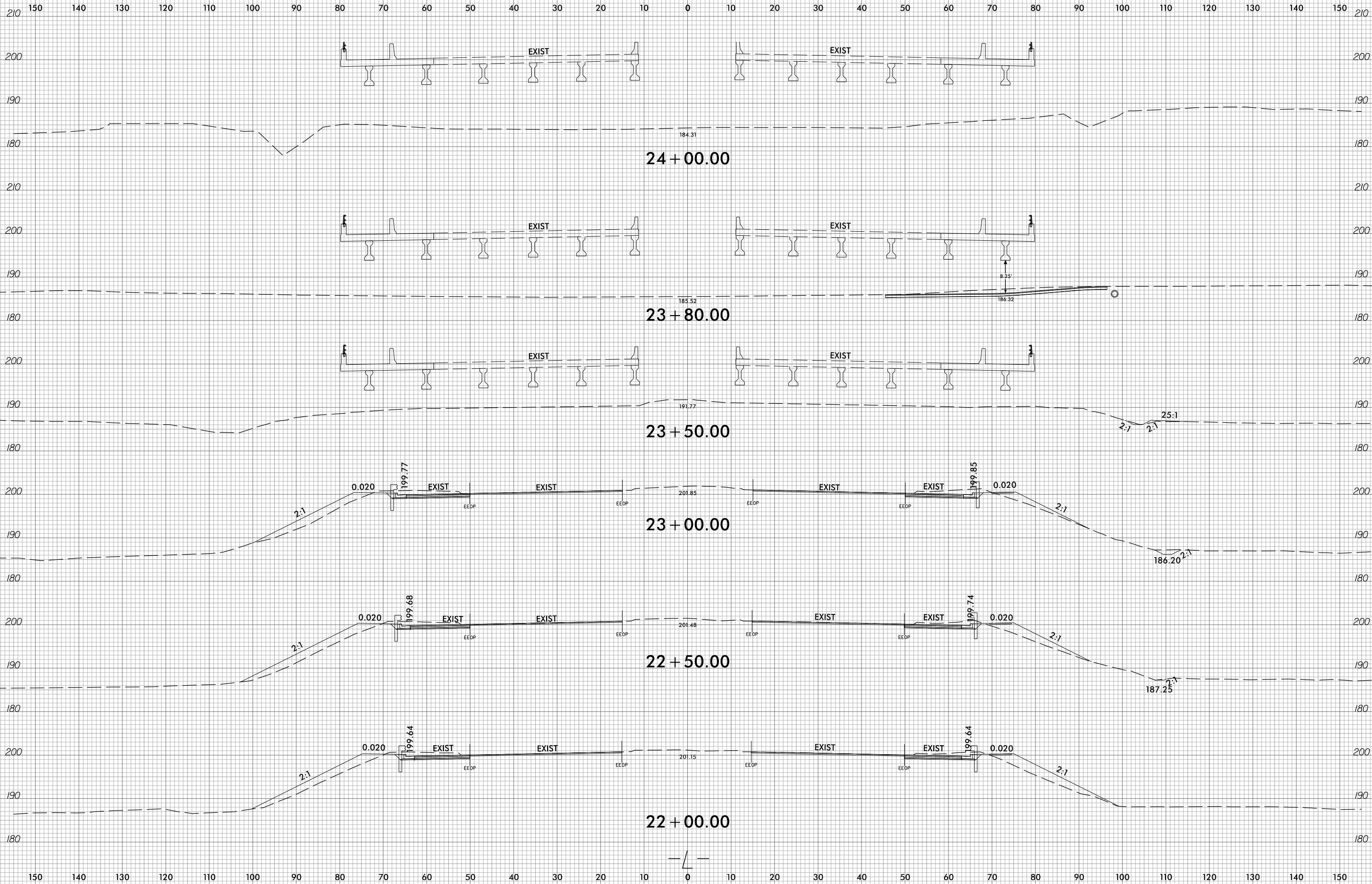

2/2/2023  
U-5748\_Road\_xpl.dwg  
patrick.meperson

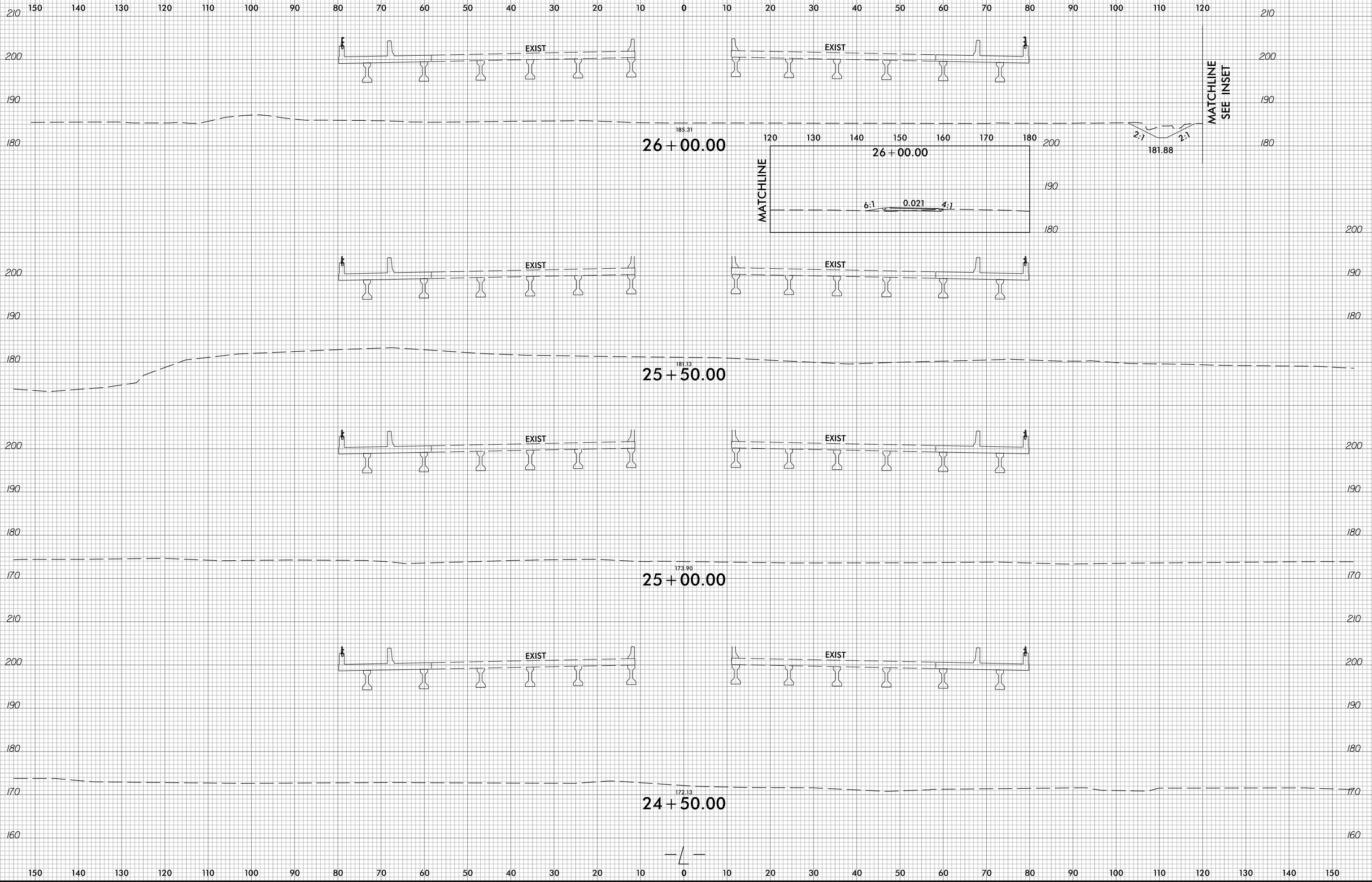

MATCHLINE  
SEE INSET

MATCHLINE



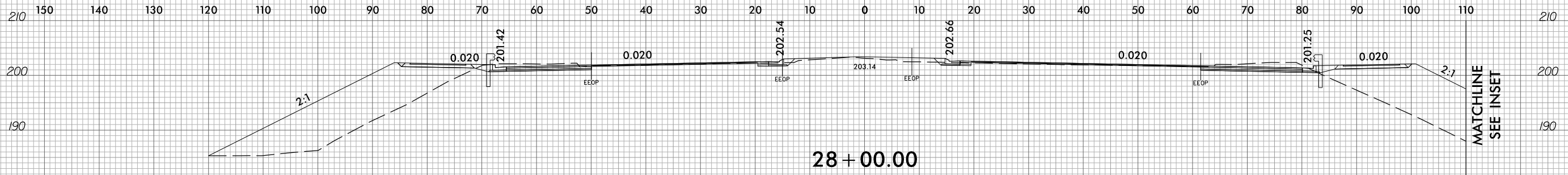
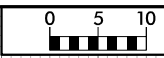

28 + 00.00

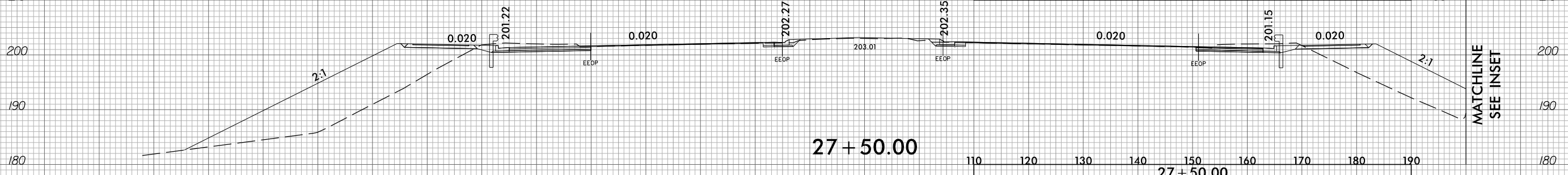
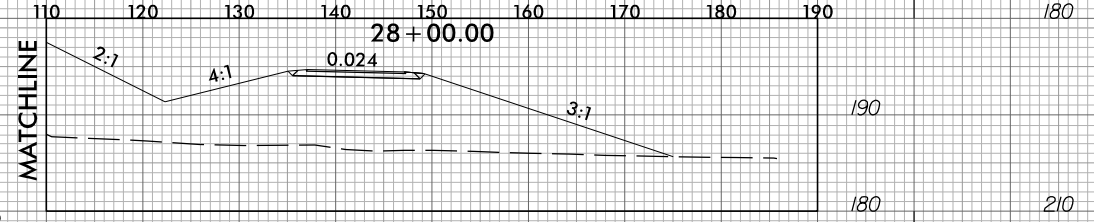

27 + 50.00

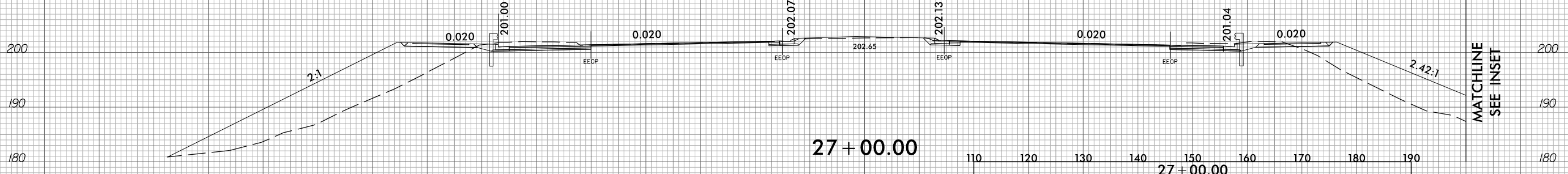
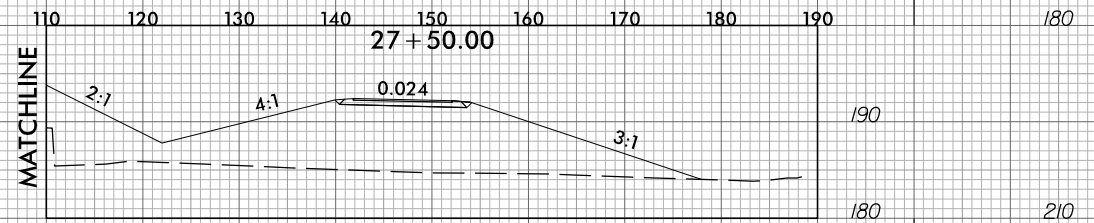

27 + 00.00

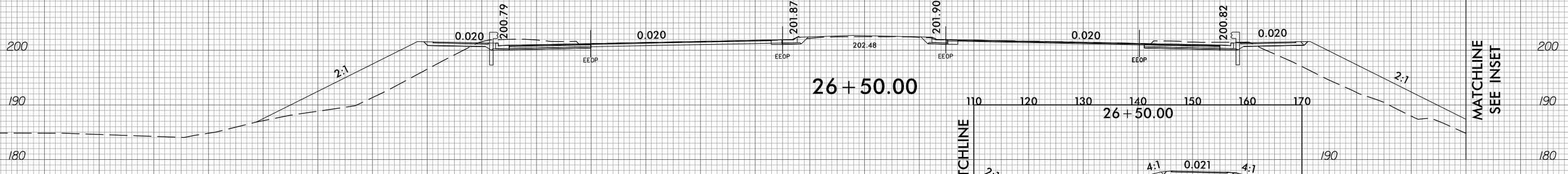
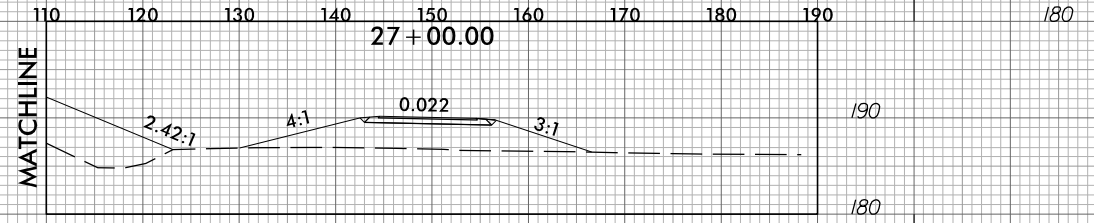

26 + 50.00

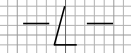
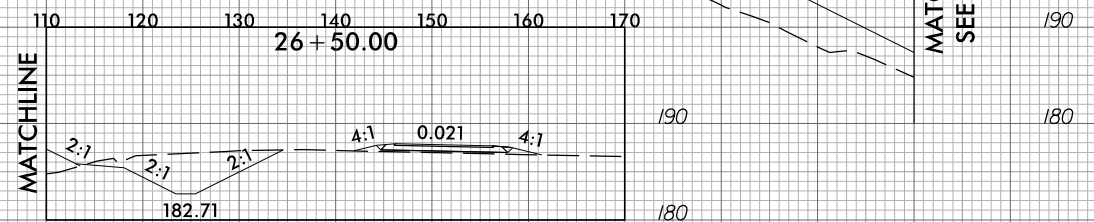

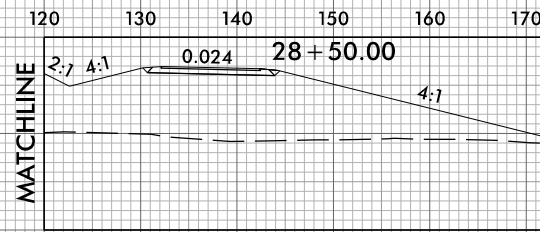
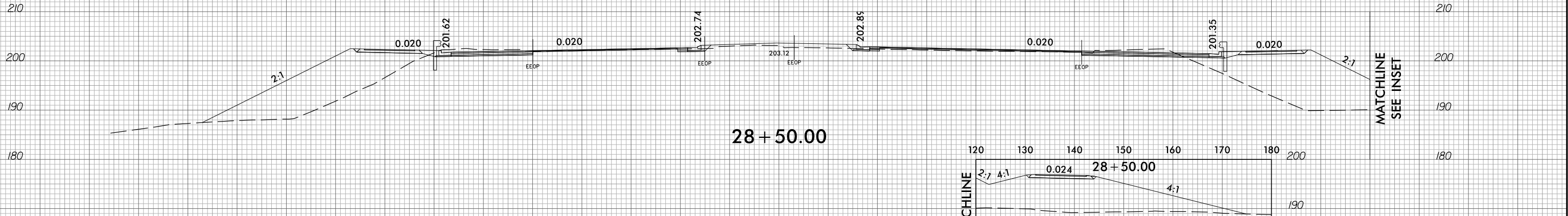
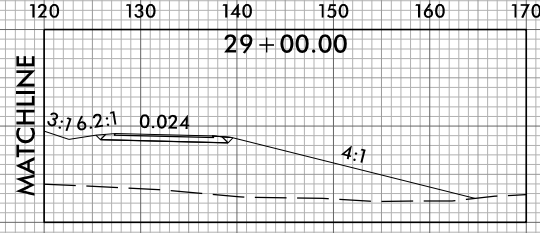
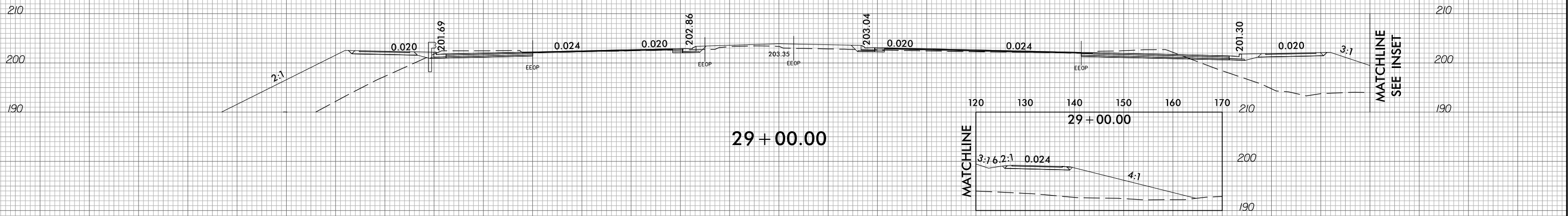
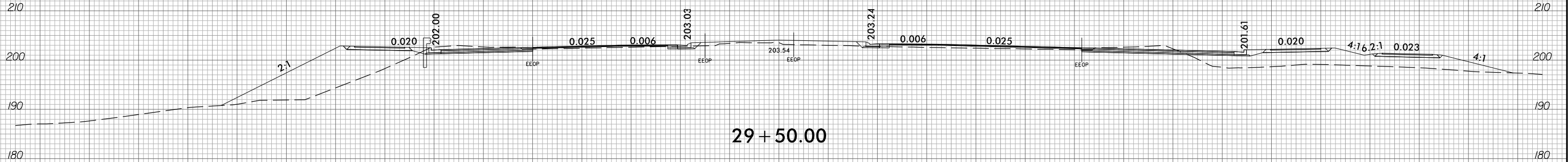
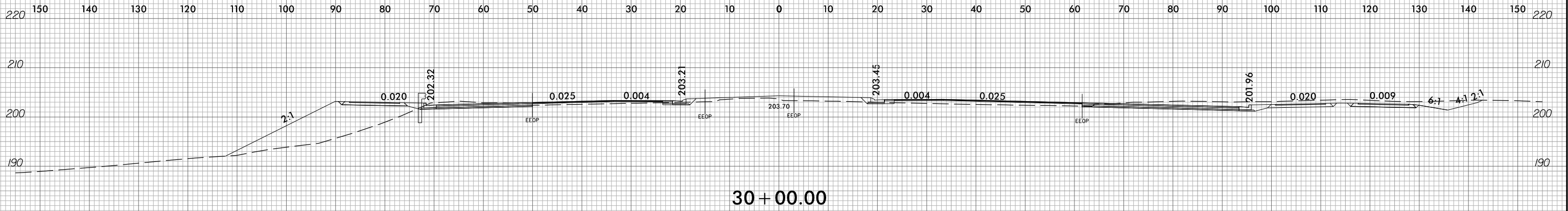

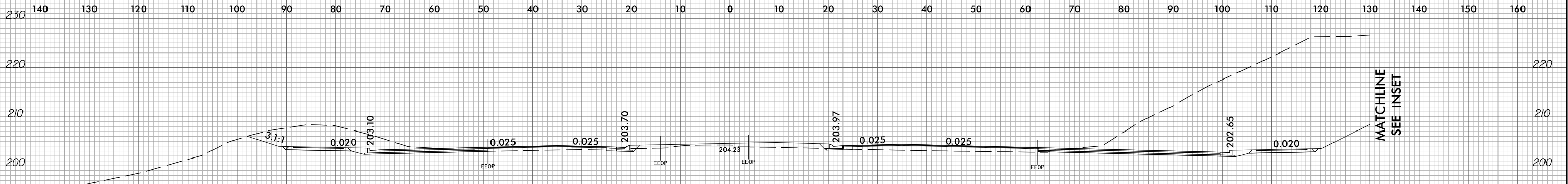

32 + 00.00

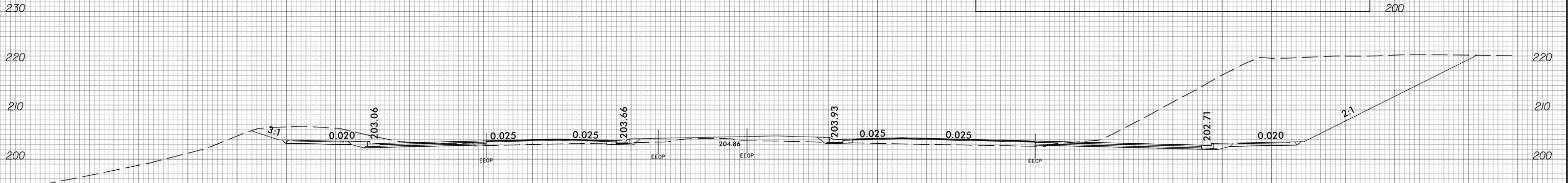

31 + 50.00

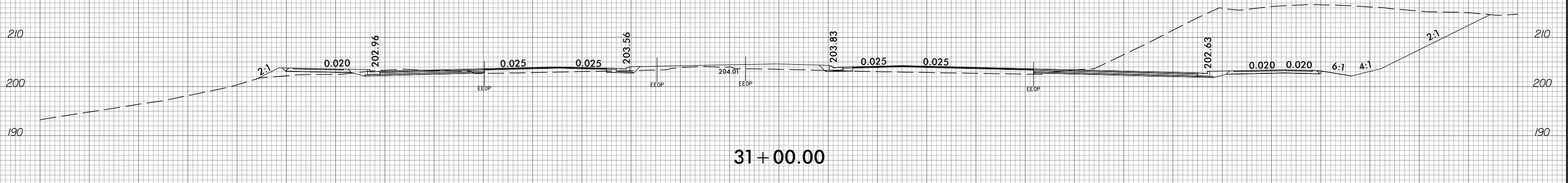

31 + 00.00

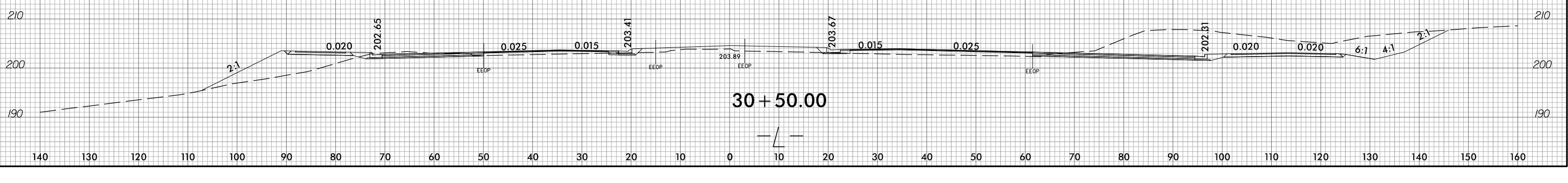

30 + 50.00

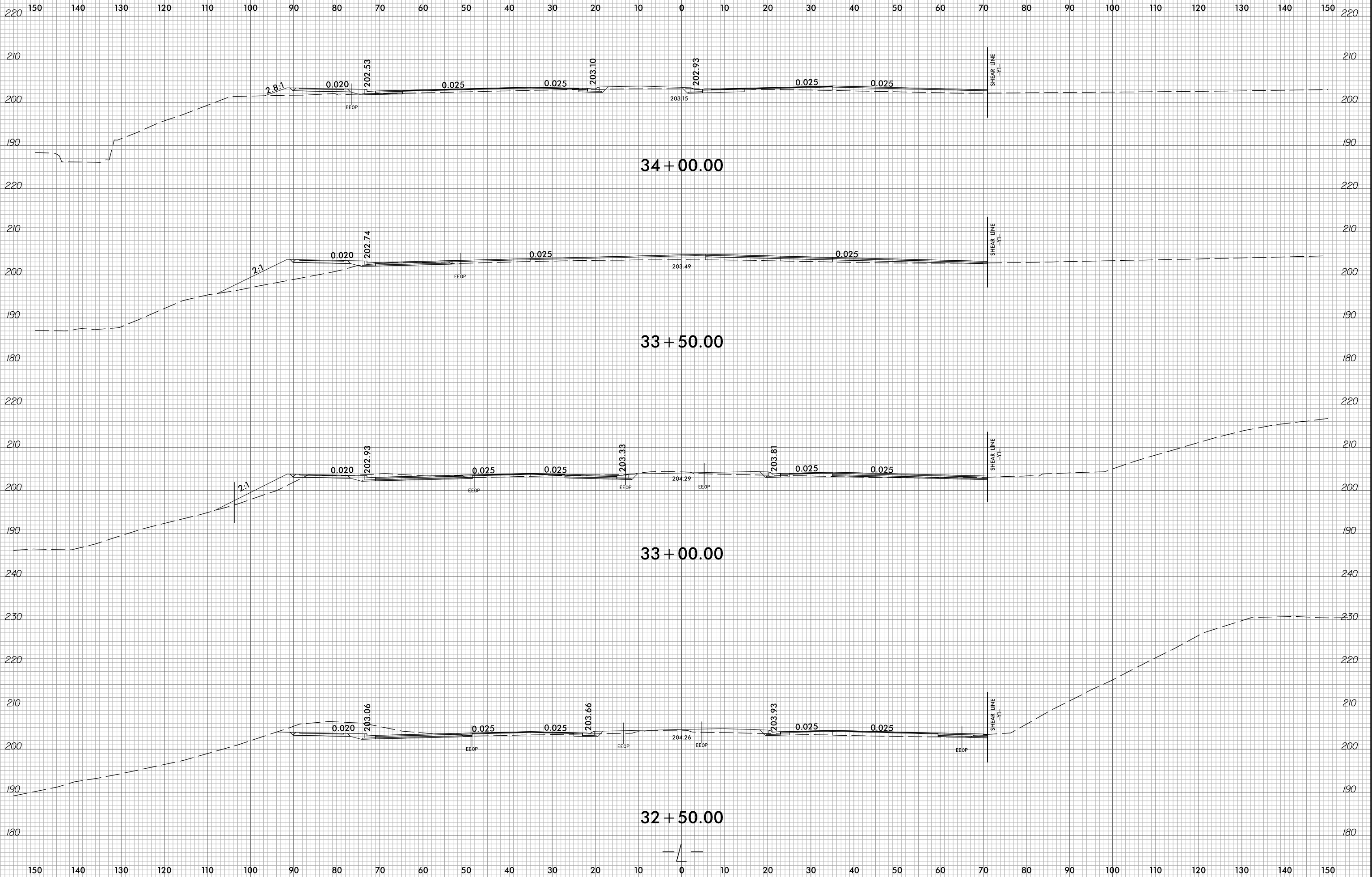

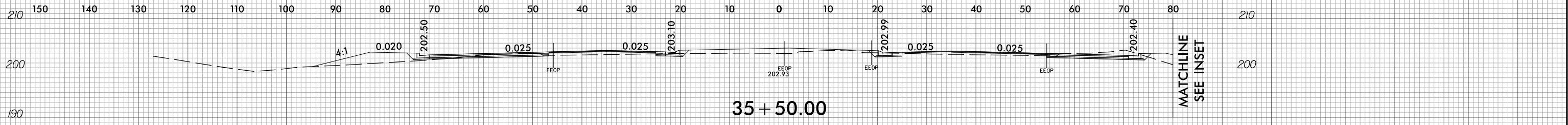

35 + 50.00

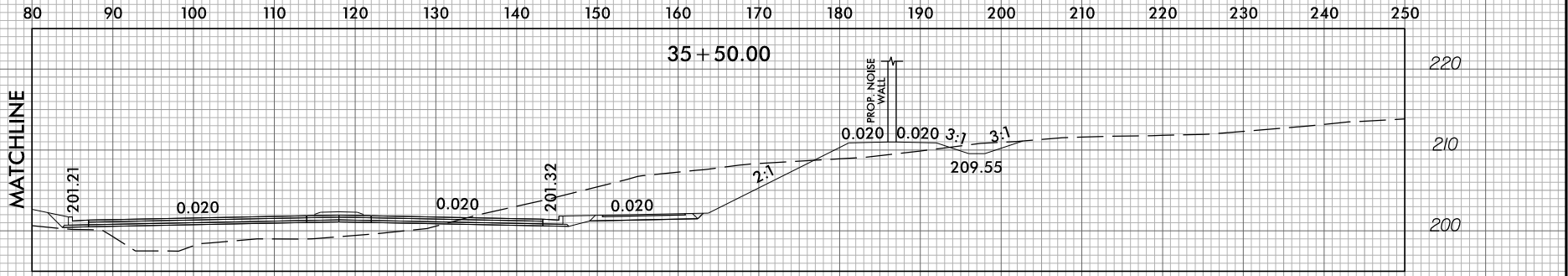

35 + 50.00

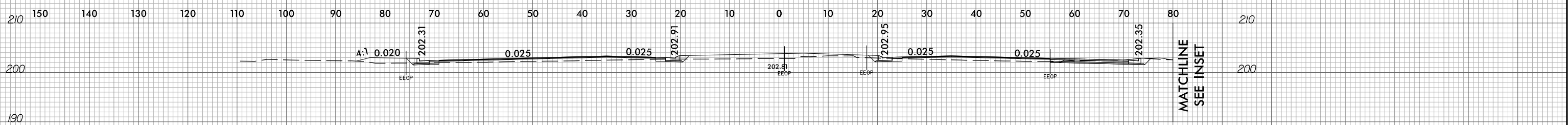

35 + 00.00

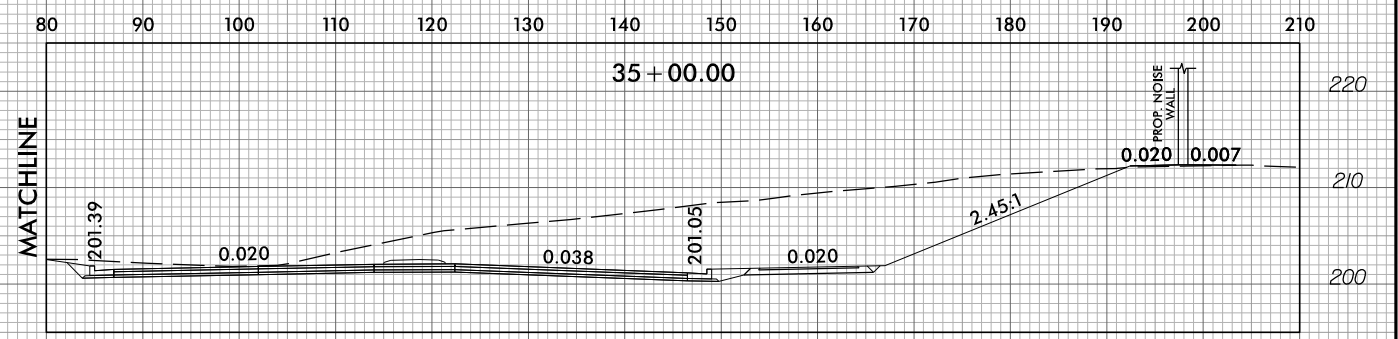

35 + 00.00

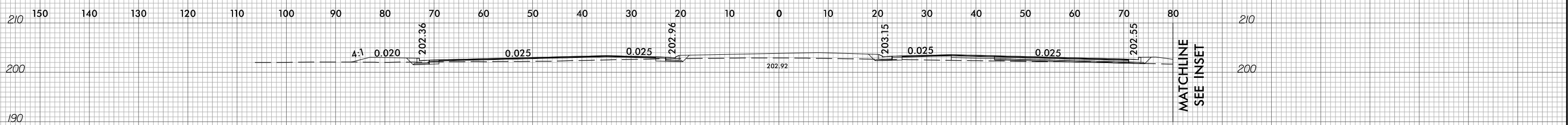

34 + 50.00

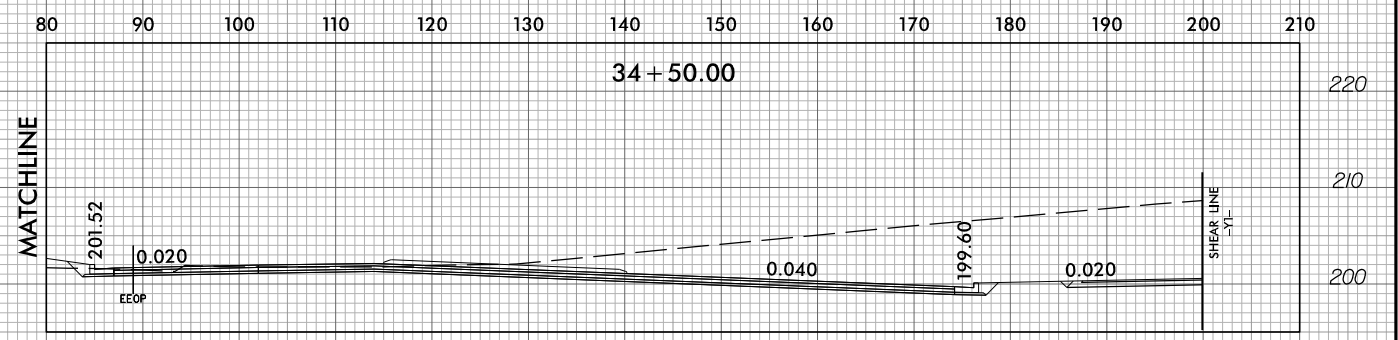

34 + 50.00

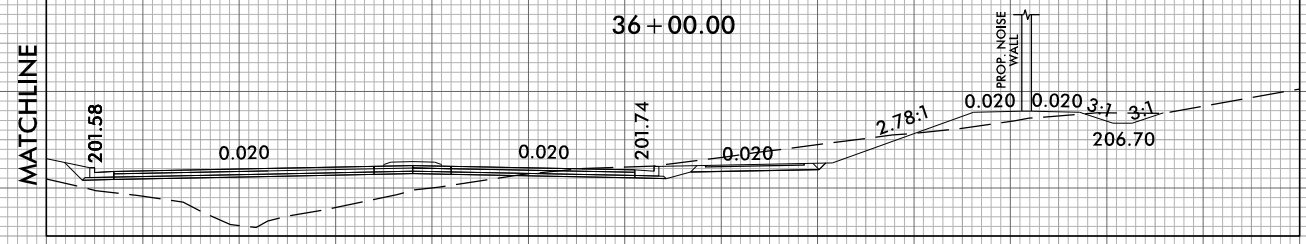
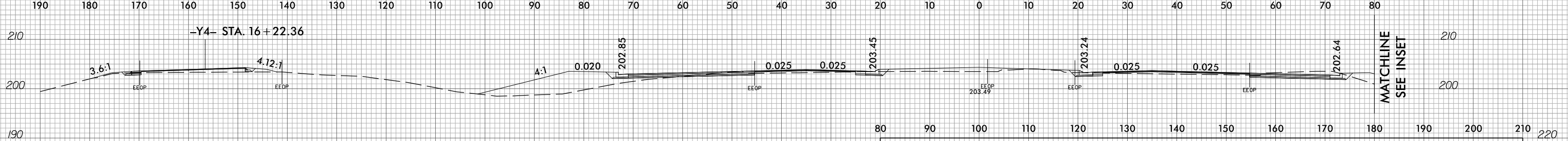
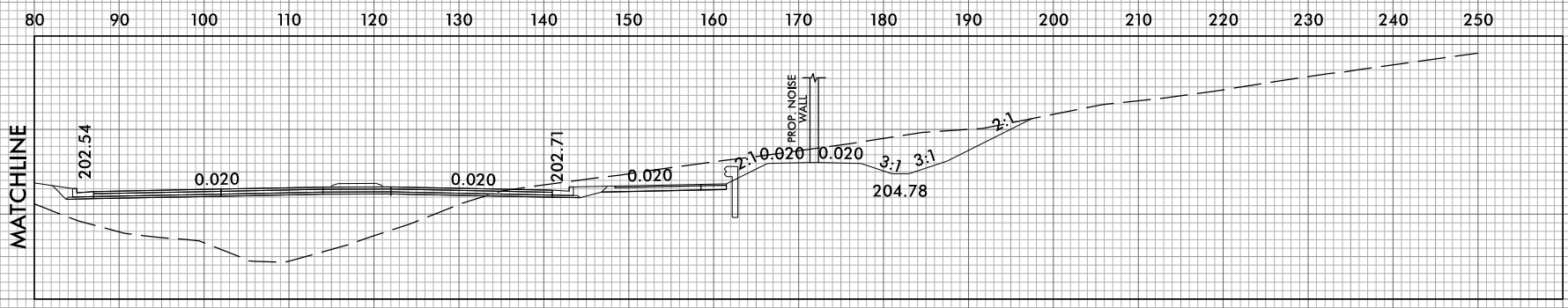
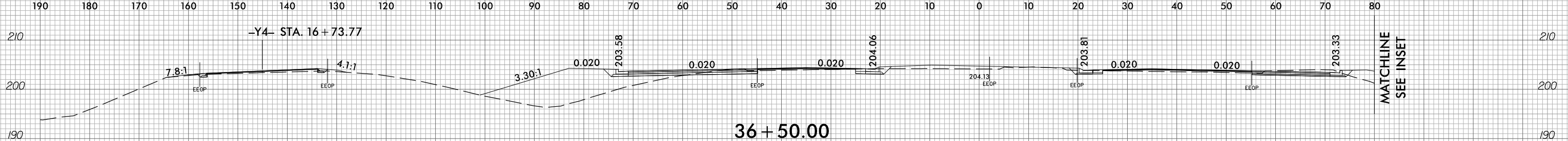
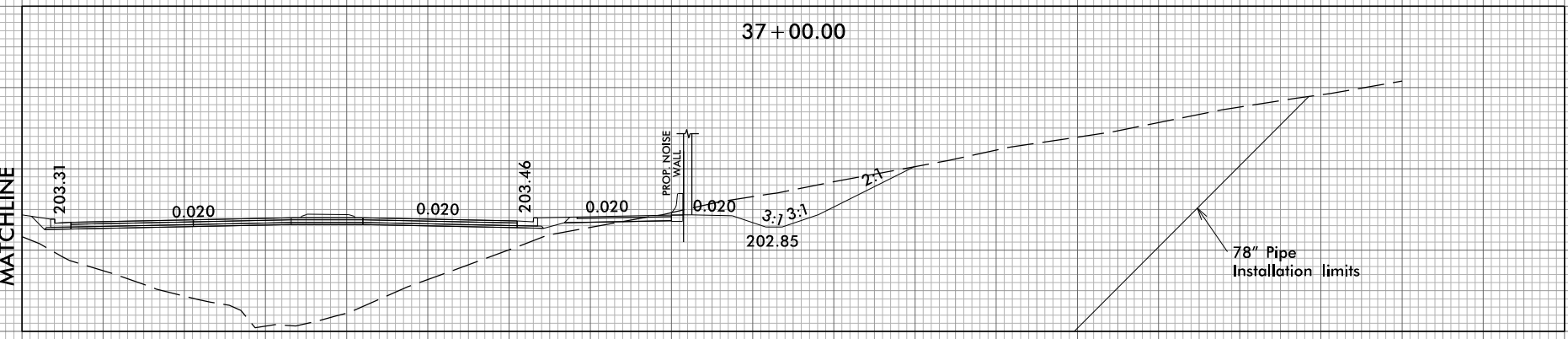
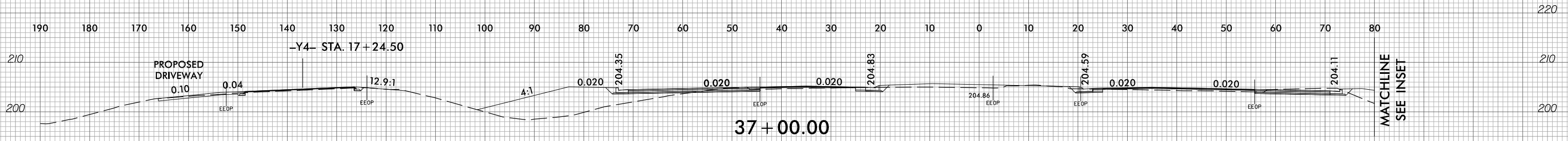
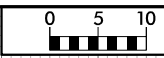



38+00.00

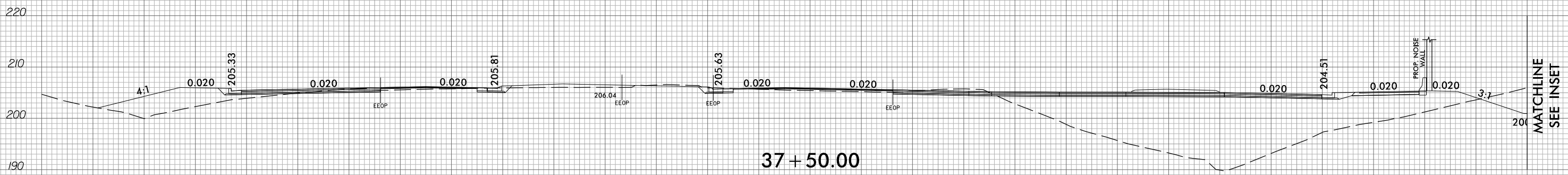
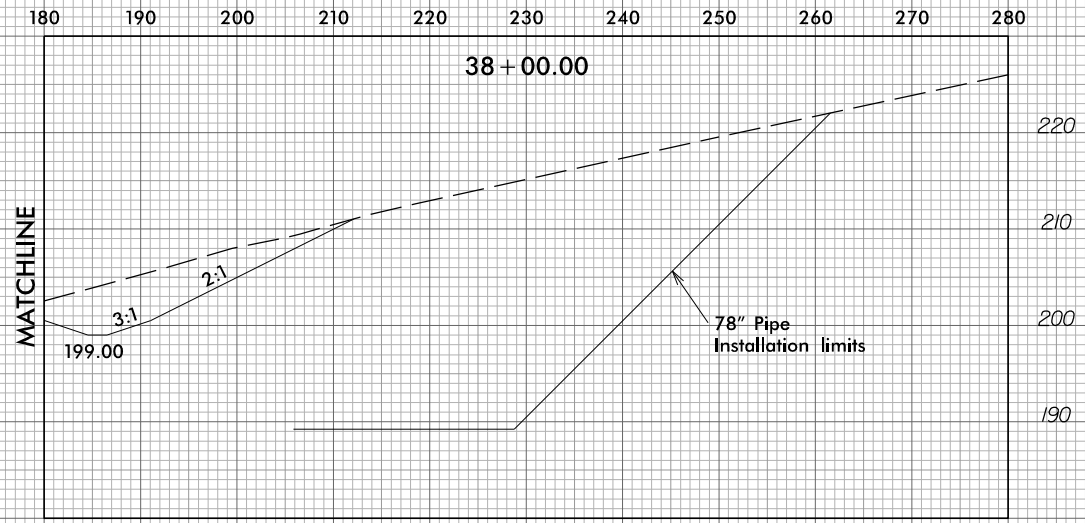

37+50.00

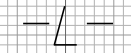
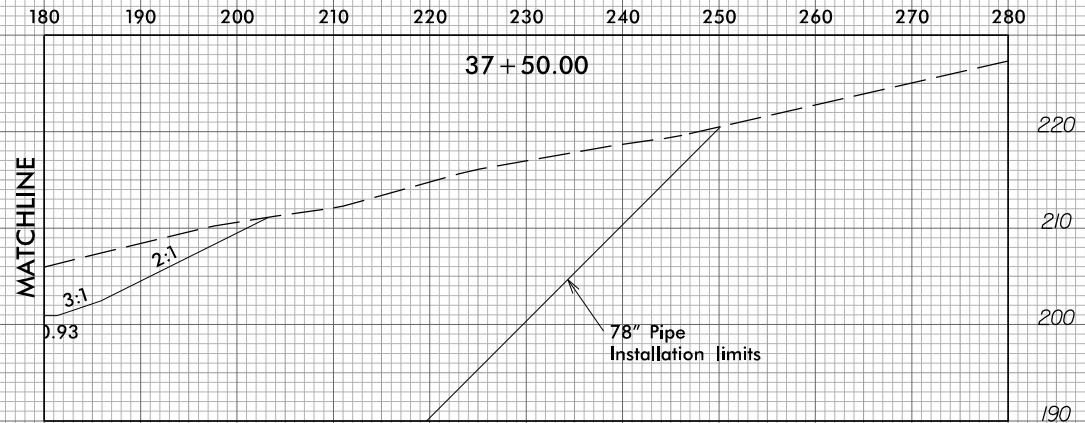

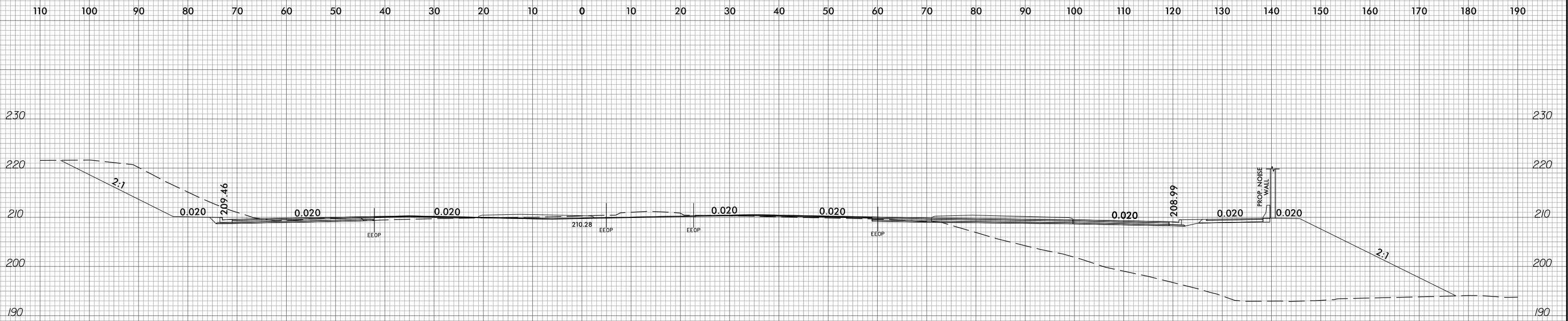

39 + 00.00

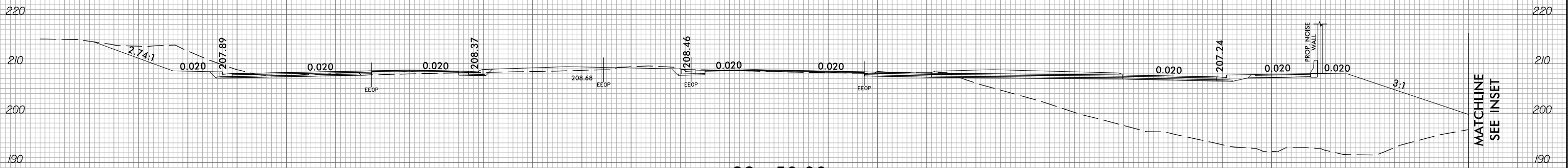

38 + 50.00

MATCHLINE  
SEE INSET

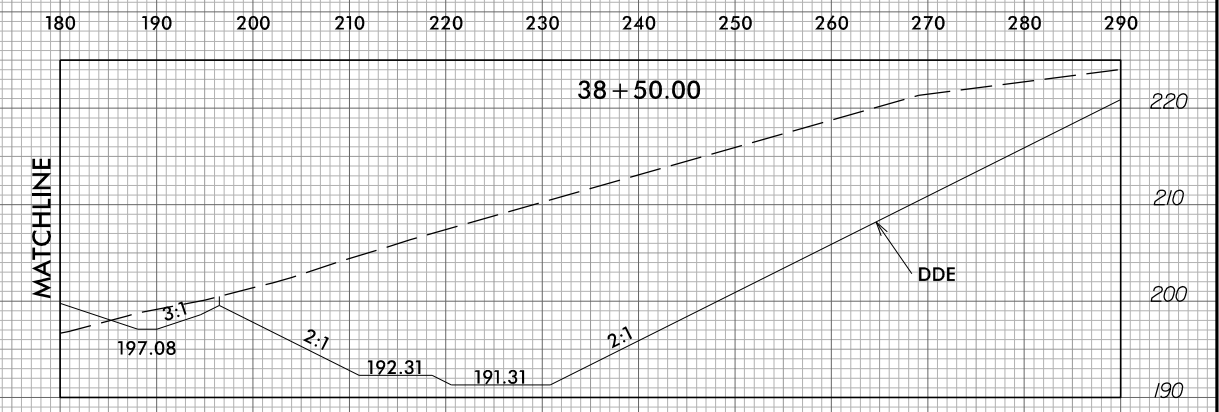



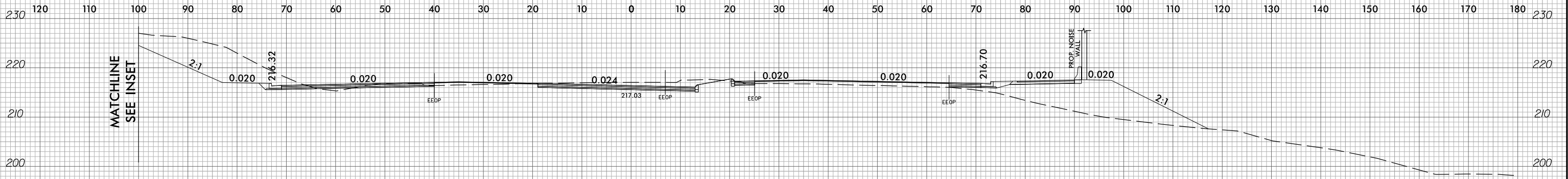

41+00.00

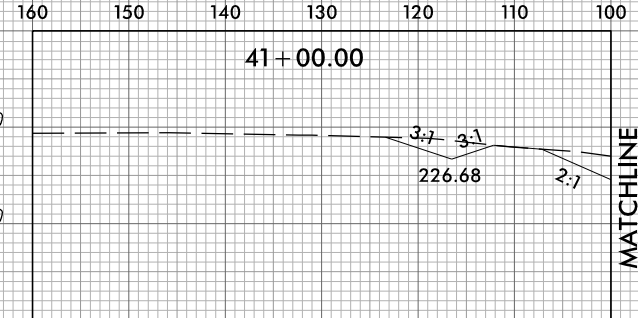

40+50.00

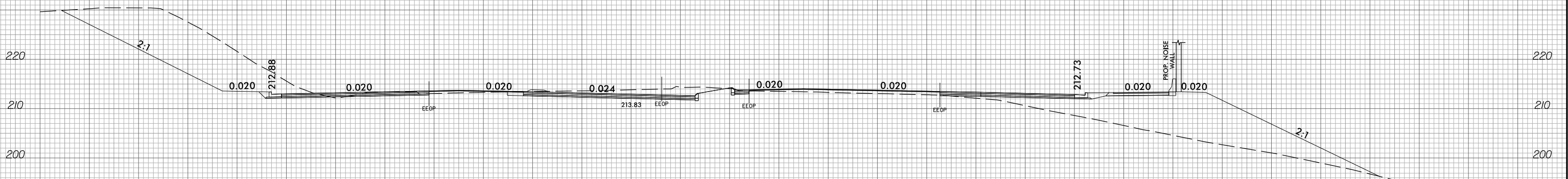

40+00.00

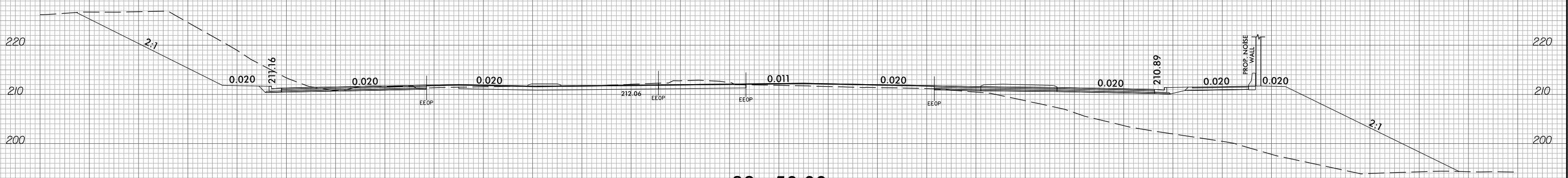

39+50.00

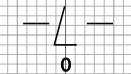
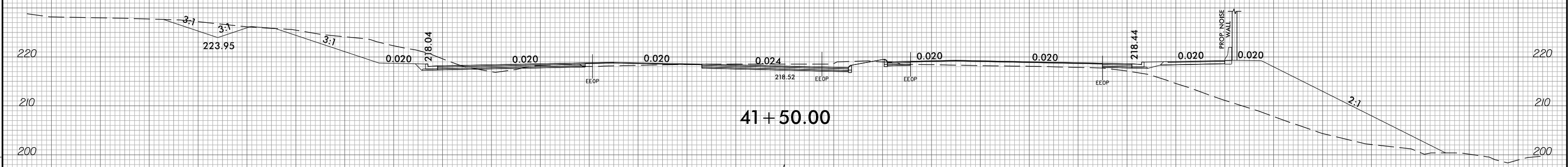
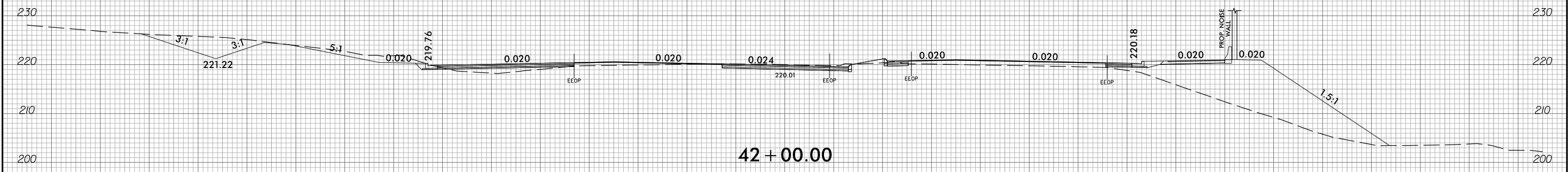
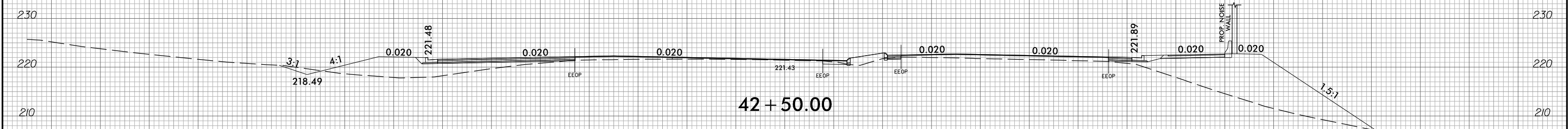
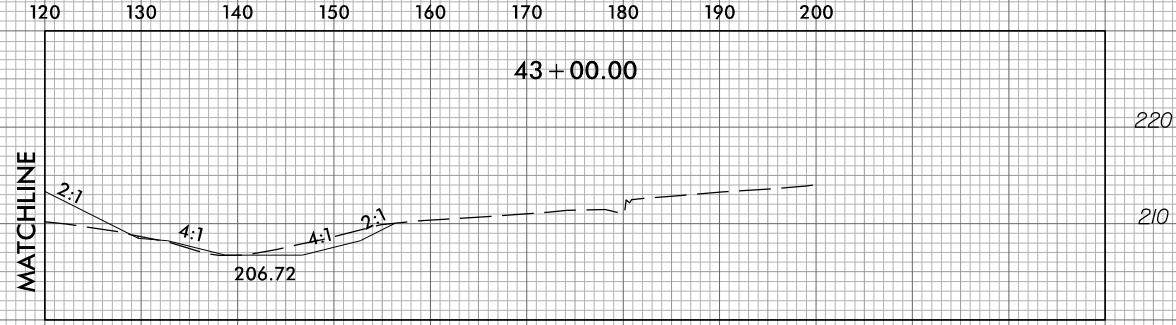
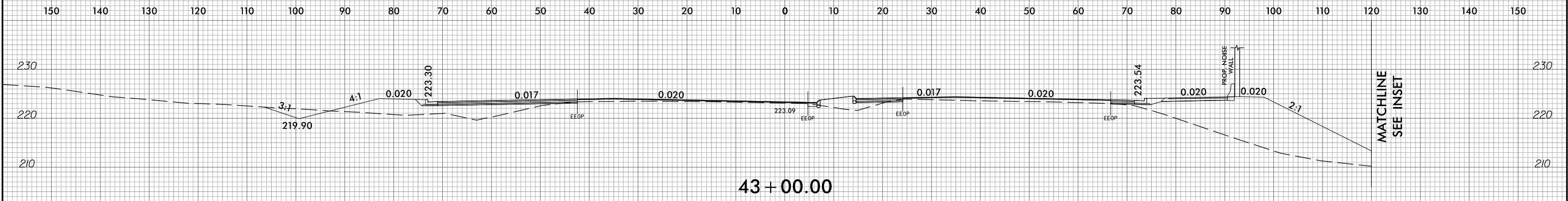

6/23/16

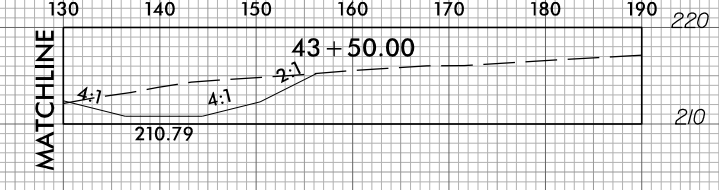
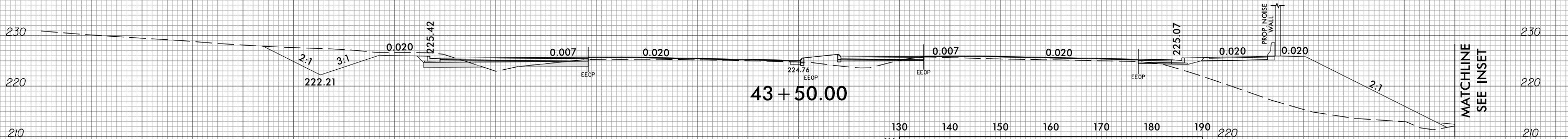
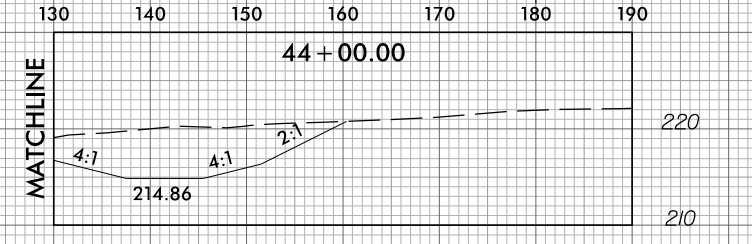
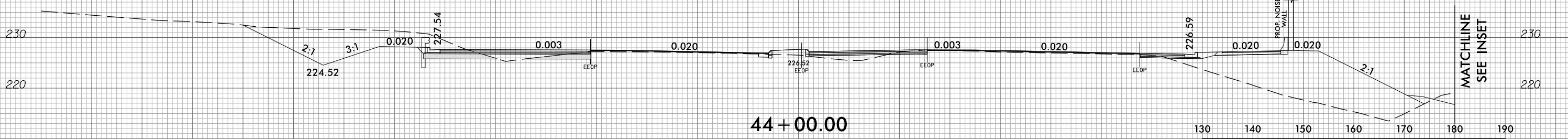
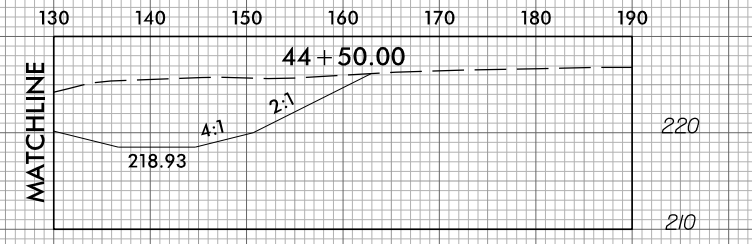
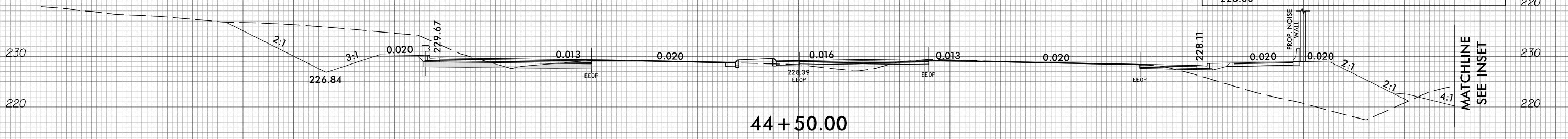
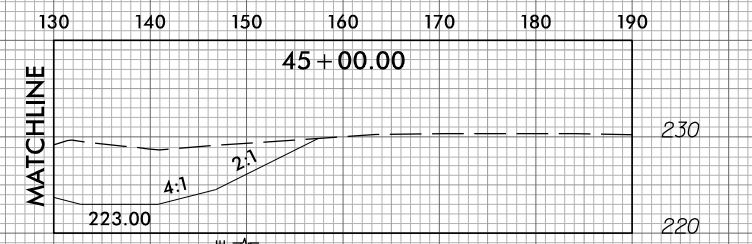
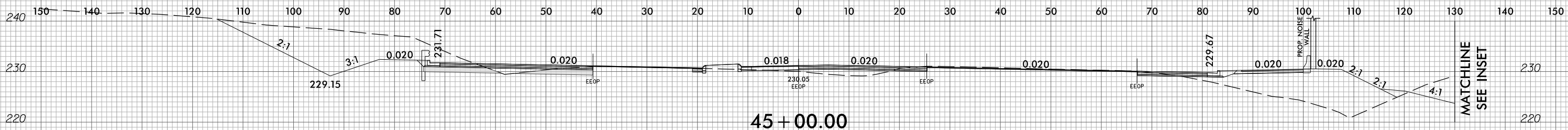

2/2/2023 15:48:00 p.du xp1.Ledgn patrick.mepherston

6/23/16

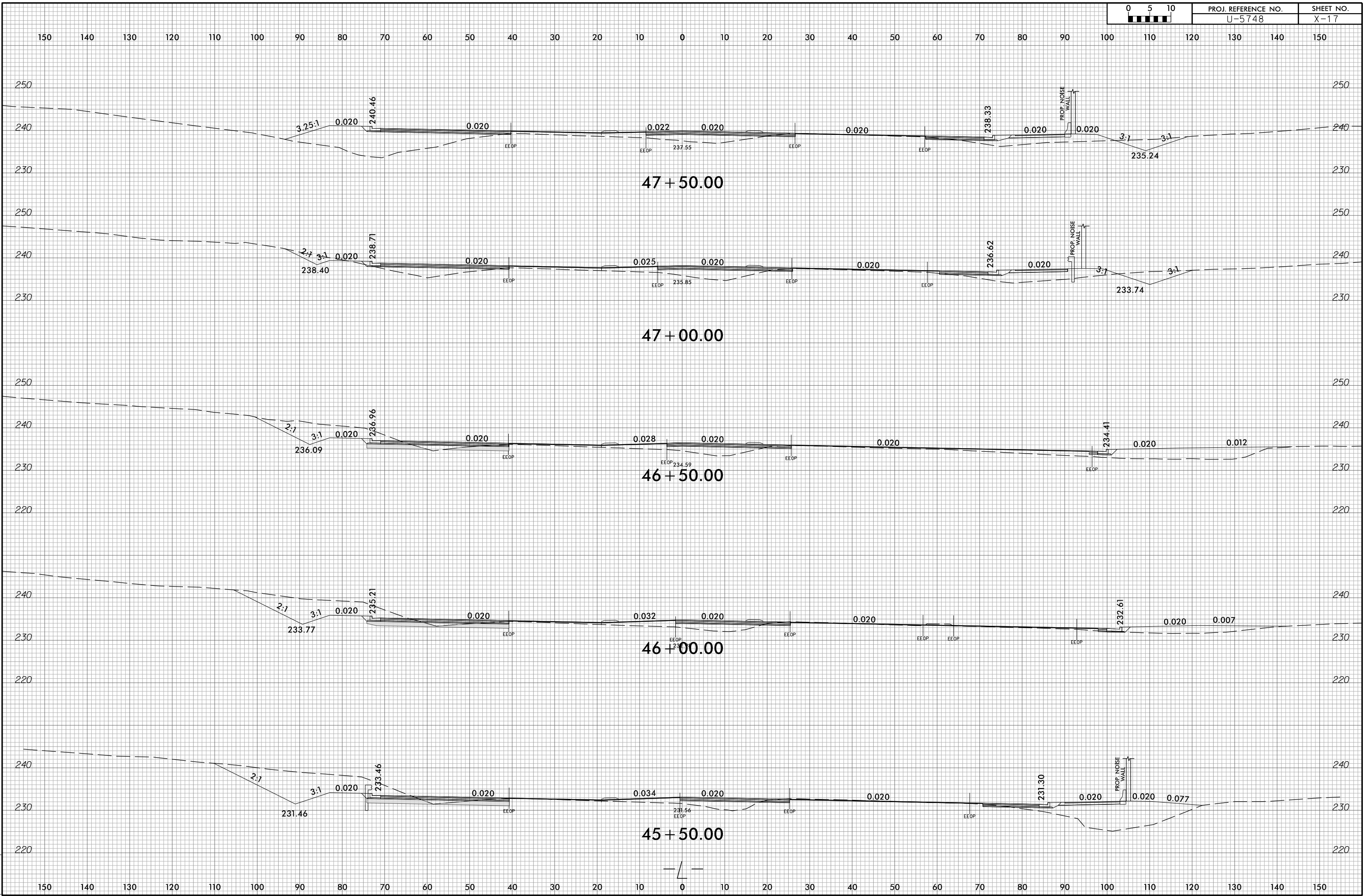

2/2/2013  
U-5748.dwg  
patrick.mepner

6/23/16

0 5 10	PROJ. REFERENCE NO.	SHEET NO.
	U-5748	X-18

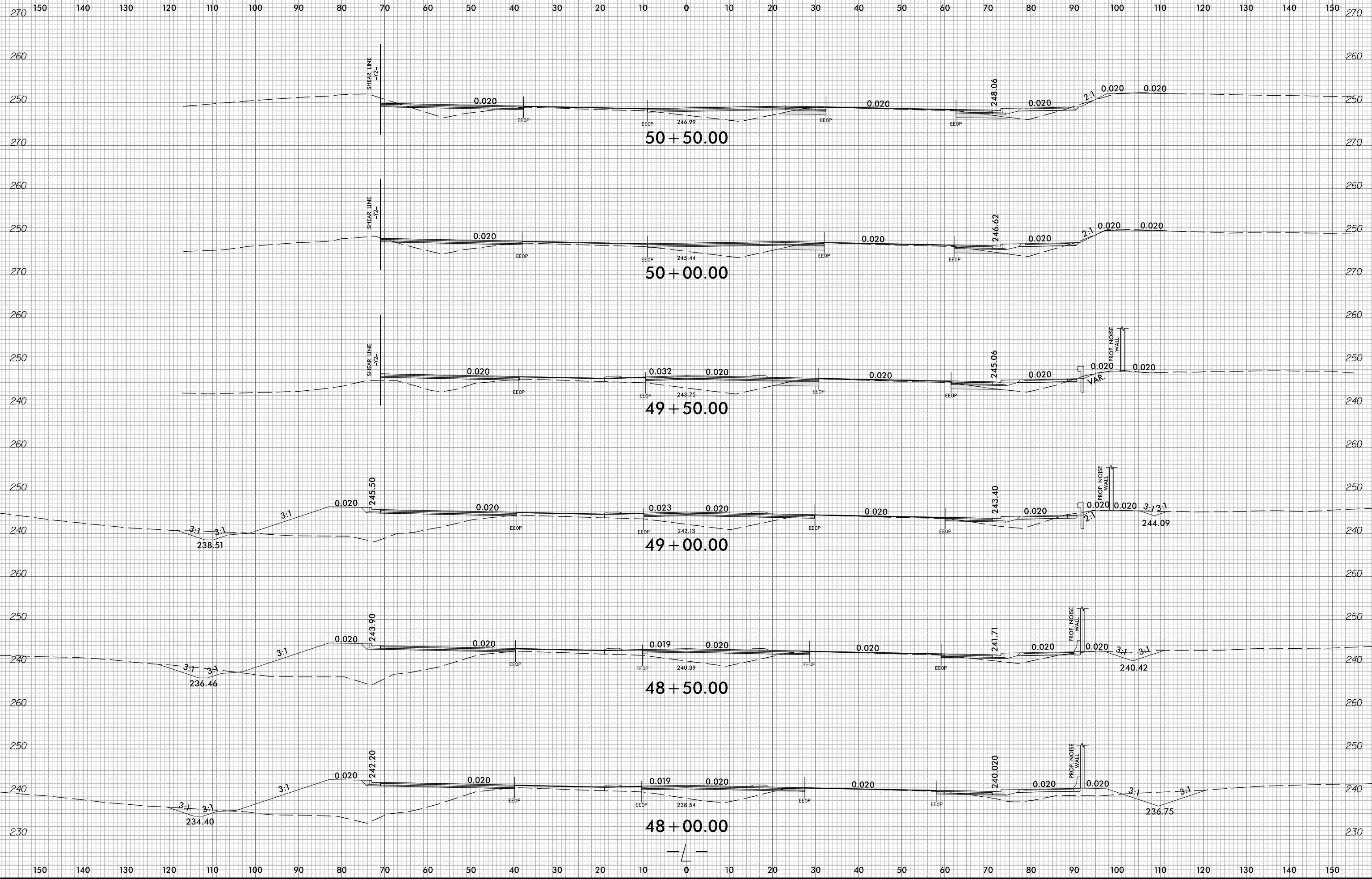

2/2/2023 15:48:00 p.d. xp1.Ldgn patrick.mepner

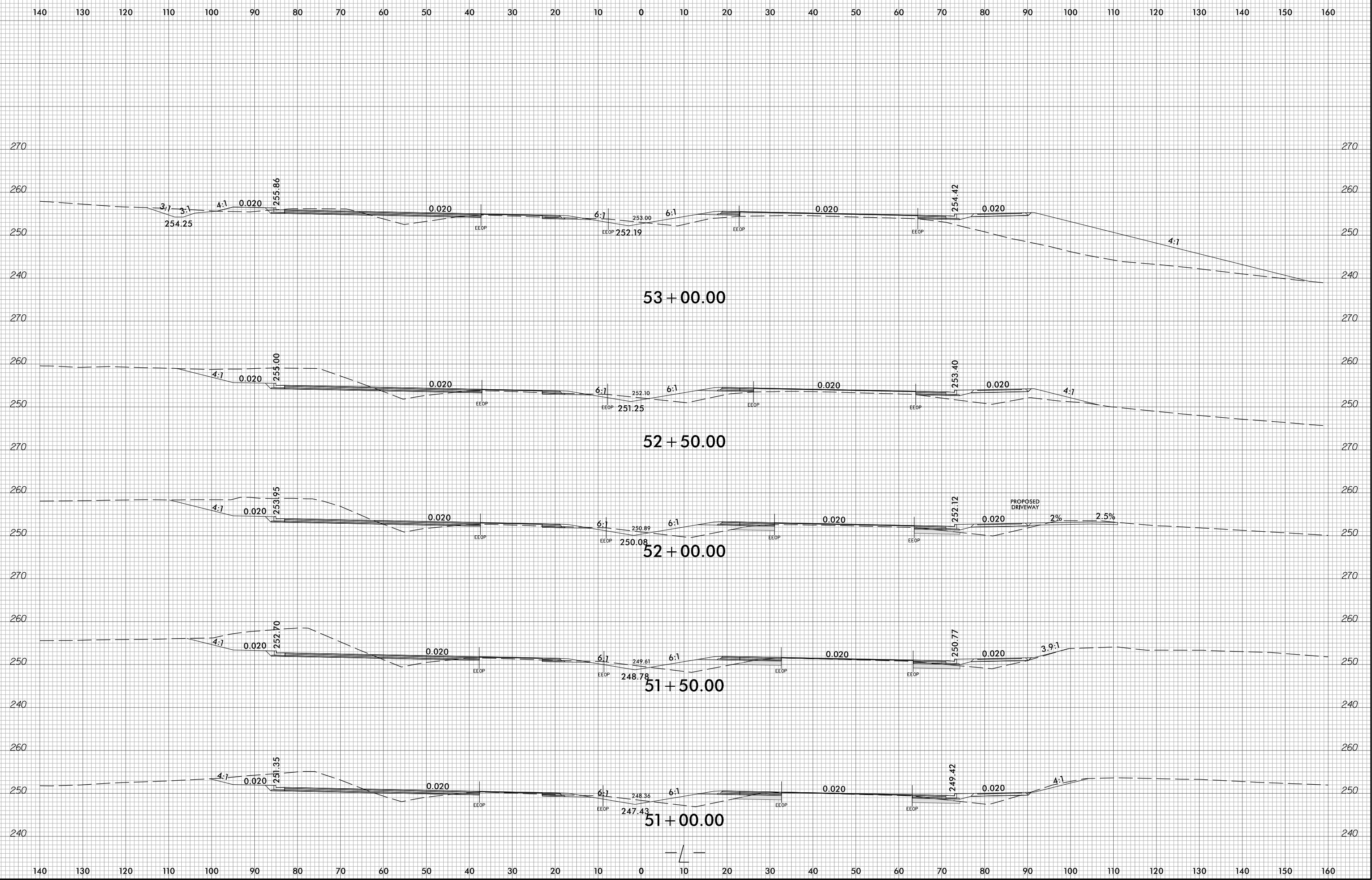

6/23/16

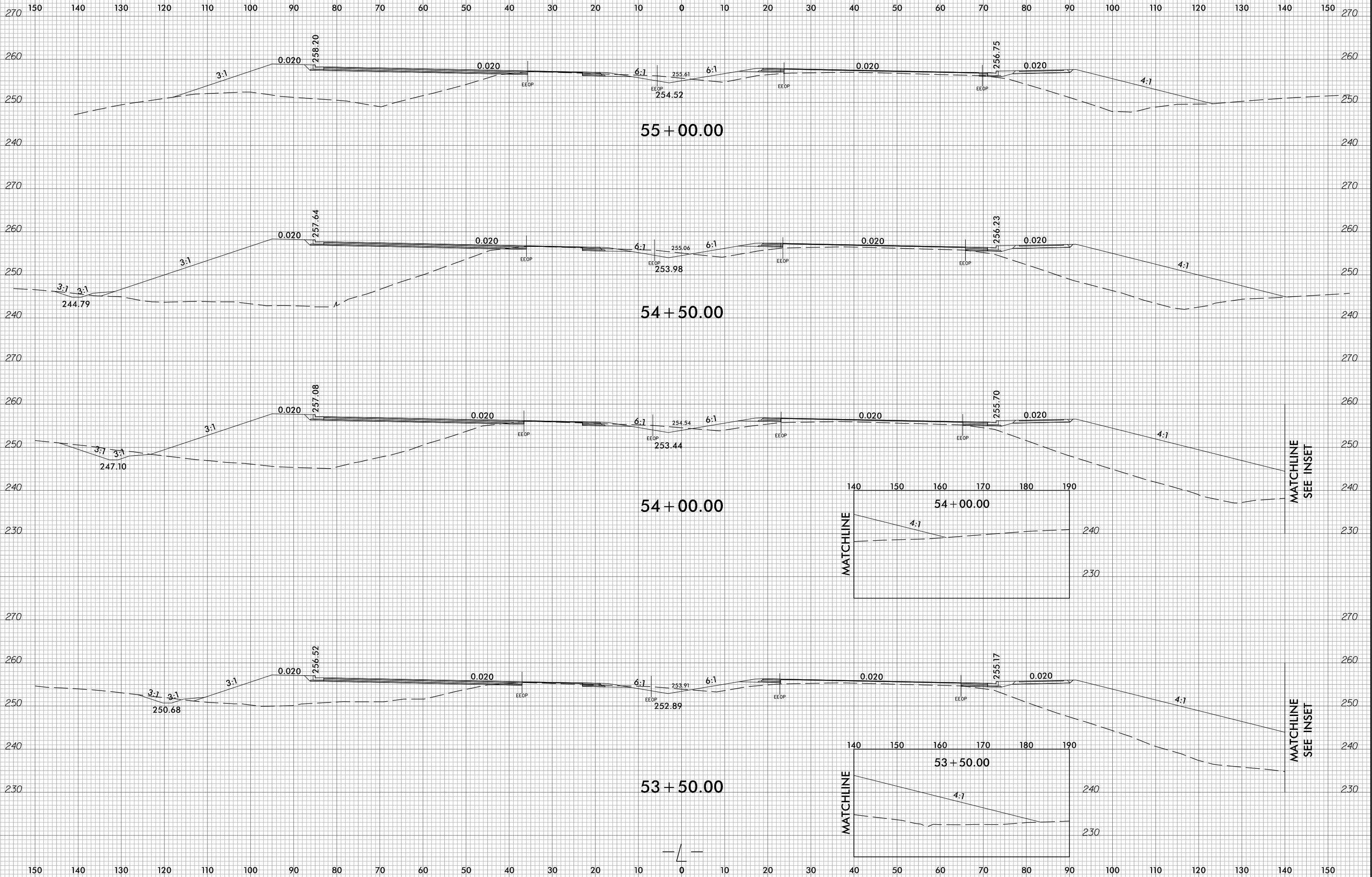

2/2/2023  
U-5748.dwg  
patrick.mpherson

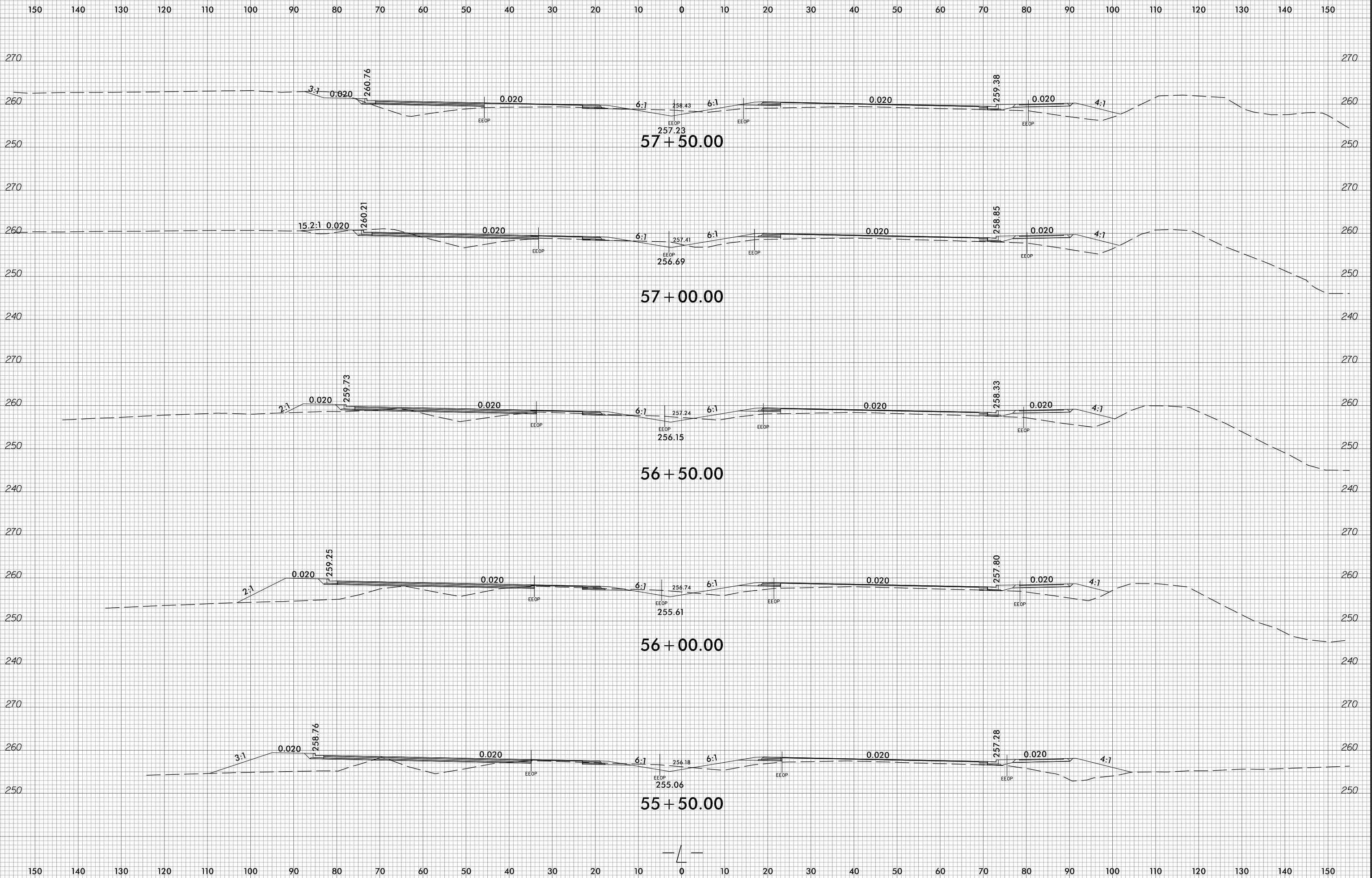



140 130 120 110 100 90 80 70 60 50 40 30 20 10 0 10 20 30 40 50 60 70 80 90 100 110 120 130 140 150 160

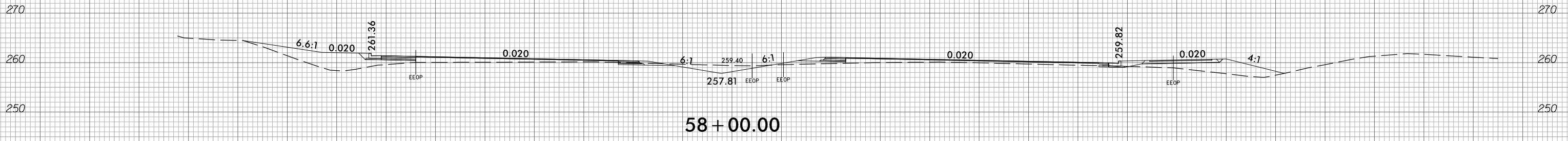
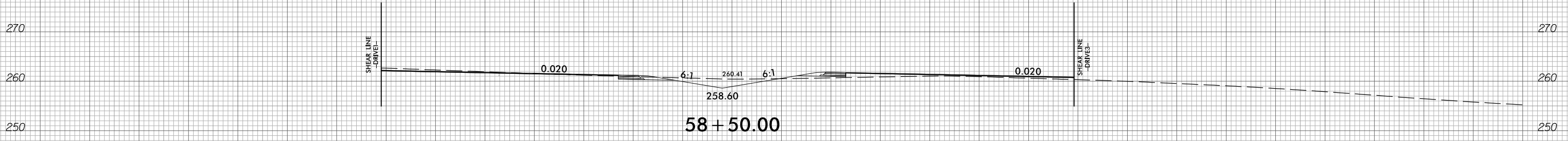
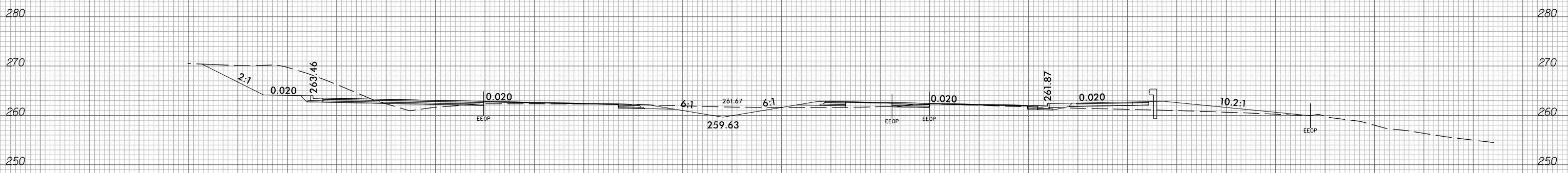
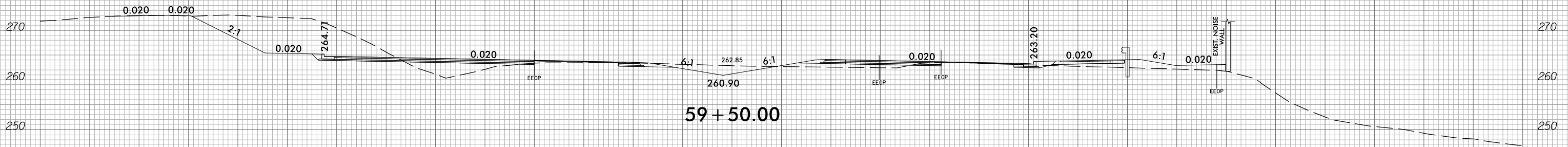

140 130 120 110 100 90 80 70 60 50 40 30 20 10 0 10 20 30 40 50 60 70 80 90 100 110 120 130 140 150 160

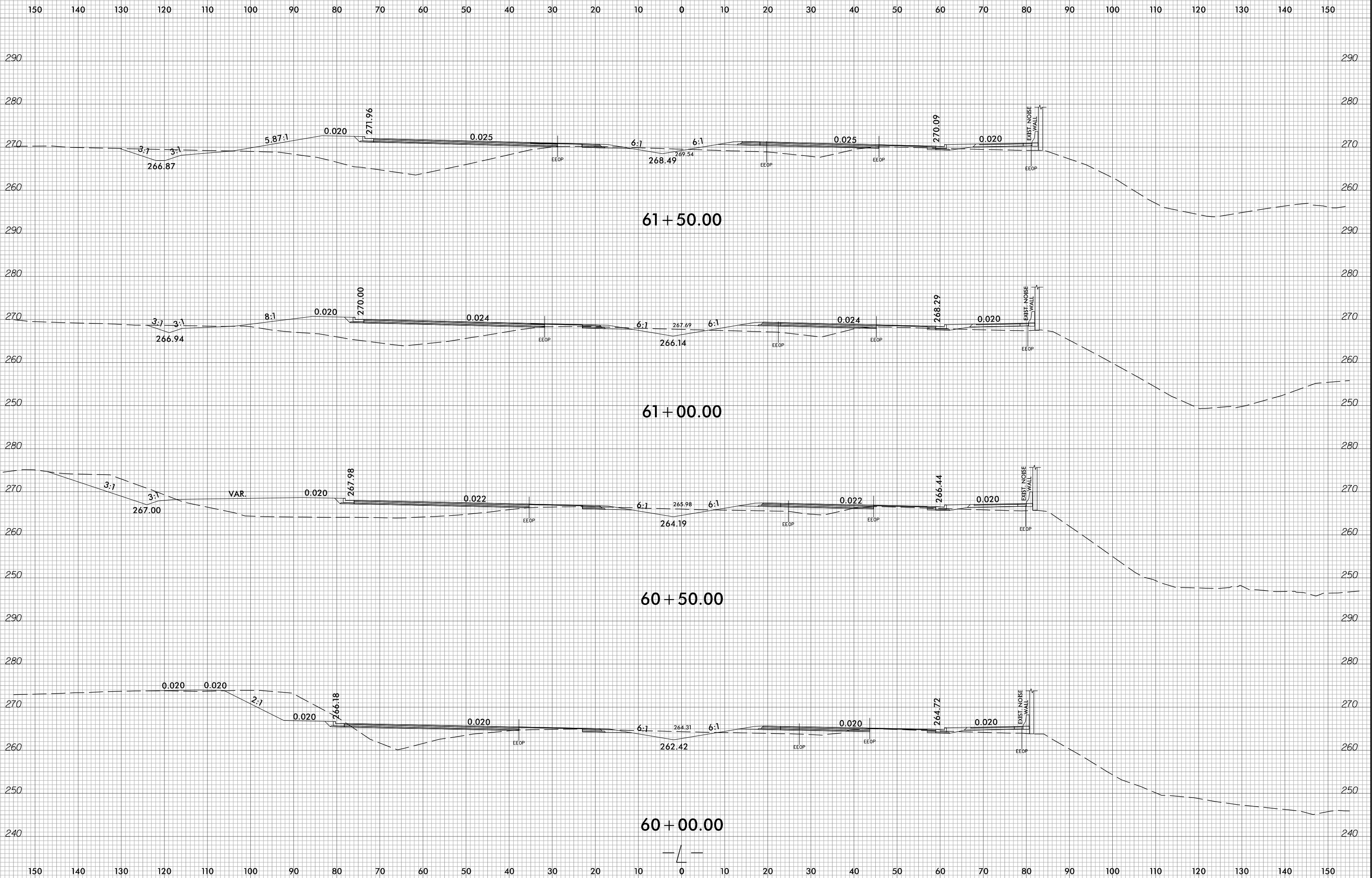

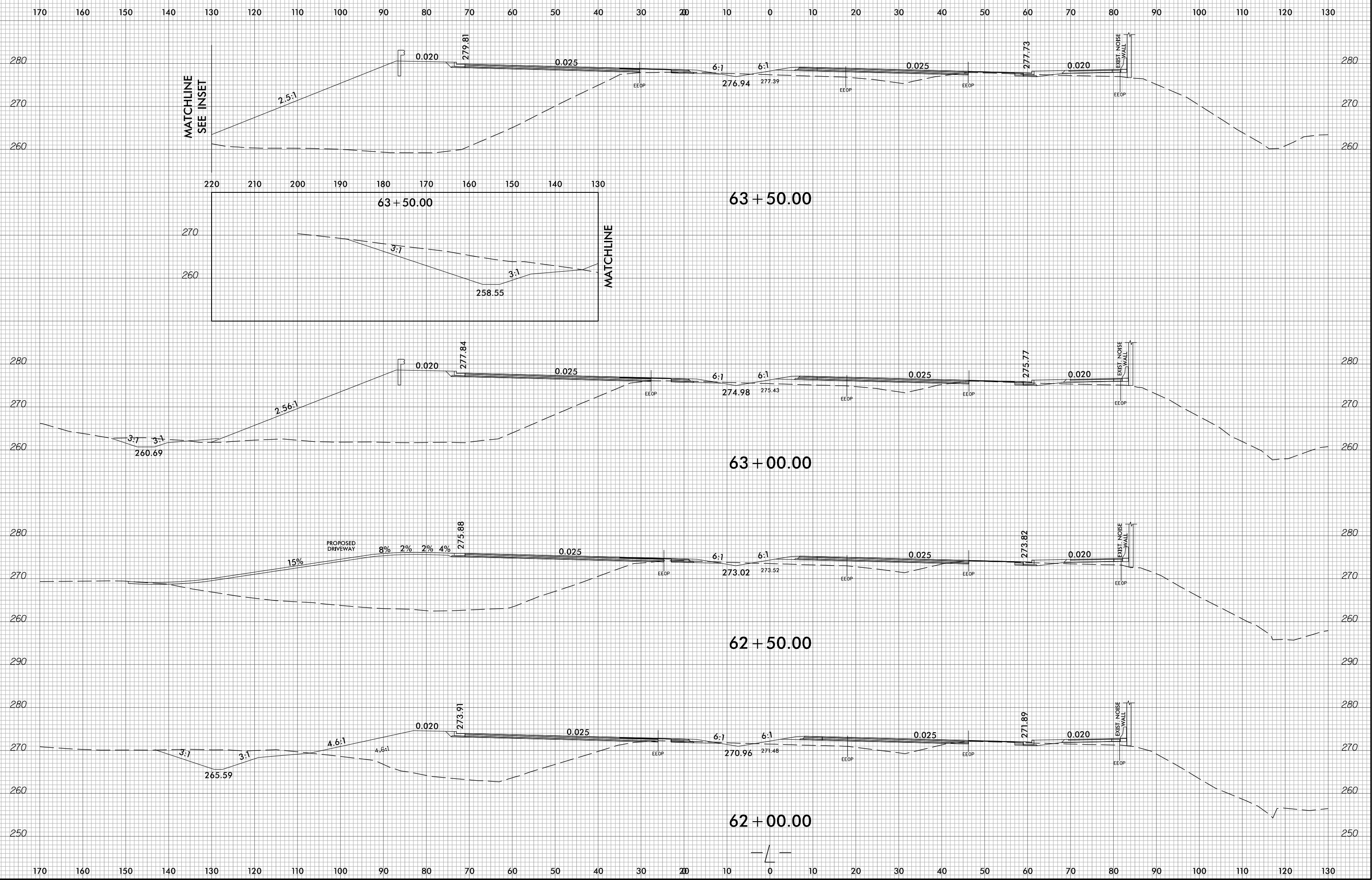

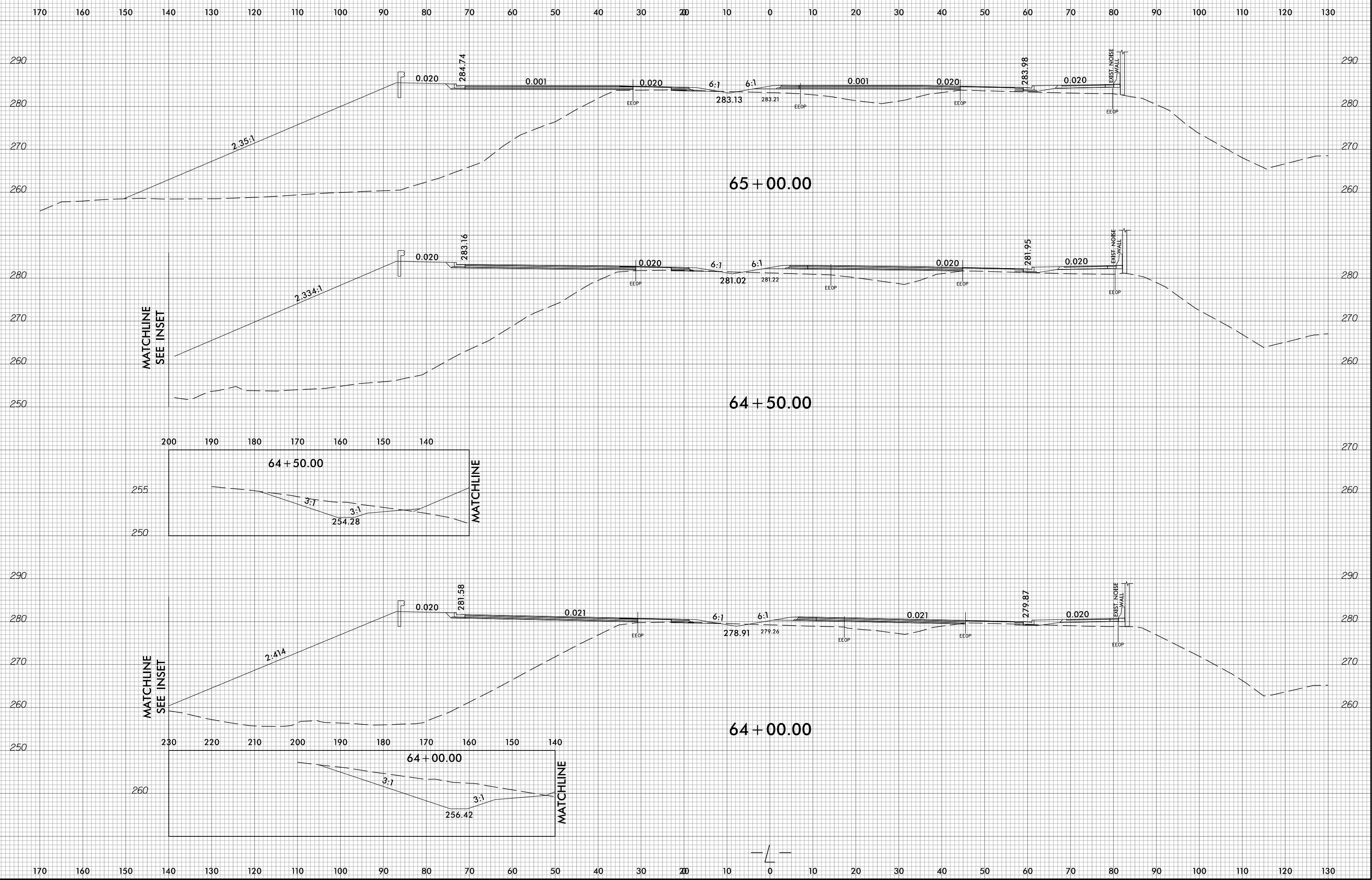

MATCHLINE  
SEE INSET

MATCHLINE  
SEE INSET

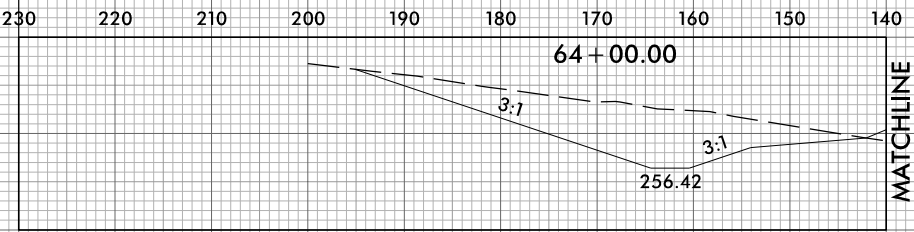
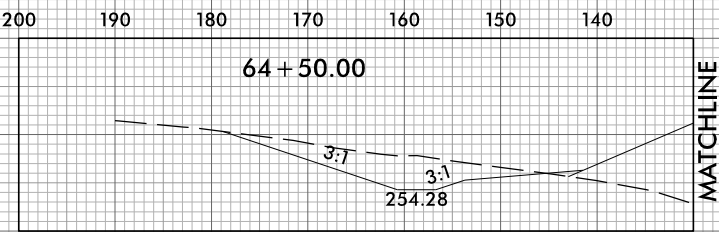

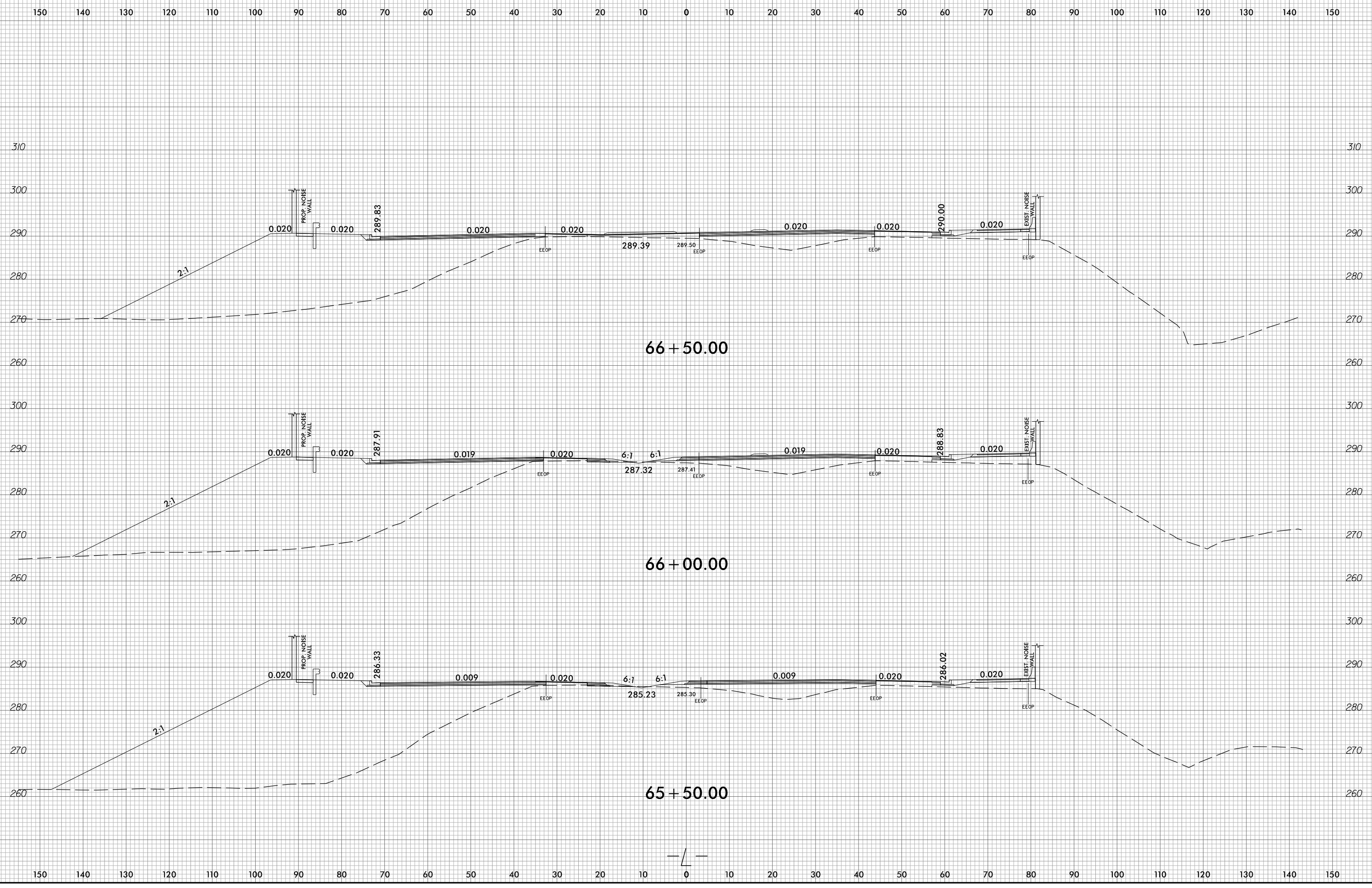

150 140 130 120 110 100 90 80 70 60 50 40 30 20 10 0 10 20 30 40 50 60 70 80 90 100 110 120 130 140 150

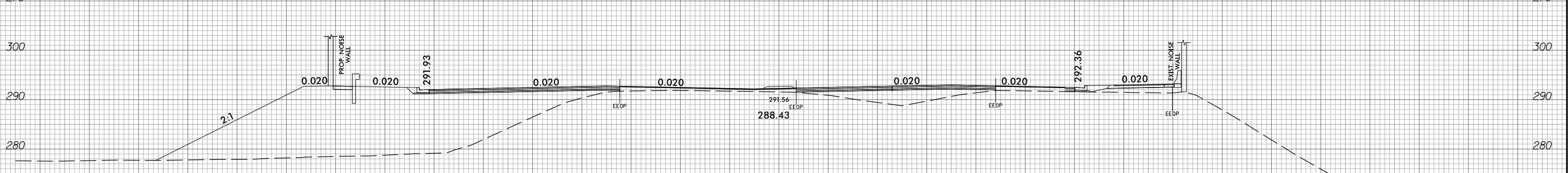
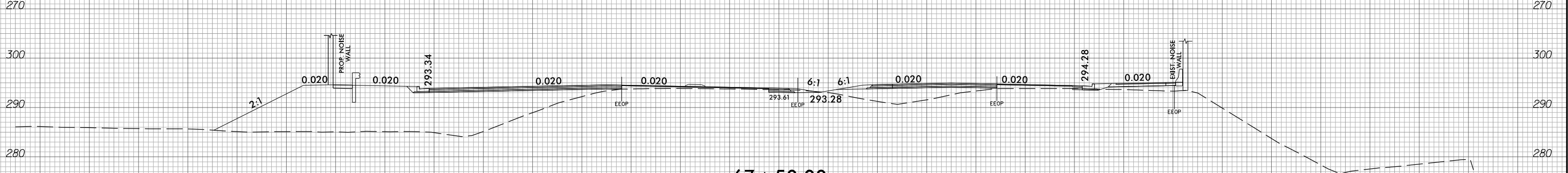
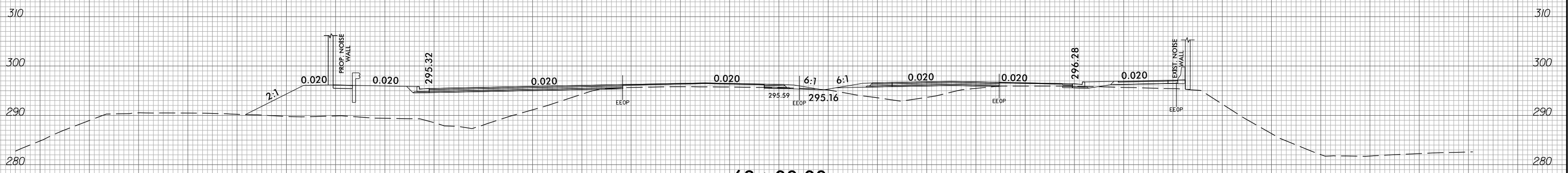
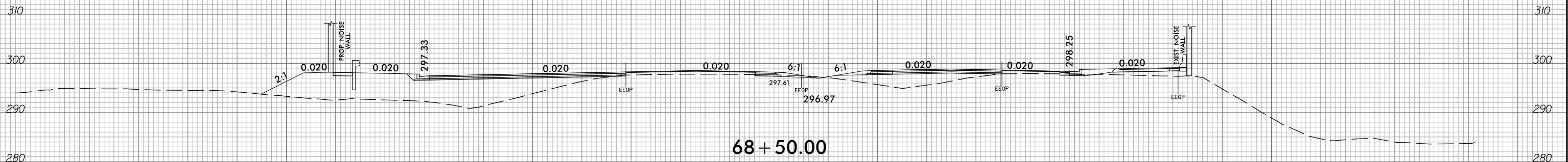

150 140 130 120 110 100 90 80 70 60 50 40 30 20 10 0 10 20 30 40 50 60 70 80 90 100 110 120 130 140 150

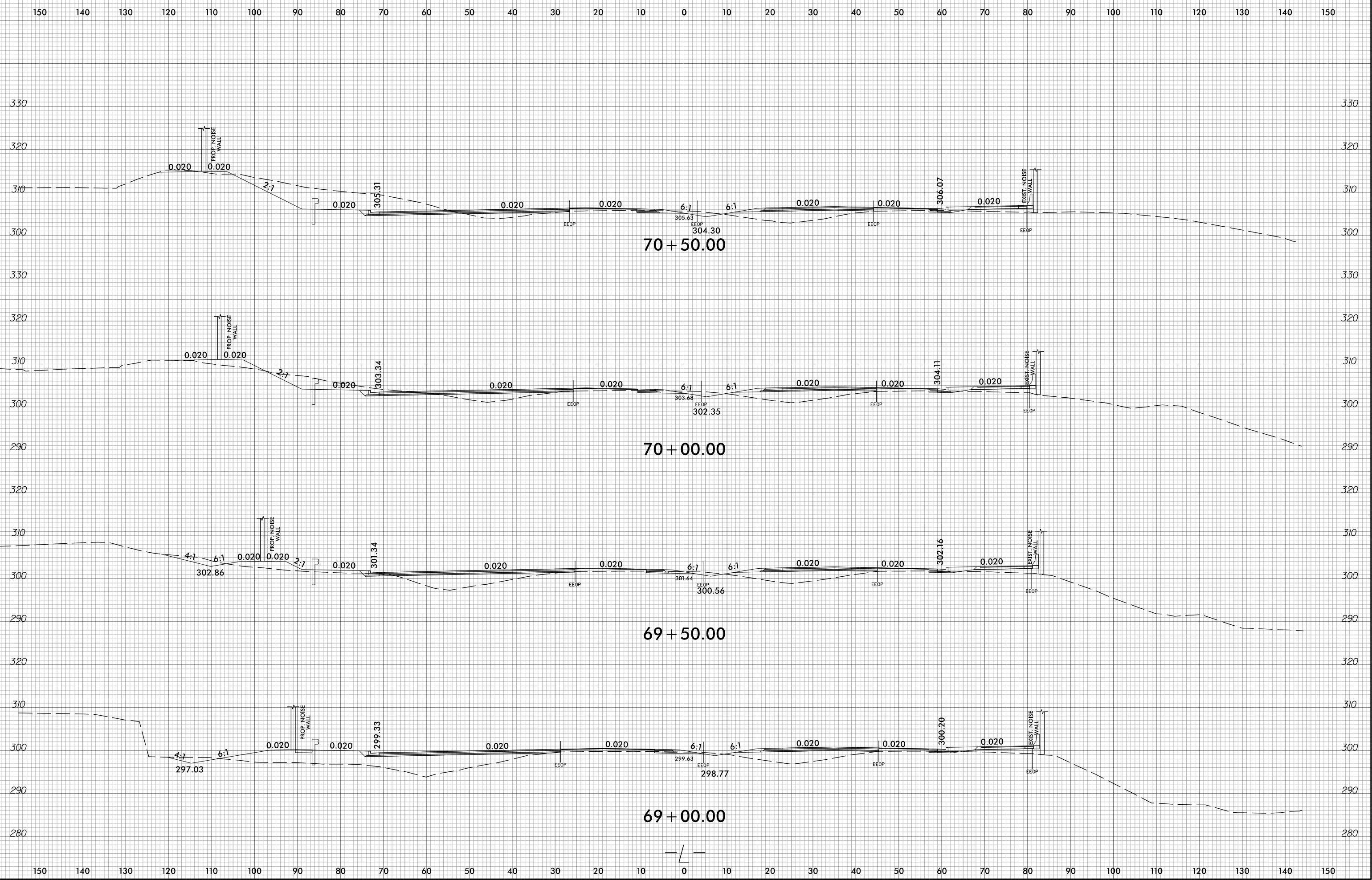

150 140 130 120 110 100 90 80 70 60 50 40 30 20 10 0 10 20 30 40 50 60 70 80 90 100 110 120 130 140 150

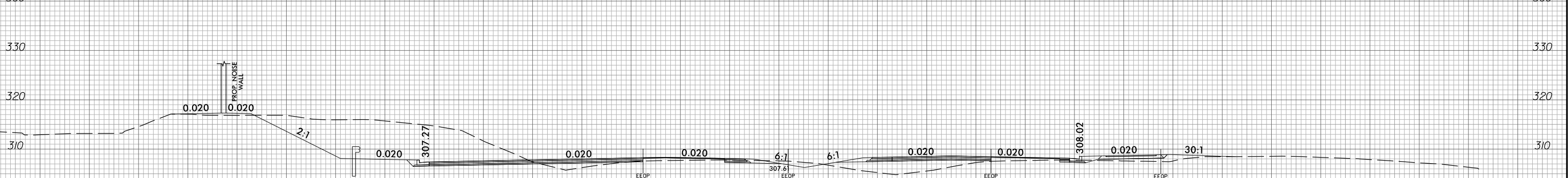
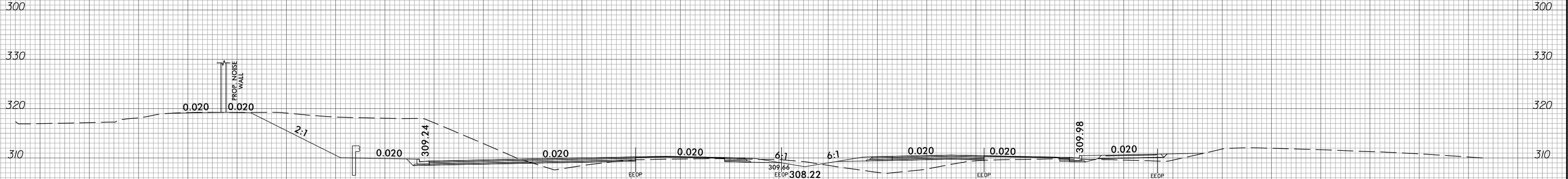
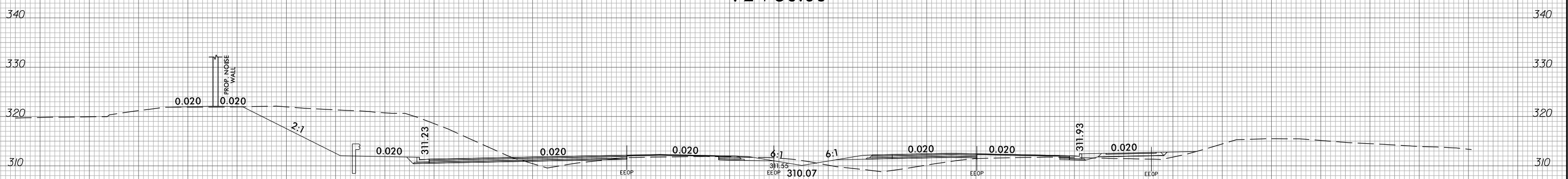
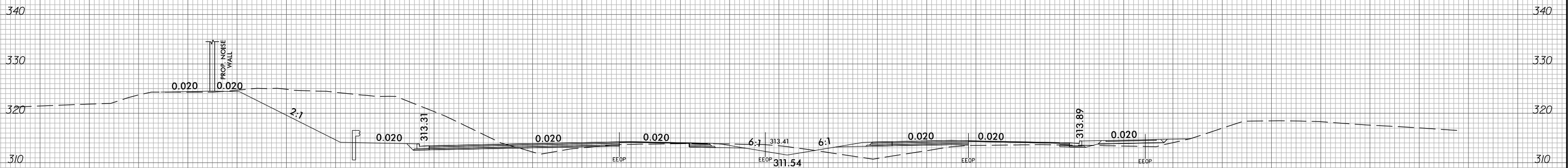

150 140 130 120 110 100 90 80 70 60 50 40 30 20 10 0 10 20 30 40 50 60 70 80 90 100 110 120 130 140 150



150 140 130 120 110 100 90 80 70 60 50 40 30 20 10 0 10 20 30 40 50 60 70 80 90 100 110 120 130 140 150

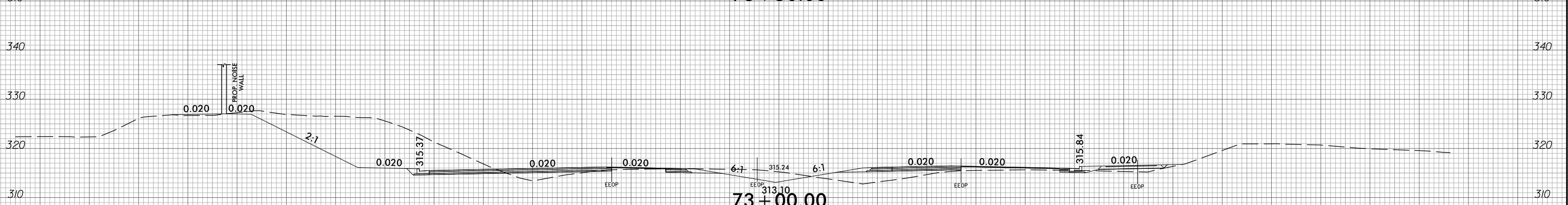
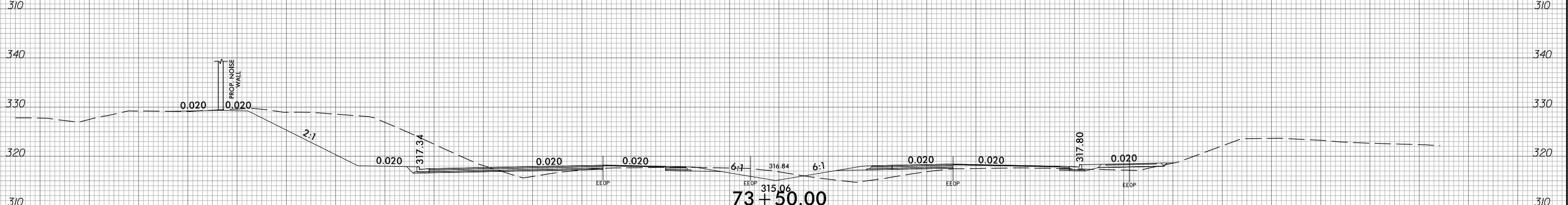
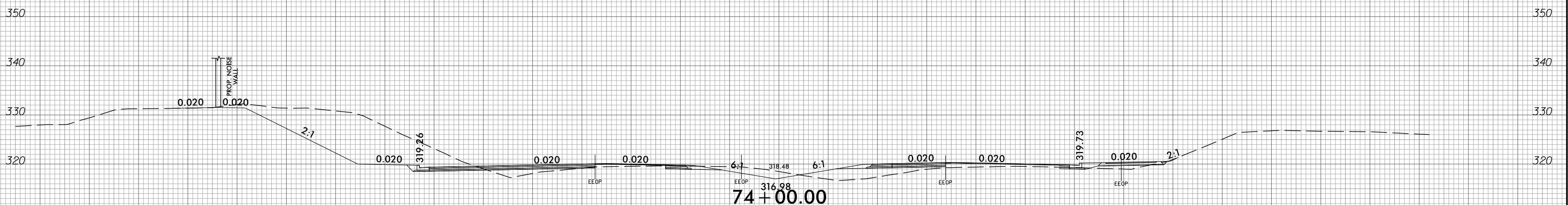
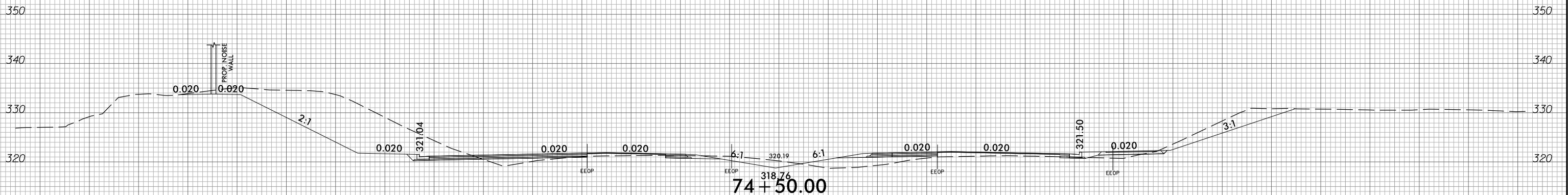

150 140 130 120 110 100 90 80 70 60 50 40 30 20 10 0 10 20 30 40 50 60 70 80 90 100 110 120 130 140 150

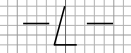

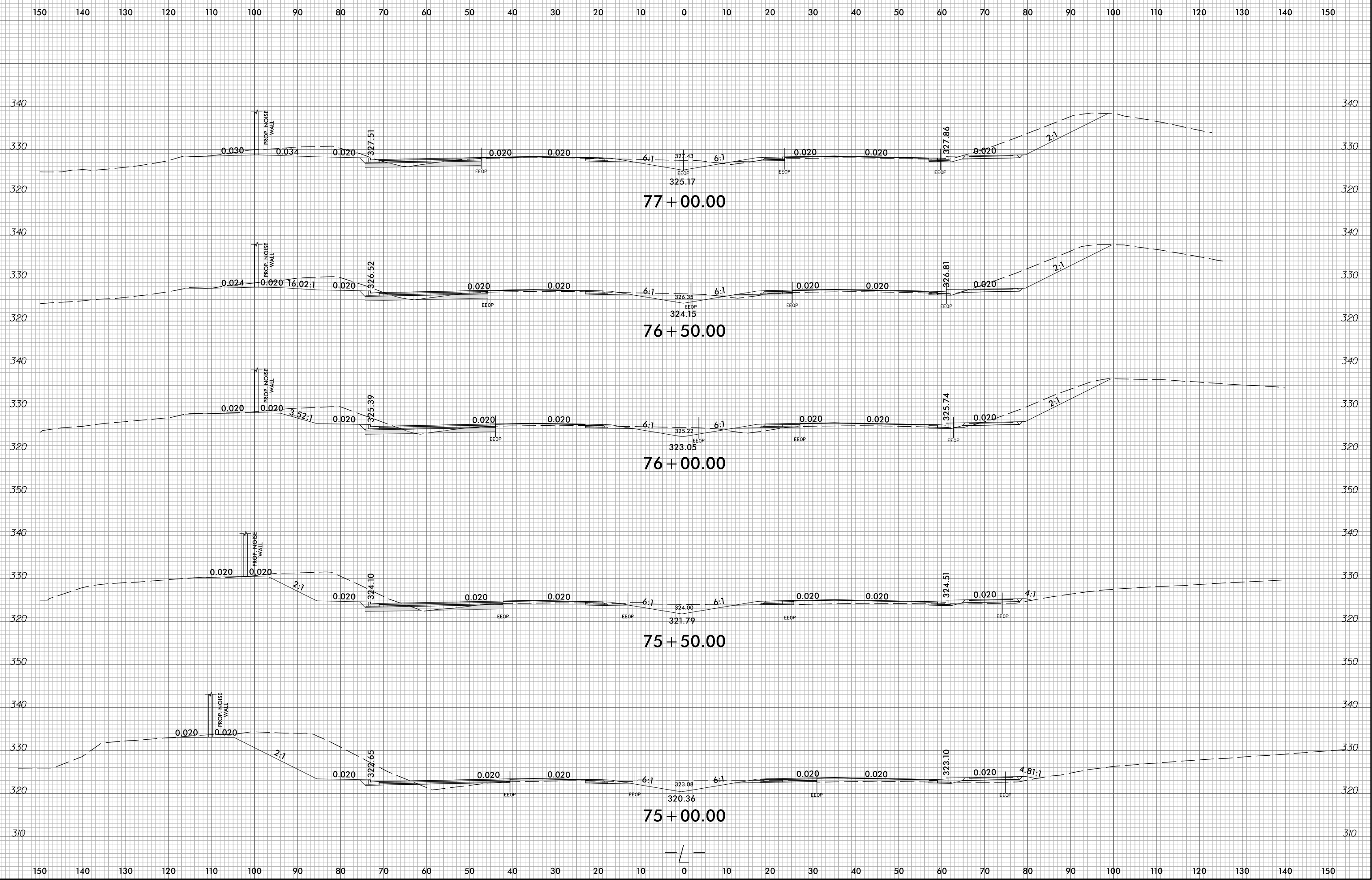

6/23/16

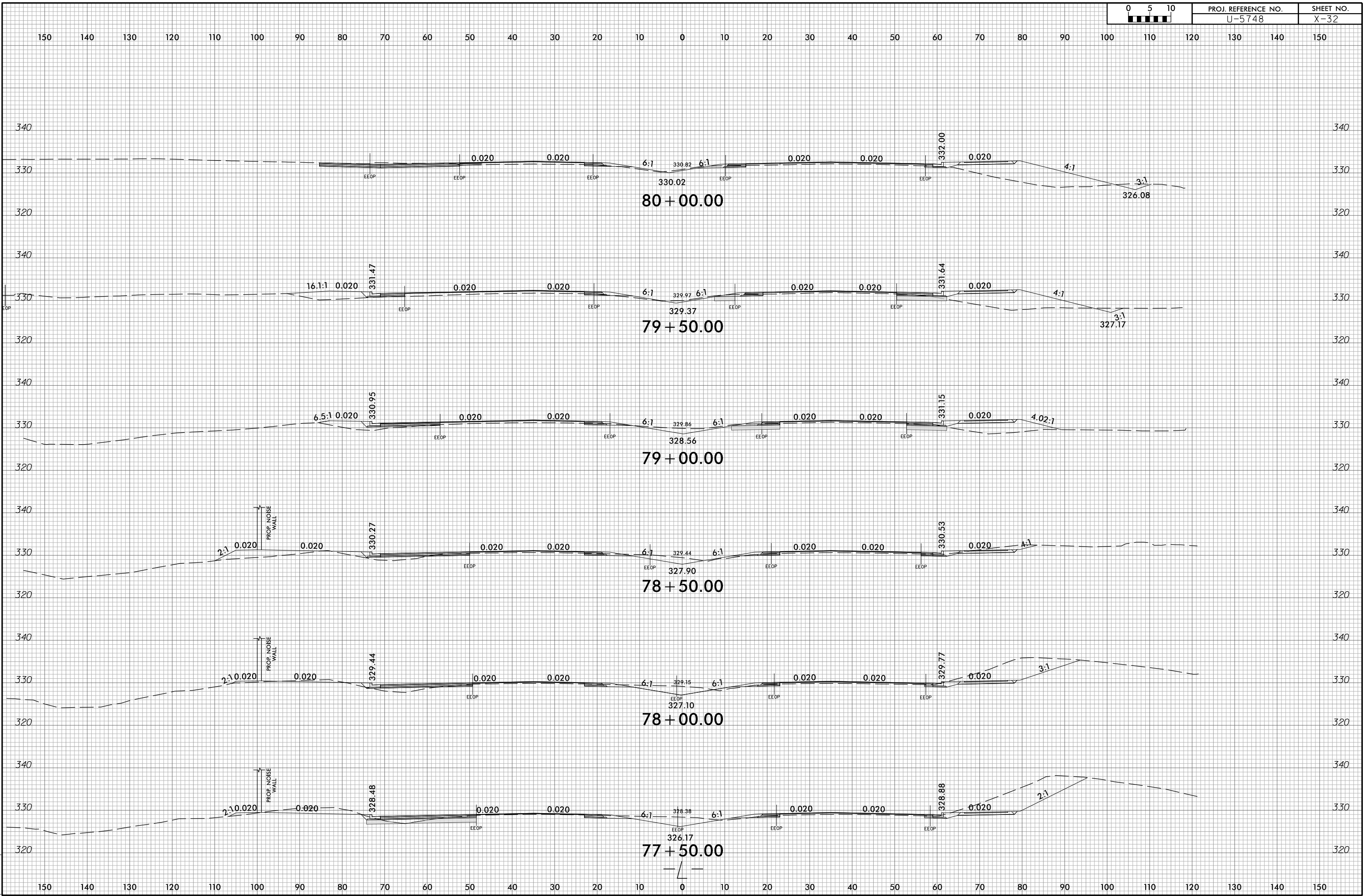

2/2/2023  
U-5748-Edg.L.dgn  
patrick.meperson

6/23/16

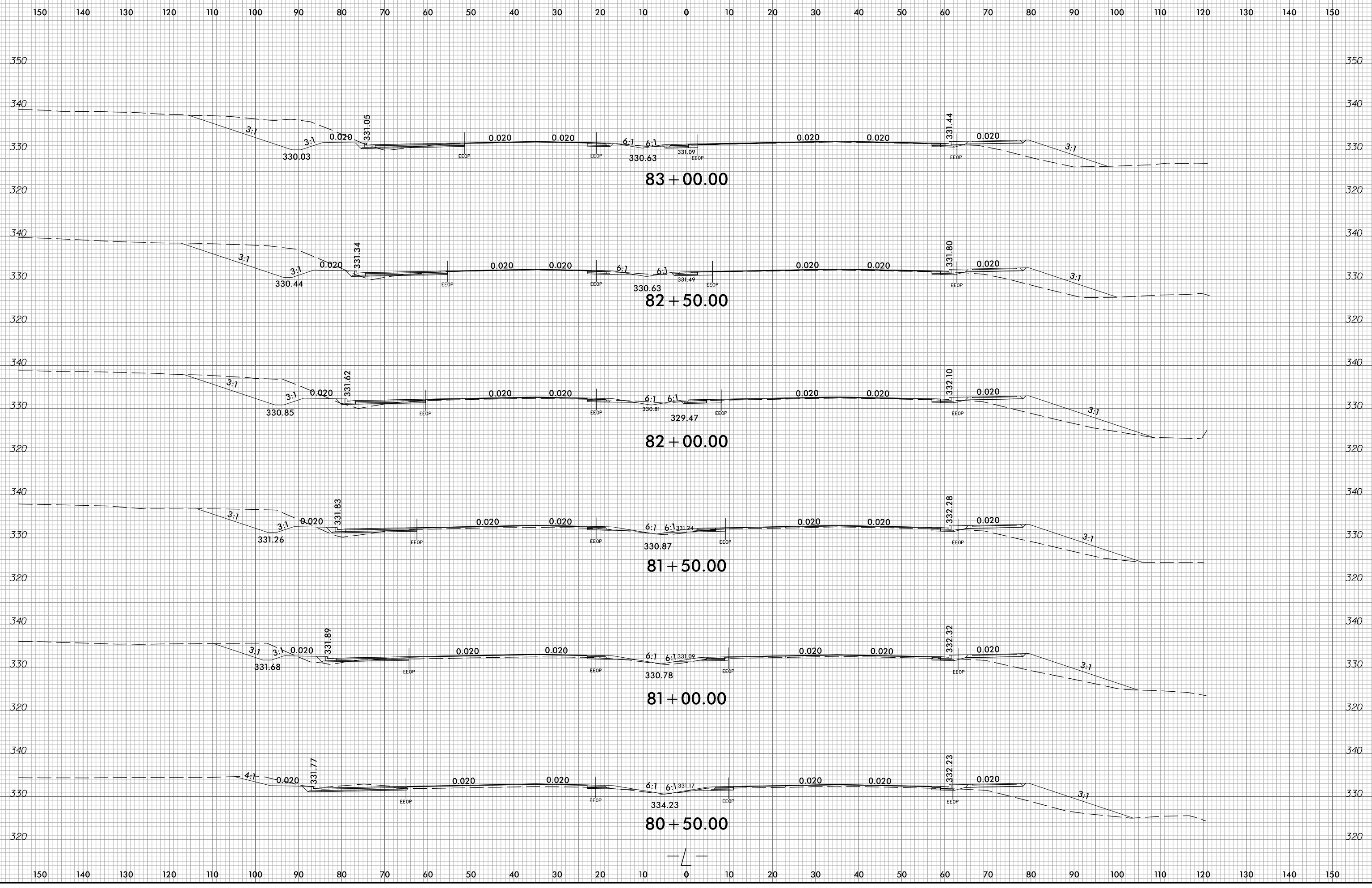

2/2/2023  
U-5748\_Road.xpl.Ledger  
patrick.meperson

6/23/16

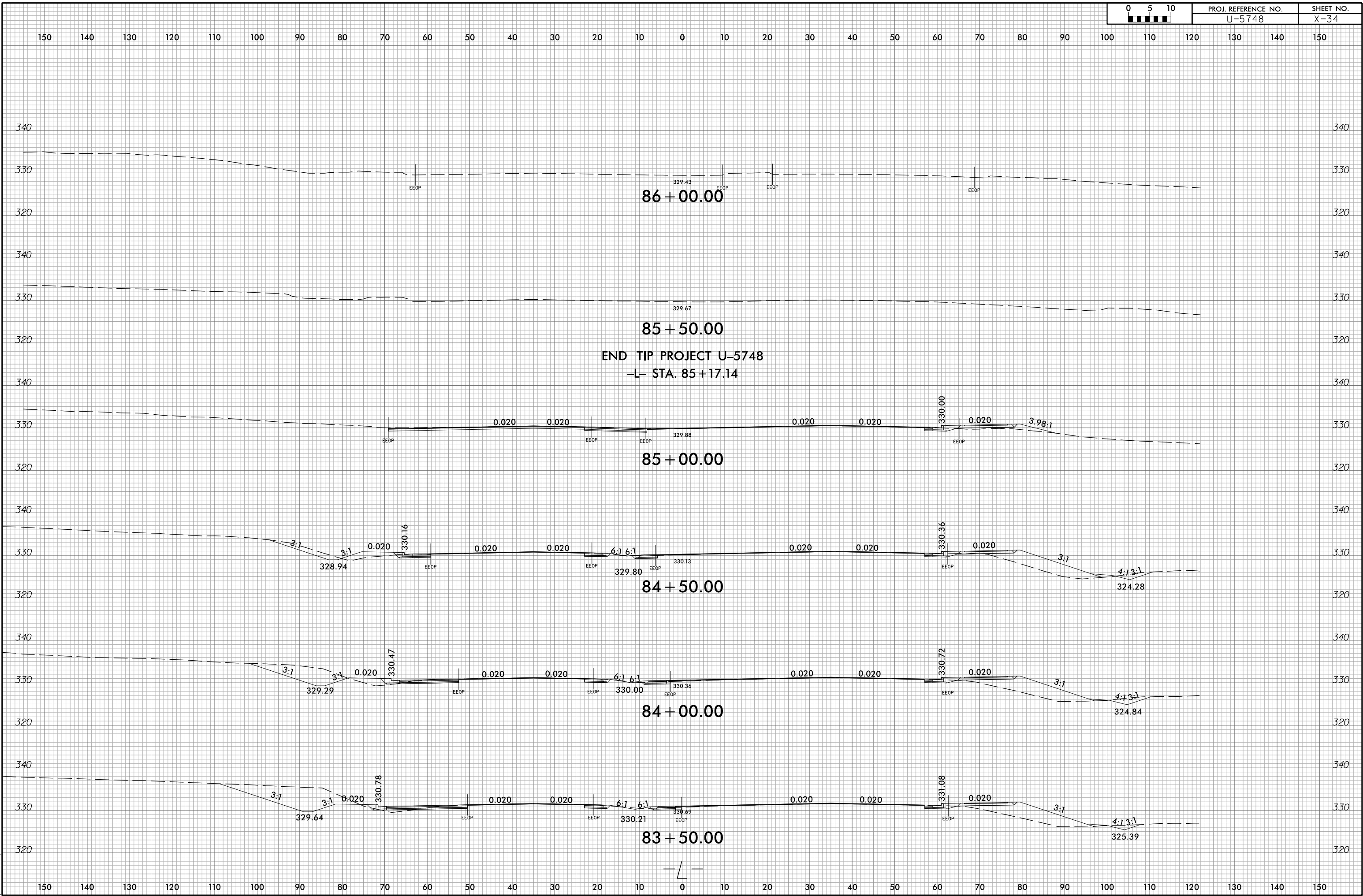

2/2/2023  
U-5748 - Rd - xpl - L.dgn  
patrick.meperson

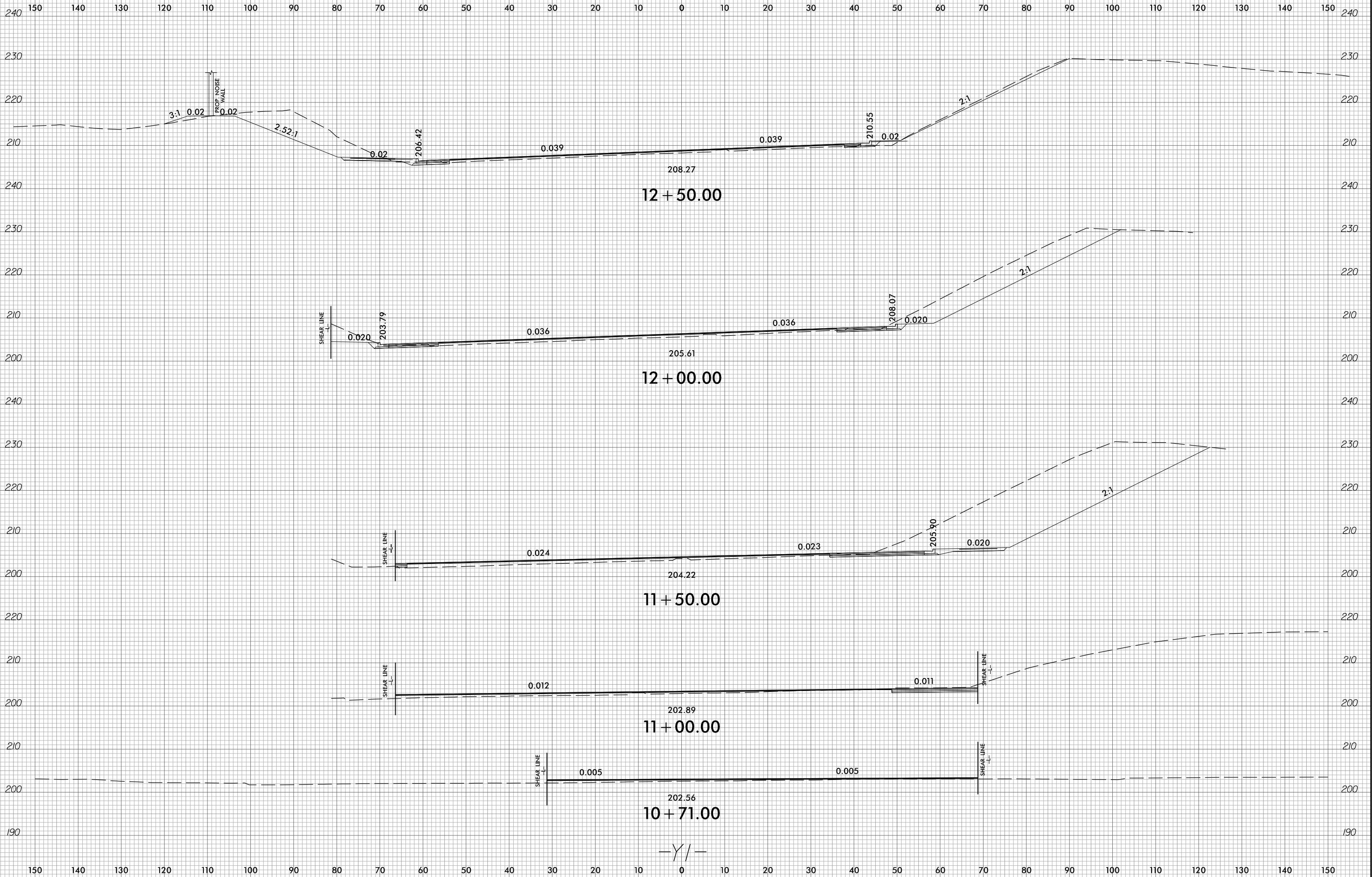

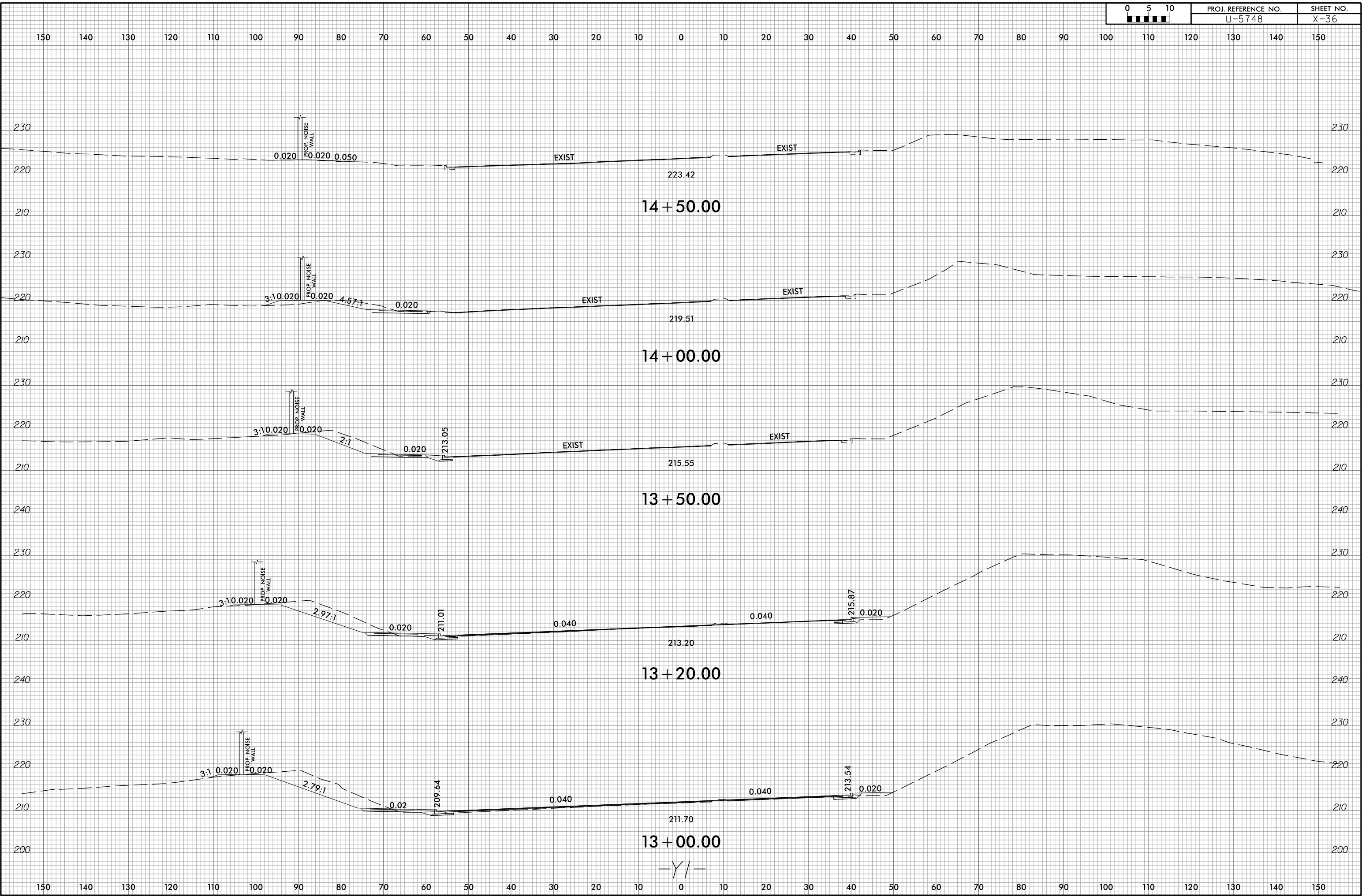

6/23/16

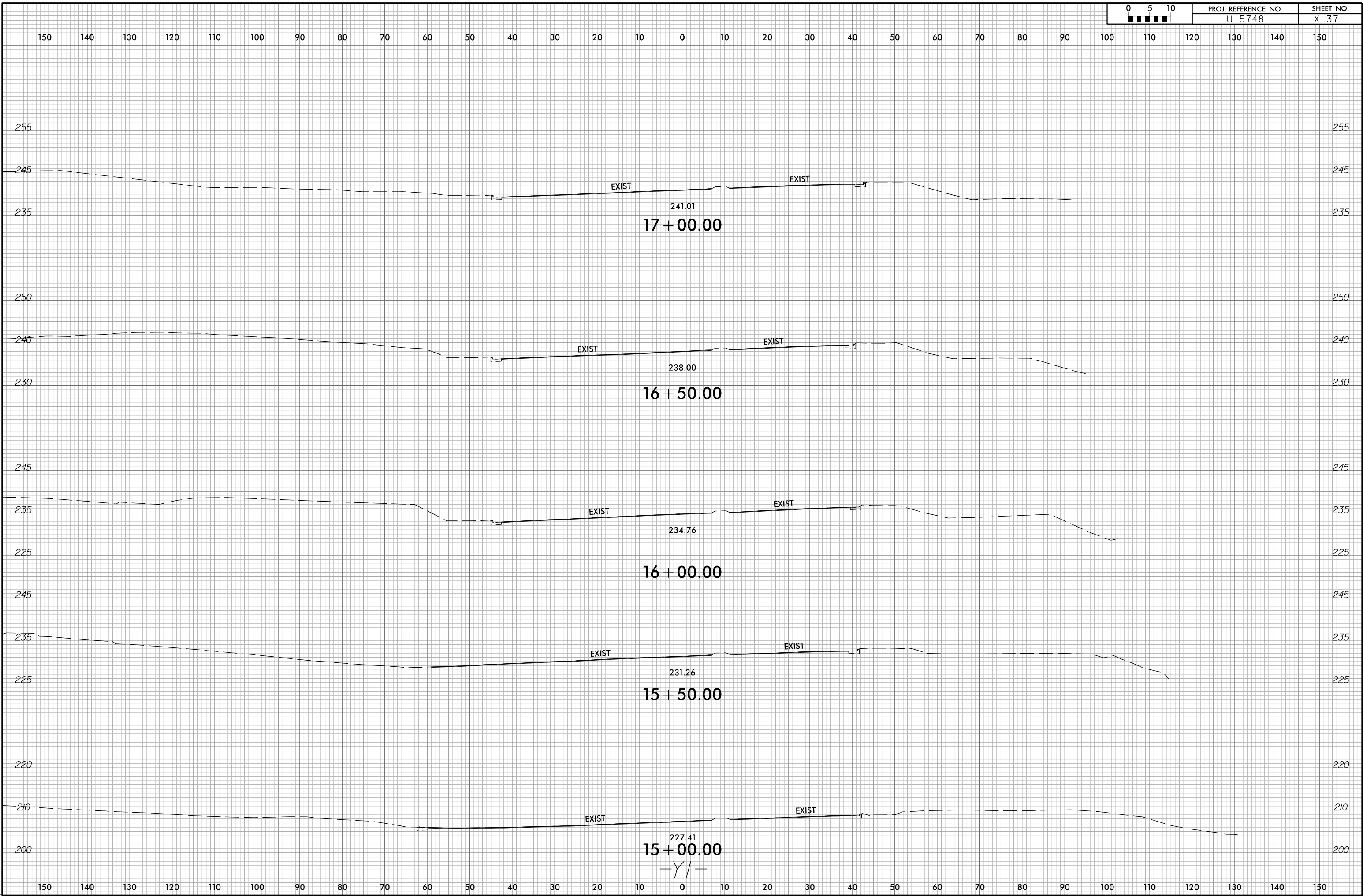

2/2/2023  
U-5748.dwg  
patrick.mepner



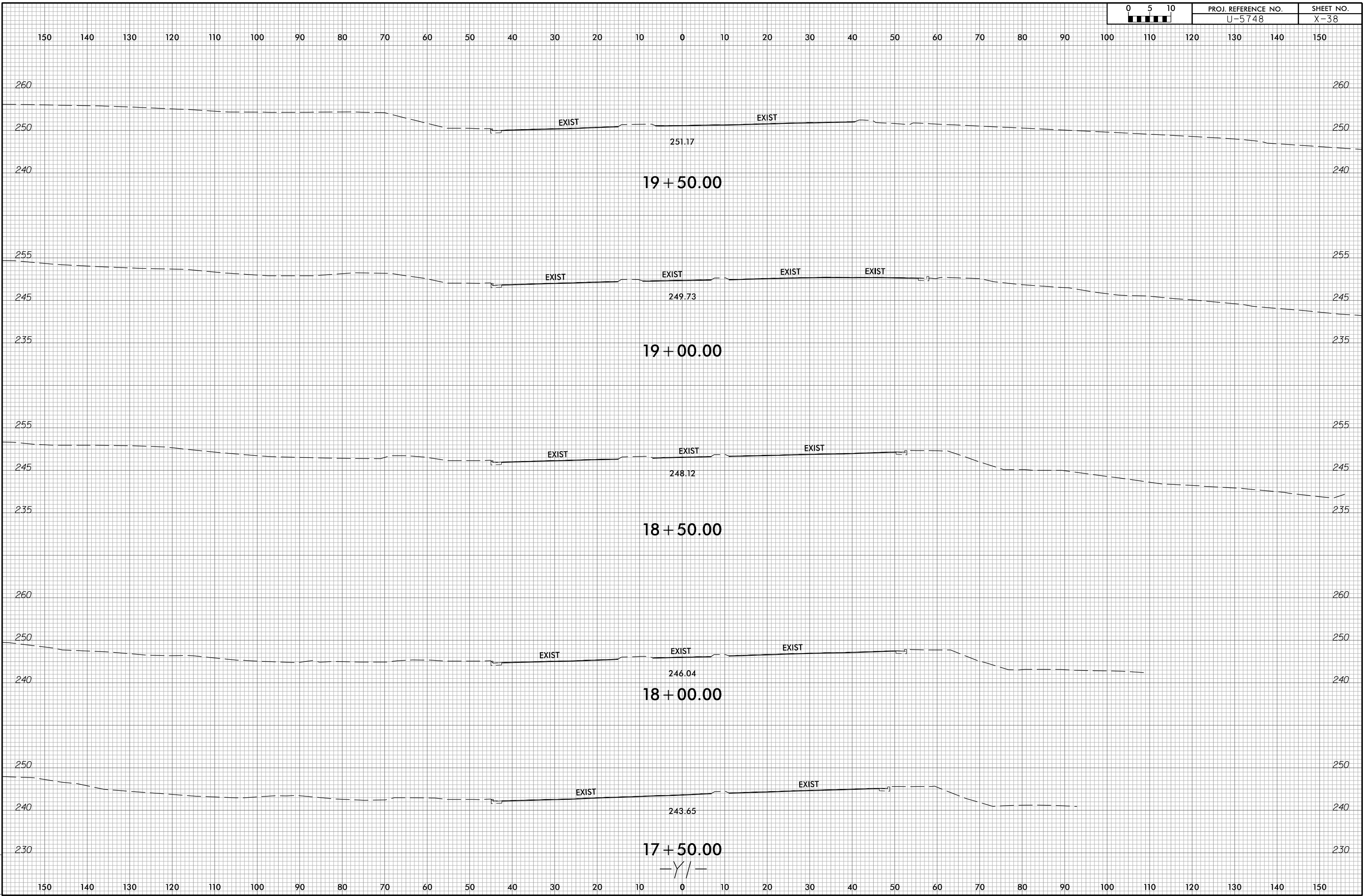

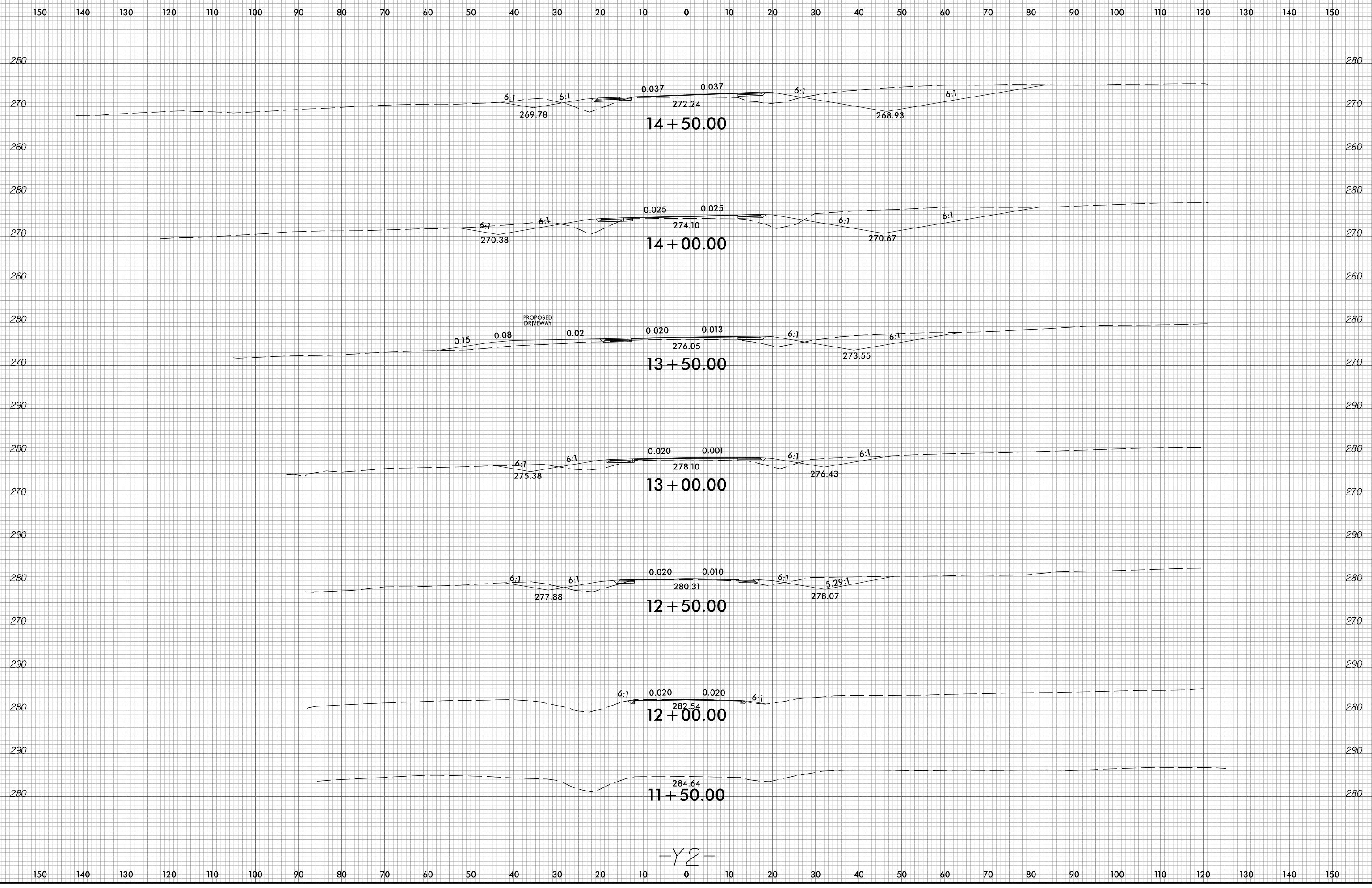

-Y2-

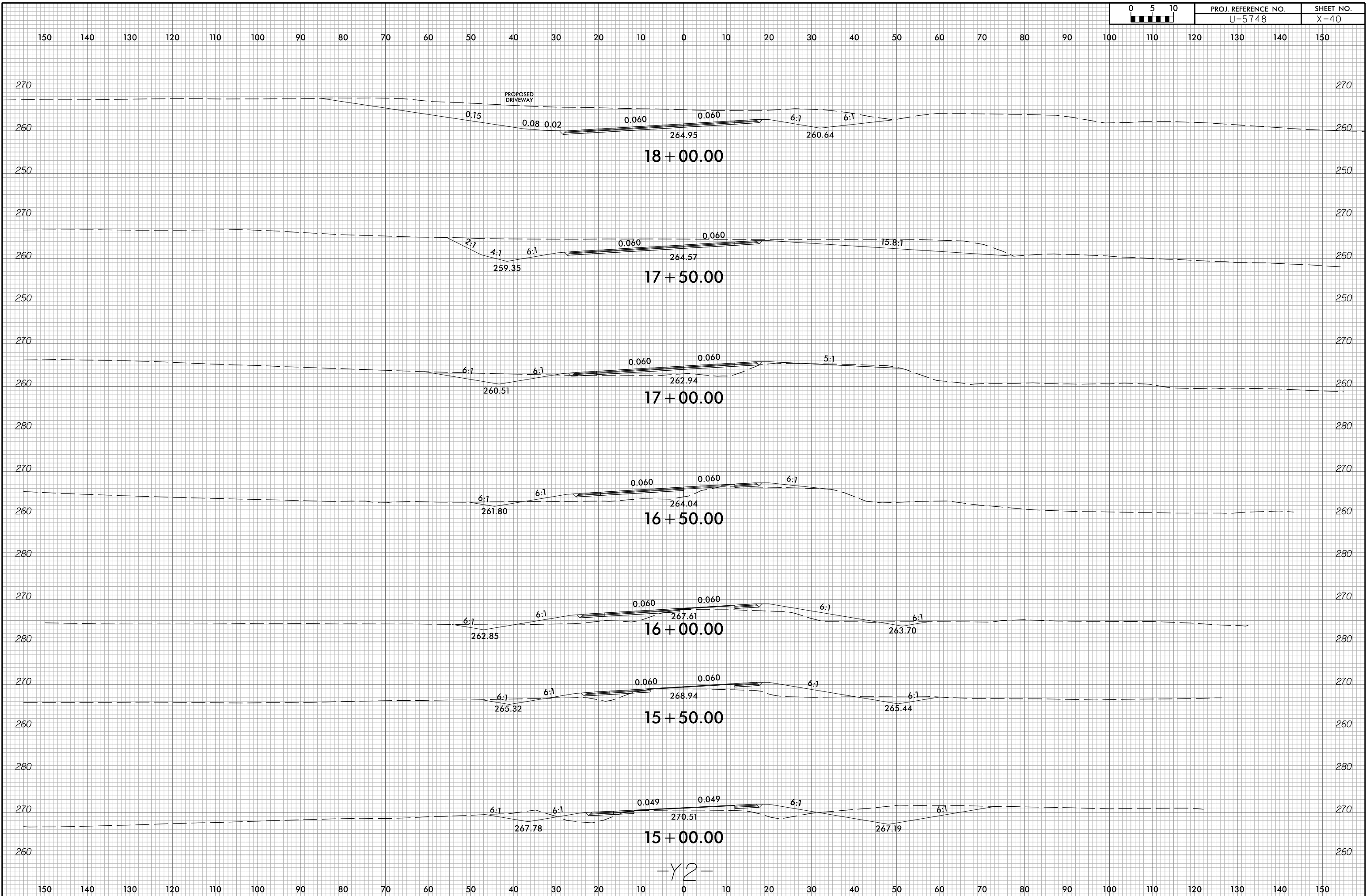

-Y2-

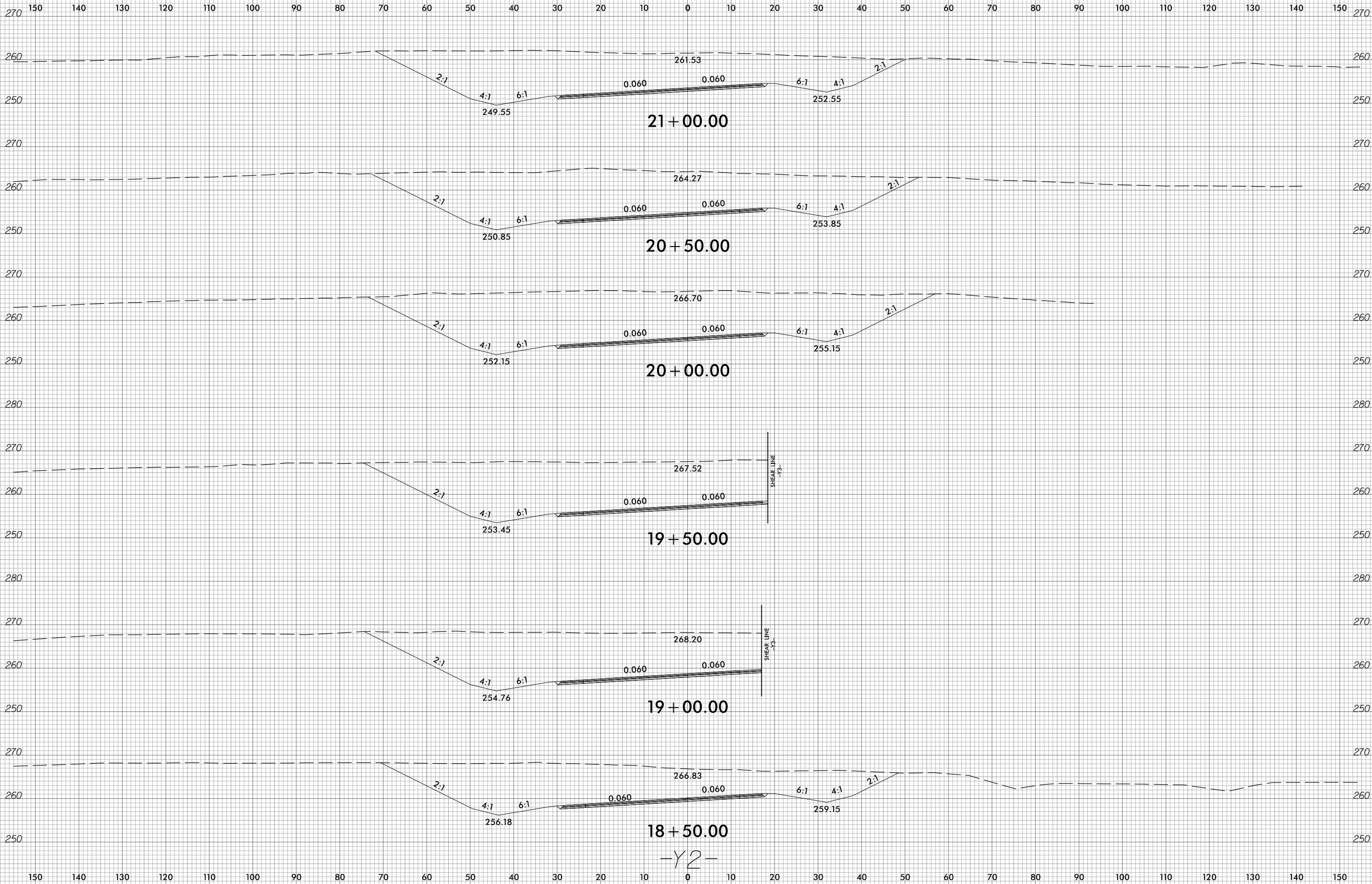

2/2/2023  
15748.dwg  
patrick.mcferson

-Y2-

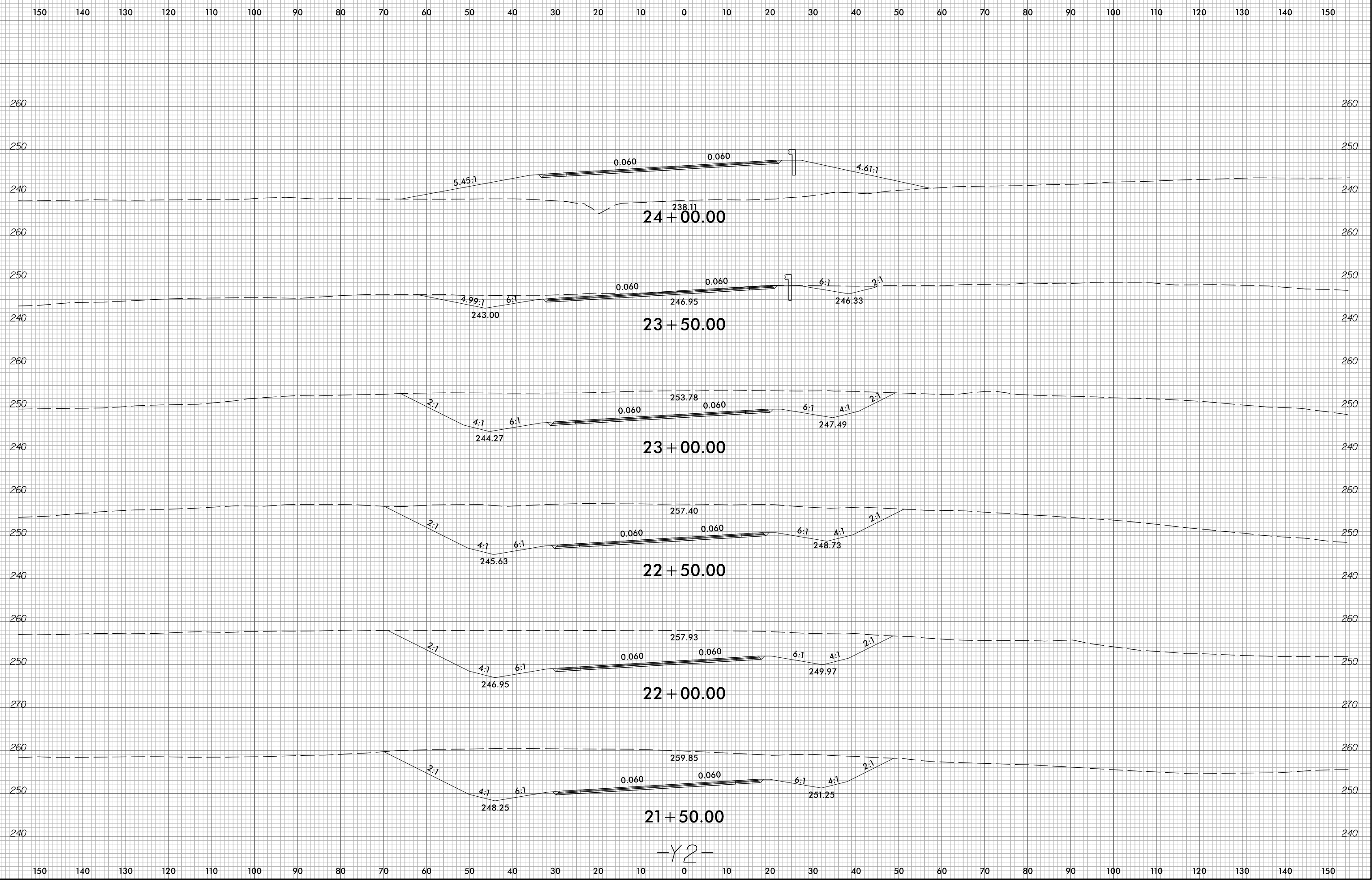

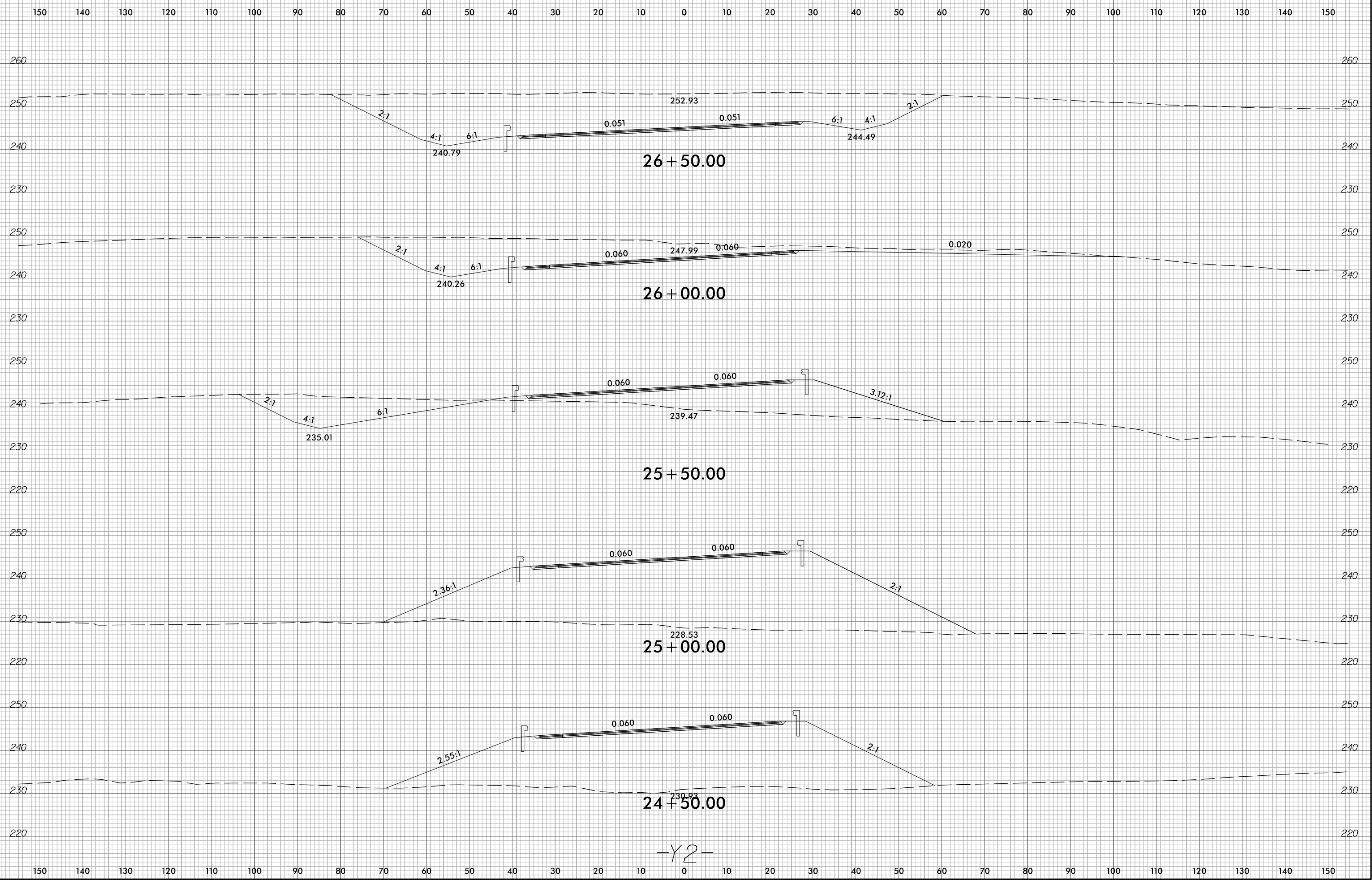

2/2/2023  
U-5748-R.dwg  
patrick.mepferson

-Y2-

6/23/16

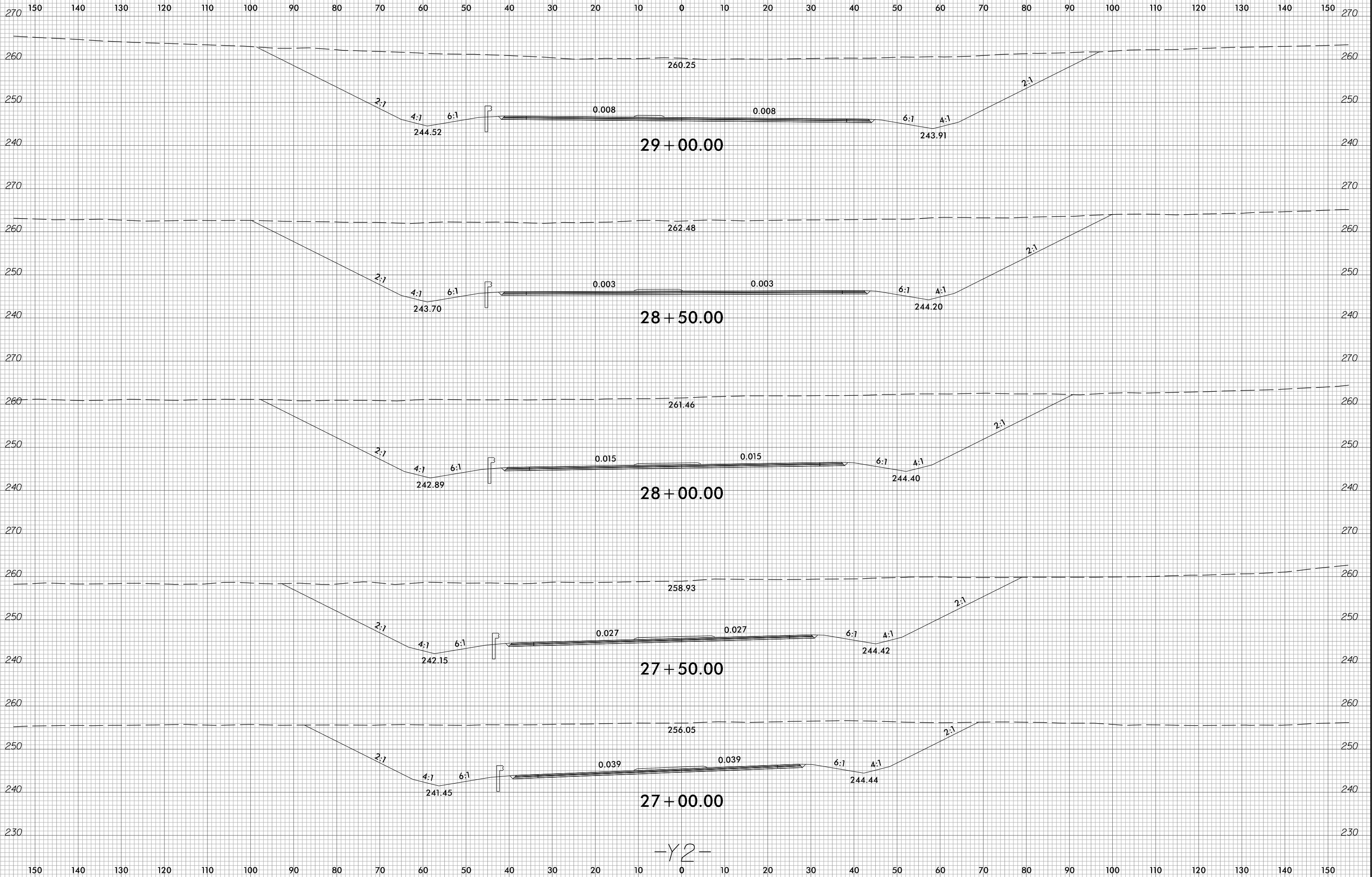

-Y2-

2/2/2023  
U-5748-16.dwg  
pat-ick.mcferson

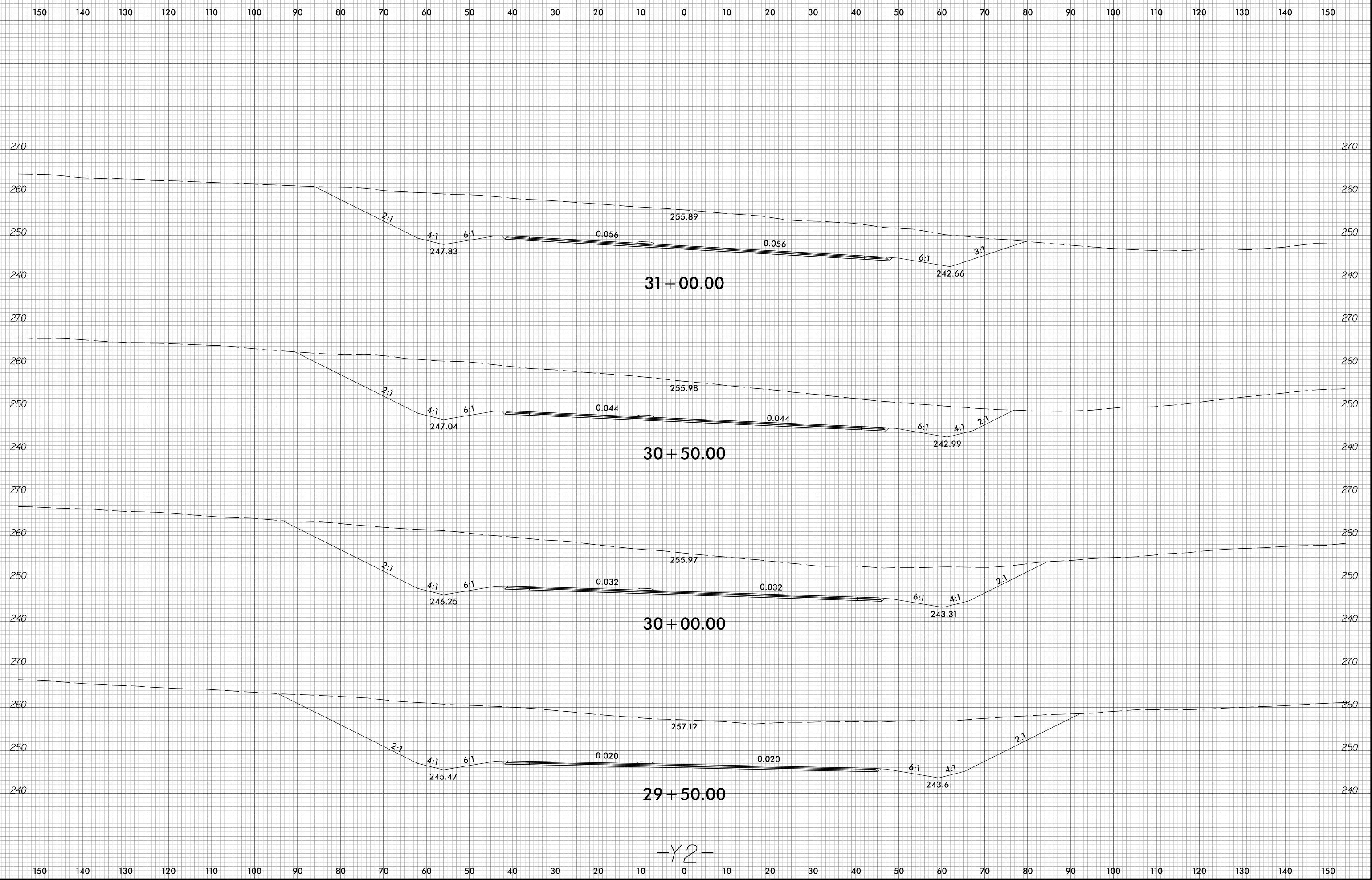

-Y2-



6/23/16

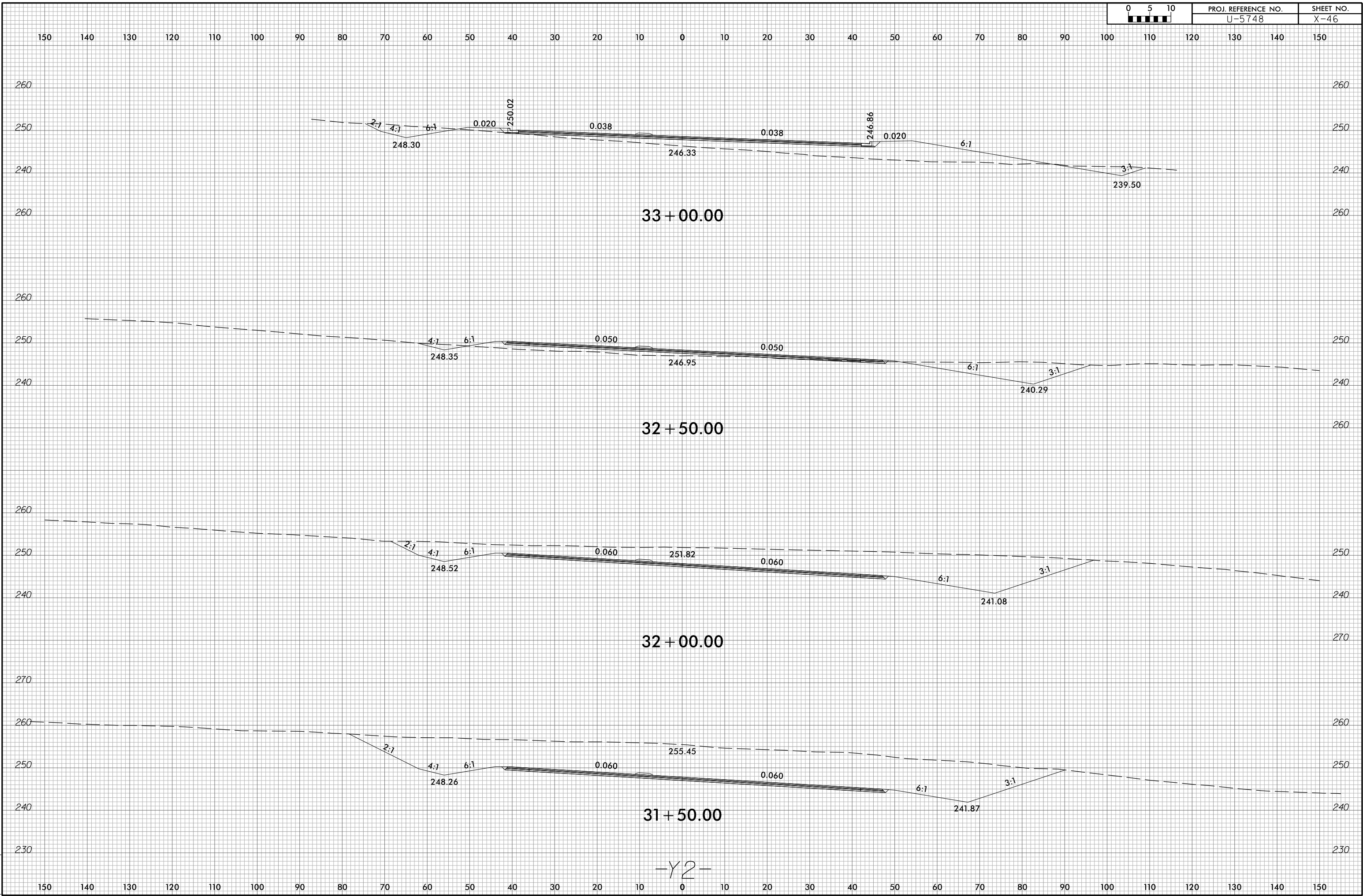

33 + 00.00

32 + 50.00

32 + 00.00

31 + 50.00

-Y2-

2/2/2023  
U-5748-R.dwg  
patrick.mcfarson

6/23/16

0 5 10	PROJ. REFERENCE NO.	SHEET NO.
	U-5748	X-47

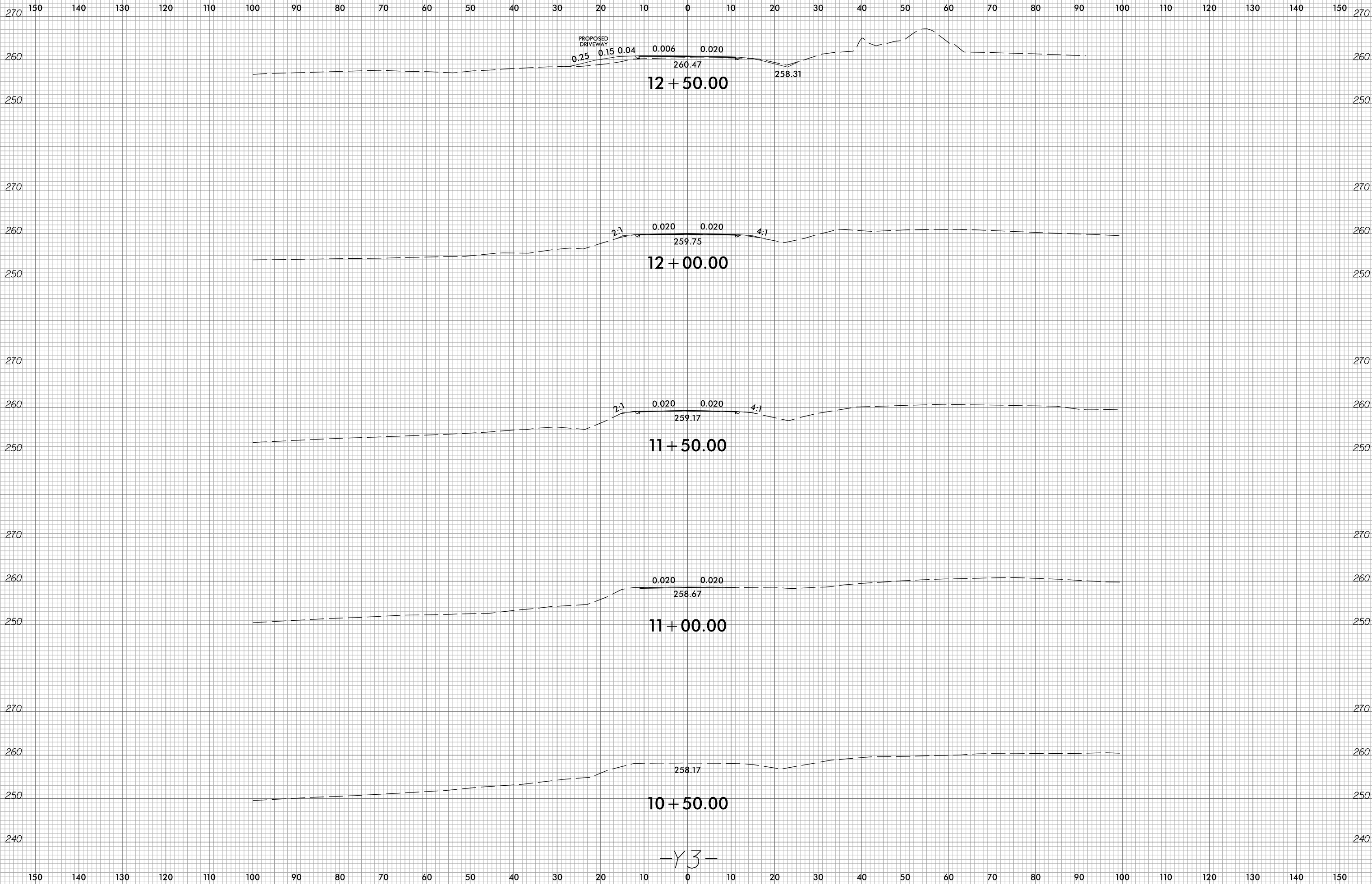

-Y3-

2/2/2023  
U-5748.dwg  
patrick.mcfarson

6/23/16

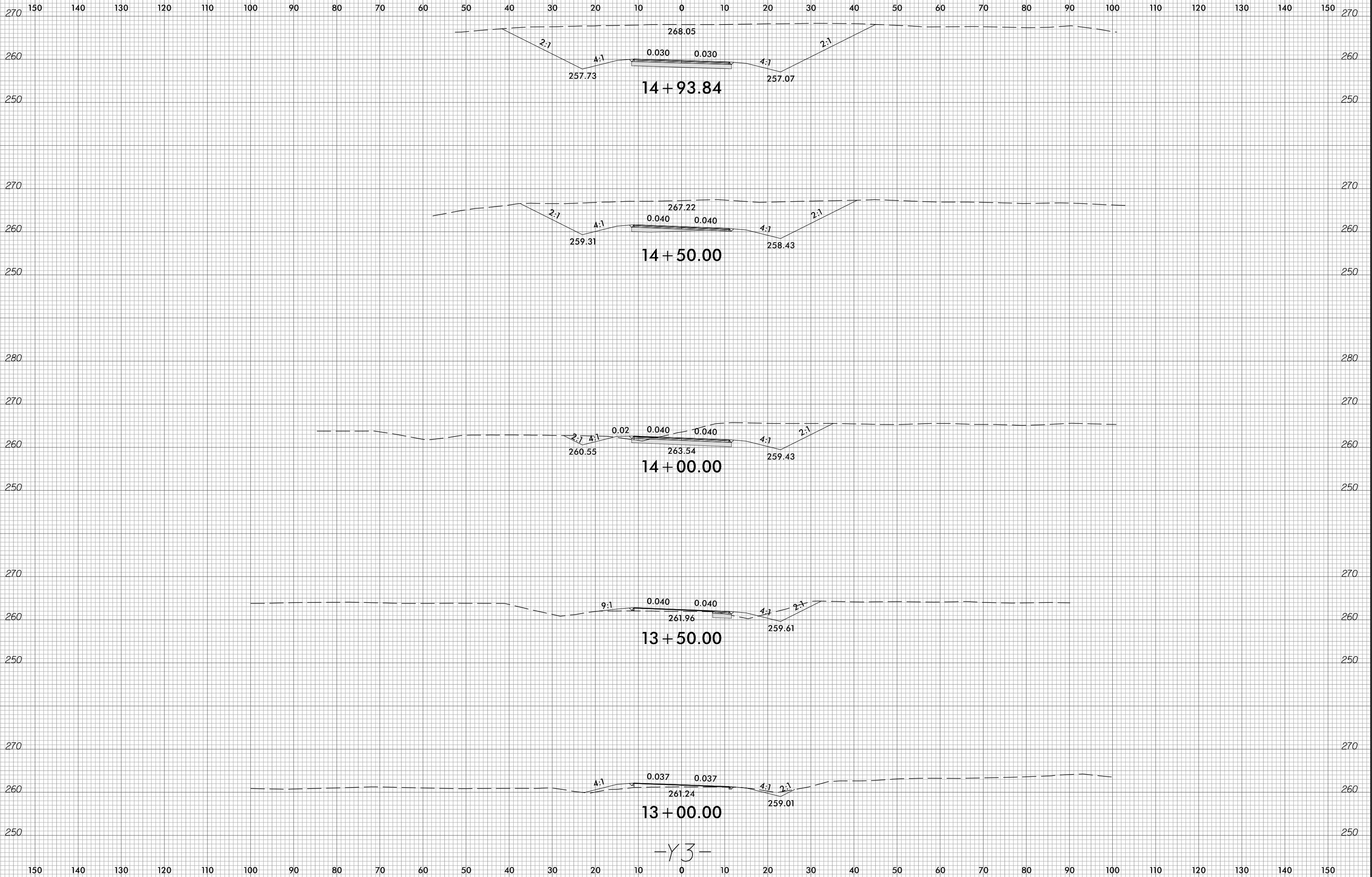

2/2/2023  
15748.dwg  
patrick.mepferson

-Y3-

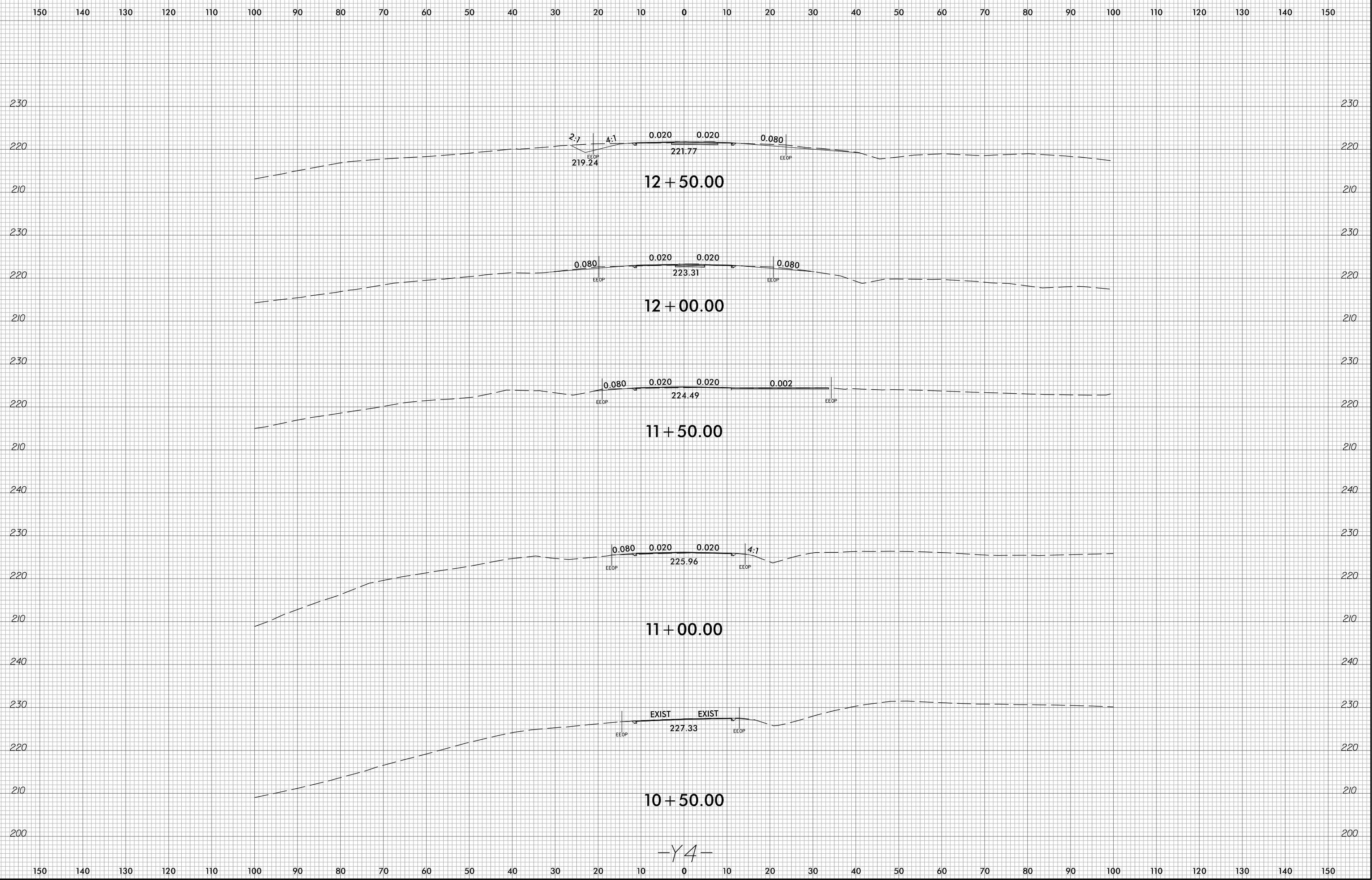

6/23/16

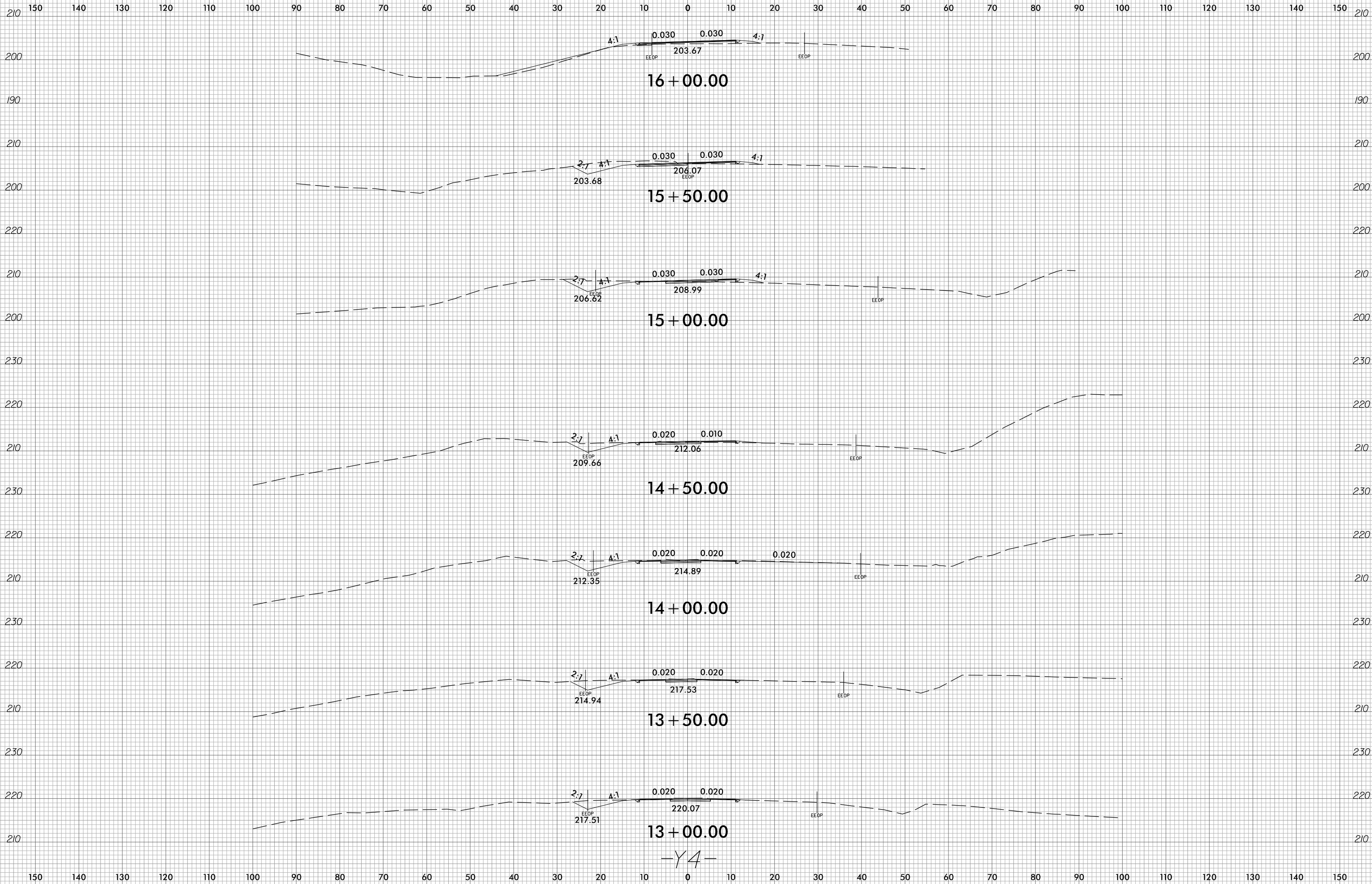

2/2/2023 15:48:00 p.du xp1\_Y4.dgn patrick.mcfarson

-Y4-

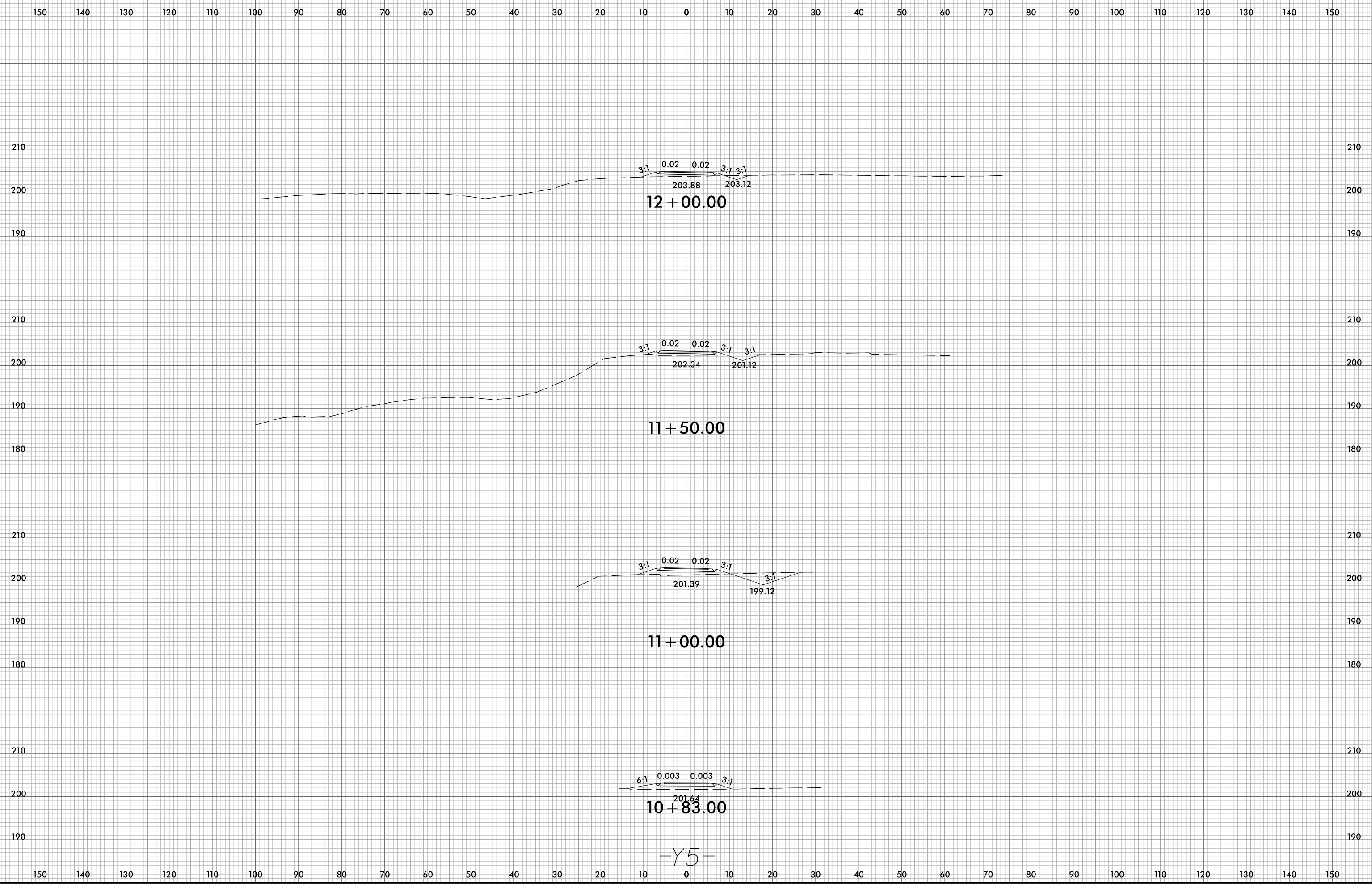

-Y5-

6/23/16

0 5 10	PROJ. REFERENCE NO.	SHEET NO.
	U-5748	X-52

150 140 130 120 110 100 90 80 70 60 50 40 30 20 10 0 10 20 30 40 50 60 70 80 90 100 110 120 130 140 150

230  
220  
210  
200  
190  
180  
220  
210  
200

230  
220  
210  
200  
190  
180  
220  
210  
200

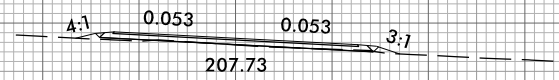

12 + 85.27

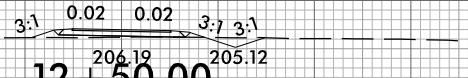

12 + 50.00

-Y5-

150 140 130 120 110 100 90 80 70 60 50 40 30 20 10 0 10 20 30 40 50 60 70 80 90 100 110 120 130 140 150

2/2/2013  
15748.dwg  
patrick.mcfarson

150 140 130 120 110 100 90 80 70 60 50 40 30 20 10 0 10 20 30 40 50 60 70 80 90 100 110 120 130 140 150

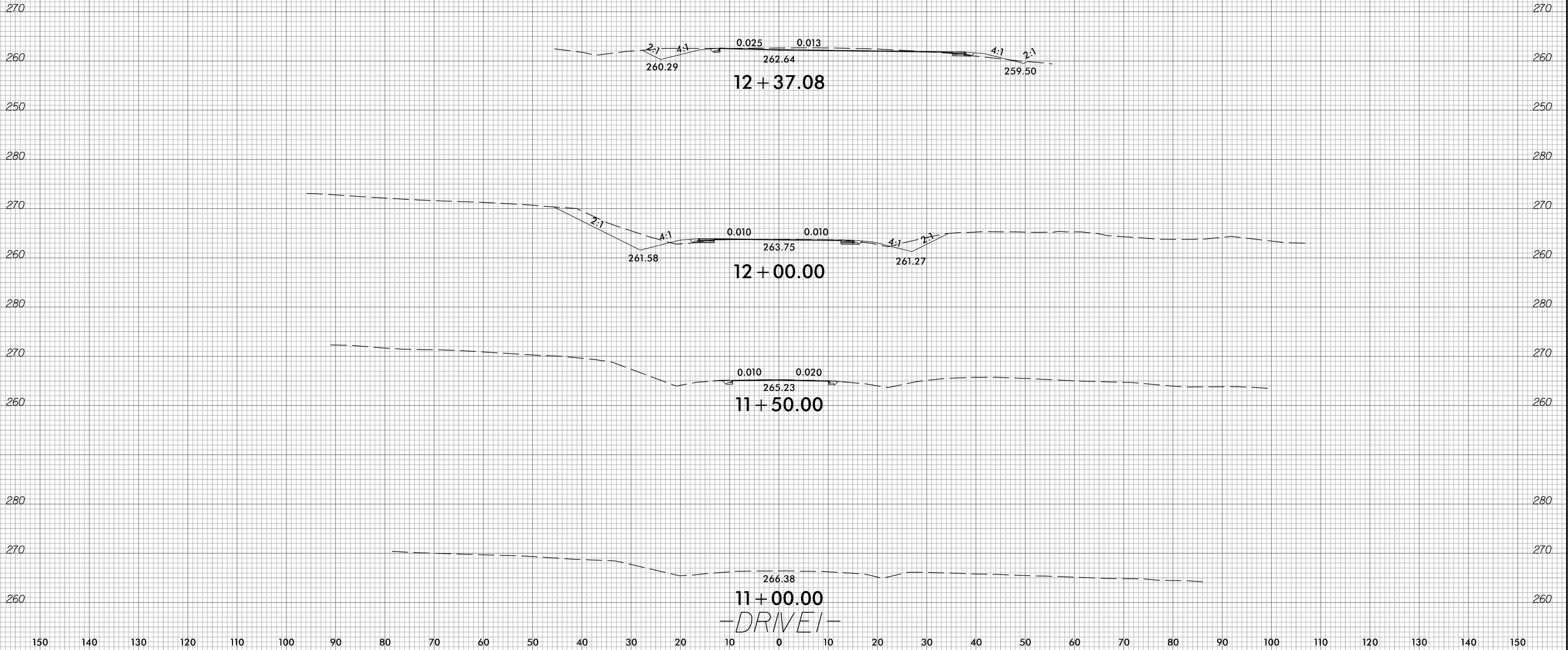



150 140 130 120 110 100 90 80 70 60 50 40 30 20 10 0 10 20 30 40 50 60 70 80 90 100 110 120 130 140 150

240

240

230

230

250

250

240

240

230

230

220

220

250

250

240

240

230

230

220

220

250

250

240

240

230

230

220

220

233.12  
11 + 50.00

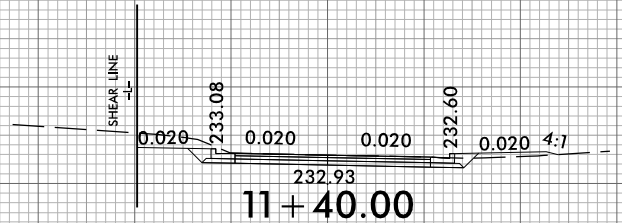

232.93  
11 + 40.00

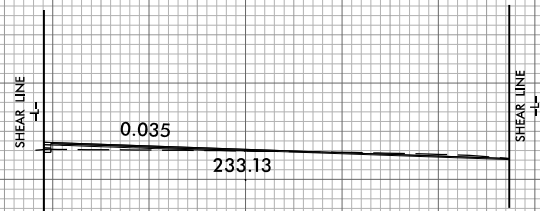

233.13  
11 + 00.00

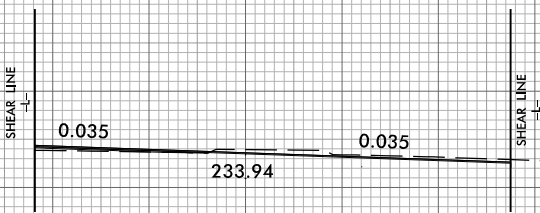

233.94  
10 + 83.00

-DRIVE 2-

150 140 130 120 110 100 90 80 70 60 50 40 30 20 10 0 10 20 30 40 50 60 70 80 90 100 110 120 130 140 150

6/23/16

0 5 10	PROJ. REFERENCE NO.	SHEET NO.
	U-5748	X-55

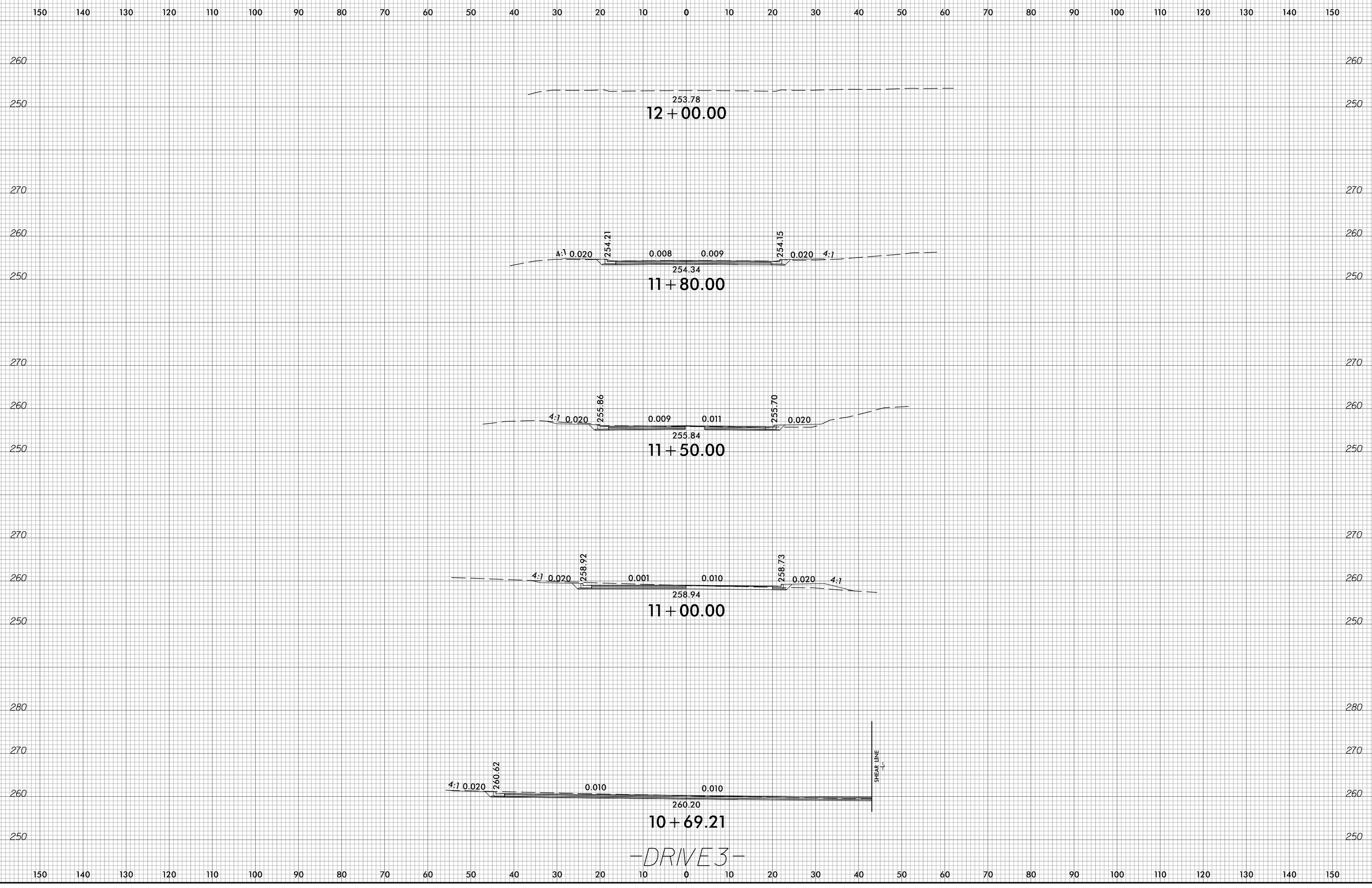

2/2/2023  
15748.dwg  
patrick.meperson

-DRIVE 3-

150 140 130 120 110 100 90 80 70 60 50 40 30 20 10 0 10 20 30 40 50 60 70 80 90 100 110 120 130 140 150

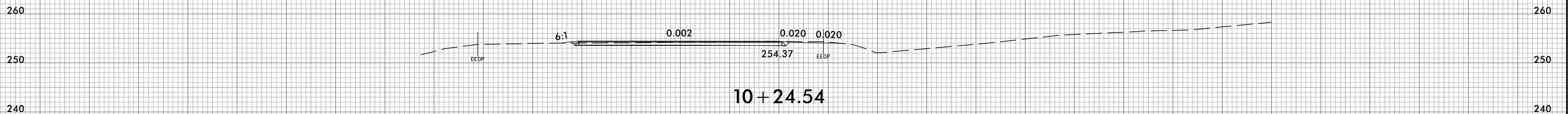
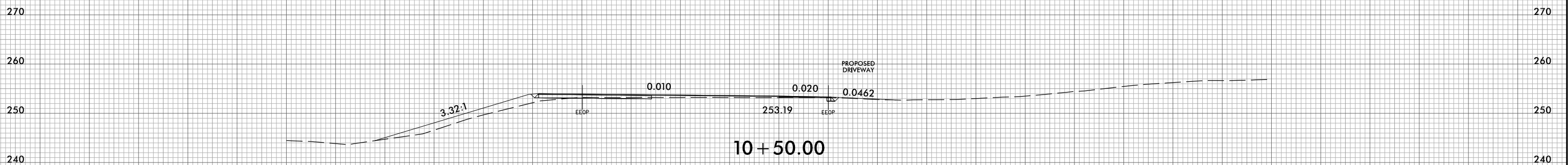
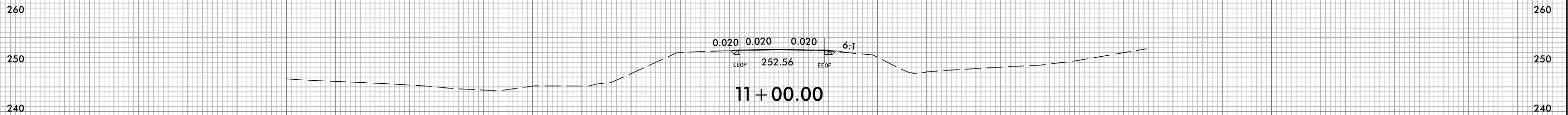
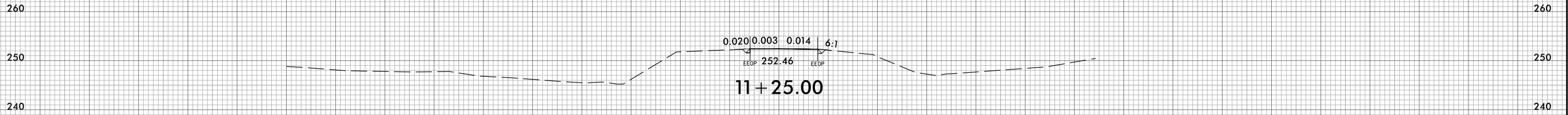

150 140 130 120 110 100 90 80 70 60 50 40 30 20 10 0 10 20 30 40 50 60 70 80 90 100 110 120 130 140 150

6/23/16



PROJ. REFERENCE NO.  
U-5748

SHEET NO.  
X-57

150 140 130 120 110 100 90 80 70 60 50 40 30 20 10 0 10 20 30 40 50 60 70 80 90 100 110 120 130 140 150

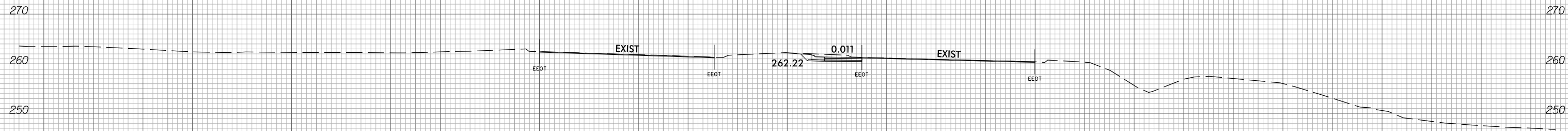

20 + 50.00

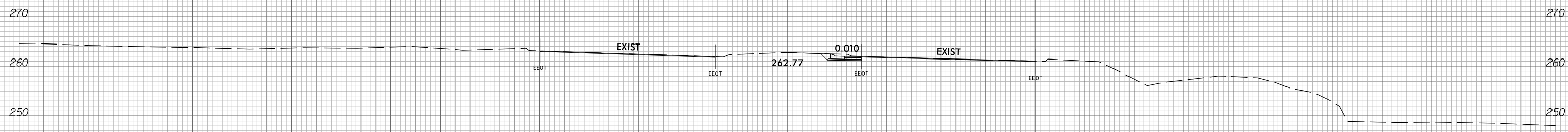

20 + 00.00

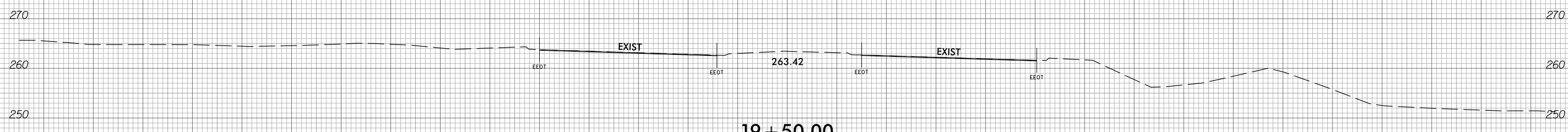

19 + 50.00

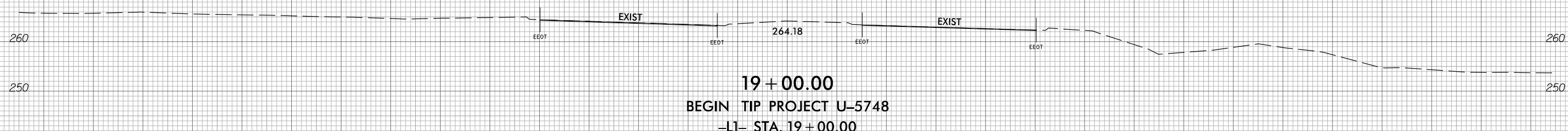

19 + 00.00

BEGIN TIP PROJECT U-5748  
-L1- STA. 19 + 00.00

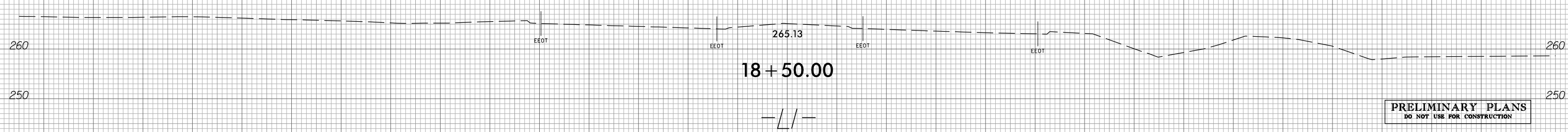

18 + 50.00

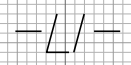

**PRELIMINARY PLANS**  
DO NOT USE FOR CONSTRUCTION

2/2/2023  
05748\_rdy\_xpl.l1  
patric.mcferson

150 140 130 120 110 100 90 80 70 60 50 40 30 20 10 0 10 20 30 40 50 60 70 80 90 100 110 120 130 140 150

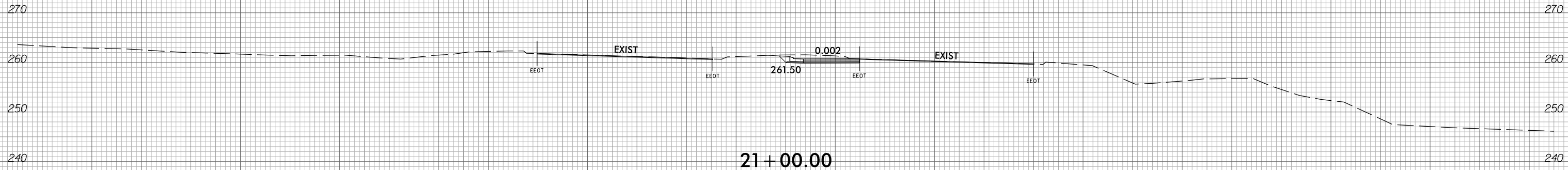
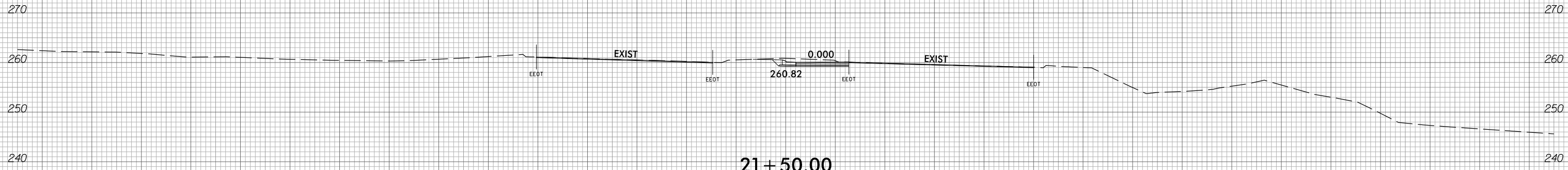
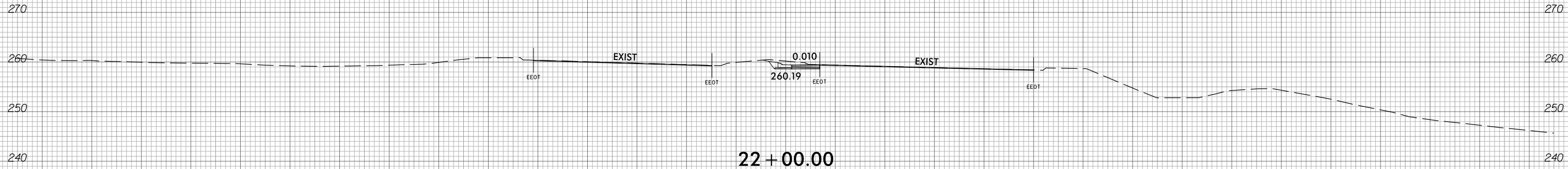
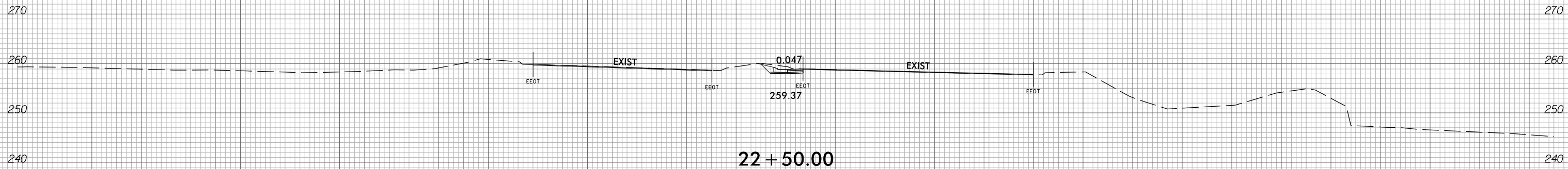

—//—

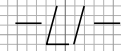
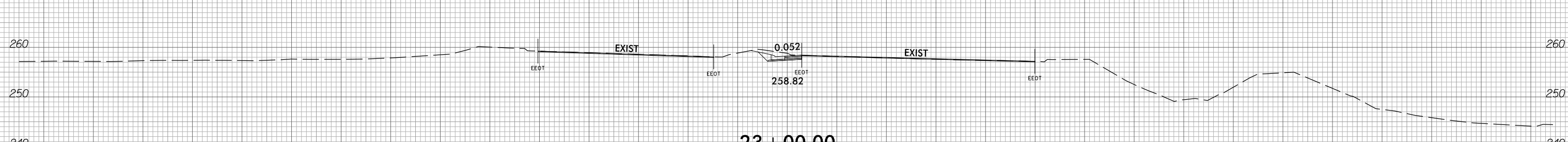
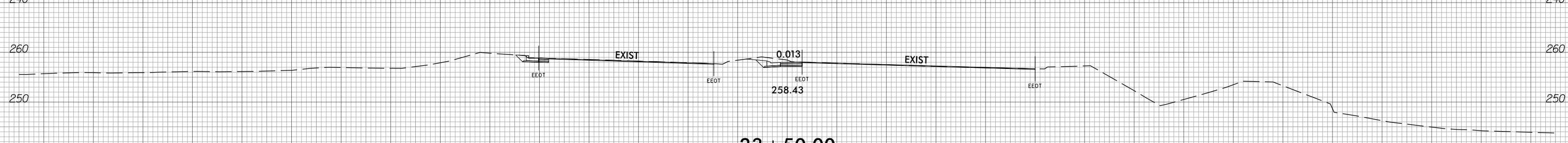
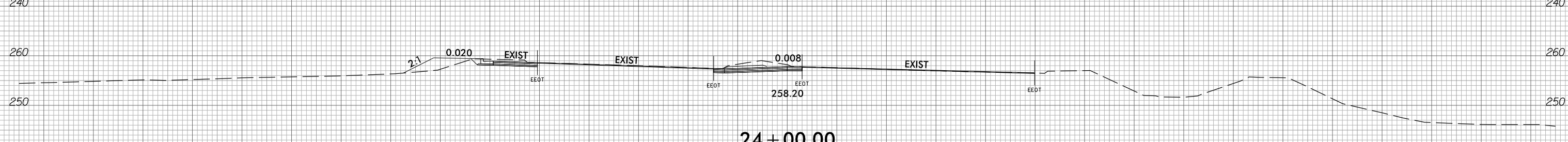
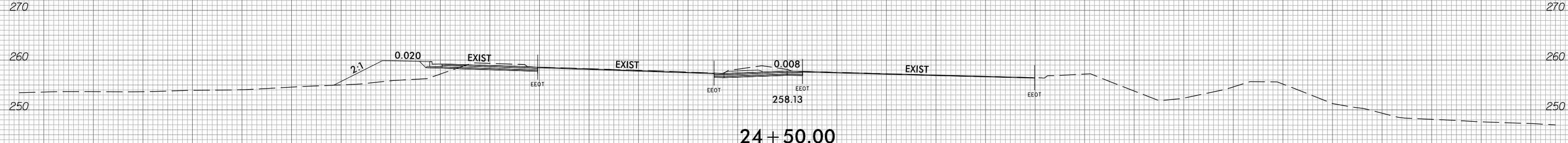
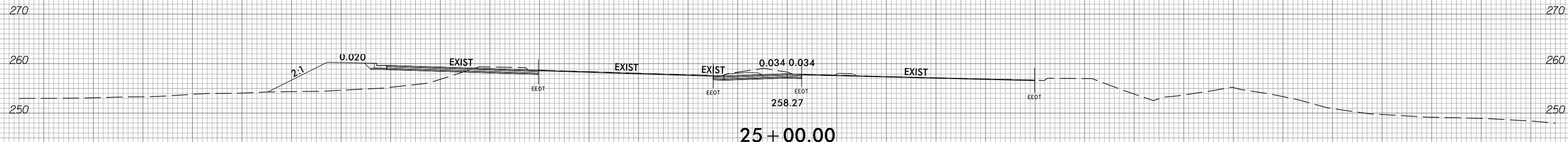
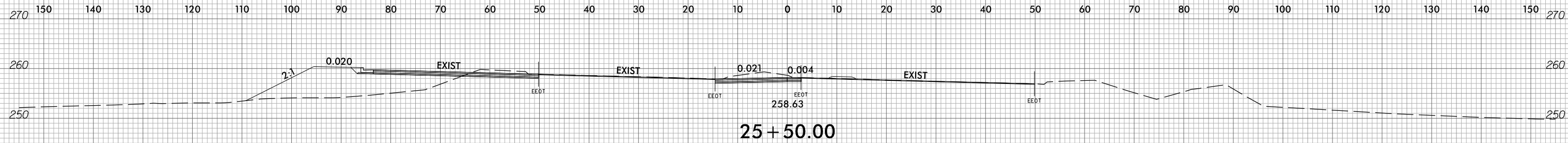

6/23/16



PROJ. REFERENCE NO.  
U-5748

SHEET NO.  
X-60

150 140 130 120 110 100 90 80 70 60 50 40 30 20 10 0 10 20 30 40 50 60 70 80 90 100 110 120 130 140 150

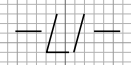
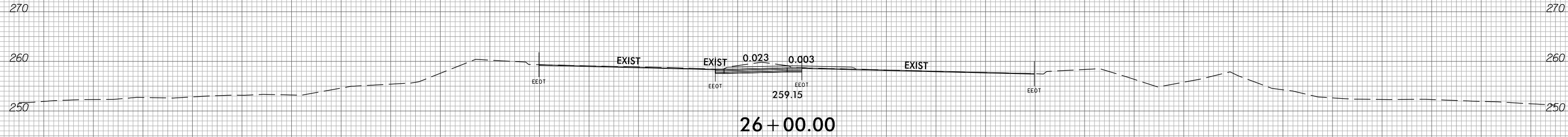
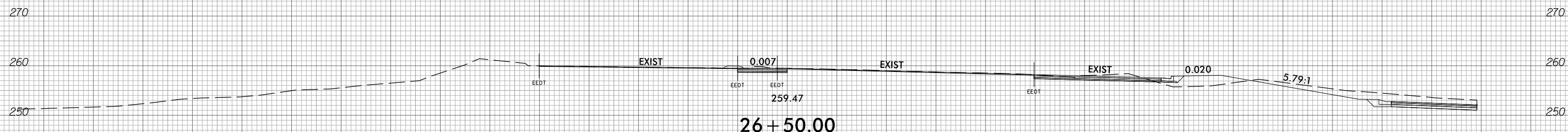
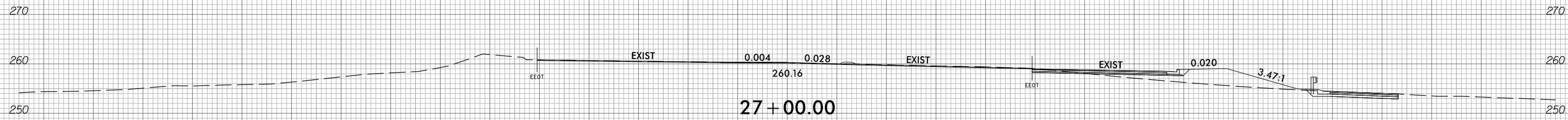
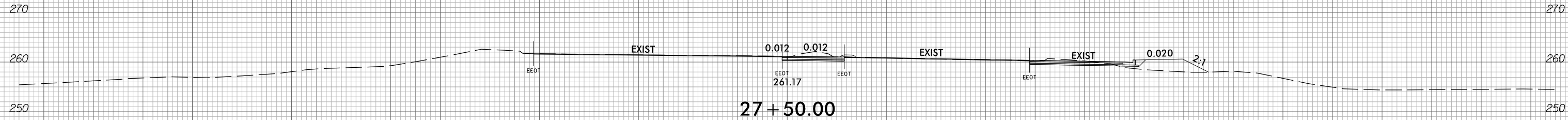
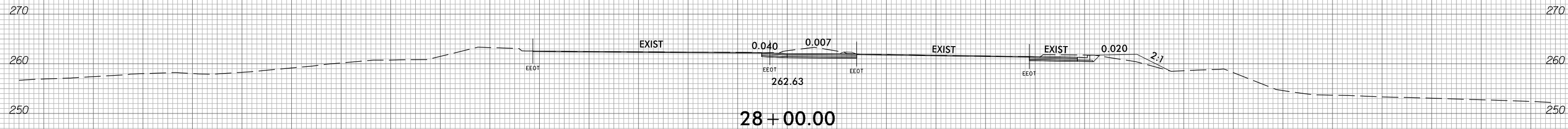
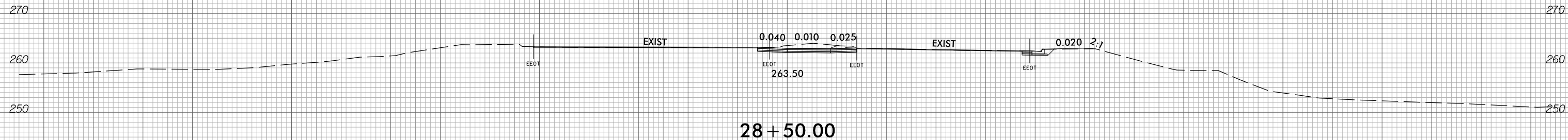

150 140 130 120 110 100 90 80 70 60 50 40 30 20 10 0 10 20 30 40 50 60 70 80 90 100 110 120 130 140 150

2/2/2023  
05748\_rdy\_xpl.l1  
patricimperson

150 140 130 120 110 100 90 80 70 60 50 40 30 20 10 0 10 20 30 40 50 60 70 80 90 100 110 120 130 140 150

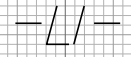
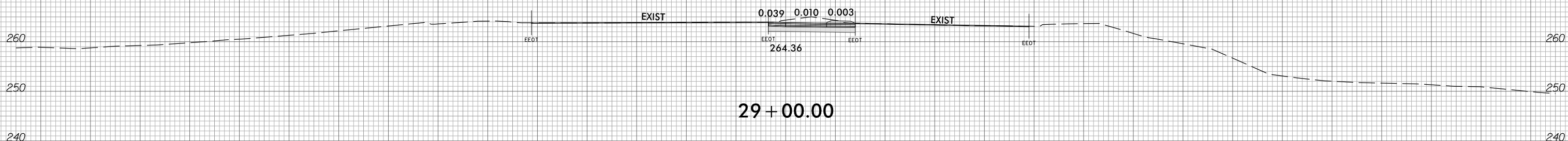
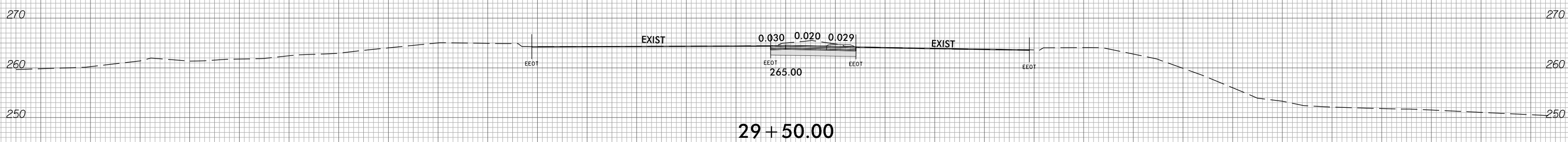
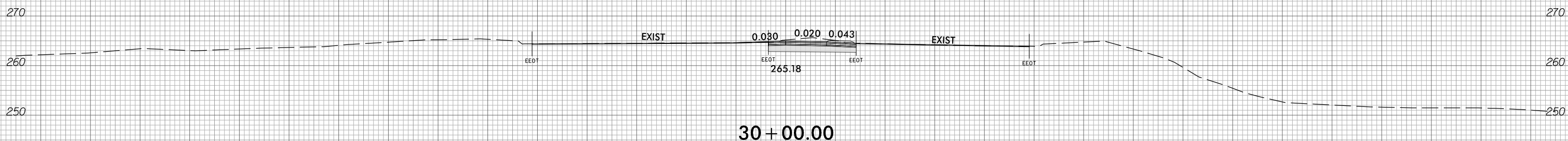
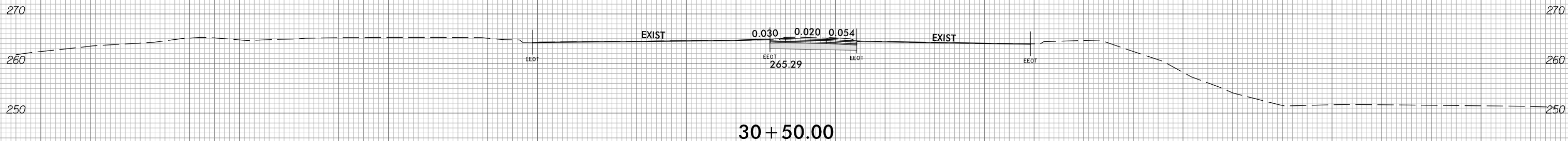
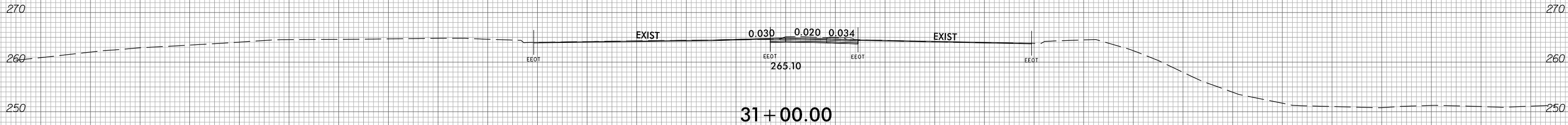

150 140 130 120 110 100 90 80 70 60 50 40 30 20 10 0 10 20 30 40 50 60 70 80 90 100 110 120 130 140 150



6/23/16



PROJ. REFERENCE NO.  
U-5748

SHEET NO.  
X-62

150 140 130 120 110 100 90 80 70 60 50 40 30 20 10 0 10 20 30 40 50 60 70 80 90 100 110 120 130 140 150

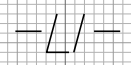
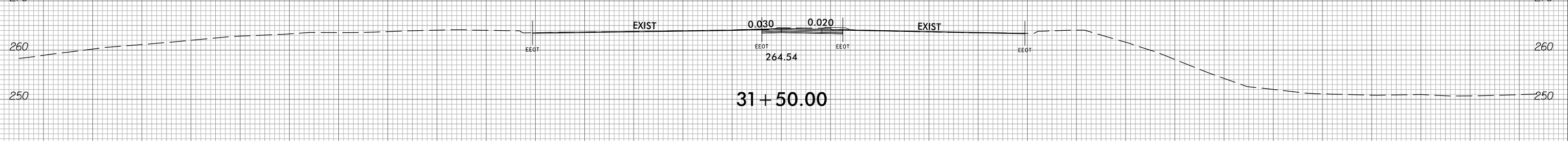
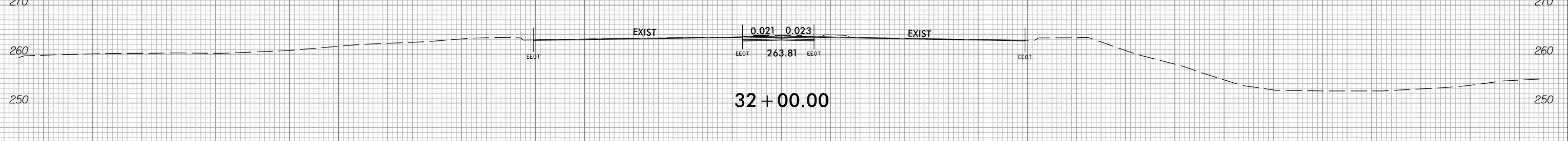
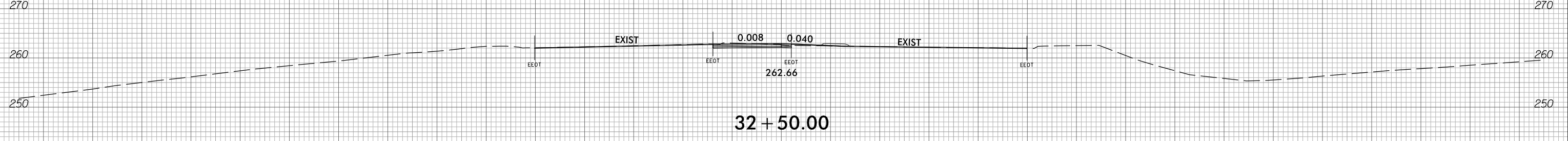
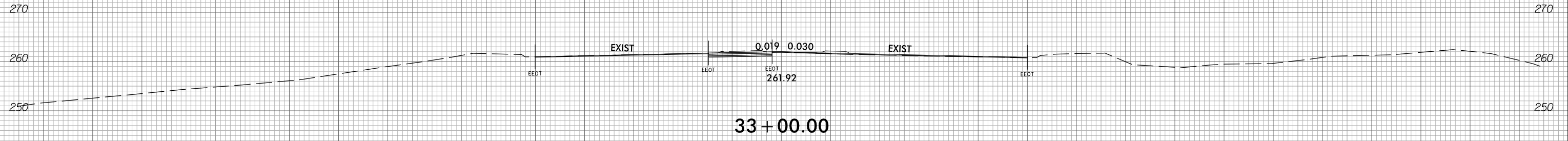
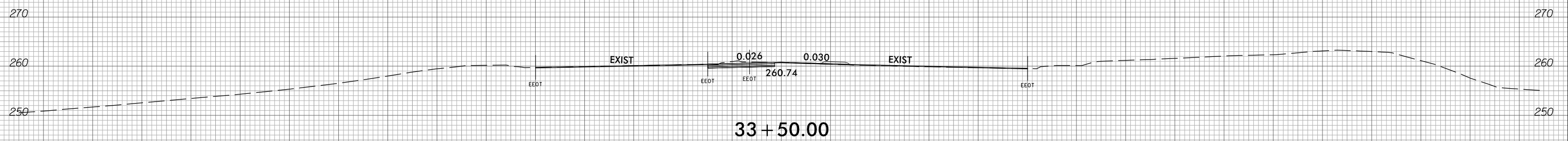
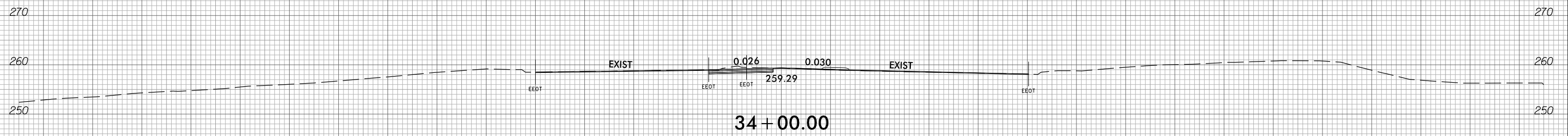

150 140 130 120 110 100 90 80 70 60 50 40 30 20 10 0 10 20 30 40 50 60 70 80 90 100 110 120 130 140 150

2/2/2023  
05748\_rdy\_xpl.l1  
patric.mpherson

6/23/16



PROJ. REFERENCE NO.  
U-5748

SHEET NO.  
X-63

150 140 130 120 110 100 90 80 70 60 50 40 30 20 10 0 10 20 30 40 50 60 70 80 90 100 110 120 130 140 150

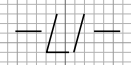
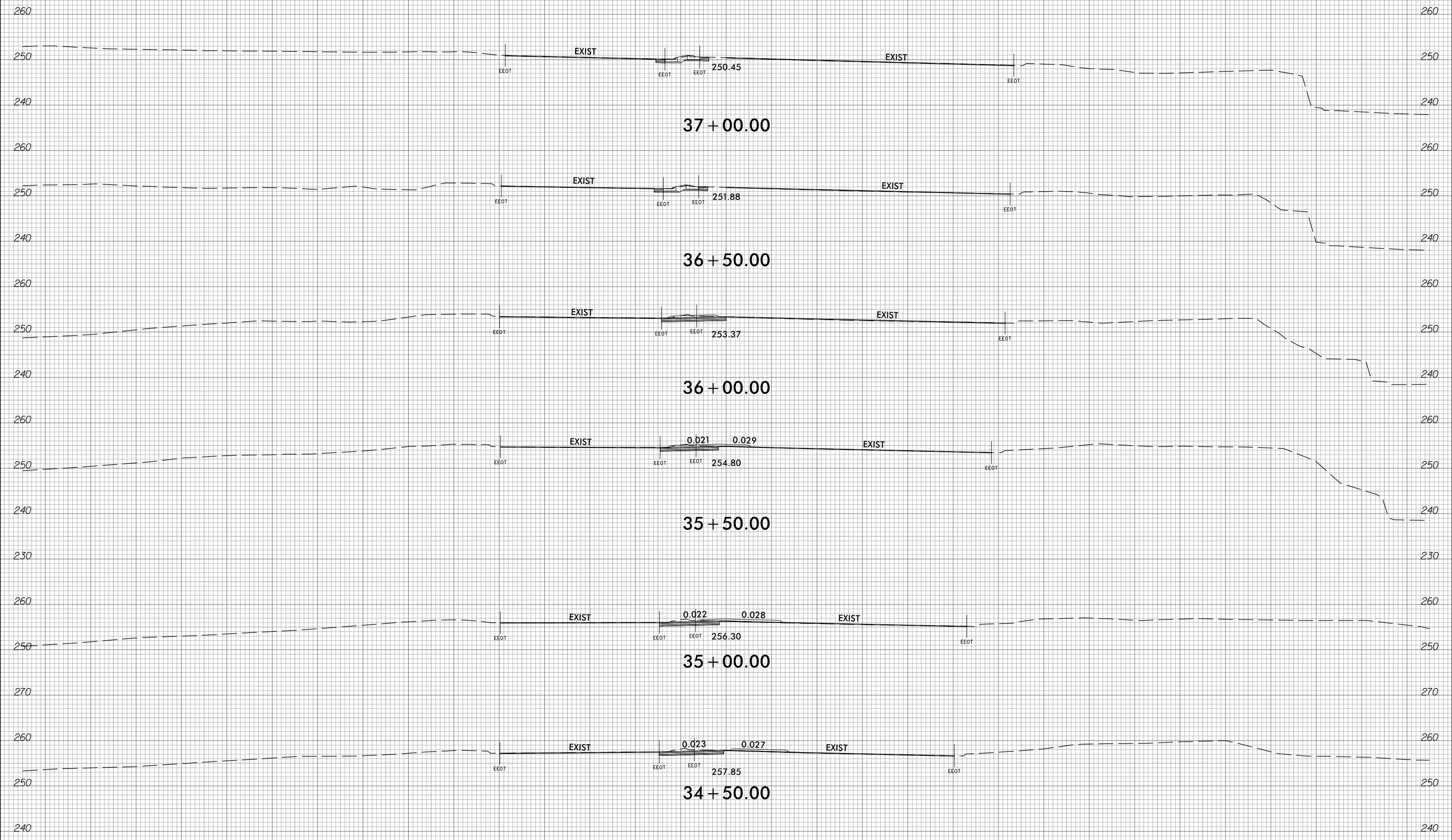

2/2/2023  
05748\_rdy\_xpl.l1  
patrick.mcferson

6/23/16



PROJ. REFERENCE NO.	SHEET NO.
U-5748	X-64

150 140 130 120 110 100 90 80 70 60 50 40 30 20 10 0 10 20 30 40 50 60 70 80 90 100 110 120 130 140 150

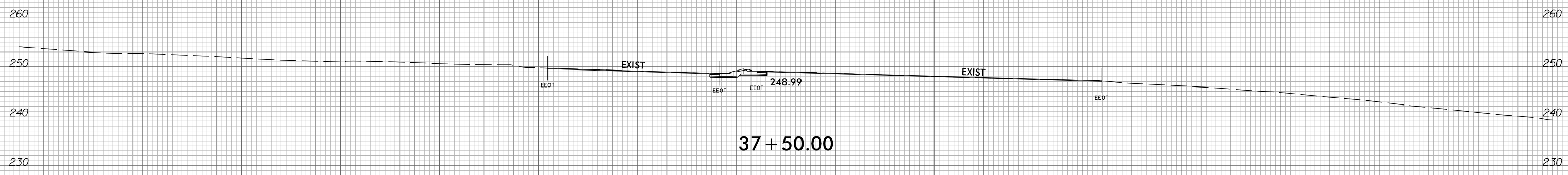
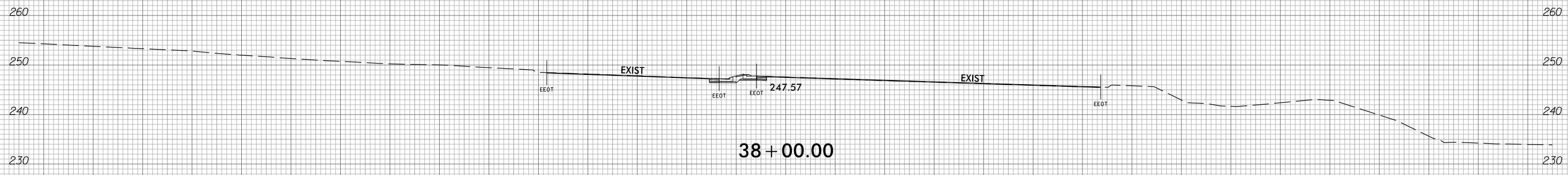
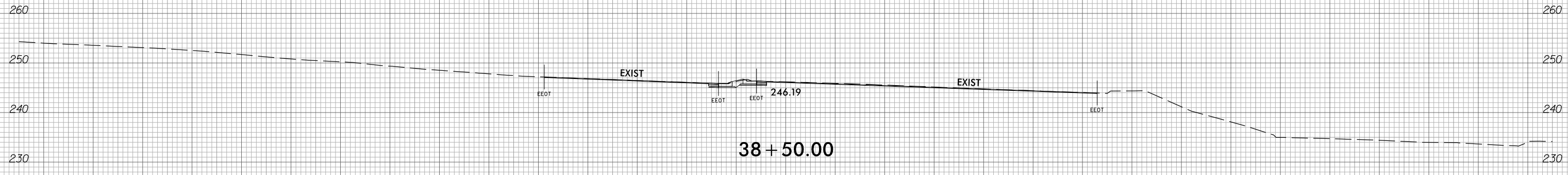
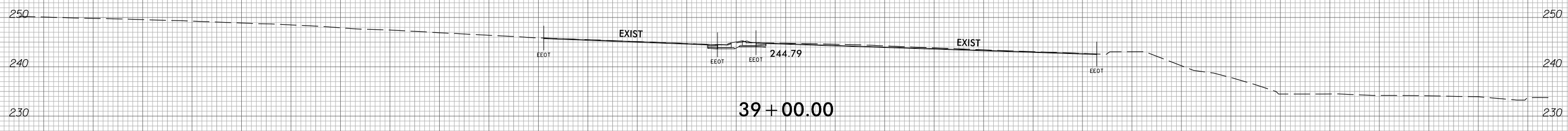
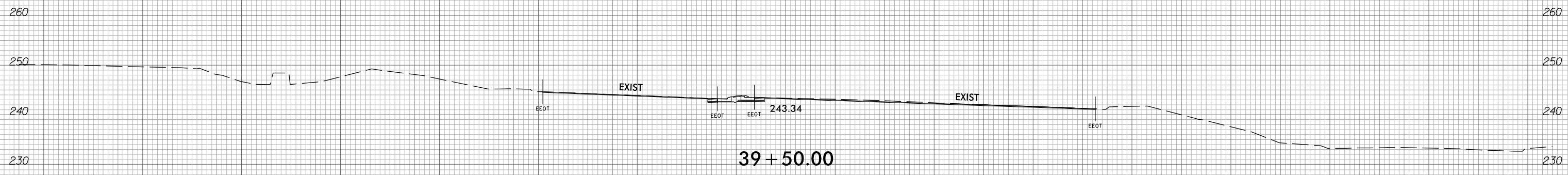

—//—

150 140 130 120 110 100 90 80 70 60 50 40 30 20 10 0 10 20 30 40 50 60 70 80 90 100 110 120 130 140 150

2/2/2023  
05748\_rdy\_xpl.l1  
patrick.mplerson

6/23/16



PROJ. REFERENCE NO.  
U-5748

SHEET NO.  
X-65

150 140 130 120 110 100 90 80 70 60 50 40 30 20 10 0 10 20 30 40 50 60 70 80 90 100 110 120 130 140 150

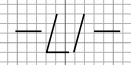
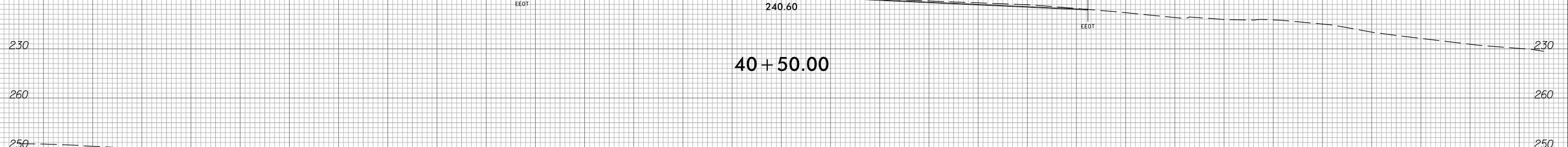
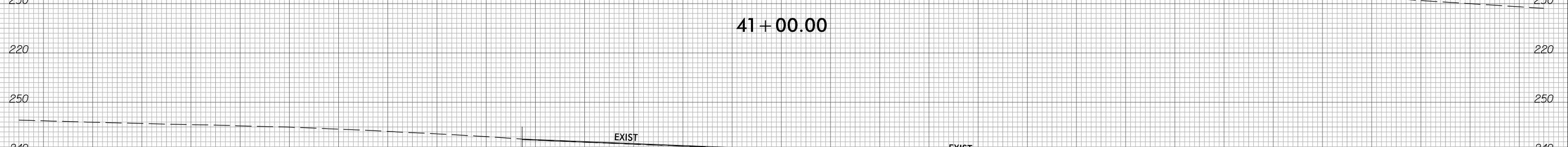
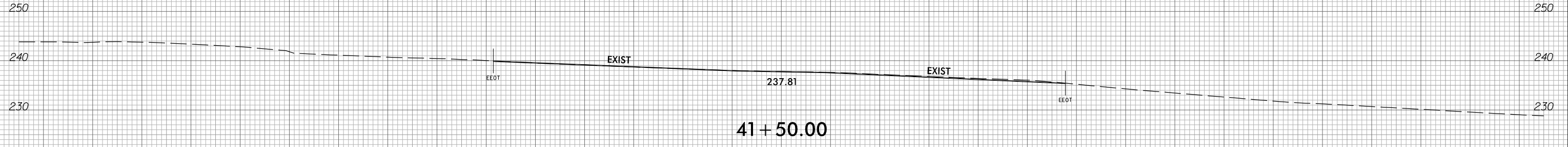
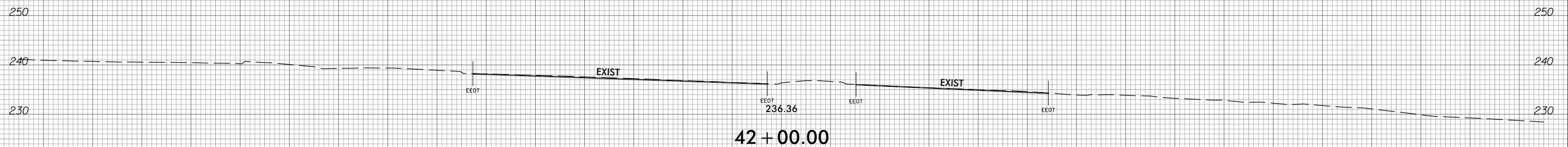

150 140 130 120 110 100 90 80 70 60 50 40 30 20 10 0 10 20 30 40 50 60 70 80 90 100 110 120 130 140 150

2/2/2023  
05748\_rdy\_xpl.l1  
patric.mcferson

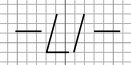
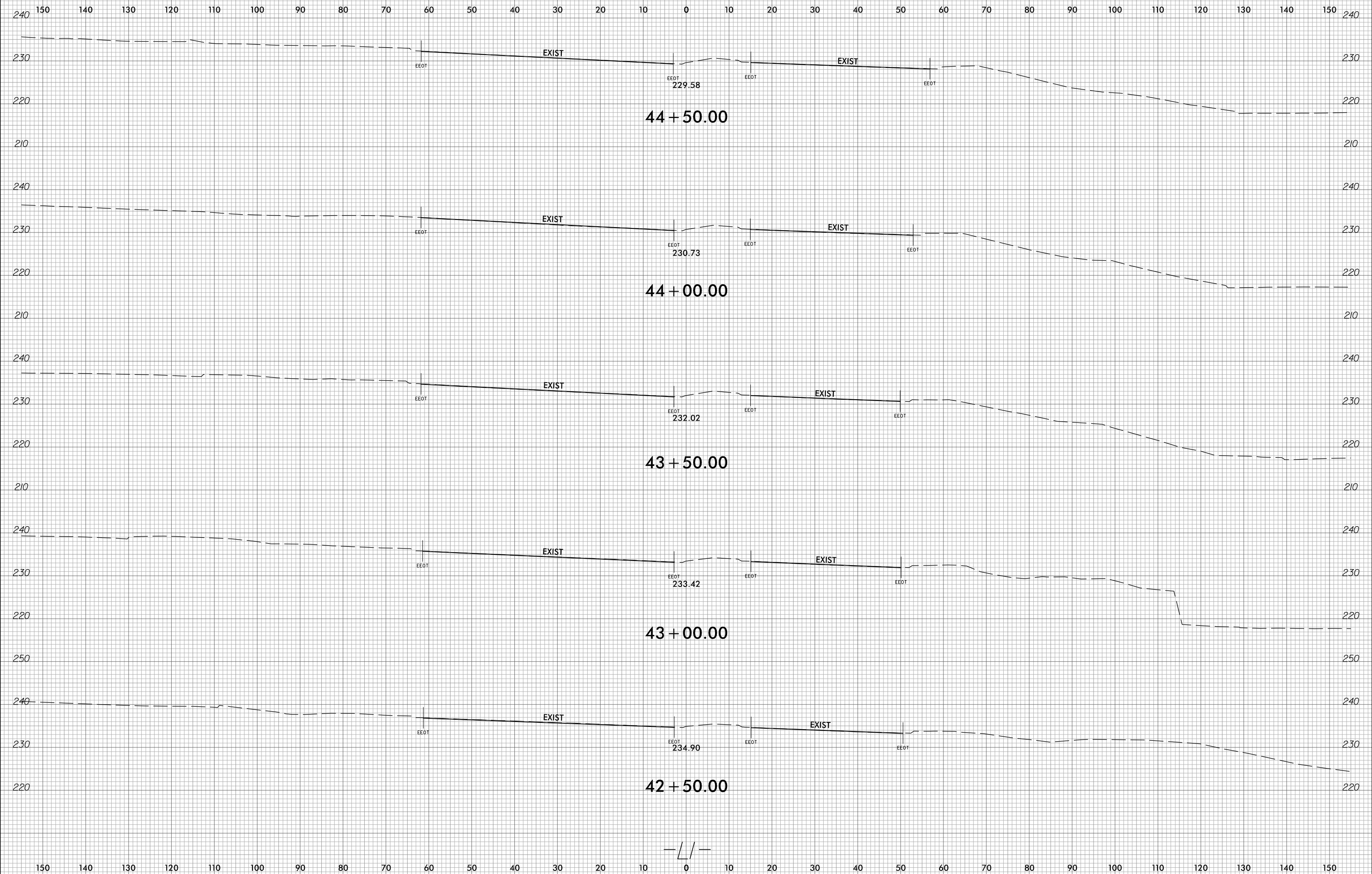

150 140 130 120 110 100 90 80 70 60 50 40 30 20 10 0 10 20 30 40 50 60 70 80 90 100 110 120 130 140 150

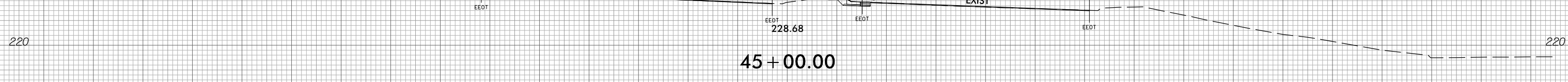
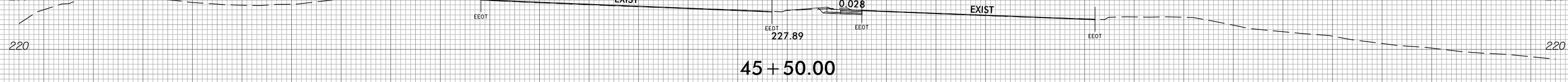
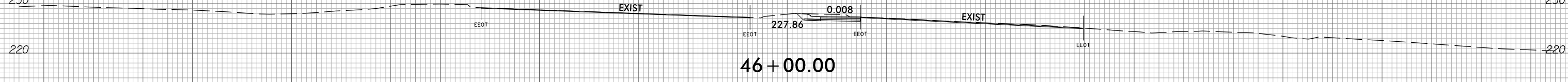
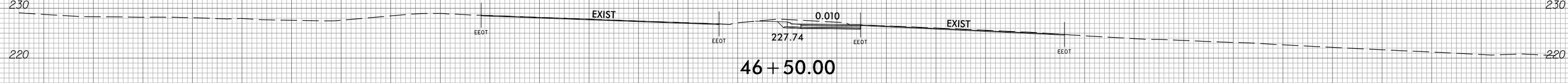
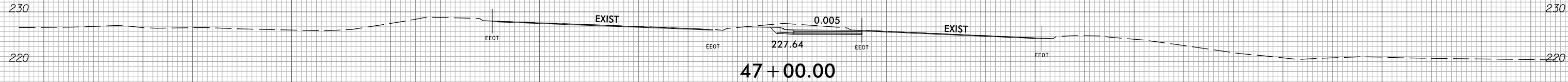
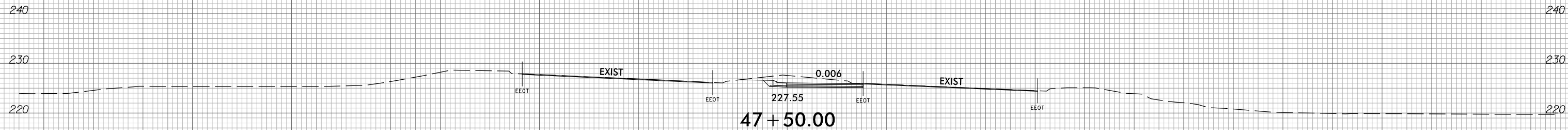

—//—

150 140 130 120 110 100 90 80 70 60 50 40 30 20 10 0 10 20 30 40 50 60 70 80 90 100 110 120 130 140 150

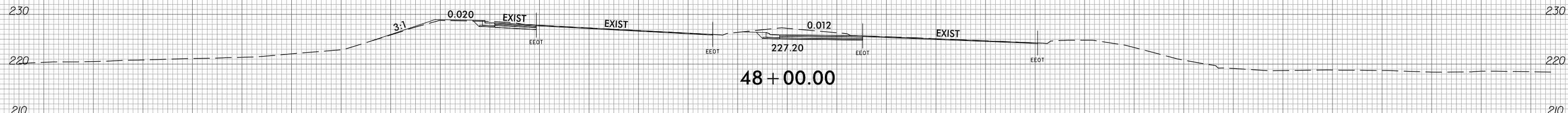
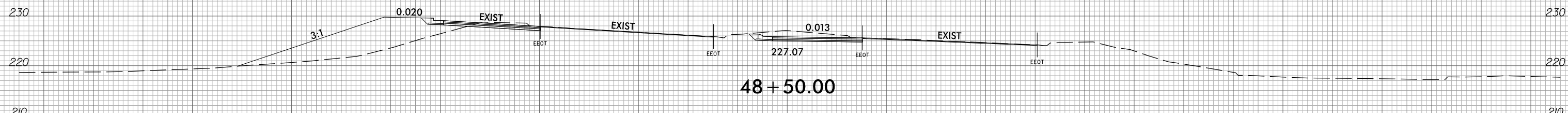
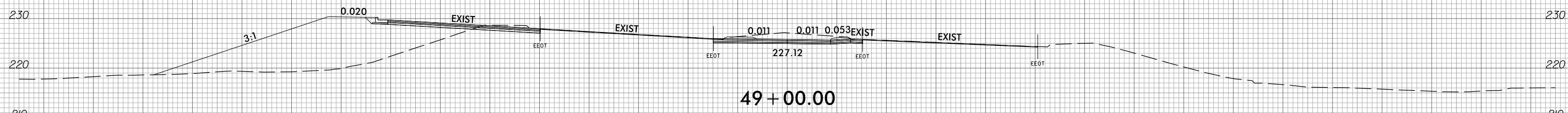
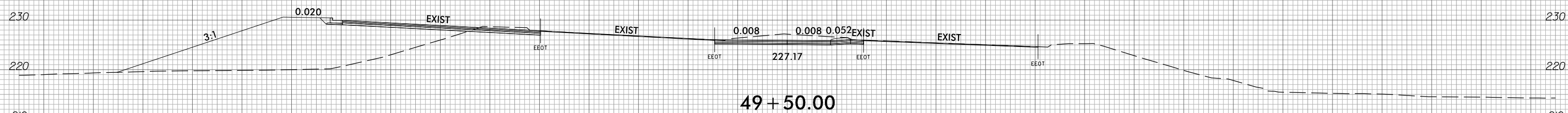
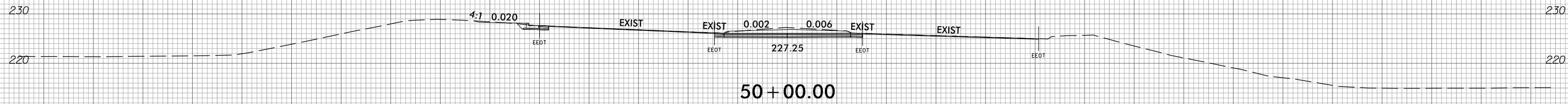
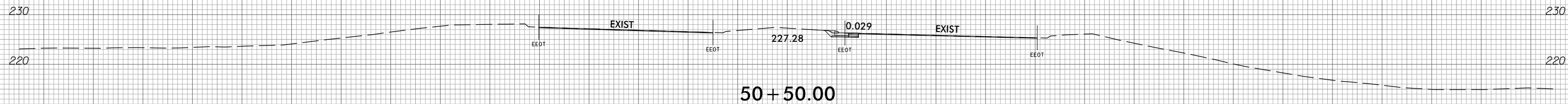

150 140 130 120 110 100 90 80 70 60 50 40 30 20 10 0 10 20 30 40 50 60 70 80 90 100 110 120 130 140 150

6/23/16



PROJ. REFERENCE NO.  
U-5748

SHEET NO.  
X-69

150 140 130 120 110 100 90 80 70 60 50 40 30 20 10 0 10 20 30 40 50 60 70 80 90 100 110 120 130 140 150

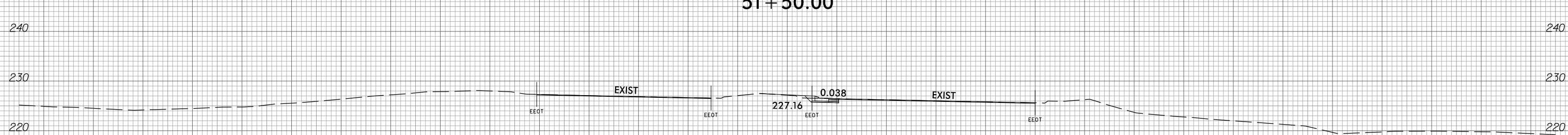
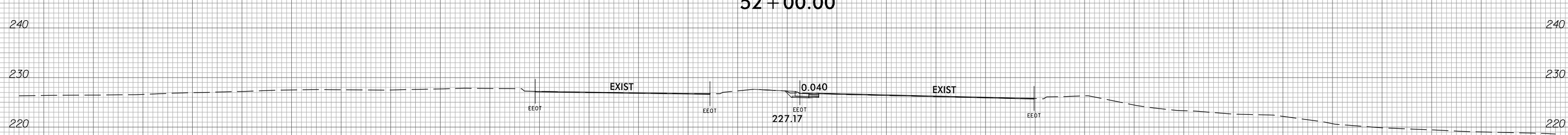
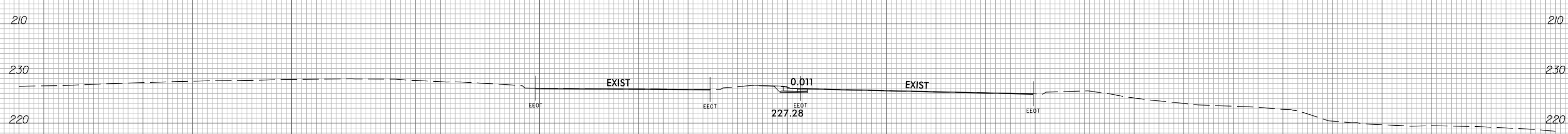
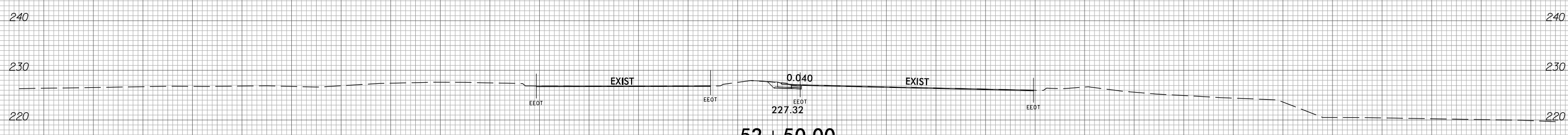
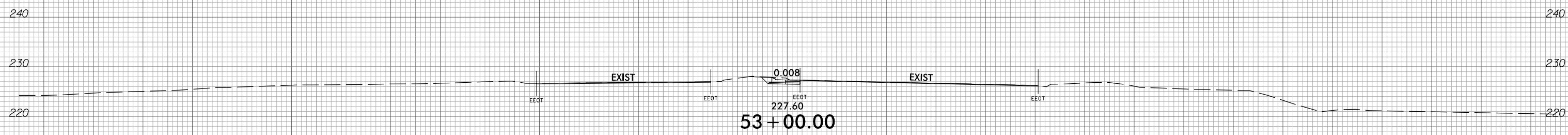
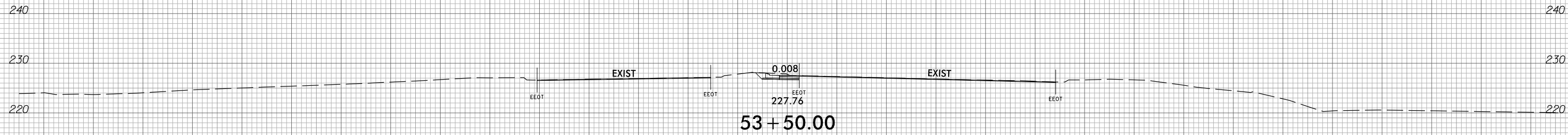

150 140 130 120 110 100 90 80 70 60 50 40 30 20 10 0 10 20 30 40 50 60 70 80 90 100 110 120 130 140 150

2/2/2023  
05748\_rdy\_xpl.l1  
patric.mcferson

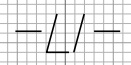



6/23/16



PROJ. REFERENCE NO.  
U-5748

SHEET NO.  
X-70

150 140 130 120 110 100 90 80 70 60 50 40 30 20 10 0 10 20 30 40 50 60 70 80 90 100 110 120 130 140 150

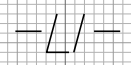
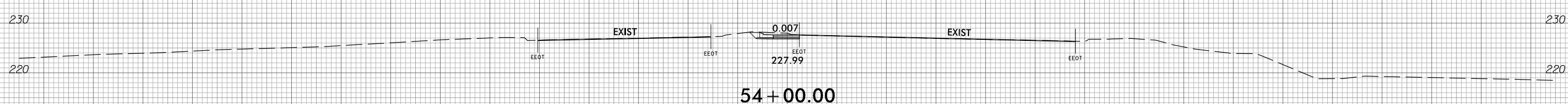
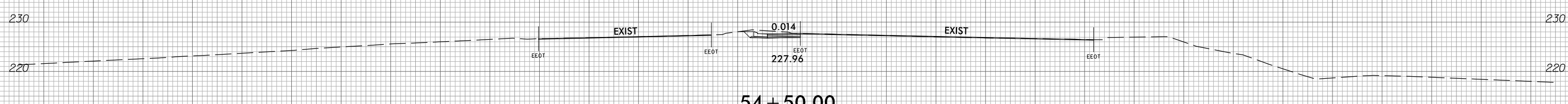
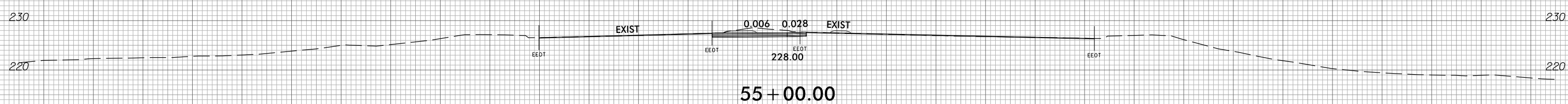
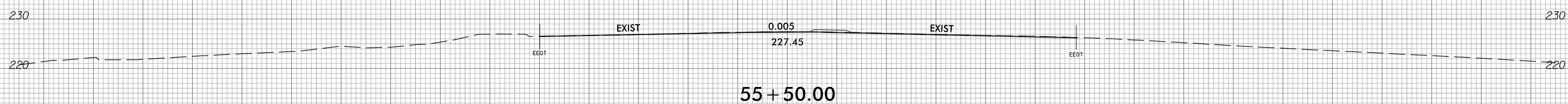
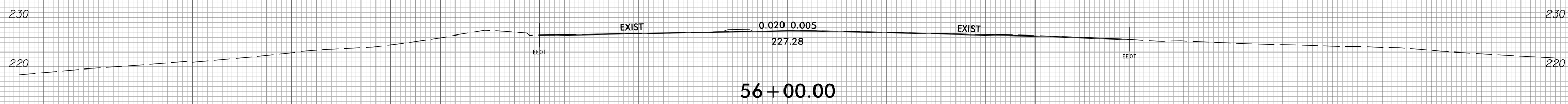
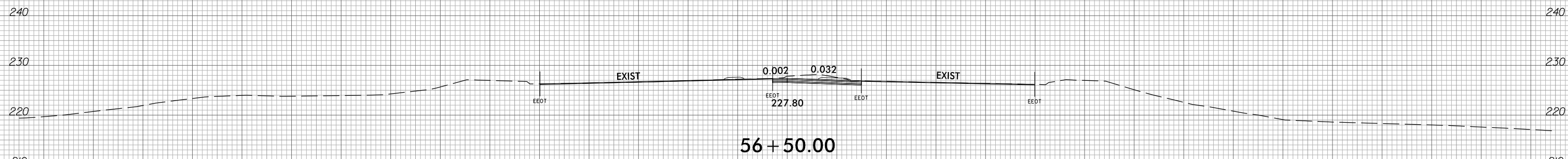

2/2/2023  
05748\_rdy\_xpl.l1  
patric.mcferson

150 140 130 120 110 100 90 80 70 60 50 40 30 20 10 0 10 20 30 40 50 60 70 80 90 100 110 120 130 140 150

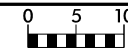

150 140 130 120 110 100 90 80 70 60 50 40 30 20 10 0 10 20 30 40 50 60 70 80 90 100 110 120 130 140 150

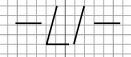
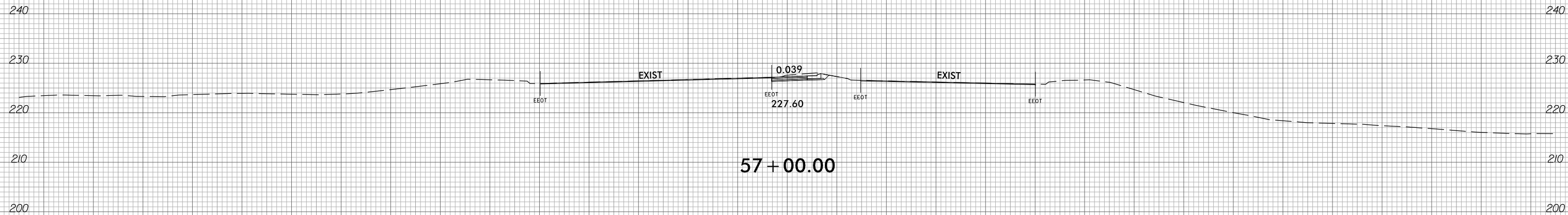
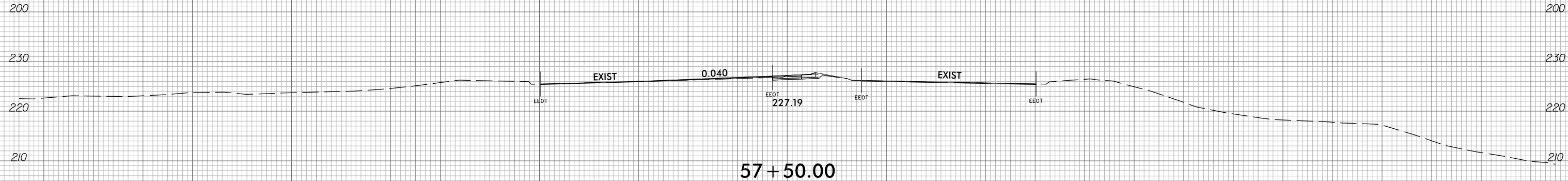
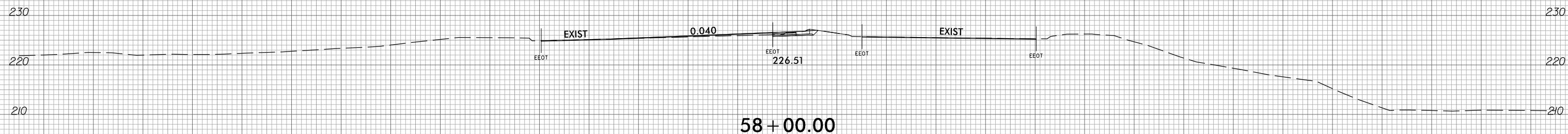
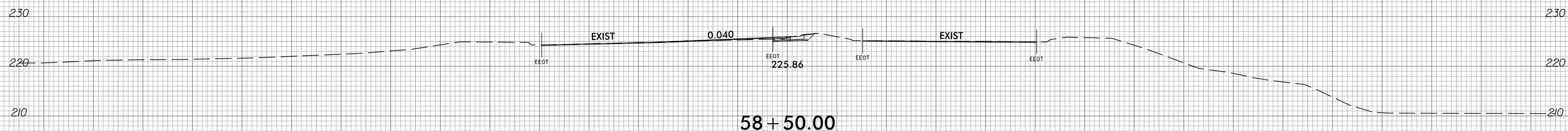
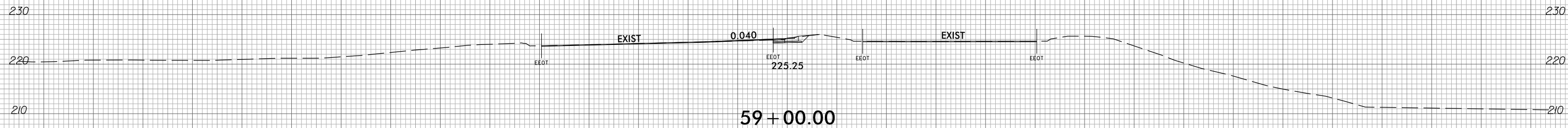

6/23/16



PROJ. REFERENCE NO.  
U-5748

SHEET NO.  
X-72

150 140 130 120 110 100 90 80 70 60 50 40 30 20 10 0 10 20 30 40 50 60 70 80 90 100 110 120 130 140 150

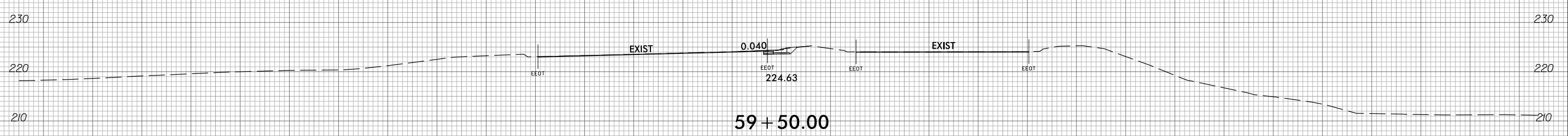
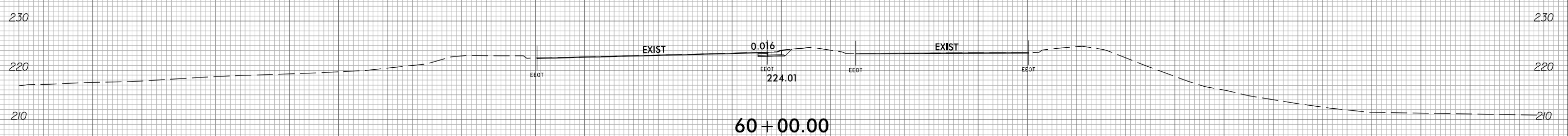
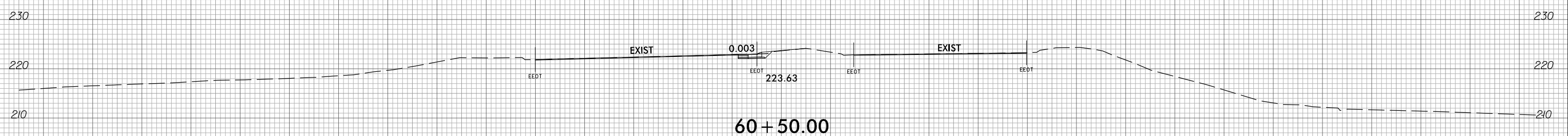
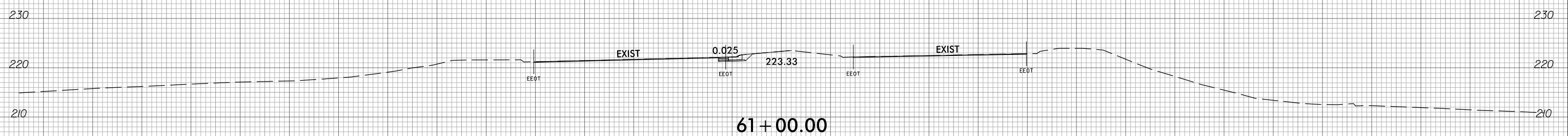
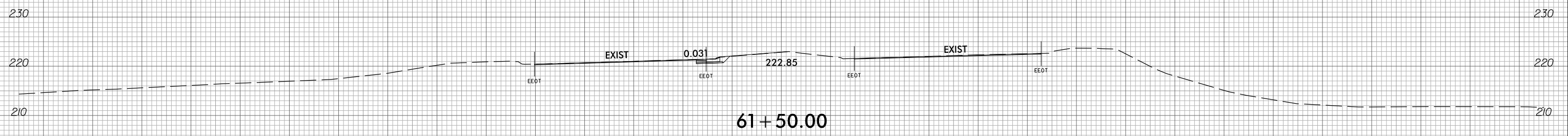
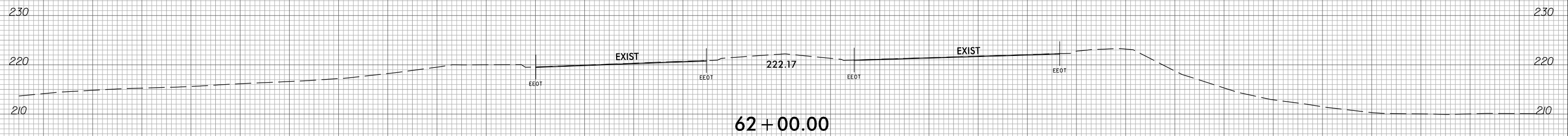

150 140 130 120 110 100 90 80 70 60 50 40 30 20 10 0 10 20 30 40 50 60 70 80 90 100 110 120 130 140 150

2/2/2023  
05748\_rdy\_xpl.l1  
patric.mplerson

