

DATE: NOVEMBER 4, 2022

**DOCUMENT NOT CONSIDERED FINAL
 UNLESS ALL SIGNATURES COMPLETED**

CROSS SECTION INDEX

LOCATION

- CROSS SECTION INDEX
- CROSS SECTION SUMMARY
- L- CROSS SECTIONS
- R1- CROSS SECTIONS

SHEET NO.

- X-0
- X-0A
- X-1 THRU X-14
- X-15 THRU X-29

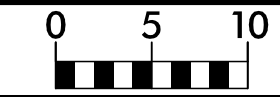

PROJ. REFERENCE NO.
P-5705A

SHEET NO.
X-1

150 140 130 120 110 100 90 80 70 60 50 40 30 20 10 0 10 20 30 40 50 60 70 80 90 100 110 120 130 140 150

NOTE:

THE TYPICAL SECTIONS TAKE PRECEDENCE OVER THE CROSS SECTIONS. CROSS SECTIONS ARE INCLUDED FOR REFERENCE ONLY

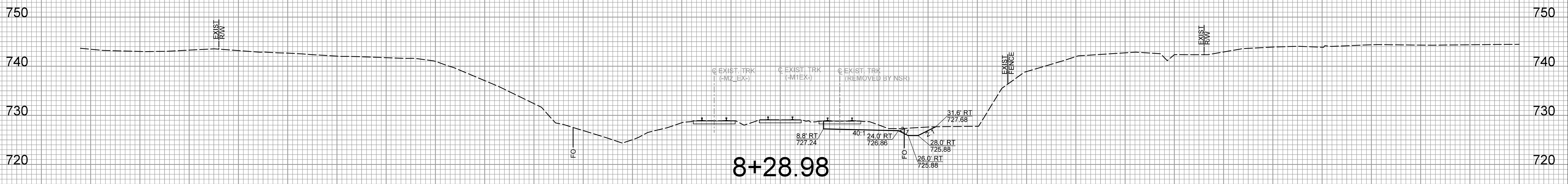
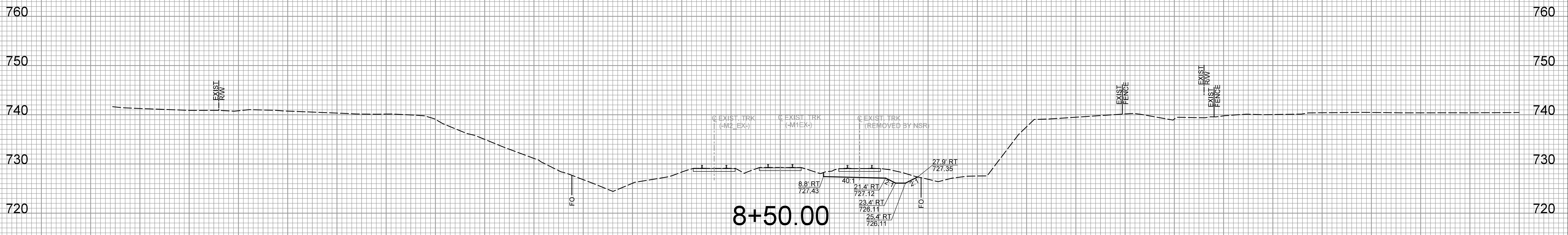
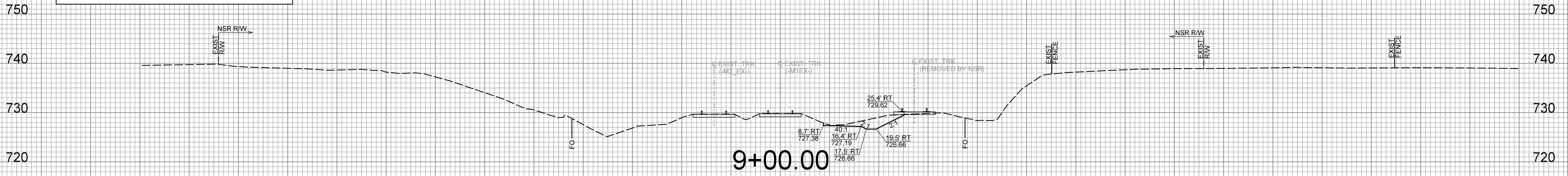

150 140 130 120 110 100 90 80 70 60 50 40 30 20 10 0 10 20 30 40 50 60 70 80 90 100 110 120 130 140 150

NOTE:
THE TYPICAL SECTIONS TAKE PRECEDENCE OVER THE CROSS SECTIONS. CROSS SECTIONS ARE INCLUDED FOR REFERENCE ONLY

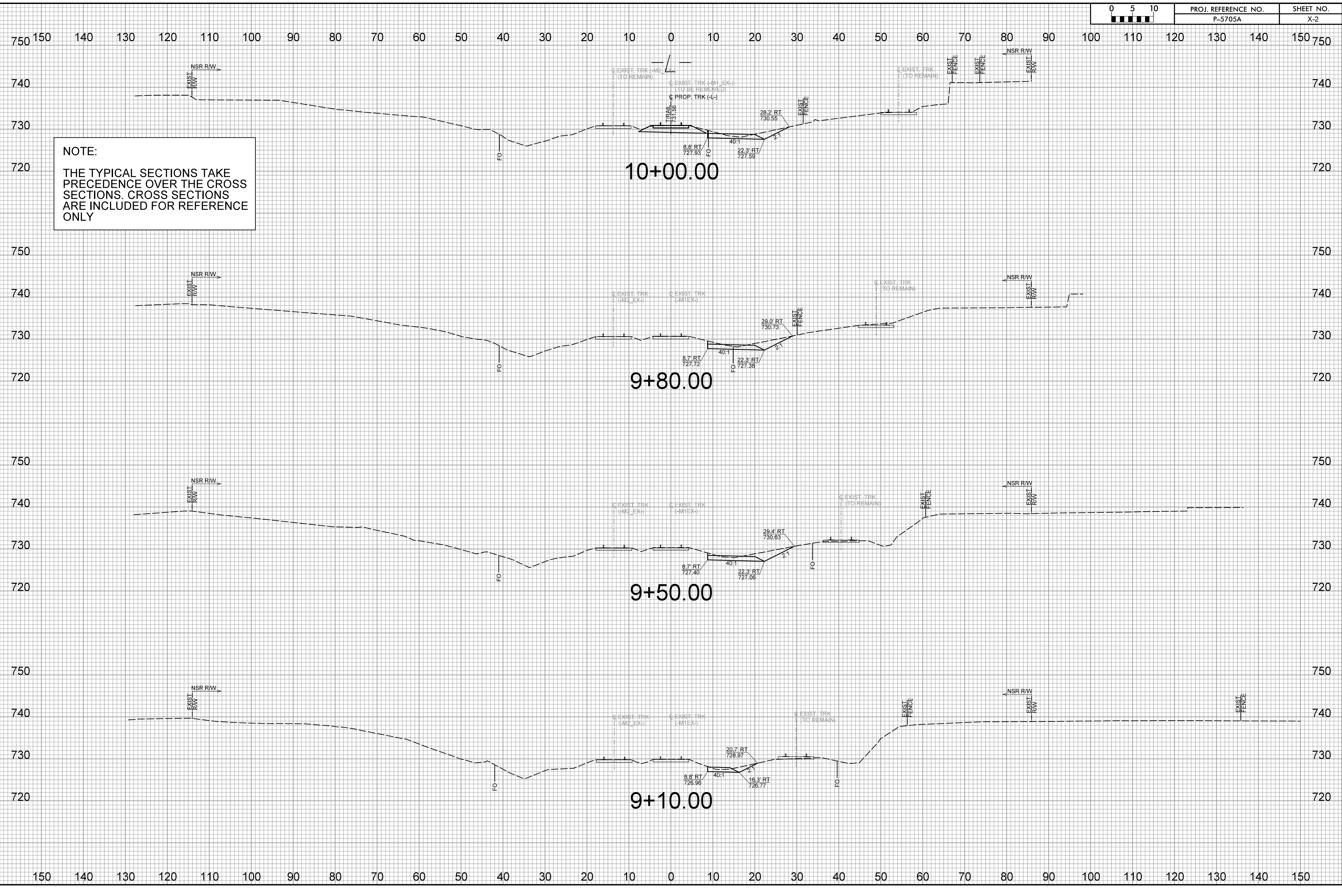

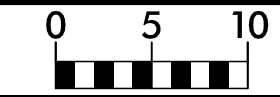

750 150 140 130 120 110 100 90 80 70 60 50 40 30 20 10 0 10 20 30 40 50 60 70 80 90 100 110 120 130 140 150 750

NOTE:
THE TYPICAL SECTIONS TAKE
PRECEDENCE OVER THE CROSS
SECTIONS. CROSS SECTIONS
ARE INCLUDED FOR REFERENCE
ONLY

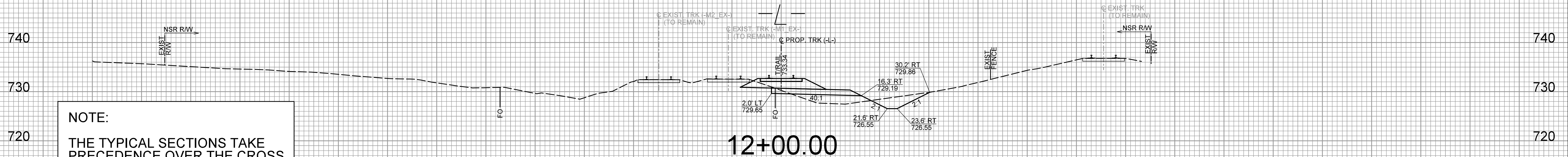

12+00.00

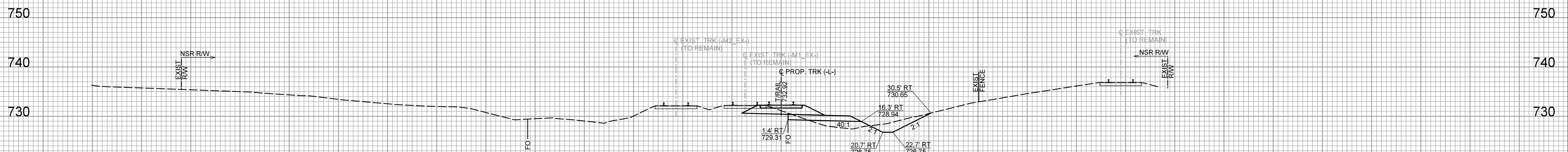

11+50.00

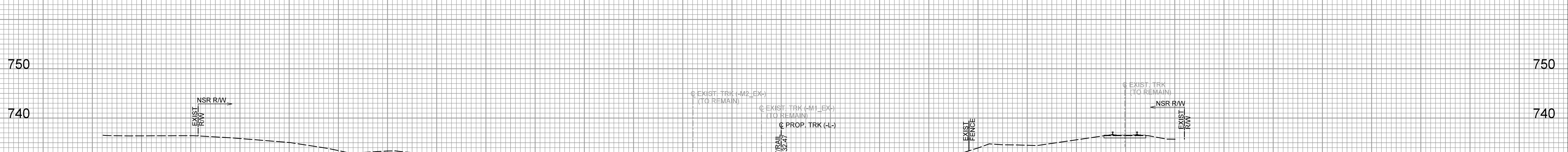

11+00.00

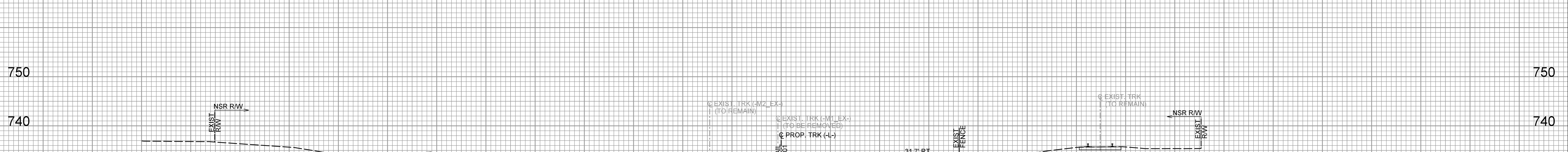

10+50.00

150 140 130 120 110 100 90 80 70 60 50 40 30 20 10 0 10 20 30 40 50 60 70 80 90 100 110 120 130 140 150

150 140 130 120 110 100 90 80 70 60 50 40 30 20 10 0 10 20 30 40 50 60 70 80 90 100 110 120 130 140 150

NOTE:
THE TYPICAL SECTIONS TAKE
PRECEDENCE OVER THE CROSS
SECTIONS. CROSS SECTIONS
ARE INCLUDED FOR REFERENCE
ONLY

-L-

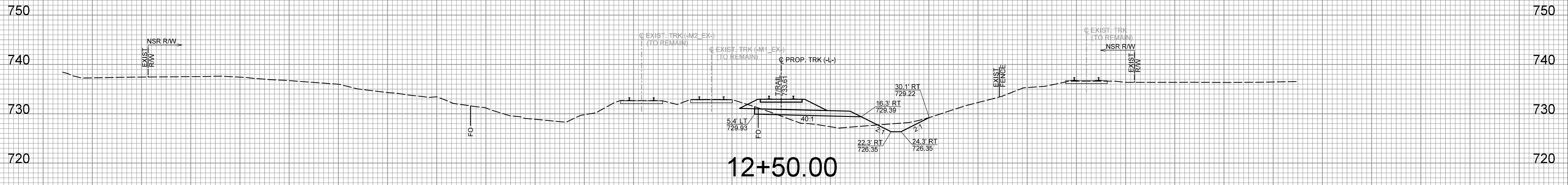
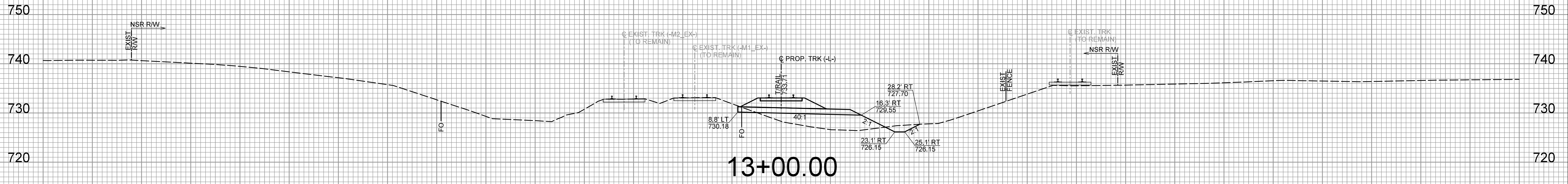
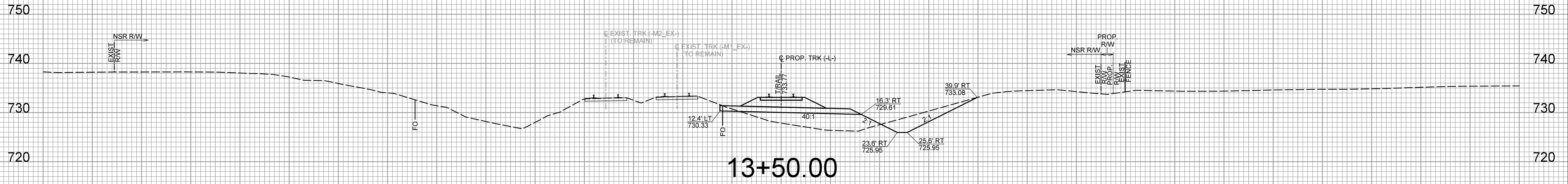

150 140 130 120 110 100 90 80 70 60 50 40 30 20 10 0 10 20 30 40 50 60 70 80 90 100 110 120 130 140 150

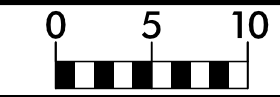

PROJ. REFERENCE NO.
P-5705A

SHEET NO.
X-5

150 140 130 120 110 100 90 80 70 60 50 40 30 20 10 0 10 20 30 40 50 60 70 80 90 100 110 120 130 140 150

NOTE:
THE TYPICAL SECTIONS TAKE
PRECEDENCE OVER THE CROSS
SECTIONS. CROSS SECTIONS
ARE INCLUDED FOR REFERENCE
ONLY

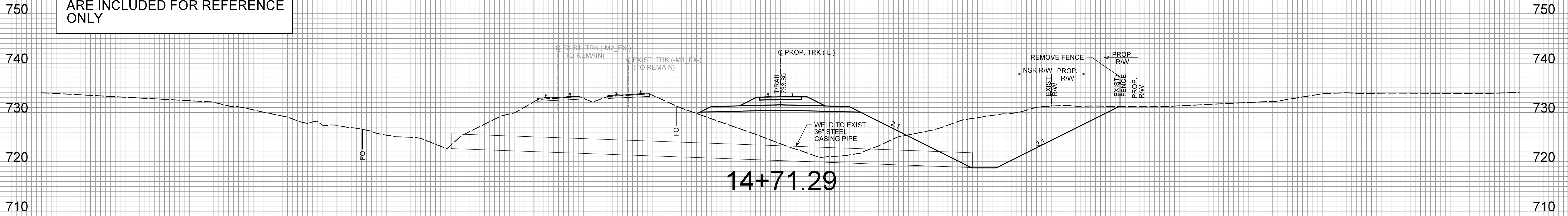

14+71.29

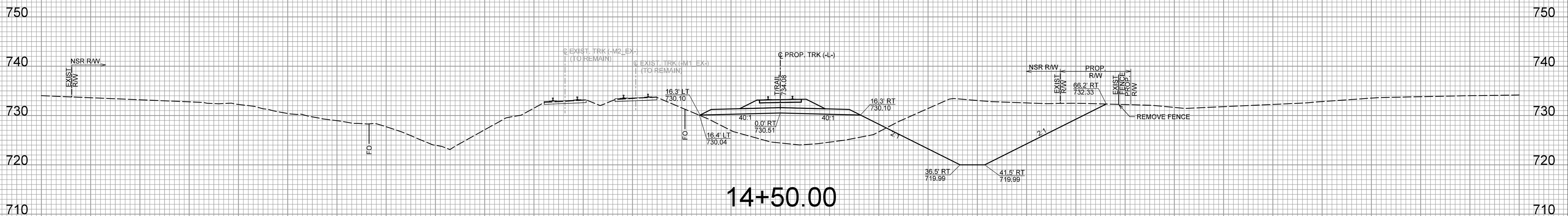

14+50.00

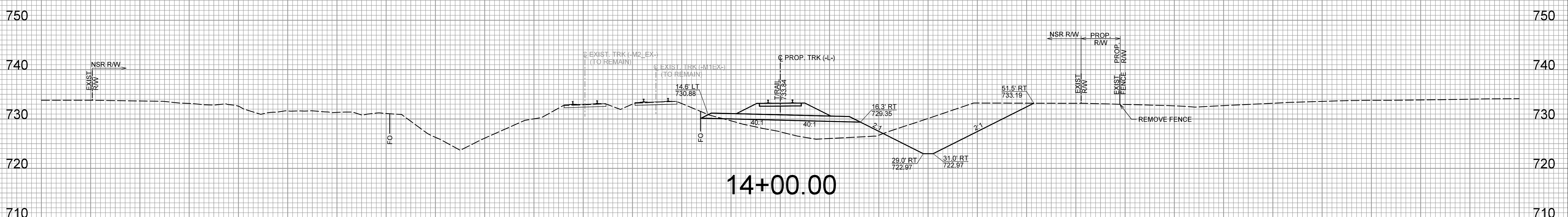

14+00.00

150 140 130 120 110 100 90 80 70 60 50 40 30 20 10 0 10 20 30 40 50 60 70 80 90 100 110 120 130 140 150

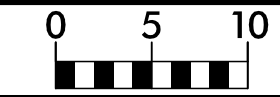

PROJ. REFERENCE NO.
P-5705A

SHEET NO.
X-6

150 140 130 120 110 100 90 80 70 60 50 40 30 20 10 0 10 20 30 40 50 60 70 80 90 100 110 120 130 140 150

NOTE:
THE TYPICAL SECTIONS TAKE
PRECEDENCE OVER THE CROSS
SECTIONS. CROSS SECTIONS
ARE INCLUDED FOR REFERENCE
ONLY

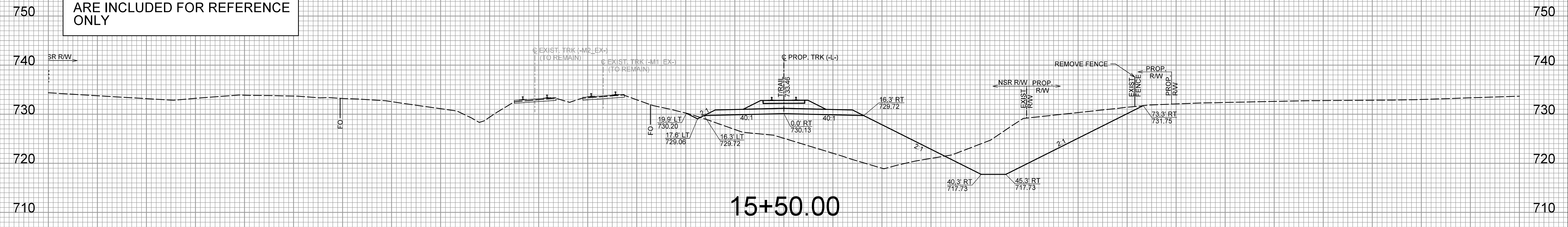
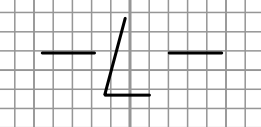

15+50.00

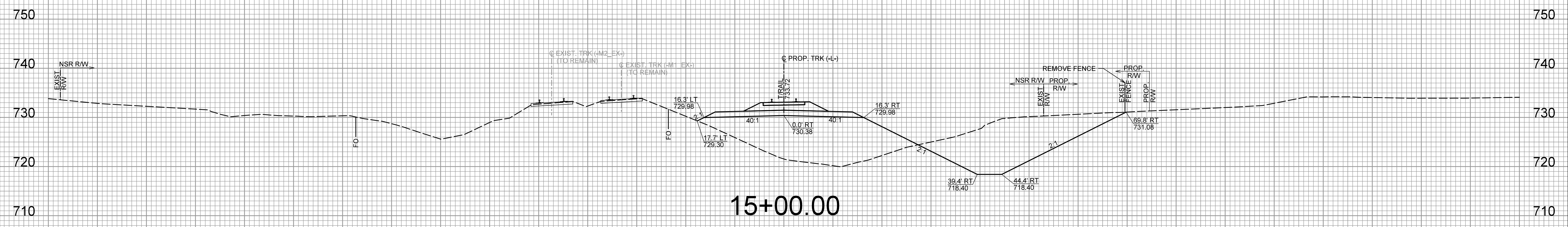

15+00.00

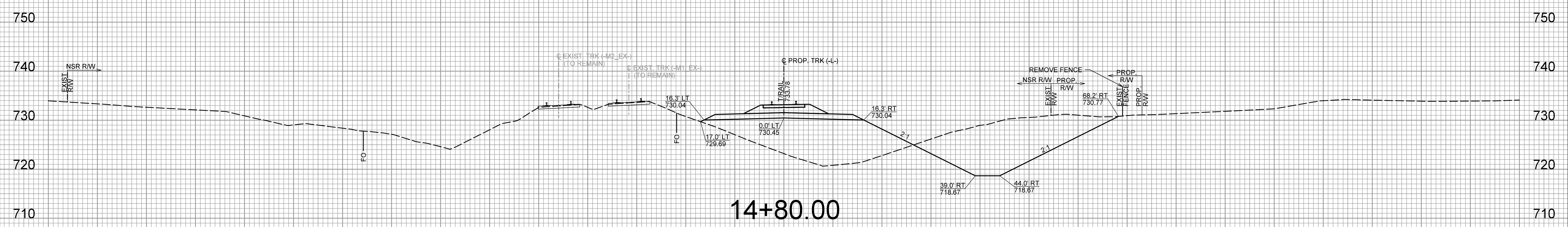

14+80.00

6/11/2023
11:18:05 a.m.
P-5705a_psh_X-1 thru X-14.dgn

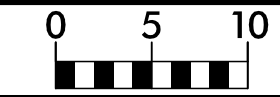

150 140 130 120 110 100 90 80 70 60 50 40 30 20 10 0 10 20 30 40 50 60 70 80 90 100 110 120 130 140 150

NOTE:
THE TYPICAL SECTIONS TAKE PRECEDENCE OVER THE CROSS SECTIONS. CROSS SECTIONS ARE INCLUDED FOR REFERENCE ONLY

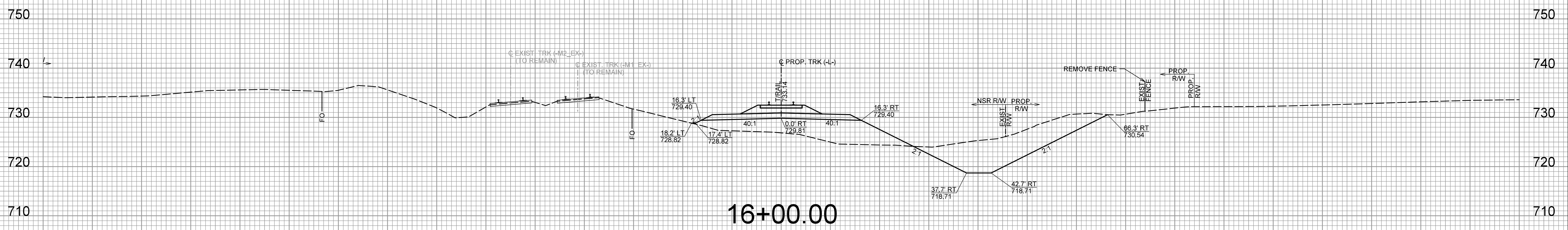
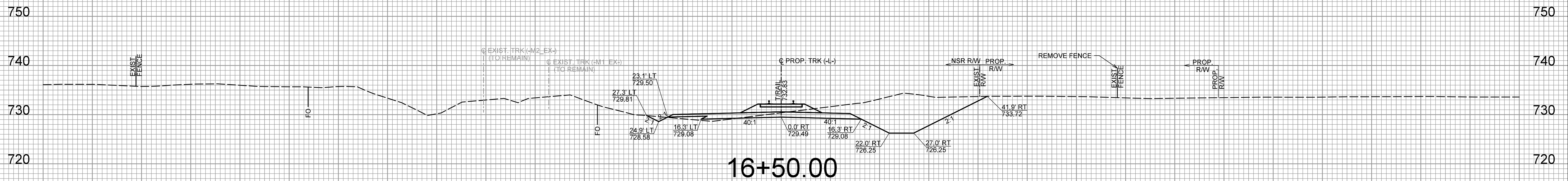
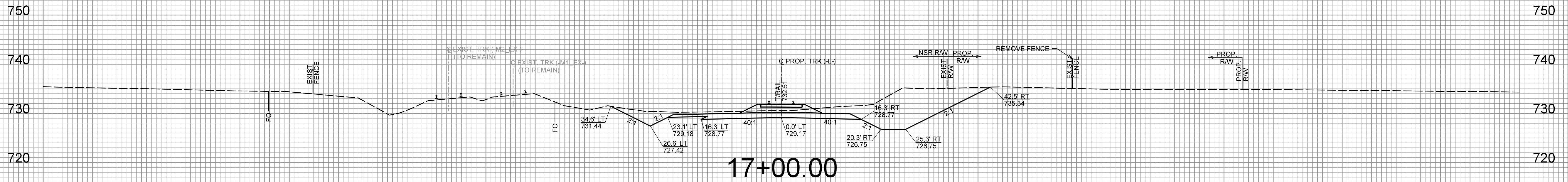
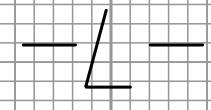

150 140 130 120 110 100 90 80 70 60 50 40 30 20 10 0 10 20 30 40 50 60 70 80 90 100 110 120 130 140 150

150 140 130 120 110 100 90 80 70 60 50 40 30 20 10 0 10 20 30 40 50 60 70 80 90 100 110 120 130 140 150

NOTE:
THE TYPICAL SECTIONS TAKE
PRECEDENCE OVER THE CROSS
SECTIONS. CROSS SECTIONS
ARE INCLUDED FOR REFERENCE
ONLY

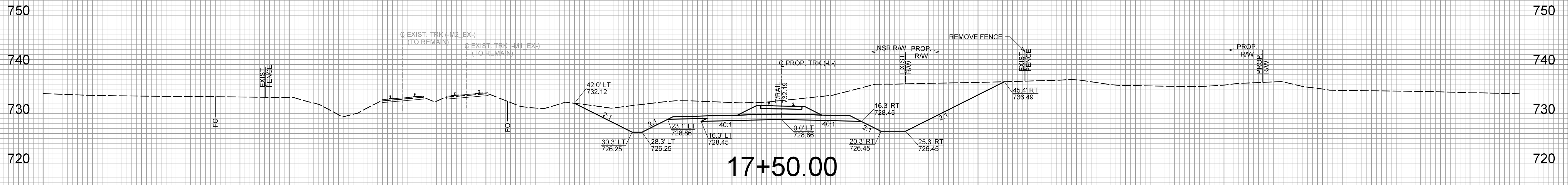
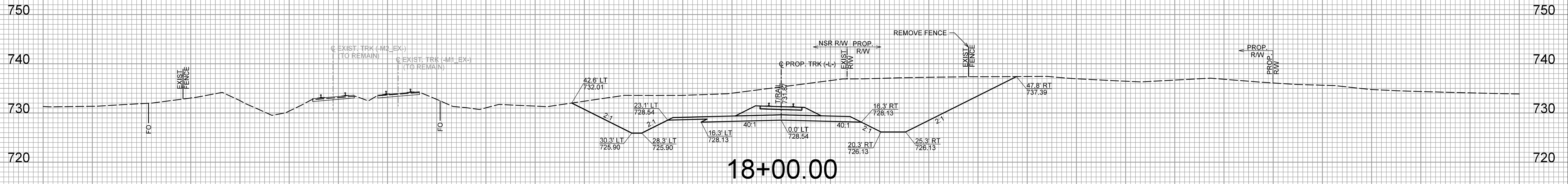
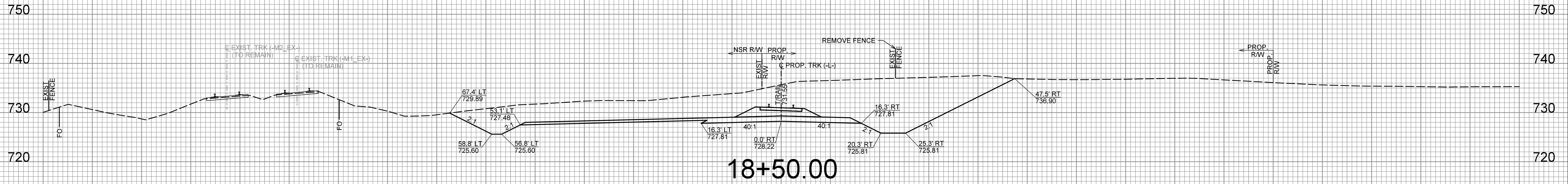
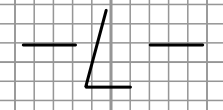

150 140 130 120 110 100 90 80 70 60 50 40 30 20 10 0 10 20 30 40 50 60 70 80 90 100 110 120 130 140 150

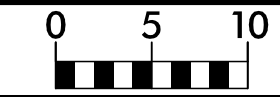

PROJ. REFERENCE NO.
P-5705A

SHEET NO.
X-9

150 140 130 120 110 100 90 80 70 60 50 40 30 20 10 0 10 20 30 40 50 60 70 80 90 100 110 120 130 140 150

NOTE:
THE TYPICAL SECTIONS TAKE
PRECEDENCE OVER THE CROSS
SECTIONS. CROSS SECTIONS
ARE INCLUDED FOR REFERENCE
ONLY

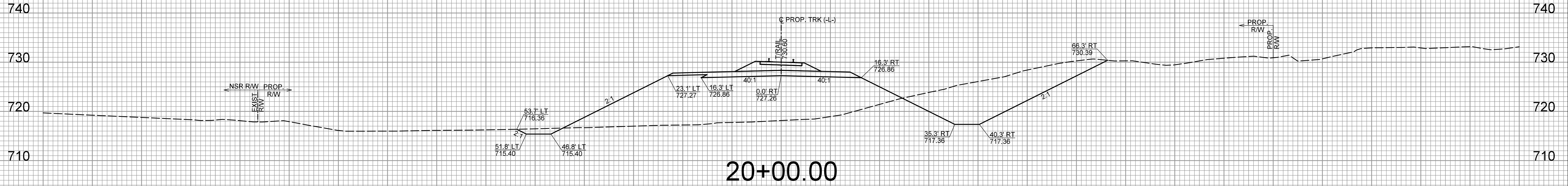
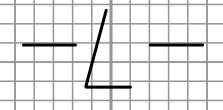

20+00.00

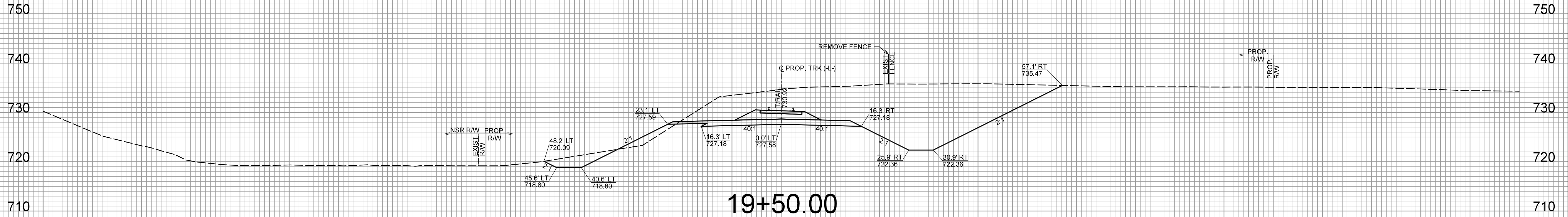

19+50.00

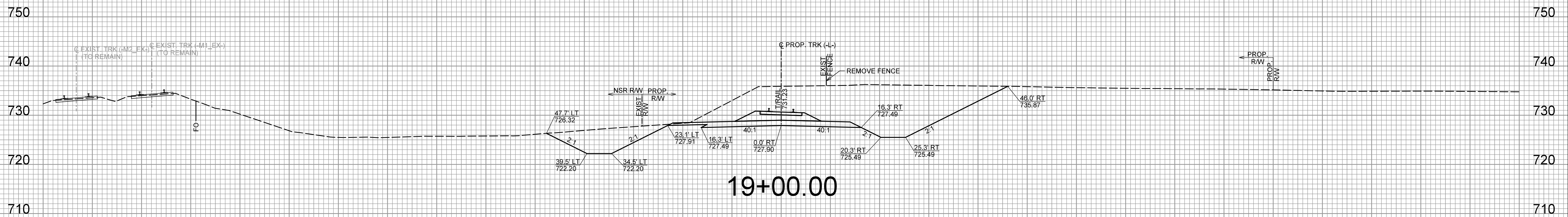

19+00.00

150 140 130 120 110 100 90 80 70 60 50 40 30 20 10 0 10 20 30 40 50 60 70 80 90 100 110 120 130 140 150

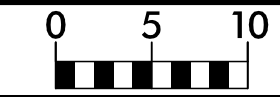

PROJ. REFERENCE NO.
P-5705A

SHEET NO.
X-10

150 140 130 120 110 100 90 80 70 60 50 40 30 20 10 0 10 20 30 40 50 60 70 80 90 100 110 120 130 140 150

NOTE:
THE TYPICAL SECTIONS TAKE
PRECEDENCE OVER THE CROSS
SECTIONS. CROSS SECTIONS
ARE INCLUDED FOR REFERENCE
ONLY

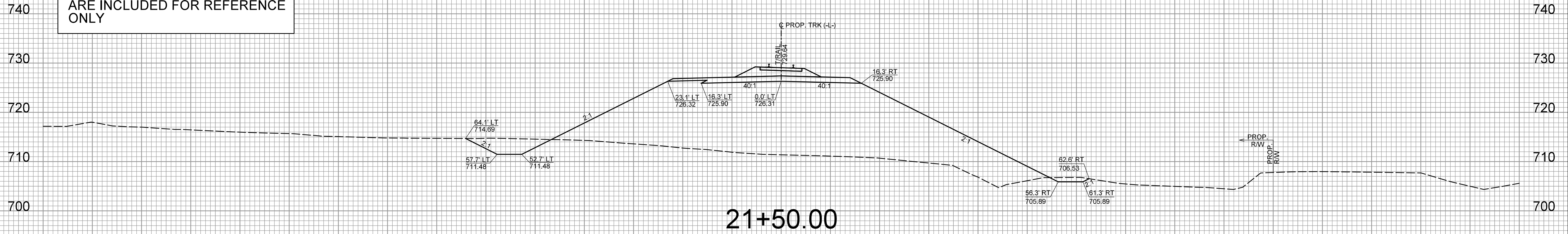
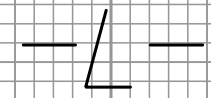

21+50.00

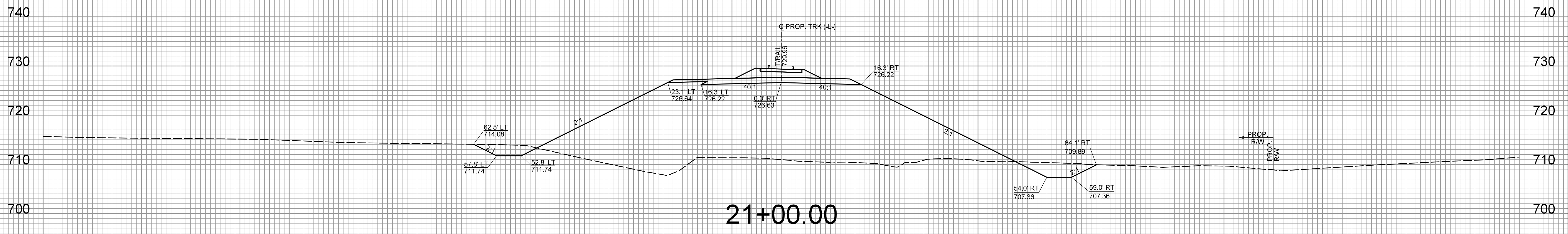

21+00.00

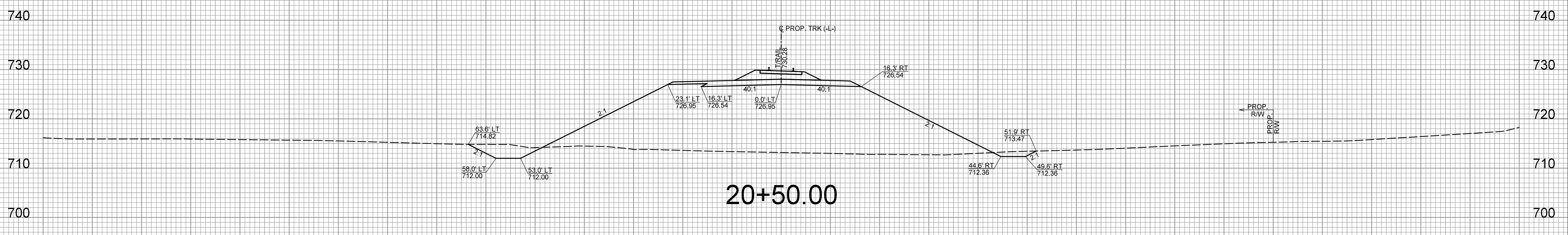

20+50.00

150 140 130 120 110 100 90 80 70 60 50 40 30 20 10 0 10 20 30 40 50 60 70 80 90 100 110 120 130 140 150

150 140 130 120 110 100 90 80 70 60 50 40 30 20 10 0 10 20 30 40 50 60 70 80 90 100 110 120 130 140 150

NOTE:
THE TYPICAL SECTIONS TAKE
PRECEDENCE OVER THE CROSS
SECTIONS. CROSS SECTIONS
ARE INCLUDED FOR REFERENCE
ONLY

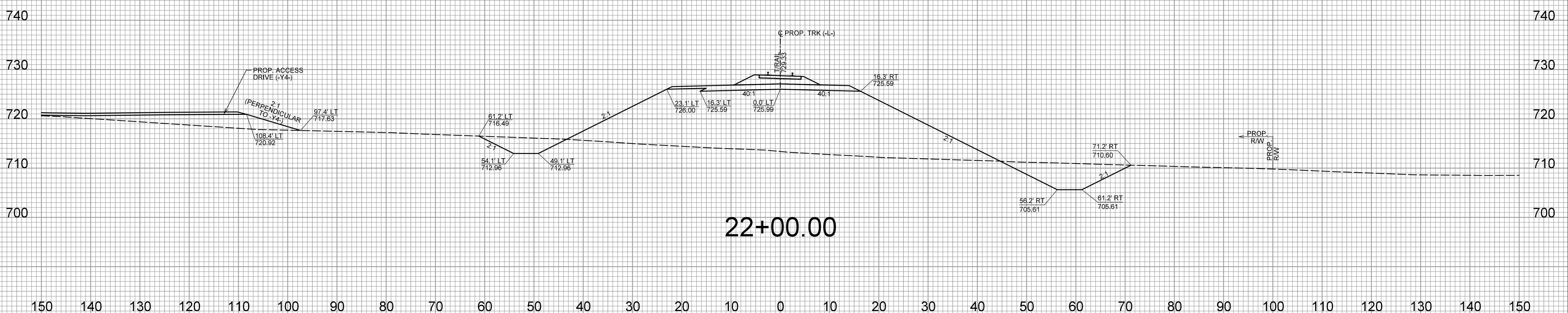
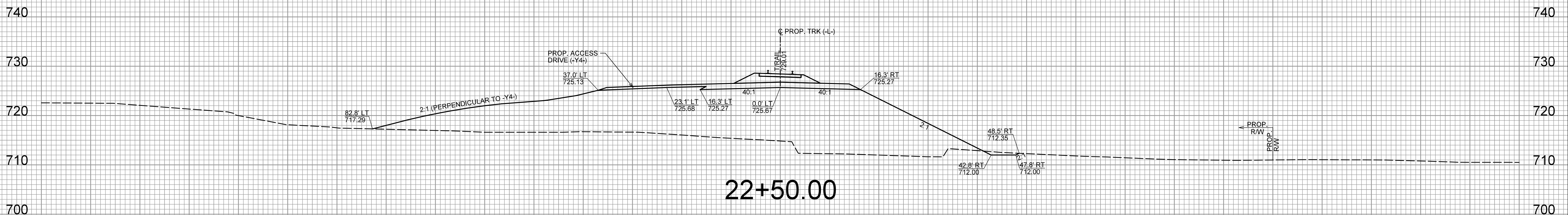
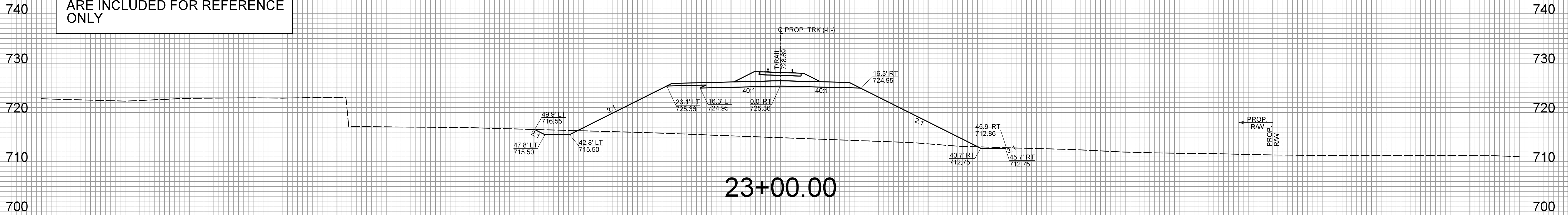

150 140 130 120 110 100 90 80 70 60 50 40 30 20 10 0 10 20 30 40 50 60 70 80 90 100 110 120 130 140 150

150 140 130 120 110 100 90 80 70 60 50 40 30 20 10 0 10 20 30 40 50 60 70 80 90 100 110 120 130 140 150

NOTE:
THE TYPICAL SECTIONS TAKE
PRECEDENCE OVER THE CROSS
SECTIONS. CROSS SECTIONS
ARE INCLUDED FOR REFERENCE
ONLY

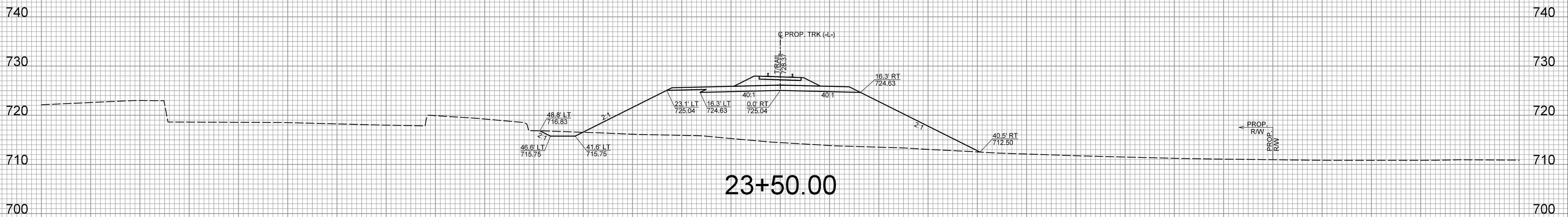
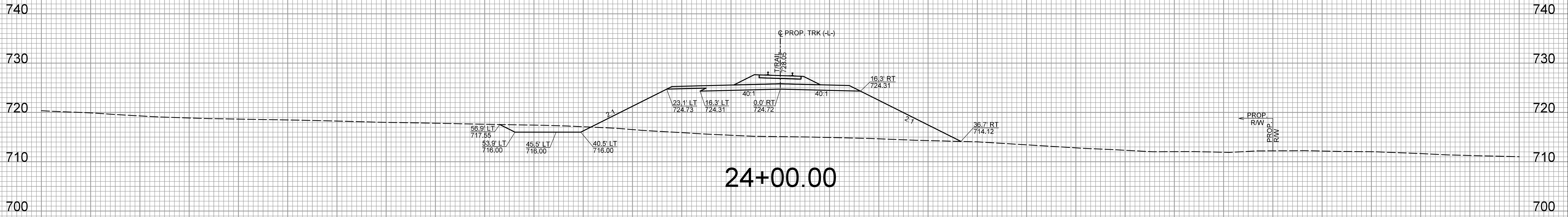
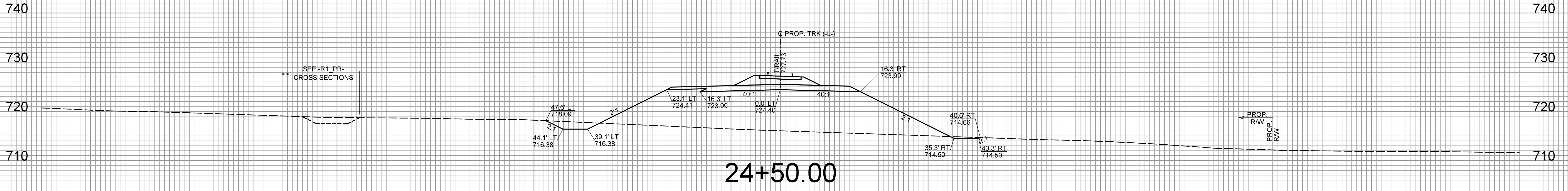

150 140 130 120 110 100 90 80 70 60 50 40 30 20 10 0 10 20 30 40 50 60 70 80 90 100 110 120 130 140 150

150 140 130 120 110 100 90 80 70 60 50 40 30 20 10 0 10 20 30 40 50 60 70 80 90 100 110 120 130 140 150

NOTE:
THE TYPICAL SECTIONS TAKE PRECEDENCE OVER THE CROSS SECTIONS. CROSS SECTIONS ARE INCLUDED FOR REFERENCE ONLY

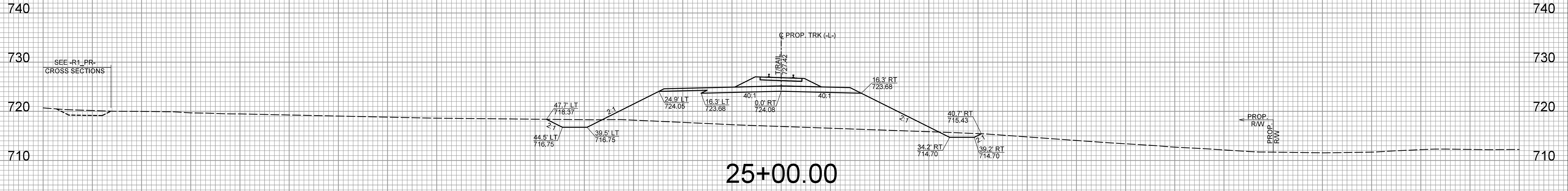
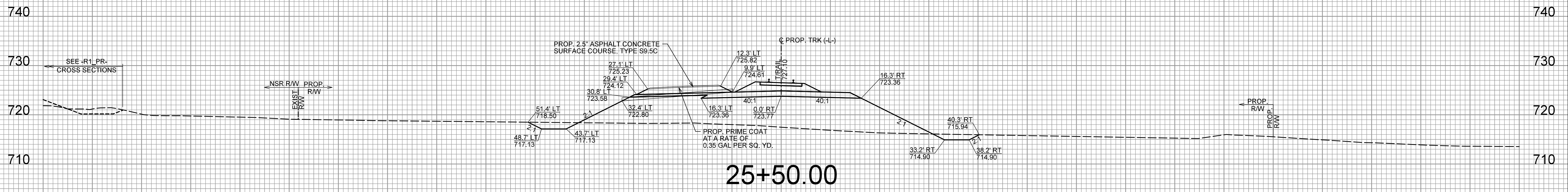
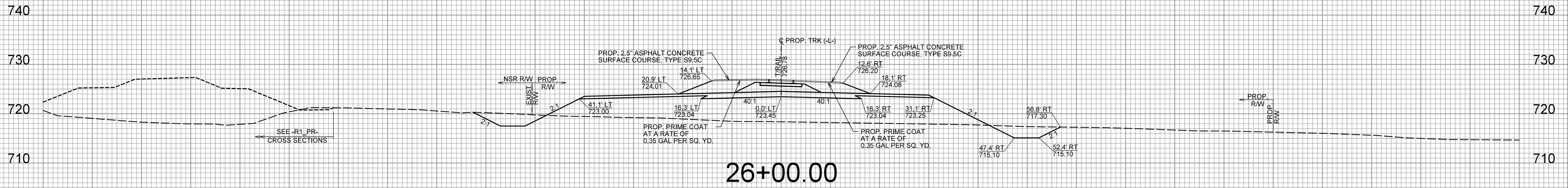
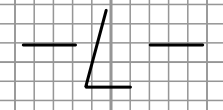

150 140 130 120 110 100 90 80 70 60 50 40 30 20 10 0 10 20 30 40 50 60 70 80 90 100 110 120 130 140 150

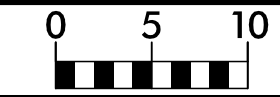

PROJ. REFERENCE NO.
P-5705A

SHEET NO.
X-14

150 140 130 120 110 100 90 80 70 60 50 40 30 20 10 0 10 20 30 40 50 60 70 80 90 100 110 120 130 140 150

NOTE:
THE TYPICAL SECTIONS TAKE
PRECEDENCE OVER THE CROSS
SECTIONS. CROSS SECTIONS
ARE INCLUDED FOR REFERENCE
ONLY

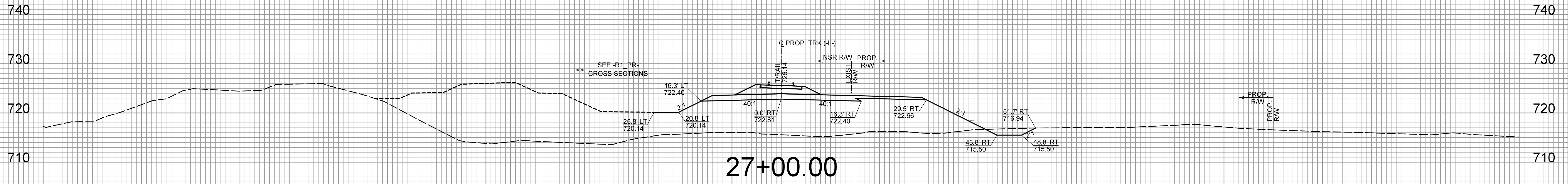
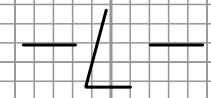

27+00.00

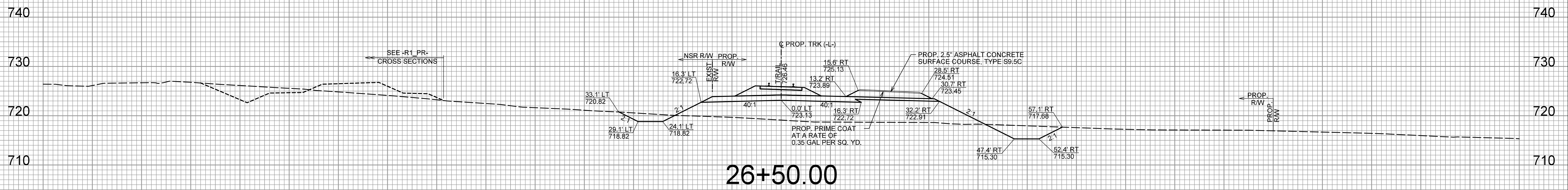

26+50.00

150 140 130 120 110 100 90 80 70 60 50 40 30 20 10 0 10 20 30 40 50 60 70 80 90 100 110 120 130 140 150

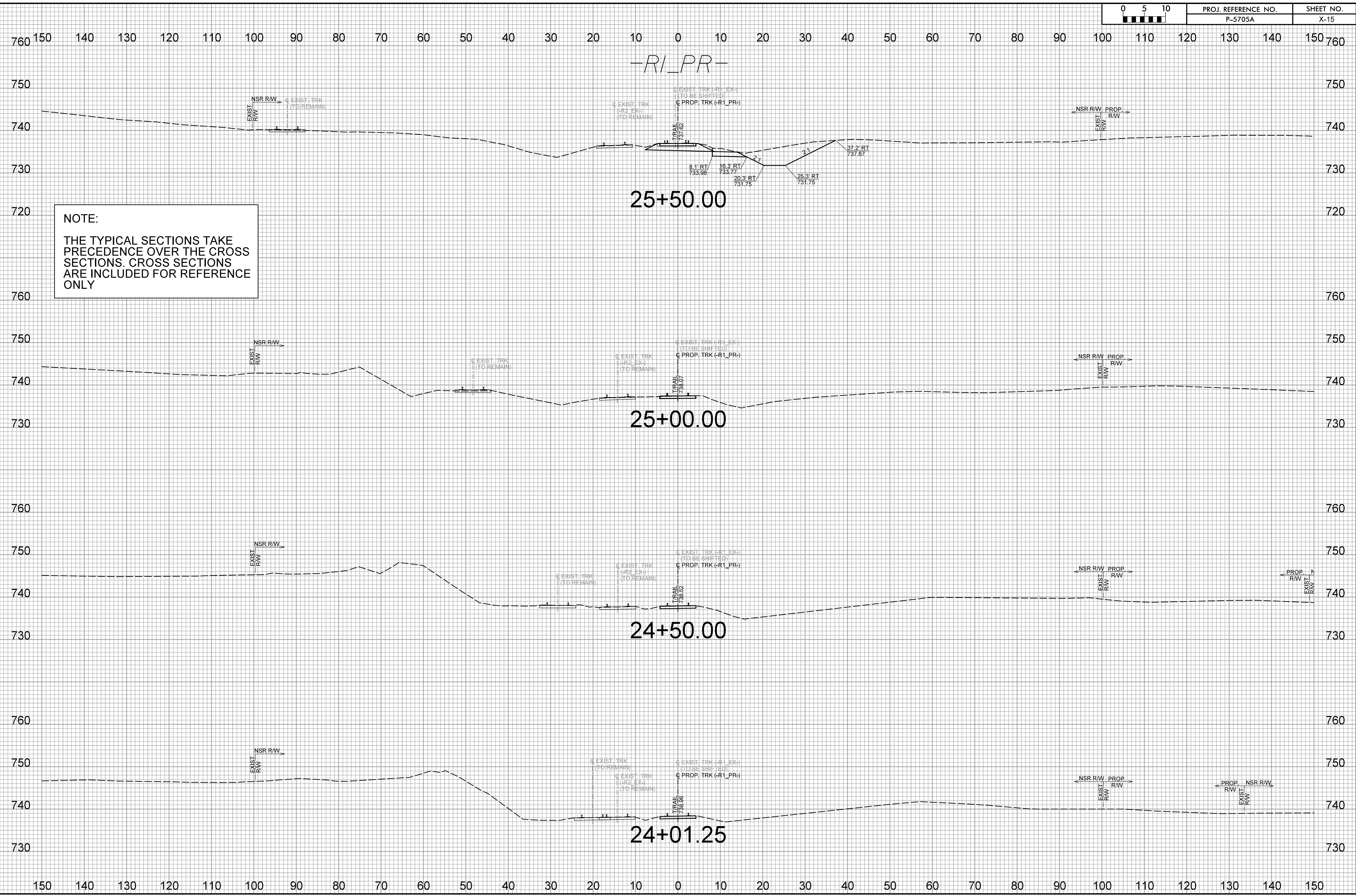
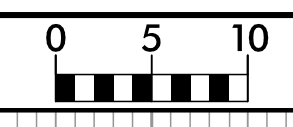

NOTE:
THE TYPICAL SECTIONS TAKE PRECEDENCE OVER THE CROSS SECTIONS. CROSS SECTIONS ARE INCLUDED FOR REFERENCE ONLY

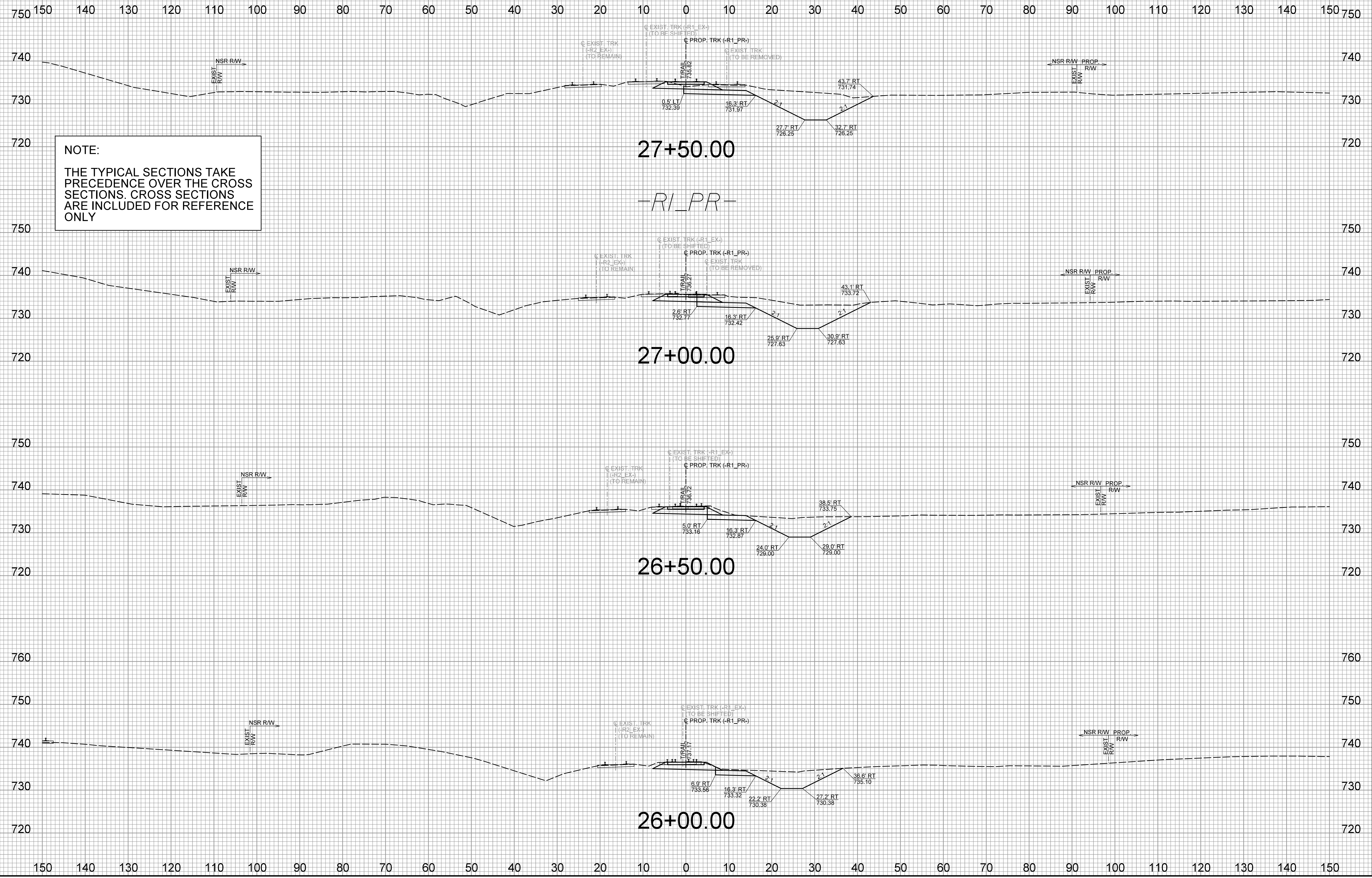
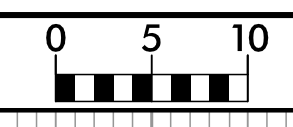

NOTE:
THE TYPICAL SECTIONS TAKE PRECEDENCE OVER THE CROSS SECTIONS. CROSS SECTIONS ARE INCLUDED FOR REFERENCE ONLY

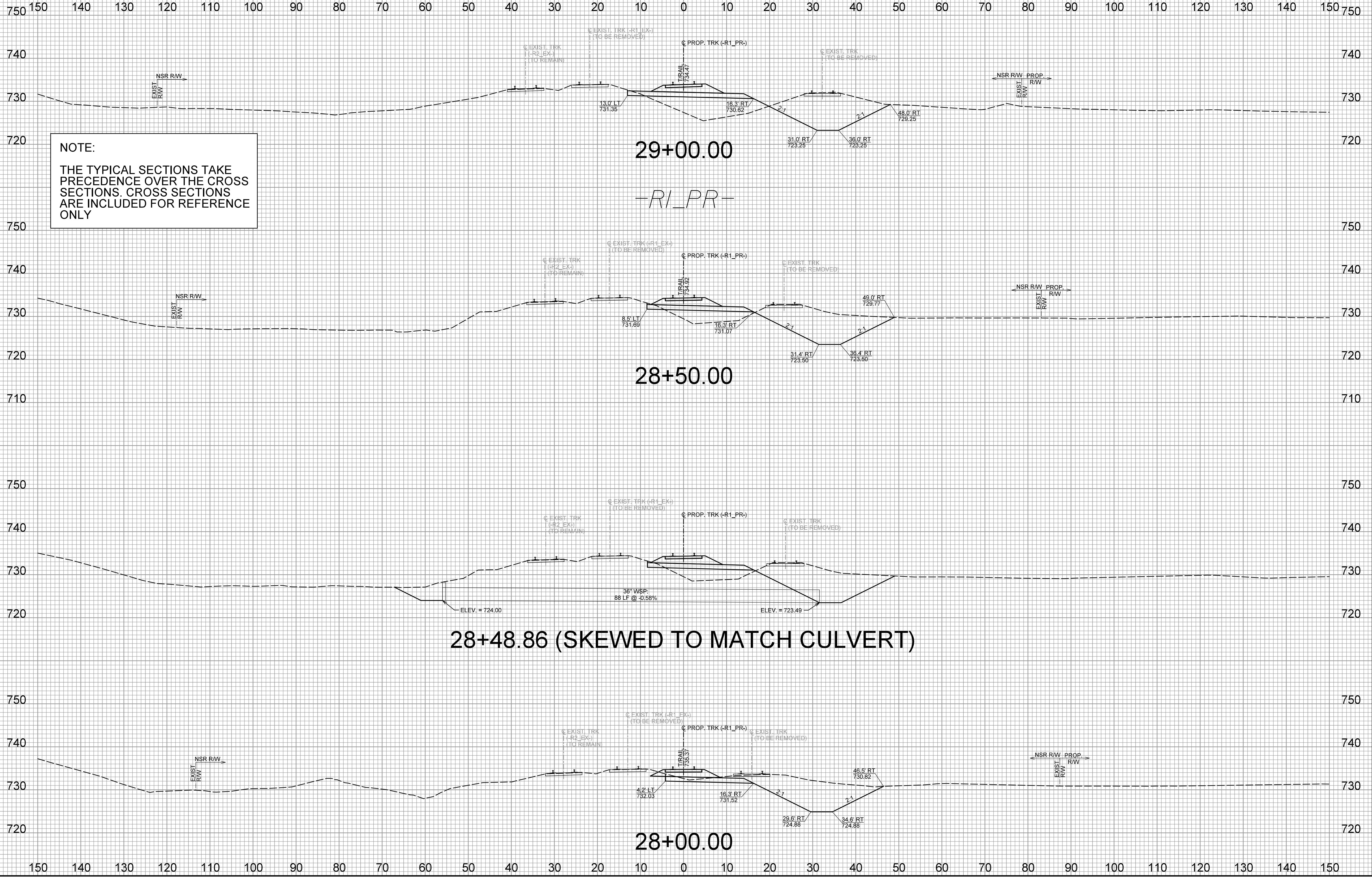
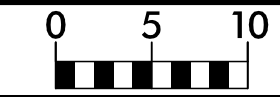

NOTE:
THE TYPICAL SECTIONS TAKE PRECEDENCE OVER THE CROSS SECTIONS. CROSS SECTIONS ARE INCLUDED FOR REFERENCE ONLY

150 140 130 120 110 100 90 80 70 60 50 40 30 20 10 0 10 20 30 40 50 60 70 80 90 100 110 120 130 140 150

NOTE:
THE TYPICAL SECTIONS TAKE
PRECEDENCE OVER THE CROSS
SECTIONS. CROSS SECTIONS
ARE INCLUDED FOR REFERENCE
ONLY

-R1_PR-

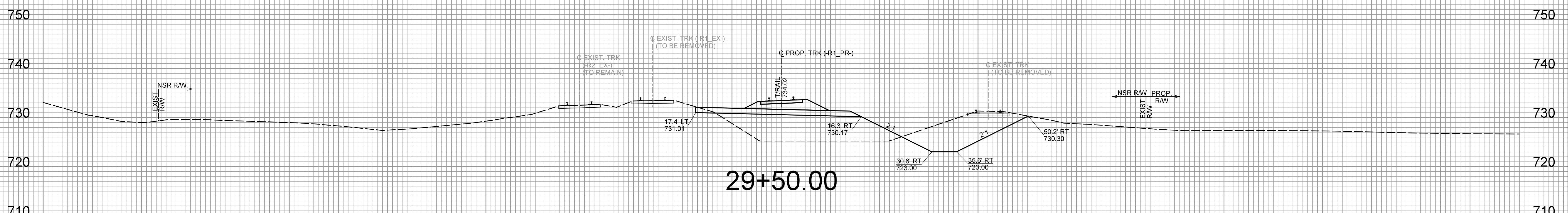
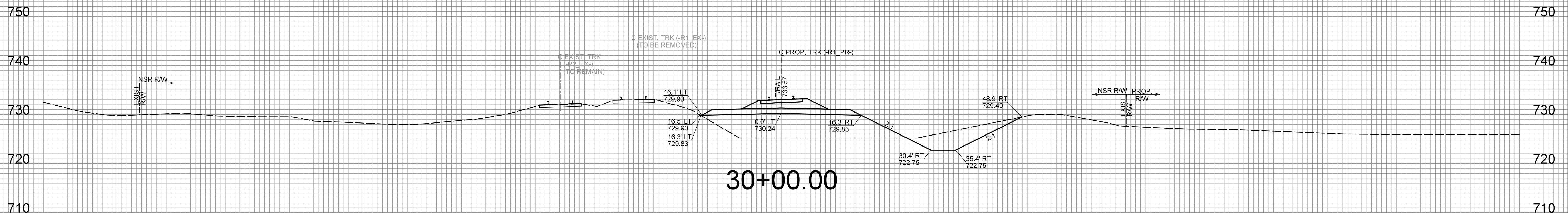
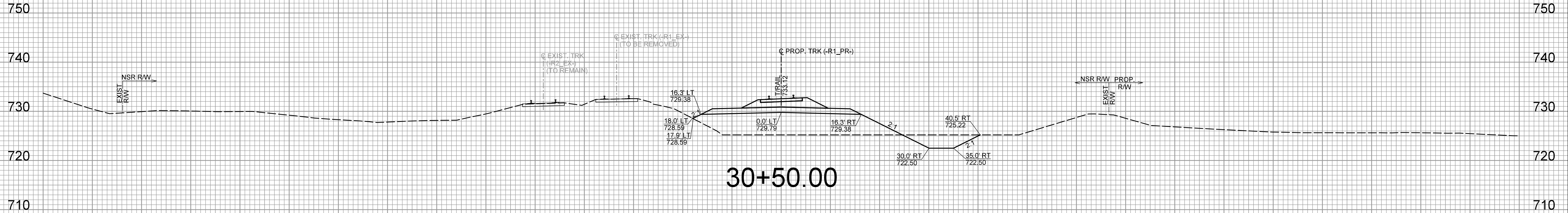

150 140 130 120 110 100 90 80 70 60 50 40 30 20 10 0 10 20 30 40 50 60 70 80 90 100 110 120 130 140 150

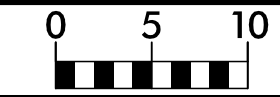

150 140 130 120 110 100 90 80 70 60 50 40 30 20 10 0 10 20 30 40 50 60 70 80 90 100 110 120 130 140 150

NOTE:
THE TYPICAL SECTIONS TAKE
PRECEDENCE OVER THE CROSS
SECTIONS. CROSS SECTIONS
ARE INCLUDED FOR REFERENCE
ONLY

-R1_PR-

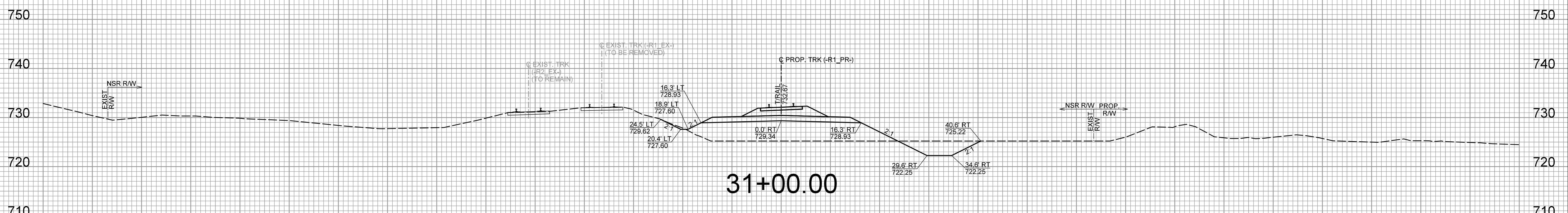
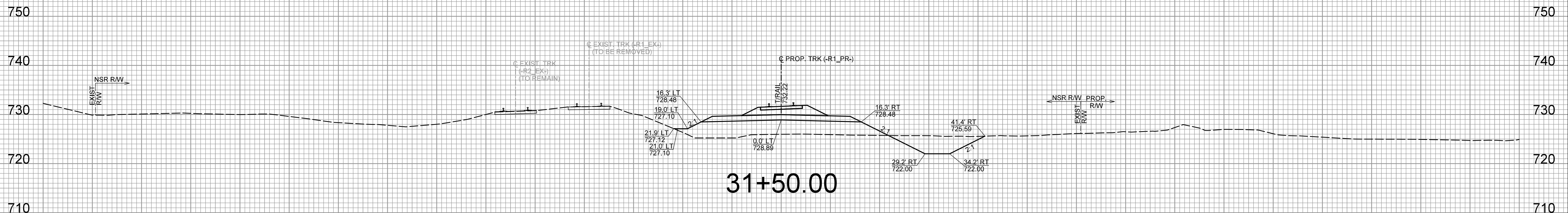
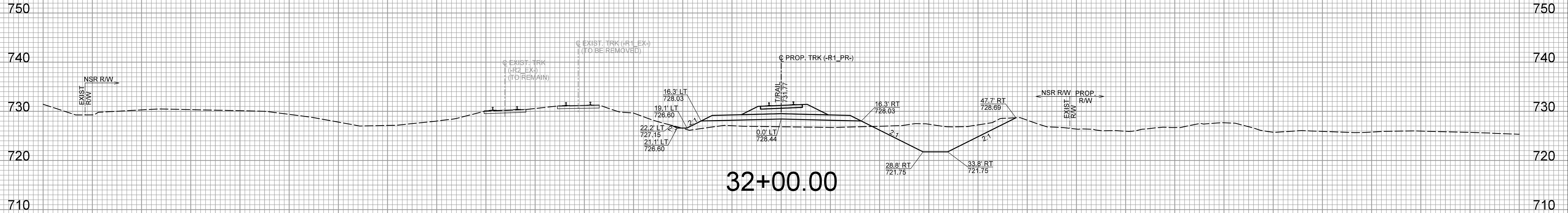

150 140 130 120 110 100 90 80 70 60 50 40 30 20 10 0 10 20 30 40 50 60 70 80 90 100 110 120 130 140 150

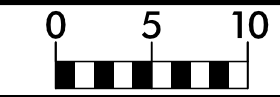

150 140 130 120 110 100 90 80 70 60 50 40 30 20 10 0 10 20 30 40 50 60 70 80 90 100 110 120 130 140 150

NOTE:
 THE TYPICAL SECTIONS TAKE
 PRECEDENCE OVER THE CROSS
 SECTIONS. CROSS SECTIONS
 ARE INCLUDED FOR REFERENCE
 ONLY

-R1_PR-

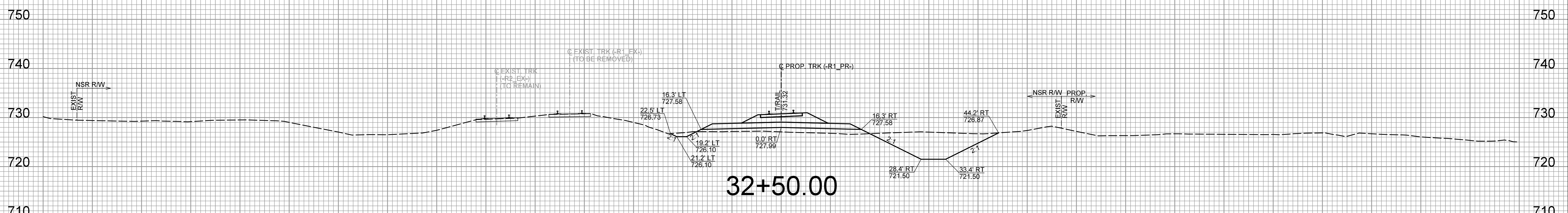
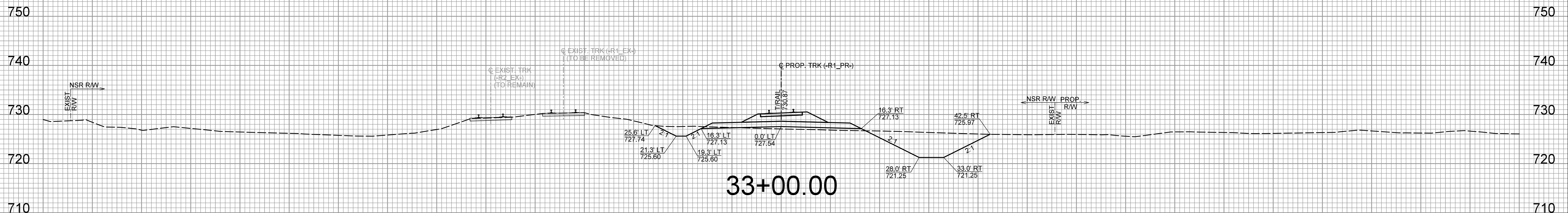
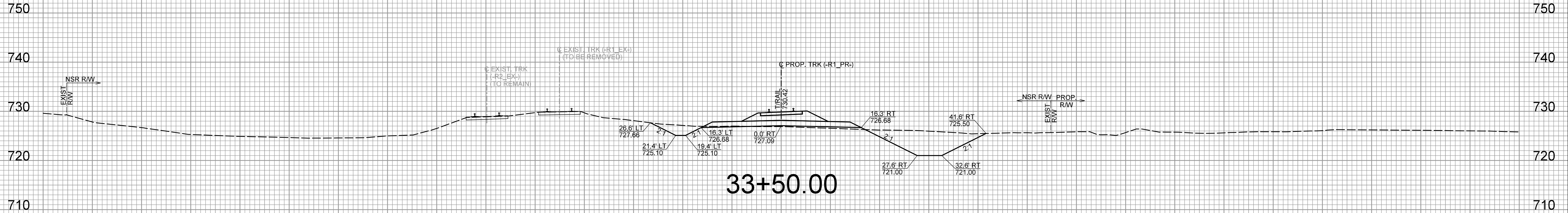

150 140 130 120 110 100 90 80 70 60 50 40 30 20 10 0 10 20 30 40 50 60 70 80 90 100 110 120 130 140 150

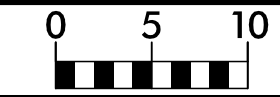

150 140 130 120 110 100 90 80 70 60 50 40 30 20 10 0 10 20 30 40 50 60 70 80 90 100 110 120 130 140 150

NOTE:
THE TYPICAL SECTIONS TAKE
PRECEDENCE OVER THE CROSS
SECTIONS. CROSS SECTIONS
ARE INCLUDED FOR REFERENCE
ONLY

-R1_PR-

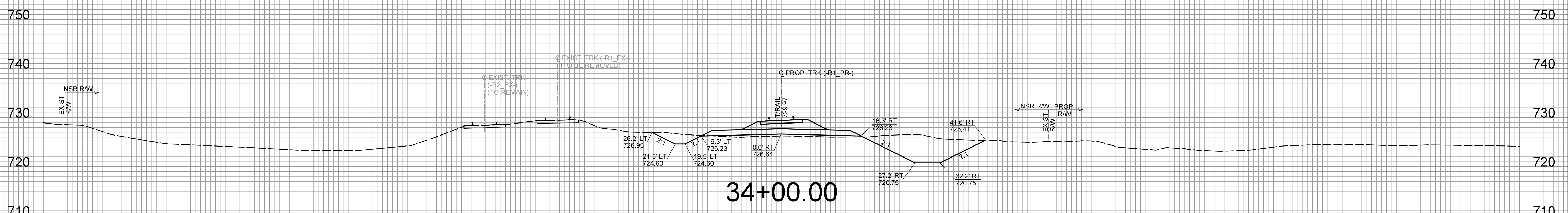
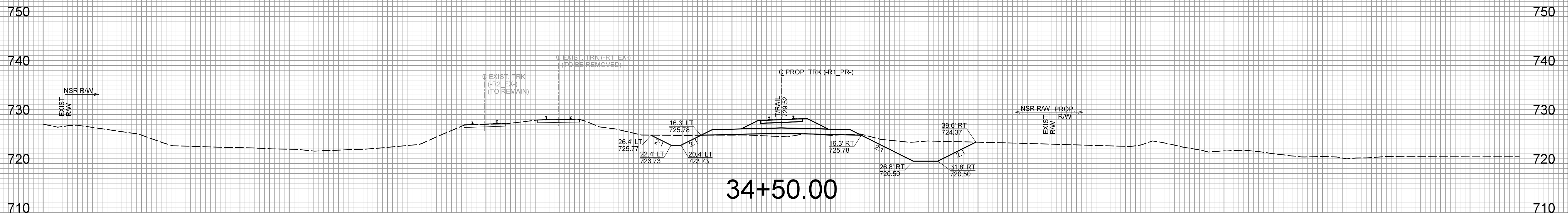
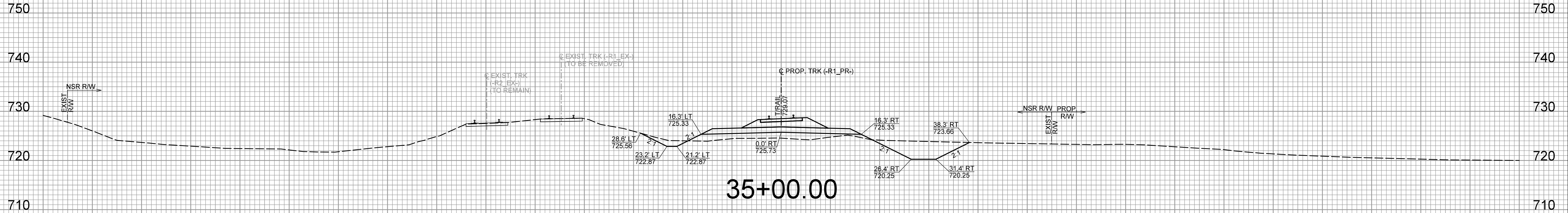

150 140 130 120 110 100 90 80 70 60 50 40 30 20 10 0 10 20 30 40 50 60 70 80 90 100 110 120 130 140 150

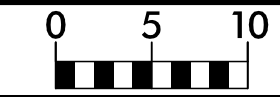

150 140 130 120 110 100 90 80 70 60 50 40 30 20 10 0 10 20 30 40 50 60 70 80 90 100 110 120 130 140 150

NOTE:
THE TYPICAL SECTIONS TAKE PRECEDENCE OVER THE CROSS SECTIONS. CROSS SECTIONS ARE INCLUDED FOR REFERENCE ONLY

-R1_PR-

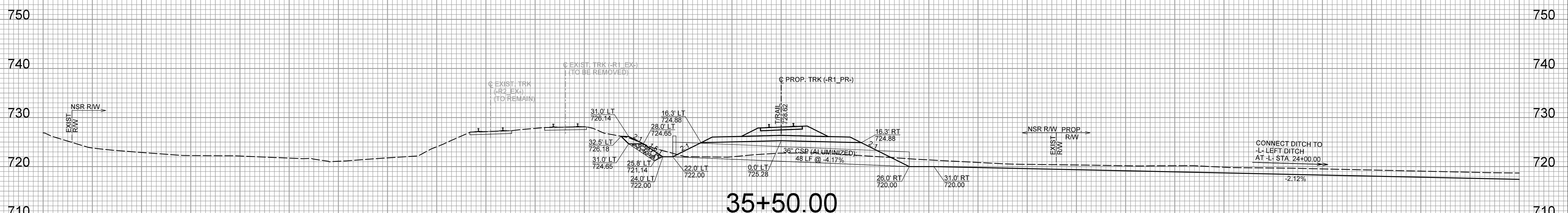
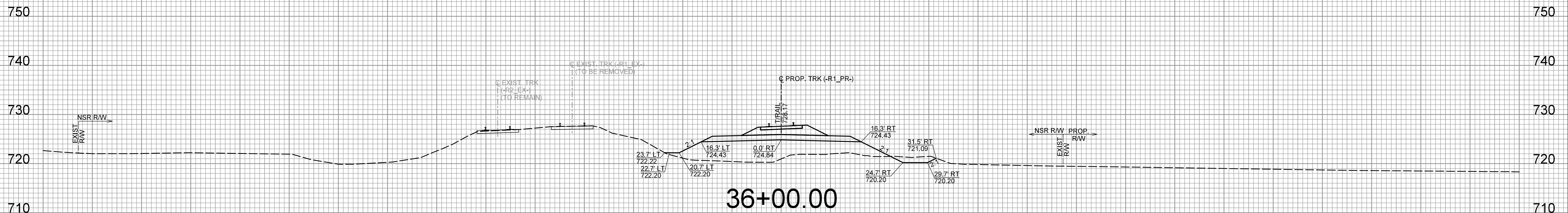
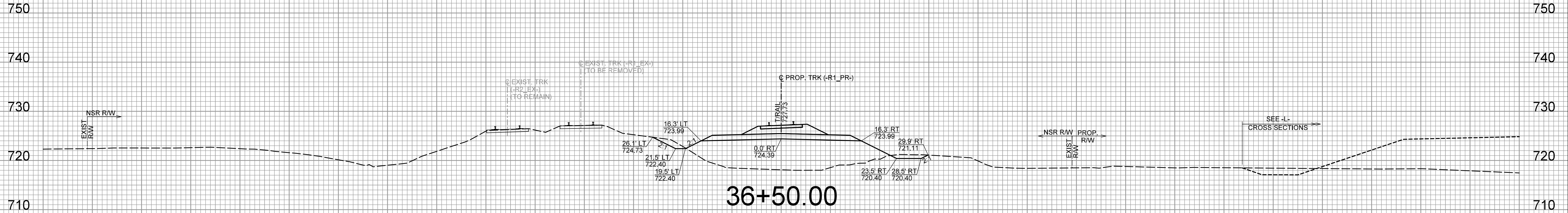

150 140 130 120 110 100 90 80 70 60 50 40 30 20 10 0 10 20 30 40 50 60 70 80 90 100 110 120 130 140 150

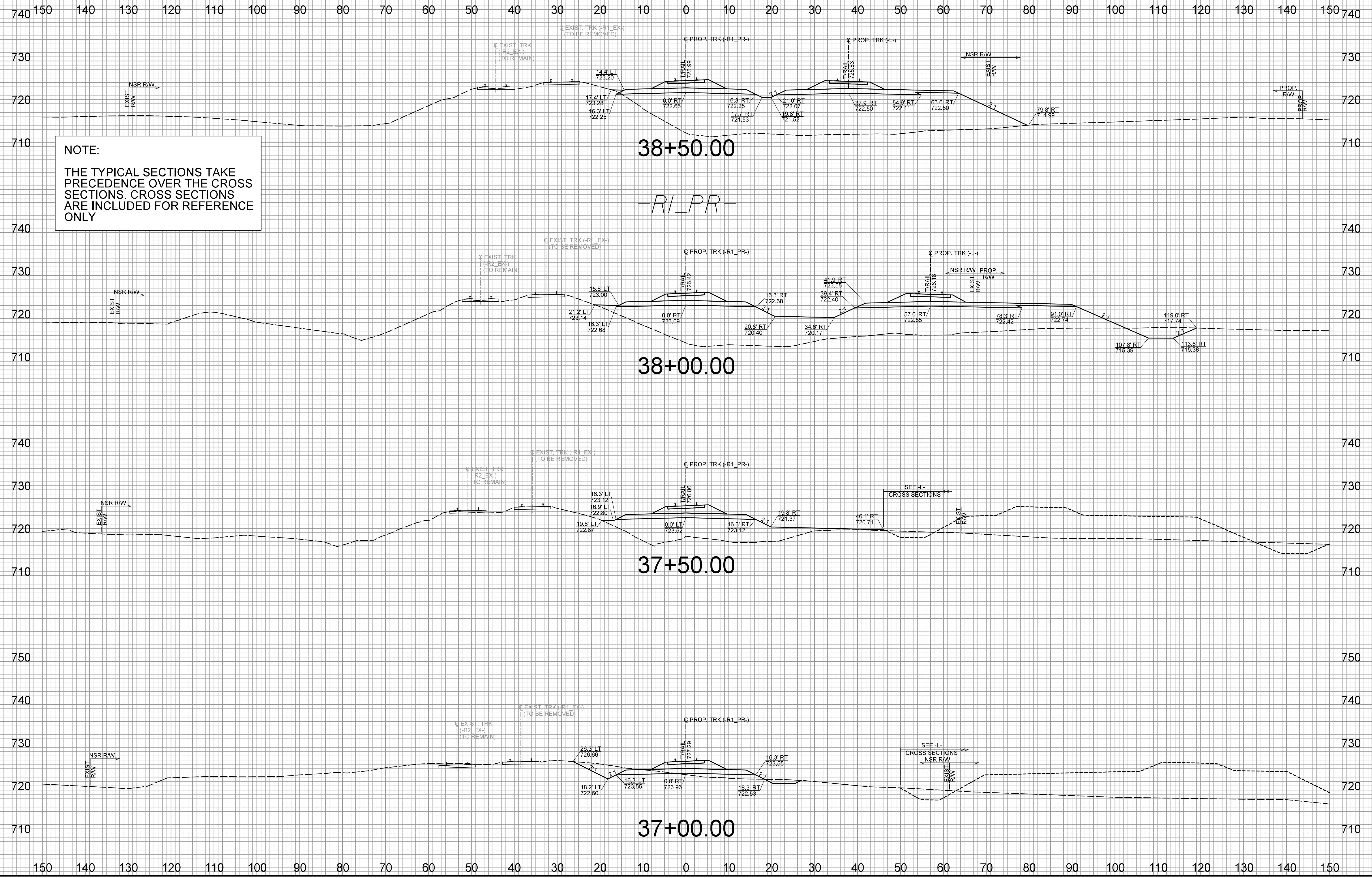
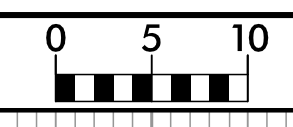

NOTE:
 THE TYPICAL SECTIONS TAKE PRECEDENCE OVER THE CROSS SECTIONS. CROSS SECTIONS ARE INCLUDED FOR REFERENCE ONLY

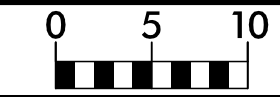

150 140 130 120 110 100 90 80 70 60 50 40 30 20 10 0 10 20 30 40 50 60 70 80 90 100 110 120 130 140 150

NOTE:
THE TYPICAL SECTIONS TAKE
PRECEDENCE OVER THE CROSS
SECTIONS. CROSS SECTIONS
ARE INCLUDED FOR REFERENCE
ONLY

-R1_PR-

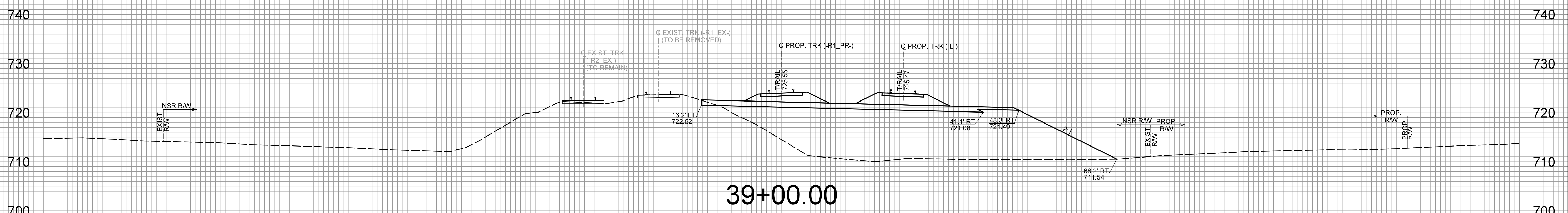
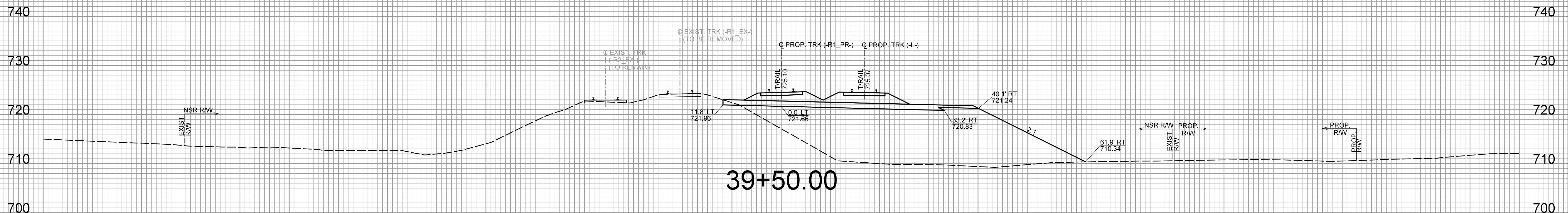
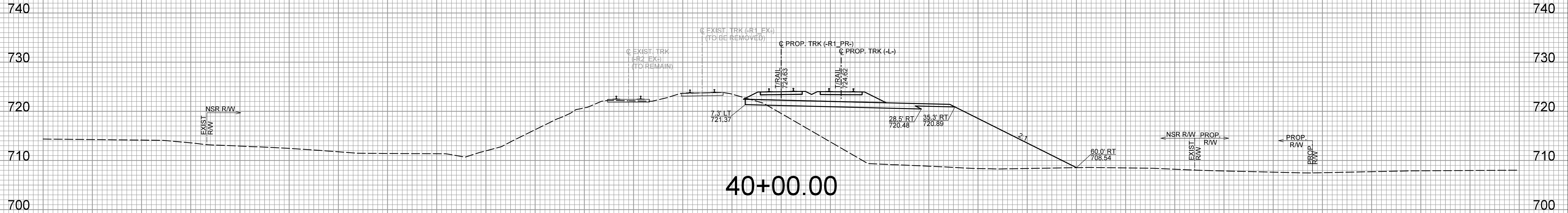

150 140 130 120 110 100 90 80 70 60 50 40 30 20 10 0 10 20 30 40 50 60 70 80 90 100 110 120 130 140 150

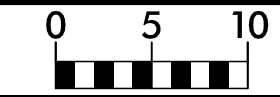

150 140 130 120 110 100 90 80 70 60 50 40 30 20 10 0 10 20 30 40 50 60 70 80 90 100 110 120 130 140 150

NOTE:
THE TYPICAL SECTIONS TAKE
PRECEDENCE OVER THE CROSS
SECTIONS. CROSS SECTIONS
ARE INCLUDED FOR REFERENCE
ONLY

-R1_PR-

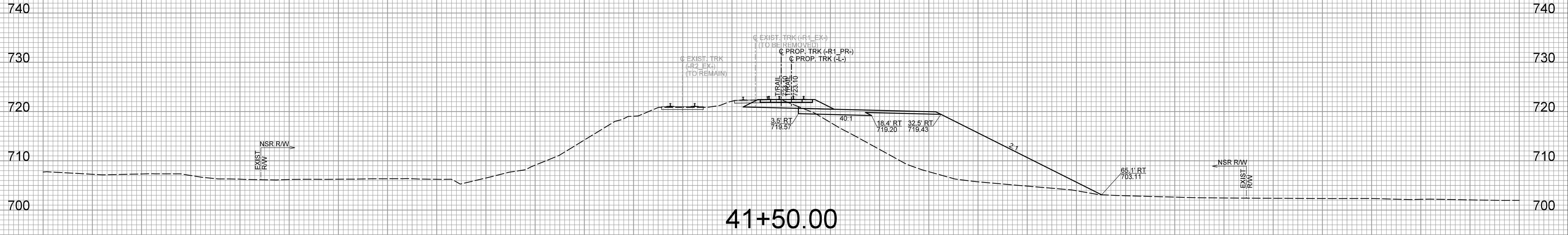

41+50.00

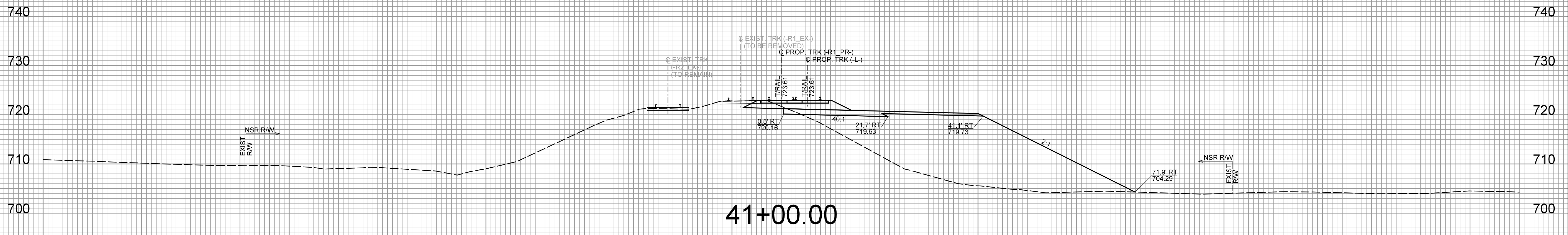

41+00.00

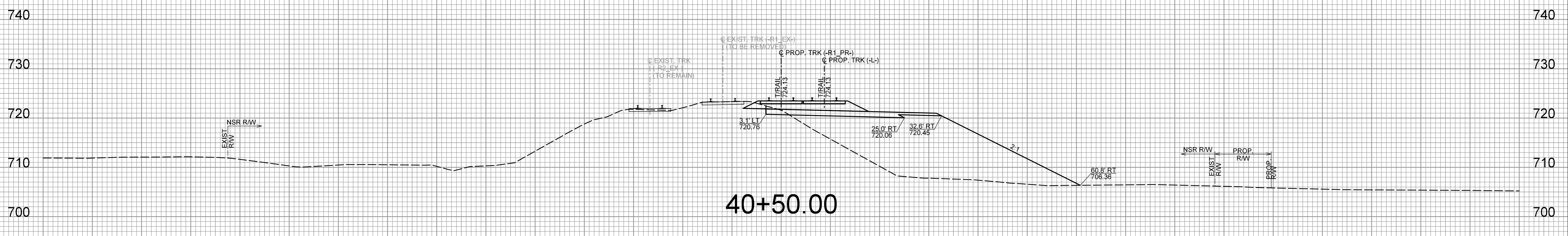

40+50.00

150 140 130 120 110 100 90 80 70 60 50 40 30 20 10 0 10 20 30 40 50 60 70 80 90 100 110 120 130 140 150

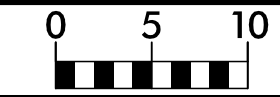

PROJ. REFERENCE NO.
P-5705A

SHEET NO.
X-26

150 140 130 120 110 100 90 80 70 60 50 40 30 20 10 0 10 20 30 40 50 60 70 80 90 100 110 120 130 140 150

-R1_PR-

NOTE:

THE TYPICAL SECTIONS TAKE PRECEDENCE OVER THE CROSS SECTIONS. CROSS SECTIONS ARE INCLUDED FOR REFERENCE ONLY

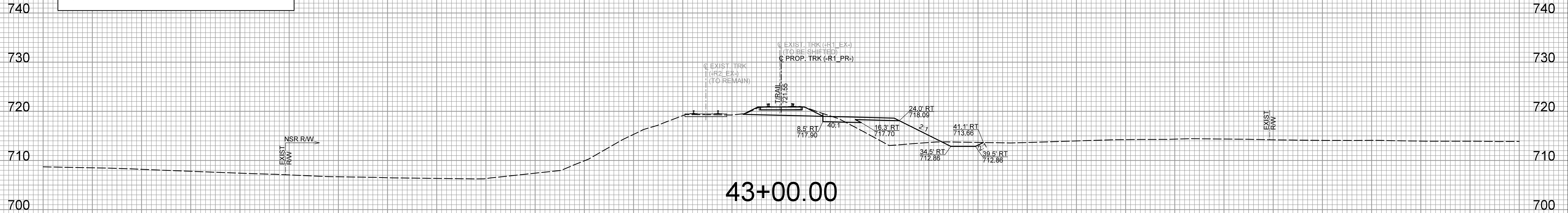

43+00.00

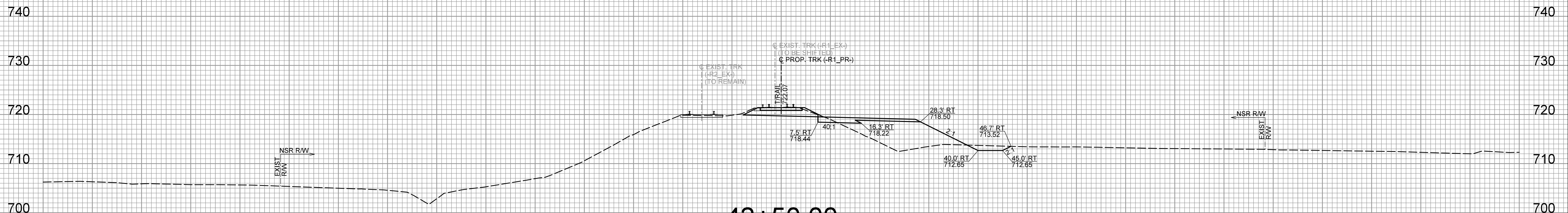

42+50.00

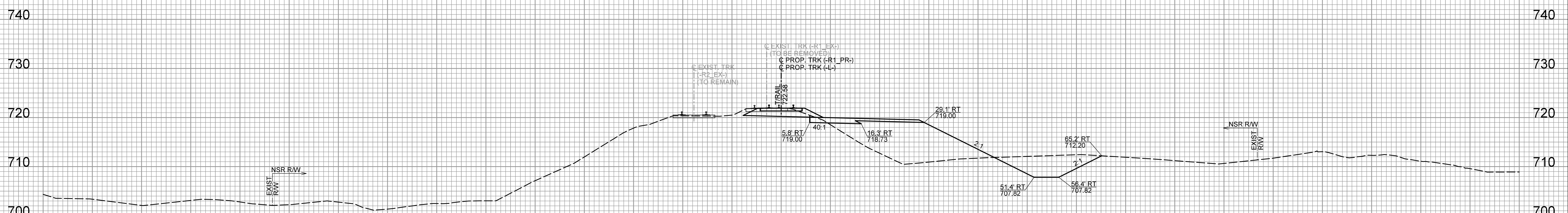

42+00.00

150 140 130 120 110 100 90 80 70 60 50 40 30 20 10 0 10 20 30 40 50 60 70 80 90 100 110 120 130 140 150

150 140 130 120 110 100 90 80 70 60 50 40 30 20 10 0 10 20 30 40 50 60 70 80 90 100 110 120 130 140 150

-R1_PR-

NOTE:

THE TYPICAL SECTIONS TAKE PRECEDENCE OVER THE CROSS SECTIONS. CROSS SECTIONS ARE INCLUDED FOR REFERENCE ONLY

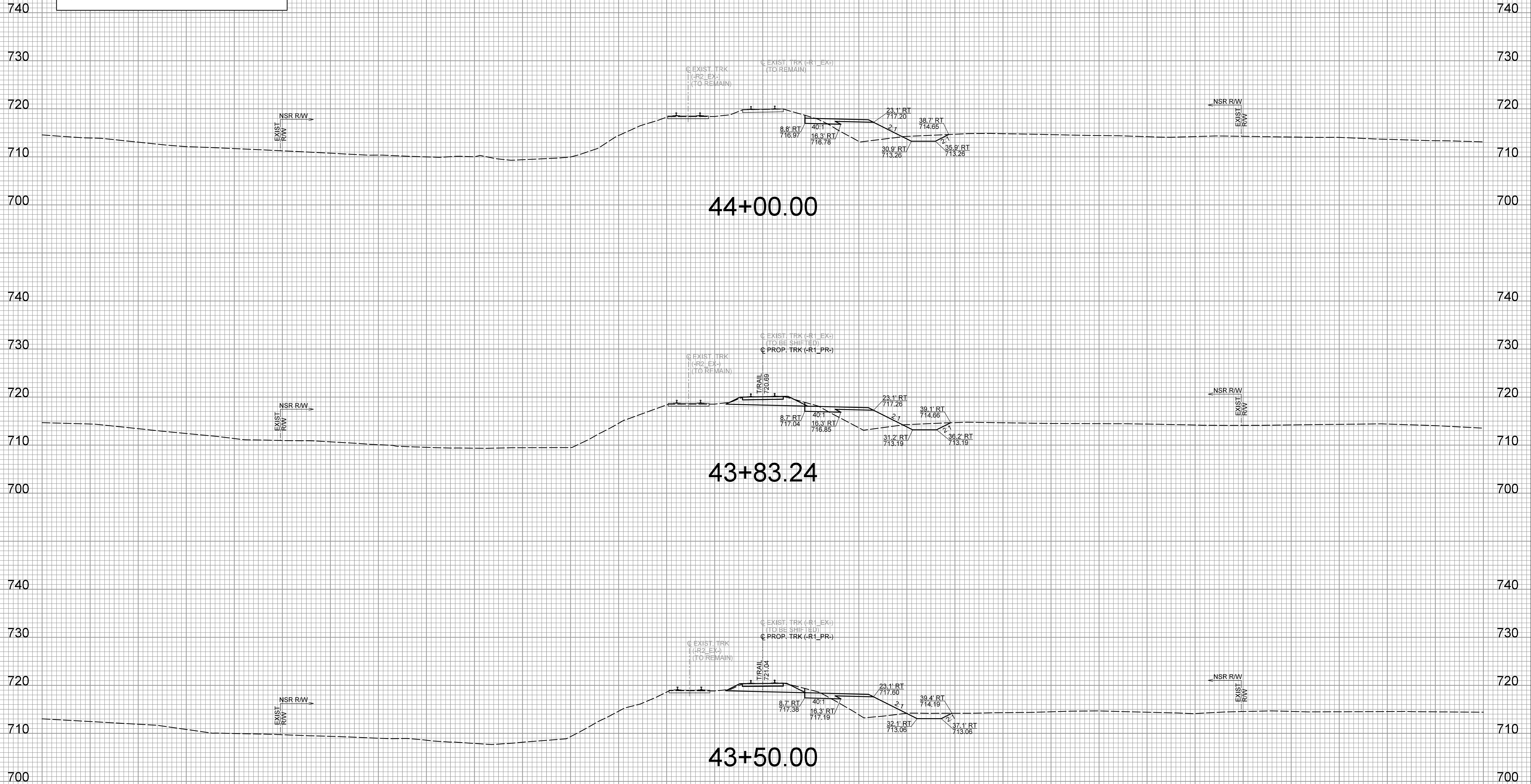

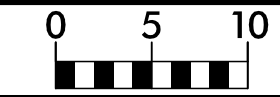

PROJ. REFERENCE NO.
P-5705A

SHEET NO.
X-28

150 140 130 120 110 100 90 80 70 60 50 40 30 20 10 0 10 20 30 40 50 60 70 80 90 100 110 120 130 140 150

-RI_PR-

NOTE:

THE TYPICAL SECTIONS TAKE PRECEDENCE OVER THE CROSS SECTIONS. CROSS SECTIONS ARE INCLUDED FOR REFERENCE ONLY

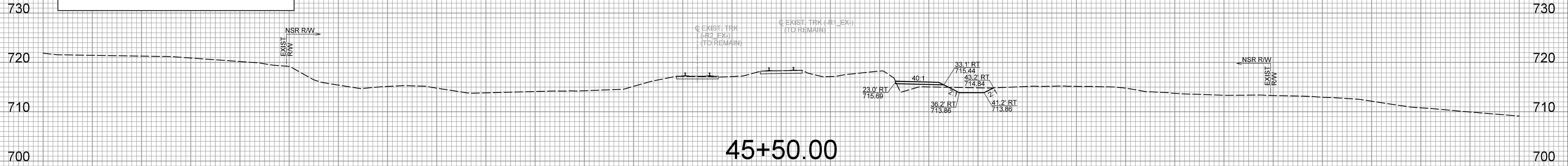

45+50.00

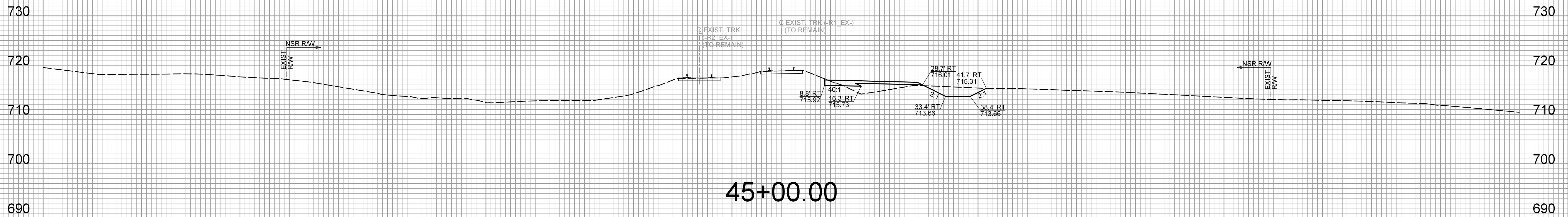

45+00.00

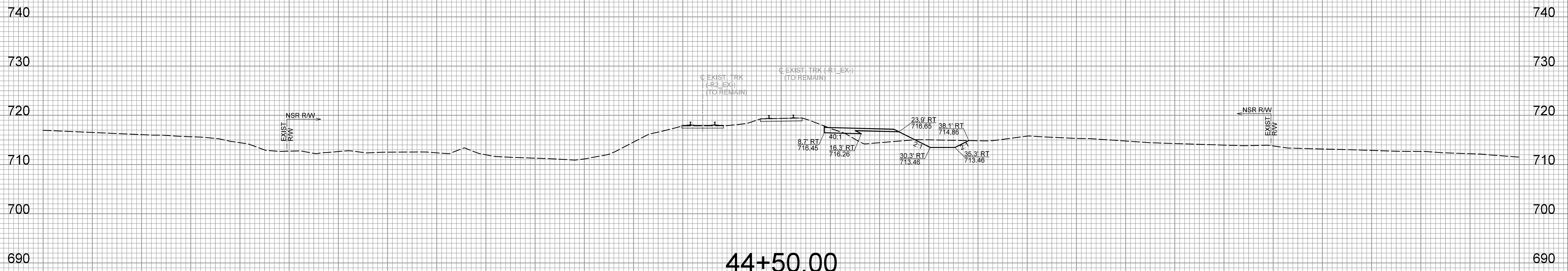

44+50.00

150 140 130 120 110 100 90 80 70 60 50 40 30 20 10 0 10 20 30 40 50 60 70 80 90 100 110 120 130 140 150

150 140 130 120 110 100 90 80 70 60 50 40 30 20 10 0 10 20 30 40 50 60 70 80 90 100 110 120 130 140 150

-RI_PR-

NOTE:
 THE TYPICAL SECTIONS TAKE
 PRECEDENCE OVER THE CROSS
 SECTIONS. CROSS SECTIONS
 ARE INCLUDED FOR REFERENCE
 ONLY

