

T.I.P.: R-2707E

CONTRACT NO.: C204851

**STATE OF NORTH CAROLINA  
DEPARTMENT OF TRANSPORTATION**

**PAVEMENT MARKING PLAN  
CLEVELAND COUNTY**

**LOCATION: US 74 SHELBY BYPASS FROM EXISTING US 74 WEST OF  
SR 2238 (LONG BRANCH RD) TO WEST OF SR 1001**

TIP NO. <b>R-2707E</b>	SHEET NO. <b>PMP - 1</b>
APPROVED: <b>Betsy L. Watson</b> <small>REGISTERED PROFESSIONAL ENGINEER</small>	
DATE: 4/24/2023	
<b>DOCUMENT NOT CONSIDERED FINAL UNLESS ALL SIGNATURES COMPLETED</b>	

**ROADWAY STANDARD DRAWINGS**

THE FOLLOWING ROADWAY STANDARDS AS APPEAR IN "ROADWAY STANDARD DRAWINGS" - PROJECT SERVICES UNIT - N.C. DEPARTMENT OF TRANSPORTATION - RALEIGH, N.C., DATED JANUARY 2018 ARE APPLICABLE TO THIS PROJECT AND BY REFERENCE HEREBY ARE CONSIDERED A PART OF THESE PLANS:

STD. NO.	TITLE
1205.01	PAVEMENT MARKINGS - LINE TYPES & OFFSETS
1205.02	PAVEMENT MARKINGS - 2 LANE & MULTILANE ROADWAYS
1205.03	PAVEMENT MARKINGS - EXIT & ENTRANCE RAMPS
1205.04	PAVEMENT MARKINGS - INTERSECTIONS (SEE SHEET 1A FOR SHEET 2 OF 2)
1205.06	PAVEMENT MARKINGS - LANE DROPS
1205.08	PAVEMENT MARKINGS - SYMBOLS & WORD MESSAGES
1205.09	PAVEMENT MARKINGS - PAINTED ISLANDS
1205.12	PAVEMENT MARKINGS - BRIDGES (SEE SHEET 1B)
1205.13	PAVEMENT MARKINGS - LANE REDUCTIONS
1205.14	PAVEMENT MARKINGS - ROUNDABOUTS
1250.01	RAISED PAVEMENT MARKERS - INSTALLATION SPACING
1251.01	RAISED PAVEMENT MARKERS - PERMANENT & TEMPORARY
1253.01	RAISED PAVEMENT MARKERS - SNOWPLOWABLE
1261.01	GUARDRAIL & BARRIER DELINEATORS - INSTALLATION SPACING
1261.02	GUARDRAIL & BARRIER DELINEATORS - TYPES & MOUNTING
1262.01	GUARDRAIL END DELINEATION

**GENERAL NOTES**

THE FOLLOWING GENERAL NOTES APPLY AT ALL TIMES FOR THE DURATION OF THE CONSTRUCTION PROJECT, EXCEPT WHEN OTHERWISE NOTED IN THE PLAN, OR DIRECTED BY THE ENGINEER.

- A) INSTALL PAVEMENT MARKINGS AND PAVEMENT MARKERS ON THE FINAL SURFACE AS FOLLOWS:
 

ROAD NAME	MARKING	MARKER
-L-	POLYUREA WITH STANDARD GLASS BEADS	SNOWPLOWABLE
-Y- LINES	THERMOPLASTIC	SNOWPLOWABLE
-Y- LINE BRIDGES	COLD APPLIED PLASTIC	RAISED
- B) TIE PROPOSED PAVEMENT MARKING LINES TO EXISTING PAVEMENT MARKING LINES.
- C) REMOVE/REPLACE ANY CONFLICTING/DAMAGED PAVEMENT MARKINGS AND MARKERS.
- D) PASSING ZONES WILL BE DETERMINED IN THE FIELD AND MUST BE APPROVED BY THE ENGINEER.
- E) STOP BAR LOCATION AT NON-SIGNALIZED INTERSECTIONS MAY BE ADJUSTED AS DIRECTED BY THE ENGINEER.
- F) REMOVE ALL RESIDUE AND SURFACE LAITANCE BY ACCEPTABLE METHODS ON CONCRETE BRIDGE DECKS PRIOR TO PLACING POLYUREA OR COLD APPLIED PLASTIC PAVEMENT MARKING MATERIAL.
- G) UNLESS OTHERWISE SPECIFIED, HEATED-IN-PLACE THERMOPLASTIC MAY BE USED IN LIEU OF EXTRUDED THERMOPLASTIC FOR STOP BARS, SYMBOLS, CHARACTERS AND DIAGONALS. IF HEATED-IN-PLACE IS USED, IT SHALL BE PAID FOR USING THE EXTRUDED THERMOPLASTIC PAY ITEM.
- H) UNLESS OTHERWISE SPECIFIED, HEATED-IN-PLACE THERMOPLASTIC MAY BE USED IN LIEU OF COLD APPLIED PLASTIC FOR STOP BARS, SYMBOLS, CHARACTERS AND DIAGONALS ON ASPHALT OR CONCRETE ROADWAYS. IF HEATED-IN-PLACE IS USED, IT SHALL BE PAID FOR USING THE COLD APPLIED PAY ITEM.
- I) TYPE III COLD APPLIED PLASTIC MAY BE USED IN LIEU OF TYPE II COLD APPLIED PLASTIC. IF TYPE III COLD APPLIED PLASTIC IS USED, IT SHALL BE PAID FOR USING THE TYPE II COLD APPLIED PLASTIC PAY ITEM.

**FINAL PAVEMENT MARKING SCHEDULE**

SYMBOL	DESCRIPTION	PAY ITEM
C1	WHITE EDGELINE	(4") COLD APPLIED PLASTIC
C13	YELLOW DOUBLE CENTER	(4") COLD APPLIED PLASTIC
C51	WHITE DIAGONAL	(12") COLD APPLIED PLASTIC
C71	RIGHT TURN ARROW	COLD APPLIED PLASTIC
C74	COMBO STRAIGHT/RIGHT ARROW	COLD APPLIED PLASTIC
C79	MERGE ARROW	COLD APPLIED PLASTIC
C100	ALPHANUMERIC CHAR	COLD APPLIED PLASTIC
T1	WHITE EDGELINE	(4", 90 MILS) THERMOPLASTIC
T5	2 FT-6FT/SP WHITE MINISKIP	(4", 90 MILS) THERMOPLASTIC
T10	YELLOW EDGELINE	(4", 90 MILS) THERMOPLASTIC
T13	YELLOW DOUBLE CENTER	(4", 90 MILS) THERMOPLASTIC
T40	WHITE GORELINE	(8", 90 MILS) THERMOPLASTIC
T45	3 FT-3FT/SP WHITE MINISKIP	(8", 90 MILS) THERMOPLASTIC
T52	YELLOW DIAGONAL	(12", 90 MILS) THERMOPLASTIC
T61	WHITE STOPBAR	(24", 90 MILS) THERMOPLASTIC
T80	WRONG-WAY RAMP ARROW SYMBOL	(90 MILS) THERMOPLASTIC
T103	24" YIELD LINE TRIANGLE	(90 MILS) THERMOPLASTIC
V20	WHITE EDGELINE	(6", 20 MILS) POLYUREA WITH STANDARD GLASS BEADS
V22	10 FT WHITE SKIP	(6", 20 MILS) POLYUREA WITH STANDARD GLASS BEADS
V23	3 FT-9FT/SP WHITE MINISKIP	(6", 20 MILS) POLYUREA WITH STANDARD GLASS BEADS
V30	YELLOW EDGELINE	(6", 20 MILS) POLYUREA WITH STANDARD GLASS BEADS
V50	WHITE GORELINE	(12", 20 MILS) POLYUREA WITH STANDARD GLASS BEADS
V53	WHITE SOLID LANE LINE	(12", 20 MILS) POLYUREA WITH STANDARD GLASS BEADS
V54	3 FT-9FT/SP WHITE MINISKIP	(12", 20 MILS) POLYUREA WITH STANDARD GLASS BEADS

**PLAN PREPARED BY:**

**BETSY L. WATSON, P.E.** SENIOR TRANSPORTATION ENGINEER  
**ROSI R. HENNEIN** TRANSPORTATION DESIGNER



Stantec Consulting Services Inc.  
801 Jones Franklin Road  
Suite 300  
Raleigh, NC 27606  
Tel. (919) 851-6866  
Fax. (919) 851-7024  
www.stantec.com  
License No. F-0672

**INDEX**

_SHEET NO._	_DESCRIPTION
PMP - 1	PAVEMENT MARKING PLAN TITLE & SCHEDULE SHEET
PMP - 2 - 16	PAVEMENT MARKING DETAIL



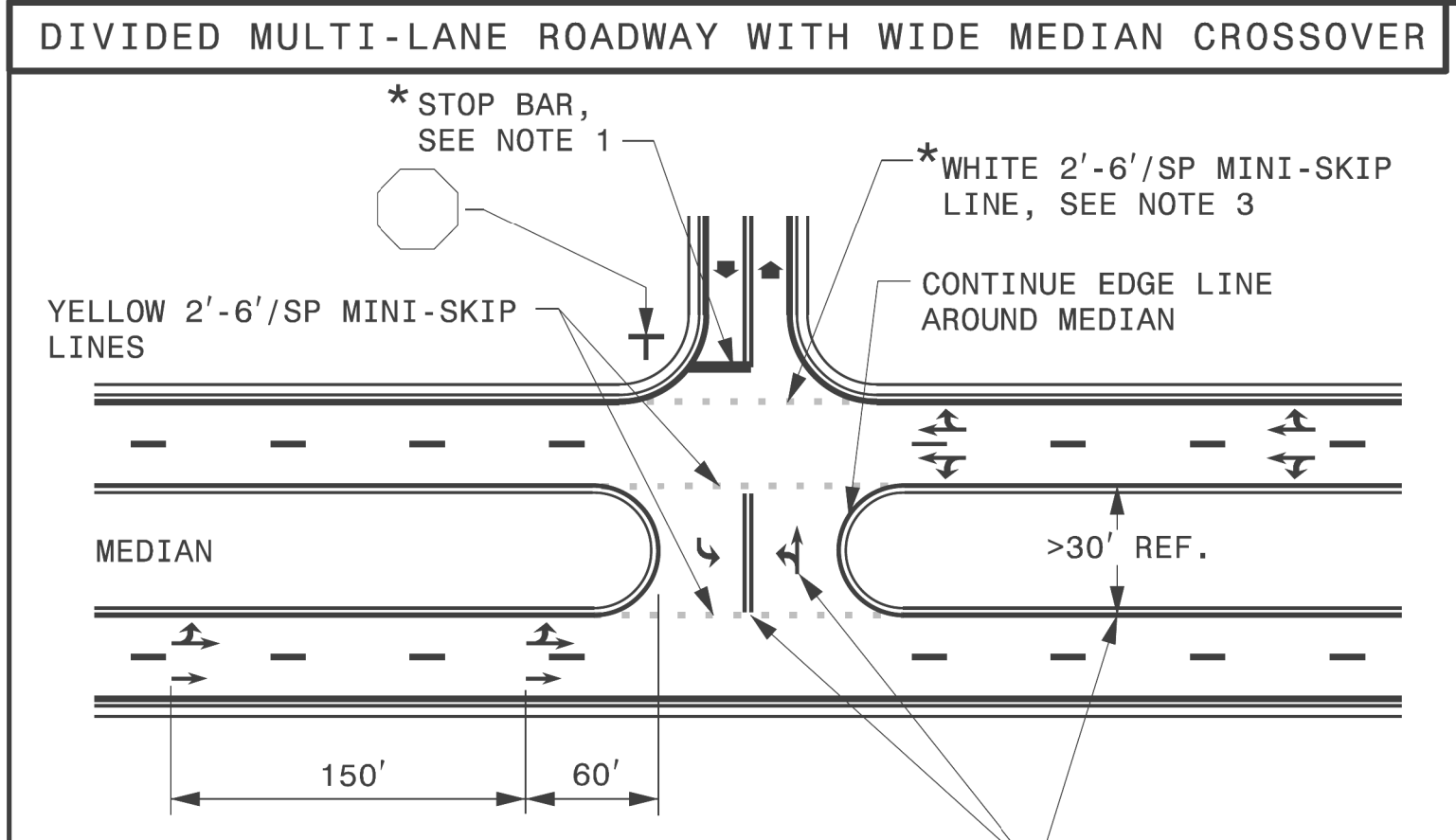
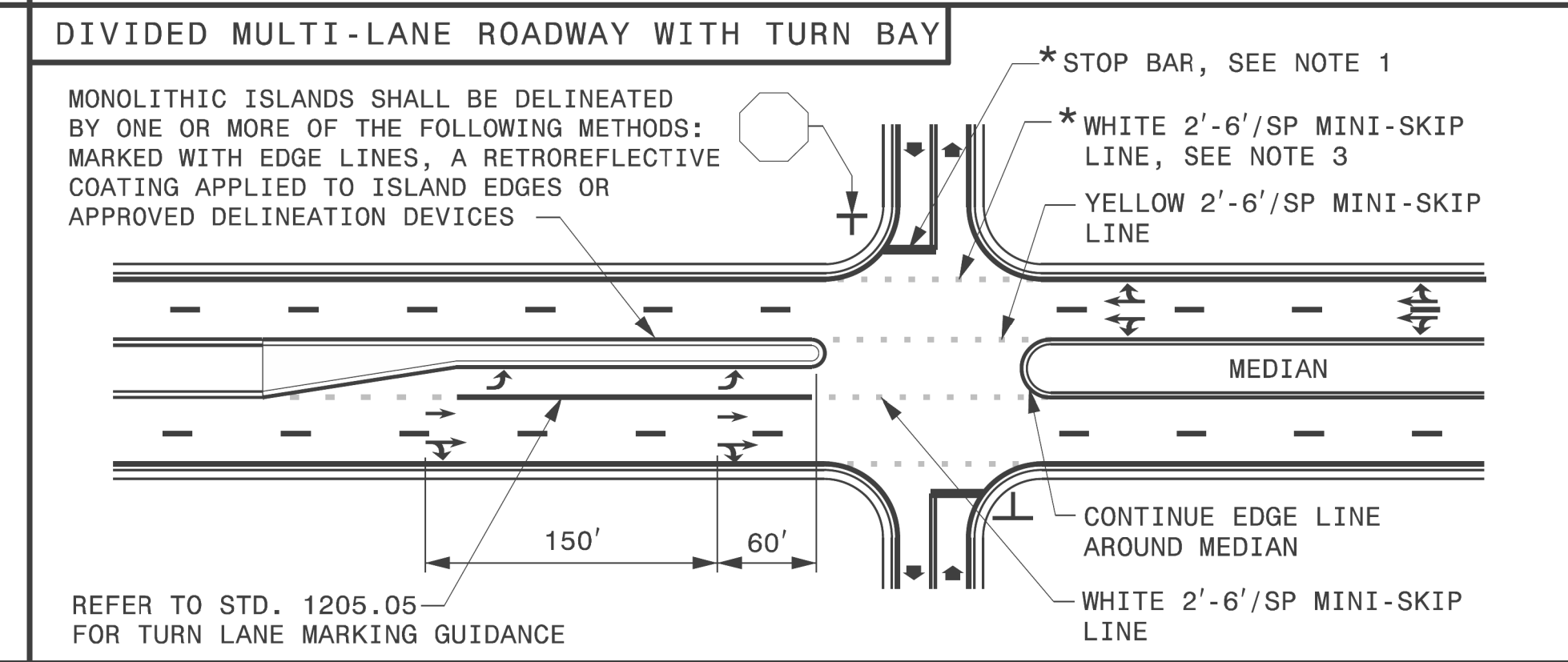
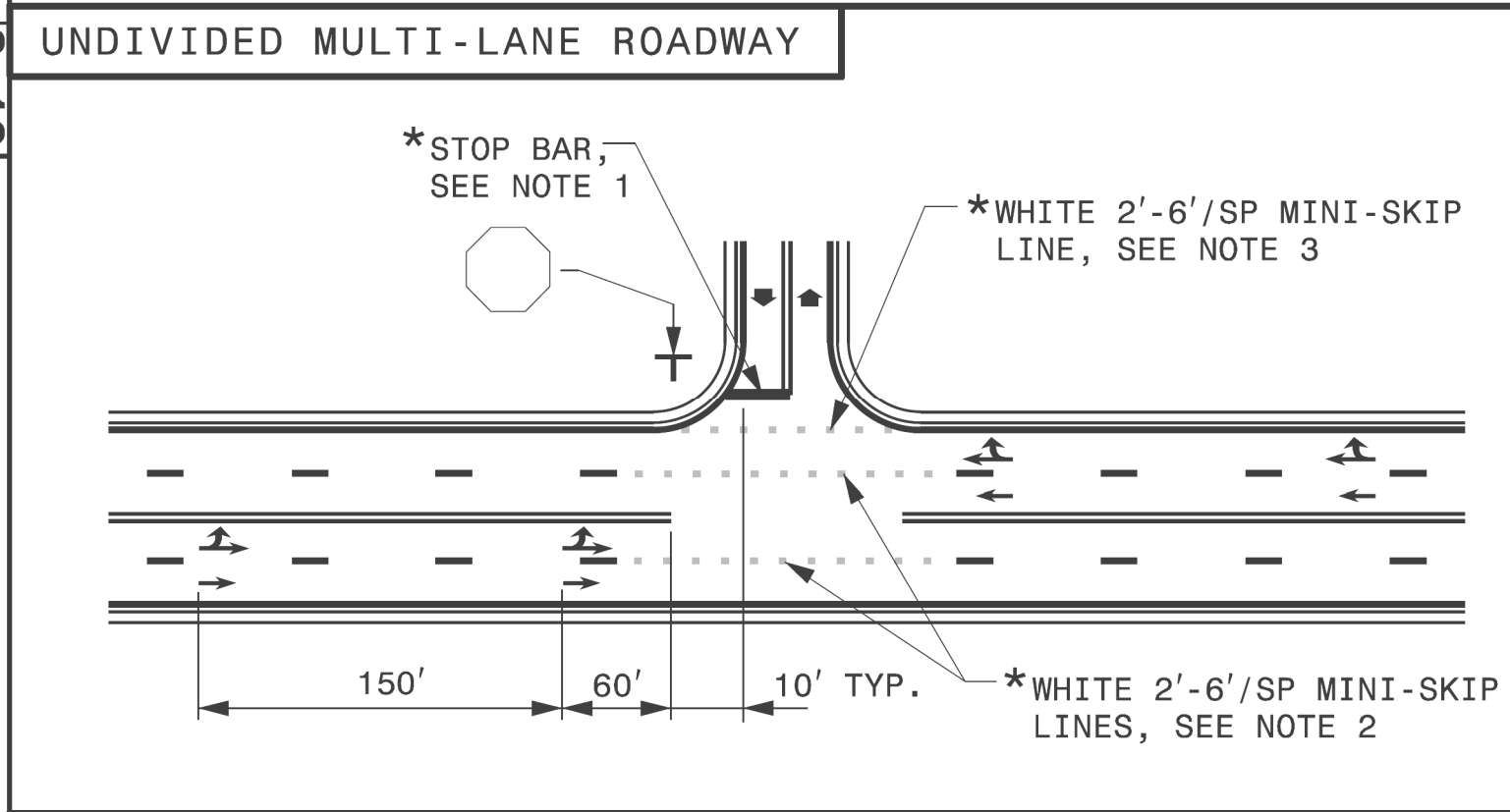
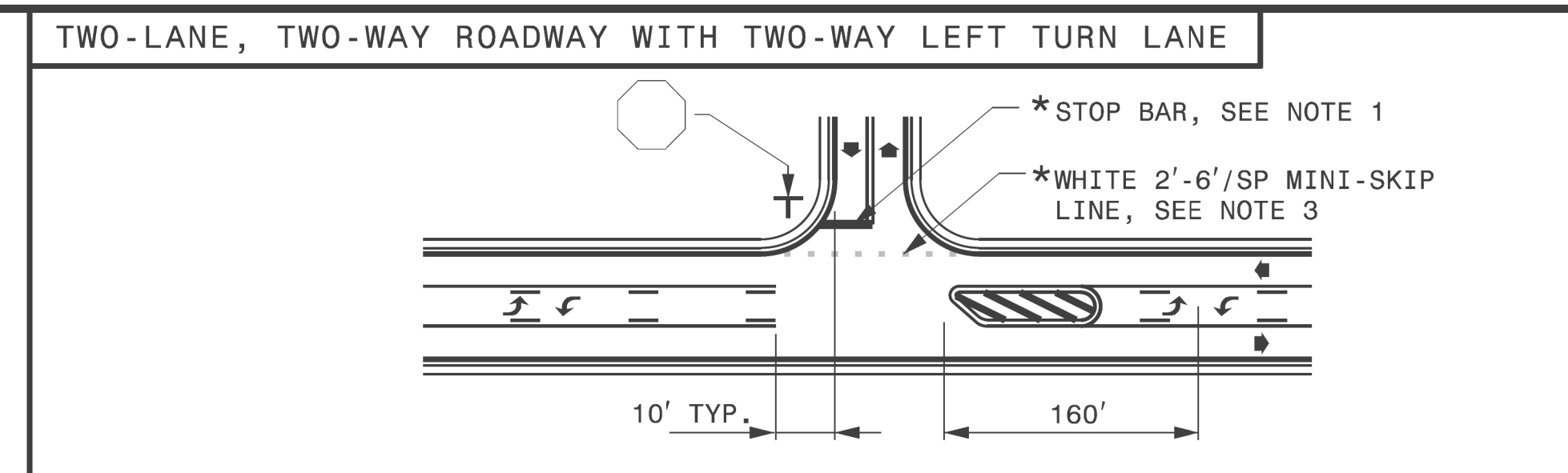
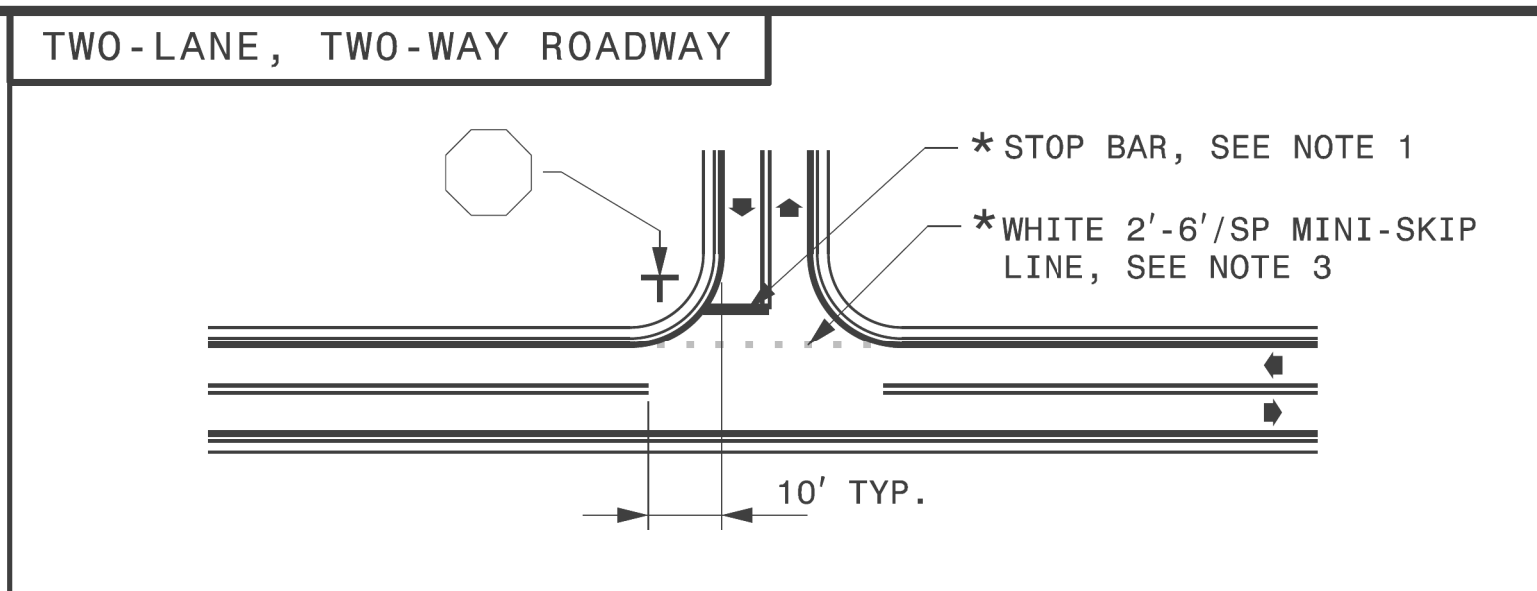

TIP NO.	SHEET NO.
DocuSigned by:	
<i>Matthew V. Springer</i>	
APPROVED:	8/13/2019
DATE:	8/13/2019 8:58:44 AM
SEAL	
	

STATE OF NORTH CAROLINA  
DEPT. OF TRANSPORTATION  
DIVISION OF HIGHWAYS  
RALEIGH, N.C.

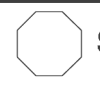

- GENERAL NOTES:**
- 1- PLACEMENT OF STOP BARS AT NON-SIGNALIZED INTERSECTIONS IS OPTIONAL AND USED WHERE IT IS IMPORTANT TO INDICATE THE POINT WHICH VEHICLES ARE REQUIRED TO STOP. PLACE STOP BARS NO LESS THAN 4 FEET AND NO MORE THAN 30 FEET FROM THE NEAREST EDGE OF THE INTERSECTING ROADWAY. USE 10 FEET AS THE TYPICAL SETBACK DISTANCE OR AS DIRECTED BY THE ENGINEER.
  - 2- MINI-SKIP LANE LINE EXTENSIONS SHOULD BE USED AT INTERSECTIONS THAT HAVE REDUCED VISIBILITY CONDITIONS SUCH AS OFFSET, SKEWED, OR CURVED ROADWAYS.
  - 3- MINI-SKIP EDGE LINE EXTENSIONS MAY BE PLACED THROUGH INTERSECTIONS AND MAJOR DRIVEWAYS.
  - 4- REFER TO ROADWAY STANDARD DRAWINGS 1205.01, 1205.02, 1205.05, 1205.08 AND 1205.09 FOR ADDITIONAL PAVEMENT MARKING GUIDANCE.

**LEGEND**

 STOP SIGN	 STATIONARY SIGN
 DIRECTION OF TRAFFIC FLOW	 PAVEMENT MARKING SYMBOLS
* OPTIONAL	

USE DOUBLE YELLOW CENTER LINE AND ARROW SYMBOLS IN MEDIAN CROSSOVER WHEN WIDTH OF MEDIAN EXCEEDS 30 FT, OTHERWISE THEY ARE NOT REQUIRED.

SHEET 2 OF 2  
**1205D04**

STATE OF NORTH CAROLINA  
DEPT. OF TRANSPORTATION  
DIVISION OF HIGHWAYS  
RALEIGH, N.C.

ENGLISH DETAIL DRAWING FOR  
**PAVEMENT MARKINGS**  
INTERSECTIONS

SHEET 2 OF 2  
**1205D04**

**REVISED PAVEMENT MARKING  
ROADWAY STANDARD DRAWING**

REVISED ROADWAY STANDARD DRAWING  
1205.04 SHEET 2 OF 2

\$\$\$\$\$SYTIME\$\$\$\$\$  
\$\$\$\$\$DGN\$\$\$\$\$  
\$\$\$\$\$USERNAME\$\$\$\$\$

C:\Users\jstokes\Documents\Standards and Drawings\Drawings\2018 Standard Dwg\Division 12 Final\12050402\_08-13-19.dgn  
User: jstokes



TIP NO.	SHEET NO.
DocuSigned by:	
<i>Matthew V. Springs</i>	
APPROVED:	8/30/2019
DATE:	8/30/2019 06:58:4403...
SEAL	
	

STATE OF NORTH CAROLINA  
DEPT. OF TRANSPORTATION  
DIVISION OF HIGHWAYS  
RALEIGH, N.C.

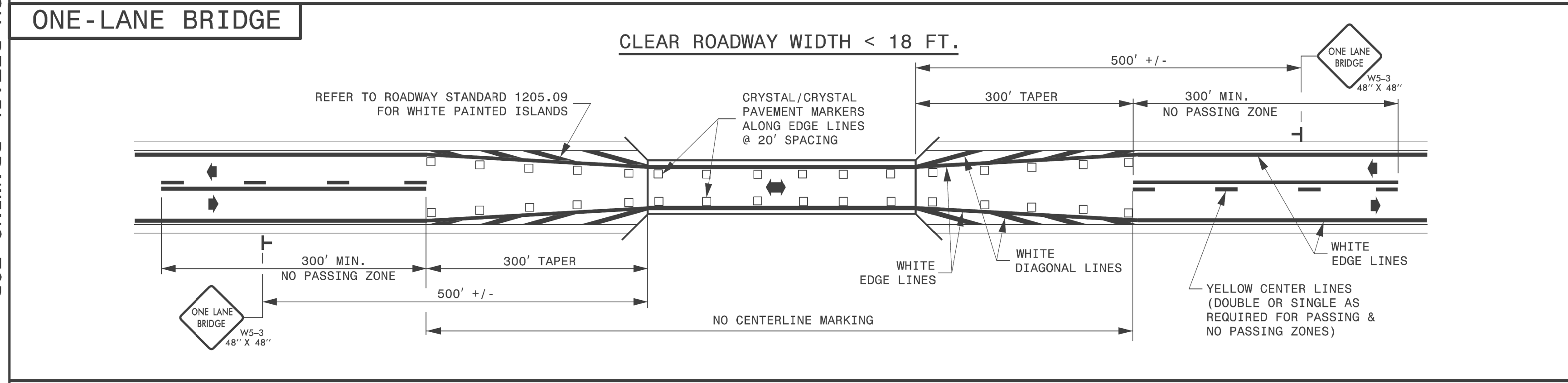
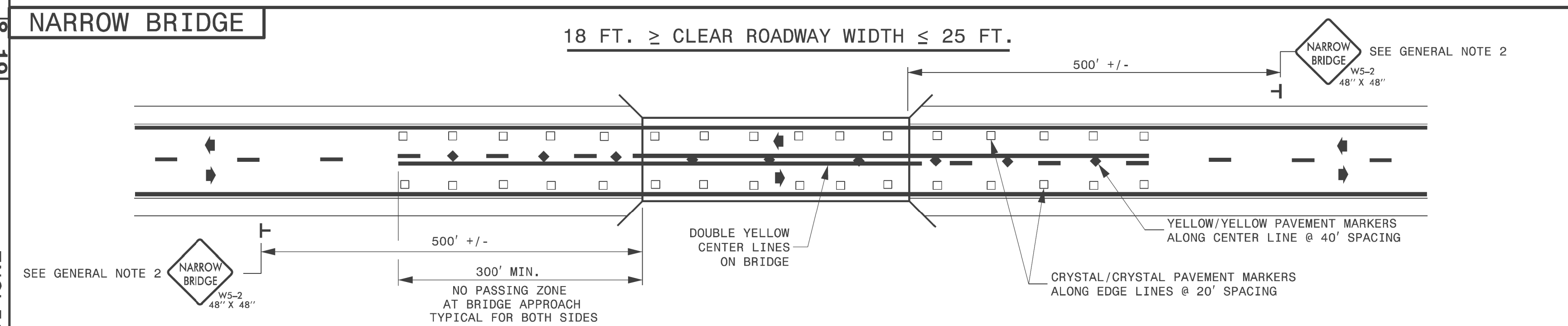
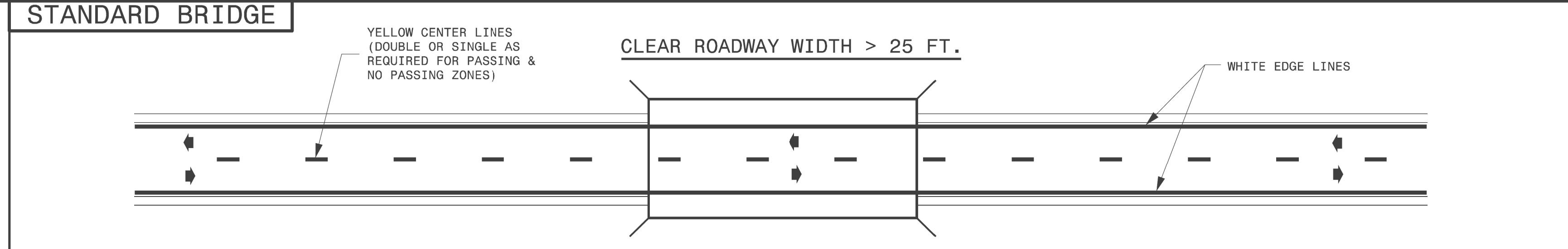

- GENERAL NOTES:
- NO PASSING ZONES SHOWN ARE MINIMUMS. APPLY MINIMUM PASSING AND STOPPING SIGHT DISTANCES AS DETERMINED BY THE ENGINEER.
  - FOR BRIDGES WITH 18 TO 25 FEET CLEAR ROADWAY WIDTH, SIGNS MUST BE USED WHEN THE APPROACH PAVEMENT WIDTH IS 2 FOOT OR GREATER THAN THE CLEAR ROADWAY WIDTH.

LEGEND	
➔	DIRECTION OF TRAFFIC FLOW
◆	YELLOW/YELLOW PAVEMENT MARKER
⊥	STATIONARY SIGN
□	CRYSTAL/CRYSTAL PAVEMENT MARKER

SHEET 1 OF 1  
**1205D12**

SHEET 1 OF 1  
**1205D12**

ENGLISH DETAIL DRAWING FOR  
**PAVEMENT MARKINGS**  
BRIDGES

ENGLISH DETAIL DRAWING FOR  
**PAVEMENT MARKINGS**  
BRIDGES

**REVISED PAVEMENT MARKING  
ROADWAY STANDARD DRAWING**

REVISED ROADWAY STANDARD DRAWING  
1205.12 SHEET 1 OF 1

\$\$\$\$\$SYTIME\$\$\$\$\$  
\$\$\$\$\$DDGN\$\$\$\$\$  
\$\$\$\$\$USERNAME\$\$\$\$\$

08/30/19  
I:\3800\Standards and Drawings\Drawings\2018 Standard Dwg\Division 12 Final\205120L\_08-29-19.dgn  
User:msprings

TIP NO. R-2707E	SHEET NO. PMP-2
APPROVED: <i>Betsy L. Watson</i>	
DATE: 4/24/2023	
SEAL	
<b>DOCUMENT NOT CONSIDERED FINAL UNLESS ALL SIGNATURES COMPLETED</b>	

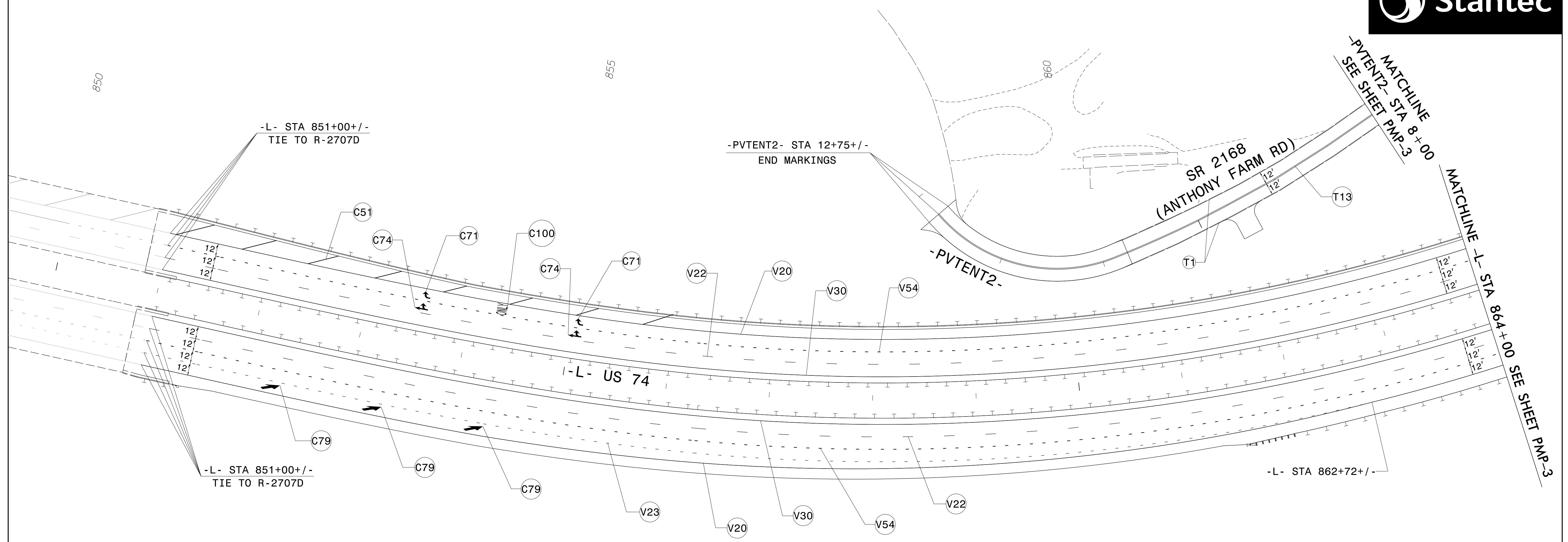
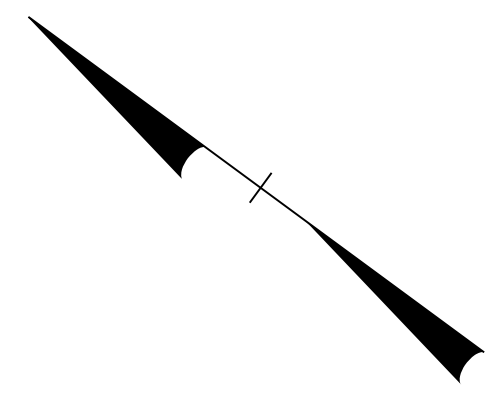

POLYUREA PAVEMENT MARKING LEGEND		COLD APPLIED PLASTIC PAVEMENT MARKING LEGEND	
V20	WHITE EDGELINE (6")	C51	WHITE DIAGONAL (12")
V22	10 FT WHITE SKIP (6")	C71	RIGHT TURN ARROW
V23	3 FT-9 FT/SP WHITE MINISKIP (6")	C74	STRAIGHT/RIGHT ARROW
V30	YELLOW EDGELINE (6")	C79	MERGE ARROW
V54	3 FT-9 FT/SP WHITE MINISKIP (12")	C100	ONLY ALPHANUMERIC CHARACTERS
		THERMOPLASTIC PAVEMENT MARKING LEGEND	
		T1	WHITE EDGELINE (4")
		T13	YELLOW DOUBLE CENTER (4")

\$\$\$\$\$SYTIME\$\$\$\$\$  
 \$\$\$\$DGN\$\$\$\$\$  
 \$\$\$\$.USERNAME\$\$\$\$\$

PAVEMENT MARKING DETAIL

TIP NO. R-2707E	SHEET NO. PMP-3
APPROVED: <i>Betsy L. Watson</i>	
DATE: 4/24/2023	
SEAL	
<b>DOCUMENT NOT CONSIDERED FINAL UNLESS ALL SIGNATURES COMPLETED</b>	

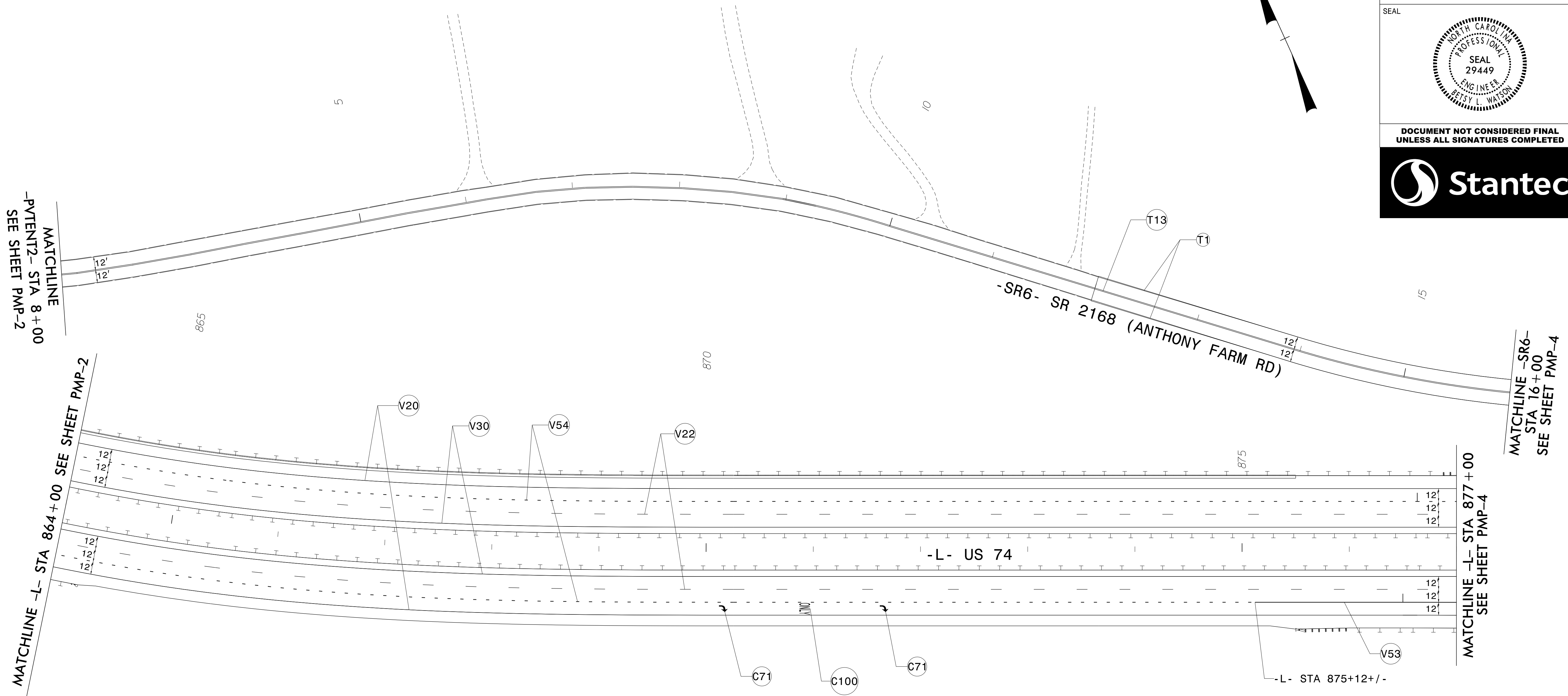



POLYUREA PAVEMENT MARKING LEGEND		COLD APPLIED PLASTIC PAVEMENT MARKING LEGEND		THERMOPLASTIC PAVEMENT MARKING LEGEND	
	WHITE EDGELINE (6")		RIGHT TURN ARROW		WHITE EDGELINE (4")
	10 FT WHITE SKIP (6")		ONLY ALPHANUMERIC CHARACTERS		YELLOW DOUBLE CENTER (4")
	YELLOW EDGELINE (6")				
	WHITE SOLID LANE LINE (12")				
	3 FT-9 FT/SP WHITE MINISKIP (12")				

PAVEMENT MARKING DETAIL

\$\$\$SYTIME\$\$\$  
 \$\$\$DGN\$\$\$  
 \$\$\$USERNAME\$\$\$



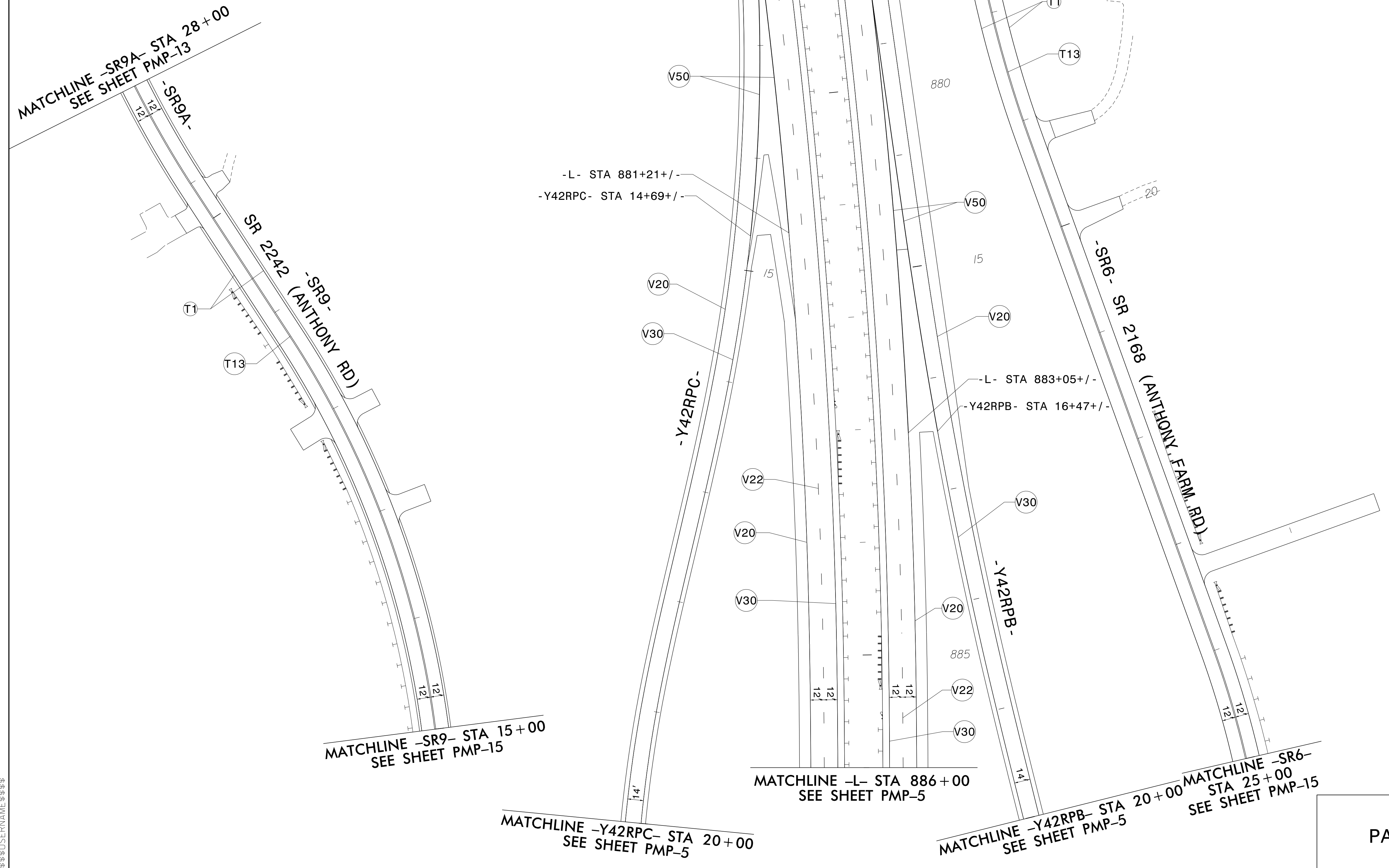
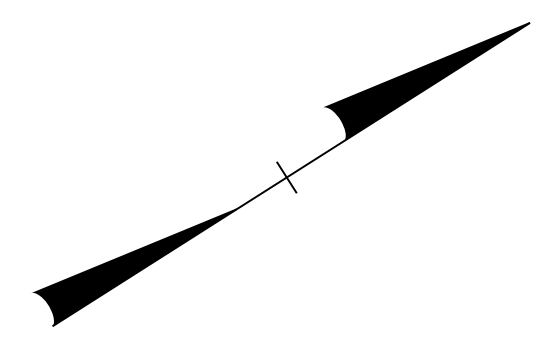

TIP NO. R-2707E	SHEET NO. PMP-4
APPROVED: <i>Betsy L. Watson</i>	
DATE: 4/24/2023	
SEAL	
	
DOCUMENT NOT CONSIDERED FINAL UNLESS ALL SIGNATURES COMPLETED	
	

POLYUREA PAVEMENT MARKING LEGEND	
(V20) WHITE EDGELINE (6")	
(V22) 10 FT WHITE SKIP (6")	
(V30) YELLOW EDGELINE (6")	
(V50) WHITE GORELINE (12")	
(V53) WHITE SOLID LANE LINE (12")	
(V54) 3 FT-9 FT/SP WHITE MINISKIP (12")	
THERMOPLASTIC PAVEMENT MARKING LEGEND	
(T1) WHITE EDGELINE (4")	
(T13) YELLOW DOUBLE CENTER (4")	







\$\$\$\$\$SYTIME\$\$\$\$\$  
 \$\$\$DGN\$\$\$\$\$  
 \$\$\$USERNAME\$\$\$\$\$

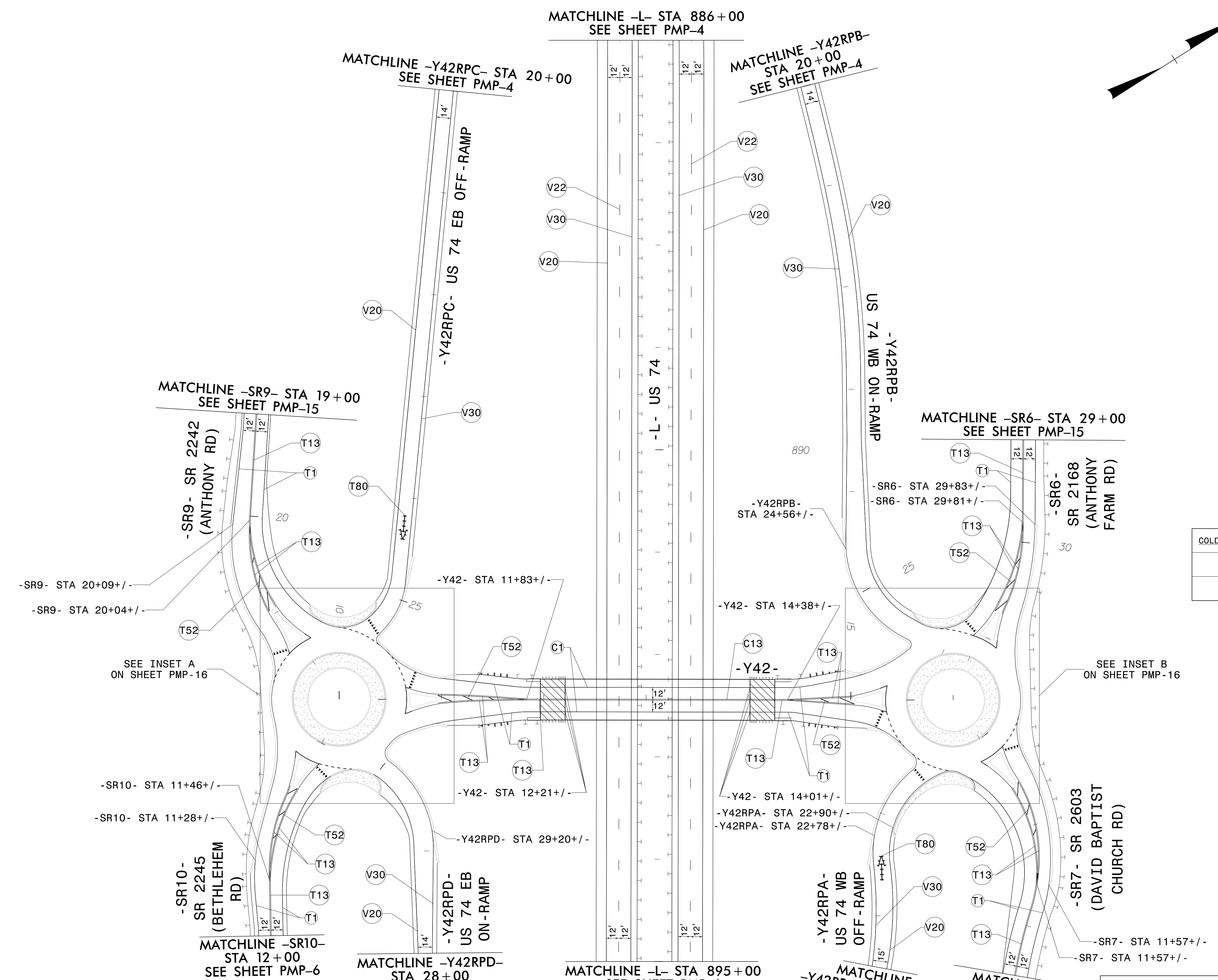
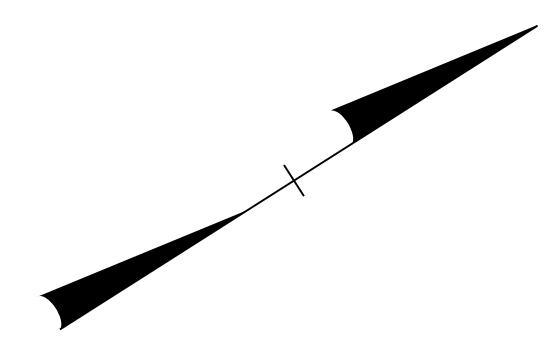



PAVEMENT MARKING DETAIL

TIP NO. R-2707E	SHEET NO. PMP-5
APPROVED: <i>Betsy L. Watson</i>	
DATE: 4/24/2023	
SEAL	
	
DOCUMENT NOT CONSIDERED FINAL UNLESS ALL SIGNATURES COMPLETED	
	



POLYUREA PAVEMENT MARKING LEGEND	
	WHITE EDGELINE (6")
	10 FT WHITE SKIP (6")
	YELLOW EDGELINE (6")

COLD APPLIED PLASTIC PAVEMENT MARKING LEGEND	
	WHITE EDGELINE (4")
	YELLOW DOUBLE CENTER (4")

THERMOPLASTIC PAVEMENT MARKING LEGEND	
	WHITE EDGELINE (4")
	YELLOW DOUBLE CENTER (4")
	YELLOW DIAGONAL (12")
	WRONG-WAY RAMP ARROW

### PAVEMENT MARKING DETAIL

\$\$\$\$\$SYTIME\$\$\$\$\$  
\$\$\$\$\$DGN\$\$\$\$\$  
\$\$\$\$\$USERNAME\$\$\$\$\$



TIP NO. R-2707E	SHEET NO. PMP-6
APPROVED: <i>Betsy L. Watson</i>	
DATE: 4/24/2023	
SEAL	

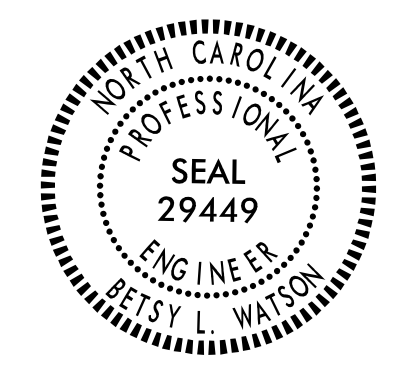

DOCUMENT NOT CONSIDERED FINAL  
UNLESS ALL SIGNATURES COMPLETED

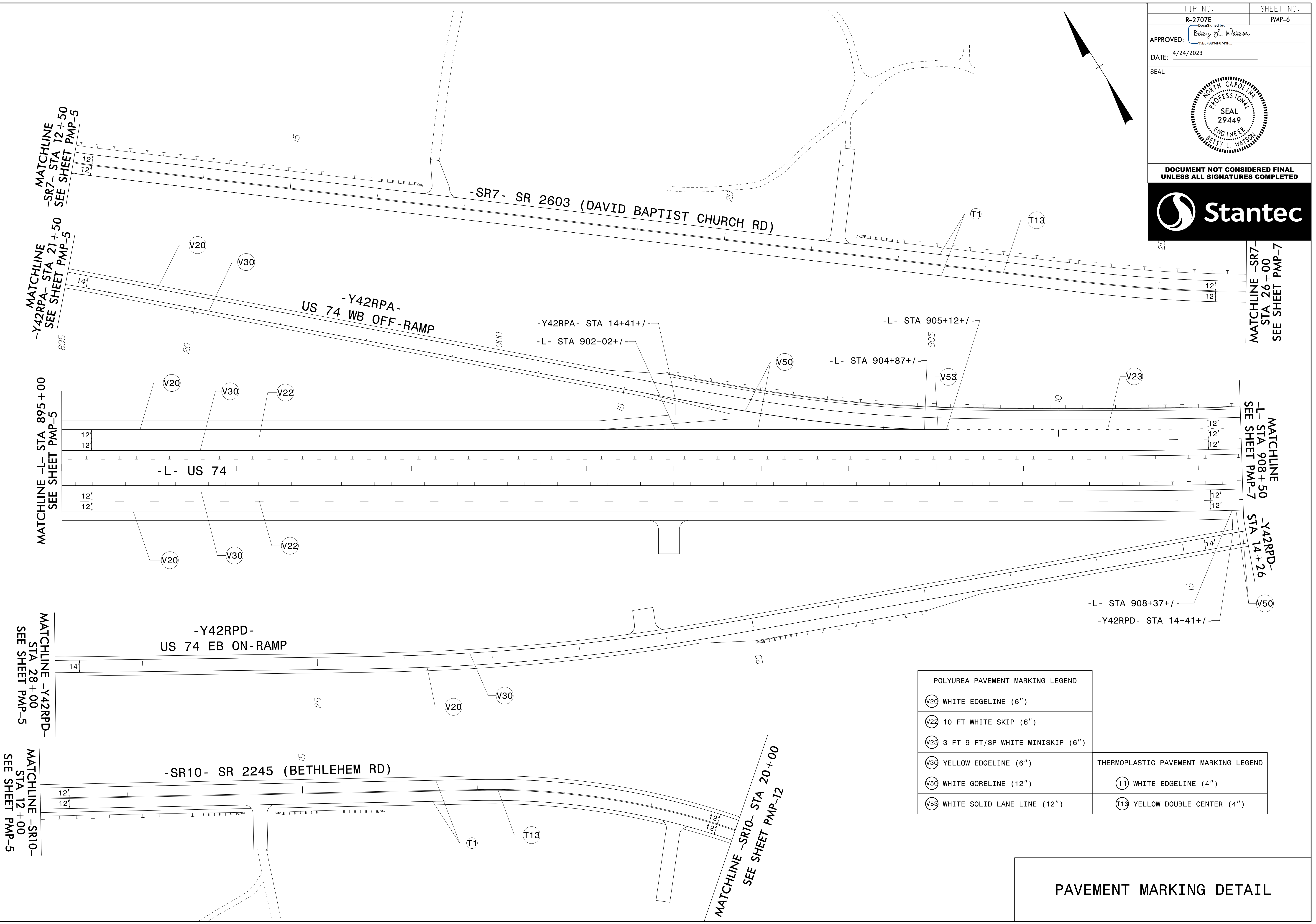

POLYUREA PAVEMENT MARKING LEGEND	
V20	WHITE EDGELINE (6")
V22	10 FT WHITE SKIP (6")
V23	3 FT-9 FT/SP WHITE MINISKIP (6")
V30	YELLOW EDGELINE (6")
V50	WHITE GORELINE (12")
V53	WHITE SOLID LANE LINE (12")



  

THERMOPLASTIC PAVEMENT MARKING LEGEND	
T1	WHITE EDGELINE (4")
T13	YELLOW DOUBLE CENTER (4")

PAVEMENT MARKING DETAIL

\$\$\$\$\$SYTIME\$\$\$\$\$  
\$\$\$\$\$DGN\$\$\$\$\$  
\$\$\$\$\$USERNAME\$\$\$\$\$



TIP NO. R-2707E	SHEET NO. PMP-7
APPROVED: <i>Petsy L. Watson</i>	
DATE: 4/24/2023	
SEAL	
	
<p><b>DOCUMENT NOT CONSIDERED FINAL UNLESS ALL SIGNATURES COMPLETED</b></p> 	

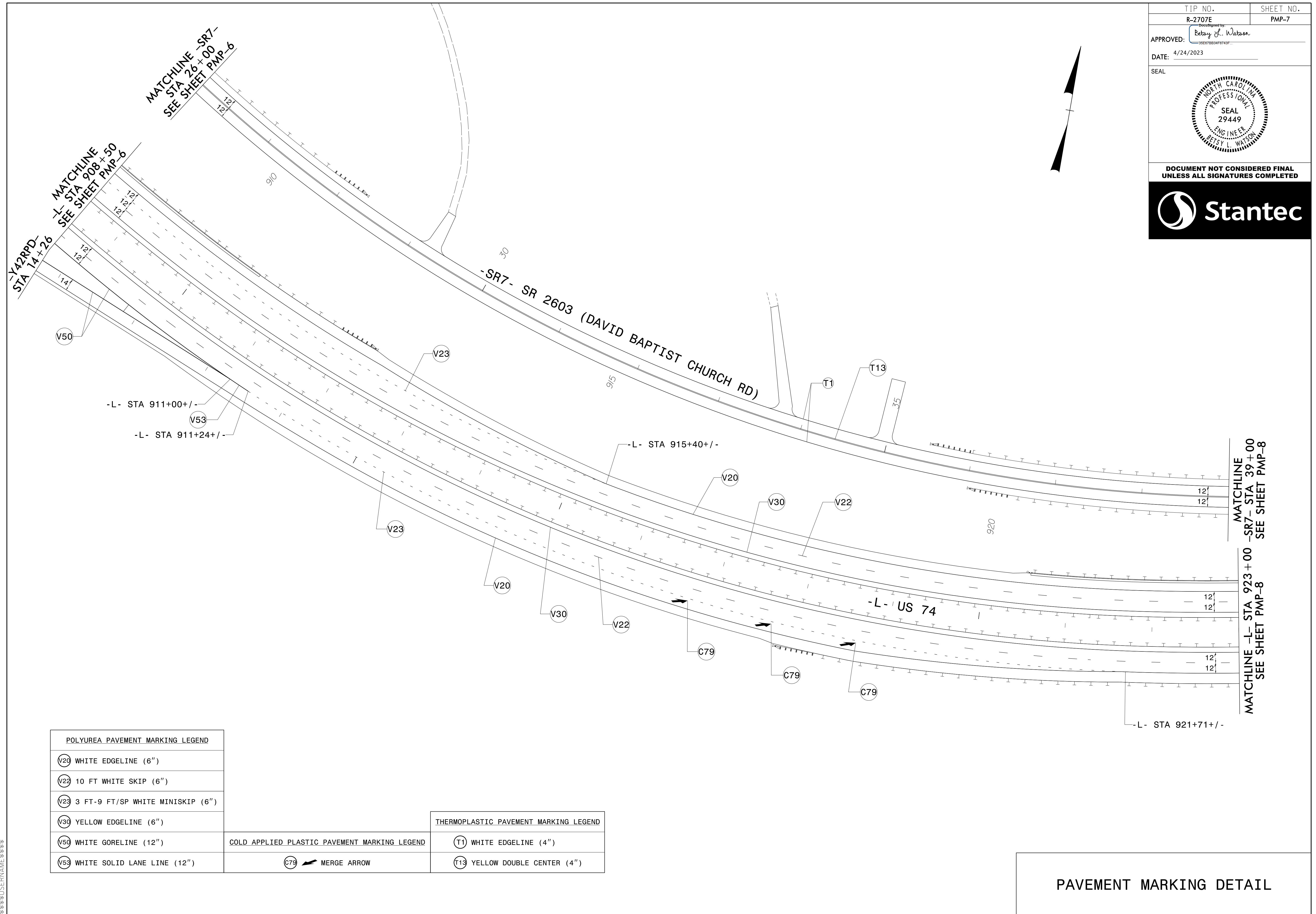
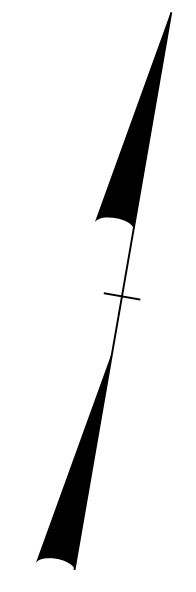

POLYUREA PAVEMENT MARKING LEGEND	
(V20)	WHITE EDGELINE (6")
(V22)	10 FT WHITE SKIP (6")
(V23)	3 FT-9 FT/SP WHITE MINISKIP (6")
(V30)	YELLOW EDGELINE (6")
(V50)	WHITE GORELINE (12")
(V53)	WHITE SOLID LANE LINE (12")

COLD APPLIED PLASTIC PAVEMENT MARKING LEGEND

(C79)  MERGE ARROW

THERMOPLASTIC PAVEMENT MARKING LEGEND	
(T1)	WHITE EDGELINE (4")
(T13)	YELLOW DOUBLE CENTER (4")

\$\$\$\$\$SYTIME\$\$\$\$\$  
\$\$\$\$\$DGN\$\$\$\$\$  
\$\$\$\$\$USERNAME\$\$\$\$\$

**PAVEMENT MARKING DETAIL**

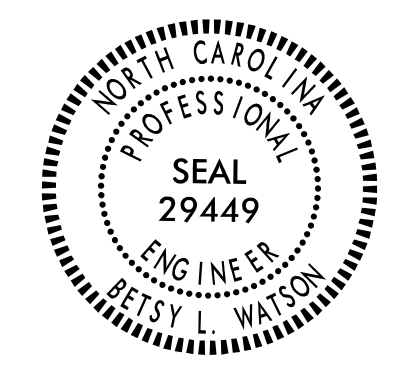
TIP NO. R-2707E	SHEET NO. PMP-8
APPROVED: <i>Betsy L. Watson</i>	
DATE: 4/24/2023	
SEAL	
	
DOCUMENT NOT CONSIDERED FINAL UNLESS ALL SIGNATURES COMPLETED	



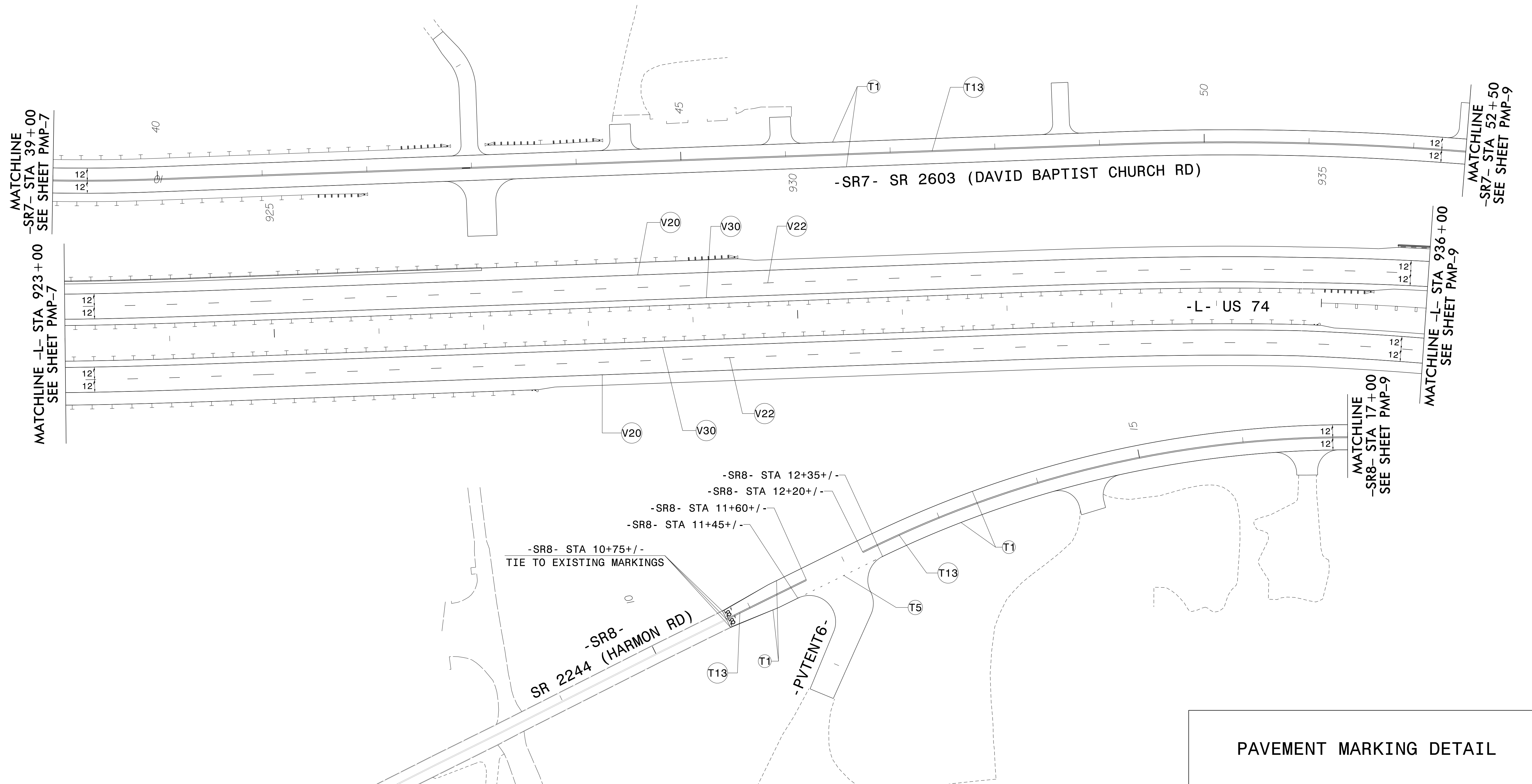
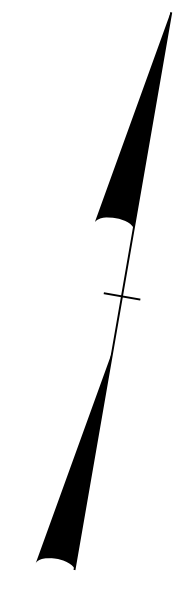

POLYUREA PAVEMENT MARKING LEGEND	THERMOPLASTIC PAVEMENT MARKING LEGEND
V20 WHITE EDGELINE (6")	T1 WHITE EDGELINE (4")
V22 10 FT WHITE SKIP (6")	T5 2 FT-6 FT/SP WHITE MINISKIP (4")
V30 YELLOW EDGELINE (6")	T13 YELLOW DOUBLE CENTER (4")



\$\$\$\$\$SYTIME\$\$\$\$\$  
 \$\$\$\$DGN\$\$\$\$\$  
 \$\$\$USERNAME\$\$\$\$\$

PAVEMENT MARKING DETAIL



TIP NO. R-2707E	SHEET NO. PMP-9
APPROVED: <i>Betsy L. Watson</i>	
DATE: 4/24/2023	
SEAL	
	
<p><b>DOCUMENT NOT CONSIDERED FINAL UNLESS ALL SIGNATURES COMPLETED</b></p> 	

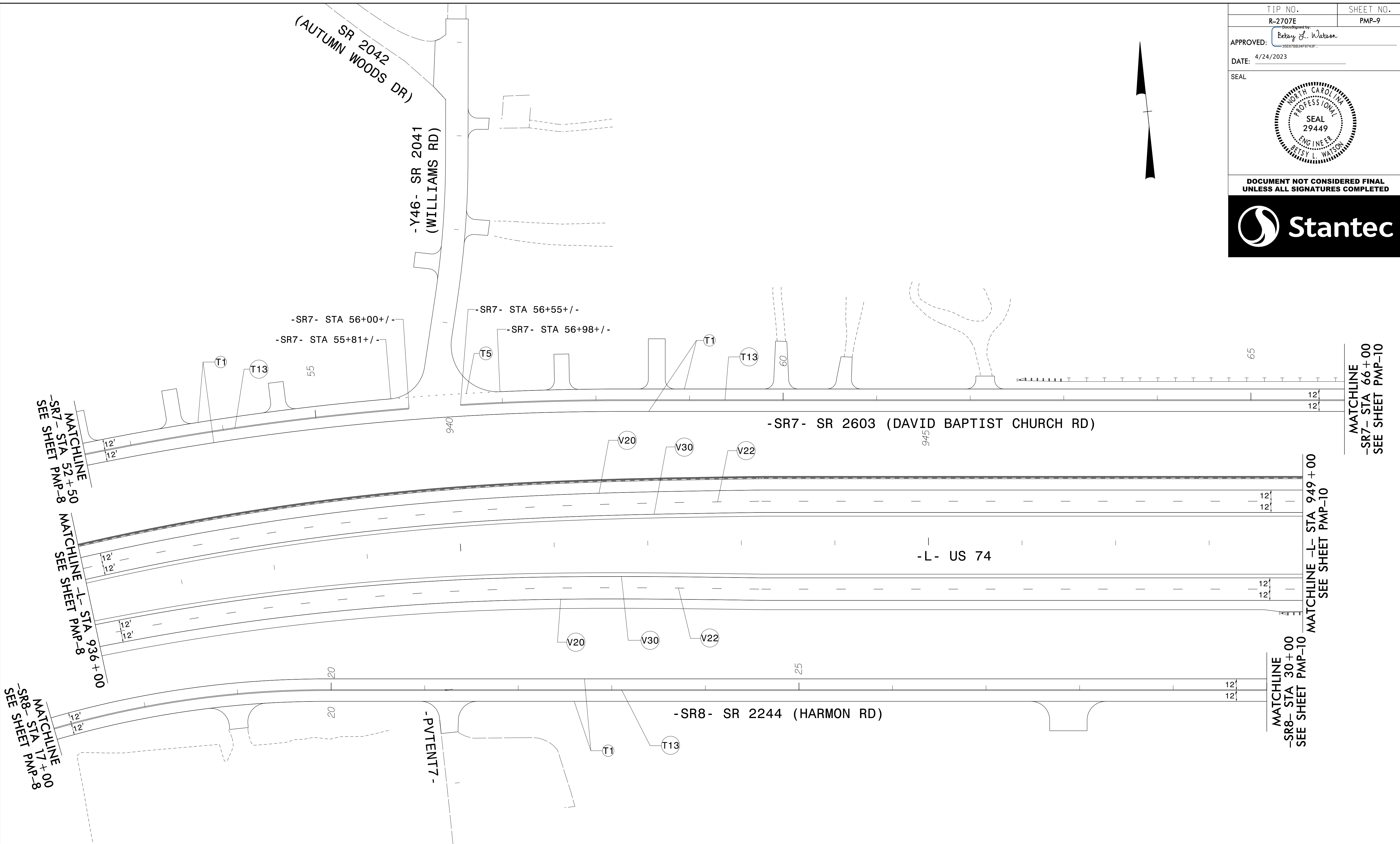
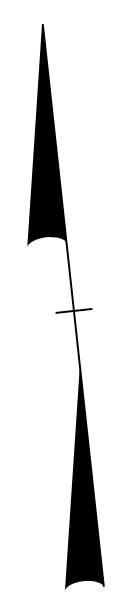

POLYUREA PAVEMENT MARKING LEGEND	THERMOPLASTIC PAVEMENT MARKING LEGEND
WHITE EDGELINE (6")	WHITE EDGELINE (4")
10 FT WHITE SKIP (6")	2 FT-6 FT/SP WHITE MINISKIP (4")
YELLOW EDGELINE (6")	YELLOW DOUBLE CENTER (4")

\$\$\$\$\$SYTIME\$\$\$\$\$  
 \$\$\$\$\$\$DGN\$\$\$\$\$  
 \$\$\$\$\$\$USERNAME\$\$\$\$\$

**PAVEMENT MARKING DETAIL**

TIP NO. R-2707E	SHEET NO. PMP-10
APPROVED: <i>Petsy L. Watson</i>	
DATE: 4/24/2023	
SEAL	
DOCUMENT NOT CONSIDERED FINAL UNLESS ALL SIGNATURES COMPLETED	

POLYUREA PAVEMENT MARKING LEGEND	THERMOPLASTIC PAVEMENT MARKING LEGEND
(V20) WHITE EDGELINE (6")	(T1) WHITE EDGELINE (4")
(V22) 10 FT WHITE SKIP (6")	(T13) YELLOW DOUBLE CENTER (4")
(V30) YELLOW EDGELINE (6")	

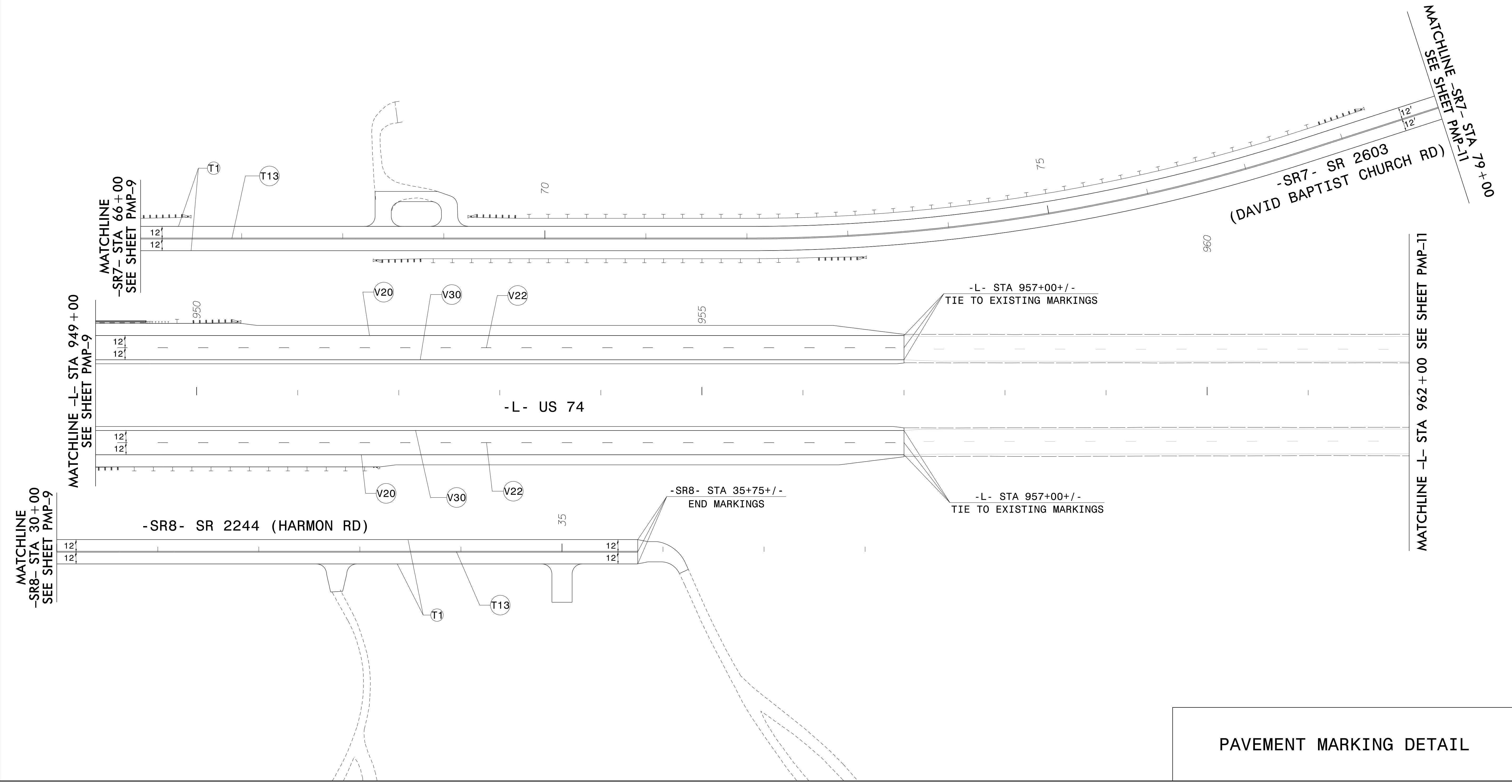
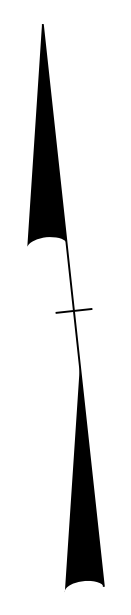

\$\$\$\$\$SYTIME\$\$\$\$\$  
 \$\$\$DDGN\$\$\$\$\$  
 \$\$\$USERNAME\$\$\$\$\$

PAVEMENT MARKING DETAIL



TIP NO. R-2707E	SHEET NO. PMP-11
APPROVED: <i>Petsy L. Watson</i>	
DATE: 4/24/2023	
SEAL	
DOCUMENT NOT CONSIDERED FINAL UNLESS ALL SIGNATURES COMPLETED	

MATCHLINE -L- STA 962+00 SEE SHEET PMP-10

MATCHLINE -SR7- STA 79+00  
SEE SHEET PMP-10

-SR7- SR 2603 (DAVID BAPTIST CHURCH RD)

-SR7- STA 79+52+/-  
TIE TO EXISTING MARKINGS

-L- US 74



THERMOPLASTIC PAVEMENT MARKING LEGEND	
	WHITE EDGELINE (4")
	YELLOW DOUBLE CENTER (4")

PAVEMENT MARKING DETAIL

\$\$\$\$\$SYTIME\$\$\$\$\$  
\$\$\$\$\$DGN\$\$\$\$\$  
\$\$\$\$\$USERNAME\$\$\$\$\$

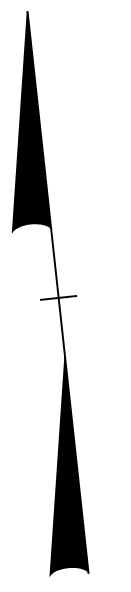
975

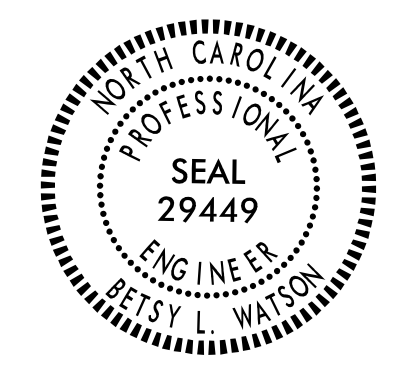

TIP NO. R-2707E	SHEET NO. PMP-12
APPROVED: <i>Betsy L. Watson</i>	
DATE: 4/24/2023	
	
<b>DOCUMENT NOT CONSIDERED FINAL UNLESS ALL SIGNATURES COMPLETED</b>	
	

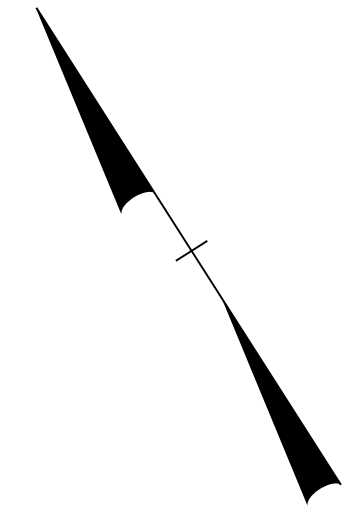

MATCHLINE -SR10- STA 20+00  
SEE SHEET PMP-6

12'  
12'

T1

T13

-SR10- SR 2245 (BETHLEHEM RD)

-SR10- STA 28+50+/-  
TIE TO EXISTING MARKINGS

9.5'  
9.5'

30



SR 2244 (HARMON RD)

\$\$\$\$\$SYTIME\$\$\$\$\$  
\$\$\$\$\$DGN\$\$\$\$\$  
\$\$\$\$\$USERNAME\$\$\$\$\$

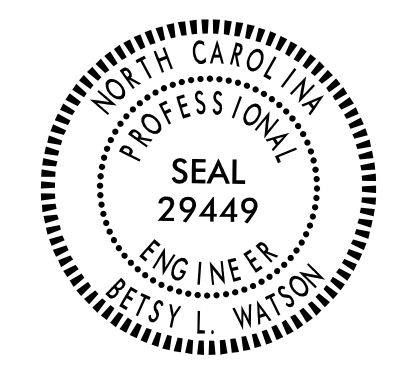

THERMOPLASTIC PAVEMENT MARKING LEGEND	
(T1)	WHITE EDGELINE (4")
(T13)	YELLOW DOUBLE CENTER (4")

PAVEMENT MARKING DETAIL



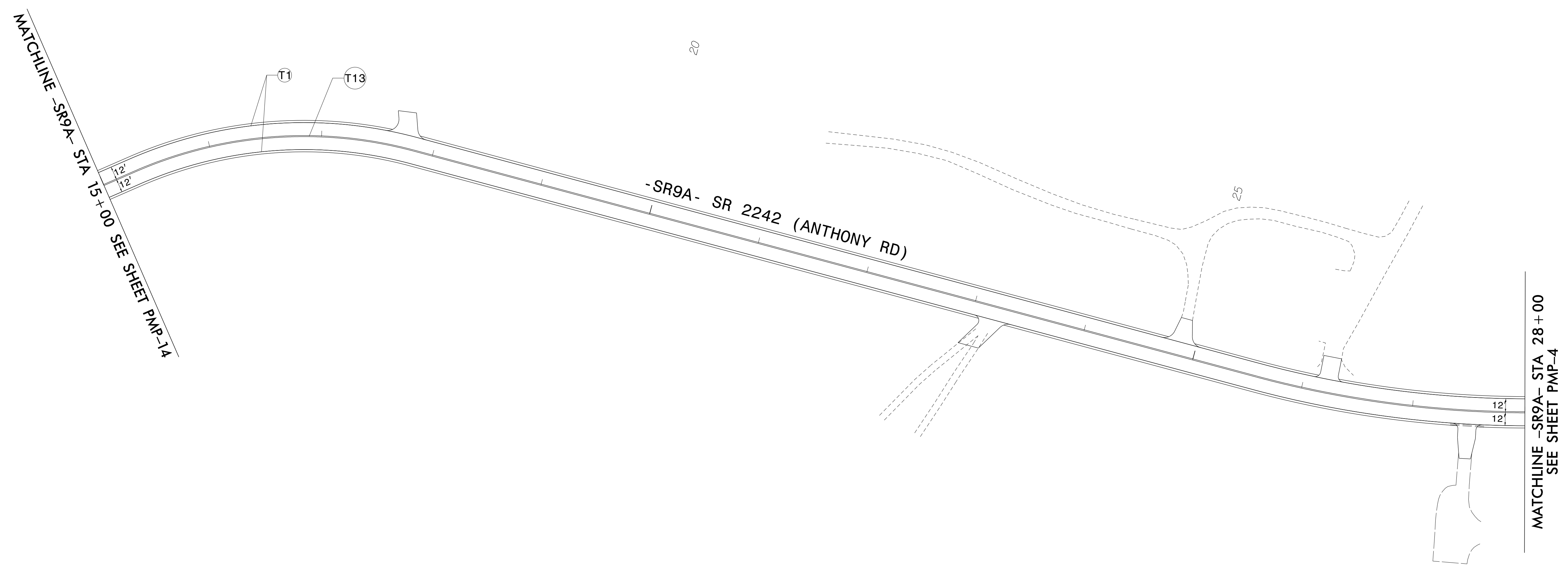
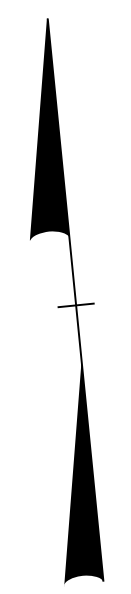

TIP NO. R-2707E	SHEET NO. PMP-13
APPROVED: <i>Petsy L. Watson</i>	
DATE: 4/24/2023	
SEAL	
	
DOCUMENT NOT CONSIDERED FINAL UNLESS ALL SIGNATURES COMPLETED	
	



THERMOPLASTIC PAVEMENT MARKING LEGEND	
	WHITE EDGELINE (4")
	YELLOW DOUBLE CENTER (4")

PAVEMENT MARKING DETAIL

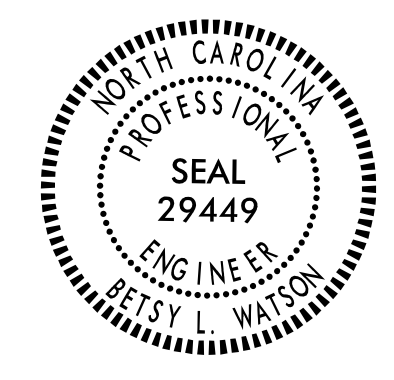
\$\$\$\$\$SYTIME\$\$\$\$\$  
 \$\$\$\$\$\$DGN\$\$\$\$\$  
 \$\$\$\$\$\$USERNAME\$\$\$\$\$

TIP NO. R-2707E	SHEET NO. PMP-14
APPROVED: <i>Petsy L. Watson</i>	
DATE: 4/24/2023	
SEAL	
	
DOCUMENT NOT CONSIDERED FINAL UNLESS ALL SIGNATURES COMPLETED	
	

THERMOPLASTIC PAVEMENT MARKING LEGEND	
(T1)	WHITE EDGELINE (4")
(T5)	2 FT-6 FT/SP WHITE MINISKIP (4")
(T13)	YELLOW DOUBLE CENTER (4")
(T61)	WHITE STOPBAR (24")

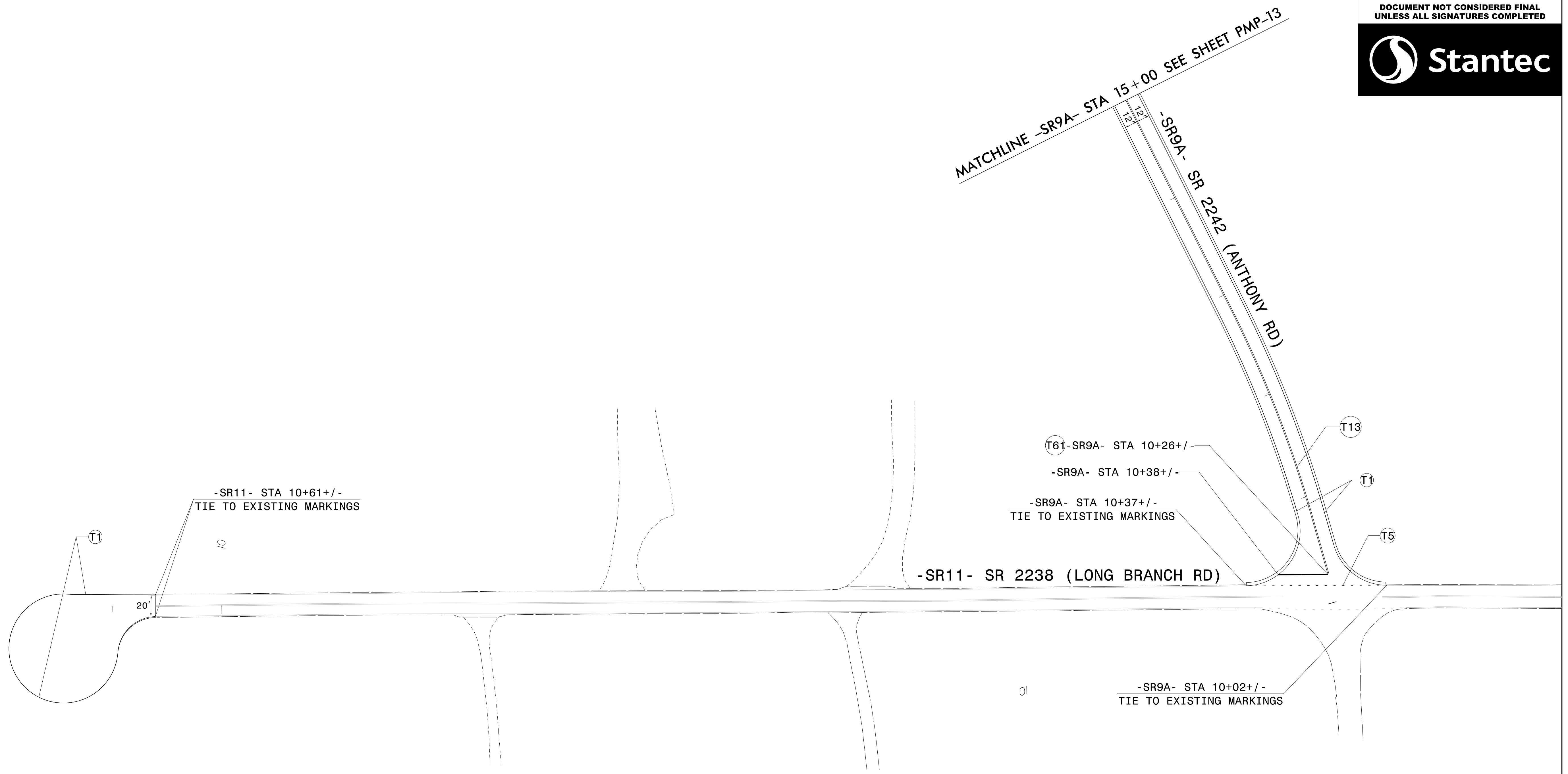
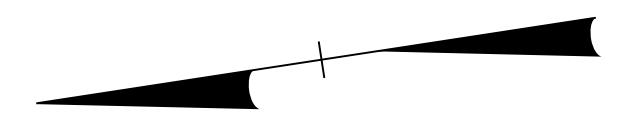

\$\$\$\$\$SYTIME\$\$\$\$\$  
 \$\$\$\$\$\$DGN\$\$\$\$\$  
 \$\$\$\$\$\$USERNAME\$\$\$\$\$

PAVEMENT MARKING DETAIL



THERMOPLASTIC PAVEMENT MARKING LEGEND	
(T1)	WHITE EDGELINE (4")
(T5)	2 FT-6 FT/SP WHITE MINISKIP (4")
(T13)	YELLOW DOUBLE CENTER (4")

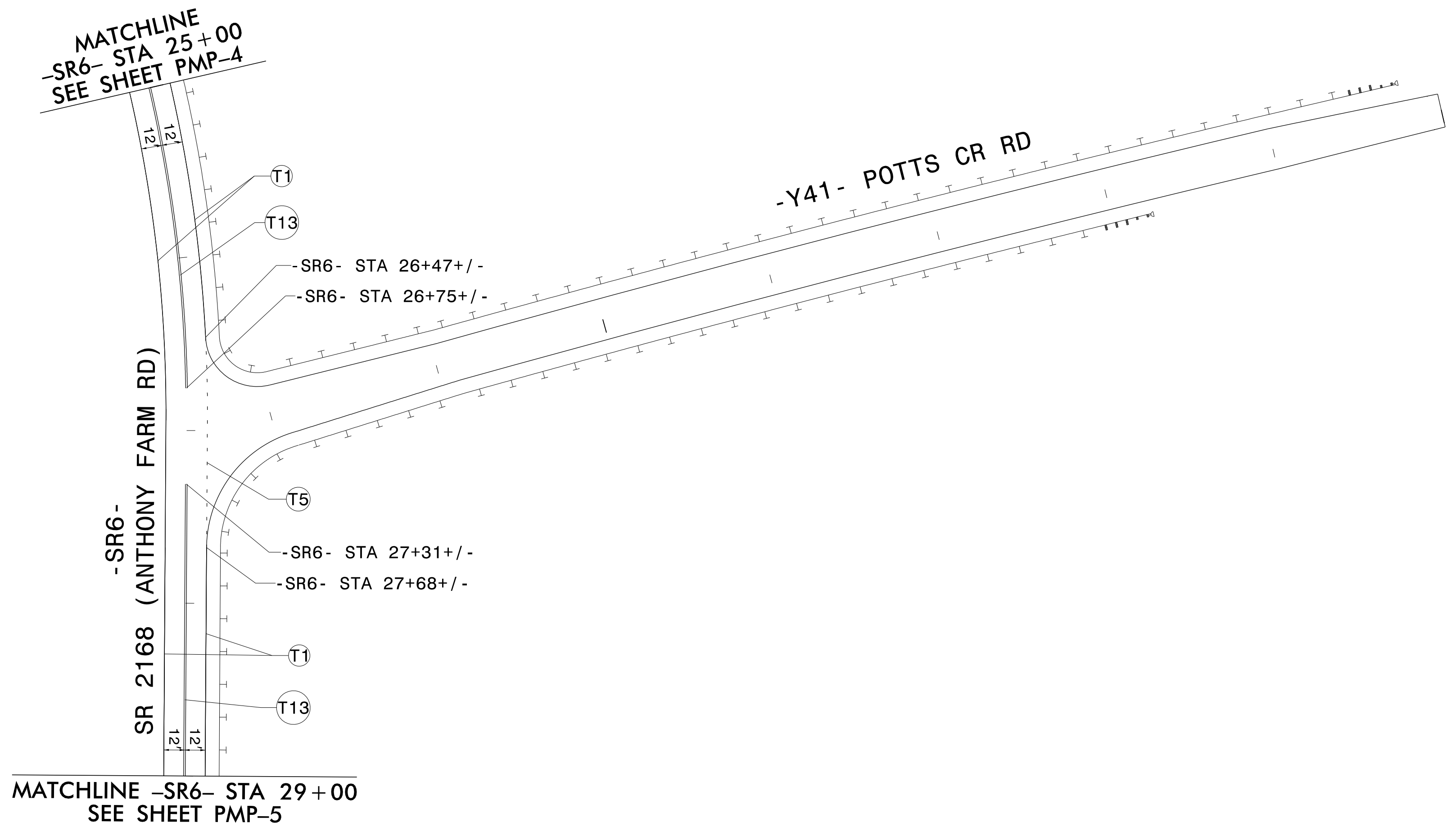
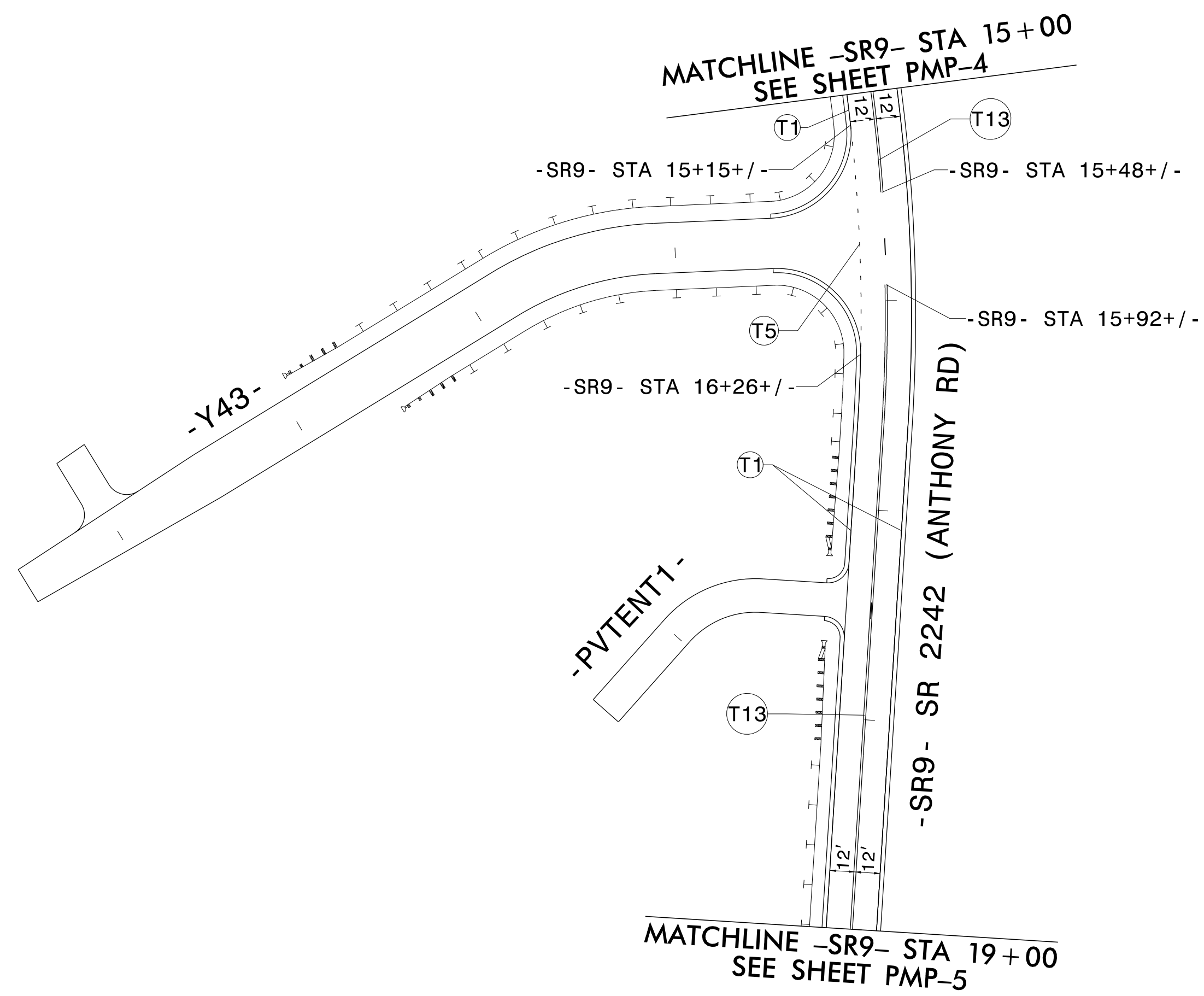

\$\$\$\$\$SYTIME\$\$\$\$\$  
\$\$\$\$\$DDGN\$\$\$\$\$  
\$\$\$\$\$USERNAME\$\$\$\$\$

TIP NO. R-2707E	SHEET NO. PMP-15
APPROVED: <i>Petsy L. Watson</i>	
DATE: 4/24/2023	
SEAL	
DOCUMENT NOT CONSIDERED FINAL UNLESS ALL SIGNATURES COMPLETED	

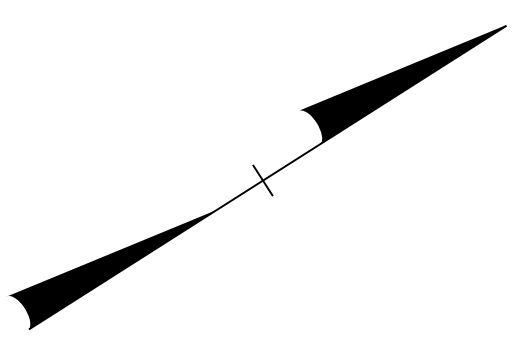

THERMOPLASTIC PAVEMENT MARKING LEGEND	
(T1)	WHITE EDGELINE (4")
(T5)	2 FT-6 FT/SP WHITE MINISKIP (4")
(T13)	YELLOW DOUBLE CENTER (4")

PAVEMENT MARKING DETAIL

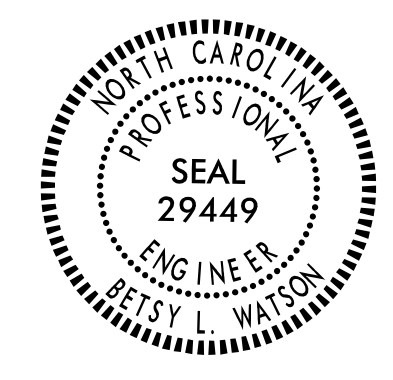

DOCUMENT NOT CONSIDERED FINAL  
UNLESS ALL SIGNATURES COMPLETED

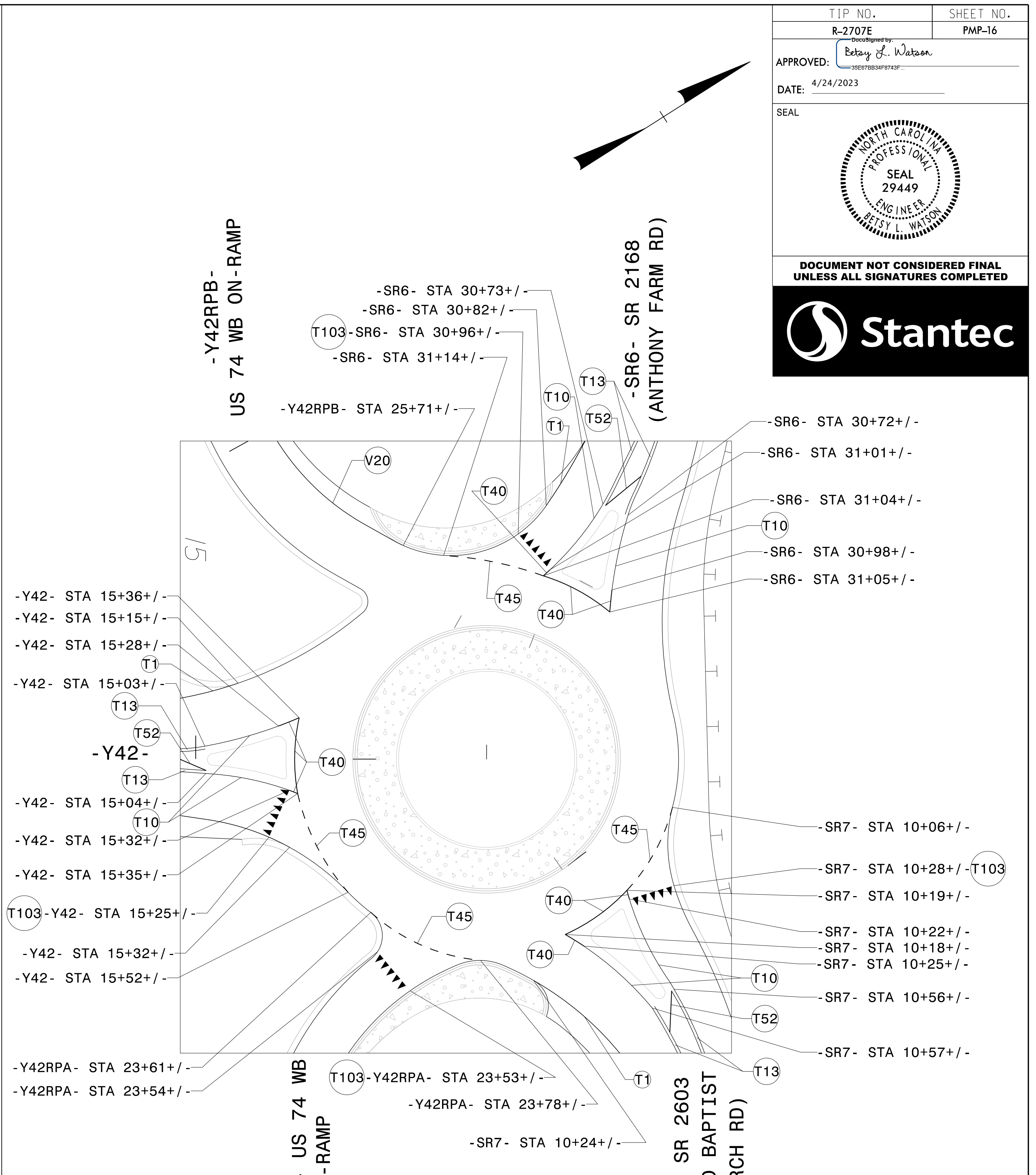
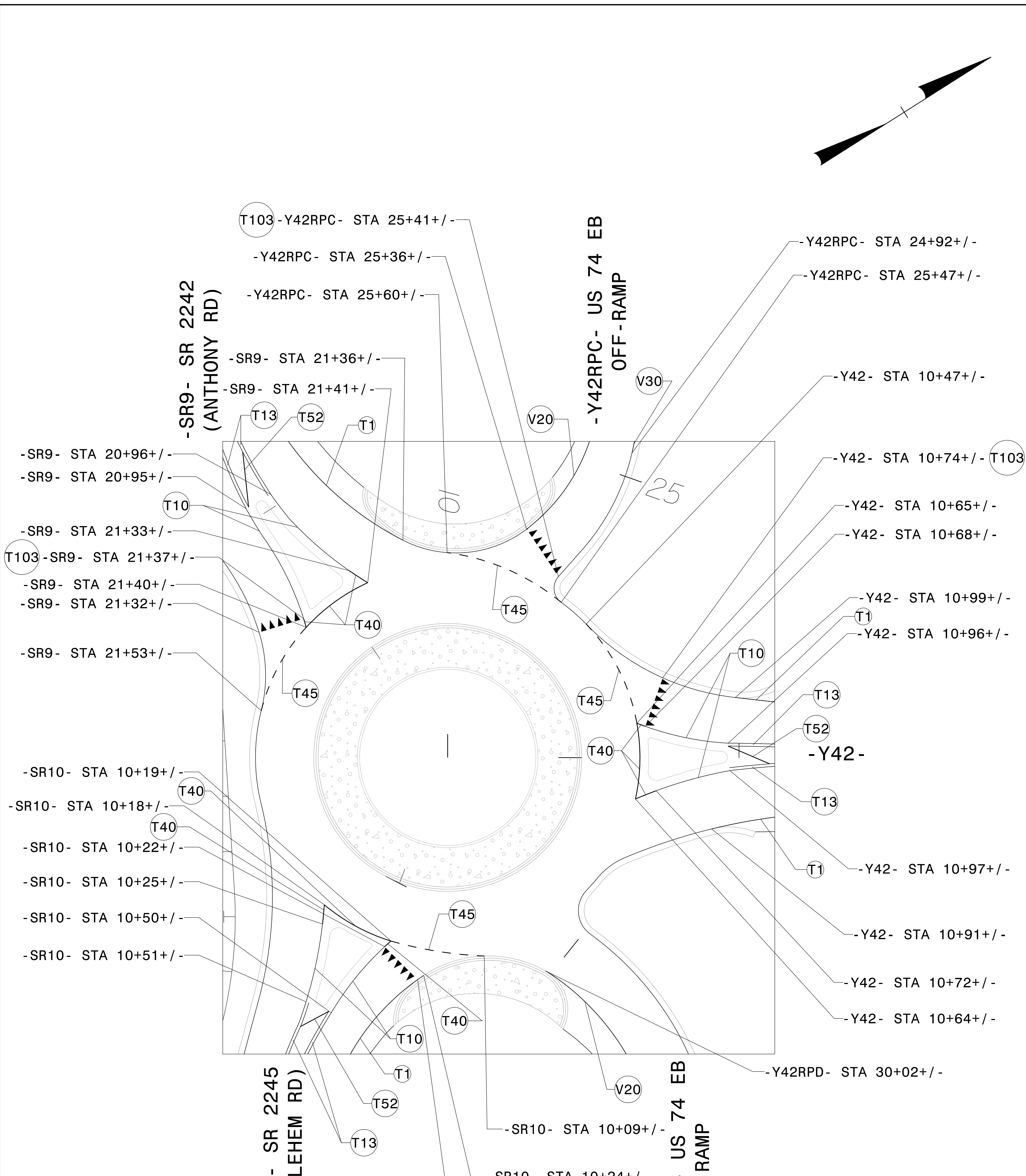

\$\$\$\$\$SYTIME\$\$\$\$\$  
\$\$\$\$\$DGN\$\$\$\$\$  
\$\$\$\$\$USERNAME\$\$\$\$\$

THERMOPLASTIC PAVEMENT MARKING LEGEND		THERMOPLASTIC PAVEMENT MARKING LEGEND	
(T1) WHITE EDGELINE (4")	(T1) WHITE EDGELINE (4")	(T1) WHITE EDGELINE (4")	(T1) WHITE EDGELINE (4")
(T10) YELLOW EDGELINE (4")	(T10) YELLOW EDGELINE (4")	(T10) YELLOW EDGELINE (4")	(T10) YELLOW EDGELINE (4")
(T13) YELLOW DOUBLE CENTER (4")	(T13) YELLOW DOUBLE CENTER (4")	(T13) YELLOW DOUBLE CENTER (4")	(T13) YELLOW DOUBLE CENTER (4")
(T40) WHITE GORELINE (8")	(T40) WHITE GORELINE (8")	(T40) WHITE GORELINE (8")	(T40) WHITE GORELINE (8")
(T45) 3 FT-3 FT/SP WHITE MINISKIP (8")	(T45) 3 FT-3 FT/SP WHITE MINISKIP (8")	(T45) 3 FT-3 FT/SP WHITE MINISKIP (8")	(T45) 3 FT-3 FT/SP WHITE MINISKIP (8")
(V20) WHITE EDGELINE (6")	(T52) YELLOW DIAGONAL (12")	(T52) YELLOW DIAGONAL (12")	(T52) YELLOW DIAGONAL (12")
(V30) YELLOW EDGELINE (6")	(T103) ▼▼▼ 24" YIELD LINE TRIANGLE	(T103) ▼▼▼ 24" YIELD LINE TRIANGLE	(V20) WHITE EDGELINE (6")

PAVEMENT MARKING DETAIL