

## U-2729

# **SR 1672 (HANES MILL ROAD) FROM MUSEUM DRIVE TO NC 66 (UNIVERSITY PARKWAY) IN WINSTON-SALEM**

### INDEX OF SHEETS

<u>TITLE</u>	<u>SHEET NO.</u>
CROSS SECTION INDEX	X-A
CROSS SECTION SUMMARY	X-B
-L-	X-1 THRU X-18
-Y1A-	X-19 THRU X-20
-Y1B-	X-21
-Y2-	X-22
-Y3A-	X-23
-Y5-	X-24
-Y6A-	X-25 THRU X-27
-Y6B-	X-28 THRU X-29
-RPA- & -LPA-	X-30 THRU X-32
-RPB- & -LPB-	X-33 THRU X-35
-RDBT-	X-36 THRU X-39
-LPB-	X-40
-DR1-	X-41
-DR2-	X-42



6/23/16

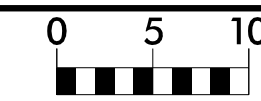

PROJ. REFERENCE NO.	SHEET NO.
U-2729	X-1

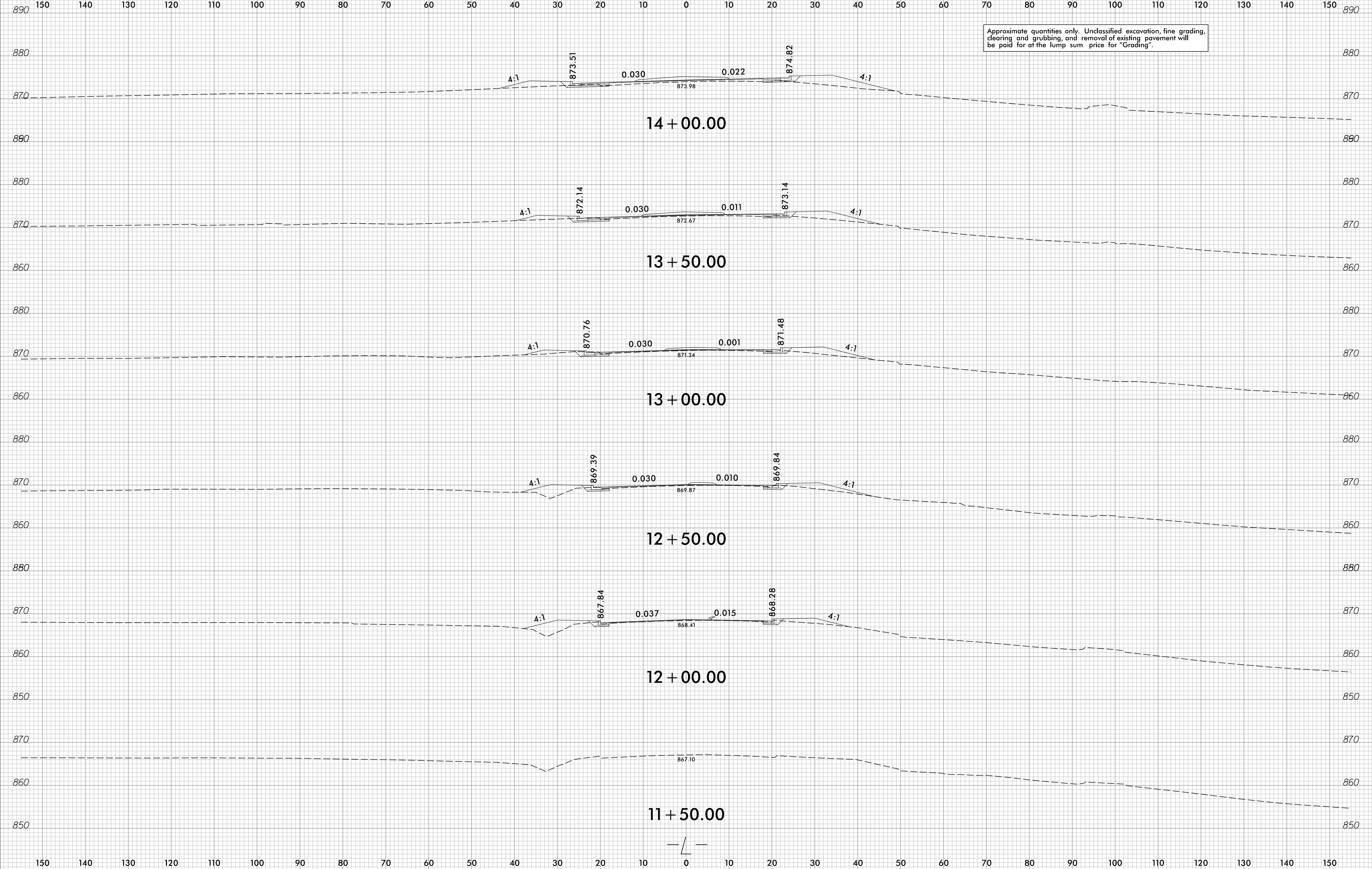

3/9/2023  
C:\Users\jgoy\OneDrive\Xsc\Xp1\U-2729\_rdy\_XPL.dgn

6/23/16

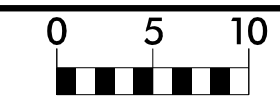

PROJ. REFERENCE NO.	SHEET NO.
U-2729	X-2

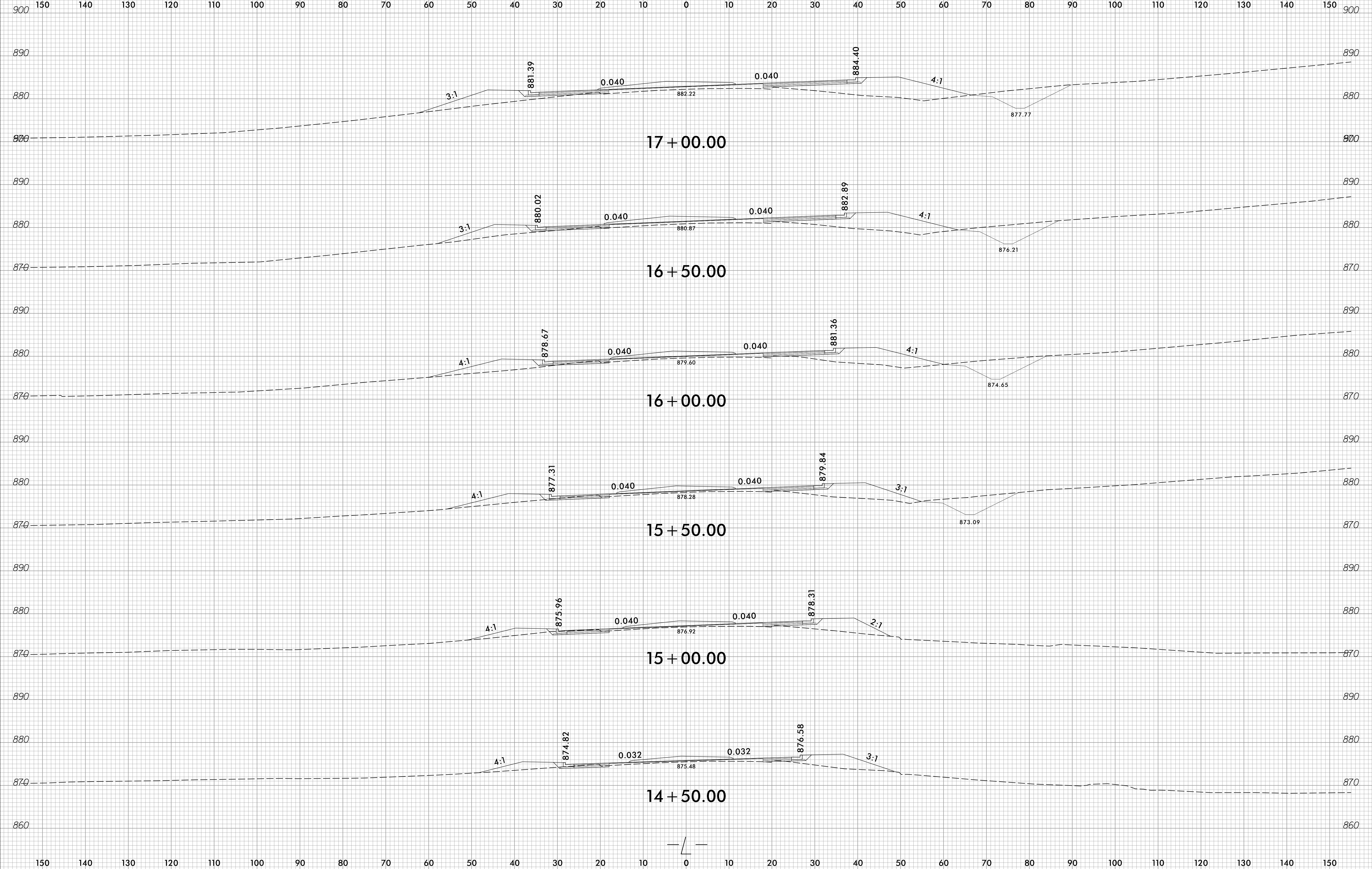

3/9/2023  
C:\Users\jgoy\Xsc\Xp1\U-2729\_r.dwg\_XPL.dgn

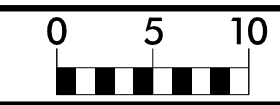

150 140 130 120 110 100 90 80 70 60 50 40 30 20 10 0 10 20 30 40 50 60 70 80 90 100 110 120 130 140 150

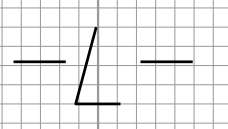
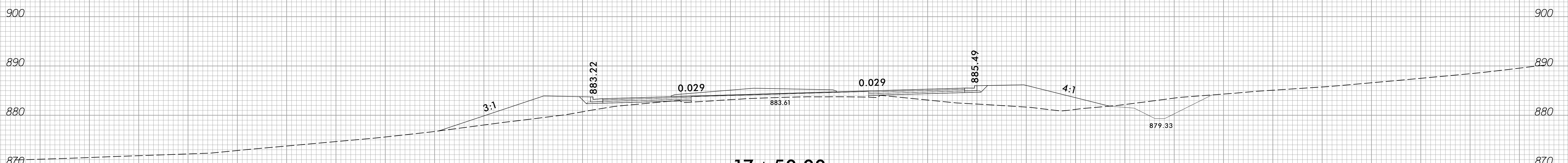
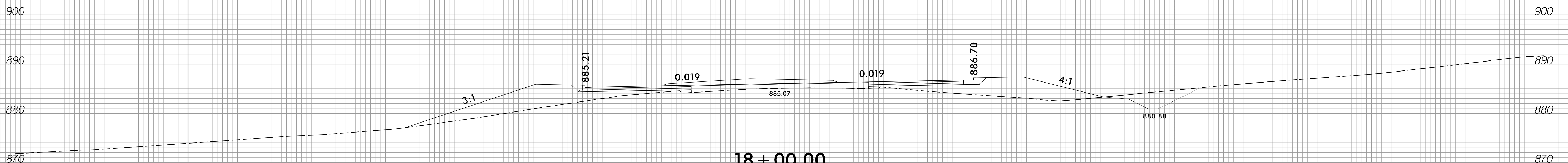
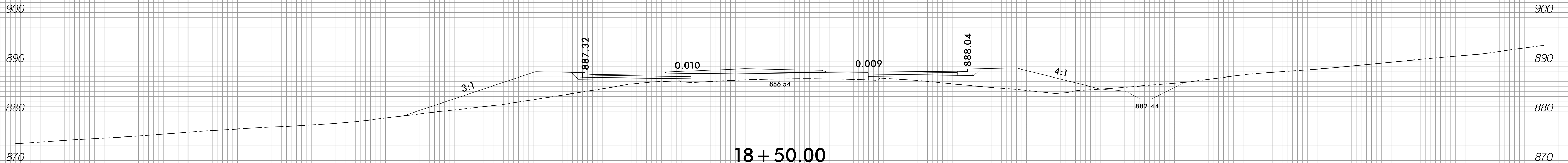
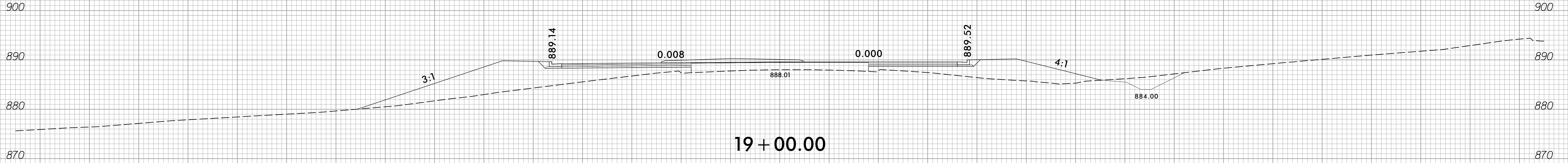

6/23/16

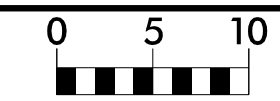

PROJ. REFERENCE NO.	SHEET NO.
U-2729	X-4

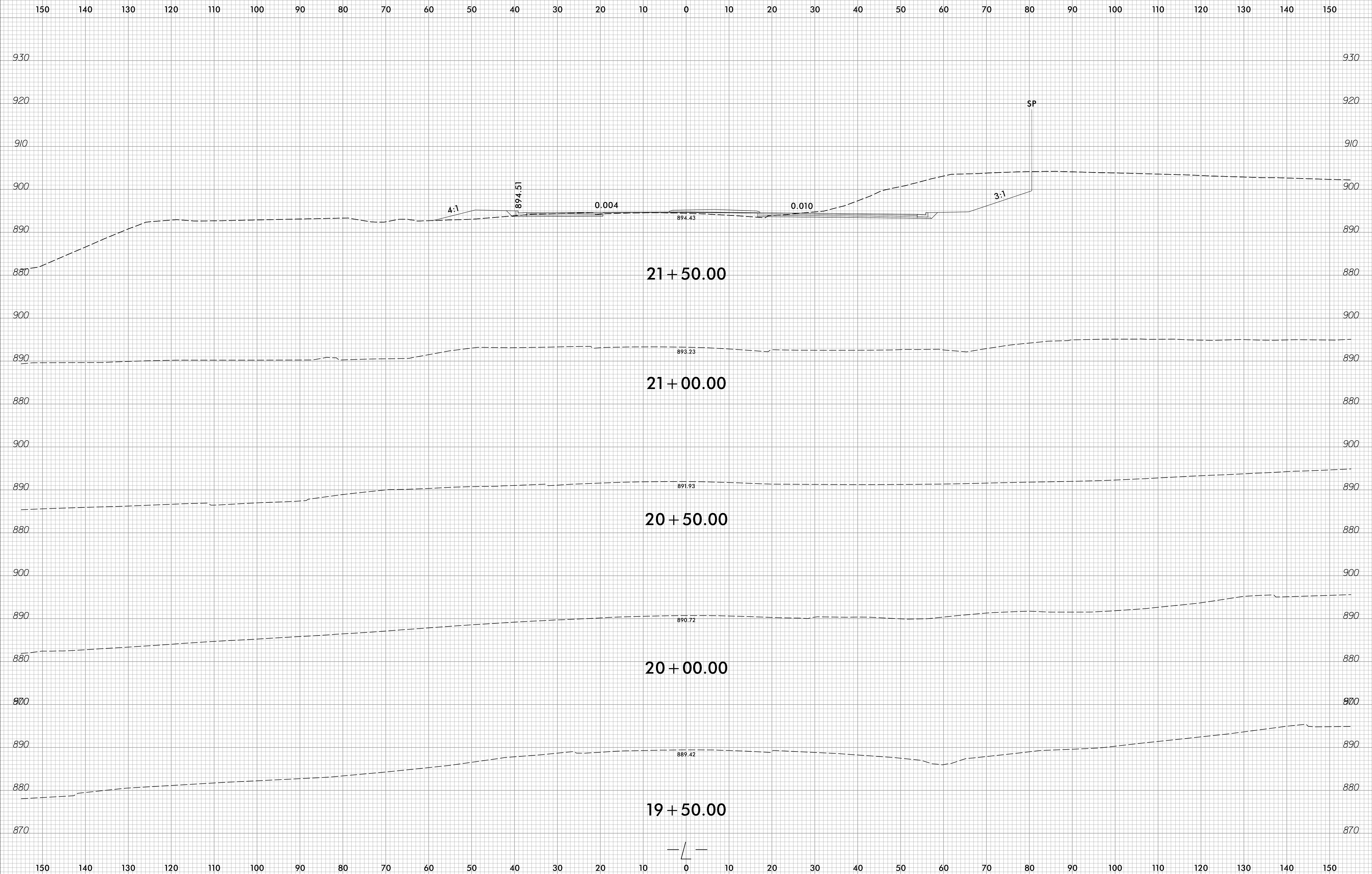

3/9/2023  
 C:\Users\jgoy\OneDrive\Xsc\Xp1\U-2729\_rdy\_XPL.dgn  
 00K02317

6/23/16

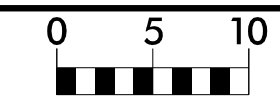

PROJ. REFERENCE NO.	SHEET NO.
U-2729	X-5

150 140 130 120 110 100 90 80 70 60 50 40 30 20 10 0 10 20 30 40 50 60 70 80 90 100 110 120 130 140 150

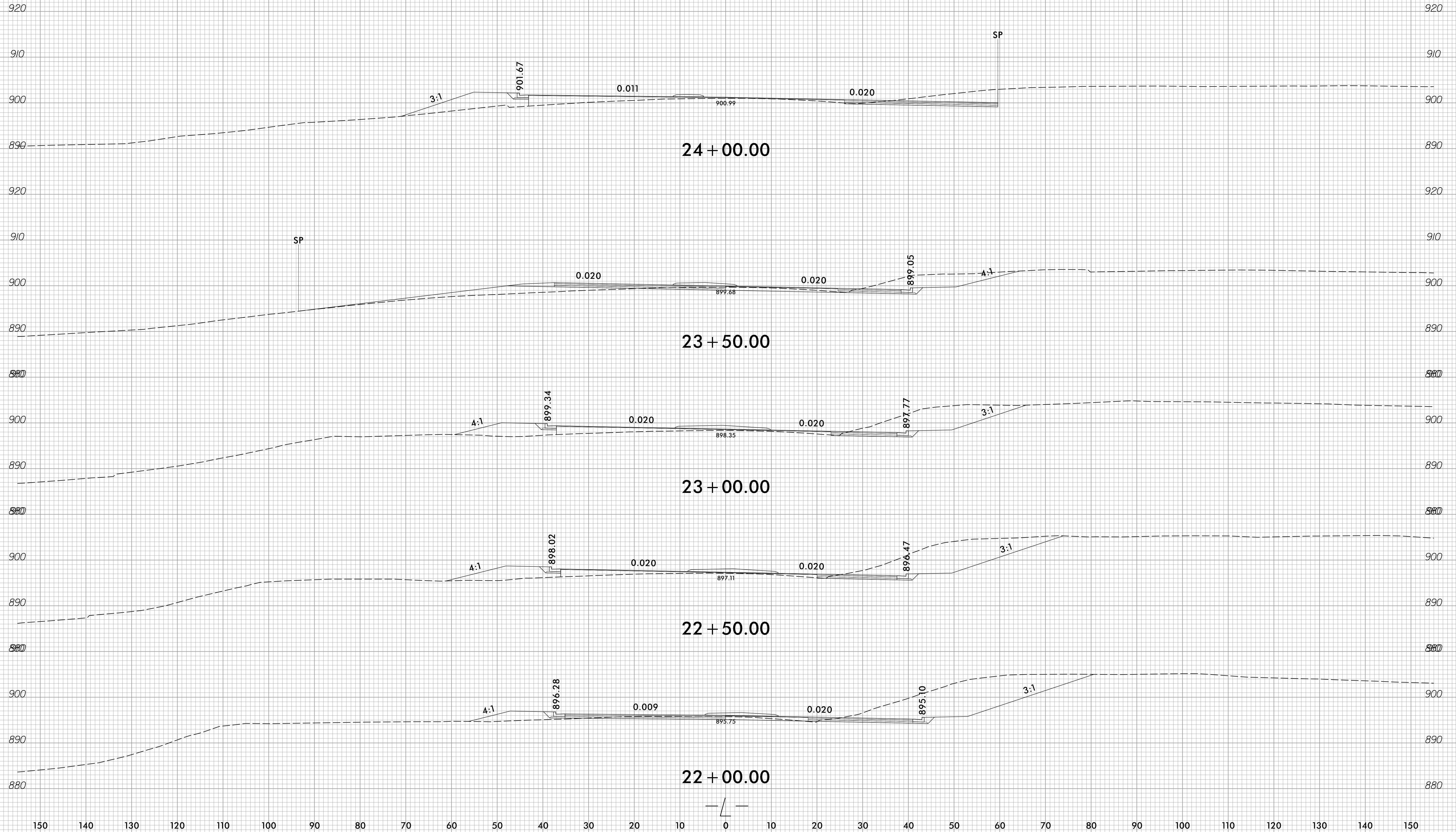

3/9/2023  
 P:\Projects\2023\U-2729\XPL.dgn  
 20230309

150 140 130 120 110 100 90 80 70 60 50 40 30 20 10 0 10 20 30 40 50 60 70 80 90 100 110 120 130 140 150

6/23/16

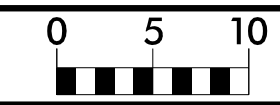

PROJ. REFERENCE NO.  
U-2729

SHEET NO.  
X-6

150 140 130 120 110 100 90 80 70 60 50 40 30 20 10 0 10 20 30 40 50 60 70 80 90 100 110 120 130 140 150

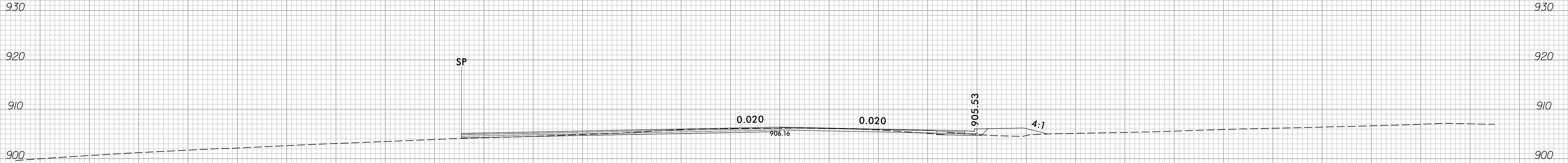

26 + 00.00

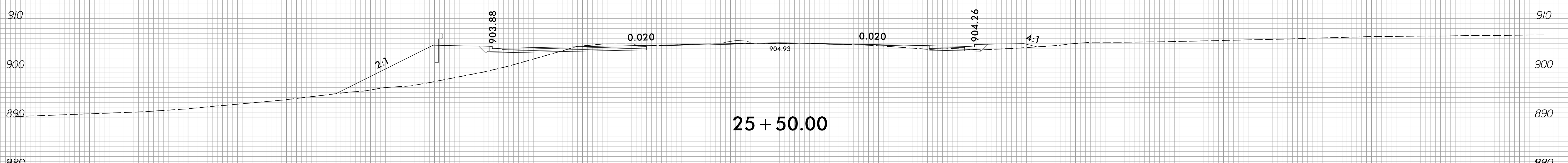

25 + 50.00

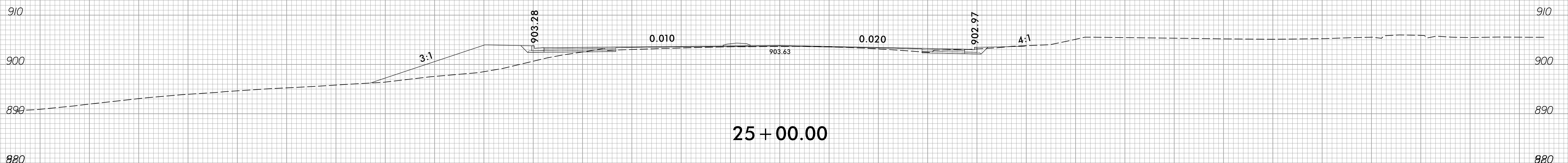

25 + 00.00

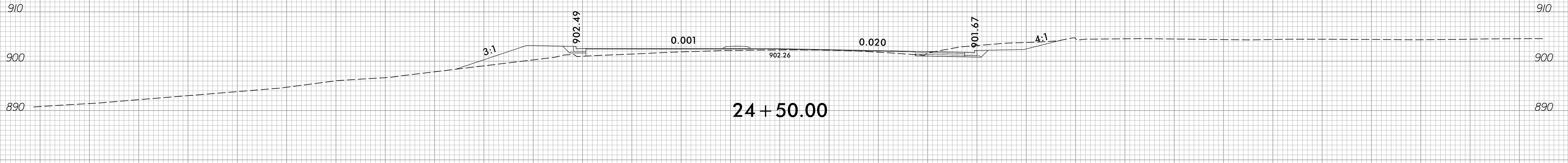

24 + 50.00

150 140 130 120 110 100 90 80 70 60 50 40 30 20 10 0 10 20 30 40 50 60 70 80 90 100 110 120 130 140 150

3/9/2023  
C:\Users\jguy\OneDrive\Documents\Xsc\Xpl\U-2729\_rdy\_XPL.dgn



6/23/16

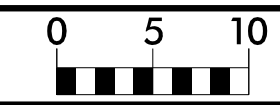

PROJ. REFERENCE NO.  
U-2729

SHEET NO.  
X-7

150 140 130 120 110 100 90 80 70 60 50 40 30 20 10 0 10 20 30 40 50 60 70 80 90 100 110 120 130 140 150

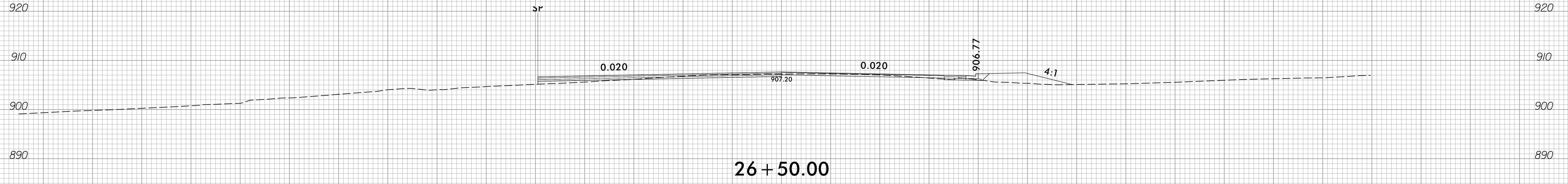
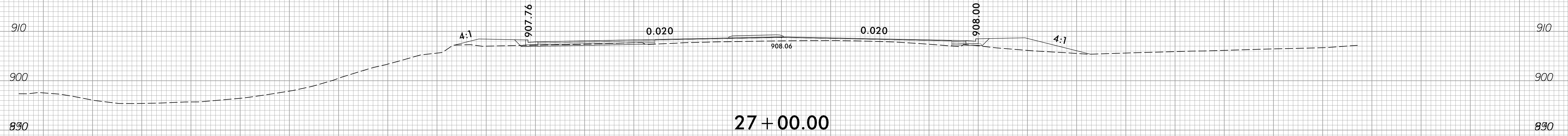
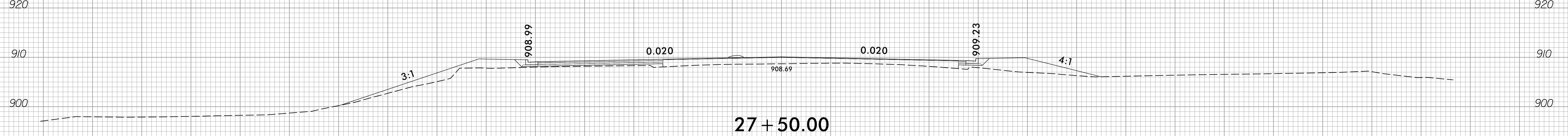
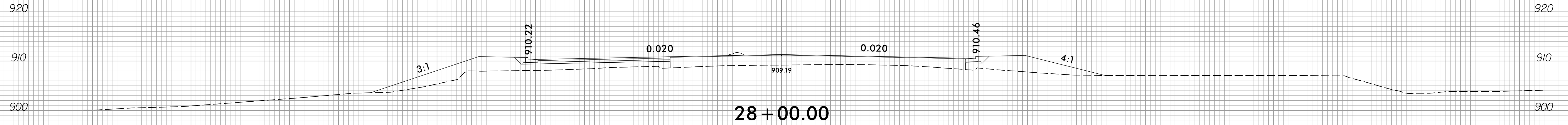
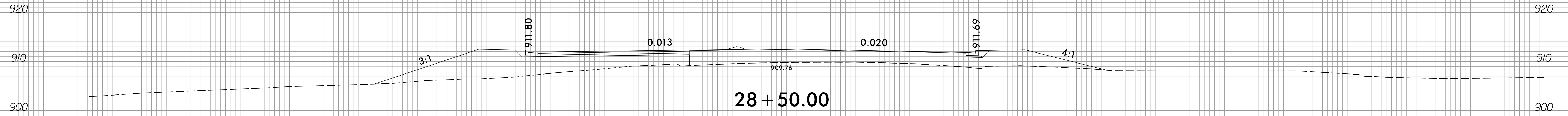

150 140 130 120 110 100 90 80 70 60 50 40 30 20 10 0 10 20 30 40 50 60 70 80 90 100 110 120 130 140 150

3/9/2023  
C:\Users\jgoy\Xsc\Xp1\U-2729\_rdy\_XPL.dgn

6/23/16

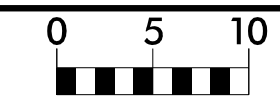

PROJ. REFERENCE NO.  
U-2729

SHEET NO.  
X-8

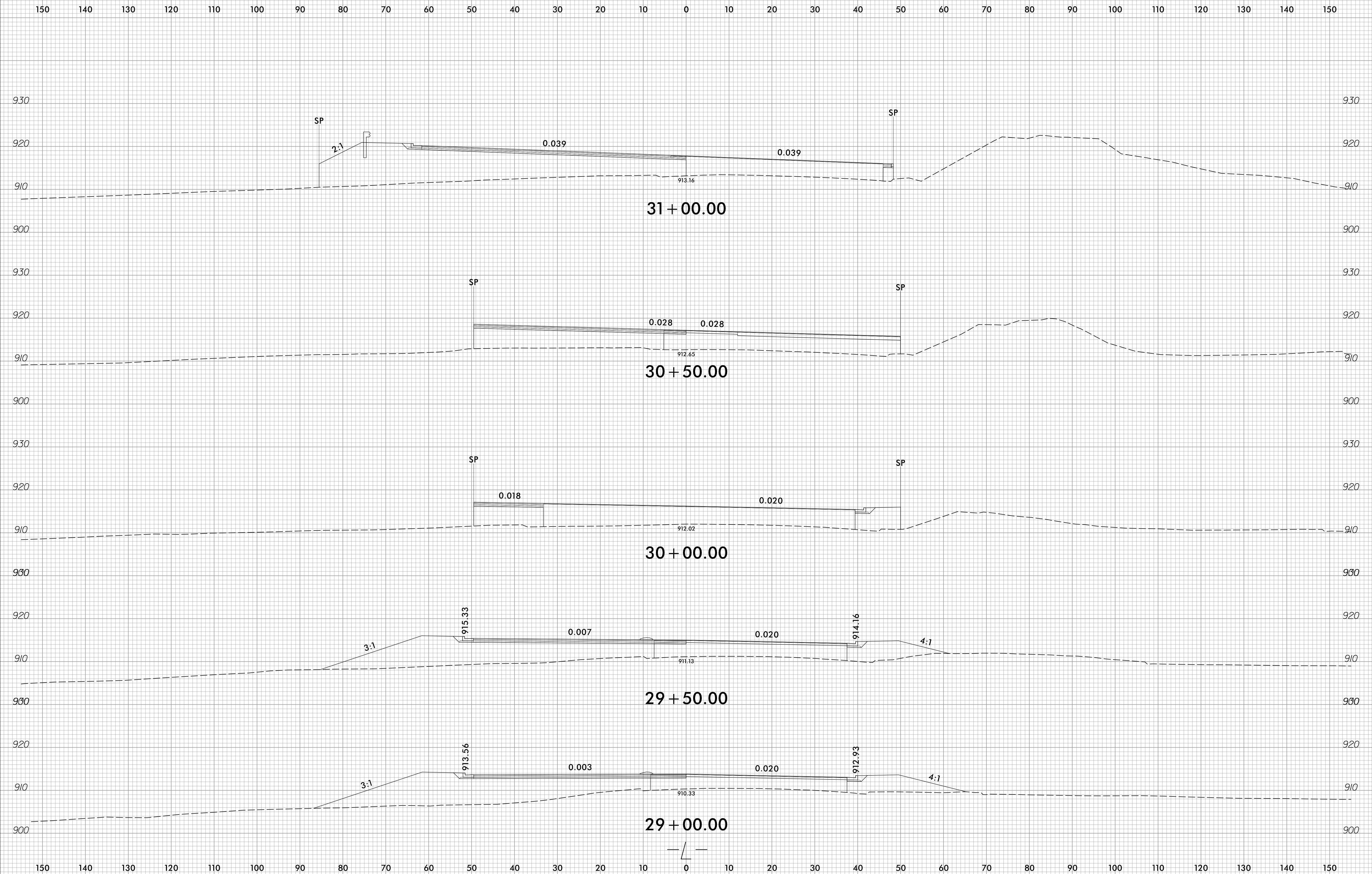

3/9/2023  
P:\Projects\2729\Xsec\Xpl\U-2729\_rdy\_XPL.dgn  
00K02317

6/23/16

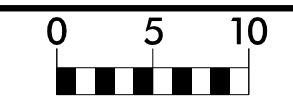

PROJ. REFERENCE NO.	SHEET NO.
U-2729	X-9

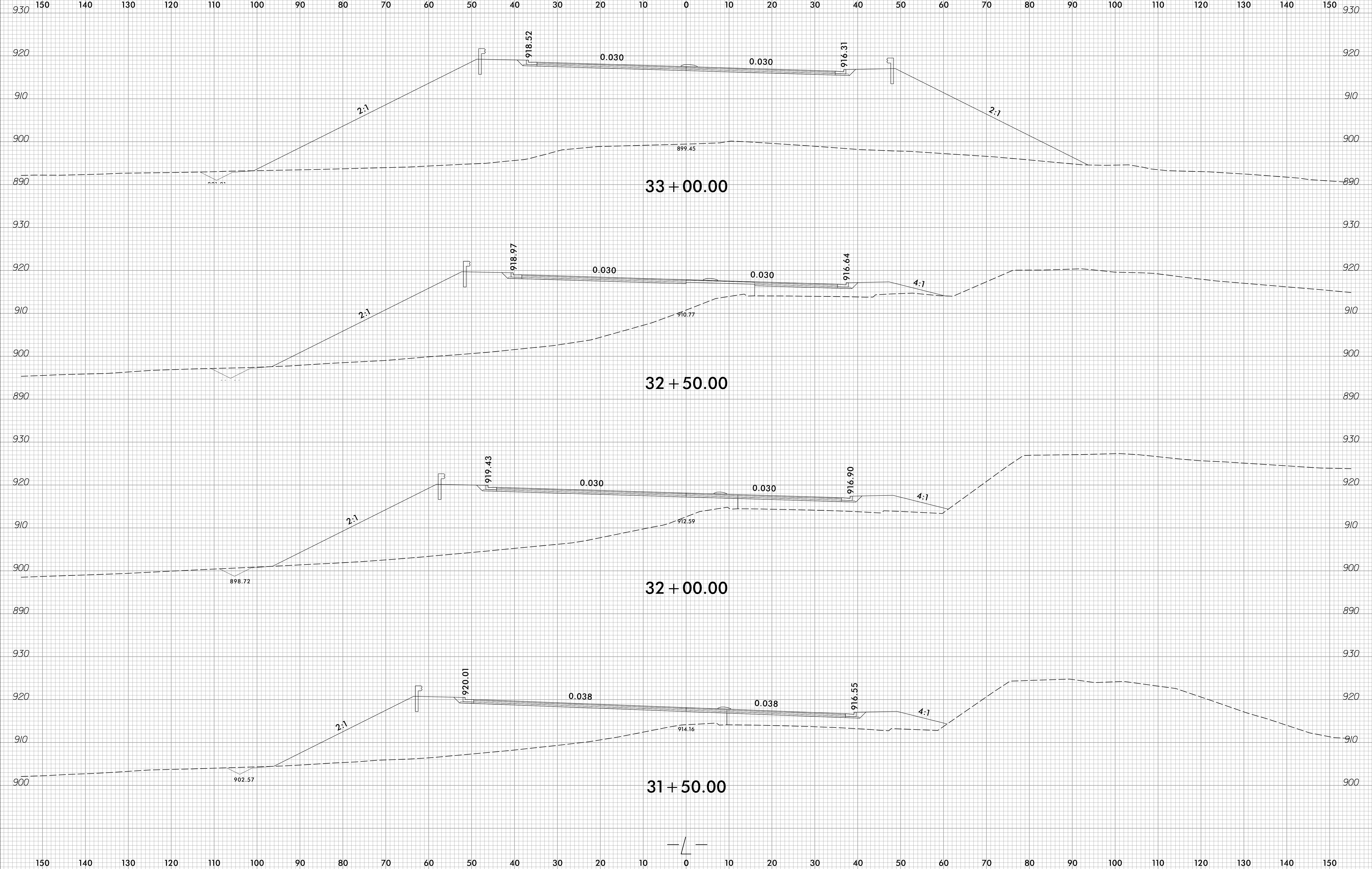

3/9/2023  
C:\Users\jguy\OneDrive\Documents\Xsc\Xpl\U-2729\_rdy\_XPL.dgn  
00K02317

150 140 130 120 110 100 90 80 70 60 50 40 30 20 10 0 10 20 30 40 50 60 70 80 90 100 110 120 130 140 150

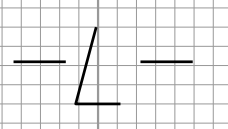
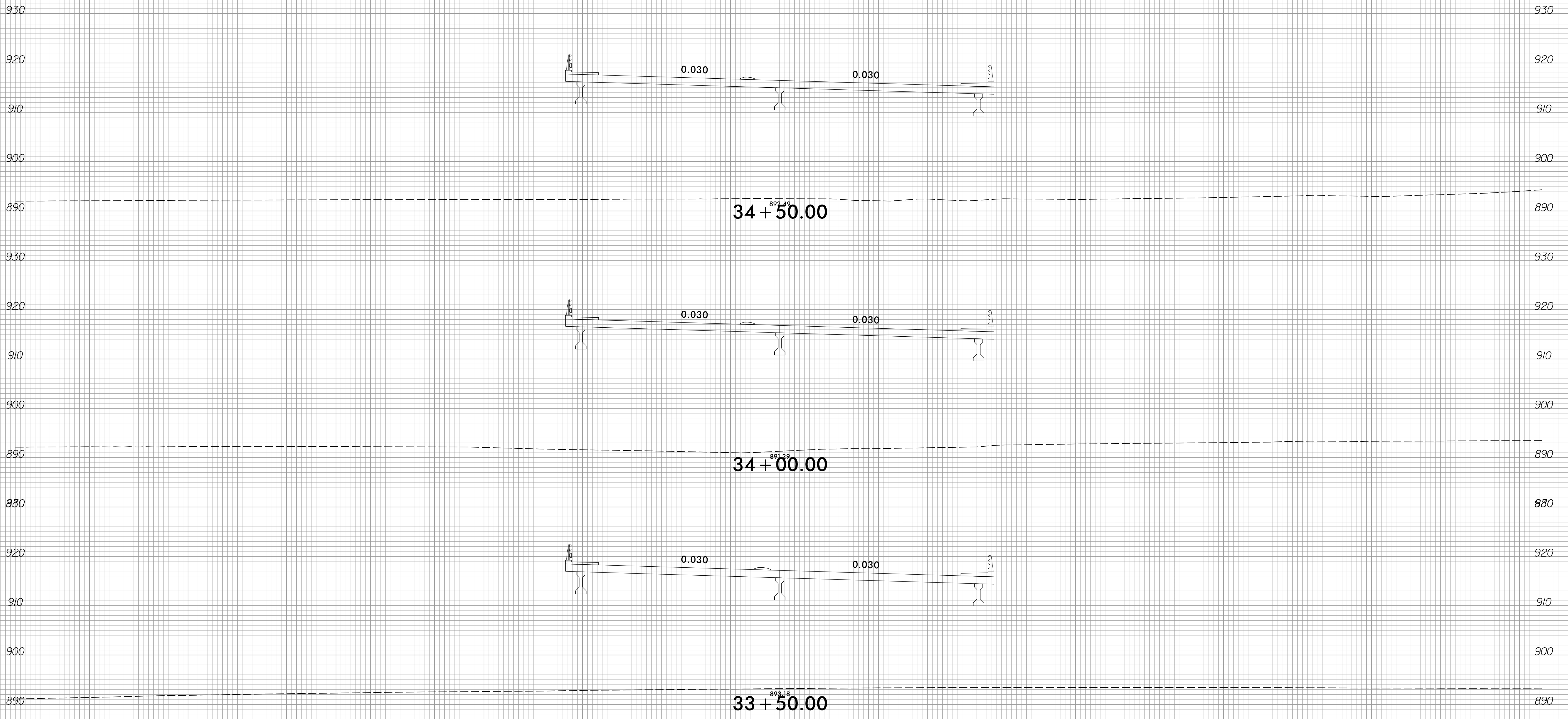

150 140 130 120 110 100 90 80 70 60 50 40 30 20 10 0 10 20 30 40 50 60 70 80 90 100 110 120 130 140 150

6/23/16

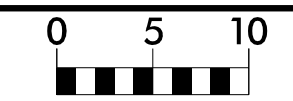

PROJ. REFERENCE NO.	SHEET NO.
U-2729	X-11

150 140 130 120 110 100 90 80 70 60 50 40 30 20 10 0 10 20 30 40 50 60 70 80 90 100 110 120 130 140 150

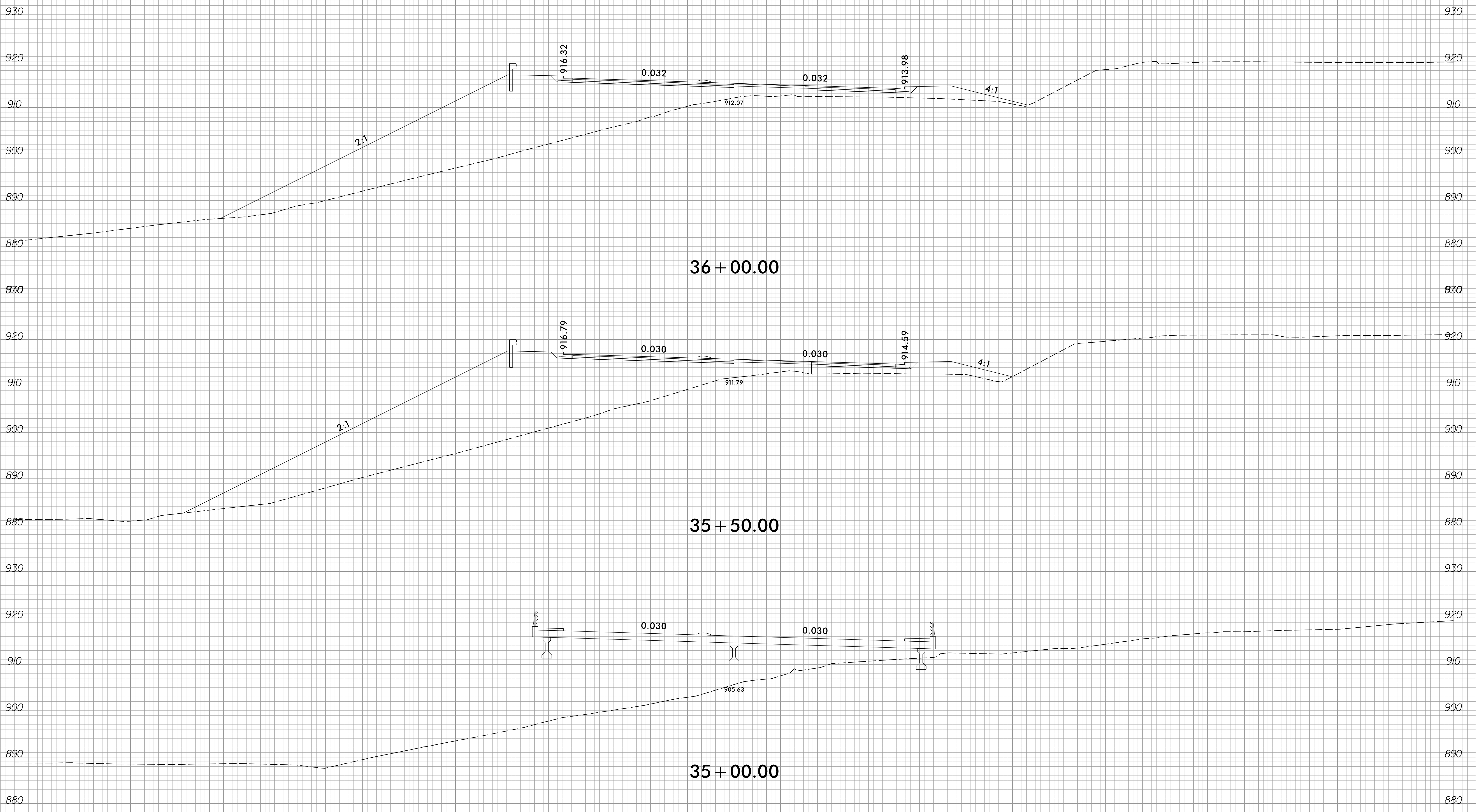

3/9/2023  
 C:\Users\jgoy\OneDrive\Xsc\Xp1\U-2729\_rdy\_XPL.dgn  
 00K02317

150 140 130 120 110 100 90 80 70 60 50 40 30 20 10 0 10 20 30 40 50 60 70 80 90 100 110 120 130 140 150

6/23/16

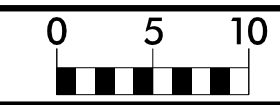

PROJ. REFERENCE NO.	SHEET NO.
U-2729	X-12

150 140 130 120 110 100 90 80 70 60 50 40 30 20 10 0 10 20 30 40 50 60 70 80 90 100 110 120 130 140 150

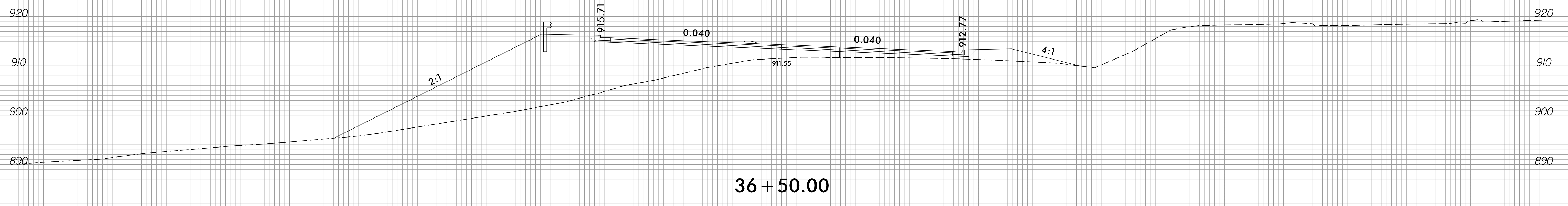
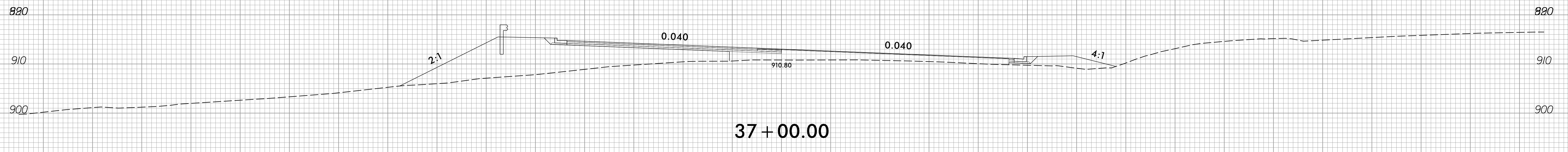
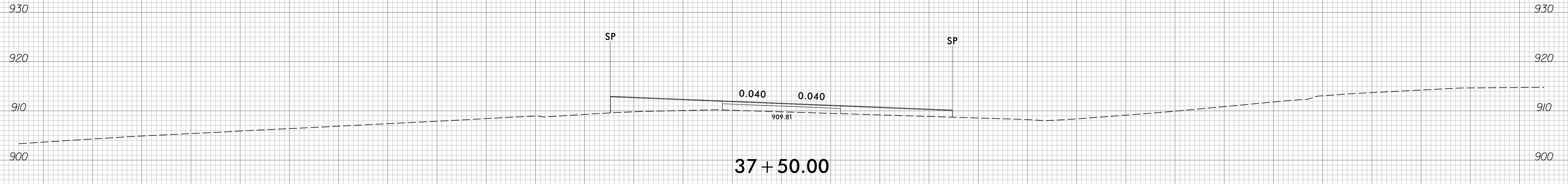
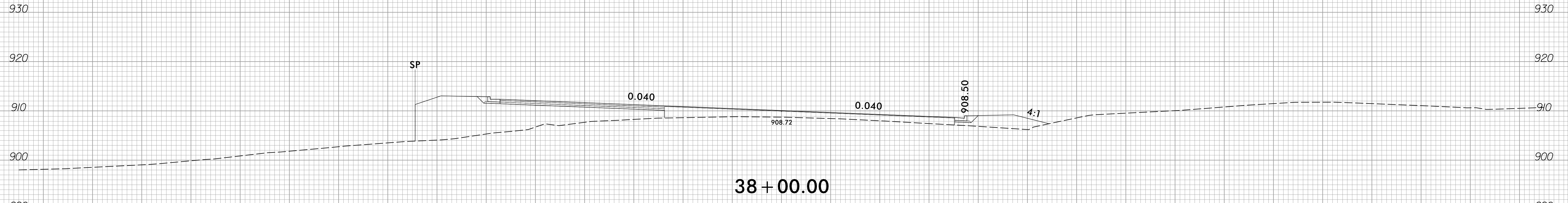

150 140 130 120 110 100 90 80 70 60 50 40 30 20 10 0 10 20 30 40 50 60 70 80 90 100 110 120 130 140 150

3/9/2023  
 P:\Projects\2023\U-2729\XPL.dgn  
 0002317

6/23/16

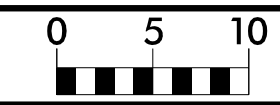

PROJ. REFERENCE NO.	SHEET NO.
U-2729	X-13

150 140 130 120 110 100 90 80 70 60 50 40 30 20 10 0 10 20 30 40 50 60 70 80 90 100 110 120 130 140 150

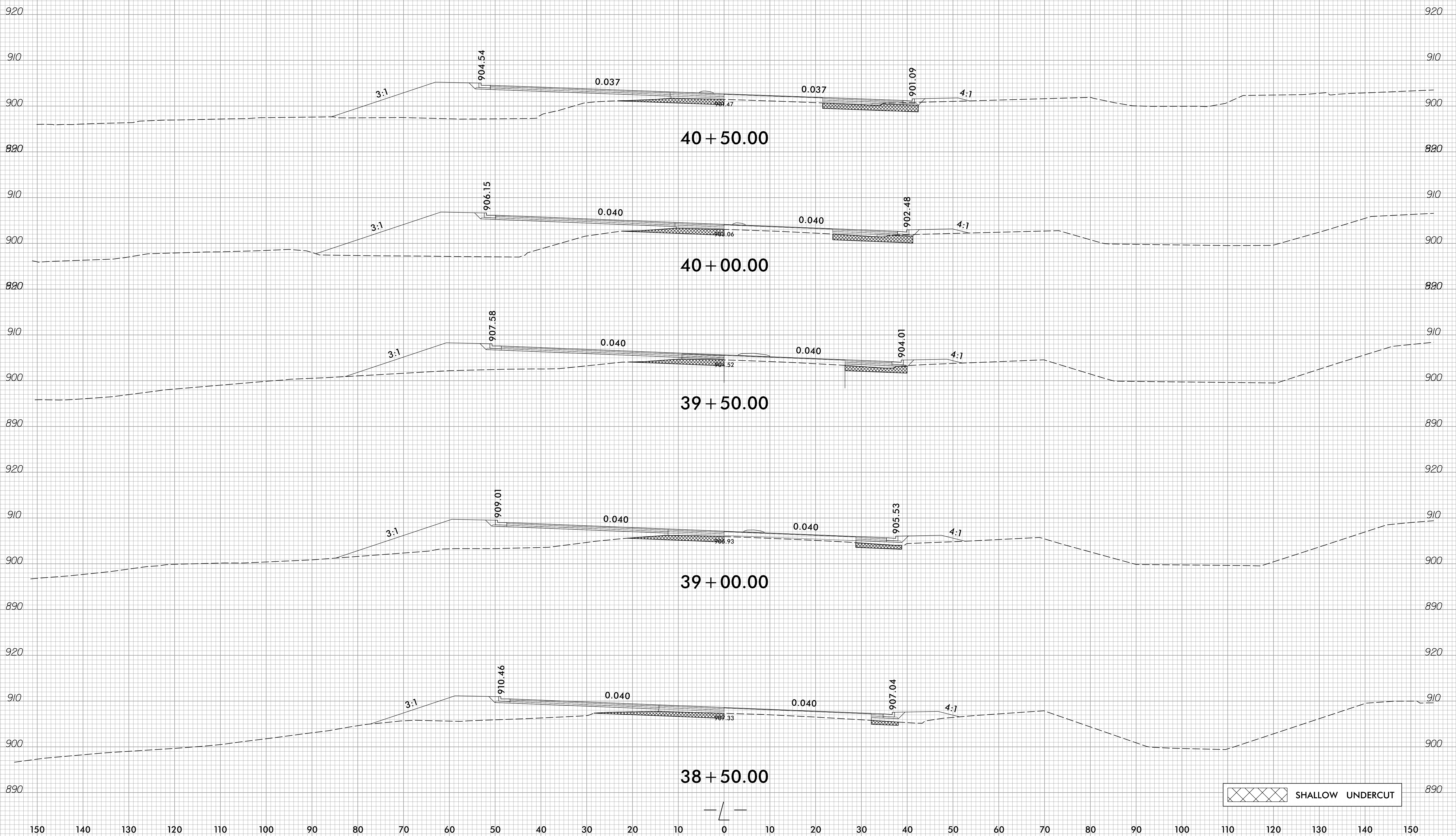

SHALLOW UNDERCUT

3/22/2023  
 P:\Projects\2023\U-2729\XPL.dgn

6/23/16

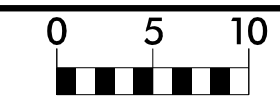

PROJ. REFERENCE NO.	SHEET NO.
U-2729	X-14

150 140 130 120 110 100 90 80 70 60 50 40 30 20 10 0 10 20 30 40 50 60 70 80 90 100 110 120 130 140 150

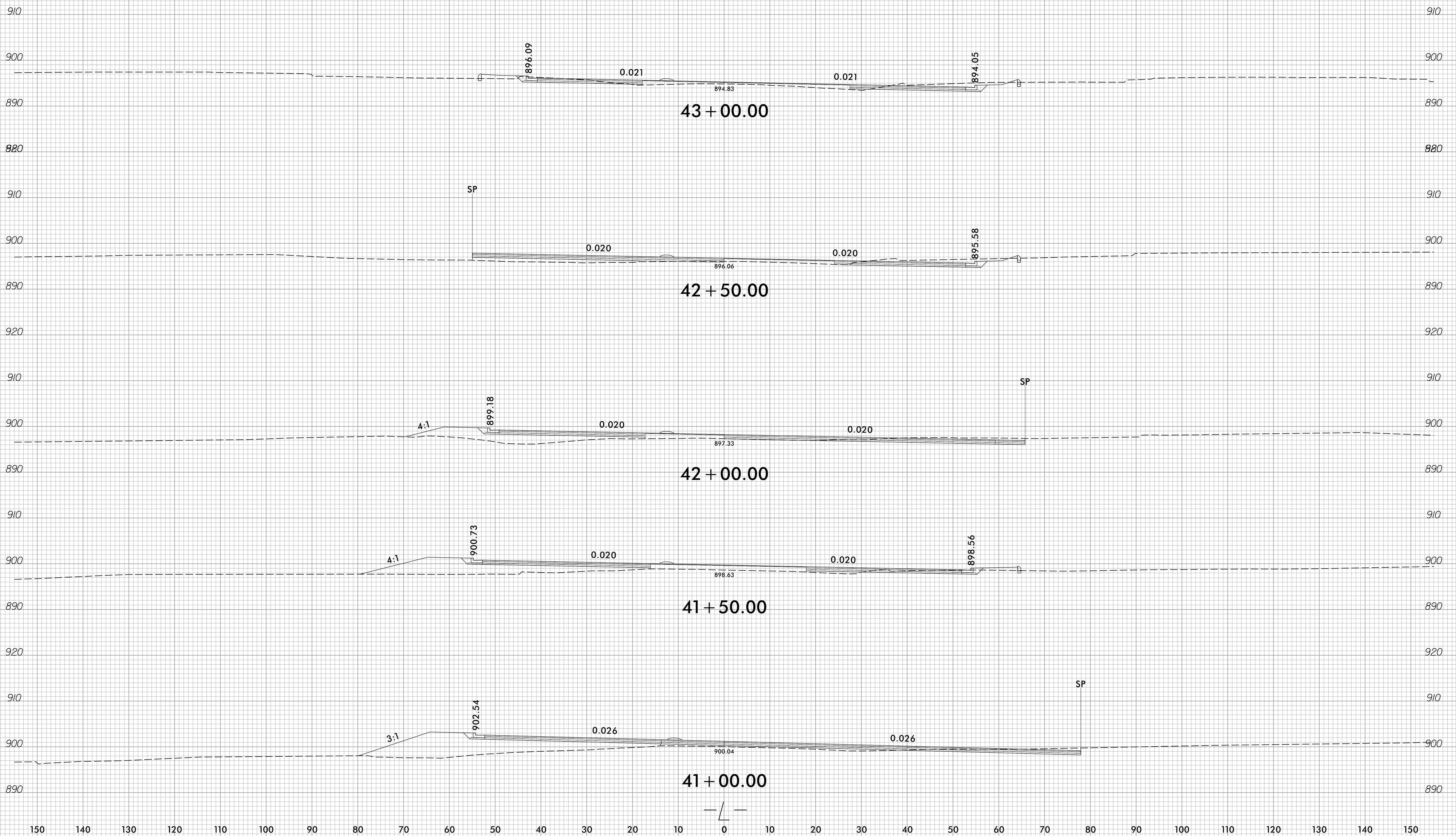

3/9/2023  
 P:\Projects\2023\U-2729\_rdy\_XPL.dgn  
 00002517



6/23/16

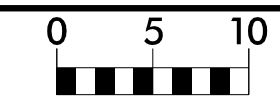

PROJ. REFERENCE NO.  
U-2729

SHEET NO.  
X-15

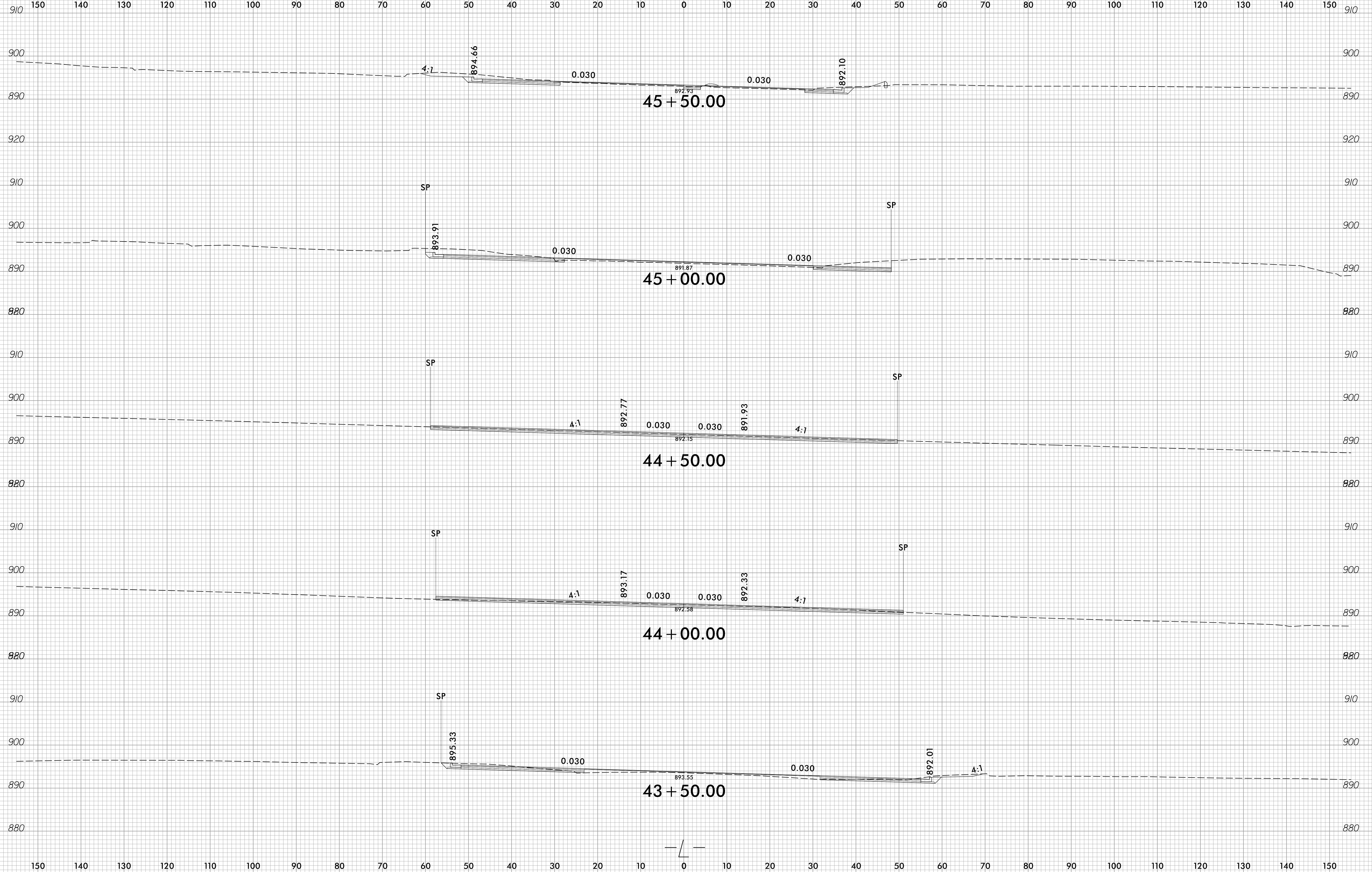

3/9/2023  
C:\Users\jgoy\Xsc\Xp1\U-2729\_rdy\_XPL\_L.dgn  
00K02517

6/23/16

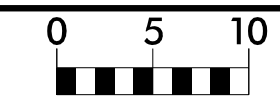

PROJ. REFERENCE NO.	SHEET NO.
U-2729	X-16

150 140 130 120 110 100 90 80 70 60 50 40 30 20 10 0 10 20 30 40 50 60 70 80 90 100 110 120 130 140 150

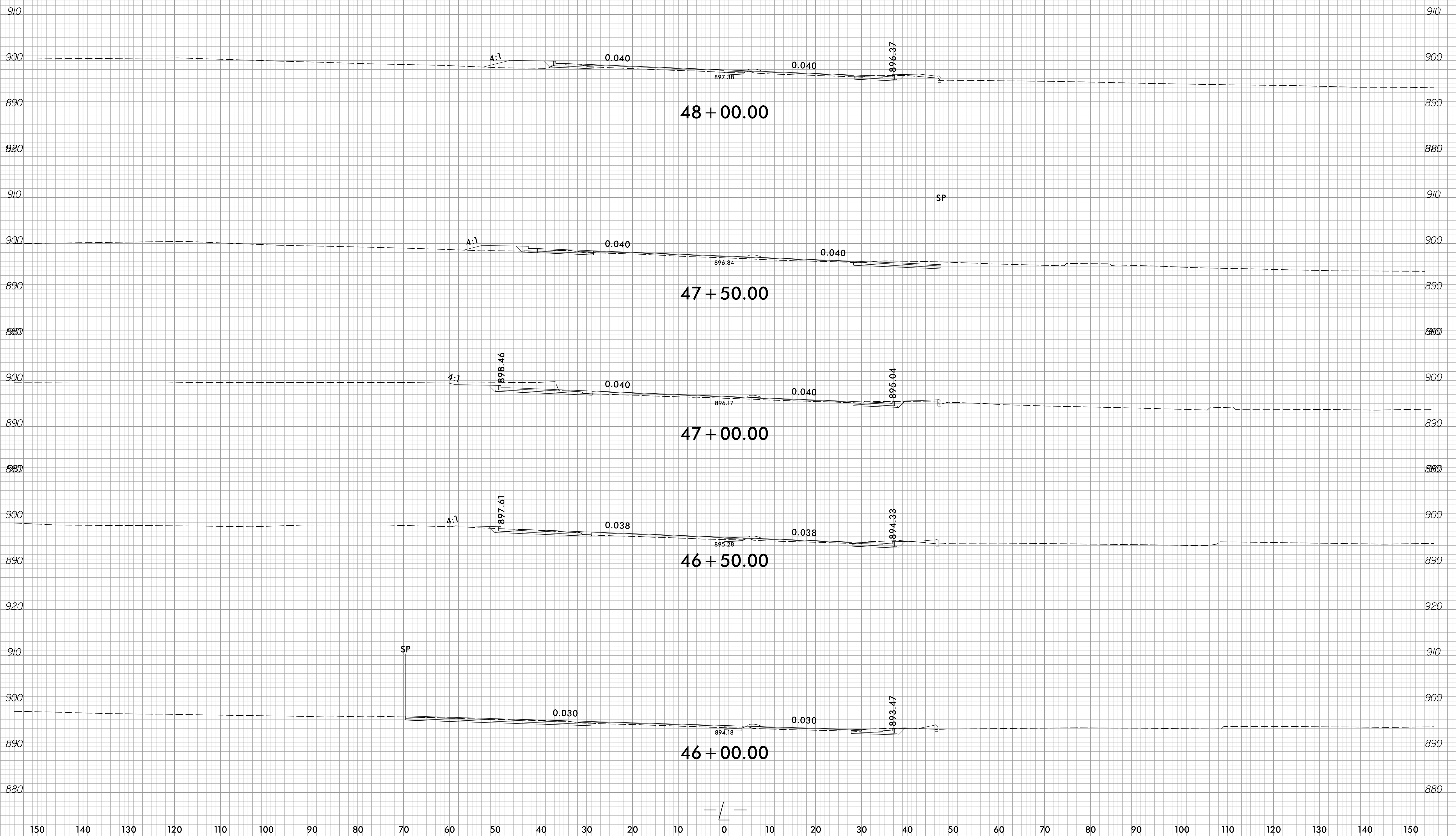

3/9/2023  
 C:\Users\jgoy\OneDrive\Xsc\Xppl\U-2729\_rdy\_XPL\_L.dgn  
 00K02317

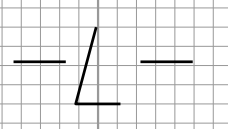

6/23/16

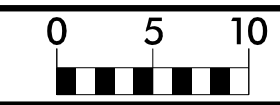

PROJ. REFERENCE NO.	SHEET NO.
U-2729	X-17

150 140 130 120 110 100 90 80 70 60 50 40 30 20 10 0 10 20 30 40 50 60 70 80 90 100 110 120 130 140 150

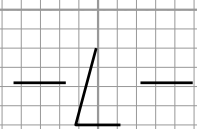
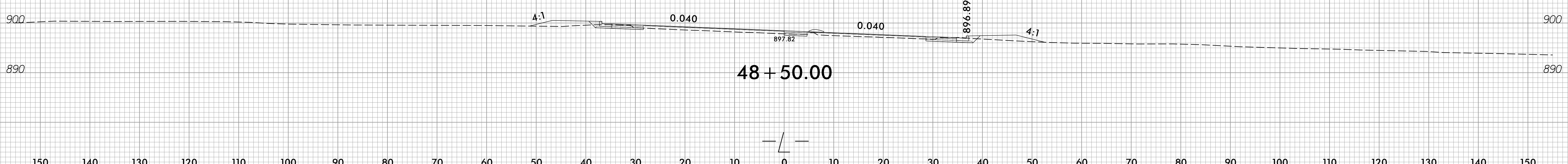
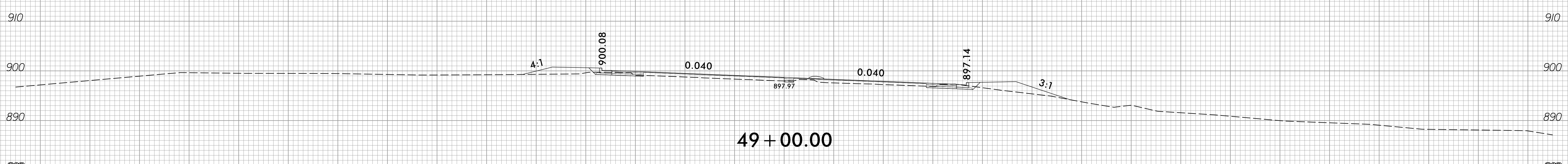
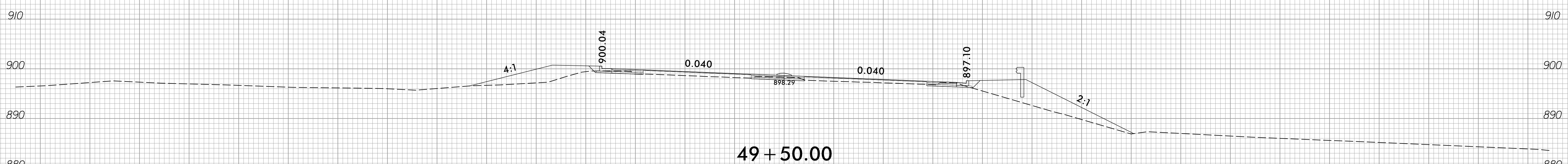
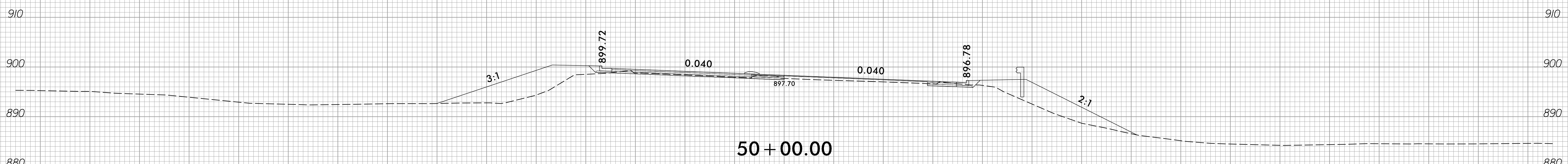
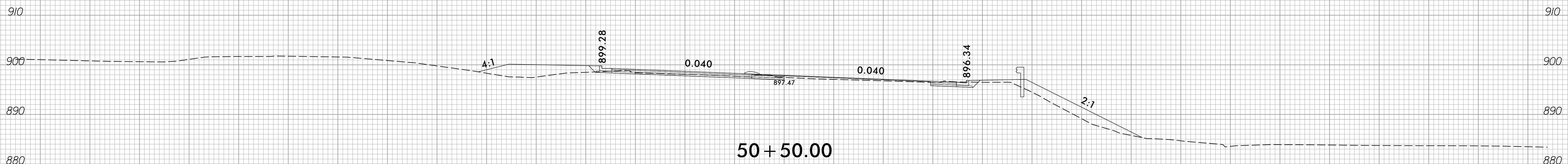

3/9/2023  
 C:\Users\jguy\OneDrive\Xsc\Xp1\U-2729\_rdy\_XPL.dgn

6/23/16

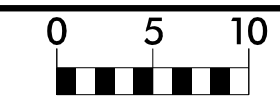

PROJ. REFERENCE NO.	SHEET NO.
U-2729	X-18

150 140 130 120 110 100 90 80 70 60 50 40 30 20 10 0 10 20 30 40 50 60 70 80 90 100 110 120 130 140 150

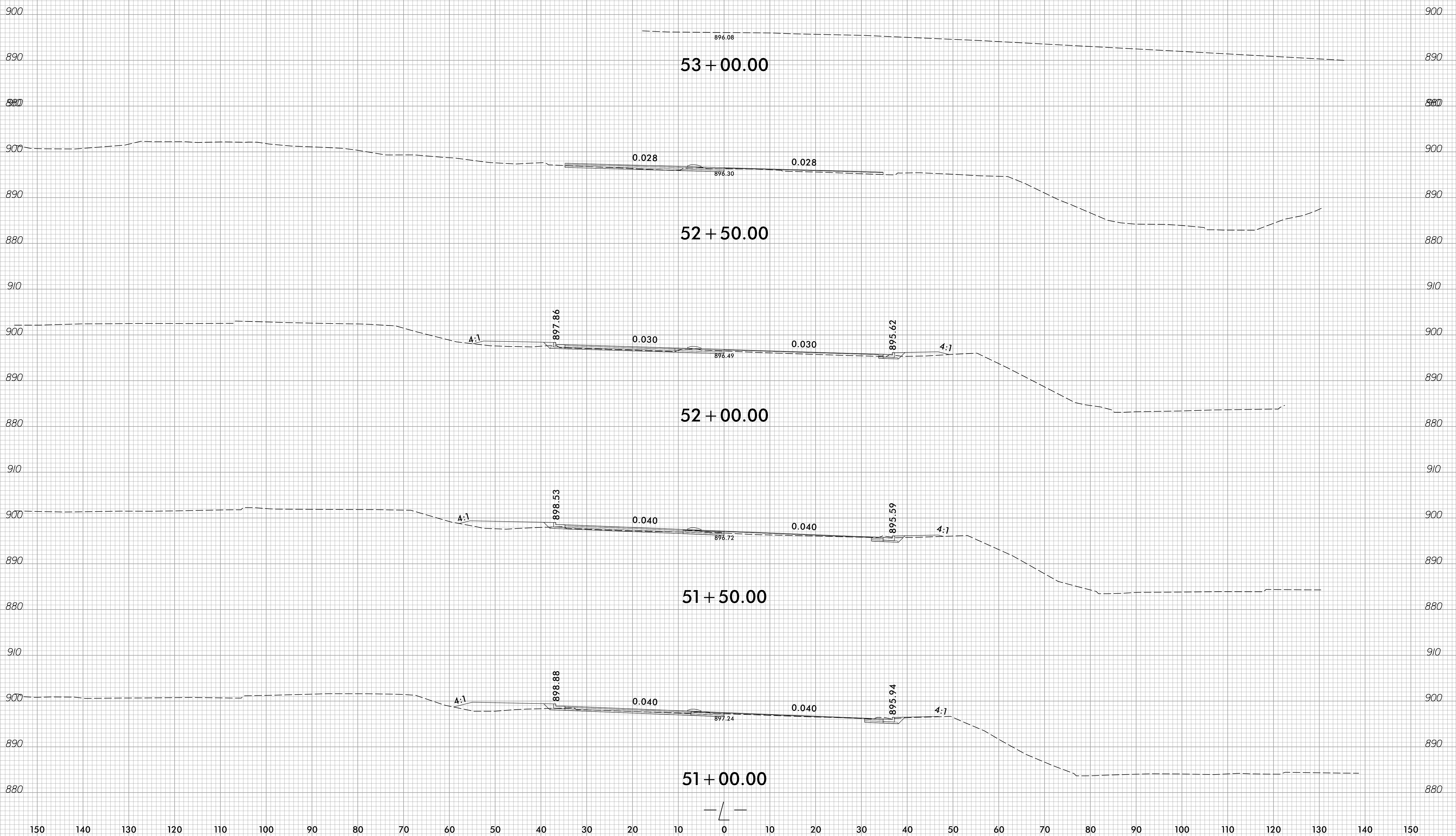

3/9/2023  
 C:\Users\jgoy\OneDrive\Documents\Xsc\Xp1\U-2729\_rdy\_XPL\_L.dgn  
 00K02317

150 140 130 120 110 100 90 80 70 60 50 40 30 20 10 0 10 20 30 40 50 60 70 80 90 100 110 120 130 140 150

6/23/16

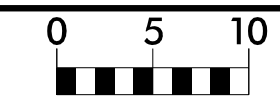

PROJ. REFERENCE NO.  
U-2729

SHEET NO.  
X-19

150 140 130 120 110 100 90 80 70 60 50 40 30 20 10 0 10 20 30 40 50 60 70 80 90 100 110 120 130 140 150

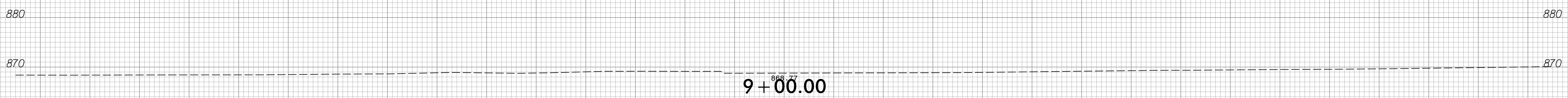
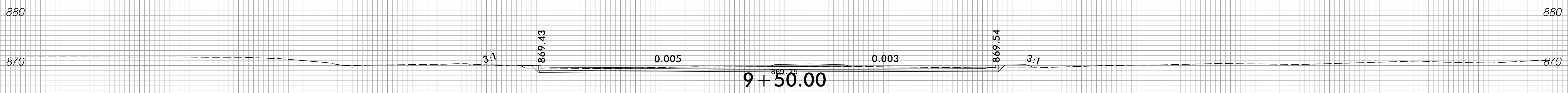
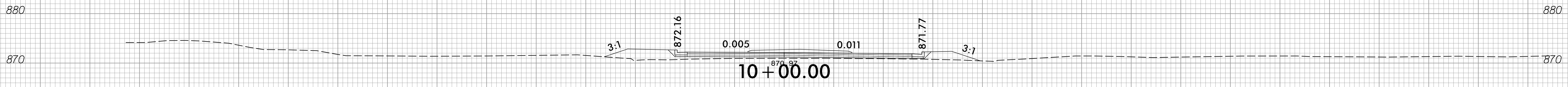
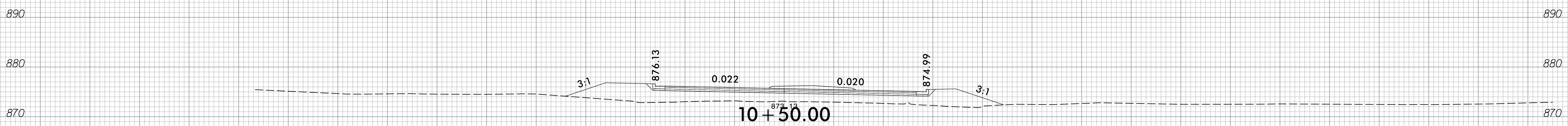
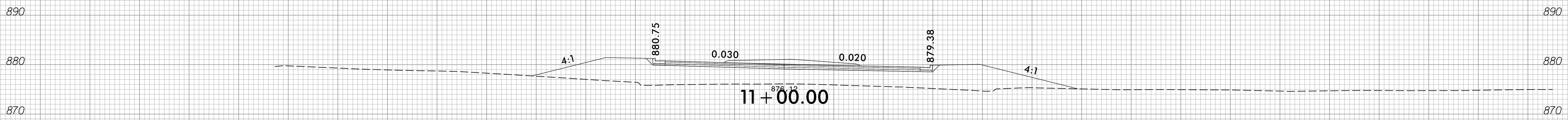

-Y/A-

150 140 130 120 110 100 90 80 70 60 50 40 30 20 10 0 10 20 30 40 50 60 70 80 90 100 110 120 130 140 150

3/9/2023  
C:\Users\jguy\OneDrive\Xsc\Xpl\U-2729\_rdy\_XPL\_Y1A.dgn  
00K02517

6/23/16

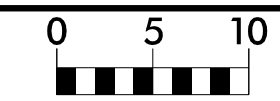

PROJ. REFERENCE NO.  
U-2729

SHEET NO.  
X-20

150 140 130 120 110 100 90 80 70 60 50 40 30 20 10 0 10 20 30 40 50 60 70 80 90 100 110 120 130 140 150

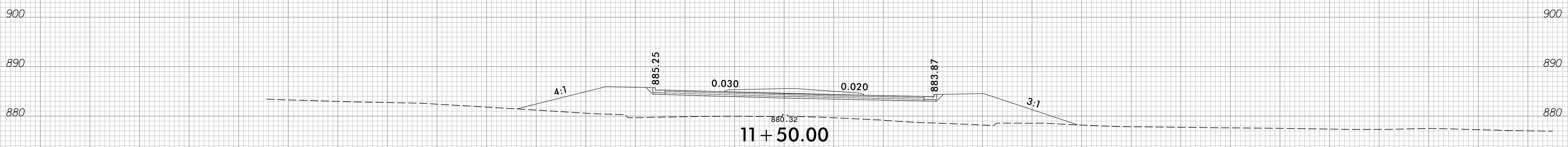
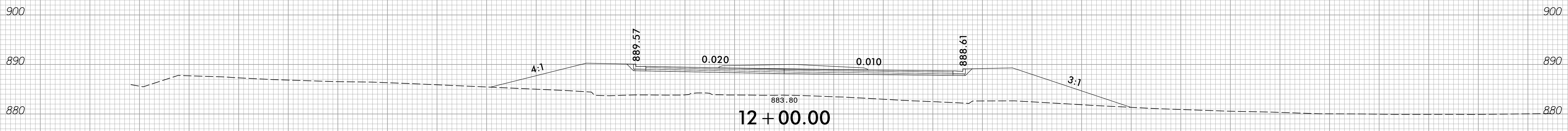
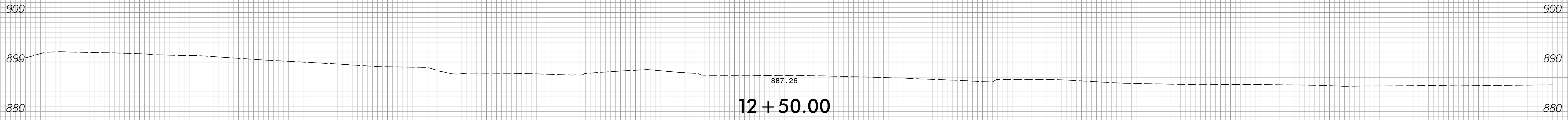

-Y/A-

3/9/2023  
C:\Users\jguy\OneDrive\Documents\Xsc\Xpl\U-2729\_rdy\_XPL\_Y1A.dgn

150 140 130 120 110 100 90 80 70 60 50 40 30 20 10 0 10 20 30 40 50 60 70 80 90 100 110 120 130 140 150

6/23/16

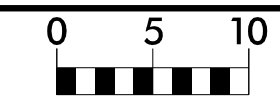

PROJ. REFERENCE NO.	SHEET NO.
U-2729	X-21

150 140 130 120 110 100 90 80 70 60 50 40 30 20 10 0 10 20 30 40 50 60 70 80 90 100 110 120 130 140 150

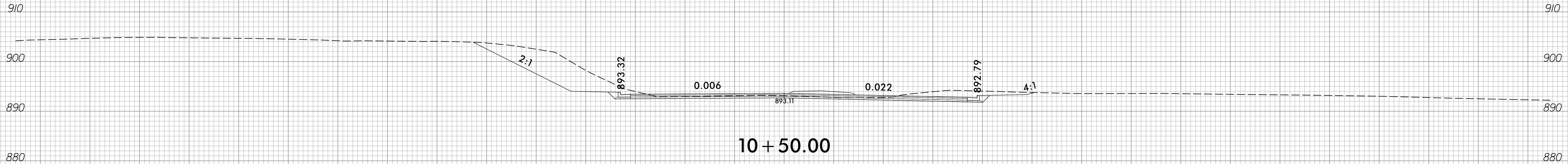
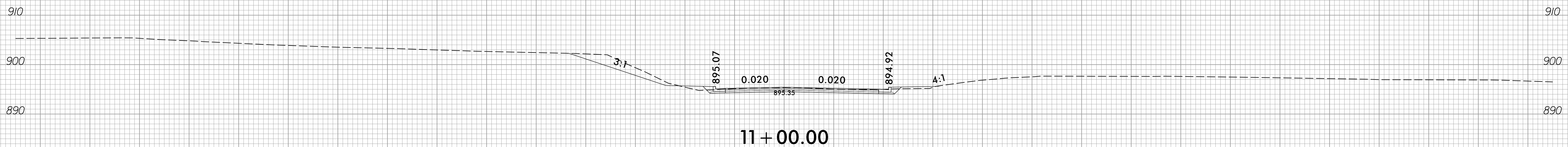
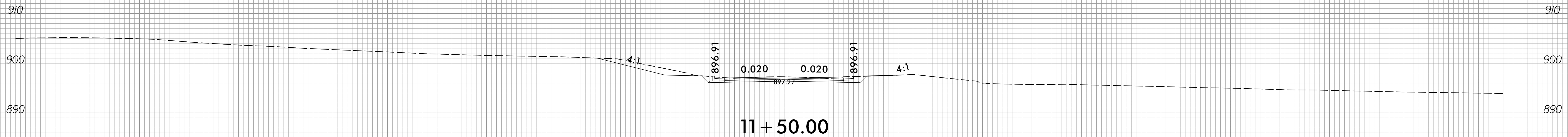

-YIB-

150 140 130 120 110 100 90 80 70 60 50 40 30 20 10 0 10 20 30 40 50 60 70 80 90 100 110 120 130 140 150

3/9/2023  
 C:\Users\jguy\OneDrive\Xsc\Xpl\U-2729\_r.dwg\_XPL\_YIB.dgn  
 00K02317

6/23/16

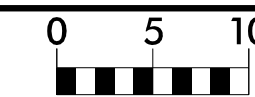

PROJ. REFERENCE NO.	SHEET NO.
U-2729	X-22

150 140 130 120 110 100 90 80 70 60 50 40 30 20 10 0 10 20 30 40 50 60 70 80 90 100 110 120 130 140 150

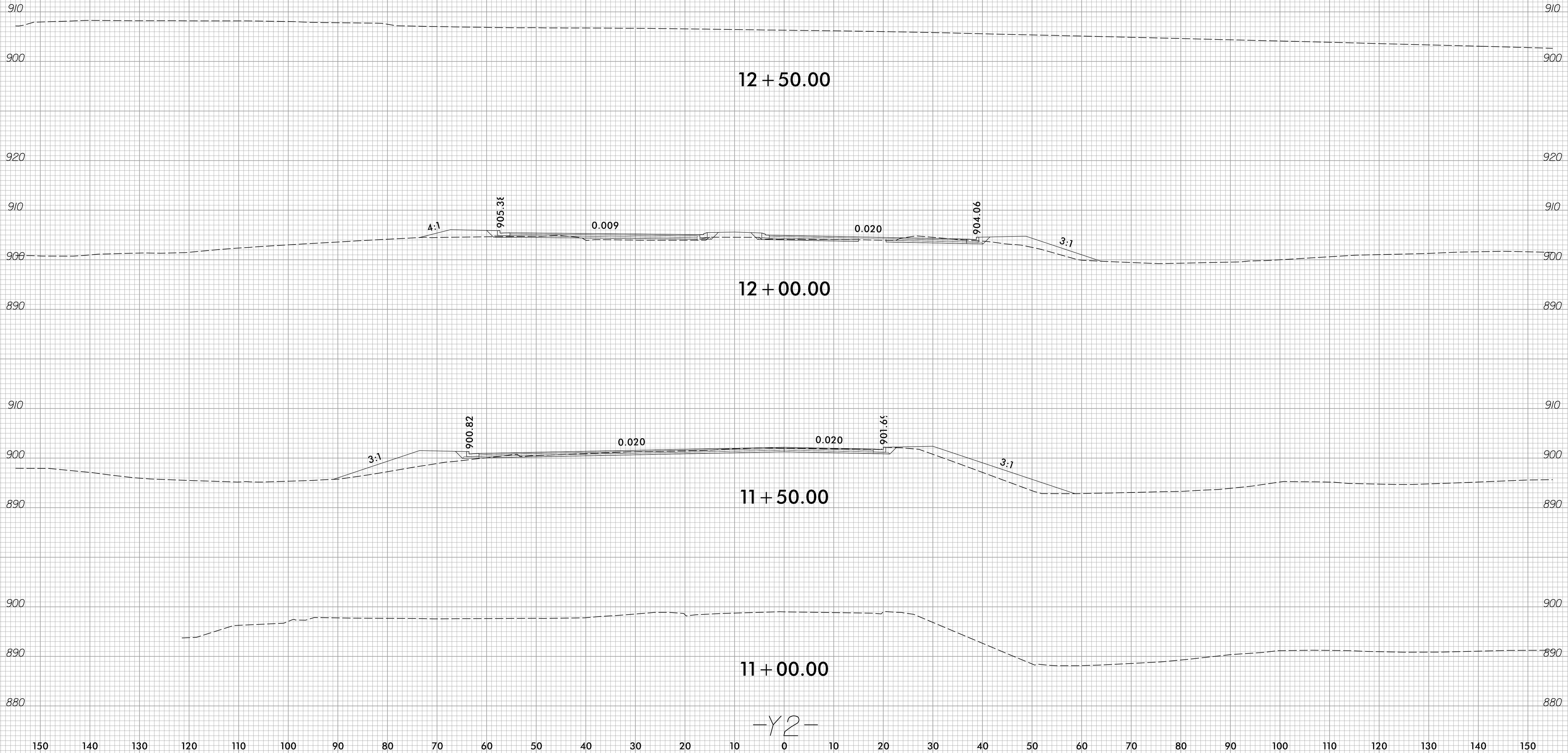

-Y2-

3/9/2023  
 C:\Users\jgoy\OneDrive\Xsc\Xp1\U-2729\_rdy\_XPL\_Y2.dgn  
 00K02317



6/23/16

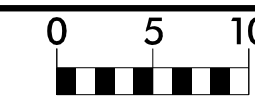

PROJ. REFERENCE NO.	SHEET NO.
U-2729	X-23

150 140 130 120 110 100 90 80 70 60 50 40 30 20 10 0 10 20 30 40 50 60 70 80 90 100 110 120 130 140 150

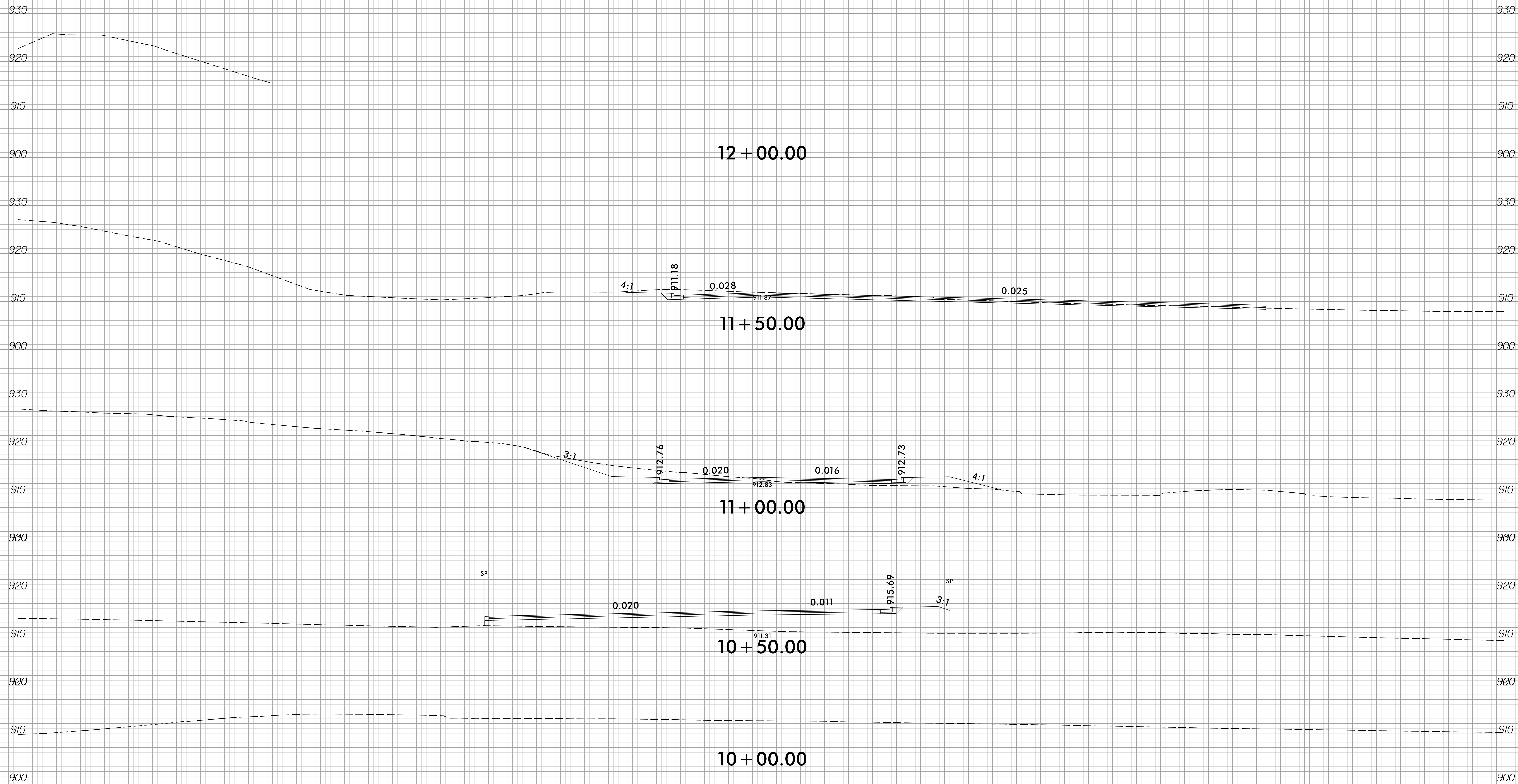

150 140 130 120 110 100 90 80 70 60 50 40 30 20 10 0 10 20 30 40 50 60 70 80 90 100 110 120 130 140 150

-Y3A-

3/9/2023  
 C:\Users\jguy\OneDrive\Documents\Xsc\Xp1\U-2729\_rdy\_XPL\_Y3A.dgn  
 00K02317

6/23/16

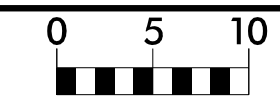

PROJ. REFERENCE NO.
U-2729

SHEET NO.
X-24

150 140 130 120 110 100 90 80 70 60 50 40 30 20 10 0 10 20 30 40 50 60 70 80 90 100 110 120 130 140 150

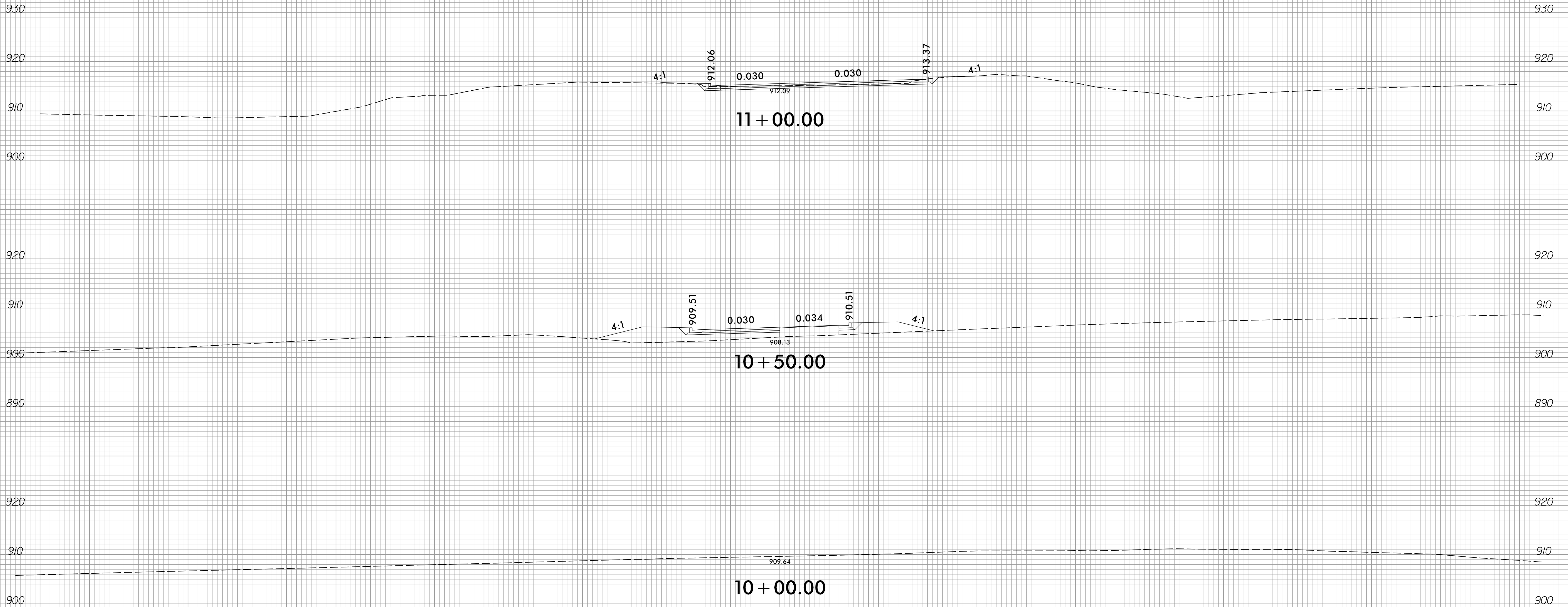

11 + 00.00

10 + 50.00

10 + 00.00

-Y5-

3/9/2023  
 P:\Projects\2023\U-2729\XPL-Y5.dgn  
 00002317

6/23/16

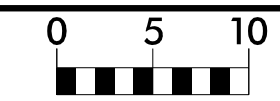

PROJ. REFERENCE NO.	SHEET NO.
U-2729	X-25

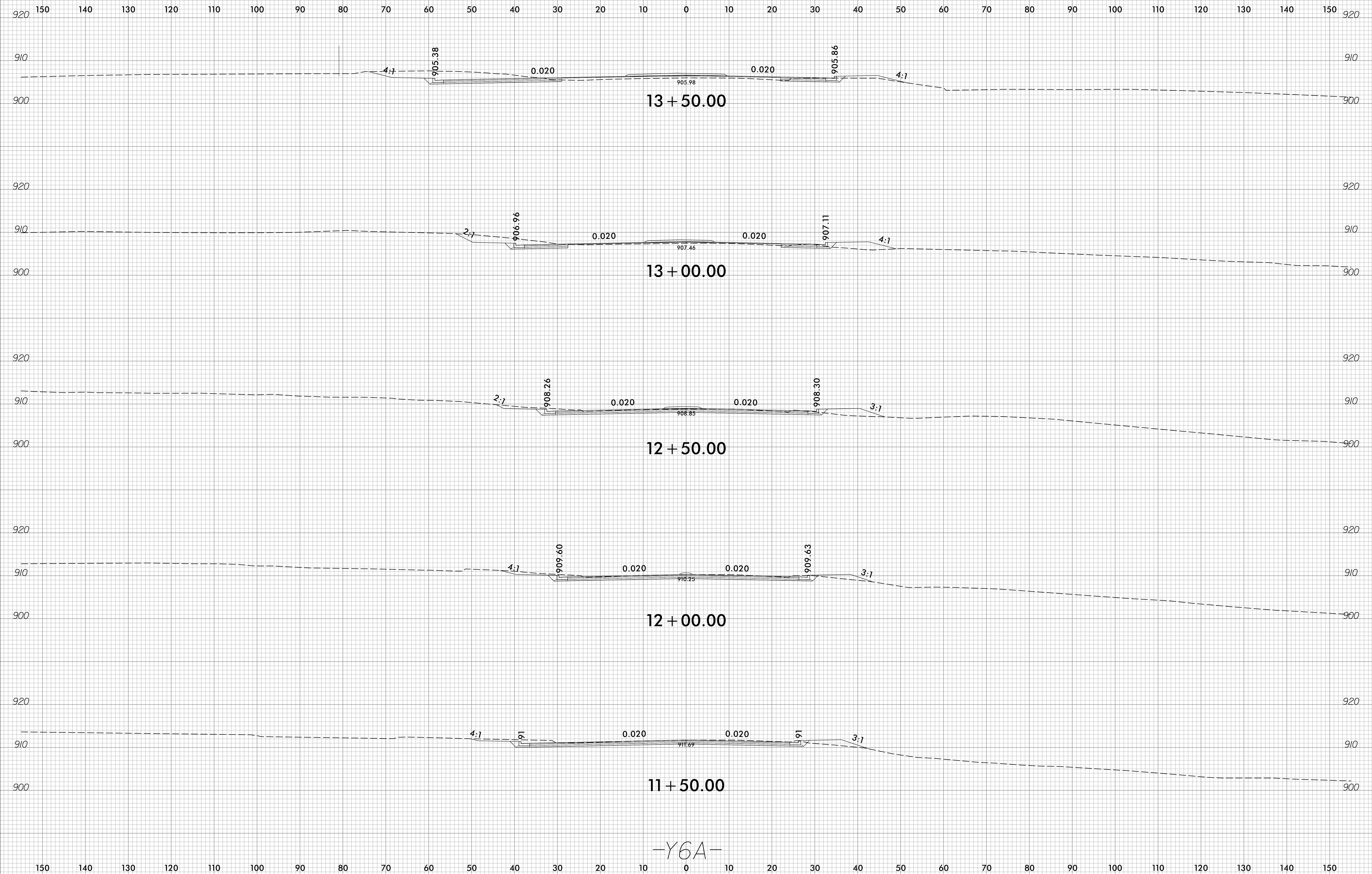

-Y6A-

3/9/2023  
C:\Users\jgoy\OneDrive\Documents\Xsc\Xpl\U-2729\_r.dwg\_XPL\_Y6A.dgn

6/23/16

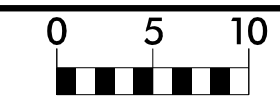

PROJ. REFERENCE NO.  
U-2729

SHEET NO.  
X-26

150 140 130 120 110 100 90 80 70 60 50 40 30 20 10 0 10 20 30 40 50 60 70 80 90 100 110 120 130 140 150

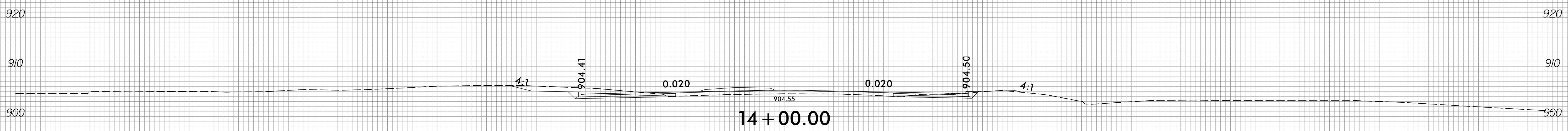
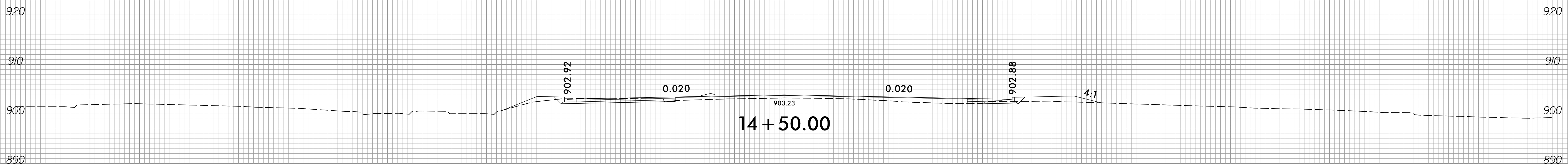
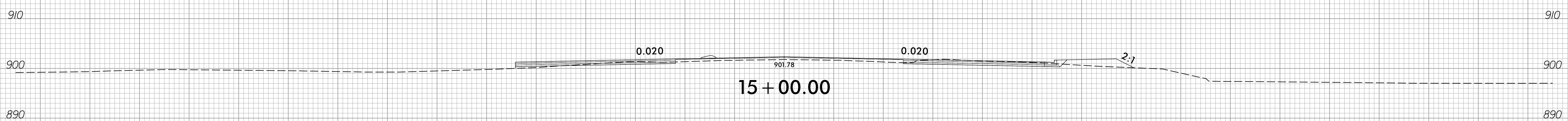
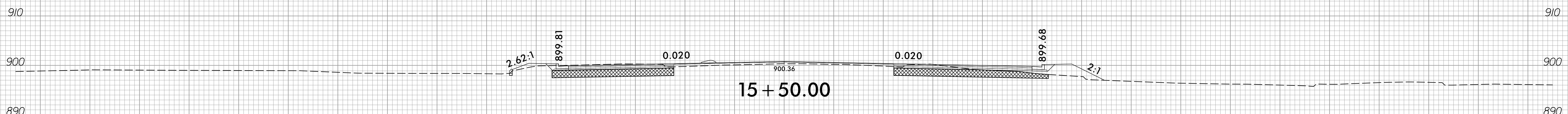

-Y6A-

SHALLOW UNDERCUT

150 140 130 120 110 100 90 80 70 60 50 40 30 20 10 0 10 20 30 40 50 60 70 80 90 100 110 120 130 140 150

3/22/2023  
C:\Users\jguy\OneDrive\Documents\Xsc\Xpl\U-2729\_rdy\_XPL\_Y6A.dgn

6/23/16

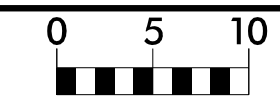

PROJ. REFERENCE NO.	SHEET NO.
U-2729	X-27

150 140 130 120 110 100 90 80 70 60 50 40 30 20 10 0 10 20 30 40 50 60 70 80 90 100 110 120 130 140 150

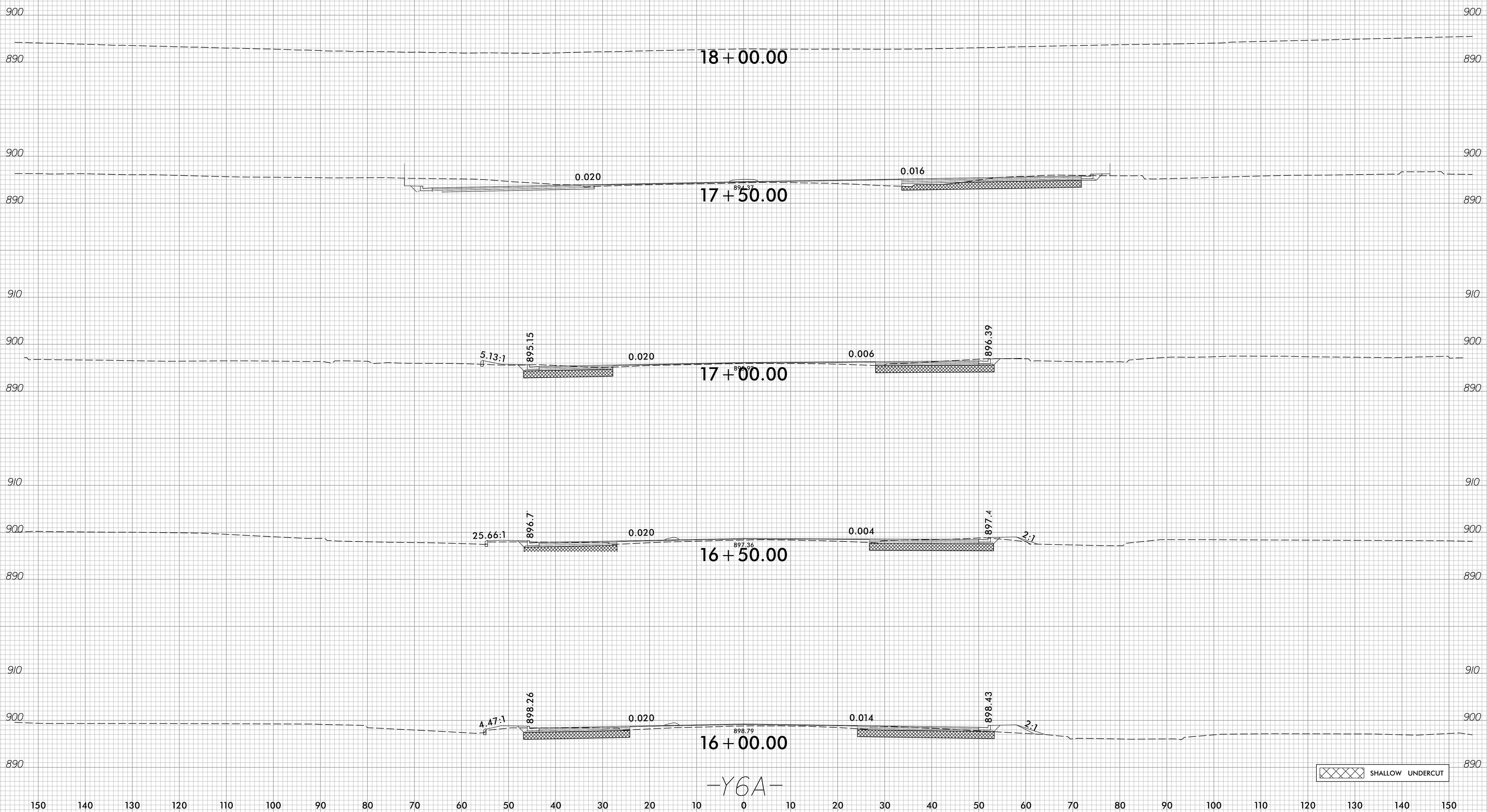

-Y6A-

SHALLOW UNDERCUT

3/22/2023  
 C:\Users\jguy\OneDrive\Documents\Xsc\Xpl\U-2729\_rdy\_XPL\_Y6A.dgn  
 00K02517

6/23/16

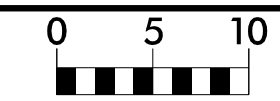

PROJ. REFERENCE NO.	SHEET NO.
U-2729	X-28

150 140 130 120 110 100 90 80 70 60 50 40 30 20 10 0 10 20 30 40 50 60 70 80 90 100 110 120 130 140 150

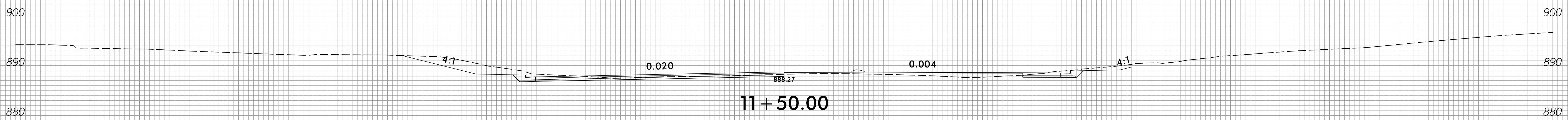

11 + 50.00

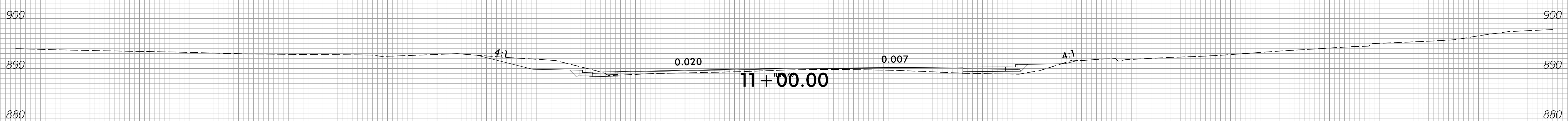

11 + 00.00

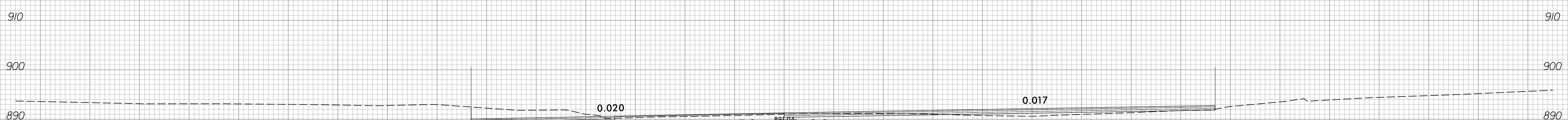

10 + 50.00

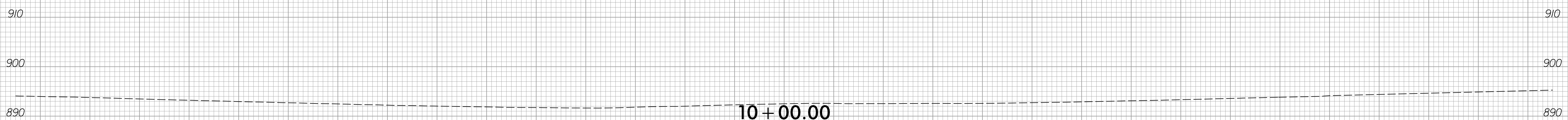

10 + 00.00

-Y6B-

150 140 130 120 110 100 90 80 70 60 50 40 30 20 10 0 10 20 30 40 50 60 70 80 90 100 110 120 130 140 150

3/9/2023  
 C:\Users\jguy\OneDrive\Documents\Xsc\Xpl\U-2729\_rdy\_XPL\_Y6B.dgn  
 00K02317

6/23/16

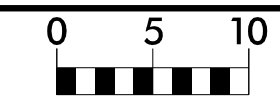

PROJ. REFERENCE NO.	SHEET NO.
U-2729	X-29

150 140 130 120 110 100 90 80 70 60 50 40 30 20 10 0 10 20 30 40 50 60 70 80 90 100 110 120 130 140 150

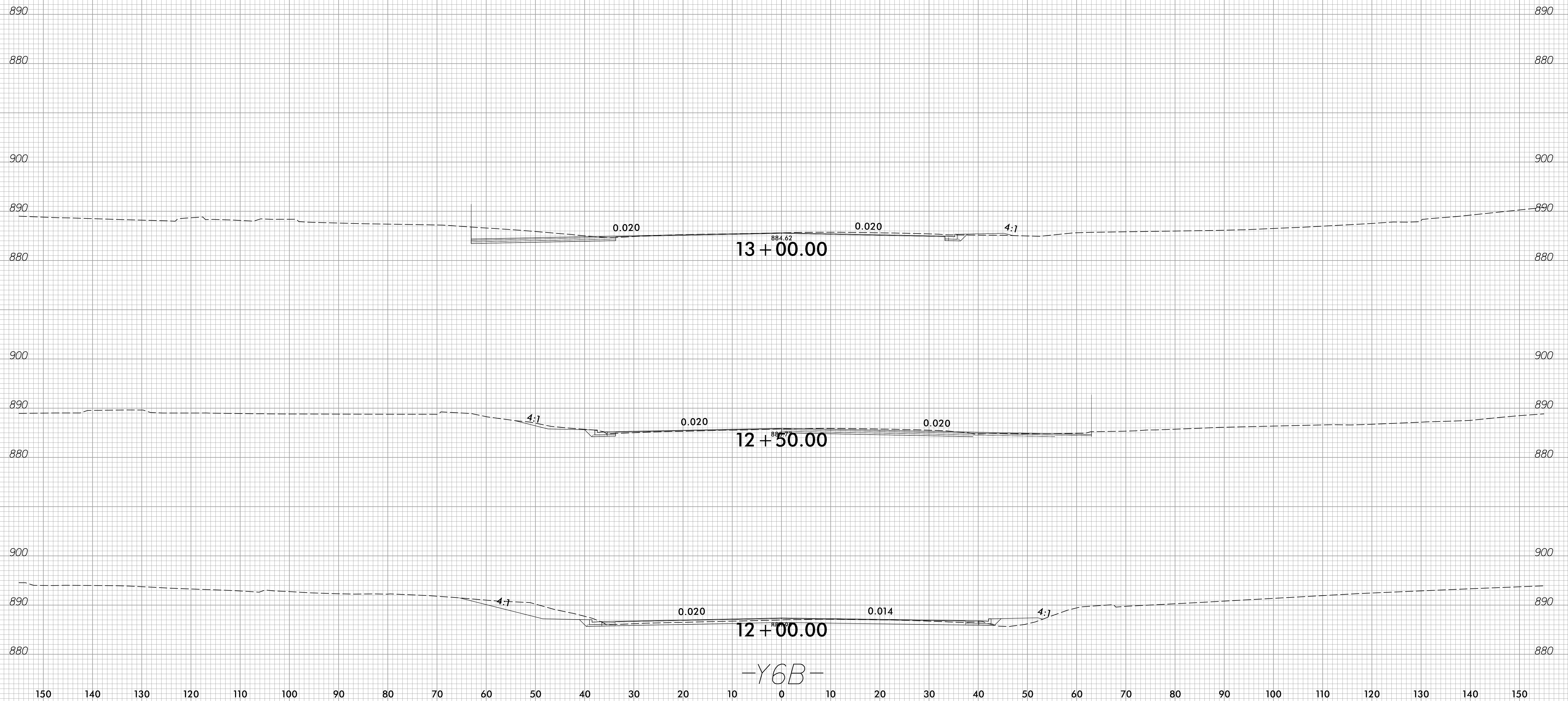

-Y6B-

3/9/2023  
 C:\Users\jgoy\OneDrive\Xsc\Xp1\U-2729\_rdy\_XPL\_Y6B.dgn  
 00K02317

6/23/16

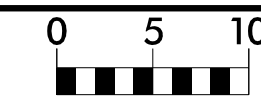

PROJ. REFERENCE NO.	SHEET NO.
U-2729	X-30

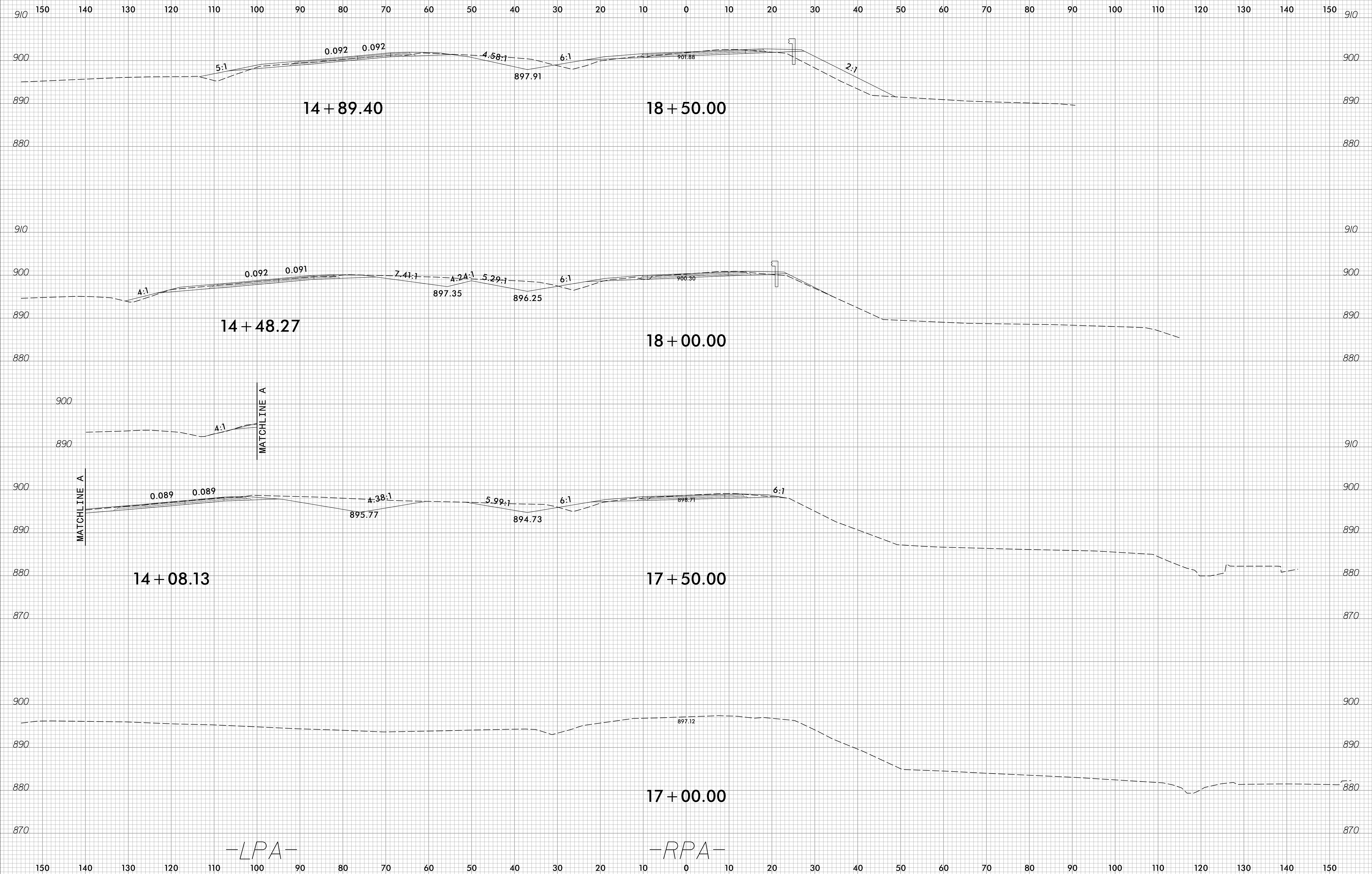

3/9/2023  
C:\Users\jguy\OneDrive\Xsc\Xp1\U-2729\_r.dwg\_XPL\_RPALFA.dgn  
00K02317



6/23/16

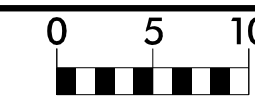

PROJ. REFERENCE NO.  
U-2729

SHEET NO.  
X-31

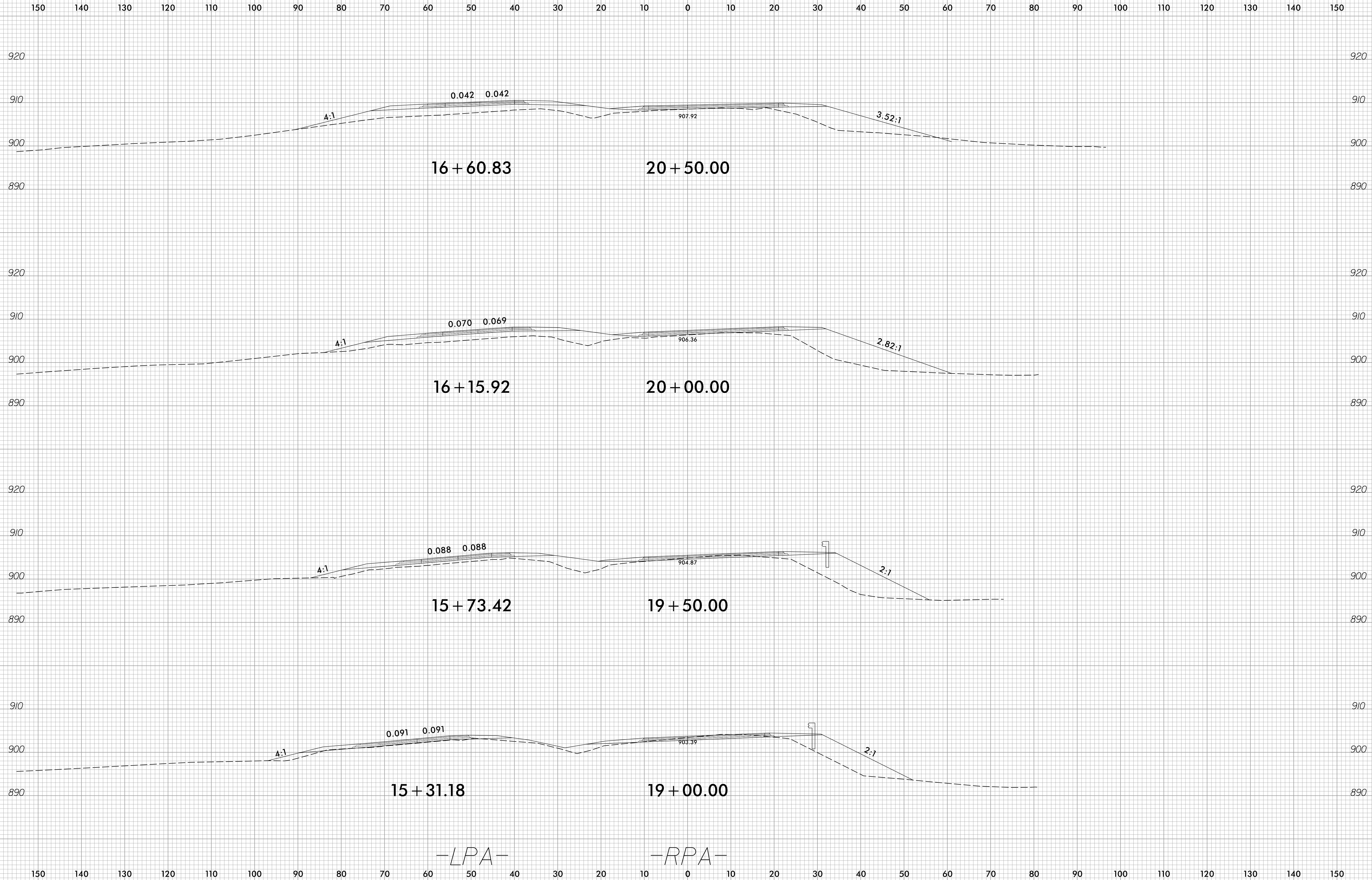

3/9/2023  
C:\Users\jgoy\OneDrive\Xsc\Xp1\U-2729\_r.dwg\_XPL\_RPALFA.dgn  
DUK02317

6/23/16

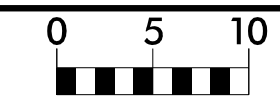

PROJ. REFERENCE NO.  
U-2729

SHEET NO.  
X-32

150 140 130 120 110 100 90 80 70 60 50 40 30 20 10 0 10 20 30 40 50 60 70 80 90 100 110 120 130 140 150

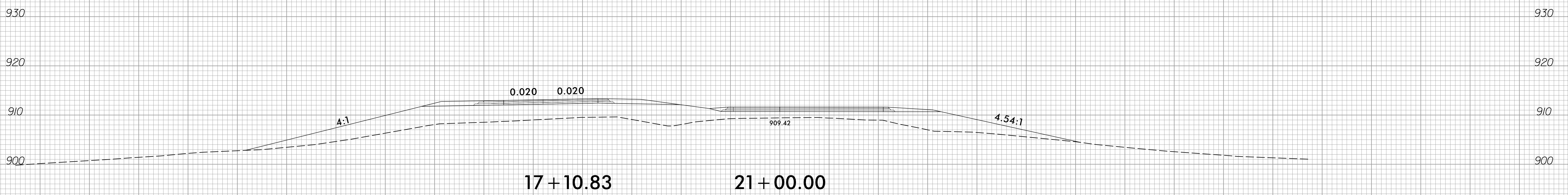
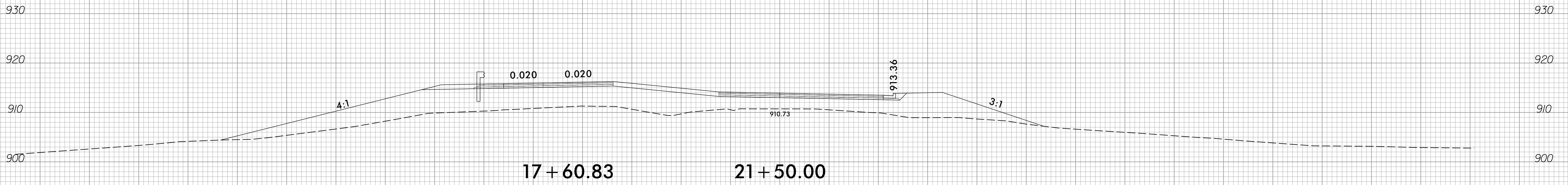

-LPA-

-RPA-

150 140 130 120 110 100 90 80 70 60 50 40 30 20 10 0 10 20 30 40 50 60 70 80 90 100 110 120 130 140 150

3/9/2023  
C:\Users\jgoy\Xsc\Xp1\U-2729\_rdy\_XPL\_RPALFA.dgn  
00K02317

6/23/16

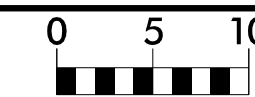

PROJ. REFERENCE NO.  
U-2729

SHEET NO.  
X-33

150 140 130 120 110 100 90 80 70 60 50 40 30 20 10 0 10 20 30 40 50 60 70 80 90 100 110 120 130 140 150

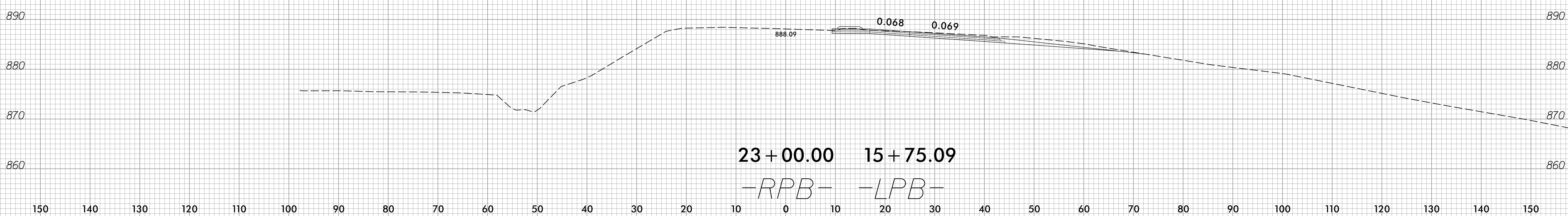
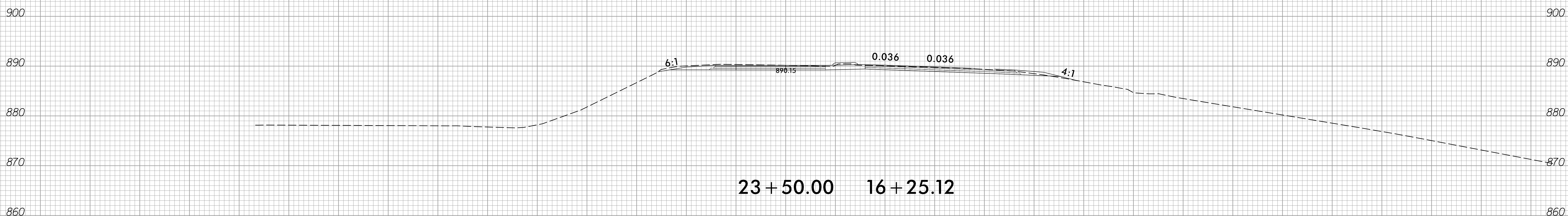
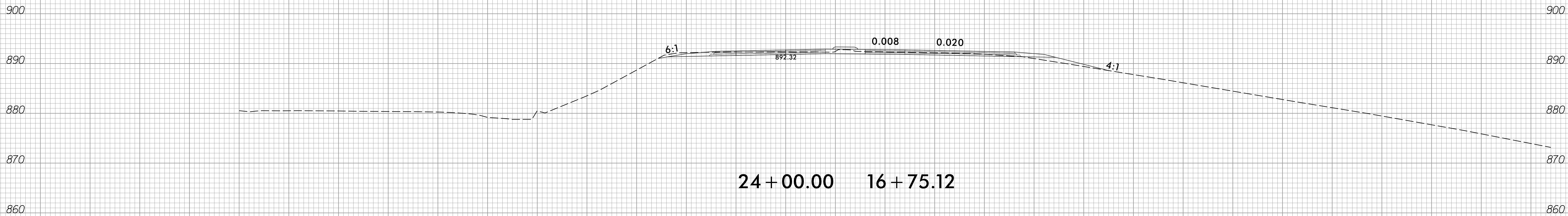

150 140 130 120 110 100 90 80 70 60 50 40 30 20 10 0 10 20 30 40 50 60 70 80 90 100 110 120 130 140 150

3/9/2023  
C:\Users\jguy\OneDrive\Documents\Xsc\Xp1\U-2729\_r.dwg\_XPL\_RPB.LPB.dgn

6/23/16

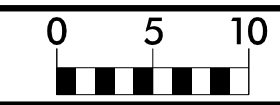

PROJ. REFERENCE NO.  
U-2729

SHEET NO.  
X-34

150 140 130 120 110 100 90 80 70 60 50 40 30 20 10 0 10 20 30 40 50 60 70 80 90 100 110 120 130 140 150

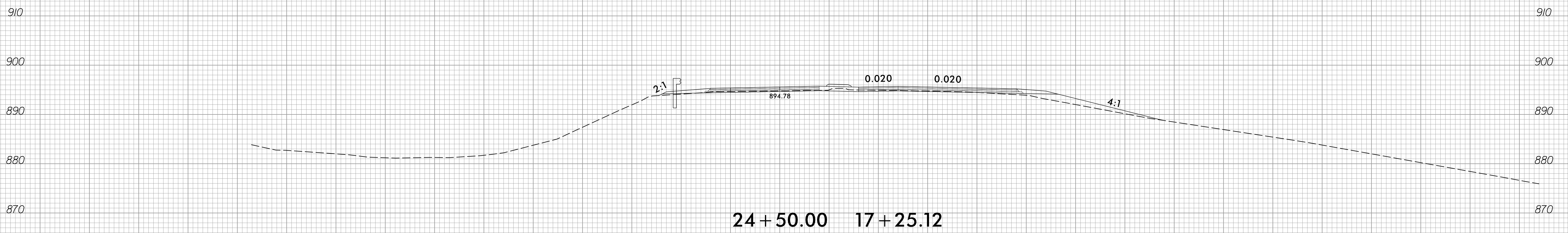
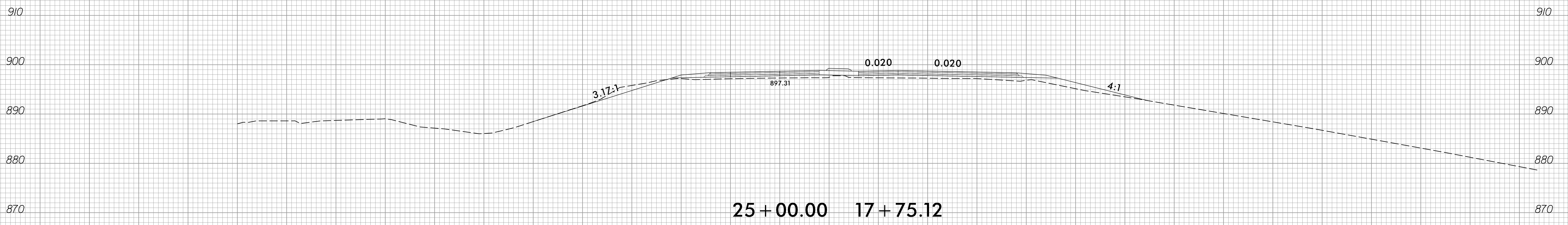
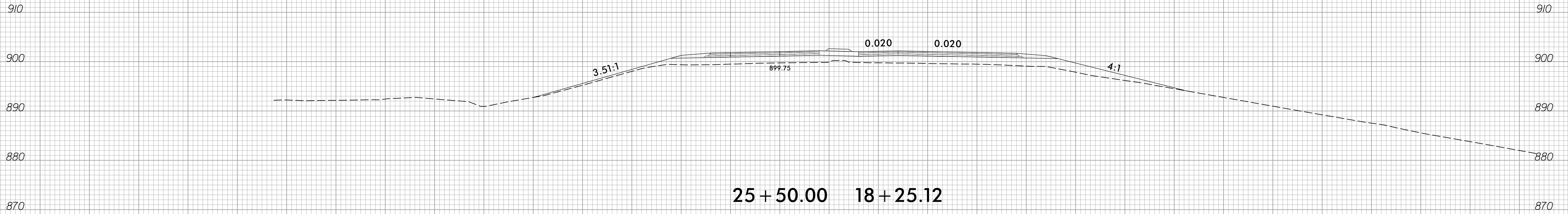

-RPB- -LPB-

3/9/2023  
C:\Users\jgoy\Xsc\Xp1\U-2729\_r.dwg\_XPL-RPB.LPB.dgn

6/23/16

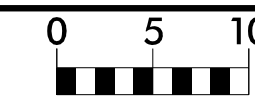

PROJ. REFERENCE NO.	SHEET NO.
U-2729	X-35

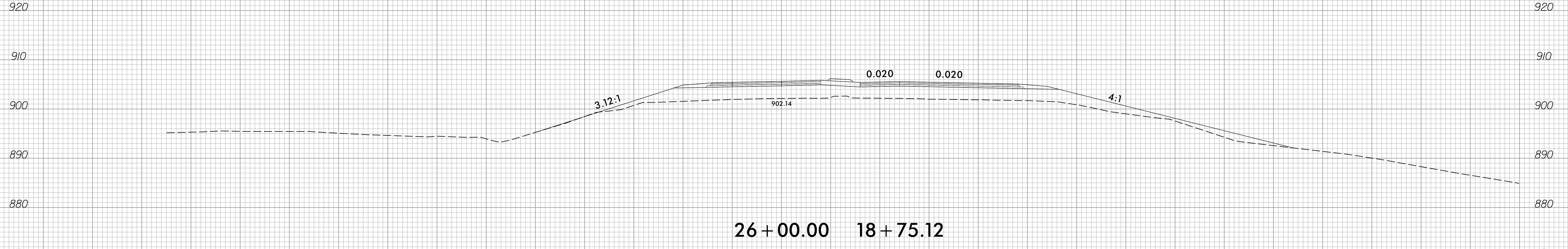
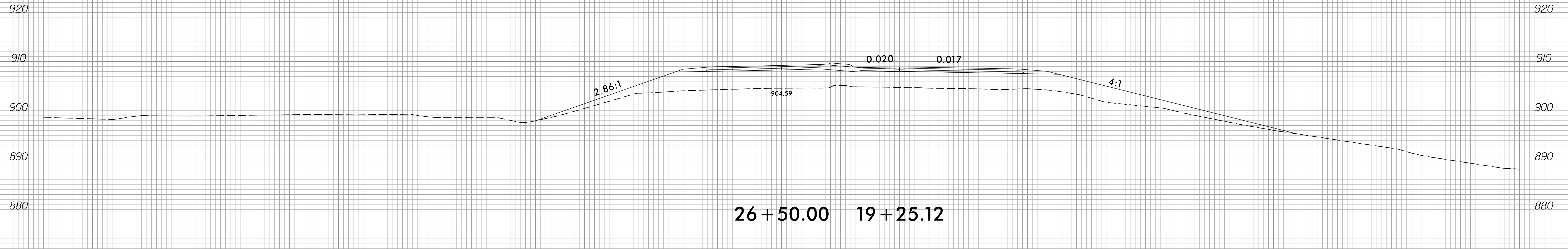
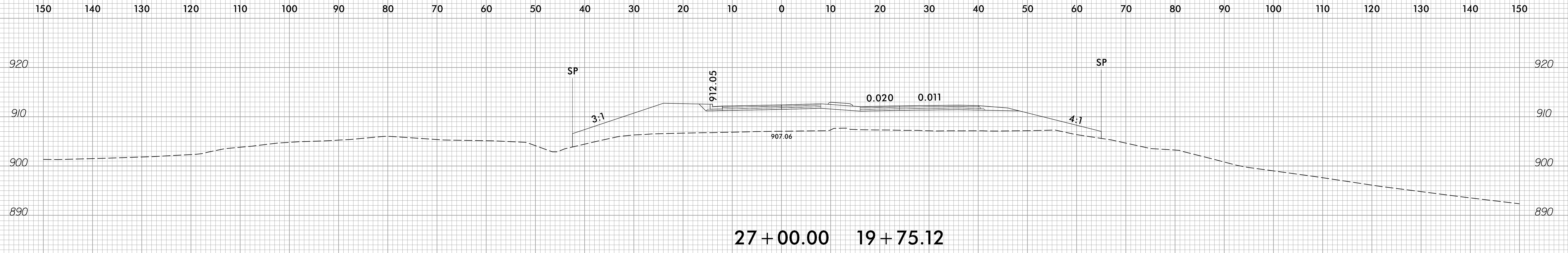

-RPB- -LPB-

3/9/2023  
 C:\Users\jgoy\Xsc\Xp1\U-2729\_r.dwg\_XPL\_RPB.LPB.dgn  
 00K02317

6/23/16

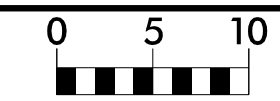

PROJ. REFERENCE NO.	SHEET NO.
U-2729	X-36

150 140 130 120 110 100 90 80 70 60 50 40 30 20 10 0 10 20 30 40 50 60 70 80 90 100 110 120 130 140 150

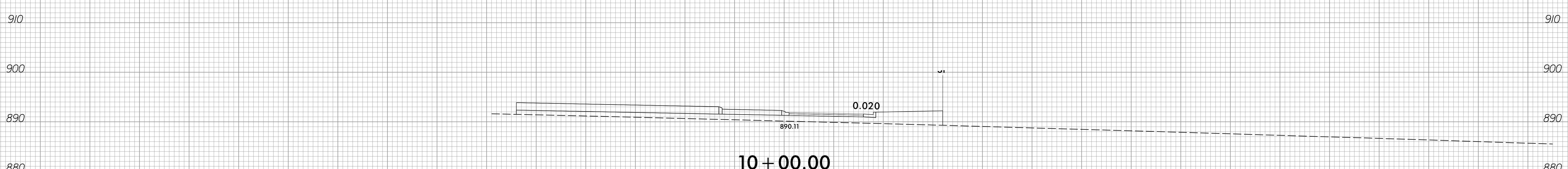
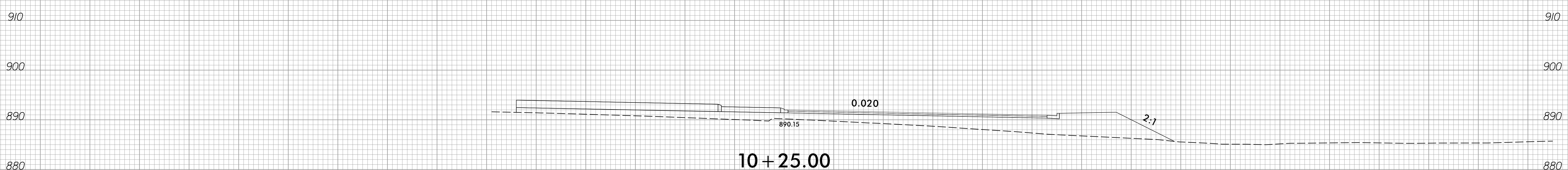
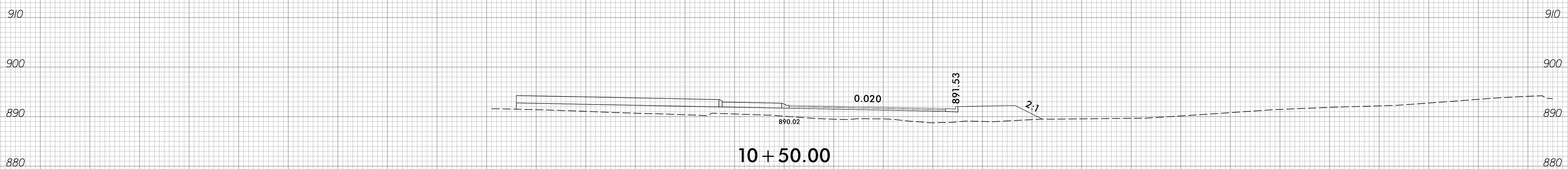

-RDBT-

150 140 130 120 110 100 90 80 70 60 50 40 30 20 10 0 10 20 30 40 50 60 70 80 90 100 110 120 130 140 150

3/9/2023  
 C:\Users\jguy\OneDrive\Documents\Xsc\Xpl\U-2729\_rdy\_XPL\_F08T.dgn

6/23/16

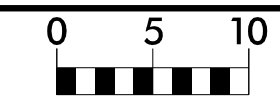

PROJ. REFERENCE NO.	SHEET NO.
U-2729	X-37

150 140 130 120 110 100 90 80 70 60 50 40 30 20 10 0 10 20 30 40 50 60 70 80 90 100 110 120 130 140 150

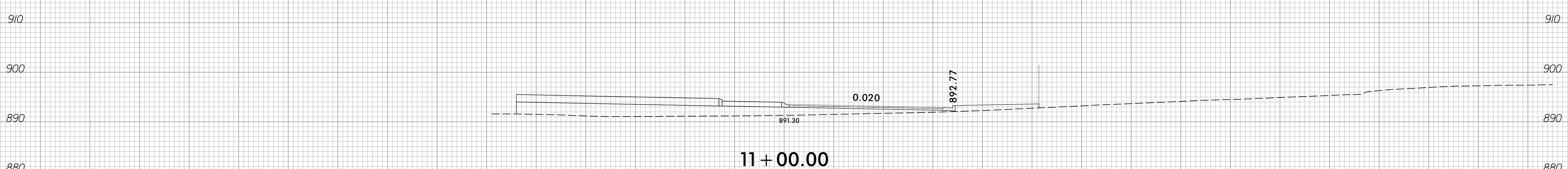
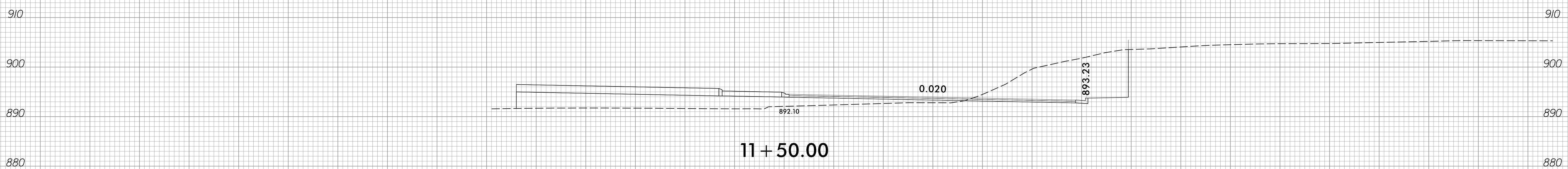
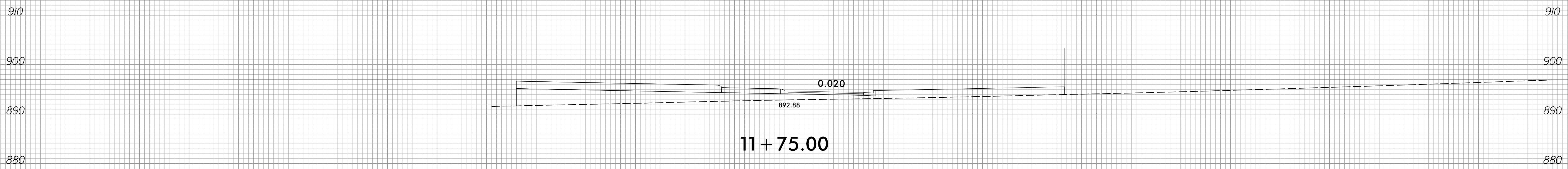

-RDBT-

150 140 130 120 110 100 90 80 70 60 50 40 30 20 10 0 10 20 30 40 50 60 70 80 90 100 110 120 130 140 150

3/9/2023  
 C:\Users\jguy\OneDrive\Documents\Xsc\Xpl\U-2729\_rdy\_XPL\_F08T.dgn

6/23/16

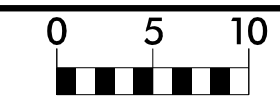

PROJ. REFERENCE NO.	SHEET NO.
U-2729	X-38

150 140 130 120 110 100 90 80 70 60 50 40 30 20 10 0 10 20 30 40 50 60 70 80 90 100 110 120 130 140 150

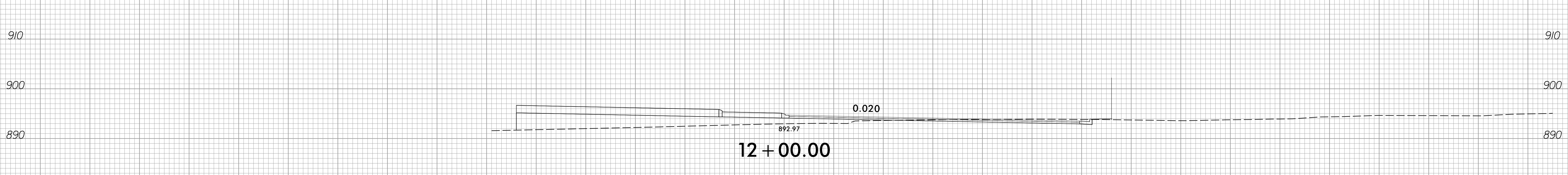
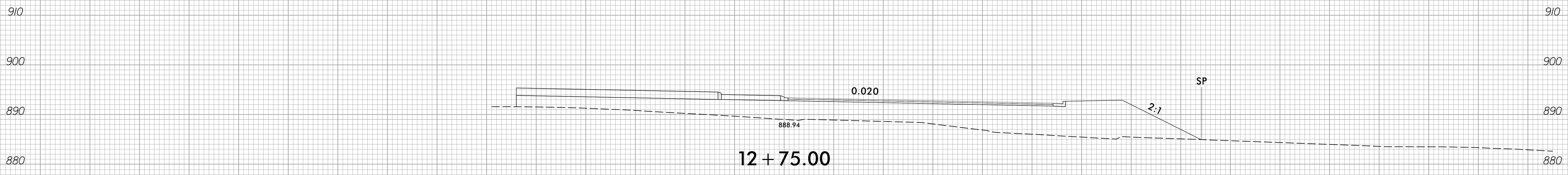

-RDBT-

150 140 130 120 110 100 90 80 70 60 50 40 30 20 10 0 10 20 30 40 50 60 70 80 90 100 110 120 130 140 150

3/9/2023  
 C:\Users\jguy\OneDrive\Xsc\Xp1\U-2729\_rdy\_XPL\_F08T.dgn



6/23/16

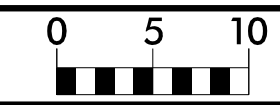

PROJ. REFERENCE NO.	SHEET NO.
U-2729	X-39

150 140 130 120 110 100 90 80 70 60 50 40 30 20 10 0 10 20 30 40 50 60 70 80 90 100 110 120 130 140 150

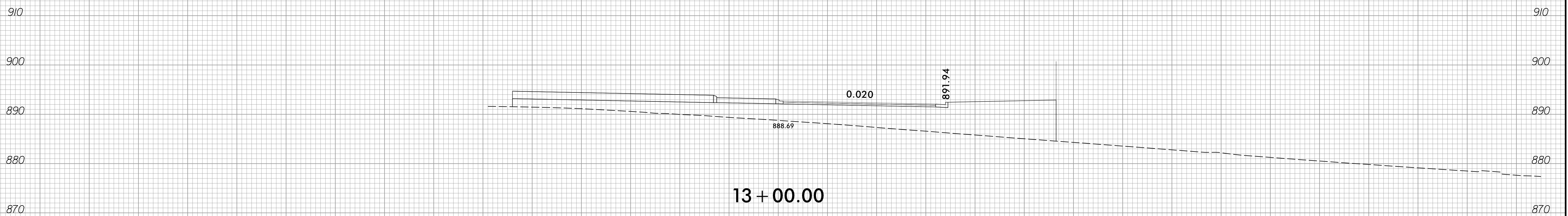
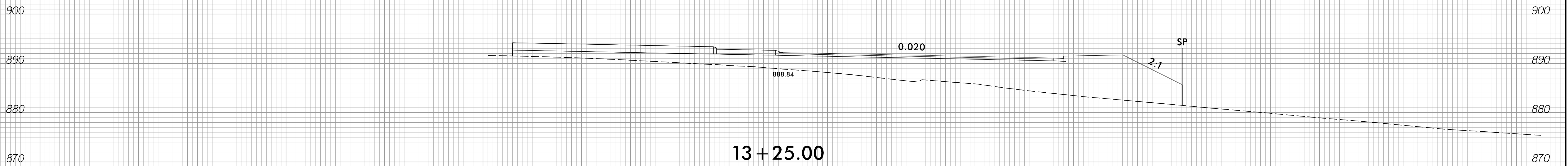
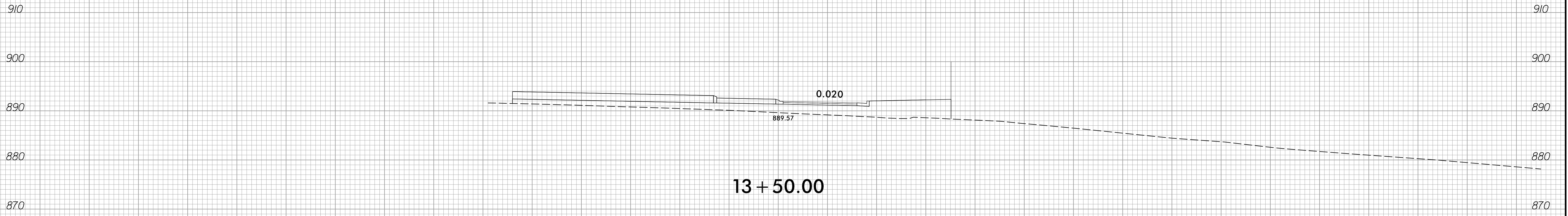

-RDBT-

3/9/2023  
 C:\Users\jguy\OneDrive\Documents\Xsc\Xpl\U-2729\_rdy\_XPL\_F08T.dgn

150 140 130 120 110 100 90 80 70 60 50 40 30 20 10 0 10 20 30 40 50 60 70 80 90 100 110 120 130 140 150

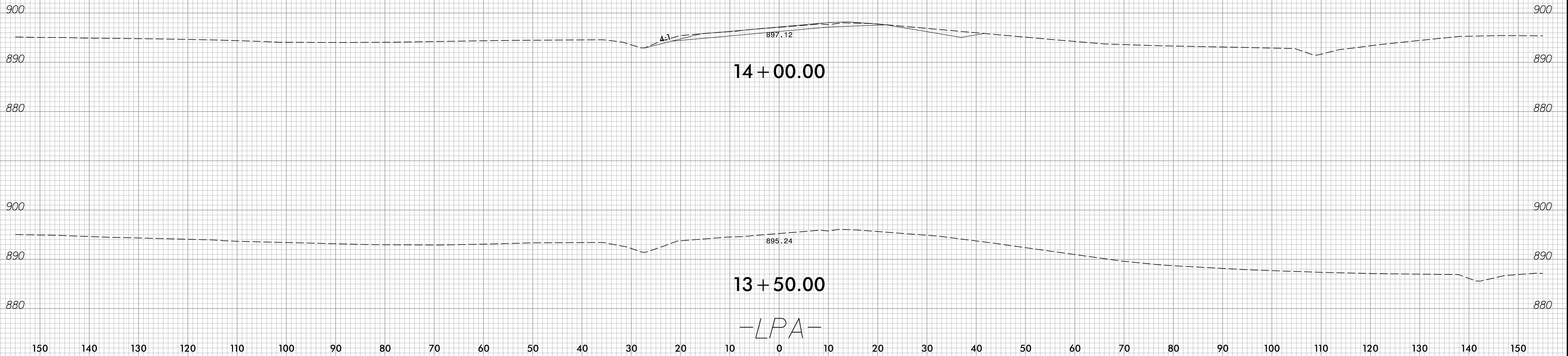

150 140 130 120 110 100 90 80 70 60 50 40 30 20 10 0 10 20 30 40 50 60 70 80 90 100 110 120 130 140 150

