

p:\gfn\p-w-bentley.com\gfn\p-w-01\Documents\Projects\67945\5-WorKing\Task 005 - I-5889B Rehab\Structures\CAD\2.0 100% Plans\405_183_I-5889B_SMU_B3D_019_100352 7/25/2022 9:01:20 AM pdf_color_gfclt_FS.plt I-5889B.tbl

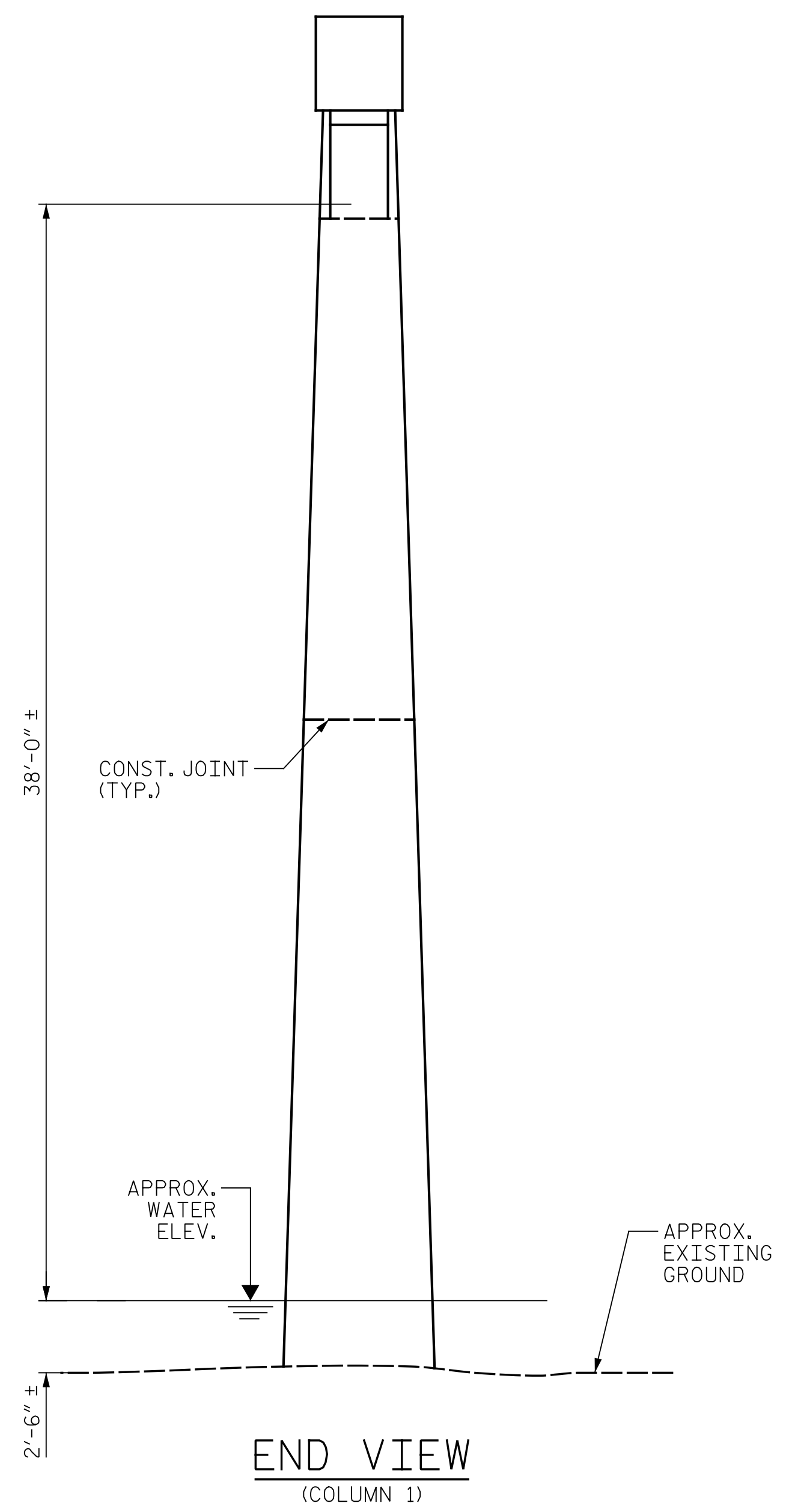
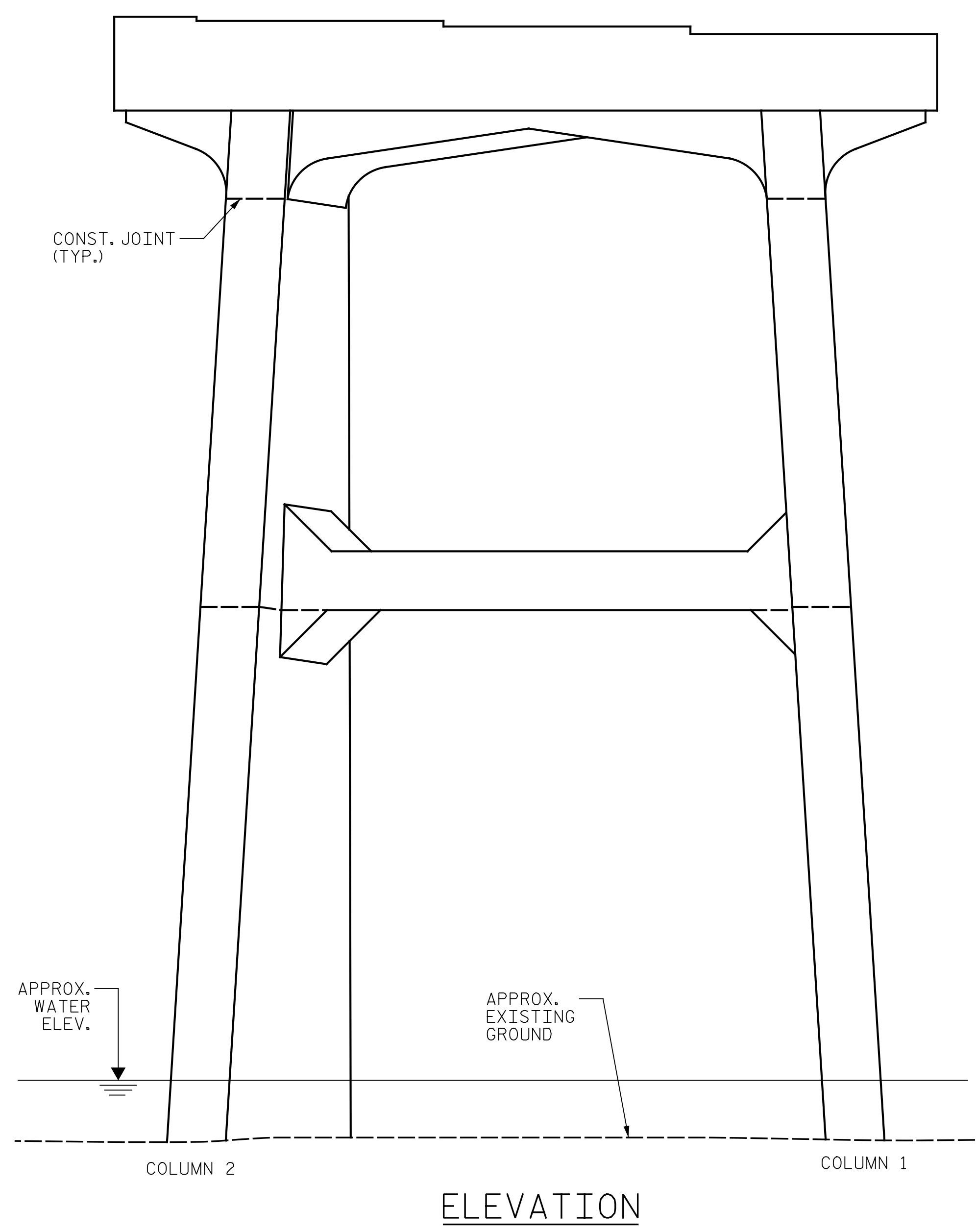
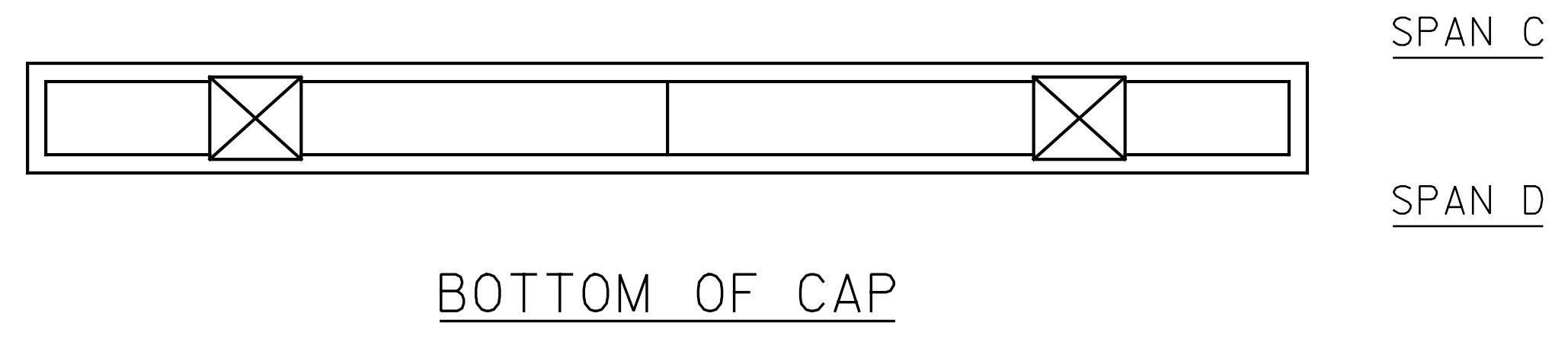

NOTES:

REPAIR LOCATIONS AND ESTIMATE OF QUANTITIES ARE BASED ON THE BEST INFORMATION AVAILABLE. IF ADDITIONAL REPAIRS NOT SHOWN ON THE DRAWINGS ARE DEEMED NECESSARY BY THE ENGINEER, THE ENGINEER WILL NOTE ON THE DRAWINGS THE APPROXIMATE LOCATIONS AND DESCRIPTION OF THE REPAIRS AND ENTER THE ACTUAL QUANTITIES INTO THE AS-BUILT REPAIR QUANTITY TABLE.

FOR REPAIRS, SEE "TYPICAL CAP AND COLUMN REPAIR DETAILS" SHEET.

FOR SHOTCRETE REPAIRS, SEE SPECIAL PROVISIONS.

FOR CONCRETE REPAIRS, SEE SPECIAL PROVISIONS.

SHOTCRETE REPAIRS MAY BE REPLACED WITH CONCRETE REPAIRS WITH THE APPROVAL OF THE ENGINEER.



CONTRACTOR SHALL SAW CUT TO A MINIMUM DEPTH OF 1/2" BUT REINFORCING STEEL SHALL NOT BE DAMAGED. CONTRACTOR SHALL REMOVE SURFACE CONCRETE TO VERIFY THAT SAW CUT DEPTH WILL NOT DAMAGE EXISTING REINFORCING STEEL.

CONTRACTOR SHALL SAW CUT THE REPAIR AREAS SO THAT THE CORNERS ARE SQUARE AS INDICATED ON THE DETAILS.

CLEAN AND REMOVE DEBRIS FROM THE TOP OF THE CAP AND APPLY EPOXY PROTECTIVE COATING. EPOXY COATING SHALL BE APPLIED TO THE TOP SURFACE OF THE CAP. THE CONTRACTOR SHALL NOT COAT THE AREA OF THE CAP BENEATH THE MASONRY PLATES. FOR EPOXY COATING, SEE SPECIAL PROVISIONS.

FOR EPOXY RESIN INJECTION, SEE SPECIAL PROVISIONS.

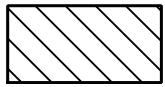
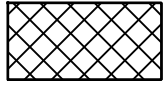
WHEN COLUMN REPAIRS ARE INDICATED TO GROUND LINE, EXTEND REPAIR ONE (1) FOOT MIN. BELOW GROUND LINE.

-  SHOTCRETE REPAIR
-  CONCRETE REPAIR (FORM & POUR)
-  ERI - EPOXY RESIN INJECTION

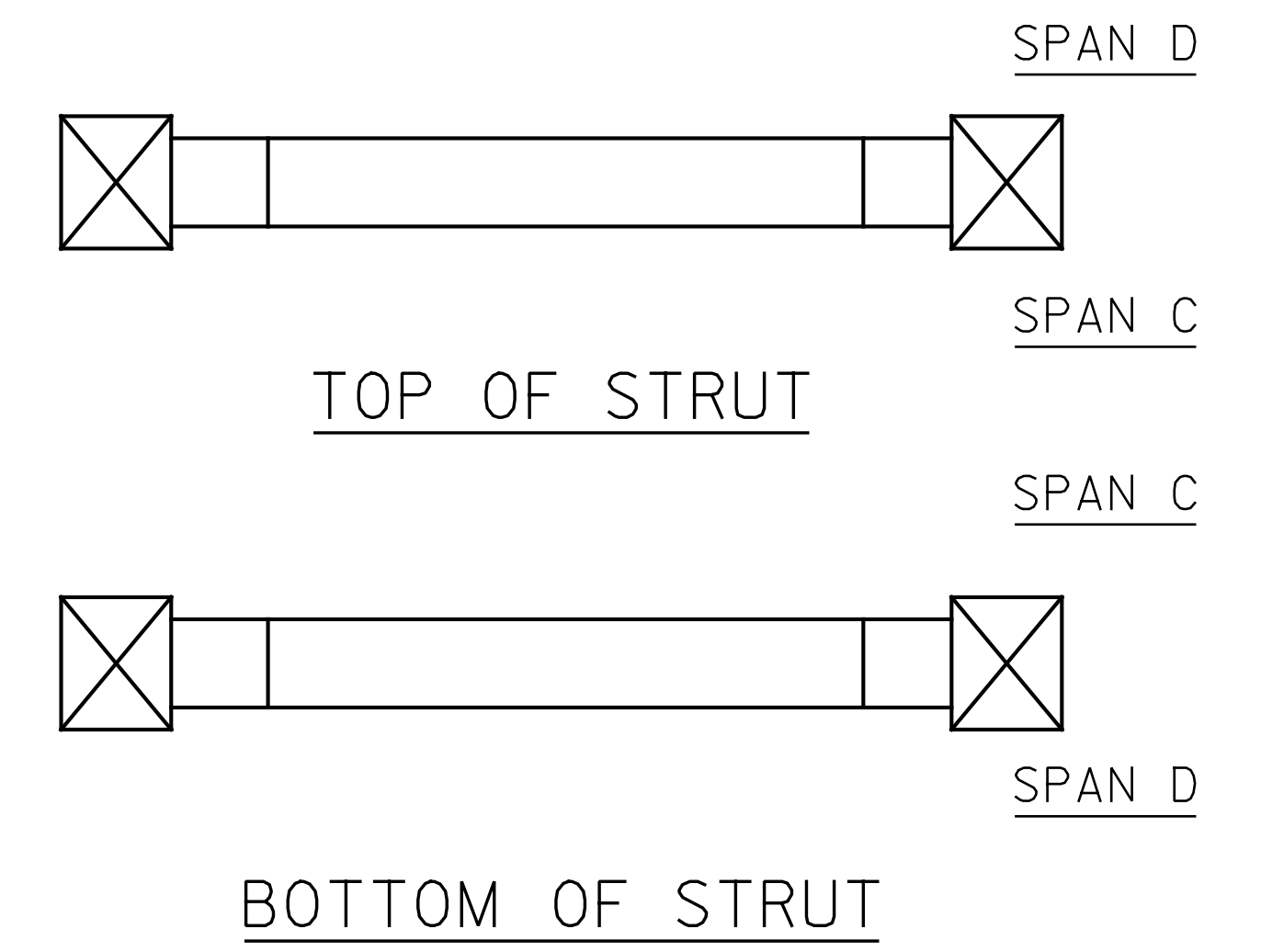

PROJECT NO. I-5889B
BUNCOMBE COUNTY
 BRIDGE NO. 100352

SHEET 2 OF 2

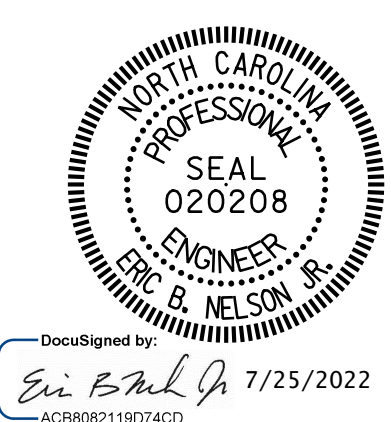

STATE OF NORTH CAROLINA
 DEPARTMENT OF TRANSPORTATION
 RALEIGH

BENT 3
SPAN D SIDE

DRAWN BY : J. HARRIS DATE : 6/2022
 CHECKED BY : J. YANACCONO DATE : 6/2022



REVISIONS						SHEET NO.
NO.	BY:	DATE:	NO.	BY:	DATE:	S5-19
1			3			TOTAL SHEETS
2			4			129

DOCUMENT NOT CONSIDERED FINAL UNLESS ALL SIGNATURES COMPLETED