

**This electronic collection of documents is provided  
for the convenience of the user  
and is Not a Certified Document –**

**The documents contained herein were originally issued  
and sealed by the individuals whose names and license  
numbers appear on each page, on the dates appearing  
with their signature on that page.**

**This file or an individual page  
shall not be considered a certified document.**

**STATE OF NORTH CAROLINA  
DEPARTMENT OF TRANSPORTATION**

<small>TIP NO.</small> W-5701B	<small>SHEET NO.</small> SIGN-1
<small>APPROVED:</small> <i>David J. Sears</i>	
<small>DATE:</small> 1/9/2023	
	
<b>DOCUMENT NOT CONSIDERED FINAL UNLESS ALL SIGNATURES COMPLETED</b>	

**T.I.P.: W-5701B**

## SIGNING PLAN NORTHAMPTON & HERTFORD COUNTIES

LOCATION: US 158 FROM WEST OF US 258 TO  
EAST OF NC 11

### ROADWAY STANDARD DRAWING

THE FOLLOWING ROADWAY STANDARDS AS APPEAR IN "ROADWAY STANDARD DRAWINGS" - PROJECT SERVICES UNIT - N.C. DEPARTMENT OF TRANSPORTATION - RALEIGH, N.C., DATED JANUARY 2018 ARE APPLICABLE TO THIS PROJECT AND BY REFERENCE HEREBY ARE CONSIDERED A PART OF THESE PLANS:

STD. NO.	TITLE
901.50	ARROWS AND SHIELDS
903.20	WOOD SIGN SUPPORTS
904.10	ORIENTATION OF GROUND MOUNTED SIGNS
904.50	MOUNTING OF TYPE D, E AND F SIGNS ON U-CHANNEL POSTS
910.30	SIGNING SIGNALIZED AND UNSIGNALIZED SUPERSTREET
1264.01	OBJECT MARKERS - TYPES
1264.02	OBJECT MARKERS - INSTALLATION

### GENERAL NOTES

- . SIGNS FURNISHED BY STATE (BUNN PLANT).
- . CONFIRM IN WRITING AT LEAST 4 MONTHS IN ADVANCE, THE ACTUAL DATE THE DEPARTMENT FURNISHED SIGNS WILL BE REQUIRED.
- . ALL TYPE 'D' SIGNS SHALL BE MOUNTED ON TWO WOOD POSTS UNLESS OTHERWISE INDICATED ON THE PLANS.
- . IF REMOVAL OR RELOCATION OF SIGNS ON PRIVATE STREET (NON-STATE MAINTAINED) IS REQUIRED DUE TO CONSTRUCTION, THE CONTRACTOR SHALL INFORM THE ENGINEER. THE WORK WILL BE COMPLETED BY OTHERS.
- . WHEN NOT STATIONED OR DIMENSIONED ON PLANS, ALL 'E' AND 'F' SIGNS SHALL BE FIELD LOCATED BY THE ENGINEER
- . ALL EXISTING SIGNS ON WOOD POST WITHIN THE PROJECT LIMITS SHALL BE REMOVED AND DISPOSED OF UNLESS OTHERWISE NOTED ON PLANS.
- . WHEN EXISTING SIGNS ARE REMOVED AND INSTALLED ON NEW SUPPORTS, THE RE-ERECTION SHALL IMMEDIATELY FOLLOW THE REMOVAL.
- . THE BACKGROUND FOR TYPE E & F SIGNS SHALL BE TYPE C REFLECTIVE SHEETING.
- . SEE ROADWAY PLANS FOR GUARD/GUIDE RAIL DETAILS.

### SUMMARY OF QUANTITIES

ITEM NO.		ITEM DESCRIPTION	QUANTITY	UNIT
DESC. NO.	SECT. NO.			
4072000000	903	SUPPORTS, 3 LB STEEL U-CHANNEL	490	L.F.
4082000000	903	SUPPORTS, WOOD	2220	L.F.
4096000000	904	SIGN ERECTION, TYPE D	18	EA.
4102000000	904	SIGN ERECTION, TYPE E	55	EA.
4108000000	904	SIGN ERECTION, TYPE F	27	EA.
4116100000	904	SIGN ERECTION, RELOCATE TYPE D	1	EA.
4141000000	907	DISPOSAL OF SUPPORT, WOOD	2	EA.
4158000000	907	DISPOSAL OF SIGN SYSTEM, WOOD	80	EA.
4238000000	907	DISPOSAL OF SIGN, D, E OR F	2	EA.
4360000000	SP	GENERIC SIGNING ITEM (DISPOSAL OF FLASHER SYSTEM)	1	EA.

### INDEX

SHEET NO.	DESCRIPTION
SIGN-1	TITLE SHEET
SIGN-3-3B	E AND F SIGNS
SIGN-3C-3G	SIGN DESIGNS
SIGN-4-11	SIGNING PLAN SHEETS

FINAL SIGNING PLANS  
SUBMITTAL NO: S-009  
DATE: 11-1-2022

**PLAN SUBMITTED TO: NCDOT Signing & Delineation, Divison 1**

*Ayman Alqudwah, PE* Signing & Delineation Regional Engineer  
*Mitch Eaton, PE* Signing & Delineation Project Design Engineer  
*Jason Davidson* Division 1 Traffic Engineer

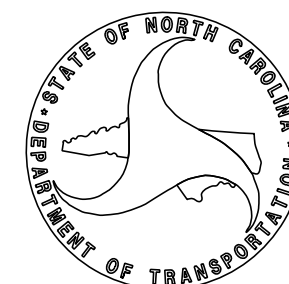

**PLAN PREPARED BY:**

*David Sears, PE, PTOE* Senior Project Engineer  
*Allen Tutt* Sr. Designer



P: (919) 878-9560  
 8601 Six Forks Road, Forum 1, Suite 700  
 Raleigh, North Carolina 27615-3960  
 NC License No. F-0112

Engineers | Construction Managers | Planners | Scientists  
 www.rkk.com  
 Responsive People | Creative Solutions

**CONTRACT:**







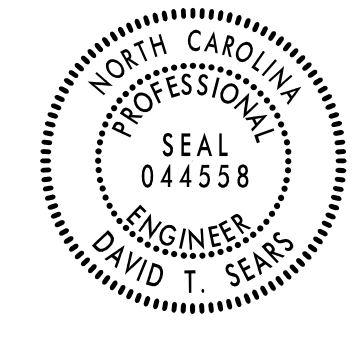

DocuSigned by:  
*David T. Seab*  
000183F2B60741E  
APPROVED: 1/9/2023

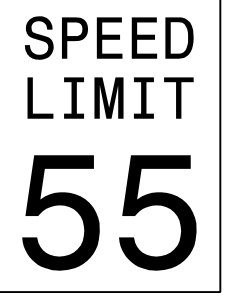
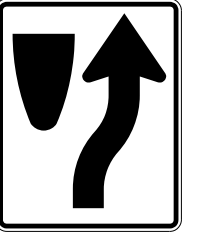
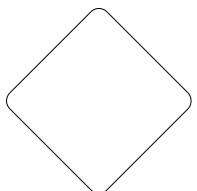
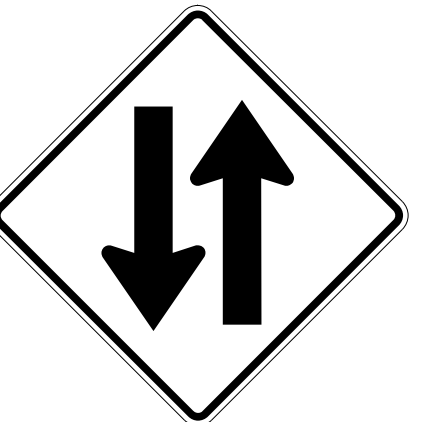
DATE: 1/9/2023

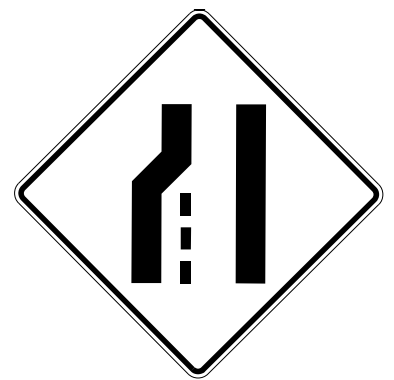
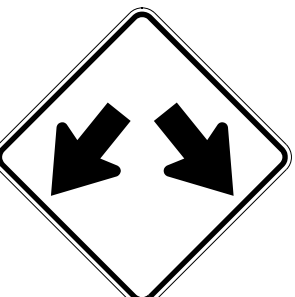
SEAL

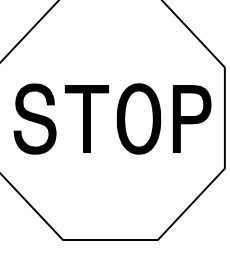
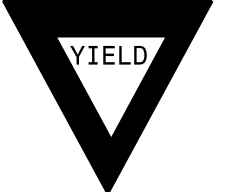
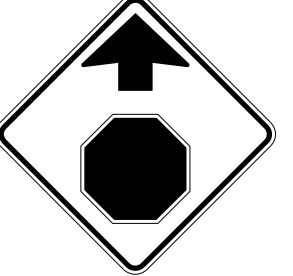

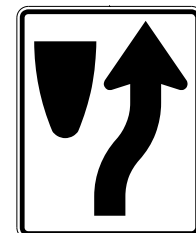
**DOCUMENT NOT CONSIDERED FINAL  
UNLESS ALL SIGNATURES COMPLETED**

<p>401 QUANTITY REQ'D 4</p>  <p>R2-1 36" X 48"</p> <p>TWO WOOD POSTS PER SIGN</p>	<p>402 QUANTITY REQ'D 5</p>  <p>R4-7 24" X 30"</p> <p>ONE WOOD POST PER SIGN</p>	<p>403 QUANTITY REQ'D 6</p>  <p>OM1-3 18" X 18"</p> <p>MOUNT BELOW SIGN 402 IN 5 INSTALLATIONS. MOUNT BELOW SIGN 414 IN 1 INSTALLATION.</p>	<p>404 QUANTITY REQ'D 1</p>  <p>W6-3 48" X 48"</p> <p>TWO WOOD POSTS</p>	<p>405 QUANTITY REQ'D 5</p>  <p>R6-1L 54" X 18"</p> <p>TWO WOOD POSTS PER SIGN</p>	<p>406 QUANTITY REQ'D 2</p>  <p>W4-2L 48" X 48"</p> <p>TWO WOOD POSTS PER SIGN</p>	<p>407 QUANTITY REQ'D 10</p>  <p>W12-1 30" X 30"</p> <p>ONE WOOD POST PER SIGN</p>	<p>408 QUANTITY REQ'D 2</p>  <p>W9-1L 48" X 48"</p> <p>TWO WOOD POSTS PER SIGN</p>	<p>409 QUANTITY REQ'D 5</p>  <p>R6-1R 36" X 12"</p> <p>MOUNT ABOVE SIGN 410 IN 5 INSTALLATIONS</p>	<p>410 QUANTITY REQ'D 5</p>  <p>R1-1 36" X 36"</p> <p>TWO WOOD POSTS PER SIGN</p>	<p>411 QUANTITY REQ'D 5</p>  <p>R1-2 36" X 36" X 36"</p> <p>ONE WOOD POST PER SIGN</p>	<p>412 QUANTITY REQ'D 1</p>  <p>W3-1 30" X 30"</p> <p>ONE WOOD POST</p>	<p>413 QUANTITY REQ'D 1</p>  <p>R2-1 24" X 30"</p> <p>ONE WOOD POST</p>		
<p>414 QUANTITY REQ'D 1</p>  <p>R4-7 36" X 48"</p> <p>TWO WOOD POSTS PER SIGN</p>	<p>415 QUANTITY REQ'D 1</p>  <p>W6-2 48" X 48"</p> <p>TWO WOOD POSTS PER SIGN</p>													
 <p>P: (919) 878-9560 8601 Six Forks Road, Forum 1, Suite 700 Raleigh, North Carolina 27615-3960 NC License No. F-0112</p> <p>Engineers   Construction Managers   Planners   Scientists www.rkk.com</p> <p>Responsive People   Creative Solutions</p>												<p><b>TYPE "E" SIGNS</b></p>		

K:\2023\11\11\11\Signing\CAD\Signing Layout Plans\W5701B\_SGN\_E.dgn

501 524



M3-4 24"X 12"  
M1-4 30"X 24"

ONE WOOD POST PER SIGN

502

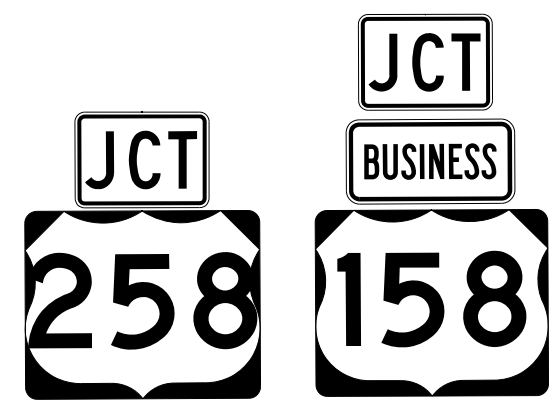

M2-1 21"X 15"  
M4-3 24"X 12"  
M1-4 30"X 24"

TWO WOOD POSTS

503

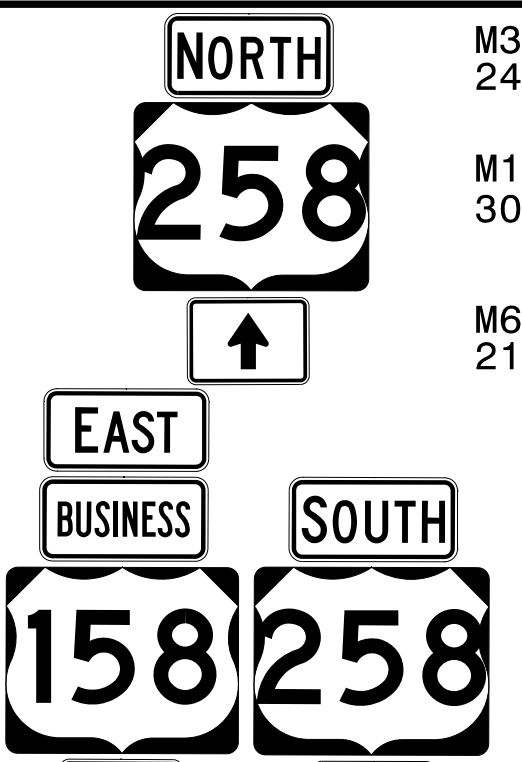

M3-1 24"X 12"  
M1-4 30"X 24"  
M6-3 21"X 15"  
M3-2 24"X 12"  
M4-3 24"X 12"  
M1-4 30"X 24"  
M3-3 24"X 12"  
M1-4 30"X 24"  
M6-1 21"X 15"

TWO WOOD POSTS

504

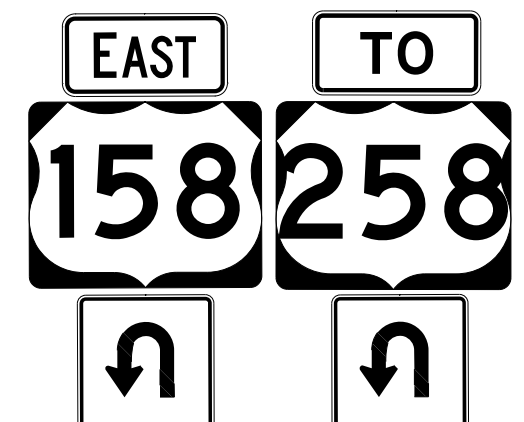

M3-2 24"X 12"  
M1-4 30"X 24"  
\*U-TURN 21"X 21"  
M4-5 24"X 12"  
M1-4 30"X 24"  
\*U-TURN 21"X 21"

TWO WOOD POSTS

505



M3-4 24"X 12"  
M1-4 30"X 24"  
M6-1 21"X 15"

MOUNT BELOW SIGN 302

506



M3-2 24"X 12"  
M4-3 24"X 12"  
M1-4 30"X 24"

ONE WOOD POST

507



M3-3 24"X 12"  
M1-4 30"X 24"

ONE WOOD POST

508



M2-1 21"X 15"  
M1-4 30"X 24"

ONE WOOD POST

509

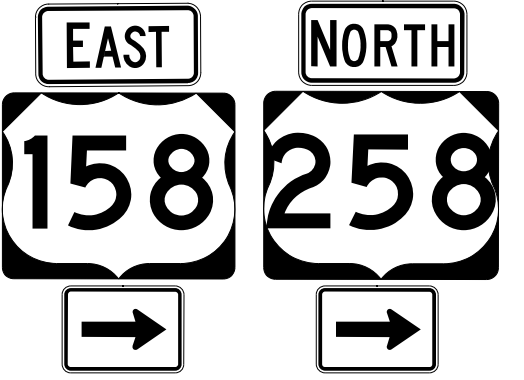

M3-2 24"X 12"  
M1-4 30"X 24"  
M6-1 21"X 15"  
M3-1 24"X 12"  
M1-4 30"X 24"  
M6-1 21"X 15"

TWO WOOD POSTS

510

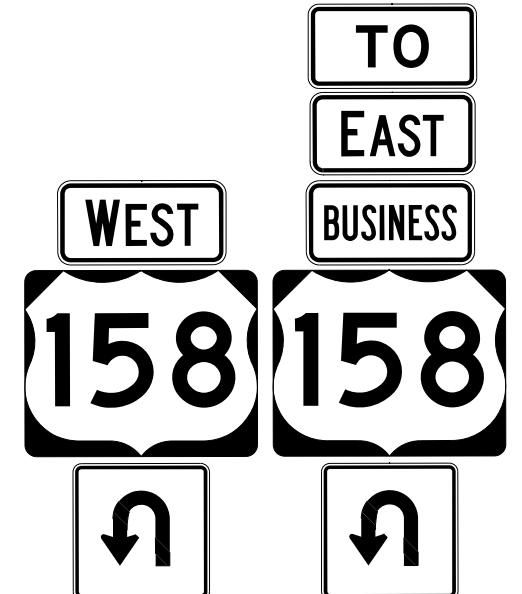

M4-5 24"X 12"  
M3-2 24"X 12"  
M4-3 24"X 12"  
M1-4 30"X 24"  
\*U-TURN 21"X 21"

TWO WOOD POSTS

511

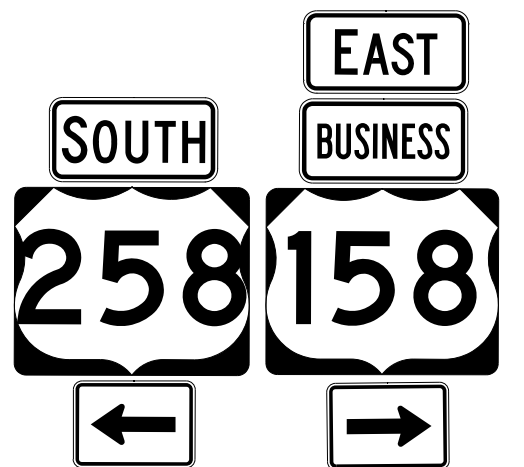

M3-3 24"X 12"  
M1-4 30"X 24"  
M6-1 21"X 15"  
M3-2 24"X 12"  
M4-3 24"X 12"  
M1-4 30"X 24"  
M6-1 21"X 15"

TWO WOOD POSTS

512

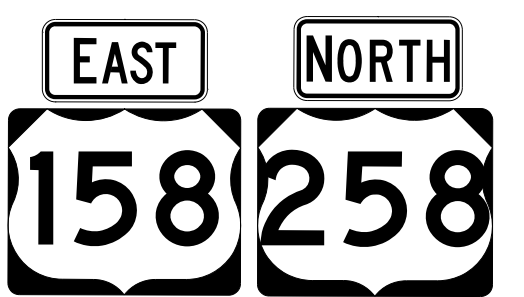

M3-2 24"X 12"  
M1-4 30"X 24"  
M3-1 24"X 12"  
M1-4 30"X 24"

TWO WOOD POSTS

513



M2-1 21"X 15"  
M4-3 24"X 12"  
M1-4 30"X 24"

ONE WOOD POST

514

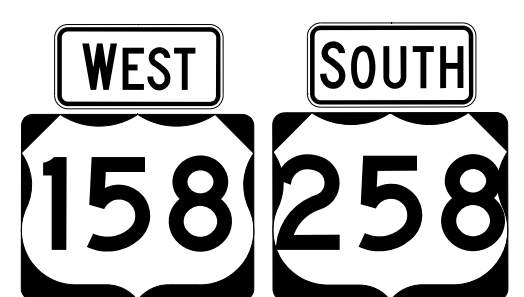

M3-4 24"X 12"  
M1-4 30"X 24"  
M3-3 24"X 12"  
M1-4 30"X 24"

TWO WOOD POSTS

515

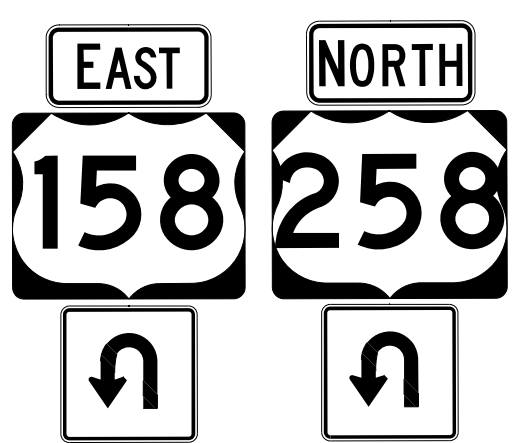

M3-2 24"X 12"  
M1-4 30"X 24"  
\*U-TURN 21"X 21"  
M3-1 24"X 12"  
M1-4 30"X 24"  
\*U-TURN 21"X 21"

TWO WOOD POSTS

516

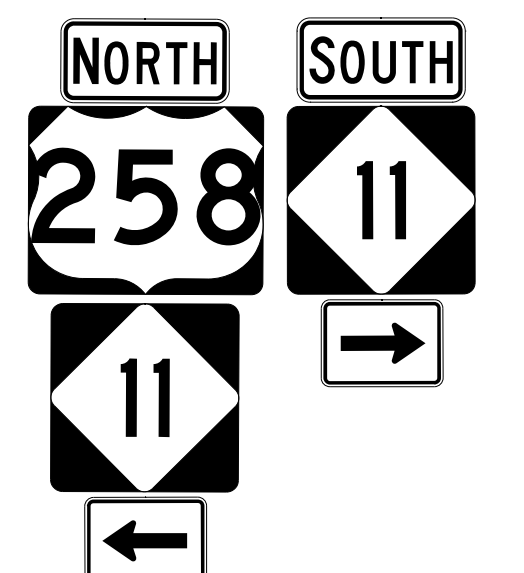

M3-1 24"X 12"  
M1-4 30"X 24"  
M1-5 24"X 24"  
M6-1 21"X 15"  
M3-3 24"X 12"  
M1-5 24"X 24"  
M6-1 21"X 15"

TWO WOOD POSTS

517

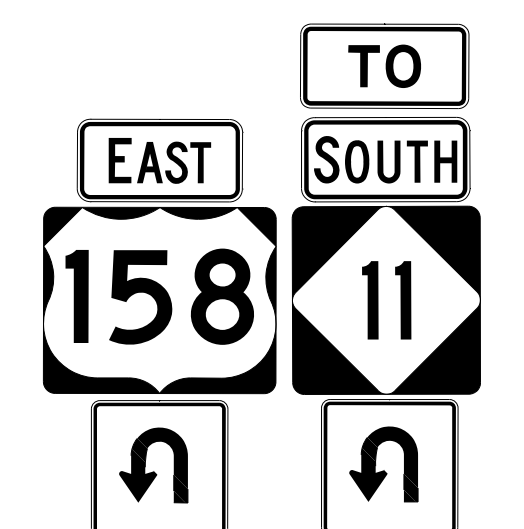

M3-2 24"X 12"  
M1-4 30"X 24"  
\*U-TURN 21"X 21"  
M4-5 24"X 12"  
M3-3 24"X 12"  
M1-5 24"X 24"  
\*U-TURN 21"X 21"

TWO WOOD POSTS



P: (919) 878-9560  
8601 Six Forks Road, Forum 1, Suite 700  
Raleigh, North Carolina 27615-3960  
NC License No. F-0112

Engineers | Construction Managers | Planners | Scientists  
www.rkk.com

Responsive People | Creative Solutions

518

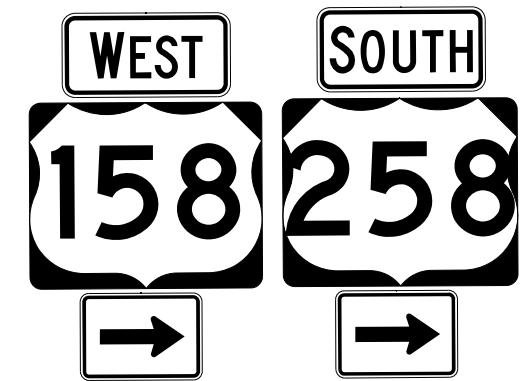

M3-4 24"X 12"  
M1-4 30"X 24"  
M6-1 21"X 15"  
M3-3 24"X 12"  
M1-4 30"X 24"  
M6-1 21"X 15"

TWO WOOD POSTS

519



M3-1 24"X 12"  
M1-4 30"X 24"  
M1-5 24"X 24"

ONE WOOD POST

520



M3-3 24"X 12"  
M1-5 24"X 24"

ONE WOOD POST

\*U-TURN PANEL SEE SHEET SIGN-3F FOR SIGN DESIGN

**TYPE "F" SIGNS**

04/08/23-SCN-F.dgn

521



M3-2  
24" X 12"  
M1-4  
30" X 24"  
M6-1  
21" X 15"

ONE WOOD POST

526



M3-2  
24" X 12"  
M1-4  
30" X 24"

ONE WOOD POST

522

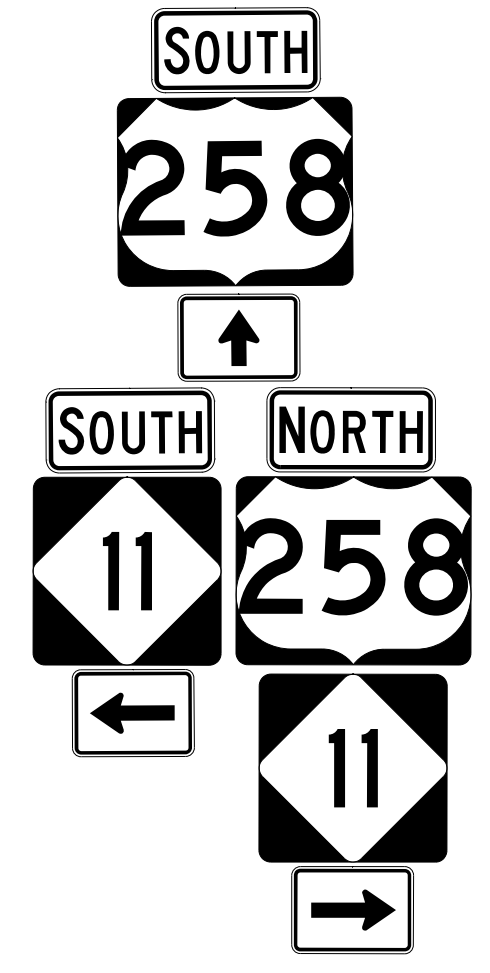

M3-3  
24" X 12"  
M1-4  
30" X 24"  
M6-3  
21" X 15"  
M3-1  
24" X 12"  
M1-4  
30" X 24"  
M1-5  
24" X 24"  
M6-1  
21" X 15"

TWO WOOD POSTS

523

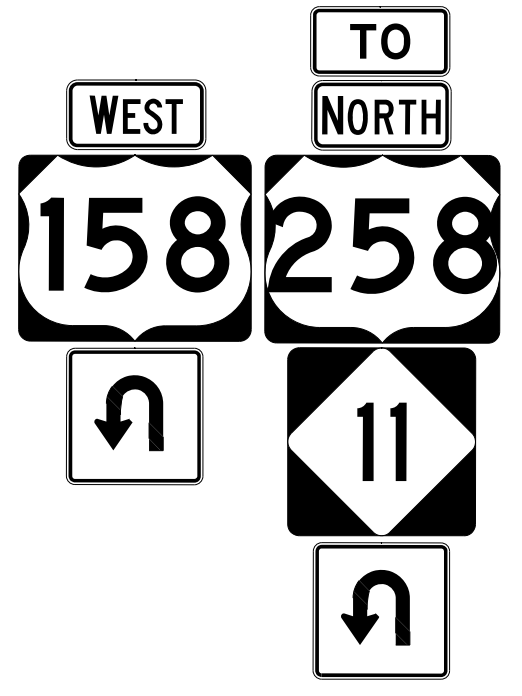

M3-4  
24" X 12"  
M1-4  
30" X 24"  
\*U-TURN  
21" X 21"  
M4-5  
24" X 12"  
M3-1  
24" X 12"  
M1-4  
30" X 24"  
M1-5  
24" X 24"  
\*U-TURN  
21" X 21"

TWO WOOD POSTS

525



M2-1  
21" X 15"  
M1-4  
30" X 24"  
M1-5  
24" X 24"

ONE WOOD POST

527

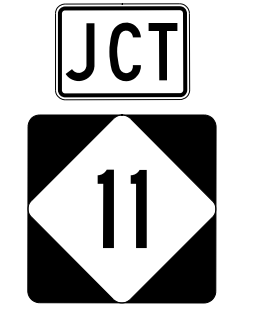

M2-1  
21" X 15"  
M1-5  
24" X 24"

ONE WOOD POST

\*U-TURN PANEL SEE SHEET SIGN-3F FOR SIGN DESIGN

**TYPE "F" SIGNS**

APPROVED: *David T. Sears*  
 DATE: 1/9/2023

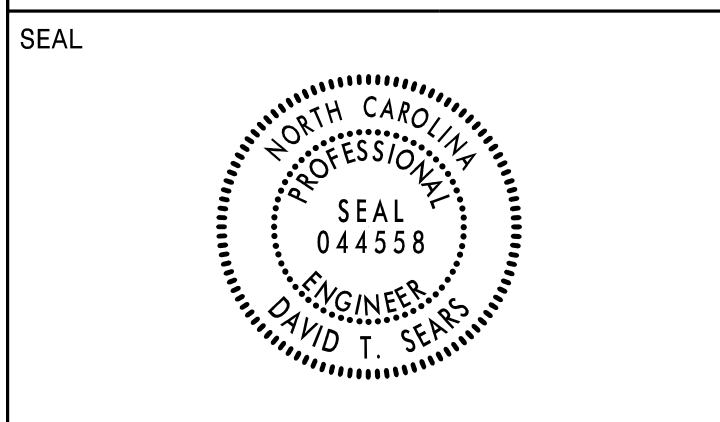

**DOCUMENT NOT CONSIDERED FINAL  
 UNLESS ALL SIGNATURES COMPLETED**

SIGN NUMBER: 301 TYPE: D QUANTITY: 1  
 SIGN WIDTH: 6'-6" HEIGHT: 3'-6" TOTAL AREA: 22.8 Sq.Ft.  
 BORDER TYPE: FLUSH RECESS: 0" WIDTH: 0.75" RADIUS: 2.25"  
 NO. Z BARS: LENGTH:

BACKG COLOR: Green COPY COLOR: White

SYMBOL	X	Y	WID	HT
AR_Type D	7.4	30.3	6	9
AR_Type D	8.5	18	6	9
AR_Type D	54.5	4.3	6	9

MAT'L: 0.125" (3.2 mm) ALUMINUM

DESIGN BY: A. TUTT CHECKED BY: D. SEARS Jun 02, 2022  
 PROJECT ID: W-5701B LOCATION: -L- STA. 34+00 DIV: 1

USE NOTES: 1,2

- Legend and border(except those that are colored black) shall be direct applied Grade C sheeting.
- Background shall be Grade C reflective sheeting.
- Shields: A, B, and C type arrows shall be on 0.032" (0.8mm) aluminum and demountable.

Spacing Factor is 1 unless specified otherwise

LETTER POSITIONS

Letter spacings are to start of next letter

	C	h	o	w	a	n	U	n	i	v		Series/Size		
	19.4	5.3	4.4	4.1	7.2	4.6	3.5	6	5.4	4.7	1.7	4.3	7.4	D 2000
														51.2
														D 2000
														46.1
														D 2000
														33.9

FILENAME: W5701B\_SGN\_Des NORTH CAROLINA D.O.T. SIGN DETAIL

SIGN NUMBER: 302,314 TYPE: D QUANTITY: 2  
 SIGN WIDTH: 5'-0" HEIGHT: 1'-6" TOTAL AREA: 7.5 Sq.Ft.  
 BORDER TYPE: FLUSH RECESS: 0" WIDTH: 0.75" RADIUS: 2.25"  
 NO. Z BARS: LENGTH:

BACKG COLOR: Green COPY COLOR: White

SYMBOL	X	Y	WID	HT
AR_Type D	43.3	6	6	9

MAT'L: 0.125" (3.2 mm) ALUMINUM

DESIGN BY: A. TUTT CHECKED BY: D. SEARS Jun 02, 2022  
 PROJECT ID: W-5701B LOCATION: -Y2- STA. 12+00, -Y7- STA. 18+00 DIV: 1

USE NOTES: 1,2

- Legend and border(except those that are colored black) shall be direct applied Grade C sheeting.
- Background shall be Grade C reflective sheeting.
- Shields: A, B, and C type arrows shall be on 0.032" (0.8mm) aluminum and demountable.

Spacing Factor is 1 unless specified otherwise

LETTER POSITIONS

Letter spacings are to start of next letter

	C	o	n	w	a	y		Series/Size	
	7.7	5	4.6	4.2	7.2	4.1	4.5	22.7	D 2000
									29.6

FILENAME: W5701B\_SGN\_Des NORTH CAROLINA D.O.T. SIGN DETAIL

SIGN NUMBER: 303 TYPE: D QUANTITY: 1  
 SIGN WIDTH: 6'-6" HEIGHT: 2'-6" TOTAL AREA: 16.3 Sq.Ft.  
 BORDER TYPE: FLUSH RECESS: 0" WIDTH: 0.75" RADIUS: 3.75"  
 NO. Z BARS: LENGTH:

BACKG COLOR: Green COPY COLOR: White

SYMBOL	X	Y	WID	HT
AR_Type D	63.1	12	6	9

MAT'L: 0.125" (3.2 mm) ALUMINUM

DESIGN BY: A. TUTT CHECKED BY: D. SEARS Oct 19, 2022  
 PROJECT ID: W-5701B LOCATION: -Y1- OFFSITE DIV: 1

USE NOTES: 1,2

- Legend and border(except those that are colored black) shall be direct applied Grade C sheeting.
- Background shall be Grade C reflective sheeting.
- Shields: A, B, and C type arrows shall be on 0.032" (0.8mm) aluminum and demountable.

Spacing Factor is 1 unless specified otherwise

LETTER POSITIONS

Letter spacings are to start of next letter

	C	h	o	w	a	n	U	n	i	v		Series/Size		
	5.9	5.3	4.4	4.1	7.2	4.6	3.5	6	5.4	4.7	1.7	4.3	20.9	D 2000
														51.2
														D 2000
														23.4

FILENAME: W5701B\_SGN\_Des NORTH CAROLINA D.O.T. SIGN DETAIL

SIGN NUMBER: 304 TYPE: D QUANTITY: 1  
 SIGN WIDTH: 7'-0" HEIGHT: 2'-6" TOTAL AREA: 17.5 Sq.Ft.  
 BORDER TYPE: FLUSH RECESS: 0" WIDTH: 0.75" RADIUS: 2.25"  
 NO. Z BARS: LENGTH:

BACKG COLOR: Green COPY COLOR: White

SYMBOL	X	Y	WID	HT
AR_Type D				

MAT'L: 0.125" (3.2 mm) ALUMINUM

DESIGN BY: A. TUTT CHECKED BY: D. SEARS Oct 10, 2022  
 PROJECT ID: W-5701B LOCATION: -L- STA. 44+50 DIV: 1

USE NOTES: 1,2

- Legend and border(except those that are colored black) shall be direct applied Grade C sheeting.
- Background shall be Grade C reflective sheeting.
- Shields: A, B, and C type arrows shall be on 0.032" (0.8mm) aluminum and demountable.

Spacing Factor is 1 unless specified otherwise

LETTER POSITIONS

Letter spacings are to start of next letter

	W	i	n	t	o	n		Series/Size	
	6	6.1	2.2	4.1	2.8	4.6	3.5	54.6	D 2000
									23.4
									D 2000
									6.9
									D 2000
									51.3
									D 2000
									9.5

FILENAME: W5701B\_SGN\_Des NORTH CAROLINA D.O.T. SIGN DETAIL

APPROVED: *David T. Sears*  
069183P285741E  
 DATE: 1/9/2023

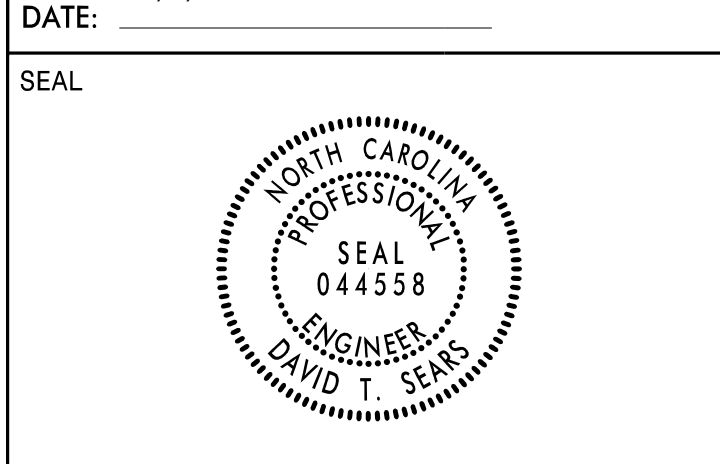

**DOCUMENT NOT CONSIDERED FINAL  
UNLESS ALL SIGNATURES COMPLETED**

SIGN NUMBER: 305 TYPE: D QUANTITY: 1 SIGN WIDTH: 6'-6" HEIGHT: 2'-6" TOTAL AREA: 16.3 Sq.Ft. BORDER TYPE: FLUSH RECESS: 0" WIDTH: 0.75" RADII: 2.25" NO. Z BARS: LENGTH:	BACKG COLOR: Green COPY COLOR: White SYMBOL AR_Type D 14.6 19.3 6 9 AR_Type D 60.5 4.7 6 9 MAT'L: 0.125" (3.2 mm) ALUMINUM	DESIGN BY: A. TUTT PROJECT ID: W-5701B CHECKED BY: D. SEARS LOCATION: -L- STA. 45+50 Jun 02, 2022 DIV: 1
---	---	---

USE NOTES: 1,2

- Legend and border(except those that are colored black) shall be direct applied Grade C sheeting.
- Background shall be Grade C reflective sheeting.
- Shields; A, B, and C type arrows shall be on 0.032" (0.8mm) aluminum and demountable.

Spacing Factor is 1 unless specified otherwise

LETTER POSITIONS

Letter spacings are to start of next letter

Series/Size	Text Length
D 2000	33.9
D 2000	46.1

FILENAME: W5701B\_SGN\_Des NORTH CAROLINA D.O.T. SIGN DETAIL

SIGN NUMBER: 306 TYPE: D QUANTITY: 1 SIGN WIDTH: 7'-0" HEIGHT: 2'-6" TOTAL AREA: 17.5 Sq.Ft. BORDER TYPE: FLUSH RECESS: 0" WIDTH: 0.75" RADII: 3.75" NO. Z BARS: LENGTH:	BACKG COLOR: Green COPY COLOR: White SYMBOL MAT'L: 0.125" (3.2 mm) ALUMINUM	DESIGN BY: A. TUTT PROJECT ID: W-5701B CHECKED BY: D. SEARS LOCATION: -L- STA. 46+50 Oct 10, 2022 DIV: 1
---	--	---

USE NOTES: 1,2

- Legend and border(except those that are colored black) shall be direct applied Grade C sheeting.
- Background shall be Grade C reflective sheeting.
- Shields; A, B, and C type arrows shall be on 0.032" (0.8mm) aluminum and demountable.

Spacing Factor is 1 unless specified otherwise

LETTER POSITIONS

Letter spacings are to start of next letter

Series/Size	Text Length
D 2000	53.9
C 2000	67.5

FILENAME: W5701B\_SGN\_Des NORTH CAROLINA D.O.T. SIGN DETAIL

SIGN NUMBER: 307 TYPE: D QUANTITY: 1 SIGN WIDTH: 5'-6" HEIGHT: 3'-0" TOTAL AREA: 16.5 Sq.Ft. BORDER TYPE: FLUSH RECESS: 0" WIDTH: 1" RADII: 4.5" NO. Z BARS: LENGTH:	BACKG COLOR: Green COPY COLOR: White SYMBOL MAT'L: 0.125" (3.2 mm) ALUMINUM	DESIGN BY: A. TUTT PROJECT ID: W-5701B CHECKED BY: D. SEARS LOCATION: -L- STA. 52+00 Oct 10, 2022 DIV: 1
---	--	---

USE NOTES: 1,2

- Legend and border(except those that are colored black) shall be direct applied Grade C sheeting.
- Background shall be Grade C reflective sheeting.
- Shields; A, B, and C type arrows shall be on 0.032" (0.8mm) aluminum and demountable.

Spacing Factor is 1 unless specified otherwise

LETTER POSITIONS

Letter spacings are to start of next letter

Series/Size	Text Length
EM 2000	55.2
E 2000	45.8
E 2000	35.9

FILENAME: W5701B\_SGN\_Des NORTH CAROLINA D.O.T. SIGN DETAIL

SIGN NUMBER: 308 TYPE: D QUANTITY: 1 SIGN WIDTH: 6'-6" HEIGHT: 3'-0" TOTAL AREA: 19.5 Sq.Ft. BORDER TYPE: FLUSH RECESS: 0" WIDTH: 1" RADII: 4.5" NO. Z BARS: LENGTH:	BACKG COLOR: Green COPY COLOR: White SYMBOL MAT'L: 0.125" (3.2 mm) ALUMINUM	DESIGN BY: A. TUTT PROJECT ID: W-5701B CHECKED BY: D. SEARS LOCATION: -L- STA. 52+00 Oct 10, 2022 DIV: 1
---	--	---

USE NOTES: 1,2

- Legend and border(except those that are colored black) shall be direct applied Grade C sheeting.
- Background shall be Grade C reflective sheeting.
- Shields; A, B, and C type arrows shall be on 0.032" (0.8mm) aluminum and demountable.

Spacing Factor is 1 unless specified otherwise

LETTER POSITIONS

Letter spacings are to start of next letter

Series/Size	Text Length
EM 2000	55.2
E 2000	65.9
E 2000	35.9

FILENAME: W5701B\_SGN\_Des NORTH CAROLINA D.O.T. SIGN DETAIL

APPROVED: *David T. Sears*  
069183F28E5741E  
 DATE: 1/9/2023

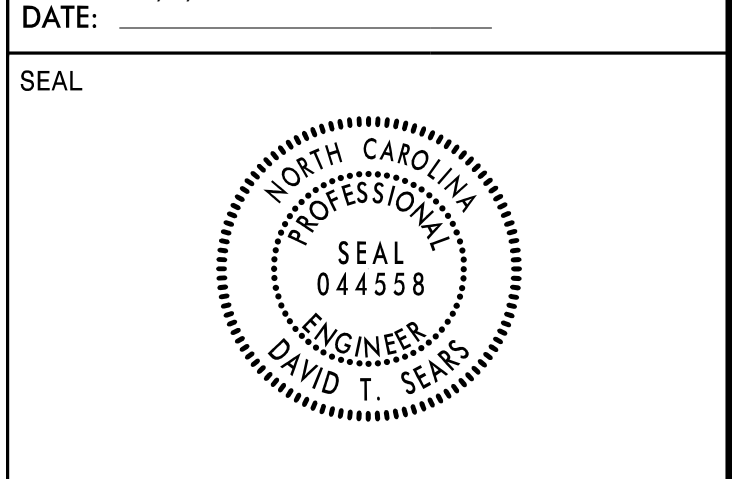

**DOCUMENT NOT CONSIDERED FINAL  
UNLESS ALL SIGNATURES COMPLETED**

SIGN NUMBER: 309 TYPE: D QUANTITY: 1 SIGN WIDTH: 6'-6" HEIGHT: 2'-6" TOTAL AREA: 16.3 Sq.Ft. BORDER TYPE: FLUSH RECESS: 0" WIDTH: 0.75" RADI: 3.75" NO. Z BARS: LENGTH:	BACKG COLOR: Green COPY COLOR: White SYMBOL X Y WID HT MAT'L: 0.125" (3.2 mm) ALUMINUM	DESIGN BY: A. TUTT PROJECT ID: W-5701B	CHECKED BY: D. SEARS LOCATION: -L- STA. 55+50	Oct 10, 2022 DIV: 1
--	---	---	--	------------------------

USE NOTES: 1,2

- Legend and border(except those that are colored black) shall be direct applied Grade C sheeting.
- Background shall be Grade C reflective sheeting.
- Shields; A, B, and C type arrows shall be on 0.032" (0.8mm) aluminum and demountable.

Spacing Factor is 1 unless specified otherwise

LETTER POSITIONS

Letter spacings are to start of next letter

	M	u	r	f	r	e	e	s	b	o	r	o	Series/Size		
	8.2	7.6	6.4	3.8	4.4	3.9	5.3	5.2	5.8	5.3	5.9	3.9	4.1	8.2	EM 2000 61.6
	N	E	X	T	R	I	C	H	T						D 2000 45.6
	16.2	5.5	4.3	4.6	3.7	6	5.1	2.3	5.4	5	3.7	16.2			

FILENAME: W5701B\_SGN\_Des NORTH CAROLINA D.O.T. SIGN DETAIL

SIGN NUMBER: 310 TYPE: D QUANTITY: 1 SIGN WIDTH: 7'-6" HEIGHT: 2'-6" TOTAL AREA: 18.8 Sq.Ft. BORDER TYPE: FLUSH RECESS: 0" WIDTH: 0.75" RADI: 2.25" NO. Z BARS: LENGTH:	BACKG COLOR: Green COPY COLOR: White SYMBOL X Y WID HT MAT'L: 0.125" (3.2 mm) ALUMINUM	DESIGN BY: A. TUTT PROJECT ID: W-5701B	CHECKED BY: D. SEARS LOCATION: -L- STA. 166+50	Oct 10, 2022 DIV: 1
--	---	---	---	------------------------

USE NOTES: 1,2

- Legend and border(except those that are colored black) shall be direct applied Grade C sheeting.
- Background shall be Grade C reflective sheeting.
- Shields; A, B, and C type arrows shall be on 0.032" (0.8mm) aluminum and demountable.

Spacing Factor is 1 unless specified otherwise

LETTER POSITIONS

Letter spacings are to start of next letter

	C	o	n	w	a	y	R	a	p	i	d	s	Series/Size				
	6	5	4.6	4.2	7.2	4.1	4.5	54.3					D 2000 29.6				
	9												D 2000 4.1				
	79.9	4.1	6										D 2000 59.5				
	6	4.7	4.3	4.6	4.4	4.6	4.3	3.5	6	4.7	4.6	4.6	1.9	4.4	2.8	24.5	D 2000 9.4
	3	8															
	74.6	5.3	4.1	6													

FILENAME: W5701B\_SGN\_Des NORTH CAROLINA D.O.T. SIGN DETAIL

SIGN NUMBER: 311 TYPE: D QUANTITY: 1 SIGN WIDTH: 6'-6" HEIGHT: 1'-6" TOTAL AREA: 9.8 Sq.Ft. BORDER TYPE: FLUSH RECESS: 0" WIDTH: 0.75" RADI: 2.25" NO. Z BARS: LENGTH:	BACKG COLOR: Green COPY COLOR: White SYMBOL X Y WID HT AR_Type D 5.9 6 6 9 MAT'L: 0.125" (3.2 mm) ALUMINUM	DESIGN BY: A. TUTT PROJECT ID: W-5701B	CHECKED BY: D. SEARS LOCATION: -L- STA. 166+50	Oct 19, 2022 DIV: 1
---	--	---	---	------------------------

USE NOTES: 1,2

- Legend and border(except those that are colored black) shall be direct applied Grade C sheeting.
- Background shall be Grade C reflective sheeting.
- Shields; A, B, and C type arrows shall be on 0.032" (0.8mm) aluminum and demountable.

Spacing Factor is 1 unless specified otherwise

LETTER POSITIONS

Letter spacings are to start of next letter

	C	h	o	w	a	n	U	n	i	v	Series/Size			
	20.9	5.3	4.4	4.1	7.2	4.6	3.5	6	5.4	4.7	1.7	4.3	5.9	D 2000 51.2

FILENAME: W5701B\_SGN\_Des NORTH CAROLINA D.O.T. SIGN DETAIL

SIGN NUMBER: 312 TYPE: D QUANTITY: 1 SIGN WIDTH: 6'-6" HEIGHT: 1'-6" TOTAL AREA: 9.8 Sq.Ft. BORDER TYPE: FLUSH RECESS: 0" WIDTH: 0.75" RADI: 2.25" NO. Z BARS: LENGTH:	BACKG COLOR: Green COPY COLOR: White SYMBOL X Y WID HT AR_Type D 63.1 6 6 9 MAT'L: 0.125" (3.2 mm) ALUMINUM	DESIGN BY: A. TUTT PROJECT ID: W-5701B	CHECKED BY: D. SEARS LOCATION: -L- STA. 177+50	Oct 19, 2022 DIV: 1
---	---	---	---	------------------------

USE NOTES: 1,2

- Legend and border(except those that are colored black) shall be direct applied Grade C sheeting.
- Background shall be Grade C reflective sheeting.
- Shields; A, B, and C type arrows shall be on 0.032" (0.8mm) aluminum and demountable.

Spacing Factor is 1 unless specified otherwise

LETTER POSITIONS

Letter spacings are to start of next letter

	C	h	o	w	a	n	U	n	i	v	Series/Size			
	5.9	5.3	4.4	4.1	7.2	4.6	3.5	6	5.4	4.7	1.7	4.3	20.9	D 2000 51.2

FILENAME: W5701B\_SGN\_Des NORTH CAROLINA D.O.T. SIGN DETAIL



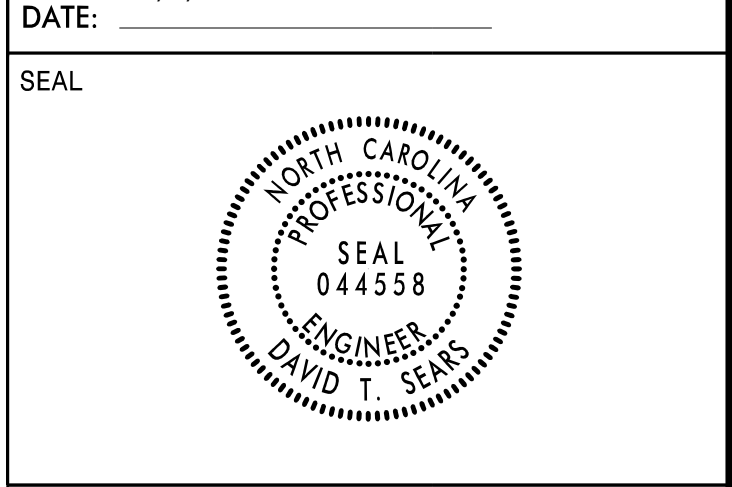

**DOCUMENT NOT CONSIDERED FINAL  
UNLESS ALL SIGNATURES COMPLETED**

SIGN NUMBER: 313      BACKG COLOR: Green      DESIGN BY: A. TUTT      CHECKED BY: D. SEARS      Jun 02, 2022  
 TYPE: D      COPY COLOR: White      PROJECT ID: W-5701B      LOCATION: -L- STA. 177+50      DIV: 1

QUANTITY: 1

SYMBOL	X	Y	WID	HT
AR_Type D	8.5	19.3	6	9
AR_Type D	51.6	4.8	6	9

SIGN WIDTH: 6'-6"  
 HEIGHT: 2'-6"  
 TOTAL AREA: 16.3 Sq.Ft.

BORDER TYPE: FLUSH  
 RECESS: 0"  
 WIDTH: 0.75"  
 RADII: 2.25"

NO. Z BARS:  
 LENGTH:

MAT'L: 0.125" (3.2 mm) ALUMINUM

USE NOTES: 1,2

- Legend and border(except those that are colored black) shall be direct applied Grade C sheeting.
- Background shall be Grade C reflective sheeting.
- Shields; A, B, and C type arrows shall be on 0.032" (0.8mm) aluminum and demountable.

Spacing Factor is 1 unless specified otherwise

LETTER POSITIONS

Letter spacings are to start of next letter

Text	Series/Size	Text Length
M u r f r e e s b o r o	D 2000	46.1
A h o s k i e	D 2000	28.2

FILENAME: W5701B\_SGN\_Des      NORTH CAROLINA D.O.T. SIGN DETAIL

SIGN NUMBER: 315      BACKG COLOR: Green      DESIGN BY: A. TUTT      CHECKED BY: D. SEARS      Jun 02, 2022  
 TYPE: D      COPY COLOR: White      PROJECT ID: W-5701B      LOCATION: -Y7- STA. 18+50      DIV: 1

QUANTITY: 1

SYMBOL	X	Y	WID	HT
AR_Type D	8.5	19.3	6	9
AR_Type D	51.6	4.8	6	9

SIGN WIDTH: 6'-6"  
 HEIGHT: 2'-6"  
 TOTAL AREA: 16.3 Sq.Ft.

BORDER TYPE: FLUSH  
 RECESS: 0"  
 WIDTH: 0.75"  
 RADII: 2.25"

NO. Z BARS:  
 LENGTH:

MAT'L: 0.125" (3.2 mm) ALUMINUM

USE NOTES: 1,2

- Legend and border(except those that are colored black) shall be direct applied Grade C sheeting.
- Background shall be Grade C reflective sheeting.
- Shields; A, B, and C type arrows shall be on 0.032" (0.8mm) aluminum and demountable.

Spacing Factor is 1 unless specified otherwise

LETTER POSITIONS

Letter spacings are to start of next letter

Text	Series/Size	Text Length
M u r f r e e s b o r o	D 2000	46.1
1	D 2000	1.5
F r a n k l i n	D 2000	28.9
2	D 2000	9.4

FILENAME: W5701B\_SGN\_Des      NORTH CAROLINA D.O.T. SIGN DETAIL

SIGN NUMBER: 316      BACKG COLOR: Green      DESIGN BY: A. TUTT      CHECKED BY: D. SEARS      Jun 02, 2022  
 TYPE: D      COPY COLOR: White      PROJECT ID: W-5701B      LOCATION: -Y7- STA. 11+00      DIV: 1

QUANTITY: 1

SYMBOL	X	Y	WID	HT
AR_Type D	37.2	6	6	9

SIGN WIDTH: 4'-6"  
 HEIGHT: 1'-6"  
 TOTAL AREA: 6.8 Sq.Ft.

BORDER TYPE: FLUSH  
 RECESS: 0"  
 WIDTH: 0.75"  
 RADII: 2.25"

NO. Z BARS:  
 LENGTH:

MAT'L: 0.125" (3.2 mm) ALUMINUM

USE NOTES: 1,2

- Legend and border(except those that are colored black) shall be direct applied Grade C sheeting.
- Background shall be Grade C reflective sheeting.
- Shields; A, B, and C type arrows shall be on 0.032" (0.8mm) aluminum and demountable.

Spacing Factor is 1 unless specified otherwise

LETTER POSITIONS

Letter spacings are to start of next letter

Text	Series/Size	Text Length
W i n t o n	D 2000	23.4

FILENAME: W5701B\_SGN\_Des      NORTH CAROLINA D.O.T. SIGN DETAIL

SIGN NUMBER: 317      BACKG COLOR: Green      DESIGN BY: A. TUTT      CHECKED BY: D. SEARS      Jun 02, 2022  
 TYPE: D      COPY COLOR: White      PROJECT ID: W-5701B      LOCATION: -Y7- STA. 9+00      DIV: 1

QUANTITY: 1

SYMBOL	X	Y	WID	HT
AR_Type D	8.5	19.3	6	9
AR_Type D	51.6	4.8	6	9

SIGN WIDTH: 5'-6"  
 HEIGHT: 2'-6"  
 TOTAL AREA: 13.8 Sq.Ft.

BORDER TYPE: FLUSH  
 RECESS: 0"  
 WIDTH: 0.75"  
 RADII: 2.25"

NO. Z BARS:  
 LENGTH:

MAT'L: 0.125" (3.2 mm) ALUMINUM

USE NOTES: 1,2

- Legend and border(except those that are colored black) shall be direct applied Grade C sheeting.
- Background shall be Grade C reflective sheeting.
- Shields; A, B, and C type arrows shall be on 0.032" (0.8mm) aluminum and demountable.

Spacing Factor is 1 unless specified otherwise

LETTER POSITIONS

Letter spacings are to start of next letter

Text	Series/Size	Text Length
A h o s k i e	D 2000	28.2
1 2	D 2000	6.9
O o k C i t y	D 2000	33.5
4 4	D 2000	9.8

FILENAME: W5701B\_SGN\_Des      NORTH CAROLINA D.O.T. SIGN DETAIL

SIGN NUMBER: 317		BACKG. COLOR: Green	
TYPE: D		COPY COLOR: White	
QUANTITY: 1	<b>SYMBOL</b>	<b>X</b>	<b>Y</b>
SIGN WIDTH: 6'-6"	AR_Type D	17.4	19.3
HEIGHT: 2'-6"	AR_Type D	60.5	4.7
TOTAL AREA: 16.3 Sq.Ft.			
<b>BORDER TYPE: FLUSH</b>			
RECESS: 0"			
WIDTH: 0.75"			
RADI: 2.25"			
<b>NO. Z BARS:</b>		<b>MAT'L: 0.125" (3.2 mm) ALUMINUM</b>	
<b>LENGTH:</b>			

DESIGN BY: A. TUTT      CHECKED BY: D. SEARS      Jun 02, 2022  
 PROJECT ID: W-5701B      LOCATION: -L- STA. 186+00      DIV: 1



- USE NOTES: 1,2**
1. Legend and border(except those that are colored black) shall be direct applied Grade C sheeting.
  2. Background shall be Grade C reflective sheeting.
  3. Shields; A, B, and C type arrows shall be on 0.032" (0.8mm) aluminum and demountable.

**LETTER POSITIONS**

Letter spacings are to start of next letter														Series/Size	Text Length	
	A	h	o	s	k	i	e								D	2000
32.4	5.9	4.4	4.3	3.6	4.6	1.9	3.5	17.4								28.2
	M	u	r	f	r	e	e	s	b	o	r	o			D	2000
8.5	5.9	4.7	2.6	2.9	2.8	4.1	4	3.6	4.3	4.6	2.8	3.7	23.5		46.1	

FILENAME: W5701B\_SGN\_Des      NORTH CAROLINA D.O.T. SIGN DETAIL

SIGN NUM: 504,510,515,517,523      BACKG. COLOR: White      DESIGN BY:      CHK BY:      STD #:      N. C. DEPARTMENT OF TRANSPORTATION  
 TYPE: F Ground      COPY COLOR: Black      PROJECT ID:      DIV:      DATE:      DIVISION OF HIGHWAYS  
 QUANTITY: 10      MAT'L: 0.063" ALUMINUM      TRANSPORTATION MOBILITY & SAFETY  
 SIGN WIDTH: 1'-9"      RECESS: 0.38"      DIVISION OF SIGNING & DELINEATION UNIT

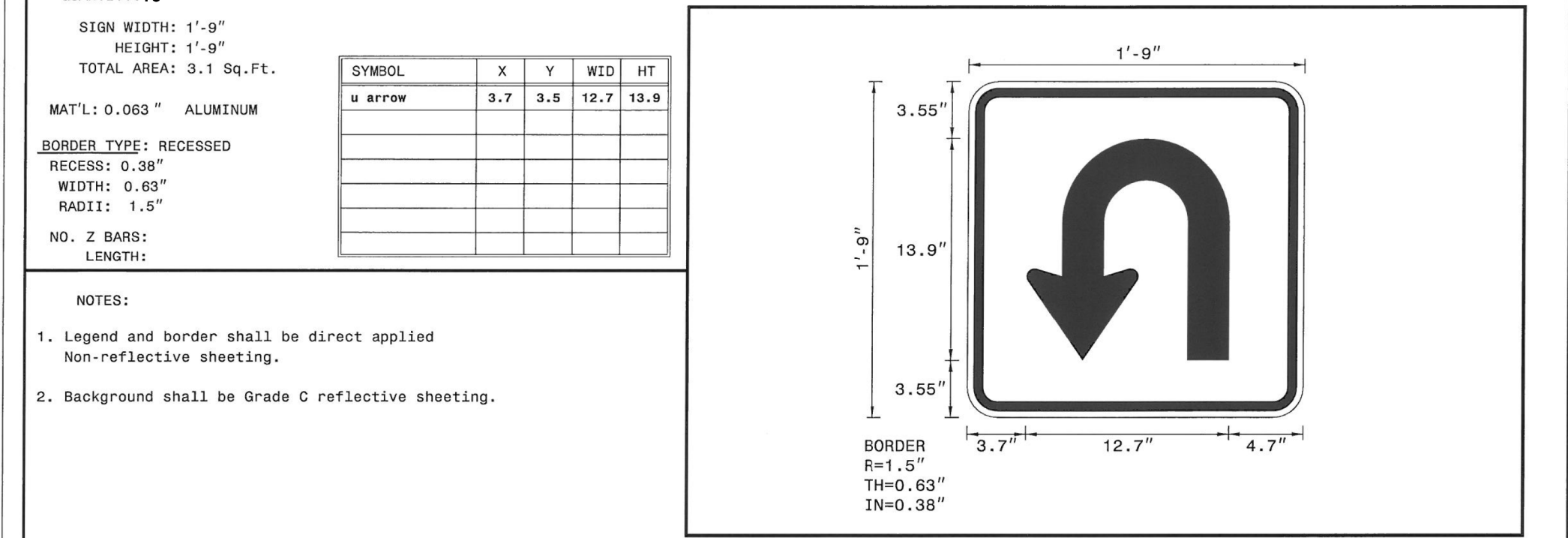

- NOTES:**
1. Legend and border shall be direct applied Non-reflective sheeting.
  2. Background shall be Grade C reflective sheeting.

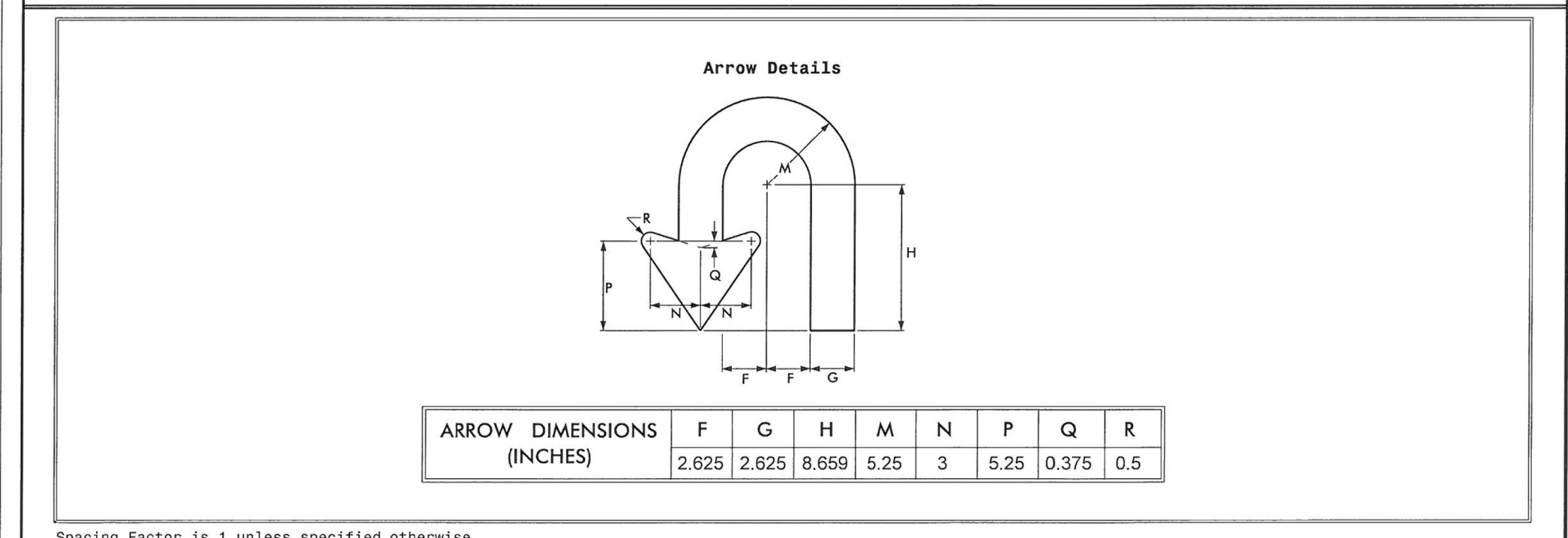

Spacing Factor is 1 unless specified otherwise      FILENAME: GSENG

APPROVED: *David T. Sears*  
 DATE: 1/9/2023

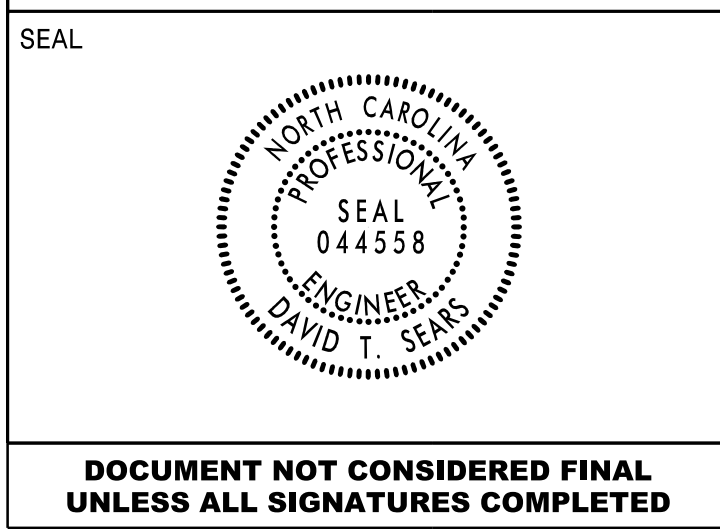

**DOCUMENT NOT CONSIDERED FINAL UNLESS ALL SIGNATURES COMPLETED**

PROJECT REFERENCE NO.	SHEET NO.
W-5701B	SIGN-4
APPROVED: <i>David T. Sears</i>	
DATE: 1/9/2023	
SEAL	
	
<b>DOCUMENT NOT CONSIDERED FINAL UNLESS ALL SIGNATURES COMPLETED</b>	

NAD 83/NA 2011

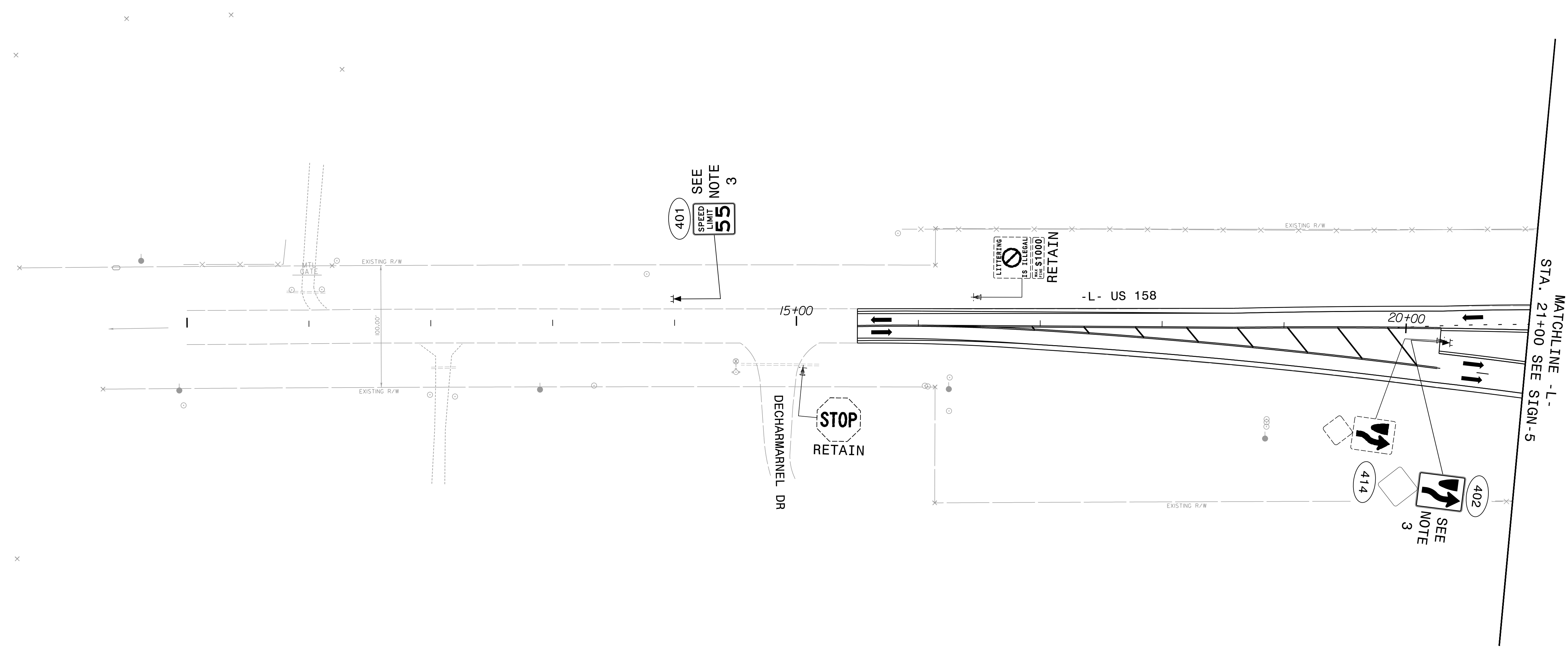

R:\2023\11\11\Signing\CA00\Signing Layout Plans\W5701B\_SGN\_PSH04.dgn  
1/9/2023 11:11:11 AM

**RK&K**  
 P: (919) 878-9560  
 8601 Six Forks Road, Forum 1, Suite 700  
 Raleigh, North Carolina 27615-3960  
 NC License No. F-0112  
 Engineers | Construction Managers | Planners | Scientists  
 www.rkk.com  
 Responsive People | Creative Solutions

- PROJECT NOTES**
- 1 DISPOSAL OF SUPPORT, WOOD
  - 2 DISPOSAL OF SIGN, D, E OR F
  - 3 SIGN ERECTION, TYPE D, E, AND F
  - 4 SIGN ERECTION, RELOCATE SIGN TYPE D
  - 5 DISPOSAL OF FLASHER SYSTEM

**SIGNING PLAN**



**PROJECT NOTES**

- 1 DISPOSAL OF SUPPORT, WOOD
- 2 DISPOSAL OF SIGN, D, E OR F
- 3 SIGN ERECTION, TYPE D, E, AND F
- 4 SIGN ERECTION, RELOCATE SIGN TYPE D
- 5 DISPOSAL OF FLASHER SYSTEM

PROJECT REFERENCE NO. W-5701B	SHEET NO. SIGN-6
APPROVED: <i>David J. Sears</i> 1/9/2023	
DATE: 1/9/2023	
SEAL 	
DOCUMENT NOT CONSIDERED FINAL UNLESS ALL SIGNATURES COMPLETED	

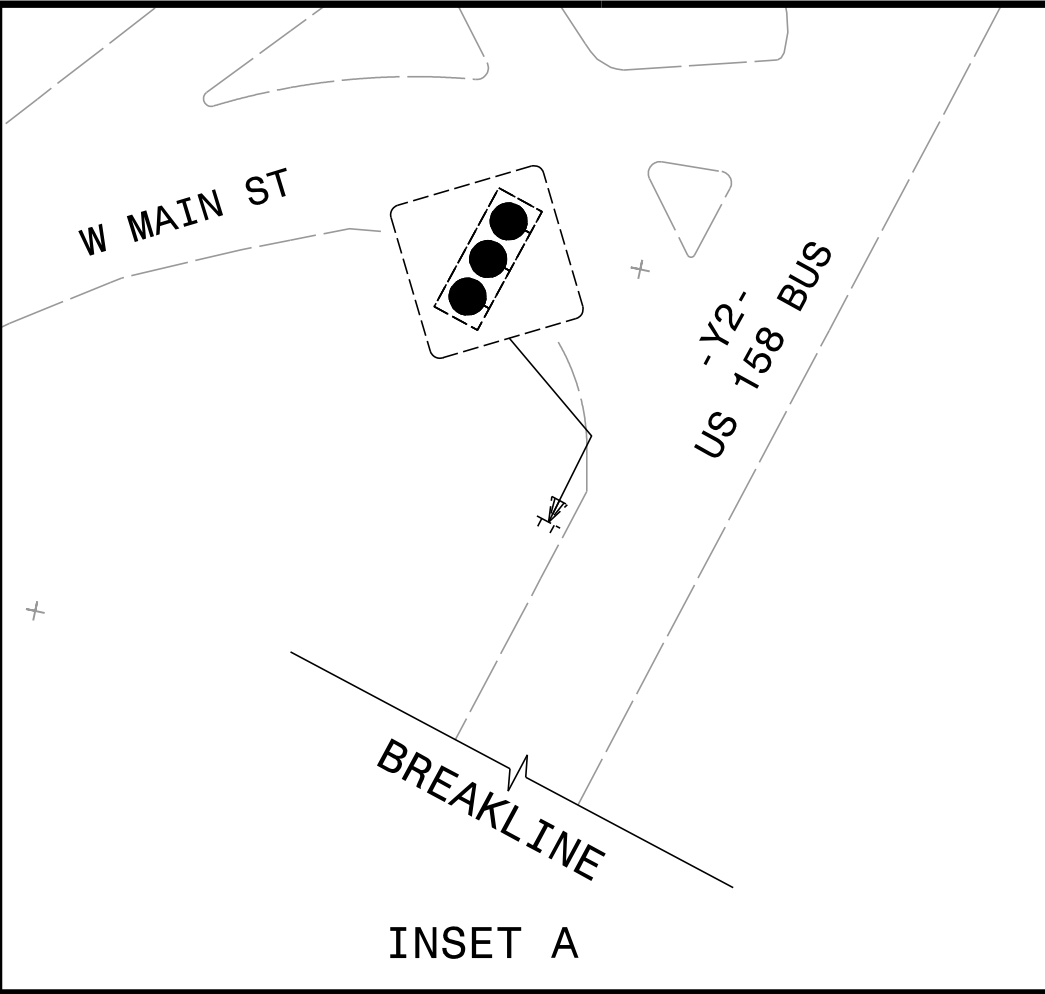

MAD 83NA 2011

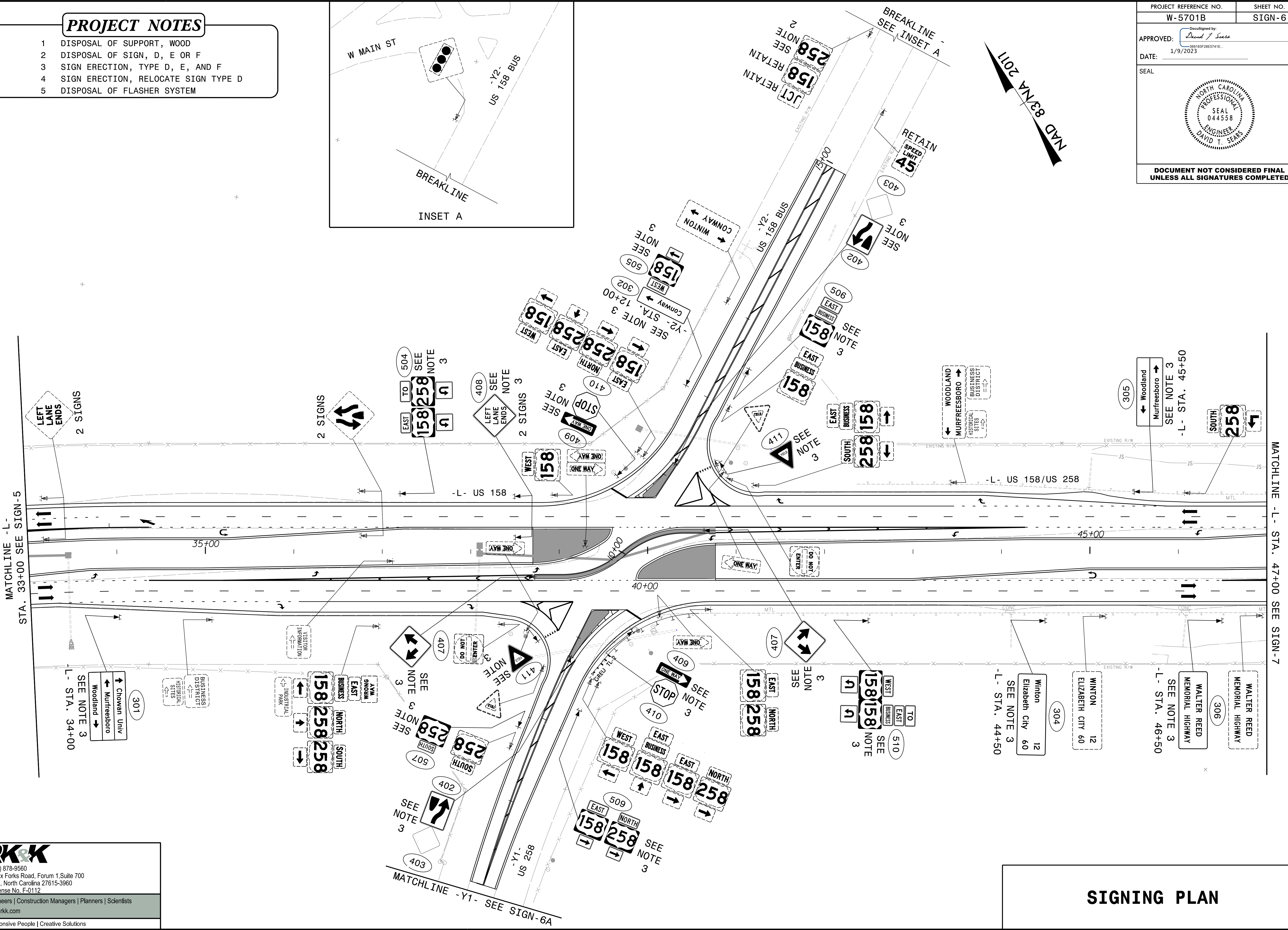

R:\2023\11\11\Signing\CADD\Signing Layout Plans\K5701B\_SGN\_PSH06.dgn

**RK&K**  
 P: (919) 878-9560  
 8601 Six Forks Road, Forum 1, Suite 700  
 Raleigh, North Carolina 27615-3960  
 NC License No. F-0112  
 Engineers | Construction Managers | Planners | Scientists  
 www.rkk.com  
 Responsive People | Creative Solutions

**SIGNING PLAN**

NAD 83/NA 2011

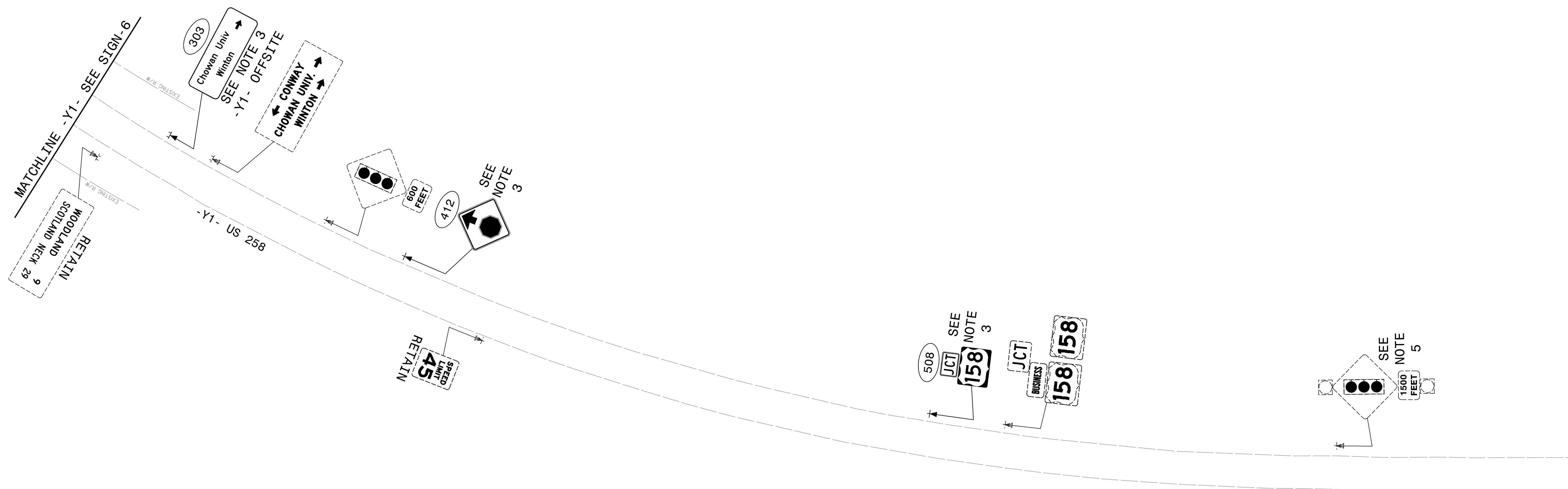

**PROJECT NOTES**

- 1 DISPOSAL OF SUPPORT, WOOD
- 2 DISPOSAL OF SIGN, D, E OR F
- 3 SIGN ERECTION, TYPE D, E, AND F
- 4 SIGN ERECTION, RELOCATE SIGN TYPE D
- 5 DISPOSAL OF FLASHER SYSTEM

**SIGNING PLAN**

01/09/23 11:35:01 AM P:\SH06A.dgn

MAD 831A 2011

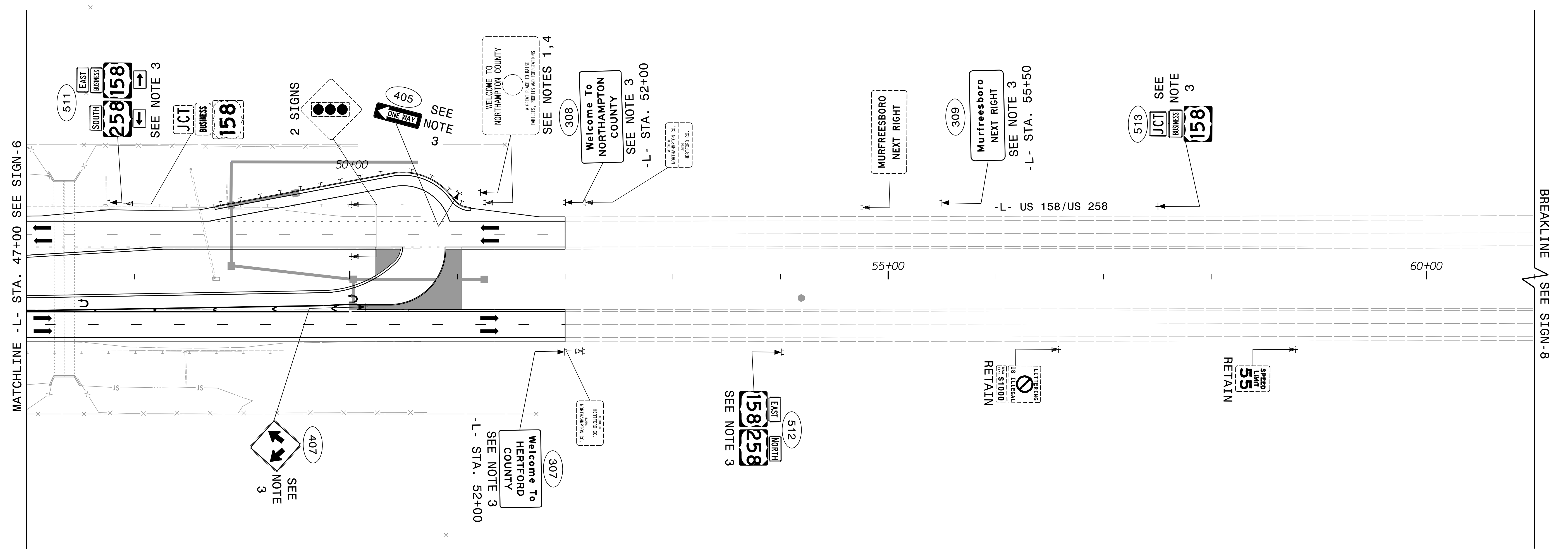

**PROJECT NOTES**

- 1 DISPOSAL OF SUPPORT, WOOD
- 2 DISPOSAL OF SIGN, D, E OR F
- 3 SIGN ERECTION, TYPE D, E, AND F
- 4 SIGN ERECTION, RELOCATE SIGN TYPE D
- 5 DISPOSAL OF FLASHER SYSTEM

**SIGNING PLAN**

K:\2023\Traffic\Signing\CADD\Signing Layout Plans\K5701B\_SGN\_PSH07.dgn



P: (919) 878-9560  
 8601 Six Forks Road, Forum 1, Suite 700  
 Raleigh, North Carolina 27615-3960  
 NC License No. F-0112  
 Engineers | Construction Managers | Planners | Scientists  
 www.rkk.com  
 Responsive People | Creative Solutions

PROJECT REFERENCE NO.	SHEET NO.
W-5701B	SIGN-8
APPROVED: <i>David T. Sears</i> 1/9/2023	
DATE: 1/9/2023	
SEAL	
	
<b>DOCUMENT NOT CONSIDERED FINAL UNLESS ALL SIGNATURES COMPLETED</b>	

NAD 83/NA 2011

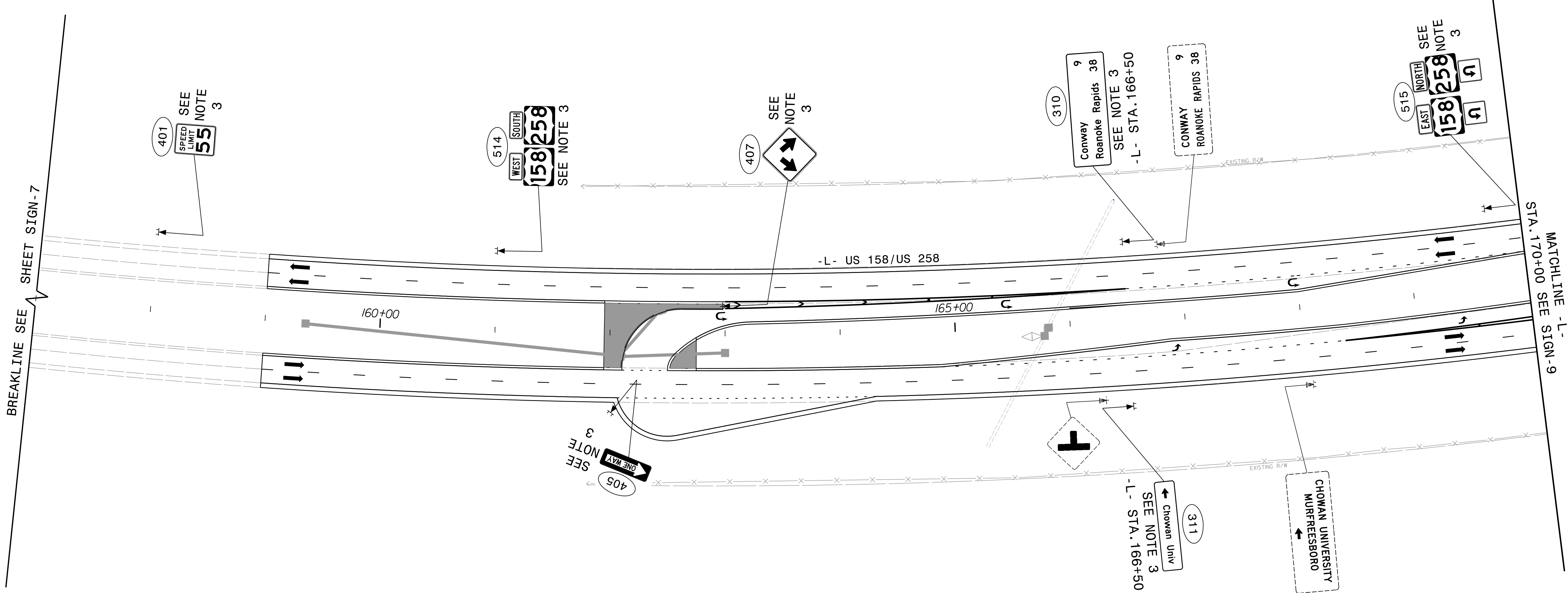

**PROJECT NOTES**

- 1 DISPOSAL OF SUPPORT, WOOD
- 2 DISPOSAL OF SIGN, D, E OR F
- 3 SIGN ERECTION, TYPE D, E, AND F
- 4 SIGN ERECTION, RELOCATE SIGN TYPE D
- 5 DISPOSAL OF FLASHER SYSTEM

**SIGNING PLAN**



P: (919) 878-9560  
 8601 Six Forks Road, Forum 1, Suite 700  
 Raleigh, North Carolina 27615-3960  
 NC License No. F-0112

Engineers | Construction Managers | Planners | Scientists  
 www.rkk.com

Responsive People | Creative Solutions

R:\2023\231111\Signing\CADD\Signing\_Layout\_Plans\K5701B\_SGN\_PSH08.dgn





DOCUMENT NOT CONSIDERED FINAL  
UNLESS ALL SIGNATURES COMPLETED

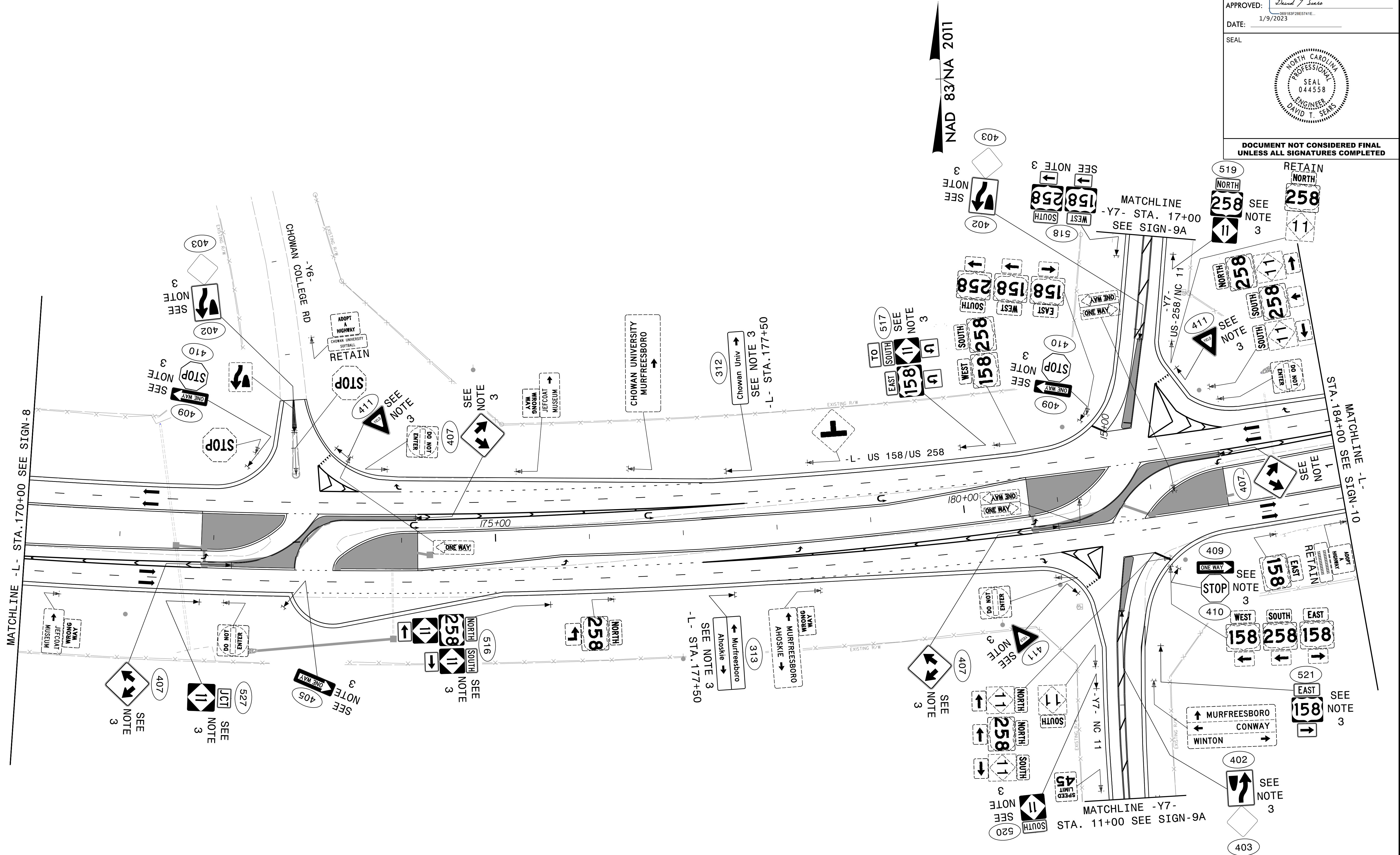

**RK&K**  
P: (919) 878-9560  
8601 Six Forks Road, Forum 1, Suite 700  
Raleigh, North Carolina 27615-3960  
NC License No. F-0112  
Engineers | Construction Managers | Planners | Scientists  
www.rkk.com  
Responsive People | Creative Solutions

- | PROJECT NOTES |                                     |
|---------------|-------------------------------------|
| 1             | DISPOSAL OF SUPPORT, WOOD           |
| 2             | DISPOSAL OF SIGN, D, E OR F         |
| 3             | SIGN ERECTION, TYPE D, E, AND F     |
| 4             | SIGN ERECTION, RELOCATE SIGN TYPE D |
| 5             | DISPOSAL OF FLASHER SYSTEM          |

# SIGNING PLAN

R:\2023\11\11\11\Signing\CA000\Signing Layout Plans\K5701B\_SGN\_PSH09.dgn

NAD 83/NA 2011

NAD 83/NA 2011

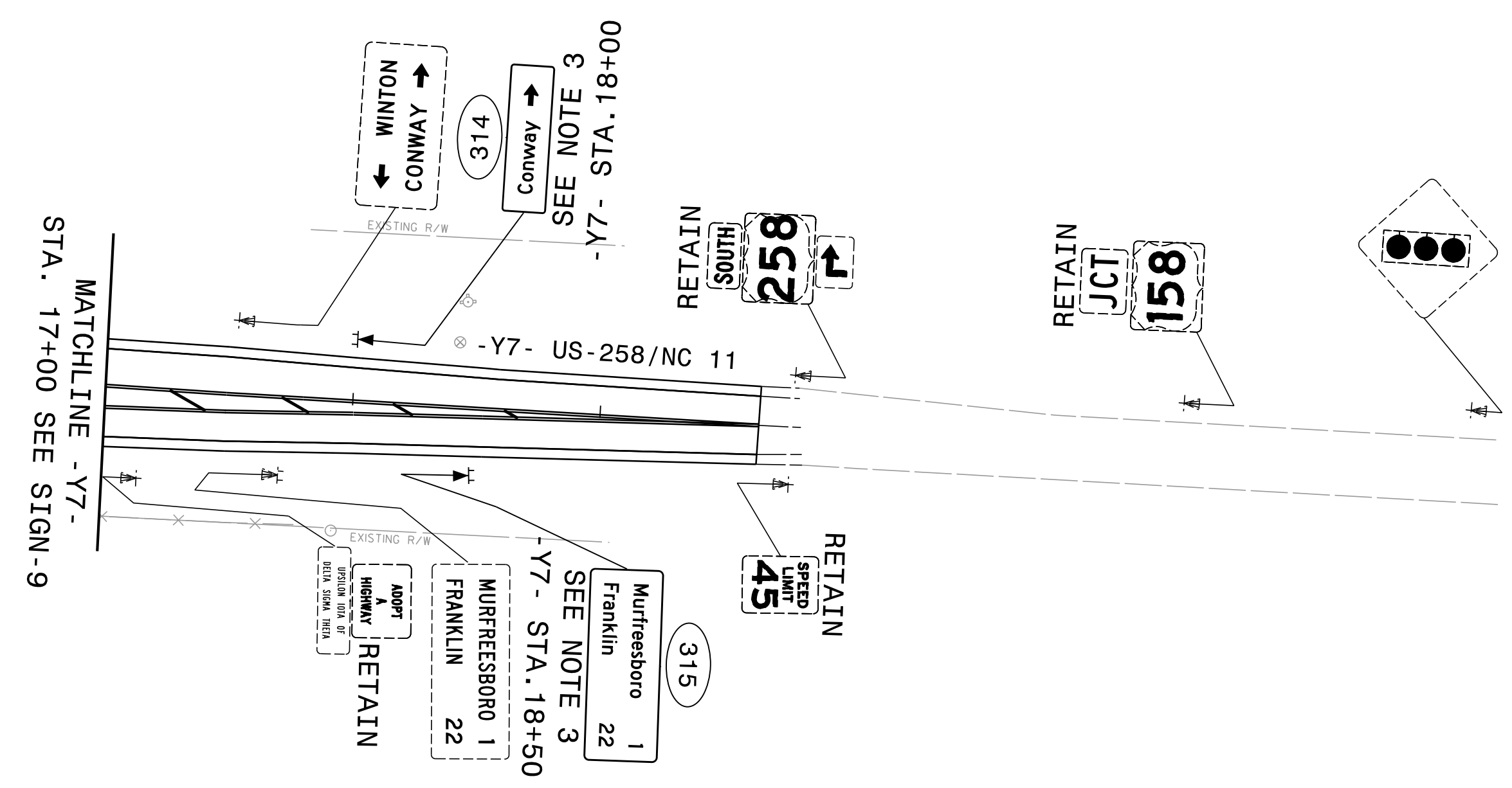
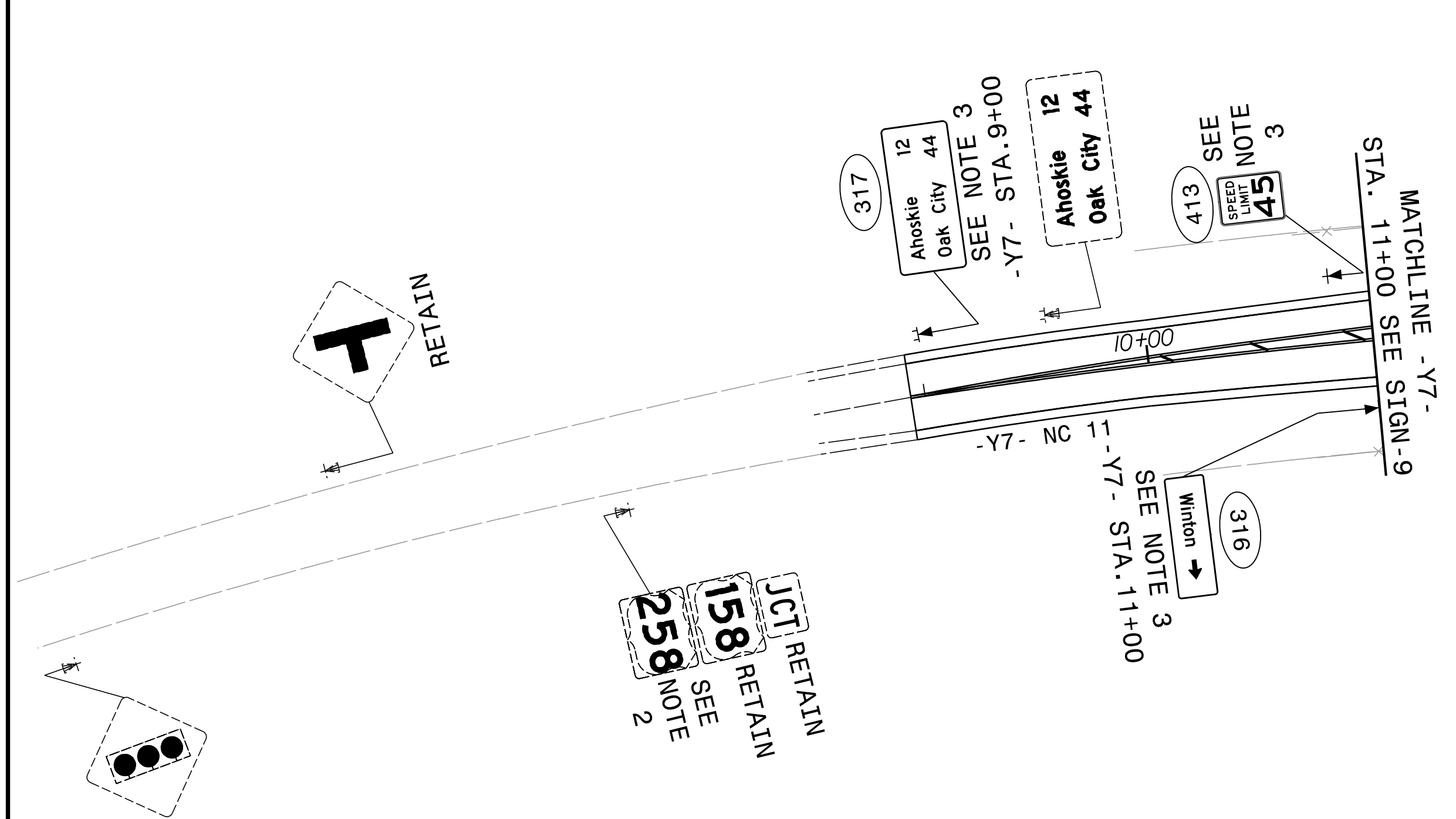

- PROJECT NOTES**
- 1 DISPOSAL OF SUPPORT, WOOD
  - 2 DISPOSAL OF SIGN, D, E OR F
  - 3 SIGN ERECTION, TYPE D, E, AND F
  - 4 SIGN ERECTION, RELOCATE SIGN TYPE D
  - 5 DISPOSAL OF FLASHER SYSTEM

**SIGNING PLAN**

PROJECT REFERENCE NO. <b>W-5701B</b>	SHEET NO. <b>SIGN-10</b>
APPROVED: <i>David T. Sears</i> <small>069183F28E5741E...</small>	
DATE: 1/9/2023	
SEAL	
	
<b>DOCUMENT NOT CONSIDERED FINAL UNLESS ALL SIGNATURES COMPLETED</b>	

NAD 83/NA 2011

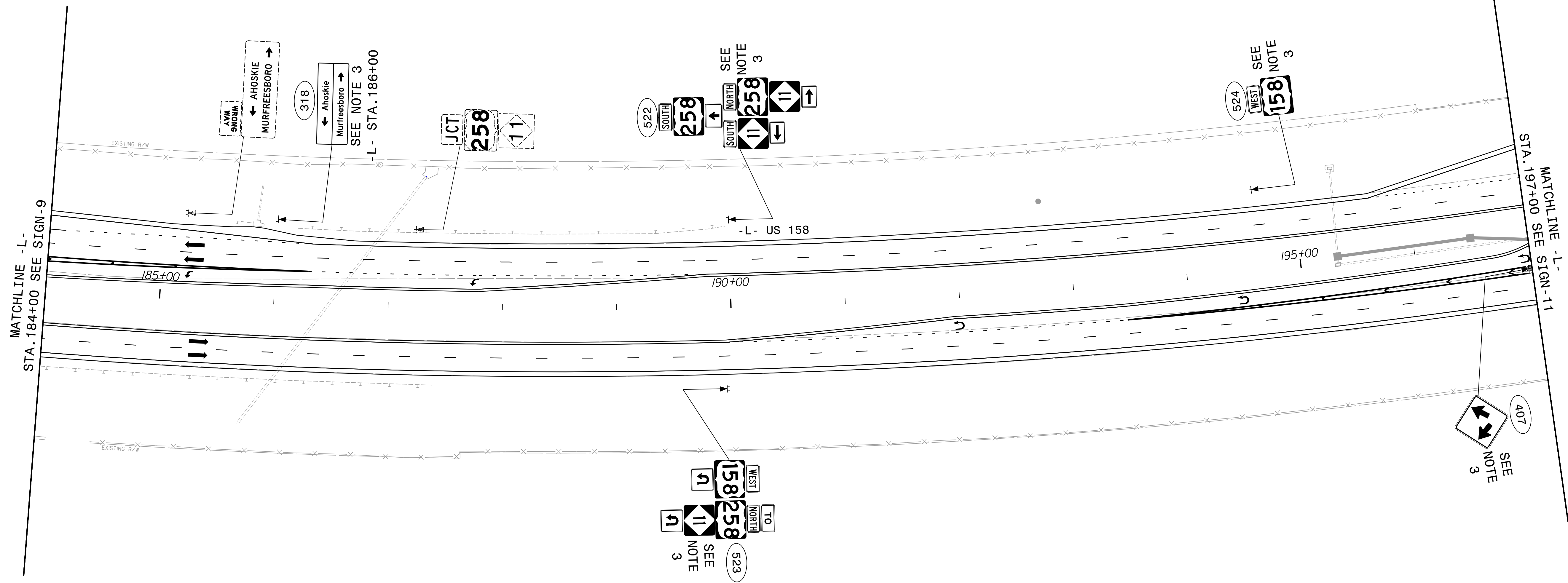



**PROJECT NOTES**

- 1 DISPOSAL OF SUPPORT, WOOD
- 2 DISPOSAL OF SIGN, D, E OR F
- 3 SIGN ERECTION, TYPE D, E, AND F
- 4 SIGN ERECTION, RELOCATE SIGN TYPE D
- 5 DISPOSAL OF FLASHER SYSTEM

**SIGNING PLAN**

K:\2023\Traffic\Signing\CADD\Signing\_Layout\_Plans\K5701B\_SGN\_PSH010.dgn  
 1/9/2023 11:11:11 AM  
 dksears

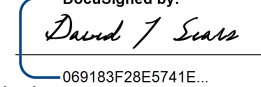
**RK&K**  
 P: (919) 878-9560  
 8601 Six Forks Road, Forum 1, Suite 700  
 Raleigh, North Carolina 27615-3960  
 NC License No. F-0112  
 Engineers | Construction Managers | Planners | Scientists  
 www.rkk.com  
 Responsive People | Creative Solutions

PROJECT REFERENCE NO.	SHEET NO.
W-5701B	SIGN-11
APPROVED: 	
DATE: 1/9/2023	
SEAL	
	
<b>DOCUMENT NOT CONSIDERED FINAL UNLESS ALL SIGNATURES COMPLETED</b>	

NAD 83/NA 2011

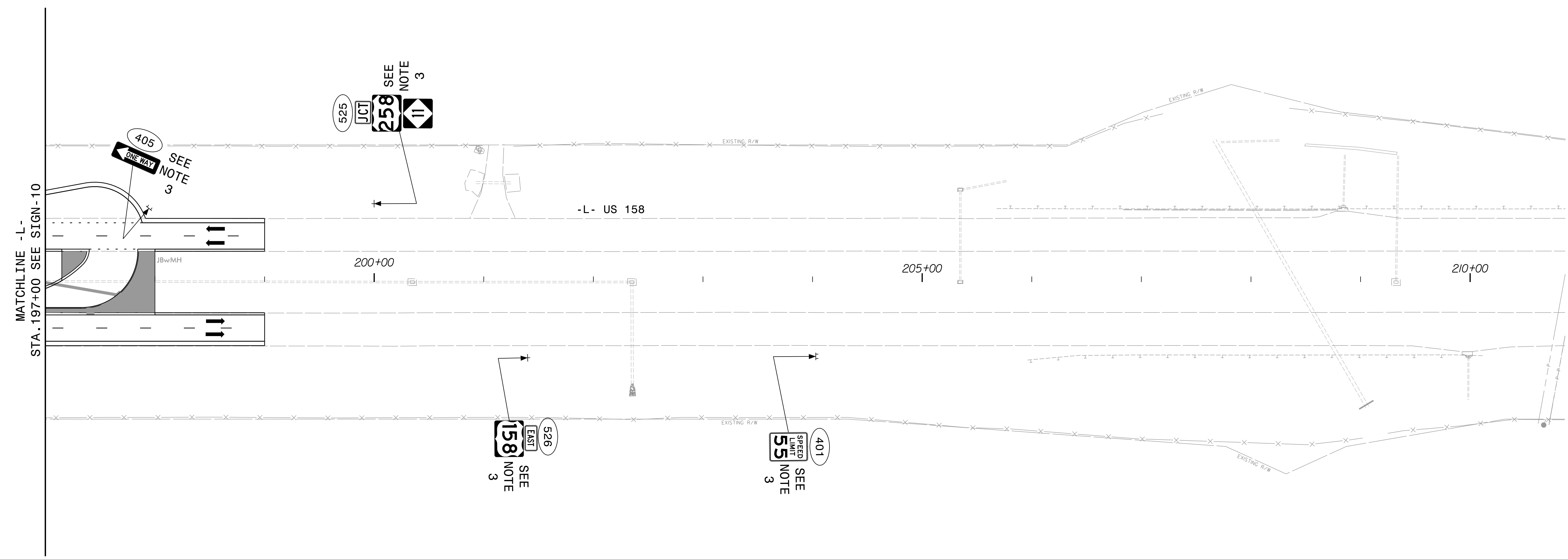

R:\2023\Projects\11c\Signing\CA00\Signing Layout Plans\K5701B\_SGN\_PSH011.dgn

**RK&K**  
P: (919) 878-9560  
8601 Six Forks Road, Forum 1, Suite 700  
Raleigh, North Carolina 27615-3960  
NC License No. F-0112

Engineers | Construction Managers | Planners | Scientists  
www.rkk.com

Responsive People | Creative Solutions

- PROJECT NOTES**
- 1 DISPOSAL OF SUPPORT, WOOD
  - 2 DISPOSAL OF SIGN, D, E OR F
  - 3 SIGN ERECTION, TYPE D, E, AND F
  - 4 SIGN ERECTION, RELOCATE SIGN TYPE D
  - 5 DISPOSAL OF FLASHER SYSTEM

SIGNING PLAN