

**This electronic collection of documents is provided
for the convenience of the user
and is Not a Certified Document –**

**The documents contained herein were originally issued
and sealed by the individuals whose names and license
numbers appear on each page, on the dates appearing
with their signature on that page.**

**This file or an individual page
shall not be considered a certified document.**

8/23/99

INCOMPLETE PLANS
DO NOT USE FOR R/W ACQUISITION

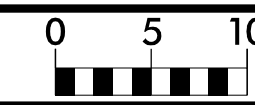

PROJ. REFERENCE NO.
BR-0070

SHEET NO.
X-2

150 140 130 120 110 100 90 80 70 60 50 40 30 20 10 0 10 20 30 40 50 60 70 80 90 100 110 120 130 140 150

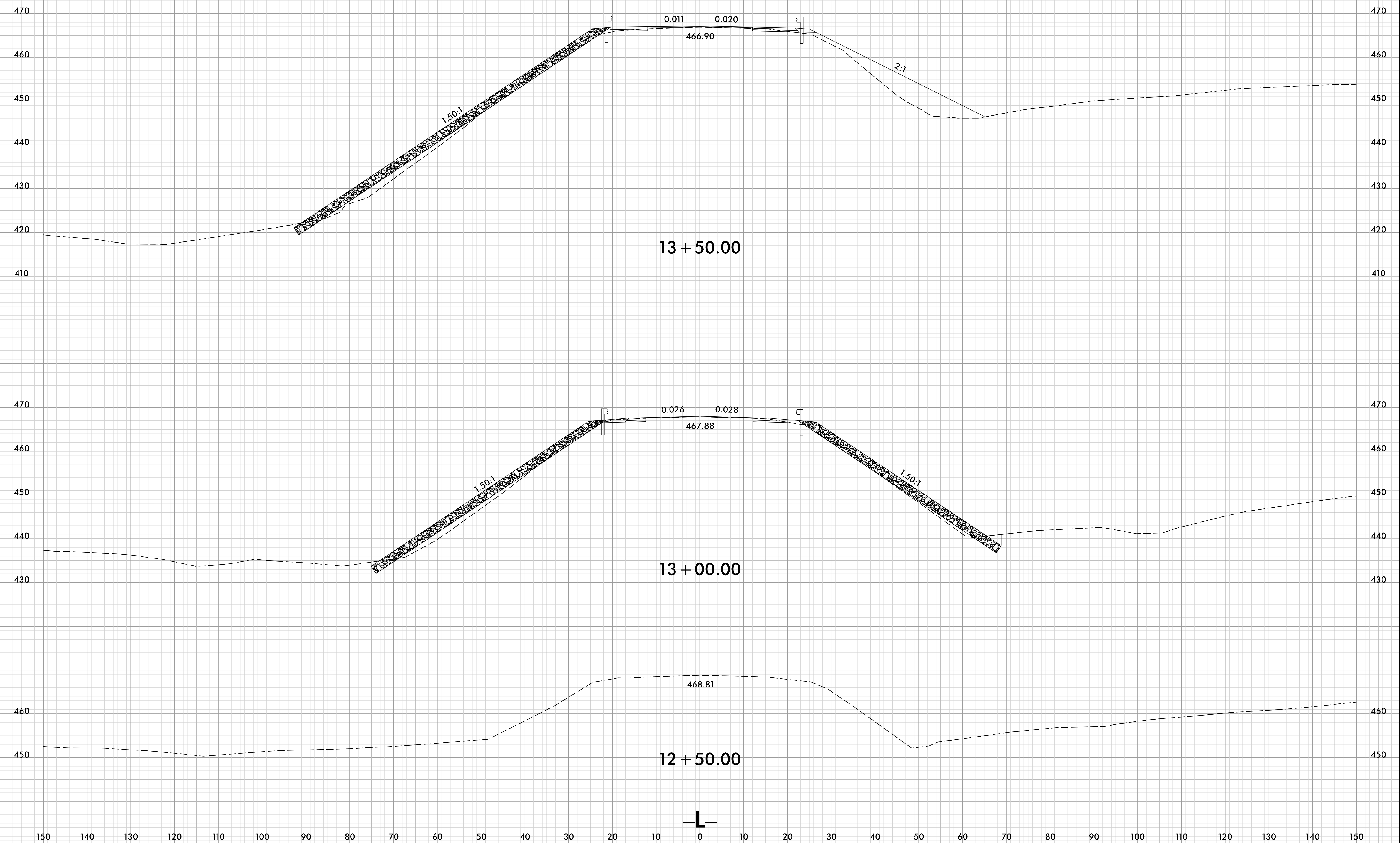

13 + 50.00

13 + 00.00

12 + 50.00

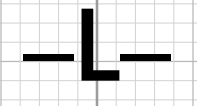

9/27/2022
J:\S:\BR0070_Rdwy_xpl.L.dgn
JSE/rdw

8/23/99

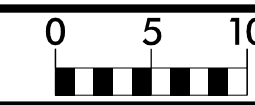

PROJ. REFERENCE NO.	SHEET NO.
BR-0070	X-3

150 140 130 120 110 100 90 80 70 60 50 40 30 20 10 0 10 20 30 40 50 60 70 80 90 100 110 120 130 140 150

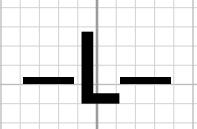
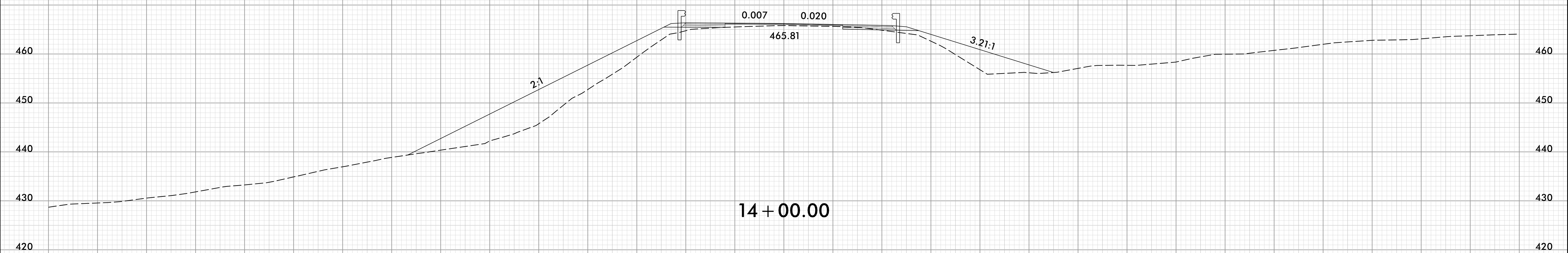
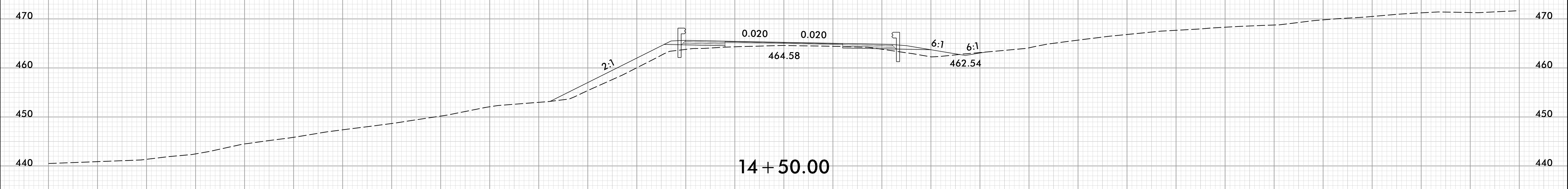
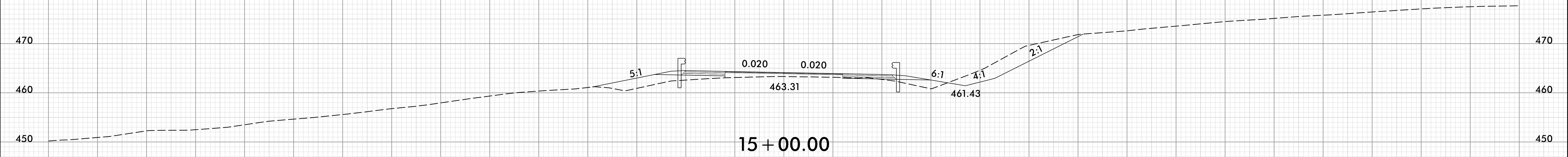

150 140 130 120 110 100 90 80 70 60 50 40 30 20 10 0 10 20 30 40 50 60 70 80 90 100 110 120 130 140 150

9/27/2022
 J:\S:\BR0070_Rdy_xpl.L.dgn
 J:\S\BR0070

8/23/99

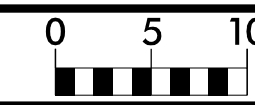

PROJ. REFERENCE NO.	SHEET NO.
BR-0070	X-4

150 140 130 120 110 100 90 80 70 60 50 40 30 20 10 0 10 20 30 40 50 60 70 80 90 100 110 120 130 140 150

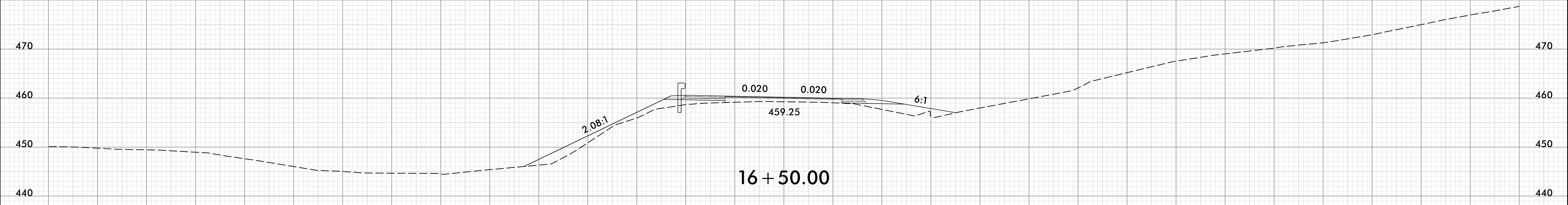

16 + 50.00

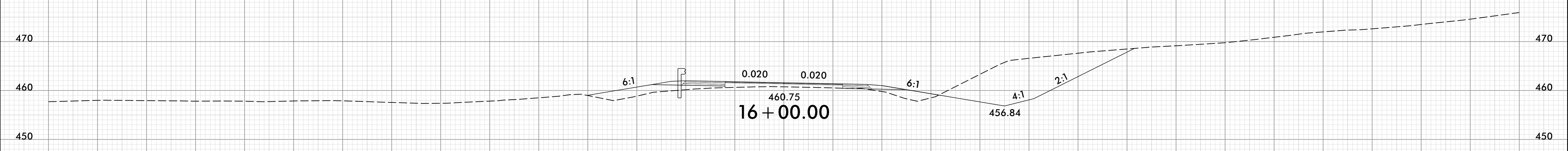

16 + 00.00

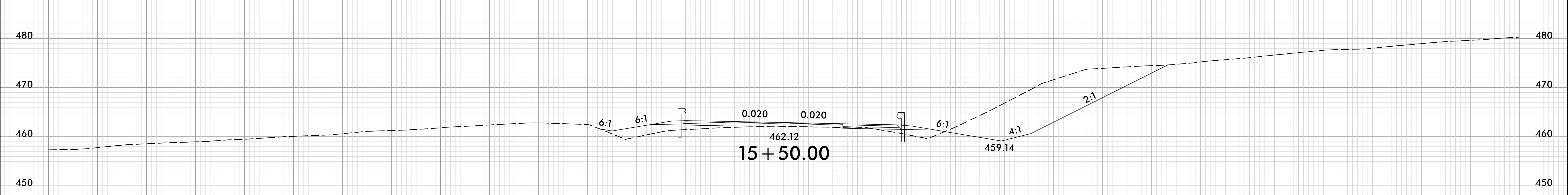

15 + 50.00

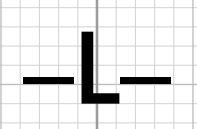

9/27/2002
J:\PROJECTS\BR0070_Rdy_xpl.L.dgn
J:\E:\RDM

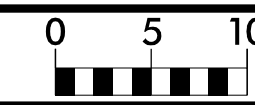

150 140 130 120 110 100 90 80 70 60 50 40 30 20 10 0 10 20 30 40 50 60 70 80 90 100 110 120 130 140 150

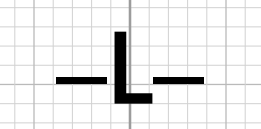
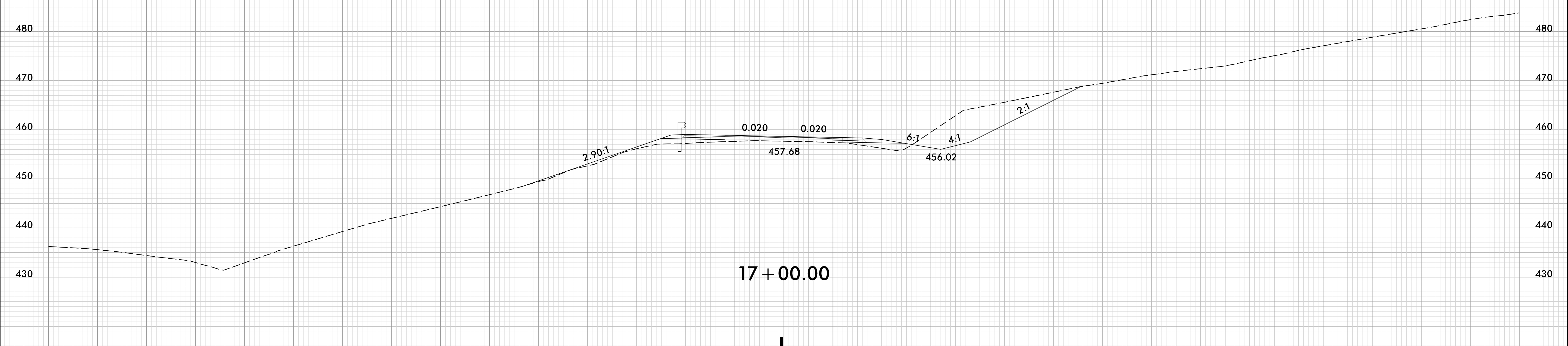
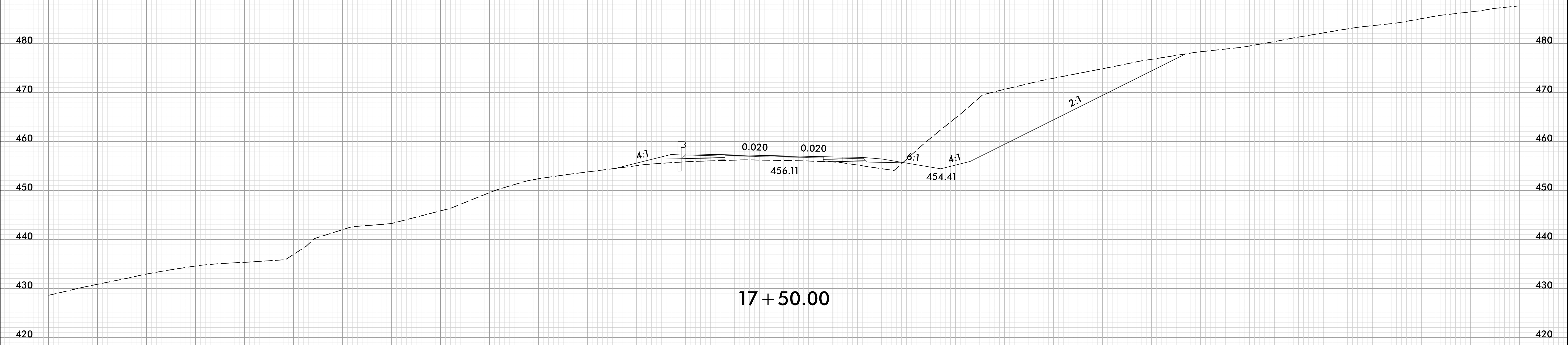

8/23/99

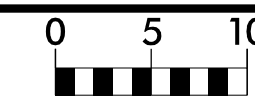

PROJ. REFERENCE NO.
BR-0070

SHEET NO.
X-6

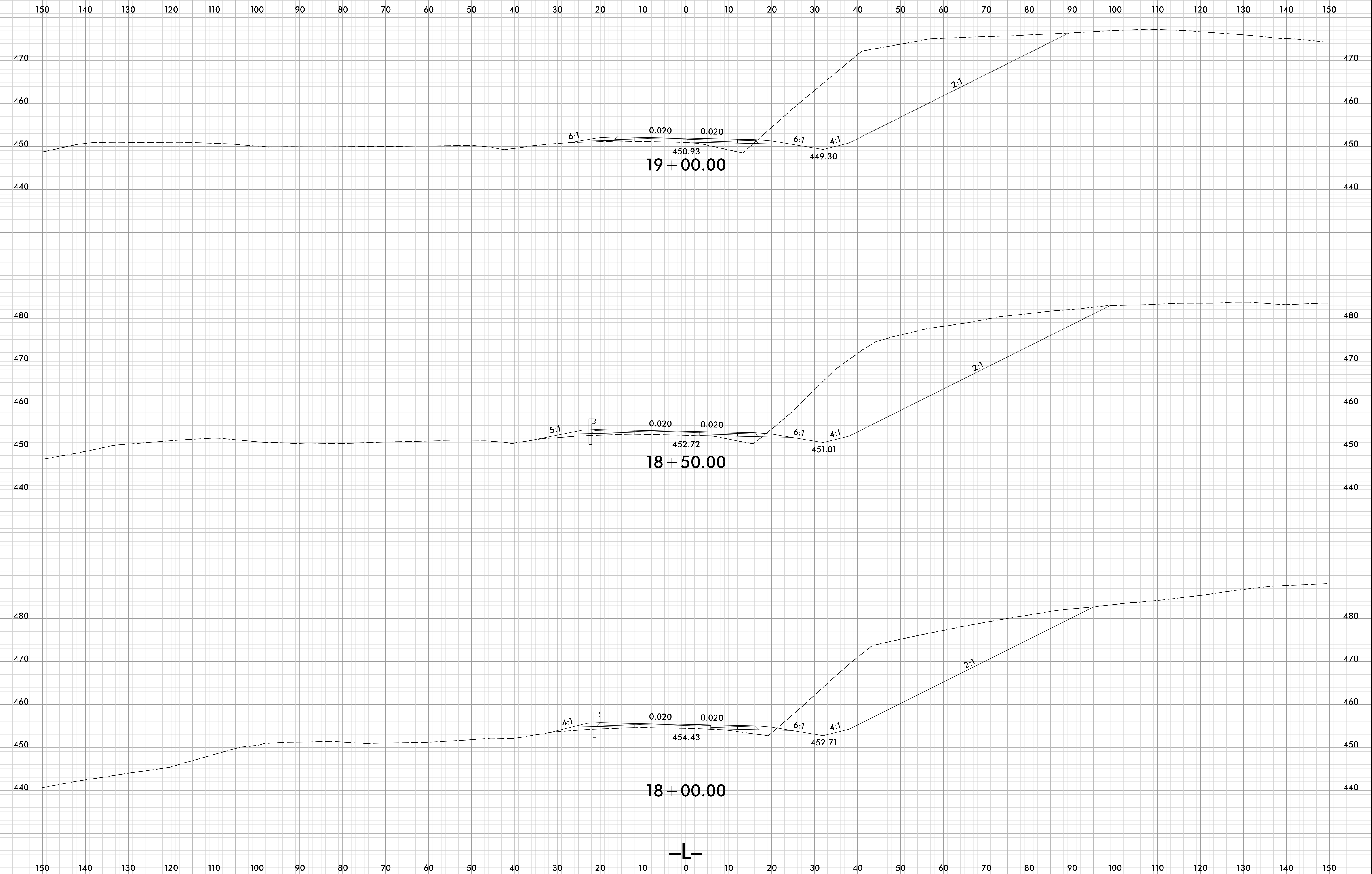

9/27/2002
J:\S:\BR0070_RdJ_xpl.L.dgn
J:\S\BR0070

8/23/99

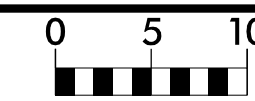

PROJ. REFERENCE NO.
BR-0070

SHEET NO.
X-7

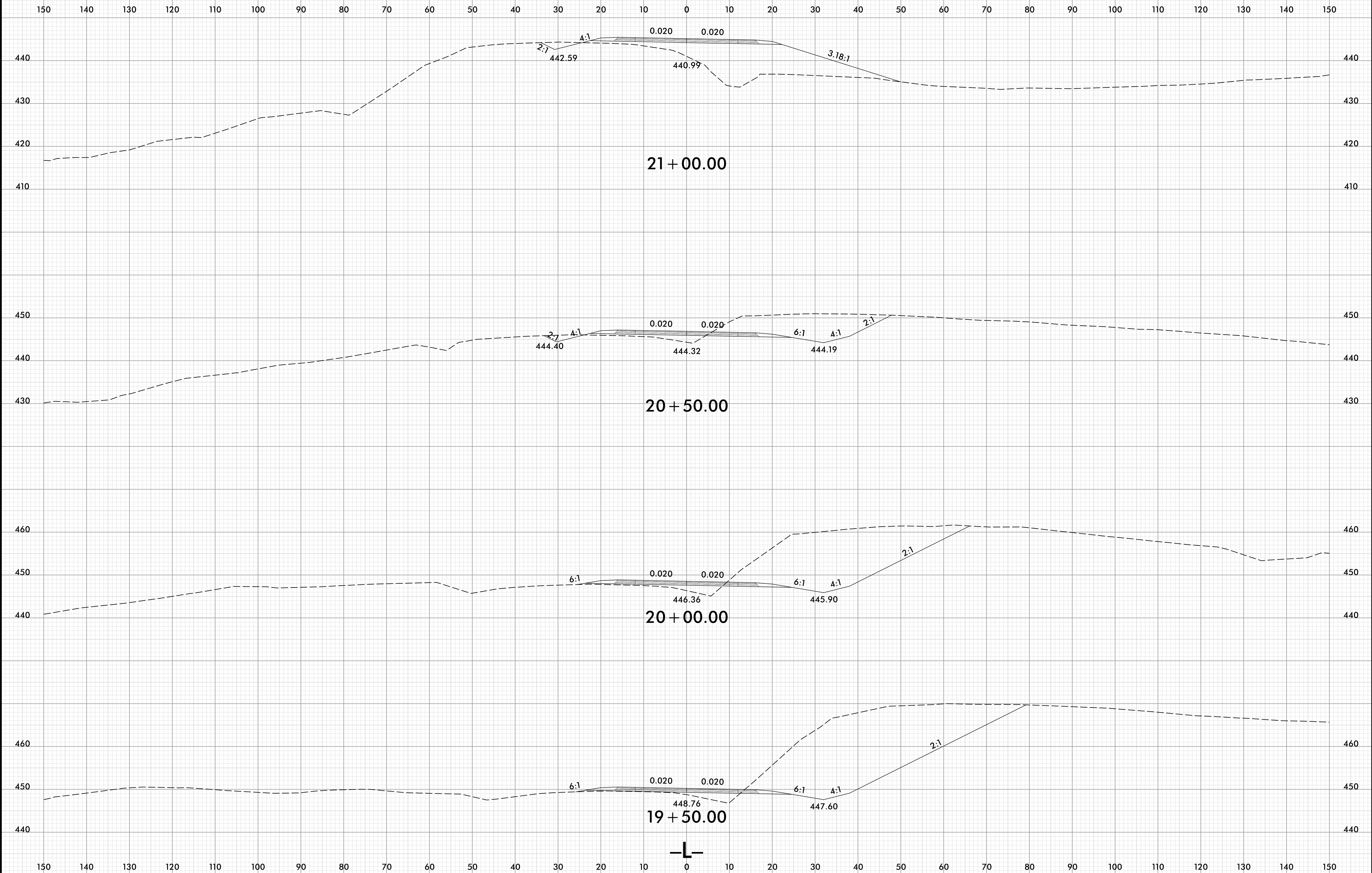

9/27/2002
J:\S:\BR0070_Rdy_xpl.L.dgn
J:\S\BR0070

8/23/99

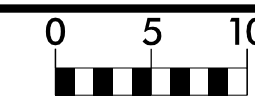

PROJ. REFERENCE NO.
BR-0070

SHEET NO.
X-8

150 140 130 120 110 100 90 80 70 60 50 40 30 20 10 0 10 20 30 40 50 60 70 80 90 100 110 120 130 140 150

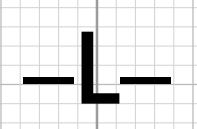
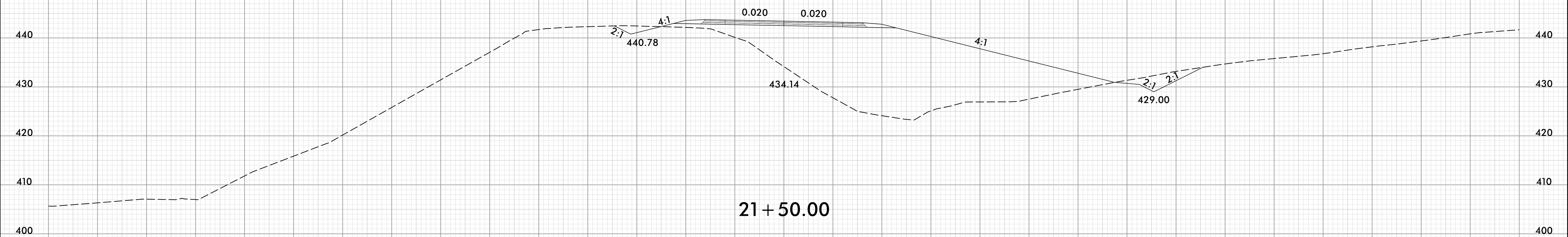
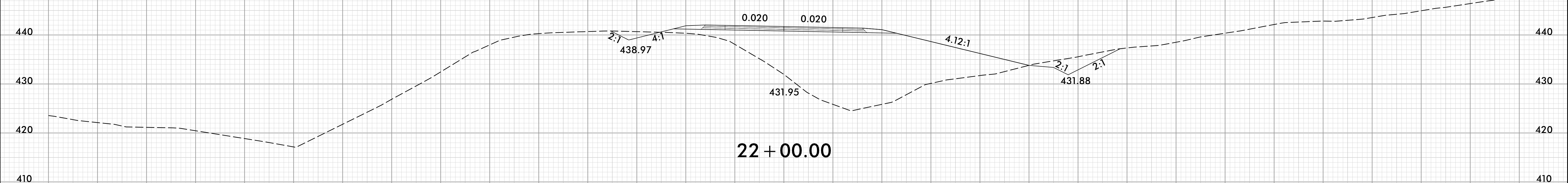
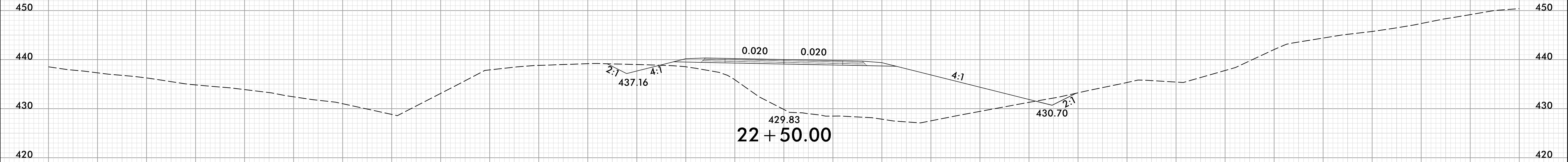

9/27/2022
J:\S\BR0070_Rdy_xpl.L.dgn
JUS:RDM

8/23/99

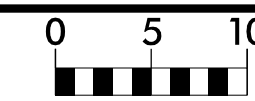

PROJ. REFERENCE NO.	SHEET NO.
BR-0070	X-9

150 140 130 120 110 100 90 80 70 60 50 40 30 20 10 0 10 20 30 40 50 60 70 80 90 100 110 120 130 140 150

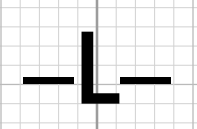
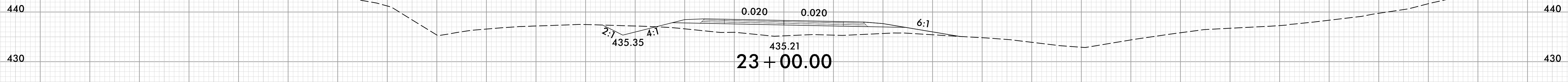
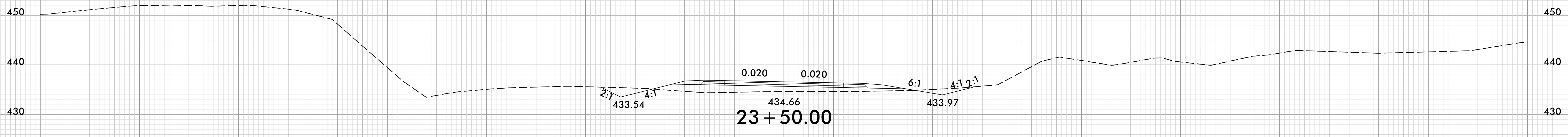
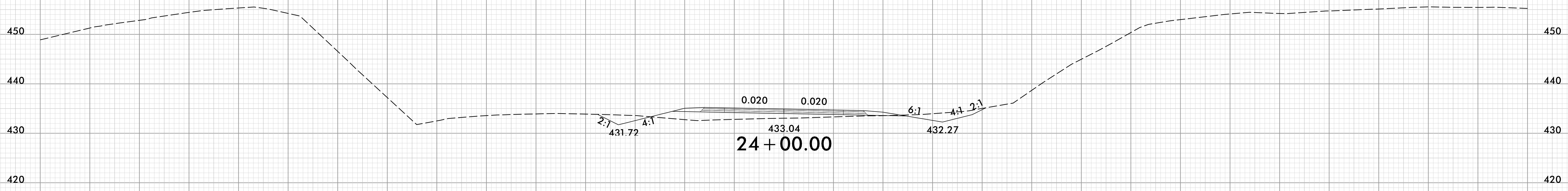

150 140 130 120 110 100 90 80 70 60 50 40 30 20 10 0 10 20 30 40 50 60 70 80 90 100 110 120 130 140 150

9/27/2022
J:\S\BR0070_RdJ_xpl.L.dgn
J:\S\BR0070

8/23/99

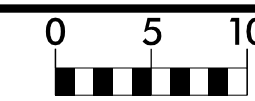

PROJ. REFERENCE NO.
BR-0070

SHEET NO.
X-10

150 140 130 120 110 100 90 80 70 60 50 40 30 20 10 0 10 20 30 40 50 60 70 80 90 100 110 120 130 140 150

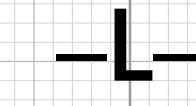
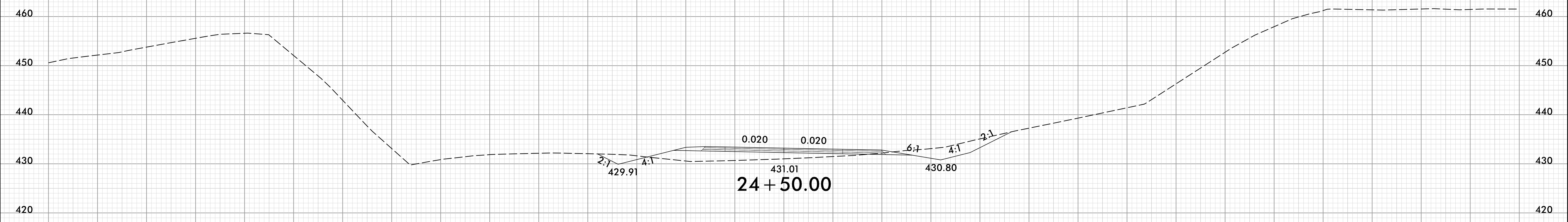
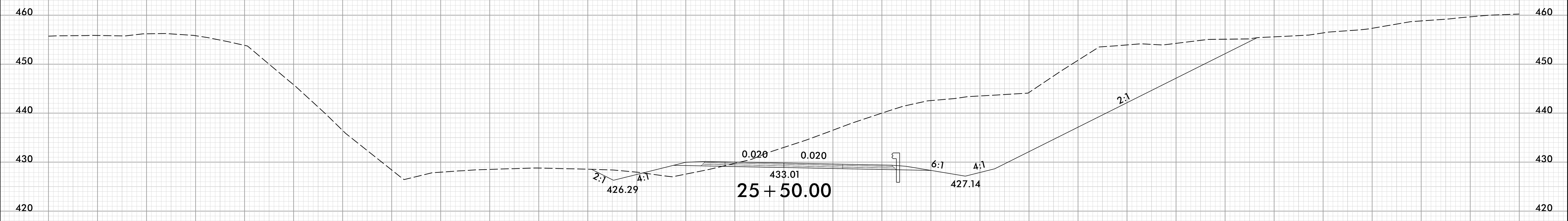

150 140 130 120 110 100 90 80 70 60 50 40 30 20 10 0 10 20 30 40 50 60 70 80 90 100 110 120 130 140 150

9/27/2022
J:\S:\BR0070_Rdwy_xpl.L.dgn
J:\S\BR0070

8/23/99

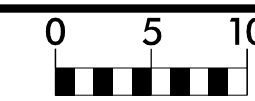

PROJ. REFERENCE NO.	SHEET NO.
BR-0070	X-11

150 140 130 120 110 100 90 80 70 60 50 40 30 20 10 0 10 20 30 40 50 60 70 80 90 100 110 120 130 140 150

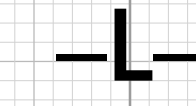
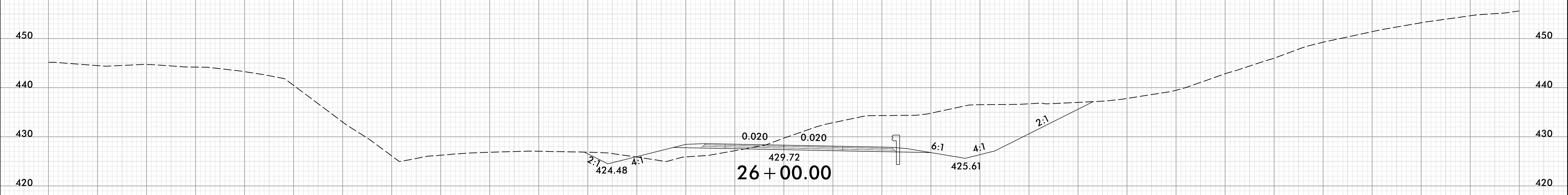
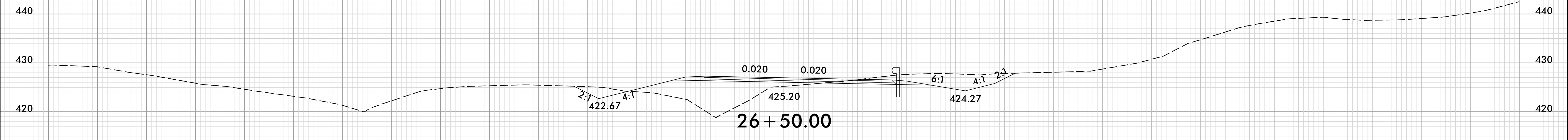
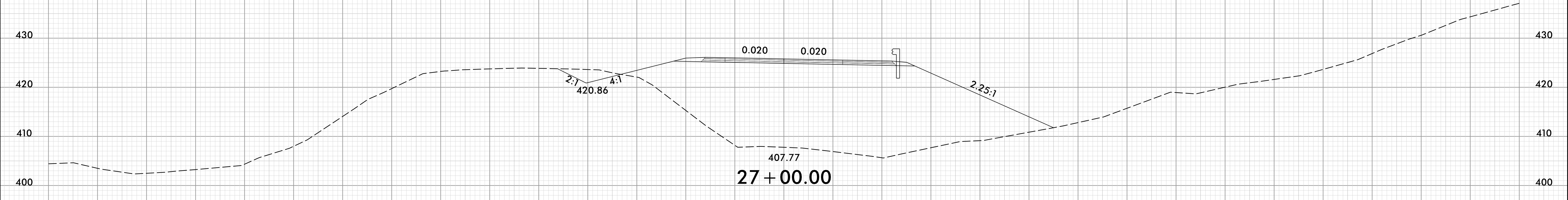

150 140 130 120 110 100 90 80 70 60 50 40 30 20 10 0 10 20 30 40 50 60 70 80 90 100 110 120 130 140 150

9/27/2022
 J:\S\BR0070_Rdy_xpl.L.dgn
 J:\S\BR0070

8/23/99

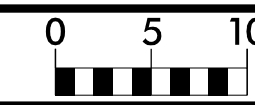

PROJ. REFERENCE NO.	SHEET NO.
BR-0070	X-12

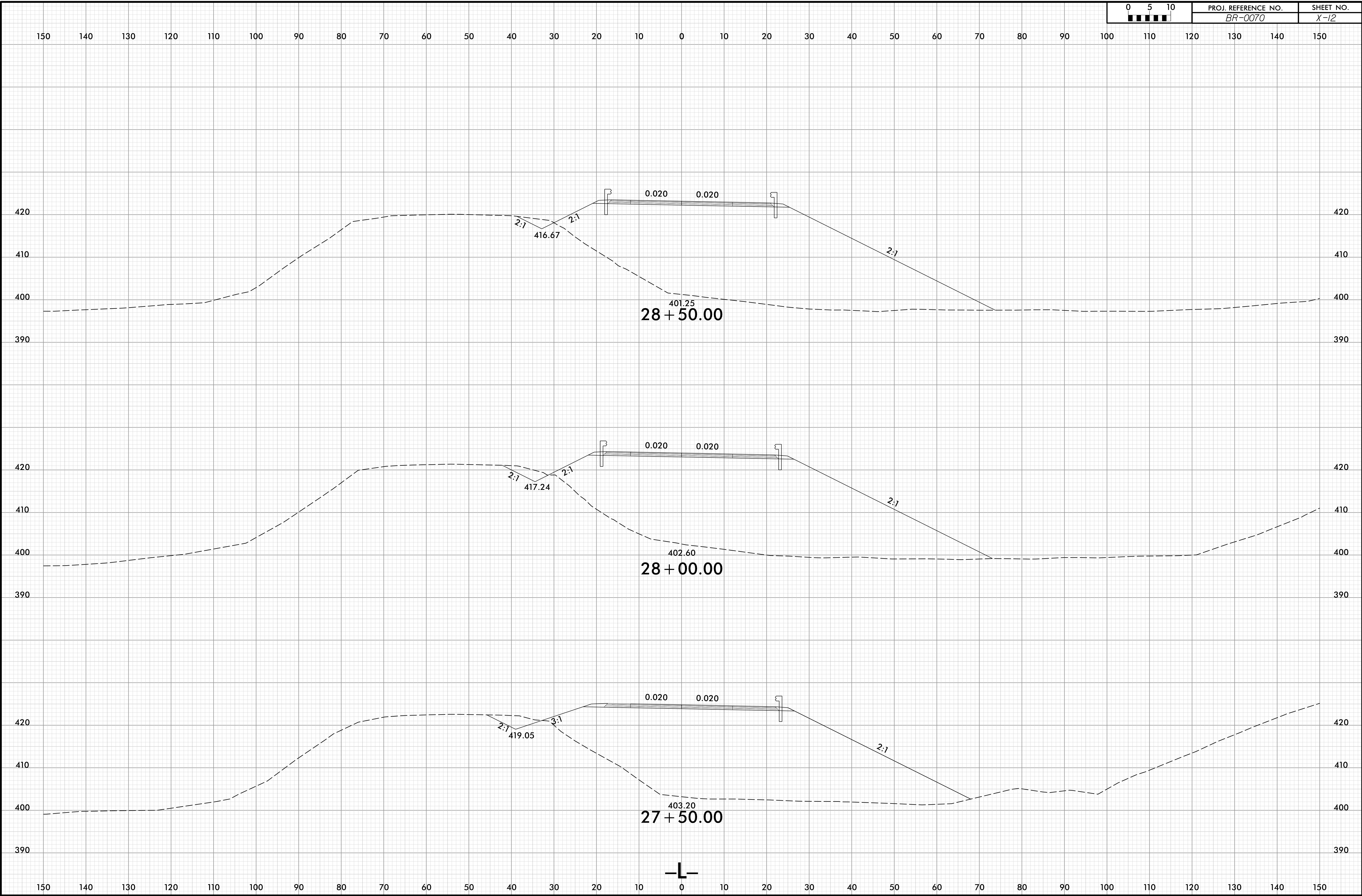

9/27/2022
J:\S:\BR0070_RdJxp1.L.dgn
J:\S\BR0070

8/23/99

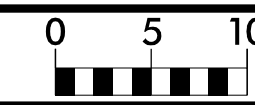

PROJ. REFERENCE NO.
BR-0070

SHEET NO.
X-13

150 140 130 120 110 100 90 80 70 60 50 40 30 20 10 0 10 20 30 40 50 60 70 80 90 100 110 120 130 140 150

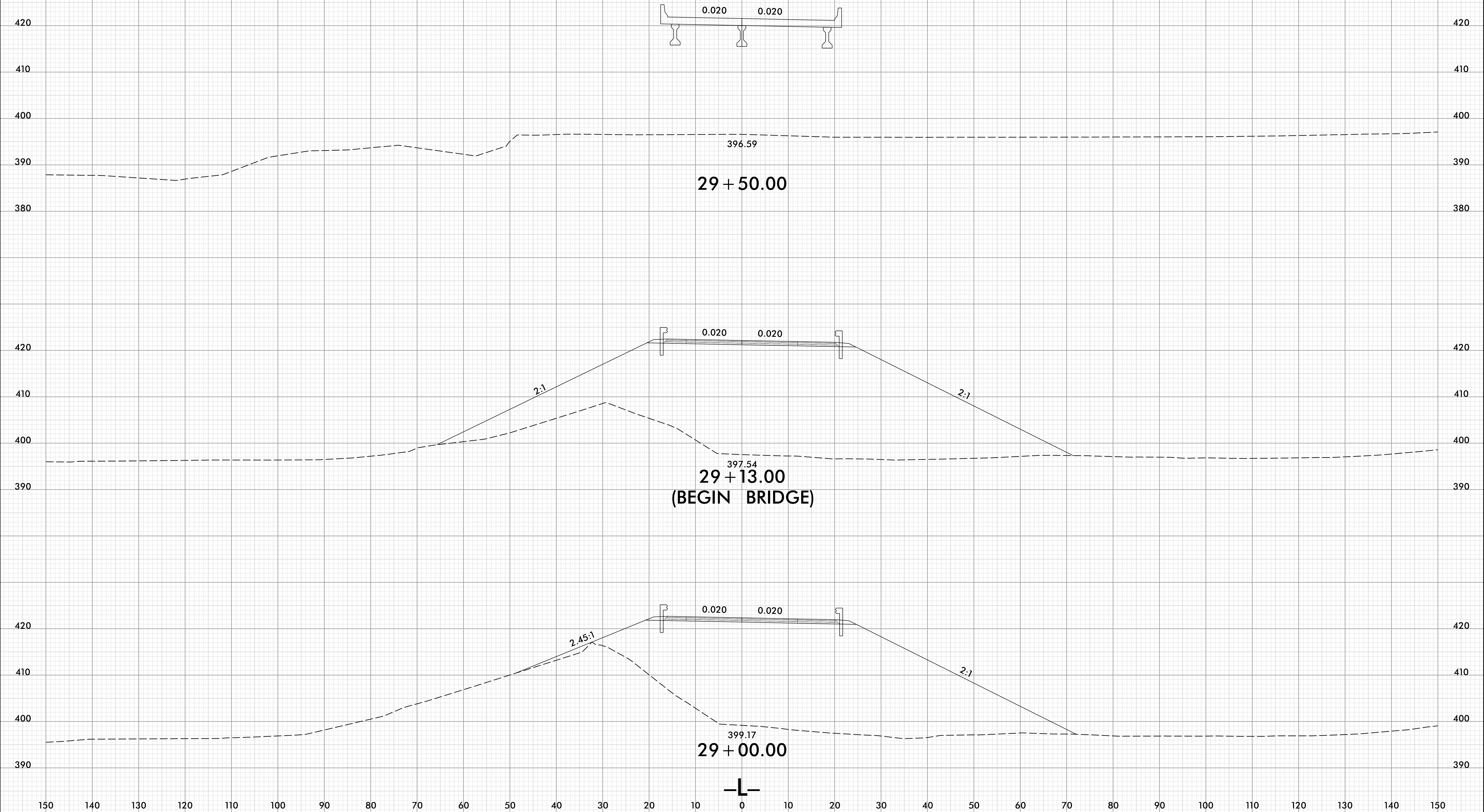

29 + 50.00

29 + 13.00
(BEGIN BRIDGE)

29 + 00.00

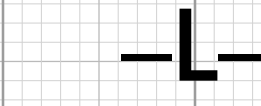

9/27/2002
J:\S:\BR0070_Rdy_xpl.L.dgn
J:\S\BR0070

8/23/99

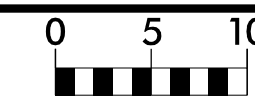

PROJ. REFERENCE NO.	SHEET NO.
BR-0070	X-14

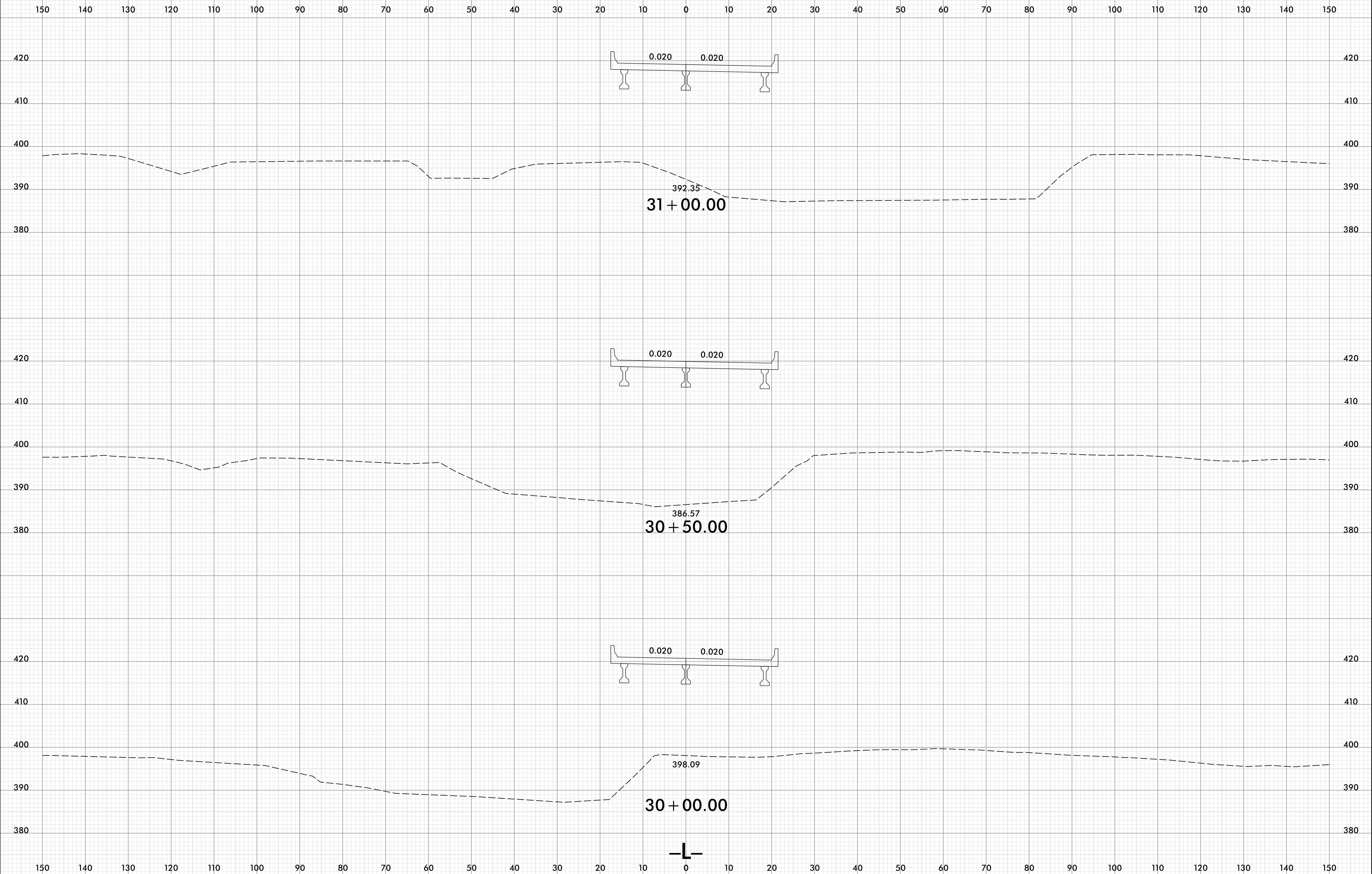

9/27/2002
J:\S\BR0070_Rdy_xpl.L.dgn
JUS:RDM

8/23/99

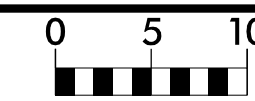

PROJ. REFERENCE NO. BR-0070	SHEET NO. X-15
--------------------------------	-------------------

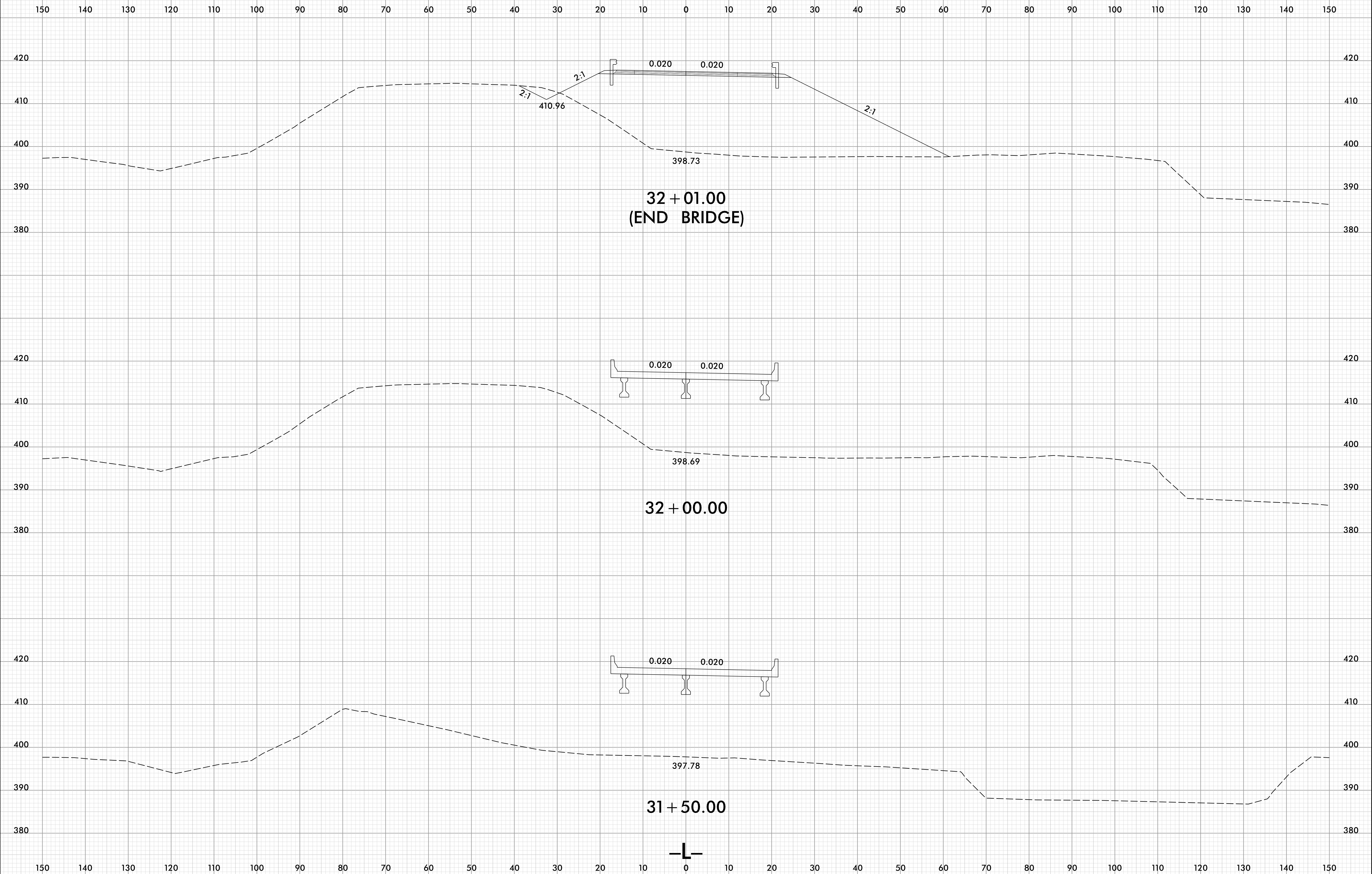

32 + 01.00
(END BRIDGE)

32 + 00.00

31 + 50.00

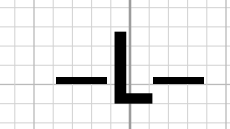

9/27/2002
J:\S\BR0070_Rdy_xpl.L.dgn
J:\S\BR0070

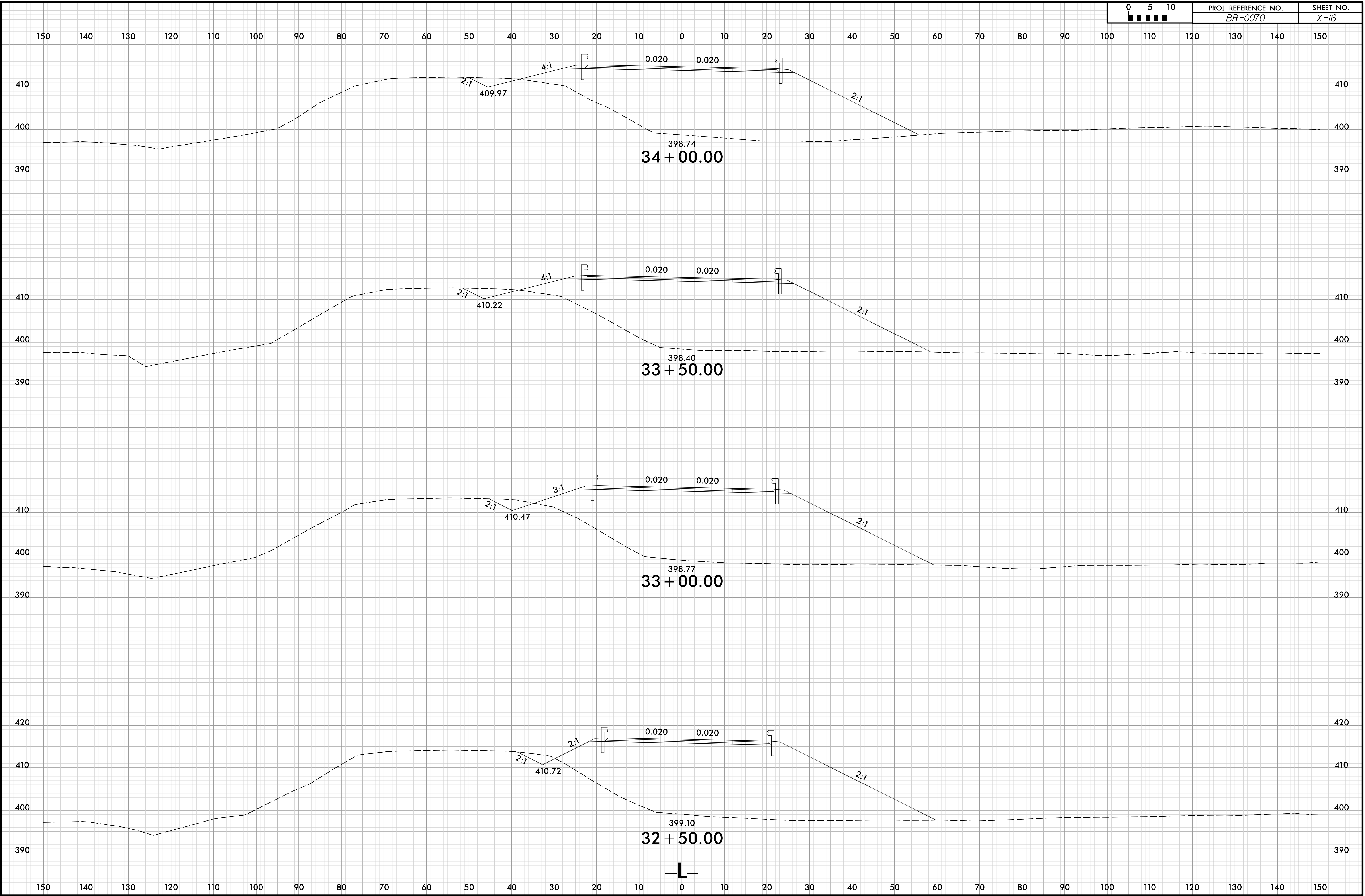
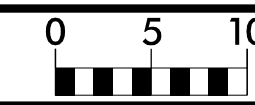

8/23/99

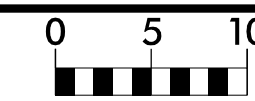

PROJ. REFERENCE NO.
BR-0070

SHEET NO.
X-17

150 140 130 120 110 100 90 80 70 60 50 40 30 20 10 0 10 20 30 40 50 60 70 80 90 100 110 120 130 140 150

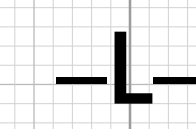
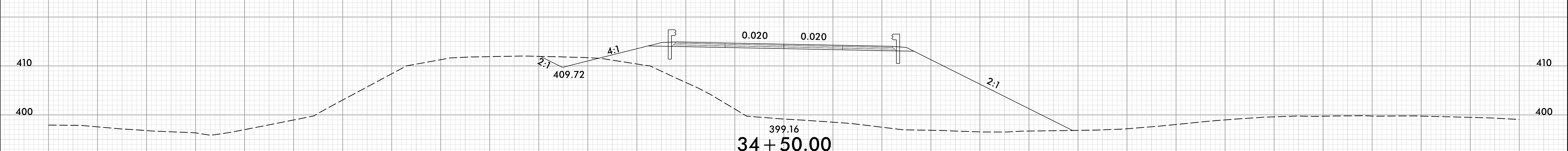
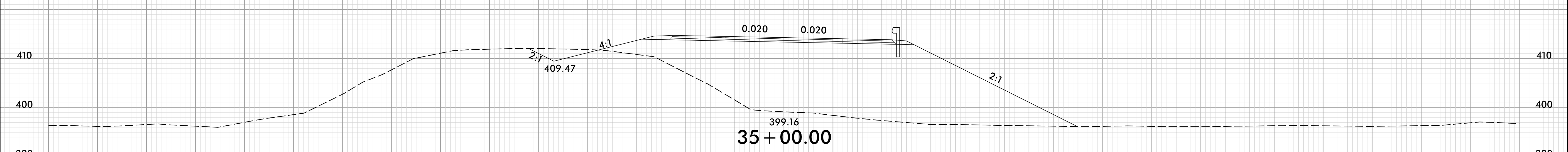
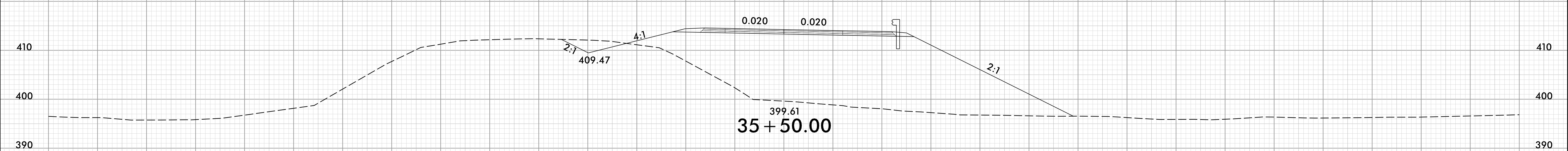
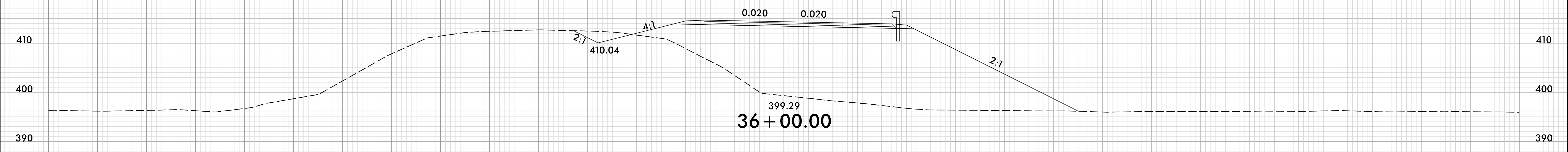

150 140 130 120 110 100 90 80 70 60 50 40 30 20 10 0 10 20 30 40 50 60 70 80 90 100 110 120 130 140 150

9/27/2022
J:\PROJECTS\BR0070_Rdwy_xpl.L.dgn
JUS:ELG:RWS

8/23/99

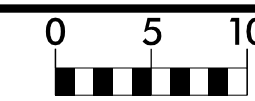

PROJ. REFERENCE NO.	SHEET NO.
BR-0070	X-18

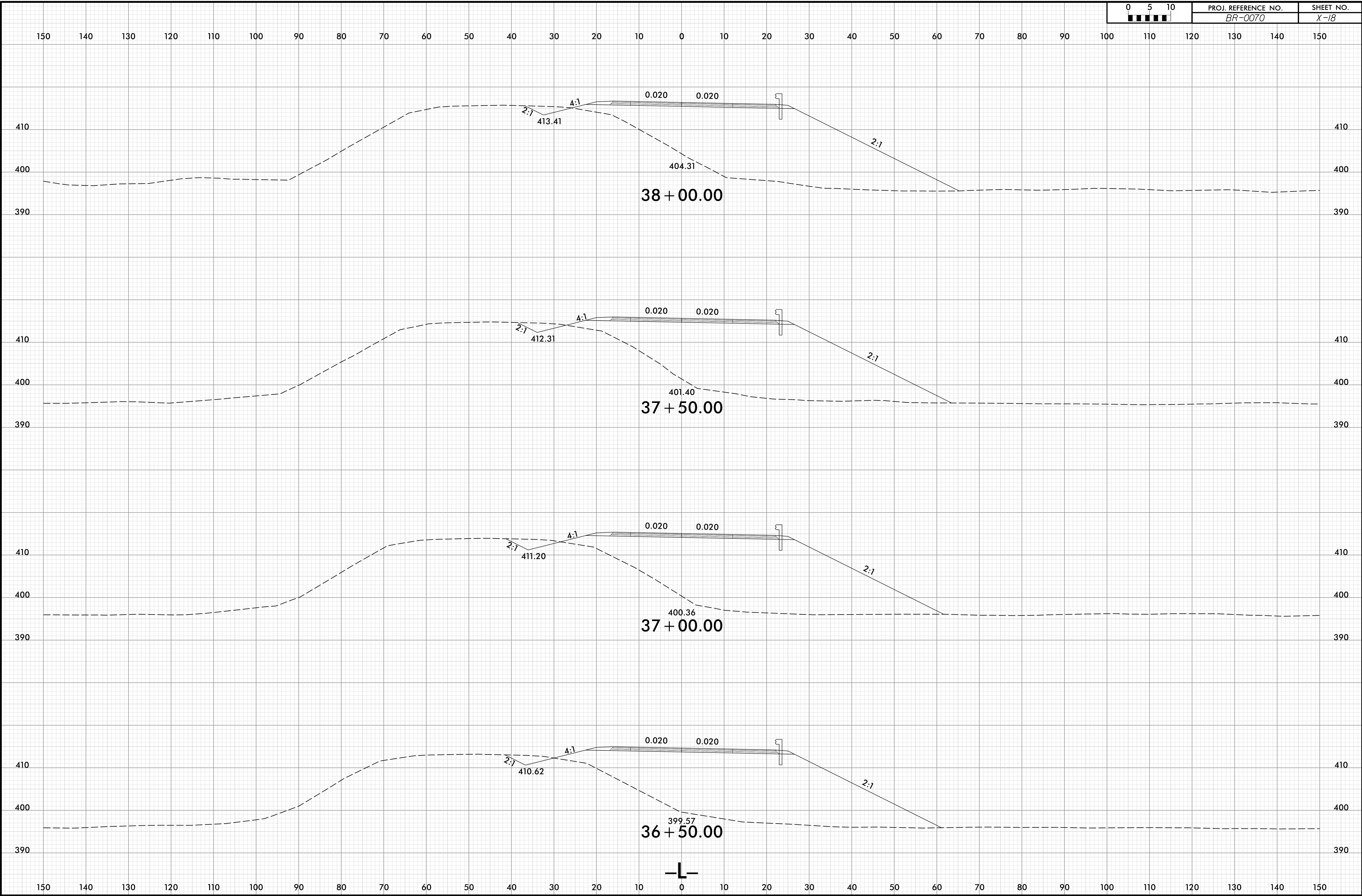

9/27/2022
J:\S:\BR0070_Rdy_xpl.L.dgn
JSE/rdw

8/23/99

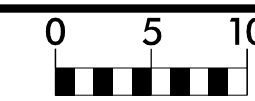

PROJ. REFERENCE NO.
BR-0070

SHEET NO.
X-19

150 140 130 120 110 100 90 80 70 60 50 40 30 20 10 0 10 20 30 40 50 60 70 80 90 100 110 120 130 140 150

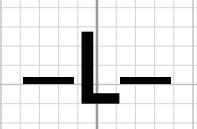
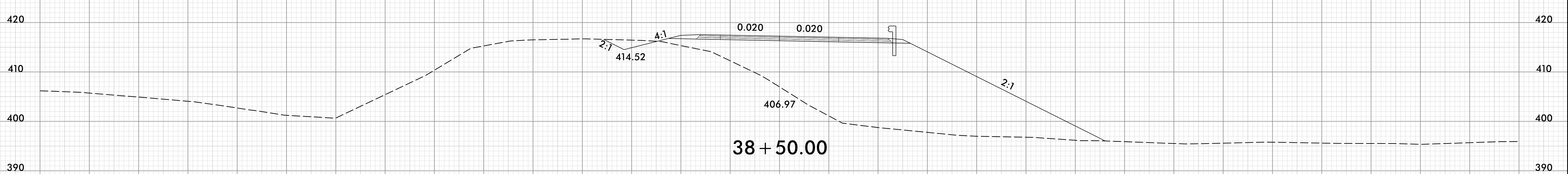
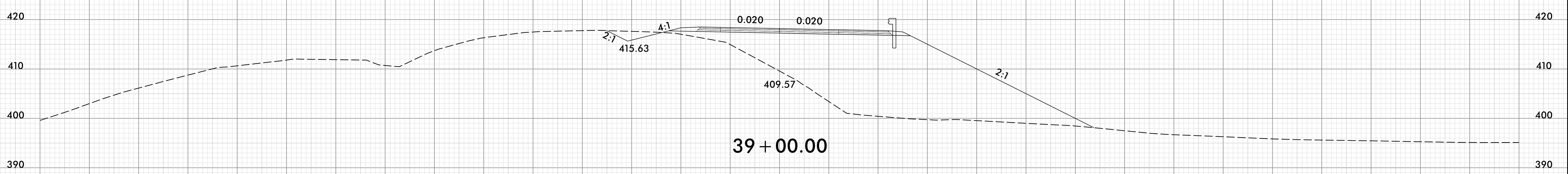
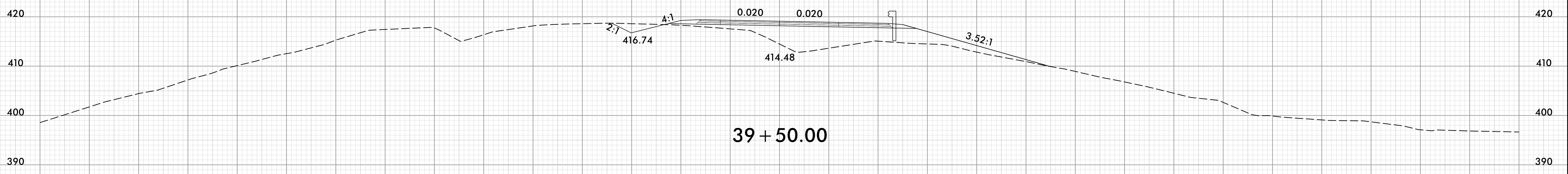

9/27/2022
J:\PROJECTS\BR0070_Rdy_xpl.L.dgn
JUS:RDM

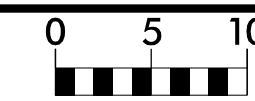

150 140 130 120 110 100 90 80 70 60 50 40 30 20 10 0 10 20 30 40 50 60 70 80 90 100 110 120 130 140 150

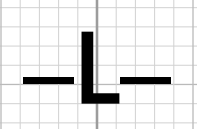
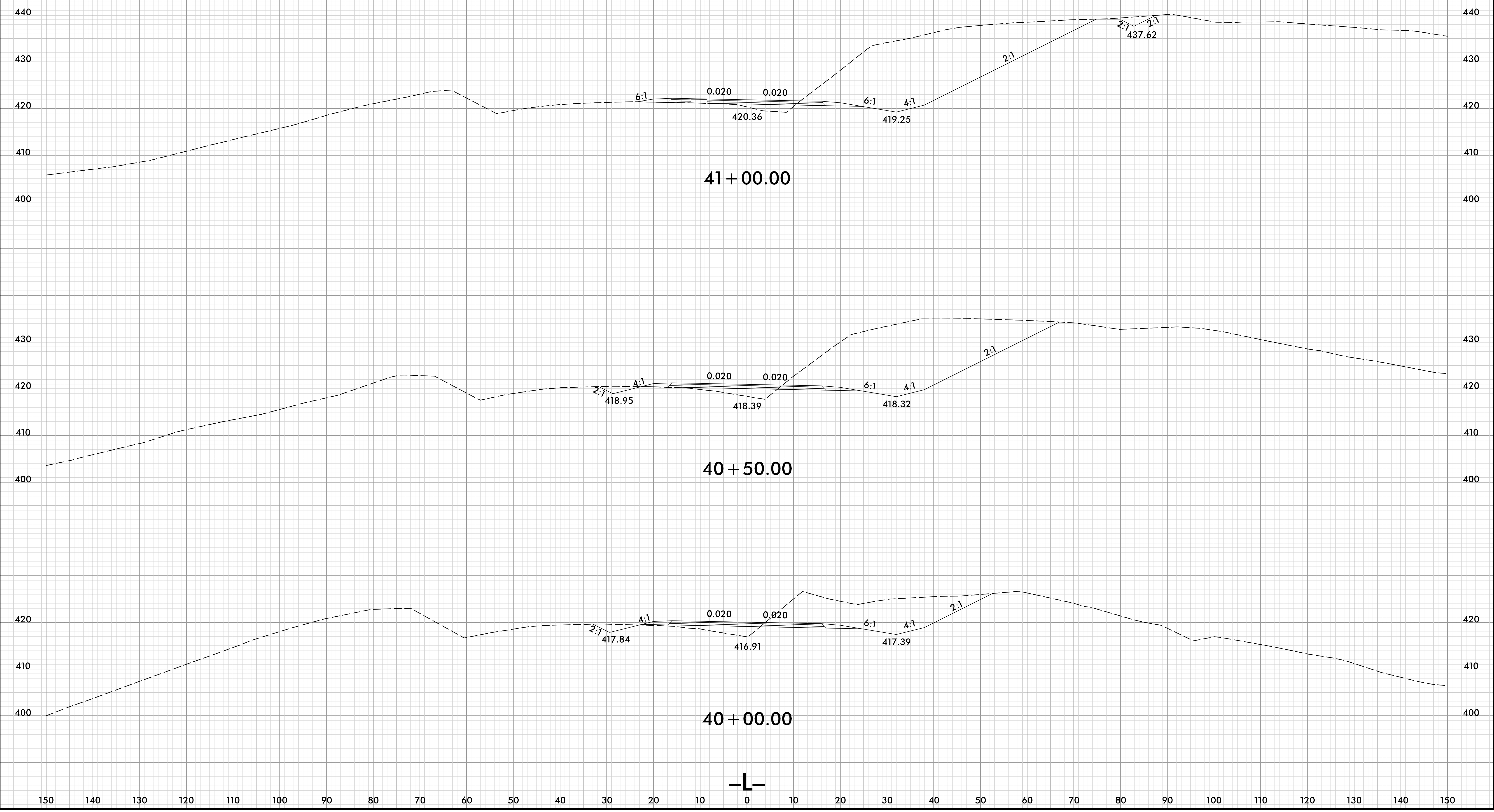

8/23/99

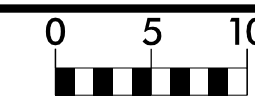

PROJ. REFERENCE NO.
BR-0070

SHEET NO.
X-21

150 140 130 120 110 100 90 80 70 60 50 40 30 20 10 0 10 20 30 40 50 60 70 80 90 100 110 120 130 140 150

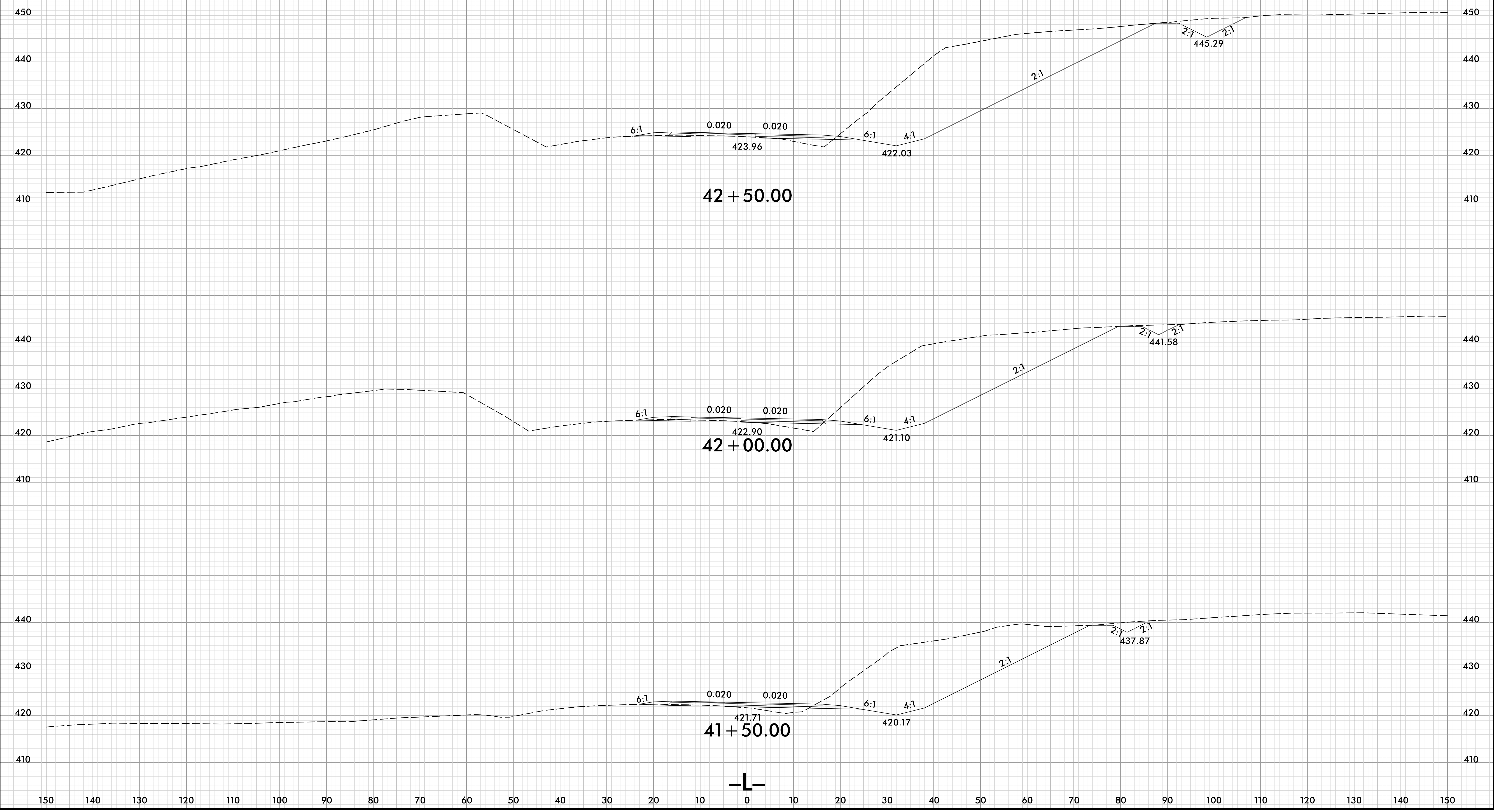

9/27/2022
J:\Projects\BR0070_Rdy_xpl.L.dgn
J:\Users\jrowe

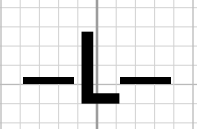

8/23/99

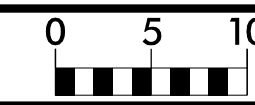

PROJ. REFERENCE NO. BR-0070	SHEET NO. X-22
--------------------------------	-------------------

150 140 130 120 110 100 90 80 70 60 50 40 30 20 10 0 10 20 30 40 50 60 70 80 90 100 110 120 130 140 150

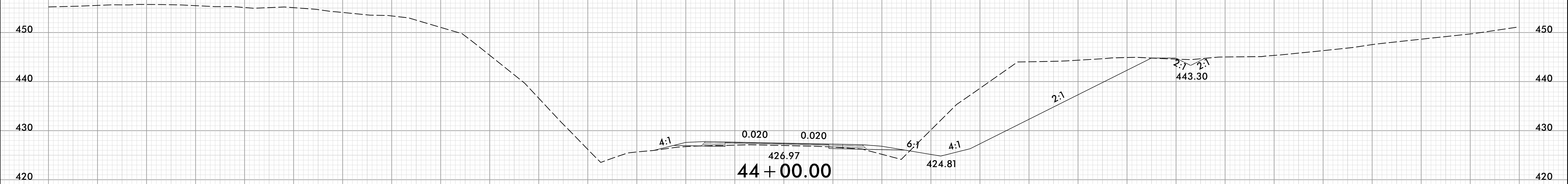

44 + 00.00



43 + 50.00

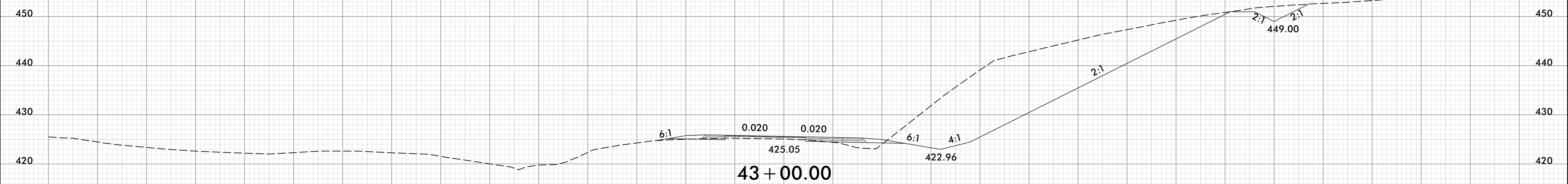

43 + 00.00

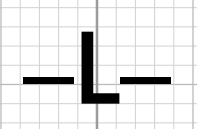

150 140 130 120 110 100 90 80 70 60 50 40 30 20 10 0 10 20 30 40 50 60 70 80 90 100 110 120 130 140 150

9/27/2022
J:\PROJECTS\BR0070_Rdwy_xpl.L.dgn
JUS:RIS:RWS

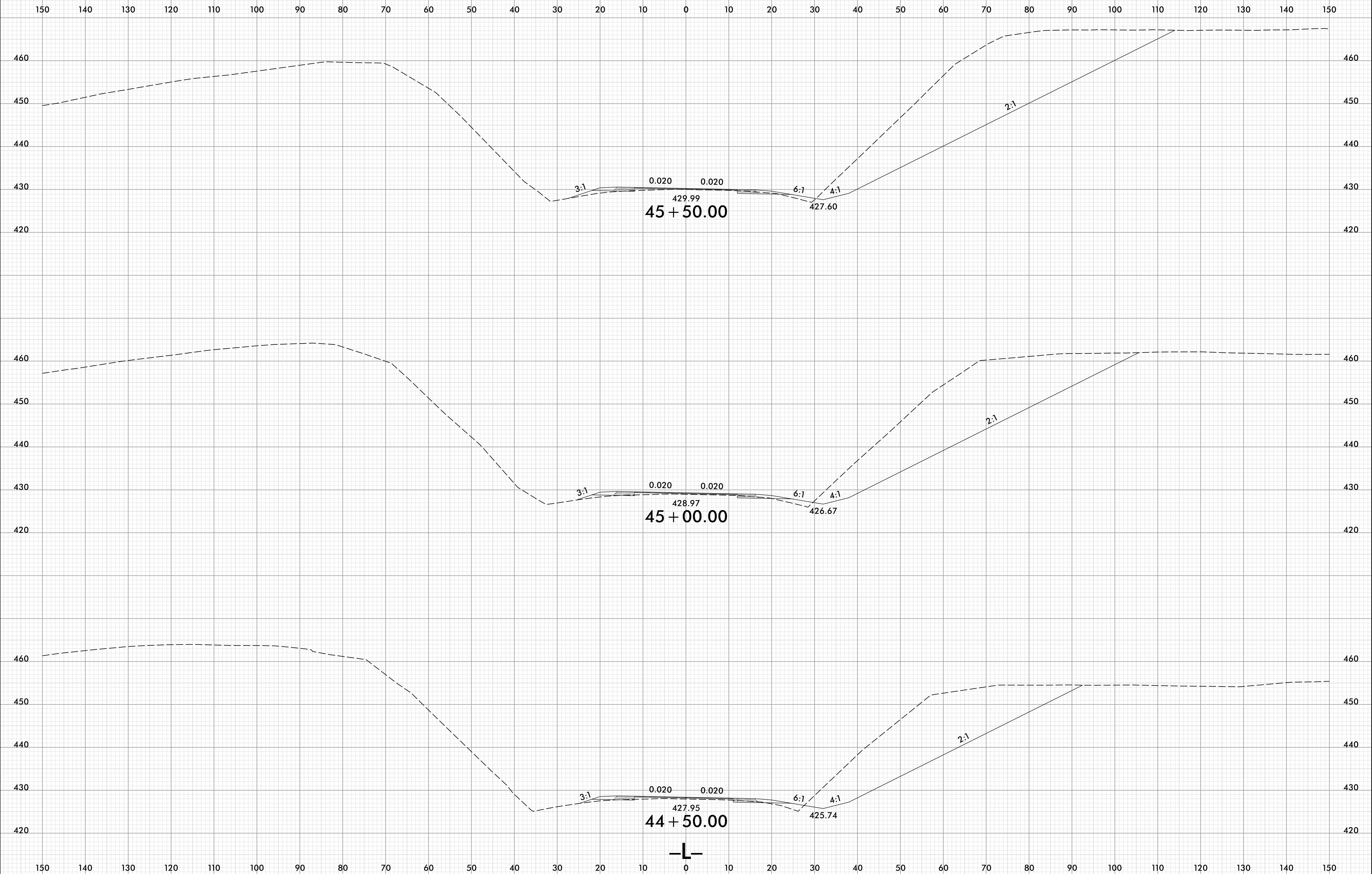
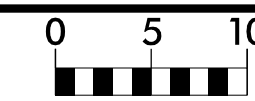

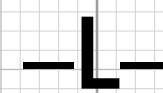
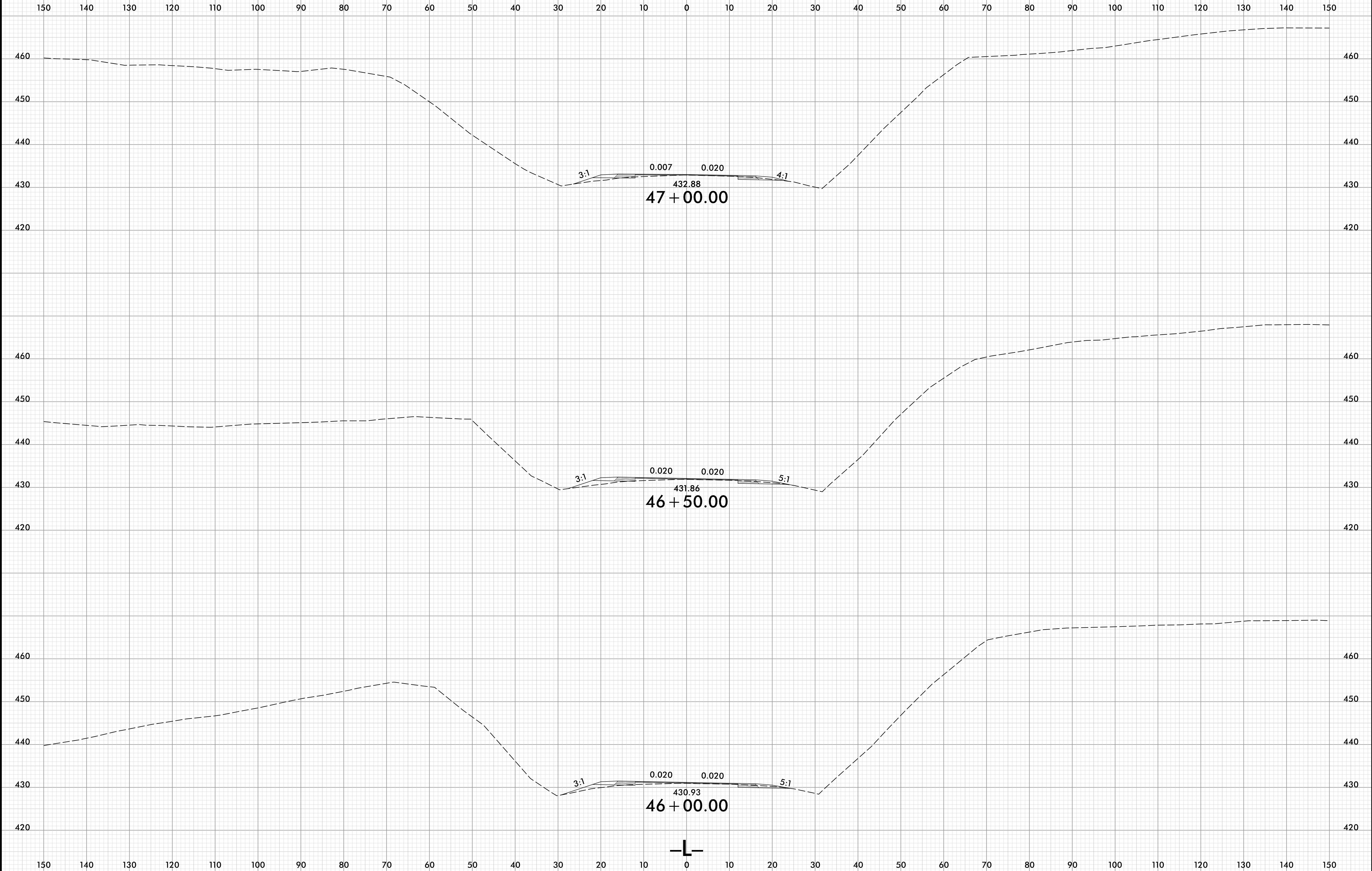
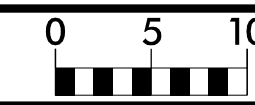

8/23/99

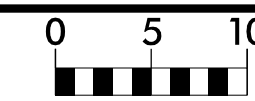

PROJ. REFERENCE NO.	SHEET NO.
BR-0070	X-25

PROJ. REFERENCE NO.	SHEET NO.
BR-0070	X-25

150 140 130 120 110 100 90 80 70 60 50 40 30 20 10 0 10 20 30 40 50 60 70 80 90 100 110 120 130 140 150

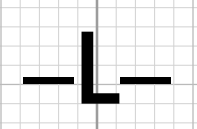
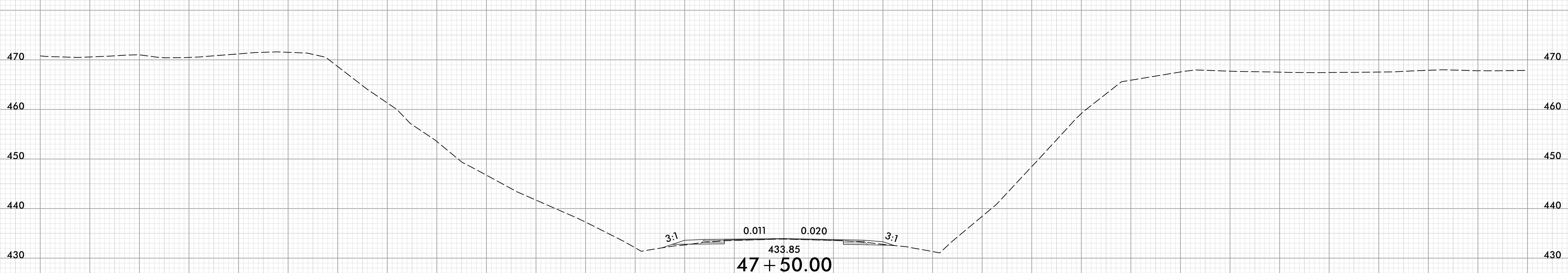
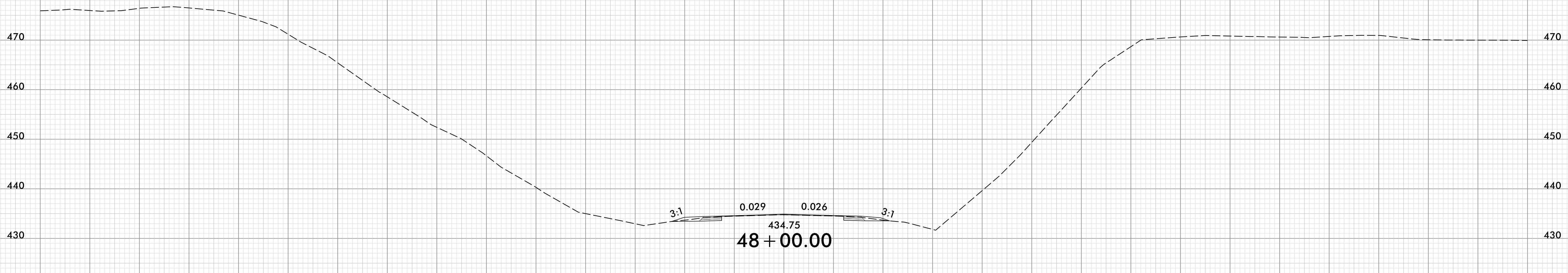

150 140 130 120 110 100 90 80 70 60 50 40 30 20 10 0 10 20 30 40 50 60 70 80 90 100 110 120 130 140 150

9/27/2002
 J:\S:\BR0070_Rdy_xpl.L.dgn
 J:\S\BR0070

8/23/99

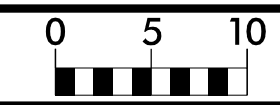

PROJ. REFERENCE NO.
BR-0070

SHEET NO.
X-26

150 140 130 120 110 100 90 80 70 60 50 40 30 20 10 0 10 20 30 40 50 60 70 80 90 100 110 120 130 140 150

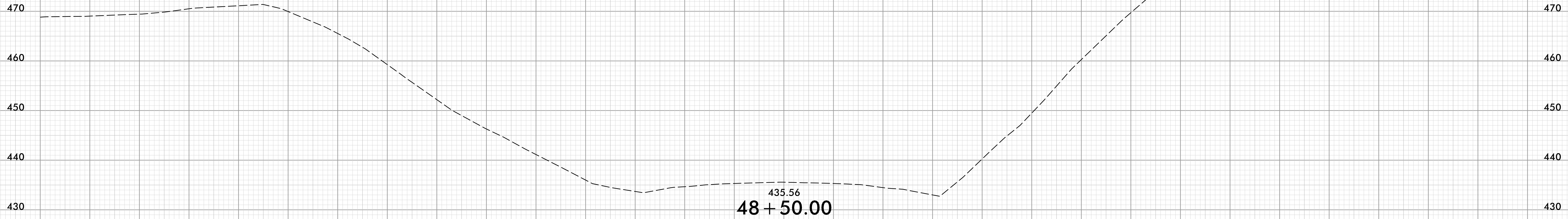

435.56
48 + 50.00

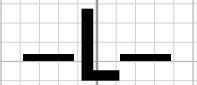

9/27/2022
J:\EIR\BR0070_RdJ_xpl.L.dgn
J:\EIR\BR0070