



PROJECT REFERENCE NO. U-2579AA	SHEET NO. SIGN-3
	
7/12/2022	
DOCUMENT NOT CONSIDERED FINAL UNLESS ALL SIGNATURES COMPLETED	
 HDR Engineering, Inc. of the Carolinas 555 Fayetteville St., Suite 900 Raleigh, N.C. 27601 N.C.B.E.L.S. License Number: F-0116	

401 QUANTITY REQ'D 1

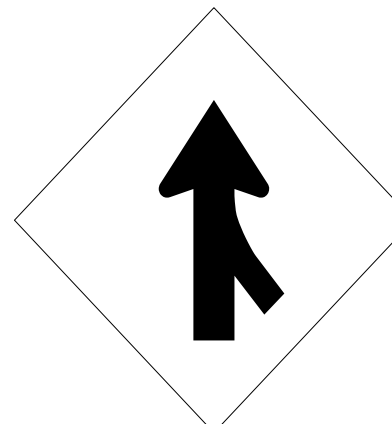

48 X 48
W4-1 (R)

TWO "U" POSTS

406 QUANTITY REQ'D 22

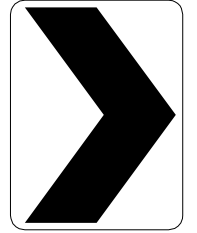

36 X 48
W1-8(R)

ONE "U" POST PER SIGN

411 QUANTITY REQ'D 2



54 X 18
R6-1 (R)

TWO "U" POSTS PER SIGN

416 QUANTITY REQ'D 1

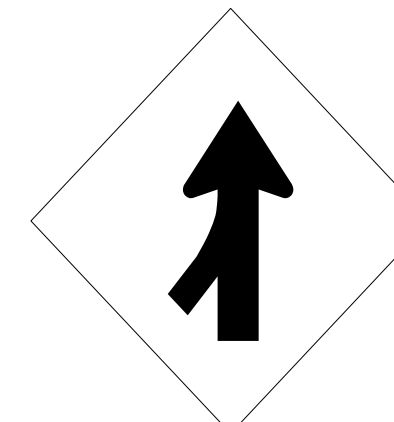

48 X 48
W4-1 (L)

TWO "U" POST

402 QUANTITY REQ'D 2



36 X 60
W13-6

TWO "U" POSTS PER SIGN

407 QUANTITY REQ'D 4

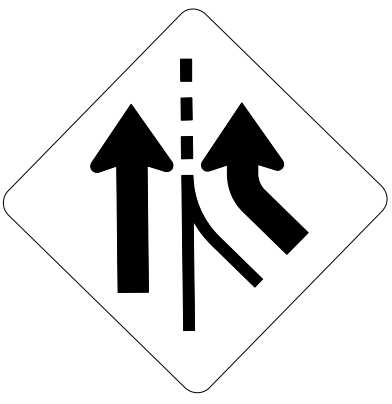

48 X 48
W4-3R

TWO "U" POSTS PER SIGN

412 QUANTITY REQ'D 2

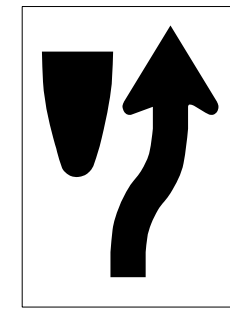

24 X 30
R4-7

ONE "U" POST PER SIGN

417 QUANTITY REQ'D 2

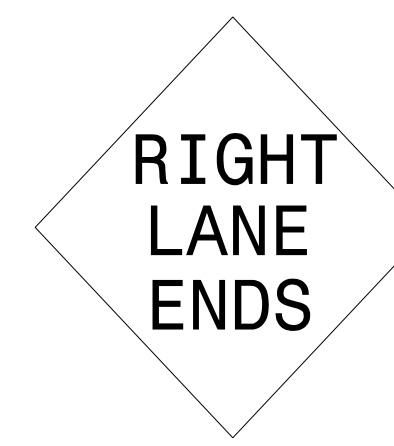

48 X 48
W9-2(R)

TWO "U" POSTS PER SIGN

403 QUANTITY REQ'D 4



30 X 30
W13-1

MOUNT BELOW SIGN 406
IN 4 INSTALLATION

TWO "U" POSTS PER SIGN

408 QUANTITY REQ'D 1

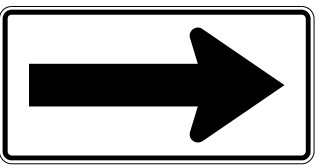

60 X 30
W1-6R

TWO "U" POSTS

413 QUANTITY REQ'D 2

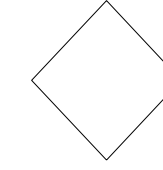

18 X 18
OM1-3

MOUNT BELOW SIGN 422
IN 2 INSTALLATIONS

418 QUANTITY REQ'D 2

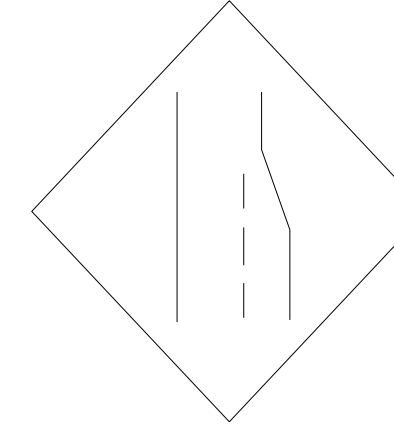

48 X 48
W4-2(R)

TWO "U" POSTS PER SIGN

404 QUANTITY REQ'D 2

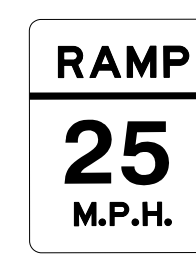

36 X 60
W13-7

TWO "U" POSTS PER SIGN

409 QUANTITY REQ'D 2

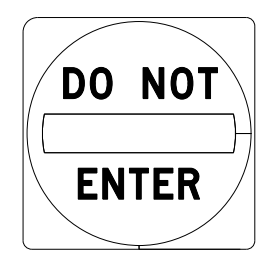

36 X 36
R5-1

ONE "U" POST PER SIGN

414 QUANTITY REQ'D 4

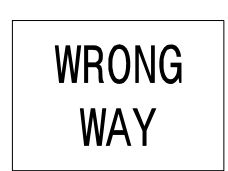

42 X 30
R5-1a

ONE "U" POST PER SIGN

405 QUANTITY REQ'D 4

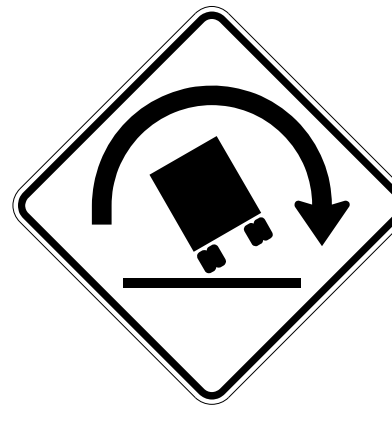

48 X 48
W1-13(R)

TWO "U" POSTS PER SIGN

410 QUANTITY REQ'D 4

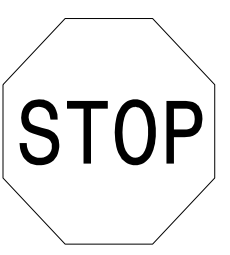

36 X 36
R1-1

ONE "U" POST PER SIGN

415 QUANTITY REQ'D 6



36 X 48
R2-1

TWO "U" POSTS PER SIGN

TYPE "E" SIGNS