

**This electronic collection of documents is provided
for the convenience of the user
and is Not a Certified Document –**

**The documents contained herein were originally issued
and sealed by the individuals whose names and license
numbers appear on each page, on the dates appearing
with their signature on that page.**

**This file or an individual page
shall not be considered a certified document.**

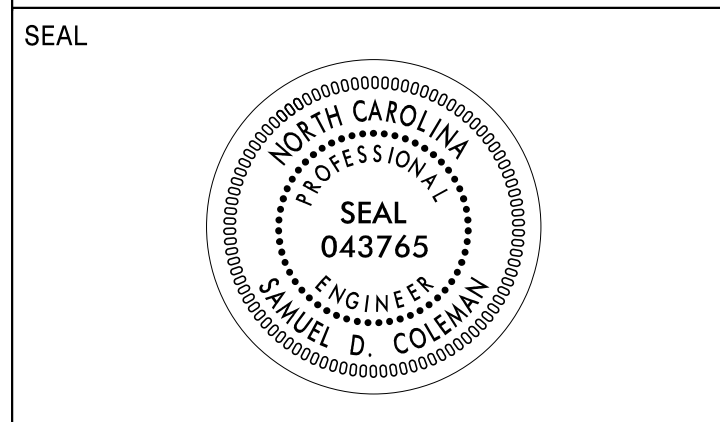

**DOCUMENT NOT CONSIDERED FINAL
 UNLESS ALL SIGNATURES COMPLETED**

**STATE OF NORTH CAROLINA
 DEPARTMENT OF TRANSPORTATION**

**SIGNING PLAN
 LEE COUNTY**

**LOCATION: NC 42 FORM US 421 TO SR 1579 (MAIN STREET)
 IN SANFORD AND ALONG SR 1579 FROM NC 42
 TO SR 1538 (E. HARRINGTON AVE.) IN BROADWAY**

T.I.P.: R-3830

CONTRACT: C204369

ROADWAY STANDARD DRAWING

THE FOLLOWING ROADWAY STANDARDS AS APPEAR IN "ROADWAY STANDARD DRAWINGS" - PROJECT SERVICES UNIT - N.C. DEPARTMENT OF TRANSPORTATION - RALEIGH, N.C., DATED JANUARY 2018 ARE APPLICABLE TO THIS PROJECT AND BY REFERENCE HEREBY ARE CONSIDERED A PART OF THESE PLANS:

STD. NO.	TITLE
901.10	TYPE 'A' SIGNS
901.50	ARROWS AND SHIELDS
901.70	SIGN STRINGERS AND SUPPORT SPACING
901.80	SIGN MOUNTING DETAILS - FOR TYPE A AND TYPE B SIGNS
903.10	GROUND MOUNTED SIGN SUPPORTS
904.10	ORIENTATION OF GROUND MOUNTED SIGNS
904.50	MOUNTING OF TYPE 'D', 'E' AND 'F' SIGNS ON 'U' CHANNEL POSTS
910.20	SCHOOL MARKED AND UNMARKED CROSSWALKS / SPEED REDUCTION REQUIREMENTS
910.30	SIGNING SIGNALIZED AND UNSIGNALIZED SUPERSTREET
910.50	SIGNING FOR SPEED REDUCTION ZONE

GENERAL NOTES

- SIGNS FURNISHED BY STATE
- CONFIRM IN WRITING AT LEAST 4 MONTHS IN ADVANCE, THE ACTUAL DATE THE DEPARTMENT FURNISHED SIGNS WILL BE REQUIRED.
- ALL TYPE 'D' SIGNS SHALL BE MOUNTED ON TWO U-CHANNEL POSTS UNLESS OTHERWISE INDICATED ON THE PLANS.
- IF REMOVAL OR RELOCATION OF SIGNS ON PRIVATE STREET (NON-STATE MAINTAINED) IS REQUIRED DUE TO CONSTRUCTION, THE CONTRACTOR SHALL INFORM THE ENGINEER. THE WORK WILL BE COMPLETED BY OTHERS.
- WHEN NOT STATIONED OR DIMENSIONED ON PLANS, ALL 'E' AND 'F' SIGNS SHALL BE FIELD LOCATED BY THE ENGINEER
- ALL EXISTING SIGNS ON "U" CHANNEL POST WITHIN THE PROJECT LIMITS SHALL BE REMOVED AND DISPOSED OF UNLESS OTHERWISE NOTED ON PLANS.
- WHEN EXISTING SIGNS ARE REMOVED AND INSTALLED ON NEW SUPPORTS, THE RE-ERECTION SHALL IMMEDIATELY FOLLOW THE REMOVAL.
- THE BACKGROUND FOR TYPE E & F SIGNS SHALL BE TYPE C REFLECTIVE SHEETING.
- DO NOT BEGIN FABRICATION FOR TYPES A & B SIGNS MOUNTED ON OVERHEAD STRUCTURES OR STEEL SUPPORTS UNTIL "S" DIMENSIONS HAVE BEEN FIELD VERIFIED.
- SEE ROADWAY PLANS FOR GUARD/GUIDE RAIL DETAILS.

SUMMARY OF QUANTITIES

ITEM NO.	ITEM DESCRIPTION	QUANTITY	UNIT
4048000000	902 REINFORCED CONCRETE SIGN FOUNDATION	1	C.Y.
4060000000	903 SUPPORTS, BREAKAWAY STEEL BEAM	607	LB.
4072000000	903 SUPPORTS, 3 LB. STEEL U-CHANNEL	3400	L.F.
4096000000	904 SIGN ERECTION, TYPE D	8	EA.
4102000000	904 SIGN ERECTION, TYPE E	125	EA.
4108000000	904 SIGN ERECTION, TYPE F	37	EA.
4110000000	904 SIGN ERECTION, TYPE A (GROUND MOUNTED)	2	EA.
4116100000	904 SIGN ERECTION, RELOCATE SIGN TYPE D	1	EA.
4116100000	904 SIGN ERECTION, RELOCATE SIGN TYPE E	6	EA.
4155000000	907 DISPOSAL OF SIGN SYSTEM, U-CHANNEL	100	EA.
4192000000	907 DISPOSAL OF SUPPORT, U-CHANNEL	5	EA.

PROJECT NOTES

- | | |
|---|--------------------------------------|
| 1 | DISPOSAL OF SIGN SYSTEM, U-CHANNEL |
| 2 | DISPOSAL OF SUPPORT, U-CHANNEL |
| 3 | SIGN ERECTION, RELOCATE SIGN, TYPE D |
| 4 | SIGN ERECTION, RELOCATE SIGN, TYPE E |

INDEX

SHEET NO.	DESCRIPTION
SIGN-1	TITLE SHEET
SIGN-2	GM SUPPORT INFORMATION
SIGN-3 SERIES	SIGN DESIGNS
SIGN-4 SERIES	E AND F SIGNS
SIGN-5-25A	SIGNING PLAN DETAIL SHEETS

PLAN REVIEWED BY: N.C.D.O.T. SIGNING AND DELINEATION UNIT

AYMAN ALQUDWAH, P.E. SIGNING & DELINEATION REGIONAL ENGINEER
 MITCH EATON, P.E. SIGNING & DELINEATION PROJECT DESIGN ENGINEER

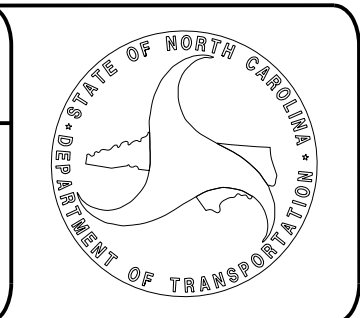

9/10/2019 9:56:59 AM NCDOT_2018_Traffic-LSA\Proj\VAL-R-3830\Traffic\Signing\CADD\Signing Layout Plans\R-3830_Sgn-SIGN_1.dgn
 User: C0188144

PLANS PREPARED FOR THE NCDOT BY:
M MOTT MACDONALD
 P.O. Box 708
 Fuquay-Varina, NC 27526
 (919) 552-2233
 www.mottmacdonald.com
 LICENSE NO. F-8669

PROJECT REFERENCE NO.	R-3830	SHEET NO.	SIGN-2
APPROVED	DocuSigned by: Samuel D. Coleman 8B28967FD7254D9...		
DATE:	8/27/2019		
SEAL			
DOCUMENT NOT CONSIDERED FINAL UNLESS ALL SIGNATURES COMPLETED			

Version: 3.1 Posted: 6/2/2017

NUMBER	SIGN TYPE	SIGN SIZE (in.)			ROADWAY STATION	NUMBER OF SUPPORTS	BEAM SECTION	SUPPORT TYPE BA or S	OMNI COUPLER	ATTACHMENT METHOD	MOUNTING METHOD	HORIZONTAL CLEARANCE* (ft.)	SUPPORT SPACING	LENGTH (ft)			LEFT SUPPORT (ft)			CENTER SUPPORT (ft)			RIGHT SUPPORT (ft)			SUPPORT WEIGHTS		FOOTINGS				FIELD VERIFIED SEE NOTE 2 (mm/dd/yy)
		w	x	h										SNS HT "H"	MTG HT "C"	EMBED-MENT	S	L	LENGTH	S	L	LENGTH	S	L	LENGTH	B/A (lbs.)	SIMPLE (lbs.)	DIAMETER (ft.)	DEPTH (ft.)	REINFORCED (c.y.)	PLAIN (c.y.)	
101	A	78	x	72	-L- STA. 29+80	1	W6x16	BA	N/A	N/A	N/A	15.00	0.00	6.00	7.45	3.0	0.00	0.00	0.00	-0.45	13.00	16.00	0.00	0.00	0.00	303.00	0	1.5	3.5	0.23	0.00	
102	A	78	x	72	-L- STA. 40+00	1	W6x16	BA	N/A	N/A	N/A	15.00	0.00	6.00	8.21	3.0	0.00	0.00	0.00	-1.21	13.00	16.00	0.00	0.00	0.00	303.00	0	1.5	3.5	0.23	0.00	
													TOTAL			TOTAL			TOTAL				TOTAL									
													606.00			0.00			0.46				0.00									
													USE:			607.00			0.00			1.00				0.00						

8/27/2019 3:39:56 PM NCDOT_2018_Traffic_LSA_Proj\AL-R-3830\Traffic\Signing\CADD\Signing Layout Plans\R-3830_Sgn_SIGN_2.dgn

NOTES

- DIMENSION "S" REPRESENTS AN INCREASE (+), OR A DECREASE (-) IN POLE LENGTH, RELATIVE TO THE ELEVATION OF THE EDGE OF TRAVEL LANE.
- FIELD VERIFICATIONS SHALL BE REQUIRED FOR ALL SUPPORTS, SEE (*) ARTICLE 903-3. FABRICATORS SHALL BE AISC CERTIFIED IN CATEGORY 1, SEE (*) ARTICLE 1072-1. (*) = N.C.D.O.T. STANDARD SPECIFICATIONS FOR ROADS AND STRUCTURES
- PLAN LOCATIONS FOR EXISTING UTILITIES ARE BASED ON THE BEST AVAILABLE INFORMATION AND, MAY NOT BE PRECISELY ACCURATE. THEREFORE, IT IS INCUMBENT UPON THE CONTRACTOR TO DETERMINE THE EXACT LOCATION OF UTILITIES BEFORE BEGINNING WORK IN A LOCATION.

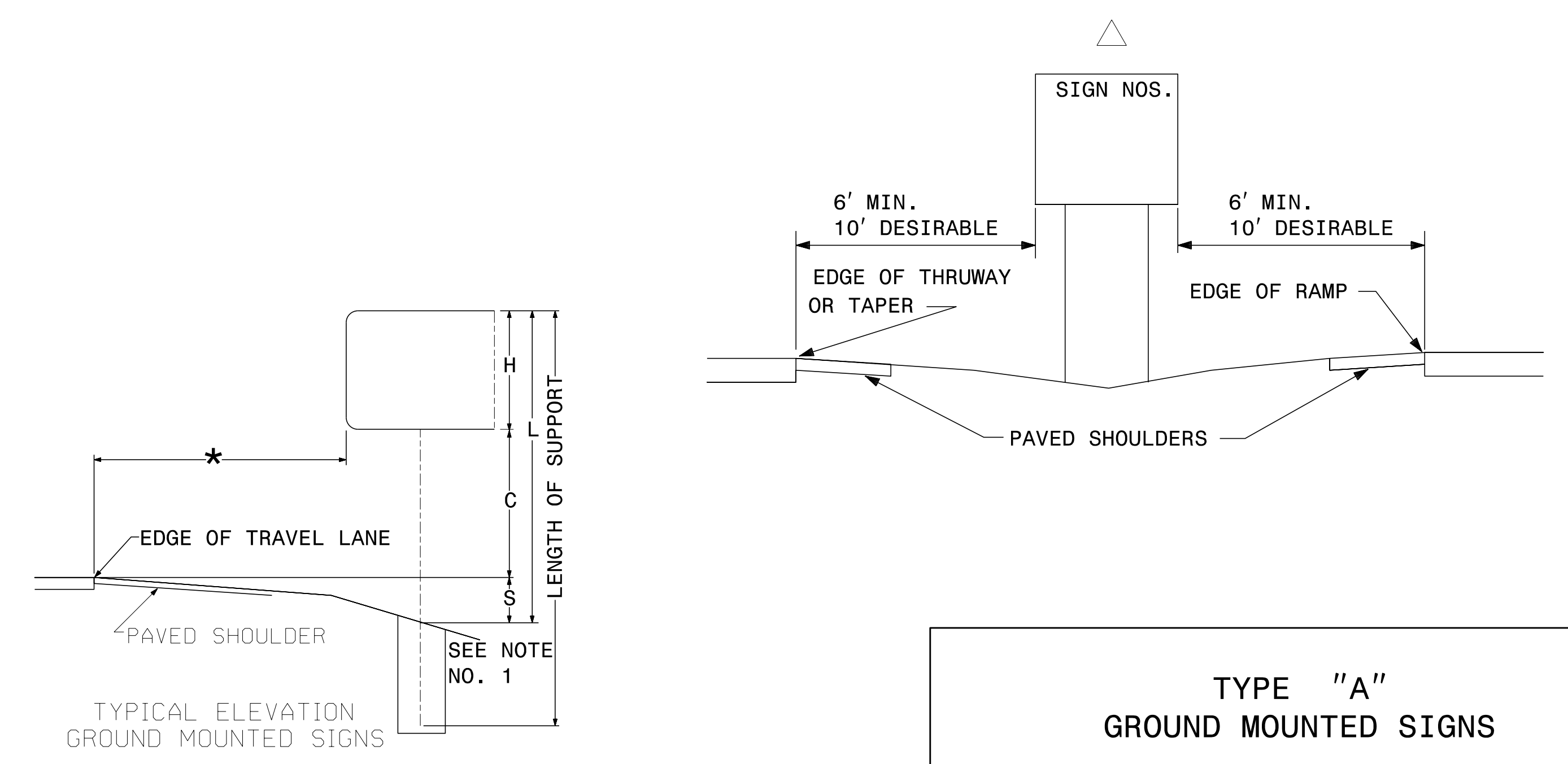

PROJECT REFERENCE NO.	SHEET NO.
R-3830	SIGN-3
APPROVED: <i>Samuel D. Coleman</i>	DocuSigned by: Samuel D. Coleman
DATE: 9/10/2019	68286707254D9
SEAL	
DOCUMENT NOT CONSIDERED FINAL UNLESS ALL SIGNATURES COMPLETED	

SIGN NUMBER: 101 **BACKG COLOR: Green / Green / Green / Brown / White**
TYPE: A **COPY COLOR: White**

DESIGN BY: S COLEMAN **CHECKED BY:** **Sep 10, 2019**
PROJECT ID: R-3830 LOCATION: NC 42/SR 1579 IN SANFORD/BROADWAY **DIV: 8**

QUANTITY: 1

SYMBOL	X	Y	WID	HT
AR_type D	4.9	60.2	5	7.5
AR_type D	4.9	42.4	5	7.5
AR_type D	4.9	24.6	5	7.5
AR_type D	4.9	6.8	5	7.5

SIGN WIDTH: 6'-6"
 HEIGHT: 6'-0"
 TOTAL AREA: 39.0 Sq.Ft.

BORDER TYPE: FLUSH
 RECESS: 0"
 WIDTH: 0.5"
 RADII: 9"

MAT'L: 0.125" (3.2 mm) ALUMINUM

NO. Z BARS: 2
 LENGTH: 70.0

USE NOTES: 1,2

- Legend and border (except those that are colored black) shall be direct applied Grade C sheeting.
- Background shall be Grade C reflective sheeting.
- Shields; A, B, and C type arrows shall be on 0.032" (0.8mm) aluminum with Grade C reflective sheeting and demountable.
- Bottom panel shall be yellow Grade C sheeting. Legend shall be direct applied black non-reflective sheeting. Arrow shall be on 0.032" aluminum, black non-reflective sheeting and demountable. Yellow panel is:

LETTER POSITIONS

Letter spacings are to start of next letter													Series/Size	Text Length						
21.7	3.3	3.6	3.1	1.5	3.7	3.3	4	2.5	4	3.6	3.3	4	3.4	2.7	10.2	D 2000	46.1			
A R M O R Y													D 2000	21.6						
34	4	3.4	4	3.7	3	3.4	22.5									D 2000	52.4			
C E N T R A L C A R O L I N A													D 2000	52.4						
18.6	3.6	3.2	3.3	3.1	3	4	2.5	4	3.2	4	3.3	3.7	3.1	1.6	3.3	3.4	7.1	D 2000	56.7	
C O M M U N I T Y C O L L E G E													D 2000	56.7						
16.4	3.5	3.7	4.1	4.1	3.7	3.7	1.2	2.7	3.4	4	3.5	3.7	3.1	3.1	3.1	3.6	2.5	4.9	D 2000	33.1
L E E C O U N T Y													D 2000	33.1						
28.2	3.1	3.2	2.5	4	3.5	3.7	3.7	3.3	2.7	3.4	16.7						D 2000	35.9		
H I G H S C H O O L													D 2000	35.9						
26.8	3.7	1.5	3.6	2.7	4	3.3	3.6	3.6	3.6	3.7	2.5	15.3						D 2000	48.2	
D E N N I S A W I C K E R													D 2000	48.2						
20.7	3.6	3.2	3.7	3.7	1.3	2.7	4	3.4	4	4.2	1.5	3.6	3.5	3.2	2.7	9.2	D 2000	35.8		
C I V I C C E N T E R													D 2000	35.8						
26.9	3.6	1.2	3.6	1.5	2.7	4	3.6	3.2	3.3	3.1	3.2	2.7	15.4						D 2000	35.8
C I V I C C E N T E R													D 2000	35.8						

FILENAME: R-3830_Sign Designs NORTH CAROLINA D.O.T. SIGN DETAIL

SIGN NUMBER: 102 **BACKG COLOR: Green / Green / Green / Brown / White**
TYPE: A **COPY COLOR: White**

DESIGN BY: S COLEMAN **CHECKED BY:** **Sep 10, 2019**
PROJECT ID: R-3830 LOCATION: NC 42/SR 1579 IN SANFORD/BROADWAY **DIV: 8**

QUANTITY: 1

SYMBOL	X	Y	WID	HT
AR_type D	65.6	60.2	5	7.5
AR_type D	65.6	42.4	5	7.5
AR_type D	65.6	24.6	5	7.5
AR_type D	65.6	6.8	5	7.5

SIGN WIDTH: 6'-6"
 HEIGHT: 6'-0"
 TOTAL AREA: 39.0 Sq.Ft.

BORDER TYPE: FLUSH
 RECESS: 0"
 WIDTH: 0.5"
 RADII: 9"

MAT'L: 0.125" (3.2 mm) ALUMINUM

NO. Z BARS: 2
 LENGTH: 70.0

USE NOTES: 1,2

- Legend and border (except those that are colored black) shall be direct applied Grade C sheeting.
- Background shall be Grade C reflective sheeting.

LETTER POSITIONS

Letter spacings are to start of next letter													Series/Size	Text Length						
10.2	3.3	3.6	3.1	1.5	3.7	3.3	4	2.5	4	3.6	3.3	4	3.4	2.7	21.7	D 2000	46.1			
A R M O R Y													D 2000	21.6						
22.5	4	3.4	4	3.7	3	3.4	33.9									D 2000	52.4			
C E N T R A L C A R O L I N A													D 2000	52.4						
7.1	3.6	3.2	3.3	3.1	3	4	2.5	4	3.2	4	3.3	3.7	3.1	1.6	3.3	3.4	18.6	D 2000	56.7	
C O M M U N I T Y C O L L E G E													D 2000	56.7						
4.9	3.5	3.7	4.1	4.1	3.7	3.7	1.2	2.7	3.4	4	3.5	3.7	3.1	3.1	3.1	3.6	2.5	16.4	D 2000	33.1
L E E C O U N T Y													D 2000	33.1						
16.7	3.1	3.2	2.5	4	3.5	3.7	3.7	3.3	2.7	3.4	28.2						D 2000	35.9		
H I G H S C H O O L													D 2000	35.9						
15.3	3.7	1.5	3.6	2.7	4	3.3	3.6	3.6	3.6	3.7	2.5	26.8						D 2000	48.2	
D E N N I S A W I C K E R													D 2000	48.2						
9.2	3.6	3.2	3.7	3.7	1.3	2.7	4	3.4	4	4.2	1.5	3.6	3.5	3.2	2.7	20.7	D 2000	35.8		
C I V I C C E N T E R													D 2000	35.8						
15.4	3.6	1.2	3.6	1.5	2.7	4	3.6	3.2	3.3	3.1	3.2	2.7	26.9						D 2000	35.8
C I V I C C E N T E R													D 2000	35.8						

FILENAME: R-3830_Sign Designs NORTH CAROLINA D.O.T. SIGN DETAIL

SIGN NUMBER: 301 **BACKG COLOR: Green / Green / Green / Brown / White**
TYPE: D **COPY COLOR: White**

DESIGN BY: S COLEMAN **CHECKED BY:** **Feb 25, 2019**
PROJECT ID: R-3830 LOCATION: NC 42/SR 1579 IN SANFORD/BROADWAY **DIV: 8**

QUANTITY: 1

SYMBOL	X	Y	WID	HT
u arrow	3.7	3.5	12.7	13.9

SIGN WIDTH: 7'-6"
 HEIGHT: 2'-6"
 TOTAL AREA: 18.8 Sq.Ft.

BORDER TYPE: FLUSH
 RECESS: 0"
 WIDTH: 0.75"
 RADII: 3"

MAT'L: 0.125" (3.2 mm) ALUMINUM

NO. Z BARS: 2
 LENGTH: 70.0

USE NOTES: 1,2

- Legend and border (except those that are colored black) shall be direct applied Grade C sheeting.
- Background shall be Grade C reflective sheeting.

LETTER POSITIONS

Letter spacings are to start of next letter													Series/Size	Text Length				
7.2	5	4.6	3	2.2	4.1	3.1	3.5	57.2					D 2000	25.6				
C o r i n t h													D 2000	6.8				
75.9	2.3	4.5	7.2									D 2000	57.4					
F u q u a y - V a r i n a													D 2000	57.4				
7.2	4.4	4.5	4.7	4.4	4.1	4.5	3	2.1	3	5	4.6	3	2.2	4.4	3.4	25.4	D 2000	9.2
2 7													D 2000	9.2				
73.6	5.1	4.1	7.2									D 2000	9.2					

FILENAME: R-3830_Sign Designs NORTH CAROLINA D.O.T. SIGN DETAIL

SIGN NUMB: 302 **BACKG. COLOR: White** **COPY COLOR: Black**

DESIGN BY: **CHECKED BY:** **STD #:** **DATE:**
PROJECT ID: **DIV:** **DATE:**

QUANTITY: 1

SIGN WIDTH: 1'-9"
 HEIGHT: 1'-9"
 TOTAL AREA: 3.1 Sq.Ft.

SYMBOL	X	Y	WID	HT
u arrow	3.7	3.5	12.7	13.9

MAT'L: 0.063" ALUMINUM

BORDER TYPE: RECESSED
 RECESS: 0.38"
 WIDTH: 0.63"
 RADII: 1.5"

NO. Z BARS: 2
 LENGTH: 70.0

USE NOTES: 1,2

- Legend and border shall be direct applied Non-reflective sheeting.
- Background shall be Grade C reflective sheeting.

LETTER POSITIONS

Letter spacings are to start of next letter													Series/Size	Text Length				
7.2	5	4.6	3	2.2	4.1	3.1	3.5	57.2					D 2000	25.6				
C o r i n t h													D 2000	6.8				
75.9	2.3	4.5	7.2									D 2000	57.4					
F u q u a y - V a r i n a													D 2000	57.4				
7.2	4.4	4.5	4.7	4.4	4.1	4.5	3	2.1	3	5	4.6	3	2.2	4.4	3.4	25.4	D 2000	9.2
2 7													D 2000	9.2				
73.6	5.1	4.1	7.2									D 2000	9.2					

FILENAME: SIGN

ARROW DIMENSIONS (INCHES)

	F	G	H	M	N	P	Q	R
	2.625	2.625	8.659	5.25	3	5.25	0.375	0.5

8/10/2019 3:56:59 PM NCDOT_2018_Traffic-LSA-Project\Traffic\Signing\CADD\Signing Layout Plans\AR-3830_Sign_Sign_3.dgn

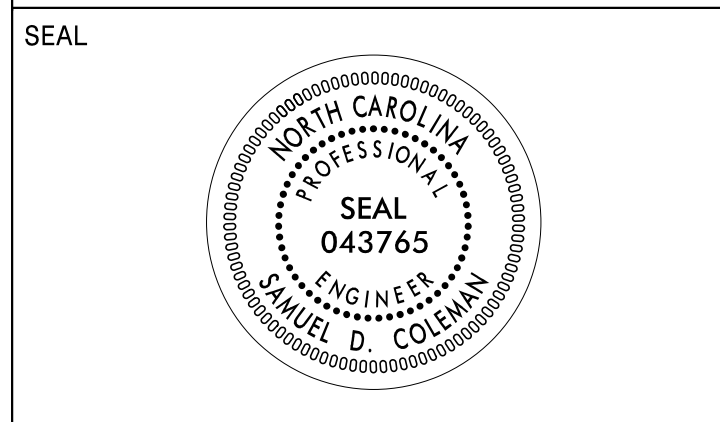

**DOCUMENT NOT CONSIDERED FINAL
 UNLESS ALL SIGNATURES COMPLETED**

SIGN NUMBER: 303 TYPE: D QUANTITY: 1 SIGN WIDTH: 5'-0" HEIGHT: 2'-6" TOTAL AREA: 12.5 Sq.Ft. BORDER TYPE: FLUSH RECESS: 0" WIDTH: 0.75" RADIUS: 3" NO. Z BARS: LENGTH:	BACKG COLOR: Green COPY COLOR: White SYMBOL X Y WID HT MAT'L: 0.125" (3.2 mm) ALUMINUM	DESIGN BY: S COLEMAN PROJECT ID: R-3830 LOCATION: NC 42/SR 1579 IN SANFORD/BROADWAY CHECKED BY: Feb 25, 2019 DIV: 8
---	--	---

USE NOTES: 1,2
 1. Legend and border(except those that are colored black) shall be direct applied Grade C sheeting.
 2. Background shall be Grade C reflective sheeting.

LETTER POSITIONS

Letter spacings are to start of next letter											Series/Size
											Text Length
	B	r	o	a	d	w	a	y			D 2000
	5.2	5	2.8	4.3	4.3	4.3	7.2	4.1	4.5	18.3	36.5
	3										D 2000
	50.7	4.1	5.2								4.1
	L	i	l	i	n	g	t	o	n		D 2000
	5.2	4.5	2.2	2.2	2.2	4.4	4.3	2.8	4.6	3.5	32.8
	1	7									D 2000
	48.1	2.6	4.1	5.2							6.7

FILENAME: R-3830_Sign Designs NORTH CAROLINA D.O.T. SIGN DETAIL

SIGN NUMBER: 304 TYPE: D QUANTITY: 1 SIGN WIDTH: 7'-0" HEIGHT: 2'-6" TOTAL AREA: 17.5 Sq.Ft. BORDER TYPE: FLUSH RECESS: 0" WIDTH: 0.75" RADIUS: 3" NO. Z BARS: LENGTH:	BACKG COLOR: Green / Green COPY COLOR: White SYMBOL X Y WID HT AR_type D 17.8 17 6 9 AR_type D 5.8 4 6 9 MAT'L: 0.125" (3.2 mm) ALUMINUM	DESIGN BY: S COLEMAN PROJECT ID: R-3830 LOCATION: NC 42/SR 1579 IN SANFORD/BROADWAY CHECKED BY: Jul 12, 2019 DIV: 8
---	--	---

USE NOTES: 1,2
 1. Legend and border(except those that are colored black) shall be direct applied Grade C sheeting.
 2. Background shall be Grade C reflective sheeting.

LETTER POSITIONS

Letter spacings are to start of next letter											Series/Size							
											Text Length							
	B	r	o	a	d	w	a	y			D 2000							
	29.8	5	2.8	4.3	4.3	4.3	7.2	4.1	4.5	17.8	36.5							
	F	u	q	u	a	y	-	V	a	r	i	n	a	D 2000				
	20.8	4.4	4.5	4.7	4.4	4.1	4.5	3	2.1	3	5	4.6	3	2.2	4.4	3.4	5.8	57.4

FILENAME: R-3830_Sign Designs NORTH CAROLINA D.O.T. SIGN DETAIL

SIGN NUMBER: 305 TYPE: D QUANTITY: 1 SIGN WIDTH: 7'-0" HEIGHT: 2'-6" TOTAL AREA: 17.5 Sq.Ft. BORDER TYPE: FLUSH RECESS: 0" WIDTH: 0.75" RADIUS: 3" NO. Z BARS: LENGTH:	BACKG COLOR: Green / Green COPY COLOR: White SYMBOL X Y WID HT AR_type D 22.4 17 6 9 AR_type D 69.2 4 6 9 MAT'L: 0.125" (3.2 mm) ALUMINUM	DESIGN BY: S COLEMAN PROJECT ID: R-3830 LOCATION: NC 42/SR 1579 IN SANFORD/BROADWAY CHECKED BY: Jul 12, 2019 DIV: 8
---	---	---

USE NOTES: 1,2
 1. Legend and border(except those that are colored black) shall be direct applied Grade C sheeting.
 2. Background shall be Grade C reflective sheeting.

LETTER POSITIONS

Letter spacings are to start of next letter											Series/Size							
											Text Length							
	S	a	n	f	o	r	d				D 2000							
	34.4	4.7	4.6	4.3	2.6	4.6	2.8	3.6	22.4		27.2							
	F	u	q	u	a	y	-	V	a	r	i	n	a	D 2000				
	5.8	4.4	4.5	4.7	4.4	4.1	4.5	3	2.1	3	5	4.6	3	2.2	4.4	3.4	20.8	57.4

FILENAME: R-3830_Sign Designs NORTH CAROLINA D.O.T. SIGN DETAIL

SIGN NUMBER: 306 TYPE: D QUANTITY: 1 SIGN WIDTH: 7'-6" HEIGHT: 2'-6" TOTAL AREA: 18.8 Sq.Ft. BORDER TYPE: FLUSH RECESS: 0" WIDTH: 0.75" RADIUS: 3" NO. Z BARS: LENGTH:	BACKG COLOR: Green COPY COLOR: White SYMBOL X Y WID HT MAT'L: 0.125" (3.2 mm) ALUMINUM	DESIGN BY: S COLEMAN PROJECT ID: R-3830 LOCATION: NC 42/SR 1579 IN SANFORD/BROADWAY CHECKED BY: Feb 26, 2019 DIV: 8
---	--	---

USE NOTES: 1,2
 1. Legend and border(except those that are colored black) shall be direct applied Grade C sheeting.
 2. Background shall be Grade C reflective sheeting.

LETTER POSITIONS

Letter spacings are to start of next letter											Series/Size							
											Text Length							
	C	o	r	i	n	t	h				D 2000							
	7.1	5	4.6	3	2.2	4.1	3.1	3.5	57.3		25.6							
	1	0									D 2000							
	75.8	2.8	4.3	7.1							7.1							
	F	u	q	u	a	y	-	V	a	r	i	n	a	D 2000				
	7.1	4.4	4.5	4.7	4.4	4.1	4.5	3	2.1	3	5	4.6	3	2.2	4.4	3.4	25.5	57.4
	2	4																D 2000
	73.5	4.8	4.5	7.2														9.3

FILENAME: R-3830_Sign Designs NORTH CAROLINA D.O.T. SIGN DETAIL

8/27/2019 8:39:56 AM NCDOT_2018_Traffic-LSA\Proj\AL-R-3830\Traffic\Signing\CADD\Signing Layout Plans\R-3830_Sign-3A.dgn User: 0185144

APPROVED: Samuel D. Coleman
 DATE: 8/27/2019

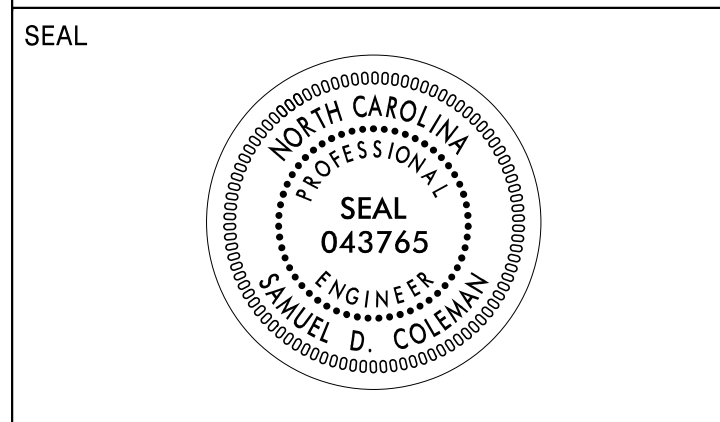

**DOCUMENT NOT CONSIDERED FINAL
 UNLESS ALL SIGNATURES COMPLETED**

SIGN NUMBER: 307 TYPE: D QUANTITY: 1 SIGN WIDTH: 4'-6" HEIGHT: 2'-0" TOTAL AREA: 9.0 Sq.Ft. BORDER TYPE: FLUSH RECESS: 0" WIDTH: 0.75" RADII: 3" NO. Z BARS: LENGTH:	BACKG COLOR: Green COPY COLOR: White SYMBOL	DESIGN BY: S COLEMAN PROJECT ID: R-3830 LOCATION: NC 42/SR 1579 IN SANFORD/BROADWAY	CHECKED BY: DIV: 8 Apr 09, 2019
---	---	--	---------------------------------------

BORDER R=3" TH=0.75"

Spacing Factor is 1 unless specified otherwise

LETTER POSITIONS													Series/Size
Letter spacings are to start of next letter													Text Length
B	R	O	A	D	W	A	Y						D 2000
5.9	5.1	5	5	6	4.9	5.7	5.5	5.2	5.9				42.3
C	I	T	Y	L	I	M	I	T					D 2000
13.3	3.6	1.2	2.7	3.4	4	3.1	1.6	4.1	1.2	2.5	13.3		27.5

FILENAME: R-3830_Sign Designs NORTH CAROLINA D.O.T. SIGN DETAIL

SIGN NUMBER: 308 TYPE: D QUANTITY: 1 SIGN WIDTH: 2'-6" HEIGHT: 1'-6" TOTAL AREA: 3.8 Sq.Ft. BORDER TYPE: FLUSH RECESS: 0" WIDTH: 0.5" RADII: 1.5" NO. Z BARS: LENGTH:	BACKG COLOR: Green COPY COLOR: White SYMBOL	DESIGN BY: S COLEMAN PROJECT ID: R-3830 LOCATION: NC 42/SR 1579 IN SANFORD/BROADWAY	CHECKED BY: DIV: 8 Apr 09, 2019
--	---	--	---------------------------------------

BORDER R=1.5" TH=0.5"

Spacing Factor is 1 unless specified otherwise

LETTER POSITIONS													Series/Size
Letter spacings are to start of next letter													Text Length
B	I	R	D										S 2000
10.1	3	1.8	2.9	2.2	10.1								9.8
S	A	N	C	T	U	A	R	Y					S 2000
2.1	2.6	3.4	3.1	2.7	2.6	2.8	3.4	2.6	2.7	2.1			25.9

FILENAME: R-3830_Sign Designs NORTH CAROLINA D.O.T. SIGN DETAIL

8/27/2019 8:39:56 AM NCDOT_2018_Traffic-LSA\Proj\AL-R-3830\Traffic\Signing\CADD\Signing Layout Plans\R-3830_Sign-SIGN_3B.dgn User: D185144

SIGN DESIGNS

PLANS PREPARED FOR THE NCDOT BY:
M M
MOTT MACDONALD
P.O. Box 705
Fayetteville, NC 27516
(919) 552-2233
(919) 552-2254 (fax)
www.mottmac.com
LICENSE NO. F-8669

PROJECT REFERENCE NO. R-3830 SHEET NO. SIGN-4

APPROVED: *Samuel D. Coleman*
DATE: 8/27/2019

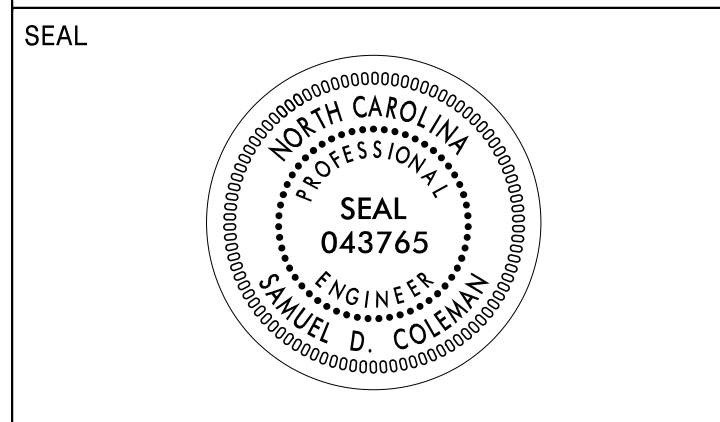

**DOCUMENT NOT CONSIDERED FINAL
UNLESS ALL SIGNATURES COMPLETED**

401 QUANTITY REQ'D 14

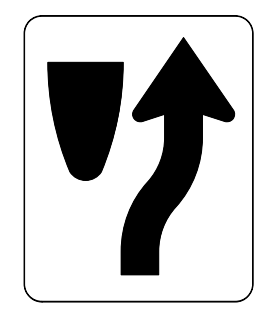

24" X 30"
R4-7

ONE "U" POST PER SIGN

402 QUANTITY REQ'D 14

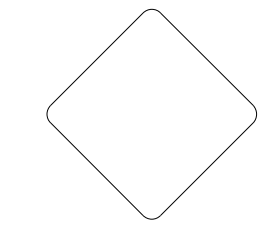

18" X 18"
OM1-3

MOUNTED BELOW SIGN 401
IN 13 INSTALLATIONS

403 QUANTITY REQ'D 7



30" X 36"
R2-1

ONE "U" POST PER SIGN

404 QUANTITY REQ'D 1

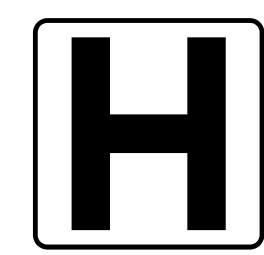

24" X 24"
D9-2

ONE "U" POST PER SIGN

405 QUANTITY REQ'D 1

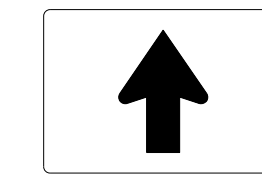

21" X 15"
M6-3

MOUNTED BELOW SIGN 404
IN 1 INSTALLATION

406 QUANTITY REQ'D 1

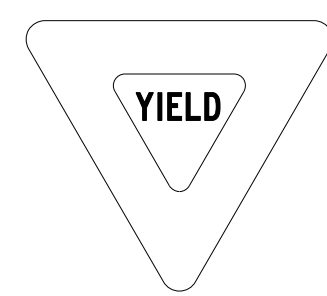

36" X 36" X 36"
R1-2

ONE "U" POST PER SIGN

407 QUANTITY REQ'D 4



30" X 24"
R3-17

ONE "U" POST PER SIGN

408 QUANTITY REQ'D 8

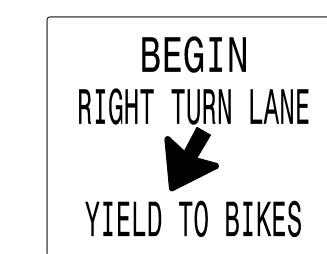

36" X 30"
R4-4

TWO "U" POSTS PER SIGN

409 QUANTITY REQ'D 2



30" X 12"
R3-17b

MOUNTED BELOW SIGN 407
IN 2 INSTALLATIONS

410 QUANTITY REQ'D 18

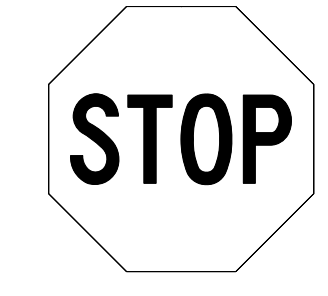

36" X 36"
R1-1

ONE "U" POST PER SIGN
MOUNTED BELOW SIGN 411
IN 7 INSTALLATIONS
USING TWO "U" POSTS PER SIGN

411 QUANTITY REQ'D 9

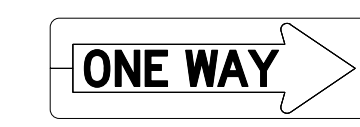

54" X 18"
R6-1R

TWO "U" POSTS PER SIGN

412 QUANTITY REQ'D 7

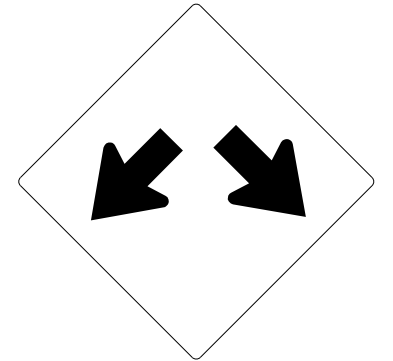

36" X 36"
W12-1

ONE "U" POST PER SIGN

413 QUANTITY REQ'D 8



30" X 36"
R2-1

ONE "U" POST PER SIGN

414 QUANTITY REQ'D 3

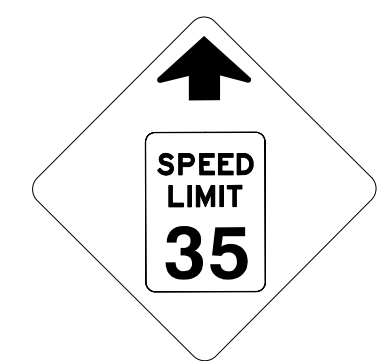

36" X 36"
W3-5

ONE "U" POST PER SIGN

415 QUANTITY REQ'D 2



36" X 36"
W8

ONE "U" POST PER SIGN

416 QUANTITY REQ'D 1



36" X 36"
W14-2

ONE "U" POST PER SIGN

417 QUANTITY REQ'D 1



54" X 18"
R6-1L

TWO "U" POSTS PER SIGN

418 QUANTITY REQ'D 2

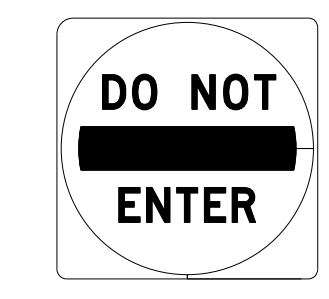

36" X 36"
R5-1

TWO "U" POSTS PER SIGN

419 QUANTITY REQ'D 5



30" X 36"
R2-1

ONE "U" POST PER SIGN

420 QUANTITY REQ'D 1

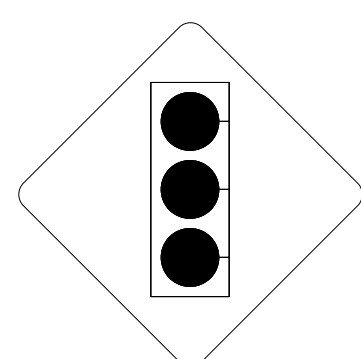

30" X 30"
W3-3

ONE "U" POST PER SIGN

421 QUANTITY REQ'D 2

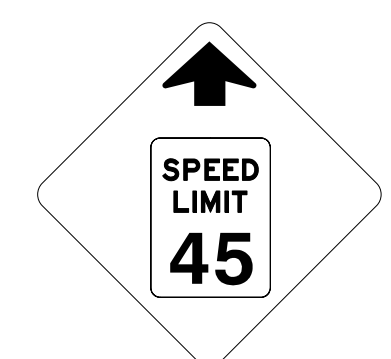

36" X 36"
W3-5

ONE "U" POST PER SIGN

422 QUANTITY REQ'D 3



36" X 36"
R3-7L

TWO "U" POSTS PER SIGN

423 QUANTITY REQ'D 2

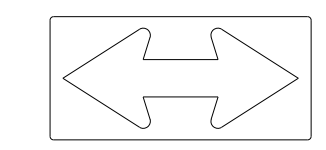

48" X 24"
W1-7

TWO "U" POSTS PER SIGN

424 QUANTITY REQ'D 1



24" X 6"
R2-5aP

MOUNTED ABOVE SIGN 403
IN 1 INSTALLATION

425 QUANTITY REQ'D 1



24" X 18"
R2-5P

MOUNTED BELOW SIGN 403
IN 1 INSTALLATION

426 QUANTITY REQ'D 1

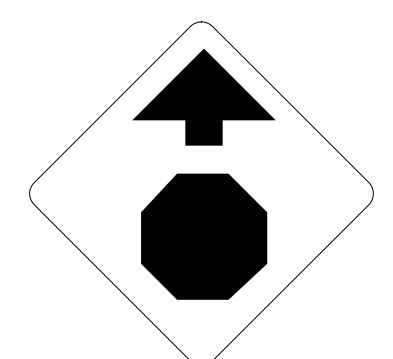

30" X 30"
W3-1

ONE "U" POST PER SIGN

427 QUANTITY REQ'D 2



30" X 36"
R2-1

ONE "U" POST PER SIGN

428 QUANTITY REQ'D 2



36" X 36"
R3-7R

TWO "U" POSTS PER SIGN

429 QUANTITY REQ'D 1



24" X 8"
S4-3P

MOUNTED ABOVE SIGN 403
IN 1 INSTALLATION

430 QUANTITY REQ'D 1

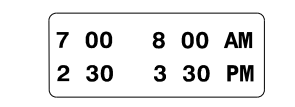

24" X 10"
S4-1P

MOUNTED BELOW SIGN 403
IN 1 INSTALLATION

TYPE "E" SIGNS

8/27/2019 3:39:56 PM C:\Users\jcl\Documents\2018_Traffic\LSA\Proj\VAL-R-3830\Traffic\Signing\CADD\Signing Layout Plans\Sign-4.dgn

PLANS PREPARED FOR THE NCDOT BY:
M M
MOTT MACDONALD
P.O. Box 705
Fayetteville, NC 27516
(919) 552-2233
www.mottmacdonald.com
LICENSE NO. F-8669

PROJECT REFERENCE NO. R-3830	SHEET NO. SIGN-4A
APPROVED: <i>Samuel D. Coleman</i> DATE: 9/10/2019	

**DOCUMENT NOT CONSIDERED FINAL
UNLESS ALL SIGNATURES COMPLETED**

501

		2 - 24" X 12"
		2 - 24" X 24"
		2 - 21" X 15"
		2 - 24" X 12"
		2 - 24" X 24"
		2 - 21" X 15"

TWO "U" POSTS PER SIGN

502

		2 - 24" X 12"
		2 - 24" X 24"
		2 - 21" X 15"
		2 - 24" X 12"
		2 - 24" X 24"
		2 - 21" X 15"

TWO "U" POSTS PER SIGN

503

		1 - 24" X 12"
		2 - 24" X 12"
		1 - 30" X 24"
		1 - 24" X 24"

TWO "U" POSTS PER SIGN

504

		2 - 24" X 12"
		2 - 24" X 24"
		2 - 21" X 15"
		2 - 24" X 12"
		2 - 24" X 24"
		2 - 21" X 15"

TWO "U" POSTS PER SIGN

505

		2 - 24" X 12"
		2 - 24" X 24"
		2 - 21" X 15"
		2 - 24" X 12"
		2 - 24" X 24"
		2 - 21" X 15"

TWO "U" POSTS PER SIGN

506

	1 - 24" X 12"	
	1 - 24" X 12"	
	1 - 30" X 24"	
		2 - 24" X 12"
		2 - 24" X 24"

TWO "U" POSTS PER SIGN

507 518 525 533

	1 - 24" X 12"
	1 - 24" X 24"

MOUNTED BELOW SIGNS 301, 306
IN 2 INSTALLATIONS

508

		2 - 24" X 12"
		2 - 24" X 24"
		2 - 21" X 15"
		2 - 24" X 12"
		2 - 24" X 24"
		2 - 21" X 15"

TWO "U" POSTS PER SIGN

509

	1 - 24" X 12"
	1 - 24" X 24"
	SEE SIGN-3 FOR DESIGN

ONE "U" POST PER SIGN

510 519

	1 - 21" X 15"
	1 - 30" X 24"
	1 - 24" X 12"
	1 - 24" X 24"

ONE "U" POST PER SIGN

511

		2 - 24" X 12"
		2 - 30" X 24"
		2 - 21" X 15"
		2 - 24" X 12"
		2 - 24" X 12"
		2 - 24" X 24"
		2 - 21" X 15"

TWO "U" POSTS PER SIGN

512

		2 - 24" X 12"
		2 - 30" X 24"
		2 - 21" X 15"
		2 - 24" X 12"
		2 - 24" X 12"
		2 - 24" X 24"
		2 - 21" X 15"

TWO "U" POSTS PER SIGN

513

	1 - 24" X 12"
	1 - 24" X 24"
	1 - 24" X 12"
	2 - 24" X 12"
	1 - 30" X 24"
	1 - 24" X 24"
	2 - 21" X 15"

TWO "U" POSTS PER SIGN

514

	1 - 24" X 12"
	2 - 24" X 12"
	1 - 30" X 24"
	1 - 24" X 24"
	2 - 21" X 15"

TWO "U" POSTS PER SIGN

515

		2 - 24" X 12"
		2 - 24" X 24"
		2 - 21" X 15"

TWO "U" POSTS PER SIGN

516 526 530

	1 - 24" X 12"
	1 - 24" X 24"

ONE "U" POST PER SIGN

517

	1 - 24" X 12"
	1 - 24" X 24"
	1 - 24" X 12"
	2 - 24" X 12"
	1 - 30" X 24"
	1 - 24" X 24"
	2 - 21" X 15"

TWO "U" POSTS PER SIGN

520

	1 - 24" X 12"
	1 - 24" X 24"
	1 - 21" X 15"

ONE "U" POST PER SIGN

521

		2 - 24" X 12"
		2 - 30" X 24"
		2 - 21" X 15"
		2 - 24" X 12"
		2 - 24" X 12"
		2 - 24" X 24"
		2 - 21" X 15"

TWO "U" POSTS PER SIGN

522

		2 - 24" X 12"
		2 - 30" X 24"
		2 - 21" X 15"
		2 - 24" X 12"
		2 - 24" X 12"
		2 - 24" X 24"
		2 - 21" X 15"

TWO "U" POSTS PER SIGN

523

	1 - 24" X 12"
	1 - 24" X 24"
	1 - 21" X 15"

ONE "U" POST PER SIGN

524

	1 - 24" X 12"
	2 - 24" X 12"
	1 - 30" X 24"
	1 - 24" X 24"
	2 - 21" X 15"

TWO "U" POSTS PER SIGN

527

		2 - 24" X 12"
		2 - 24" X 24"
		2 - 21" X 15"

TWO "U" POSTS PER SIGN

528

	1 - 24" X 12"
	1 - 24" X 24"
	1 - 21" X 15"

ONE "U" POST PER SIGN

529

	1 - 24" X 12"
	1 - 24" X 24"
	1 - 21" X 15"

ONE "U" POST PER SIGN

531

	1 - 21" X 15"
	1 - 24" X 24"

ONE "U" POST PER SIGN

532

		2 - 24" X 12"
		2 - 24" X 24"
		2 - 21" X 15"

TWO "U" POSTS PER SIGN

534

	1 - 24" X 12"
	1 - 24" X 24"
	1 - 21" X 15"

ONE "U" POST PER SIGN

535

	1 - 24" X 12"
	1 - 24" X 24"
	1 - 21" X 15"

ONE "U" POST PER SIGN

536

	1 - 21" X 15"
	1 - 24" X 24"

ONE "U" POST PER SIGN

537

	1 - 24" X 12"
	1 - 24" X 24"
	1 - 21" X 15"

ONE "U" POST PER SIGN

TYPE "F" SIGNS

9/10/2019 9:56:59 AM NCDOT_2018_Traffic_LSA_Proj_VAL_R-3830_Traffic_Signing_CADD_Signing_Layout_Plans\N-3830_Sign_Sign_4A.dgn User:COL8514

BEGIN TIP PROJECT R-3830
-L- 13+25

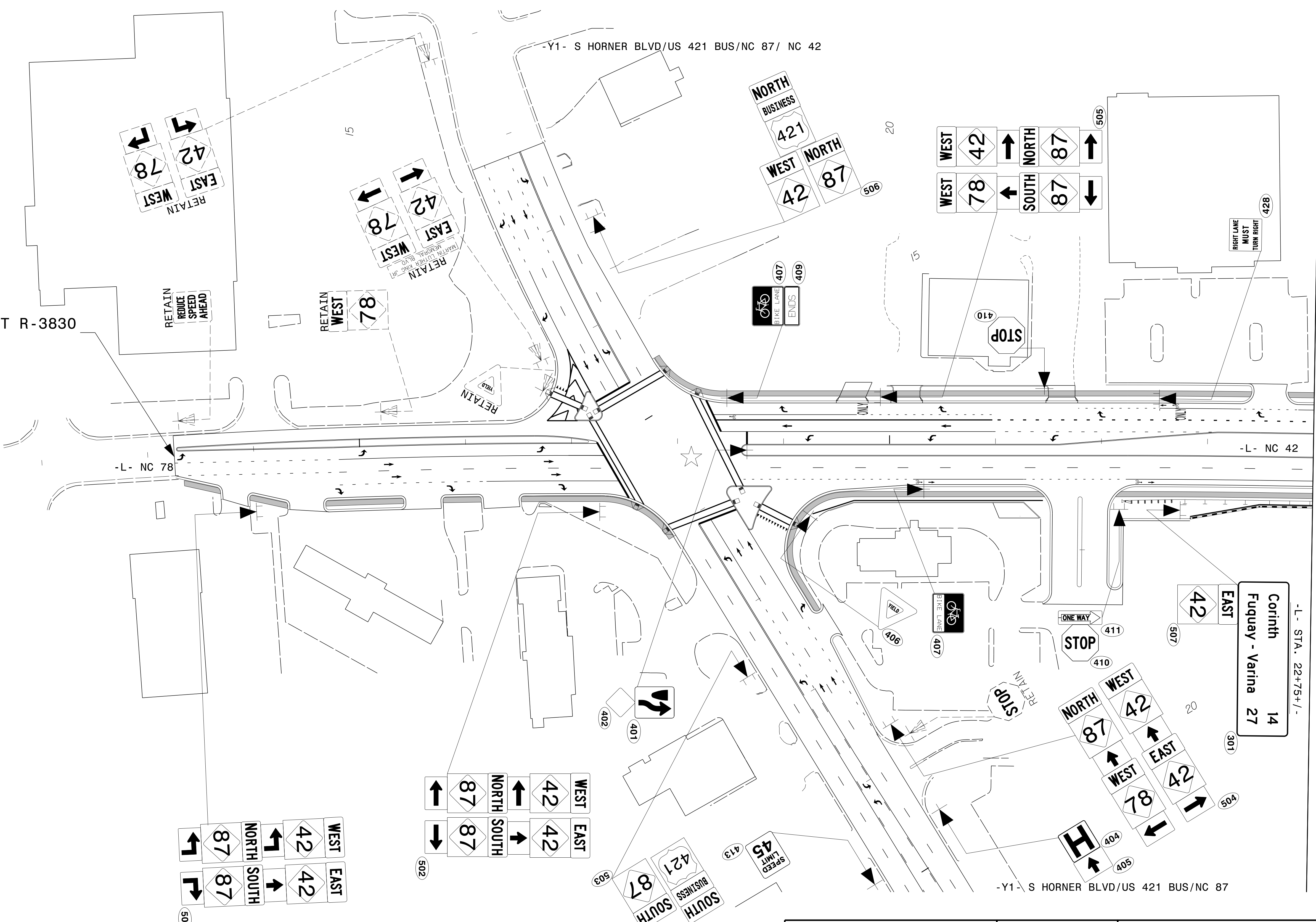
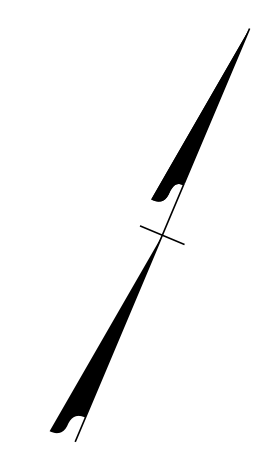

MATCHLINE - L - STA 24+00 SEE SIGN-6

- L - STA. 22+75+/-
Corinth 14
Fuquay - Varina 27

8/27/2019
G:\395689_NCDOT_2018_Traffic\LSA\Proj\ALR-3830\Traffic\Signing\CADD\Signing Layout Plans\R-3830_Sgn_SIGN_5.dgn
User:COL85144

APPROVED: *Samuel D. Coleman*
DATE: 8/27/2019

SEAL

DOCUMENT NOT CONSIDERED FINAL
UNLESS ALL SIGNATURES COMPLETED

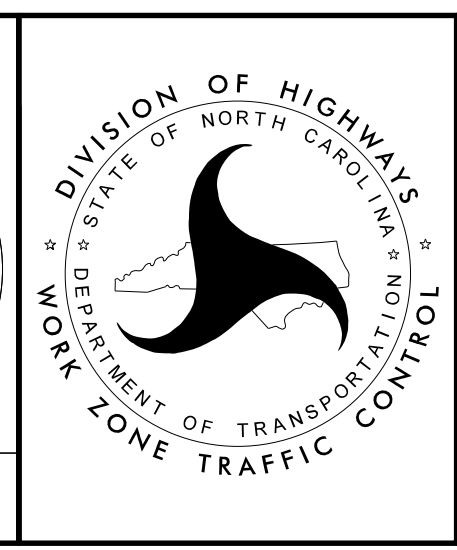

DIVISION OF HIGHWAYS
STATE OF NORTH CAROLINA
DEPARTMENT OF TRANSPORTATION
WORK ZONE TRAFFIC CONTROL

SIGNING DETAIL SHEET

BEGIN TIP PROJECT R-3830
-L- 13+25

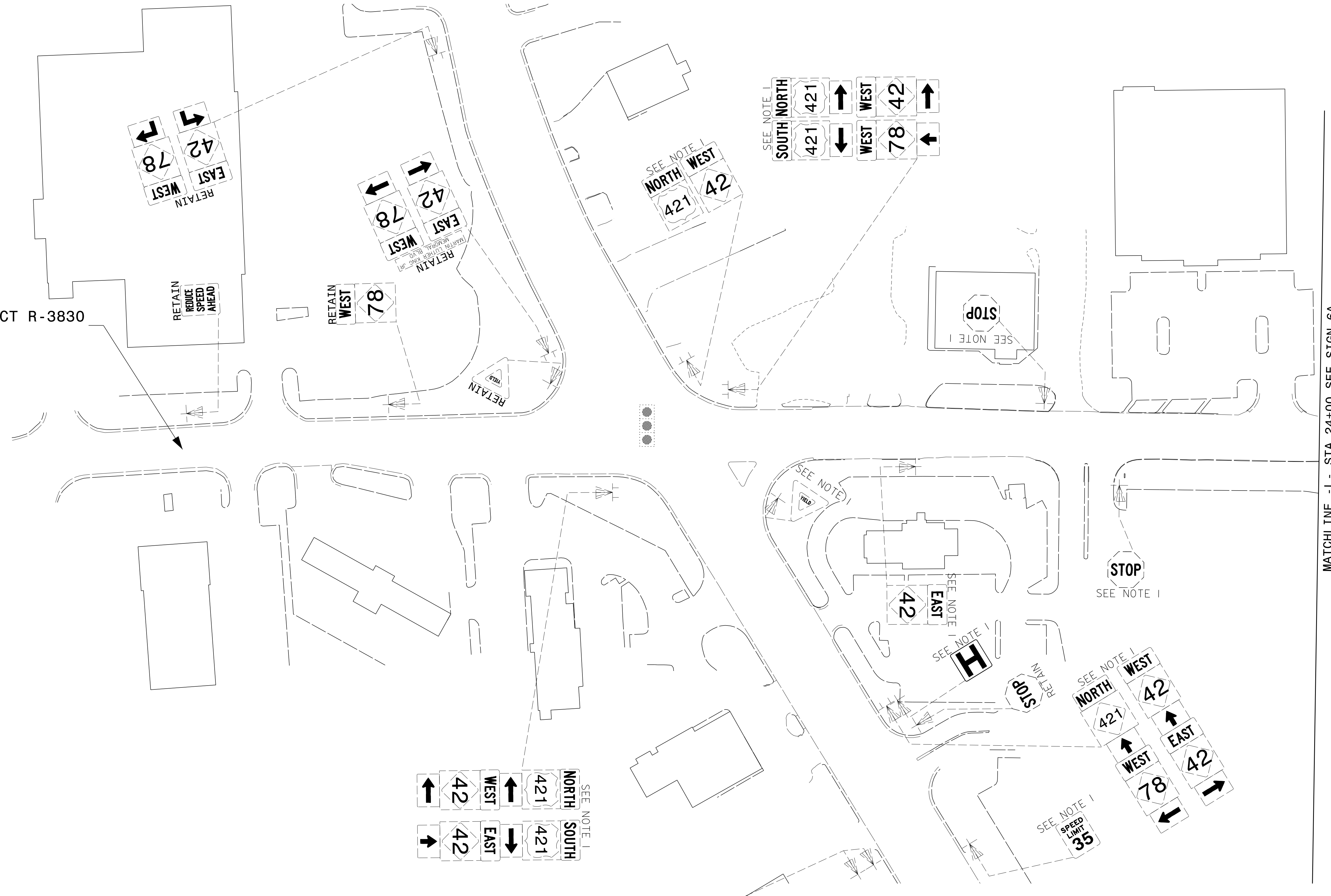
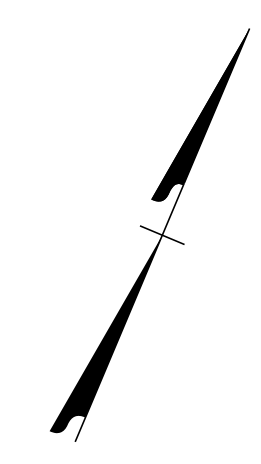

8/27/2019
G:\395689_NCDOT_2018_Traffic\LSA\Proj\ALR-3830\Traffic\Signing\CADD\Signing Layout Plans\R-3830_Sgn_SIGN_5A.dgn
User:COL85144

SEE NOTE 1
NORTH 421 EAST 421 SOUTH 421
WEST 42 EAST 42
↑ ↓

SEE NOTE 1
NORTH 421 WEST 42
WEST 78 EAST 42
↑ ↓

SEE NOTE 1
SOUTH NORTH 421 WEST 42
WEST 78 EAST 42
↑ ↓

SEE NOTE 1
H
SEE NOTE 1
STOP
RETAIN

SEE NOTE 1
NORTH 421 WEST 42
WEST 78 EAST 42
↑ ↓

SEE NOTE 1
SPEED LIMIT 35

MATCHLINE - L - STA 24+00 SEE SIGN-6A

APPROVED: *Samuel D. Coleman*
DATE: 8/27/2019

SEAL

SEAL
NORTH CAROLINA PROFESSIONAL ENGINEER
043765
SAMUEL D. COLEMAN

**DOCUMENT NOT CONSIDERED FINAL
UNLESS ALL SIGNATURES COMPLETED**

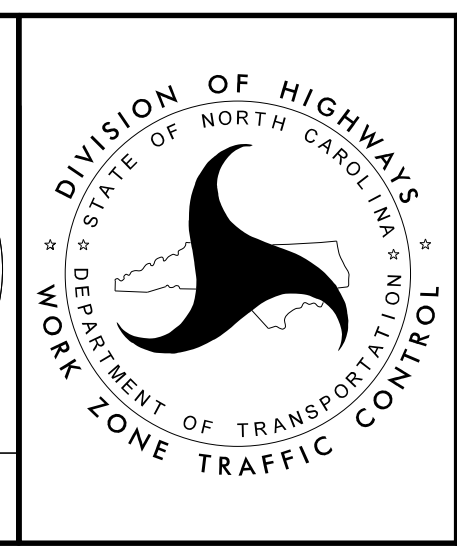

EXISTING
SIGNING DETAIL SHEET

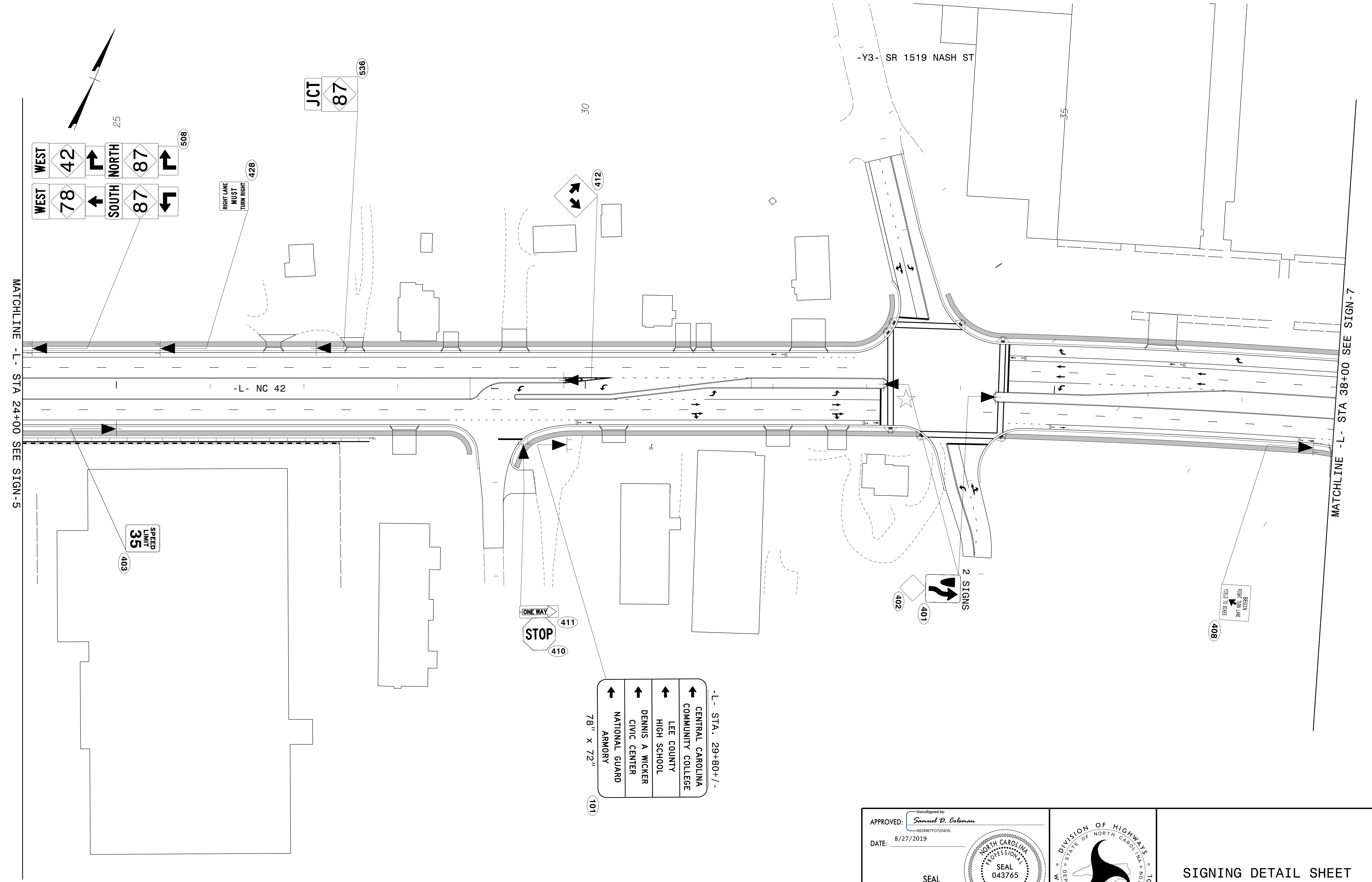

8/27/2019
G:\395689_NCDOT_2018_Traffic\LSA\Proj\ALR-3830\Traffic\Signing\CADD\Signing Layout Plans\R-3830_Sgn_Sign_L6.dgn
User:COL85144

APPROVED: *Samuel D. Coleman*
DATE: 8/27/2019

SEAL

DOCUMENT NOT CONSIDERED FINAL
UNLESS ALL SIGNATURES COMPLETED

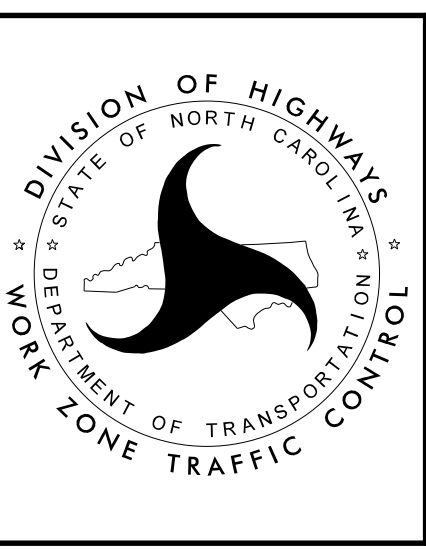

SIGNING DETAIL SHEET

PLANS PREPARED FOR THE NCDOT BY:
M MOTT
MACDONALD
PO Box 700
Cary, NC 27514
919-551-2233
919-551-2234 Fax
www.mottmacdonald.com
LICENSE NO. F-6669

PROJ. REFERENCE NO.	SHEET NO.
R-3830	SIGN-6A

MATCHLINE - L - STA 24+00 SEE SIGN - 5A

MATCHLINE - L - STA 38+00 SEE SIGN - 7A

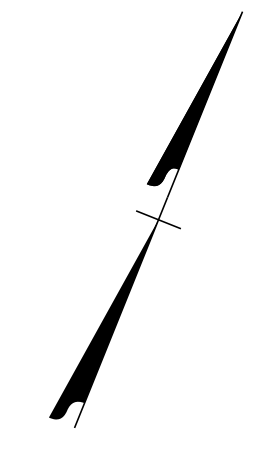

SEE NOTE 1
CORINTH 141
EUQUAY-VARINA 271

SEE NOTE 1
STOP
SEE NOTE 1
↑ NATIONAL ARMORY
↑ DENNIS A. WICKER CIVIC CENTER
↑ LEE COUNTY HIGH SCHOOL
↑ CENTRAL CAROLINA COMMUNITY COLLEGE

8/27/2019
G:\395689_NCDOT_2018_Traffic\LSA\Proj\ALR-3830\Traffic\Signing\CADD\Signing Layout Plans\AR-3830_Sgn_SIGN_6A.dgn
User:COL85144

APPROVED: *Samuel D. Coleman*
6828607F07254D9
DATE: 8/27/2019

SEAL

**DOCUMENT NOT CONSIDERED FINAL
UNLESS ALL SIGNATURES COMPLETED**

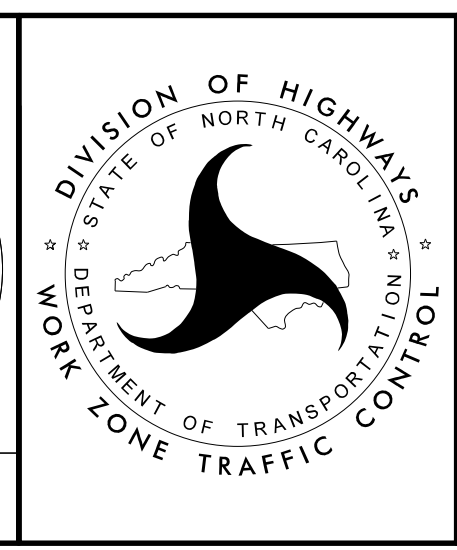

EXISTING
SIGNING DETAIL SHEET

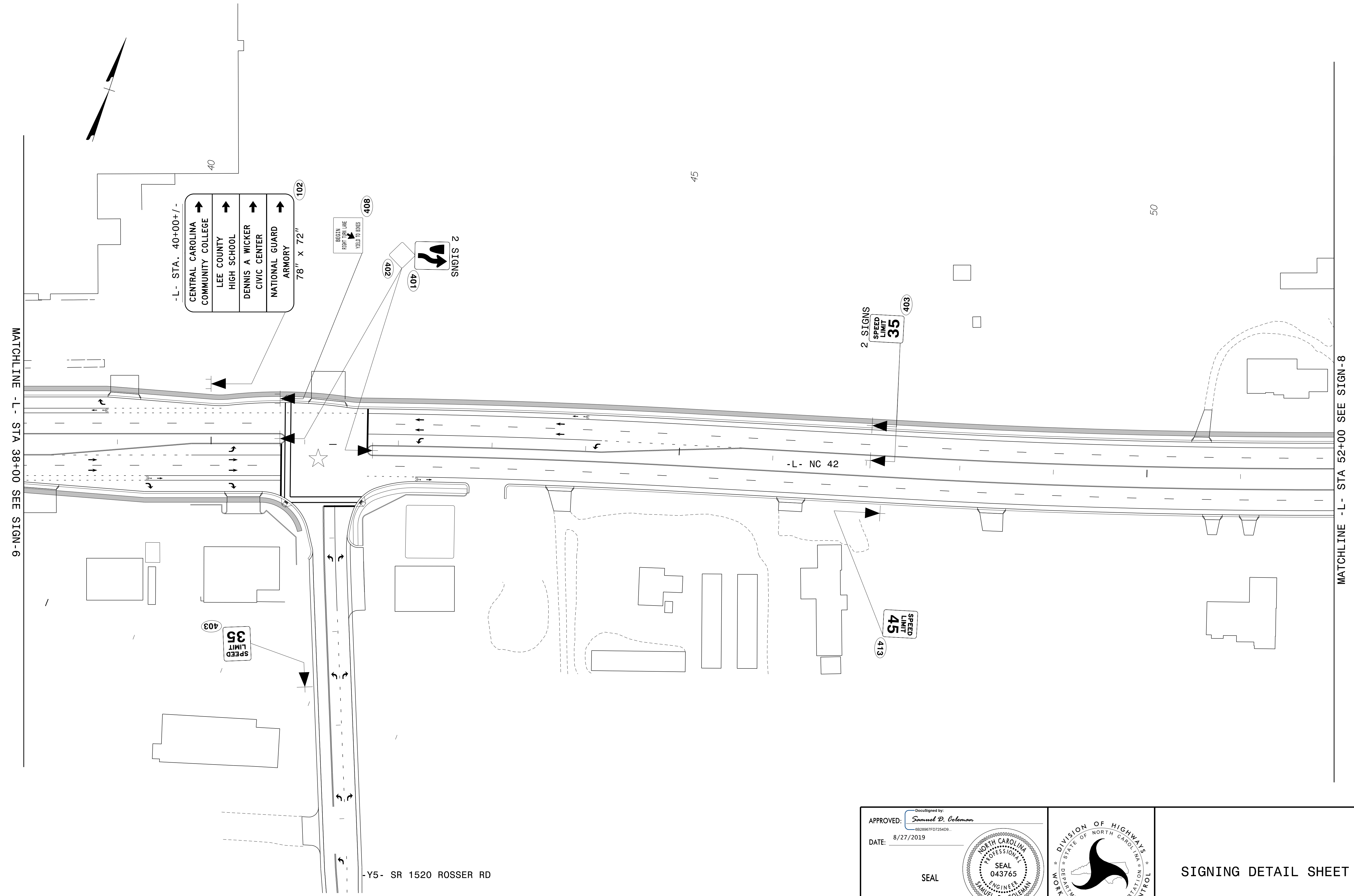

8/27/2019
G:\395689_NCDOT_2018_Traffic\LSA\Proj\ALR-3830\Traffic\Signing\CADD\Signing Layout Plans\ALR-3830_Sgn_Sign_7.dgn
User:COL85144

APPROVED: *Samuel D. Coleman*
DATE: 8/27/2019
SEAL
NORTH CAROLINA PROFESSIONAL ENGINEER
SEAL 043765
SAMUEL D. COLEMAN

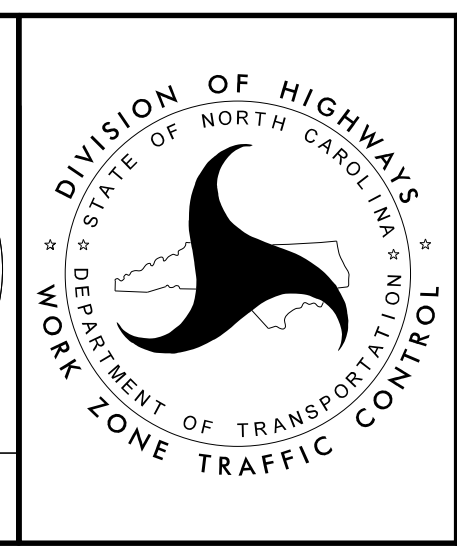

SIGNING DETAIL SHEET

DOCUMENT NOT CONSIDERED FINAL
UNLESS ALL SIGNATURES COMPLETED

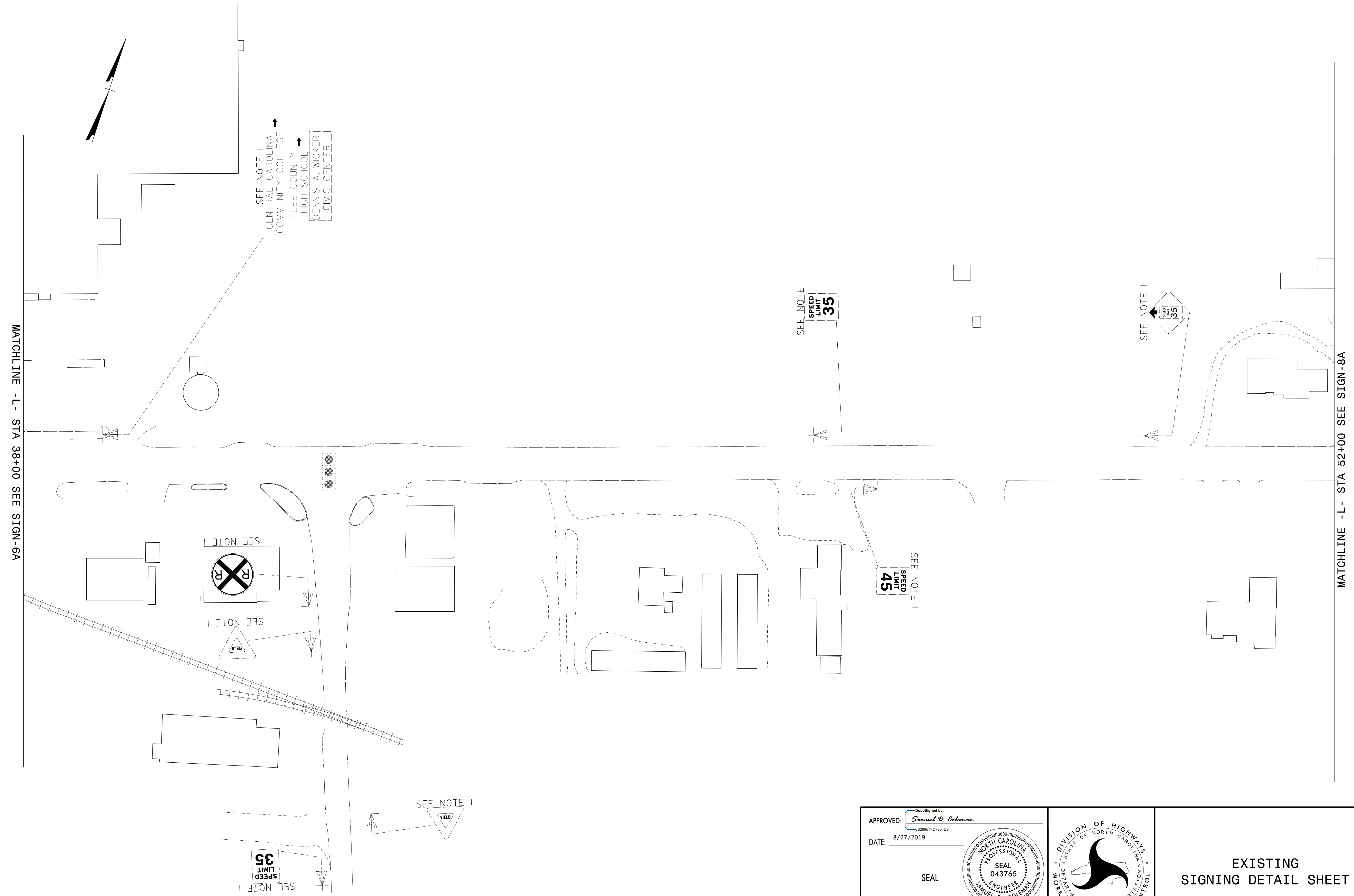

8/27/2019
G:\395689_NCDOT_2018_Traffic_LSA\Proj\ALR-3830\Traffic\Signing\CADD\Signing Layout Plans\R-3830_Sgn_SIGN_7A.dgn
User:COL85144

APPROVED: *Samuel D. Coleman*
DATE: 8/27/2019

SEAL

DOCUMENT NOT CONSIDERED FINAL
UNLESS ALL SIGNATURES COMPLETED

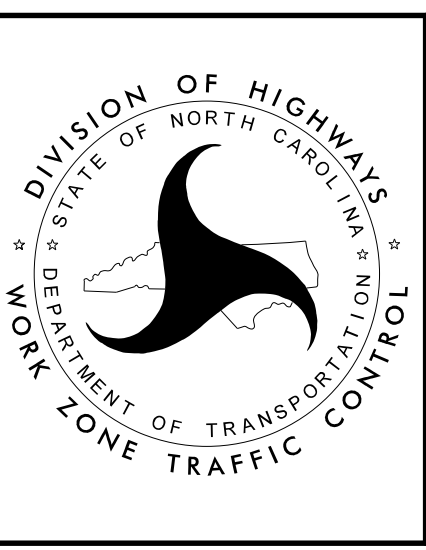

EXISTING
SIGNING DETAIL SHEET

PLANS PREPARED FOR THE NCDOT BY:
M M
MONT MACDONALD
LICENSE NO. F-9669

PROJ. REFERENCE NO.	SHEET NO.
R-3830	SIGN-8

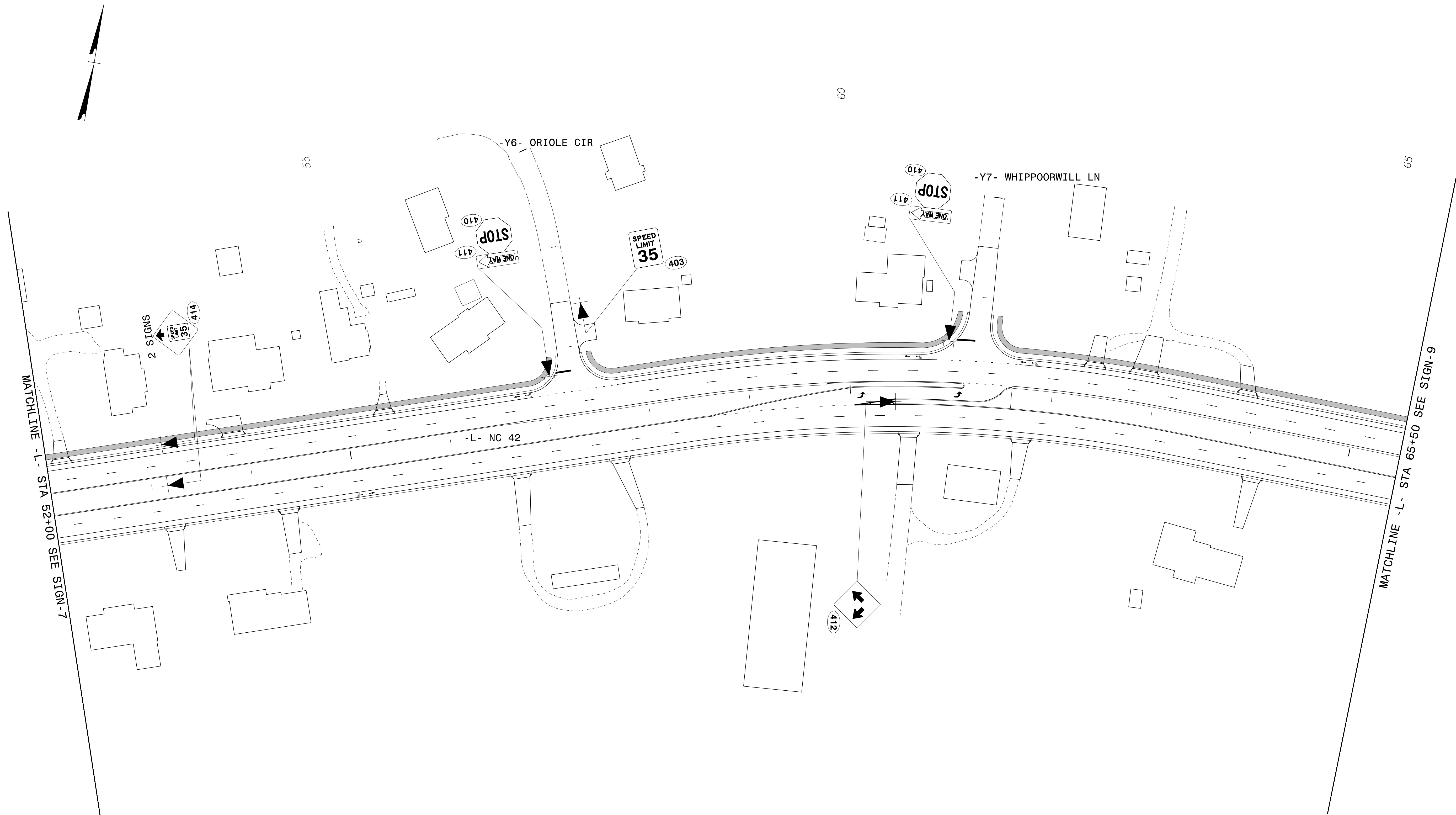

8/27/2019
G:\395689_NCDOT_2018_Traffic\LSA\Proj\ALR-3830\Traffic\Signing\CADD\Signing Layout Plans\R-3830_Sgn_SIGN-8.dgn
User:COL85144

DocuSigned by:
Samuel D. Coleman
6B28607F07254D9

APPROVED: _____
DATE: 8/27/2019

SEAL

SEAL
NORTH CAROLINA
PROFESSIONAL
ENGINEER
SAMUEL D. COLEMAN
043765

**DOCUMENT NOT CONSIDERED FINAL
UNLESS ALL SIGNATURES COMPLETED**

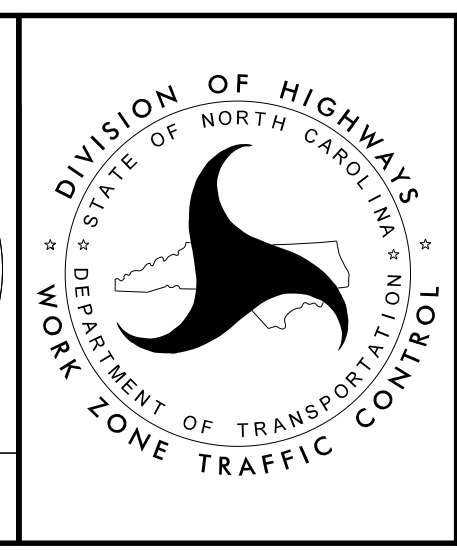

SIGNING DETAIL SHEET

PLANS PREPARED FOR THE NCDOT BY:
M M
MOY
MACDONALD
LICENSE NO. F-6669

PROJ. REFERENCE NO.	SHEET NO.
R-3830	SIGN-8A

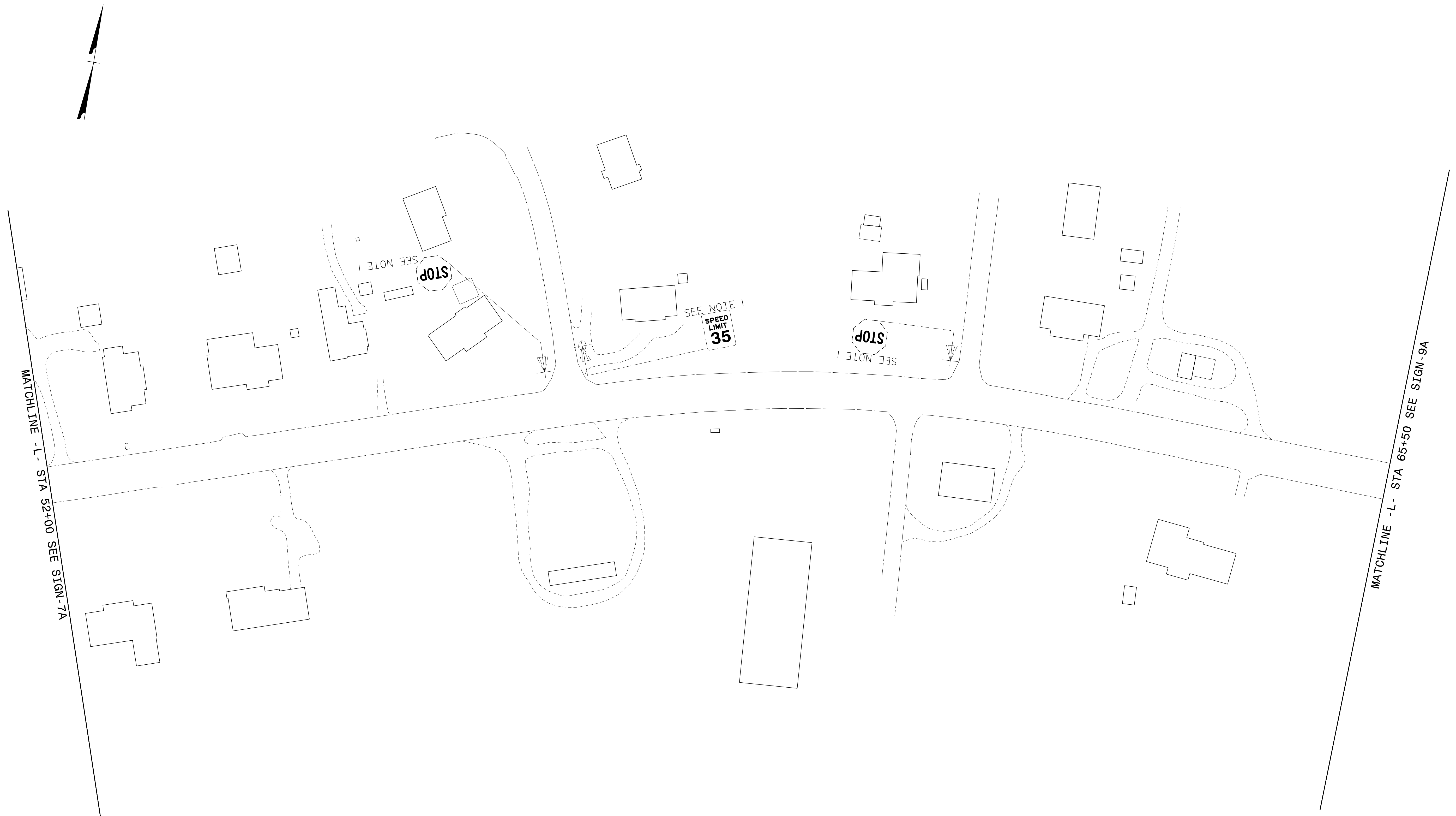

8/27/2019
G:\395689_NCDOT_2018_Traffic\LSA\Proj\ALR-3830\Traffic\Signing\CADD\Signing Layout Plans\R-3830_Sgn_SIGN_8A.dgn
User:COL85144

APPROVED: *Samuel D. Coleman*
6828607F07254D9
 DATE: 8/27/2019

SEAL

SEAL
 NORTH CAROLINA
 PROFESSIONAL
 ENGINEER
 SAMUEL D. COLEMAN
 043765

**DOCUMENT NOT CONSIDERED FINAL
 UNLESS ALL SIGNATURES COMPLETED**

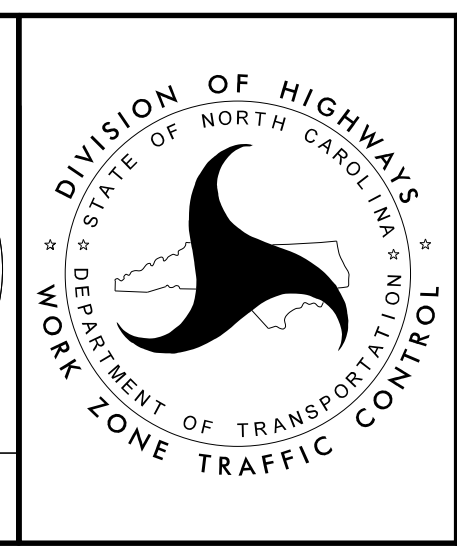

EXISTING
SIGNING
DETAIL SHEET

PLANS PREPARED FOR THE NCDOT BY:
M M
MOET
MACDONALD
LICENSE NO. F-6669

PROJ. REFERENCE NO.	SHEET NO.
R-3830	SIGN-9

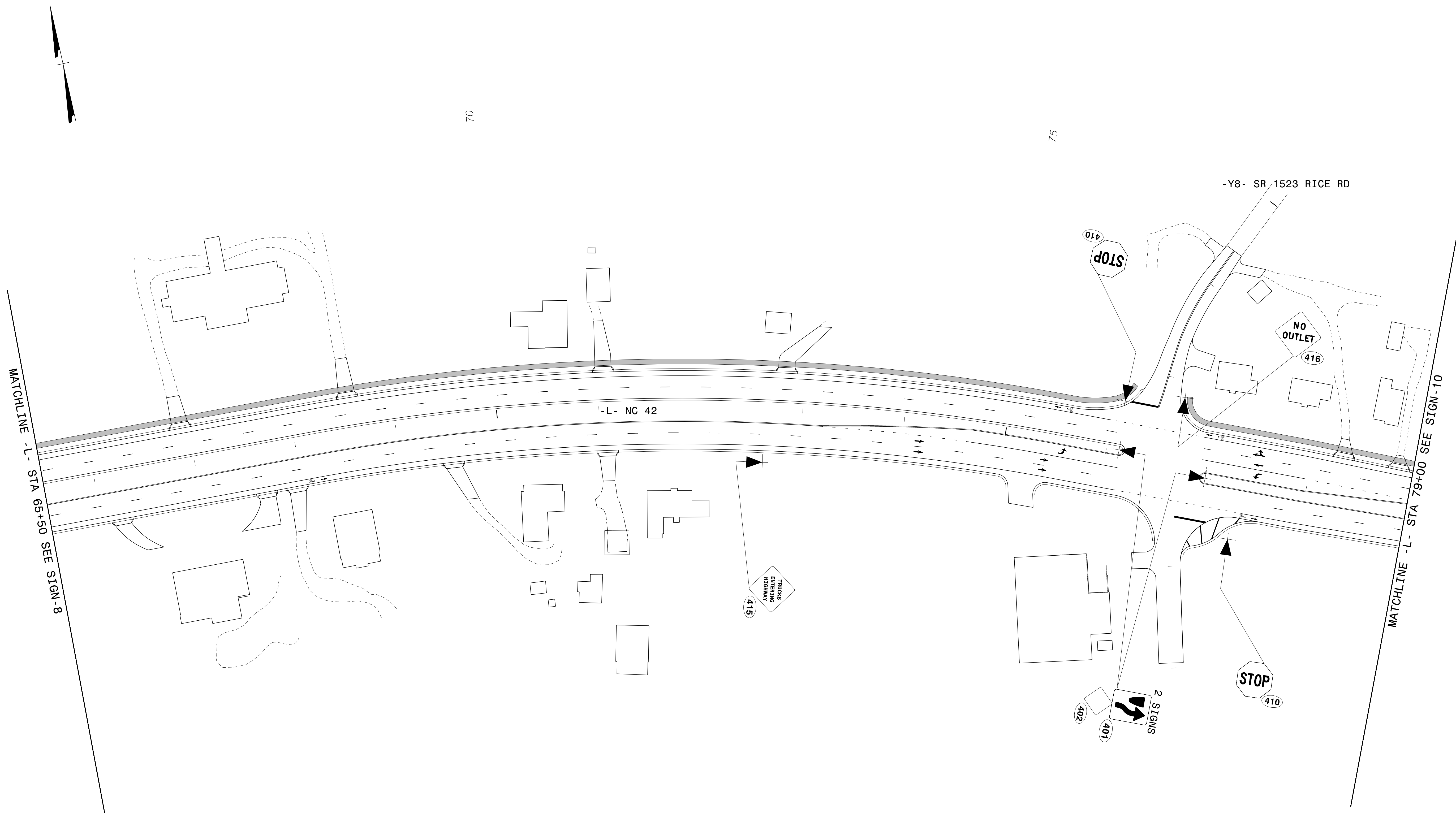

8/27/2019
G:\395689_NCDOT_2018_Traffic_LSA\Proj\ALR-3830\Traffic\Signing\CADD\Signing_Layout_Plans\R-3830_Sgn_SIGN-9.dgn
User:COL85144

APPROVED: *Samuel D. Coleman*
DATE: 8/27/2019

SEAL

DOCUMENT NOT CONSIDERED FINAL
UNLESS ALL SIGNATURES COMPLETED

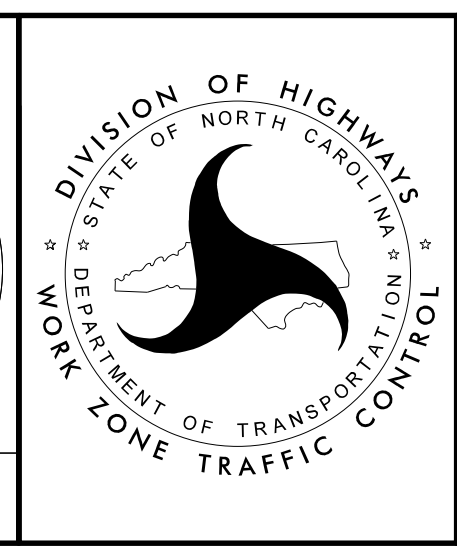

DIVISION OF HIGHWAYS
STATE OF NORTH CAROLINA
DEPARTMENT OF TRANSPORTATION
WORK ZONE TRAFFIC CONTROL

SIGNING DETAIL SHEET

PLANS PREPARED FOR THE NCDOT BY:
M M
MOY
MACDONALD
LIC. NO. F-6669

PROJ. REFERENCE NO.	SHEET NO.
R-3830	SIGN-9A

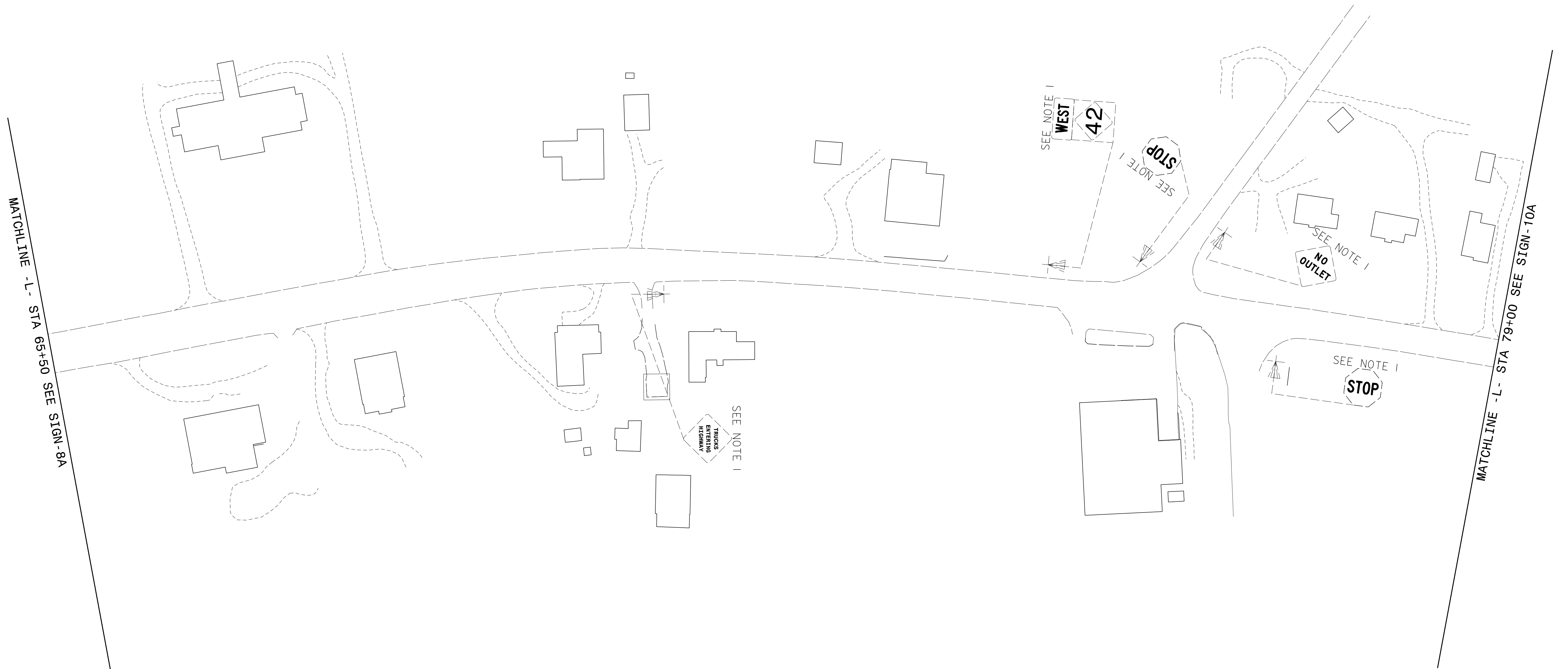
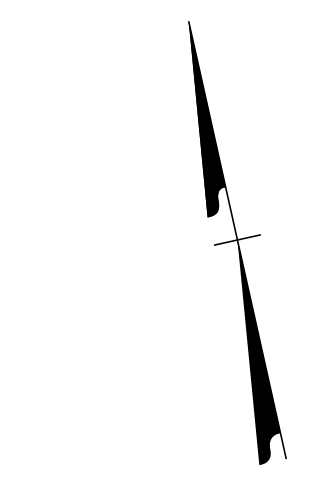

8/27/2019
G:\395689_NCDOT_2018_Traffic\ALR-3830\Traffic\Signing\CADD\Signing Layout Plans\ALR-3830_Sgn_SIGN_9A.dgn
User:COL85144

APPROVED: *Samuel D. Coleman*
DATE: 8/27/2019

SEAL

**DOCUMENT NOT CONSIDERED FINAL
UNLESS ALL SIGNATURES COMPLETED**

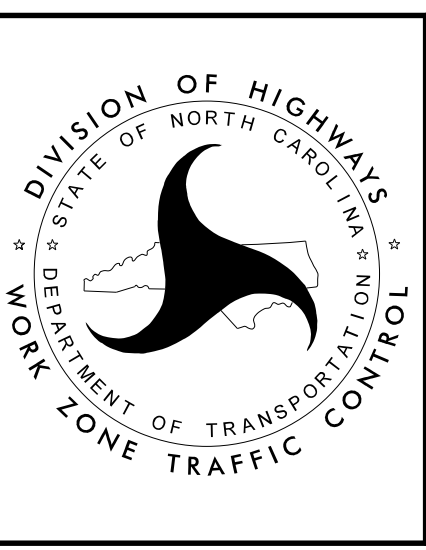

EXISTING
SIGNING DETAIL SHEET

PLANS PREPARED FOR THE NCDOT BY:
M M
MOTT
MACDONALD
LICENSE NO. F-6669

PROJ. REFERENCE NO.	SHEET NO.
R-3830	SIGN-10

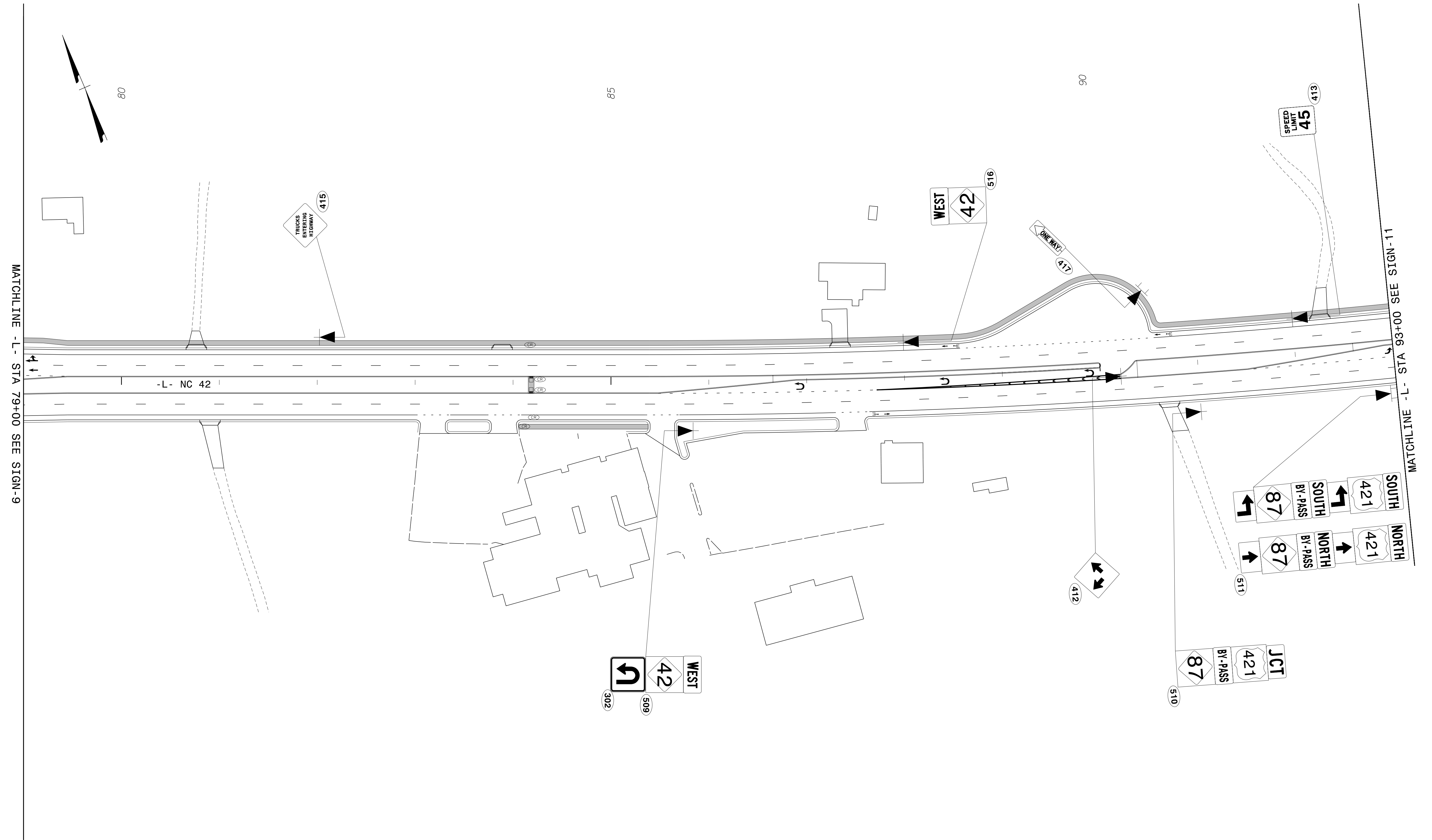

8/27/2019
G:\395689_NCDOT_2018_Traffic\ALR-3830\Traffic\Signing\CADD\Signing Layout Plans\ALR-3830_Sgn_SIGN_10.dgn
User:COL85144

APPROVED: *Samuel D. Coleman*
DATE: 8/27/2019

SEAL

DOCUMENT NOT CONSIDERED FINAL
UNLESS ALL SIGNATURES COMPLETED

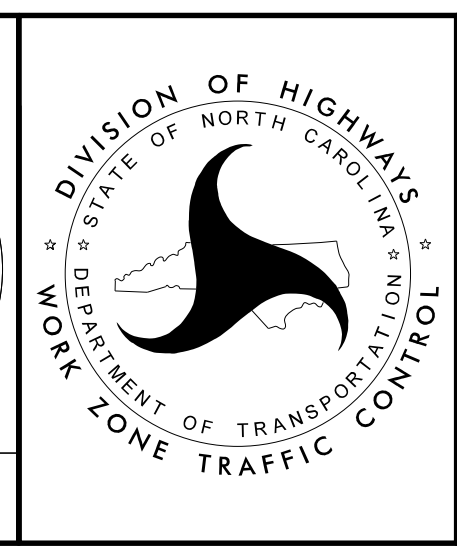

SIGNING DETAIL SHEET

PLANS PREPARED FOR THE NCDOT BY:
M M
MONT
MACDONALD
LICENSE NO. F-9669

PROJ. REFERENCE NO.	SHEET NO.
R-3830	SIGN-10A

MATCHLINE -L- STA 79+00 SEE SIGN-9A

MATCHLINE -L- STA 93+00 SEE SIGN-11A

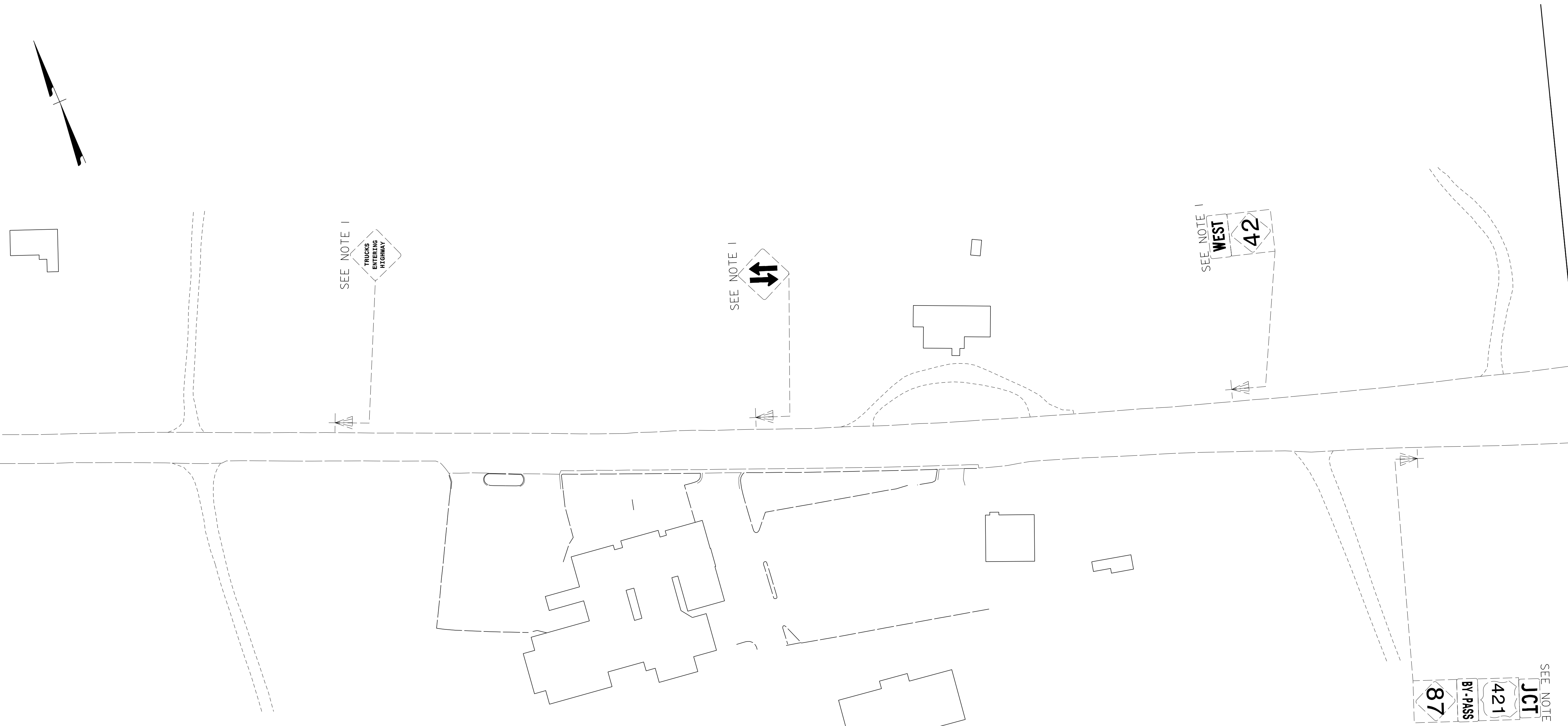

8/27/2019
G:\395689_NCDOT_2018_Traffic_LSA\Proj\ALR-3830\Traffic\Signing\CADD\Signing Layout Plans\R-3830_Sgn_SIGN_10A.dgn
User:COL85144

APPROVED: *Samuel D. Coleman*
DATE: 8/27/2019

SEAL

**DOCUMENT NOT CONSIDERED FINAL
UNLESS ALL SIGNATURES COMPLETED**

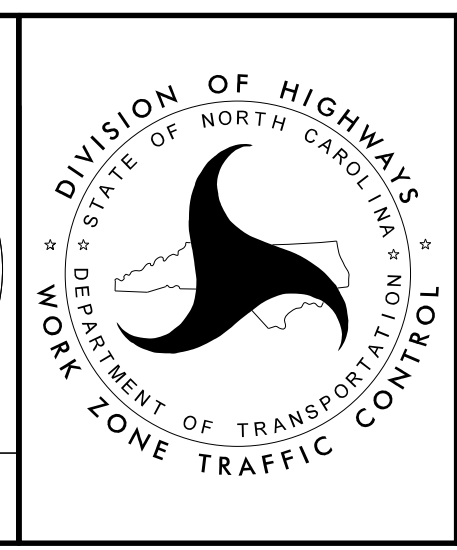

EXISTING
SIGNING DETAIL SHEET

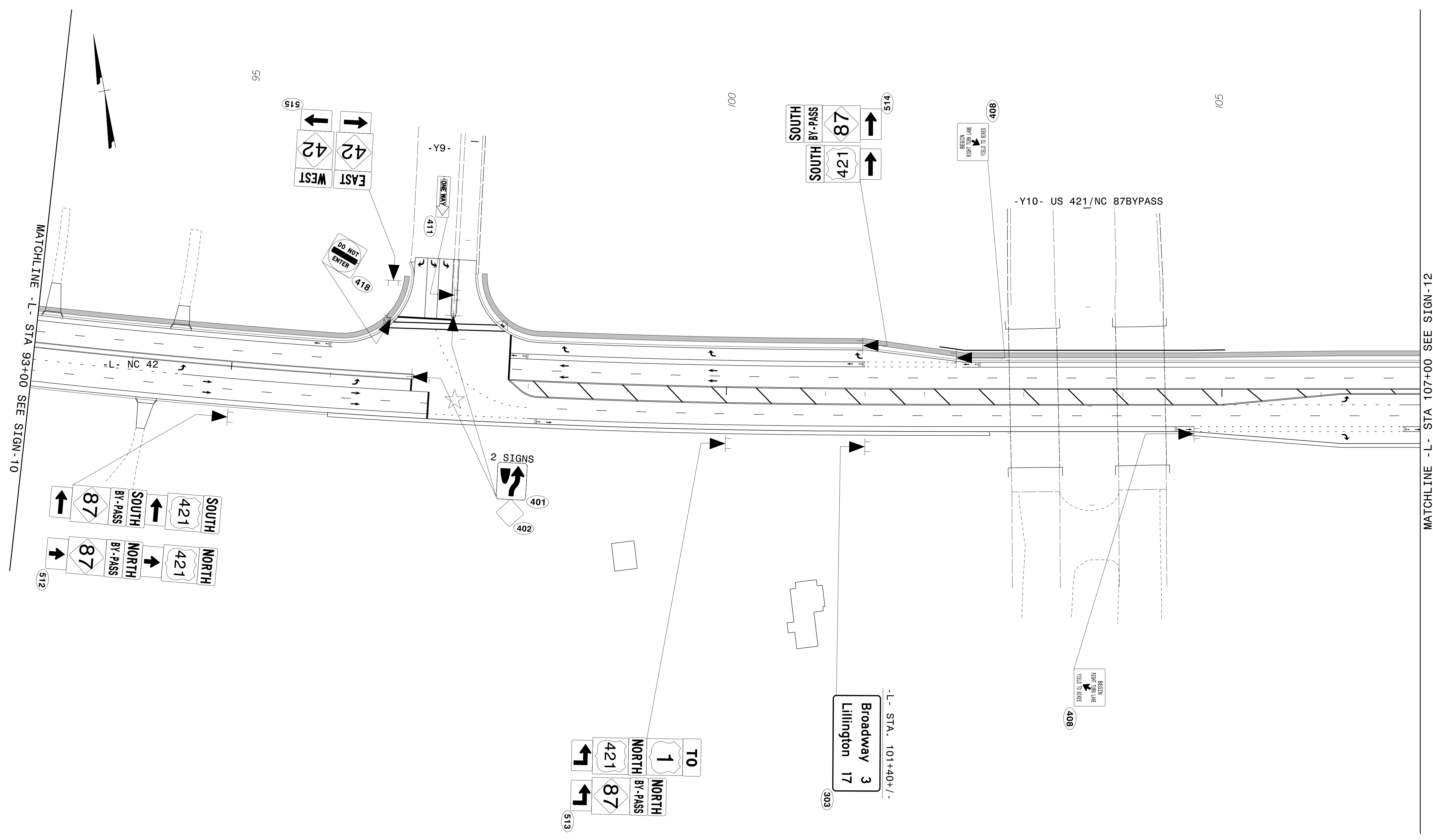

8/27/2019
G:\395689_NCDOT_2018_Traffic\LSA\Proj\ALR-3830\Traffic\Signing\CADD\Signing Layout Plans\AR-3830_Sgn_SIGN_11.dgn
User:COL85144

APPROVED: *Samuel D. Coleman*
DATE: 8/27/2019

SEAL

**DOCUMENT NOT CONSIDERED FINAL
UNLESS ALL SIGNATURES COMPLETED**

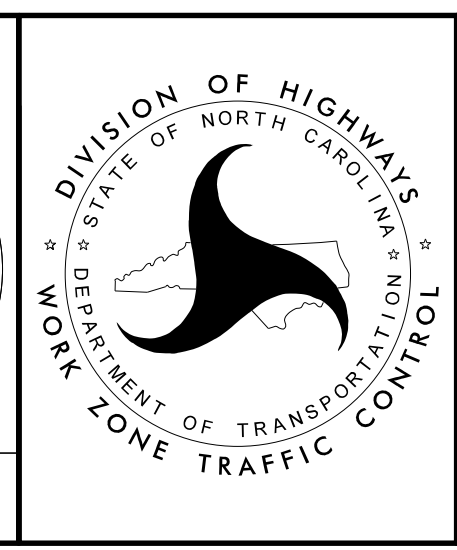

SIGNING DETAIL SHEET

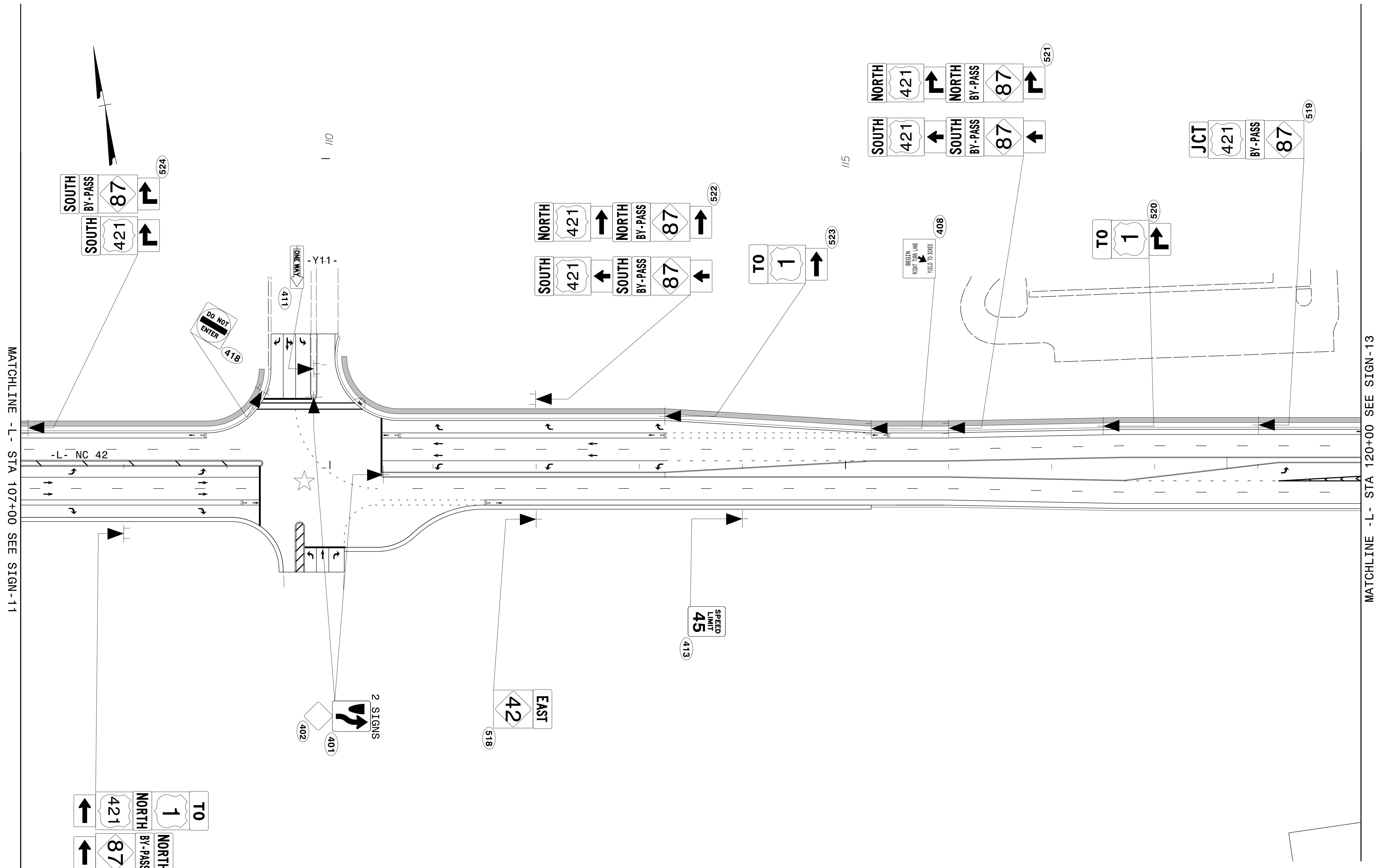

8/27/2019
 G:\395689_NCDOT_2018_Traffic\LSA\Proj\ALR-3830\Traffic\Signing\CADD\Signing Layout Plans\ALR-3830_Sgn_SIGN_12.dgn
 User:COL85144

APPROVED: *Samuel D. Coleman*
 DATE: 8/27/2019
 SEAL

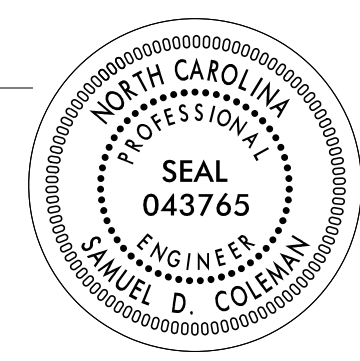

SIGNING DETAIL SHEET

DOCUMENT NOT CONSIDERED FINAL
 UNLESS ALL SIGNATURES COMPLETED

MATCHLINE -L- STA 107+00 SEE SIGN-11A

MATCHLINE -L- STA 120+00 SEE SIGN-13A

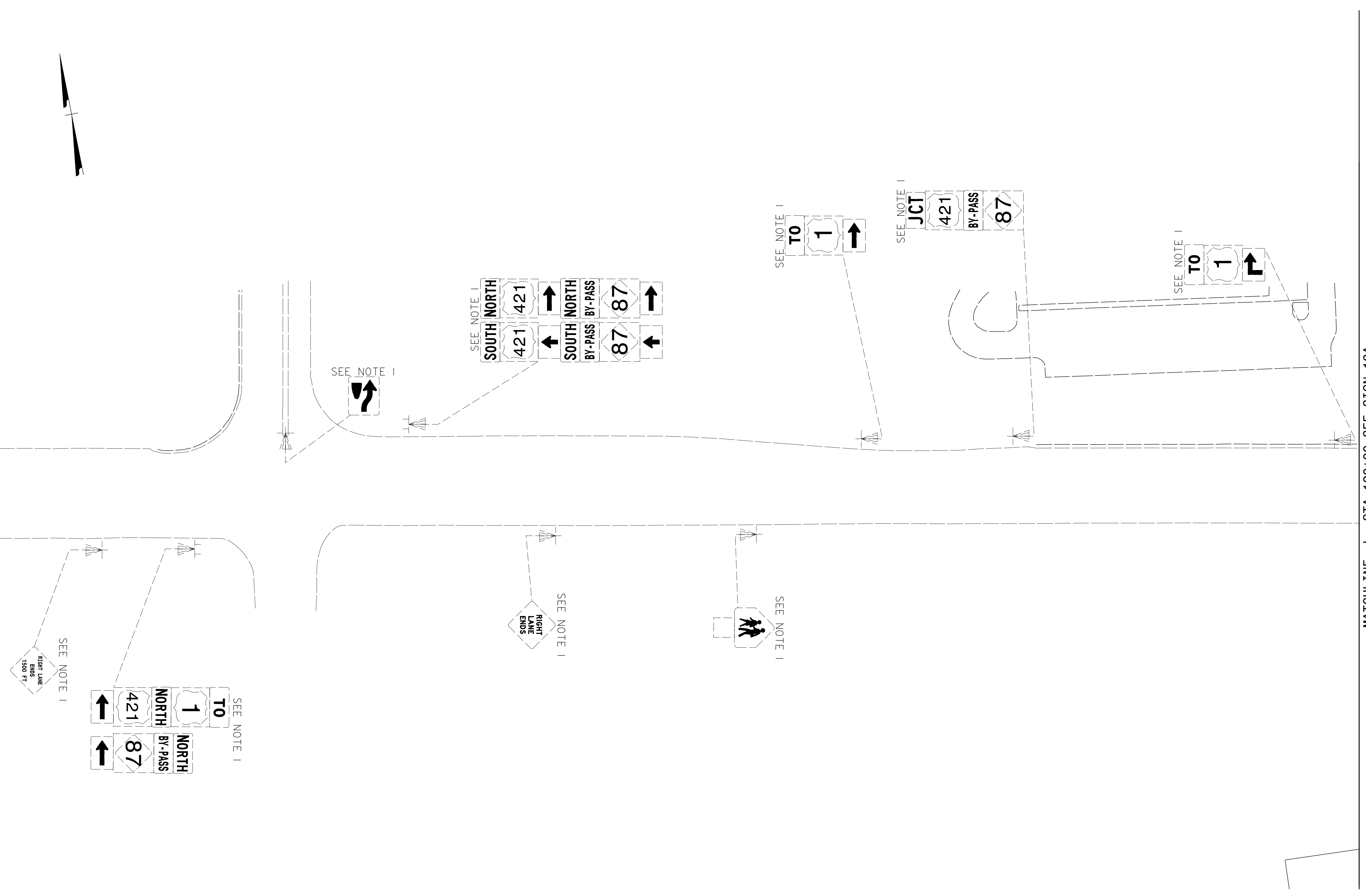

8/27/2019
G:\395689_NCDOT_2018_Traffic\LSA\Proj\ALR-3830\Traffic\Signing\CADD\Signing Layout Plans\ALR-3830_Sgn_Sign_12A.dgn
User:COL85144

APPROVED: *Samuel D. Coleman*
DATE: 8/27/2019
SEAL
NORTH CAROLINA PROFESSIONAL ENGINEER
SEAL 043765
SAMUEL D. COLEMAN

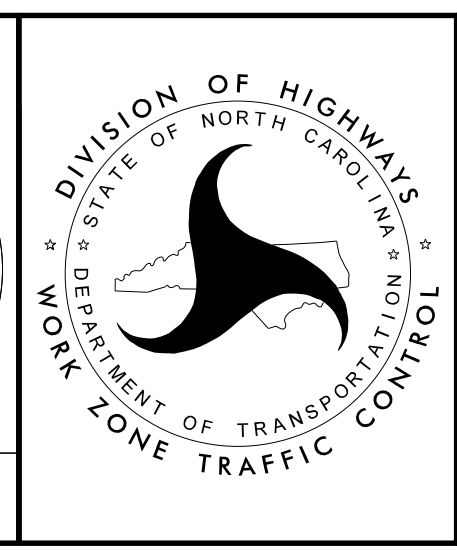

EXISTING
SIGNING
DETAIL SHEET

DOCUMENT NOT CONSIDERED FINAL
UNLESS ALL SIGNATURES COMPLETED

PLANS PREPARED FOR THE NCDOT BY:
M M
MONT
MACDONALD
LICENSE NO. F-6669

PROJ. REFERENCE NO.	SHEET NO.
R-3830	SIGN-13

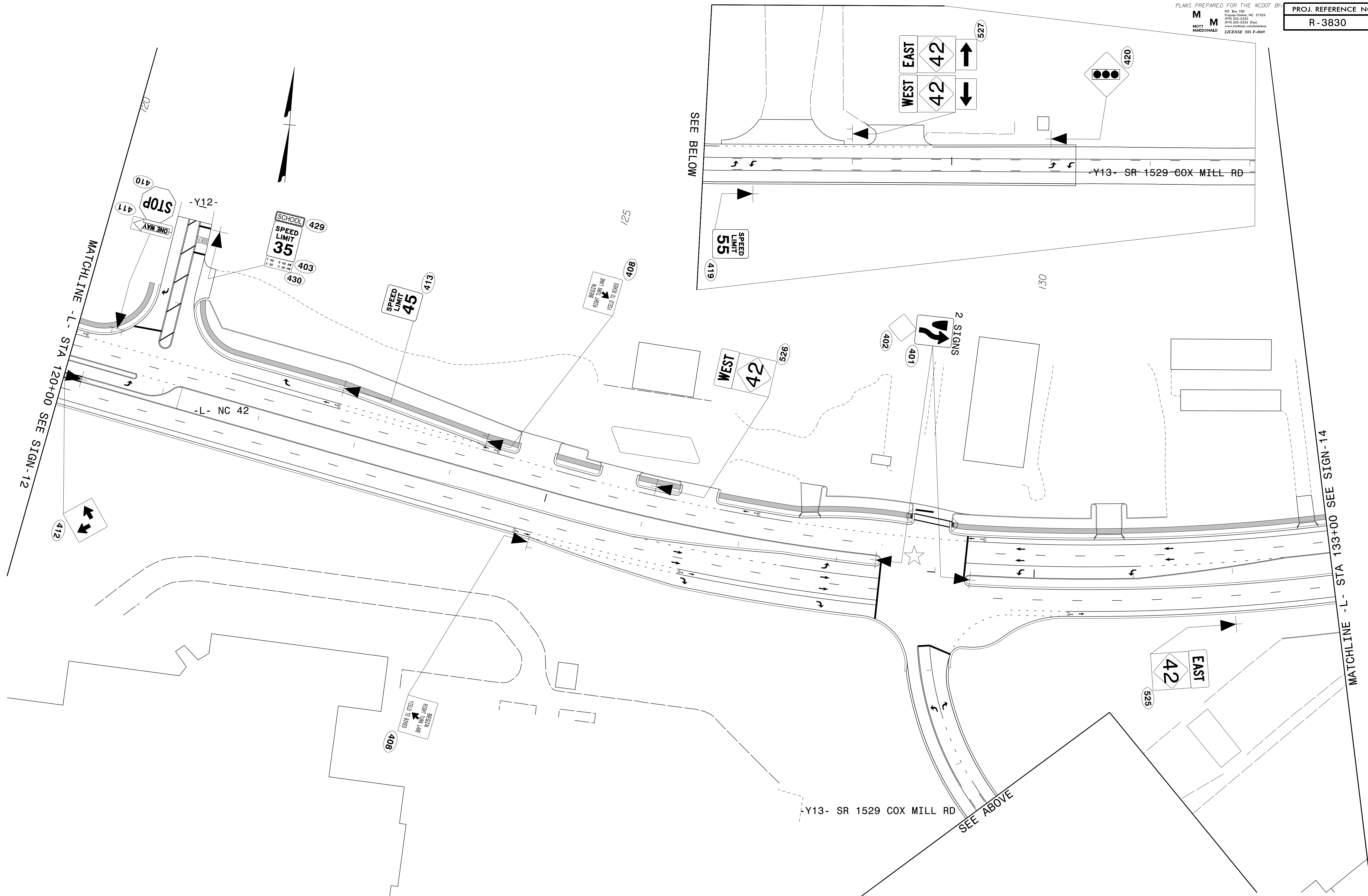

8/27/2019
G:\395689_NCDOT_2018_Traffic\SA\Proj\ALR-3830\Traffic\Signing\CADD\Signing Layout Plans\ALR-3830_Sgn_SIGN_13.dgn
User:COL85144

APPROVED: *Samuel D. Coleman*
DATE: 8/27/2019

SEAL

DOCUMENT NOT CONSIDERED FINAL
UNLESS ALL SIGNATURES COMPLETED

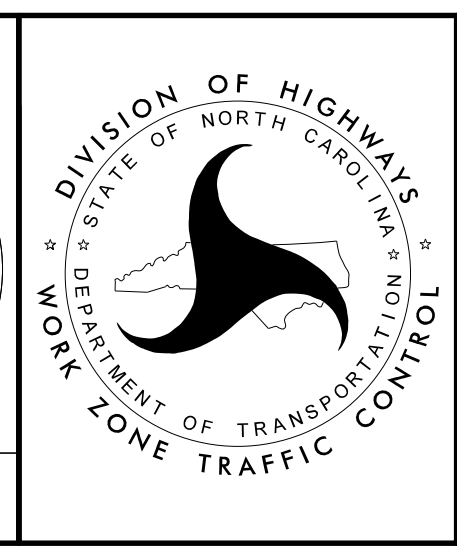
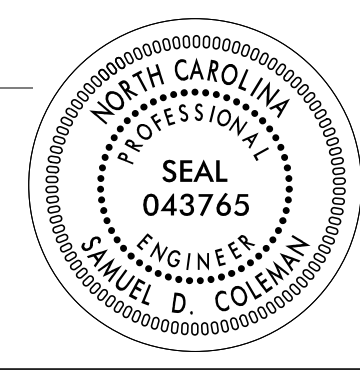

SIGNING DETAIL SHEET

PLANS PREPARED FOR THE NCDOT BY:
M M
MONT
MACDONALD
LICENSE NO. F-6669

PROJ. REFERENCE NO.	SHEET NO.
R-3830	SIGN-14

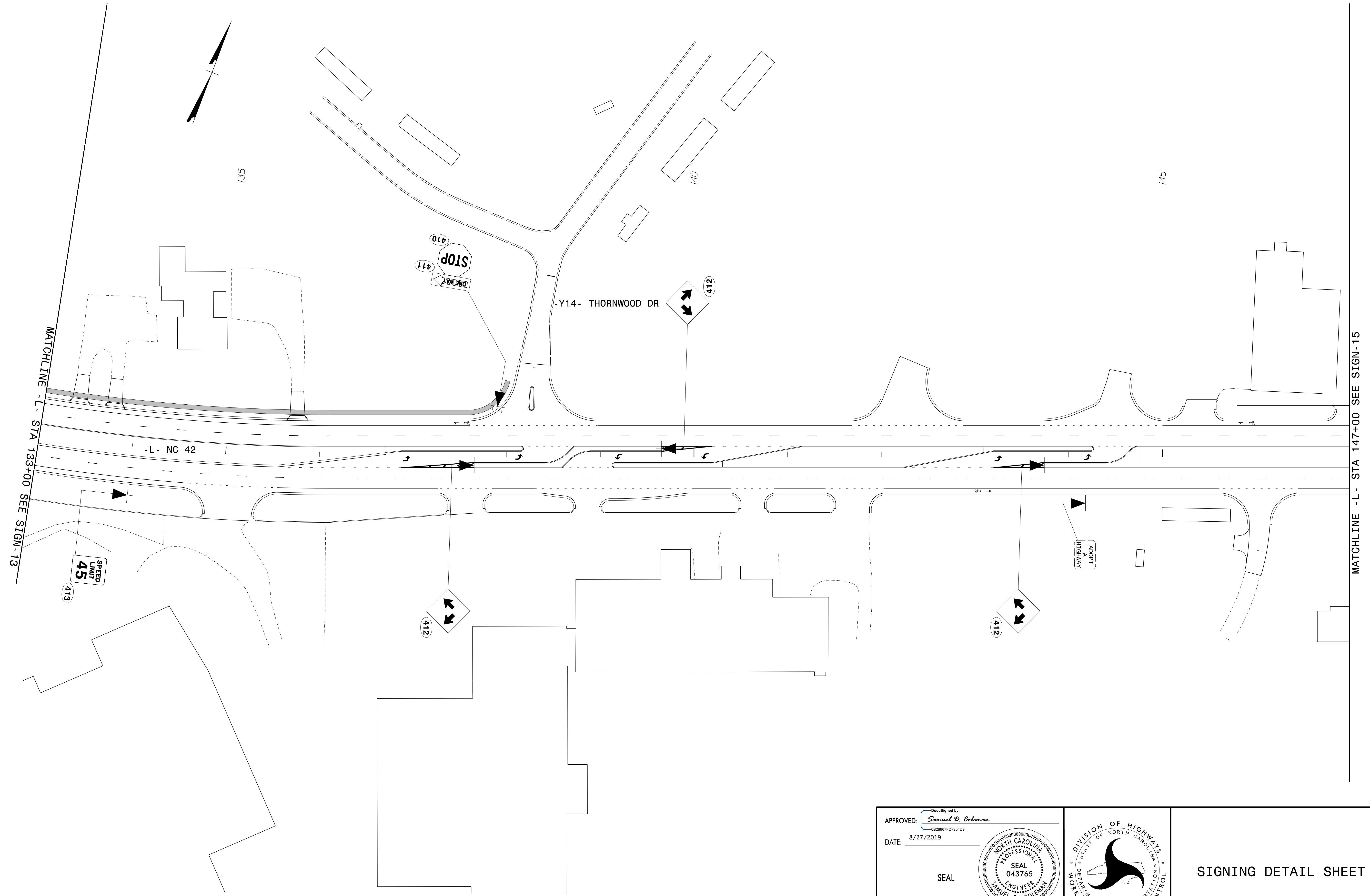

8/27/2019
G:\395688\NCDOT_2018_Traffic_LSA\Proj\ALR-3830\Traffic\Signing\CADD\Signing Layout Plans\ALR-3830_Sgn_Sign_14.dgn
User:COL85144

APPROVED: *Samuel D. Coleman*
DATE: 8/27/2019

SEAL

**DOCUMENT NOT CONSIDERED FINAL
UNLESS ALL SIGNATURES COMPLETED**

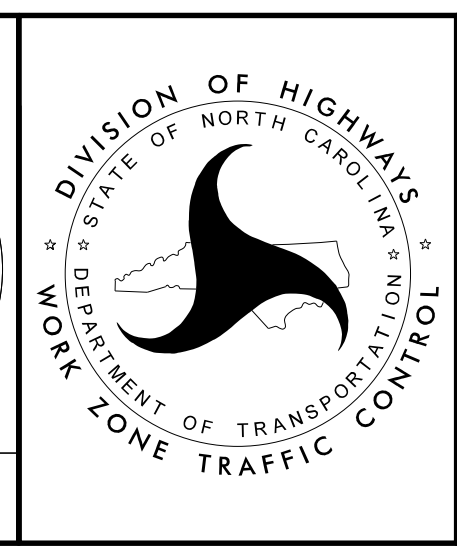

SIGNING DETAIL SHEET

PLANS PREPARED FOR THE NCDOT BY:
M M
MOTT
MACDONALD
LICENSE NO. F-6669

PROJ. REFERENCE NO.	SHEET NO.
R-3830	SIGN-14A

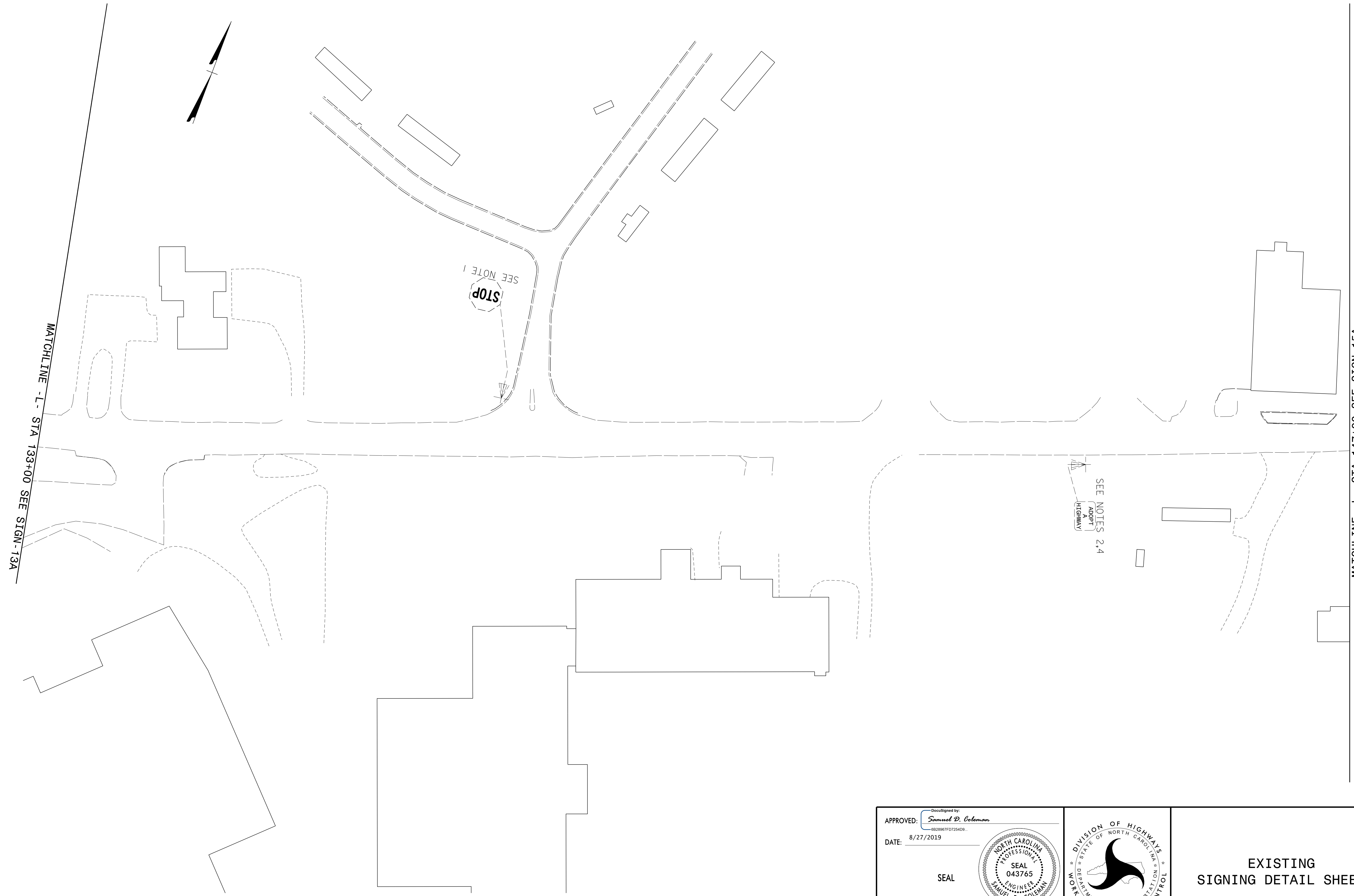

8/27/2019
G:\395689_NCDOT_2018_Traffic_LSA\Proj\ALR-3830\Traffic\Signing\CADD\Signing Layout Plans\R-3830_Sgn_SIGN_14A.dgn
User:COL85144

APPROVED: *Samuel D. Coleman*
6828607F07254D9
 DATE: 8/27/2019

SEAL

**DOCUMENT NOT CONSIDERED FINAL
UNLESS ALL SIGNATURES COMPLETED**

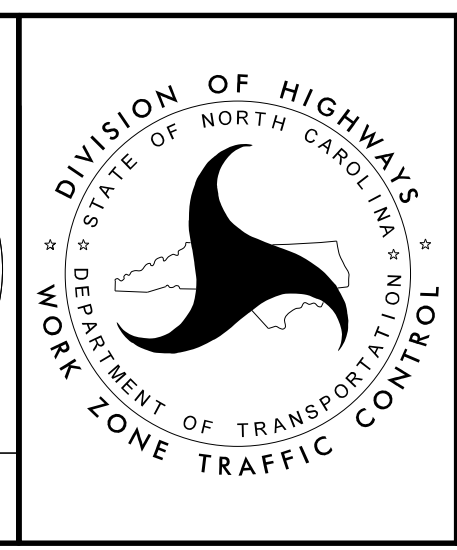

**EXISTING
SIGNING DETAIL SHEET**

PLANS PREPARED FOR THE NCDOT BY:
M M
MOTT
MACDONALD
LICENSE NO. F-6669

PROJ. REFERENCE NO.	SHEET NO.
R-3830	SIGN-15

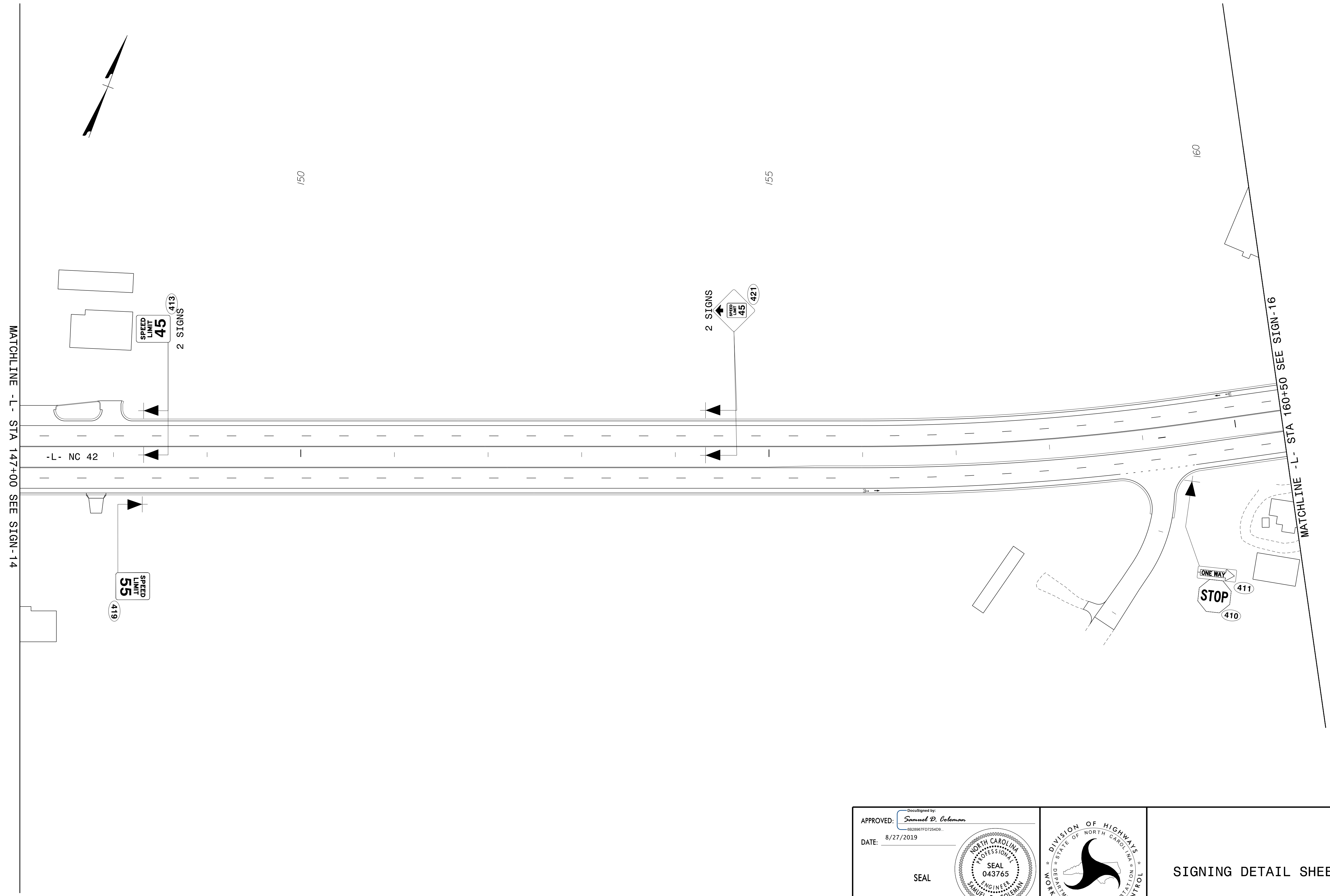

8/27/2019
G:\395689_NCDOT_2018_Traffic_LSA\Proj\ALR-3830\Traffic\Signing\CADD\Signing_Layout_Plans\R-3830_Sgn_Sign_15.dgn
User:COL85144

APPROVED: *Samuel D. Coleman*
DocuSigned by:
6B28667FD7254D9

DATE: 8/27/2019

SEAL

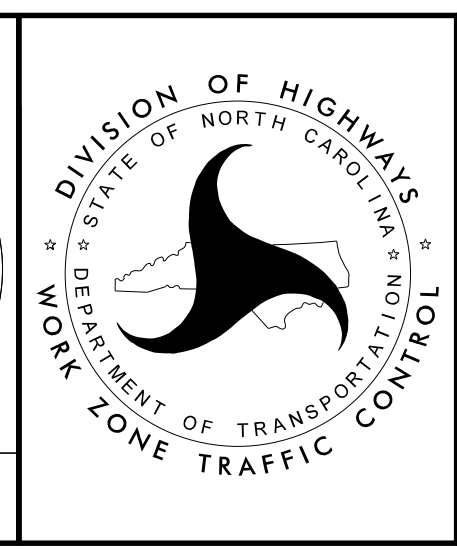

SIGNING DETAIL SHEET

DOCUMENT NOT CONSIDERED FINAL
UNLESS ALL SIGNATURES COMPLETED

PLANS PREPARED FOR THE NCDOT BY:
M MOTT
MACDONALD
LIC. NO. F-6669

PROJ. REFERENCE NO.	SHEET NO.
R-3830	SIGN-15A

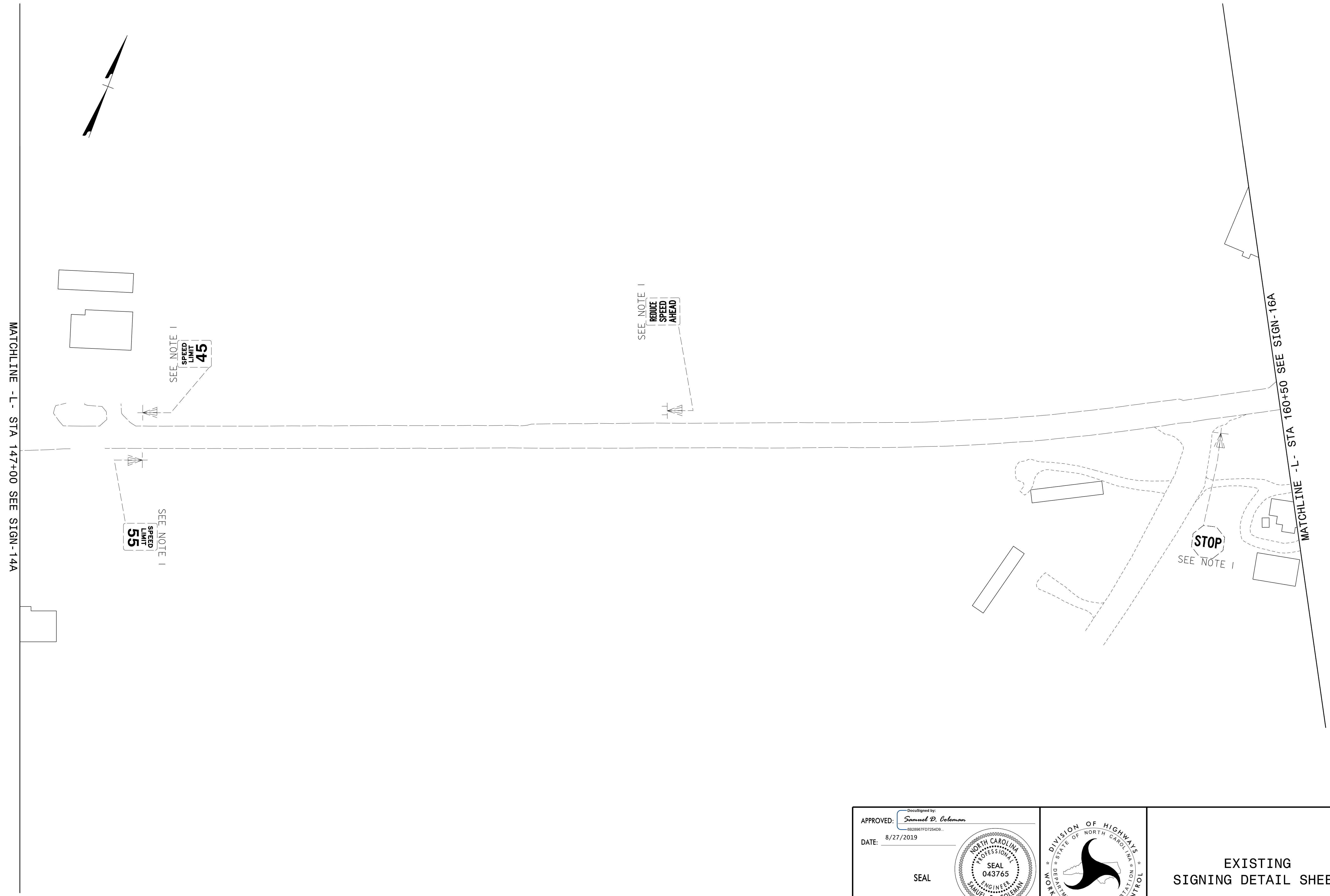

8/27/2019
G:\395689_NCDOT_2018_Traffic\LSA\Proj\ALR-3830\Traffic\Signing\CADD\Signing Layout Plans\AR-3830_Sgn_Sign_15A.dgn
User:COL85144

APPROVED: *Samuel D. Coleman*
6828667F07254D9

DATE: 8/27/2019

SEAL

**DOCUMENT NOT CONSIDERED FINAL
UNLESS ALL SIGNATURES COMPLETED**

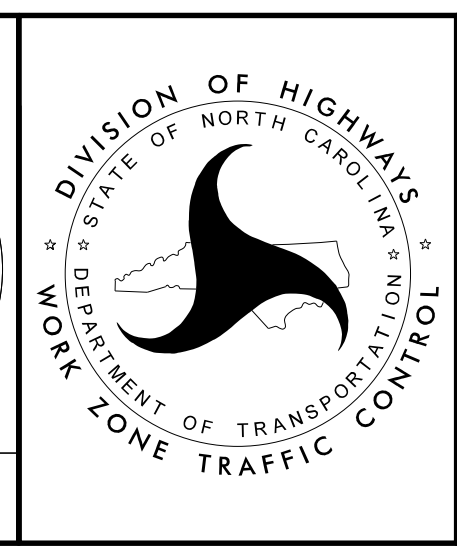

EXISTING
SIGNING DETAIL SHEET

PLANS PREPARED FOR THE NCDOT BY:
M M
MONT MACDONALD
LICENSE NO. F-9669

PROJ. REFERENCE NO.	SHEET NO.
R-3830	SIGN-16

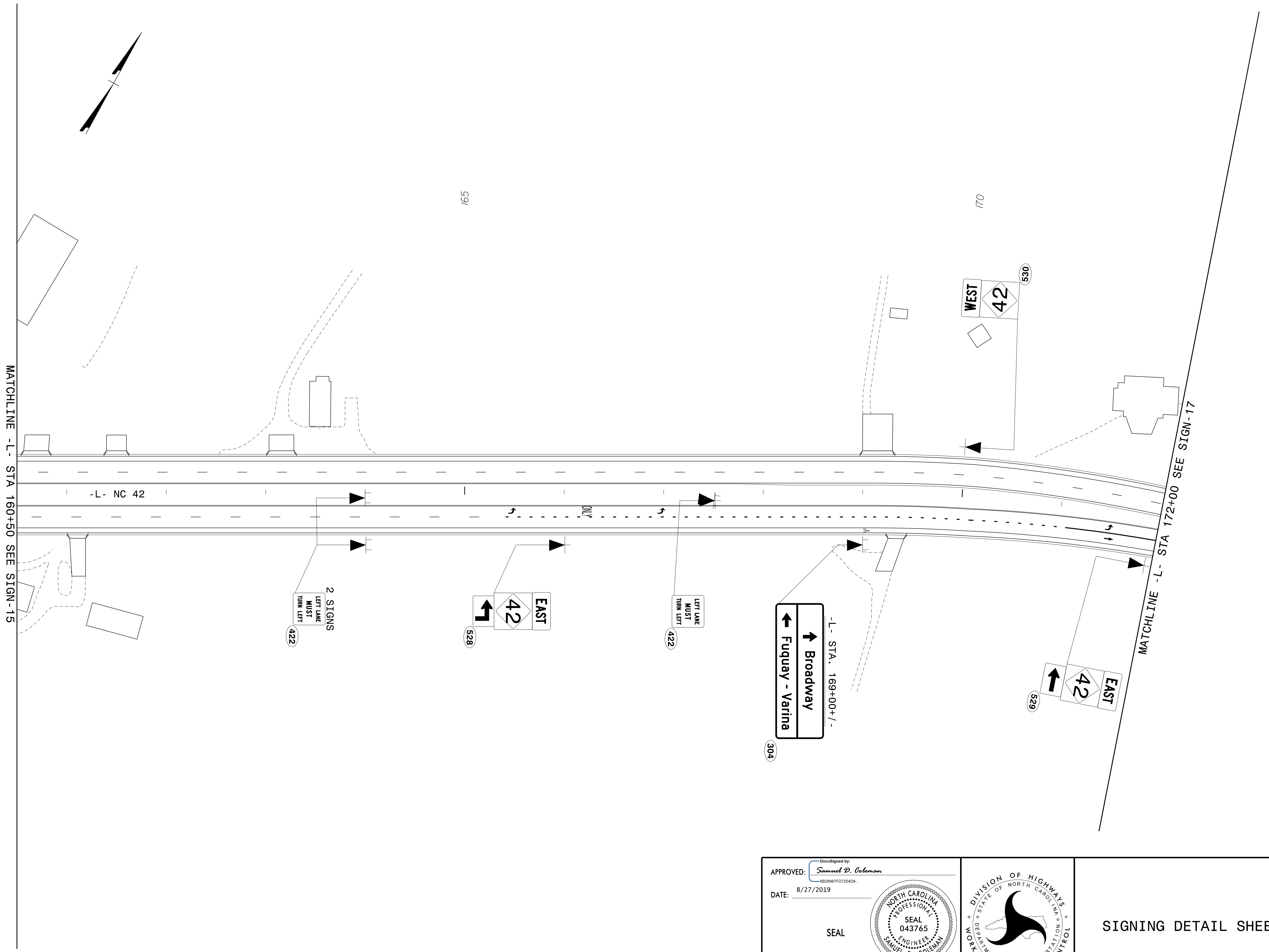

MATCHLINE -L- STA 160+50 SEE SIGN-15

MATCHLINE -L- STA 172+00 SEE SIGN-17

8/27/2019
G:\395689_NCDOT_2018_Traffic\LSA\Proj\ALR-3830\Traffic\Signing\CADD\Signing Layout Plans\R-3830_Sgn_SIGN_16.dgn
User:COL85144

APPROVED: *Samuel D. Coleman*
DATE: 8/27/2019

SEAL

**DOCUMENT NOT CONSIDERED FINAL
UNLESS ALL SIGNATURES COMPLETED**

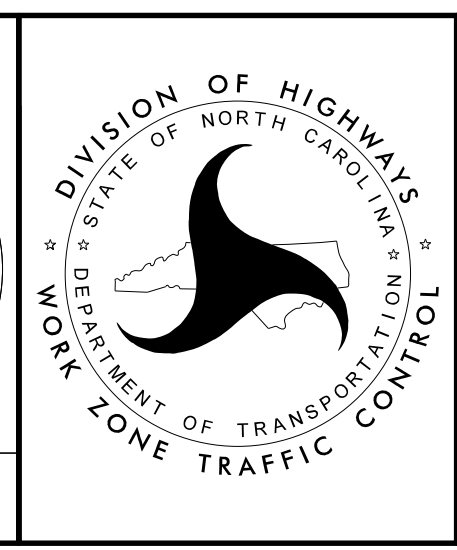

SIGNING DETAIL SHEET

PLANS PREPARED FOR THE NCDOT BY:
M M
MOT MACDONALD
PO Box 700
Raleigh, NC 27624
919-551-2233
919-551-2234 Fax
www.motmacdonald.com
LICENSE NO. F-9669

PROJ. REFERENCE NO.	SHEET NO.
R-3830	SIGN-16A

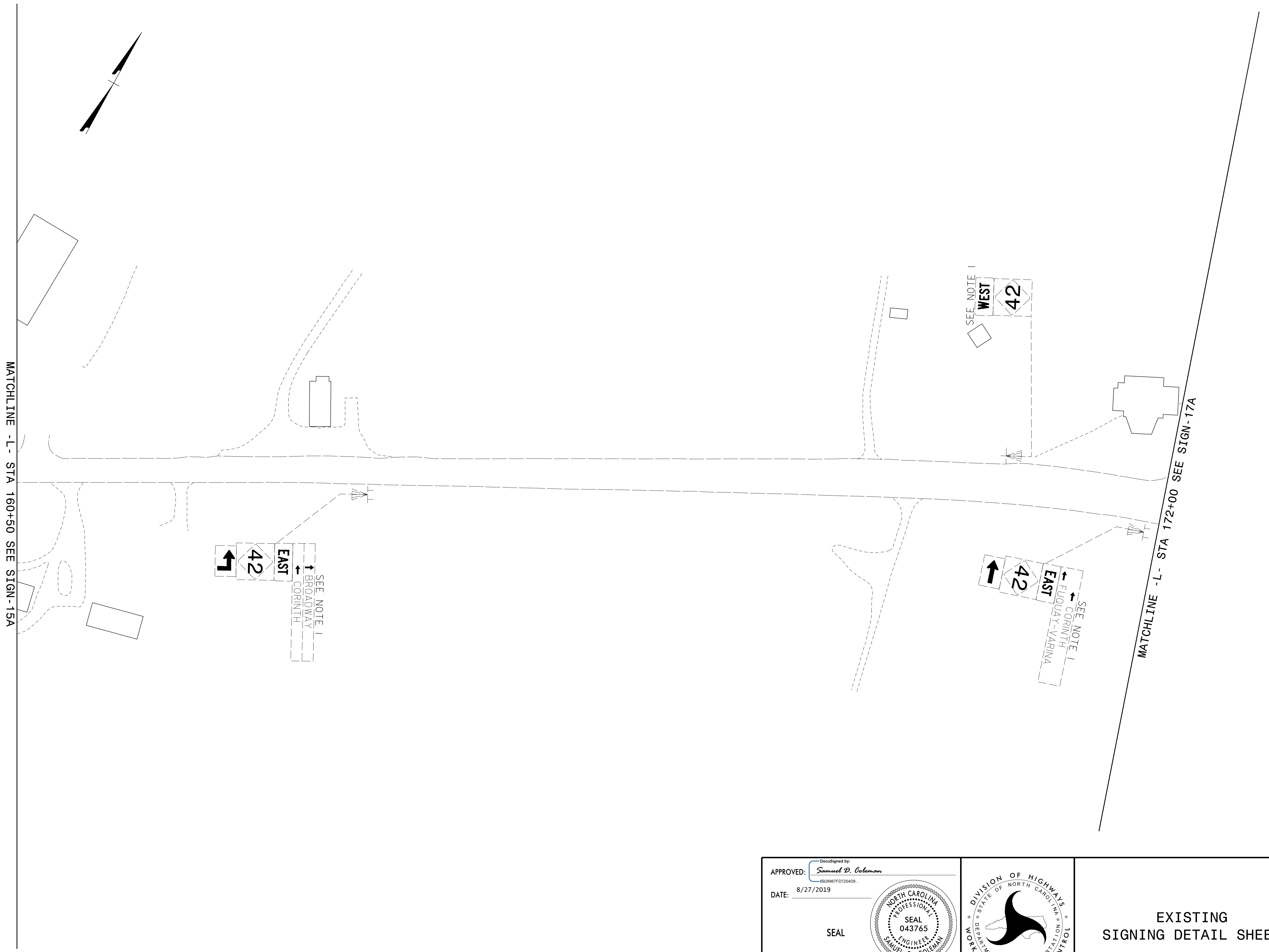

8/27/2019
G:\395689_NCDOT_2018_Traffic_LSA\Proj\ALR-3830\Traffic\Signing\CADD\Signing Layout Plans\R-3830_Sgn_Sign_16A.dgn
User:COL85144

APPROVED: *Samuel D. Coleman*
DATE: 8/27/2019

SEAL

**DOCUMENT NOT CONSIDERED FINAL
UNLESS ALL SIGNATURES COMPLETED**

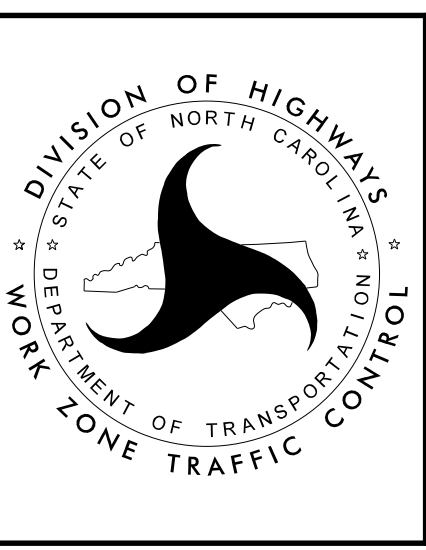

EXISTING
SIGNING DETAIL SHEET

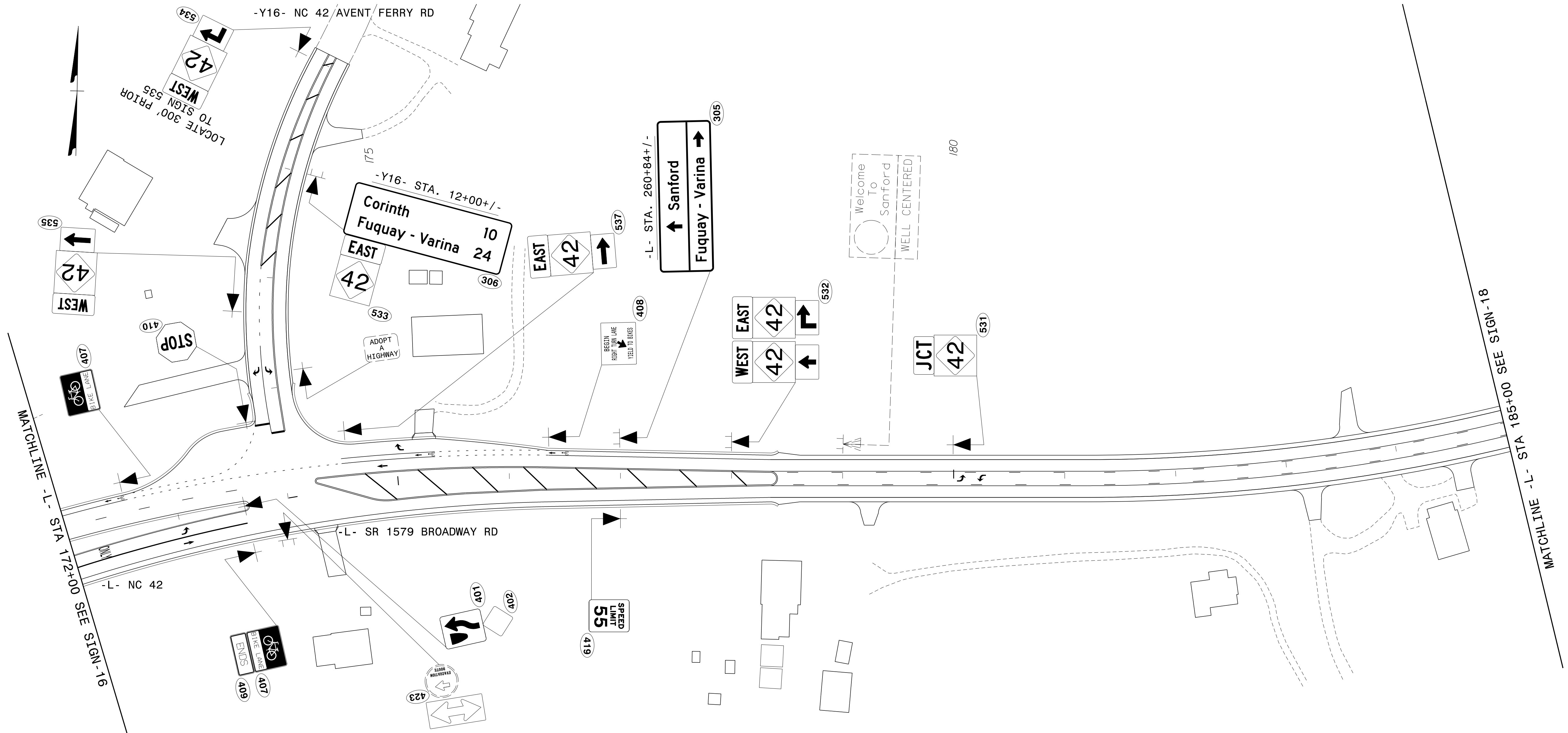

8/27/2019
G:\395689_NCDOT_2018_Traffic\LSA\Proj\ALR-3830\Traffic\Signing\CADD\Signing Layout Plans\R-3830_Sgn-SIGN-17.dgn
User:COL85144

APPROVED: *Samuel D. Coleman*
DATE: 8/27/2019
SEAL
NORTH CAROLINA PROFESSIONAL ENGINEER
SEAL 043765
SAMUEL D. COLEMAN



SIGNING DETAIL SHEET

DOCUMENT NOT CONSIDERED FINAL
UNLESS ALL SIGNATURES COMPLETED

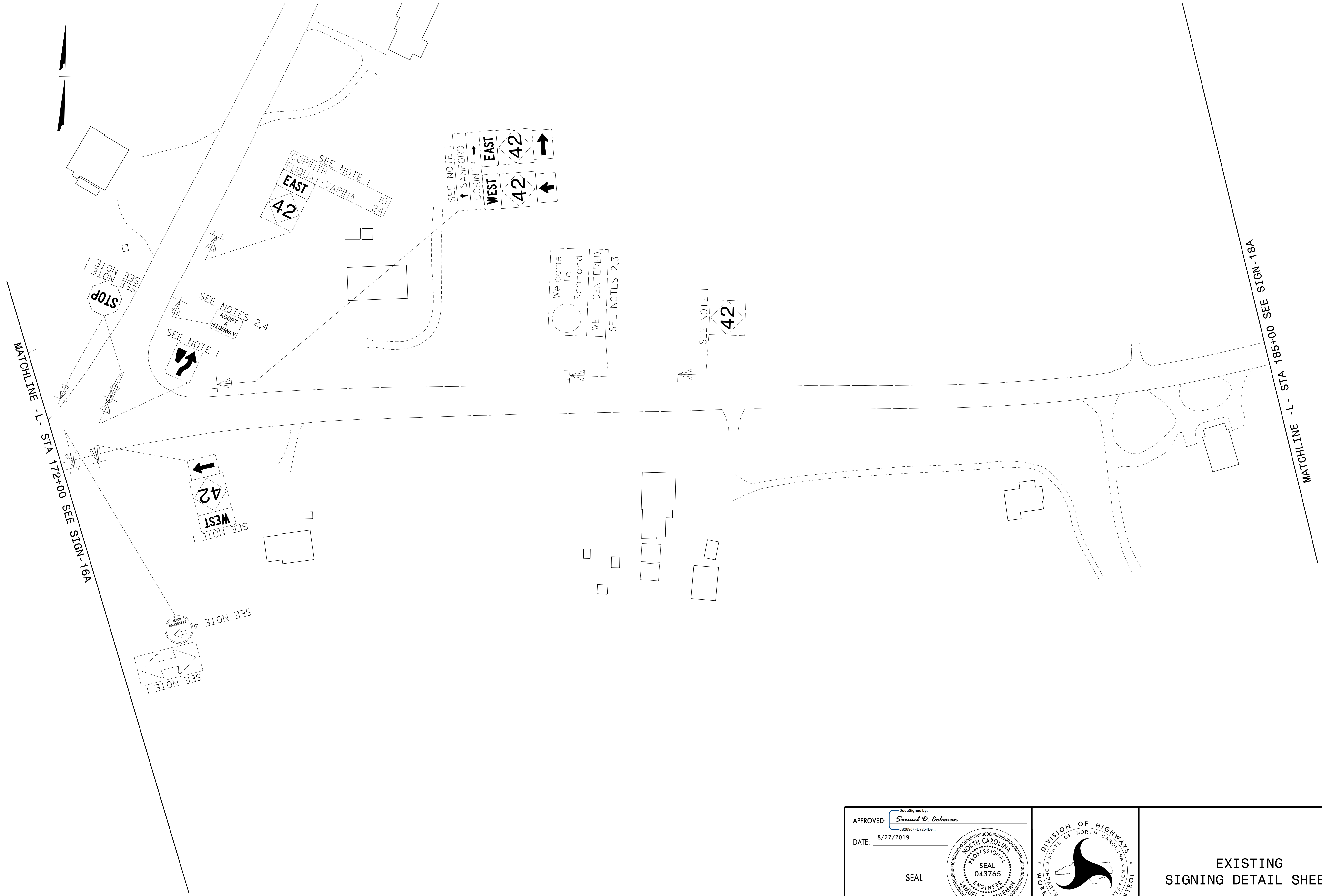

8/27/2019
 G:\395689_NCDOT_2018_Traffic\LSA\Proj\ALR-3830\Traffic\Signing\CADD\Signing Layout Plans\R-3830_Sgn-SIGN-17A.dgn
 User:COL85144

APPROVED: *Samuel D. Coleman*
 DATE: 8/27/2019
 SEAL

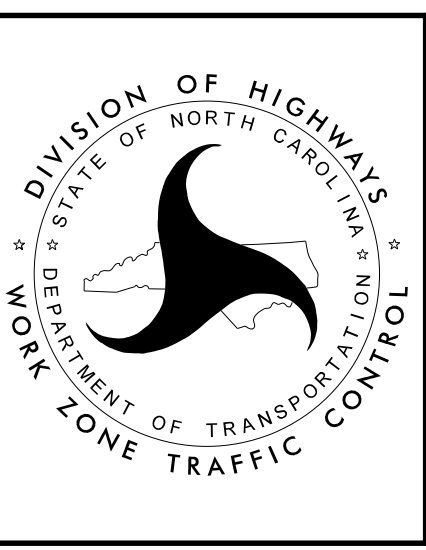
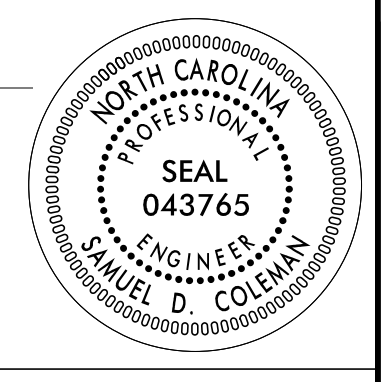

EXISTING
 SIGNING DETAIL SHEET

DOCUMENT NOT CONSIDERED FINAL
 UNLESS ALL SIGNATURES COMPLETED

PLANS PREPARED FOR THE NCDOT BY:
M M
MOTT
MACDONALD
LICENSE NO. F-6669

PROJ. REFERENCE NO.	SHEET NO.
R-3830	SIGN-18

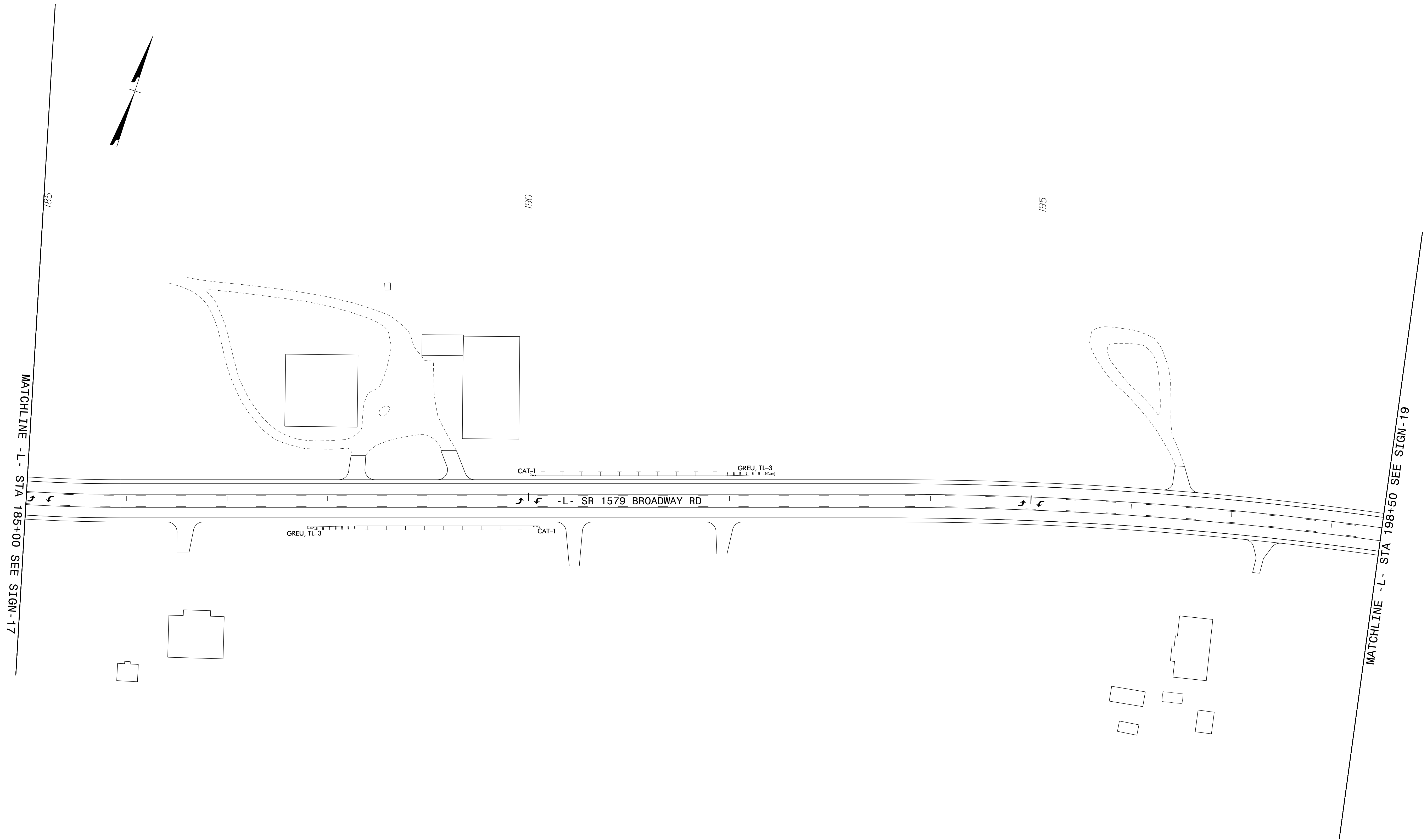

8/27/2019
G:\395689_NCDOT_2018_Traffic\ALR-3830\Traffic\Signing\CADD\Signing Layout Plans\ALR-3830_Sgn_Sign_18.dgn
User:COL85144

APPROVED: *Samuel D. Coleman*
DATE: 8/27/2019

SEAL

**DOCUMENT NOT CONSIDERED FINAL
UNLESS ALL SIGNATURES COMPLETED**

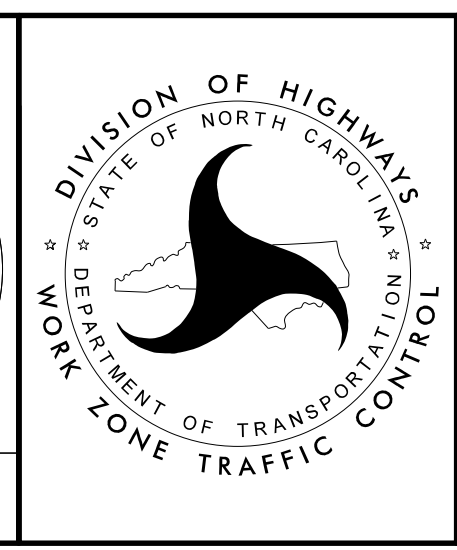

SIGNING DETAIL SHEET

PLANS PREPARED FOR THE NCDOT BY:
M M
MOTT
MACDONALD
LICENSE NO. F-6669

PROJ. REFERENCE NO.	SHEET NO.
R-3830	SIGN-18A

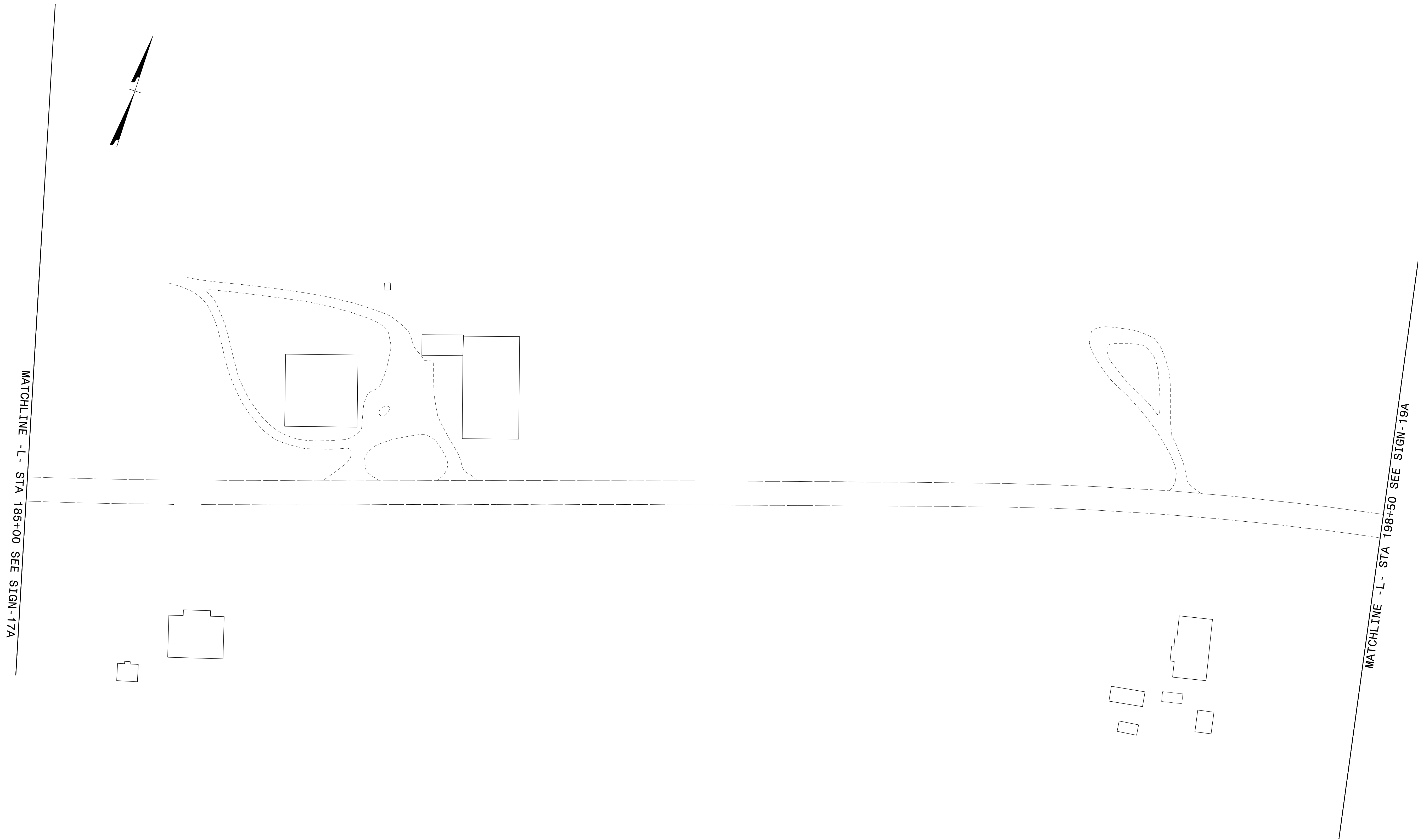

8/27/2019
G:\395689_NCDOT_2018_Traffic_LSA\Proj\ALR-3830\Traffic\Signing\CADD\Signing_Layout_Plans\R-3830_Sgn_SIGN_18A.dgn
User:COL85144

APPROVED: *Samuel D. Coleman*
DATE: 8/27/2019

SEAL

**DOCUMENT NOT CONSIDERED FINAL
UNLESS ALL SIGNATURES COMPLETED**

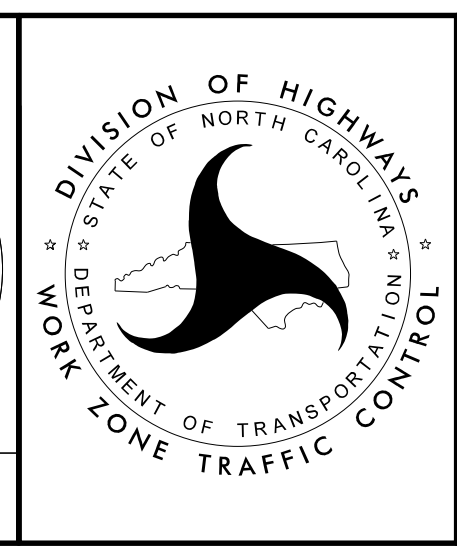

EXISTING
SIGNING DETAIL SHEET

PLANS PREPARED FOR THE NCDOT BY:
M M
MOY
MACDONALD
LICENSE NO. F-6669

PROJ. REFERENCE NO.	SHEET NO.
R-3830	SIGN-19

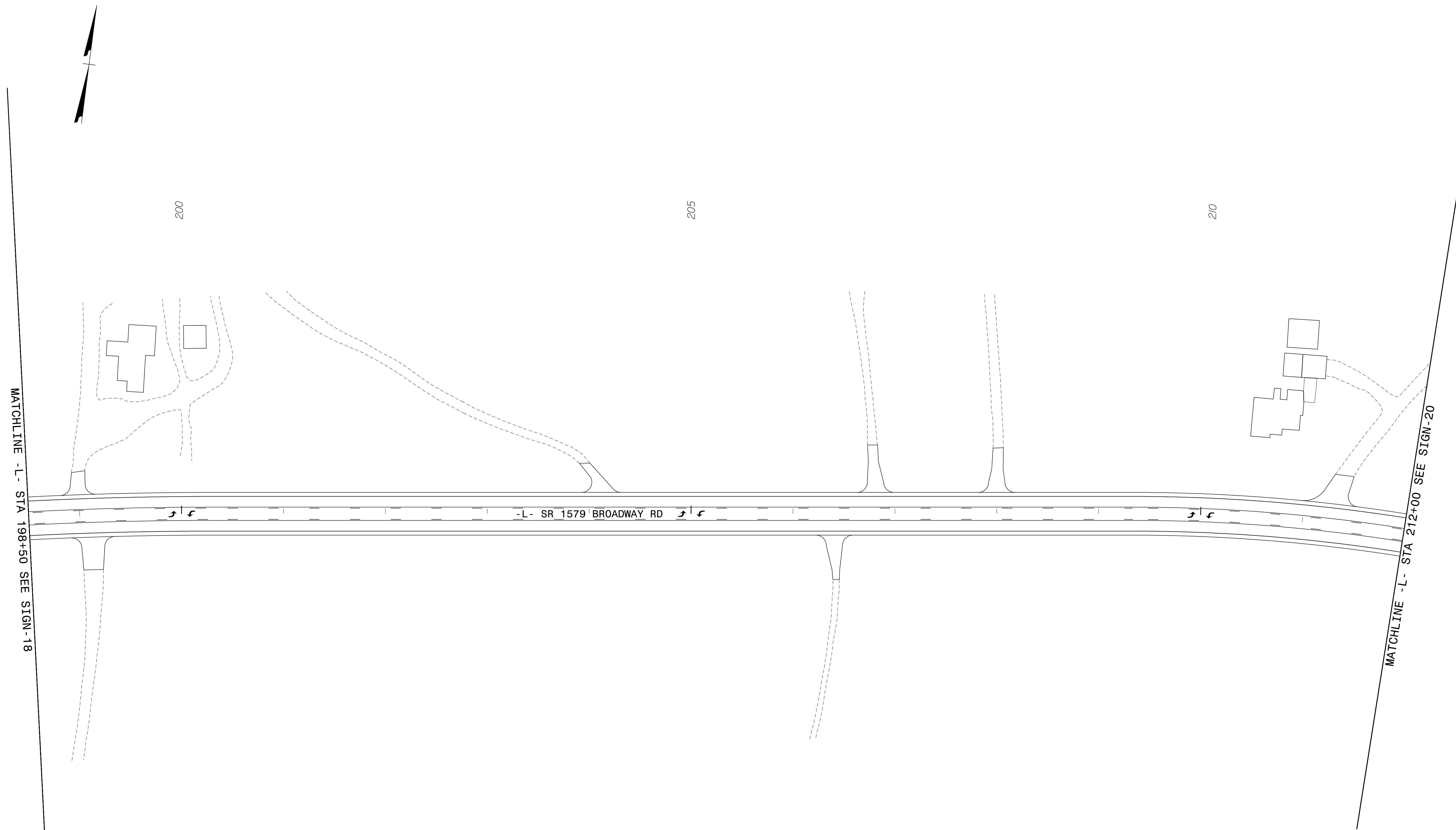

8/27/2019
G:\395689_NCDOT_2018_Traffic\LSA\Proj\ALR-3830\Traffic\Signing\CADD\Signing Layout Plans\SR-3830_Sgn_SIGN_19.dgn
User:COL85144

APPROVED: *Samuel D. Coleman*
DATE: 8/27/2019

SEAL

**DOCUMENT NOT CONSIDERED FINAL
UNLESS ALL SIGNATURES COMPLETED**

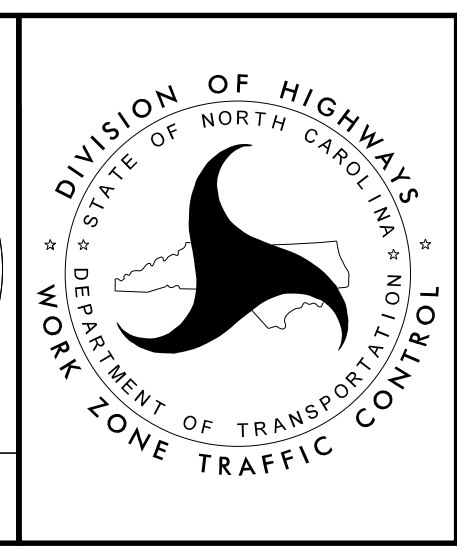

SIGNING DETAIL SHEET

M
M
MOTT
MACDONALD
PO Box 700
Raleigh, NC 27624
919-551-2233
919-551-2234 Fax
www.mottmacdonald.com
LICENSE NO. F-6669

PROJ. REFERENCE NO.	SHEET NO.
R-3830	SIGN-19A

MATCHLINE - L- STA 198+50 SEE SIGN-18A

MATCHLINE - L- STA 212+00 SEE SIGN-20A

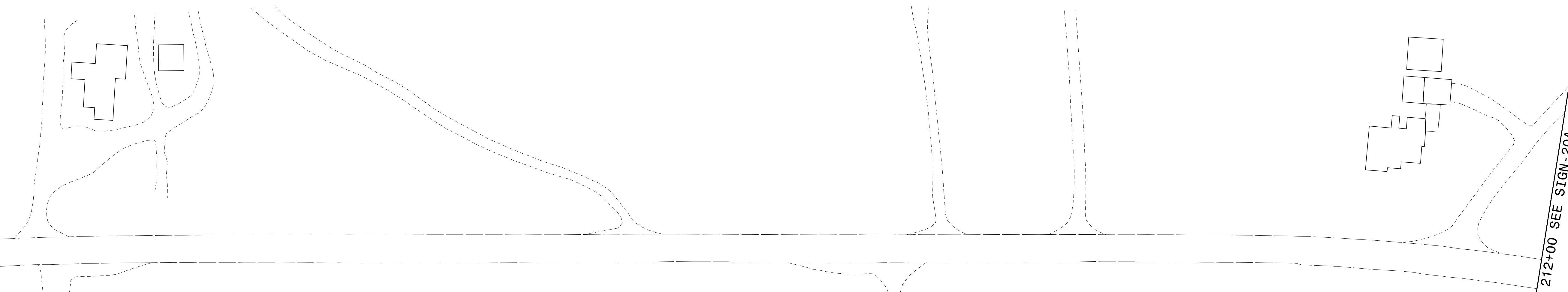
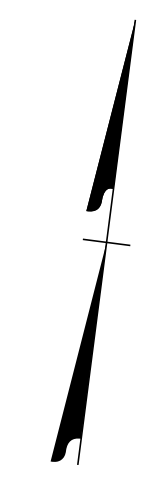

8/27/2019
G:\395689_NCDOT_2018_Traffic\LSA\Proj\ALR-3830\Traffic\Signing\CADD\Signing Layout Plans\R-3830_Sgn_SIGN_19A.dgn
User:COL85144

APPROVED: *Samuel D. Coleman*
6828067F07254D9
 DATE: 8/27/2019

SEAL

**DOCUMENT NOT CONSIDERED FINAL
UNLESS ALL SIGNATURES COMPLETED**

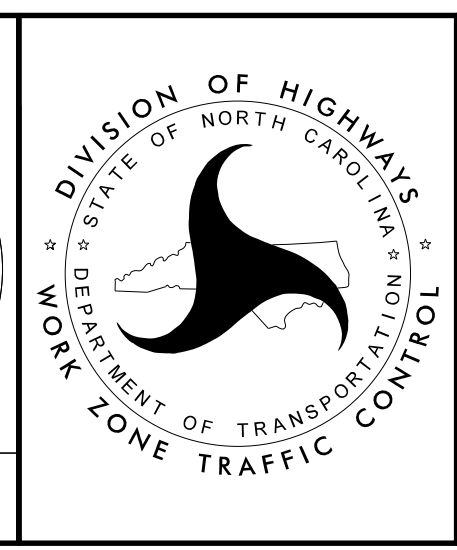

EXISTING
SIGNING
DETAIL SHEET

PLANS PREPARED FOR THE NCDOT BY:
M M
MOY
MACDONALD
LICENSE NO. F-6669

PROJ. REFERENCE NO.	SHEET NO.
R-3830	SIGN-20

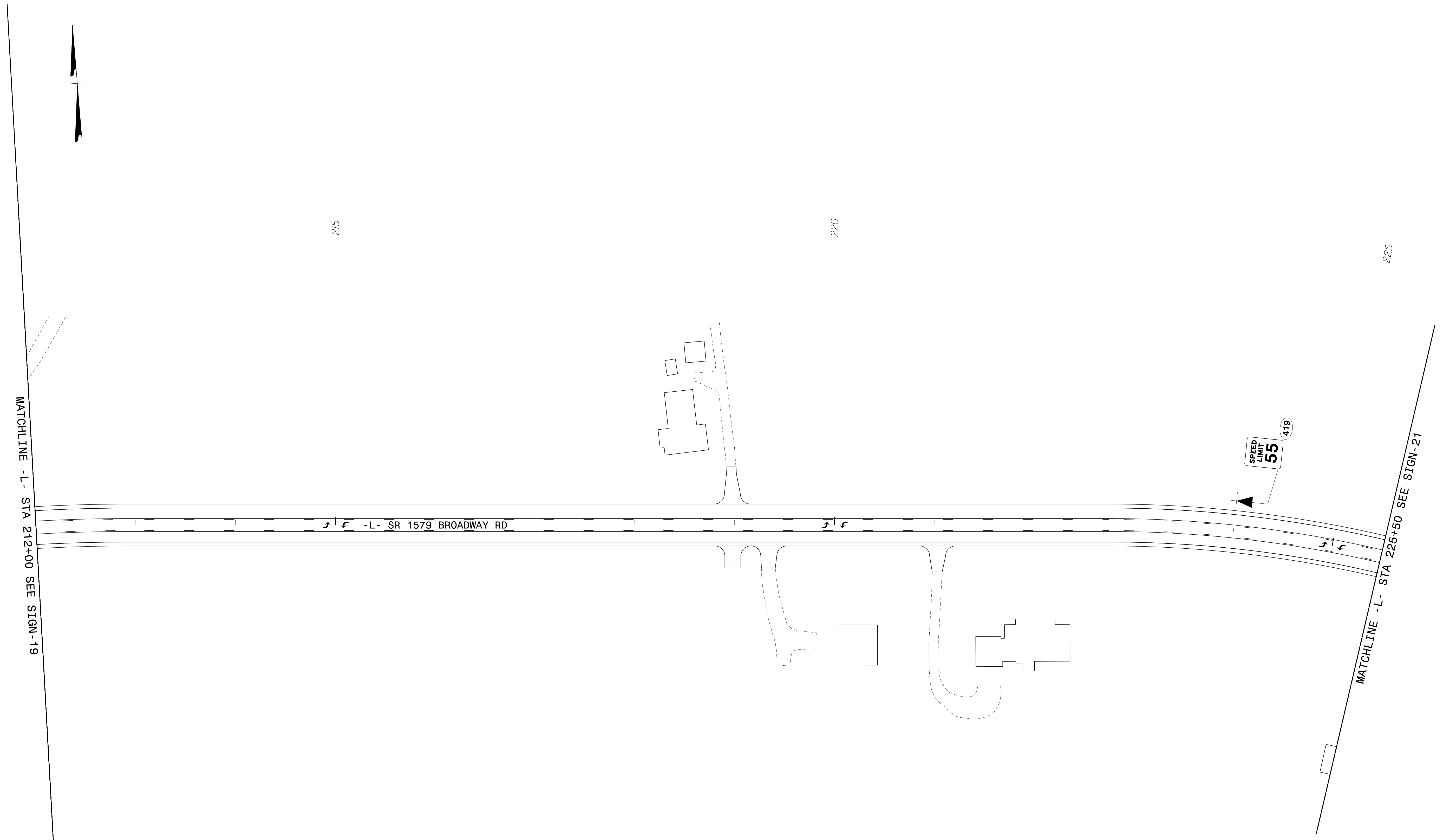

8/27/2019
G:\395689_NCDOT_2018_Traffic\LSA\Proj\ALR-3830\Traffic\Signing\CADD\Signing Layout Plans\SR-3830_Sgn_SIGN_20.dgn
User:COL85144

APPROVED: *Samuel D. Coleman*
DATE: 8/27/2019

SEAL

**DOCUMENT NOT CONSIDERED FINAL
UNLESS ALL SIGNATURES COMPLETED**

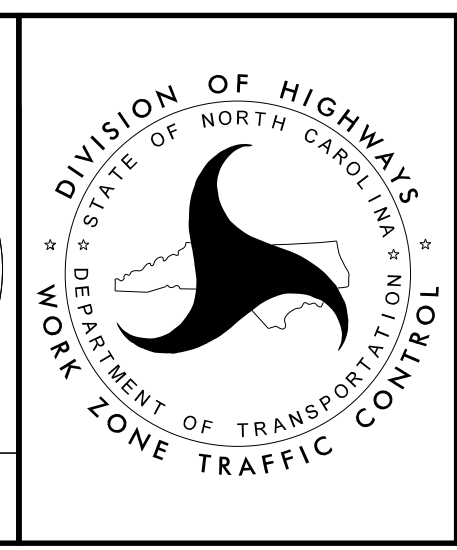

SIGNING DETAIL SHEET

PLANS PREPARED FOR THE NCDOT BY:
M M
MOY
MACDONALD
LICENSE NO. F-6669

PROJ. REFERENCE NO.	SHEET NO.
R-3830	SIGN-20A

MATCHLINE - L - STA 212+00 SEE SIGN-19A

MATCHLINE - L - STA 225+50 SEE SIGN-21A

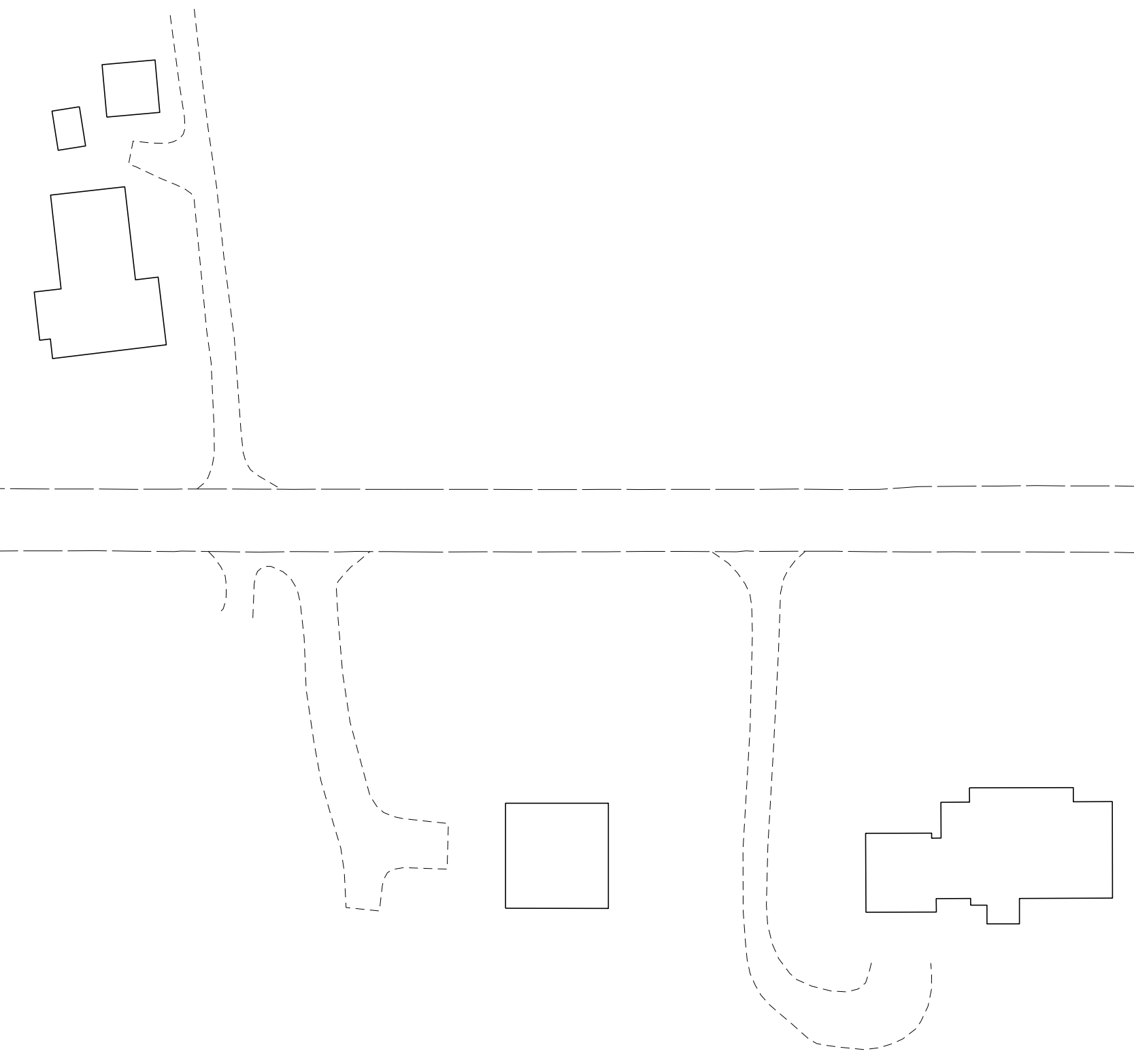
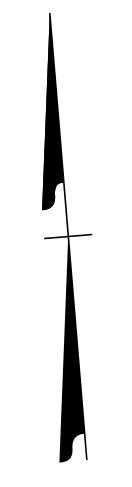

8/27/2019
G:\395689_NCDOT_2018_Traffic\LSA\Proj\ALR-3830\Traffic\Signing\CADD\Signing Layout Plans\R-3830_Sgn_SIGN_20A.dgn
User:COL85144

APPROVED: *Samuel D. Coleman*
DocuSigned by:
6B28607F07254D9

DATE: 8/27/2019

SEAL

**DOCUMENT NOT CONSIDERED FINAL
UNLESS ALL SIGNATURES COMPLETED**

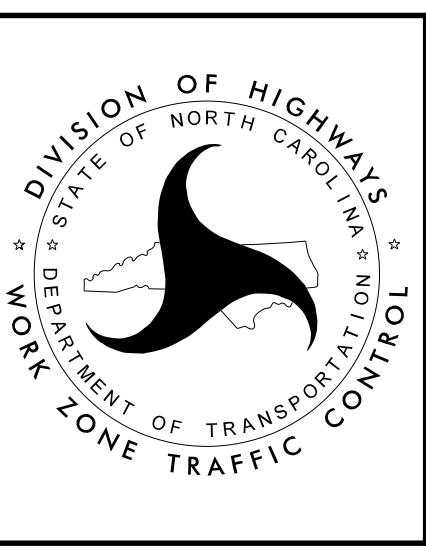

EXISTING
SIGNING
DETAIL SHEET

PLANS PREPARED FOR THE NCDOT BY:
M MOTT
MACDONALD
PO Box 700
Raleigh, NC 27624
919-551-2233
919-551-2234 Fax
www.mottmacdonald.com
LICENSE NO. F-9669

PROJ. REFERENCE NO.	SHEET NO.
R-3830	SIGN-21

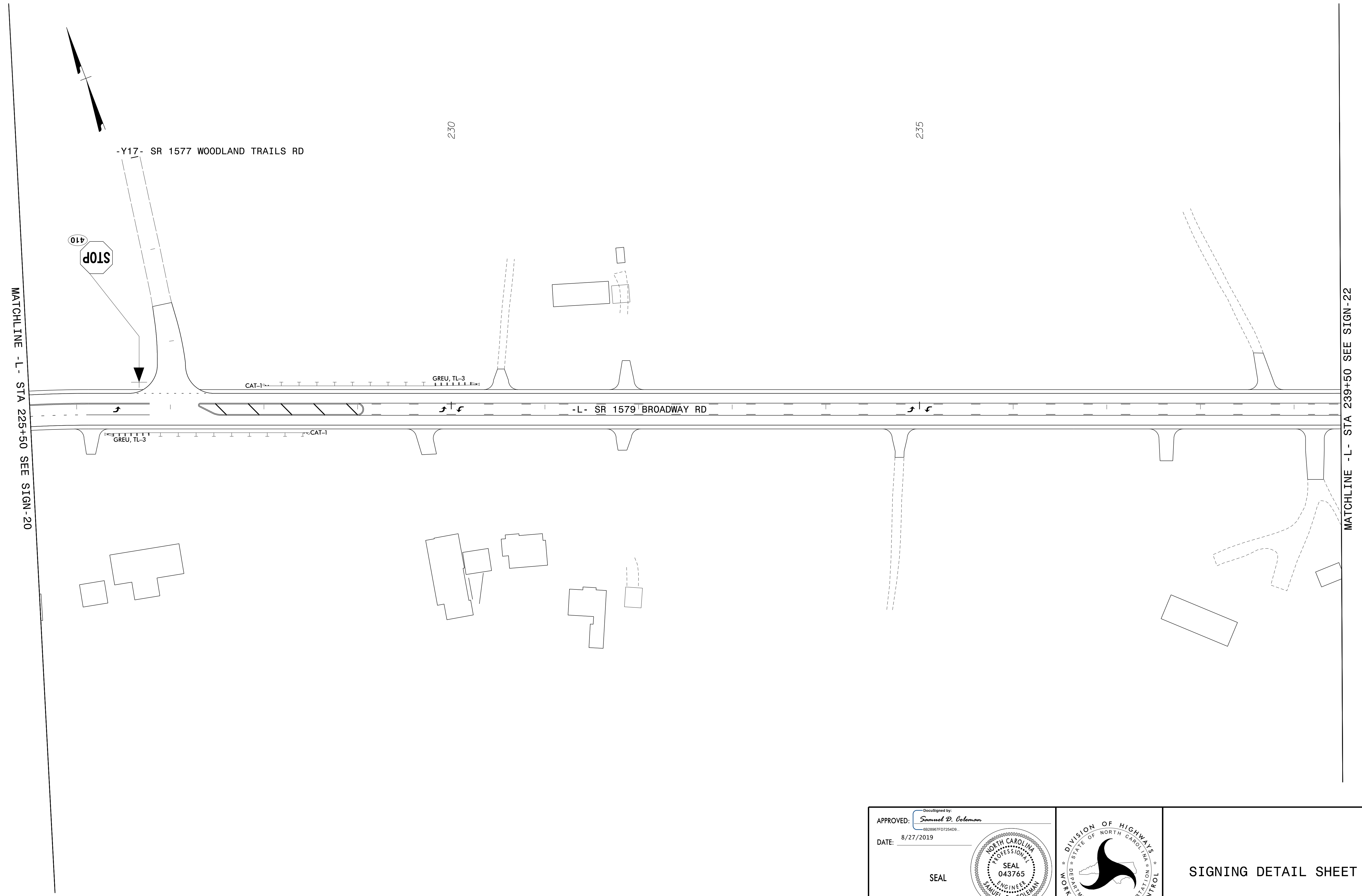

8/27/2019
G:\395689_NCDOT_2018_Traffic\ALR-3830\Traffic\Signing\CADD\Signing Layout Plans\R-3830_Sgn_SIGN-21.dgn
User:COL85144

APPROVED: *Samuel D. Coleman*
DATE: 8/27/2019

SEAL

**DOCUMENT NOT CONSIDERED FINAL
UNLESS ALL SIGNATURES COMPLETED**

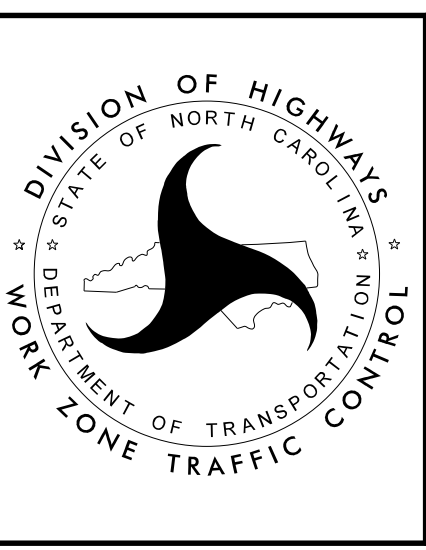

SIGNING DETAIL SHEET

PLANS PREPARED FOR THE NCDOT BY:
M M
MONT
MACDONALD
LICENSE NO. F-9669

PROJ. REFERENCE NO.	SHEET NO.
R-3830	SIGN-21A

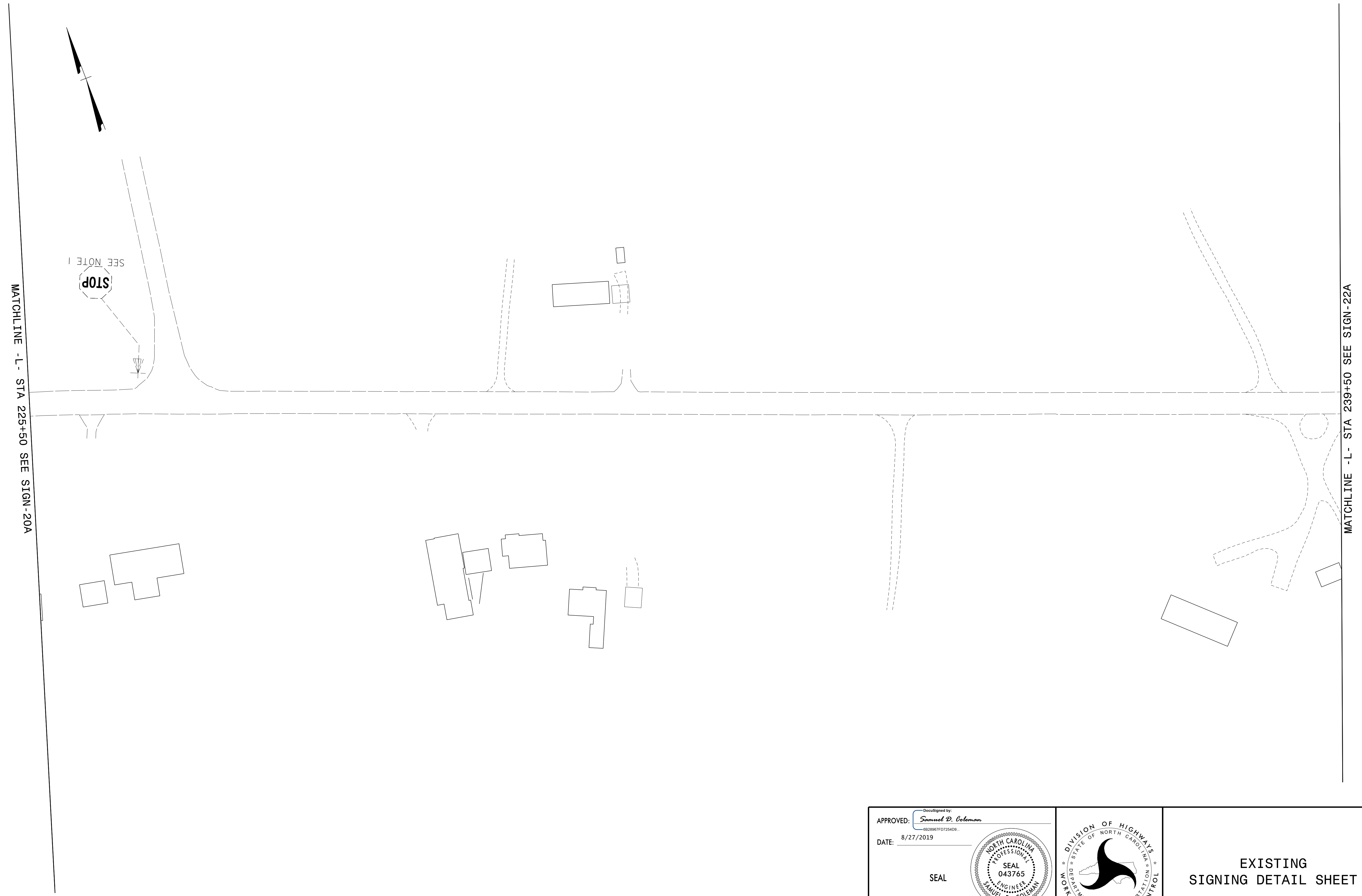

8/27/2019
G:\395689_NCDOT_2018_Traffic\ALR-3830\Traffic\Signing\CADD\Signing Layout Plans\R-3830_Sgn_SIGN_21A.dgn
User:COL85144

APPROVED: *Samuel D. Coleman*
DATE: 8/27/2019

SEAL

DOCUMENT NOT CONSIDERED FINAL
UNLESS ALL SIGNATURES COMPLETED

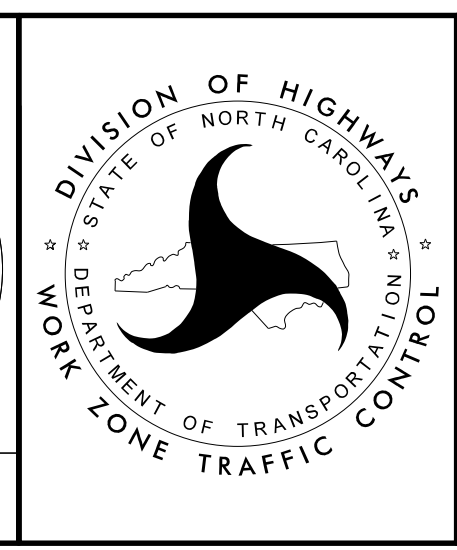

EXISTING
SIGNING DETAIL SHEET

PLANS PREPARED FOR THE NCDOT BY:
M M
MONT
MACDONALD
LICENSE NO. F-6669

PROJ. REFERENCE NO.	SHEET NO.
R-3830	SIGN-22

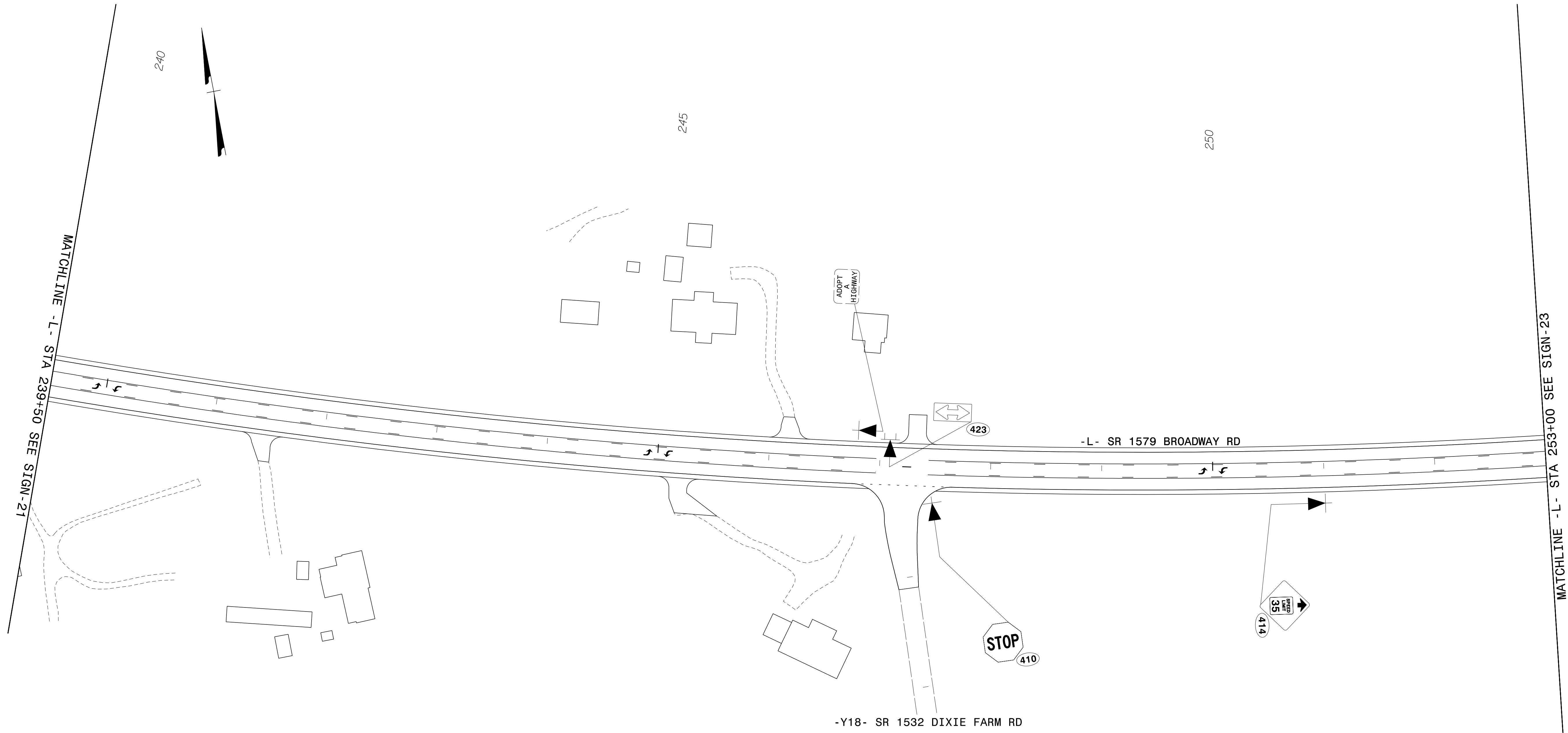

8/27/2019
G:\395689_NCDOT_2018_Traffic\LSA\Proj\ALR-3830\Traffic\Signing\CADD\Signing Layout Plans\R-3830_Sgn_SIGN_22.dgn
User:COLL85144

APPROVED: *Samuel D. Coleman*
DATE: 8/27/2019

SEAL

DOCUMENT NOT CONSIDERED FINAL
UNLESS ALL SIGNATURES COMPLETED

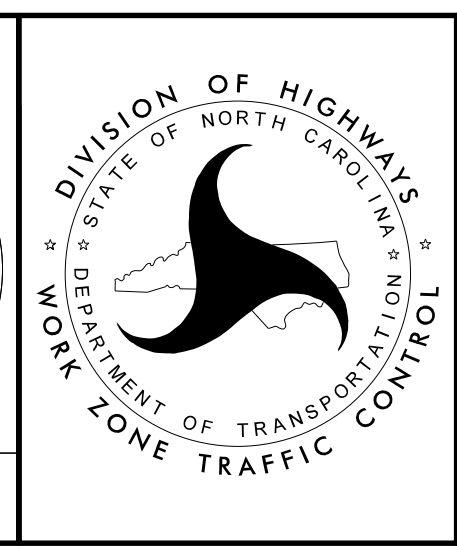

SIGNING DETAIL SHEET

PLANS PREPARED FOR THE NCDOT BY:
M M
MONT
MACDONALD
PO Box 700
Raleigh, NC 27624
919-551-2233
919-551-2234 Fax
www.mmtm.com
LICENSE NO. F-9669

PROJ. REFERENCE NO.	SHEET NO.
R-3830	SIGN-22A

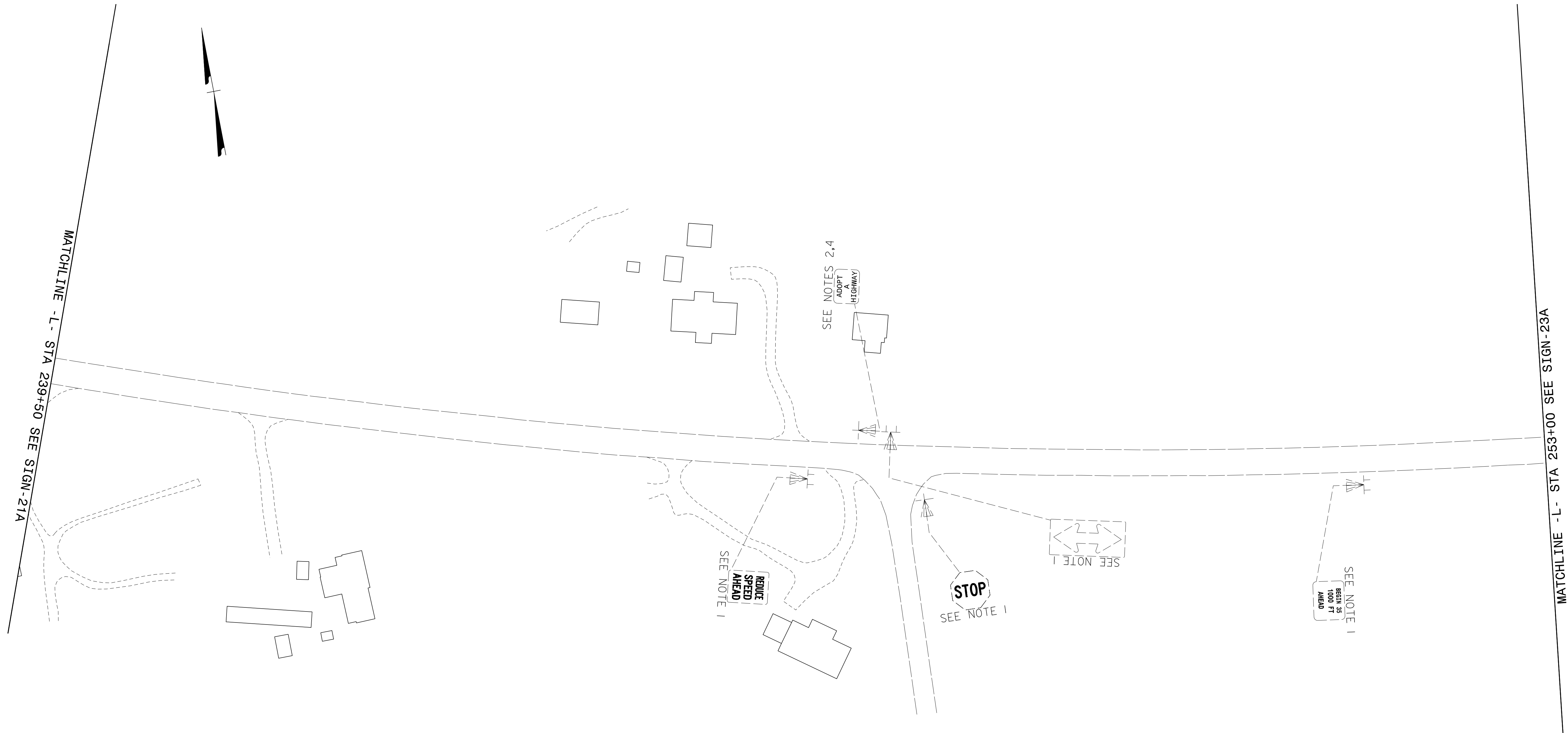

8/27/2019
G:\395689_NCDOT_2018_Traffic_LSA\Proj\ALR-3830\Traffic\Signing\CADD\Signing Layout Plans\R-3830_Sgn_SIGN_22A.dgn
User:COL85144

APPROVED: *Samuel D. Coleman*
6828607F07254D9

DATE: 8/27/2019

SEAL

**DOCUMENT NOT CONSIDERED FINAL
UNLESS ALL SIGNATURES COMPLETED**

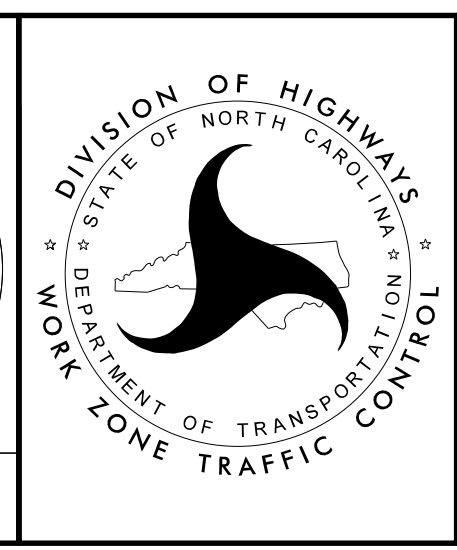

EXISTING
SIGNING DETAIL SHEET

PLANS PREPARED FOR THE NCDOT BY:
M M
MOTT
MACDONALD
LICENSE NO. F-6669

PROJ. REFERENCE NO.	SHEET NO.
R-3830	SIGN-23

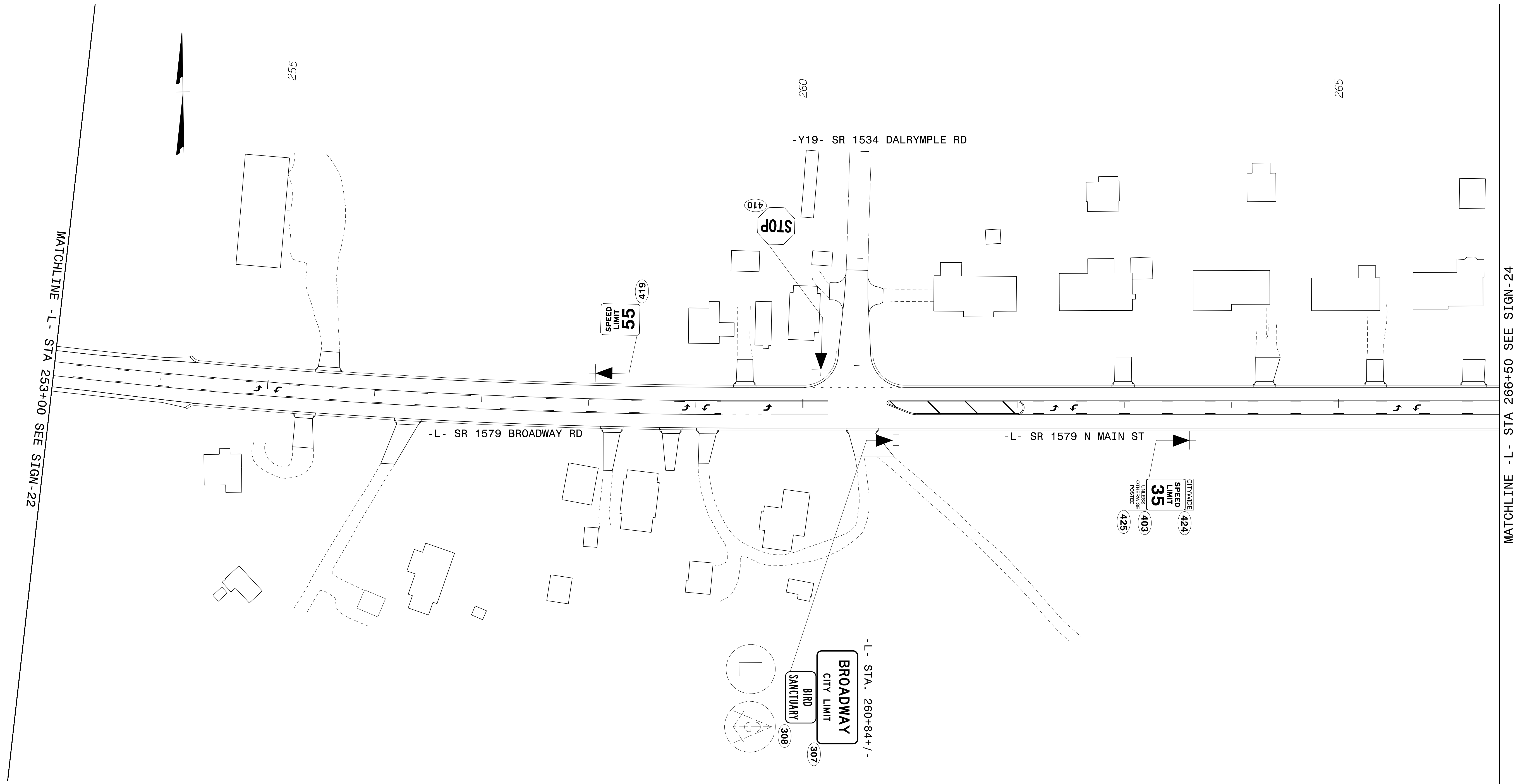

8/27/2019 8:36:56 AM
G:\3656889_NCDOT_2018_Traffic\LSA\Proj\ALR-3830\Traffic\Signing\CADD\Signing Layout Plans\ALR-3830_Sgn_SIGN_23.dgn
User:COL85144

APPROVED: *Samuel D. Coleman*
DATE: 8/27/2019

SEAL

DOCUMENT NOT CONSIDERED FINAL
UNLESS ALL SIGNATURES COMPLETED

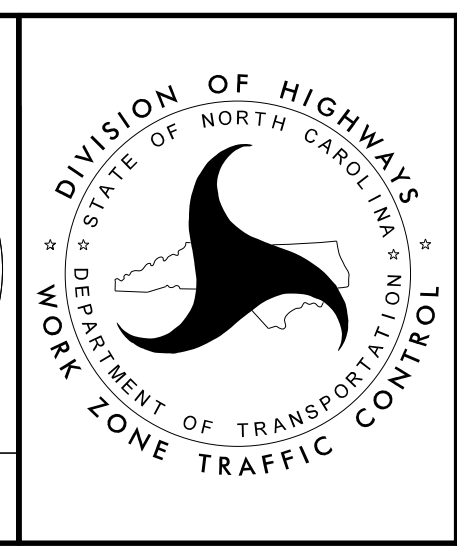

DIVISION OF HIGHWAYS
STATE OF NORTH CAROLINA
DEPARTMENT OF TRANSPORTATION
WORK ZONE TRAFFIC CONTROL

SIGNING DETAIL SHEET

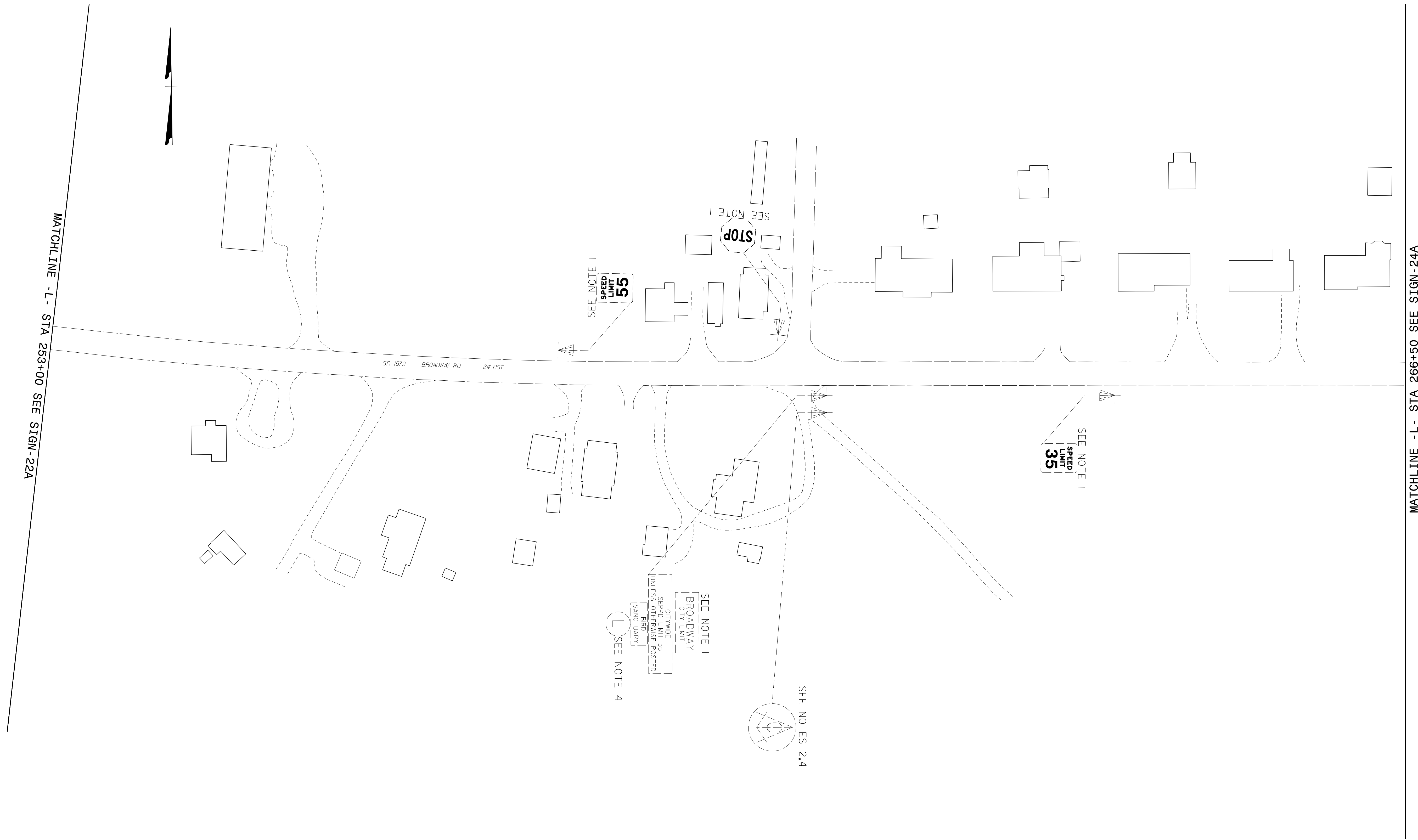

8/27/2019
G:\395689_NCDOT_2018_Traffic\SA\Proj\ALR-3830\Traffic\Signing\CADD\Signing Layout Plans\R-3830_Sgn_SIGN_23A.dgn
User:COL85144

APPROVED: *Samuel D. Coleman*
DATE: 8/27/2019

SEAL

**DOCUMENT NOT CONSIDERED FINAL
UNLESS ALL SIGNATURES COMPLETED**

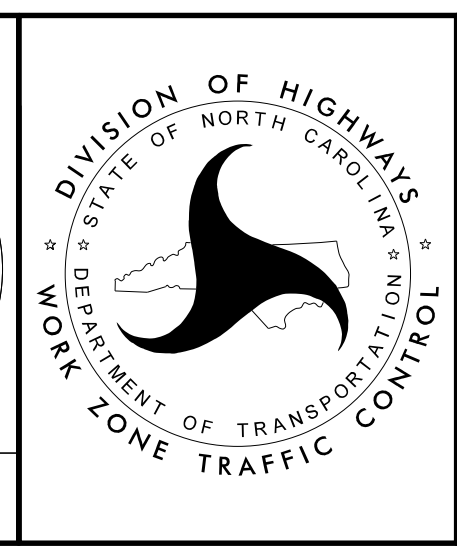

**EXISTING
SIGNING DETAIL SHEET**

PLANS PREPARED FOR THE NCDOT BY:
M M
MOY MACDONALD
LIC. NO. F-6669

PROJ. REFERENCE NO.	SHEET NO.
R-3830	SIGN-24

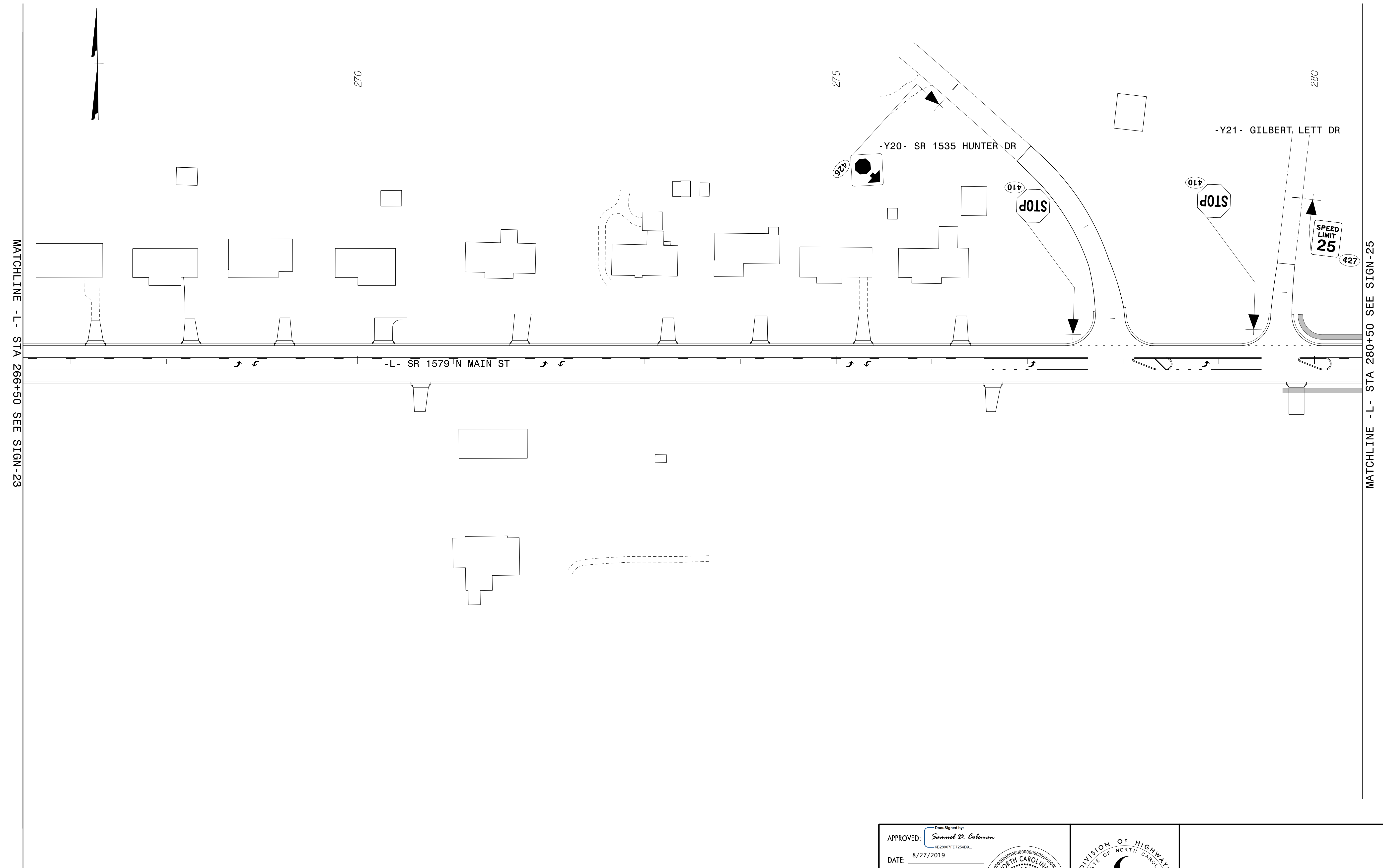

8/27/2019
G:\395689_NCDOT_2018_Traffic\SA\Proj\ALR-3830\Traffic\Signing\CADD\Signing Layout Plans\R-3830_Sgn_SIGN_24.dgn
User:COL85144

APPROVED: *Samuel D. Coleman*
DATE: 8/27/2019

SEAL

**DOCUMENT NOT CONSIDERED FINAL
UNLESS ALL SIGNATURES COMPLETED**

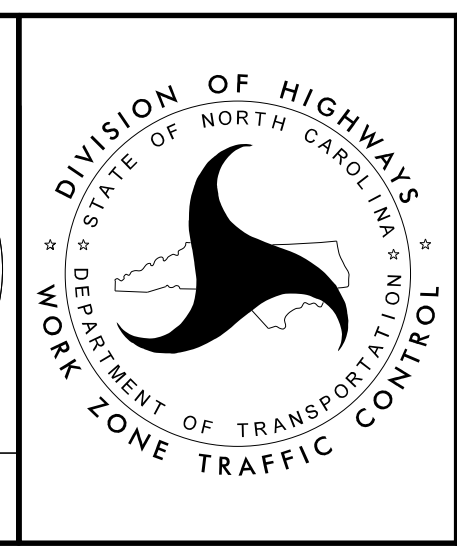

SIGNING DETAIL SHEET

PLANS PREPARED FOR THE NCDOT BY:
M M
MOY MACDONALD
LICENSE NO. F-9669

PROJ. REFERENCE NO.	SHEET NO.
R-3830	SIGN-24A

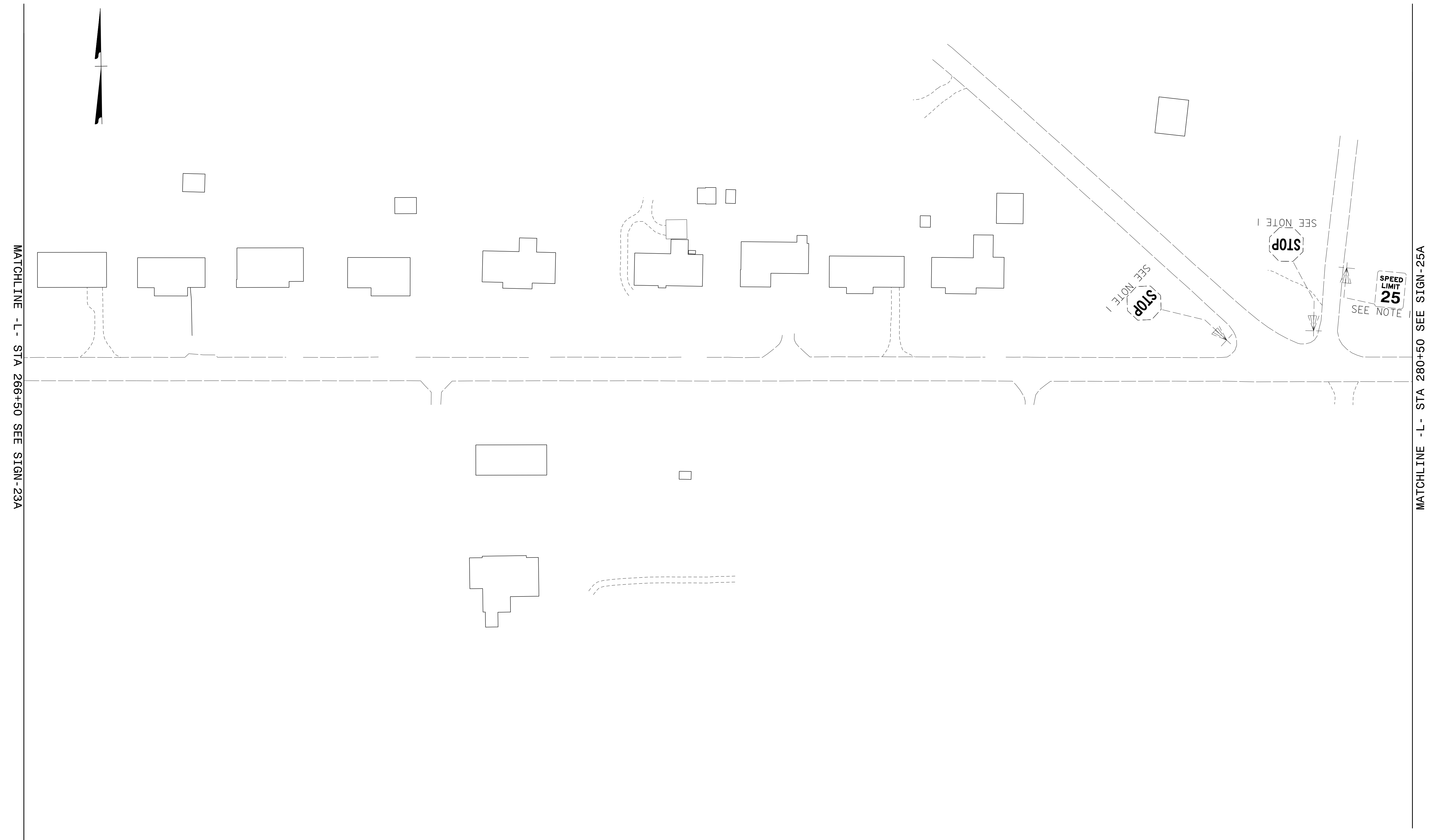

8/27/2019
G:\395689_NCDOT_2018_Traffic\LSA\Proj\ALR-3830\Traffic\Signing\CADD\Signing Layout Plans\AR-3830_Sgn_SIGN_24A.dgn
User:COLL85144

APPROVED: *Samuel D. Coleman*
DocuSigned by:
6B28607F07254D9

DATE: 8/27/2019

SEAL

NORTH CAROLINA PROFESSIONAL ENGINEER SEAL
 043765
 SAMUEL D. COLEMAN

DOCUMENT NOT CONSIDERED FINAL UNLESS ALL SIGNATURES COMPLETED

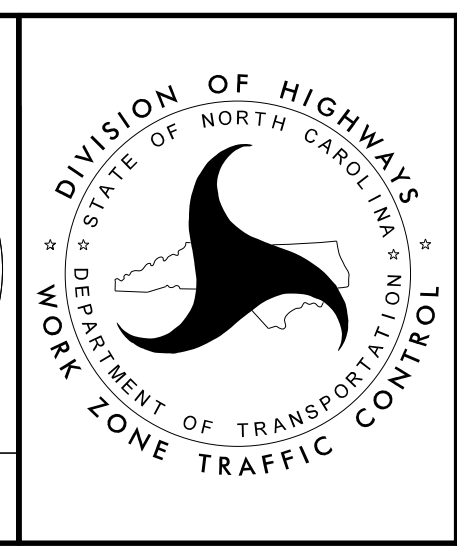

EXISTING SIGNING DETAIL SHEET

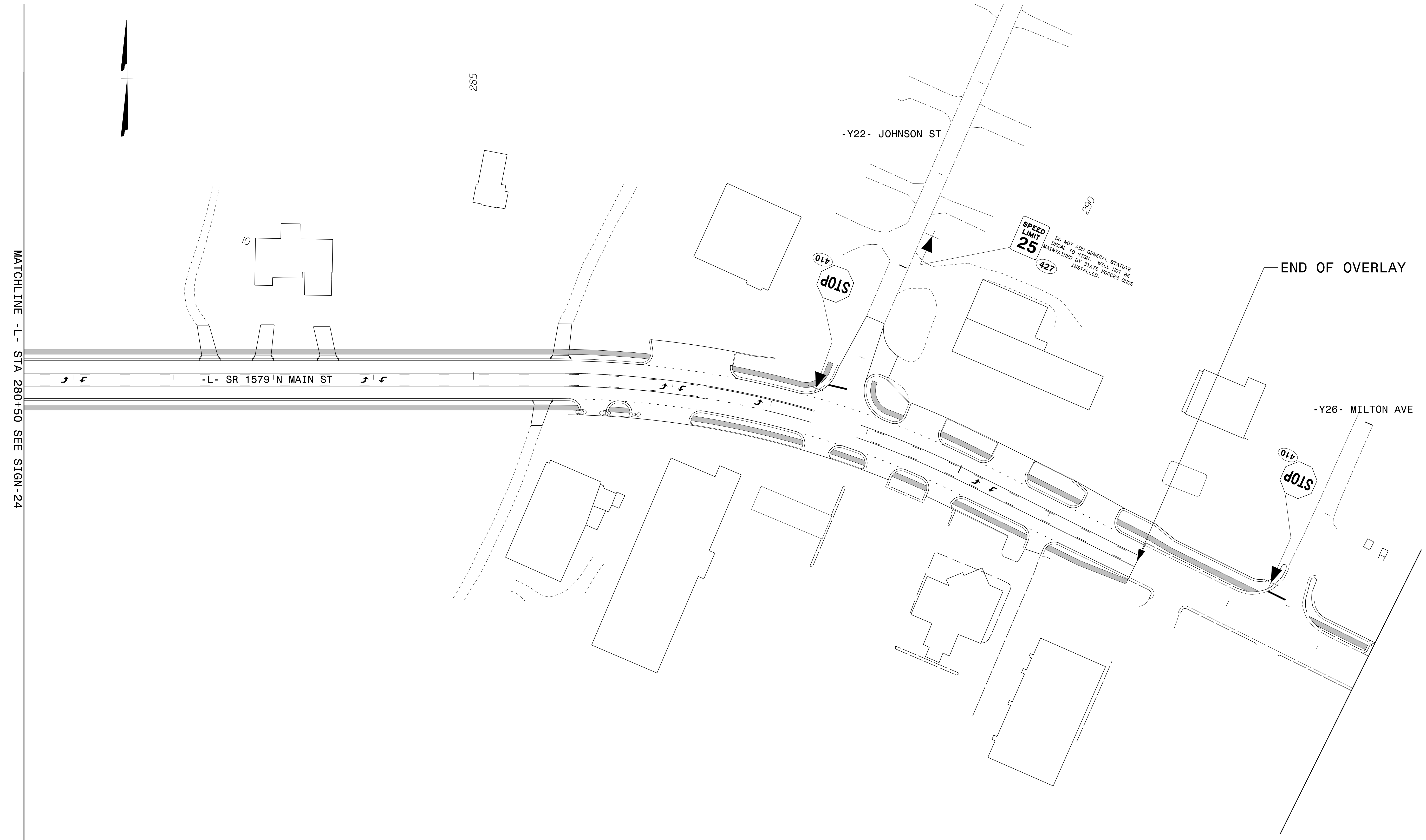

9/10/2019
 G:\395689_NCDOT_2018_Traffic_LSA\Proj\ALR-3830\Traffic\Signing\CADD\Signing Layout Plans\R-3830_Sgn_SIGN_25.dgn
 User:COL85144

APPROVED: *Samuel D. Coleman*
48286770725409

DATE: 9/10/2019

SEAL

**DOCUMENT NOT CONSIDERED FINAL
 UNLESS ALL SIGNATURES COMPLETED**

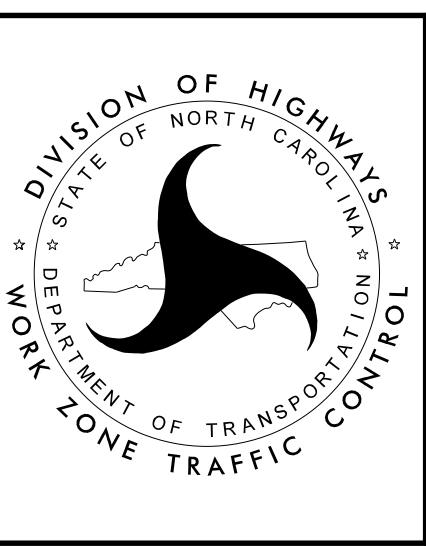

SIGNING DETAIL SHEET

PLANS PREPARED FOR THE NCDOT BY:
M M
MONT
MACDONALD
LICENSE NO. F-9669

PROJ. REFERENCE NO.	SHEET NO.
R-3830	SIGN-25A

MATCHLINE - L - STA 280+50 SEE SIGN-24A

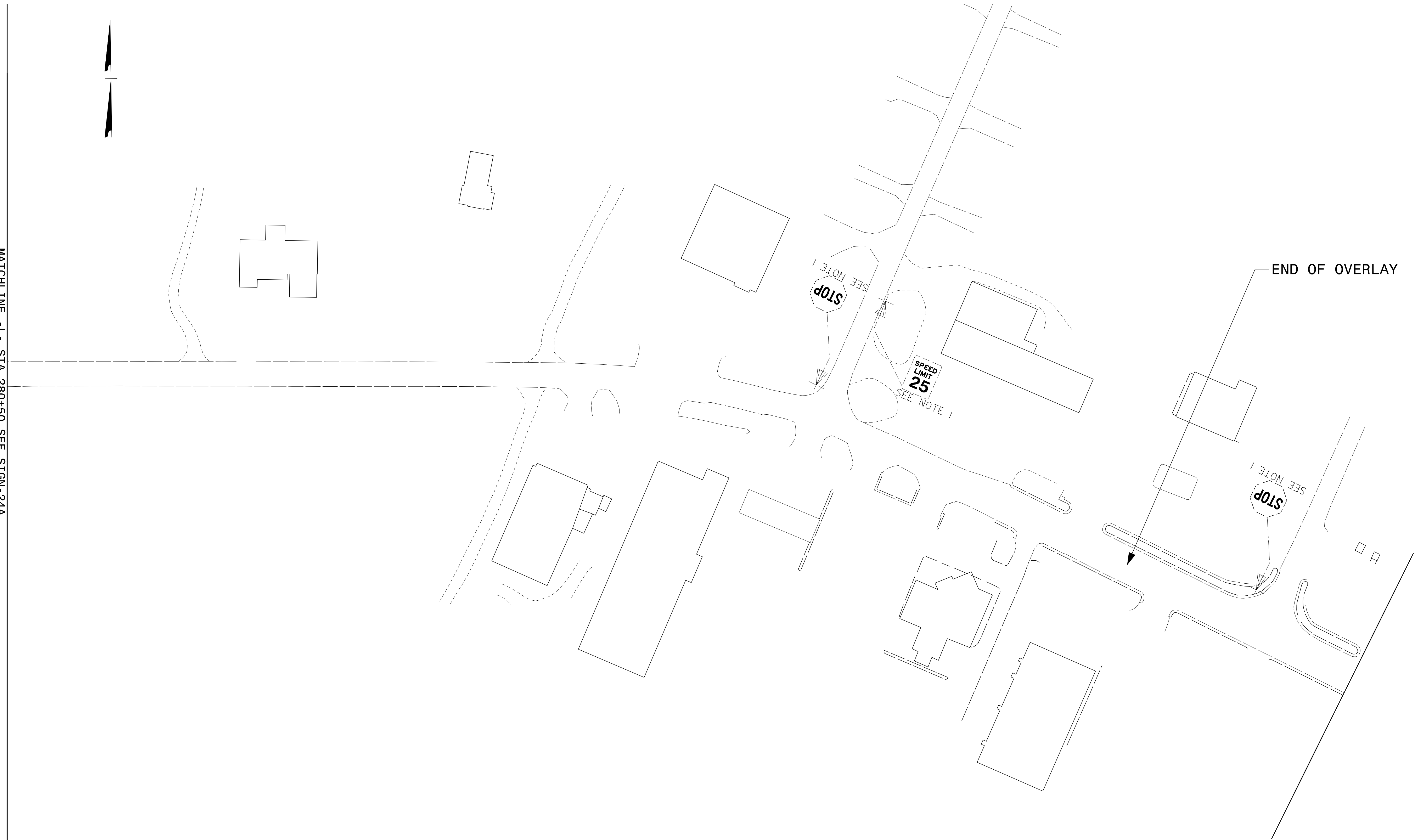
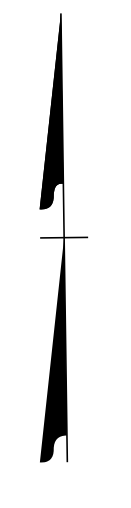

9/10/2019
G:\395689_NCDOT_2018_Traffic\ALR-3830\Traffic\Signing\CADD\Signing Layout Plans\AR-3830_Sgn_SIGN-25A.dgn
User:COL85144

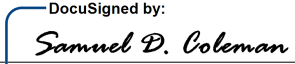
APPROVED: 
DATE: 9/10/2019

SEAL

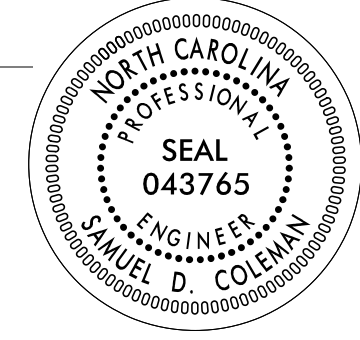

**DOCUMENT NOT CONSIDERED FINAL
UNLESS ALL SIGNATURES COMPLETED**

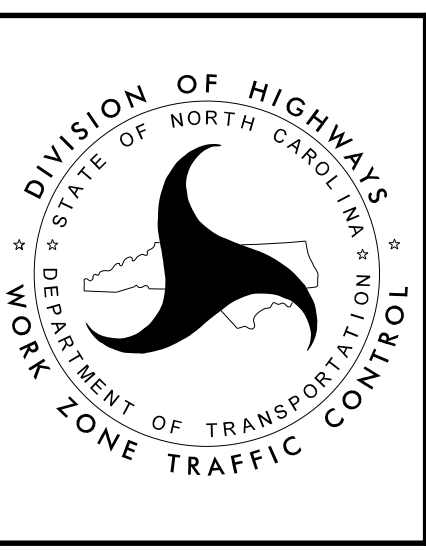

EXISTING
SIGNING DETAIL SHEET