

CHANNEL 9
SPLICE ENCLOSURE AT
(GARRISON BLVD. [SR 2466] AT
BURTONWOOD DR.)
SIG ID 12-0634
CCTV CAMERA-21

COLOR CODE
TIA/EIA 598-C

(1) BLUE	(7) RED
(2) ORANGE	(8) BLACK
(3) GREEN	(9) YELLOW
(4) BROWN	(10) VIOLET
(5) SLATE	(11) ROSE
(6) WHITE	(12) AQUA

LEGEND

X - FUSION SPLICE INDIVIDUAL FIBER
 O - EXISTING SPLICE
 □ - EXPRESS INDIVIDUAL FIBER

EXPRESS - EXPRESS ENTIRE BUFFER TUBE
 SPLICE - SPLICE ENTIRE BUFFER TUBE OR MAINTAIN IF EXISTING EXPRESSED

NOTES:
 1. FIBER INTERCONNECT CENTER RACKS ARE SCHEMATIC ONLY - ACTUAL EQUIPMENT FORM MAY VARY.
 2. ETHERNET SWITCH TERMINATION CONFIGURATIONS ARE GENERIC. CONTRACTOR IS RESPONSIBLE FOR DETERMINING /ENSURING PROPER TERMINATION.
 3. CONTRACTOR IS RESPONSIBLE FOR FIELD VERIFYING EXISTING SPlicing. THE CONTRACTOR SHALL COORDINATE WITH THE ENGINEER WHERE EXISTING SPlicing IS NOT AS EXPECTED.

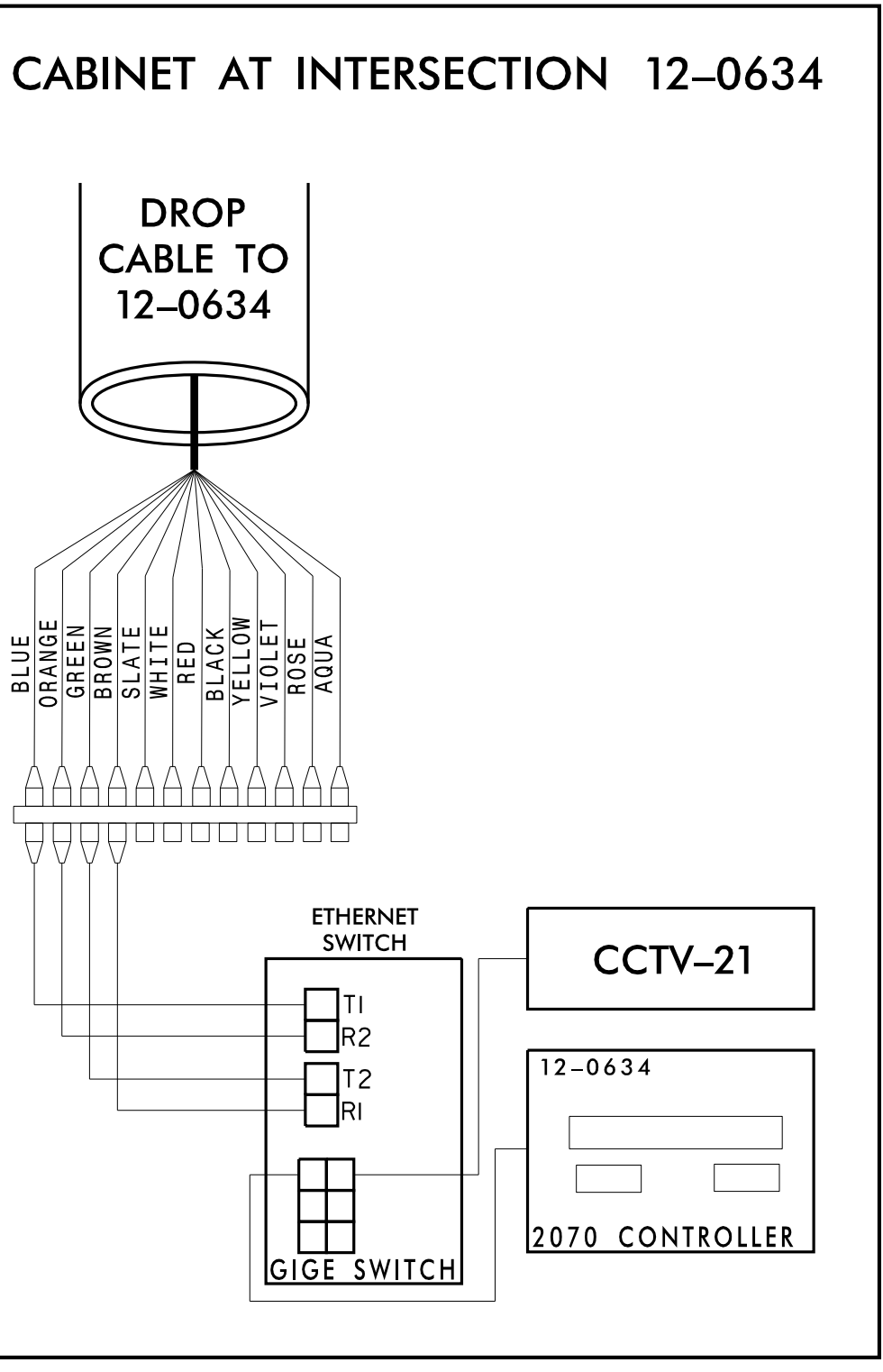
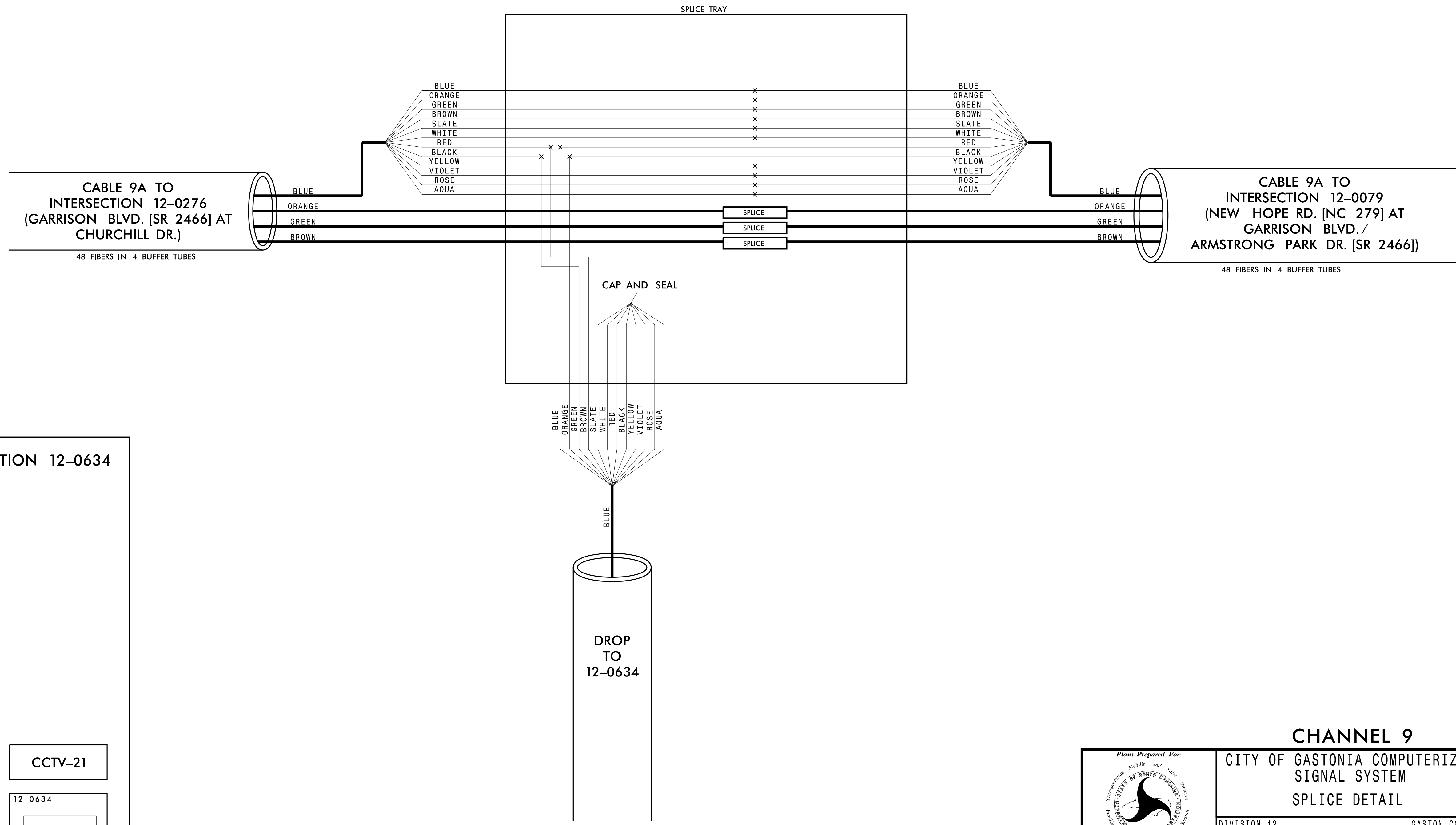

CHANNEL 9
CITY OF GASTONIA COMPUTERIZED SIGNAL SYSTEM
SPLICE DETAIL

DIVISION 12 GASTON COUNTY
 PLAN DATE: DECEMBER 2021 REVIEWED BY: K. SMITH
 PREPARED BY: S. BUTLER REVIEWED BY: I. VAN OSDELL

Scale: 0

REVISIONS: _____ DATE: _____
 INIT. DATE

DocuSigned by: Inger Van OsdeLL 3/16/2022
 SEAL: NORTH CAROLINA PROFESSIONAL SEAL 028952
 INGER Z. VAN OSDELL
 CADD File name: _____

Kimley»Horn
 NC License #F-0102
 421 Fayetteville St., Suite 600
 Raleigh, NC 27601
 Tel: (919) 677-2000
 Fax: (919) 677-2050

3/15/2022 \\kimley-horn.com\SE-RAL\NRA\1-PTO\ITS\01036569_Gastonia_Signal_System\6_Tasks\Splicing\SPL092.dgn

CHANNEL 9
SPLICE ENCLOSURE AT
(NEW HOPE RD. [NC 279] AT
GARRISON BLVD./ARMSTRONG PARK DR. [SR 2466])
SIG ID 12-0079
CCTV CAMERA-22

COLOR CODE
TIA/EIA 598-C

(1) BLUE	(7) RED
(2) ORANGE	(8) BLACK
(3) GREEN	(9) YELLOW
(4) BROWN	(10) VIOLET
(5) SLATE	(11) ROSE
(6) WHITE	(12) AQUA

LEGEND

X - FUSION SPLICE INDIVIDUAL FIBER
O - EXISTING SPLICE
□ - EXPRESS INDIVIDUAL FIBER

EXPRESS - EXPRESS ENTIRE BUFFER TUBE
SPLICE - SPLICE ENTIRE BUFFER TUBE OR MAINTAIN IF EXISTING EXPRESSED

NOTES:
1. FIBER INTERCONNECT CENTER RACKS ARE SCHEMATIC ONLY - ACTUAL EQUIPMENT FORM MAY VARY.
2. ETHERNET SWITCH TERMINATION CONFIGURATIONS ARE GENERIC. CONTRACTOR IS RESPONSIBLE FOR DETERMINING /ENSURING PROPER TERMINATION.
3. CONTRACTOR IS RESPONSIBLE FOR FIELD VERIFYING EXISTING SPLICING. THE CONTRACTOR SHALL COORDINATE WITH THE ENGINEER WHERE EXISTING SPLICING IS NOT AS EXPECTED.

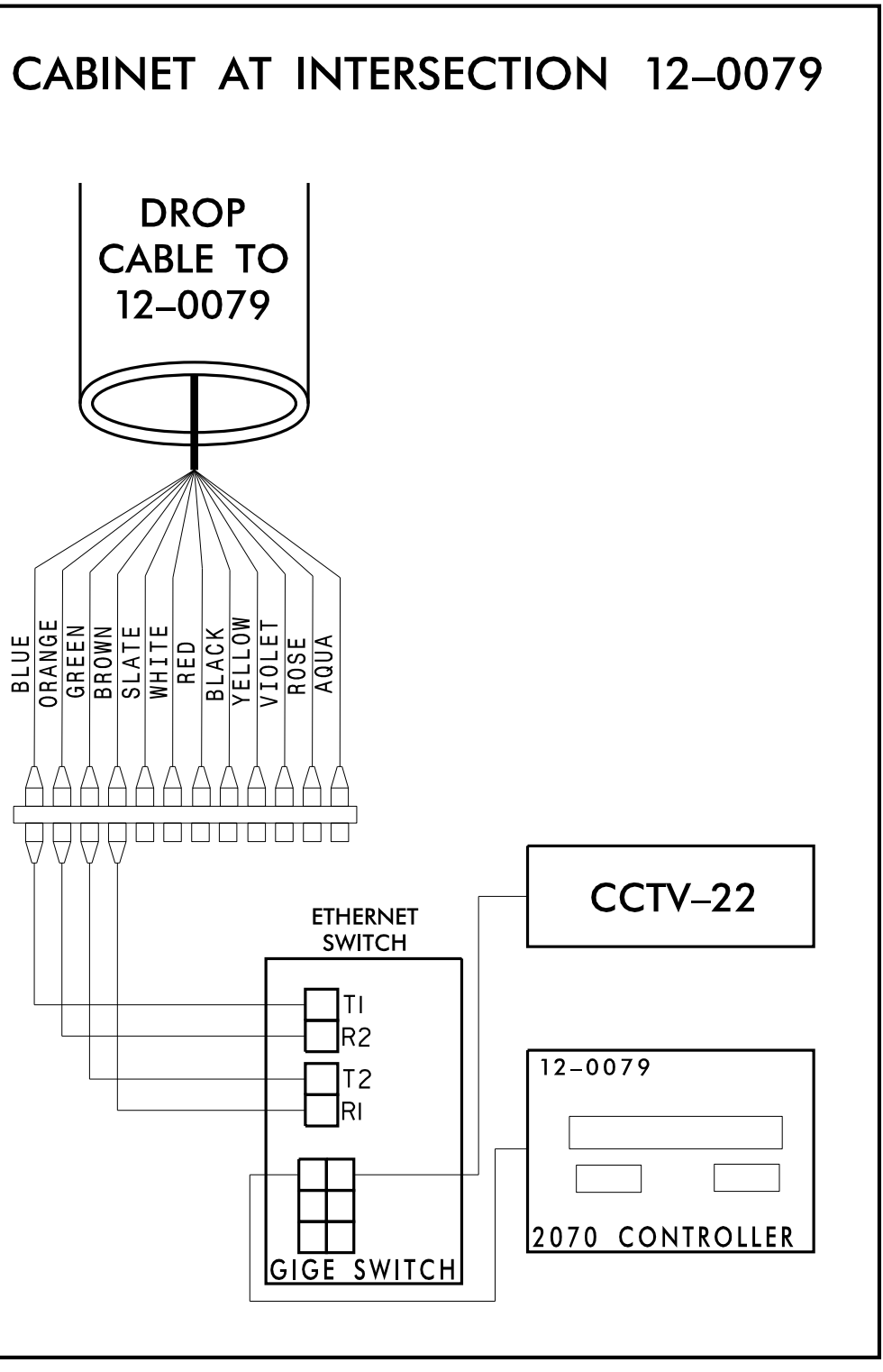
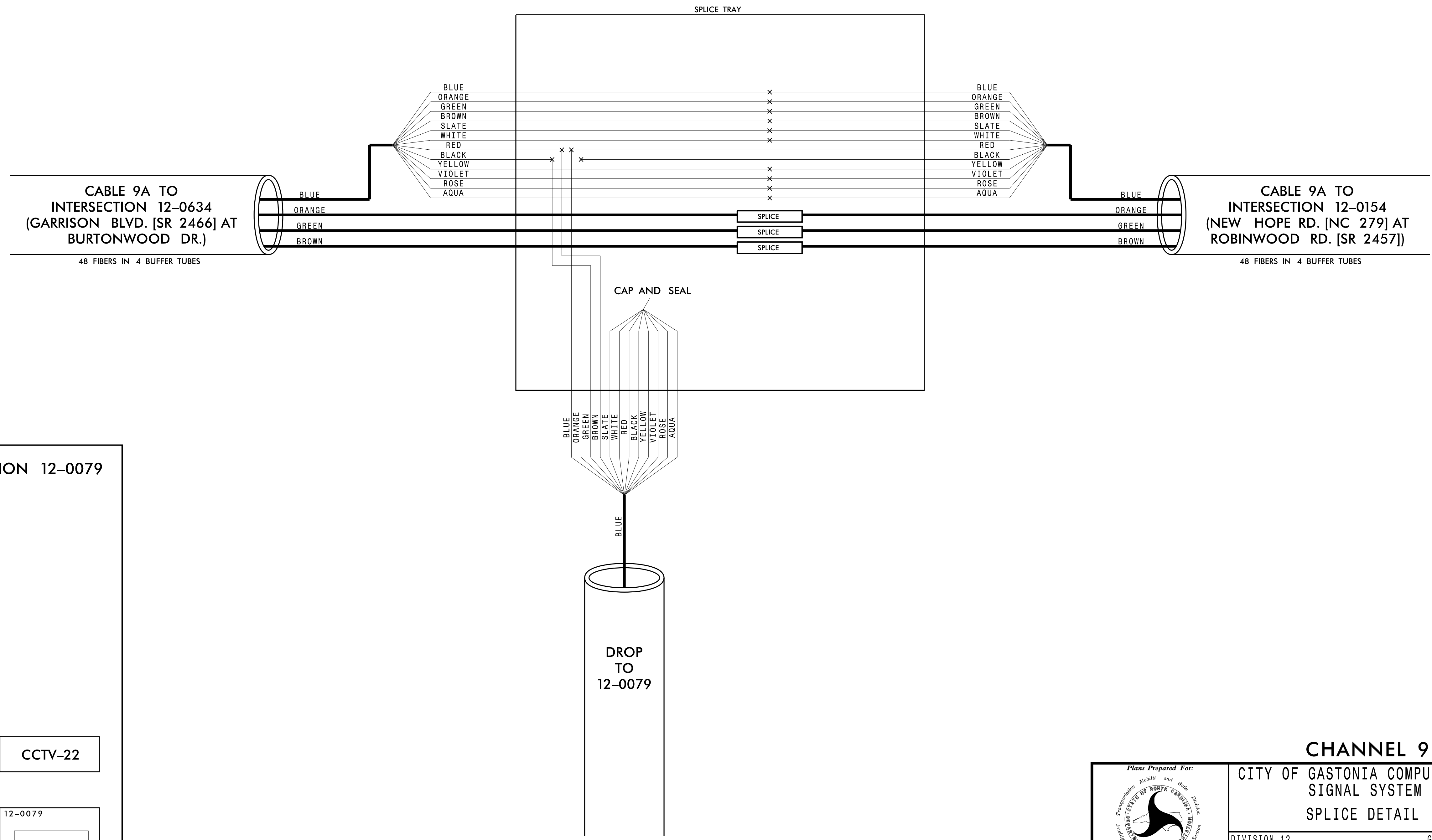

CHANNEL 9
CITY OF GASTONIA COMPUTERIZED SIGNAL SYSTEM
SPLICE DETAIL

DIVISION 12 GASTON COUNTY
PLAN DATE: DECEMBER 2021 REVIEWED BY: K. SMITH
PREPARED BY: S. BUTLER REVIEWED BY: I. VAN OSDELL

Scale: 0

Revisions table with columns: REVISIONS, INIT., DATE

DocuSigned by: Inger Van OsdeLL 3/16/2022

Kimley»Horn
NC License #F-0102
421 Fayetteville St., Suite 600
Raleigh, NC 27601
Tel: (919) 677-2000
Fax: (919) 677-2050

Professional Engineer Seal: NORTH CAROLINA PROFESSIONAL ENGINEER SEAL 028952 INGER Z. VAN OSDELL

3/15/2022 \\kimley-horn.com\SE-RAL\NRL_TPTD\ITS\01036569_Gastonia_Signal_System\6_Tasks\Splicing\SPL093.dgn

CHANNEL 9
SPLICE ENCLOSURE AT
(NEW HOPE RD. [NC 279] AT
ROBINWOOD RD. [SR 2457])
SIG ID 12-0154

COLOR CODE
TIA/EIA 598-C

(1) BLUE	(7) RED
(2) ORANGE	(8) BLACK
(3) GREEN	(9) YELLOW
(4) BROWN	(10) VIOLET
(5) SLATE	(11) ROSE
(6) WHITE	(12) AQUA

LEGEND

X - FUSION SPlice INDIVIDUAL FIBER
 O - EXISTING SPlice
 □ - EXPRESS INDIVIDUAL FIBER

EXPRESS - EXPRESS ENTIRE BUFFER TUBE
 SPlice - SPlice ENTIRE BUFFER TUBE OR MAINTAIN IF EXISTING EXPRESSED

NOTES:
 1. FIBER INTERCONNECT CENTER RACKS ARE SCHEMATIC ONLY - ACTUAL EQUIPMENT FORM MAY VARY.
 2. ETHERNET SWITCH TERMINATION CONFIGURATIONS ARE GENERIC. CONTRACTOR IS RESPONSIBLE FOR DETERMINING /ENSURING PROPER TERMINATION.
 3. CONTRACTOR IS RESPONSIBLE FOR FIELD VERIFYING EXISTING SPlicing. THE CONTRACTOR SHALL COORDINATE WITH THE ENGINEER WHERE EXISTING SPlicing IS NOT AS EXPECTED.

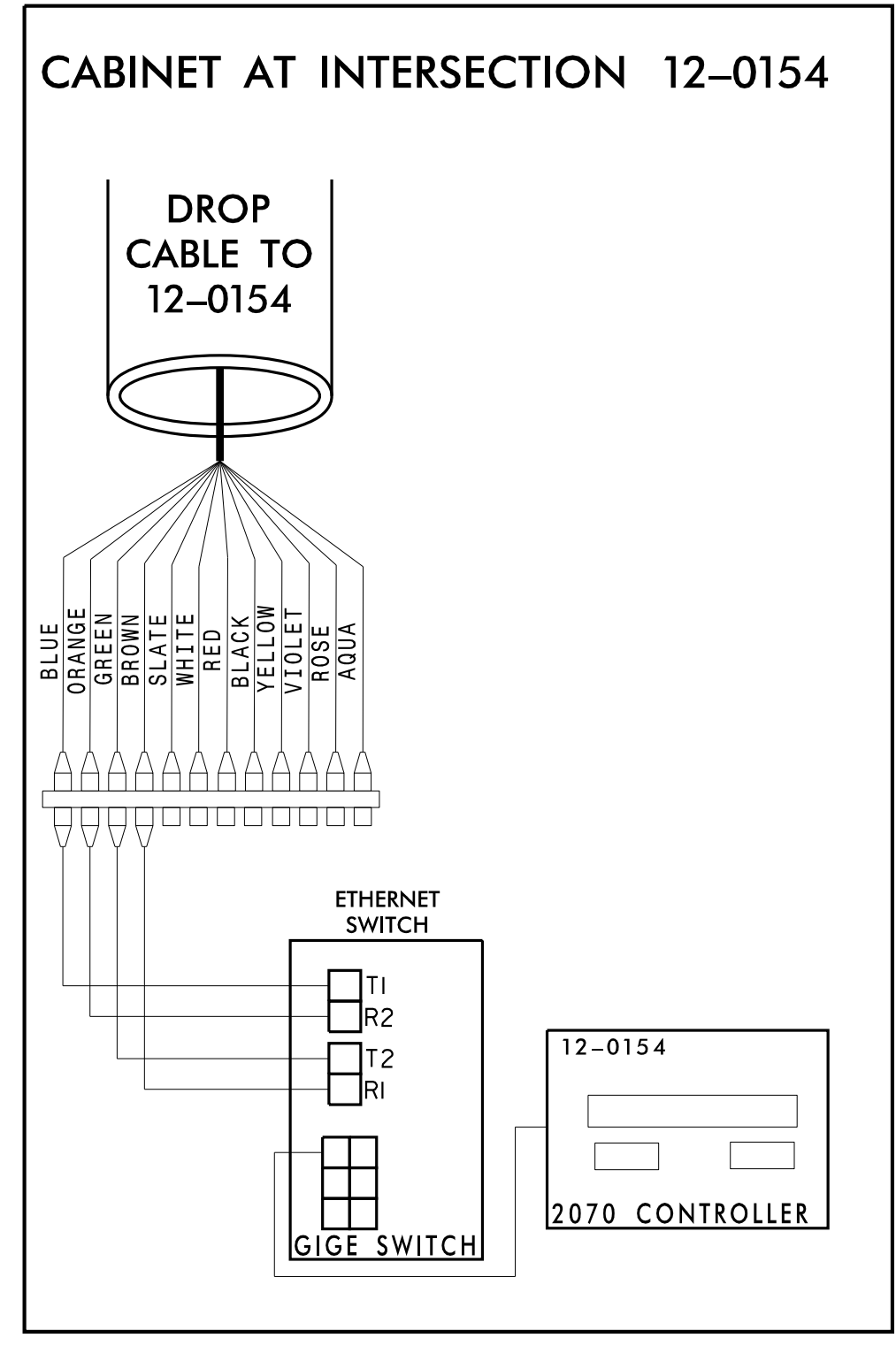
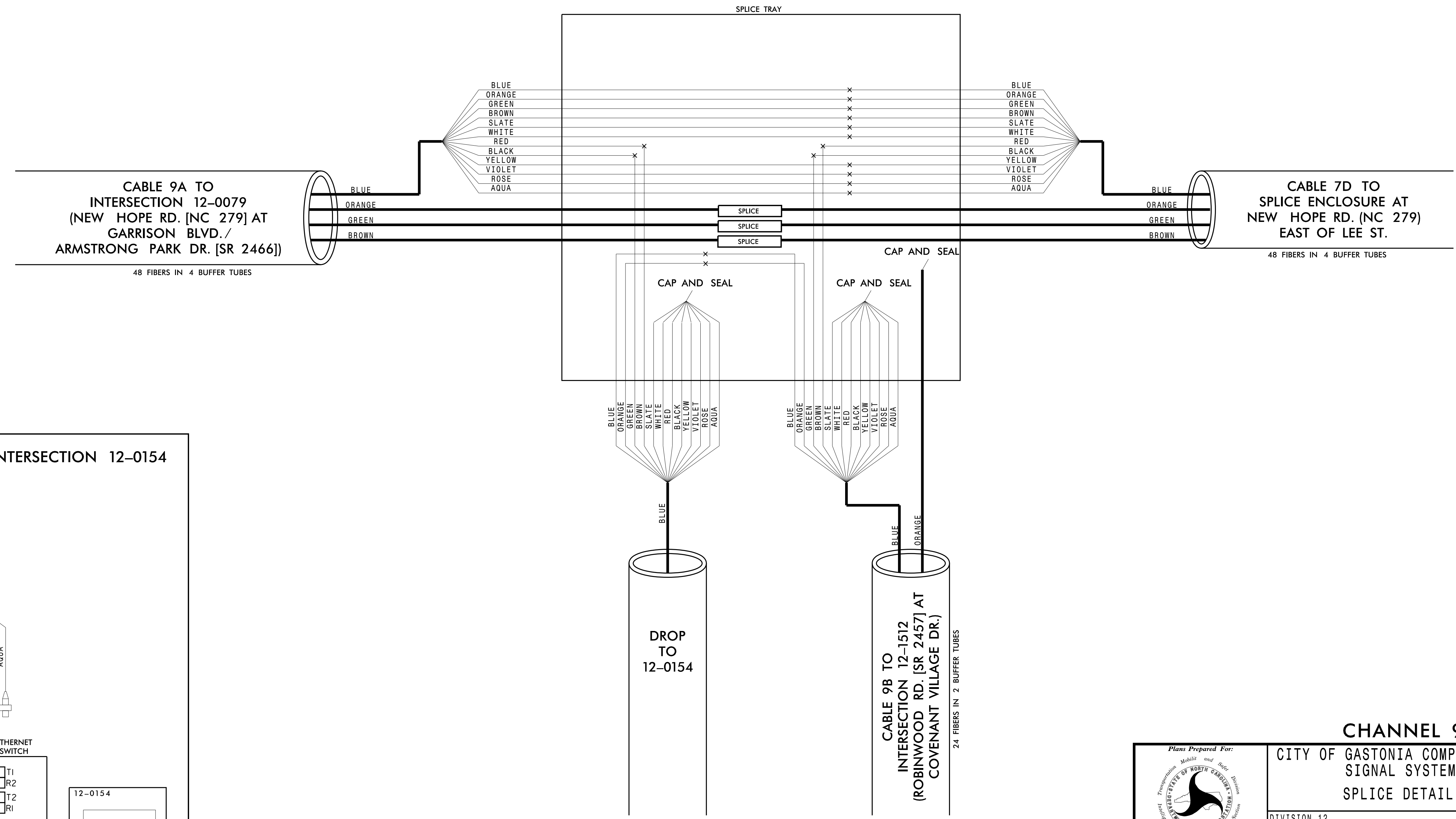

CHANNEL 9
CITY OF GASTONIA COMPUTERIZED SIGNAL SYSTEM
SPlice DETAIL

DIVISION 12 GASTON COUNTY
 PLAN DATE: DECEMBER 2021 REVIEWED BY: K. SMITH
 PREPARED BY: S. BUTLER REVIEWED BY: I. VAN OSDELL

SCALE: 0

REVISIONS: _____ DATE: _____
 INIT. DATE

DocuSigned by: Inger Van OsdeLL 3/16/2022
 SEAL: NORTH CAROLINA PROFESSIONAL SEAL 028952
 INGER Z. VAN OSDELL
 CADD File name: _____

3/15/2022 \\kimley-horn.com\SE-RAL\NRL_TPTD\ITS\01036569_Gastonia_Signal_System\6_Tasks\Splicing\SPL094.dgn

CHANNEL 9 SPLICE ENCLOSURE AT (ROBINWOOD RD. [SR 2457] AT COVENANT VILLAGE DR.) SIG ID 12-1512

COLOR CODE
TIA/EIA 598-C

(1) BLUE	(7) RED
(2) ORANGE	(8) BLACK
(3) GREEN	(9) YELLOW
(4) BROWN	(10) VIOLET
(5) SLATE	(11) ROSE
(6) WHITE	(12) AQUA

LEGEND

X - FUSION SPLICE INDIVIDUAL FIBER
 O - EXISTING SPLICE
 □ - EXPRESS INDIVIDUAL FIBER

EXPRESS - EXPRESS ENTIRE BUFFER TUBE
 SPLICE - SPLICE ENTIRE BUFFER TUBE OR MAINTAIN IF EXISTING EXPRESSED

NOTES:
 1. FIBER INTERCONNECT CENTER RACKS ARE SCHEMATIC ONLY - ACTUAL EQUIPMENT FORM MAY VARY.
 2. ETHERNET SWITCH TERMINATION CONFIGURATIONS ARE GENERIC. CONTRACTOR IS RESPONSIBLE FOR DETERMINING /ENSURING PROPER TERMINATION.
 3. CONTRACTOR IS RESPONSIBLE FOR FIELD VERIFYING EXISTING SPlicing. THE CONTRACTOR SHALL COORDINATE WITH THE ENGINEER WHERE EXISTING SPlicing IS NOT AS EXPECTED.

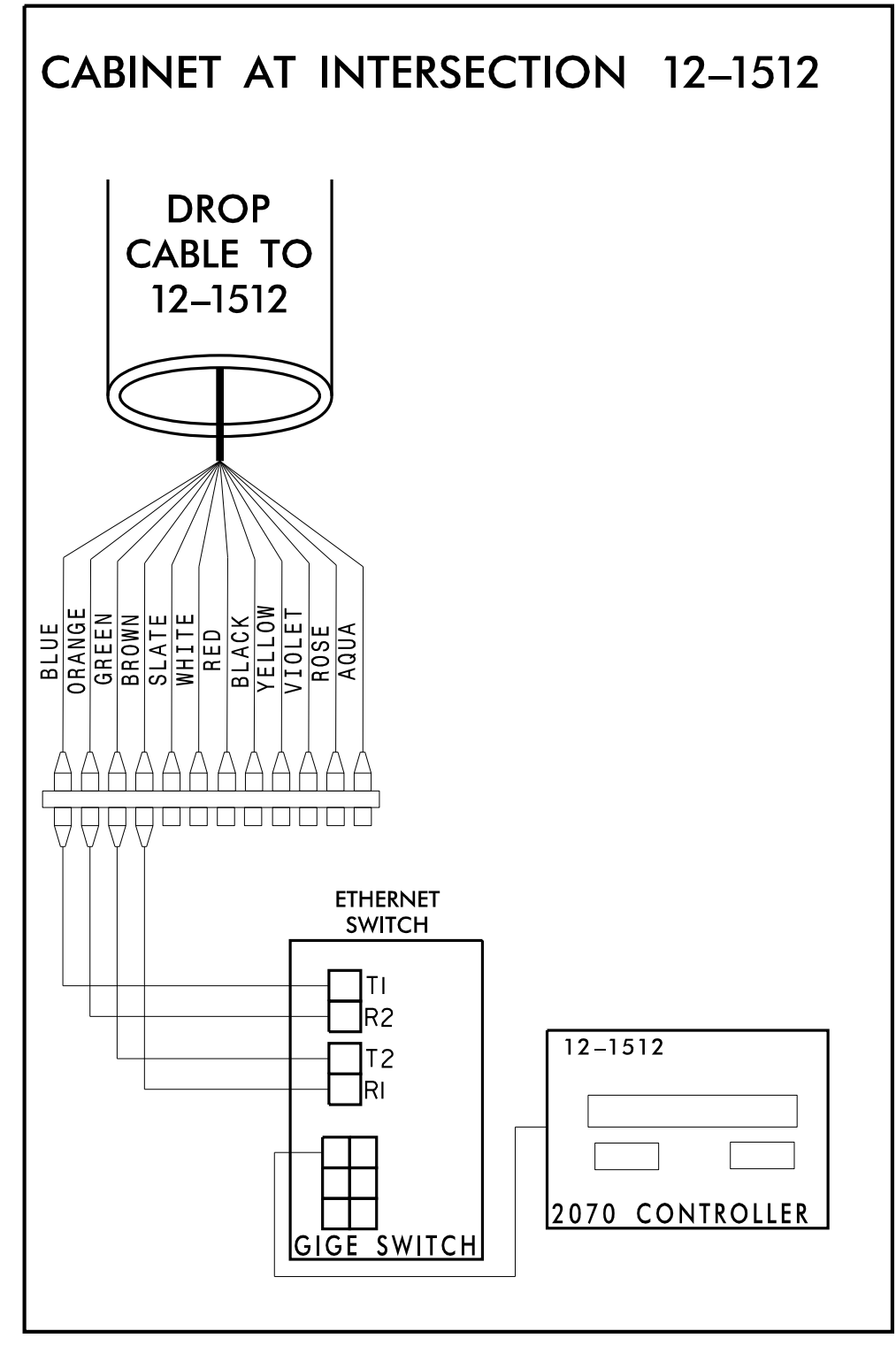
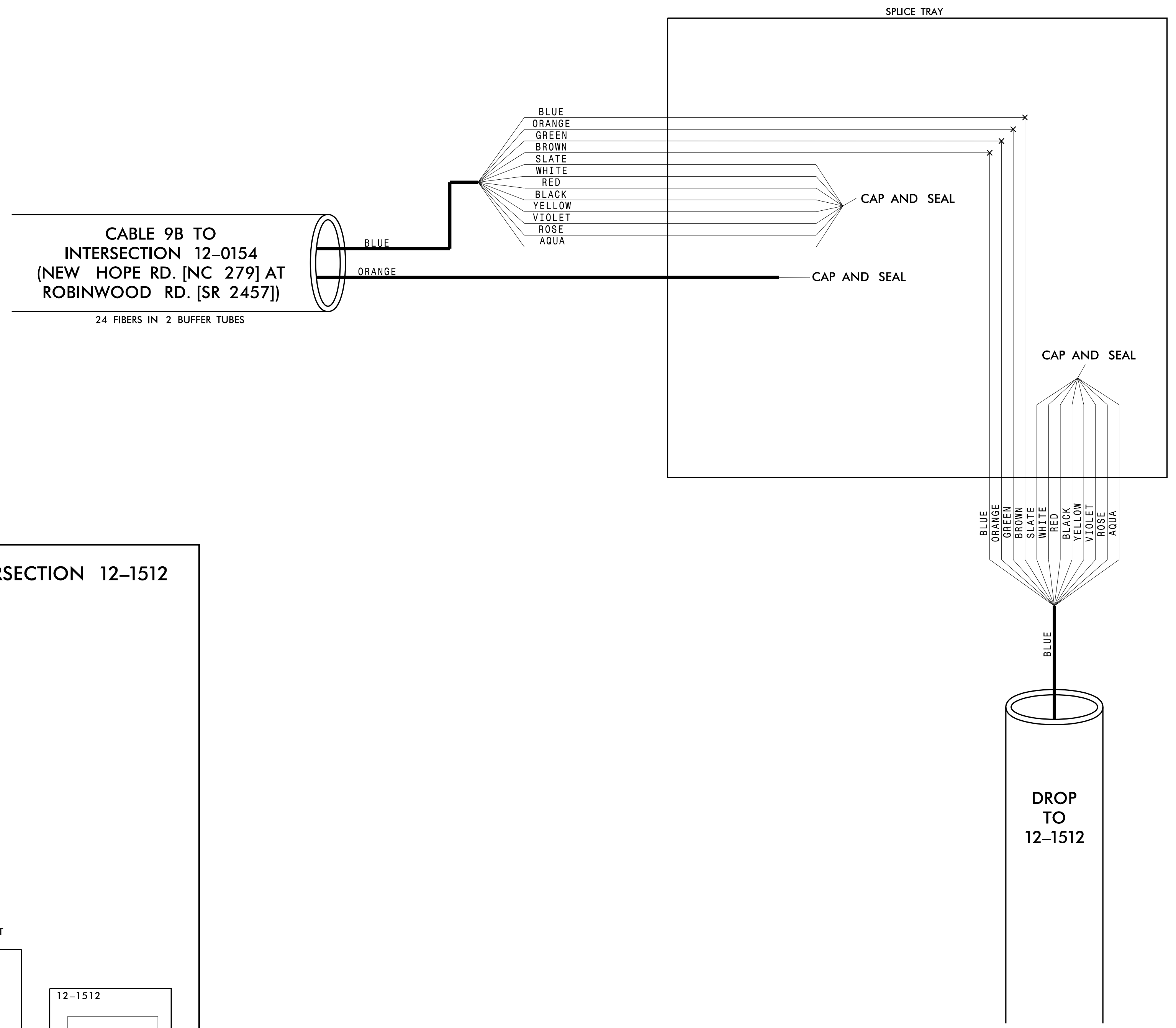

Plans Prepared For:
 Preparation, Mobiliz and Safe Division
 NORTH CAROLINA
 DEPARTMENT OF TRANSPORTATION
 250 N. Greenfield Place, Garner, NC 27529

**CITY OF GASTONIA COMPUTERIZED SIGNAL SYSTEM
SPLICE DETAIL**

DIVISION 12 GASTON COUNTY
 PLAN DATE: DECEMBER 2021 REVIEWED BY: K. SMITH
 PREPARED BY: S. BUTLER REVIEWED BY: I. VAN OSDELL

SCALE: 0

REVISIONS: _____ DATE: _____
 INIT. DATE

DocuSigned by:
 Inger Van OsdeLL 3/16/2022

CADD File name: _____

Kimley»Horn
 NC License #F-0102
 421 Fayetteville St., Suite 600
 Raleigh, NC 27601
 Tel: (919) 677-2000
 Fax: (919) 677-2050

SEAL
 NORTH CAROLINA
 PROFESSIONAL
 SEAL
 028952
 INGER Z. VAN OSDELL
 ENGINEER

3/15/2022 \\kimley-horn.com\SE-RAL\NRL_TPTD\ITS\01036569_Gastonia_Signal System\6_Tasks\Splicing\SPL095.dgn

**CHANNEL 10
 SPLICE ENCLOSURE AT
 MYRTLE SCHOOL RD. (SR 1136)
 SOUTH OF AMBER CREST DR.**

COLOR CODE TIA/EIA 598-C		LEGEND	
(1) BLUE	(7) RED	X - FUSION SPLICE INDIVIDUAL FIBER	
(2) ORANGE	(8) BLACK	O - EXISTING SPLICE	
(3) GREEN	(9) YELLOW	□ - EXPRESS INDIVIDUAL FIBER	
(4) BROWN	(10) VIOLET	EXPRESS	EXPRESS ENTIRE BUFFER TUBE
(5) SLATE	(11) ROSE	SPLICE	SPLICE ENTIRE BUFFER TUBE OR MAINTAIN IF EXISTING EXPRESSED
(6) WHITE	(12) AQUA		

NOTES:
 1. FIBER INTERCONNECT CENTER RACKS ARE SCHEMATIC ONLY - ACTUAL EQUIPMENT FORM MAY VARY.
 2. ETHERNET SWITCH TERMINATION CONFIGURATIONS ARE GENERIC. CONTRACTOR IS RESPONSIBLE FOR DETERMINING /ENSURING PROPER TERMINATION.
 3. CONTRACTOR IS RESPONSIBLE FOR FIELD VERIFYING EXISTING SPlicing. THE CONTRACTOR SHALL COORDINATE WITH THE ENGINEER WHERE EXISTING SPlicing IS NOT AS EXPECTED.

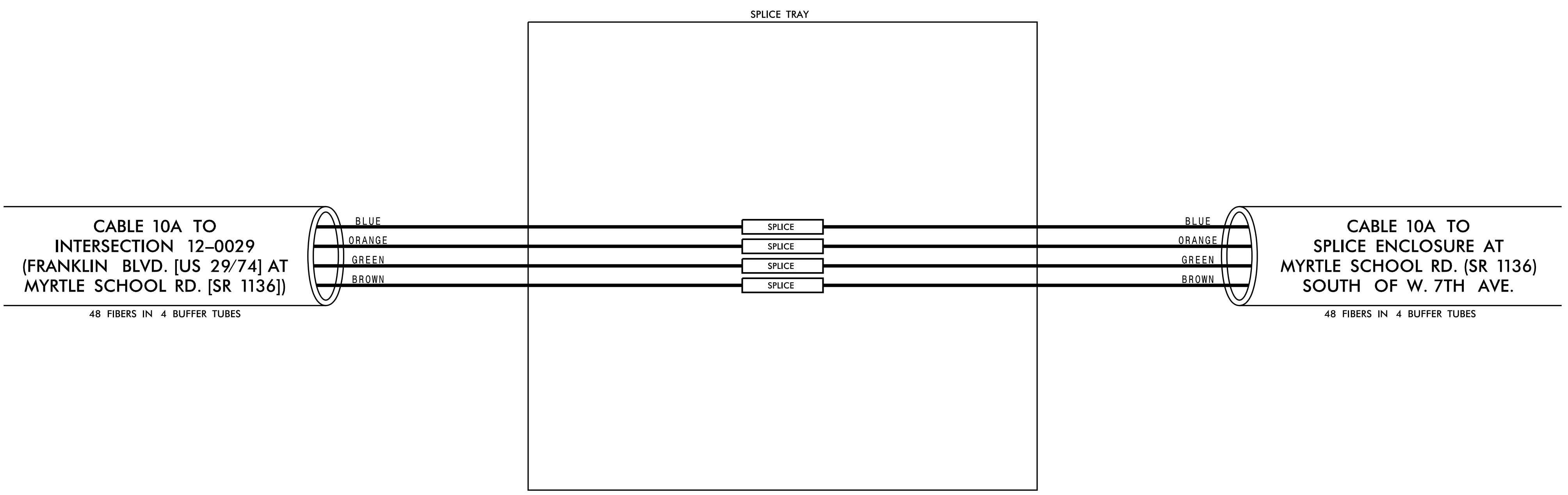

3/15/2022 \\kimley-horn.com\SE\RAL\NRA\TPTD\ITS\01036569_Gastonia_Signal_System\6_Tasks\Splicing_SPL096.dgn

	CHANNEL 10											
	CITY OF GASTONIA COMPUTERIZED SIGNAL SYSTEM SPLICE DETAIL											
Plans Prepared For: Transportation, Mobility and Safe Division DEPARTMENT OF TRANSPORTATION 250 N. Greenfield Place, Garner, NC 27529	DIVISION 12 GASTON COUNTY PLAN DATE: DECEMBER 2021 PREPARED BY: S. BUTLER		REVIEWED BY: K. SMITH REVIEWED BY: I. VAN OSDELL									
SCALE 	REVISIONS <table border="1"> <tr><th>NO.</th><th>DATE</th><th>DESCRIPTION</th></tr> <tr><td> </td><td> </td><td> </td></tr> </table>	NO.	DATE	DESCRIPTION				INIT. DATE <table border="1"> <tr><th>INIT.</th><th>DATE</th></tr> <tr><td> </td><td> </td></tr> </table>	INIT.	DATE		
NO.	DATE	DESCRIPTION										
INIT.	DATE											
DocuSigned by: 			3/16/2022									

Kimley»Horn
 NC License #F-0102
 421 Fayetteville St., Suite 600
 Raleigh, NC 27601
 Tel: (919) 677-2000
 Fax: (919) 677-2050

**CHANNEL 10
 SPLICE ENCLOSURE AT
 MYRTLE SCHOOL RD. (SR 1136)
 SOUTH OF W. 7TH AVE.**

COLOR CODE TIA/EIA 598-C		LEGEND	
(1) BLUE	(7) RED	X - FUSION SPLICE INDIVIDUAL FIBER	
(2) ORANGE	(8) BLACK	O - EXISTING SPLICE	
(3) GREEN	(9) YELLOW	□ - EXPRESS INDIVIDUAL FIBER	
(4) BROWN	(10) VIOLET	EXPRESS	EXPRESS ENTIRE BUFFER TUBE
(5) SLATE	(11) ROSE	SPLICE	SPLICE ENTIRE BUFFER TUBE OR MAINTAIN IF EXISTING EXPRESSED
(6) WHITE	(12) AQUA	NOTES:	
		1. FIBER INTERCONNECT CENTER RACKS ARE SCHEMATIC ONLY - ACTUAL EQUIPMENT FORM MAY VARY.	
		2. ETHERNET SWITCH TERMINATION CONFIGURATIONS ARE GENERIC. CONTRACTOR IS RESPONSIBLE FOR DETERMINING /ENSURING PROPER TERMINATION.	
		3. CONTRACTOR IS RESPONSIBLE FOR FIELD VERIFYING EXISTING SPlicing. THE CONTRACTOR SHALL COORDINATE WITH THE ENGINEER WHERE EXISTING SPlicing IS NOT AS EXPECTED.	

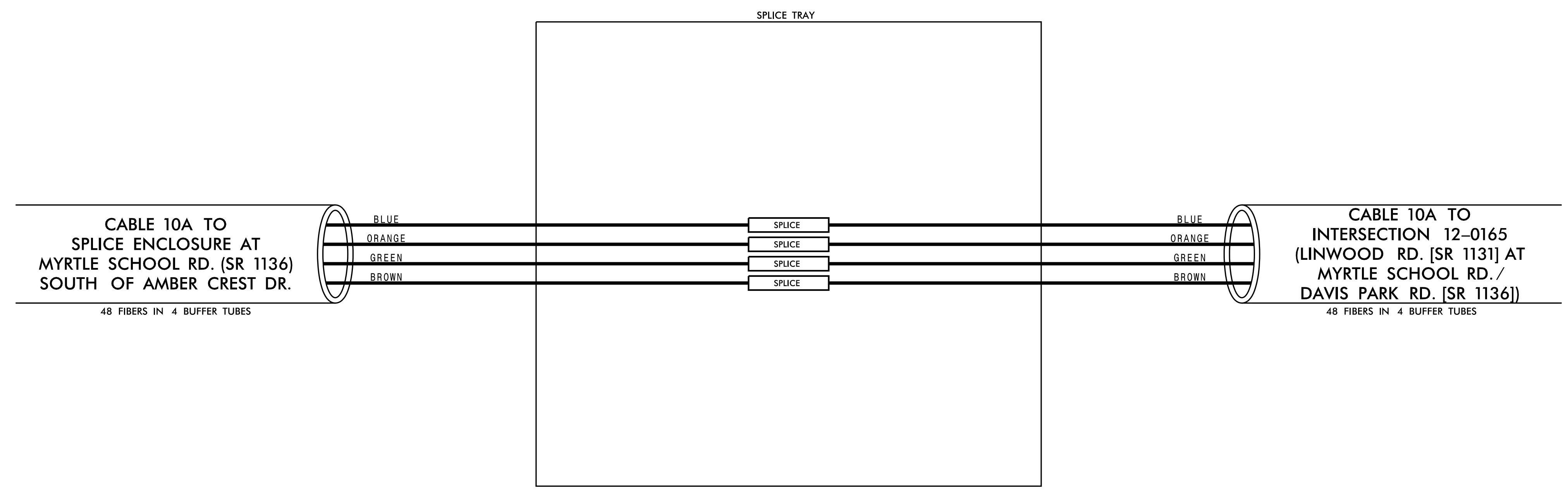

3/15/2022 \\kimley-horn.com\SE-RAL\NRA\TPTD\ITS\01036569 Gastonia Signal System\6 Tasks\Splicing\SPL097.dgn

Kimley»Horn
 NC License #F-0102
 421 Fayetteville St., Suite 600
 Raleigh, NC 27601
 Tel: (919) 677-2000
 Fax: (919) 677-2050

	CHANNEL 10		
	CITY OF GASTONIA COMPUTERIZED SIGNAL SYSTEM		
SPLICE DETAIL		SEAL	
DIVISION 12		GASTON COUNTY	
PLAN DATE: DECEMBER 2021	REVIEWED BY: K. SMITH		
PREPARED BY: S. BUTLER	REVIEWED BY: I. VAN OSDELL		
SCALE	REVISIONS	INIT.	DATE
0			
		DocuSigned by: Iger Van Osdel 3/16/2022	
		CADD Filename:	

CHANNEL 10
SPLICE ENCLOSURE AT
(LINWOOD RD. [SR 1131] AT
MYRTLE SCHOOL RD./
DAVIS PARK RD. [SR 1136])
SIG ID 12-0165

COLOR CODE
TIA/EIA 598-C

(1) BLUE	(7) RED
(2) ORANGE	(8) BLACK
(3) GREEN	(9) YELLOW
(4) BROWN	(10) VIOLET
(5) SLATE	(11) ROSE
(6) WHITE	(12) AQUA

LEGEND

X - FUSION SPLICE INDIVIDUAL FIBER
 O - EXISTING SPLICE
 □ - EXPRESS INDIVIDUAL FIBER

EXPRESS - EXPRESS ENTIRE BUFFER TUBE
 SPLICE - SPLICE ENTIRE BUFFER TUBE OR MAINTAIN IF EXISTING EXPRESSED

NOTES:

- FIBER INTERCONNECT CENTER RACKS ARE SCHEMATIC ONLY - ACTUAL EQUIPMENT FORM MAY VARY.
- ETHERNET SWITCH TERMINATION CONFIGURATIONS ARE GENERIC. CONTRACTOR IS RESPONSIBLE FOR DETERMINING /ENSURING PROPER TERMINATION.
- CONTRACTOR IS RESPONSIBLE FOR FIELD VERIFYING EXISTING SPlicing. THE CONTRACTOR SHALL COORDINATE WITH THE ENGINEER WHERE EXISTING SPlicing IS NOT AS EXPECTED.

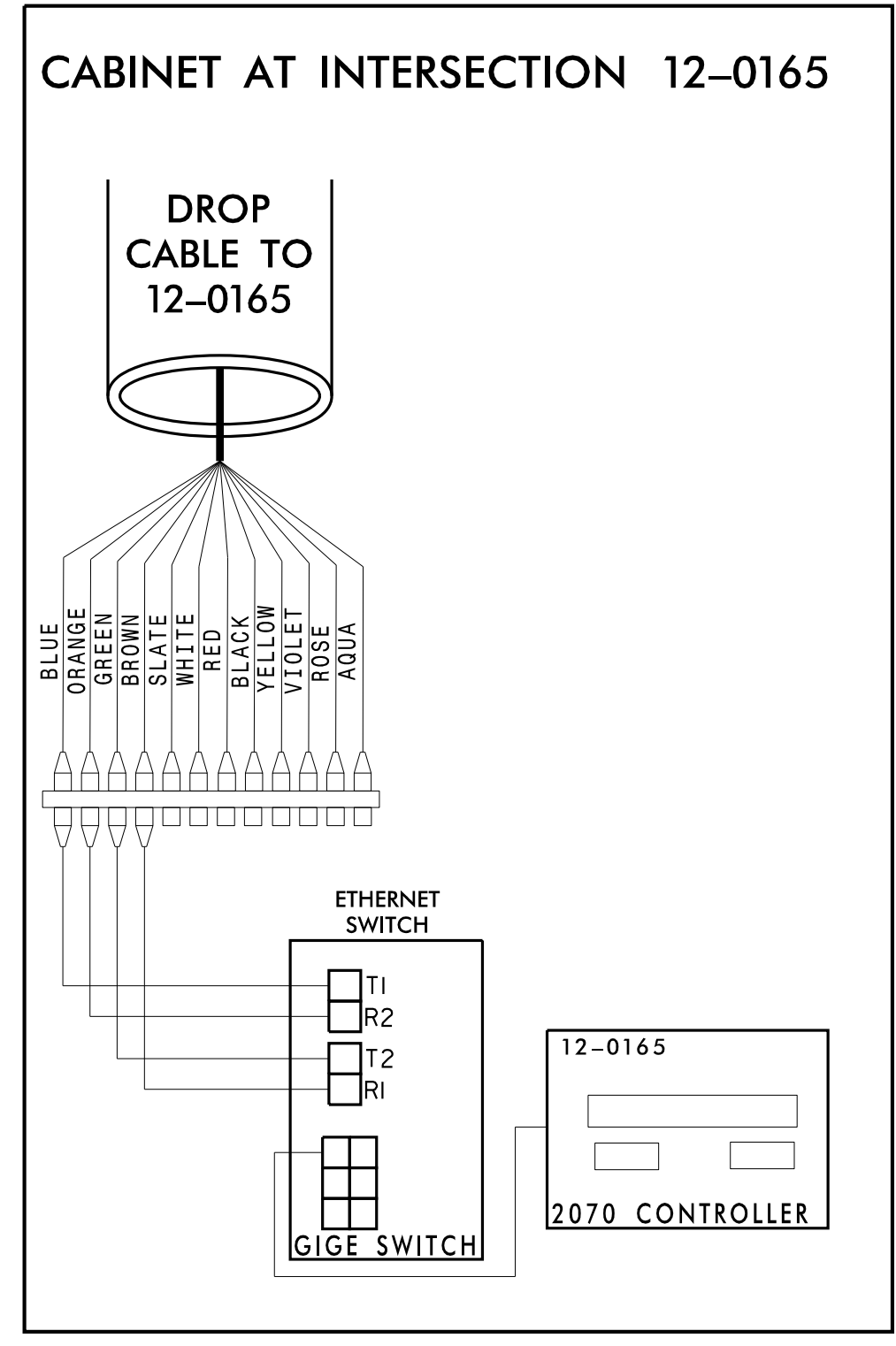
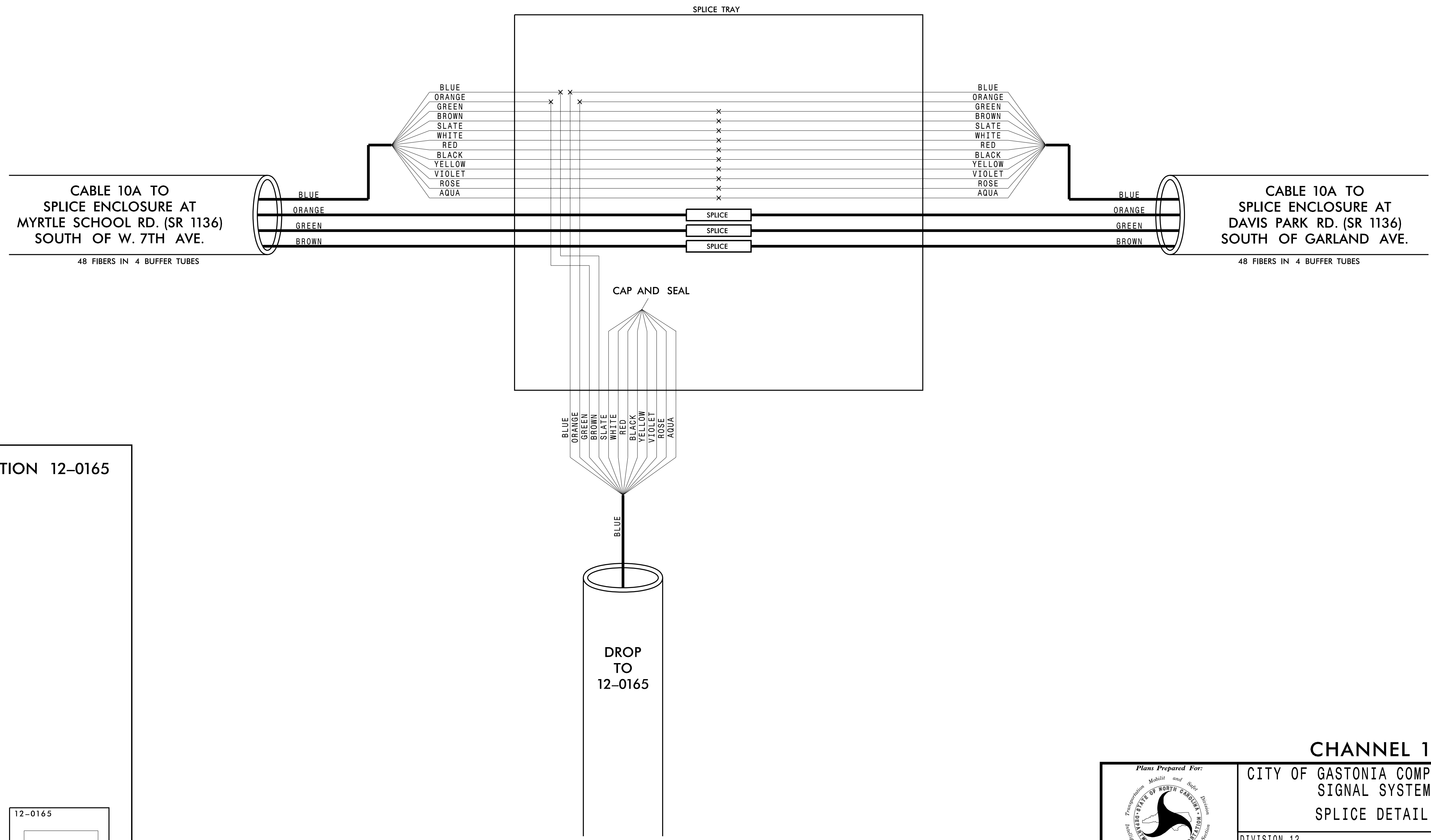

CHANNEL 10
CITY OF GASTONIA COMPUTERIZED SIGNAL SYSTEM
SPLICE DETAIL

DIVISION 12 GASTON COUNTY

PLAN DATE: DECEMBER 2021 REVIEWED BY: K. SMITH
 PREPARED BY: S. BUTLER REVIEWED BY: I. VAN OSDELL

SCALE: 0

REVISIONS: _____

INIT. DATE

DocuSigned by: Inger Van Osdel 3/16/2022

Kimley»Horn
 NC License #F-0102
 421 Fayetteville St., Suite 600
 Raleigh, NC 27601
 Tel: (919) 677-2000
 Fax: (919) 677-2050

SEAL
 NORTH CAROLINA PROFESSIONAL ENGINEER
 SEAL 028952
 INGER Z. VAN OSDEL

3/15/2022 \\kimley-horn.com\SE-RAL\NRL_TPTD\ITS\01036569_Gastonia_Signal_System\6_Tasks\Splicing\SPL098.dgn

CHANNEL 10
SPlice ENCLOSURE AT
DAVIS PARK RD. (SR 1136)
SOUTH OF GARLAND AVE.

COLOR CODE
TIA/EIA 598-C

(1) BLUE	(7) RED
(2) ORANGE	(8) BLACK
(3) GREEN	(9) YELLOW
(4) BROWN	(10) VIOLET
(5) SLATE	(11) ROSE
(6) WHITE	(12) AQUA

LEGEND

X - FUSION SPlice INDIVIDUAL FIBER
 O - EXISTING SPlice
 □ - EXPRESS INDIVIDUAL FIBER

EXPRESS - EXPRESS ENTIRE BUFFER TUBE
 SPlice - SPlice ENTIRE BUFFER TUBE OR MAINTAIN IF EXISTING EXPRESSED

NOTES:
 1. FIBER INTERCONNECT CENTER RACKS ARE SCHEMATIC ONLY - ACTUAL EQUIPMENT FORM MAY VARY.
 2. ETHERNET SWITCH TERMINATION CONFIGURATIONS ARE GENERIC. CONTRACTOR IS RESPONSIBLE FOR DETERMINING /ENSURING PROPER TERMINATION.
 3. CONTRACTOR IS RESPONSIBLE FOR FIELD VERIFYING EXISTING SPlicing. THE CONTRACTOR SHALL COORDINATE WITH THE ENGINEER WHERE EXISTING SPlicing IS NOT AS EXPECTED.

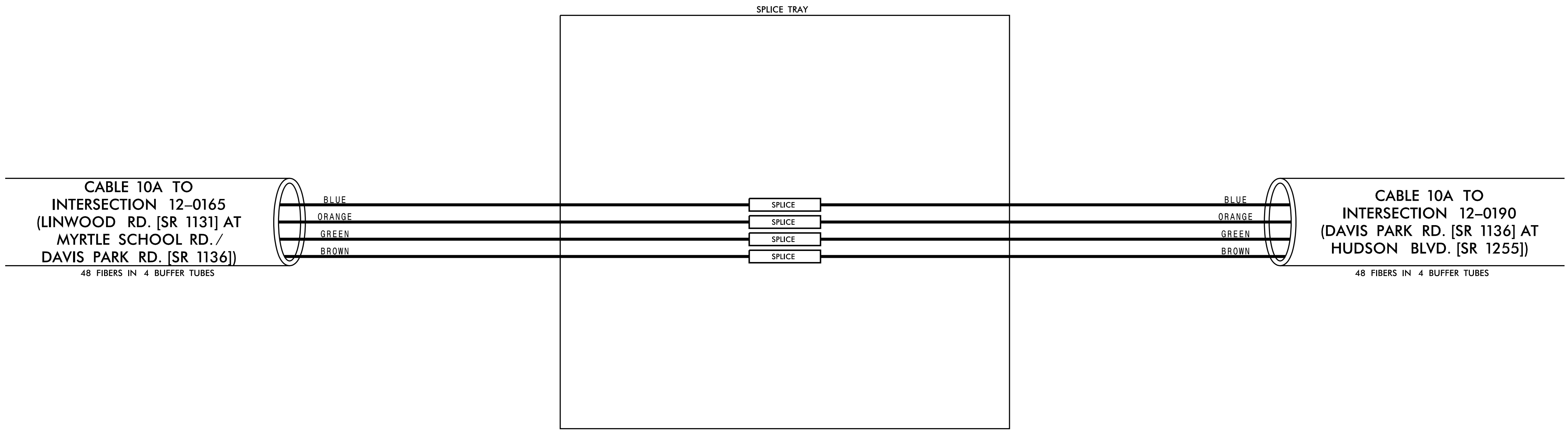

3/15/2022 \\kimley-horn.com\SE\RAL\NRA\TPTD\ITS\01036569_Gastonia_Signal_System\6_Tasks\Splicing\SPL099.dgn

Plans Prepared For:
 Transportation, Mobility and Safe Division
 DEPARTMENT OF TRANSPORTATION
 250 N. Greenfield Place, Garner, NC 27529

CHANNEL 10
 CITY OF GASTONIA COMPUTERIZED
 SIGNAL SYSTEM
 SPlice DETAIL

DIVISION 12 GASTON COUNTY

PLAN DATE: DECEMBER 2021 REVIEWED BY: K. SMITH
 PREPARED BY: S. BUTLER REVIEWED BY: I. VAN OSDELL

REVISIONS	INIT.	DATE

SCALE
 0

Kimley»Horn
 NC License #F-0102
 421 Fayetteville St., Suite 600
 Raleigh, NC 27601
 Tel: (919) 677-2000
 Fax: (919) 677-2050

SEAL
 NORTH CAROLINA
 PROFESSIONAL
 SEAL
 028952
 I. VAN OSDELL
 ENGINEER

DocuSigned by:
 Iger Van OsdeLL 3/16/2022

CADD File name:

CHANNEL 10
SPLICE ENCLOSURE AT
(DAVIS PARK RD. [SR 1136] AT
HUDSON BLVD. [SR 1255])
SIG ID 12-0190
CCTV CAMERA-25

COLOR CODE
TIA/EIA 598-C

(1) BLUE	(7) RED
(2) ORANGE	(8) BLACK
(3) GREEN	(9) YELLOW
(4) BROWN	(10) VIOLET
(5) SLATE	(11) ROSE
(6) WHITE	(12) AQUA

LEGEND

X - FUSION SPLICE INDIVIDUAL FIBER
O - EXISTING SPLICE
□ - EXPRESS INDIVIDUAL FIBER

EXPRESS - EXPRESS ENTIRE BUFFER TUBE
SPLICE - SPLICE ENTIRE BUFFER TUBE OR MAINTAIN IF EXISTING EXPRESSED

NOTES:

- FIBER INTERCONNECT CENTER RACKS ARE SCHEMATIC ONLY - ACTUAL EQUIPMENT FORM MAY VARY.
- ETHERNET SWITCH TERMINATION CONFIGURATIONS ARE GENERIC. CONTRACTOR IS RESPONSIBLE FOR DETERMINING /ENSURING PROPER TERMINATION.
- CONTRACTOR IS RESPONSIBLE FOR FIELD VERIFYING EXISTING SPlicing. THE CONTRACTOR SHALL COORDINATE WITH THE ENGINEER WHERE EXISTING SPlicing IS NOT AS EXPECTED.

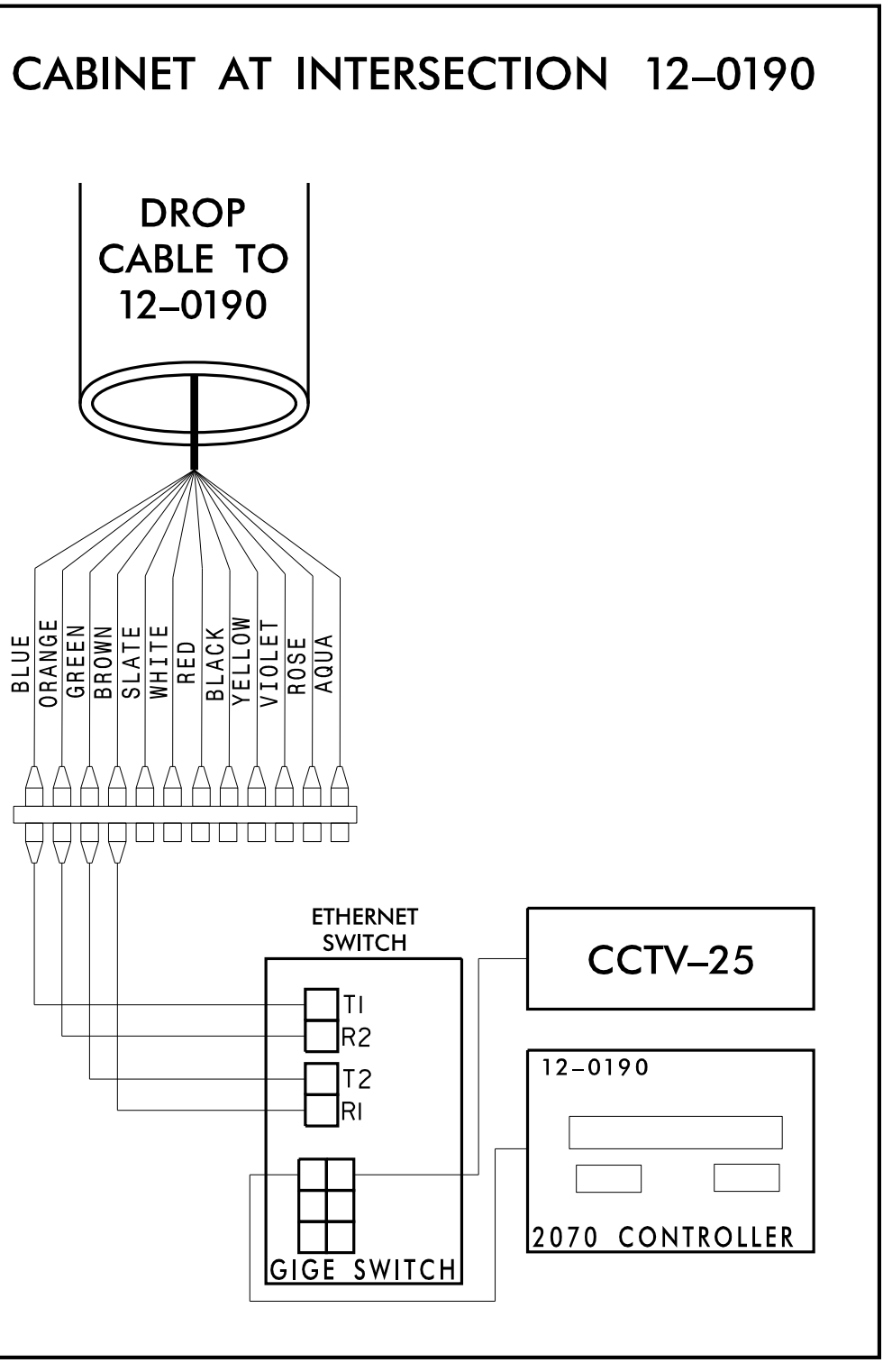
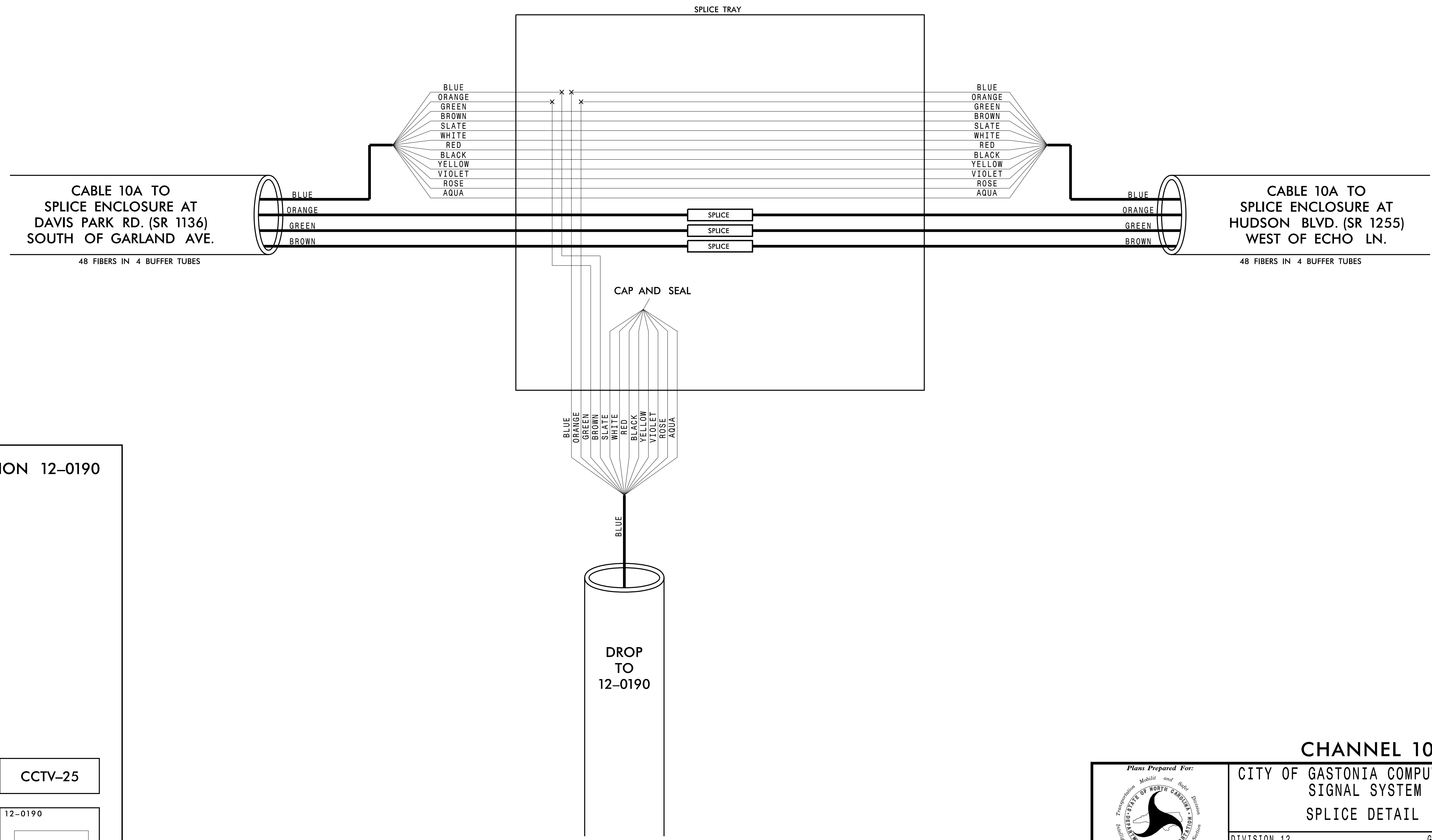

Kimley»Horn
NC License #F-0102
421 Fayetteville St., Suite 600
Raleigh, NC 27601
Tel: (919) 677-2000
Fax: (919) 677-2050

CHANNEL 10
CITY OF GASTONIA COMPUTERIZED
SIGNAL SYSTEM
SPLICE DETAIL

DIVISION 12 GASTON COUNTY
PLAN DATE: DECEMBER 2021 REVIEWED BY: K. SMITH
PREPARED BY: S. BUTLER REVIEWED BY: I. VAN OSDELL

SCALE: 0

REVISIONS: INIT. DATE

DocuSigned by: Inger Van OsdeLL 3/16/2022

SEAL: NORTH CAROLINA PROFESSIONAL SEAL 028952 INGER Z. VAN OSDELL ENGINEER

CADD File name:

3/15/2022 \\kimley-horn.com\SE-RAL\NRA\1-PTO\ITS\01036569_Gastonia_Signal_System\6_Tasks\Splicing\SPL100.dgn

CHANNEL 10
SPlice ENCLOSURE AT
HUDSON BLVD. (SR 1255)
WEST OF ECHO LN.

COLOR CODE
TIA/EIA 598-C

(1) BLUE	(7) RED
(2) ORANGE	(8) BLACK
(3) GREEN	(9) YELLOW
(4) BROWN	(10) VIOLET
(5) SLATE	(11) ROSE
(6) WHITE	(12) AQUA

LEGEND

X - FUSION SPlice INDIVIDUAL FIBER
 O - EXISTING SPlice
 □ - EXPRESS INDIVIDUAL FIBER

EXPRESS - EXPRESS ENTIRE BUFFER TUBE
 SPlice - SPlice ENTIRE BUFFER TUBE OR MAINTAIN IF EXISTING EXPRESSED

NOTES:
 1. FIBER INTERCONNECT CENTER RACKS ARE SCHEMATIC ONLY - ACTUAL EQUIPMENT FORM MAY VARY.
 2. ETHERNET SWITCH TERMINATION CONFIGURATIONS ARE GENERIC. CONTRACTOR IS RESPONSIBLE FOR DETERMINING /ENSURING PROPER TERMINATION.
 3. CONTRACTOR IS RESPONSIBLE FOR FIELD VERIFYING EXISTING SPlicing. THE CONTRACTOR SHALL COORDINATE WITH THE ENGINEER WHERE EXISTING SPlicing IS NOT AS EXPECTED.

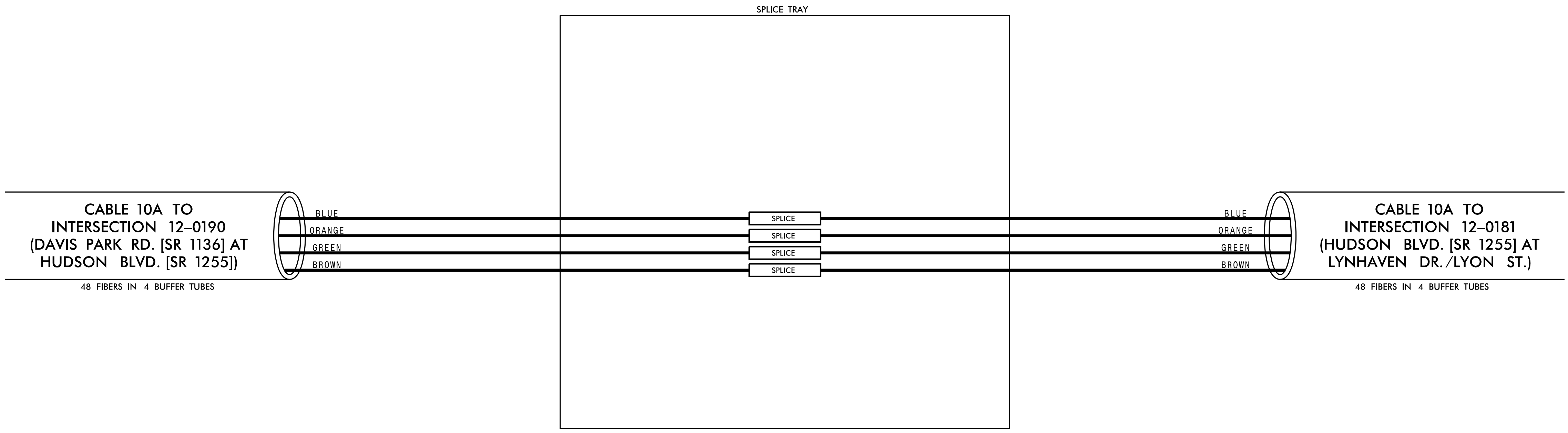

3/15/2022
\\kimley-horn.com\SE\RAL\N\RAL_T\T\T\ITS\01036569_Gastonia_Signal_System\6_Tasks\Splicing\SP101.dgn

CHANNEL 10
CITY OF GASTONIA COMPUTERIZED
SIGNAL SYSTEM
SPlice DETAIL

DIVISION 12 GASTON COUNTY

PLAN DATE: DECEMBER 2021 REVIEWED BY: K. SMITH
 PREPARED BY: S. BUTLER REVIEWED BY: I. VAN OSDELL

SCALE: 0

REVISIONS: _____ INIT. DATE: _____

DocuSigned by: *Inger Van OsdeLL* 3/16/2022

CADD File name: _____

Kimley»Horn
 NC License #F-0102
 421 Fayetteville St., Suite 600
 Raleigh, NC 27601
 Tel: (919) 677-2000
 Fax: (919) 677-2050

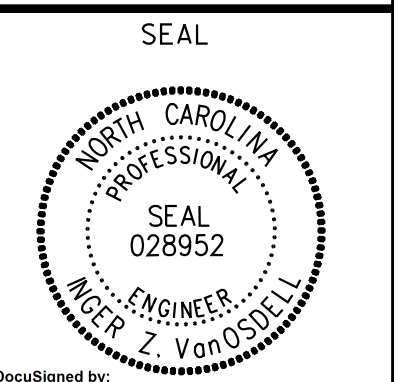

CHANNEL 10
SPLICE ENCLOSURE AT
(HUDSON BLVD. [SR 1255] AT
LYNHAVEN DR./LYON ST.)
SIG ID 12-0181

COLOR CODE
TIA/EIA 598-C

(1) BLUE	(7) RED
(2) ORANGE	(8) BLACK
(3) GREEN	(9) YELLOW
(4) BROWN	(10) VIOLET
(5) SLATE	(11) ROSE
(6) WHITE	(12) AQUA

LEGEND

X - FUSION SPlice INDIVIDUAL FIBER
 O - EXISTING SPlice
 □ - EXPRESS INDIVIDUAL FIBER

EXPRESS - EXPRESS ENTIRE BUFFER TUBE
 SPlice - SPlice ENTIRE BUFFER TUBE OR MAINTAIN IF EXISTING EXPRESSED

NOTES:

1. FIBER INTERCONNECT CENTER RACKS ARE SCHEMATIC ONLY - ACTUAL EQUIPMENT FORM MAY VARY.
2. ETHERNET SWITCH TERMINATION CONFIGURATIONS ARE GENERIC. CONTRACTOR IS RESPONSIBLE FOR DETERMINING /ENSURING PROPER TERMINATION.
3. CONTRACTOR IS RESPONSIBLE FOR FIELD VERIFYING EXISTING SPlicing. THE CONTRACTOR SHALL COORDINATE WITH THE ENGINEER WHERE EXISTING SPlicing IS NOT AS EXPECTED.

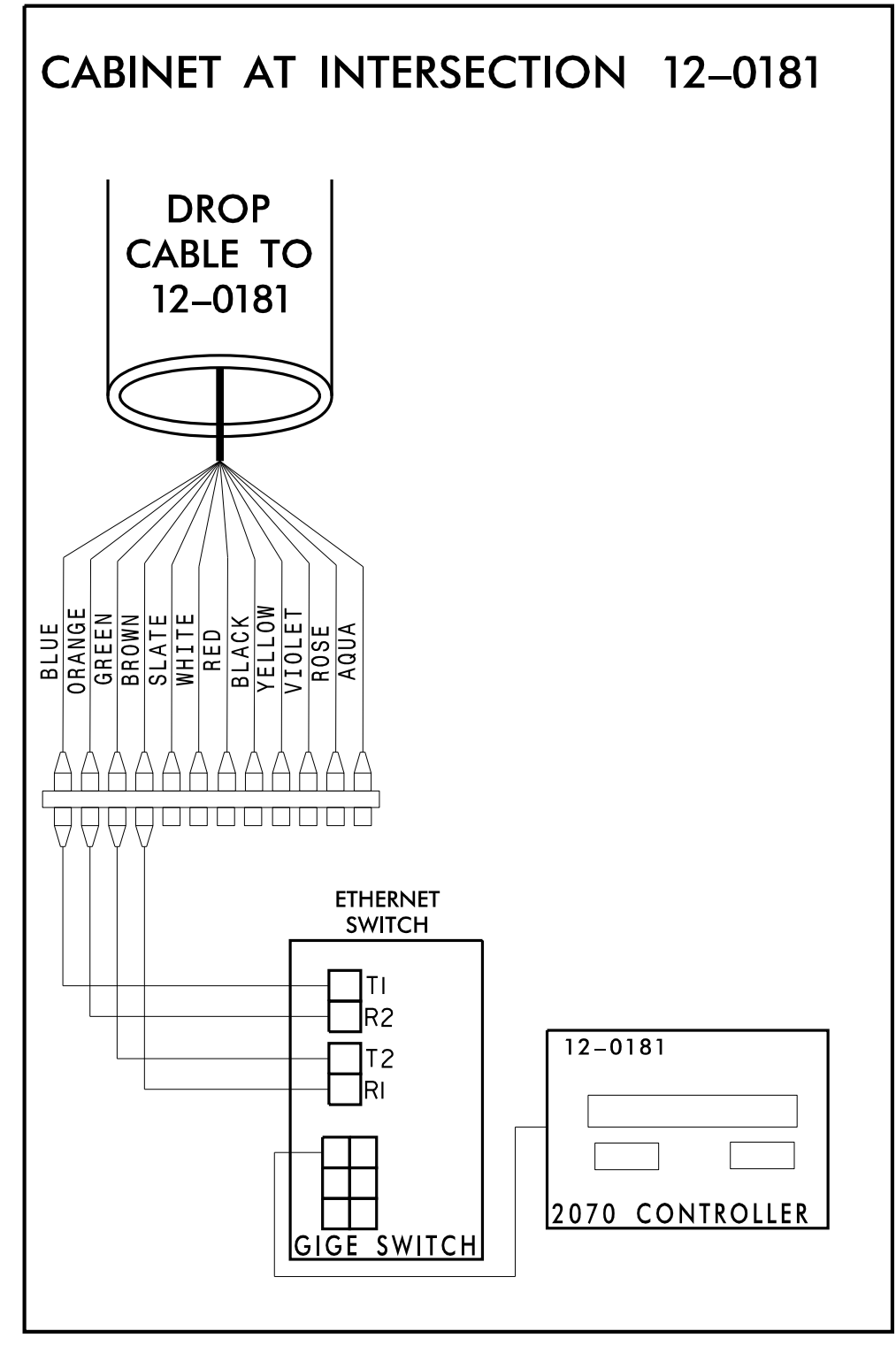
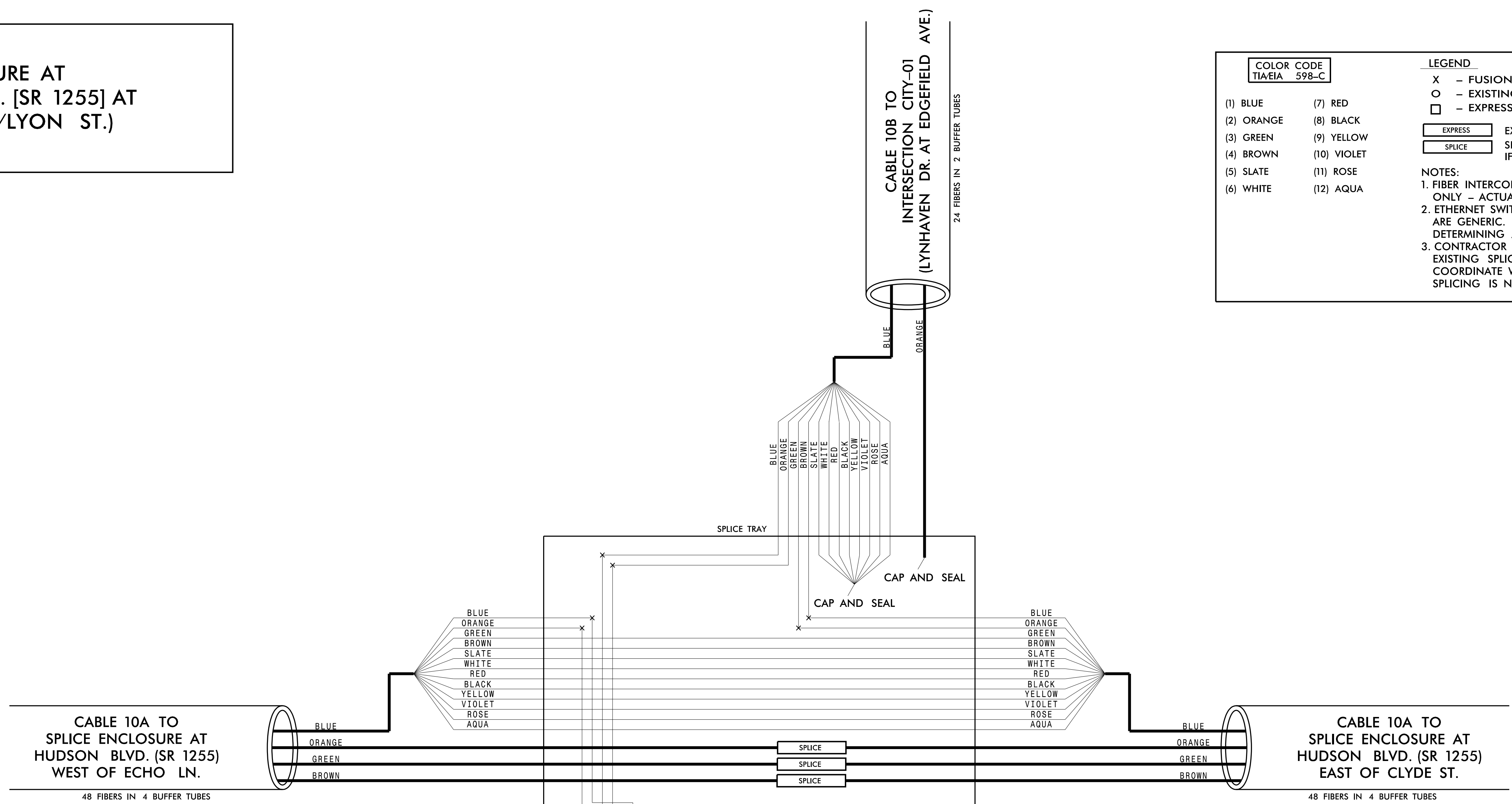

Kimley»Horn
 NC License #F-0102
 421 Fayetteville St., Suite 600
 Raleigh, NC 27601
 Tel: (919) 677-2000
 Fax: (919) 677-2050

CHANNEL 10
 CITY OF GASTONIA COMPUTERIZED
 SIGNAL SYSTEM
 SPLICE DETAIL

DIVISION 12 GASTON COUNTY
 PLAN DATE: DECEMBER 2021 REVIEWED BY: K. SMITH
 PREPARED BY: S. BUTLER REVIEWED BY: I. VAN OSDELL

SCALE: 0

REVISIONS: INIT. DATE

DocuSigned by: Inger Van OsdeLL 3/16/2022

3/15/2022 \\kimley-horn.com\SE\RAL\NRA\1\TPO\ITS\01036569_Gastonia_Signal_System\6_Tasks\Splicing_SPL102.dgn

CHANNEL 10 SPLICE ENCLOSURE AT (LYNHAVEN DR. AT EDGEFIELD AVE.) SIG ID CITY-01

COLOR CODE
TIA/EIA 598-C

(1) BLUE	(7) RED
(2) ORANGE	(8) BLACK
(3) GREEN	(9) YELLOW
(4) BROWN	(10) VIOLET
(5) SLATE	(11) ROSE
(6) WHITE	(12) AQUA

LEGEND

X - FUSION SPLICE INDIVIDUAL FIBER
 O - EXISTING SPLICE
 □ - EXPRESS INDIVIDUAL FIBER

EXPRESS - EXPRESS ENTIRE BUFFER TUBE
 SPLICE - SPLICE ENTIRE BUFFER TUBE OR MAINTAIN IF EXISTING EXPRESSED

NOTES:

- FIBER INTERCONNECT CENTER RACKS ARE SCHEMATIC ONLY - ACTUAL EQUIPMENT FORM MAY VARY.
- ETHERNET SWITCH TERMINATION CONFIGURATIONS ARE GENERIC. CONTRACTOR IS RESPONSIBLE FOR DETERMINING /ENSURING PROPER TERMINATION.
- CONTRACTOR IS RESPONSIBLE FOR FIELD VERIFYING EXISTING SPLICING. THE CONTRACTOR SHALL COORDINATE WITH THE ENGINEER WHERE EXISTING SPLICING IS NOT AS EXPECTED.

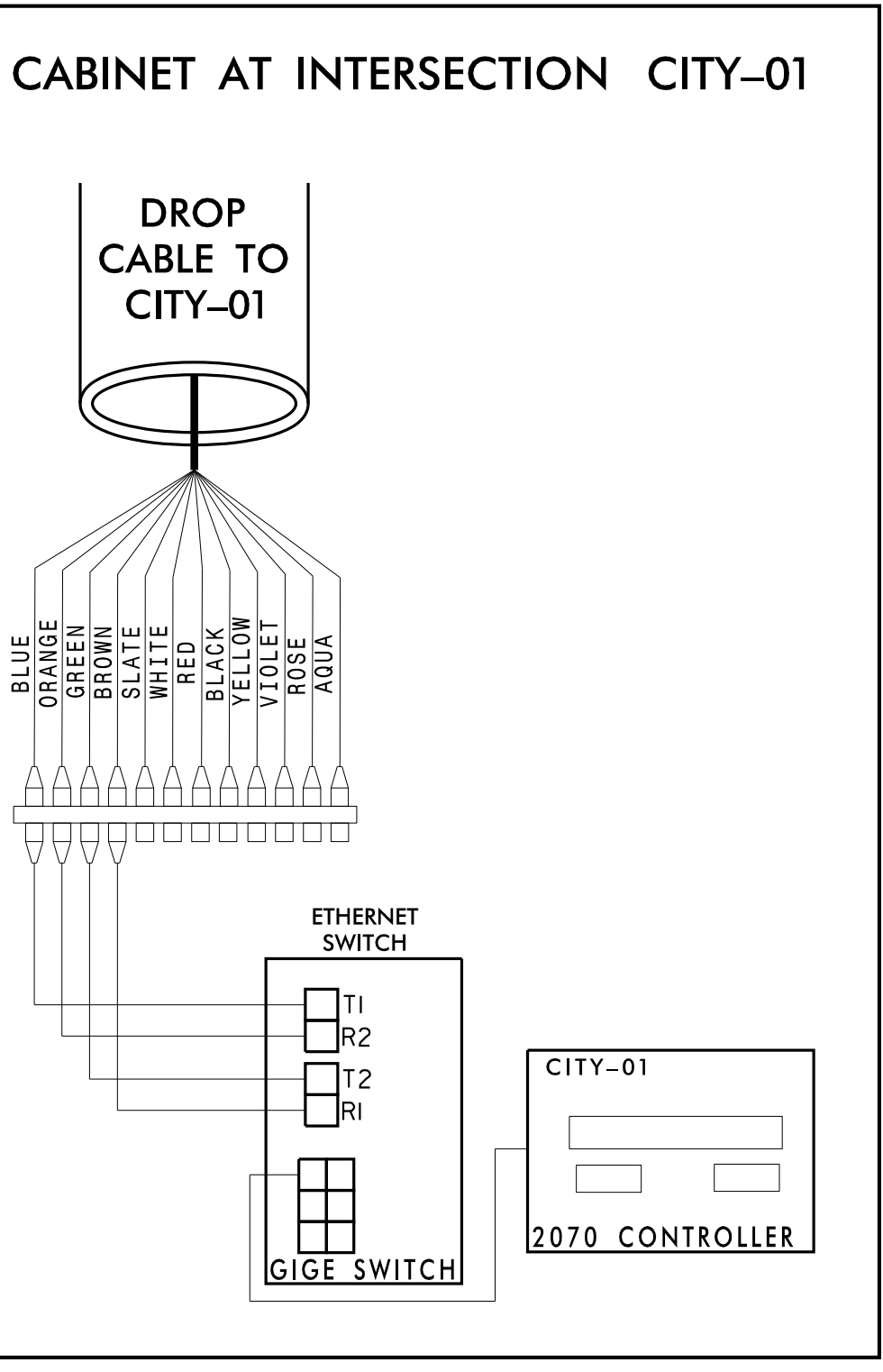
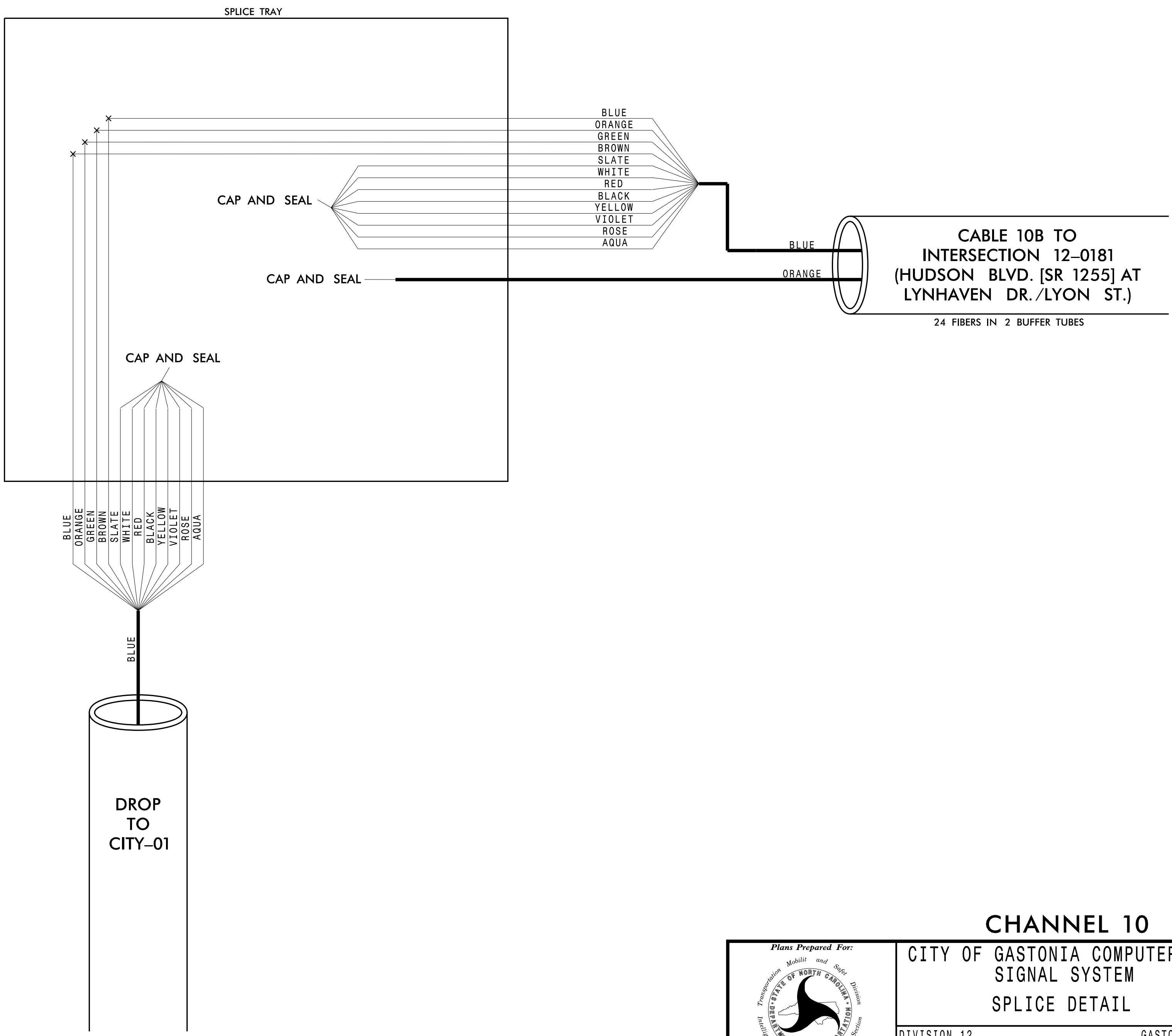

Kimley»Horn
 NC License #F-0102
 421 Fayetteville St., Suite 600
 Raleigh, NC 27601
 Tel: (919) 677-2000
 Fax: (919) 677-2050

**CHANNEL 10
CITY OF GASTONIA COMPUTERIZED
SIGNAL SYSTEM
SPLICE DETAIL**

DIVISION 12 GASTON COUNTY
 PLAN DATE: DECEMBER 2021 REVIEWED BY: K. SMITH
 PREPARED BY: S. BUTLER REVIEWED BY: I. VAN OSDELL



SCALE: 0

REVISIONS: _____ INIT. DATE

DocuSigned by: Inger Van Osdel 3/16/2022

3/15/2022 \\kimley-horn.com\SE_RAL\NRA\TPTD\ITS\01036569_Gastonia_Signal_System\6_Tasks\Splicing_SPL103.dgn

**CHANNEL 10
SPLICE ENCLOSURE AT
HUDSON BLVD. (SR 1255)
EAST OF CLYDE ST.**

COLOR CODE TIA/EIA 598-C		LEGEND	
(1) BLUE	(7) RED	X - FUSION SPLICE INDIVIDUAL FIBER	
(2) ORANGE	(8) BLACK	O - EXISTING SPLICE	
(3) GREEN	(9) YELLOW	□ - EXPRESS INDIVIDUAL FIBER	
(4) BROWN	(10) VIOLET	 EXPRESS	EXPRESS ENTIRE BUFFER TUBE
(5) SLATE	(11) ROSE	 SPLICE	SPLICE ENTIRE BUFFER TUBE OR MAINTAIN IF EXISTING EXPRESSED
(6) WHITE	(12) AQUA		

NOTES:

- FIBER INTERCONNECT CENTER RACKS ARE SCHEMATIC ONLY - ACTUAL EQUIPMENT FORM MAY VARY.
- ETHERNET SWITCH TERMINATION CONFIGURATIONS ARE GENERIC. CONTRACTOR IS RESPONSIBLE FOR DETERMINING /ENSURING PROPER TERMINATION.
- CONTRACTOR IS RESPONSIBLE FOR FIELD VERIFYING EXISTING SPLICING. THE CONTRACTOR SHALL COORDINATE WITH THE ENGINEER WHERE EXISTING SPLICING IS NOT AS EXPECTED.

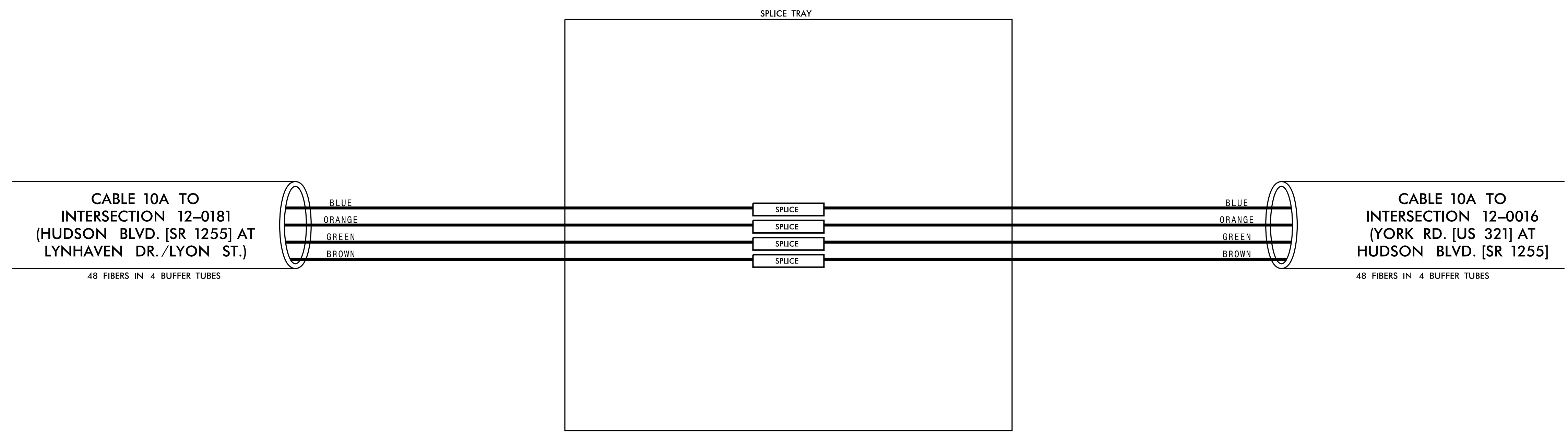

3/15/2022 \\kimley-horn.com\SE_RAL\NRA\TPTD\ITS\01036569_Gastonia_Signal_System\6_Tasks\Splicing\SPL104.dgn

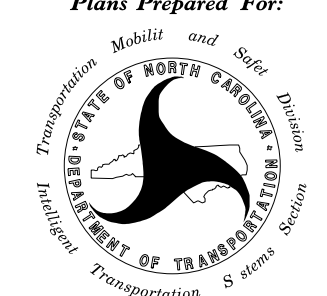
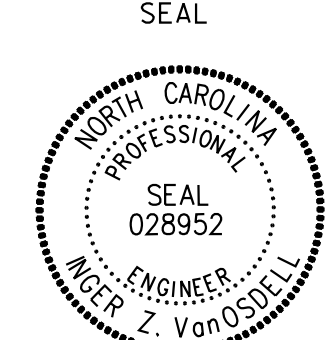
 Plans Prepared For: Transportation, Mobility and Safe Division DEPARTMENT OF TRANSPORTATION 250 N. Greenfield Place, Garner, NC 27529	CHANNEL 10		 Roger Z. Van Osdel 3/16/2022
	CITY OF GASTONIA COMPUTERIZED SIGNAL SYSTEM SPLICE DETAIL		
DIVISION 12 PLAN DATE: DECEMBER 2021 PREPARED BY: S. BUTLER	GASTON COUNTY REVIEWED BY: K. SMITH REVIEWED BY: I. VAN OSDELL	REVISIONS INIT. DATE	SCALE 0

Kimley»Horn
 NC License #F-0102
 421 Fayetteville St., Suite 600
 Raleigh, NC 27601
 Tel: (919) 677-2000
 Fax: (919) 677-2050

CHANNEL 10
SPLICE ENCLOSURE AT
YORK RD. (US 321) AT HUDSON BLVD. (SR 1255)
SIG ID 12-0016 (YORK RD. [US 321] AT HUDSON BLVD. [SR 1255])
SIG ID 12-1410 (HUDSON BLVD. [SR 1255] AT
NEAL HAWKINS RD. [SR 2400])
CCTV CAMERA-26
CCTV CAMERA-27

COLOR CODE
TIA/EIA 598-C

(1) BLUE	(7) RED
(2) ORANGE	(8) BLACK
(3) GREEN	(9) YELLOW
(4) BROWN	(10) VIOLET
(5) SLATE	(11) ROSE
(6) WHITE	(12) AQUA

LEGEND

X - FUSION SPLICE INDIVIDUAL FIBER
O - EXISTING SPLICE
□ - EXPRESS INDIVIDUAL FIBER

EXPRESS - EXPRESS ENTIRE BUFFER TUBE
SPLICE - SPLICE ENTIRE BUFFER TUBE OR MAINTAIN IF EXISTING EXPRESSED

NOTES:
1. FIBER INTERCONNECT CENTER RACKS ARE SCHEMATIC ONLY - ACTUAL EQUIPMENT FORM MAY VARY.
2. ETHERNET SWITCH TERMINATION CONFIGURATIONS ARE GENERIC. CONTRACTOR IS RESPONSIBLE FOR DETERMINING /ENSURING PROPER TERMINATION.
3. CONTRACTOR IS RESPONSIBLE FOR FIELD VERIFYING EXISTING SPlicing. THE CONTRACTOR SHALL COORDINATE WITH THE ENGINEER WHERE EXISTING SPlicing IS NOT AS EXPECTED.

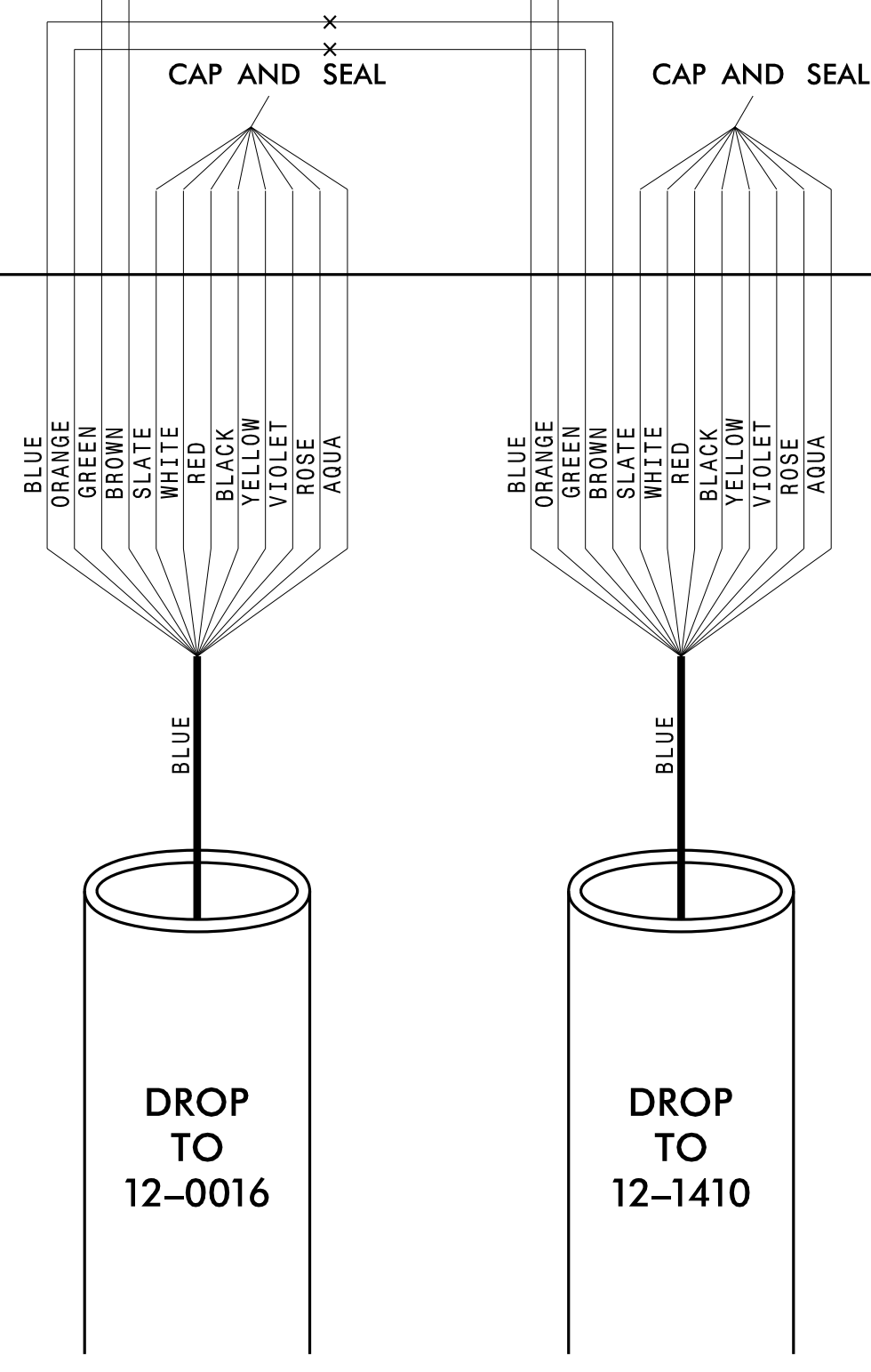
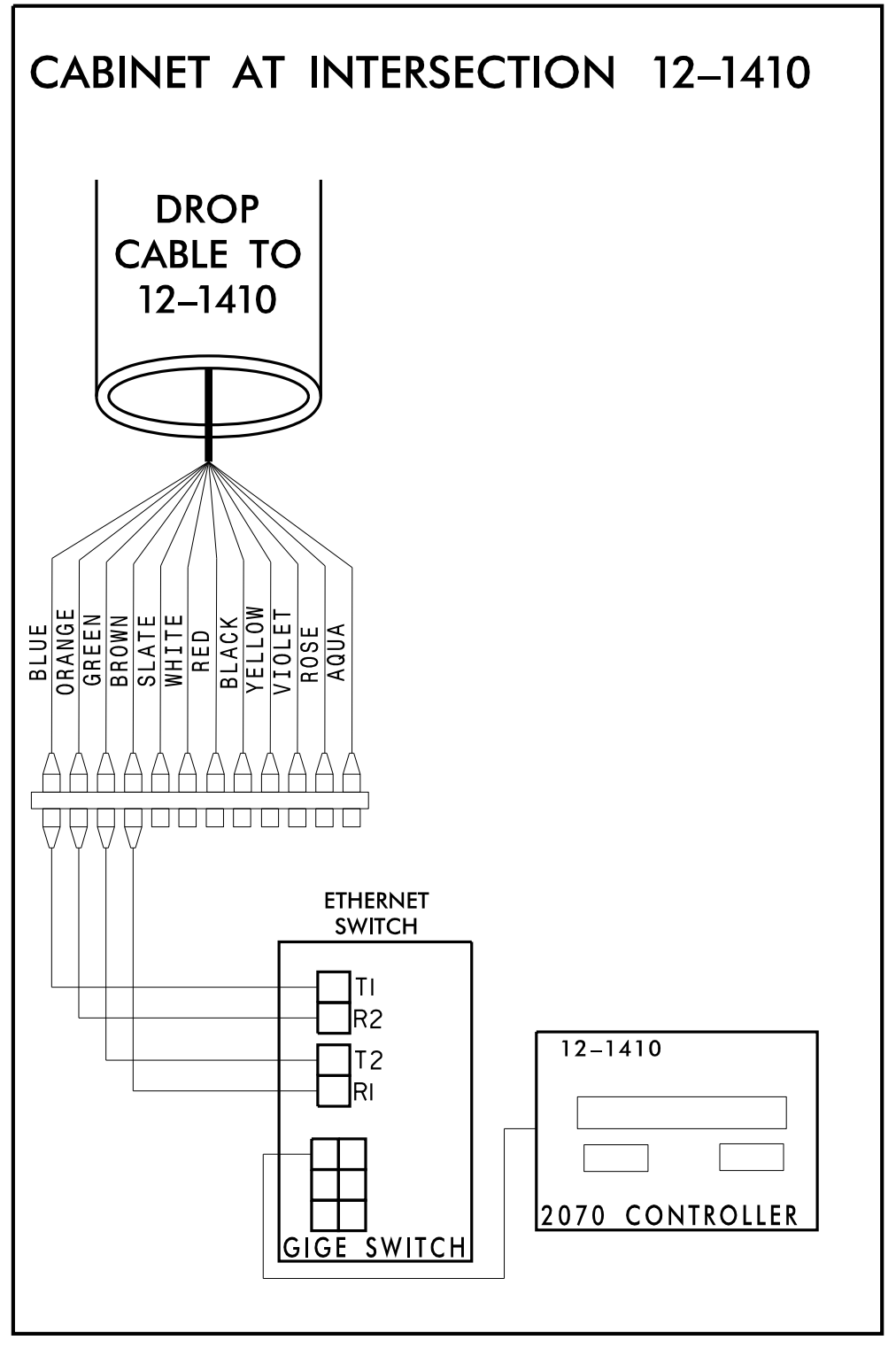
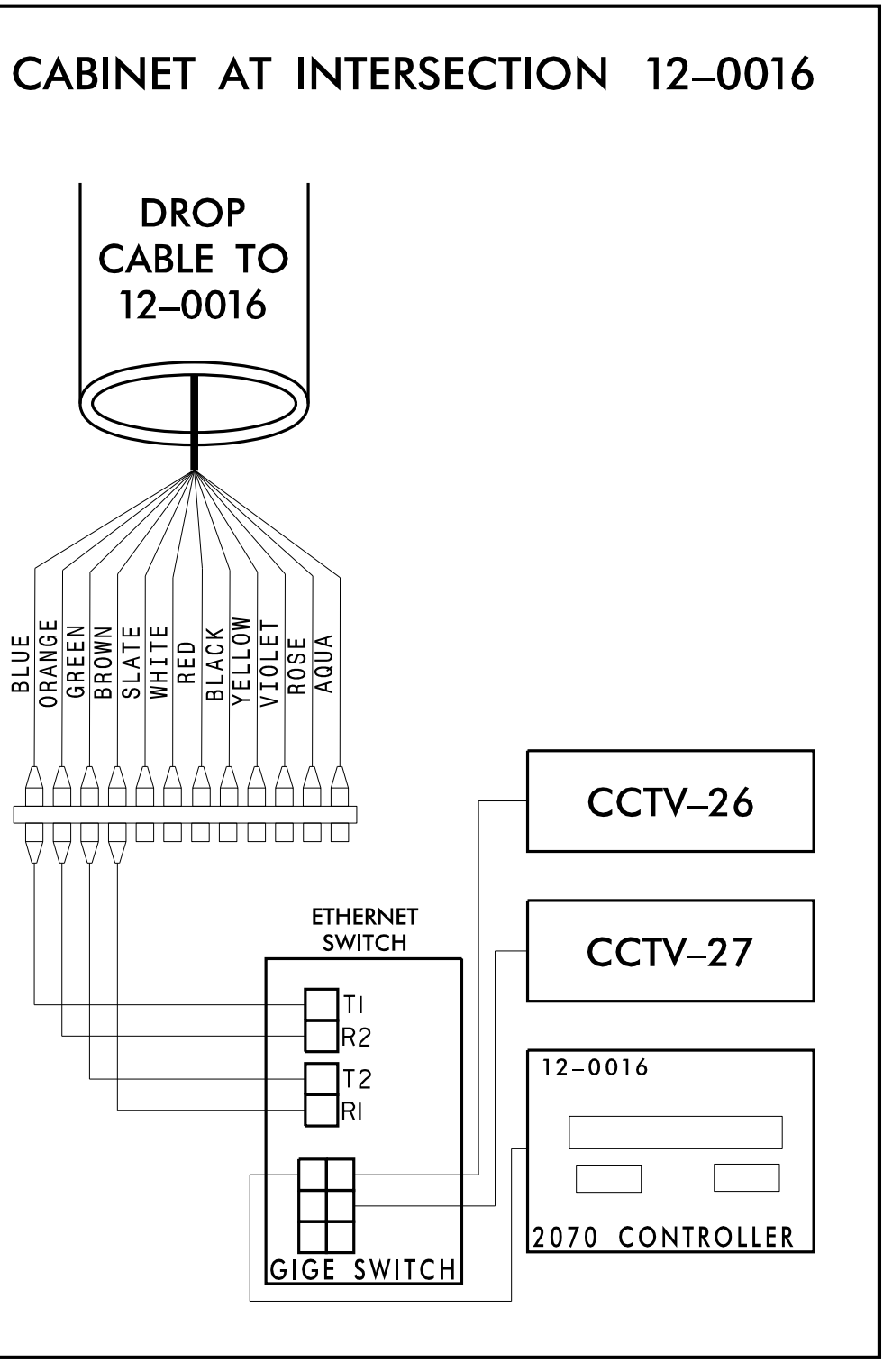
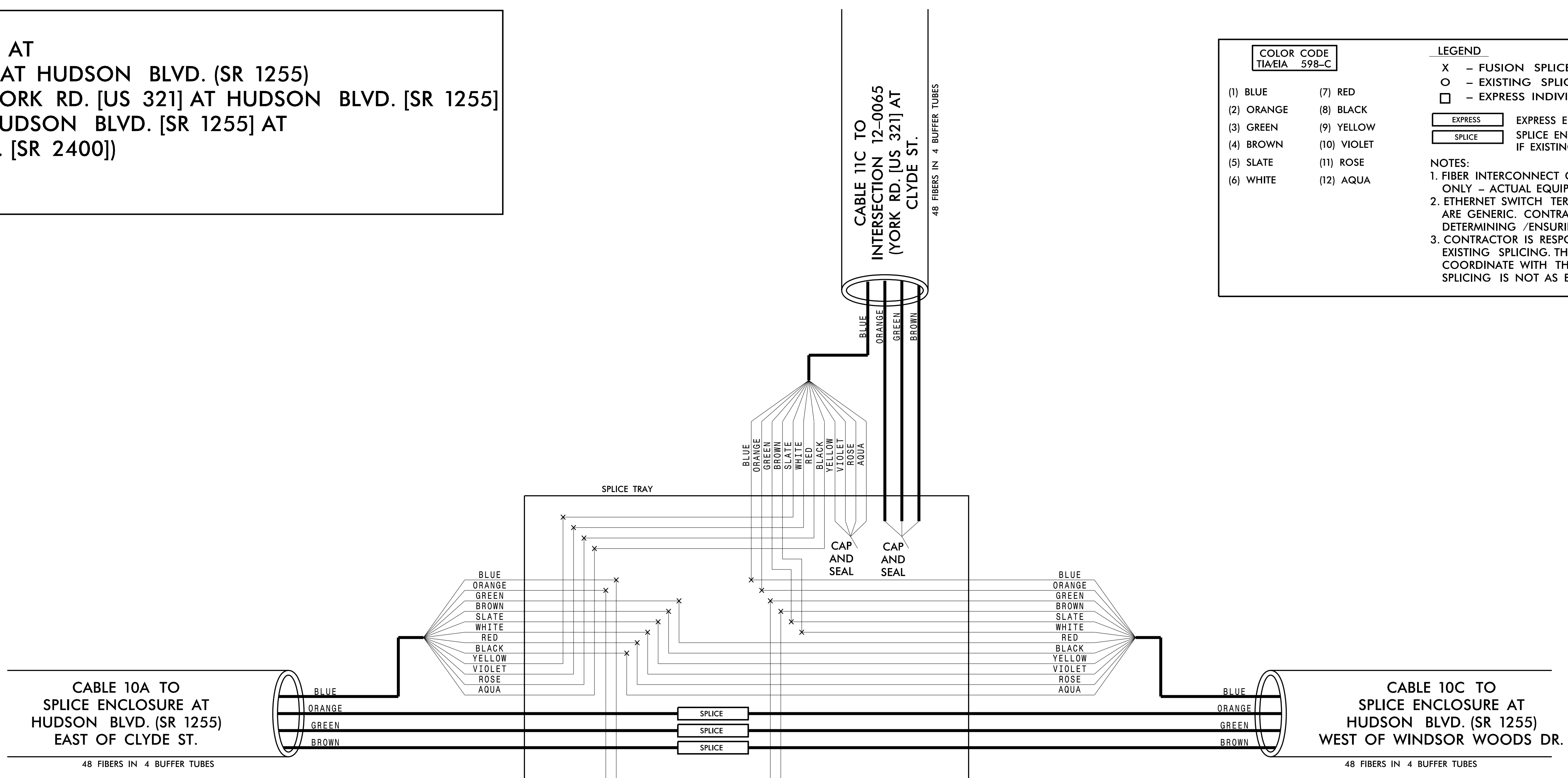

CHANNEL 10
CITY OF GASTONIA COMPUTERIZED SIGNAL SYSTEM
SPLICE DETAIL

DIVISION 12		GASTON COUNTY	
PLAN DATE: DECEMBER 2021	REVIEWED BY: K. SMITH	PREPARED BY: S. BUTLER	REVIEWED BY: I. VAN OSDELL
REVISIONS		INIT.	DATE

Kimley-Horn
NC License #F-0102
421 Fayetteville St., Suite 600
Raleigh, NC 27601
Tel: (919) 677-2000
Fax: (919) 677-2050

SEAL
NORTH CAROLINA PROFESSIONAL ENGINEER
KIMLEY-HORN, INC.
Igor Van Osdel
3/16/2022
DATE

3/15/2022 \\kimley-horn.com\SE-RAL\NRA\TPTD\ITS\01036569_Gastonia_Signal_System\6_Tasks\Splicing_SPL105.dgn

CHANNEL 10
SPlice ENCLOSURE AT
HUDSON BLVD. (SR 1255)
WEST OF WINDSOR WOODS DR.

COLOR CODE
TIA/EIA 598-C

(1) BLUE	(7) RED
(2) ORANGE	(8) BLACK
(3) GREEN	(9) YELLOW
(4) BROWN	(10) VIOLET
(5) SLATE	(11) ROSE
(6) WHITE	(12) AQUA

LEGEND

X - FUSION SPlice INDIVIDUAL FIBER
 O - EXISTING SPlice
 □ - EXPRESS INDIVIDUAL FIBER

EXPRESS - EXPRESS ENTIRE BUFFER TUBE
 SPlice - SPlice ENTIRE BUFFER TUBE OR MAINTAIN IF EXISTING EXPRESSED

NOTES:
 1. FIBER INTERCONNECT CENTER RACKS ARE SCHEMATIC ONLY - ACTUAL EQUIPMENT FORM MAY VARY.
 2. ETHERNET SWITCH TERMINATION CONFIGURATIONS ARE GENERIC. CONTRACTOR IS RESPONSIBLE FOR DETERMINING /ENSURING PROPER TERMINATION.
 3. CONTRACTOR IS RESPONSIBLE FOR FIELD VERIFYING EXISTING SPlicing. THE CONTRACTOR SHALL COORDINATE WITH THE ENGINEER WHERE EXISTING SPlicing IS NOT AS EXPECTED.

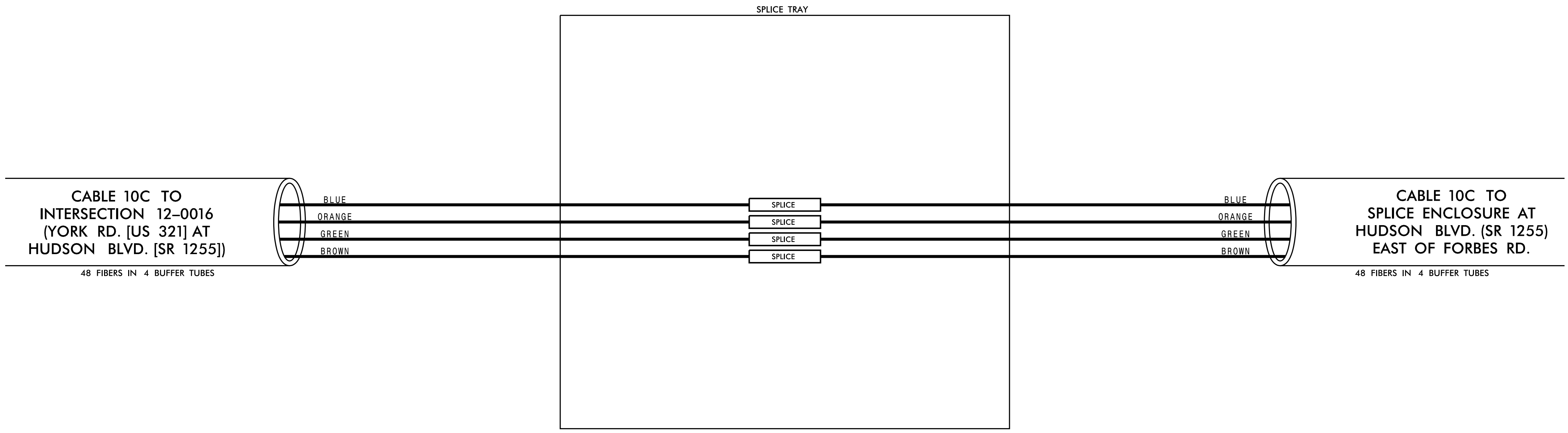

3/15/2022
\\kimley-horn.com\SE_RAL\NRA\TPTD\ITS\01036569_Gastonia_Signal_System\6_Tasks\Splicing\SP106.dgn

Plans Prepared For:
 Transportation, Mobility and Safe Division
 DEPARTMENT OF TRANSPORTATION
 250 N. Greenfield Place, Garner, NC 27529

CHANNEL 10
 CITY OF GASTONIA COMPUTERIZED
 SIGNAL SYSTEM
 SPlice DETAIL

DIVISION 12 GASTON COUNTY

PLAN DATE: DECEMBER 2021 REVIEWED BY: K. SMITH
 PREPARED BY: S. BUTLER REVIEWED BY: I. VAN OSDELL

REVISIONS	INIT.	DATE

SCALE
 0

Kimley»Horn
 NC License #F-0102
 421 Fayetteville St., Suite 600
 Raleigh, NC 27601
 Tel: (919) 677-2000
 Fax: (919) 677-2050

SEAL
 NORTH CAROLINA
 PROFESSIONAL
 SEAL
 028952
 MICHAEL Z. VAN OSDELL
 CIVIL ENGINEER

DocuSigned by:
 Inger Van OsdeLL
 3/16/2022

CADD Filename:

**CHANNEL 10
SPLICE ENCLOSURE AT
HUDSON BLVD. (SR 1255)
EAST OF FORBES RD.**

COLOR CODE TIA/EIA 598-C		LEGEND	
(1) BLUE	(7) RED	X - FUSION SPLICE INDIVIDUAL FIBER	
(2) ORANGE	(8) BLACK	O - EXISTING SPLICE	
(3) GREEN	(9) YELLOW	□ - EXPRESS INDIVIDUAL FIBER	
(4) BROWN	(10) VIOLET	EXPRESS	EXPRESS ENTIRE BUFFER TUBE
(5) SLATE	(11) ROSE	SPLICE	SPLICE ENTIRE BUFFER TUBE OR MAINTAIN IF EXISTING EXPRESSED
(6) WHITE	(12) AQUA	NOTES:	
		1. FIBER INTERCONNECT CENTER RACKS ARE SCHEMATIC ONLY - ACTUAL EQUIPMENT FORM MAY VARY.	
		2. ETHERNET SWITCH TERMINATION CONFIGURATIONS ARE GENERIC. CONTRACTOR IS RESPONSIBLE FOR DETERMINING /ENSURING PROPER TERMINATION.	
		3. CONTRACTOR IS RESPONSIBLE FOR FIELD VERIFYING EXISTING SPlicing. THE CONTRACTOR SHALL COORDINATE WITH THE ENGINEER WHERE EXISTING SPlicing IS NOT AS EXPECTED.	

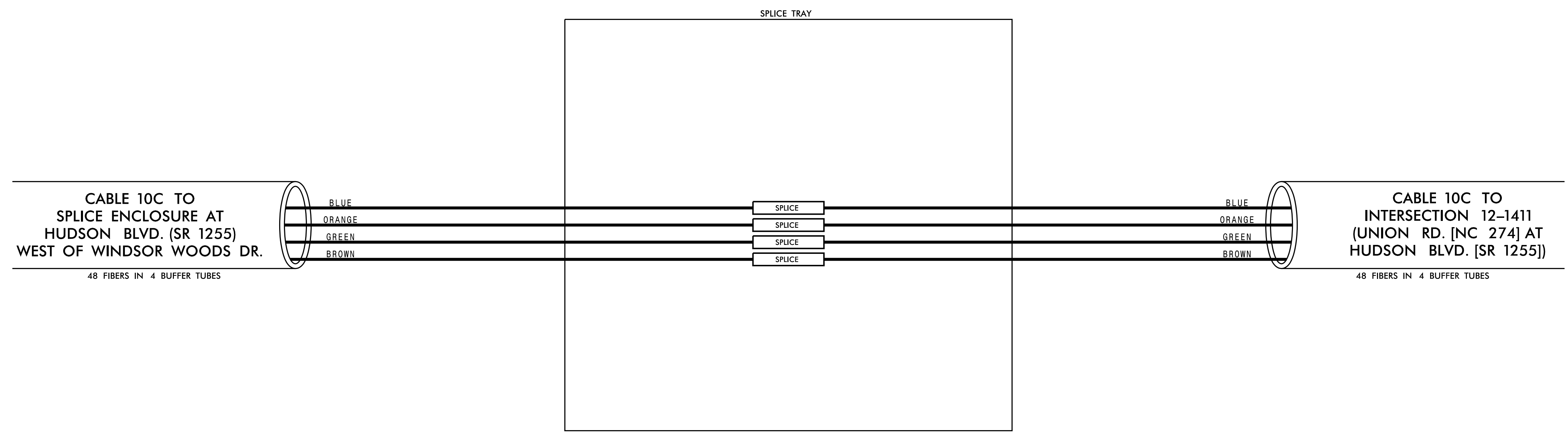

3/15/2022 \\kimley-horn.com\SE_RAL\NRA\TPTD\ITS\01036569_Gastonia_Signal_System\6_Tasks\Splicing\SPL107.dgn

	CHANNEL 10		
	CITY OF GASTONIA COMPUTERIZED SIGNAL SYSTEM SPLICE DETAIL		
DIVISION 12 PLAN DATE: DECEMBER 2021 PREPARED BY: S. BUTLER	GASTON COUNTY REVIEWED BY: K. SMITH REVIEWED BY: I. VAN OSDELL	REVISIONS INIT. DATE	SEAL NORTH CAROLINA PROFESSIONAL ENGINEER ROGER Z. VAN OSDEL 028952 DocuSigned by: Roger Van Osdel 3/16/2022 CADD Filename:

CHANNEL 10
SPLICE ENCLOSURE AT
(UNION RD. [NC 274] AT
HUDSON BLVD. [SR 1255])
SIG ID 12-1411
CCTV CAMERA-28

COLOR CODE
TIA/EIA 598-C

(1) BLUE	(7) RED
(2) ORANGE	(8) BLACK
(3) GREEN	(9) YELLOW
(4) BROWN	(10) VIOLET
(5) SLATE	(11) ROSE
(6) WHITE	(12) AQUA

LEGEND

X - FUSION SPLICE INDIVIDUAL FIBER
O - EXISTING SPLICE
□ - EXPRESS INDIVIDUAL FIBER

EXPRESS - EXPRESS ENTIRE BUFFER TUBE
SPLICE - SPLICE ENTIRE BUFFER TUBE OR MAINTAIN IF EXISTING EXPRESSED

NOTES:

- FIBER INTERCONNECT CENTER RACKS ARE SCHEMATIC ONLY - ACTUAL EQUIPMENT FORM MAY VARY.
- ETHERNET SWITCH TERMINATION CONFIGURATIONS ARE GENERIC. CONTRACTOR IS RESPONSIBLE FOR DETERMINING /ENSURING PROPER TERMINATION.
- CONTRACTOR IS RESPONSIBLE FOR FIELD VERIFYING EXISTING SPlicing. THE CONTRACTOR SHALL COORDINATE WITH THE ENGINEER WHERE EXISTING SPlicing IS NOT AS EXPECTED.

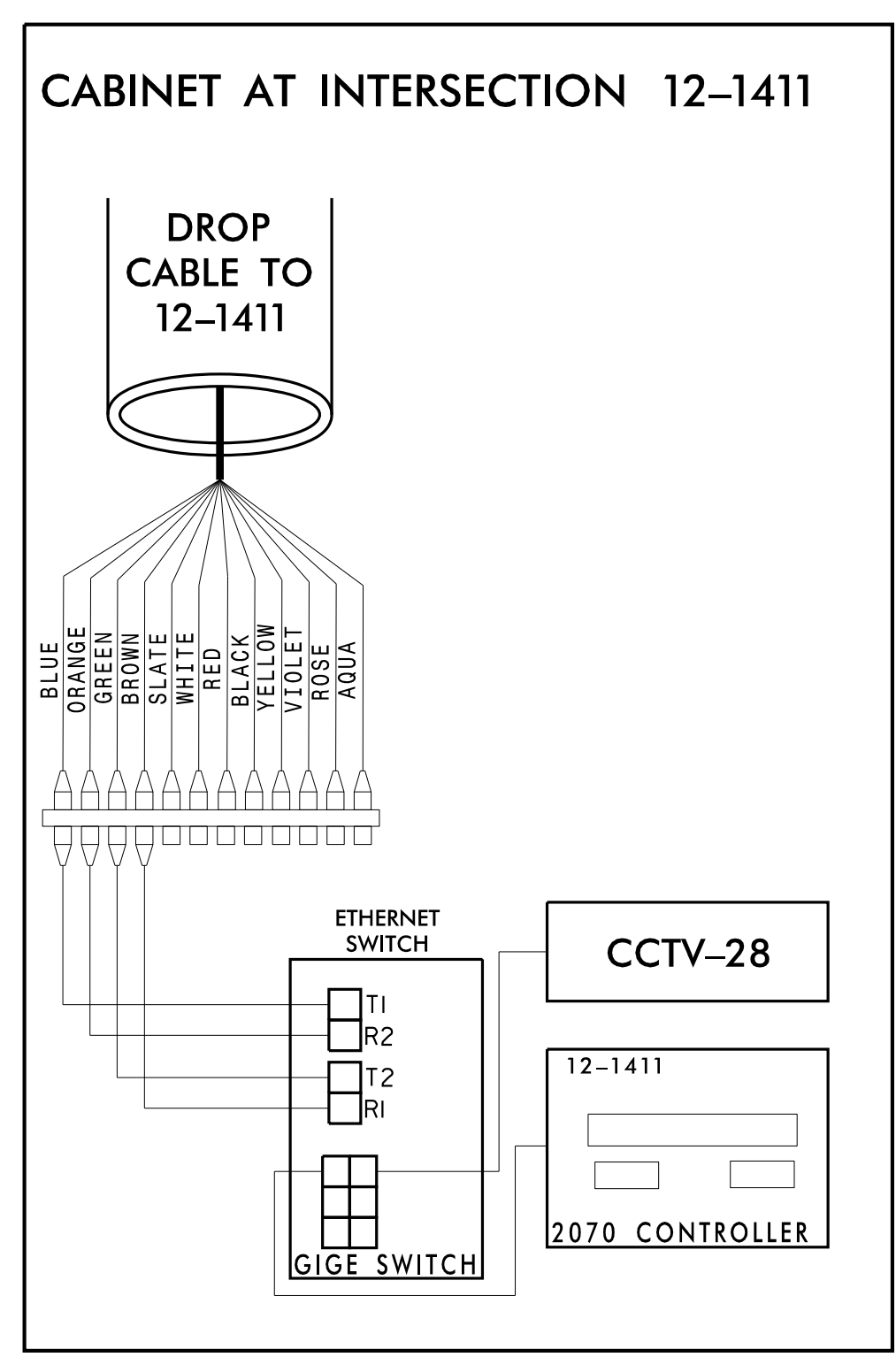
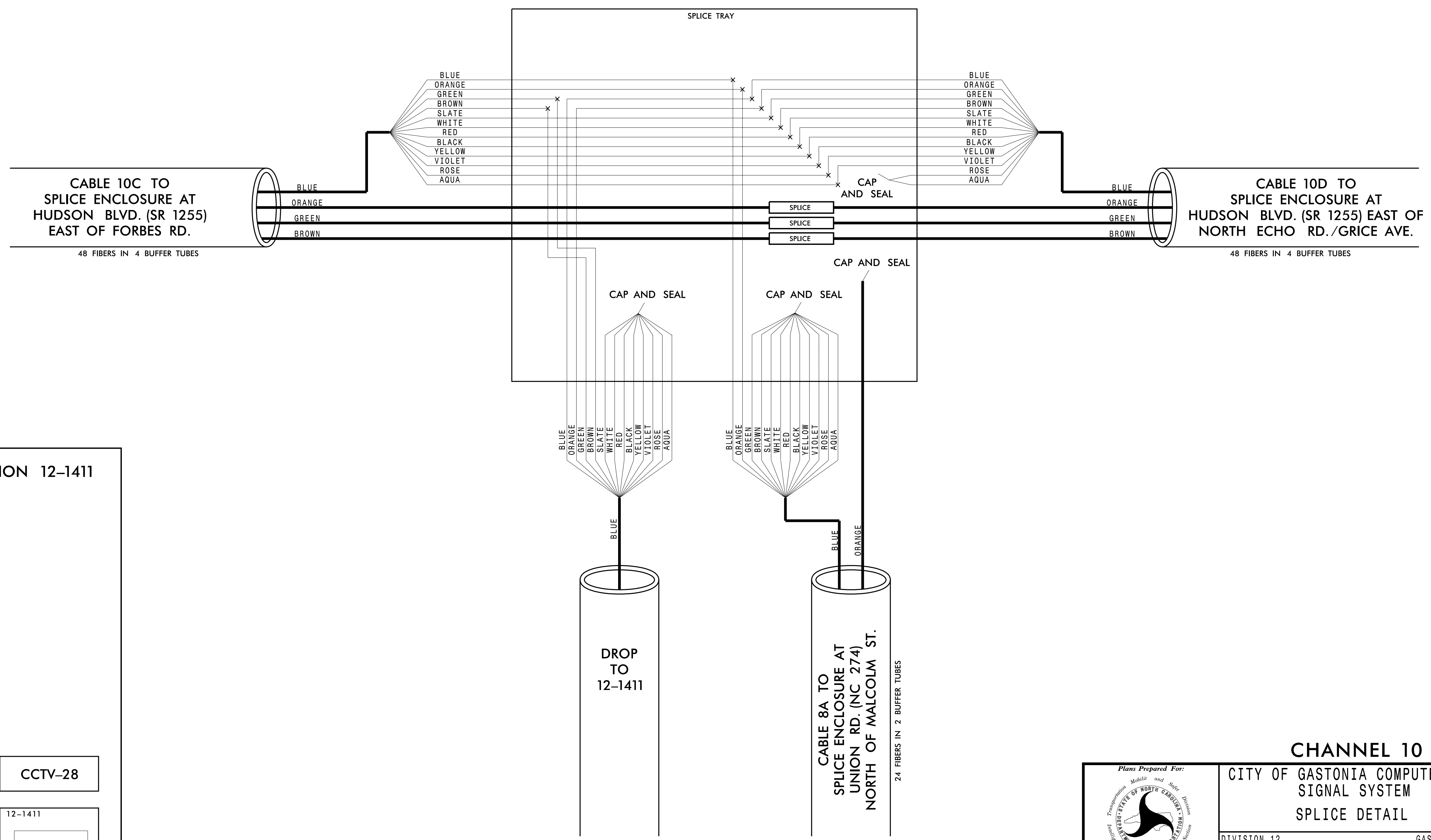

CHANNEL 10
CITY OF GASTONIA COMPUTERIZED
SIGNAL SYSTEM
SPlice DETAIL

DIVISION 12 GASTON COUNTY

PLAN DATE: DECEMBER 2021 REVIEWED BY: K. SMITH

PREPARED BY: S. BUTLER REVIEWED BY: I. VAN OSDELL

SCALE: 0

REVISIONS: INIT. DATE

DocuSigned by: Inger Van OsdeLL 3/16/2022

SEAL: NORTH CAROLINA PROFESSIONAL SEAL 028952

CADD File name:

Kimley»Horn
NC License #F-0102
421 Fayetteville St., Suite 600
Raleigh, NC 27601
Tel: (919) 677-2000
Fax: (919) 677-2050

3/15/2022 \\kimley-horn.com\SE-RAL\NRA\TPTO\ITS\01036569_Gastonia_Signal_System\6_Tasks\Splicing_SPL108.dgn

CHANNEL 10
SPlice ENCLOSURE AT
HUDSON BLVD. (SR 1255)
EAST OF NORTH ECHO RD./GRICE AVE.

COLOR CODE
TIA/EIA 598-C

(1) BLUE	(7) RED
(2) ORANGE	(8) BLACK
(3) GREEN	(9) YELLOW
(4) BROWN	(10) VIOLET
(5) SLATE	(11) ROSE
(6) WHITE	(12) AQUA

LEGEND

X - FUSION SPlice INDIVIDUAL FIBER
 O - EXISTING SPlice
 □ - EXPRESS INDIVIDUAL FIBER

EXPRESS - EXPRESS ENTIRE BUFFER TUBE OR MAINTAIN IF EXISTING EXPRESSED
 SPlice - SPlice ENTIRE BUFFER TUBE OR MAINTAIN IF EXISTING EXPRESSED

NOTES:
 1. FIBER INTERCONNECT CENTER RACKS ARE SCHEMATIC ONLY - ACTUAL EQUIPMENT FORM MAY VARY.
 2. ETHERNET SWITCH TERMINATION CONFIGURATIONS ARE GENERIC. CONTRACTOR IS RESPONSIBLE FOR DETERMINING /ENSURING PROPER TERMINATION.
 3. CONTRACTOR IS RESPONSIBLE FOR FIELD VERIFYING EXISTING SPlicing. THE CONTRACTOR SHALL COORDINATE WITH THE ENGINEER WHERE EXISTING SPlicing IS NOT AS EXPECTED.

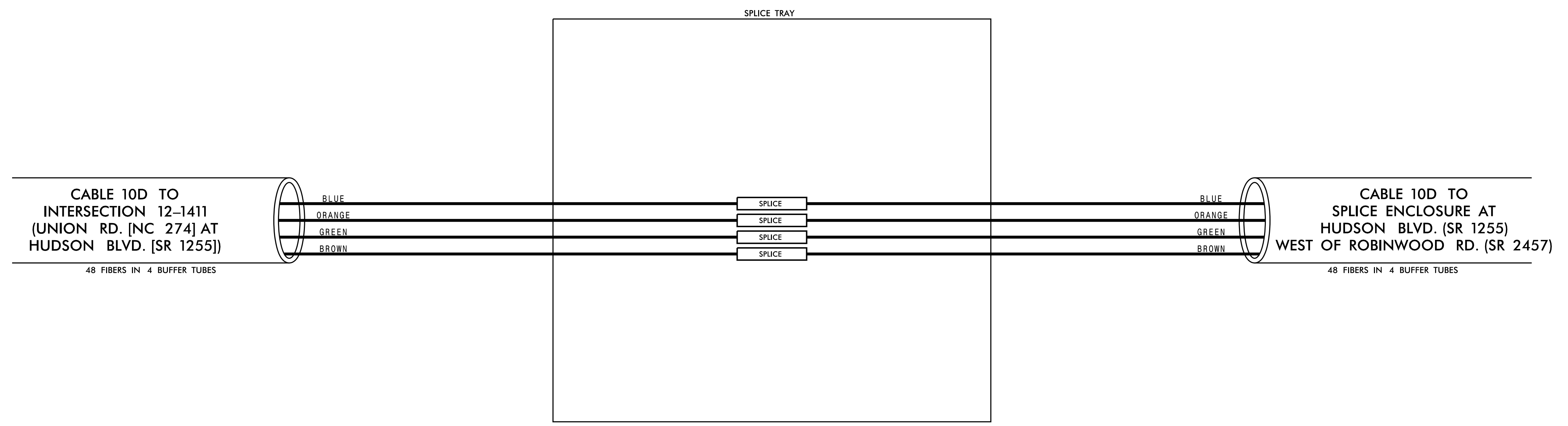

3/15/2022
\\kimley-horn.com\SE\RAL\N\RAL_TPTD\ITS\01036569_Gastonia_Signal_System\6_Tasks\Splicing\SP109.dgn

Plans Prepared For:
 Transportation, Mobility and Safe Division
 DEPARTMENT OF TRANSPORTATION
 250 N. Greenfield Place, Garner, NC 27529

CHANNEL 10
 CITY OF GASTONIA COMPUTERIZED
 SIGNAL SYSTEM
 SPlice DETAIL

DIVISION 12 GASTON COUNTY

PLAN DATE: DECEMBER 2021 REVIEWED BY: K. SMITH
 PREPARED BY: S. BUTLER REVIEWED BY: I. VAN OSDELL

REVISIONS	INIT.	DATE

SCALE
 0

Kimley»Horn
 NC License #F-0102
 421 Fayetteville St., Suite 600
 Raleigh, NC 27601
 Tel: (919) 677-2000
 Fax: (919) 677-2050

SEAL
 NORTH CAROLINA
 PROFESSIONAL
 SEAL
 028952
 I. VAN OSDELL
 CIVIL ENGINEER

DocuSigned by:
 Iger Van OsdeLL 3/16/2022

DATE

CADD Filename:

**CHANNEL 10
 SPLICE ENCLOSURE AT
 HUDSON BLVD. (SR 1255)
 WEST OF ROBINWOOD RD. (SR 2457)**

COLOR CODE TIA/EIA 598-C		LEGEND	
(1) BLUE	(7) RED	X - FUSION SPLICE INDIVIDUAL FIBER	
(2) ORANGE	(8) BLACK	O - EXISTING SPLICE	
(3) GREEN	(9) YELLOW	□ - EXPRESS INDIVIDUAL FIBER	
(4) BROWN	(10) VIOLET	EXPRESS	EXPRESS ENTIRE BUFFER TUBE
(5) SLATE	(11) ROSE	SPLICE	SPLICE ENTIRE BUFFER TUBE OR MAINTAIN IF EXISTING EXPRESSED
(6) WHITE	(12) AQUA		

NOTES:
 1. FIBER INTERCONNECT CENTER RACKS ARE SCHEMATIC ONLY - ACTUAL EQUIPMENT FORM MAY VARY.
 2. ETHERNET SWITCH TERMINATION CONFIGURATIONS ARE GENERIC. CONTRACTOR IS RESPONSIBLE FOR DETERMINING /ENSURING PROPER TERMINATION.
 3. CONTRACTOR IS RESPONSIBLE FOR FIELD VERIFYING EXISTING SPLICING. THE CONTRACTOR SHALL COORDINATE WITH THE ENGINEER WHERE EXISTING SPLICING IS NOT AS EXPECTED.

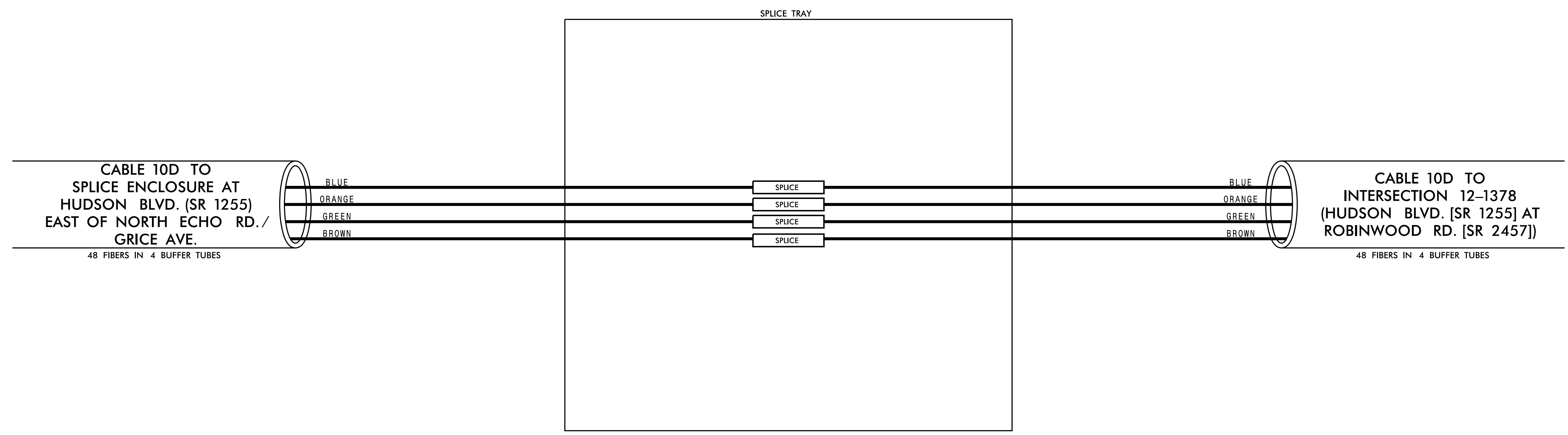

3/15/2022 \\kimley-horn.com\SE-RAL\NRA\TPTD\ITS\01036569_Gastonia_Signal_System\6_Tasks\Splicing_SPL110.dgn

	CHANNEL 10		
	CITY OF GASTONIA COMPUTERIZED SIGNAL SYSTEM SPLICE DETAIL		
DIVISION 12 PLAN DATE: DECEMBER 2021 PREPARED BY: S. BUTLER	GASTON COUNTY REVIEWED BY: K. SMITH REVIEWED BY: I. VAN OSDELL		SEAL NORTH CAROLINA PROFESSIONAL ENGINEER IGER VAN OSDELL 3/16/2022
SCALE 	REVISIONS _____ _____ _____	INIT. DATE _____ _____ _____	DocuSigned by: Iger Van Osdel 3/16/2022 CADD Filename:

Kimley»Horn
 NC License #F-0102
 421 Fayetteville St., Suite 600
 Raleigh, NC 27601
 Tel: (919) 677-2000
 Fax: (919) 677-2050

CHANNEL 11
SPLICE ENCLOSURE AT
(CHESTER ST. [US 321] AT THIRD AVE.)
SIG ID 12-0072 (THIRD AVE. AT
YORK RD. [US 321])

COLOR CODE
TIA/EIA 598-C

(1) BLUE	(7) RED
(2) ORANGE	(8) BLACK
(3) GREEN	(9) YELLOW
(4) BROWN	(10) VIOLET
(5) SLATE	(11) ROSE
(6) WHITE	(12) AQUA

LEGEND

X - FUSION SPLICE INDIVIDUAL FIBER
 O - EXISTING SPLICE
 □ - EXPRESS INDIVIDUAL FIBER

EXPRESS - EXPRESS ENTIRE BUFFER TUBE
 SPLICE - SPLICE ENTIRE BUFFER TUBE OR MAINTAIN IF EXISTING EXPRESSED

NOTES:
 1. FIBER INTERCONNECT CENTER RACKS ARE SCHEMATIC ONLY - ACTUAL EQUIPMENT FORM MAY VARY.
 2. ETHERNET SWITCH TERMINATION CONFIGURATIONS ARE GENERIC. CONTRACTOR IS RESPONSIBLE FOR DETERMINING /ENSURING PROPER TERMINATION.
 3. CONTRACTOR IS RESPONSIBLE FOR FIELD VERIFYING EXISTING SPlicing. THE CONTRACTOR SHALL COORDINATE WITH THE ENGINEER WHERE EXISTING SPlicing IS NOT AS EXPECTED.

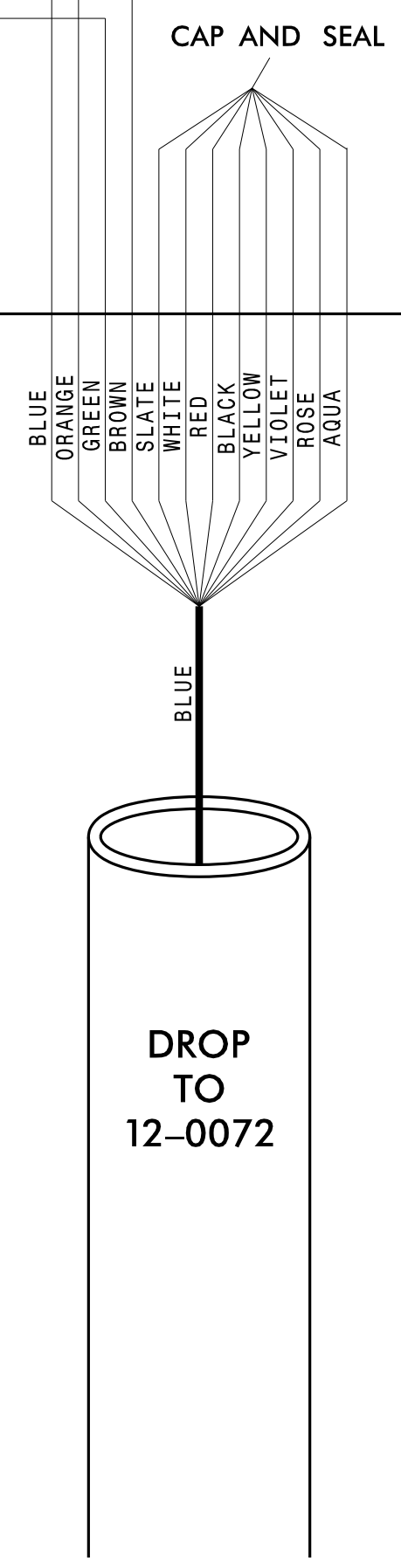
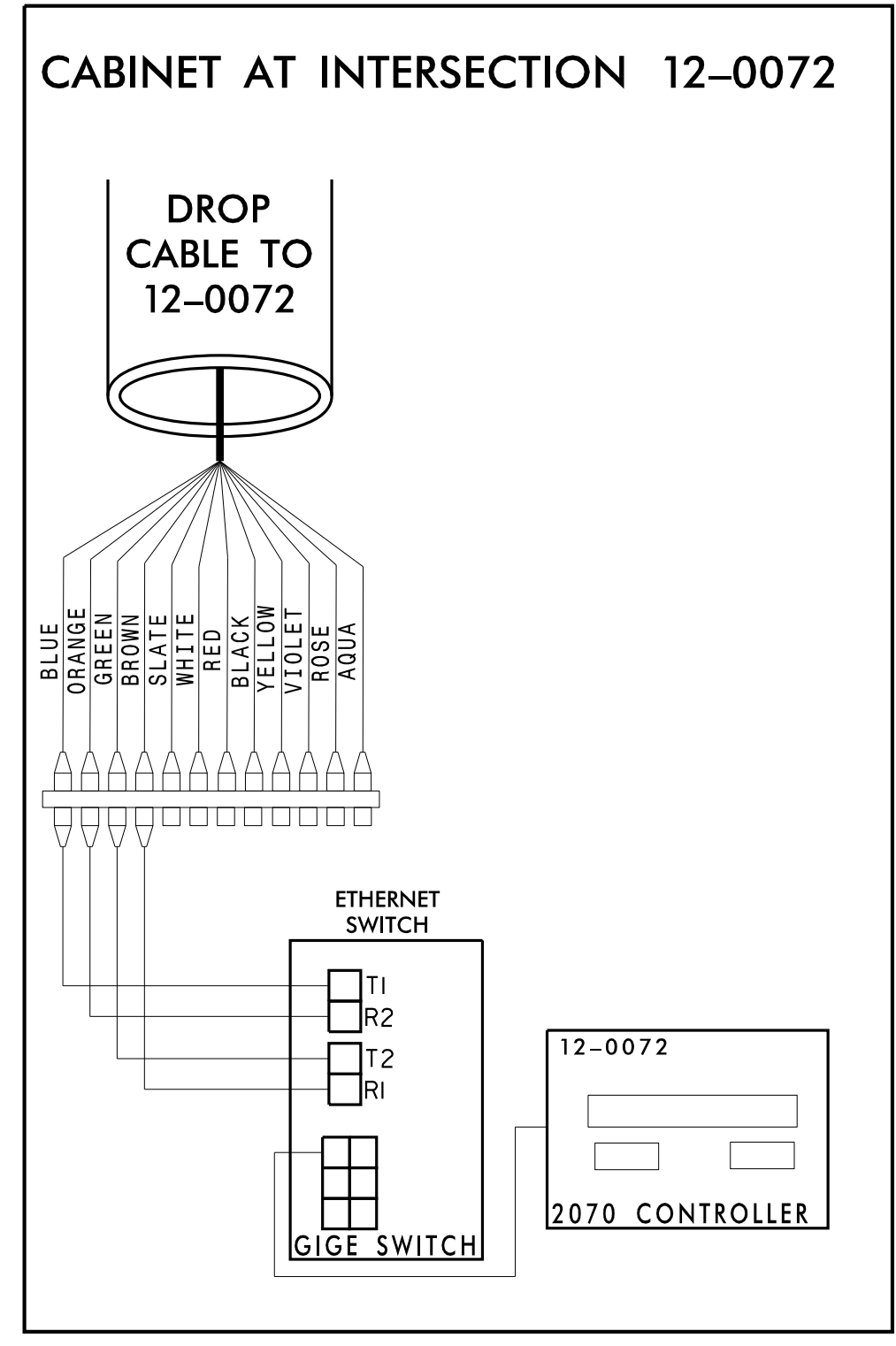
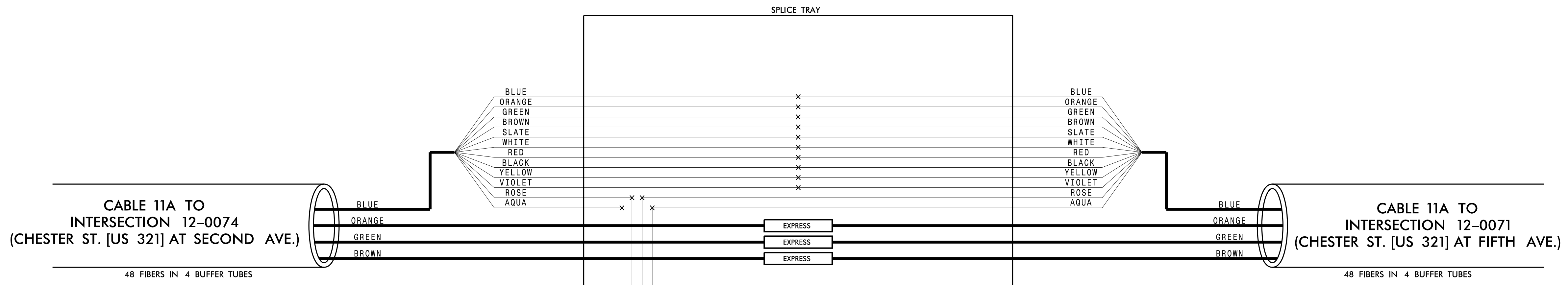

CHANNEL 11
CITY OF GASTONIA COMPUTERIZED SIGNAL SYSTEM
SPLICE DETAIL

DIVISION 12 GASTON COUNTY
 PLAN DATE: DECEMBER 2021 REVIEWED BY: K. SMITH
 PREPARED BY: S. BUTLER REVIEWED BY: I. VAN OSDELL

SCALE: 0

REVISIONS: _____ DATE: _____
 INIT. DATE

DocuSigned by: Inger Van OsdeLL 3/16/2022
 SEAL: NORTH CAROLINA PROFESSIONAL SEAL 028952
 INGER Z. VAN OSDELL
 CADD File name: _____

Kimley»Horn
 NC License #F-0102
 421 Fayetteville St., Suite 600
 Raleigh, NC 27601
 Tel: (919) 677-2000
 Fax: (919) 677-2050

3/15/2022 \\kimley-horn.com\SE-RAL\NRA\TPTD\ITS\01036569_Gastonia_Signal_System\6_Tasks\Splicing_SPL111.dgn

CHANNEL 11 SPLICE ENCLOSURE AT (CHESTER ST. [US 321] AT FIFTH AVE.) SIG ID 12-0071

COLOR CODE
TIA/EIA 598-C

(1) BLUE	(7) RED
(2) ORANGE	(8) BLACK
(3) GREEN	(9) YELLOW
(4) BROWN	(10) VIOLET
(5) SLATE	(11) ROSE
(6) WHITE	(12) AQUA

LEGEND

X - FUSION SPlice INDIVIDUAL FIBER
 O - EXISTING SPlice
 □ - EXPRESS INDIVIDUAL FIBER

EXPRESS - EXPRESS ENTIRE BUFFER TUBE
 SPLICE - SPlice ENTIRE BUFFER TUBE OR MAINTAIN IF EXISTING EXPRESSED

NOTES:
 1. FIBER INTERCONNECT CENTER RACKS ARE SCHEMATIC ONLY - ACTUAL EQUIPMENT FORM MAY VARY.
 2. ETHERNET SWITCH TERMINATION CONFIGURATIONS ARE GENERIC. CONTRACTOR IS RESPONSIBLE FOR DETERMINING /ENSURING PROPER TERMINATION.
 3. CONTRACTOR IS RESPONSIBLE FOR FIELD VERIFYING EXISTING SPlicing. THE CONTRACTOR SHALL COORDINATE WITH THE ENGINEER WHERE EXISTING SPlicing IS NOT AS EXPECTED.

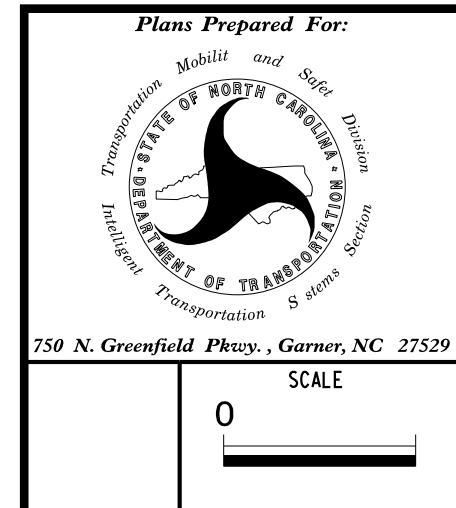
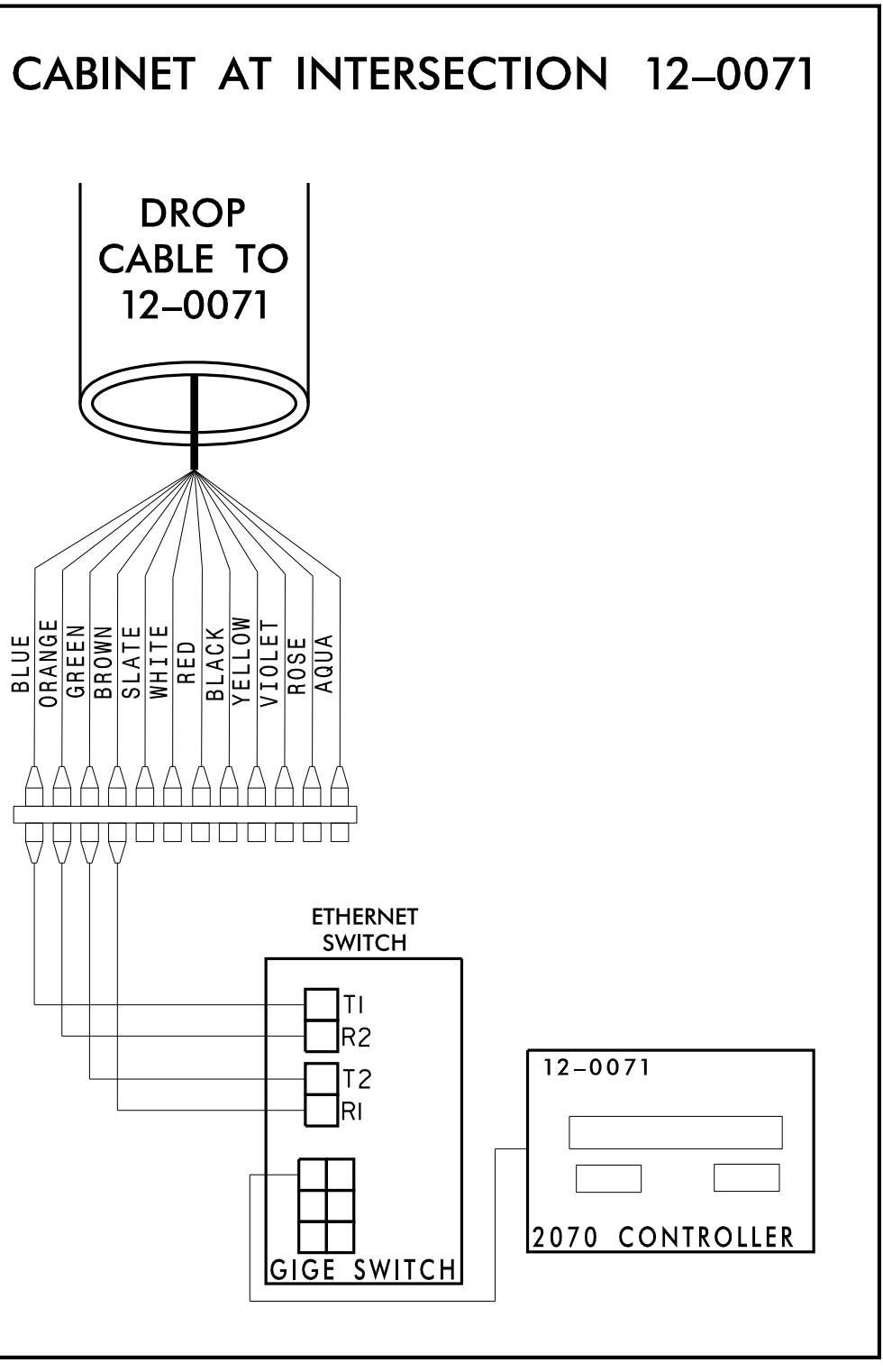
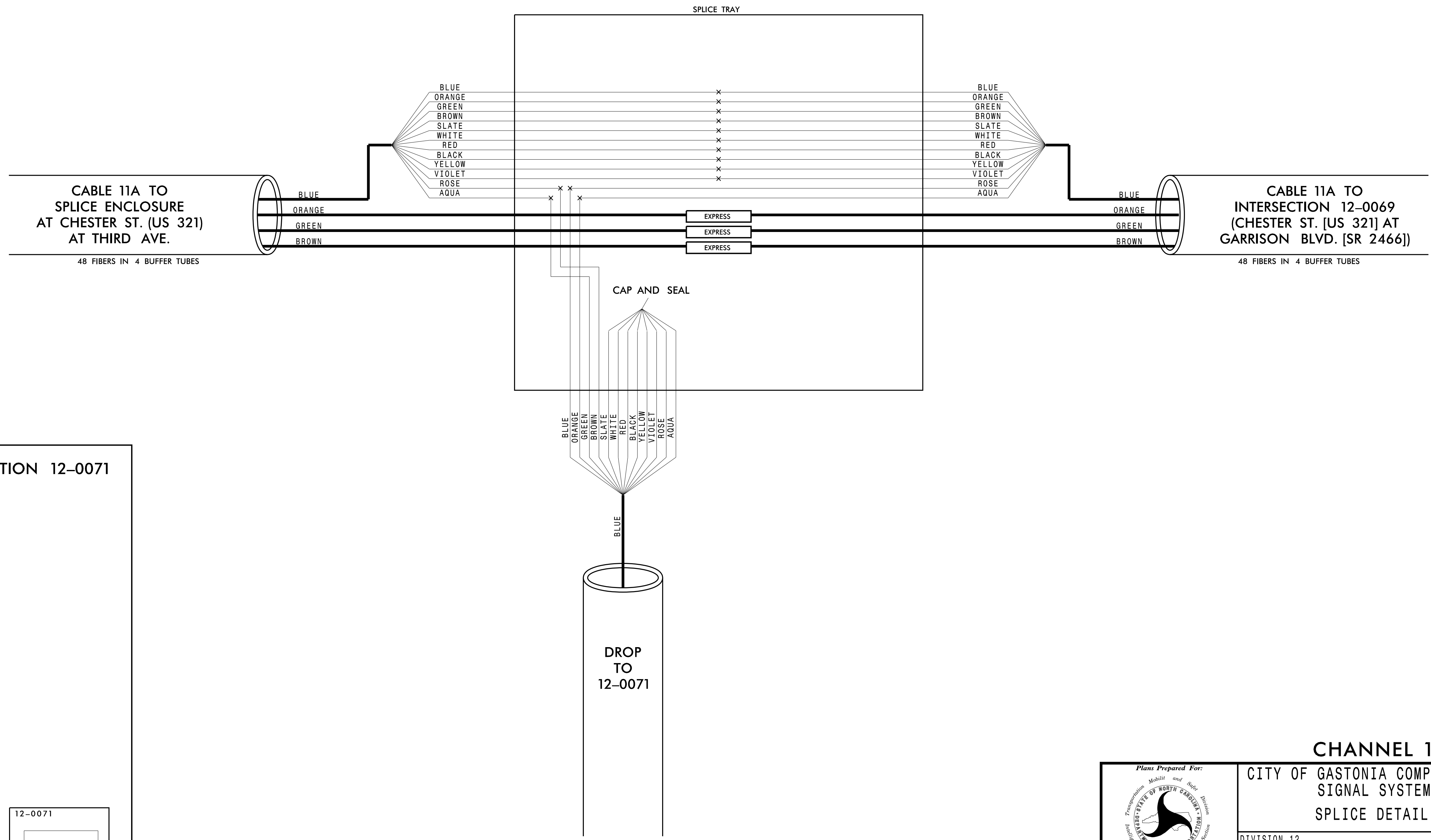

CHANNEL 11
CITY OF GASTONIA COMPUTERIZED SIGNAL SYSTEM
SPlice DETAIL

DIVISION 12		GASTON COUNTY	
PLAN DATE: DECEMBER 2021	REVIEWED BY: K. SMITH	PREPARED BY: S. BUTLER	REVIEWED BY: I. VAN OSDELL
REVISIONS	INIT.	DATE	

Kimley»Horn
 NC License #F-0102
 421 Fayetteville St., Suite 600
 Raleigh, NC 27601
 Tel: (919) 677-2000
 Fax: (919) 677-2050

SEAL
 NORTH CAROLINA PROFESSIONAL ENGINEER
 SEAL 028952
 IGER Z. VAN OSDELL

DocuSigned by: Inger Van OsdeLL
 3/16/2022

3/15/2022 \\kimley-horn.com\SE-RAL\NRA\1PTD\ITS\01036569_Gastonia_Signal_System\6_Tasks\Splicing_SPL112.dgn

CHANNEL 11
SPLICE ENCLOSURE AT
(CHESTER ST. [US 321] AT
GARRISON BLVD. [SR 2466])
SIG ID 12-0069 (CHESTER ST. [US 321] AT
GARRISON BLVD. [SR 2466])
SIG ID 12-0068 (YORK RD. [US 321] AT
GARRISON BLVD. [SR 2466])
CCTV CAMERA-19

COLOR CODE
TIA/EIA 598-C

(1) BLUE	(7) RED
(2) ORANGE	(8) BLACK
(3) GREEN	(9) YELLOW
(4) BROWN	(10) VIOLET
(5) SLATE	(11) ROSE
(6) WHITE	(12) AQUA

LEGEND

X - FUSION SPLICE INDIVIDUAL FIBER
O - EXISTING SPLICE
□ - EXPRESS INDIVIDUAL FIBER

EXPRESS - EXPRESS ENTIRE BUFFER TUBE
SPLICE - SPLICE ENTIRE BUFFER TUBE OR MAINTAIN IF EXISTING EXPRESSED

NOTES:
1. FIBER INTERCONNECT CENTER RACKS ARE SCHEMATIC ONLY - ACTUAL EQUIPMENT FORM MAY VARY.
2. ETHERNET SWITCH TERMINATION CONFIGURATIONS ARE GENERIC. CONTRACTOR IS RESPONSIBLE FOR DETERMINING /ENSURING PROPER TERMINATION.
3. CONTRACTOR IS RESPONSIBLE FOR FIELD VERIFYING EXISTING SPlicing. THE CONTRACTOR SHALL COORDINATE WITH THE ENGINEER WHERE EXISTING SPlicing IS NOT AS EXPECTED.

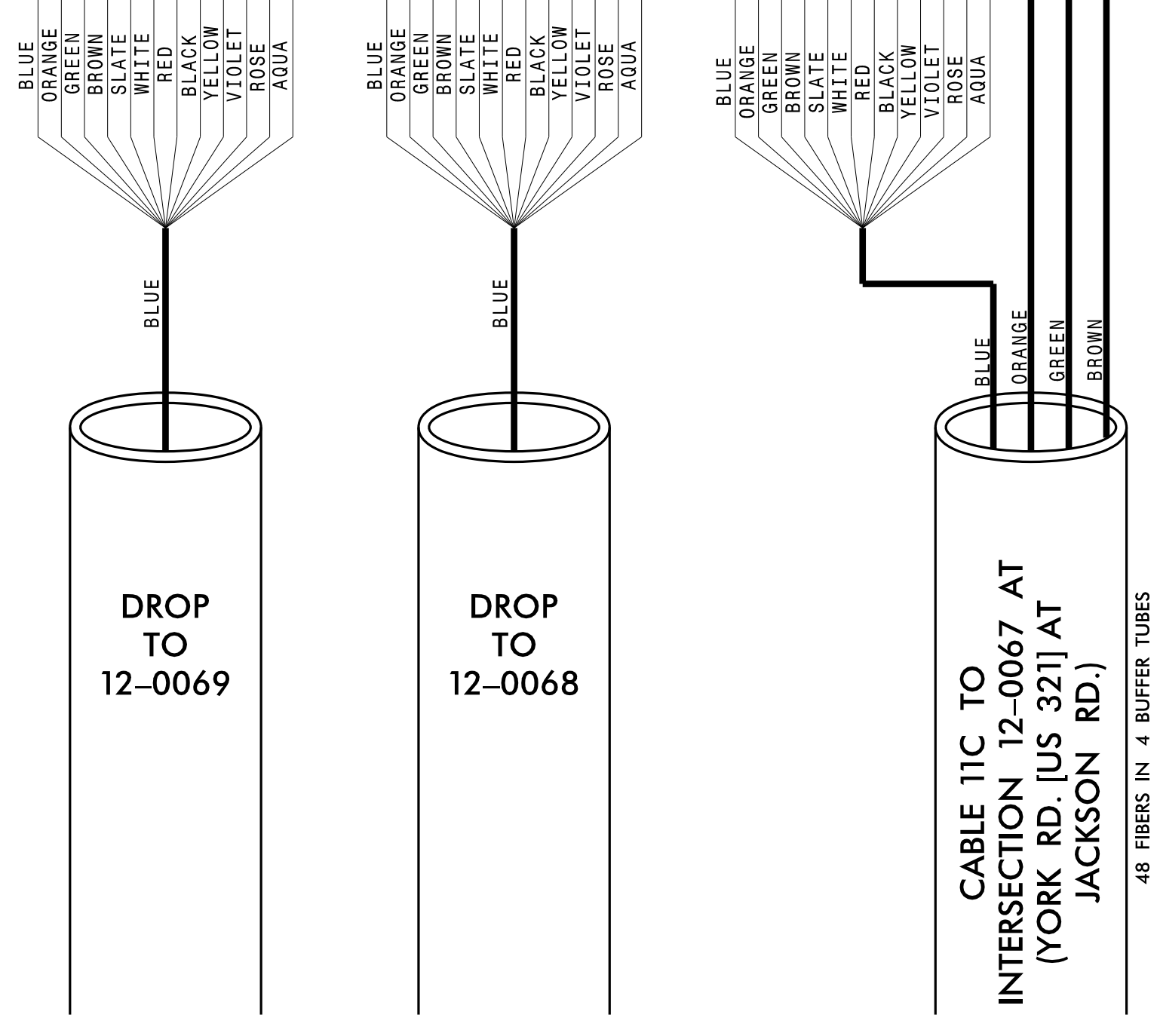
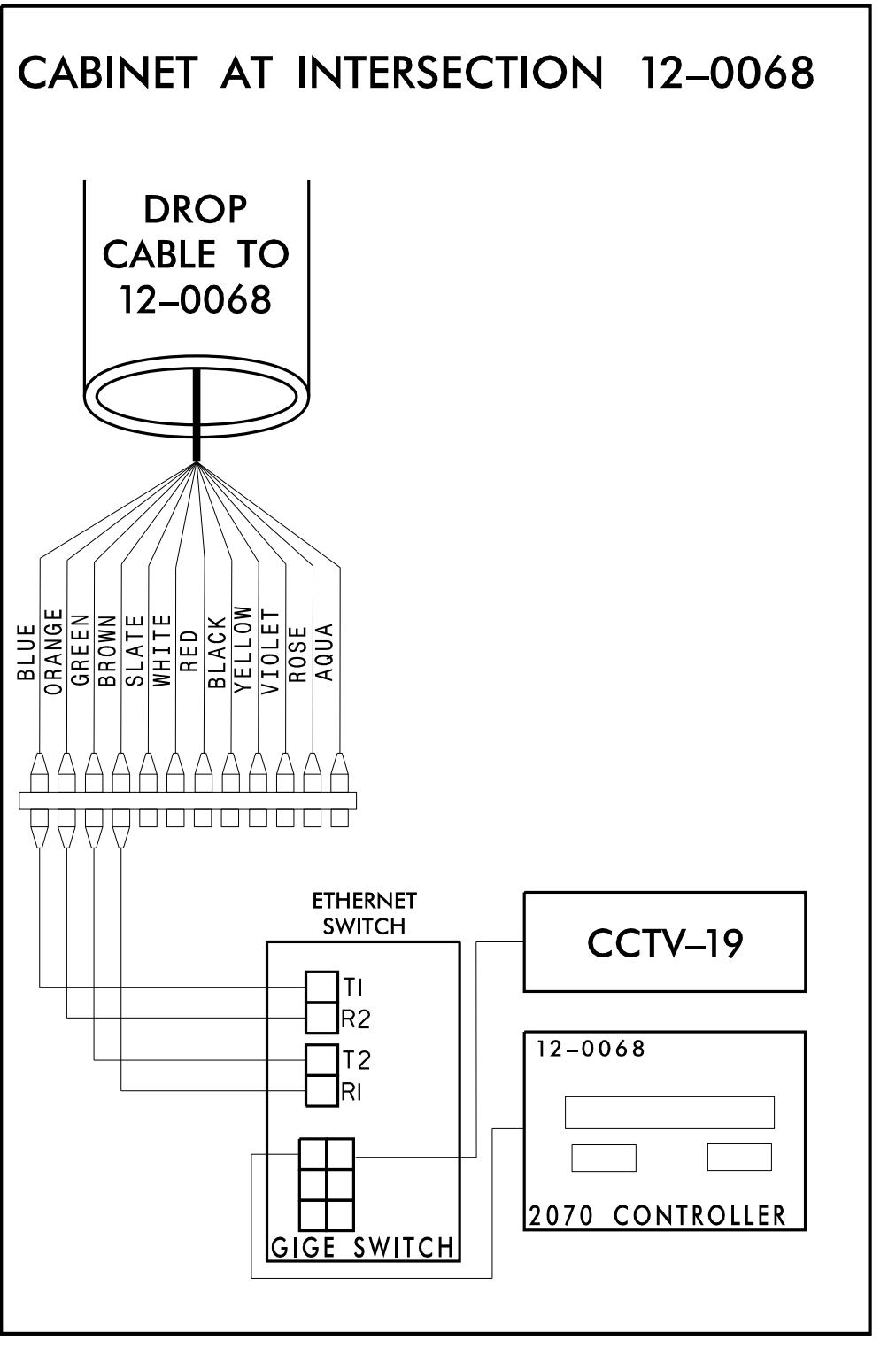
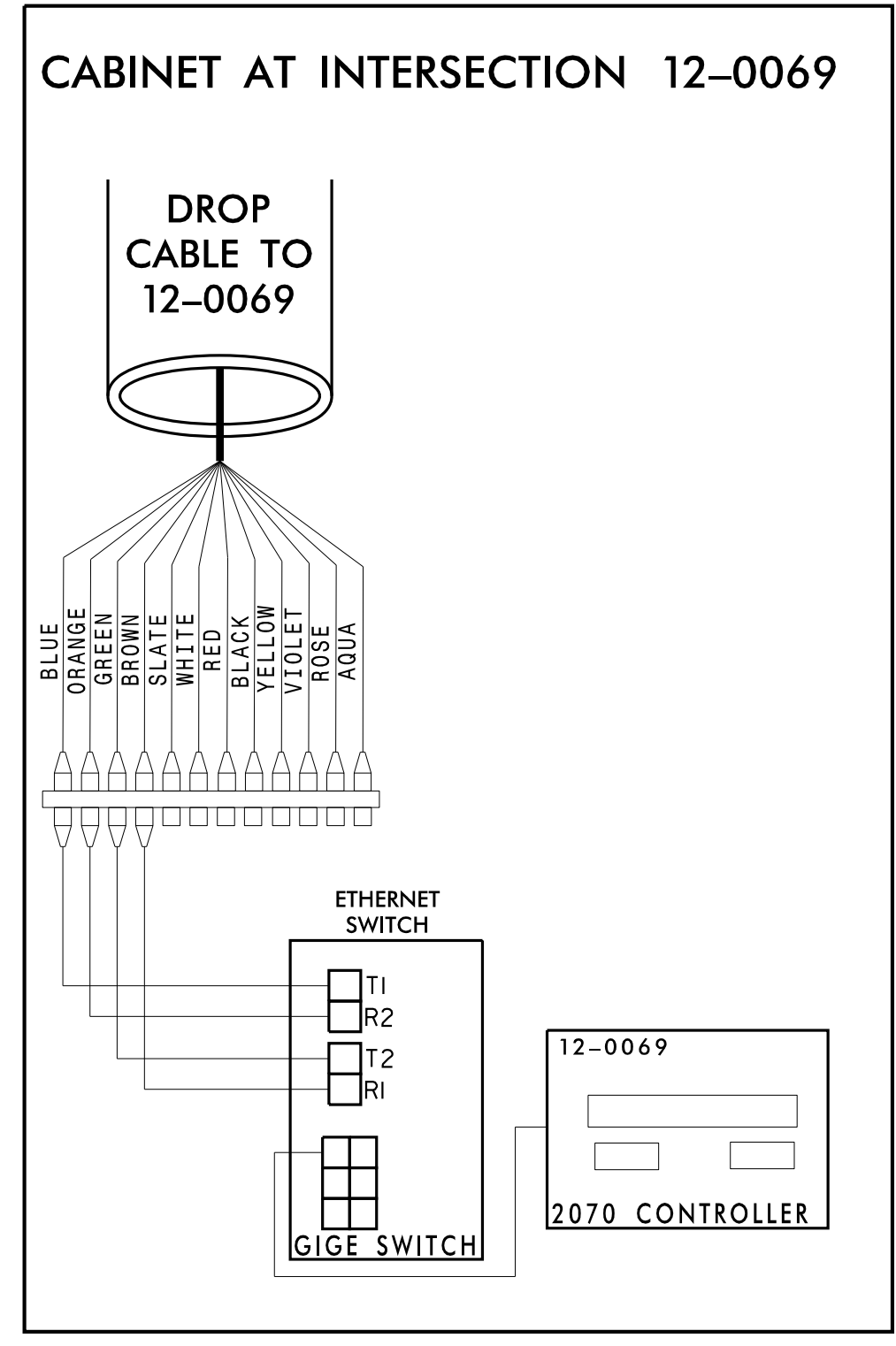
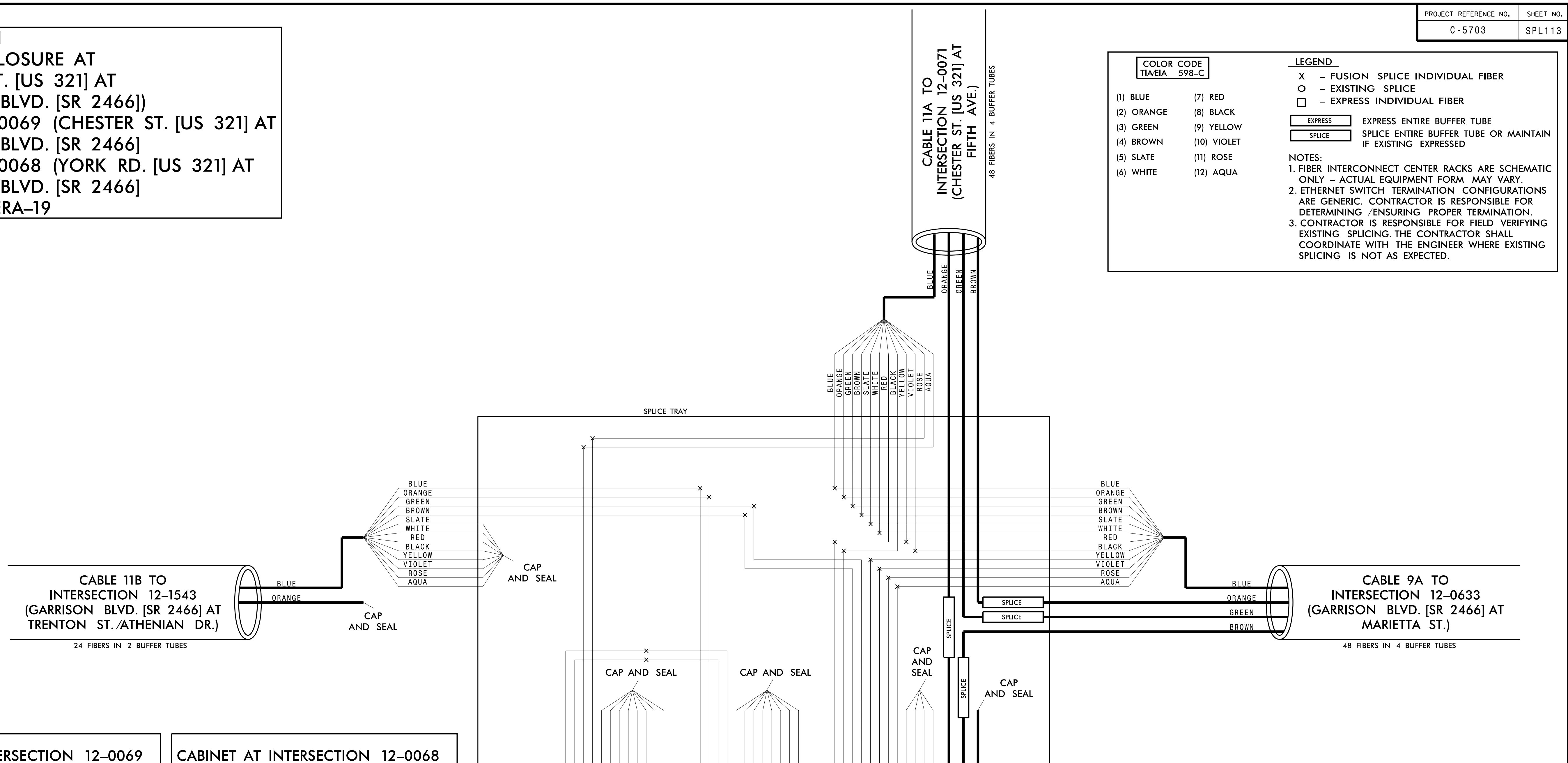

Kimley»Horn
NC License #F-0102
421 Fayetteville St., Suite 600
Raleigh, NC 27601
Tel: (919) 677-2000
Fax: (919) 677-2050

CHANNEL 11
CITY OF GASTONIA COMPUTERIZED SIGNAL SYSTEM
SPLICE DETAIL

DIVISION 12 GASTON COUNTY
PLAN DATE: DECEMBER 2021 REVIEWED BY: K. SMITH
PREPARED BY: S. BUTLER REVIEWED BY: I. VAN OSDELL

Scale: 0

Revisions table with columns: REVISIONS, INIT., DATE.

DocuSigned by: Inger Van OsdeLL 3/16/2022

3/15/2022 \\kimley-horn.com\SE-RAL\NRA\TPTO\ITS\01036569_Gastonia_Signal_System\6_Tasks\Splicing\SPL113.dgn

**CHANNEL 11
SPLICE ENCLOSURE AT
(GARRISON BLVD. [SR 2466] AT
TRENTON ST./ATHENIAN DR.)
SIG ID 12-1543**

COLOR CODE
TIA/EIA 598-C

(1) BLUE	(7) RED
(2) ORANGE	(8) BLACK
(3) GREEN	(9) YELLOW
(4) BROWN	(10) VIOLET
(5) SLATE	(11) ROSE
(6) WHITE	(12) AQUA

LEGEND

X - FUSION SPLICE INDIVIDUAL FIBER
 O - EXISTING SPLICE
 □ - EXPRESS INDIVIDUAL FIBER

EXPRESS - EXPRESS ENTIRE BUFFER TUBE
 SPLICE - SPLICE ENTIRE BUFFER TUBE OR MAINTAIN IF EXISTING EXPRESSED

NOTES:

1. FIBER INTERCONNECT CENTER RACKS ARE SCHEMATIC ONLY - ACTUAL EQUIPMENT FORM MAY VARY.
2. ETHERNET SWITCH TERMINATION CONFIGURATIONS ARE GENERIC. CONTRACTOR IS RESPONSIBLE FOR DETERMINING /ENSURING PROPER TERMINATION.
3. CONTRACTOR IS RESPONSIBLE FOR FIELD VERIFYING EXISTING SPLICING. THE CONTRACTOR SHALL COORDINATE WITH THE ENGINEER WHERE EXISTING SPLICING IS NOT AS EXPECTED.

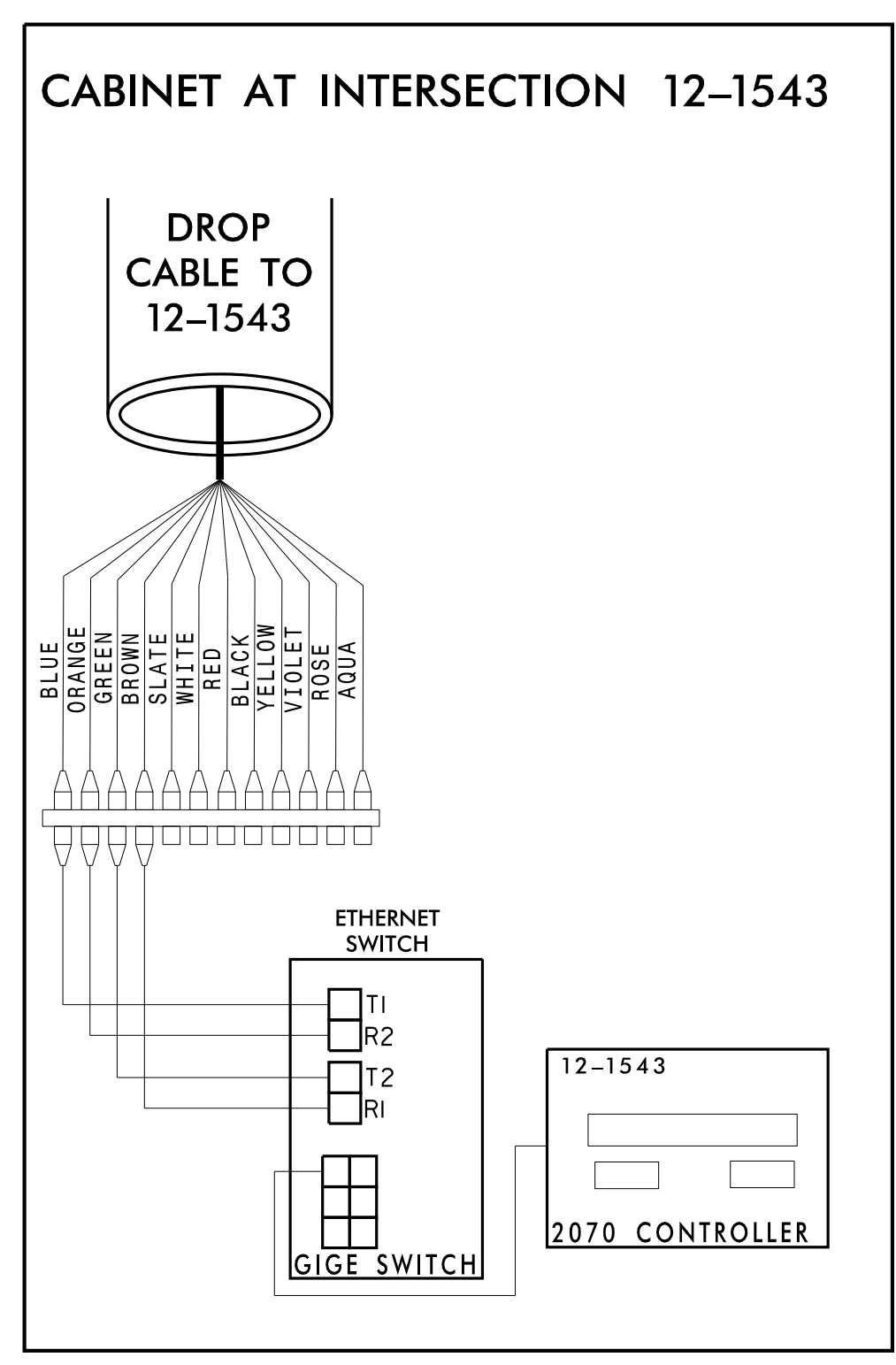
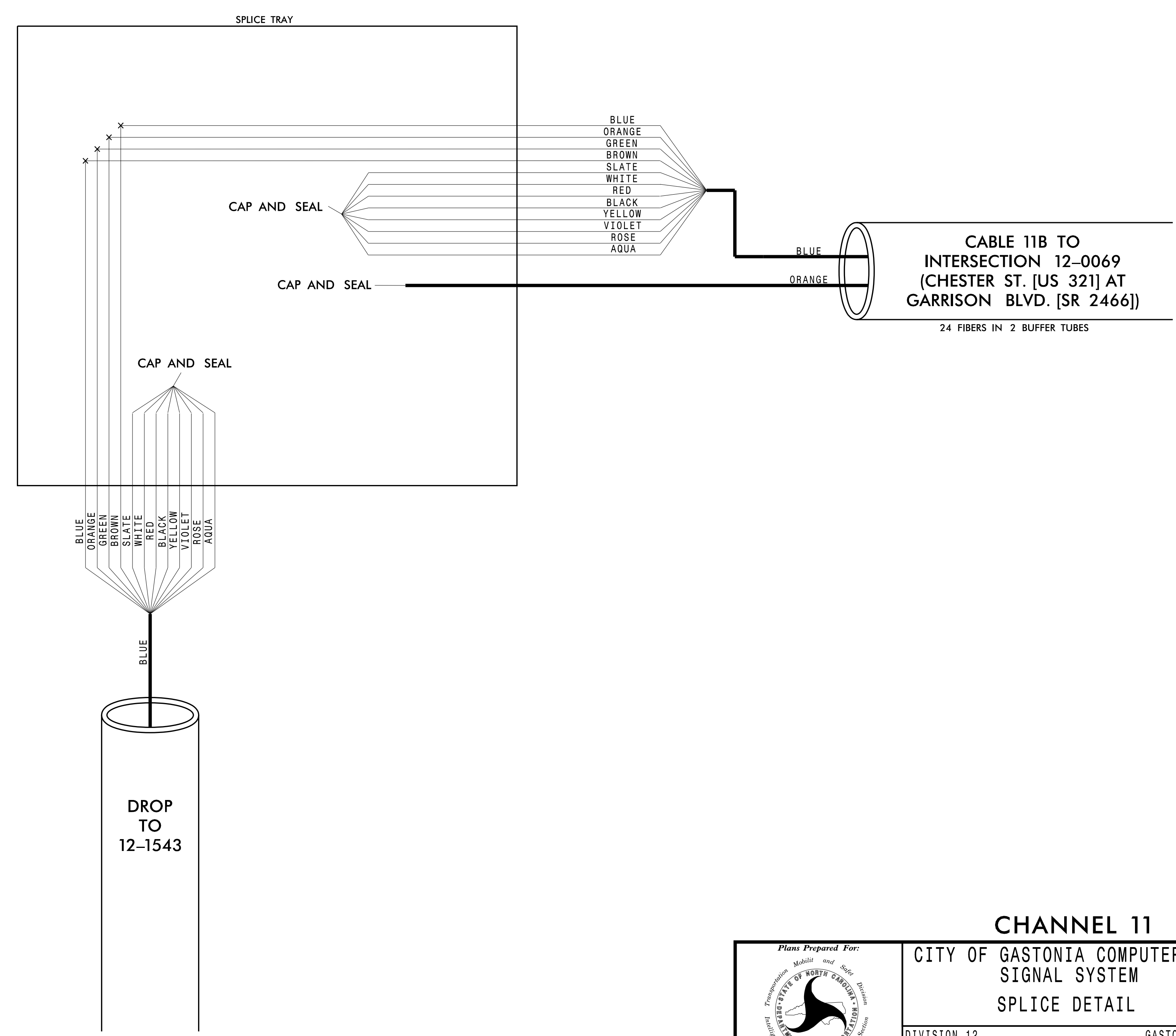

CHANNEL 11

CITY OF GASTONIA COMPUTERIZED SIGNAL SYSTEM

SPLICE DETAIL

DIVISION 12 GASTON COUNTY

PLAN DATE: DECEMBER 2021 REVIEWED BY: K. SMITH

PREPARED BY: S. BUTLER REVIEWED BY: I. VAN OSDELL

SCALE: 0

REVISIONS: _____

INIT. DATE

DocuSigned by: Inger Van Osdel 3/16/2022

SEAL: NORTH CAROLINA PROFESSIONAL SEAL 028952

INGER Z. VAN OSDELL

CADD File name: _____

3/15/2022 \\kimley-horn.com\SE-RAL\NRA\1PTD\ITS\01036569_Gastonia_Signal_System\6_Tasks\Splicing\SPL114.dgn

CHANNEL 11 SPLICE ENCLOSURE AT (YORK RD. [US 321] AT JACKSON RD.) SIG ID 12-0067

COLOR CODE
TIA/EIA 598-C

(1) BLUE	(7) RED
(2) ORANGE	(8) BLACK
(3) GREEN	(9) YELLOW
(4) BROWN	(10) VIOLET
(5) SLATE	(11) ROSE
(6) WHITE	(12) AQUA

LEGEND

X - FUSION SPlice INDIVIDUAL FIBER
 O - EXISTING SPlice
 □ - EXPRESS INDIVIDUAL FIBER

EXPRESS - EXPRESS ENTIRE BUFFER TUBE
 SPlice - SPlice ENTIRE BUFFER TUBE OR MAINTAIN IF EXISTING EXPRESSED

NOTES:
 1. FIBER INTERCONNECT CENTER RACKS ARE SCHEMATIC ONLY - ACTUAL EQUIPMENT FORM MAY VARY.
 2. ETHERNET SWITCH TERMINATION CONFIGURATIONS ARE GENERIC. CONTRACTOR IS RESPONSIBLE FOR DETERMINING /ENSURING PROPER TERMINATION.
 3. CONTRACTOR IS RESPONSIBLE FOR FIELD VERIFYING EXISTING SPlicing. THE CONTRACTOR SHALL COORDINATE WITH THE ENGINEER WHERE EXISTING SPlicing IS NOT AS EXPECTED.

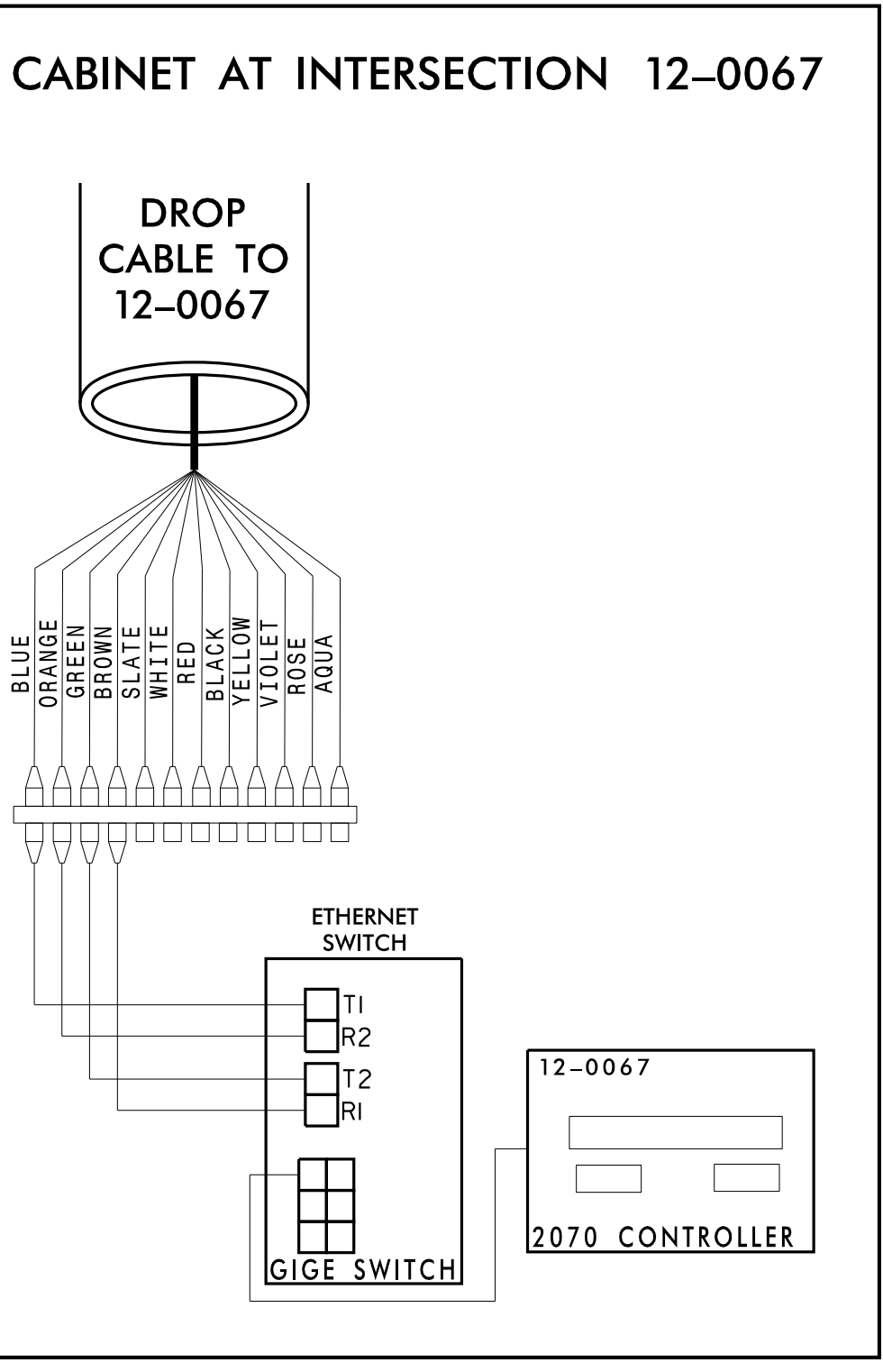
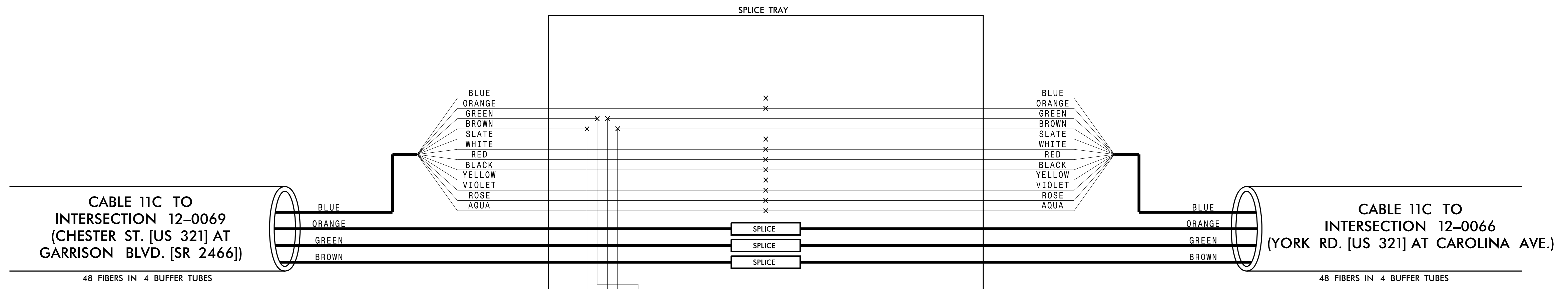

Kimley»Horn
 NC License #F-0102
 421 Fayetteville St., Suite 600
 Raleigh, NC 27601
 Tel: (919) 677-2000
 Fax: (919) 677-2050

CHANNEL 11
 CITY OF GASTONIA COMPUTERIZED
 SIGNAL SYSTEM
 SPlice DETAIL

DIVISION 12 GASTON COUNTY
 PLAN DATE: DECEMBER 2021 REVIEWED BY: K. SMITH
 PREPARED BY: S. BUTLER REVIEWED BY: I. VAN OSDELL

SCALE: 0

REVISIONS: _____ DATE: _____
 INIT. DATE

DocuSigned by: Inger Van OsdeLL 3/16/2022
 SEAL: NORTH CAROLINA PROFESSIONAL SEAL 028952
 INGER Z. VAN OSDELL
 CADD File name: _____

3/15/2022 \\kimley-horn.com\SE-RAL\NRA\1PTD\ITS\01036569_Gastonia_Signal_System\6_Tasks\Splicing_SPL115.dgn

**CHANNEL 11
SPLICE ENCLOSURE AT
(YORK RD. [US 321] AT CAROLINA AVE.)
SIG ID 12-0066**

COLOR CODE
TIA/EIA 598-C

(1) BLUE	(7) RED
(2) ORANGE	(8) BLACK
(3) GREEN	(9) YELLOW
(4) BROWN	(10) VIOLET
(5) SLATE	(11) ROSE
(6) WHITE	(12) AQUA

LEGEND

X - FUSION SPlice INDIVIDUAL FIBER
 O - EXISTING SPlice
 □ - EXPRESS INDIVIDUAL FIBER

EXPRESS - EXPRESS ENTIRE BUFFER TUBE
 SPlice - SPlice ENTIRE BUFFER TUBE OR MAINTAIN IF EXISTING EXPRESSED

NOTES:
 1. FIBER INTERCONNECT CENTER RACKS ARE SCHEMATIC ONLY - ACTUAL EQUIPMENT FORM MAY VARY.
 2. ETHERNET SWITCH TERMINATION CONFIGURATIONS ARE GENERIC. CONTRACTOR IS RESPONSIBLE FOR DETERMINING /ENSURING PROPER TERMINATION.
 3. CONTRACTOR IS RESPONSIBLE FOR FIELD VERIFYING EXISTING SPlicing. THE CONTRACTOR SHALL COORDINATE WITH THE ENGINEER WHERE EXISTING SPlicing IS NOT AS EXPECTED.

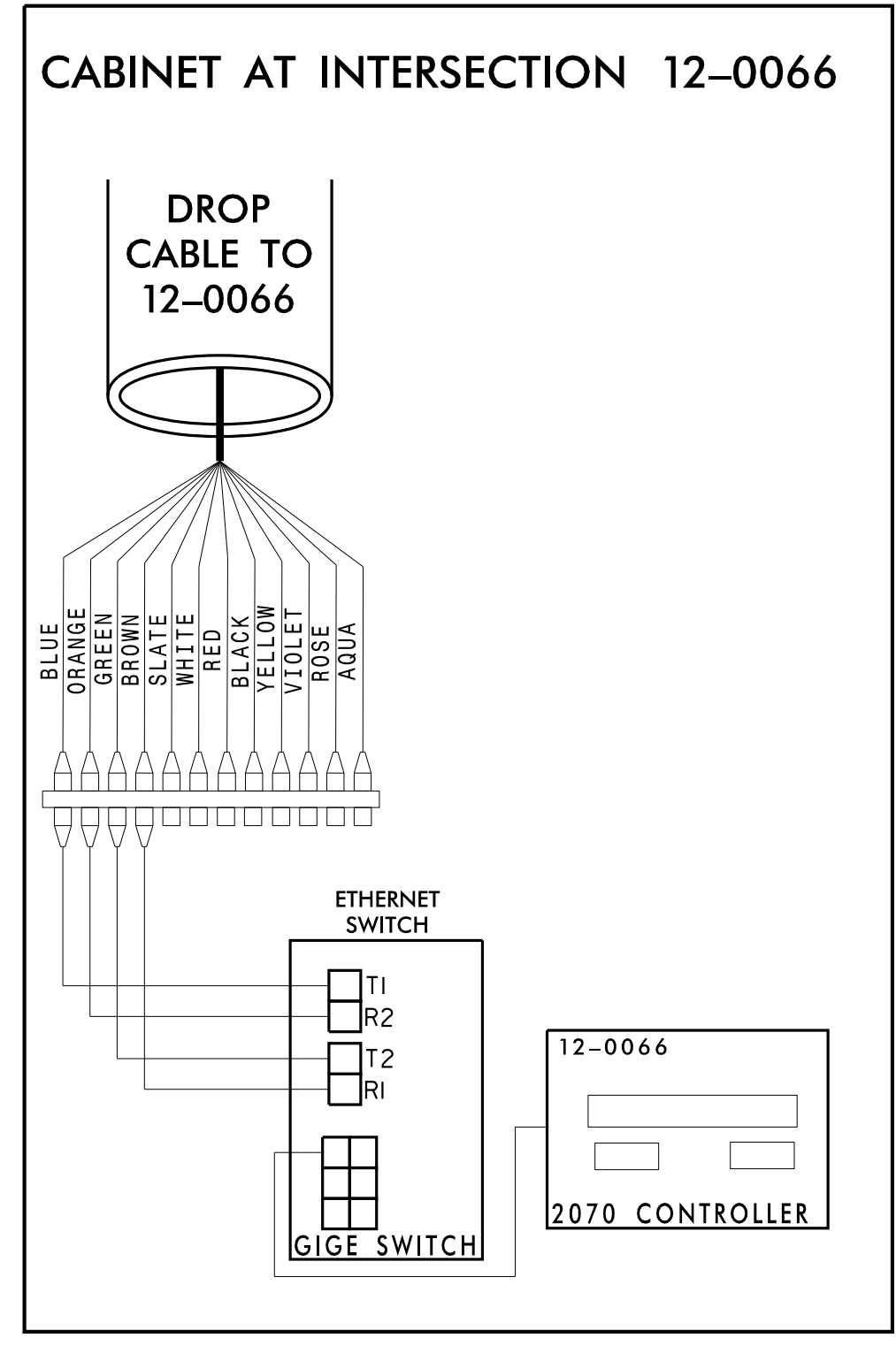
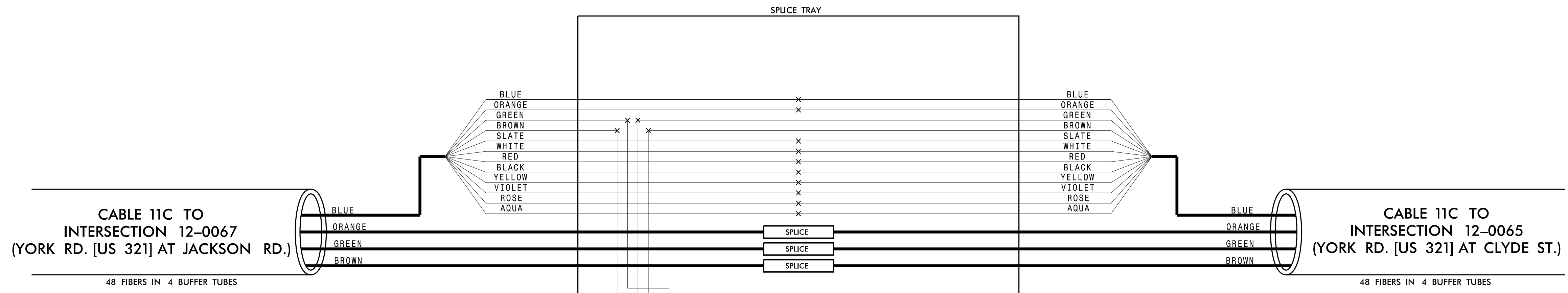

**CHANNEL 11
CITY OF GASTONIA COMPUTERIZED
SIGNAL SYSTEM
SPlice DETAIL**

DIVISION 12 GASTON COUNTY
 PLAN DATE: DECEMBER 2021 REVIEWED BY: K. SMITH
 PREPARED BY: S. BUTLER REVIEWED BY: I. VAN OSDELL

SCALE: 0

REVISIONS: _____ DATE: _____
 INIT. DATE

DocuSigned by: Inger Van OsdeLL 3/16/2022
 SEAL: NORTH CAROLINA PROFESSIONAL SEAL 028952
 INGER Z. VAN OSDELL
 CADD File name: _____

Kimley»Horn
 NC License #F-0102
 421 Fayetteville St., Suite 600
 Raleigh, NC 27601
 Tel: (919) 677-2000
 Fax: (919) 677-2050

3/15/2022
 \\kimley-horn.com\SE-RAL\NRA\1PTD\ITS\01036569_Gastonia_Signal_System\6_Tasks\Splicing_SPL116.dgn

CHANNEL 11 SPLICE ENCLOSURE AT (YORK RD. [US 321] AT CLYDE ST.) SIG ID 12-0065

COLOR CODE
TIA/EIA 598-C

(1) BLUE	(7) RED
(2) ORANGE	(8) BLACK
(3) GREEN	(9) YELLOW
(4) BROWN	(10) VIOLET
(5) SLATE	(11) ROSE
(6) WHITE	(12) AQUA

LEGEND

X - FUSION SPlice INDIVIDUAL FIBER
 O - EXISTING SPlice
 □ - EXPRESS INDIVIDUAL FIBER

EXPRESS - EXPRESS ENTIRE BUFFER TUBE
 SPlice - SPlice ENTIRE BUFFER TUBE OR MAINTAIN IF EXISTING EXPRESSED

NOTES:

- FIBER INTERCONNECT CENTER RACKS ARE SCHEMATIC ONLY - ACTUAL EQUIPMENT FORM MAY VARY.
- ETHERNET SWITCH TERMINATION CONFIGURATIONS ARE GENERIC. CONTRACTOR IS RESPONSIBLE FOR DETERMINING /ENSURING PROPER TERMINATION.
- CONTRACTOR IS RESPONSIBLE FOR FIELD VERIFYING EXISTING SPlicing. THE CONTRACTOR SHALL COORDINATE WITH THE ENGINEER WHERE EXISTING SPlicing IS NOT AS EXPECTED.

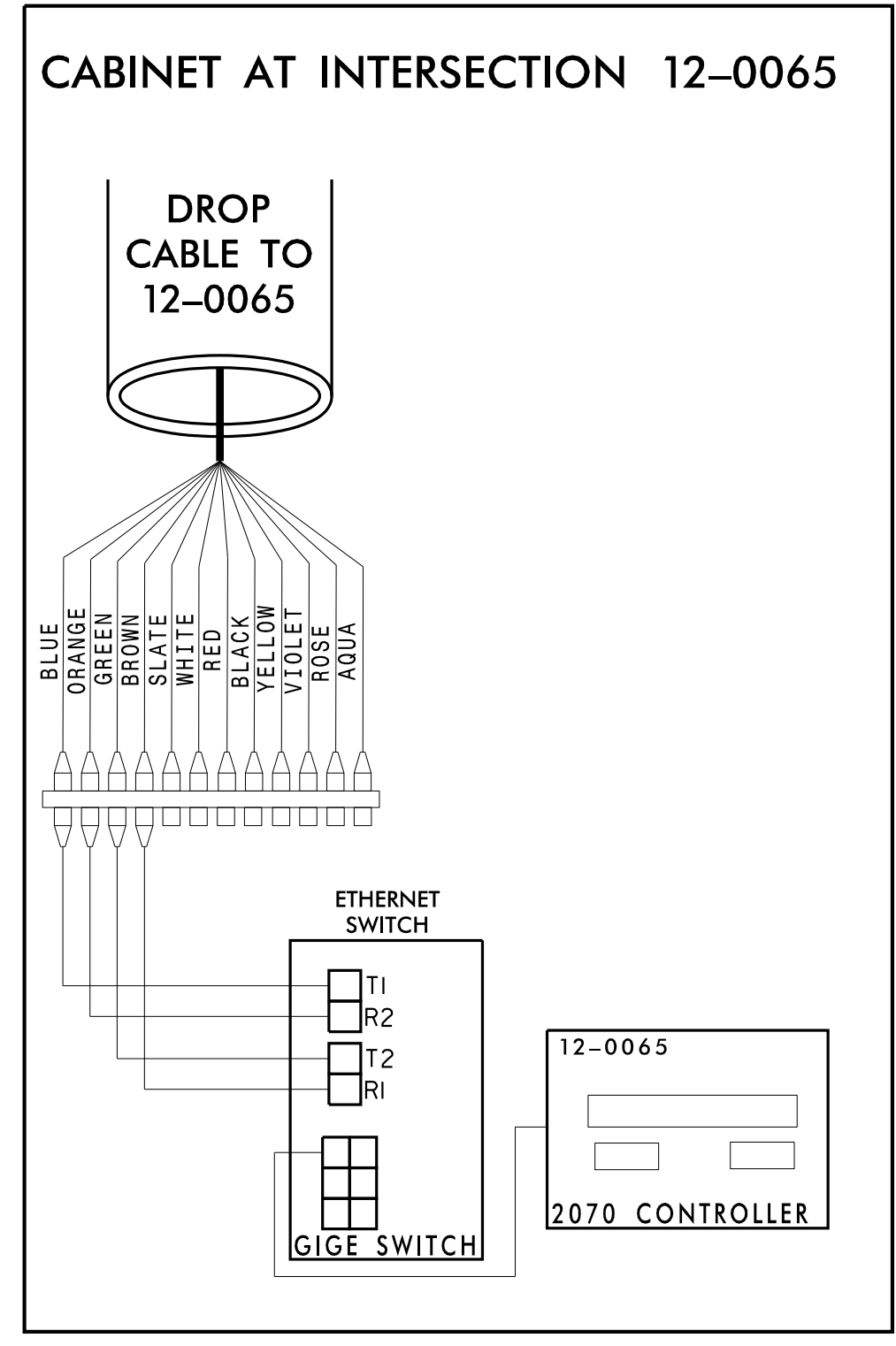
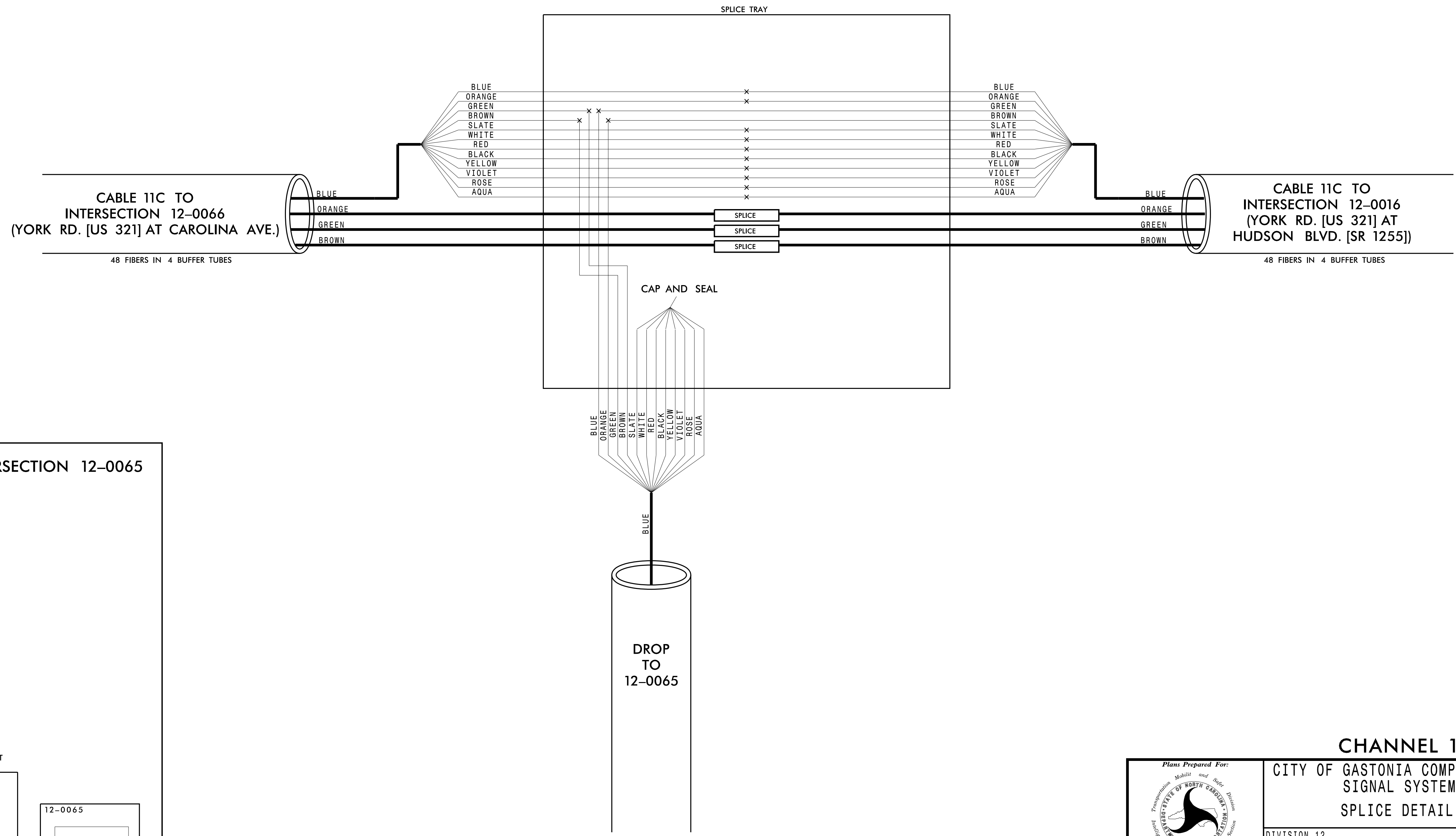

Kimley»Horn
 NC License #F-0102
 421 Fayetteville St., Suite 600
 Raleigh, NC 27601
 Tel: (919) 677-2000
 Fax: (919) 677-2050

CHANNEL 11
 CITY OF GASTONIA COMPUTERIZED
 SIGNAL SYSTEM
 SPLICE DETAIL

DIVISION 12 GASTON COUNTY
 PLAN DATE: DECEMBER 2021 REVIEWED BY: K. SMITH
 PREPARED BY: S. BUTLER REVIEWED BY: I. VAN OSDELL

SCALE: 0

REVISIONS: _____ DATE: _____
 INIT. DATE

DocuSigned by: Inger Van OsdeLL 3/16/2022
 SEAL: NORTH CAROLINA PROFESSIONAL SEAL 028952
 INGER Z. VAN OSDELL
 CADD File name: _____

3/15/2022 \\kimley-horn.com\SE-RAL\NRA\1PTD\ITS\01036569_Gastonia_Signal_System\6_Tasks\Splicing\SPLIT.dgn

CHANNEL 12
SPLICE ENCLOSURE AT
FRANKLIN BLVD. (US 29/74) AT SADLER ES
SIG ID 12-1715 (FRANKLIN BLVD. [US 29/74] AT
SADLER ELEMENTARY SCHOOL)
SIG ID 12-0157 (FRANKLIN BLVD. [US 29/74] AT
ARCHIE WHITESIDES RD./EDGEWOOD RD)
CCTV CAMERA-01

COLOR CODE
TIA/EIA 598-C

(1) BLUE	(7) RED
(2) ORANGE	(8) BLACK
(3) GREEN	(9) YELLOW
(4) BROWN	(10) VIOLET
(5) SLATE	(11) ROSE
(6) WHITE	(12) AQUA

LEGEND

X - FUSION SPLICE INDIVIDUAL FIBER
 O - EXISTING SPLICE
 □ - EXPRESS INDIVIDUAL FIBER

EXPRESS - EXPRESS ENTIRE BUFFER TUBE
 SPLICE - SPLICE ENTIRE BUFFER TUBE OR MAINTAIN IF EXISTING EXPRESSED

NOTES:
 1. FIBER INTERCONNECT CENTER RACKS ARE SCHEMATIC ONLY - ACTUAL EQUIPMENT FORM MAY VARY.
 2. ETHERNET SWITCH TERMINATION CONFIGURATIONS ARE GENERIC. CONTRACTOR IS RESPONSIBLE FOR DETERMINING /ENSURING PROPER TERMINATION.
 3. CONTRACTOR IS RESPONSIBLE FOR FIELD VERIFYING EXISTING SPlicing. THE CONTRACTOR SHALL COORDINATE WITH THE ENGINEER WHERE EXISTING SPlicing IS NOT AS EXPECTED.

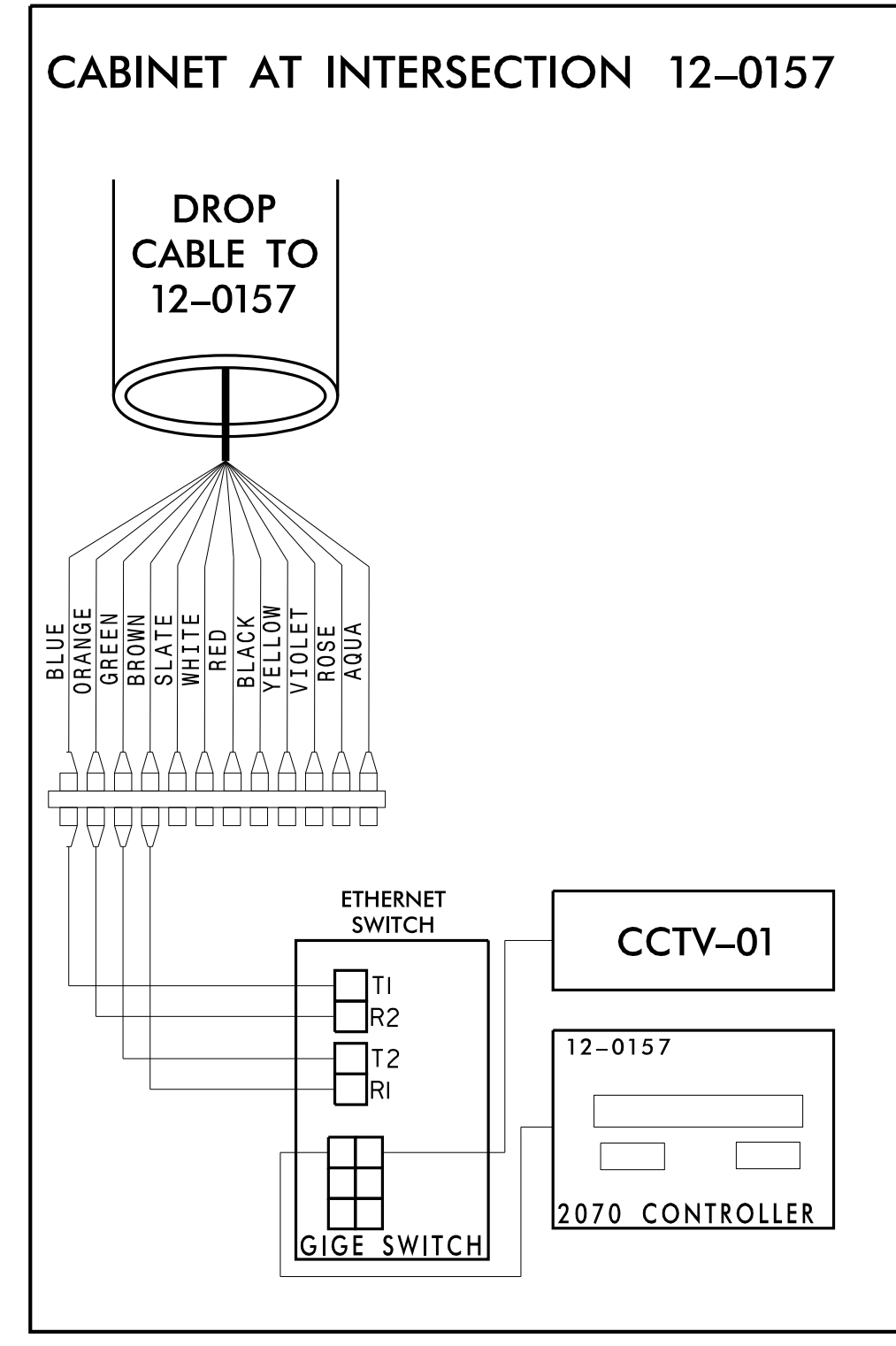
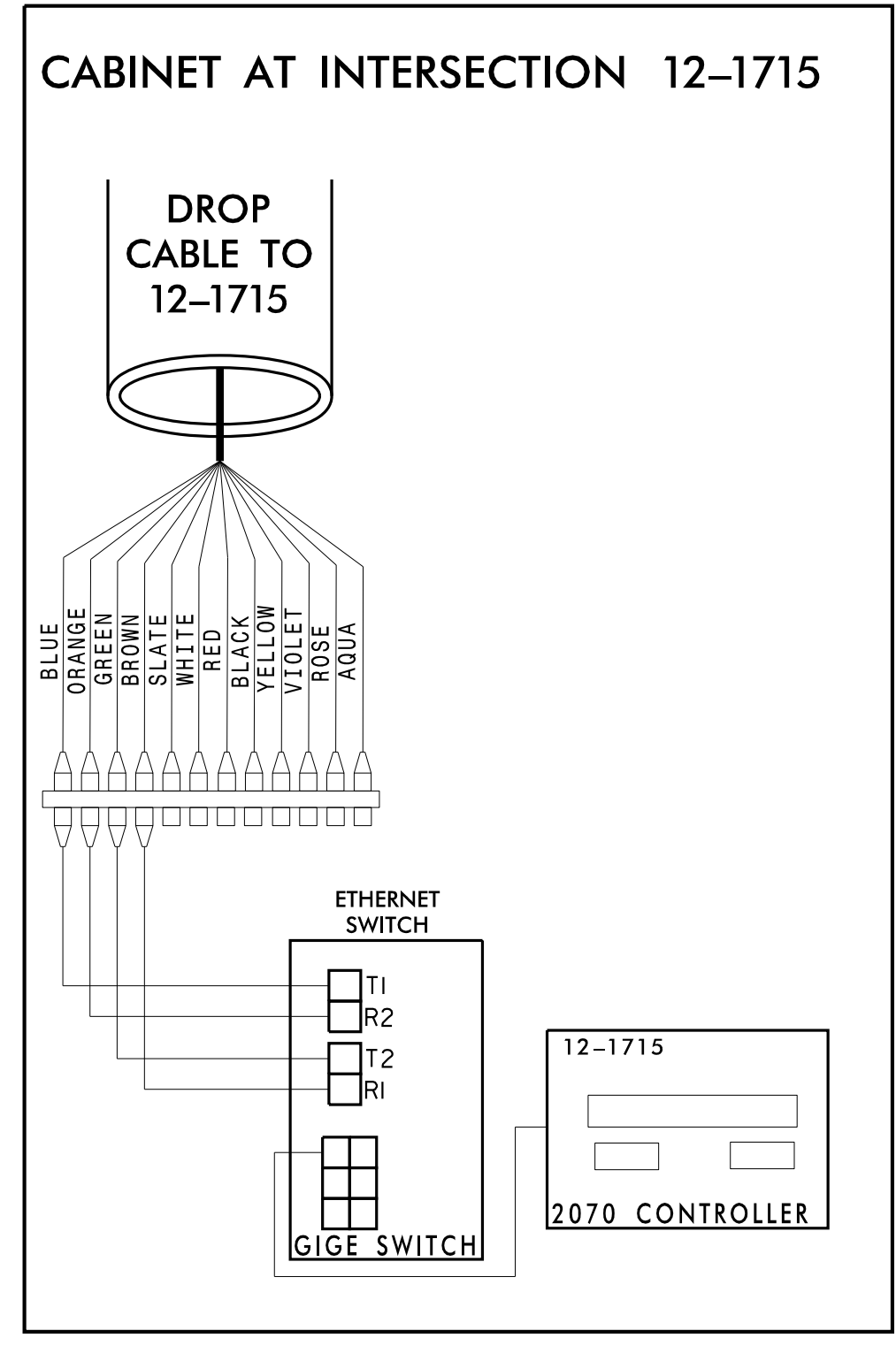
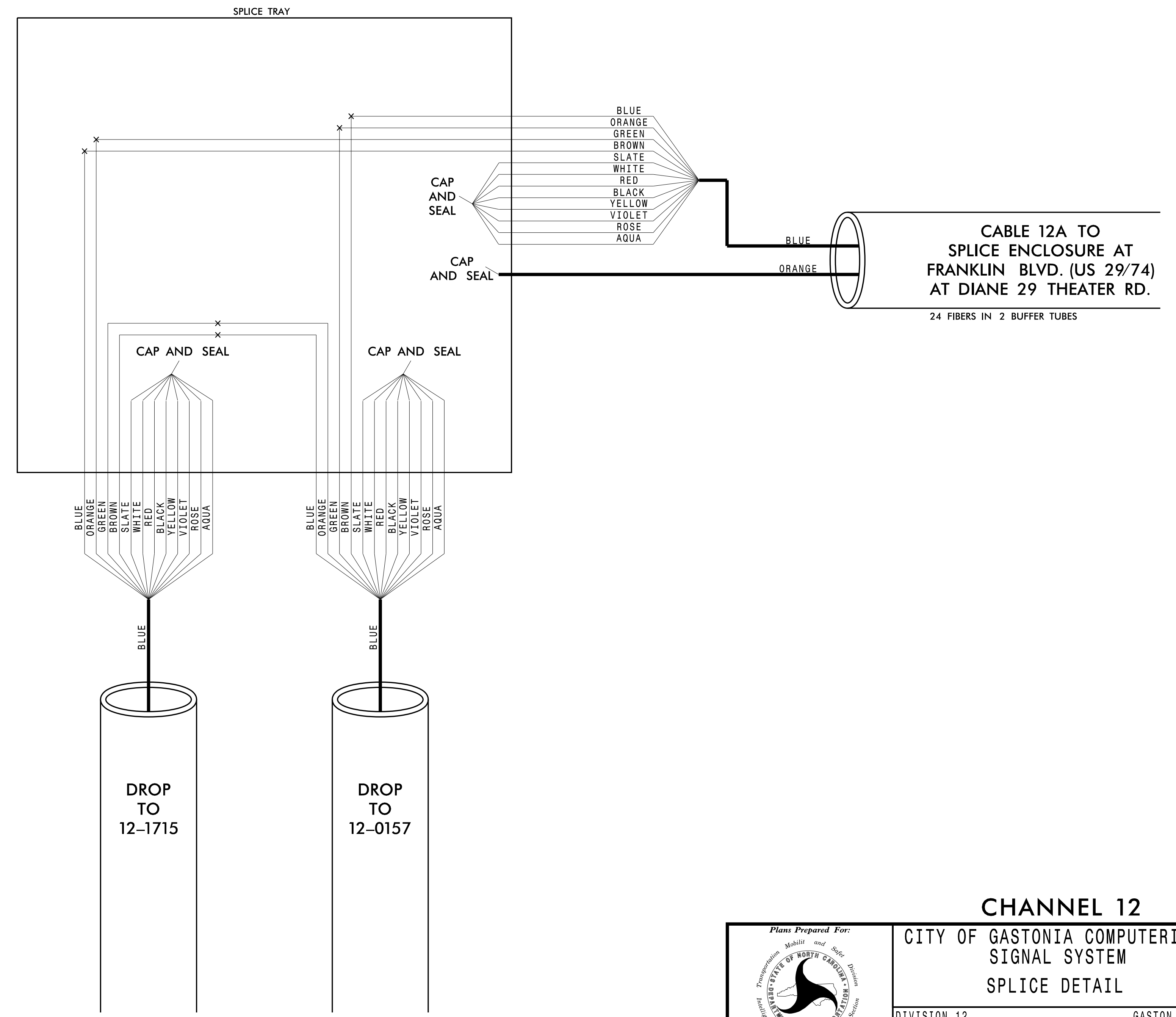

CHANNEL 12
CITY OF GASTONIA COMPUTERIZED SIGNAL SYSTEM
SPLICE DETAIL

DIVISION 12 GASTON COUNTY
 PLAN DATE: DECEMBER 2021 REVIEWED BY: K. SMITH
 PREPARED BY: S. BUTLER REVIEWED BY: I. VAN OSDELL

Scale: 0

Revisions table with columns: REVISIONS, INIT., DATE

DocuSigned by: Inger Van Osdel 3/16/2022

Professional Engineer Seal: I. VAN OSDELL, No. 028952, State of North Carolina

3/15/2022 \\kimley-horn.com\SE-RAL\NRA\TPTD\ITS\01036569_Gastonia_Signal_System\6_Tasks\Splicing_SPL118.dgn

CHANNEL 12
SPLICE ENCLOSURE AT
FRANKLIN BLVD. (US 29/74)
AT DIANE 29 THEATER RD.

COLOR CODE
TIA/EIA 598-C

(1) BLUE	(7) RED
(2) ORANGE	(8) BLACK
(3) GREEN	(9) YELLOW
(4) BROWN	(10) VIOLET
(5) SLATE	(11) ROSE
(6) WHITE	(12) AQUA

LEGEND

X - FUSION SPlice INDIVIDUAL FIBER
 O - EXISTING SPlice
 □ - EXPRESS INDIVIDUAL FIBER

EXPRESS - EXPRESS ENTIRE BUFFER TUBE
 SPlice - SPlice ENTIRE BUFFER TUBE OR MAINTAIN IF EXISTING EXPRESSED

NOTES:

- FIBER INTERCONNECT CENTER RACKS ARE SCHEMATIC ONLY - ACTUAL EQUIPMENT FORM MAY VARY.
- ETHERNET SWITCH TERMINATION CONFIGURATIONS ARE GENERIC. CONTRACTOR IS RESPONSIBLE FOR DETERMINING /ENSURING PROPER TERMINATION.
- CONTRACTOR IS RESPONSIBLE FOR FIELD VERIFYING EXISTING SPlicing. THE CONTRACTOR SHALL COORDINATE WITH THE ENGINEER WHERE EXISTING SPlicing IS NOT AS EXPECTED.

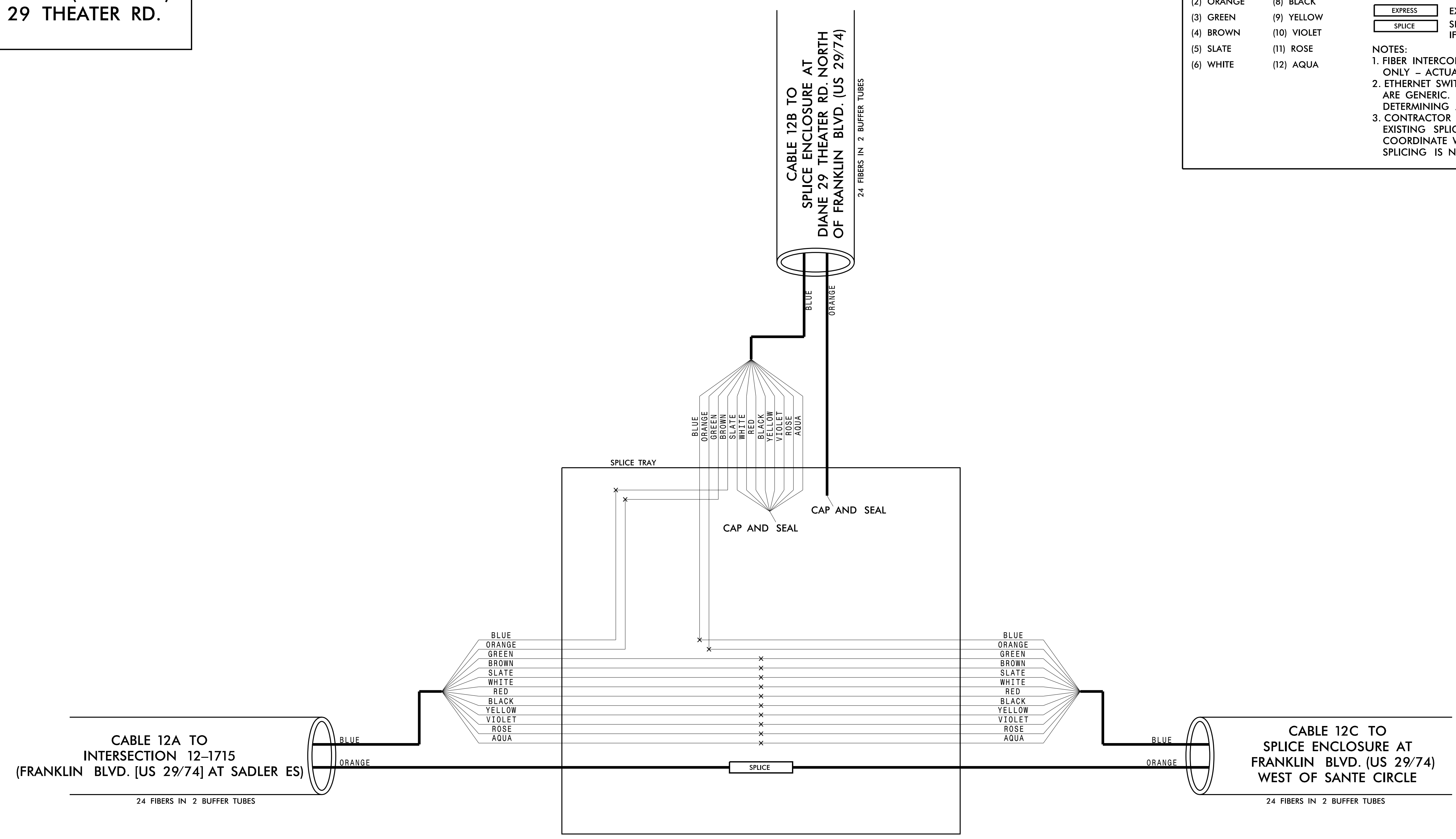

3/15/2022
\\kimley-horn.com\SE_RAL\NRA\TPTD\ITS\01036569_Gastonia_Signal_System\6_Tasks\Splicing_SPL119.dgn



CHANNEL 12
CITY OF GASTONIA COMPUTERIZED SIGNAL SYSTEM
SPlice DETAIL

DIVISION 12 GASTON COUNTY

PLAN DATE: DECEMBER 2021 REVIEWED BY: K. SMITH
 PREPARED BY: S. BUTLER REVIEWED BY: I. VAN OSDELL

Kimley»Horn

NC License #F-0102
 421 Fayetteville St., Suite 600
 Raleigh, NC 27601
 Tel: (919) 677-2000
 Fax: (919) 677-2050

SEAL

NORTH CAROLINA PROFESSIONAL ENGINEER
 SEAL 028952
 I. VAN OSDELL

DocuSigned by:
 Inger Van OsdeLL
 3/16/2022

CADD File name:

**CHANNEL 12
 SPLICE ENCLOSURE AT
 DIANE 29 THEATER RD.
 NORTH OF FRANKLIN BLVD. (US 29/74)**

COLOR CODE TIA/EIA 598-C		LEGEND	
(1) BLUE	(7) RED	X	- FUSION SPLICE INDIVIDUAL FIBER
(2) ORANGE	(8) BLACK	O	- EXISTING SPLICE
(3) GREEN	(9) YELLOW	□	- EXPRESS INDIVIDUAL FIBER
(4) BROWN	(10) VIOLET	EXPRESS	EXPRESS ENTIRE BUFFER TUBE
(5) SLATE	(11) ROSE	SPLICE	SPLICE ENTIRE BUFFER TUBE OR MAINTAIN IF EXISTING EXPRESSED
(6) WHITE	(12) AQUA	NOTES:	
1. FIBER INTERCONNECT CENTER RACKS ARE SCHEMATIC ONLY - ACTUAL EQUIPMENT FORM MAY VARY.			
2. ETHERNET SWITCH TERMINATION CONFIGURATIONS ARE GENERIC. CONTRACTOR IS RESPONSIBLE FOR DETERMINING /ENSURING PROPER TERMINATION.			
3. CONTRACTOR IS RESPONSIBLE FOR FIELD VERIFYING EXISTING SPlicing. THE CONTRACTOR SHALL COORDINATE WITH THE ENGINEER WHERE EXISTING SPlicing IS NOT AS EXPECTED.			

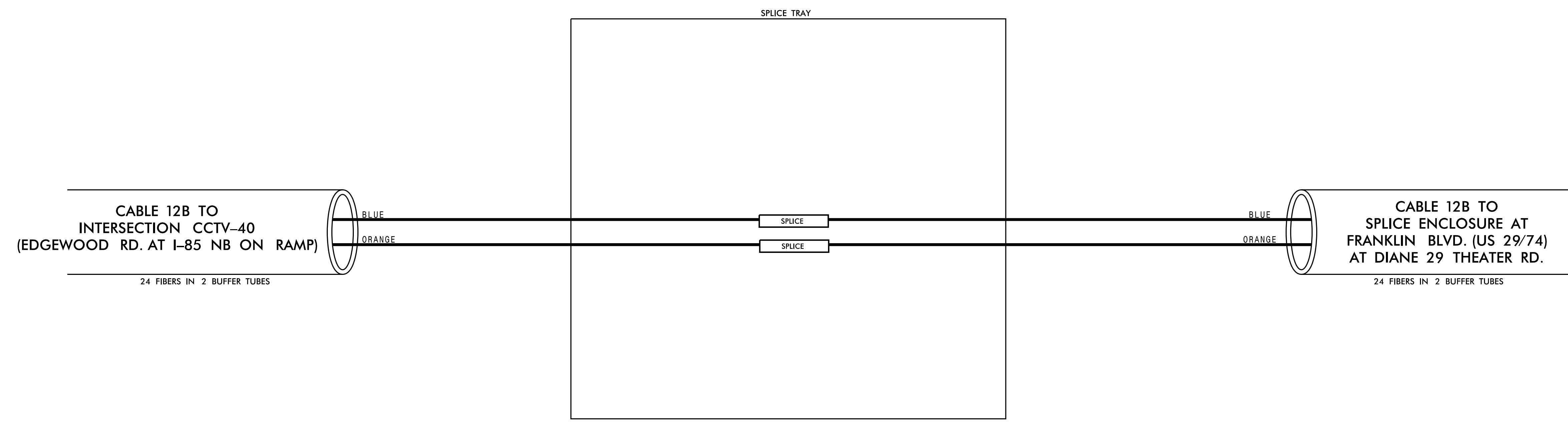

3/15/2022 \\kimley-horn.com\SE\RAL\NRA\TPTD\ITS\01036569_Gastonia_Signal_System\6_Tasks\Splicing\SPL120.dgn

	CHANNEL 12											
	CITY OF GASTONIA COMPUTERIZED SIGNAL SYSTEM SPLICE DETAIL											
Plans Prepared For: Transportation, Mobility and Safe Division DEPARTMENT OF TRANSPORTATION 250 N. Greenfield Place, Garner, NC 27529	DIVISION 12 GASTON COUNTY PLAN DATE: DECEMBER 2021 PREPARED BY: S. BUTLER		REVIEWED BY: K. SMITH REVIEWED BY: I. VAN OSDELL									
SCALE 	REVISIONS <table border="1"> <tr><th>NO.</th><th>DATE</th><th>DESCRIPTION</th></tr> <tr><td> </td><td> </td><td> </td></tr> </table>	NO.	DATE	DESCRIPTION				INIT. DATE <table border="1"> <tr><th>INIT.</th><th>DATE</th></tr> <tr><td> </td><td> </td></tr> </table>	INIT.	DATE		
NO.	DATE	DESCRIPTION										
INIT.	DATE											
DocuSigned by: 			3/16/2022 DATE									

Kimley»Horn
 NC License #F-0102
 421 Fayetteville St., Suite 600
 Raleigh, NC 27601
 Tel: (919) 677-2000
 Fax: (919) 677-2050

CHANNEL 12 SPLICE ENCLOSURE AT EDGEWOOD RD. AT I-85 NB ON RAMP CCTV CAMERA-40

COLOR CODE TIA/EIA 598-C		LEGEND	
(1) BLUE	(7) RED	X	FUSION SPLICE INDIVIDUAL FIBER
(2) ORANGE	(8) BLACK	O	EXISTING SPLICE
(3) GREEN	(9) YELLOW	□	EXPRESS INDIVIDUAL FIBER
(4) BROWN	(10) VIOLET	EXPRESS	EXPRESS ENTIRE BUFFER TUBE
(5) SLATE	(11) ROSE	SPLICE	SPLICE ENTIRE BUFFER TUBE OR MAINTAIN IF EXISTING EXPRESSED
(6) WHITE	(12) AQUA	NOTES:	
		1. FIBER INTERCONNECT CENTER RACKS ARE SCHEMATIC ONLY - ACTUAL EQUIPMENT FORM MAY VARY.	
		2. ETHERNET SWITCH TERMINATION CONFIGURATIONS ARE GENERIC. CONTRACTOR IS RESPONSIBLE FOR DETERMINING /ENSURING PROPER TERMINATION.	
		3. CONTRACTOR IS RESPONSIBLE FOR FIELD VERIFYING EXISTING SPlicing. THE CONTRACTOR SHALL COORDINATE WITH THE ENGINEER WHERE EXISTING SPlicing IS NOT AS EXPECTED.	

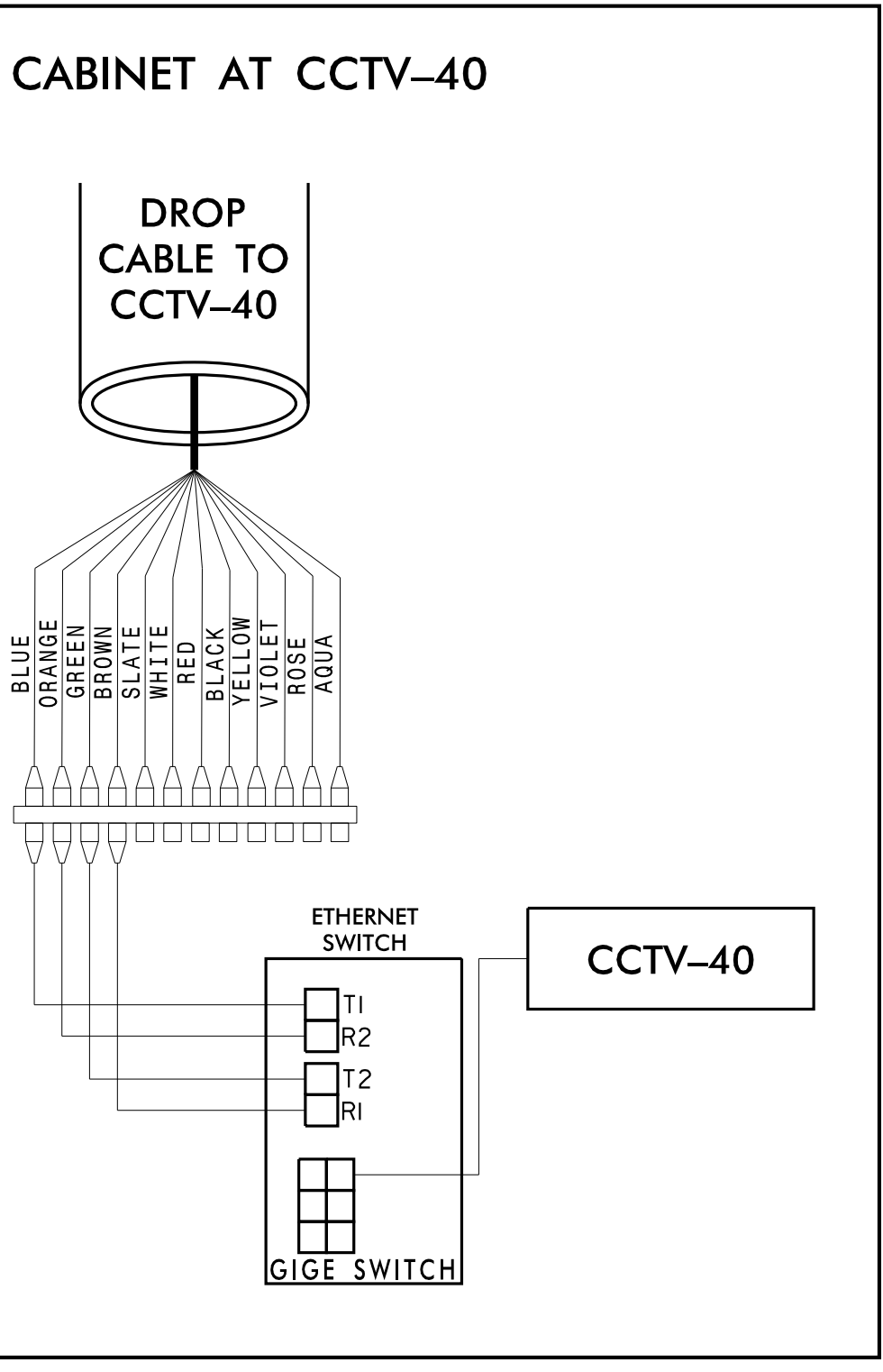
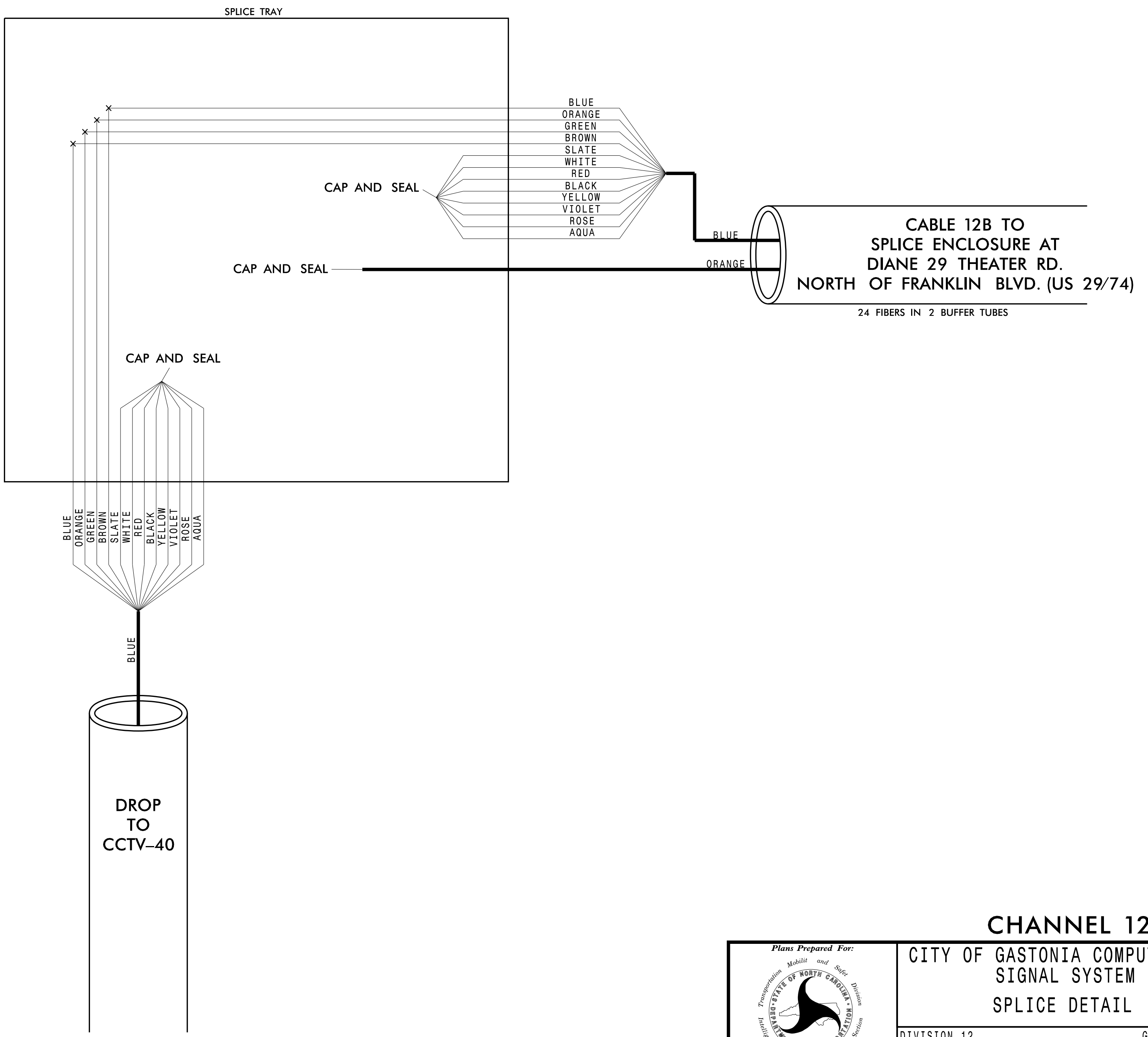

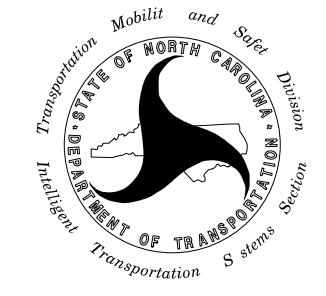
Plans Prepared For:

 250 N. Greenfield Place, Garner, NC 27529

CHANNEL 12

CITY OF GASTONIA COMPUTERIZED SIGNAL SYSTEM

SPLICE DETAIL

DIVISION 12		GASTON COUNTY	
PLAN DATE: DECEMBER 2021	REVIEWED BY: K. SMITH	PREPARED BY: S. BUTLER	REVIEWED BY: I. VAN OSDELL

NC License #F-0102
 421 Fayetteville St., Suite 600
 Raleigh, NC 27601
 Tel: (919) 677-2000
 Fax: (919) 677-2050

SEAL

 Iger Van OsdeLL
 3/16/2022



SCALE: 0

REVISIONS	INIT.	DATE

CADD File name: _____

3/15/2022 \\kimley-horn.com\SE-RAL\NRL_TPTD\ITS\01036569_Gastonia_Signal_System\6_Tasks\Splicing\SPL121.dgn

**CHANNEL 12
SPlice ENCLOSURE AT
FRANKLIN BLVD. (US 29/74)
WEST OF SANTE CIRCLE**

COLOR CODE TIA/EIA 598-C		LEGEND	
(1) BLUE	(7) RED	X - FUSION SPlice INDIVIDUAL FIBER	
(2) ORANGE	(8) BLACK	O - EXISTING SPlice	
(3) GREEN	(9) YELLOW	□ - EXPRESS INDIVIDUAL FIBER	
(4) BROWN	(10) VIOLET	 EXPRESS	EXPRESS ENTIRE BUFFER TUBE
(5) SLATE	(11) ROSE	 SPlice	SPlice ENTIRE BUFFER TUBE OR MAINTAIN IF EXISTING EXPRESSED
(6) WHITE	(12) AQUA	NOTES:	
		1. FIBER INTERCONNECT CENTER RACKS ARE SCHEMATIC ONLY - ACTUAL EQUIPMENT FORM MAY VARY.	
		2. ETHERNET SWITCH TERMINATION CONFIGURATIONS ARE GENERIC. CONTRACTOR IS RESPONSIBLE FOR DETERMINING /ENSURING PROPER TERMINATION.	
		3. CONTRACTOR IS RESPONSIBLE FOR FIELD VERIFYING EXISTING SPlicing. THE CONTRACTOR SHALL COORDINATE WITH THE ENGINEER WHERE EXISTING SPlicing IS NOT AS EXPECTED.	

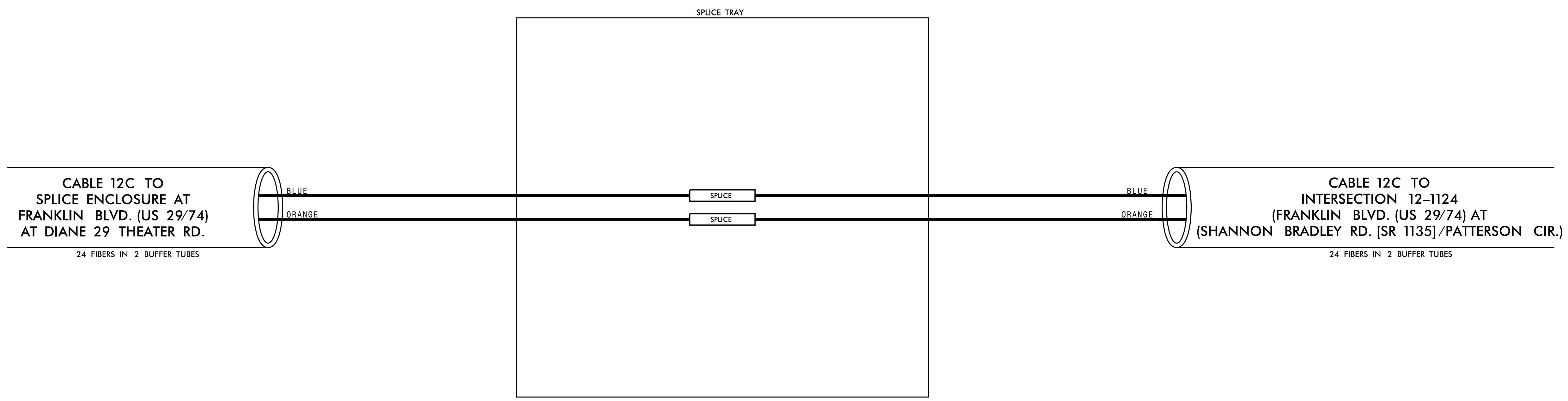

3/15/2022 \\kimley-horn.com\SE-RAL\NRA\TPTD\ITS\01036569_Gastonia_Signal_System\6_Tasks\Splicing\SPL122.dgn

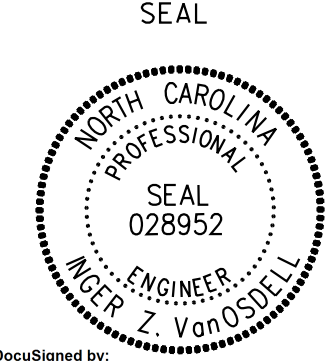
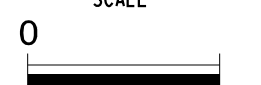
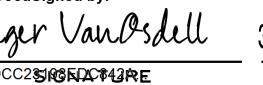
 Plans Prepared For: Transportation, Mobility and Safe Division DEPARTMENT OF TRANSPORTATION 250 N. Greenfield Place, Garner, NC 27529	CHANNEL 12		 SEAL NORTH CAROLINA PROFESSIONAL ENGINEER ROGER Z. VAN OSDEL
	CITY OF GASTONIA COMPUTERIZED SIGNAL SYSTEM SPlice DETAIL		
DIVISION 12 GASTON COUNTY		PLAN DATE: DECEMBER 2021 REVIEWED BY: K. SMITH	
PREPARED BY: S. BUTLER REVIEWED BY: I. VAN OSDELL		REVISIONS INIT. DATE	
SCALE 		DocuSigned by:  3/16/2022	
CADD File name:		DATE	

CHANNEL 12
SPLICE ENCLOSURE AT
(FRANKLIN BLVD. [US 29/74] AT SHANNON BRADLEY RD. [SR 1135]
/PATTERSON CIR.)
SIG ID 12-1124
CCTV CAMERA-02
CCTV CAMERA-03

COLOR CODE
TIA/EIA 598-C

(1) BLUE	(7) RED
(2) ORANGE	(8) BLACK
(3) GREEN	(9) YELLOW
(4) BROWN	(10) VIOLET
(5) SLATE	(11) ROSE
(6) WHITE	(12) AQUA

LEGEND

X - FUSION SPLICE INDIVIDUAL FIBER
 O - EXISTING SPLICE
 □ - EXPRESS INDIVIDUAL FIBER

EXPRESS - EXPRESS ENTIRE BUFFER TUBE
 SPLICE - SPLICE ENTIRE BUFFER TUBE OR MAINTAIN IF EXISTING EXPRESSED

NOTES:
 1. FIBER INTERCONNECT CENTER RACKS ARE SCHEMATIC ONLY - ACTUAL EQUIPMENT FORM MAY VARY.
 2. ETHERNET SWITCH TERMINATION CONFIGURATIONS ARE GENERIC. CONTRACTOR IS RESPONSIBLE FOR DETERMINING /ENSURING PROPER TERMINATION.
 3. CONTRACTOR IS RESPONSIBLE FOR FIELD VERIFYING EXISTING SPlicing. THE CONTRACTOR SHALL COORDINATE WITH THE ENGINEER WHERE EXISTING SPlicing IS NOT AS EXPECTED.

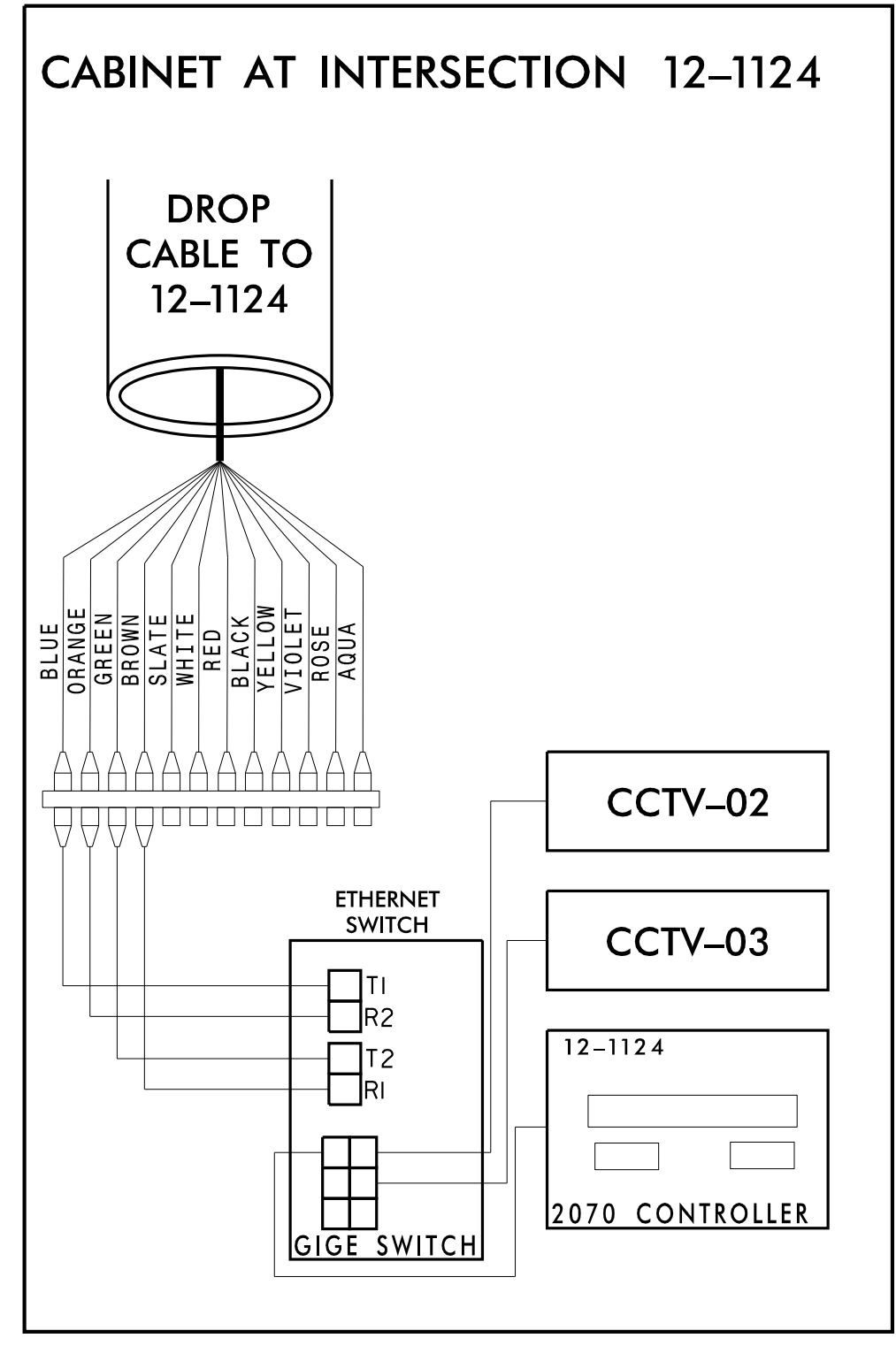
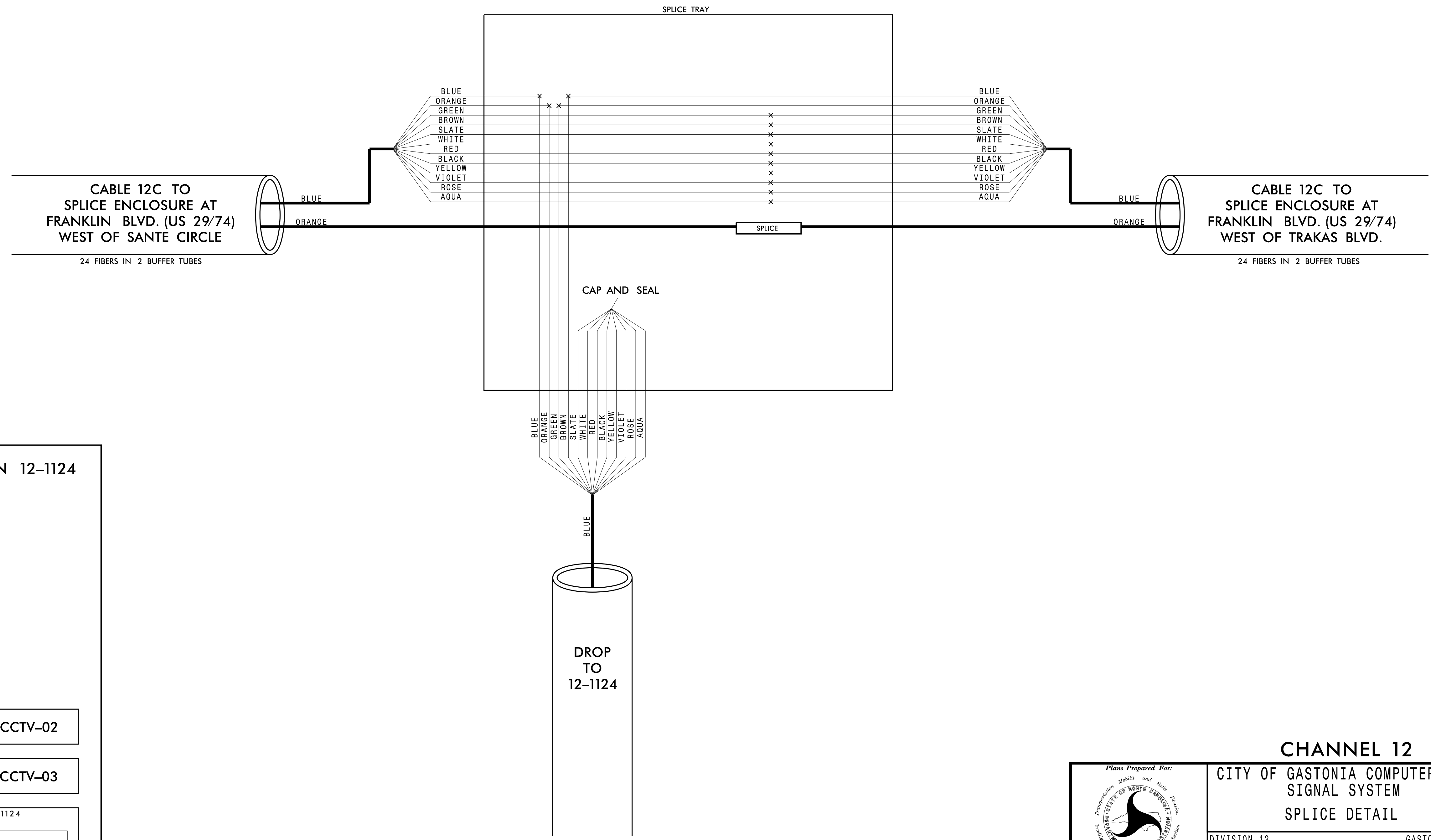

Kimley»Horn
 NC License #F-0102
 421 Fayetteville St., Suite 600
 Raleigh, NC 27601
 Tel: (919) 677-2000
 Fax: (919) 677-2050

CHANNEL 12
 CITY OF GASTONIA COMPUTERIZED
 SIGNAL SYSTEM
 SPLICE DETAIL

DIVISION 12 GASTON COUNTY
 PLAN DATE: DECEMBER 2021 REVIEWED BY: K. SMITH
 PREPARED BY: S. BUTLER REVIEWED BY: I. VAN OSDELL

SCALE: 0

REVISIONS: _____ INIT. DATE _____

DocuSigned by: Inger Van Osdel 3/16/2022

CADD File name: _____



3/15/2022 \\kimley-horn.com\SE-RAL\NRL_TPTD\ITS\01036569_Gastonia_Signal_System\6_Tasks\Splicing\SPL123.dgn

**CHANNEL 12
 SPLICE ENCLOSURE AT
 FRANKLIN BLVD. (US 29/74)
 WEST OF TRAKAS BLVD.**

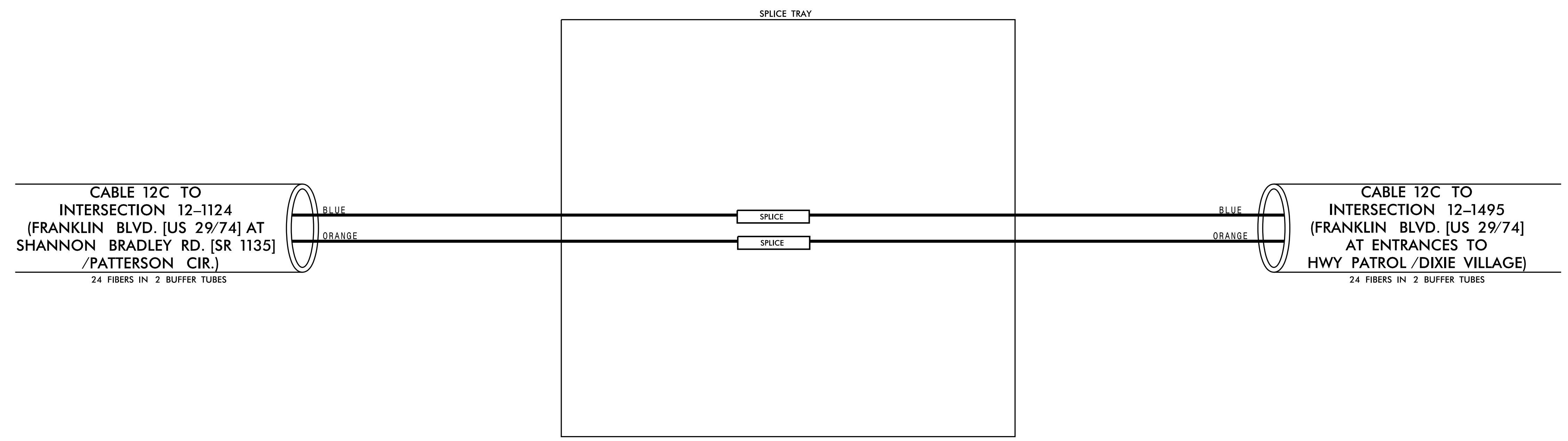
COLOR CODE TIA/EIA 598-C		LEGEND	
(1) BLUE	(7) RED	X - FUSION SPLICE INDIVIDUAL FIBER	
(2) ORANGE	(8) BLACK	O - EXISTING SPLICE	
(3) GREEN	(9) YELLOW	□ - EXPRESS INDIVIDUAL FIBER	
(4) BROWN	(10) VIOLET	EXPRESS	EXPRESS ENTIRE BUFFER TUBE
(5) SLATE	(11) ROSE	SPLICE	SPLICE ENTIRE BUFFER TUBE OR MAINTAIN IF EXISTING EXPRESSED
(6) WHITE	(12) AQUA	NOTES:	
		1. FIBER INTERCONNECT CENTER RACKS ARE SCHEMATIC ONLY - ACTUAL EQUIPMENT FORM MAY VARY.	
		2. ETHERNET SWITCH TERMINATION CONFIGURATIONS ARE GENERIC. CONTRACTOR IS RESPONSIBLE FOR DETERMINING /ENSURING PROPER TERMINATION.	
		3. CONTRACTOR IS RESPONSIBLE FOR FIELD VERIFYING EXISTING SPLICING. THE CONTRACTOR SHALL COORDINATE WITH THE ENGINEER WHERE EXISTING SPLICING IS NOT AS EXPECTED.	

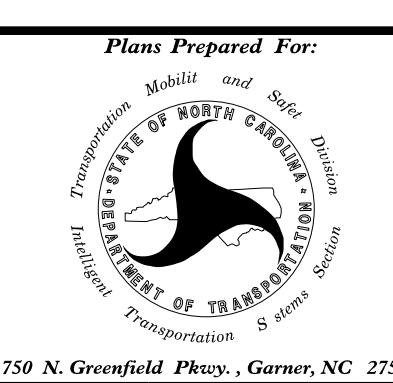

3/15/2022 \\kimley-horn.com\SE-RAL\NRA\TPTD\ITS\01036569_Gastonia_Signal_System\6_Tasks\Splicing\SPL124.dgn

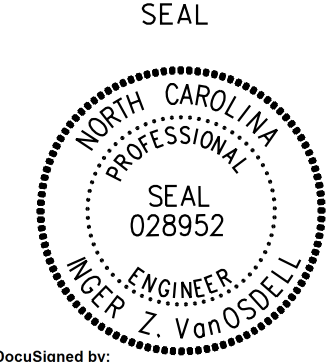
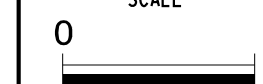
 Plans Prepared For: Transportation, Mobility and Safe Division DEPARTMENT OF TRANSPORTATION 250 N. Greenfield Place, Garner, NC 27529	CHANNEL 12		 NC License #F-0102 421 Fayetteville St., Suite 600 Raleigh, NC 27601 Tel: (919) 677-2000 Fax: (919) 677-2050											
	CITY OF GASTONIA COMPUTERIZED SIGNAL SYSTEM SPLICE DETAIL													
DIVISION 12 PLAN DATE: DECEMBER 2021 PREPARED BY: S. BUTLER	GASTON COUNTY REVIEWED BY: K. SMITH REVIEWED BY: I. VAN OSDELL	SEAL  I. Van OsdeLL 3/16/2022												
SCALE 	REVISIONS <table border="1"> <tr> <th>NO.</th> <th>DATE</th> <th>DESCRIPTION</th> </tr> <tr> <td> </td> <td> </td> <td> </td> </tr> </table>	NO.	DATE	DESCRIPTION				INIT. DATE <table border="1"> <tr> <th>NO.</th> <th>DATE</th> <th>INIT.</th> </tr> <tr> <td> </td> <td> </td> <td> </td> </tr> </table>	NO.	DATE	INIT.			
NO.	DATE	DESCRIPTION												
NO.	DATE	INIT.												

CHANNEL 12 SPLICE ENCLOSURE AT (FRANKLIN BLVD. [US 29/74] AT ENTRANCES TO HWY PATROL /DIXIE VILLAGE) SIG ID 12-1495

COLOR CODE TIA/EIA 598-C		LEGEND	
(1) BLUE	(7) RED	X - FUSION SPLICE INDIVIDUAL FIBER	
(2) ORANGE	(8) BLACK	O - EXISTING SPLICE	
(3) GREEN	(9) YELLOW	□ - EXPRESS INDIVIDUAL FIBER	
(4) BROWN	(10) VIOLET	EXPRESS	EXPRESS ENTIRE BUFFER TUBE
(5) SLATE	(11) ROSE	SPLICE	SPLICE ENTIRE BUFFER TUBE OR MAINTAIN IF EXISTING EXPRESSED
(6) WHITE	(12) AQUA	NOTES:	
		1. FIBER INTERCONNECT CENTER RACKS ARE SCHEMATIC ONLY - ACTUAL EQUIPMENT FORM MAY VARY.	
		2. ETHERNET SWITCH TERMINATION CONFIGURATIONS ARE GENERIC. CONTRACTOR IS RESPONSIBLE FOR DETERMINING /ENSURING PROPER TERMINATION.	
		3. CONTRACTOR IS RESPONSIBLE FOR FIELD VERIFYING EXISTING SPLICING. THE CONTRACTOR SHALL COORDINATE WITH THE ENGINEER WHERE EXISTING SPLICING IS NOT AS EXPECTED.	

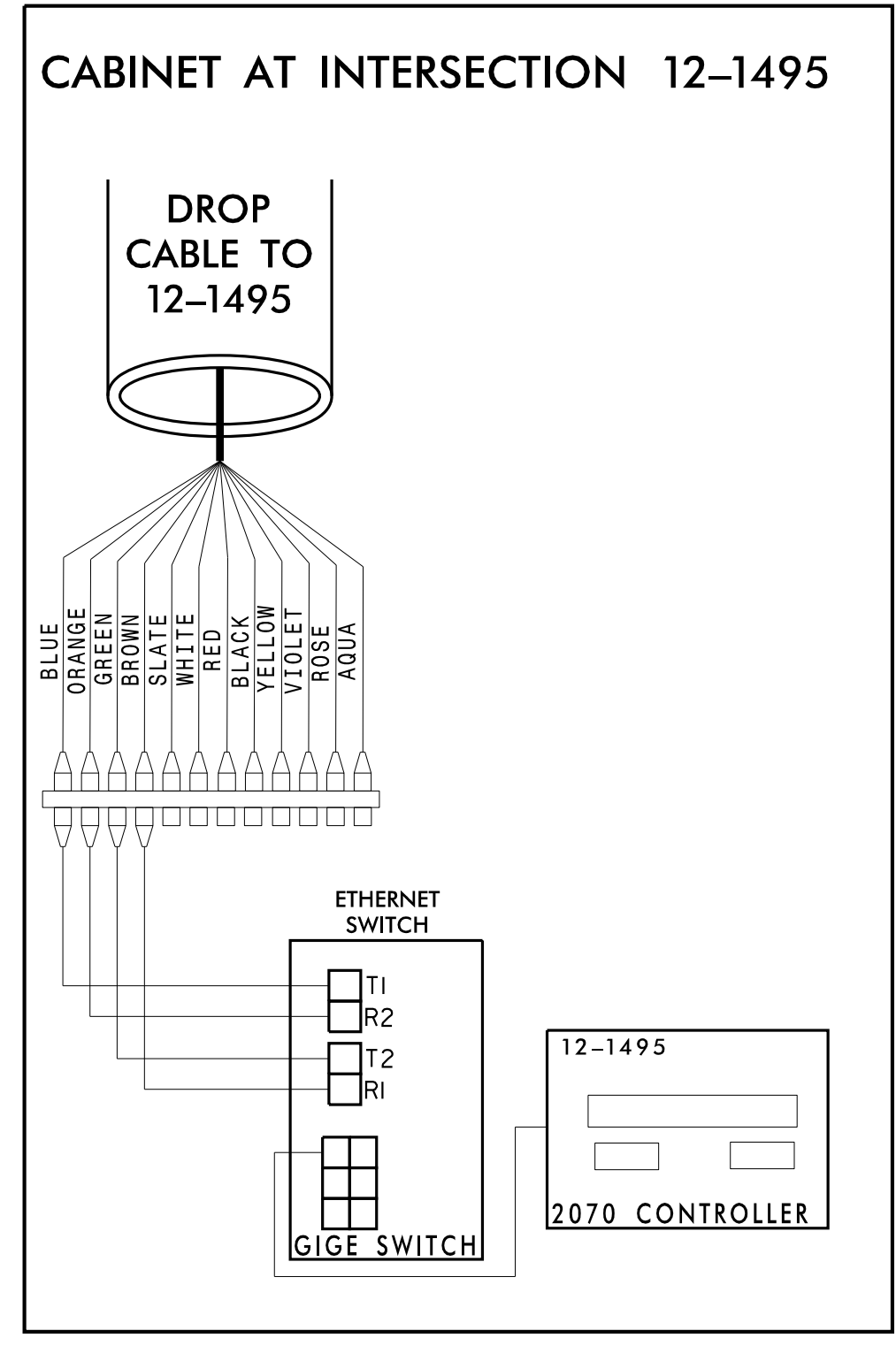
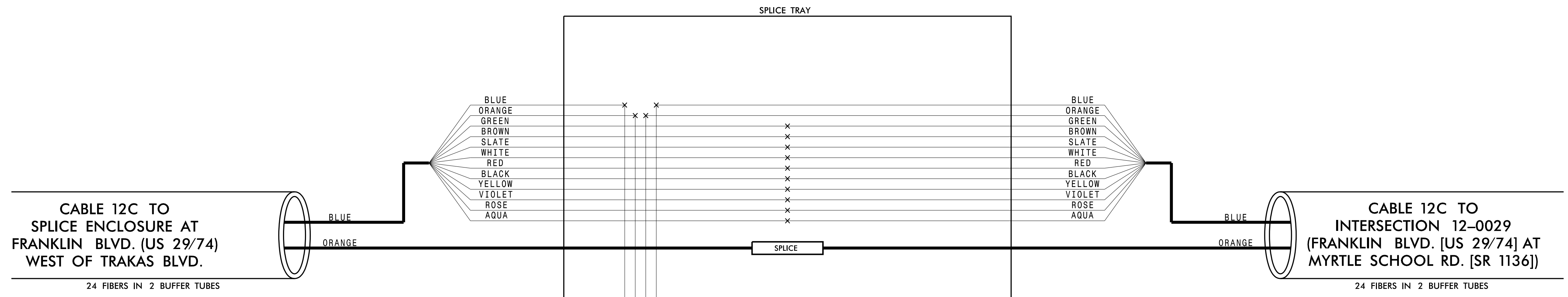

CHANNEL 12

CITY OF GASTONIA COMPUTERIZED SIGNAL SYSTEM

SPLICE DETAIL

DIVISION 12		GASTON COUNTY	
PLAN DATE: DECEMBER 2021	REVIEWED BY: K. SMITH	PREPARED BY: S. BUTLER	REVIEWED BY: I. VAN OSDELL
SCALE	0	REVISIONS	INIT. DATE

DocuSigned by:
Roger Van Osdel
3/16/2022

CADD File name:

3/15/2022 \\kimley-horn.com\SE\RAL\NRL_TPTD\ITS\01036569_Gastonia_Signal_System\6_Tasks\Splicing\SPL125.dgn

CHANNEL 12
SPLICE ENCLOSURE AT
FRANKLIN BLVD. (US 29/74) AT MYRTLE SCHOOL RD. (SR 1136)
SIG ID 12-0029 (FRANKLIN BLVD. [US 29/74] AT
MYRTLE SCHOOL RD. [SR 1136])
SIG ID 12-1706 (MYRTLE SCHOOL RD. [SR 1136] AT
WALMART ENTRANCE)
CCTV CAMERA-04

COLOR CODE
TIA/EIA 598-C

(1) BLUE	(7) RED
(2) ORANGE	(8) BLACK
(3) GREEN	(9) YELLOW
(4) BROWN	(10) VIOLET
(5) SLATE	(11) ROSE
(6) WHITE	(12) AQUA

LEGEND

X - FUSION SPLICE INDIVIDUAL FIBER
O - EXISTING SPLICE
□ - EXPRESS INDIVIDUAL FIBER

EXPRESS - EXPRESS ENTIRE BUFFER TUBE
SPLICE - SPLICE ENTIRE BUFFER TUBE OR MAINTAIN IF EXISTING EXPRESSED

NOTES:
1. FIBER INTERCONNECT CENTER RACKS ARE SCHEMATIC ONLY - ACTUAL EQUIPMENT FORM MAY VARY.
2. ETHERNET SWITCH TERMINATION CONFIGURATIONS ARE GENERIC. CONTRACTOR IS RESPONSIBLE FOR DETERMINING /ENSURING PROPER TERMINATION.
3. CONTRACTOR IS RESPONSIBLE FOR FIELD VERIFYING EXISTING SPLICING. THE CONTRACTOR SHALL COORDINATE WITH THE ENGINEER WHERE EXISTING SPLICING IS NOT AS EXPECTED.

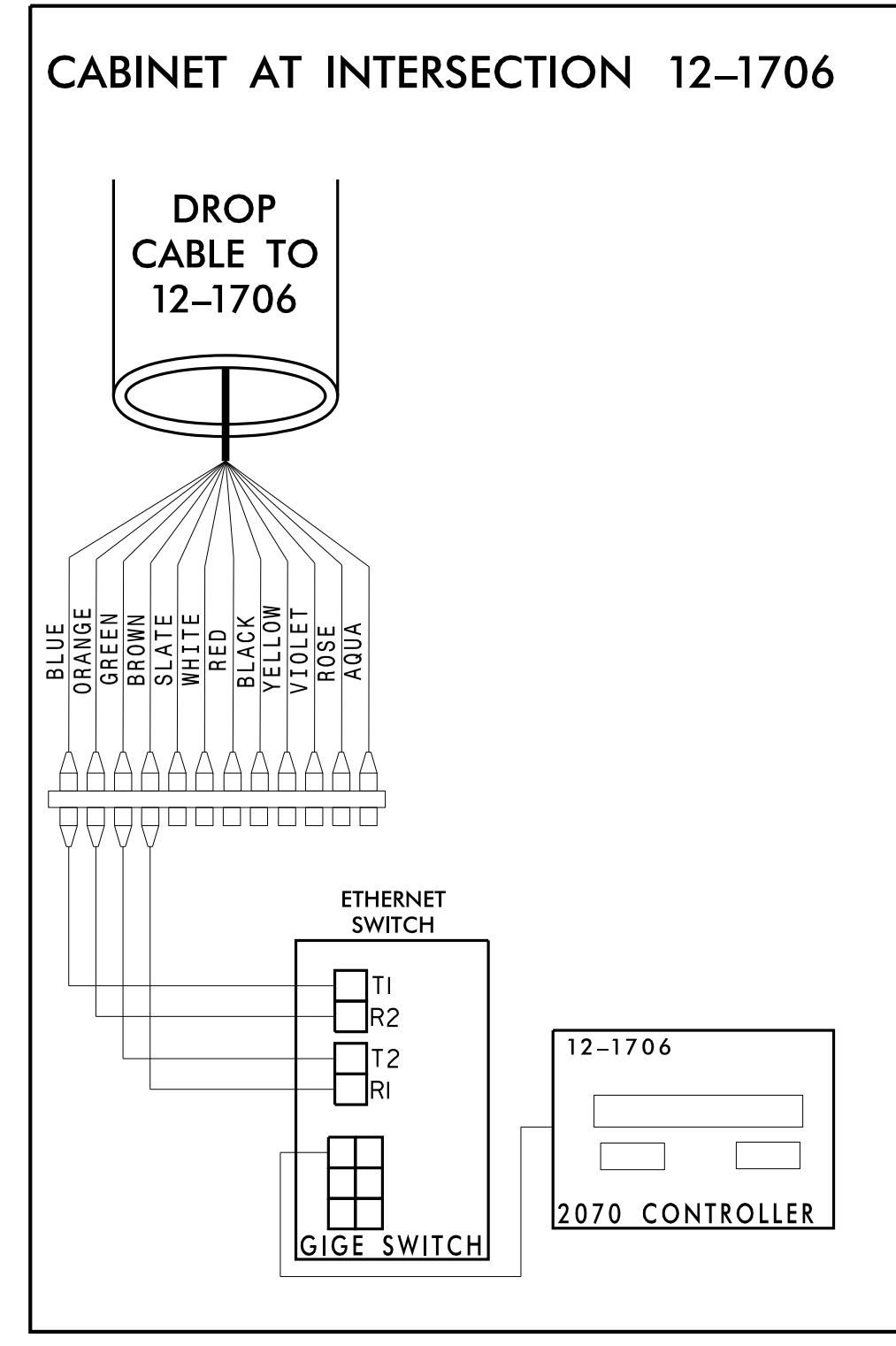
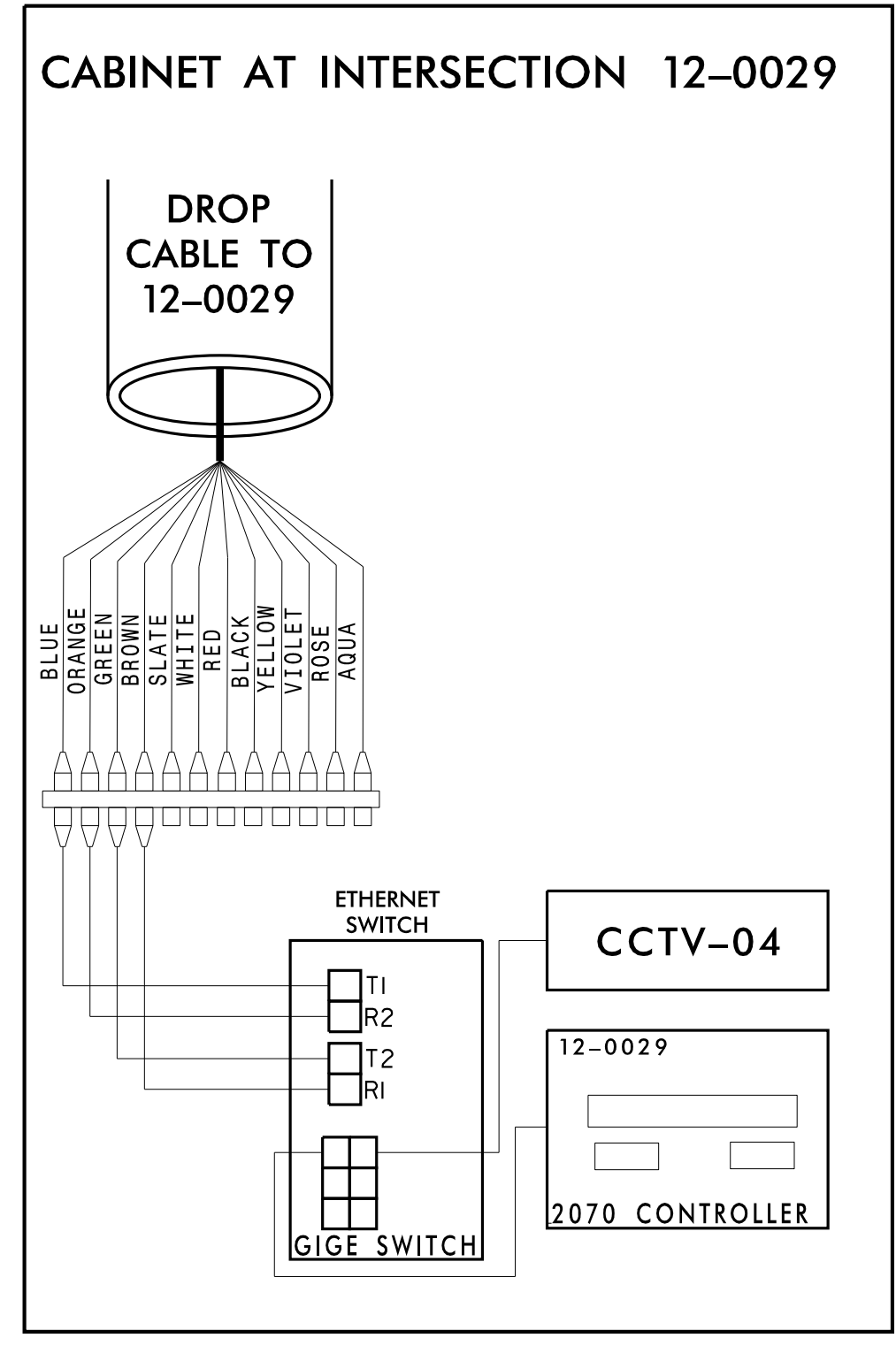
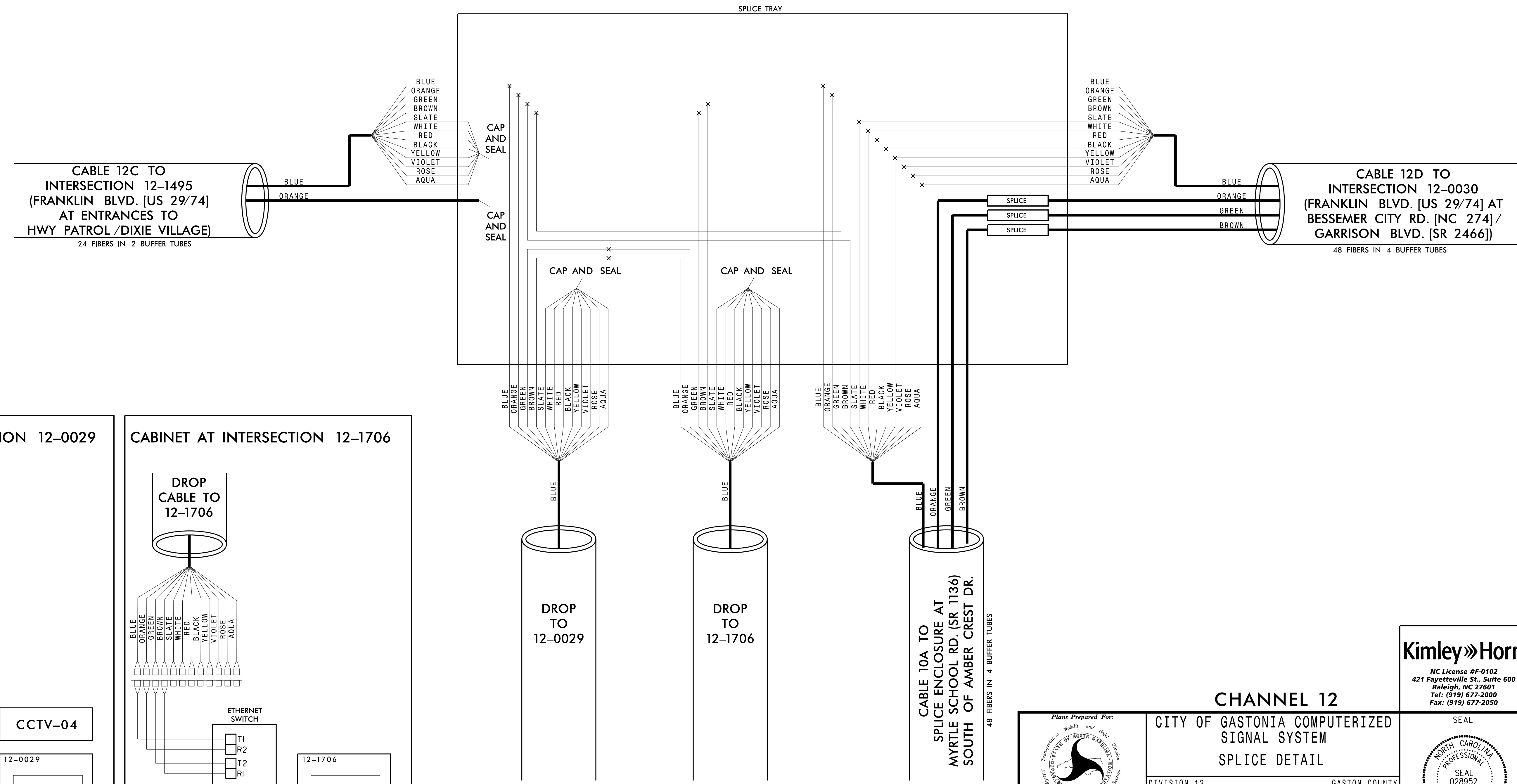

CHANNEL 12
CITY OF GASTONIA COMPUTERIZED SIGNAL SYSTEM
SPLICE DETAIL

Division 12 GASTON COUNTY
PLAN DATE: DECEMBER 2021 REVIEWED BY: K. SMITH
PREPARED BY: S. BUTLER REVIEWED BY: I. VAN OSDELL

Scale: 0

Revisions table with columns: REVISIONS, INIT., DATE.

Professional Engineer Seal: **Kimley»Horn**, NC License #F-0102, 421 Fayetteville St., Suite 600, Raleigh, NC 27601. Seal number: 028952. Engineer: **Inger Van OsdeLL**, dated 3/16/2022.

3/15/2022 \\kimley-horn.com\SE-RAL\NRA\TPTO\ITS\01036569_Gastonia_Signal_System\6_Tasks\Splicing\SPL126.dgn

CHANNEL 12
SPLICE ENCLOSURE AT
(FRANKLIN BLVD. [US 29/74] AT
BESSEMER CITY RD. [NC 274]/
GARRISON BLVD. [SR 2466])
SIG ID 12-0030
CCTV CAMERA-05

COLOR CODE
TIA/EIA 598-C

(1) BLUE	(7) RED
(2) ORANGE	(8) BLACK
(3) GREEN	(9) YELLOW
(4) BROWN	(10) VIOLET
(5) SLATE	(11) ROSE
(6) WHITE	(12) AQUA

LEGEND

X - FUSION SPLICE INDIVIDUAL FIBER
O - EXISTING SPLICE
□ - EXPRESS INDIVIDUAL FIBER

EXPRESS - EXPRESS ENTIRE BUFFER TUBE
SPLICE - SPLICE ENTIRE BUFFER TUBE OR MAINTAIN IF EXISTING EXPRESSED

NOTES:

- FIBER INTERCONNECT CENTER RACKS ARE SCHEMATIC ONLY - ACTUAL EQUIPMENT FORM MAY VARY.
- ETHERNET SWITCH TERMINATION CONFIGURATIONS ARE GENERIC. CONTRACTOR IS RESPONSIBLE FOR DETERMINING /ENSURING PROPER TERMINATION.
- CONTRACTOR IS RESPONSIBLE FOR FIELD VERIFYING EXISTING SPLICING. THE CONTRACTOR SHALL COORDINATE WITH THE ENGINEER WHERE EXISTING SPLICING IS NOT AS EXPECTED.

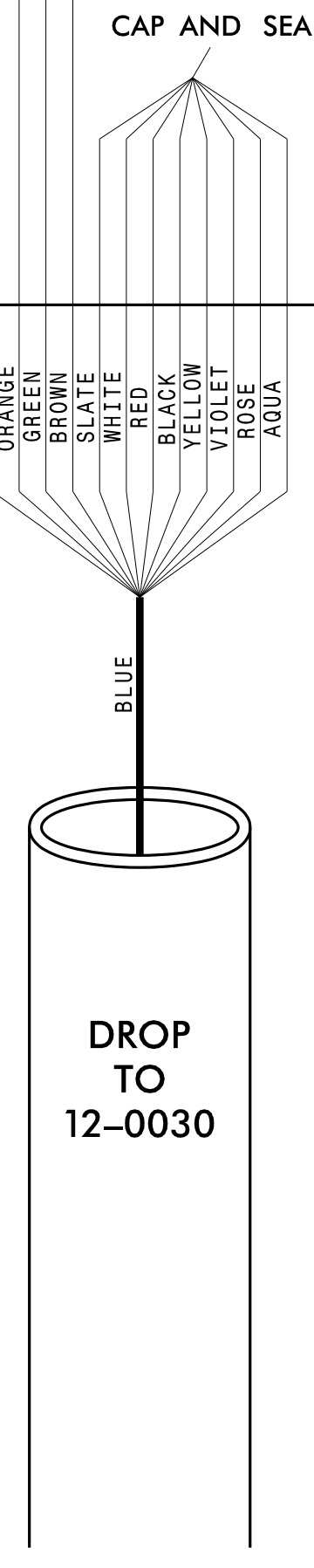
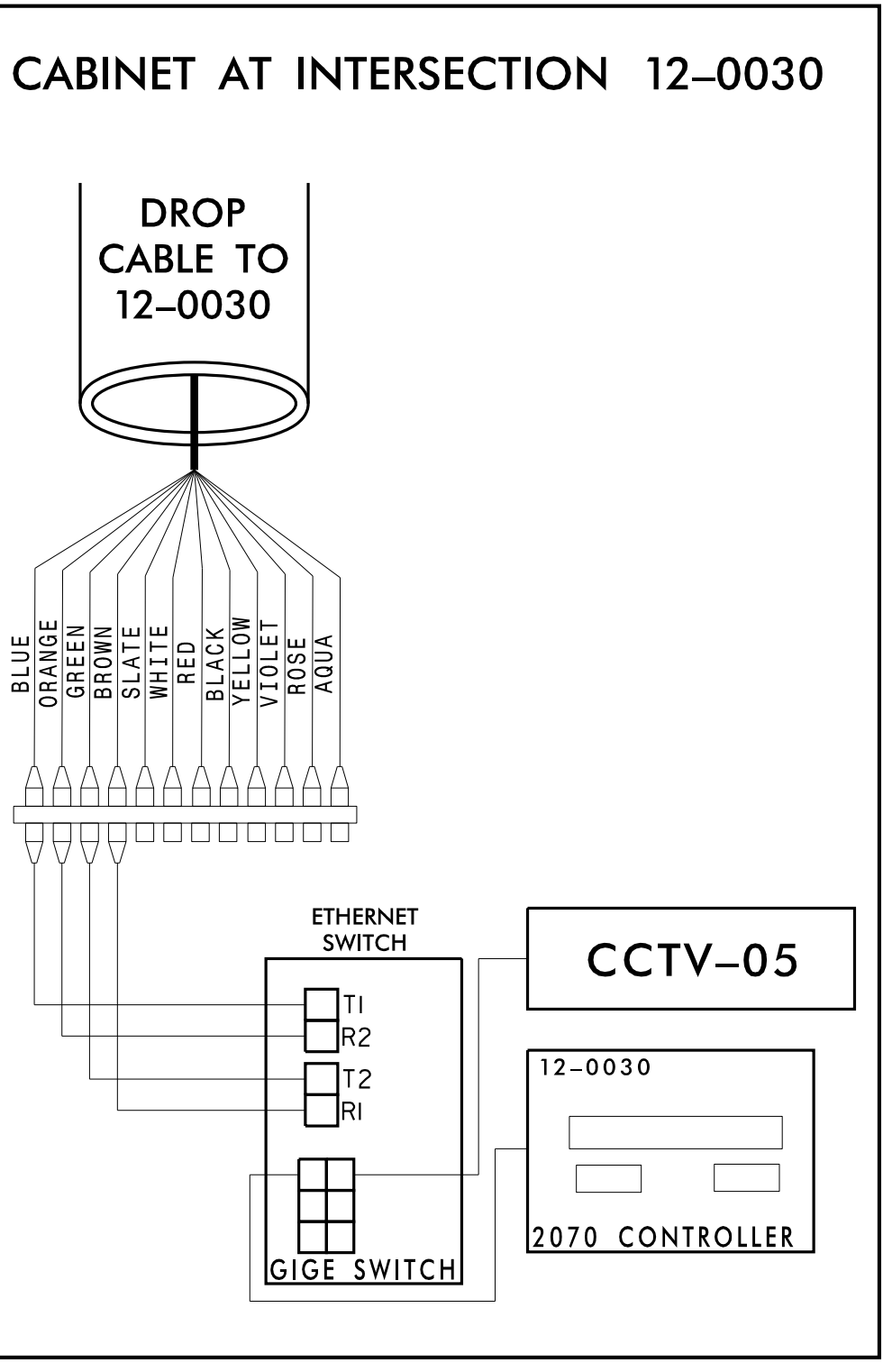
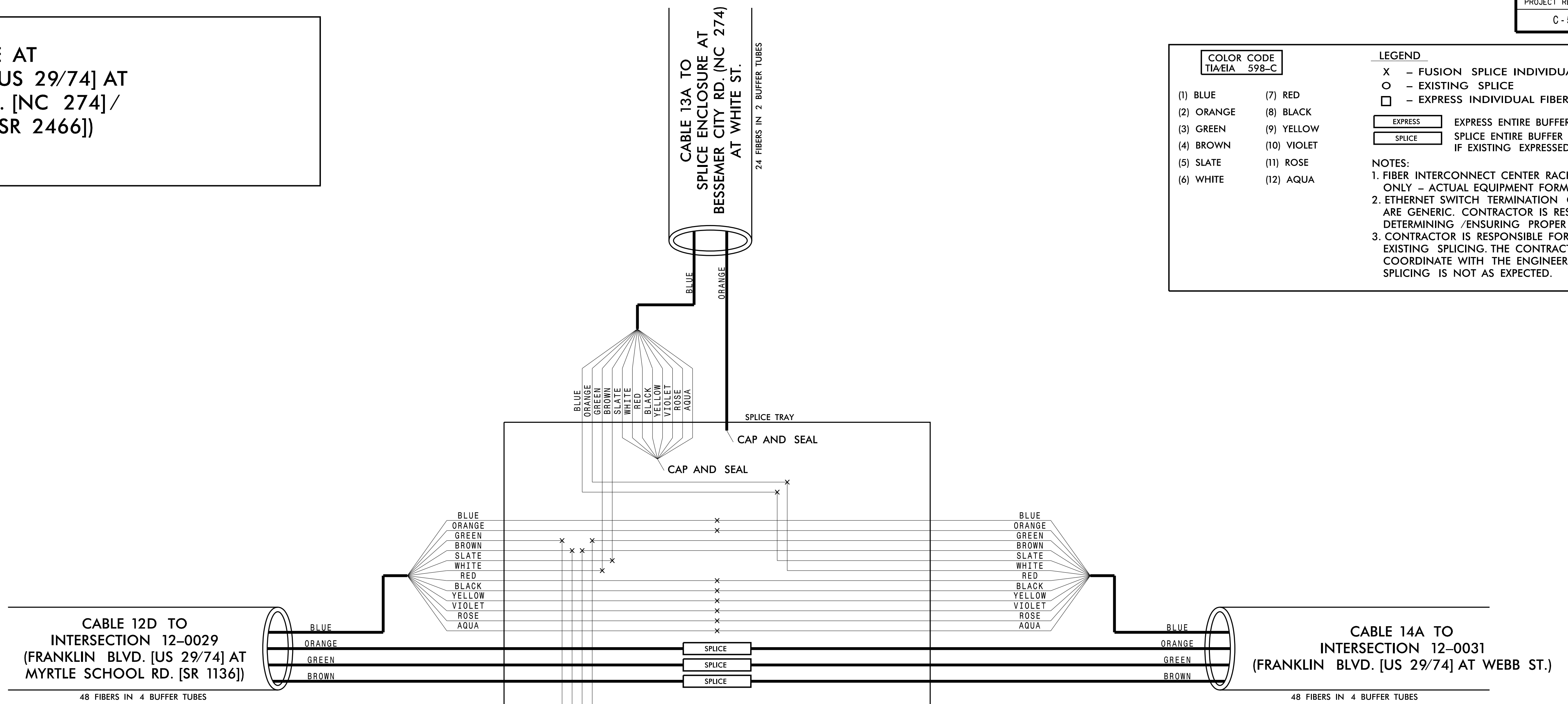

CHANNEL 12
CITY OF GASTONIA COMPUTERIZED SIGNAL SYSTEM
SPLICE DETAIL

DIVISION 12 GASTON COUNTY
PLAN DATE: DECEMBER 2021 REVIEWED BY: K. SMITH
PREPARED BY: S. BUTLER REVIEWED BY: I. VAN OSDELL

Scale: 0

REVISIONS	INIT.	DATE

DocuSigned by: Inger Van Osdel 3/16/2022

CADD Filename: _____

Kimley»Horn
NC License #F-0102
421 Fayetteville St., Suite 600
Raleigh, NC 27601
Tel: (919) 677-2000
Fax: (919) 677-2050

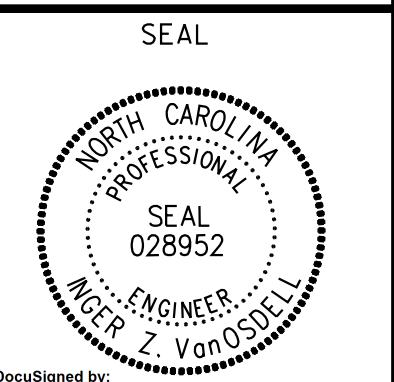

3/15/2022 \\kimley-horn.com\SE-RAL\NRL_TPTD\ITS\01036569_Gastonia_Signal_System\6_Tasks\Splicing\SPL127.dgn

CHANNEL 13
SPlice ENCLOSURE AT
(BESSEMER CITY RD. [NC 274] AT
DALLAS-BESSEMER CITY RD. [NC 275]/OATES RD. [SR 1312])
SIG ID 12-0012
CCTV CAMERA-38

COLOR CODE
TIA/EIA 598-C

(1) BLUE	(7) RED
(2) ORANGE	(8) BLACK
(3) GREEN	(9) YELLOW
(4) BROWN	(10) VIOLET
(5) SLATE	(11) ROSE
(6) WHITE	(12) AQUA

LEGEND

X - FUSION SPlice INDIVIDUAL FIBER
O - EXISTING SPlice
□ - EXPRESS INDIVIDUAL FIBER

EXPRESS - EXPRESS ENTIRE BUFFER TUBE
SPlice - SPlice ENTIRE BUFFER TUBE OR MAINTAIN IF EXISTING EXPRESSED

NOTES:
1. FIBER INTERCONNECT CENTER RACKS ARE SCHEMATIC ONLY - ACTUAL EQUIPMENT FORM MAY VARY.
2. ETHERNET SWITCH TERMINATION CONFIGURATIONS ARE GENERIC. CONTRACTOR IS RESPONSIBLE FOR DETERMINING /ENSURING PROPER TERMINATION.
3. CONTRACTOR IS RESPONSIBLE FOR FIELD VERIFYING EXISTING SPlicing. THE CONTRACTOR SHALL COORDINATE WITH THE ENGINEER WHERE EXISTING SPlicing IS NOT AS EXPECTED.

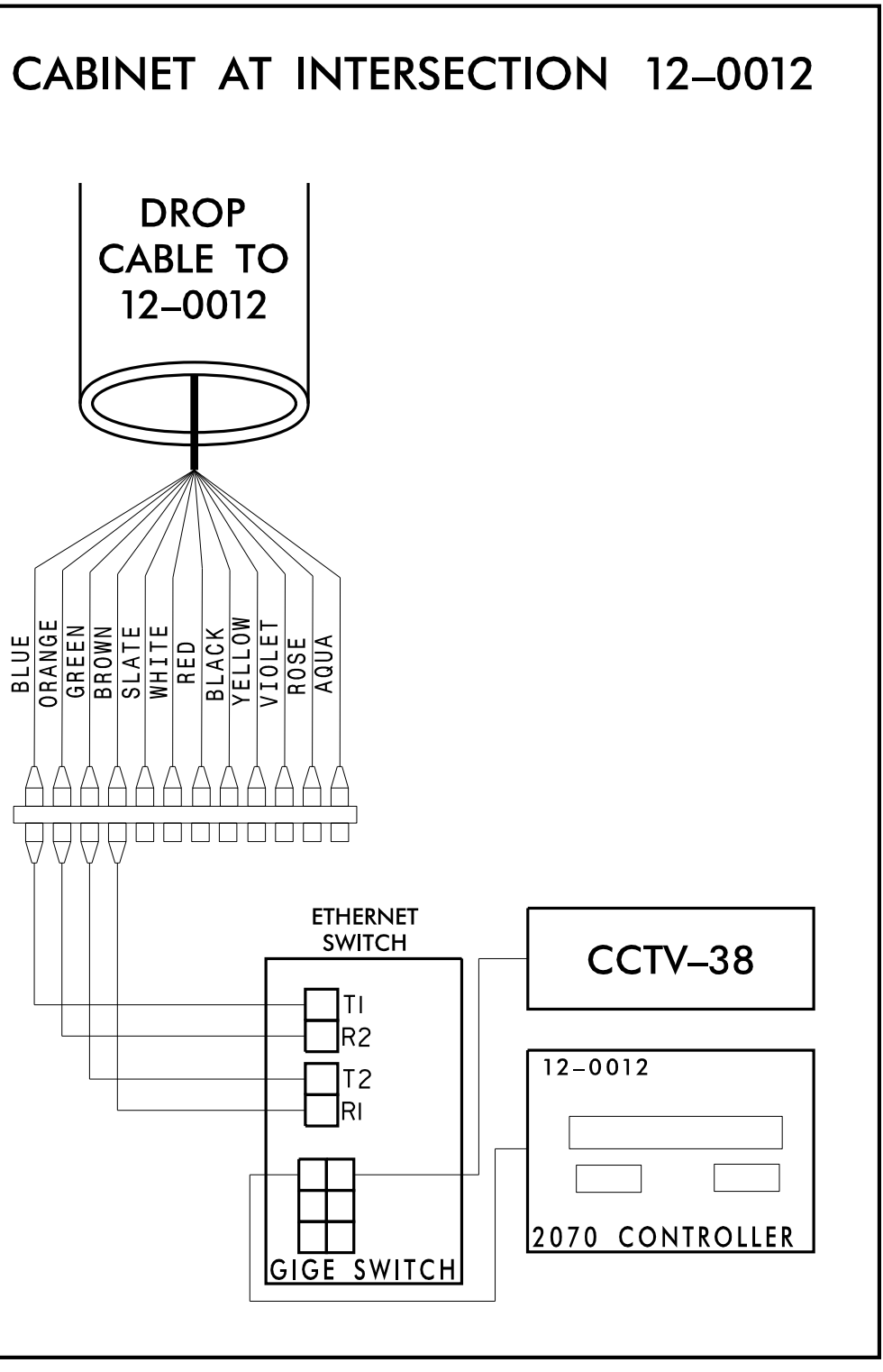
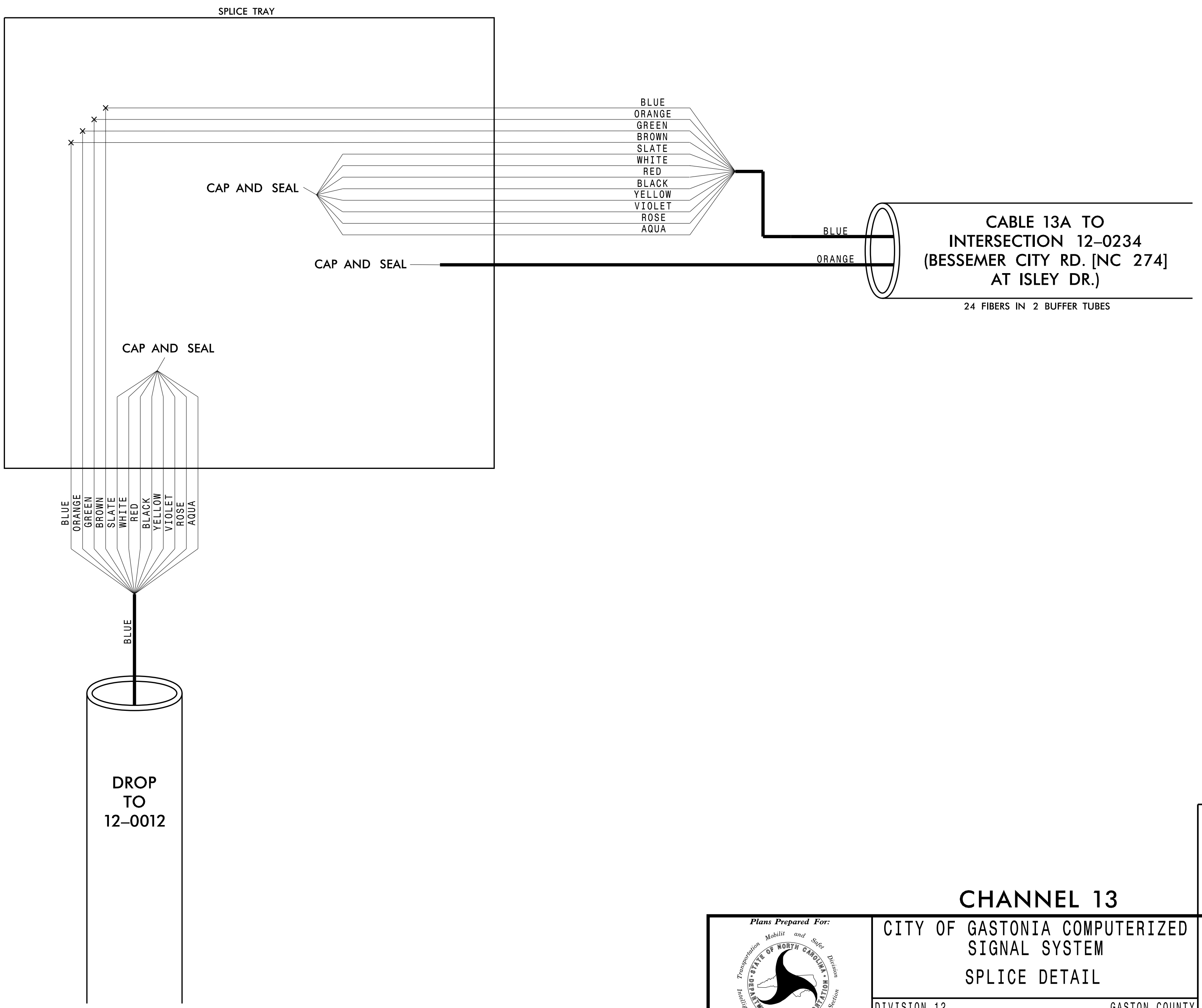

Plans Prepared For:

 250 N. Greenfield Place, Garner, NC 27529

CHANNEL 13
CITY OF GASTONIA COMPUTERIZED SIGNAL SYSTEM
SPlice DETAIL

DIVISION 12 GASTON COUNTY

PLAN DATE: DECEMBER 2021 REVIEWED BY: K. SMITH
 PREPARED BY: S. BUTLER REVIEWED BY: I. VAN OSDELL

REVISIONS	INIT.	DATE

SCALE
0

Kimley»Horn
 NC License #F-0102
 421 Fayetteville St., Suite 600
 Raleigh, NC 27601
 Tel: (919) 677-2000
 Fax: (919) 677-2050

SEAL

 Iger Van OsdeLL
 3/16/2022
 DATE

3/15/2022 \\kimley-horn.com\SE-RAL\NRL_TPTD\ITS\01036569_Gastonia_Signal_System\6_Tasks\Splicing\SPL128.dgn

CHANNEL 13
SPlice ENCLOSURE AT
(BESSEMER CITY RD. [NC 274] AT
ISLEY DR.)
SIG ID 12-0234

COLOR CODE
TIA/EIA 598-C

(1) BLUE	(7) RED
(2) ORANGE	(8) BLACK
(3) GREEN	(9) YELLOW
(4) BROWN	(10) VIOLET
(5) SLATE	(11) ROSE
(6) WHITE	(12) AQUA

LEGEND

X - FUSION SPlice INDIVIDUAL FIBER
 O - EXISTING SPlice
 □ - EXPRESS INDIVIDUAL FIBER

EXPRESS - EXPRESS ENTIRE BUFFER TUBE
 SPlice - SPlice ENTIRE BUFFER TUBE OR MAINTAIN IF EXISTING EXPRESSED

NOTES:
 1. FIBER INTERCONNECT CENTER RACKS ARE SCHEMATIC ONLY - ACTUAL EQUIPMENT FORM MAY VARY.
 2. ETHERNET SWITCH TERMINATION CONFIGURATIONS ARE GENERIC. CONTRACTOR IS RESPONSIBLE FOR DETERMINING /ENSURING PROPER TERMINATION.
 3. CONTRACTOR IS RESPONSIBLE FOR FIELD VERIFYING EXISTING SPlicing. THE CONTRACTOR SHALL COORDINATE WITH THE ENGINEER WHERE EXISTING SPlicing IS NOT AS EXPECTED.

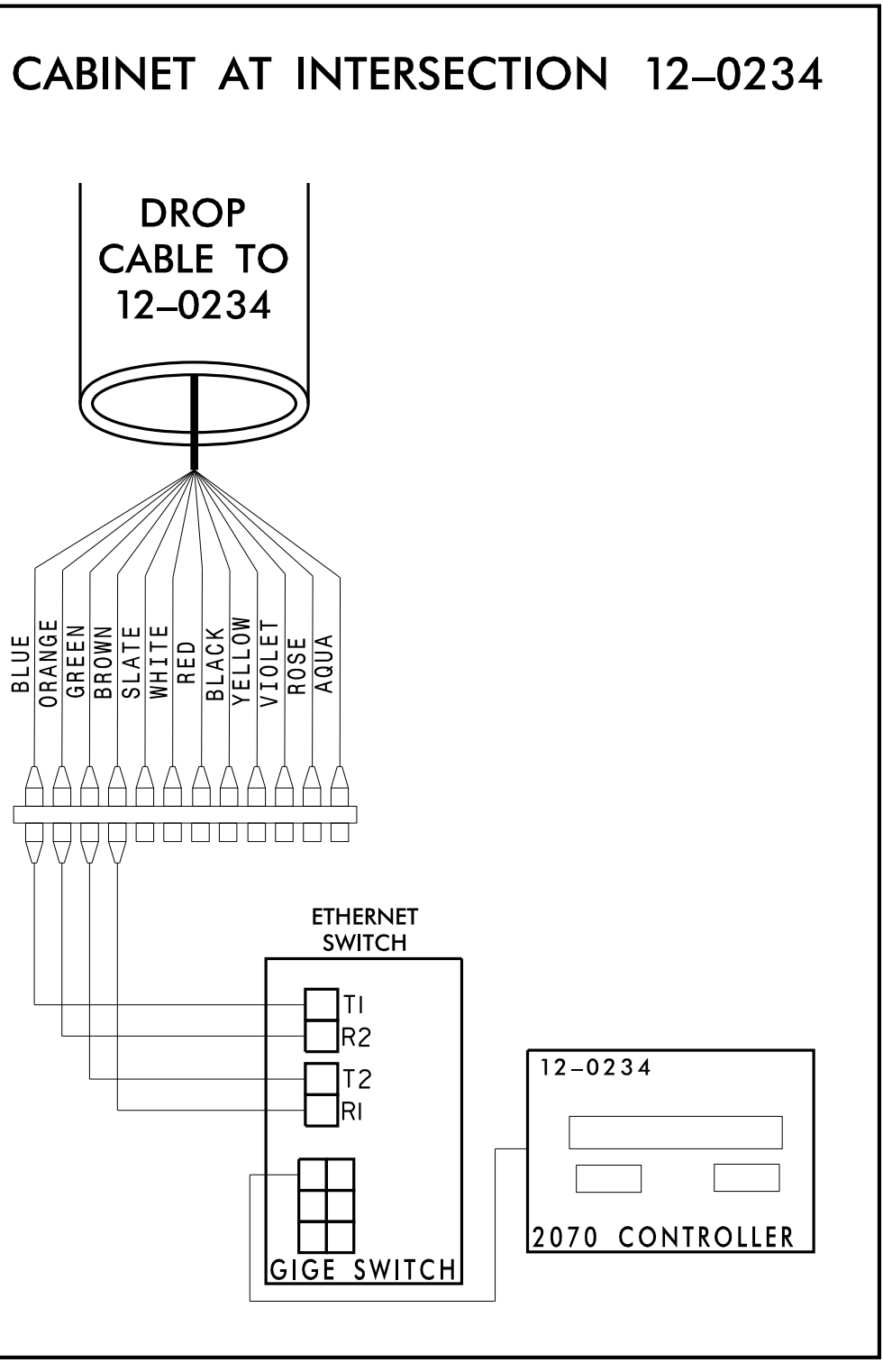
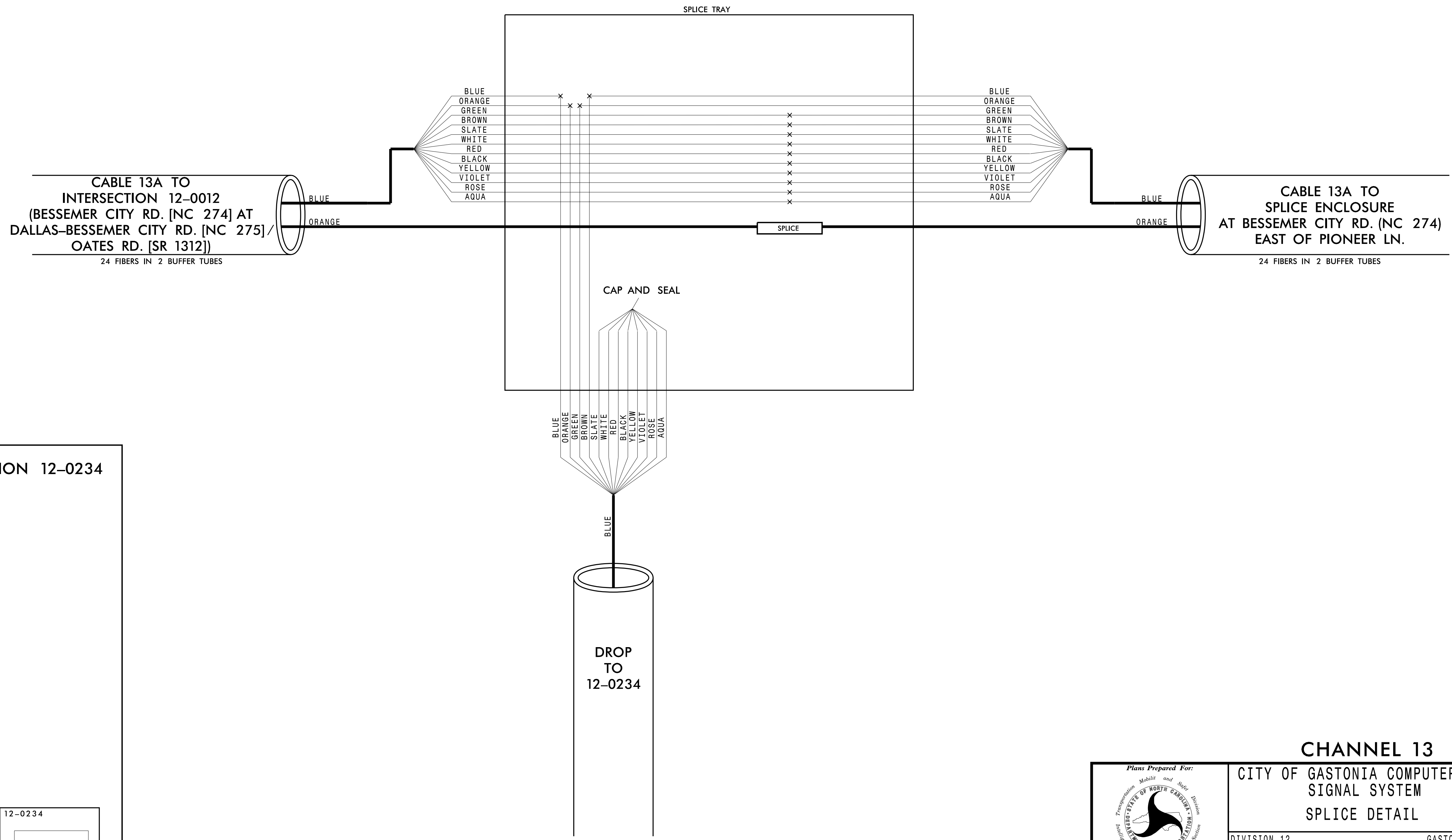

Kimley»Horn
 NC License #F-0102
 421 Fayetteville St., Suite 600
 Raleigh, NC 27601
 Tel: (919) 677-2000
 Fax: (919) 677-2050

CHANNEL 13
 CITY OF GASTONIA COMPUTERIZED
 SIGNAL SYSTEM
 SPlice DETAIL

DIVISION 12 GASTON COUNTY
 PLAN DATE: DECEMBER 2021 REVIEWED BY: K. SMITH
 PREPARED BY: S. BUTLER REVIEWED BY: I. VAN OSDELL

SCALE: 0

REVISIONS: _____ INIT. DATE _____

DocuSigned by: Inger Van OsdeLL 3/16/2022

3/15/2022 \\kimley-horn.com\SE-RAL\NRL_TPTD\ITS\01036569_Gastonia_Signal_System\6_Tasks\Splicing_SPL129.dgn

**CHANNEL 13
 SPLICE ENCLOSURE AT
 BESSEMER CITY RD. (NC 274)
 EAST OF PIONEER LN.**

COLOR CODE TIA/EIA 598-C		LEGEND	
(1) BLUE	(7) RED	X - FUSION SPLICE INDIVIDUAL FIBER	
(2) ORANGE	(8) BLACK	O - EXISTING SPLICE	
(3) GREEN	(9) YELLOW	□ - EXPRESS INDIVIDUAL FIBER	
(4) BROWN	(10) VIOLET	EXPRESS	EXPRESS ENTIRE BUFFER TUBE
(5) SLATE	(11) ROSE	SPLICE	SPLICE ENTIRE BUFFER TUBE OR MAINTAIN IF EXISTING EXPRESSED
(6) WHITE	(12) AQUA	NOTES:	
		1. FIBER INTERCONNECT CENTER RACKS ARE SCHEMATIC ONLY - ACTUAL EQUIPMENT FORM MAY VARY.	
		2. ETHERNET SWITCH TERMINATION CONFIGURATIONS ARE GENERIC. CONTRACTOR IS RESPONSIBLE FOR DETERMINING /ENSURING PROPER TERMINATION.	
		3. CONTRACTOR IS RESPONSIBLE FOR FIELD VERIFYING EXISTING SPLICING. THE CONTRACTOR SHALL COORDINATE WITH THE ENGINEER WHERE EXISTING SPLICING IS NOT AS EXPECTED.	

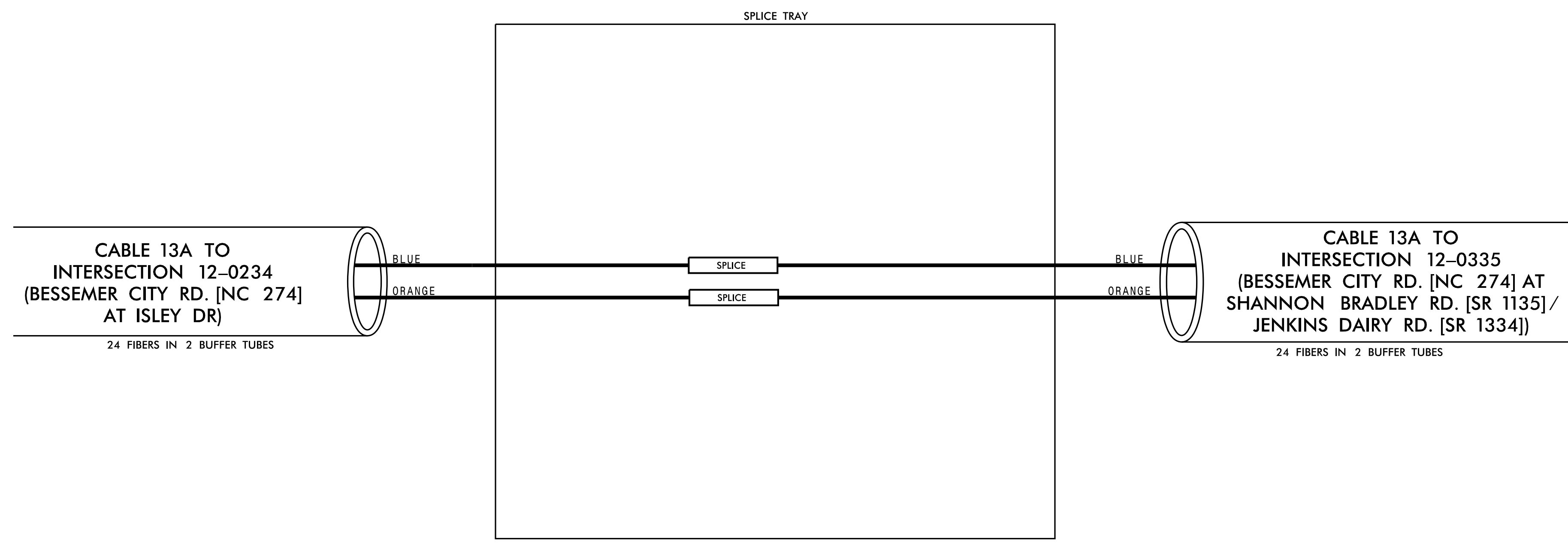

3/15/2022 \\kimley-horn.com\SE\RAL\NRA\TPTD\ITS\01036569_Gastonia_Signal_System\6_Tasks\Splicing\SPL130.dgn

Plans Prepared For:
 Transportation, Mobility and Safe Division
 DEPARTMENT OF TRANSPORTATION
 250 N. Greenfield Place, Garner, NC 27529

CHANNEL 13
 CITY OF GASTONIA COMPUTERIZED
 SIGNAL SYSTEM
 SPLICE DETAIL

DIVISION 12		GASTON COUNTY	
PLAN DATE: DECEMBER 2021	REVIEWED BY: K. SMITH		
PREPARED BY: S. BUTLER	REVIEWED BY: I. VAN OSDELL		
REVISIONS	INIT.	DATE	

Kimley»Horn
 NC License #F-0102
 421 Fayetteville St., Suite 600
 Raleigh, NC 27601
 Tel: (919) 677-2000
 Fax: (919) 677-2050

SEAL

DocuSigned by:
 Iger Van OsdeLL 3/16/2022

 SIGNATURE DATE

CADD Filename:

**CHANNEL 13
 SPLICE ENCLOSURE AT
 (BESSEMER CITY RD. [NC 274] AT
 SHANNON BRADLEY RD. [SR 1135] /
 JENKINS DAIRY RD. [SR 1334])
 SIG ID 12-0335**

COLOR CODE TIA/EIA 598-C		LEGEND	
(1) BLUE	(7) RED	X	- FUSION SPLICE INDIVIDUAL FIBER
(2) ORANGE	(8) BLACK	O	- EXISTING SPLICE
(3) GREEN	(9) YELLOW	□	- EXPRESS INDIVIDUAL FIBER
(4) BROWN	(10) VIOLET	EXPRESS	EXPRESS ENTIRE BUFFER TUBE
(5) SLATE	(11) ROSE	SPLICE	SPLICE ENTIRE BUFFER TUBE OR MAINTAIN IF EXISTING EXPRESSED
(6) WHITE	(12) AQUA	NOTES:	
1. FIBER INTERCONNECT CENTER RACKS ARE SCHEMATIC ONLY - ACTUAL EQUIPMENT FORM MAY VARY.			
2. ETHERNET SWITCH TERMINATION CONFIGURATIONS ARE GENERIC. CONTRACTOR IS RESPONSIBLE FOR DETERMINING /ENSURING PROPER TERMINATION.			
3. CONTRACTOR IS RESPONSIBLE FOR FIELD VERIFYING EXISTING SPLICING. THE CONTRACTOR SHALL COORDINATE WITH THE ENGINEER WHERE EXISTING SPLICING IS NOT AS EXPECTED.			

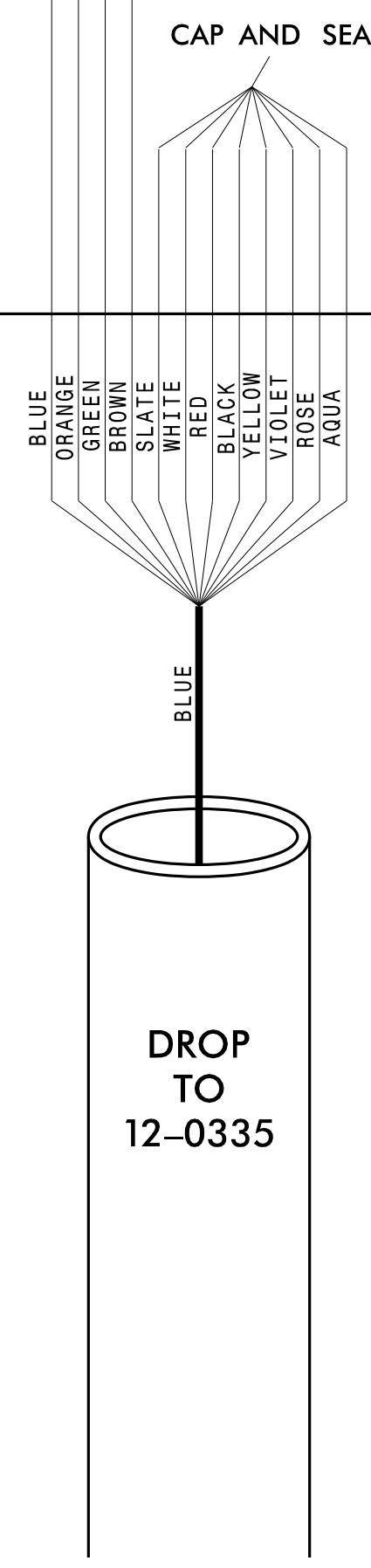
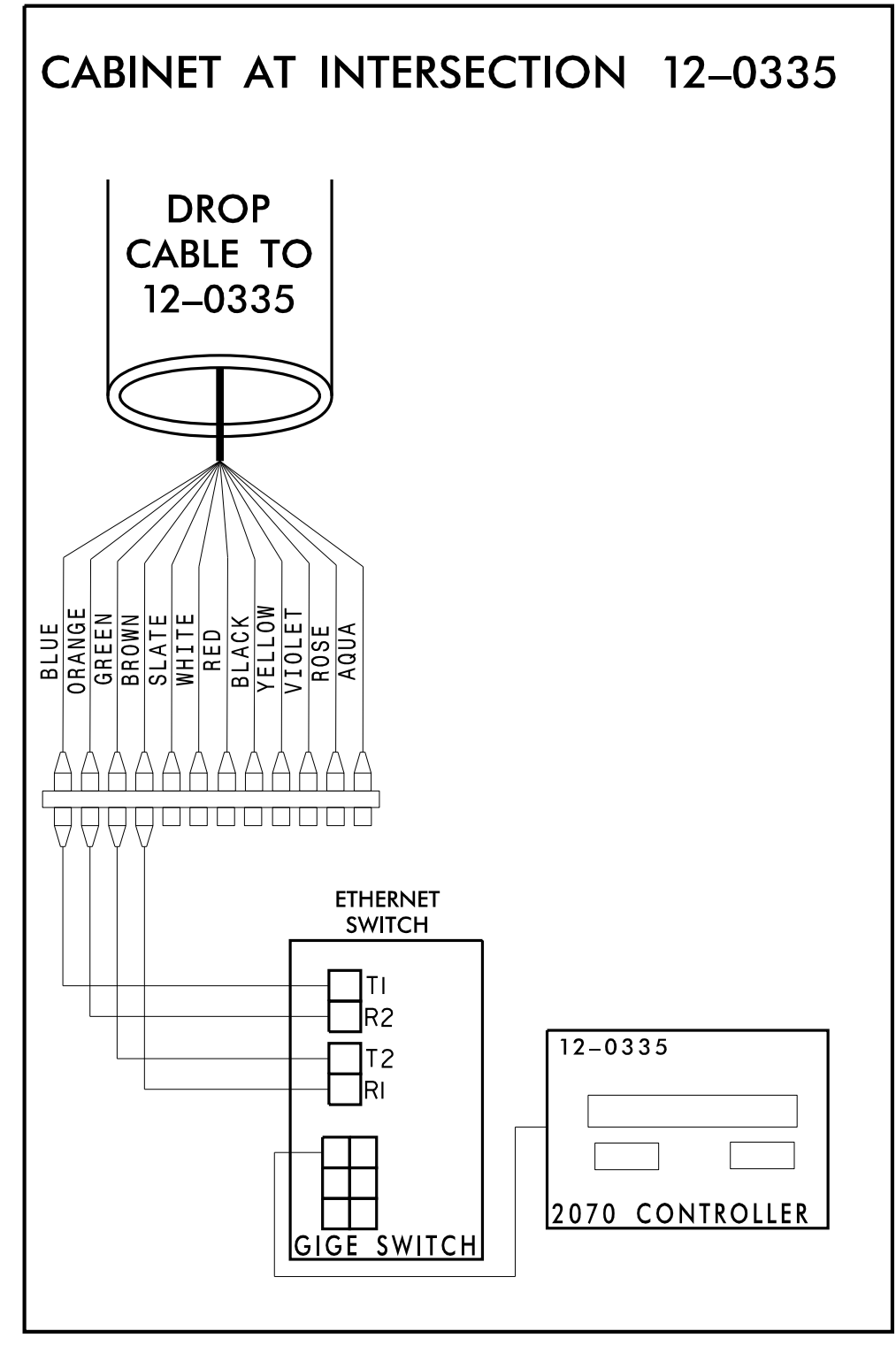
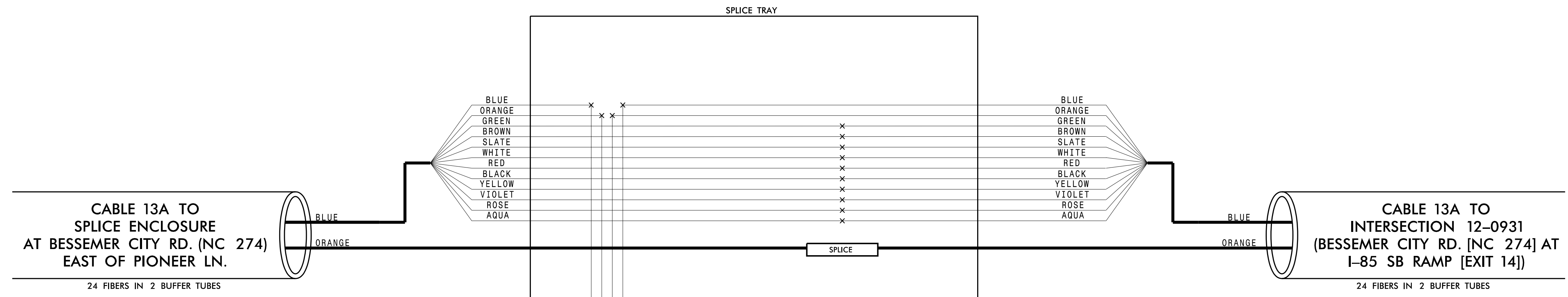

CHANNEL 13

CITY OF GASTONIA COMPUTERIZED SIGNAL SYSTEM

SPLICE DETAIL

DIVISION 12		GASTON COUNTY	
PLAN DATE: DECEMBER 2021	REVIEWED BY: K. SMITH	PREPARED BY: S. BUTLER	REVIEWED BY: I. VAN OSDELL
REVISIONS	INIT.	DATE	

Scale: 0

DocuSigned by: *Inger Van OsdeLL* 3/16/2022

CADD File name:

Kimley»Horn
 NC License #F-0102
 421 Fayetteville St., Suite 600
 Raleigh, NC 27601
 Tel: (919) 677-2000
 Fax: (919) 677-2050

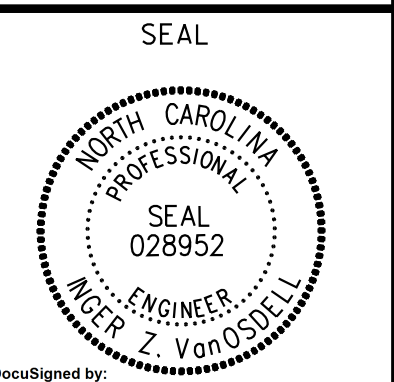

3/15/2022 \\kimley-horn.com\SE-RAL\NRL_TPTD\ITS\01036569_Gastonia_Signal_System\6_Tasks\Splicing_SPL131.dgn

CHANNEL 13 SPLICE ENCLOSURE AT (BESSEMER CITY RD. [NC 274] AT I-85 SB RAMP [EXIT 14]) SIG ID 12-0931

COLOR CODE
TIA/EIA 598-C

(1) BLUE	(7) RED
(2) ORANGE	(8) BLACK
(3) GREEN	(9) YELLOW
(4) BROWN	(10) VIOLET
(5) SLATE	(11) ROSE
(6) WHITE	(12) AQUA

LEGEND

X - FUSION SPLICE INDIVIDUAL FIBER
 O - EXISTING SPLICE
 □ - EXPRESS INDIVIDUAL FIBER

EXPRESS - EXPRESS ENTIRE BUFFER TUBE
 SPLICE - SPLICE ENTIRE BUFFER TUBE OR MAINTAIN IF EXISTING EXPRESSED

NOTES:

- FIBER INTERCONNECT CENTER RACKS ARE SCHEMATIC ONLY - ACTUAL EQUIPMENT FORM MAY VARY.
- ETHERNET SWITCH TERMINATION CONFIGURATIONS ARE GENERIC. CONTRACTOR IS RESPONSIBLE FOR DETERMINING /ENSURING PROPER TERMINATION.
- CONTRACTOR IS RESPONSIBLE FOR FIELD VERIFYING EXISTING SPLICING. THE CONTRACTOR SHALL COORDINATE WITH THE ENGINEER WHERE EXISTING SPLICING IS NOT AS EXPECTED.

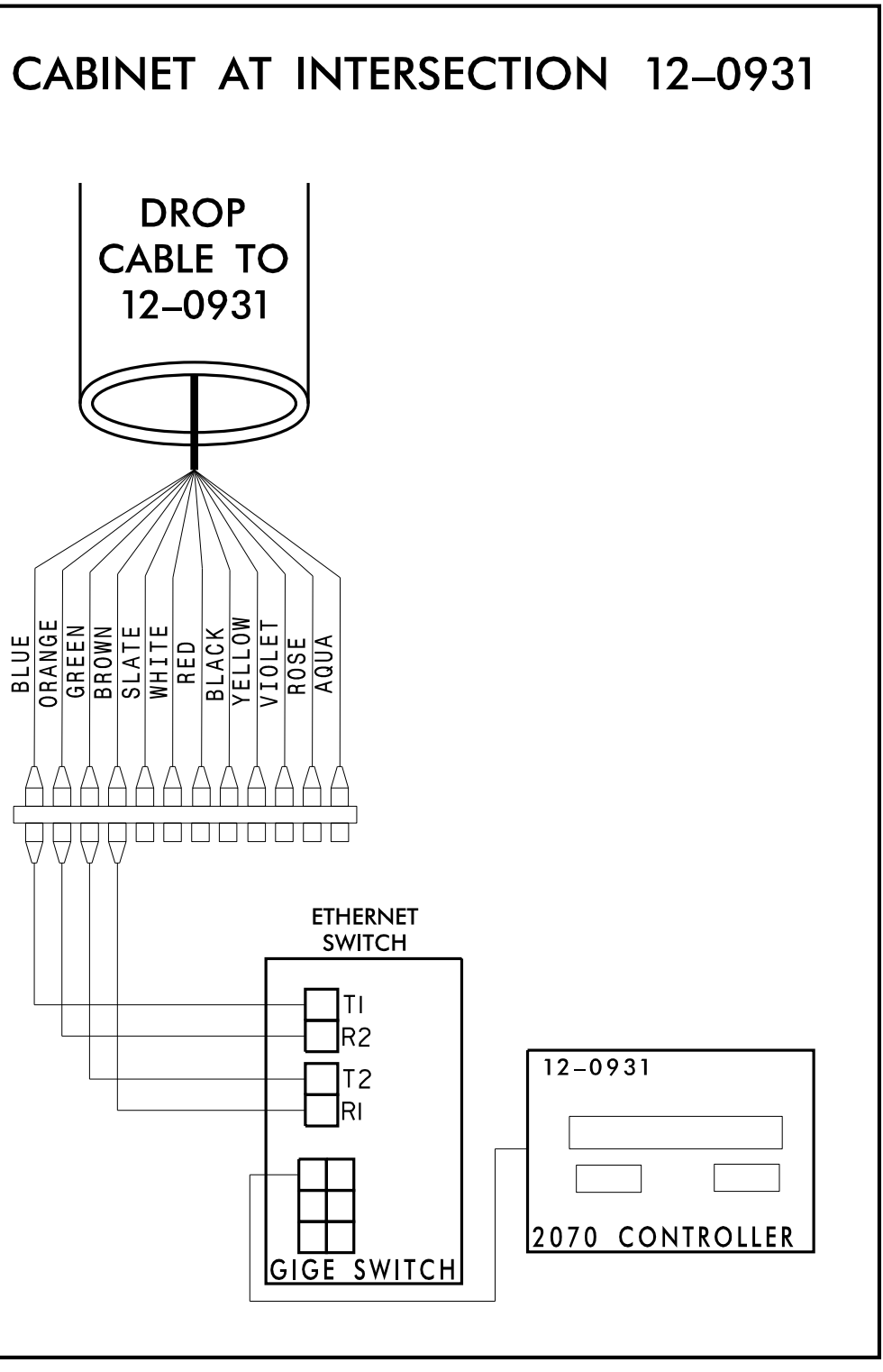
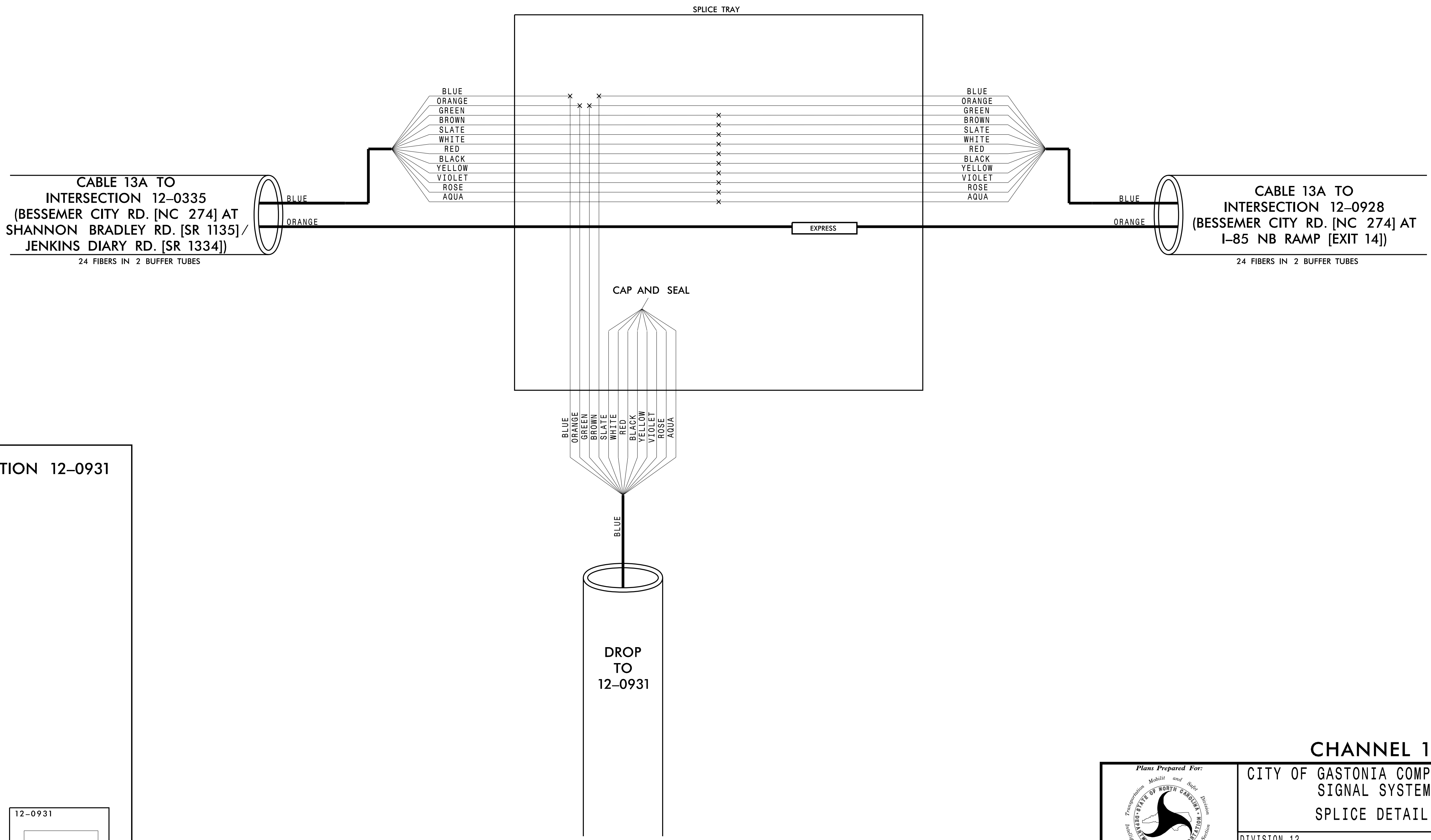

CHANNEL 13
CITY OF GASTONIA COMPUTERIZED SIGNAL SYSTEM
SPLICE DETAIL

DIVISION 12		GASTON COUNTY	
PLAN DATE: DECEMBER 2021	REVIEWED BY: K. SMITH	PREPARED BY: S. BUTLER	REVIEWED BY: I. VAN OSDELL
REVISIONS	INIT.	DATE	

Kimley»Horn
 NC License #F-0102
 421 Fayetteville St., Suite 600
 Raleigh, NC 27601
 Tel: (919) 677-2000
 Fax: (919) 677-2050

SEAL
 NORTH CAROLINA PROFESSIONAL ENGINEER
 SEAL 028952
 IGER VAN OSDELL
 3/16/2022
 DATE

3/15/2022
 \\kimley-horn.com\SE-RAL\NRA\TPTD\ITS\01036569_Gastonia_Signal_System\6_Tasks\Splicing\SPL132.dgn

**CHANNEL 13
 SPLICE ENCLOSURE AT
 (BESSEMER CITY RD. [NC 274] AT
 I-85 NB RAMP [EXIT 14])
 SIG ID 12-0928
 CCTV CAMERA-39**

COLOR CODE TIA/EIA 598-C		LEGEND	
(1) BLUE	(7) RED	X - FUSION SPLICE INDIVIDUAL FIBER	
(2) ORANGE	(8) BLACK	O - EXISTING SPLICE	
(3) GREEN	(9) YELLOW	□ - EXPRESS INDIVIDUAL FIBER	
(4) BROWN	(10) VIOLET	EXPRESS	EXPRESS ENTIRE BUFFER TUBE
(5) SLATE	(11) ROSE	SPLICE	SPLICE ENTIRE BUFFER TUBE OR MAINTAIN IF EXISTING EXPRESSED
(6) WHITE	(12) AQUA	NOTES:	
1. FIBER INTERCONNECT CENTER RACKS ARE SCHEMATIC ONLY - ACTUAL EQUIPMENT FORM MAY VARY.			
2. ETHERNET SWITCH TERMINATION CONFIGURATIONS ARE GENERIC. CONTRACTOR IS RESPONSIBLE FOR DETERMINING /ENSURING PROPER TERMINATION.			
3. CONTRACTOR IS RESPONSIBLE FOR FIELD VERIFYING EXISTING SPLICING. THE CONTRACTOR SHALL COORDINATE WITH THE ENGINEER WHERE EXISTING SPLICING IS NOT AS EXPECTED.			

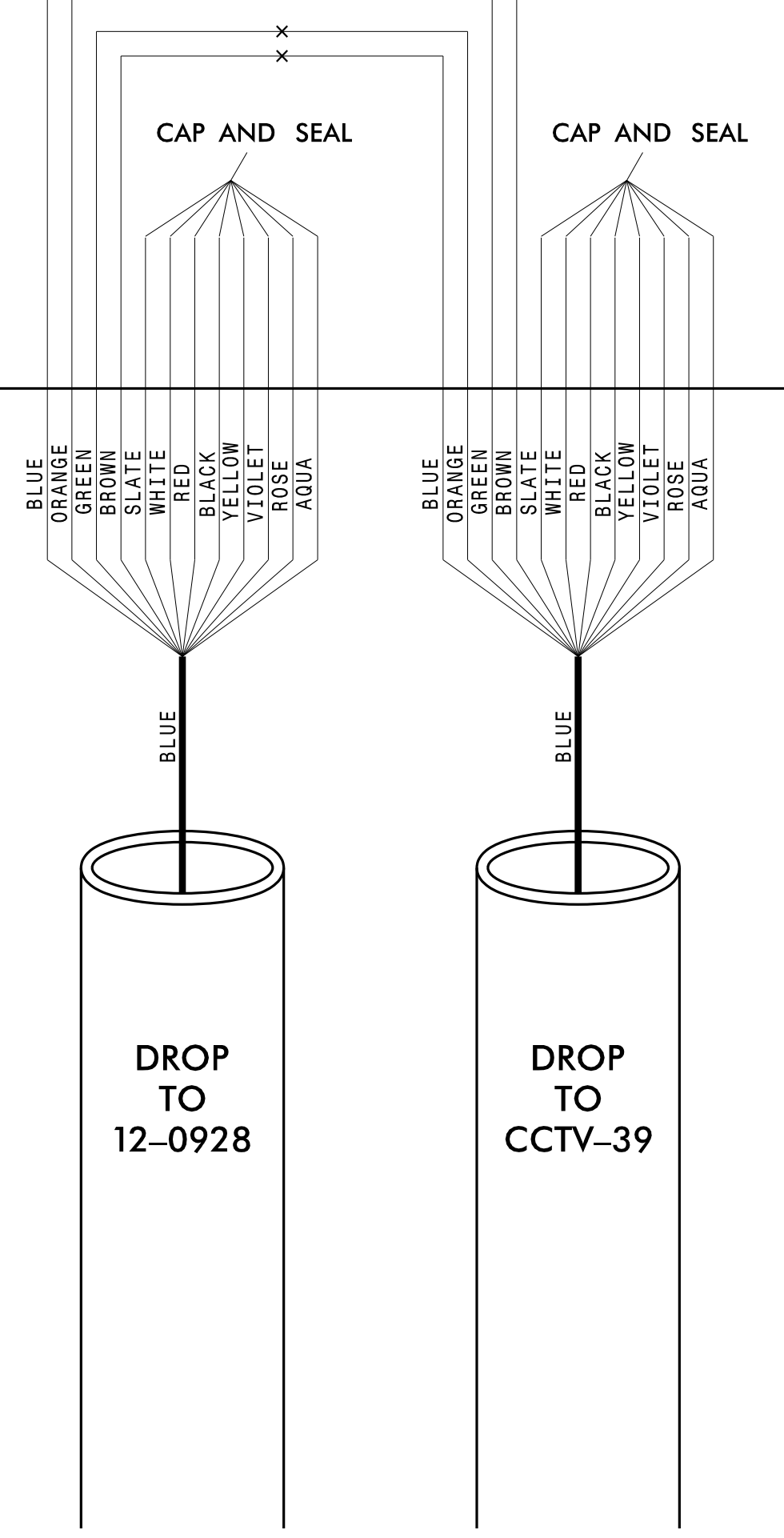
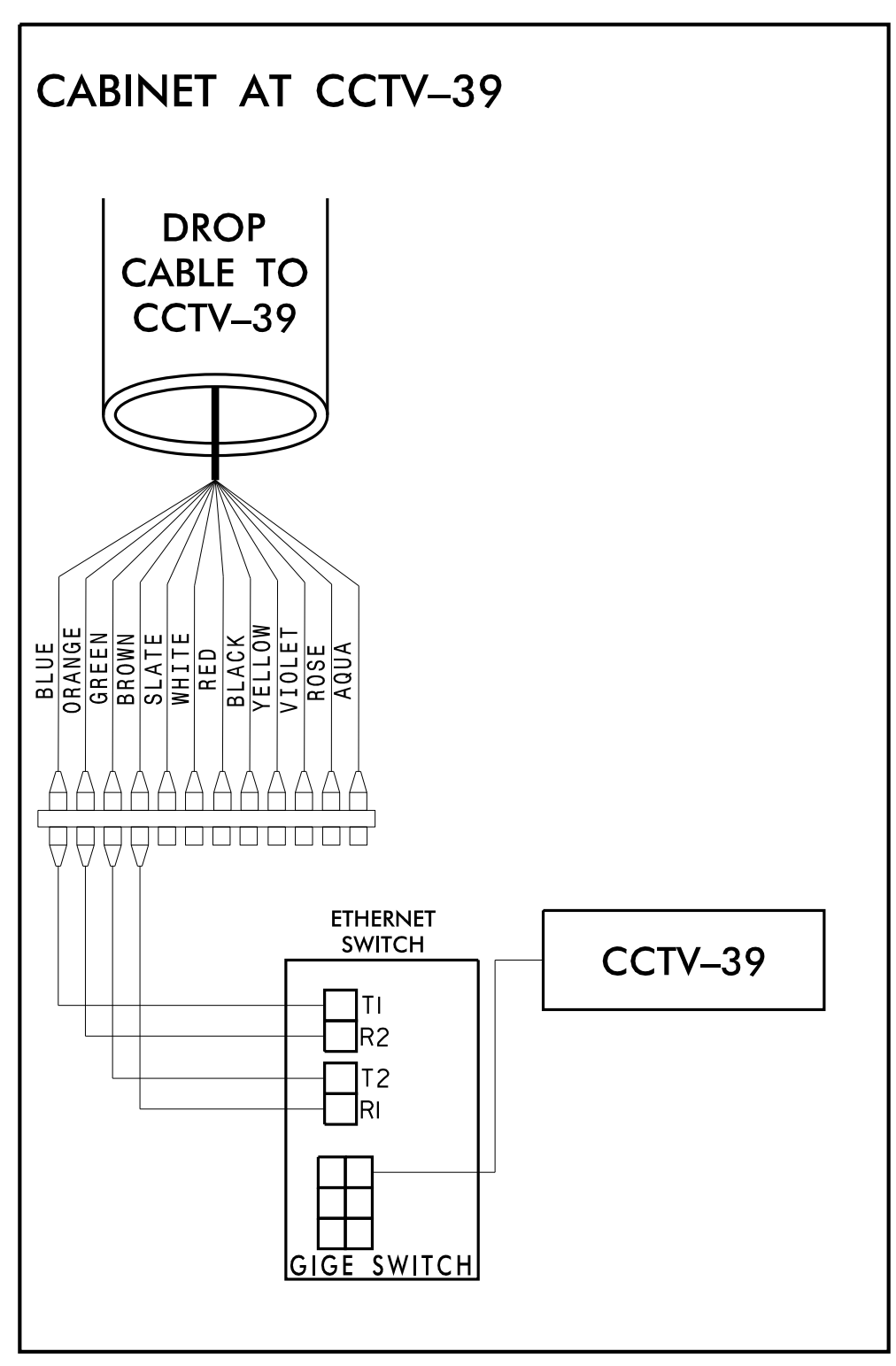
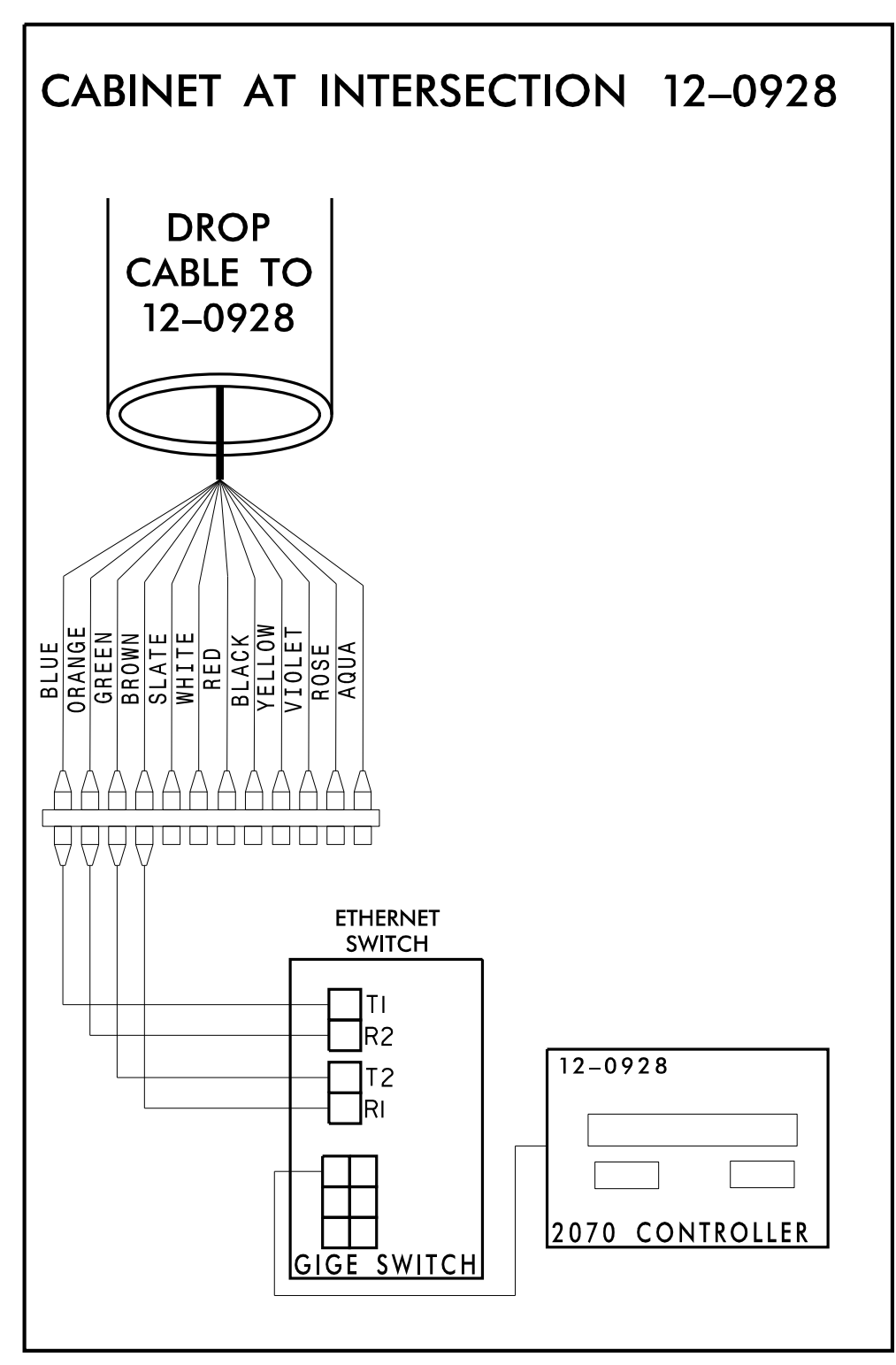
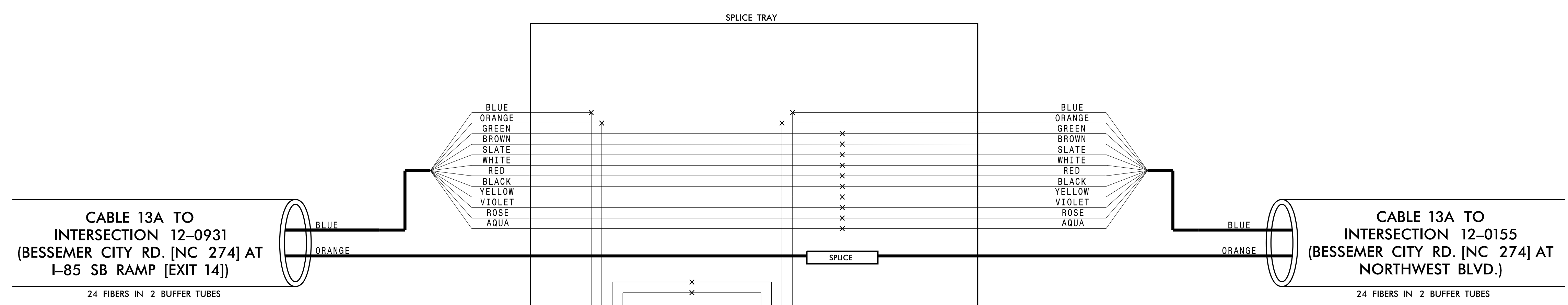

**CHANNEL 13
 CITY OF GASTONIA COMPUTERIZED
 SIGNAL SYSTEM
 SPLICE DETAIL**

Division 12 GASTON COUNTY
 PLAN DATE: DECEMBER 2021 REVIEWED BY: K. SMITH
 PREPARED BY: S. BUTLER REVIEWED BY: I. VAN OSDELL

Scale: 0

Revisions table with columns: REVISIONS, INIT., DATE

Seal: **Kimley»Horn**
 NC License #F-0102
 421 Fayetteville St., Suite 600
 Raleigh, NC 27601
 Tel: (919) 677-2000
 Fax: (919) 677-2050

Professional Engineer Seal: **INGER Z. VAN OSDELL**
 SEAL 028952
 DATE 3/16/2022

3/15/2022 \\kimley-horn.com\SE\RAL\NRA\TPTD\ITS\01036569_Gastonia_Signal_System\6_Tasks\Splicing\SPL133.dgn

CHANNEL 13 SPLICE ENCLOSURE AT (BESSEMER CITY RD. [NC 274] AT NORTHWEST BLVD.) SIG ID 12-0155

COLOR CODE
TIA/EIA 598-C

(1) BLUE	(7) RED
(2) ORANGE	(8) BLACK
(3) GREEN	(9) YELLOW
(4) BROWN	(10) VIOLET
(5) SLATE	(11) ROSE
(6) WHITE	(12) AQUA

LEGEND

X - FUSION SPLICE INDIVIDUAL FIBER
 O - EXISTING SPLICE
 □ - EXPRESS INDIVIDUAL FIBER

EXPRESS - EXPRESS ENTIRE BUFFER TUBE
 SPLICE - SPLICE ENTIRE BUFFER TUBE OR MAINTAIN IF EXISTING EXPRESSED

NOTES:
 1. FIBER INTERCONNECT CENTER RACKS ARE SCHEMATIC ONLY - ACTUAL EQUIPMENT FORM MAY VARY.
 2. ETHERNET SWITCH TERMINATION CONFIGURATIONS ARE GENERIC. CONTRACTOR IS RESPONSIBLE FOR DETERMINING /ENSURING PROPER TERMINATION.
 3. CONTRACTOR IS RESPONSIBLE FOR FIELD VERIFYING EXISTING SPlicing. THE CONTRACTOR SHALL COORDINATE WITH THE ENGINEER WHERE EXISTING SPlicing IS NOT AS EXPECTED.

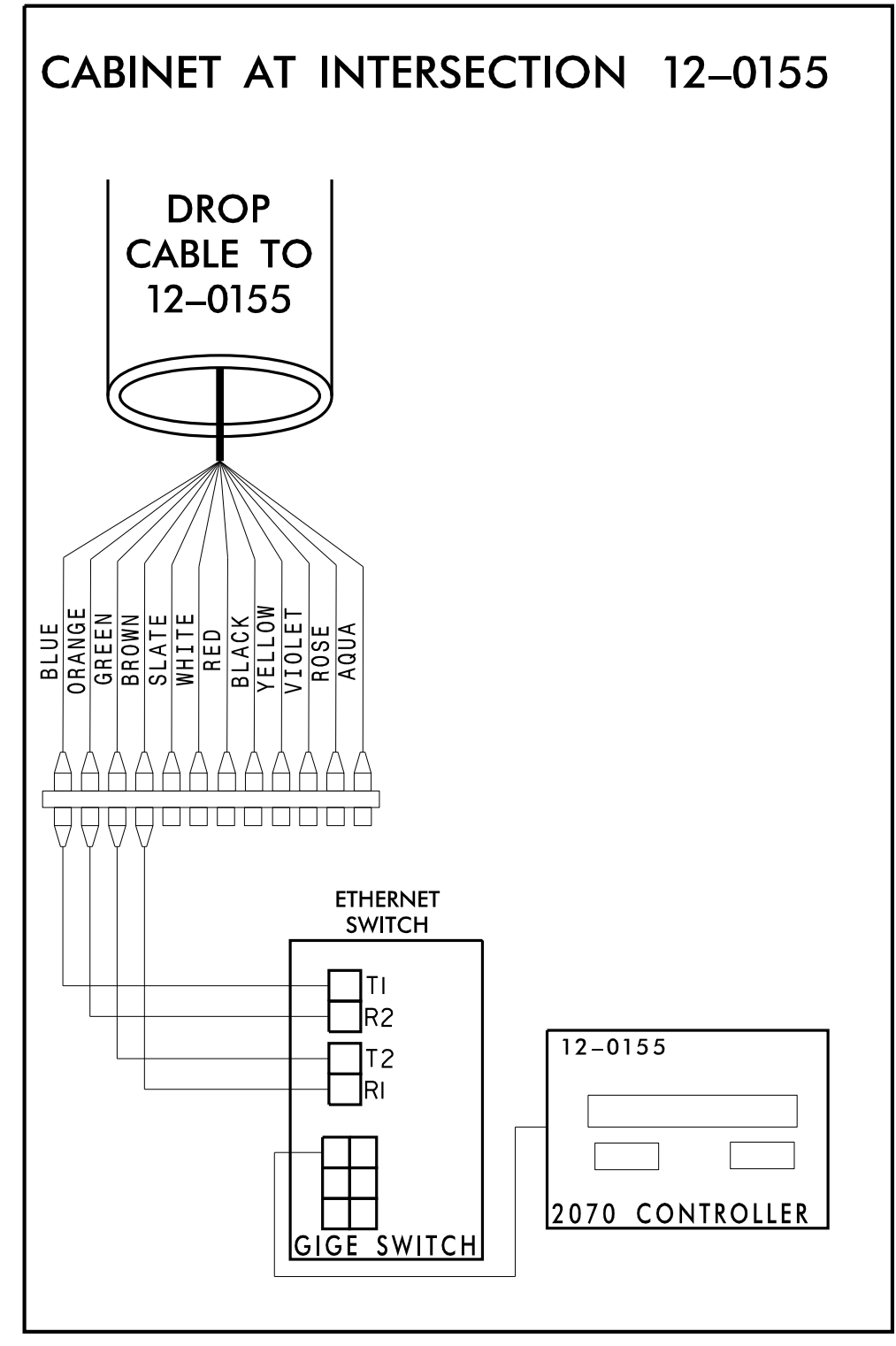
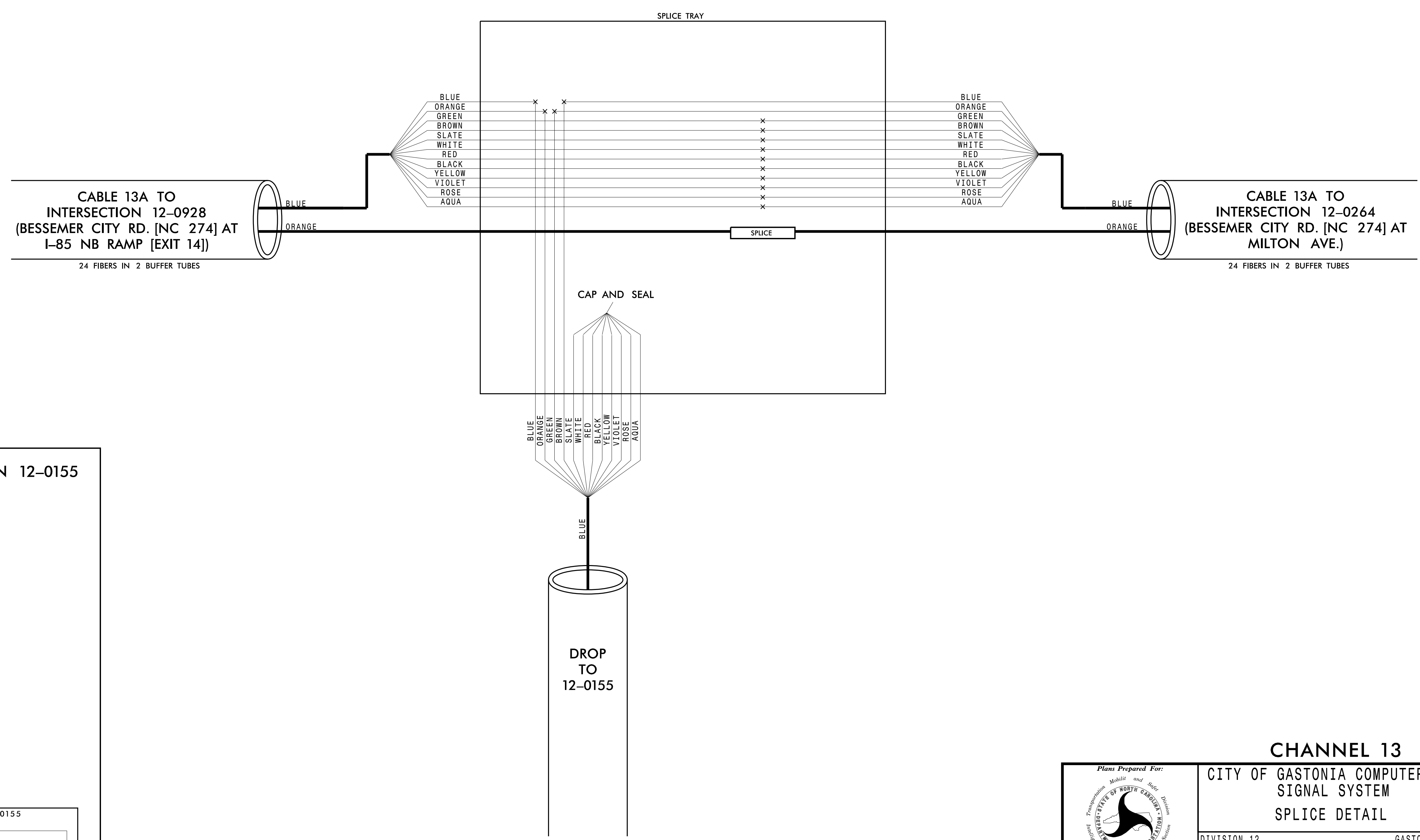

CHANNEL 13
CITY OF GASTONIA COMPUTERIZED SIGNAL SYSTEM
SPLICE DETAIL

DIVISION 12 GASTON COUNTY
 PLAN DATE: DECEMBER 2021 REVIEWED BY: K. SMITH
 PREPARED BY: S. BUTLER REVIEWED BY: I. VAN OSDELL

Scale: 0

Revisions table with columns: REVISIONS, INIT., DATE

DocuSigned by: Inger Van OsdeLL 3/16/2022

Kimley»Horn
 NC License #F-0102
 421 Fayetteville St., Suite 600
 Raleigh, NC 27601
 Tel: (919) 677-2000
 Fax: (919) 677-2050

Professional Engineer Seal: NORTH CAROLINA PROFESSIONAL ENGINEER SEAL 028952 INGER Z. VAN OSDELL

3/15/2022 \\kimley-horn.com\SE-RAL\NRL_TPTD\ITS\01036569_Gastonia_Signal_System\6_Tasks\Splicing\SPL134.dgn

CHANNEL 13
SPLICE ENCLOSURE AT
BESSEMER CITY RD. (NC 274) AT MILTON AVE.
SIG ID 12-0264 (BESSEMER CITY RD [NC 274] AT MILTON AVE.)
SIG ID 12-0636 (BESSEMER CITY RD [NC 274] AT ARKRAY ST/
MYRTLE SCHOOL RD. [SR 1136])

COLOR CODE
TIA/EIA 598-C

(1) BLUE	(7) RED
(2) ORANGE	(8) BLACK
(3) GREEN	(9) YELLOW
(4) BROWN	(10) VIOLET
(5) SLATE	(11) ROSE
(6) WHITE	(12) AQUA

LEGEND

X - FUSION SPLICE INDIVIDUAL FIBER
O - EXISTING SPLICE
□ - EXPRESS INDIVIDUAL FIBER

EXPRESS - EXPRESS ENTIRE BUFFER TUBE
SPLICE - SPLICE ENTIRE BUFFER TUBE OR MAINTAIN IF EXISTING EXPRESSED

NOTES:
1. FIBER INTERCONNECT CENTER RACKS ARE SCHEMATIC ONLY - ACTUAL EQUIPMENT FORM MAY VARY.
2. ETHERNET SWITCH TERMINATION CONFIGURATIONS ARE GENERIC. CONTRACTOR IS RESPONSIBLE FOR DETERMINING /ENSURING PROPER TERMINATION.
3. CONTRACTOR IS RESPONSIBLE FOR FIELD VERIFYING EXISTING SPLICING. THE CONTRACTOR SHALL COORDINATE WITH THE ENGINEER WHERE EXISTING SPLICING IS NOT AS EXPECTED.

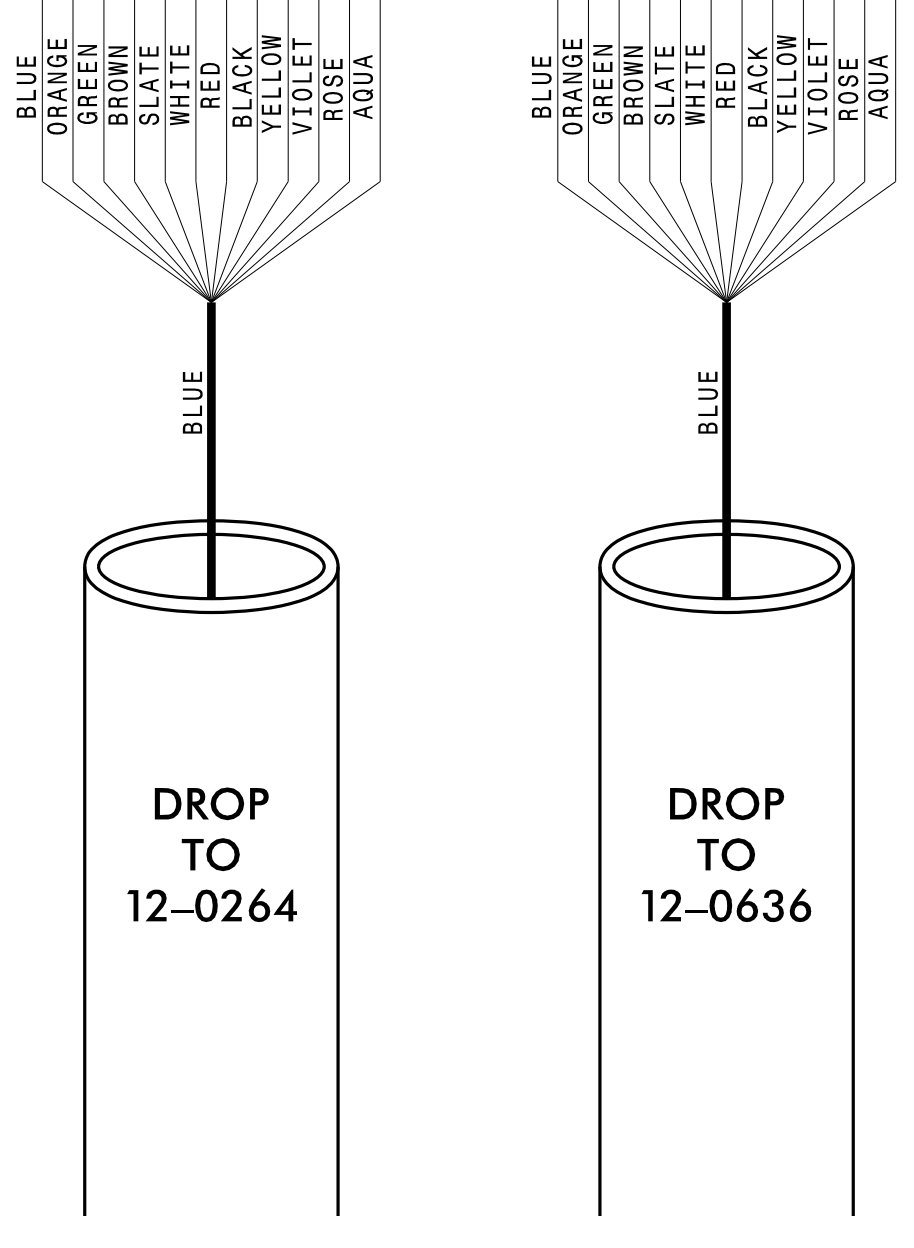
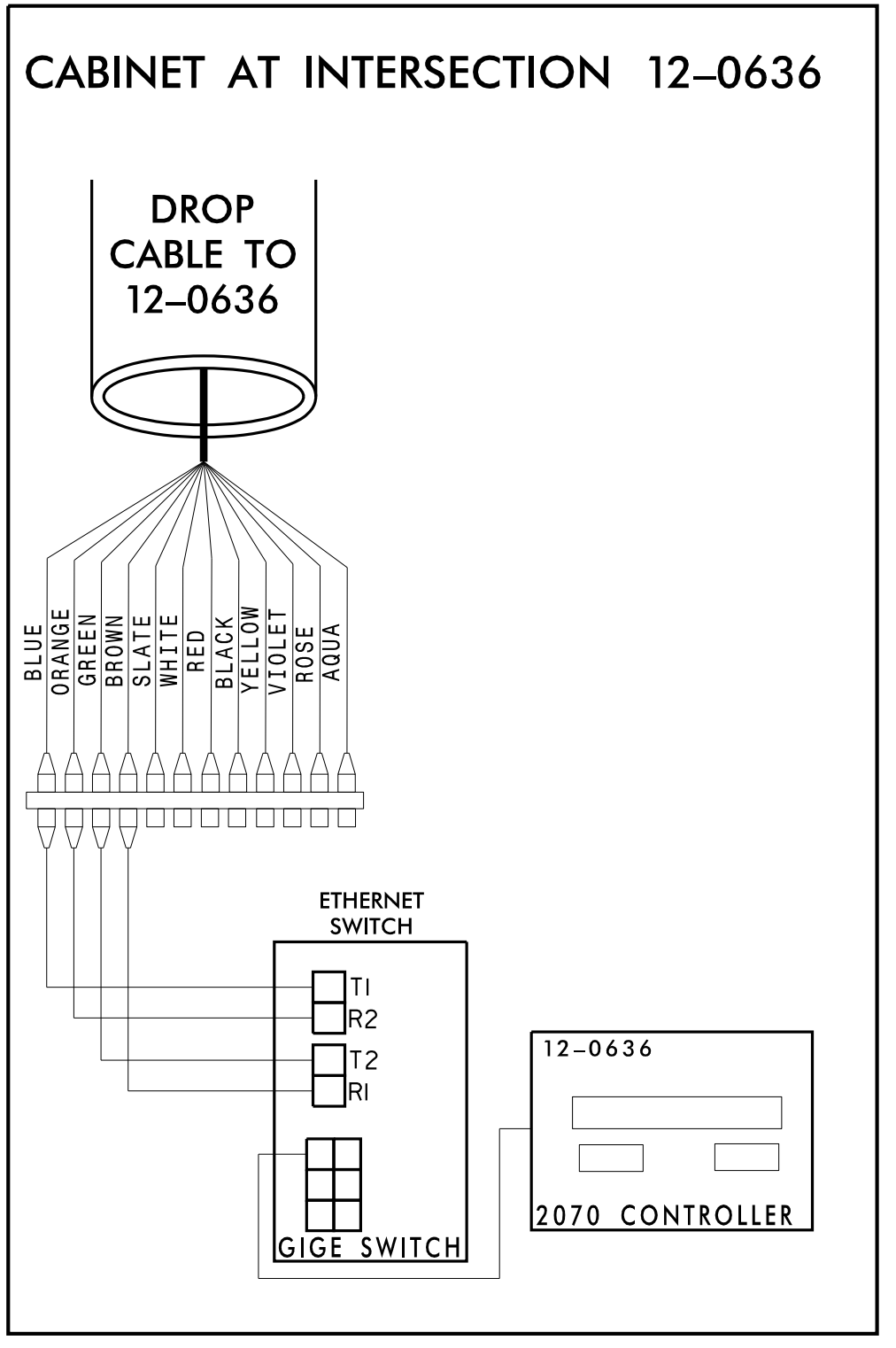
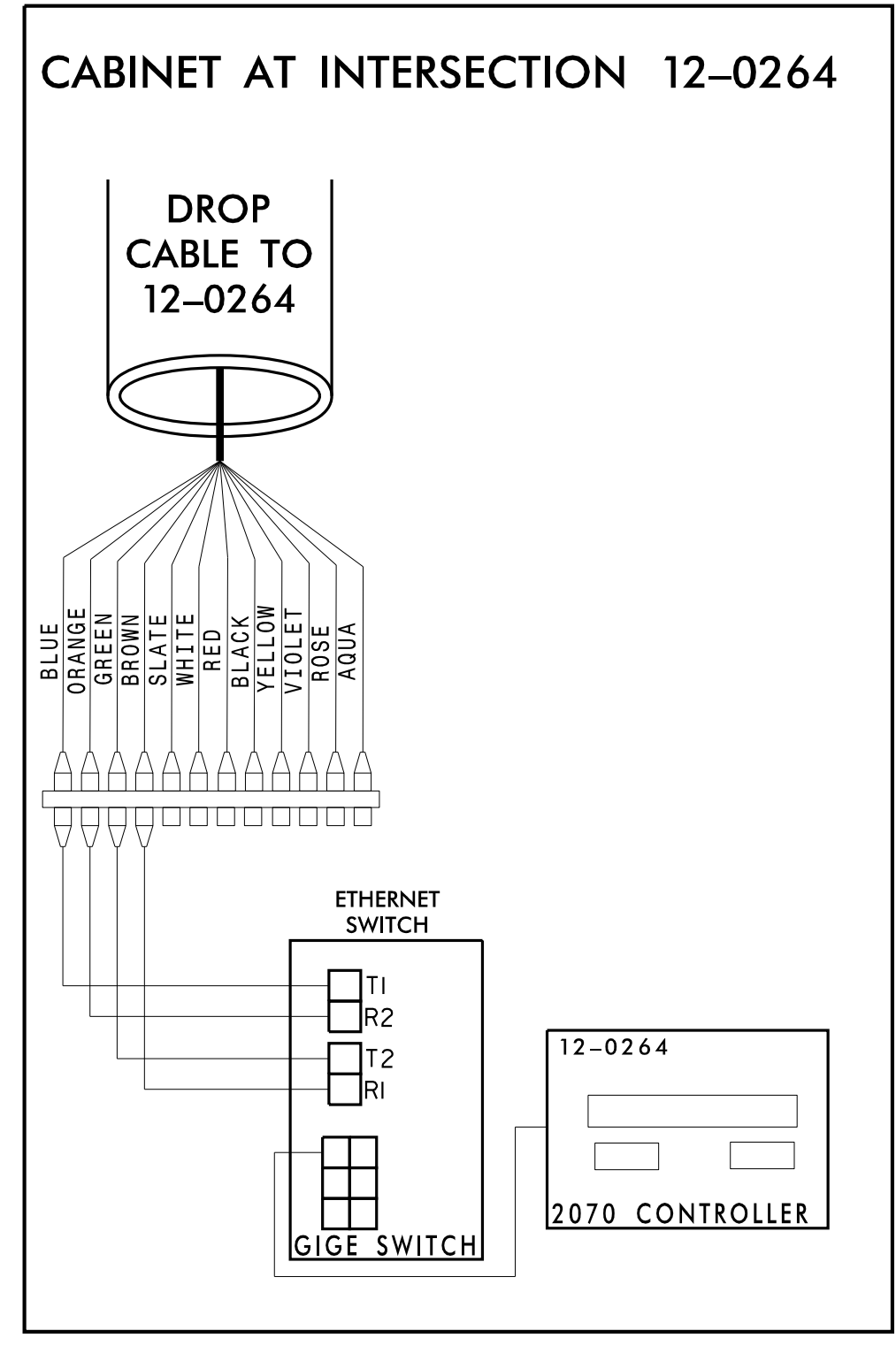
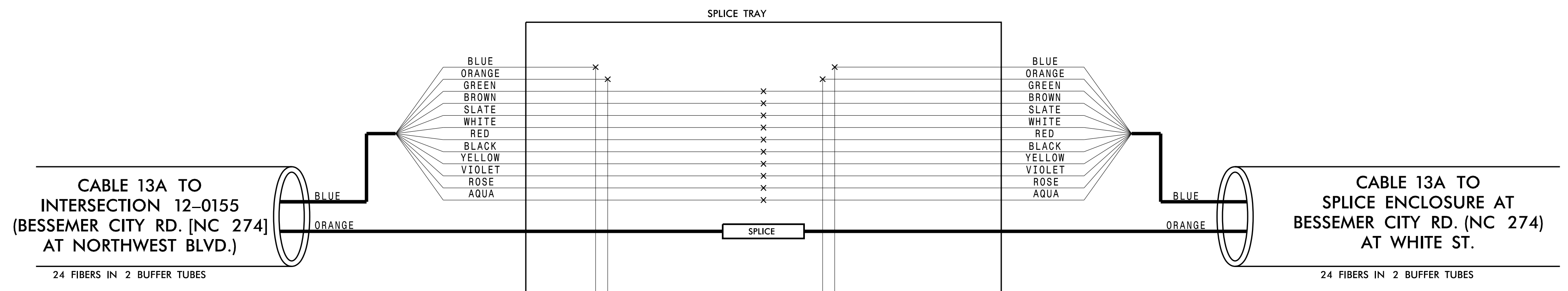

CHANNEL 13
CITY OF GASTONIA COMPUTERIZED SIGNAL SYSTEM
SPLICE DETAIL

Division 12 GASTON COUNTY
PLAN DATE: DECEMBER 2021 REVIEWED BY: K. SMITH
PREPARED BY: S. BUTLER REVIEWED BY: I. VAN OSDELL

Scale: 0

Revisions table with columns: REVISIONS, INIT., DATE

Professional Engineer Seal: **Kimley-Horn**, NC License #F-0102, 421 Fayetteville St., Suite 600, Raleigh, NC 27601. Engineer: **Iger Van Osdel**, Seal 028952, Date 3/16/2022.

3/15/2022 \\kimley-horn.com\SE-RAL\NRA\TPTD\ITS\01036569_Gastonia_Signal_System\6_Tasks\Splcing\SPL135.dgn

**CHANNEL 13
SPLICE ENCLOSURE AT
BESSEMER CITY RD. (NC 274) AT WHITE ST.**

COLOR CODE TIA/EIA 598-C		LEGEND	
(1) BLUE	(7) RED	X	- FUSION SPLICE INDIVIDUAL FIBER
(2) ORANGE	(8) BLACK	O	- EXISTING SPLICE
(3) GREEN	(9) YELLOW	□	- EXPRESS INDIVIDUAL FIBER
(4) BROWN	(10) VIOLET	EXPRESS	EXPRESS ENTIRE BUFFER TUBE
(5) SLATE	(11) ROSE	SPLICE	SPLICE ENTIRE BUFFER TUBE OR MAINTAIN IF EXISTING EXPRESSED
(6) WHITE	(12) AQUA	NOTES:	
1. FIBER INTERCONNECT CENTER RACKS ARE SCHEMATIC ONLY - ACTUAL EQUIPMENT FORM MAY VARY.			
2. ETHERNET SWITCH TERMINATION CONFIGURATIONS ARE GENERIC. CONTRACTOR IS RESPONSIBLE FOR DETERMINING /ENSURING PROPER TERMINATION.			
3. CONTRACTOR IS RESPONSIBLE FOR FIELD VERIFYING EXISTING SPlicing. THE CONTRACTOR SHALL COORDINATE WITH THE ENGINEER WHERE EXISTING SPlicing IS NOT AS EXPECTED.			

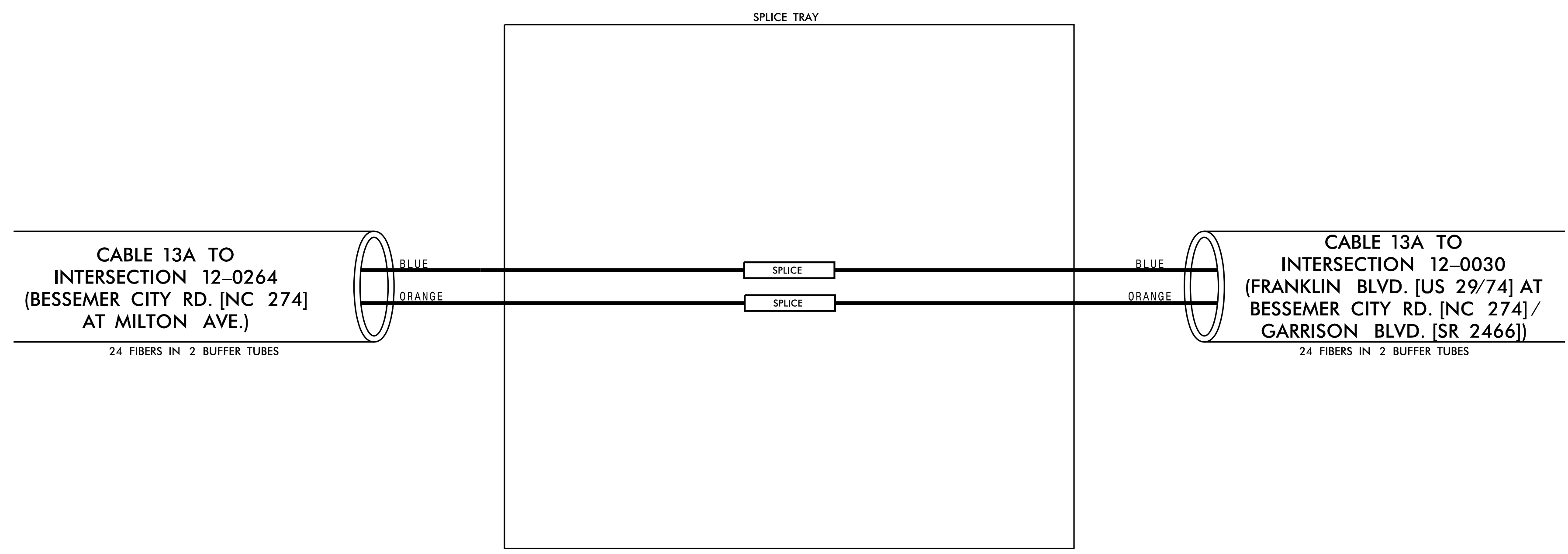

3/15/2022 \\kimley-horn.com\SE\RAL\NRA\TPTD\ITS\01036569_Gastonia_Signal_System\6_Tasks\Splicing\SPL136.dgn

Kimley»Horn
NC License #F-0102
421 Fayetteville St., Suite 600
Raleigh, NC 27601
Tel: (919) 677-2000
Fax: (919) 677-2050

CHANNEL 13

**CITY OF GASTONIA COMPUTERIZED
SIGNAL SYSTEM
SPLICE DETAIL**



250 N. Greenfield Place, Garner, NC 27529

DIVISION 12	GASTON COUNTY
PLAN DATE: DECEMBER 2021	REVIEWED BY: K. SMITH
PREPARED BY: S. BUTLER	REVIEWED BY: I. VAN OSDELL

REVISIONS	INIT.	DATE

SEAL

DocuSigned by:
Iuger Van OsdeLL 3/16/2022

DATE

CADD Filename:

CHANNEL 14
SPLICE ENCLOSURE AT
FRANKLIN BLVD. (US 29/74) AT WEBB ST.
SIG ID 12-0031 (FRANKLIN BLVD. [US 29/74] AT WEBB ST.)
SIG ID 12-0032 (FRANKLIN BLVD. [US 29/74] AT
LINWOOD RD. [SR 1131]/GASTON AVE. [SR 1339])
CCTV CAMERA-06

COLOR CODE
TIA/EIA 598-C

(1) BLUE	(7) RED
(2) ORANGE	(8) BLACK
(3) GREEN	(9) YELLOW
(4) BROWN	(10) VIOLET
(5) SLATE	(11) ROSE
(6) WHITE	(12) AQUA

LEGEND

X - FUSION SPlice INDIVIDUAL FIBER
O - EXISTING SPlice
□ - EXPRESS INDIVIDUAL FIBER

EXPRESS - EXPRESS ENTIRE BUFFER TUBE
SPlice - SPlice ENTIRE BUFFER TUBE OR MAINTAIN IF EXISTING EXPRESSED

NOTES:
1. FIBER INTERCONNECT CENTER RACKS ARE SCHEMATIC ONLY - ACTUAL EQUIPMENT FORM MAY VARY.
2. ETHERNET SWITCH TERMINATION CONFIGURATIONS ARE GENERIC. CONTRACTOR IS RESPONSIBLE FOR DETERMINING /ENSURING PROPER TERMINATION.
3. CONTRACTOR IS RESPONSIBLE FOR FIELD VERIFYING EXISTING SPlicing. THE CONTRACTOR SHALL COORDINATE WITH THE ENGINEER WHERE EXISTING SPlicing IS NOT AS EXPECTED.

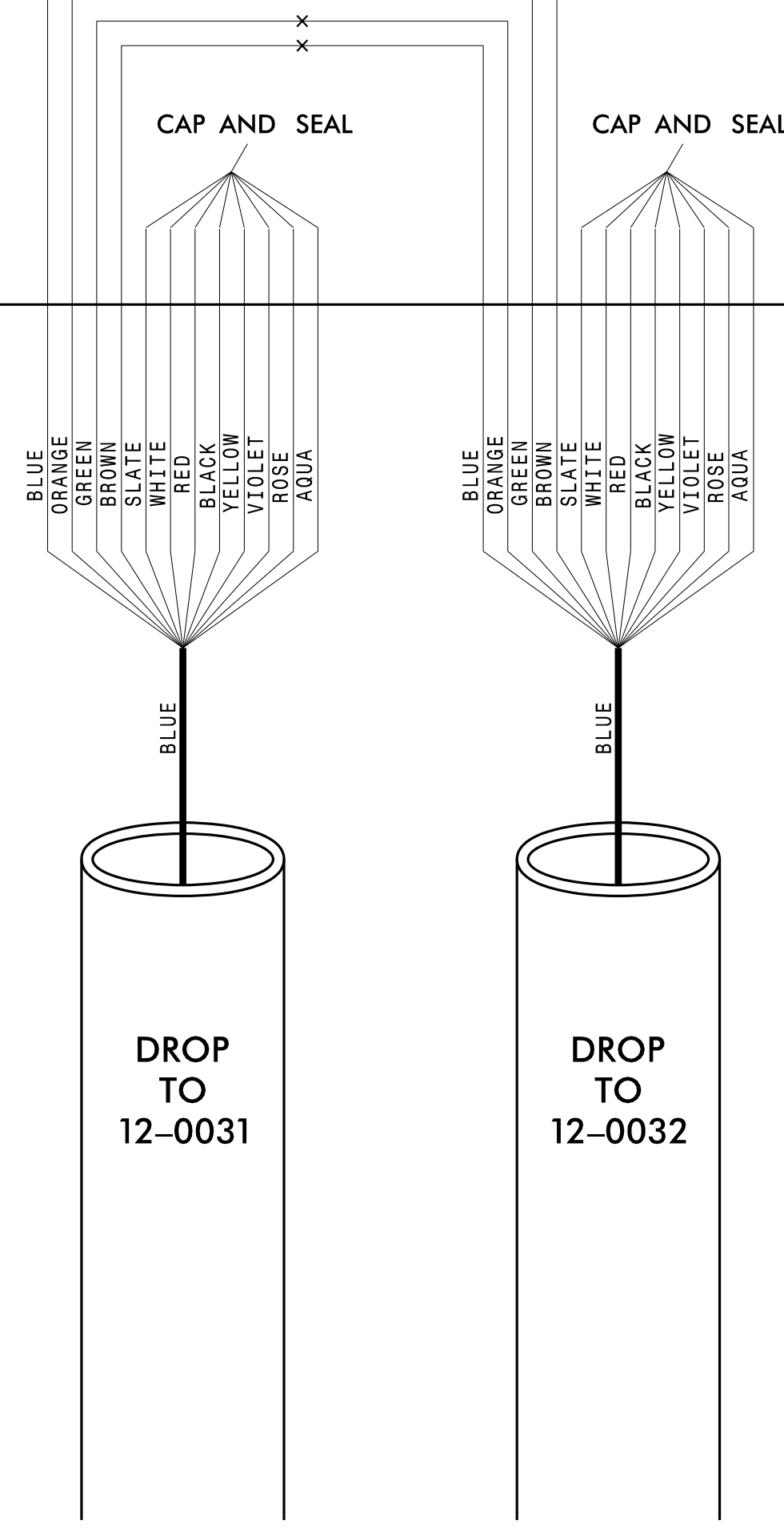
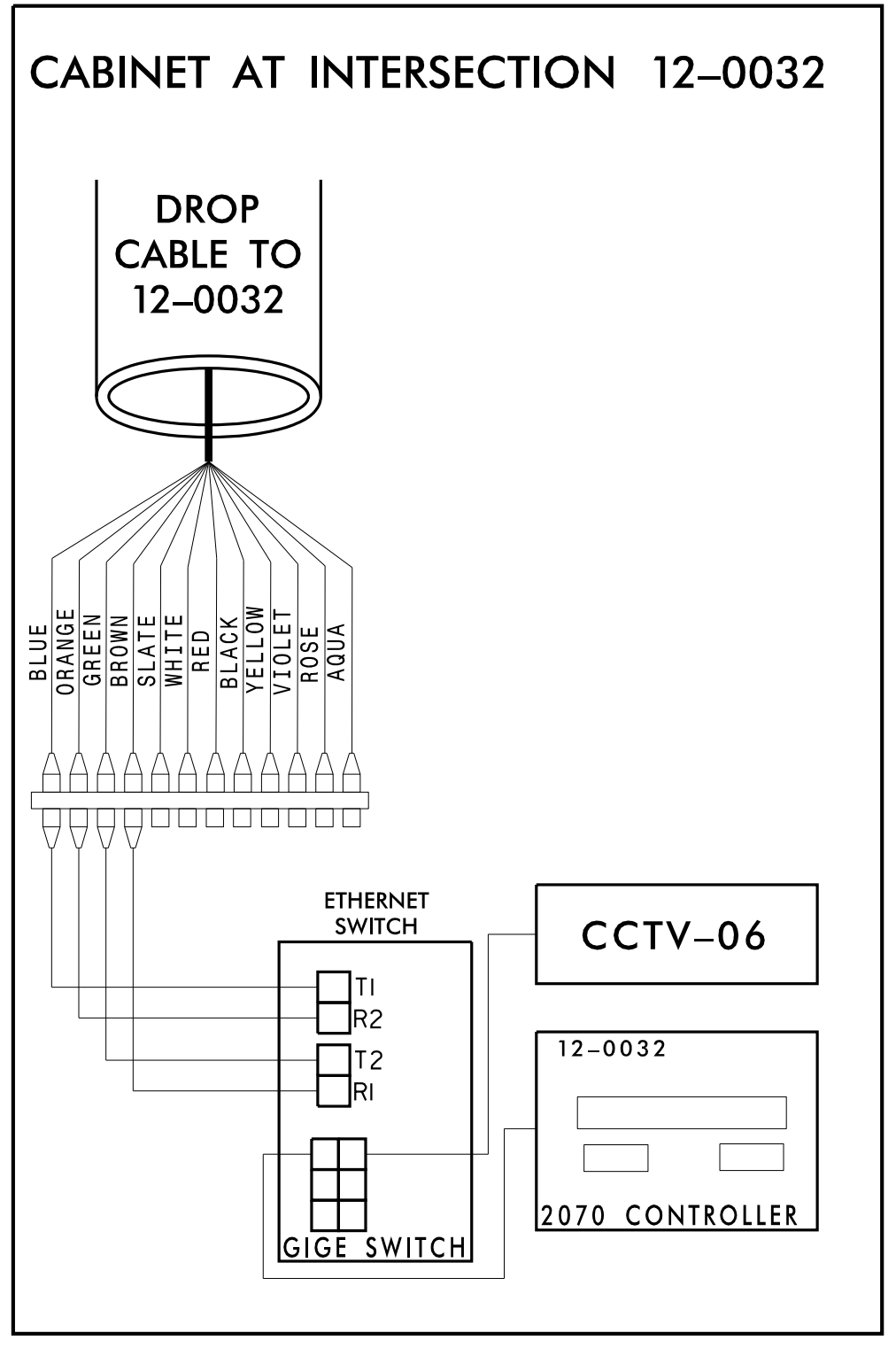
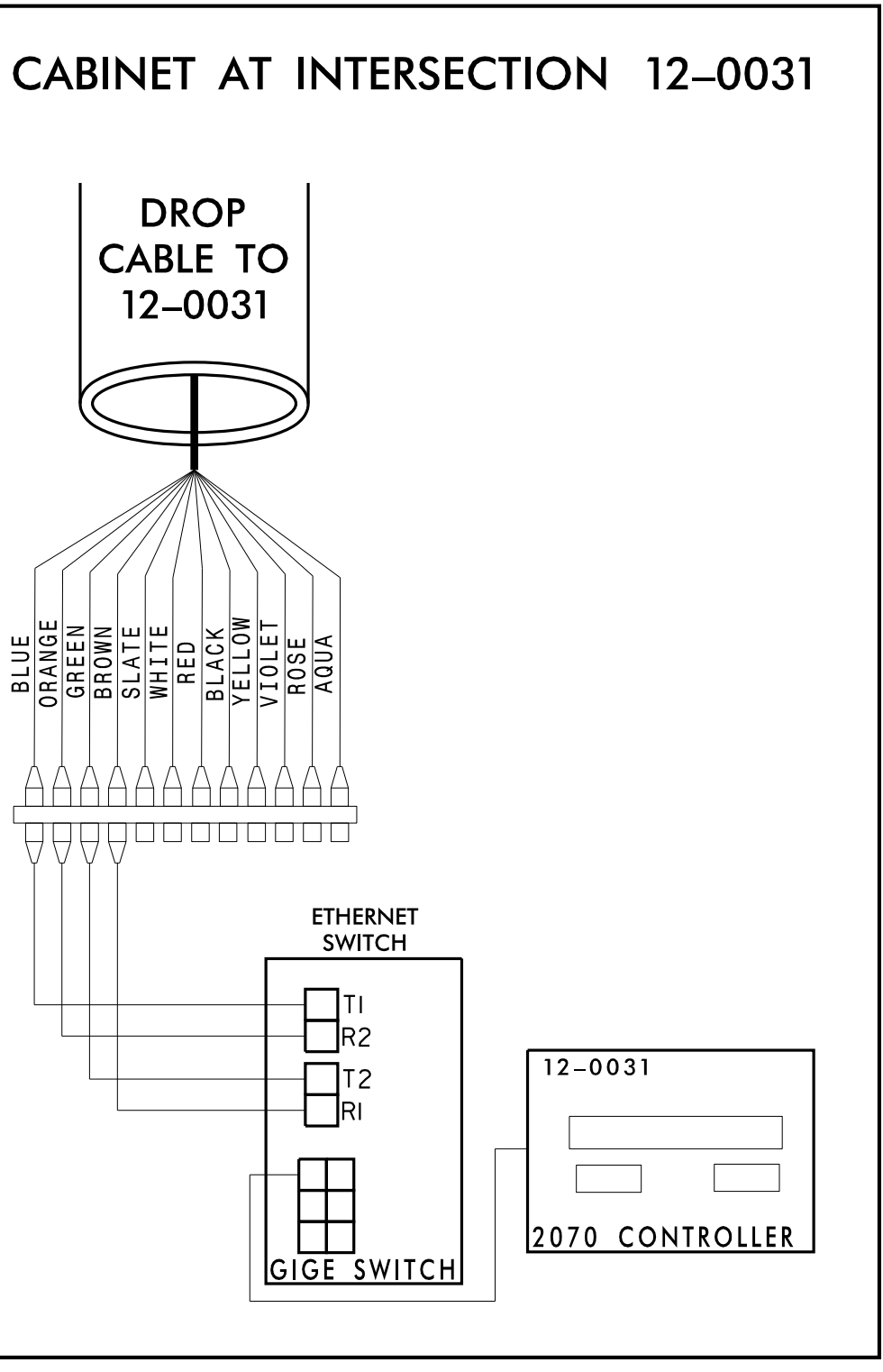
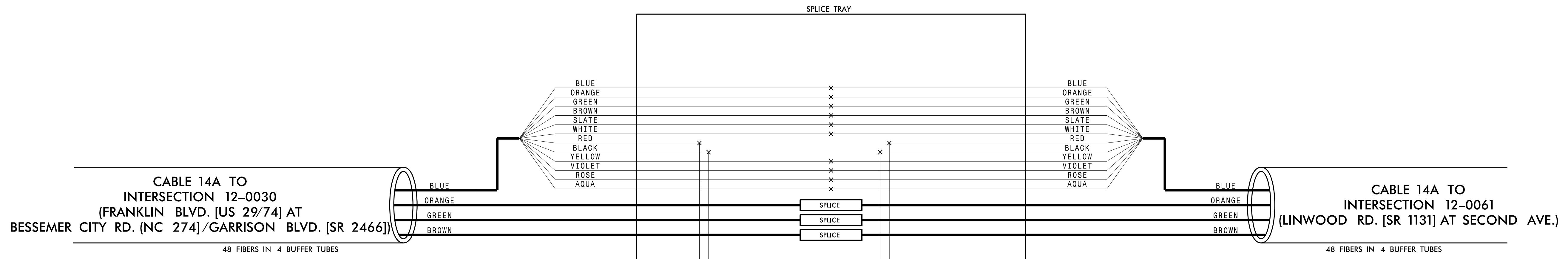

CHANNEL 14
CITY OF GASTONIA COMPUTERIZED SIGNAL SYSTEM
SPlice DETAIL

DIVISION 12		GASTON COUNTY	
PLAN DATE: DECEMBER 2021	REVIEWED BY: K. SMITH	PREPARED BY: S. BUTLER	REVIEWED BY: I. VAN OSDELL
REVISIONS	INIT.	DATE	

Kimley»Horn
NC License #F-0102
421 Fayetteville St., Suite 600
Raleigh, NC 27601
Tel: (919) 677-2000
Fax: (919) 677-2050

SEAL
NORTH CAROLINA PROFESSIONAL ENGINEER
No. 028952
Inger Van Osdel
3/16/2022

3/15/2022 \\kimley-horn.com\SE-RAL\NRA\TPTO\ITS\01036569_Gastonia_Signal_System\6_Tasks\Splicing\SPL137.dgn

CHANNEL 14
SPLICE ENCLOSURE AT
LINWOOD RD. (SR 1131) AT SECOND AVE.
SIG ID 12-0061 (LINWOOD RD. [SR 1131] AT SECOND AVE.)
SIG ID 12-0632 (LINWOOD RD. [SR 1131]
AT GARRISON BLVD. [SR 2466])

COLOR CODE
TIA/EIA 598-C

(1) BLUE	(7) RED
(2) ORANGE	(8) BLACK
(3) GREEN	(9) YELLOW
(4) BROWN	(10) VIOLET
(5) SLATE	(11) ROSE
(6) WHITE	(12) AQUA

LEGEND

X - FUSION SPLICE INDIVIDUAL FIBER
 O - EXISTING SPLICE
 □ - EXPRESS INDIVIDUAL FIBER

EXPRESS - EXPRESS ENTIRE BUFFER TUBE
 SPLICE - SPLICE ENTIRE BUFFER TUBE OR MAINTAIN IF EXISTING EXPRESSED

NOTES:

1. FIBER INTERCONNECT CENTER RACKS ARE SCHEMATIC ONLY - ACTUAL EQUIPMENT FORM MAY VARY.
2. ETHERNET SWITCH TERMINATION CONFIGURATIONS ARE GENERIC. CONTRACTOR IS RESPONSIBLE FOR DETERMINING /ENSURING PROPER TERMINATION.
3. CONTRACTOR IS RESPONSIBLE FOR FIELD VERIFYING EXISTING SPLICING. THE CONTRACTOR SHALL COORDINATE WITH THE ENGINEER WHERE EXISTING SPLICING IS NOT AS EXPECTED.

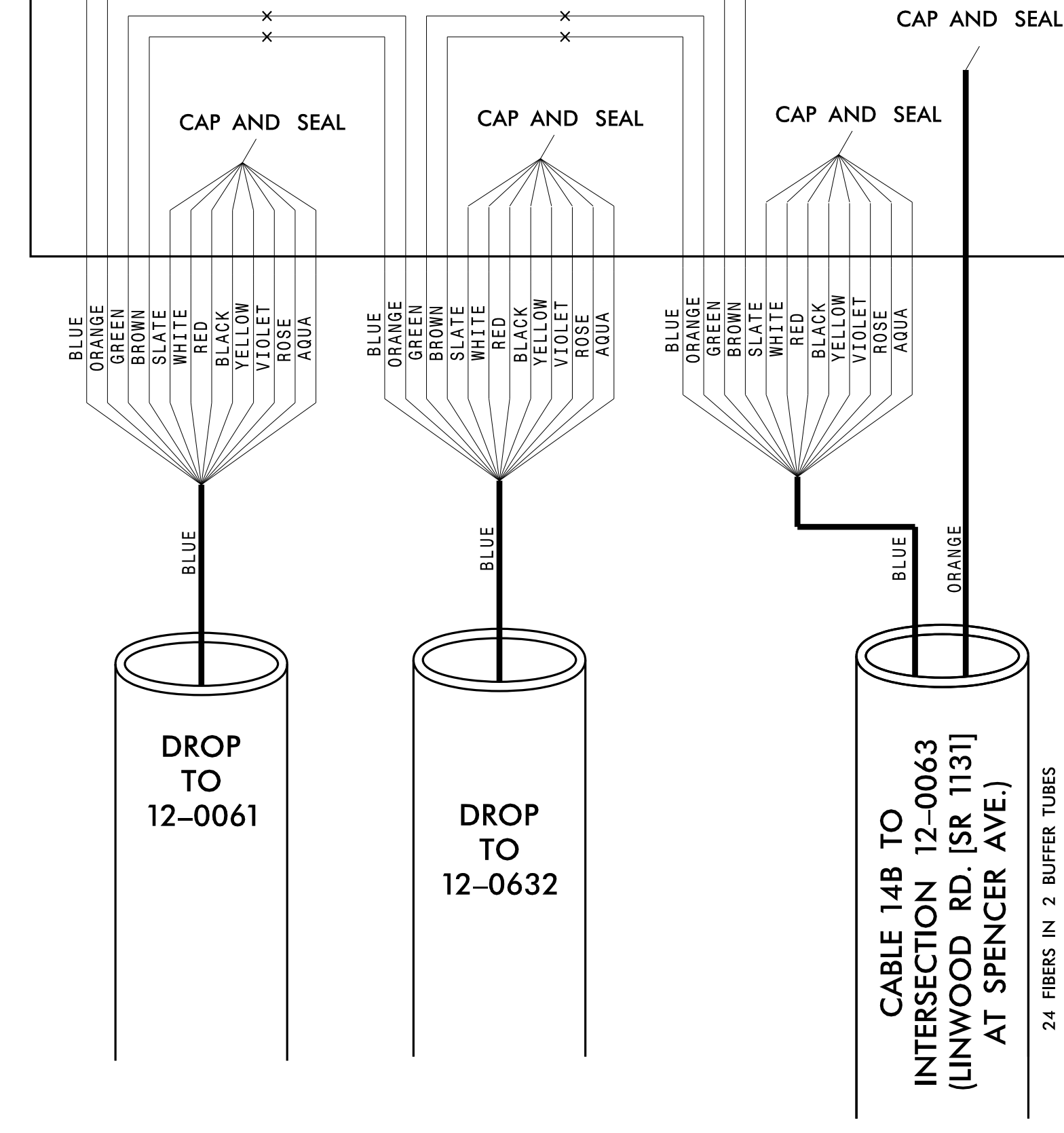
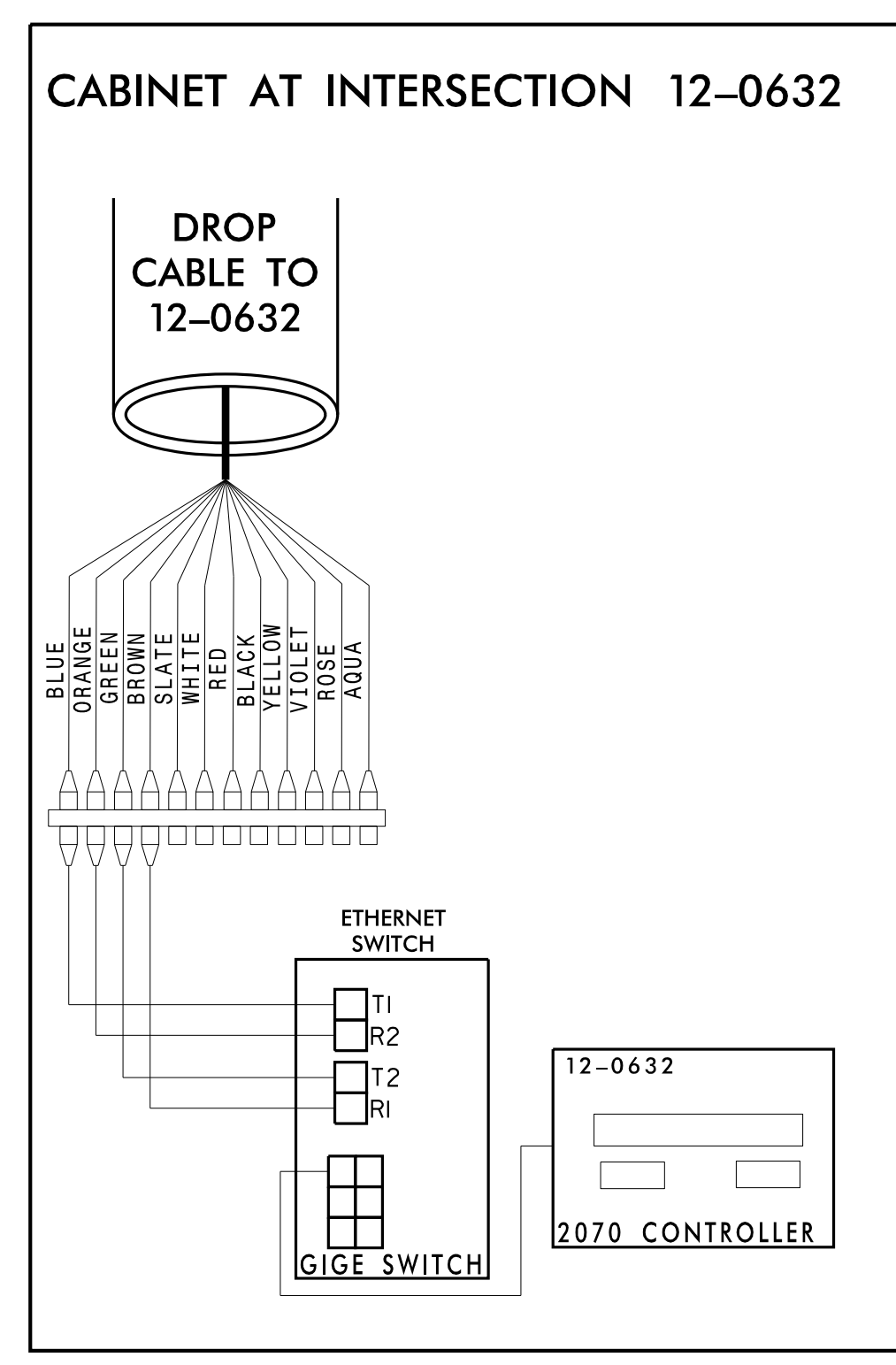
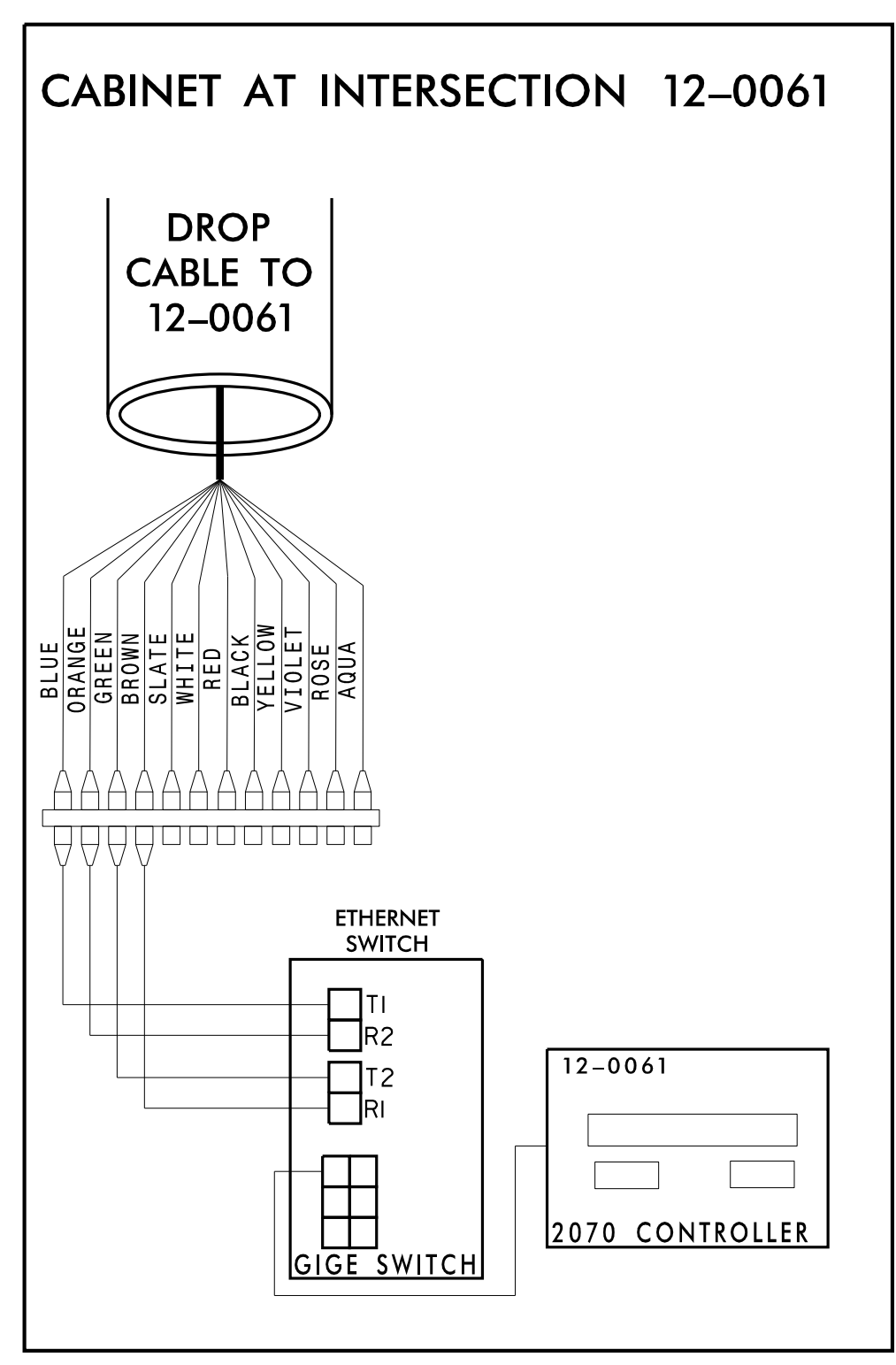
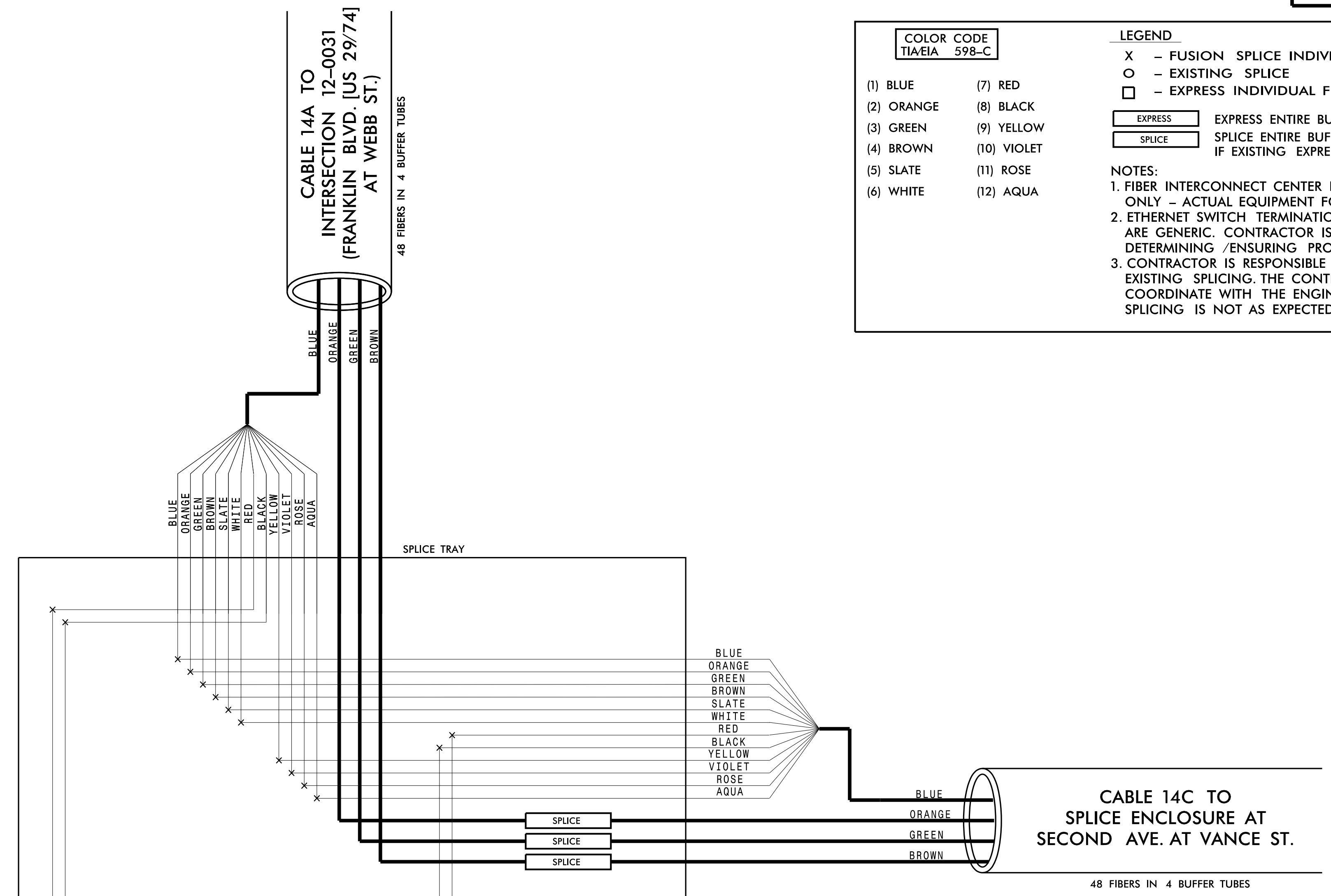

Kimley»Horn
 NC License #F-0102
 421 Fayetteville St., Suite 600
 Raleigh, NC 27601
 Tel: (919) 677-2000
 Fax: (919) 677-2050

CHANNEL 14
 CITY OF GASTONIA COMPUTERIZED
 SIGNAL SYSTEM
 SPLICE DETAIL

DIVISION 12 GASTON COUNTY
 PLAN DATE: DECEMBER 2021 REVIEWED BY: K. SMITH
 PREPARED BY: S. BUTLER REVIEWED BY: I. VAN OSDELL

SCALE: 0

REVISIONS: INIT. DATE

DocuSigned by: Inger Van OsdeLL 3/16/2022

3/15/2022 \\kimley-horn.com\SE-RAL\NRA\TPTO\ITS\01036569_Gastonia_Signal_System\6_Tasks\Splicing\SPL138.dgn

CHANNEL 14
SPLICE ENCLOSURE AT
(LINWOOD RD. [SR 1131] AT SPENCER AVE.)
SIG ID 12-0063

COLOR CODE
TIA/EIA 598-C

(1) BLUE	(7) RED
(2) ORANGE	(8) BLACK
(3) GREEN	(9) YELLOW
(4) BROWN	(10) VIOLET
(5) SLATE	(11) ROSE
(6) WHITE	(12) AQUA

LEGEND

X - FUSION SPLICE INDIVIDUAL FIBER
 O - EXISTING SPLICE
 □ - EXPRESS INDIVIDUAL FIBER

EXPRESS - EXPRESS ENTIRE BUFFER TUBE
 SPLICE - SPLICE ENTIRE BUFFER TUBE OR MAINTAIN IF EXISTING EXPRESSED

NOTES:
 1. FIBER INTERCONNECT CENTER RACKS ARE SCHEMATIC ONLY - ACTUAL EQUIPMENT FORM MAY VARY.
 2. ETHERNET SWITCH TERMINATION CONFIGURATIONS ARE GENERIC. CONTRACTOR IS RESPONSIBLE FOR DETERMINING /ENSURING PROPER TERMINATION.
 3. CONTRACTOR IS RESPONSIBLE FOR FIELD VERIFYING EXISTING SPlicing. THE CONTRACTOR SHALL COORDINATE WITH THE ENGINEER WHERE EXISTING SPlicing IS NOT AS EXPECTED.

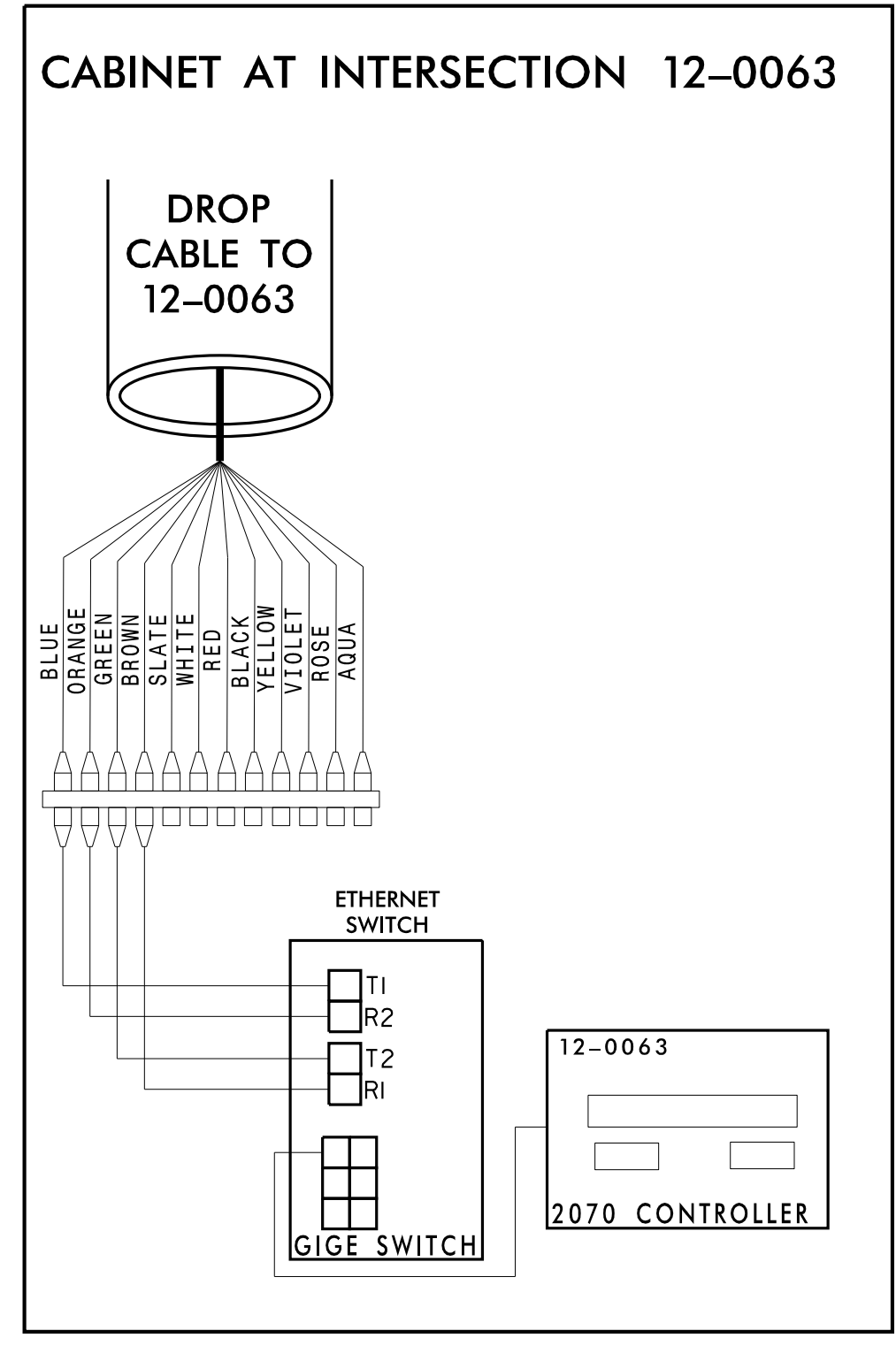
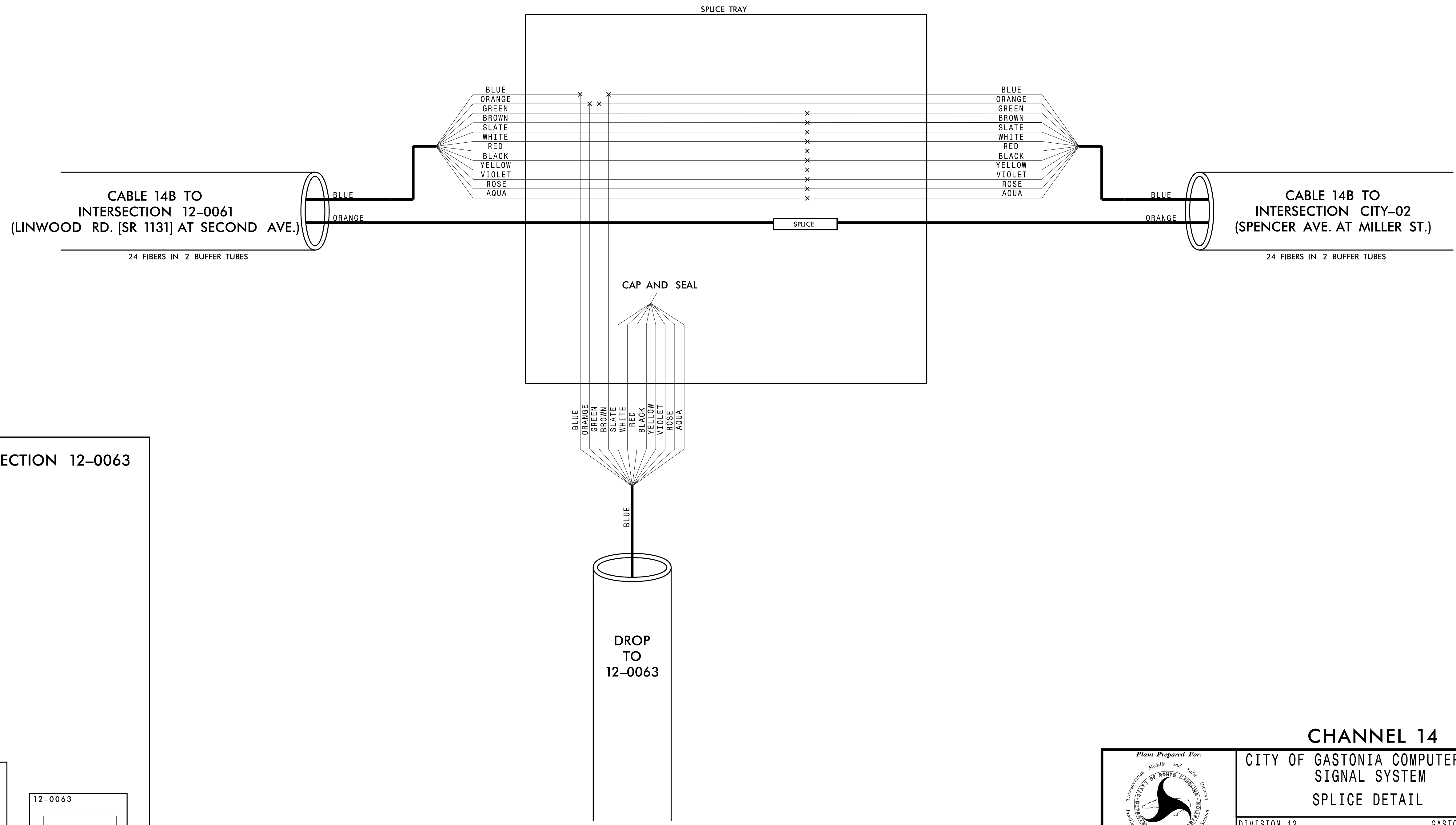

CHANNEL 14
CITY OF GASTONIA COMPUTERIZED SIGNAL SYSTEM
SPLICE DETAIL

DIVISION 12		GASTON COUNTY	
PLAN DATE: DECEMBER 2021	REVIEWED BY: K. SMITH	PREPARED BY: S. BUTLER	REVIEWED BY: I. VAN OSDELL
REVISIONS	INIT.	DATE	

Kimley»Horn
 NC License #F-0102
 421 Fayetteville St., Suite 600
 Raleigh, NC 27601
 Tel: (919) 677-2000
 Fax: (919) 677-2050

SEAL

DocuSigned by: Iger Van OsdeLL
 3/16/2022

3/15/2022 \\kimley-horn.com\SE-RAL\NRL_TPTD\ITS\01036569_Gastonia_Signal_System\6_Tasks\Splicing\SPL139.dgn

**CHANNEL 14
SPLICE ENCLOSURE AT
(SPENCER AVE. AT MILLER ST.)
SIG ID CITY-02**

COLOR CODE TIA/EIA 598-C		LEGEND	
(1) BLUE	(7) RED	X - FUSION SPLICE INDIVIDUAL FIBER	
(2) ORANGE	(8) BLACK	O - EXISTING SPLICE	
(3) GREEN	(9) YELLOW	□ - EXPRESS INDIVIDUAL FIBER	
(4) BROWN	(10) VIOLET	EXPRESS	EXPRESS ENTIRE BUFFER TUBE
(5) SLATE	(11) ROSE	SPLICE	SPLICE ENTIRE BUFFER TUBE OR MAINTAIN IF EXISTING EXPRESSED
(6) WHITE	(12) AQUA	NOTES:	
1. FIBER INTERCONNECT CENTER RACKS ARE SCHEMATIC ONLY - ACTUAL EQUIPMENT FORM MAY VARY.			
2. ETHERNET SWITCH TERMINATION CONFIGURATIONS ARE GENERIC. CONTRACTOR IS RESPONSIBLE FOR DETERMINING /ENSURING PROPER TERMINATION.			
3. CONTRACTOR IS RESPONSIBLE FOR FIELD VERIFYING EXISTING SPLICING. THE CONTRACTOR SHALL COORDINATE WITH THE ENGINEER WHERE EXISTING SPLICING IS NOT AS EXPECTED.			

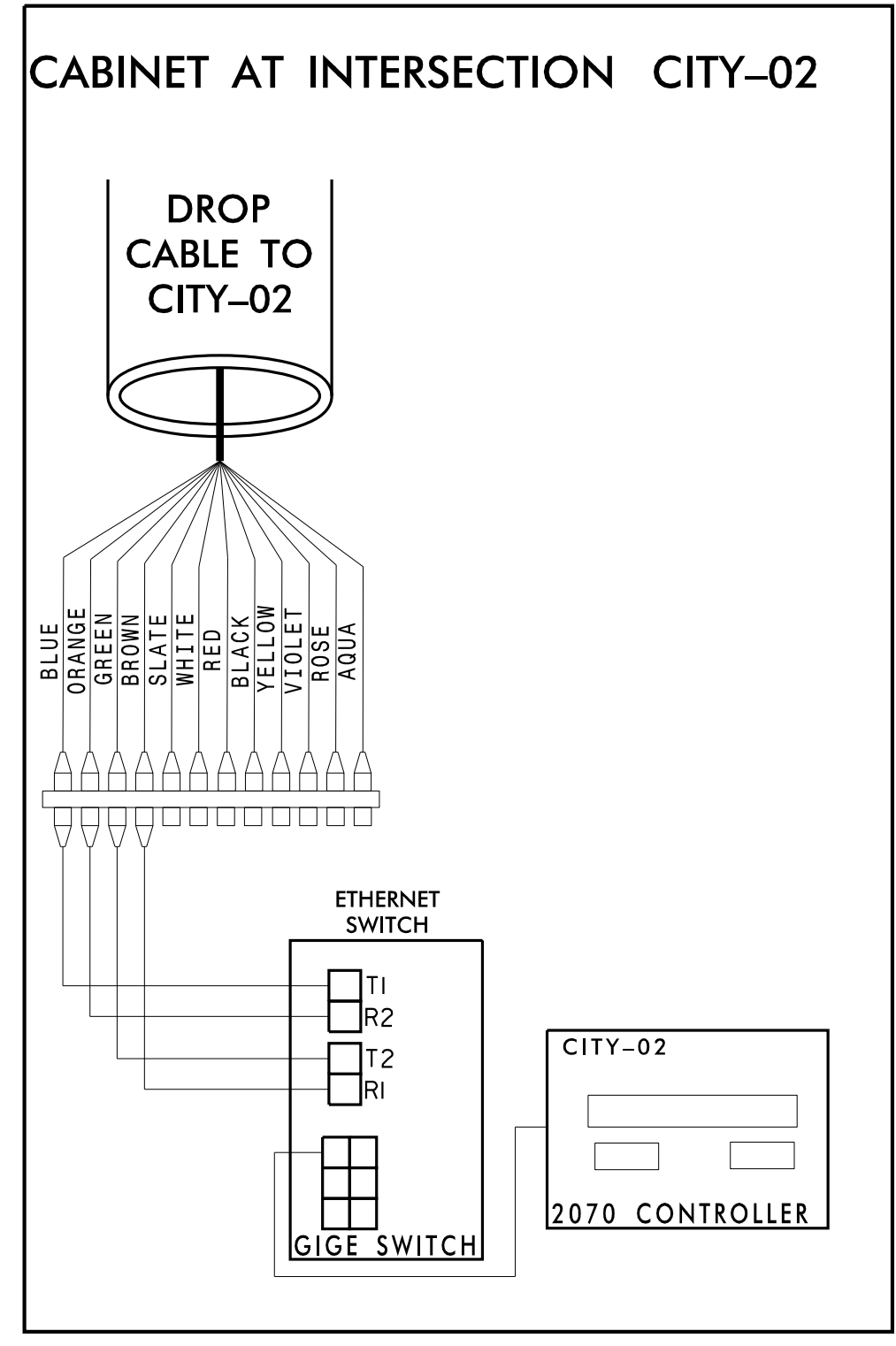
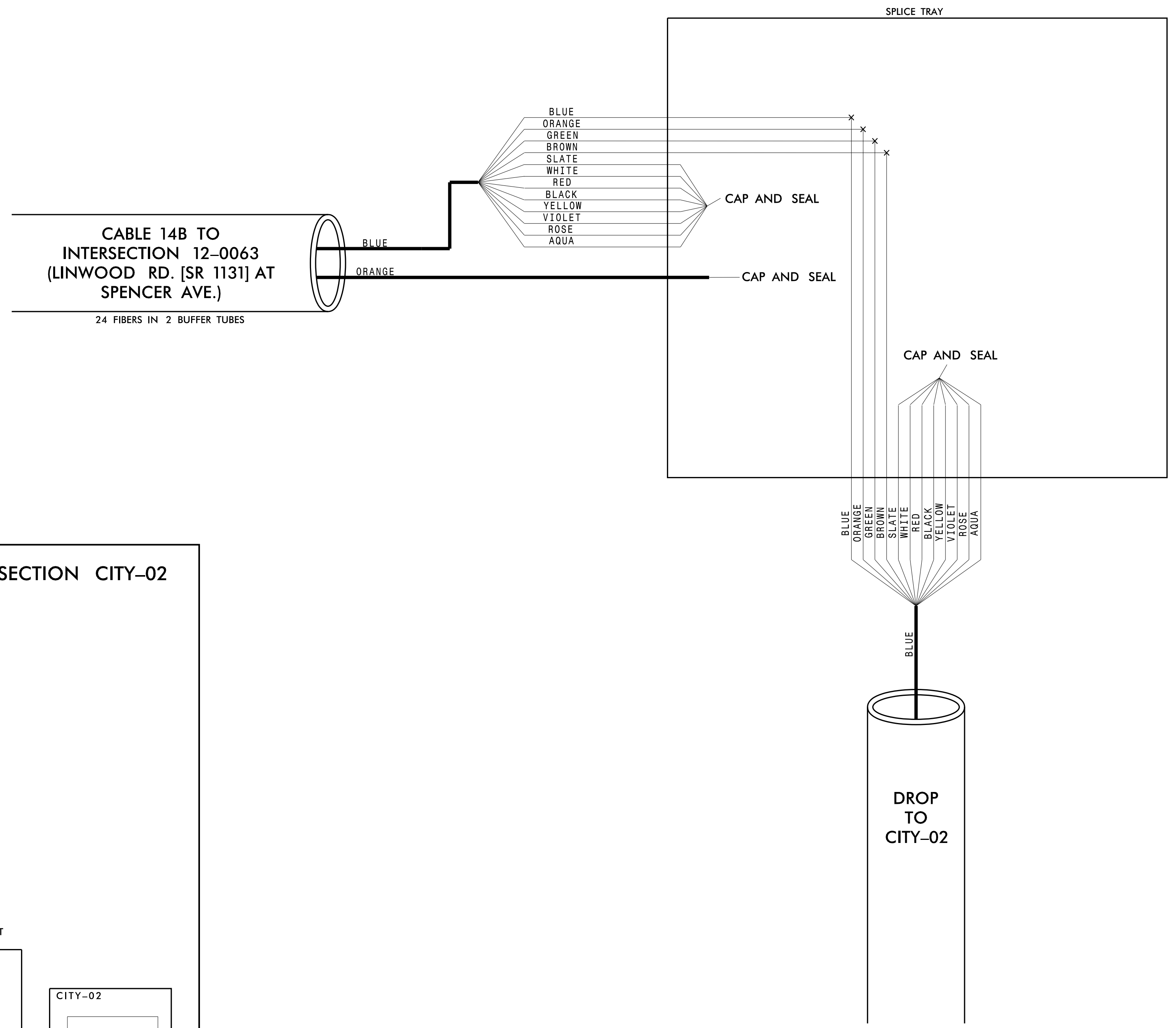

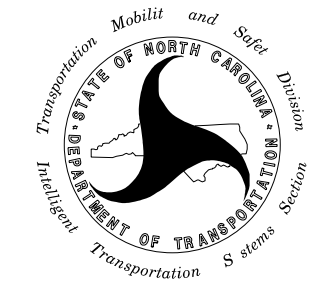
Plans Prepared For:

 250 N. Greenfield Place, Garner, NC 27529

CHANNEL 14
CITY OF GASTONIA COMPUTERIZED SIGNAL SYSTEM
SPLICE DETAIL

DIVISION 12		GASTON COUNTY	
PLAN DATE: DECEMBER 2021	REVIEWED BY: K. SMITH	PREPARED BY: S. BUTLER	REVIEWED BY: I. VAN OSDELL
REVISIONS	INIT.	DATE	

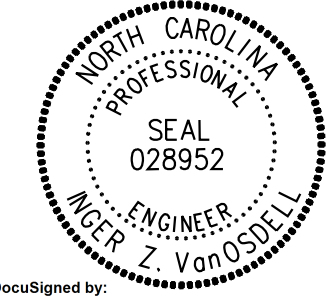
Kimley»Horn
 NC License #F-0102
 421 Fayetteville St., Suite 600
 Raleigh, NC 27601
 Tel: (919) 677-2000
 Fax: (919) 677-2050

SEAL

 Iger Van OsdeLL
 3/16/2022
 DATE

3/15/2022 \\kimley-horn.com\SE-RAL\NRA\1PTD\ITS\01036569_Gastonia_Signal_System\6_Tasks\Splicing\SPL140.dgn

CHANNEL 14
SPLICE ENCLOSURE AT
(SECOND AVE. AT VANCE ST.)
SIG ID 12-0033 (FRANKLIN BLVD. [US 29/74]
AT VANCE ST.)

COLOR CODE
TIA/EIA 598-C

(1) BLUE	(7) RED
(2) ORANGE	(8) BLACK
(3) GREEN	(9) YELLOW
(4) BROWN	(10) VIOLET
(5) SLATE	(11) ROSE
(6) WHITE	(12) AQUA

LEGEND

X - FUSION SPLICE INDIVIDUAL FIBER
 O - EXISTING SPLICE
 □ - EXPRESS INDIVIDUAL FIBER

EXPRESS - EXPRESS ENTIRE BUFFER TUBE
 SPLICE - SPLICE ENTIRE BUFFER TUBE OR MAINTAIN IF EXISTING EXPRESSED

NOTES:

- FIBER INTERCONNECT CENTER RACKS ARE SCHEMATIC ONLY - ACTUAL EQUIPMENT FORM MAY VARY.
- ETHERNET SWITCH TERMINATION CONFIGURATIONS ARE GENERIC. CONTRACTOR IS RESPONSIBLE FOR DETERMINING /ENSURING PROPER TERMINATION.
- CONTRACTOR IS RESPONSIBLE FOR FIELD VERIFYING EXISTING SPlicing. THE CONTRACTOR SHALL COORDINATE WITH THE ENGINEER WHERE EXISTING SPlicing IS NOT AS EXPECTED.

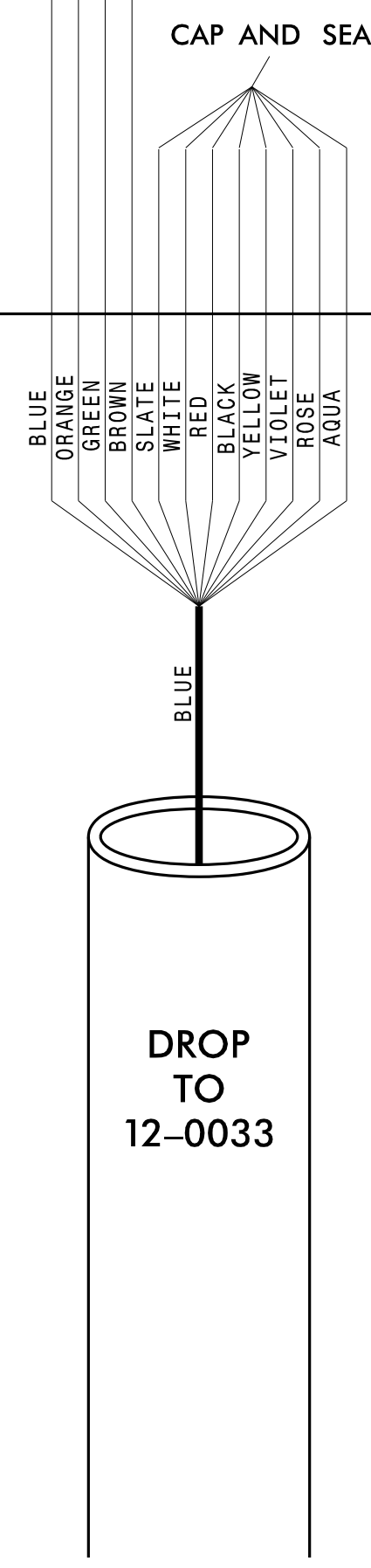
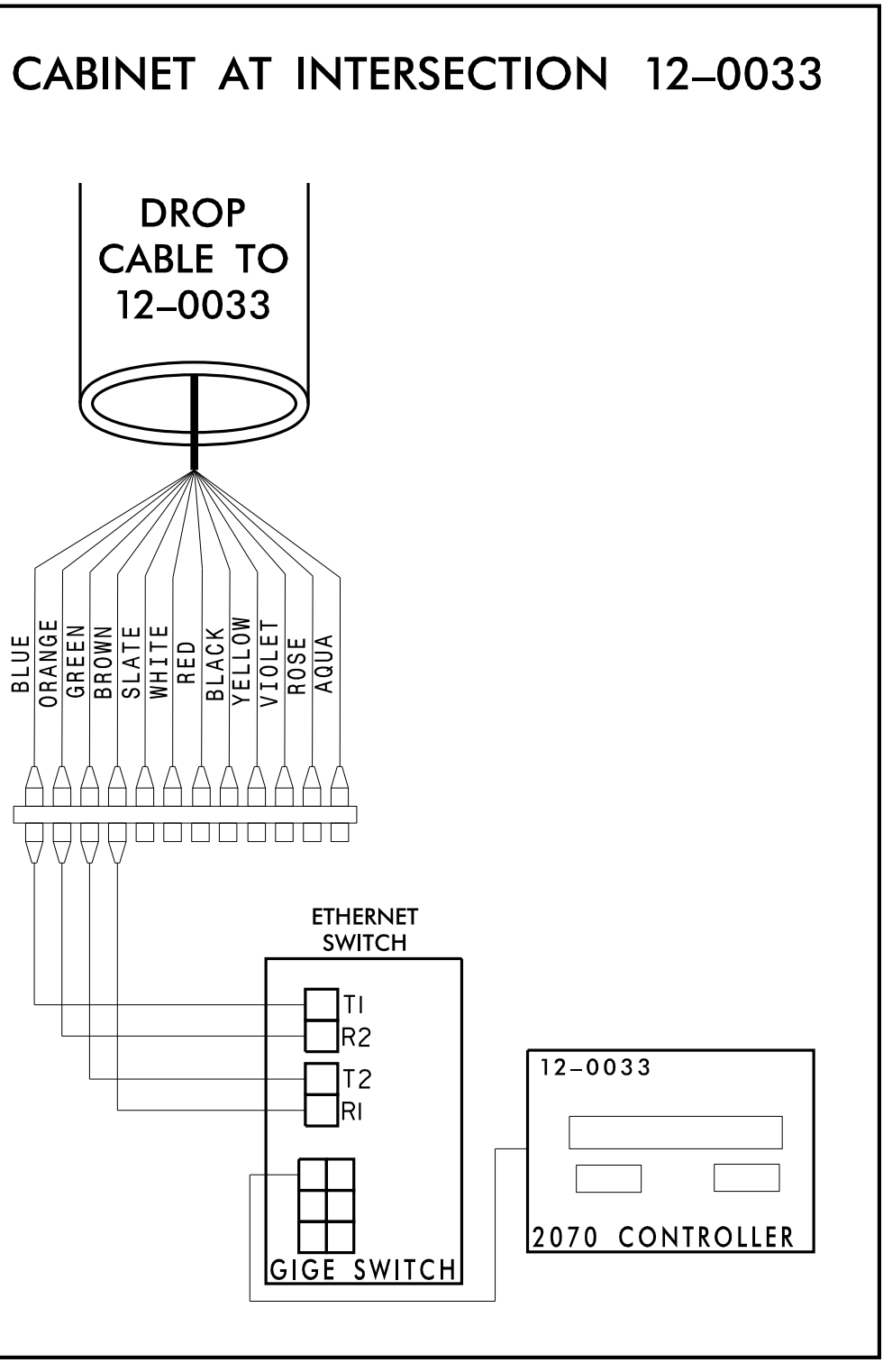
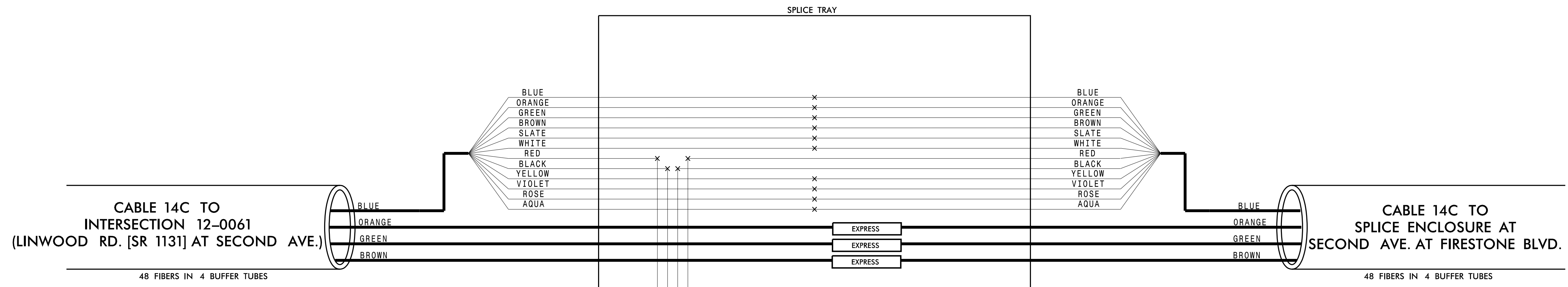

CHANNEL 14
CITY OF GASTONIA COMPUTERIZED
SIGNAL SYSTEM
SPLICE DETAIL

DIVISION 12 GASTON COUNTY
 PLAN DATE: DECEMBER 2021 REVIEWED BY: K. SMITH
 PREPARED BY: S. BUTLER REVIEWED BY: I. VAN OSDELL

Scale: 0

Kimley»Horn
 NC License #F-0102
 421 Fayetteville St., Suite 600
 Raleigh, NC 27601
 Tel: (919) 677-2000
 Fax: (919) 677-2050

SEAL
 NORTH CAROLINA PROFESSIONAL ENGINEER
 SEAL 028952
 I. VAN OSDELL
 3/16/2022

3/15/2022 \\kimley-horn.com\SE-RAL\NRA\1-PTD\ITS\01036569_Gastonia_Signal_System\6_Tasks\Splicing\SPL141.dgn

CHANNEL 14
SPLICE ENCLOSURE AT
(SECOND AVE. AT FIRESTONE BLVD.)
SIG ID 12-0034 (FRANKLIN BLVD. [US 29/74]
AT FIRESTONE BLVD.)

COLOR CODE
TIA/EIA 598-C

(1) BLUE	(7) RED
(2) ORANGE	(8) BLACK
(3) GREEN	(9) YELLOW
(4) BROWN	(10) VIOLET
(5) SLATE	(11) ROSE
(6) WHITE	(12) AQUA

LEGEND

X - FUSION SPLICE INDIVIDUAL FIBER
 O - EXISTING SPLICE
 □ - EXPRESS INDIVIDUAL FIBER

EXPRESS - EXPRESS ENTIRE BUFFER TUBE
 SPLICE - SPLICE ENTIRE BUFFER TUBE OR MAINTAIN IF EXISTING EXPRESSED

NOTES:
 1. FIBER INTERCONNECT CENTER RACKS ARE SCHEMATIC ONLY - ACTUAL EQUIPMENT FORM MAY VARY.
 2. ETHERNET SWITCH TERMINATION CONFIGURATIONS ARE GENERIC. CONTRACTOR IS RESPONSIBLE FOR DETERMINING /ENSURING PROPER TERMINATION.
 3. CONTRACTOR IS RESPONSIBLE FOR FIELD VERIFYING EXISTING SPLICING. THE CONTRACTOR SHALL COORDINATE WITH THE ENGINEER WHERE EXISTING SPLICING IS NOT AS EXPECTED.

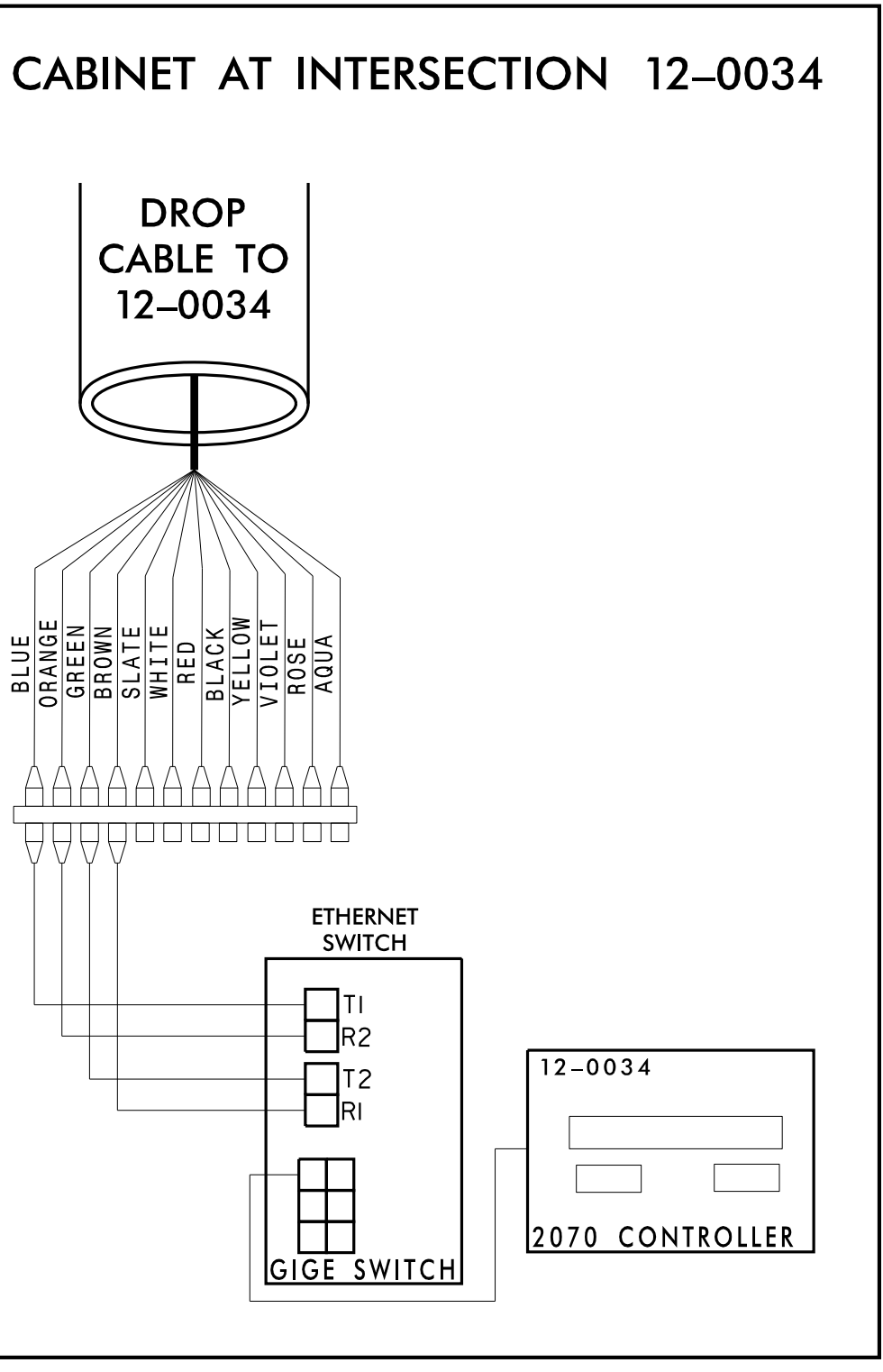
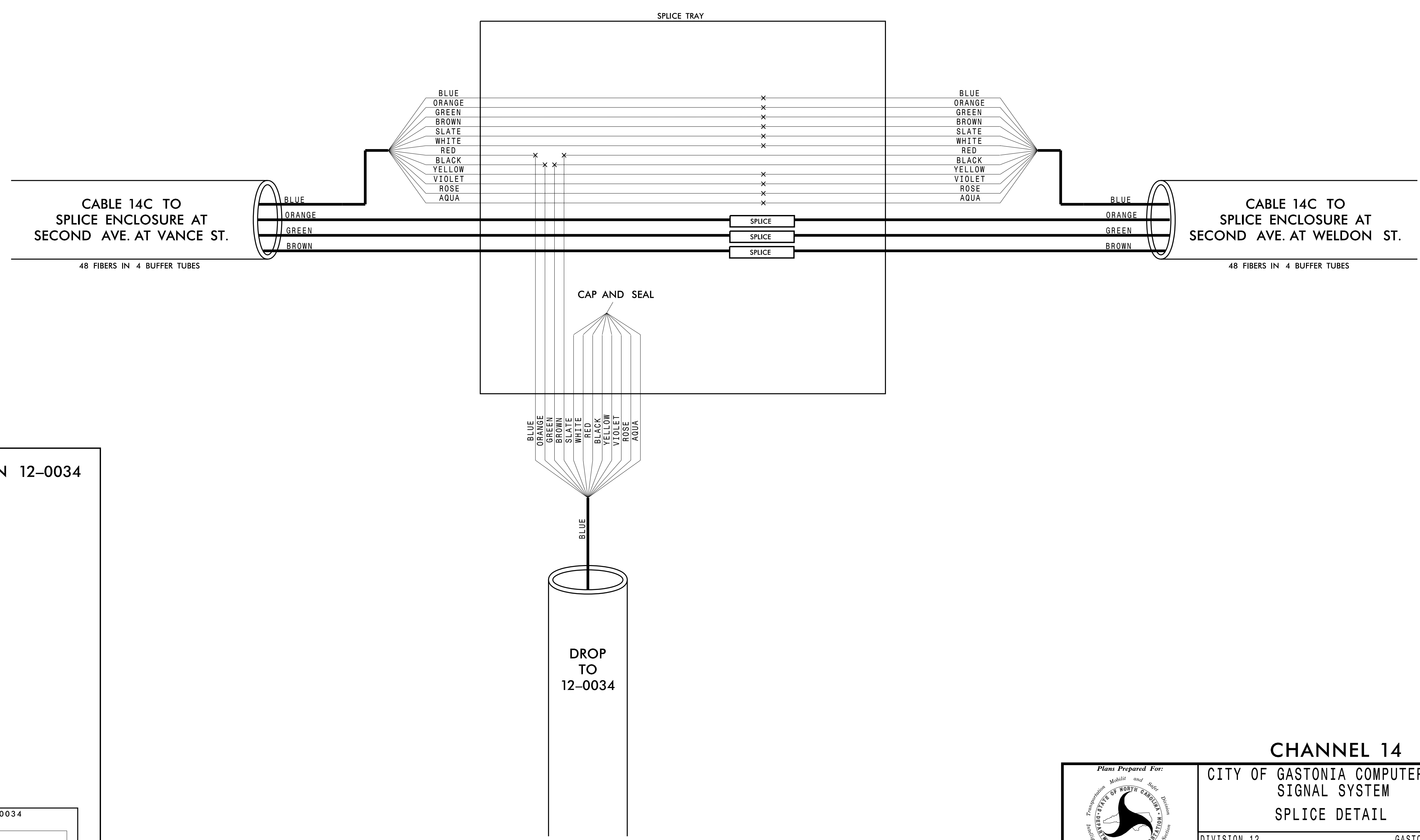

Kimley»Horn
 NC License #F-0102
 421 Fayetteville St., Suite 600
 Raleigh, NC 27601
 Tel: (919) 677-2000
 Fax: (919) 677-2050

CHANNEL 14
 CITY OF GASTONIA COMPUTERIZED
 SIGNAL SYSTEM
 SPLICE DETAIL

DIVISION 12 GASTON COUNTY
 PLAN DATE: DECEMBER 2021 REVIEWED BY: K. SMITH
 PREPARED BY: S. BUTLER REVIEWED BY: I. VAN OSDELL

SCALE: 0

REVISIONS: INIT. DATE

DocuSigned by: *Inger Van OsdeLL* 3/16/2022
 SEAL: NORTH CAROLINA PROFESSIONAL SEAL 028952
 INGER Z. VAN OSDELL
 CADD File name: _____

3/15/2022 \\kimley-horn.com\SE-RAL\NRL_TPTD\ITS\01036569_Gastonia_Signal_System\6_Tasks\Splicing\SPL142.dgn

CHANNEL 14
SPLICE ENCLOSURE AT
(SECOND AVE. AT WELDON ST.)
SIG ID 12-0035 (FRANKLIN BLVD. [US 29/74]
AT WELDON ST.)
CCTV CAMERA-07

COLOR CODE
TIA/EIA 598-C

(1) BLUE	(7) RED
(2) ORANGE	(8) BLACK
(3) GREEN	(9) YELLOW
(4) BROWN	(10) VIOLET
(5) SLATE	(11) ROSE
(6) WHITE	(12) AQUA

LEGEND

X - FUSION SPLICE INDIVIDUAL FIBER
 O - EXISTING SPLICE
 □ - EXPRESS INDIVIDUAL FIBER

EXPRESS - EXPRESS ENTIRE BUFFER TUBE
 SPLICE - SPLICE ENTIRE BUFFER TUBE OR MAINTAIN IF EXISTING EXPRESSED

NOTES:
 1. FIBER INTERCONNECT CENTER RACKS ARE SCHEMATIC ONLY - ACTUAL EQUIPMENT FORM MAY VARY.
 2. ETHERNET SWITCH TERMINATION CONFIGURATIONS ARE GENERIC. CONTRACTOR IS RESPONSIBLE FOR DETERMINING /ENSURING PROPER TERMINATION.
 3. CONTRACTOR IS RESPONSIBLE FOR FIELD VERIFYING EXISTING SPlicing. THE CONTRACTOR SHALL COORDINATE WITH THE ENGINEER WHERE EXISTING SPlicing IS NOT AS EXPECTED.

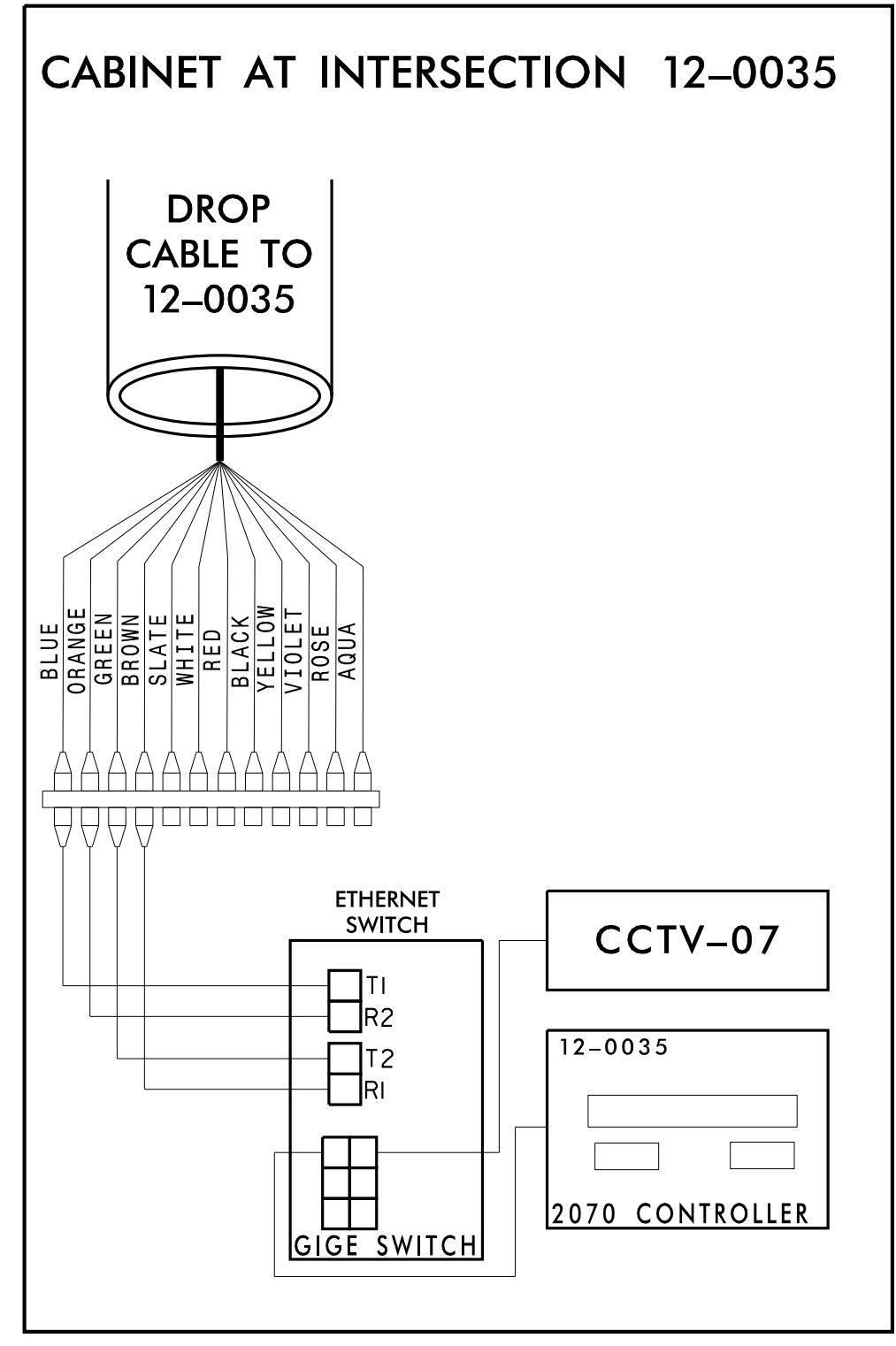
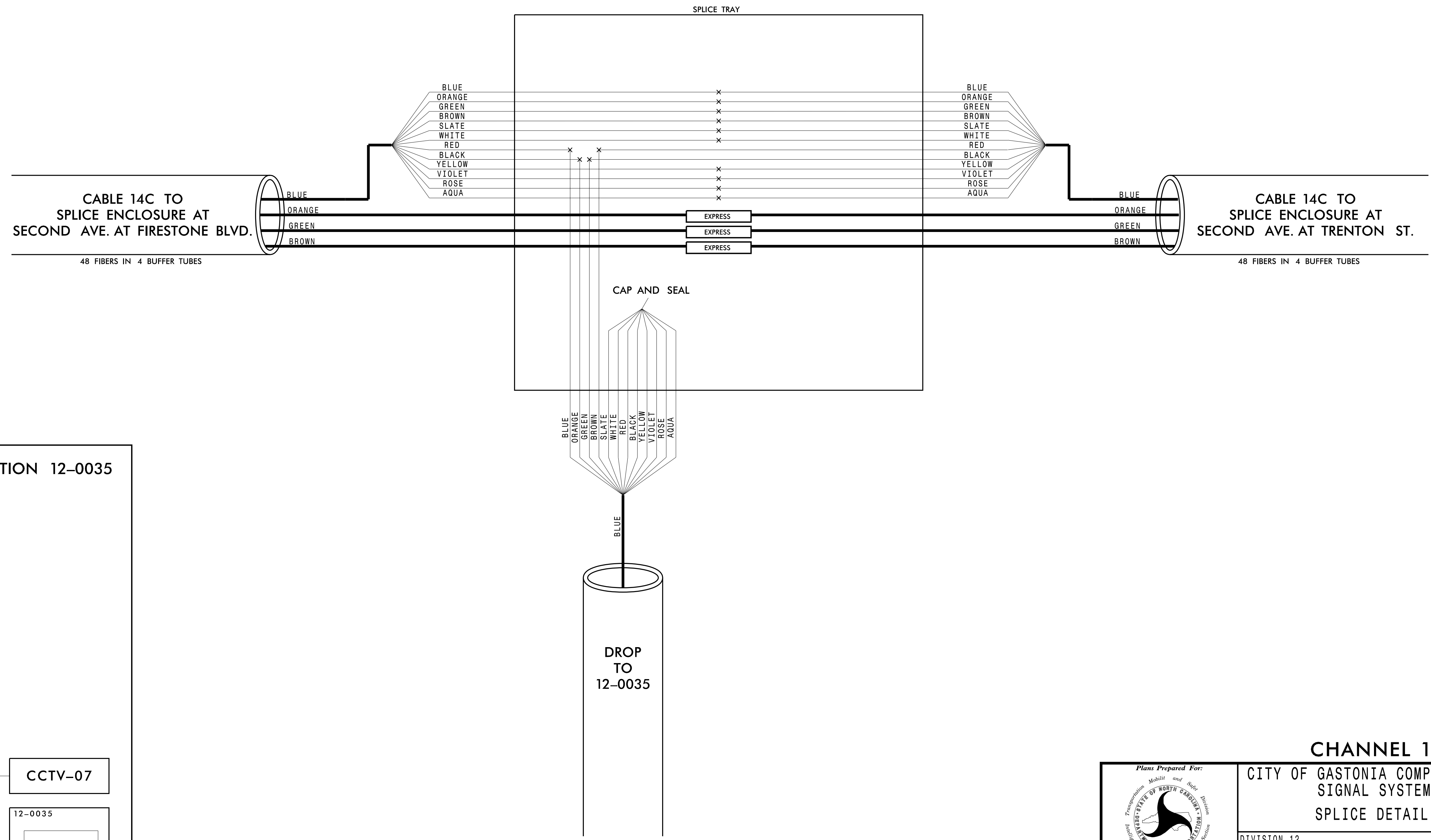

CHANNEL 14
CITY OF GASTONIA COMPUTERIZED SIGNAL SYSTEM
SPLICE DETAIL

Division 12 GASTON COUNTY
 PLAN DATE: DECEMBER 2021 REVIEWED BY: K. SMITH
 PREPARED BY: S. BUTLER REVIEWED BY: I. VAN OSDELL

Scale: 0

Revisions table with columns: REVISIONS, INIT., DATE

DocuSigned by: *Iger Van OsdeLL* 3/16/2022

CADD File name:

Kimley»Horn
 NC License #F-0102
 421 Fayetteville St., Suite 600
 Raleigh, NC 27601
 Tel: (919) 677-2000
 Fax: (919) 677-2050

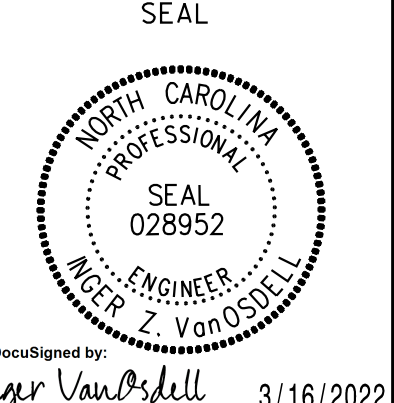

3/15/2022 \\kimley-horn.com\SE-RAL\NRA\TPTD\ITS\01003569 Gastonia Signal System\6 Tasks\Splicing\SPL143.dgn

CHANNEL 14
SPlice ENCLOSURE AT
(SECOND AVE. AT TRENTON ST.)
SIG ID 12-0036 (FRANKLIN BLVD. [US 29/74]
AT TRENTON ST.)

COLOR CODE
TIA/EIA 598-C

(1) BLUE	(7) RED
(2) ORANGE	(8) BLACK
(3) GREEN	(9) YELLOW
(4) BROWN	(10) VIOLET
(5) SLATE	(11) ROSE
(6) WHITE	(12) AQUA

LEGEND

X - FUSION SPlice INDIVIDUAL FIBER
 O - EXISTING SPlice
 □ - EXPRESS INDIVIDUAL FIBER

EXPRESS - EXPRESS ENTIRE BUFFER TUBE
 SPlice - SPlice ENTIRE BUFFER TUBE OR MAINTAIN IF EXISTING EXPRESSED

NOTES:

1. FIBER INTERCONNECT CENTER RACKS ARE SCHEMATIC ONLY - ACTUAL EQUIPMENT FORM MAY VARY.
2. ETHERNET SWITCH TERMINATION CONFIGURATIONS ARE GENERIC. CONTRACTOR IS RESPONSIBLE FOR DETERMINING /ENSURING PROPER TERMINATION.
3. CONTRACTOR IS RESPONSIBLE FOR FIELD VERIFYING EXISTING SPlicing. THE CONTRACTOR SHALL COORDINATE WITH THE ENGINEER WHERE EXISTING SPlicing IS NOT AS EXPECTED.

SPlice TBD DUE TO CONSTRUCTION

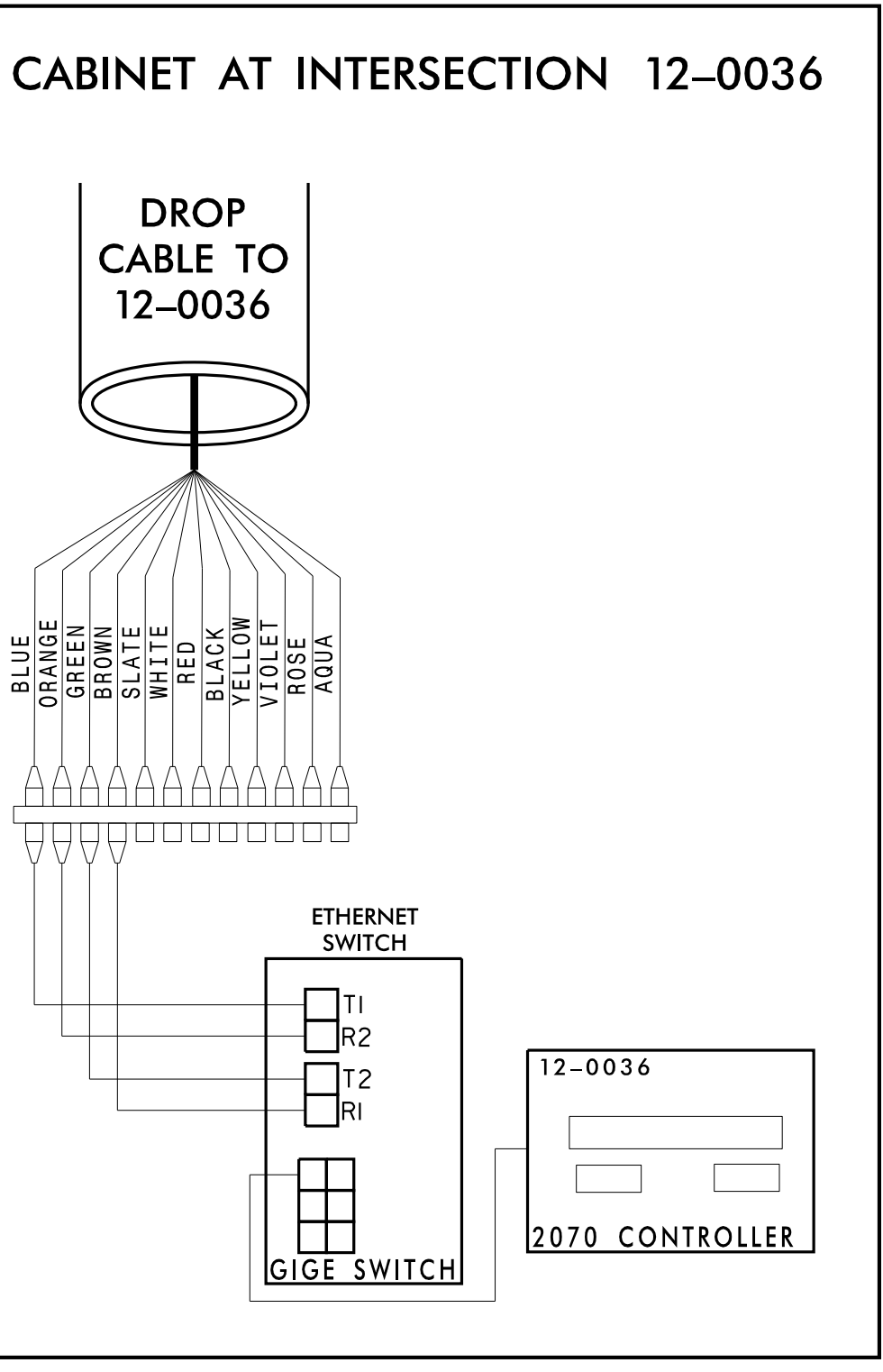
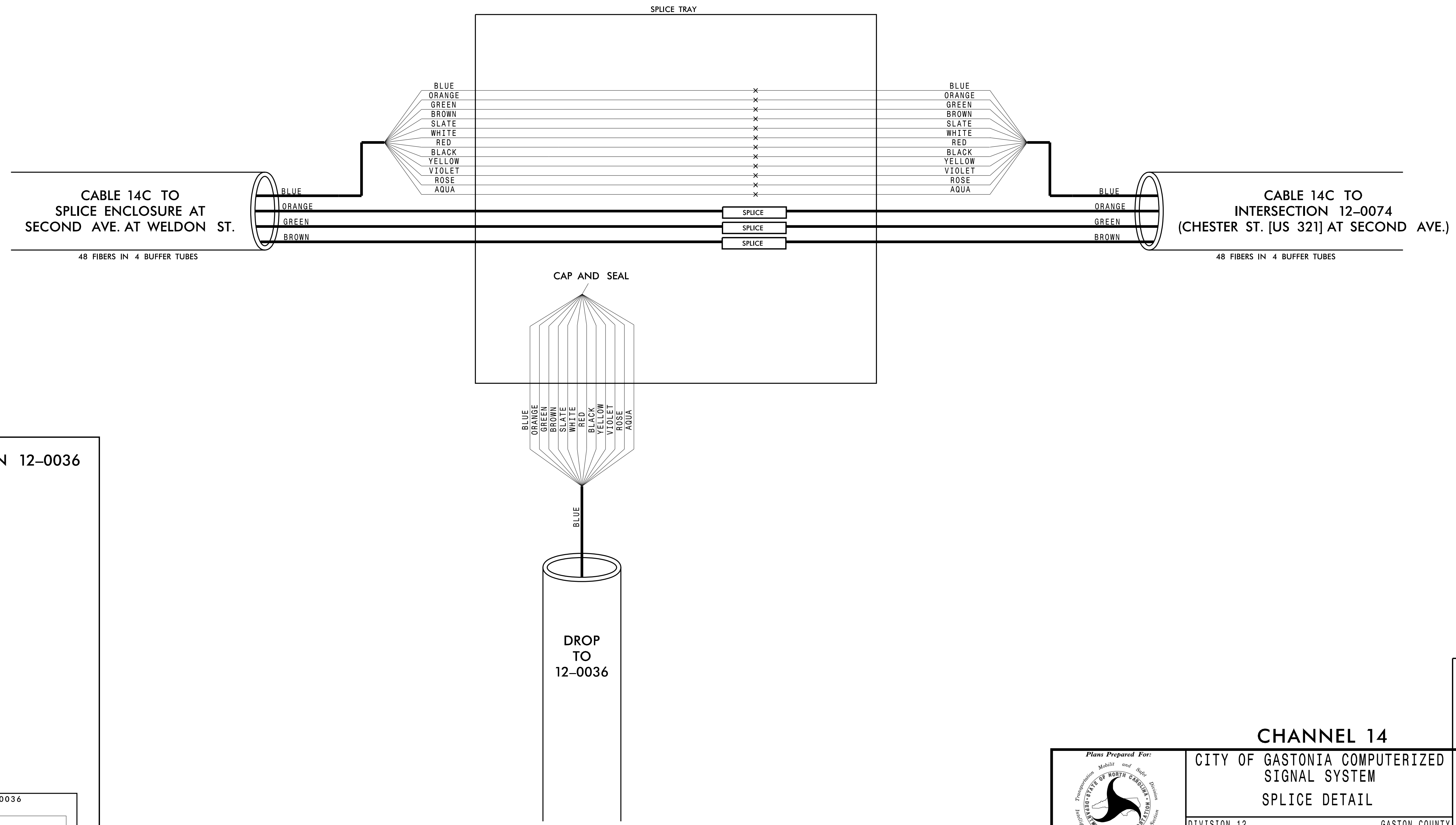

CHANNEL 14
CITY OF GASTONIA COMPUTERIZED SIGNAL SYSTEM
SPlice DETAIL

DIVISION 12 GASTON COUNTY
 PLAN DATE: DECEMBER 2021 REVIEWED BY: K. SMITH
 PREPARED BY: S. BUTLER REVIEWED BY: I. VAN OSDELL

SCALE: 0

REVISIONS: _____ INIT. DATE _____

DocuSigned by: *Inger Van OsdeLL* 3/16/2022

SEAL: NORTH CAROLINA PROFESSIONAL SEAL 028952
 INGER Z. VAN OSDELL
 ENGINEER

CADD File name: _____

Kimley»Horn
 NC License #F-0102
 421 Fayetteville St., Suite 600
 Raleigh, NC 27601
 Tel: (919) 677-2000
 Fax: (919) 677-2050

3/15/2022 \\kimley-horn.com\SE-RAL\NRL_TPTD\ITS\01036569_Gastonia_Signal_System\6_Tasks\Splicing\SPL144.dgn

**CHANNEL 14
SPLICE ENCLOSURE AT
(CHESTER ST. [US 321] AT SECOND AVE.)
SIG ID 12-0074**

COLOR CODE
TIA/EIA 598-C

(1) BLUE	(7) RED
(2) ORANGE	(8) BLACK
(3) GREEN	(9) YELLOW
(4) BROWN	(10) VIOLET
(5) SLATE	(11) ROSE
(6) WHITE	(12) AQUA

LEGEND

X - FUSION SPLICE INDIVIDUAL FIBER
 O - EXISTING SPLICE
 □ - EXPRESS INDIVIDUAL FIBER

EXPRESS - EXPRESS ENTIRE BUFFER TUBE
 SPLICE - SPLICE ENTIRE BUFFER TUBE OR MAINTAIN IF EXISTING EXPRESSED

NOTES:

- FIBER INTERCONNECT CENTER RACKS ARE SCHEMATIC ONLY - ACTUAL EQUIPMENT FORM MAY VARY.
- ETHERNET SWITCH TERMINATION CONFIGURATIONS ARE GENERIC. CONTRACTOR IS RESPONSIBLE FOR DETERMINING /ENSURING PROPER TERMINATION.
- CONTRACTOR IS RESPONSIBLE FOR FIELD VERIFYING EXISTING SPLICING. THE CONTRACTOR SHALL COORDINATE WITH THE ENGINEER WHERE EXISTING SPLICING IS NOT AS EXPECTED.

CABLE 14C TO
SPLICE ENCLOSURE AT
SECOND AVE. AT TRENTON ST.

48 FIBERS IN 4 BUFFER TUBES

CABLE 14D TO
INTERSECTION 12-0038
(FRANKLIN BLDV. [US 29/74]
AT CHESTER ST. [US 321])

72 FIBERS IN 6 BUFFER TUBES

CABLE 5A TO
INTERSECTION 12-0073
(YORK RD. [US 321] AT SECOND AVE.)

72 FIBERS IN 6 BUFFER TUBES

CABINET AT INTERSECTION 12-0074

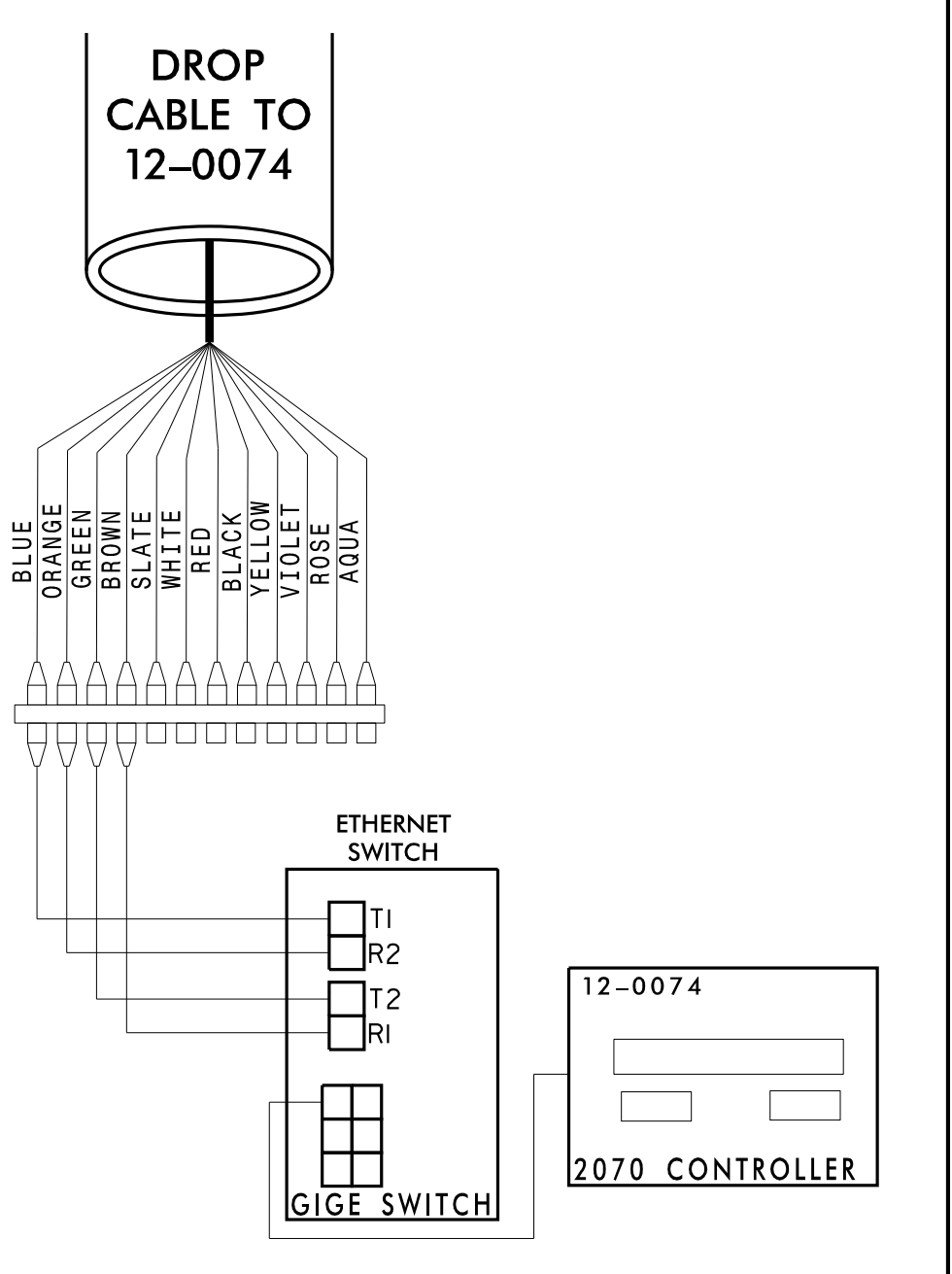

CAP AND SEAL

DROP TO 12-0074

CABLE 11A TO
INTERSECTION 12-0072
AT (CHESTER ST. [US 321]
AT THIRD AVE.)

48 FIBERS IN 4 BUFFER TUBES

CHANNEL 14

**CITY OF GASTONIA COMPUTERIZED
SIGNAL SYSTEM
SPLICE DETAIL**

DIVISION 12		GASTON COUNTY	
PLAN DATE: DECEMBER 2021	REVIEWED BY: K. SMITH	PREPARED BY: S. BUTLER	REVIEWED BY: I. VAN OSDELL
REVISIONS		INIT.	DATE

Plans Prepared For:

250 N. Greenfield Place, Gaston, NC 27529

SCALE

0

Kimley»Horn

NC License #F-0102
421 Fayetteville St., Suite 600
Raleigh, NC 27601
Tel: (919) 677-2000
Fax: (919) 677-2050

SEAL

DocuSigned by:
Iger Van OsdeLL
3/16/2022

CADD File name:

3/15/2022 \\kimley-horn.com\SE-RAL\NRA\TPTD\ITS\01036569 Gastonia Signal System\6 Tasks\Splicing\SPL145.dgn

CHANNEL 14
MODIFY SPLICE ENCLOSURE AT
FRANKLIN BLVD. (US 29/74) AT
CHESTER ST. (US 321)
SIG ID 12-0038
CCTV CAMERA-08

COLOR CODE
TIA/EIA 598-C

(1) BLUE	(7) RED
(2) ORANGE	(8) BLACK
(3) GREEN	(9) YELLOW
(4) BROWN	(10) VIOLET
(5) SLATE	(11) ROSE
(6) WHITE	(12) AQUA

LEGEND

X - FUSION SPLICE INDIVIDUAL FIBER
 O - EXISTING SPLICE
 □ - EXPRESS INDIVIDUAL FIBER

EXPRESS - EXPRESS ENTIRE BUFFER TUBE
 SPLICE - SPLICE ENTIRE BUFFER TUBE OR MAINTAIN IF EXISTING EXPRESSED

NOTES:
 1. FIBER INTERCONNECT CENTER RACKS ARE SCHEMATIC ONLY - ACTUAL EQUIPMENT FORM MAY VARY.
 2. ETHERNET SWITCH CONFIGURATIONS ARE GENERIC. CONTRACTOR IS RESPONSIBLE FOR DETERMINING /ENSURING PROPER TERMINATION.
 3. CONTRACTOR IS RESPONSIBLE FOR FIELD VERIFYING EXISTING SPLICING. THE CONTRACTOR SHALL COORDINATE WITH THE ENGINEER WHERE EXISTING SPLICING IS NOT AS EXPECTED.

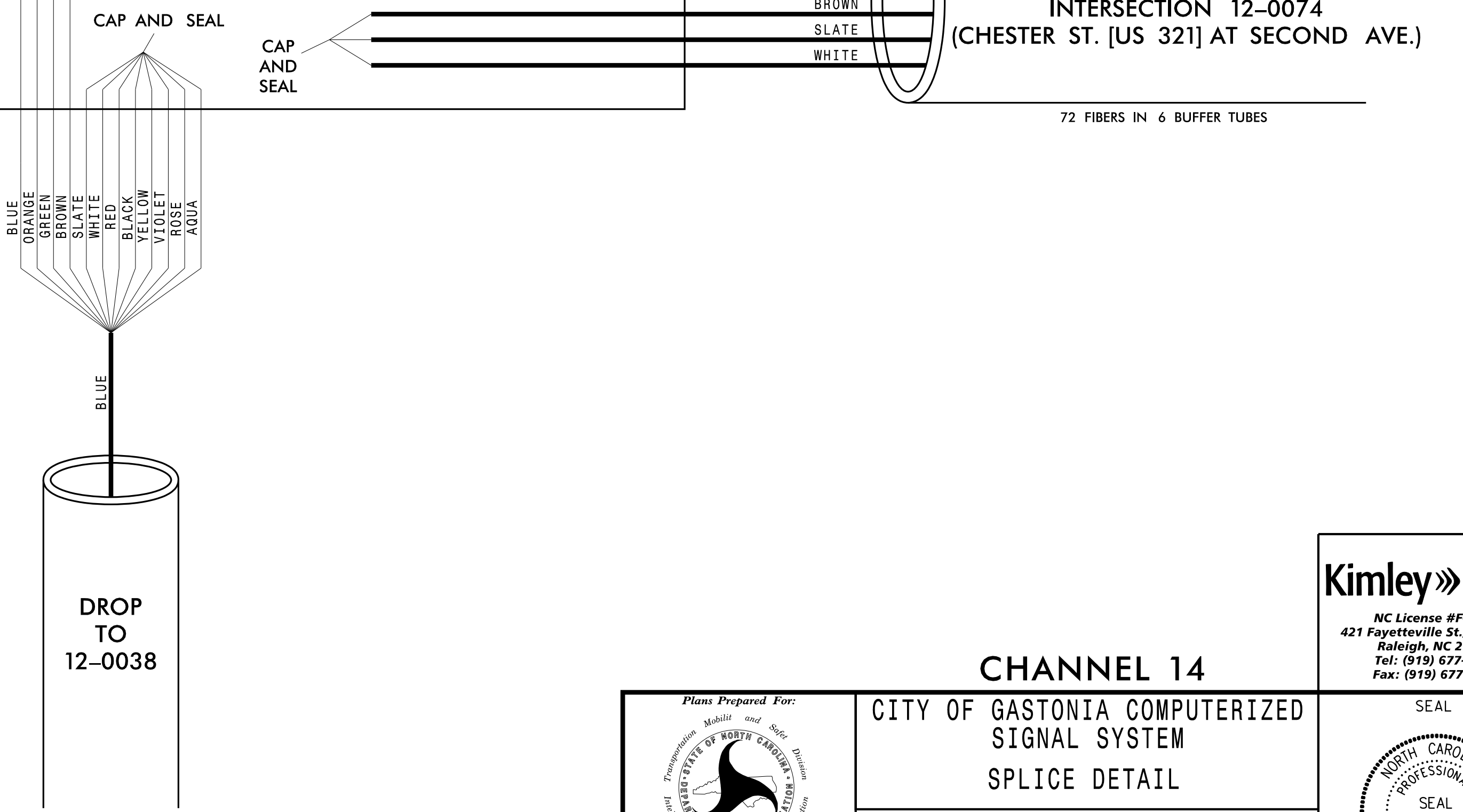
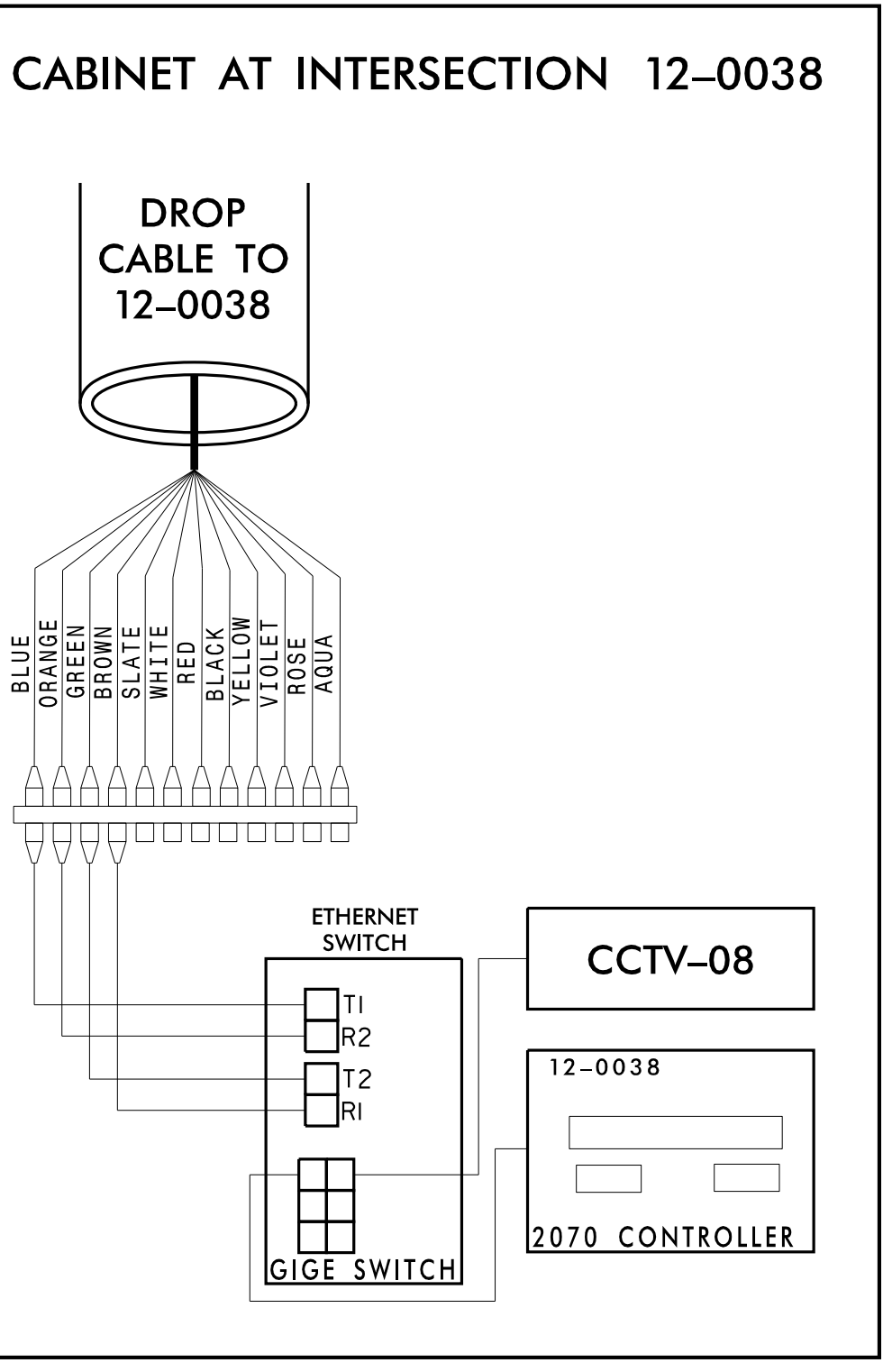
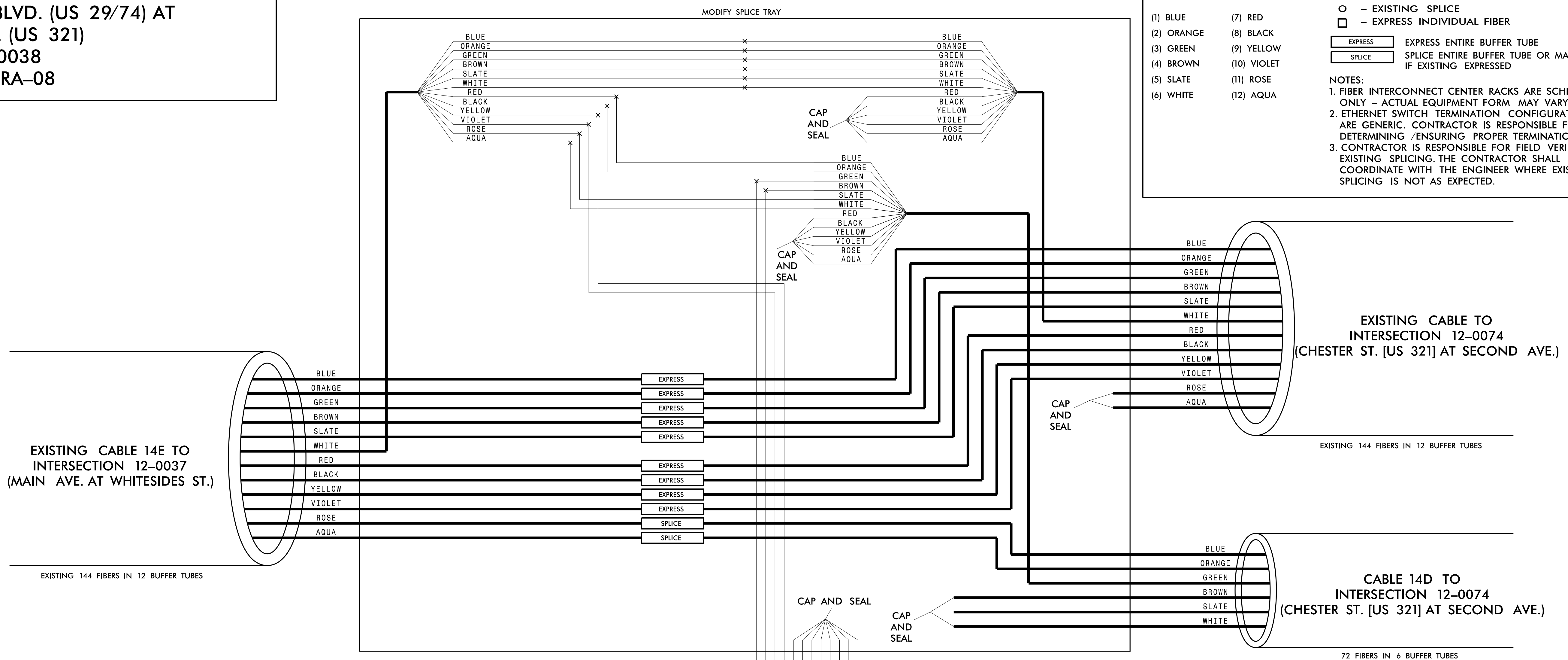

Kimley»Horn
 NC License #F-0102
 421 Fayetteville St., Suite 600
 Raleigh, NC 27601
 Tel: (919) 677-2000
 Fax: (919) 677-2050

CHANNEL 14
CITY OF GASTONIA COMPUTERIZED
SIGNAL SYSTEM
SPLICE DETAIL

DIVISION 12 GASTON COUNTY
 PLAN DATE: DECEMBER 2021 REVIEWED BY: K. SMITH
 PREPARED BY: S. BUTLER REVIEWED BY: I. VAN OSDELL

SEAL
 NORTH CAROLINA PROFESSIONAL SEAL 028952
 INCE Z. VAN OSDELL
 DATE 3/16/2022

SCALE 0

REVISIONS INIT. DATE

DocuSigned by: Inger Van OsdeLL
 DATE 3/16/2022
 CADD File name:

3/15/2022 \\kimley-horn.com\SE-RAL\NRA\TPTO\ITS\01036569_Gastonia_Signal_System\6_Tasks\Splicing\SPL146.dgn

CHANNEL 14
MODIFY SPLICE ENCLOSURE AT
FRANKLIN BLVD. (US 29/74) AT
CHESTER ST. (US 321)
SIG ID 12-0038
CCTV CAMERA-08

COLOR CODE
TIA/EIA 598-C

(1) BLUE	(7) RED
(2) ORANGE	(8) BLACK
(3) GREEN	(9) YELLOW
(4) BROWN	(10) VIOLET
(5) SLATE	(11) ROSE
(6) WHITE	(12) AQUA

LEGEND

X - FUSION SPLICE INDIVIDUAL FIBER
 O - EXISTING SPLICE
 □ - EXPRESS INDIVIDUAL FIBER

EXPRESS - EXPRESS ENTIRE BUFFER TUBE
 SPLICE - SPLICE ENTIRE BUFFER TUBE OR MAINTAIN IF EXISTING EXPRESSED

NOTES:

1. FIBER INTERCONNECT CENTER RACKS ARE SCHEMATIC ONLY - ACTUAL EQUIPMENT FORM MAY VARY.
2. ETHERNET SWITCH TERMINATION CONFIGURATIONS ARE GENERIC. CONTRACTOR IS RESPONSIBLE FOR DETERMINING /ENSURING PROPER TERMINATION.
3. CONTRACTOR IS RESPONSIBLE FOR FIELD VERIFYING EXISTING SPlicing. THE CONTRACTOR SHALL COORDINATE WITH THE ENGINEER WHERE EXISTING SPlicing IS NOT AS EXPECTED.

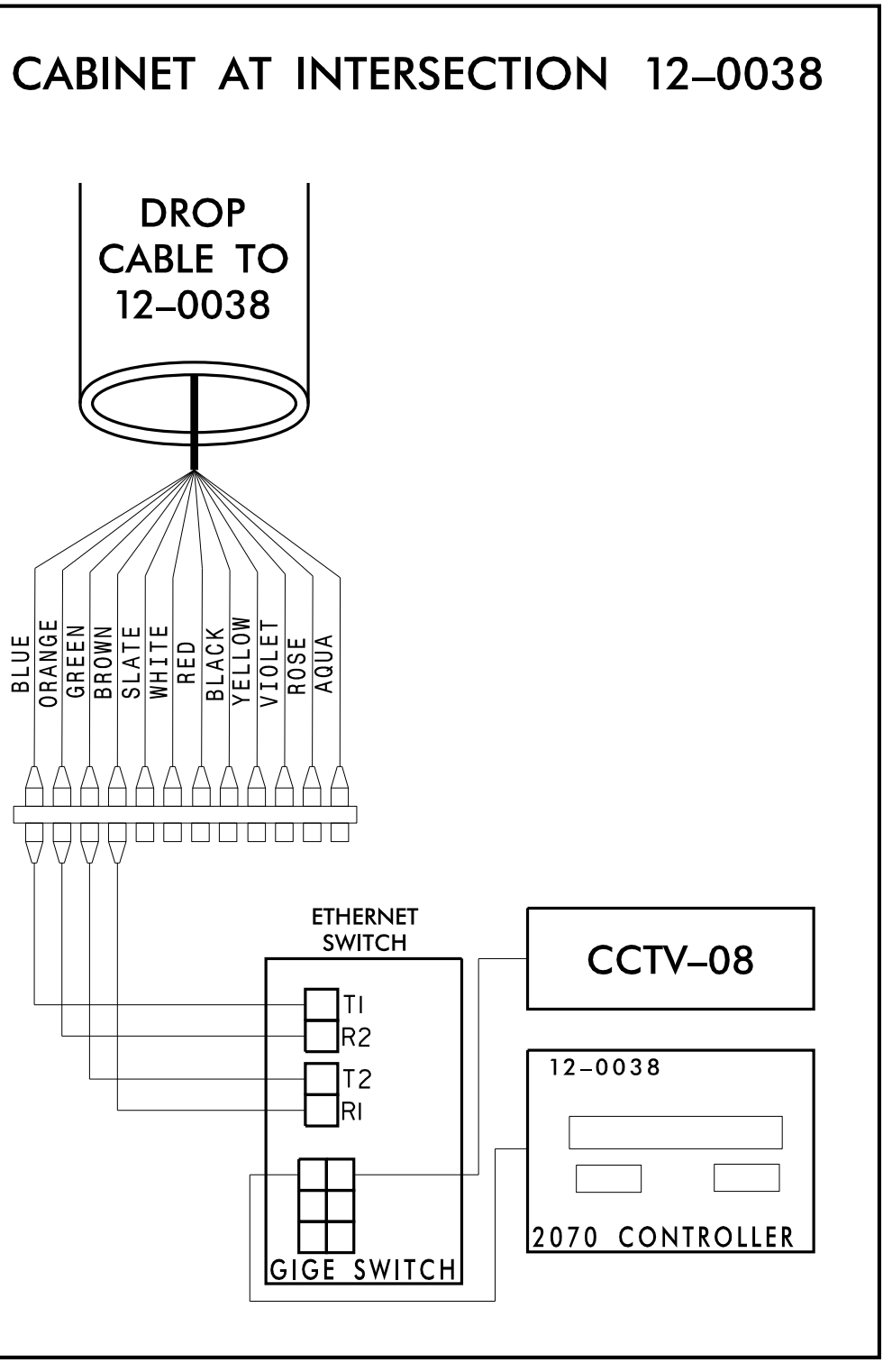
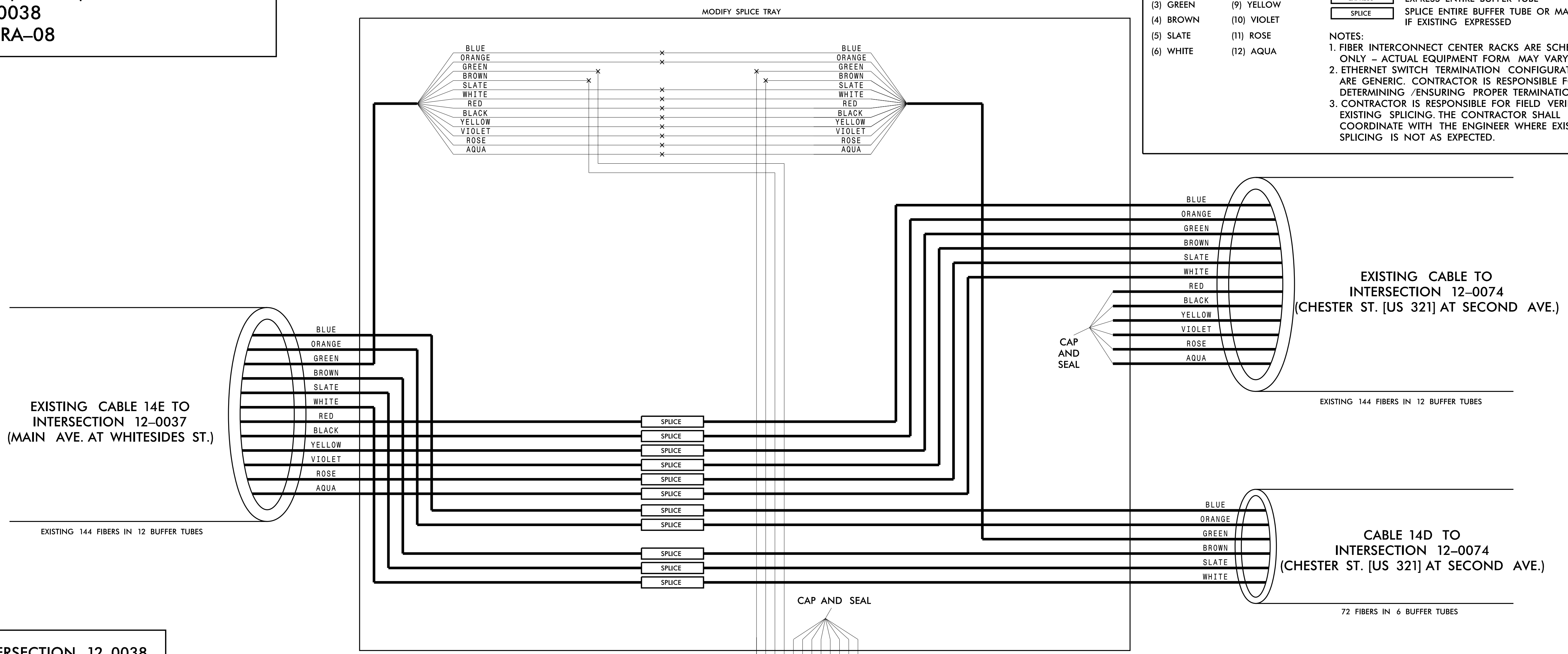

PHASE 2: MODIFY SPLICE ENCLOSURE SPL-146
AT FRANKLIN BLVD. (US 29/74) AT
CHESTER ST. (US 321)
ONCE ALL CONNECTIONS FOR NEW
GASTONIA FIBER OPTIC CABLE
HAVE BEEN COMPLETED

Kimley»Horn
 NC License #F-0102
 421 Fayetteville St., Suite 600
 Raleigh, NC 27601
 Tel: (919) 677-2000
 Fax: (919) 677-2050

CHANNEL 14
CITY OF GASTONIA COMPUTERIZED
SIGNAL SYSTEM
SPLICE DETAIL

DIVISION 12 GASTON COUNTY
 PLAN DATE: DECEMBER 2021 REVIEWED BY: K. SMITH
 PREPARED BY: S. BUTLER REVIEWED BY: I. VAN OSDELL

SCALE: 0

REVISIONS: INIT. DATE

DocuSigned by: Inger Van OsdeLL 3/16/2022

3/15/2022 KARAL_TPTD_LTS_01036569 Gastonia SignalSystem\6_Tasks\Splicing\SPL146A.dgn

CHANNEL 14
MODIFY SPLICE ENCLOSURE AT
MAIN AVE. AT WHITESIDES ST.
SIG IS 12-0037 (FRANKLIN BLVD. [US 29/74]
AT WHITESIDES ST.)
SIG ID 12-0924 (CHESTER ST. [US 321] AT
MAIN AVE.)

COLOR CODE
TIA/EIA 598-C

(1) BLUE	(7) RED
(2) ORANGE	(8) BLACK
(3) GREEN	(9) YELLOW
(4) BROWN	(10) VIOLET
(5) SLATE	(11) ROSE
(6) WHITE	(12) AQUA

LEGEND

X - FUSION SPLICE INDIVIDUAL FIBER
 O - EXISTING SPLICE
 □ - EXPRESS INDIVIDUAL FIBER

EXPRESS - EXPRESS ENTIRE BUFFER TUBE
 SPLICE - SPLICE ENTIRE BUFFER TUBE OR MAINTAIN IF EXISTING EXPRESSED

NOTES:
 1. FIBER INTERCONNECT CENTER RACKS ARE SCHEMATIC ONLY - ACTUAL EQUIPMENT FORM MAY VARY.
 2. ETHERNET SWITCH TERMINATION CONFIGURATIONS ARE GENERIC. CONTRACTOR IS RESPONSIBLE FOR DETERMINING /ENSURING PROPER TERMINATION.
 3. CONTRACTOR IS RESPONSIBLE FOR FIELD VERIFYING EXISTING SPLICING. THE CONTRACTOR SHALL COORDINATE WITH THE ENGINEER WHERE EXISTING SPLICING IS NOT AS EXPECTED.

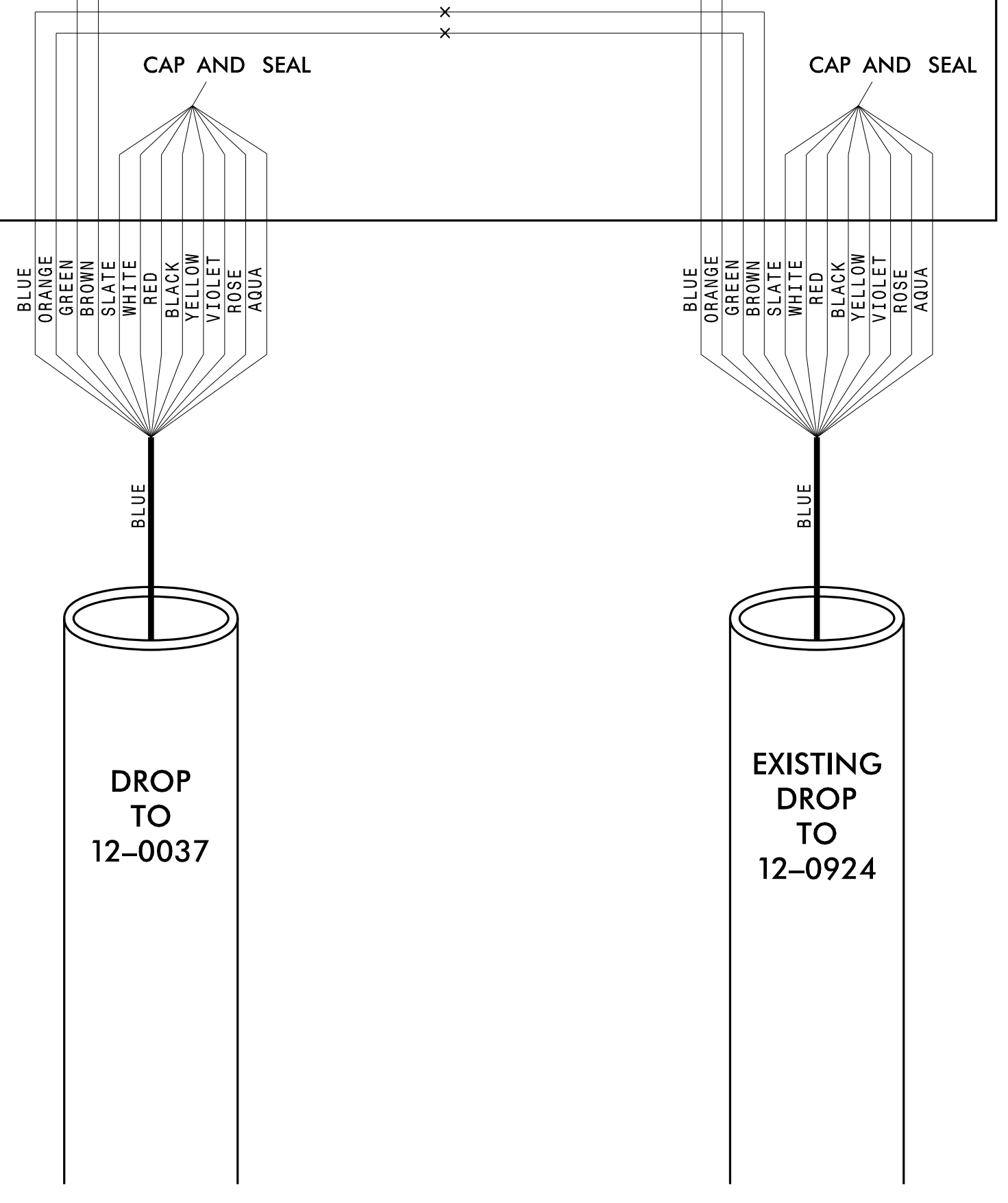
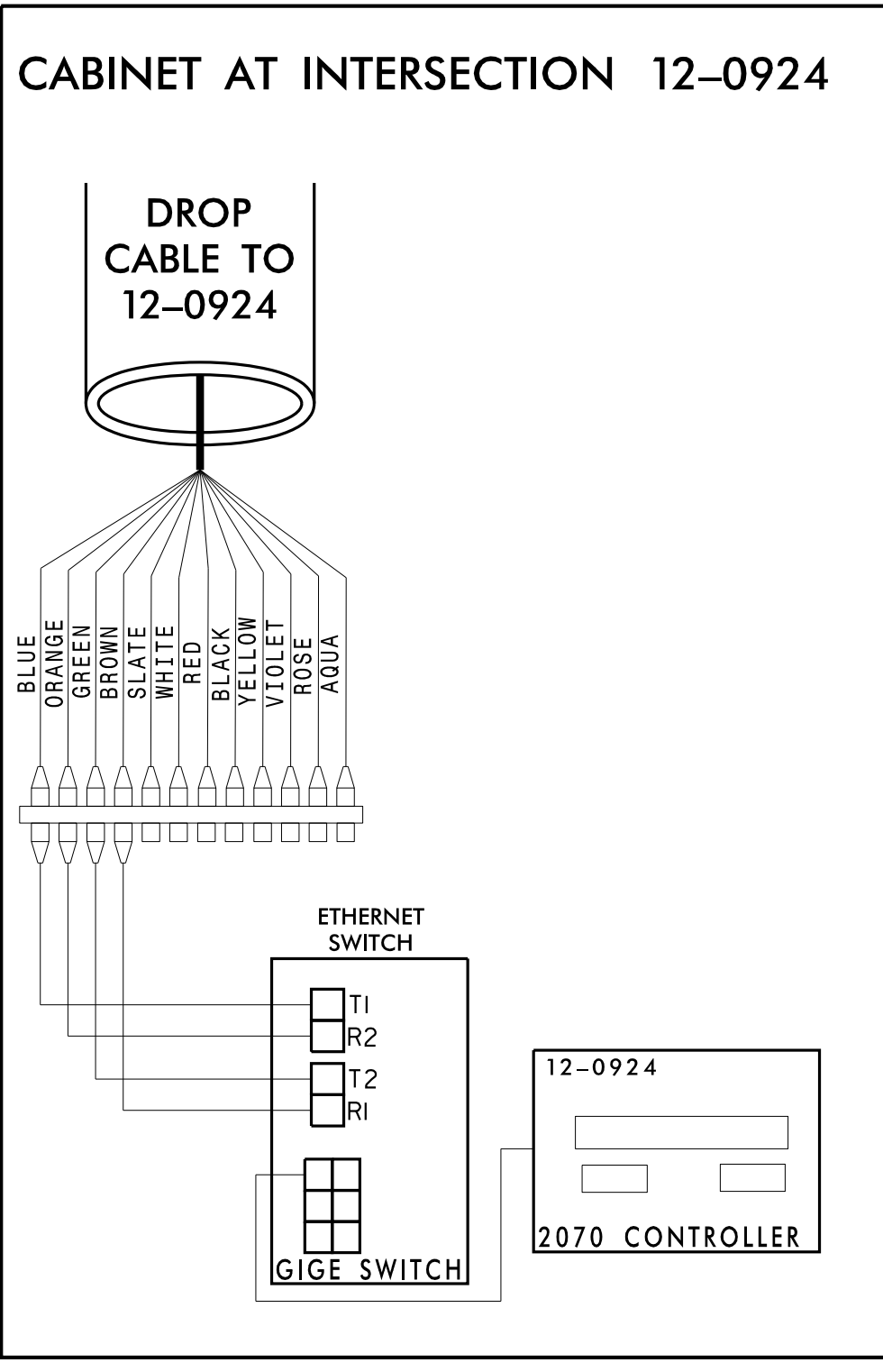
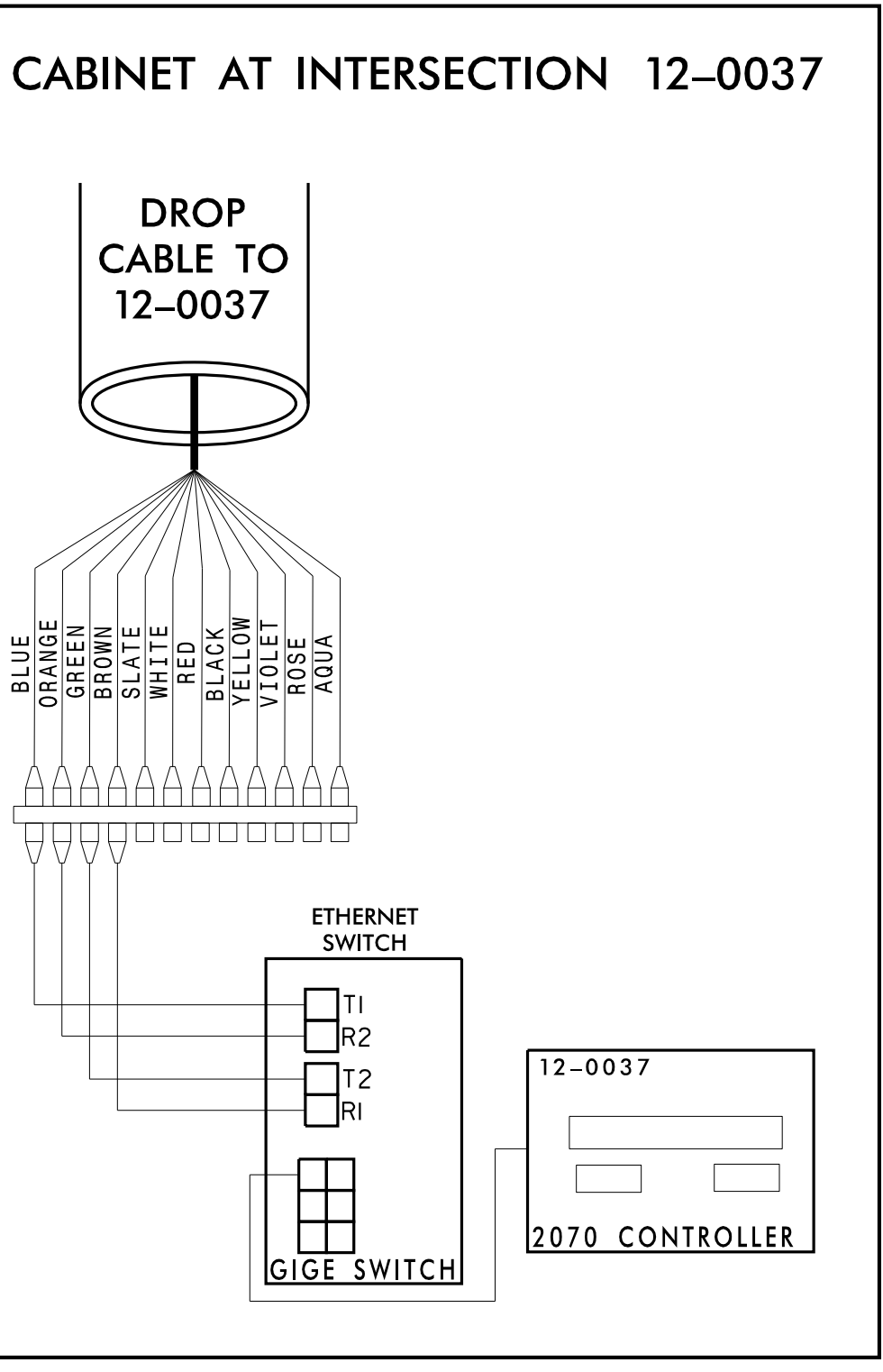
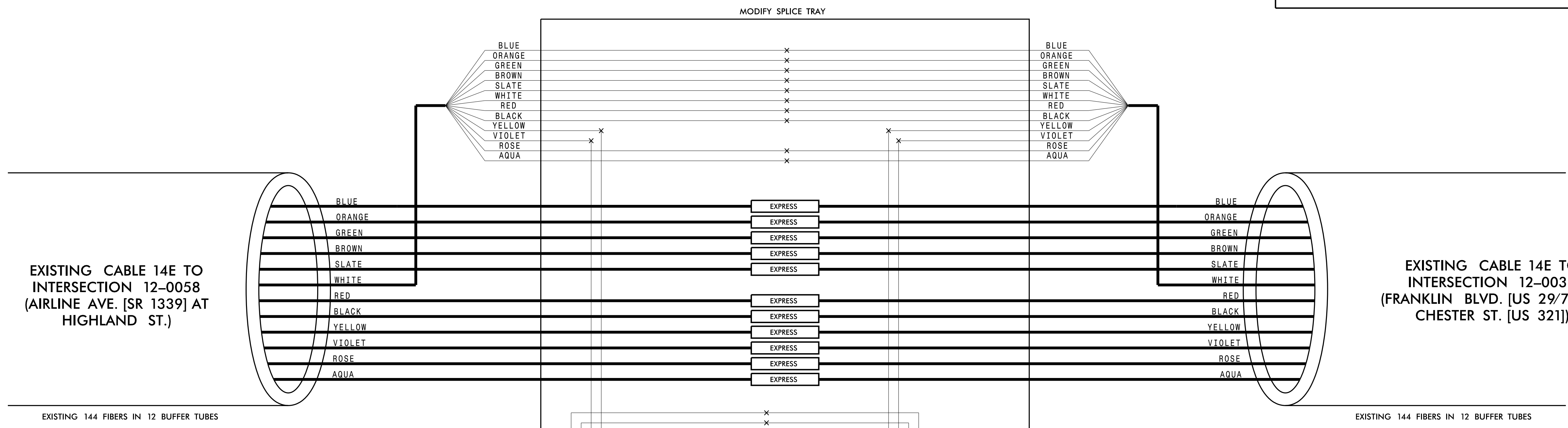

CHANNEL 14
CITY OF GASTONIA COMPUTERIZED SIGNAL SYSTEM
SPLICE DETAIL

DIVISION 12		GASTON COUNTY	
PLAN DATE: DECEMBER 2021	REVIEWED BY: K. SMITH	PREPARED BY: S. BUTLER	REVIEWED BY: I. VAN OSDELL
REVISIONS		INIT.	DATE

Kimley»Horn
 NC License #F-0102
 421 Fayetteville St., Suite 600
 Raleigh, NC 27601
 Tel: (919) 677-2000
 Fax: (919) 677-2050

SEAL
 NORTH CAROLINA PROFESSIONAL ENGINEER
 SEAL 028952
 INGER Z. VAN OSDELL

DocuSigned by:
 Inger Van Osdel
 3/16/2022

CADD File name:

3/15/2022 \\kimley-horn.com\SE-RAL\NRA\TPTD\ITS\01036569_Gastonia_Signal_System\6_Tasks\Splicing\SPL147.dgn

CHANNEL 14
MODIFY SPLICE ENCLOSURE AT
MAIN AVE. AT WHITESIDES ST.
SIG ID 12-0037 (FRANKLIN BLVD. [US 29/74]
AT WHITESIDES ST.)
SIG ID 12-0924 (CHESTER ST. [US 321] AT
MAIN AVE.)

PHASE 2: MODIFY SPLICE ENCLOSURE SPL-147
AT MAIN AVE. AT WHITESIDES ST.
ONCE ALL CONNECTIONS FOR NEW
GASTONIA FIBER OPTIC CABLE
HAVE BEEN COMPLETED

COLOR CODE
TIA/EIA 598-C

(1) BLUE	(7) RED
(2) ORANGE	(8) BLACK
(3) GREEN	(9) YELLOW
(4) BROWN	(10) VIOLET
(5) SLATE	(11) ROSE
(6) WHITE	(12) AQUA

LEGEND

X - FUSION SPLICE INDIVIDUAL FIBER
O - EXISTING SPLICE
□ - EXPRESS INDIVIDUAL FIBER

EXPRESS - EXPRESS ENTIRE BUFFER TUBE
SPLICE - SPLICE ENTIRE BUFFER TUBE OR MAINTAIN IF EXISTING EXPRESSED

NOTES:

- FIBER INTERCONNECT CENTER RACKS ARE SCHEMATIC ONLY - ACTUAL EQUIPMENT FORM MAY VARY.
- ETHERNET SWITCH TERMINATION CONFIGURATIONS ARE GENERIC. CONTRACTOR IS RESPONSIBLE FOR DETERMINING /ENSURING PROPER TERMINATION.
- CONTRACTOR IS RESPONSIBLE FOR FIELD VERIFYING EXISTING SPLICING. THE CONTRACTOR SHALL COORDINATE WITH THE ENGINEER WHERE EXISTING SPLICING IS NOT AS EXPECTED.

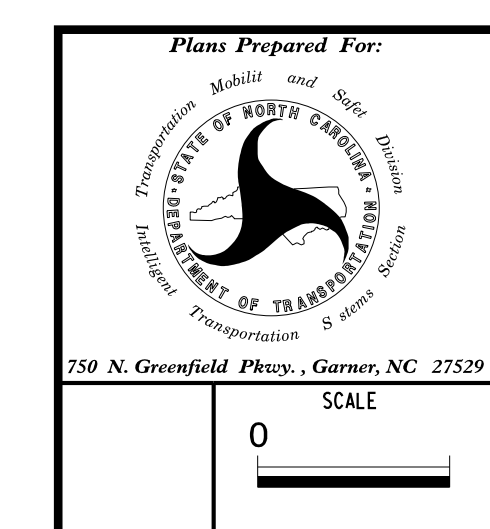
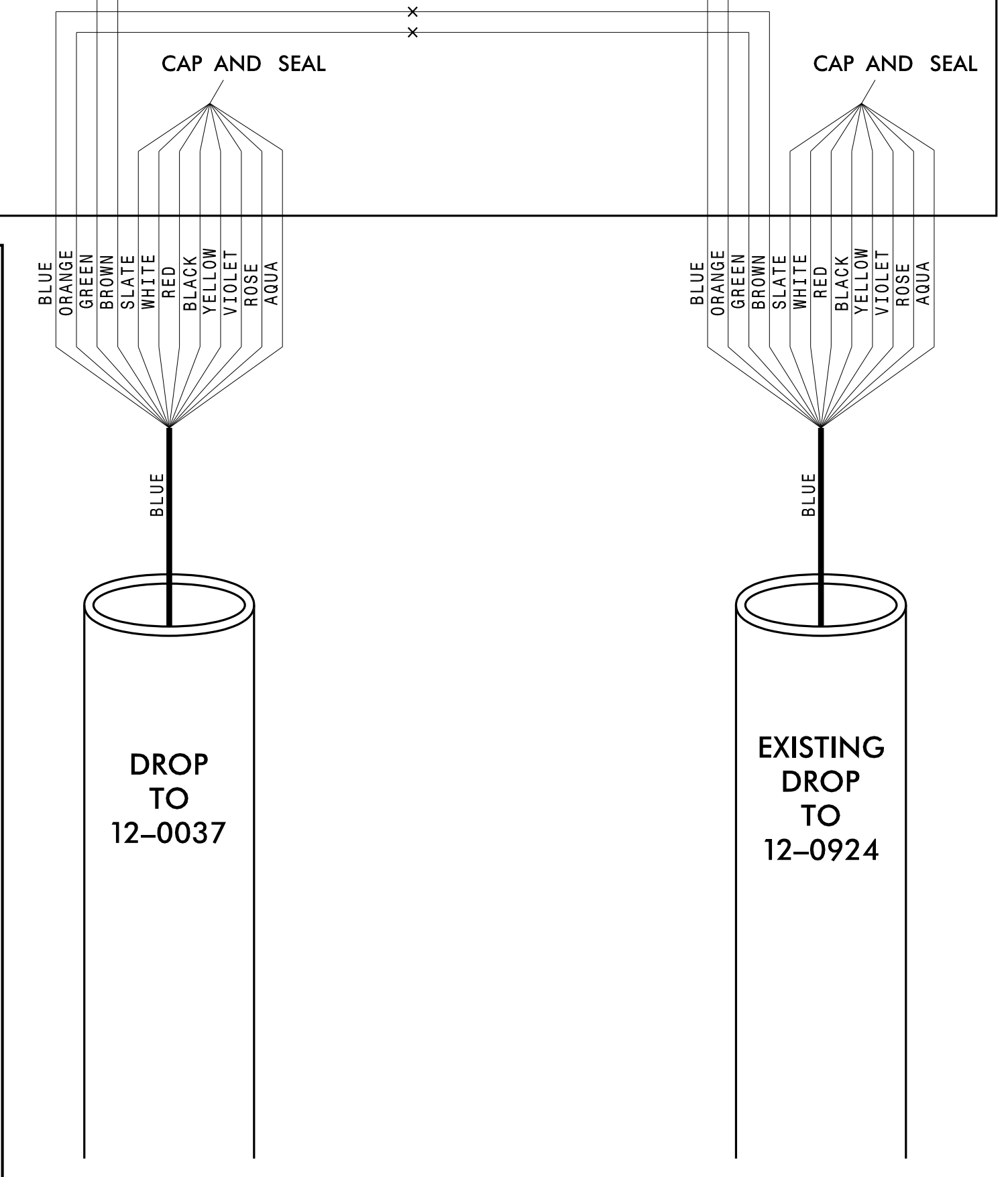
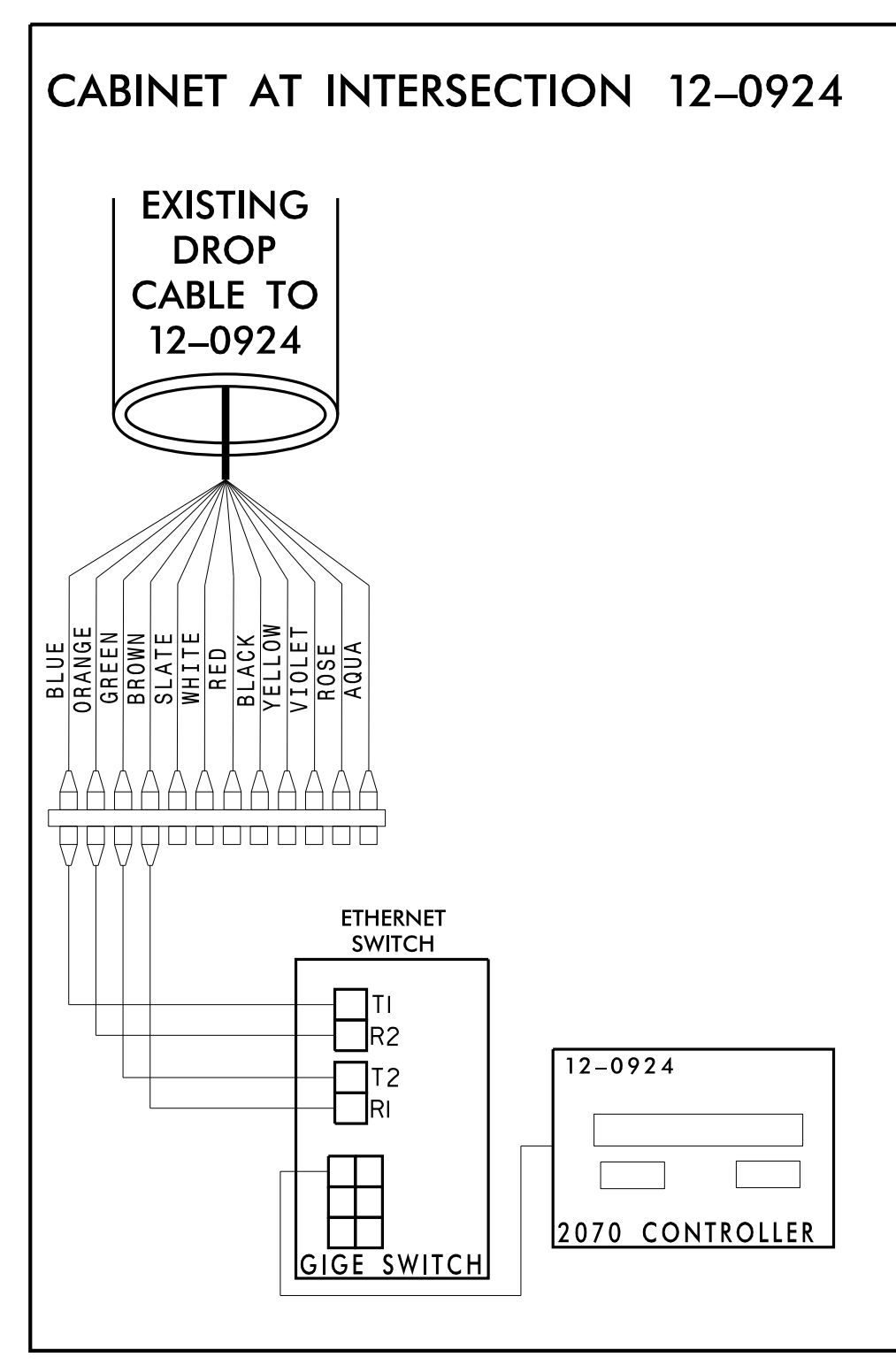
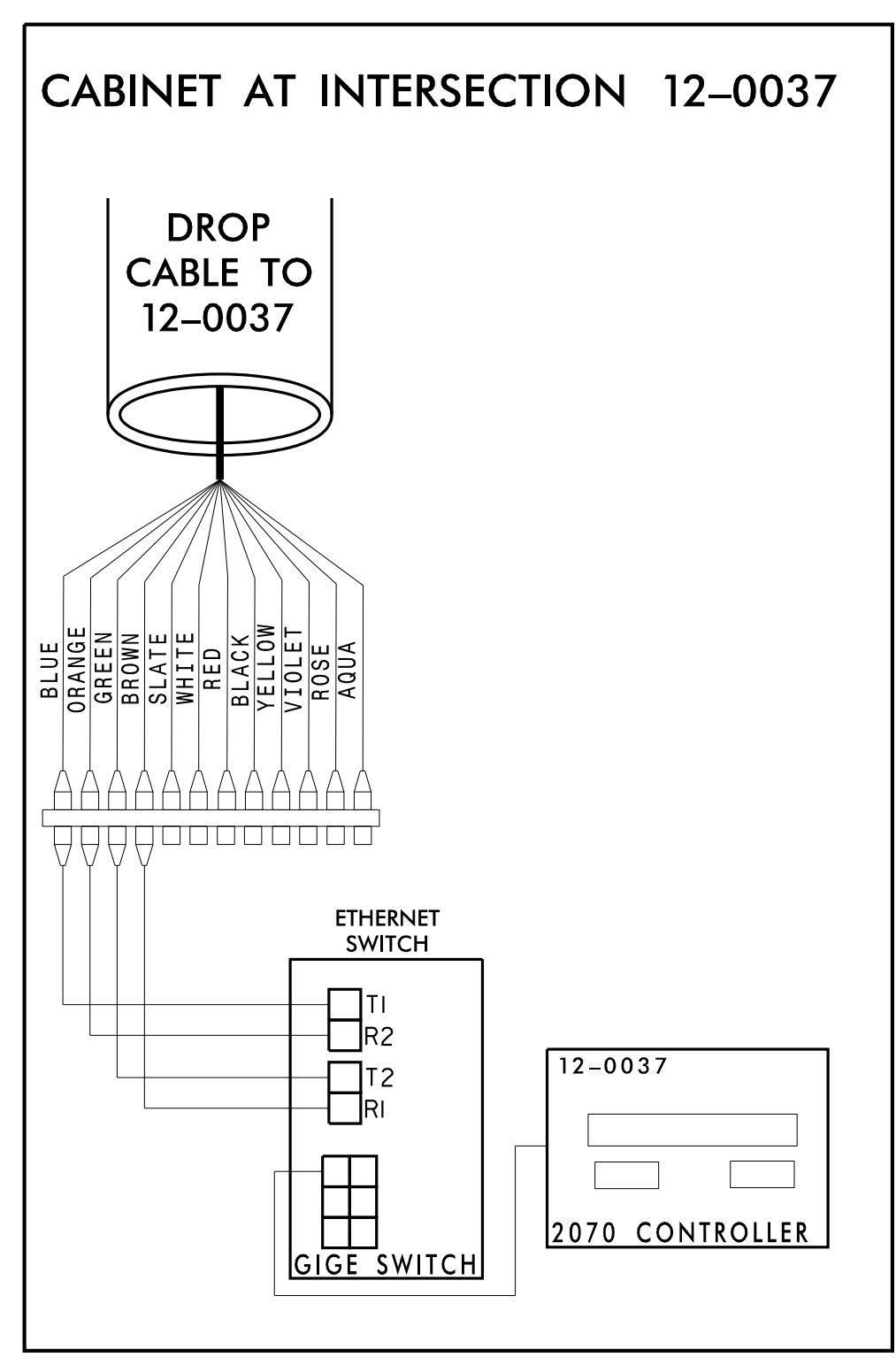
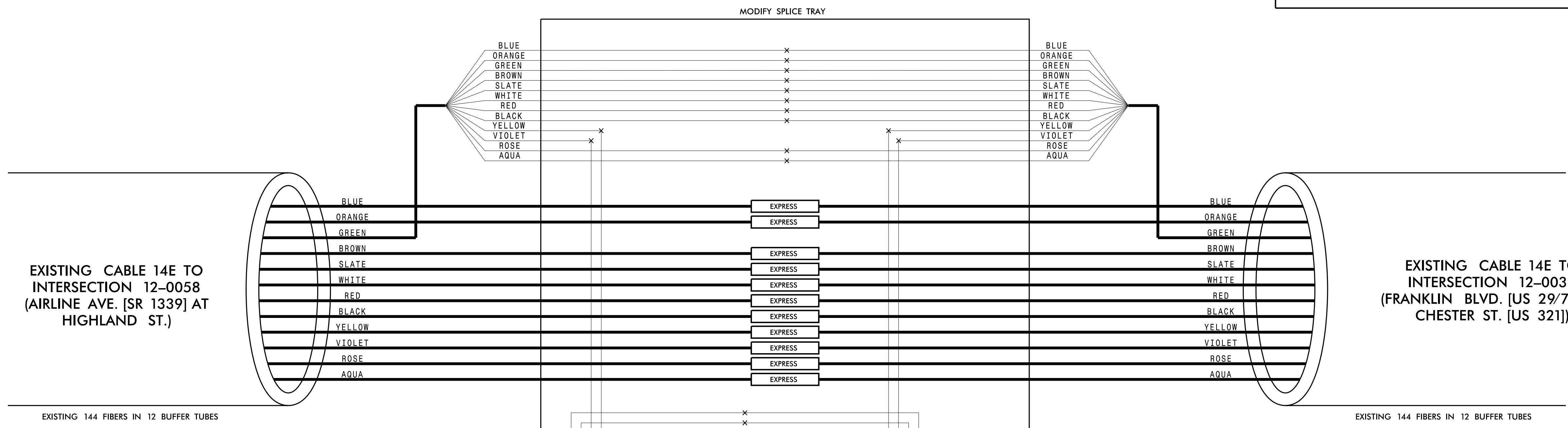

CHANNEL 14
CITY OF GASTONIA COMPUTERIZED
SIGNAL SYSTEM
SPLICE DETAIL

DIVISION 12 GASTON COUNTY

PLAN DATE: DECEMBER 2021 REVIEWED BY: K. SMITH

PREPARED BY: S. BUTLER REVIEWED BY: I. VAN OSDELL

REVISIONS	INIT.	DATE

SCALE: 0

Kimley»Horn

NC License #F-0102
421 Fayetteville St., Suite 600
Raleigh, NC 27601
Tel: (919) 677-2000
Fax: (919) 677-2050

SEAL
NORTH CAROLINA
PROFESSIONAL
ENGINEER
Inger Z. Van Osdel
3/16/2022

DocuSigned by:
Inger Van Osdel
3/16/2022

CADD File name:

3/15/2022 K:\ARL_TPTD_LITS\01036569_Gastonia_SignalSystem\6_Tasks\Splicing\SPL147A.dgn