

**This electronic collection of documents is provided  
for the convenience of the user  
and is Not a Certified Document –**

**The documents contained herein were originally issued  
and sealed by the individuals whose names and license  
numbers appear on each page, on the dates appearing  
with their signature on that page.**

**This file or an individual page  
shall not be considered a certified document.**

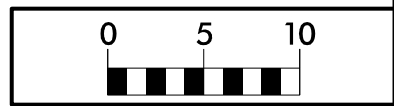

**Y-5500JC**  
**SR 1432 (TORY PATH ROAD) CROSSING CLOSURE AT**  
**CSX TRANSPORTATION, AND EXTENSION**  
**TO SR 1300 (HELMS ROAD) IN WAXHAW**

INDEX OF SHEETS

<u>TITLE</u>	<u>SHEET NO.</u>
CROSS SECTION INDEX	X-1
CROSS SECTION SUMMARY	X-1A
-L-	X-2 THRU X-34
-Y1-	X-35 THRU X-41
-Y2-	X-42
-DR1-	X-43 THRU X-44



6/23/16

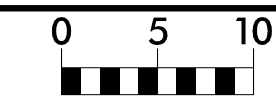

PROJ. REFERENCE NO.  
Y-5500JC

SHEET NO.  
X-2

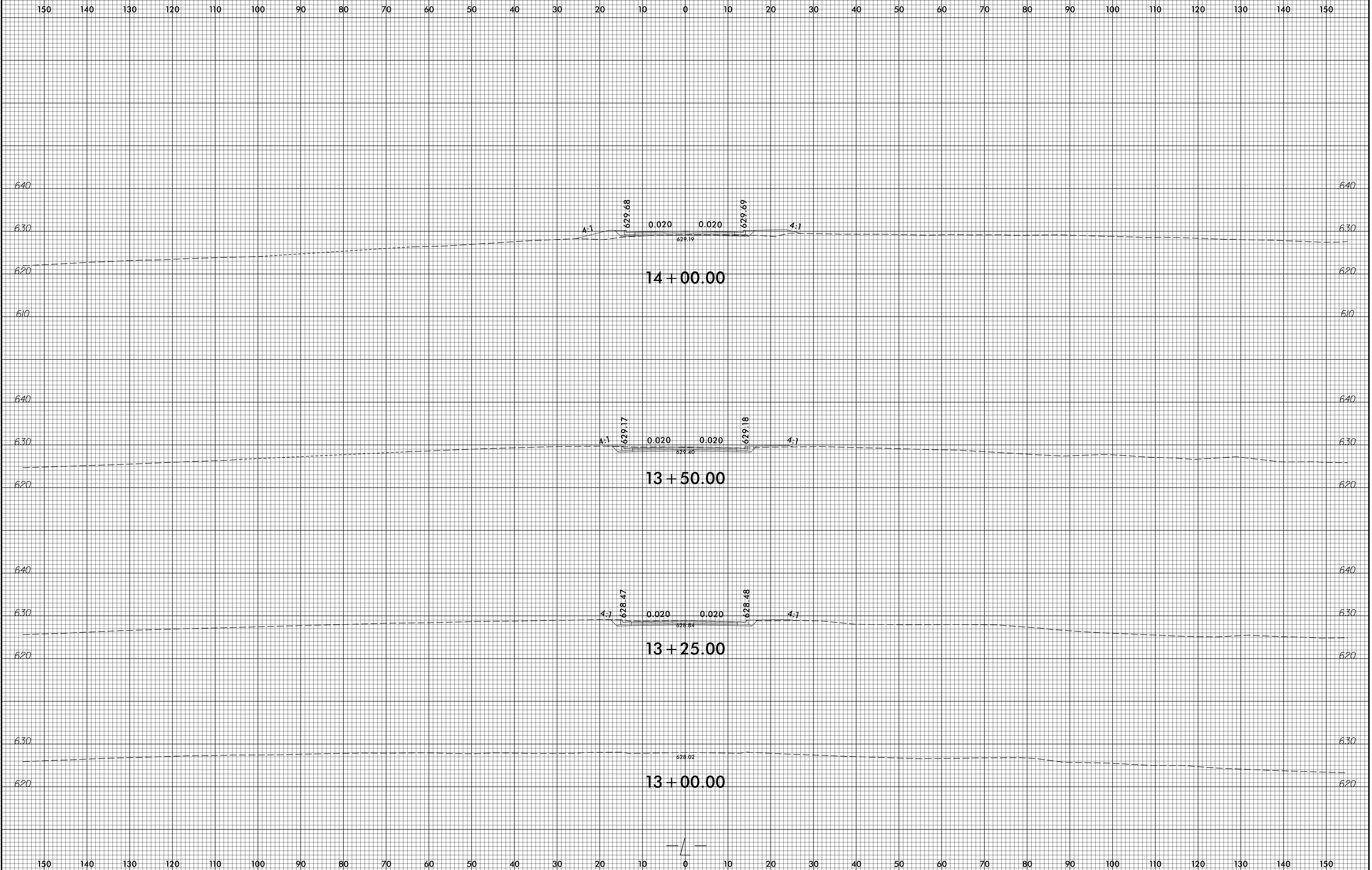

DATE: 6/23/16  
 TIME: 11:00 AM  
 DRAWN BY: J. RYAN  
 CHECKED BY: J. RYAN

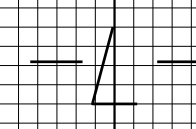

6/23/16

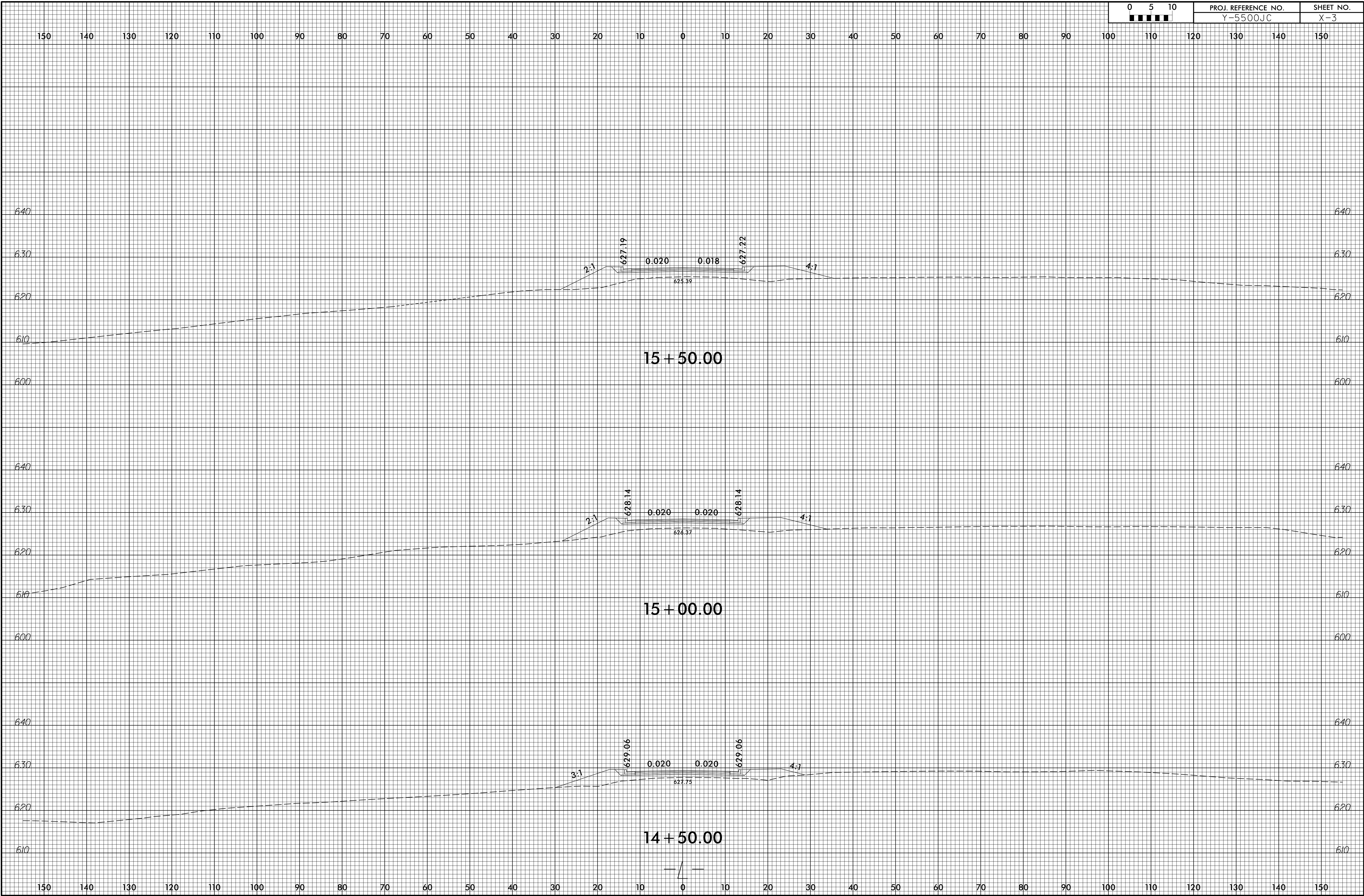

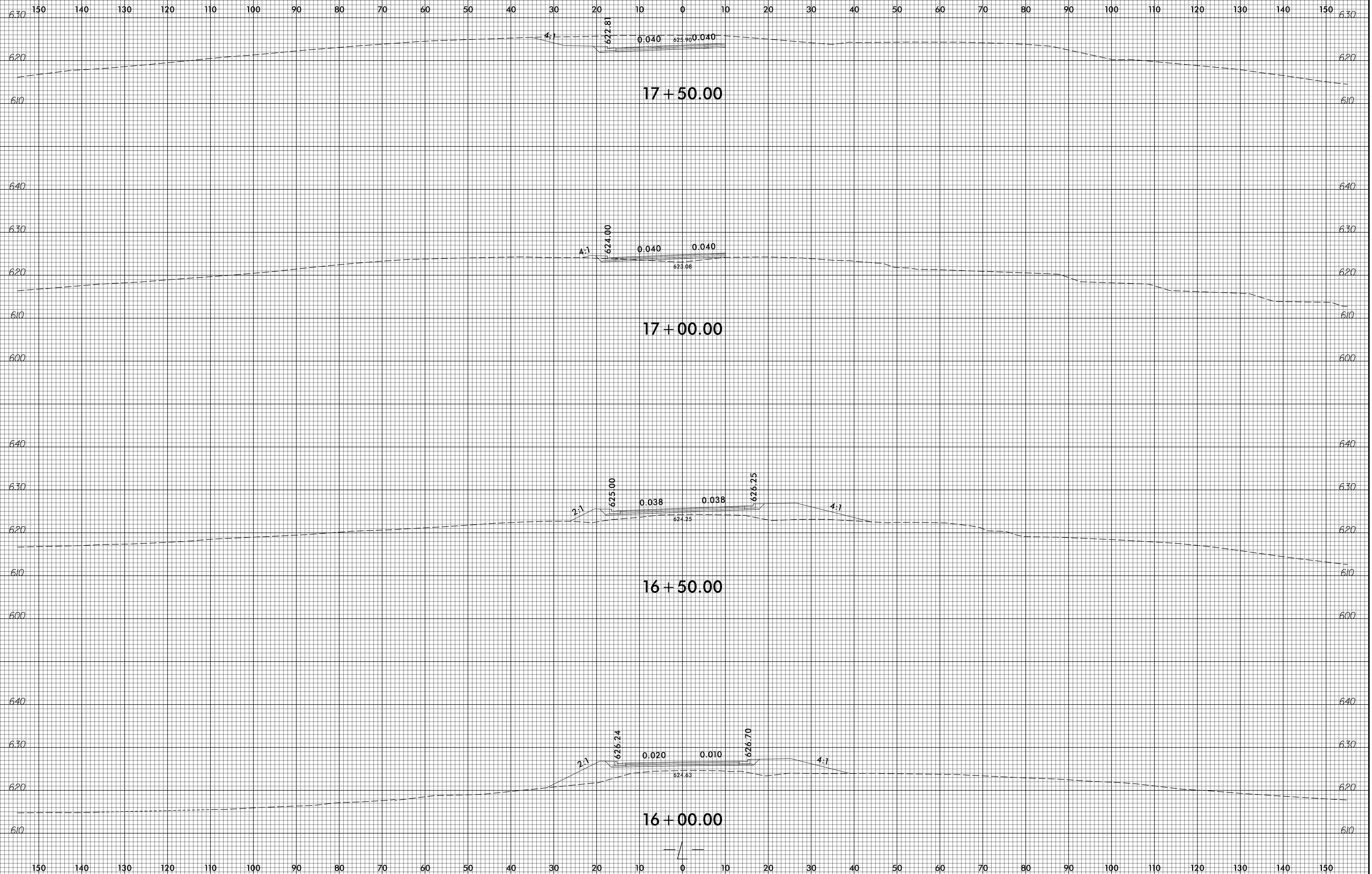

SYTIME  
CON  
RVA

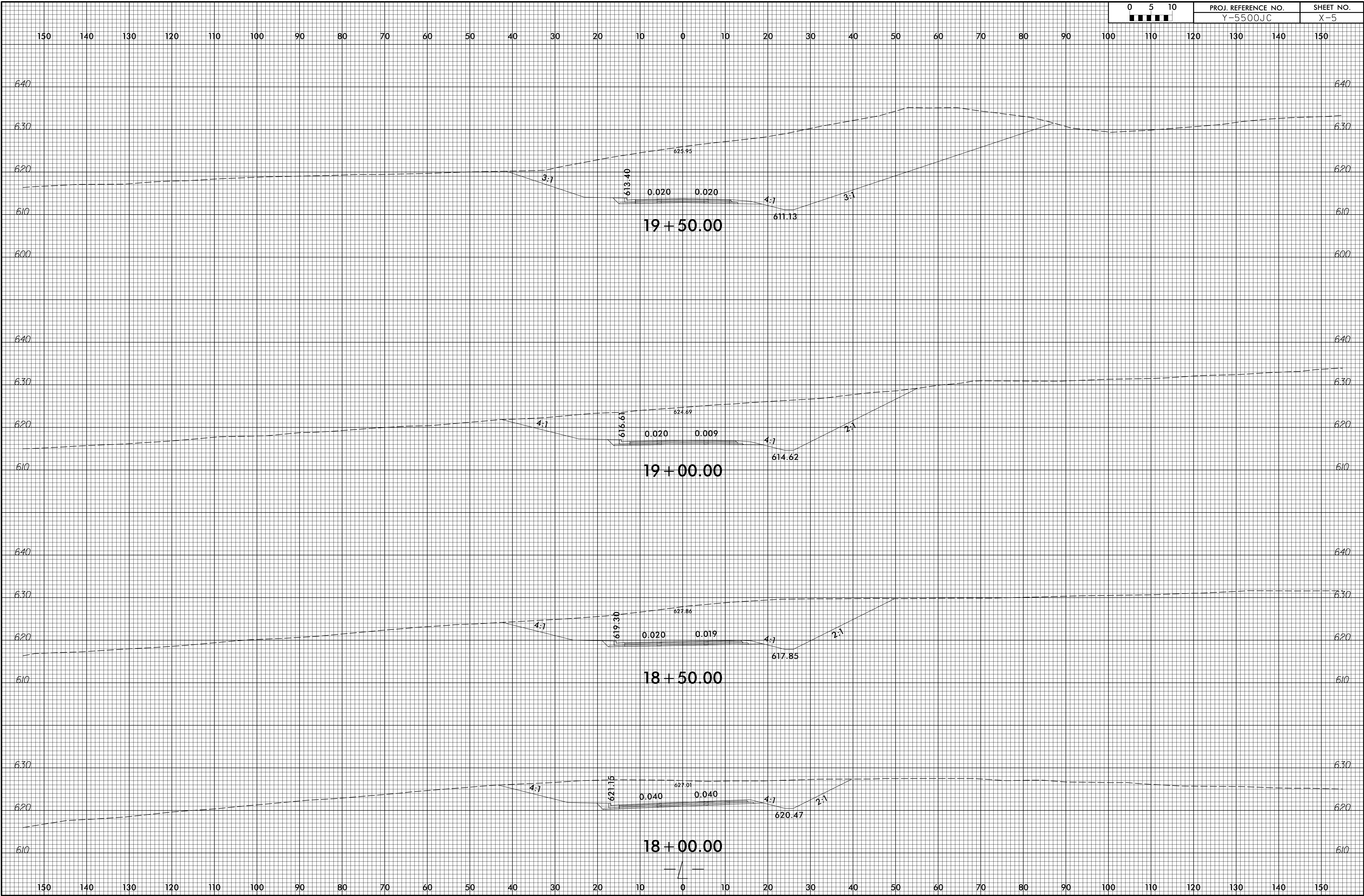

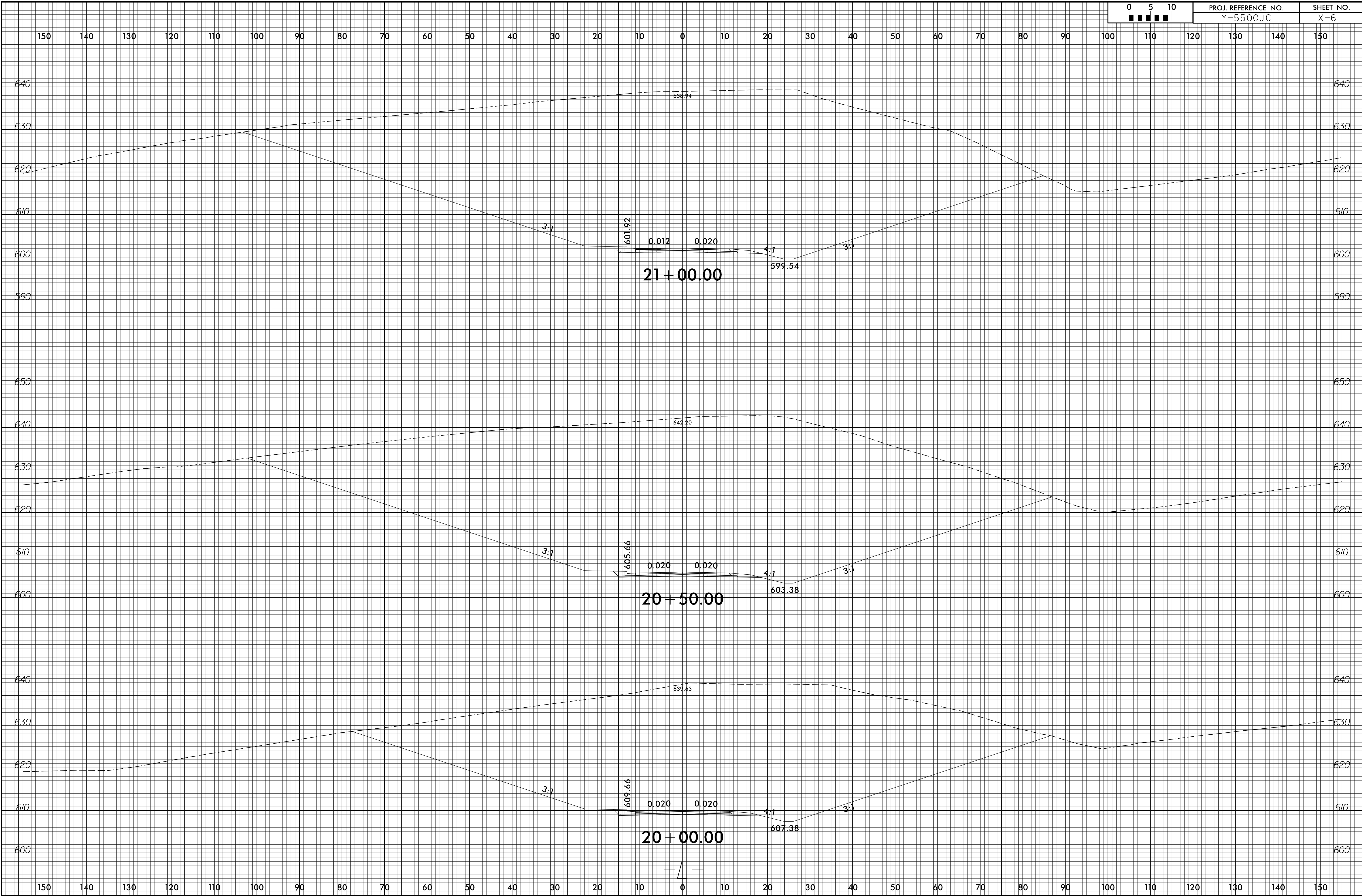



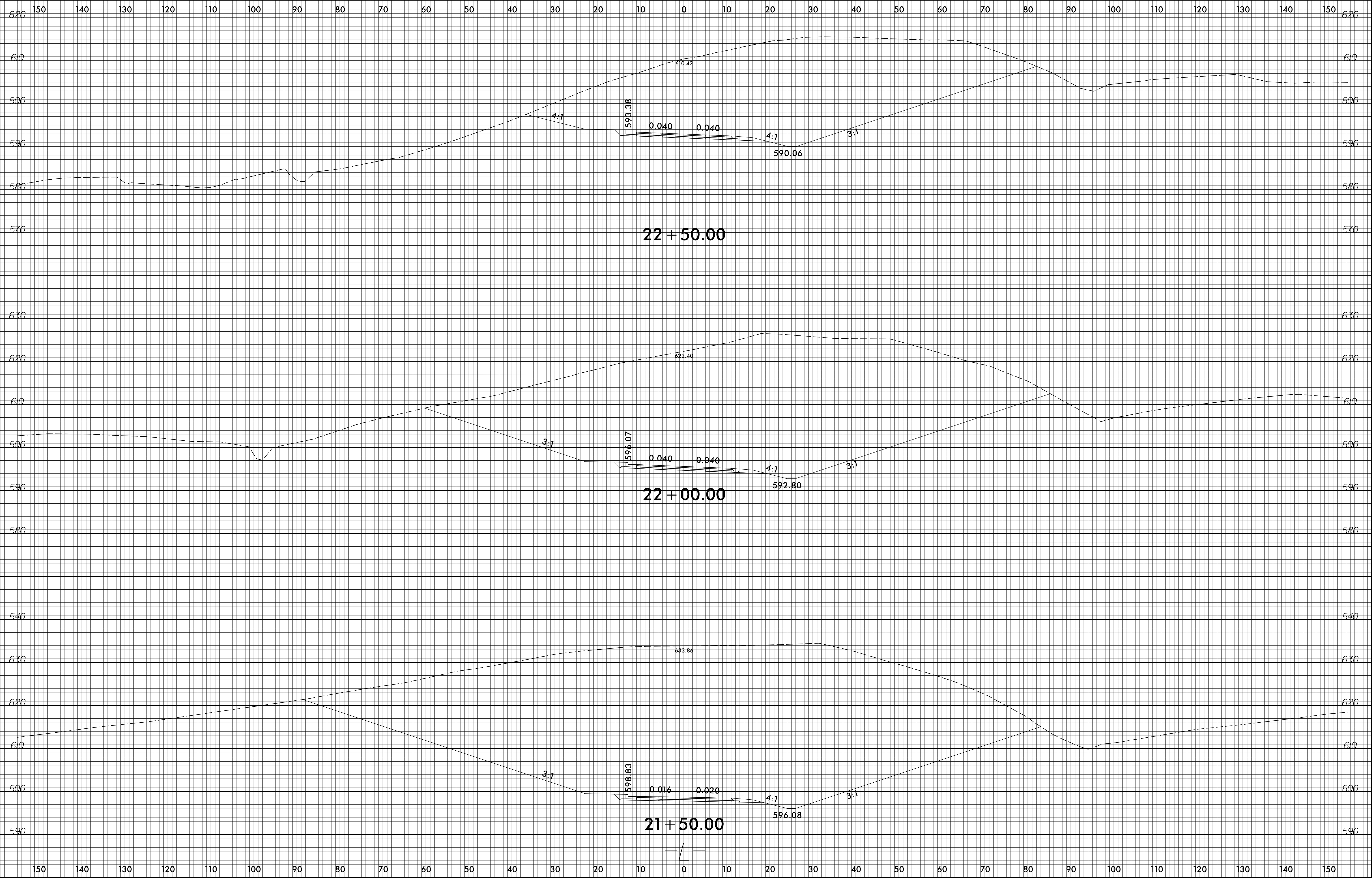

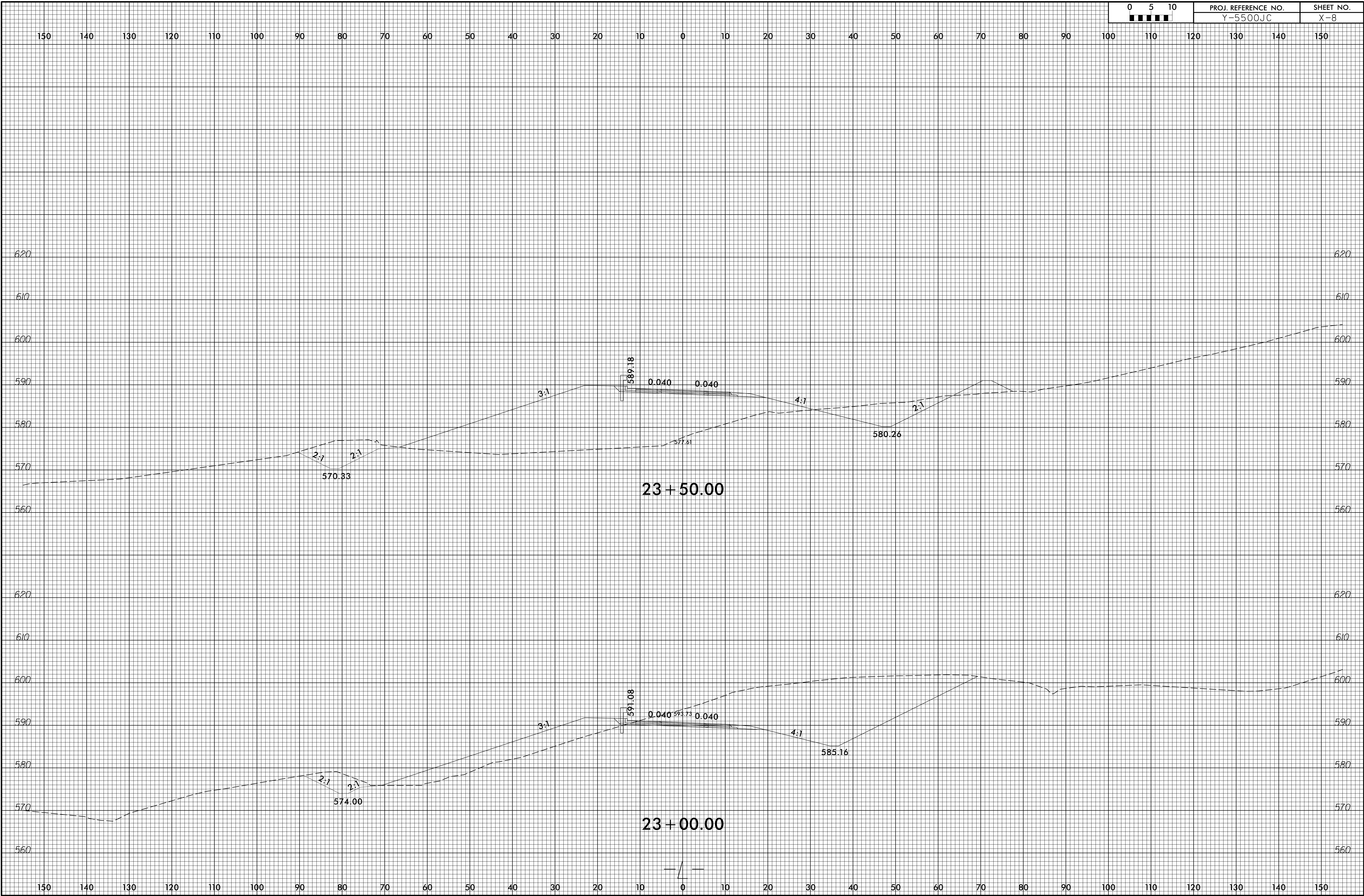

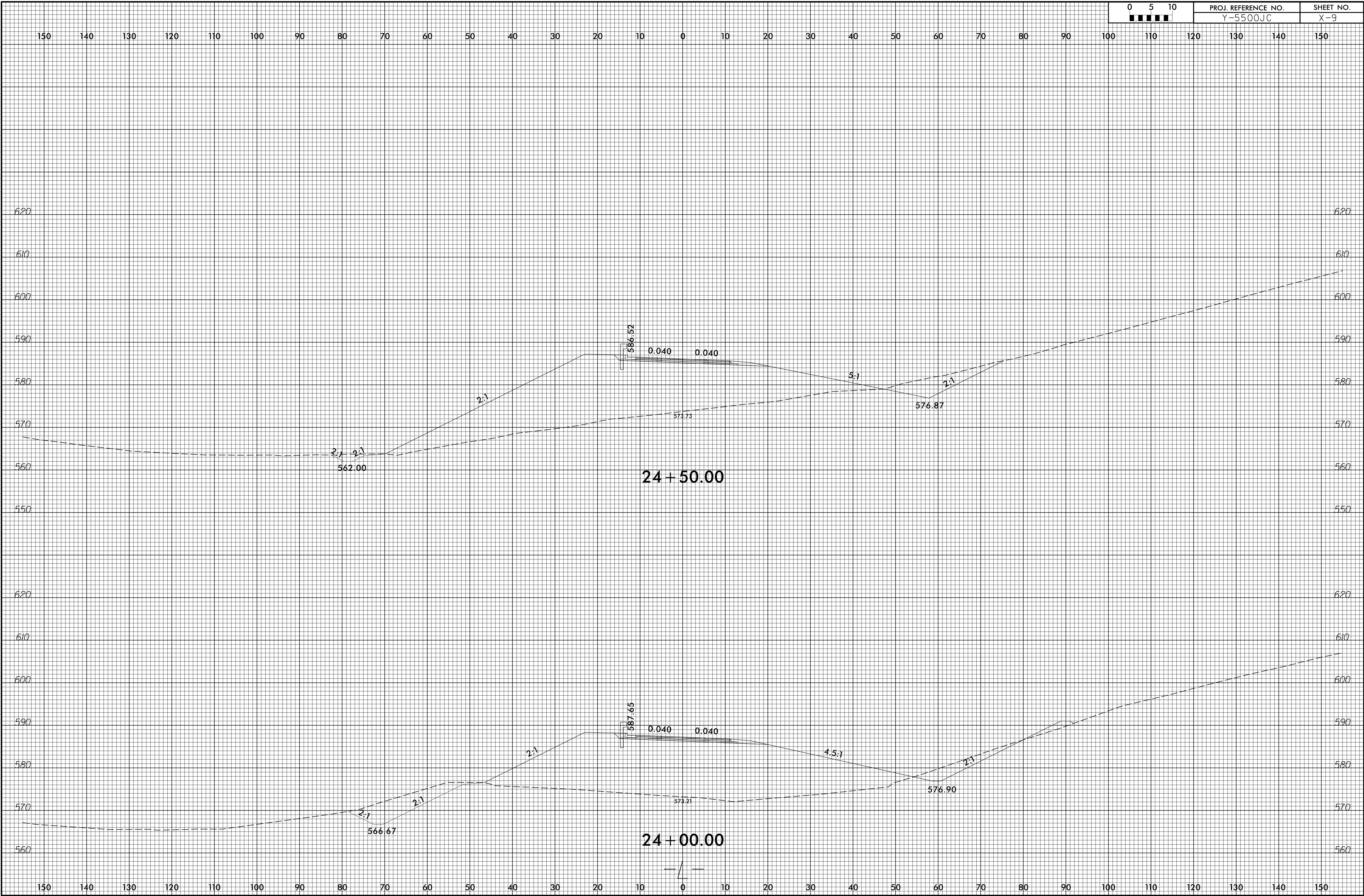

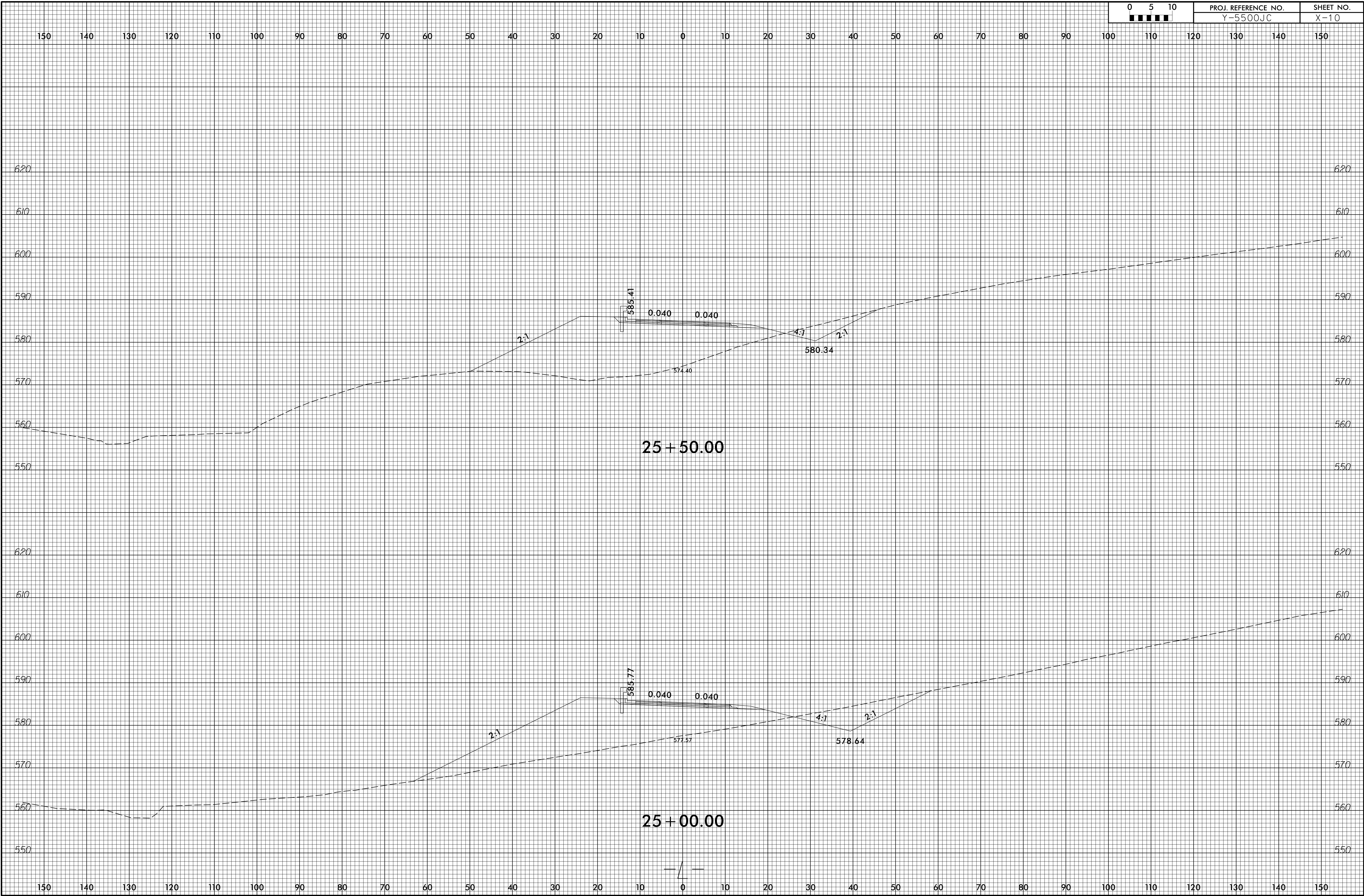

150 140 130 120 110 100 90 80 70 60 50 40 30 20 10 0 10 20 30 40 50 60 70 80 90 100 110 120 130 140 150

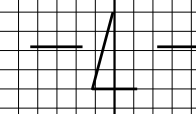
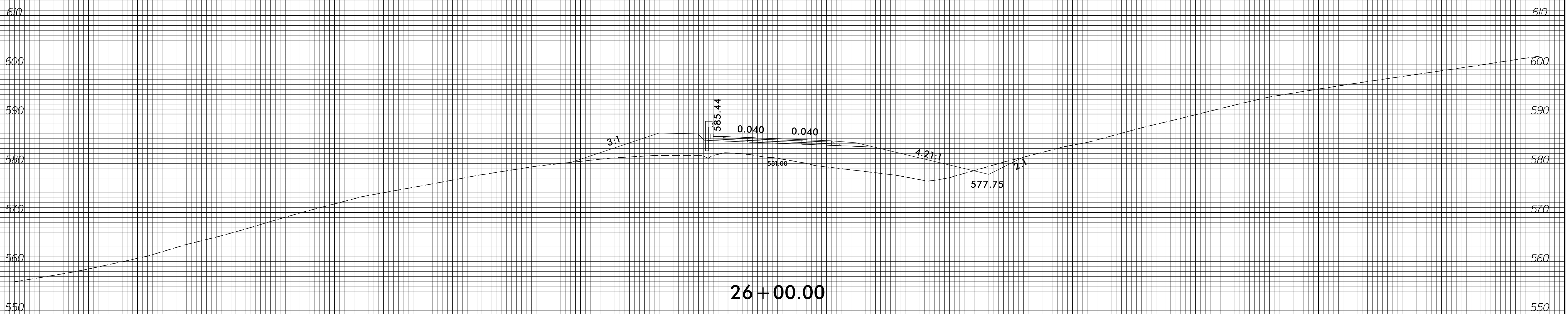
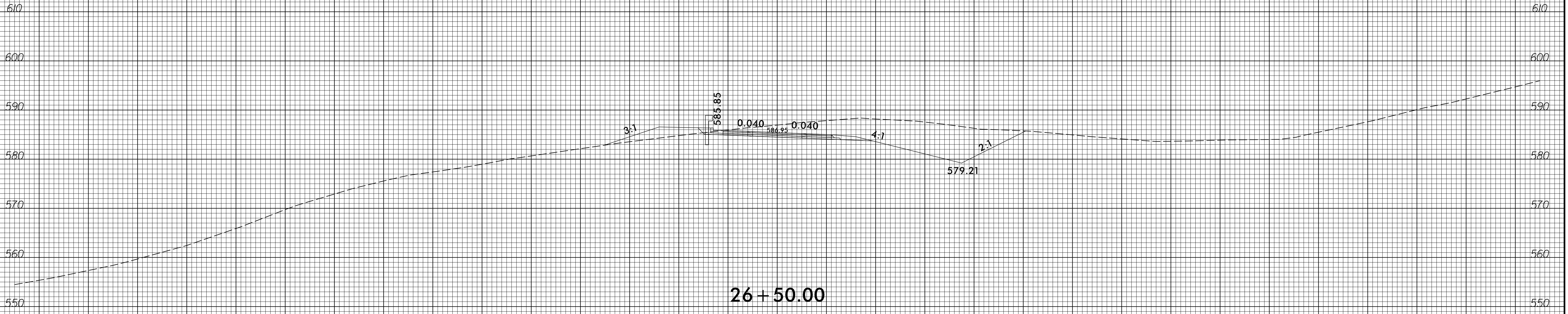

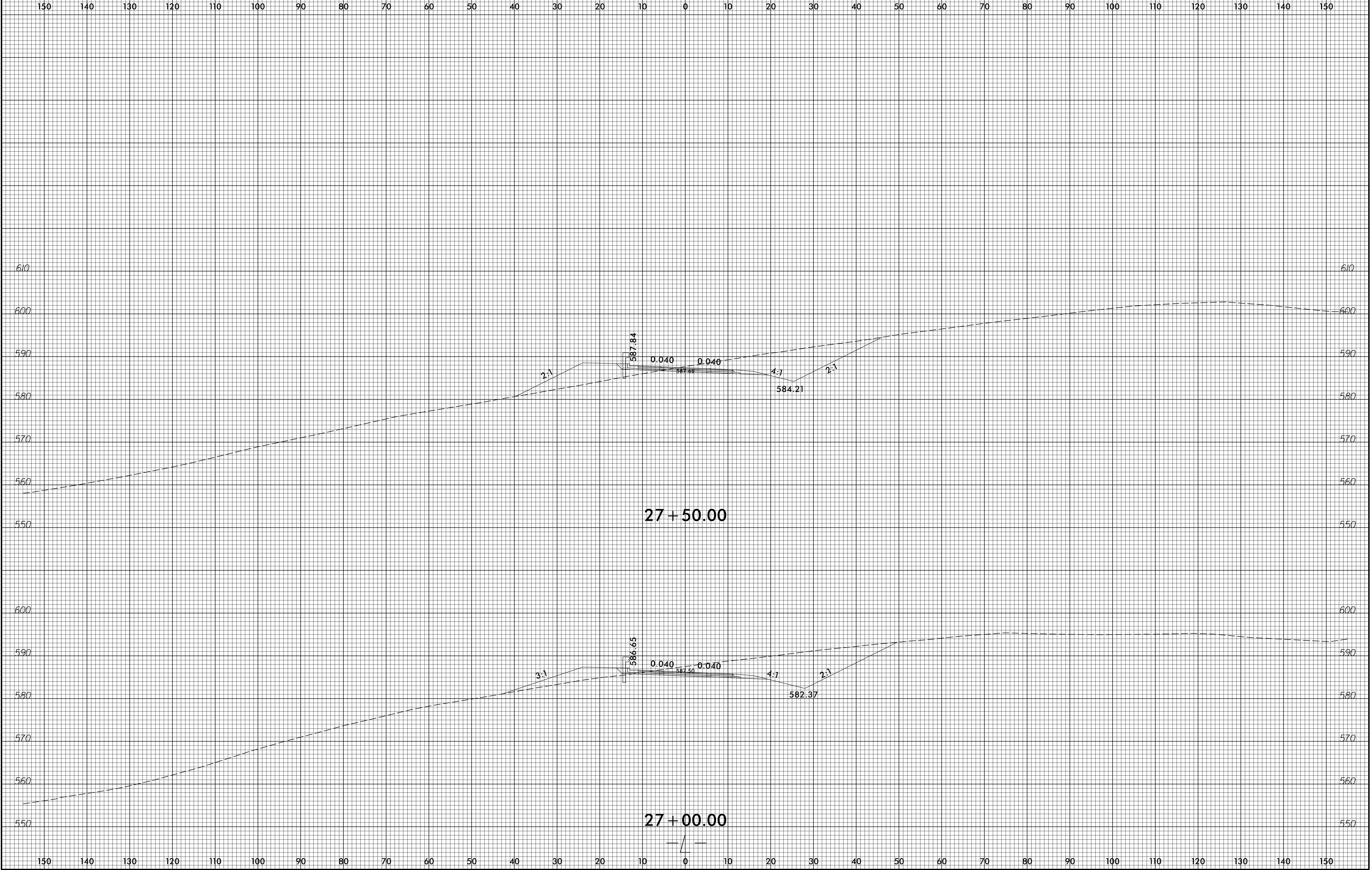
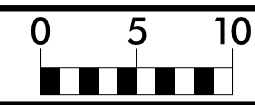

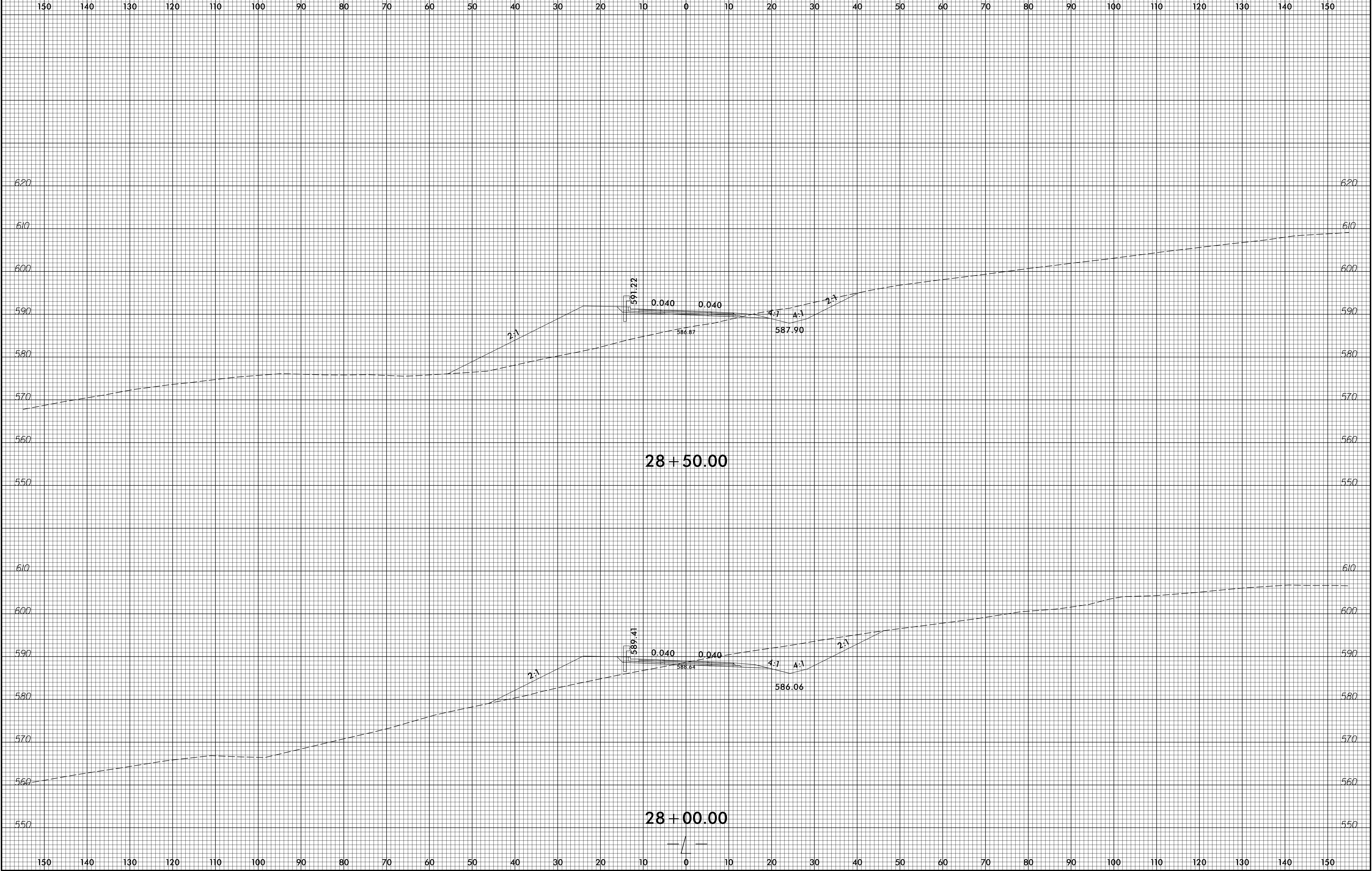

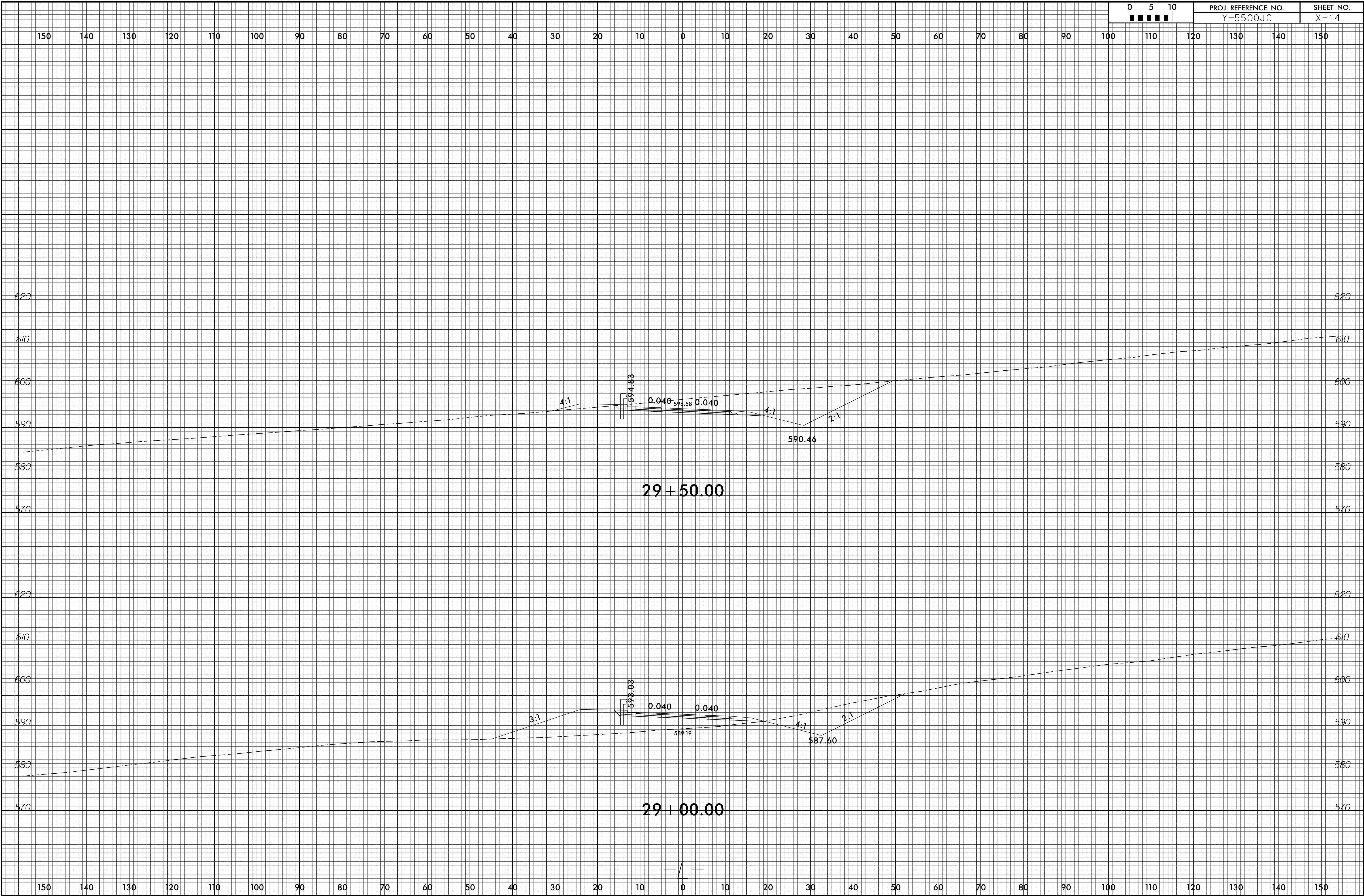



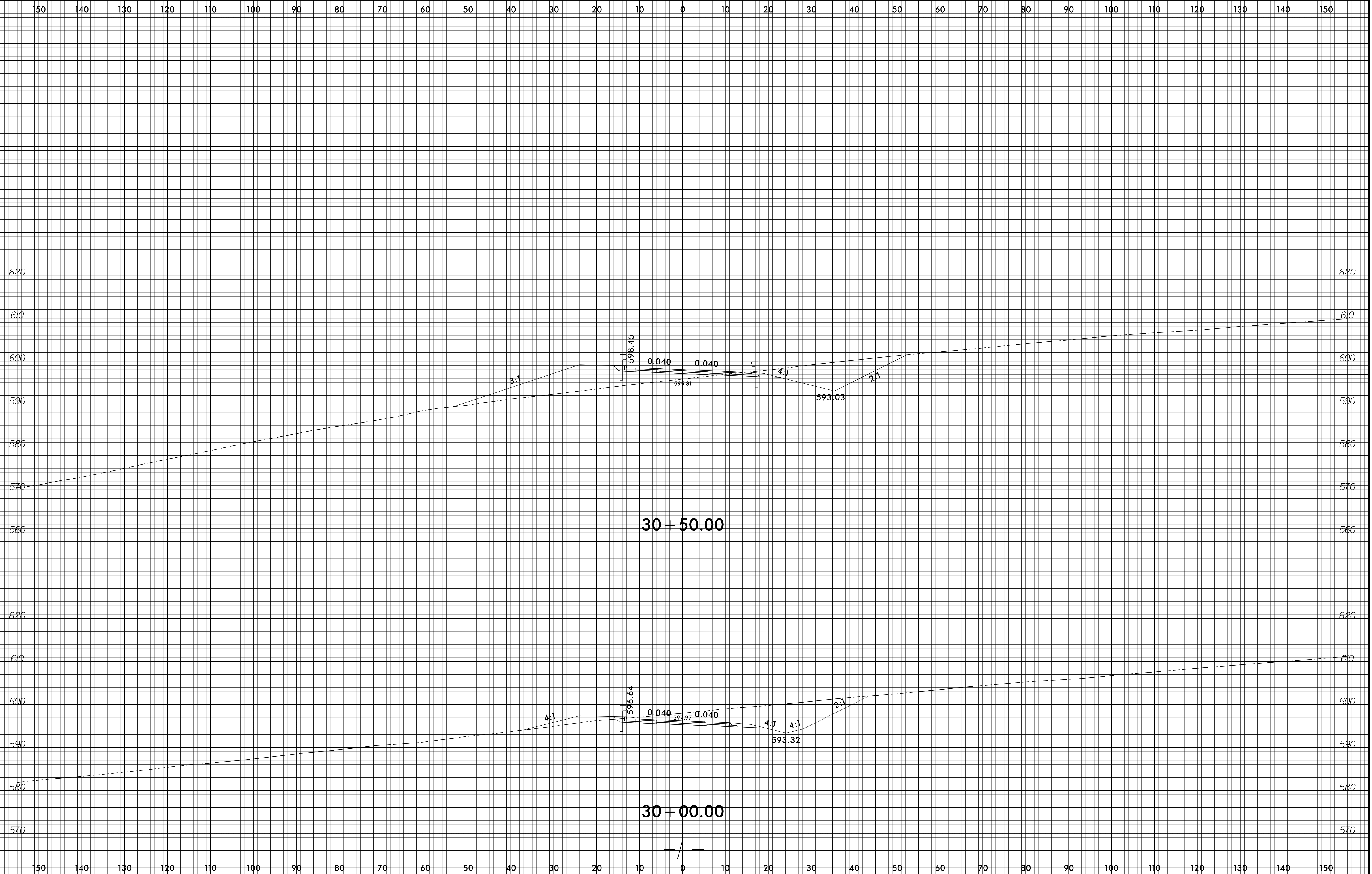
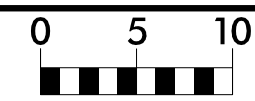

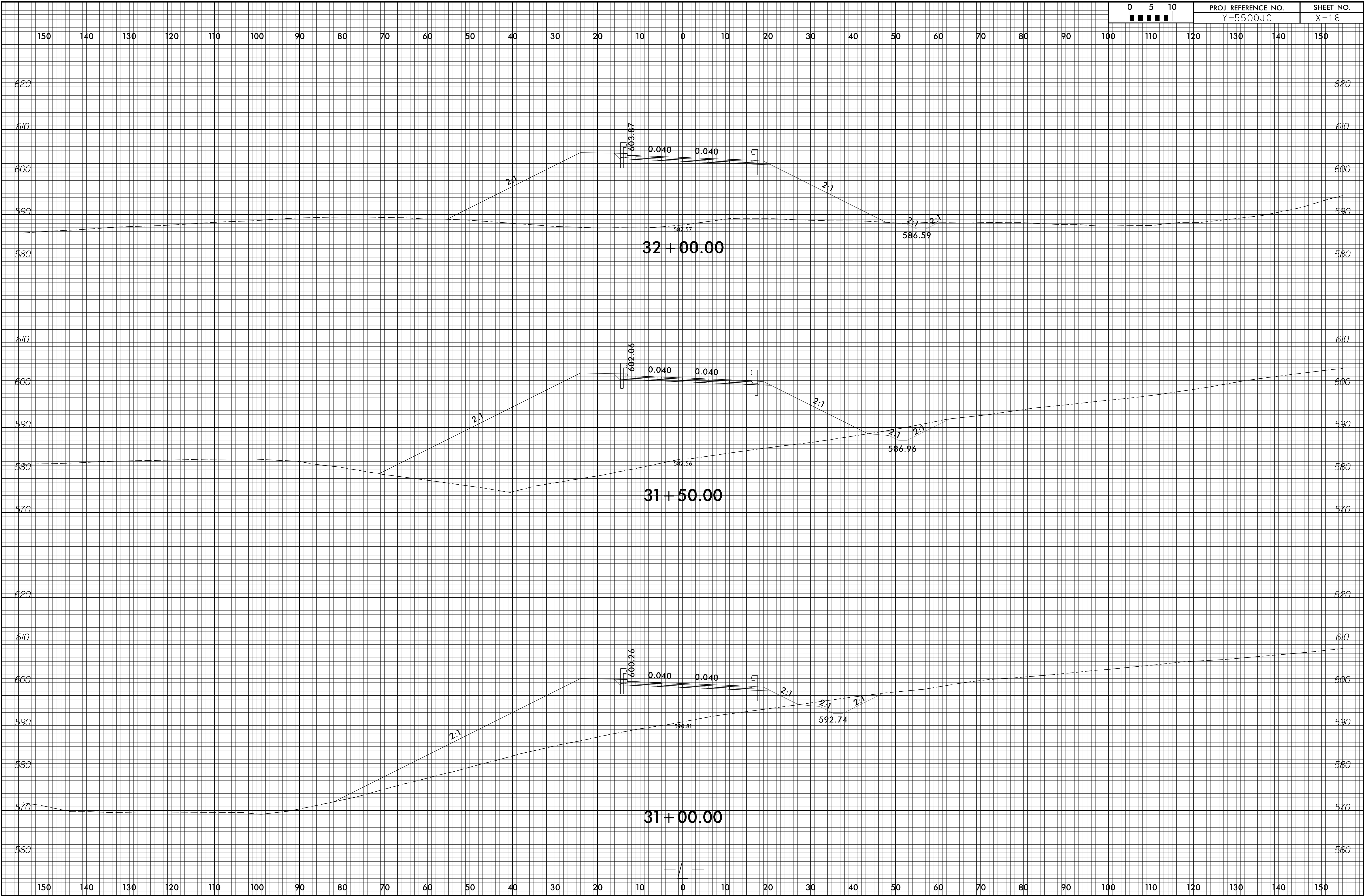

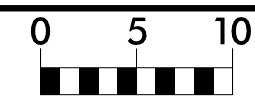

150 140 130 120 110 100 90 80 70 60 50 40 30 20 10 0 10 20 30 40 50 60 70 80 90 100 110 120 130 140 150

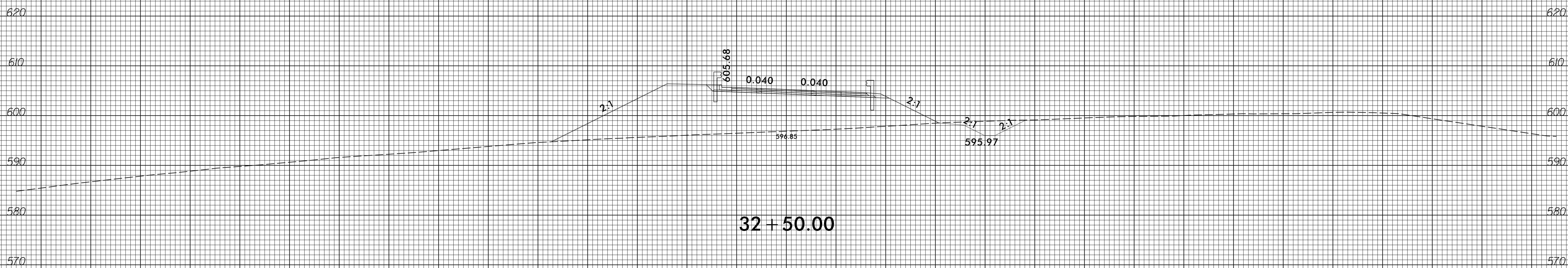
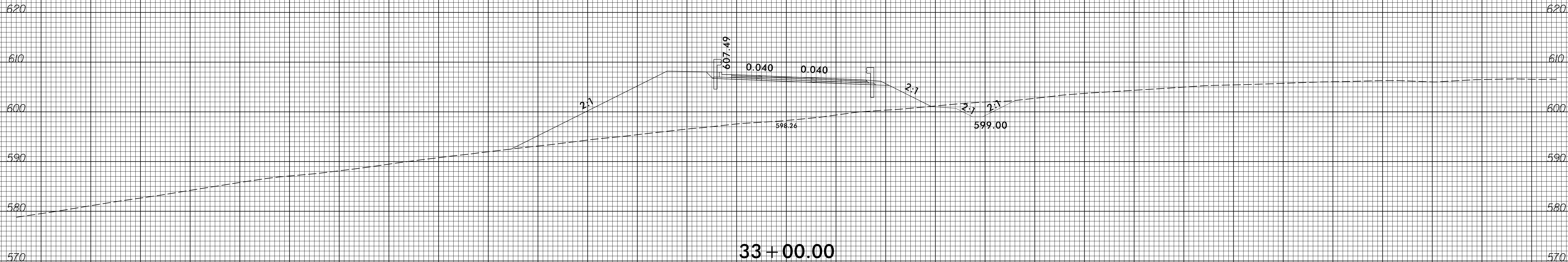

150 140 130 120 110 100 90 80 70 60 50 40 30 20 10 0 10 20 30 40 50 60 70 80 90 100 110 120 130 140 150

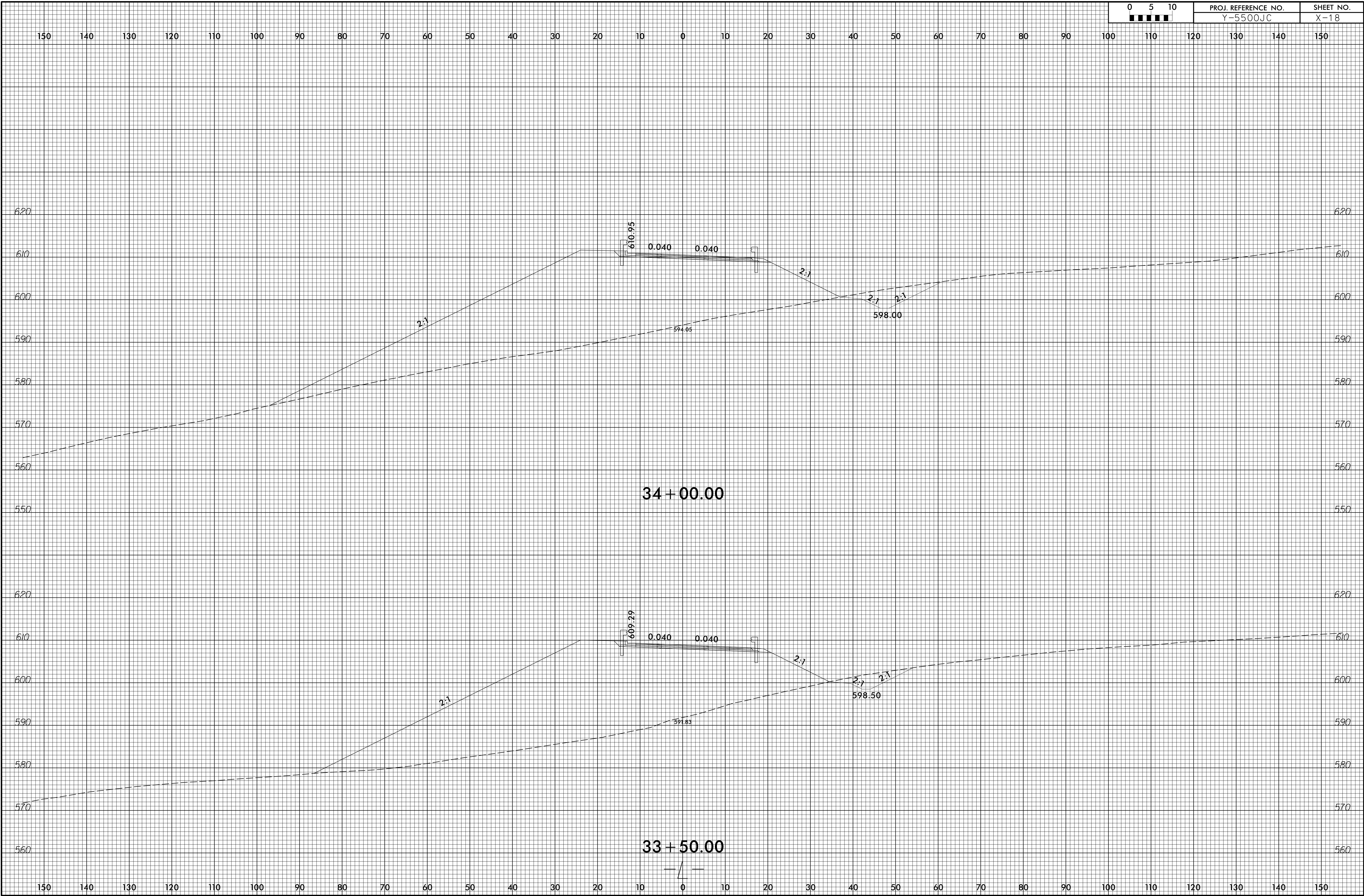

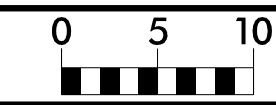

150 140 130 120 110 100 90 80 70 60 50 40 30 20 10 0 10 20 30 40 50 60 70 80 90 100 110 120 130 140 150

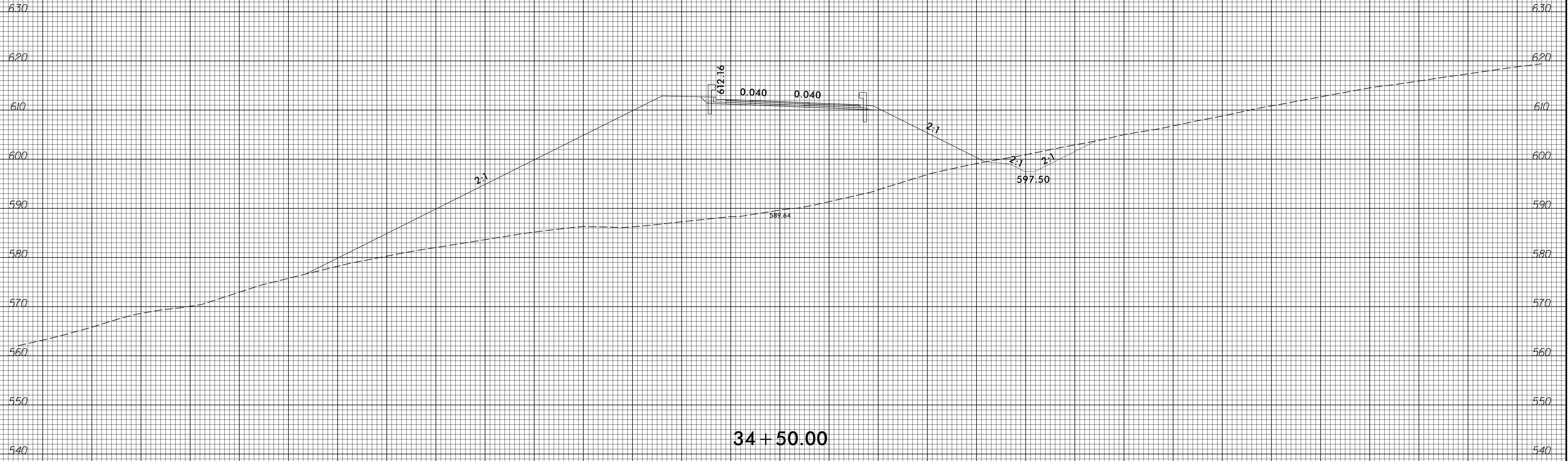

150 140 130 120 110 100 90 80 70 60 50 40 30 20 10 0 10 20 30 40 50 60 70 80 90 100 110 120 130 140 150

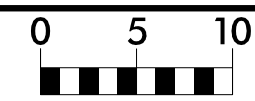

150 140 130 120 110 100 90 80 70 60 50 40 30 20 10 0 10 20 30 40 50 60 70 80 90 100 110 120 130 140 150

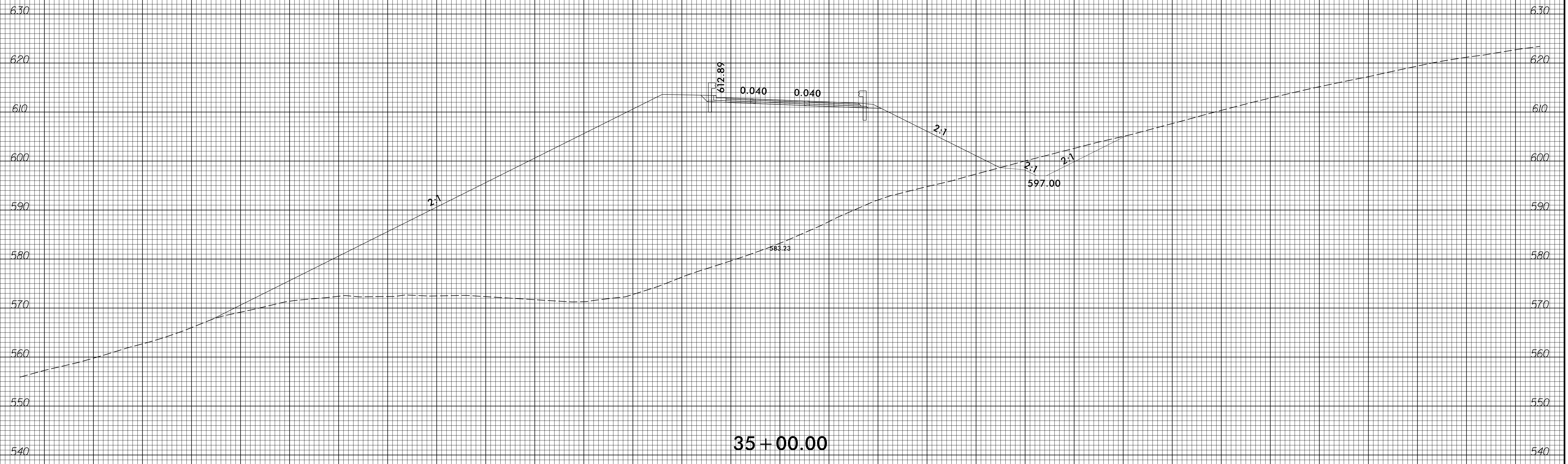

150 140 130 120 110 100 90 80 70 60 50 40 30 20 10 0 10 20 30 40 50 60 70 80 90 100 110 120 130 140 150

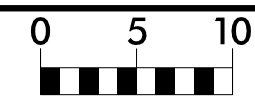

150 140 130 120 110 100 90 80 70 60 50 40 30 20 10 0 10 20 30 40 50 60 70 80 90 100 110 120 130 140 150

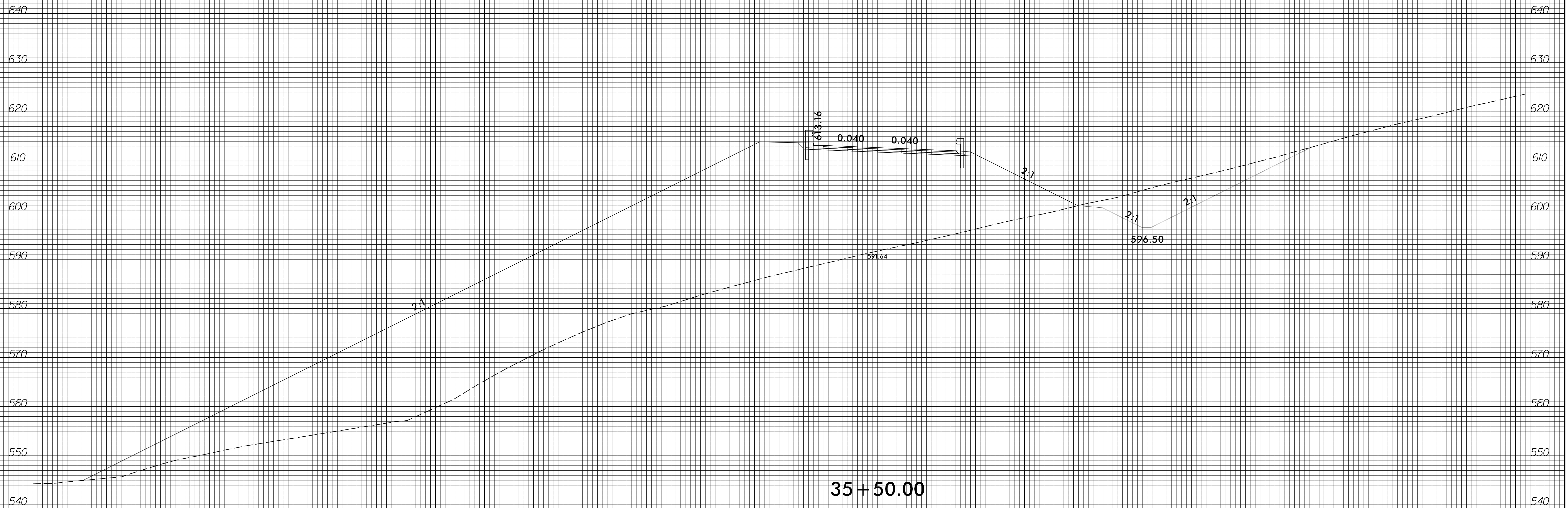

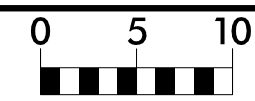

150 140 130 120 110 100 90 80 70 60 50 40 30 20 10 0 10 20 30 40 50 60 70 80 90 100 110 120 130 140 150

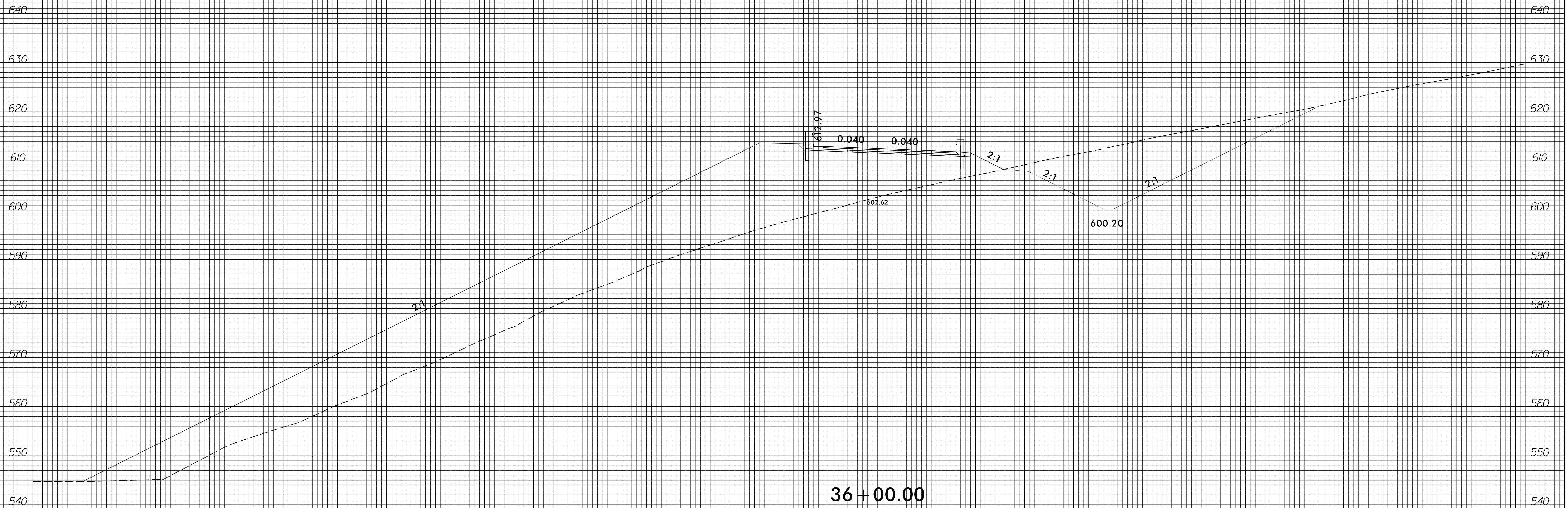

36 + 00.00





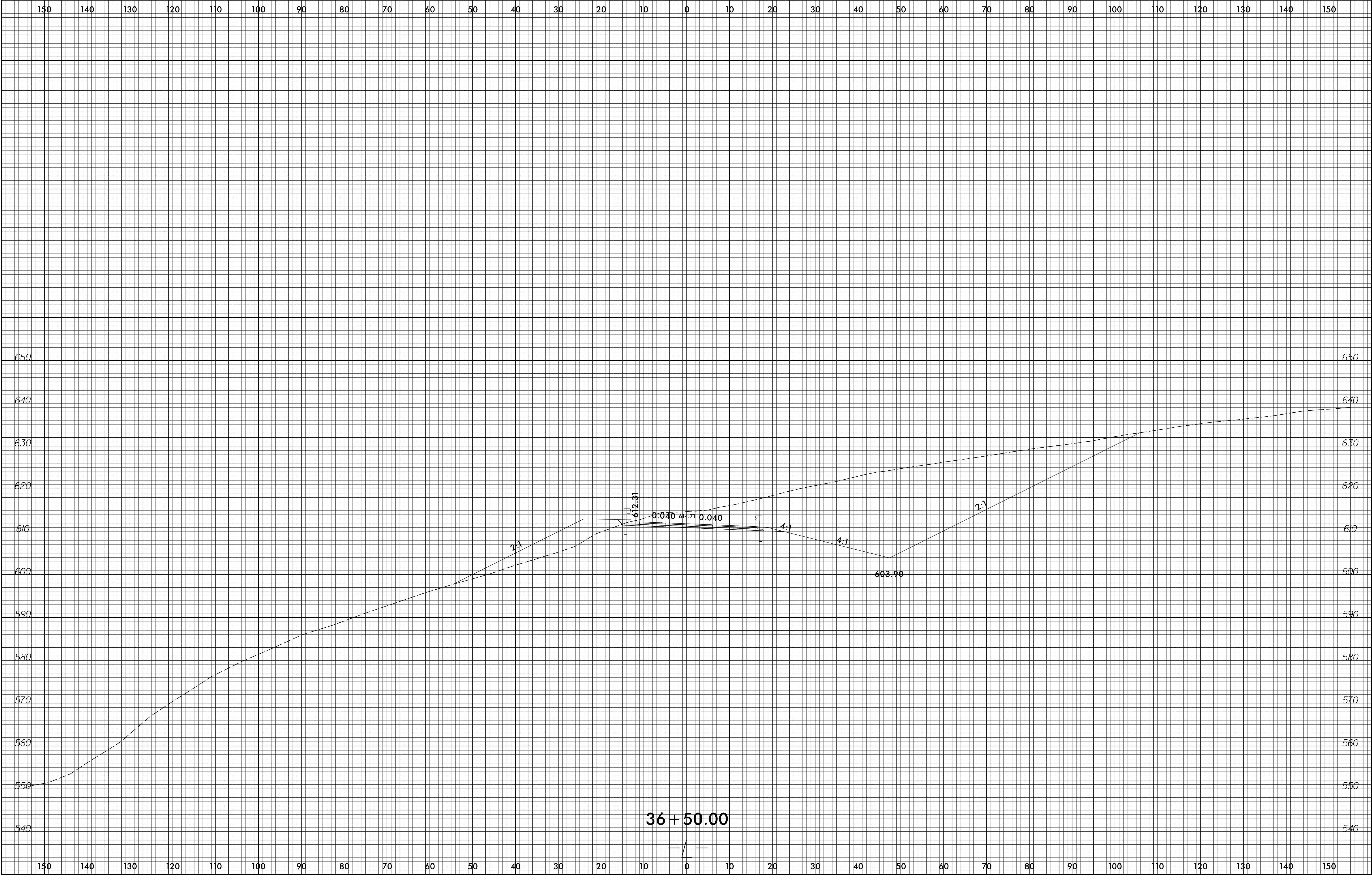
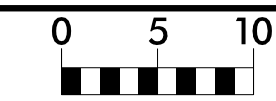

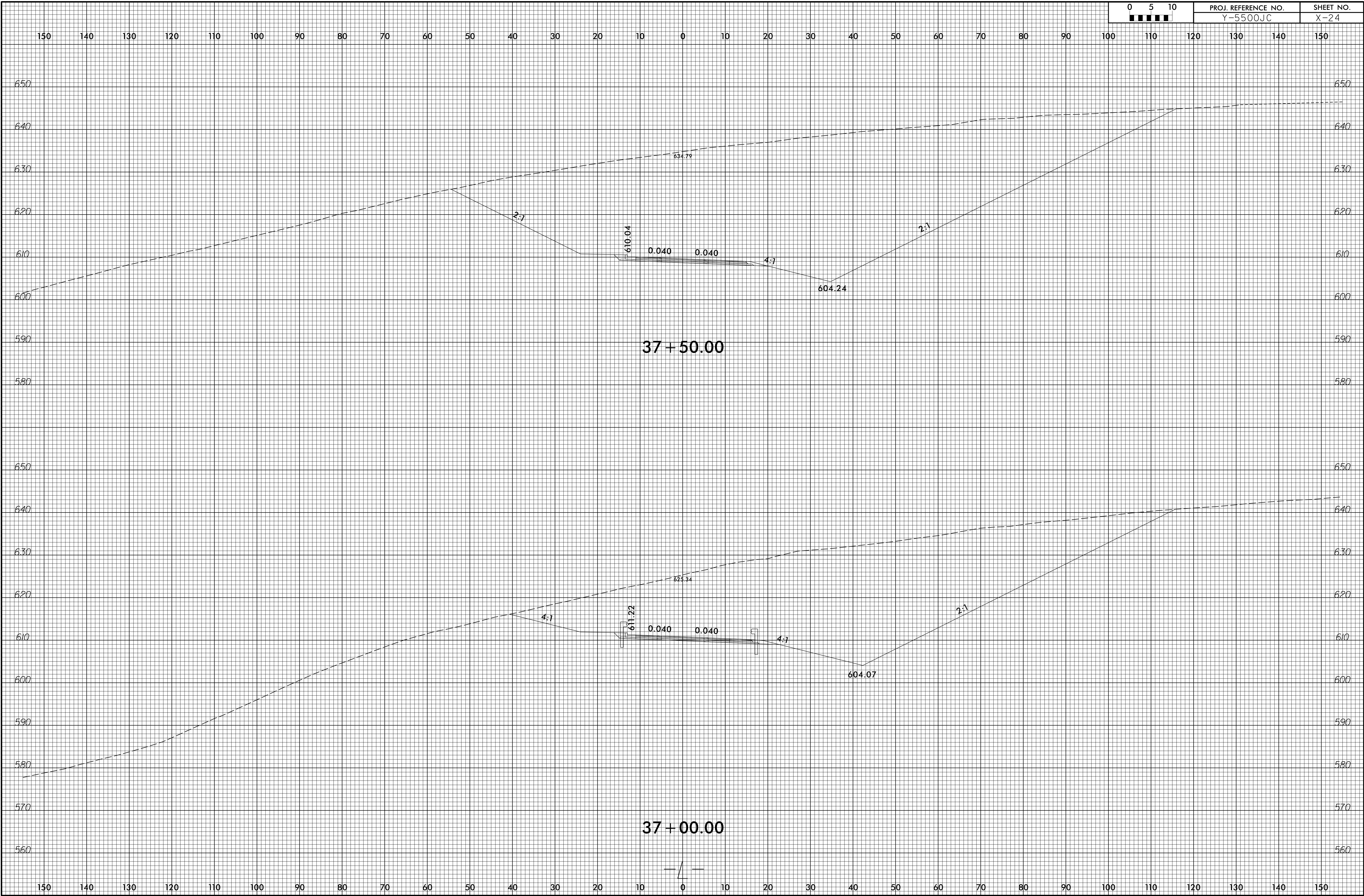

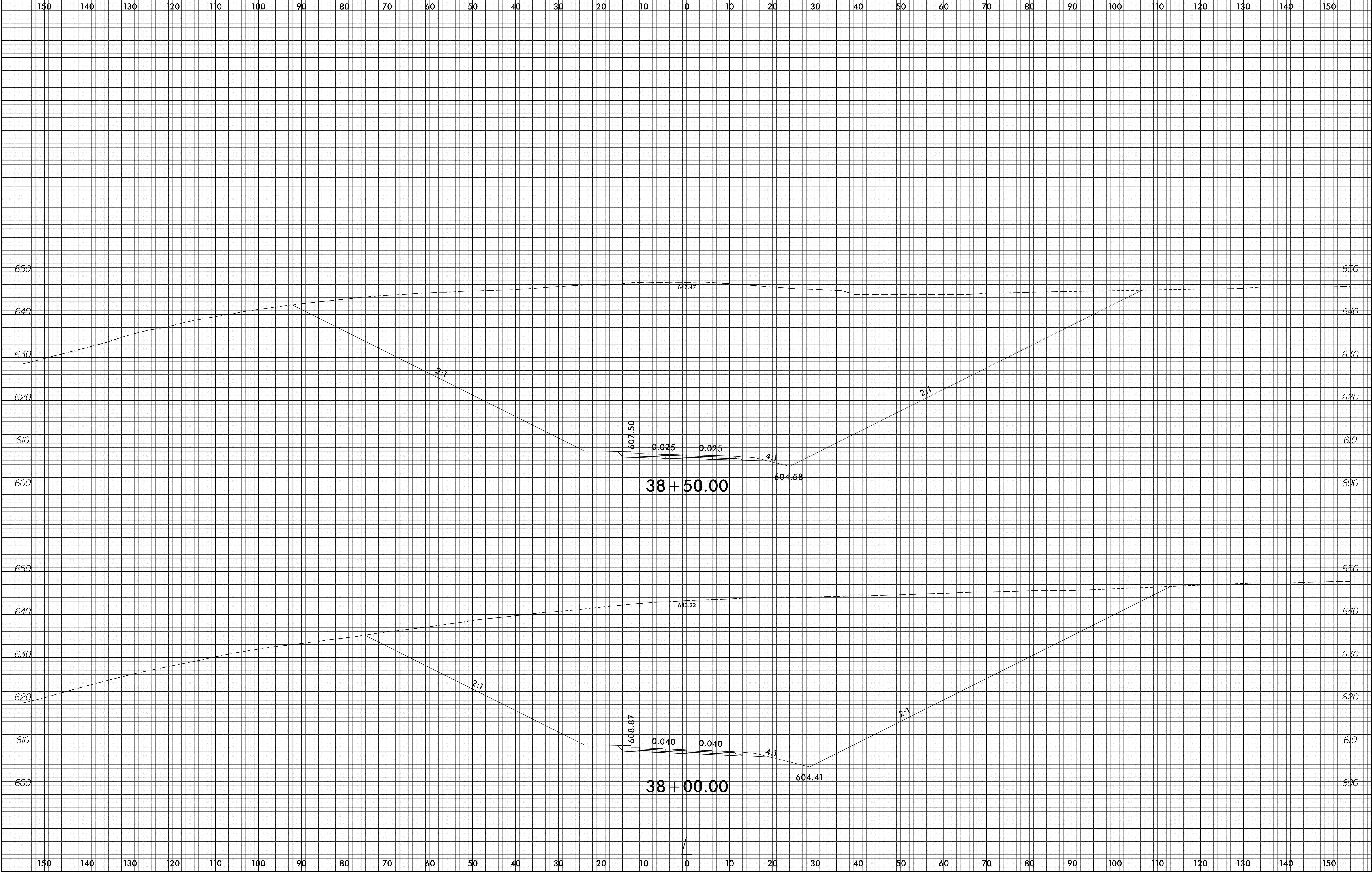

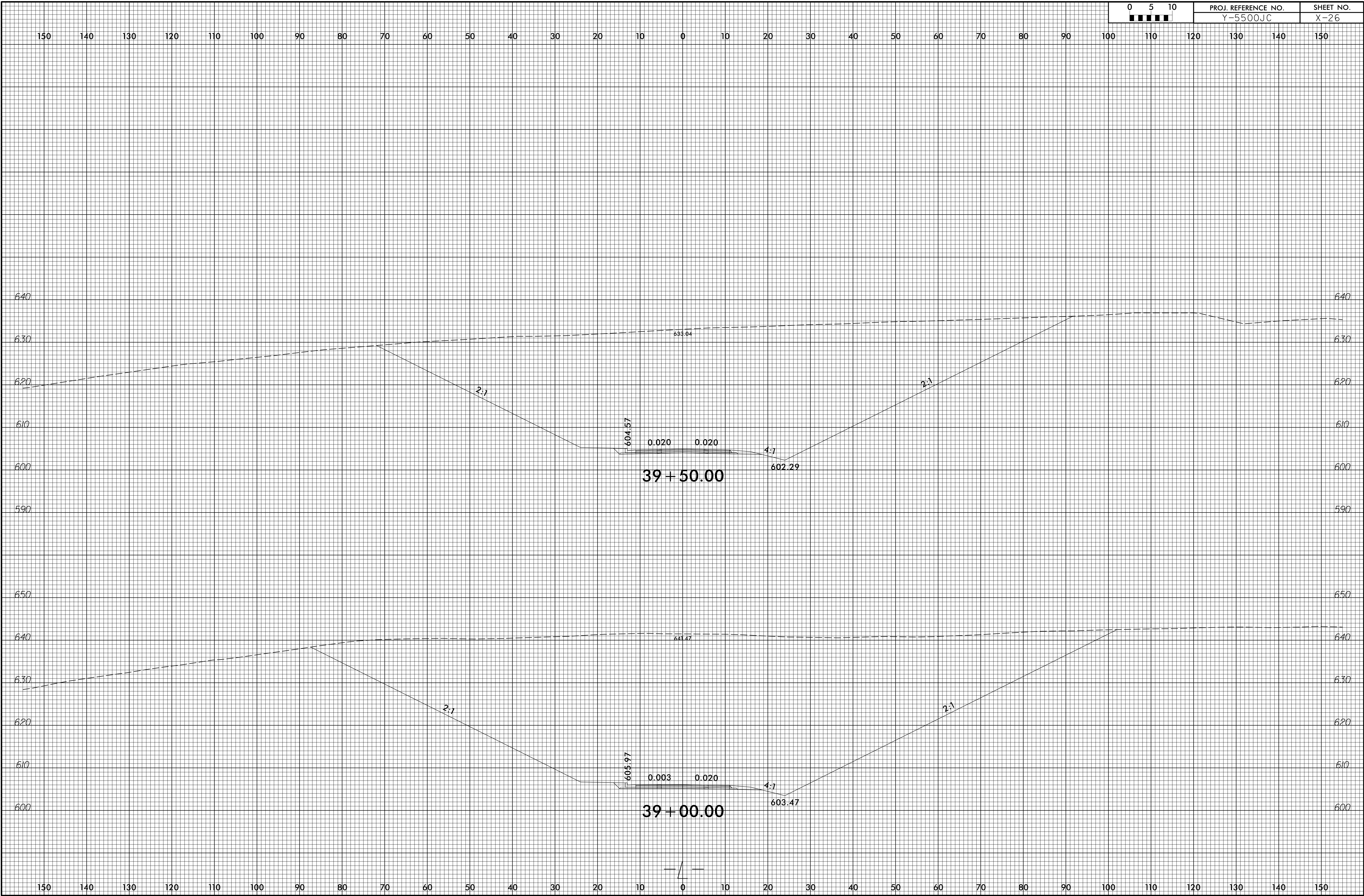

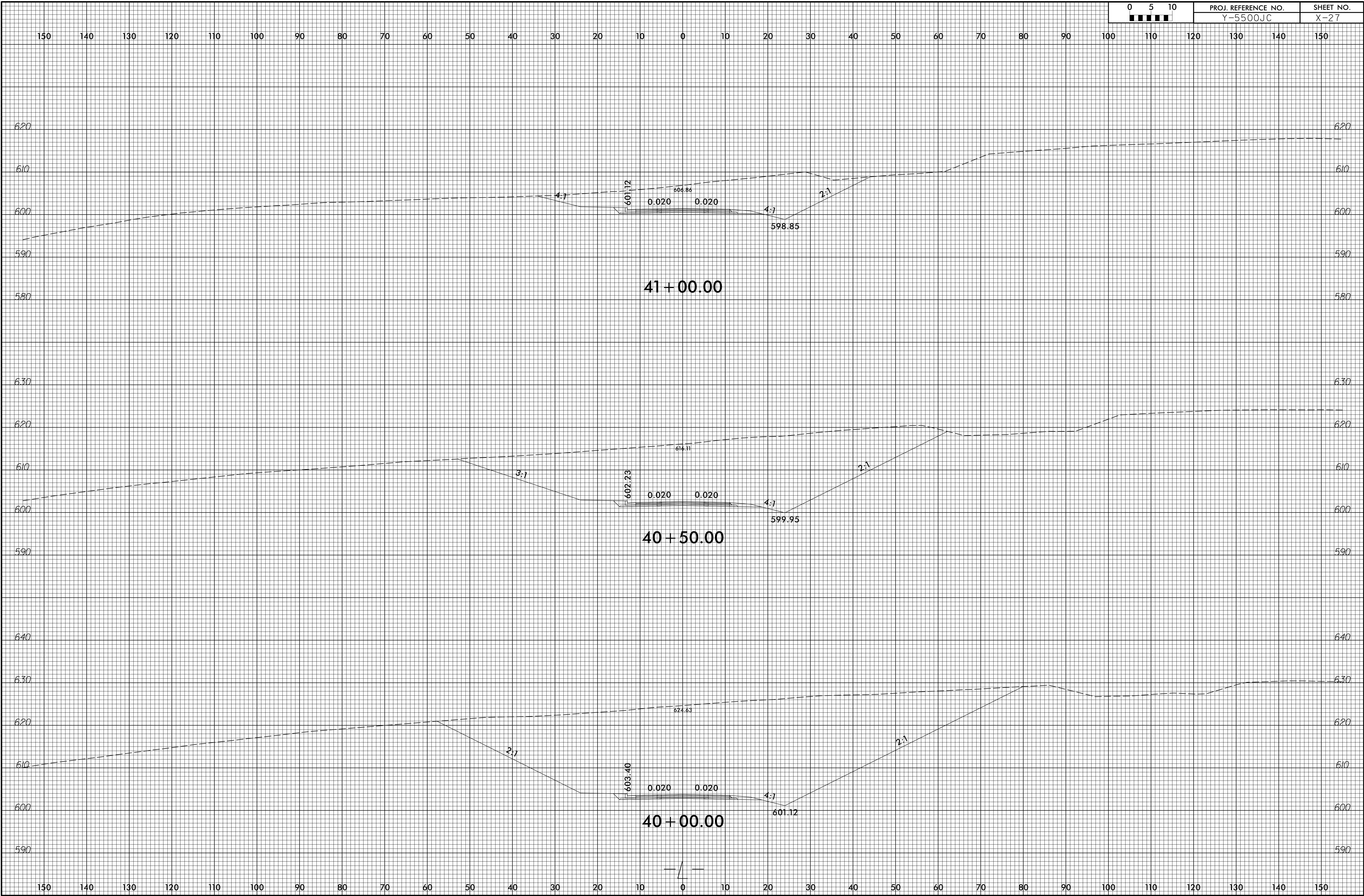

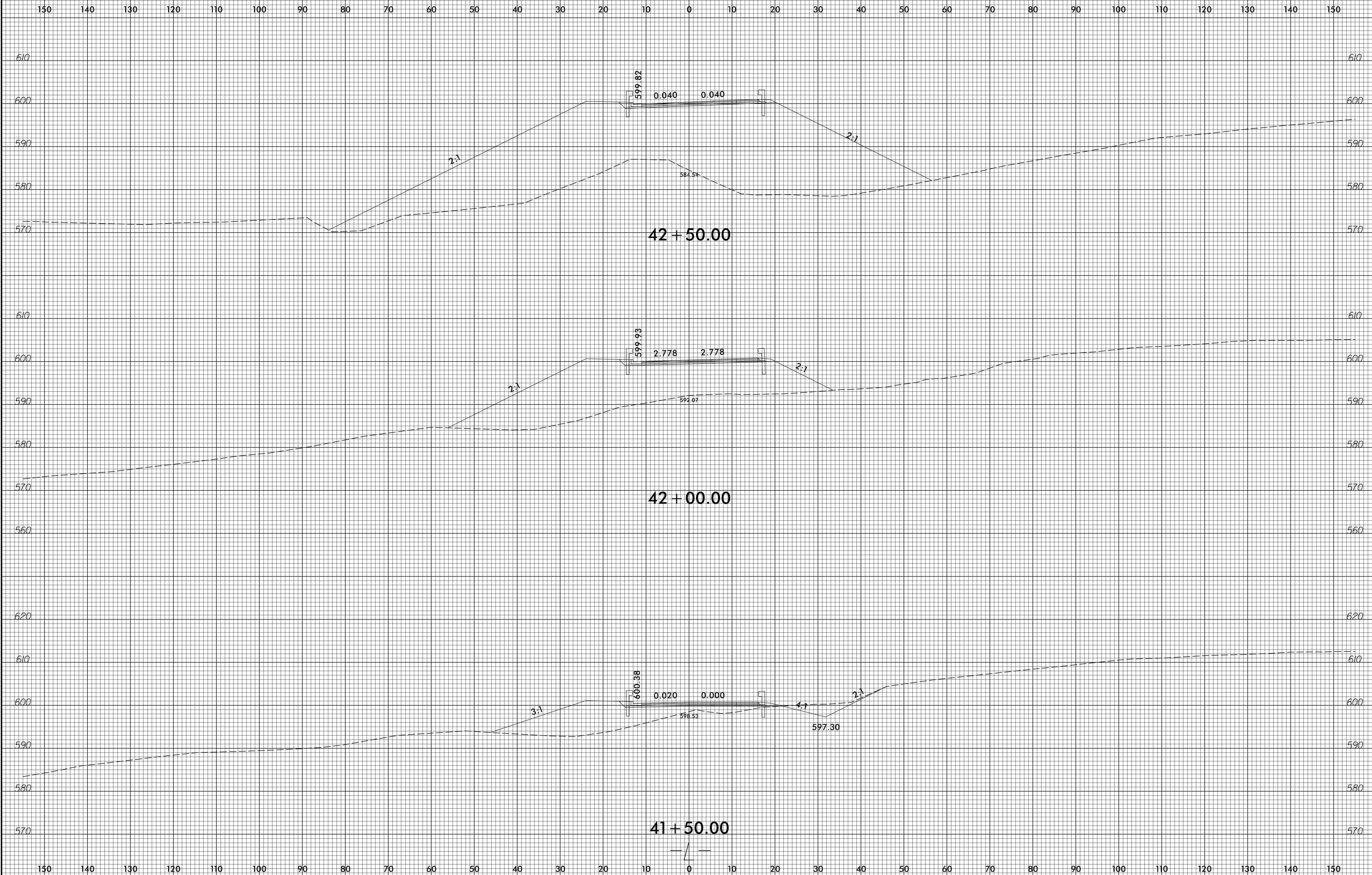

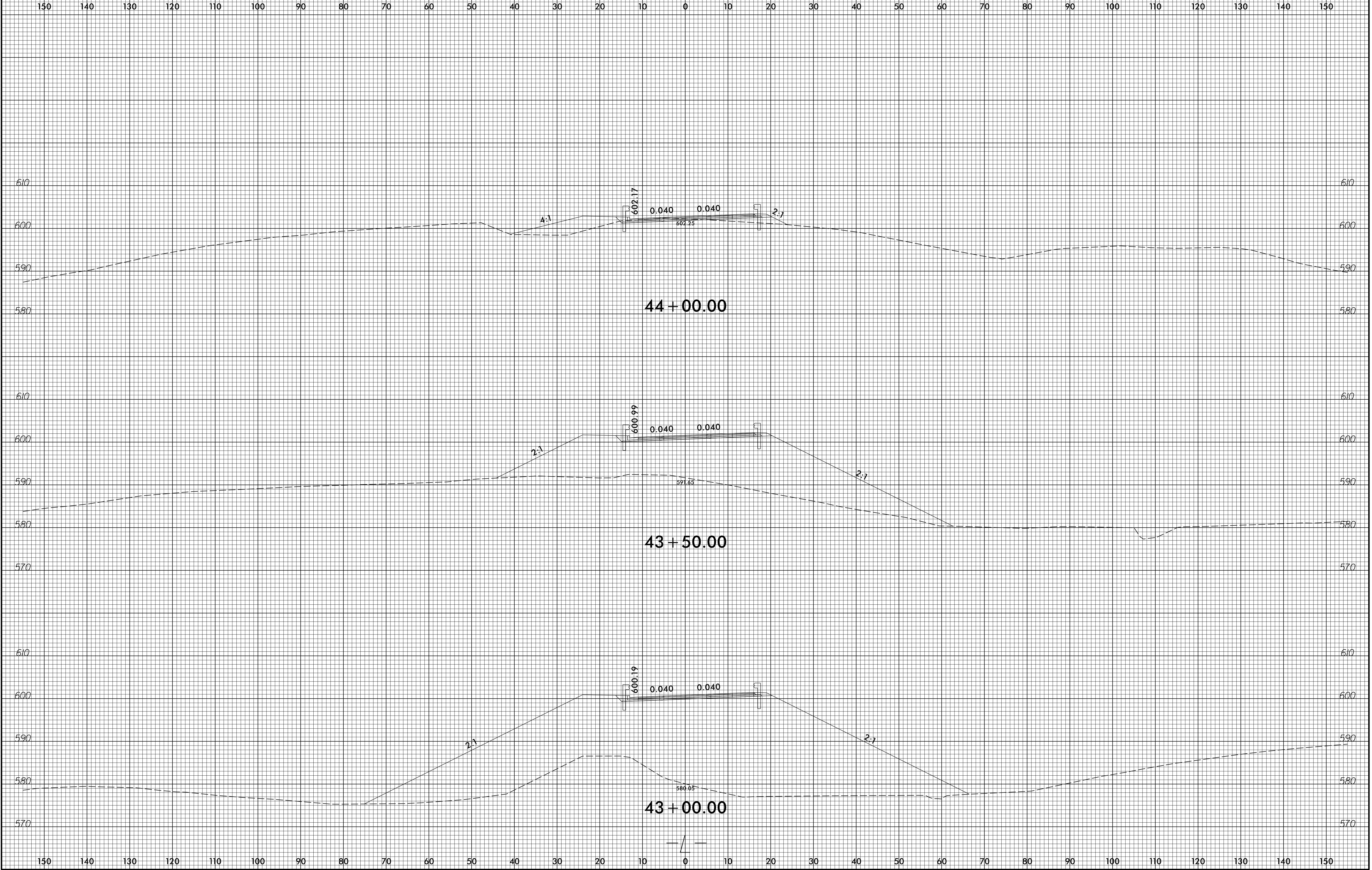

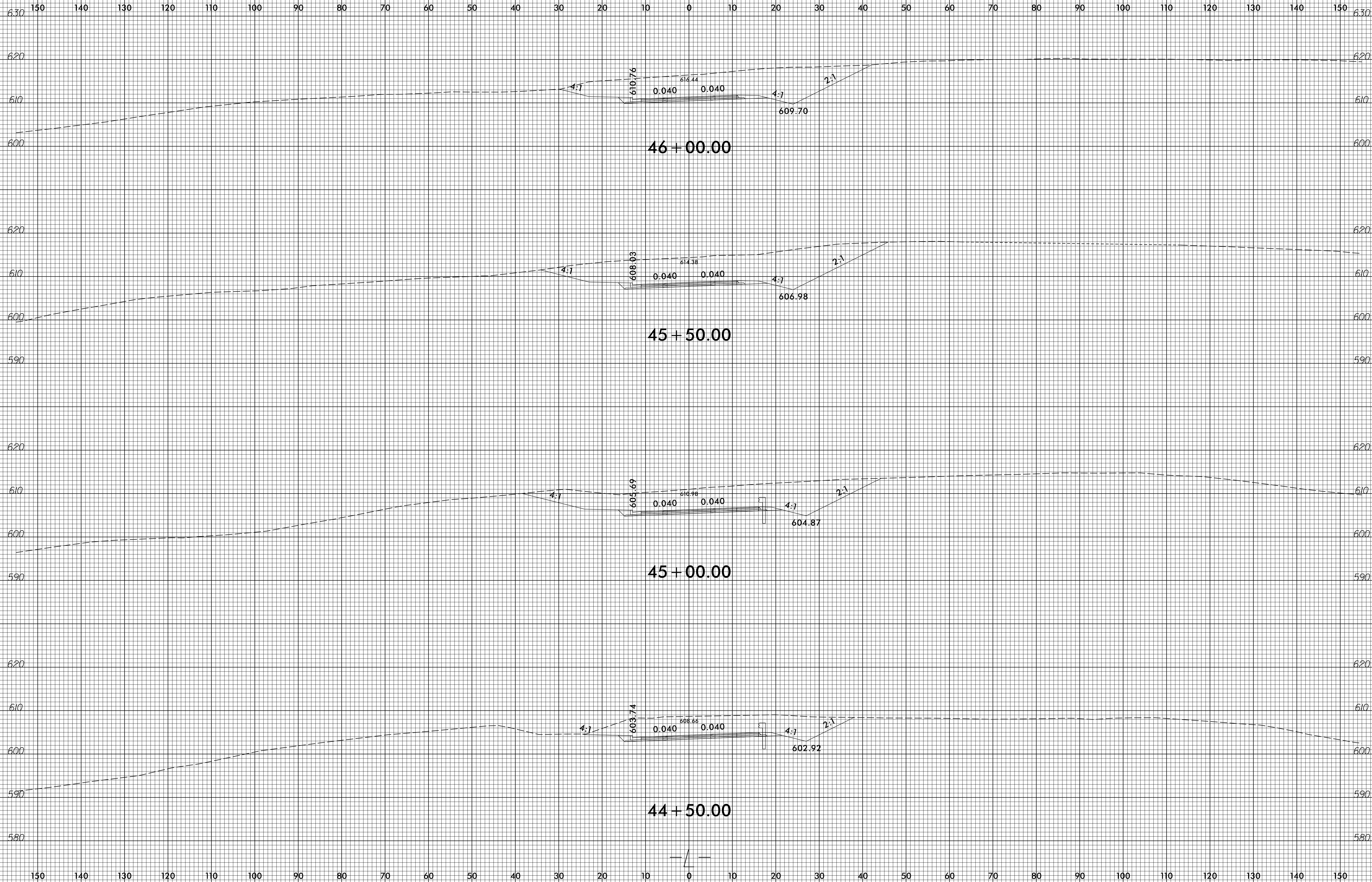



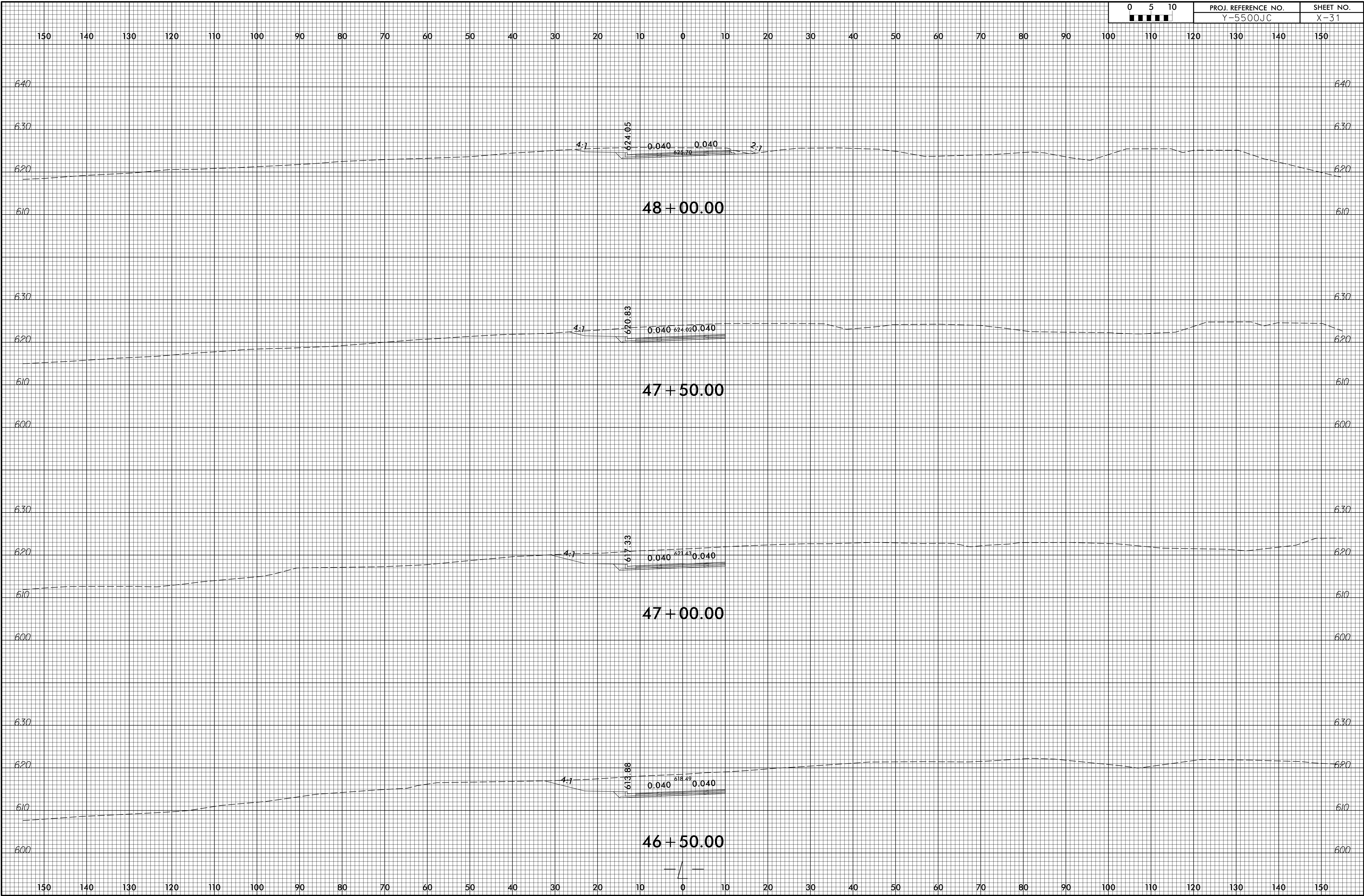

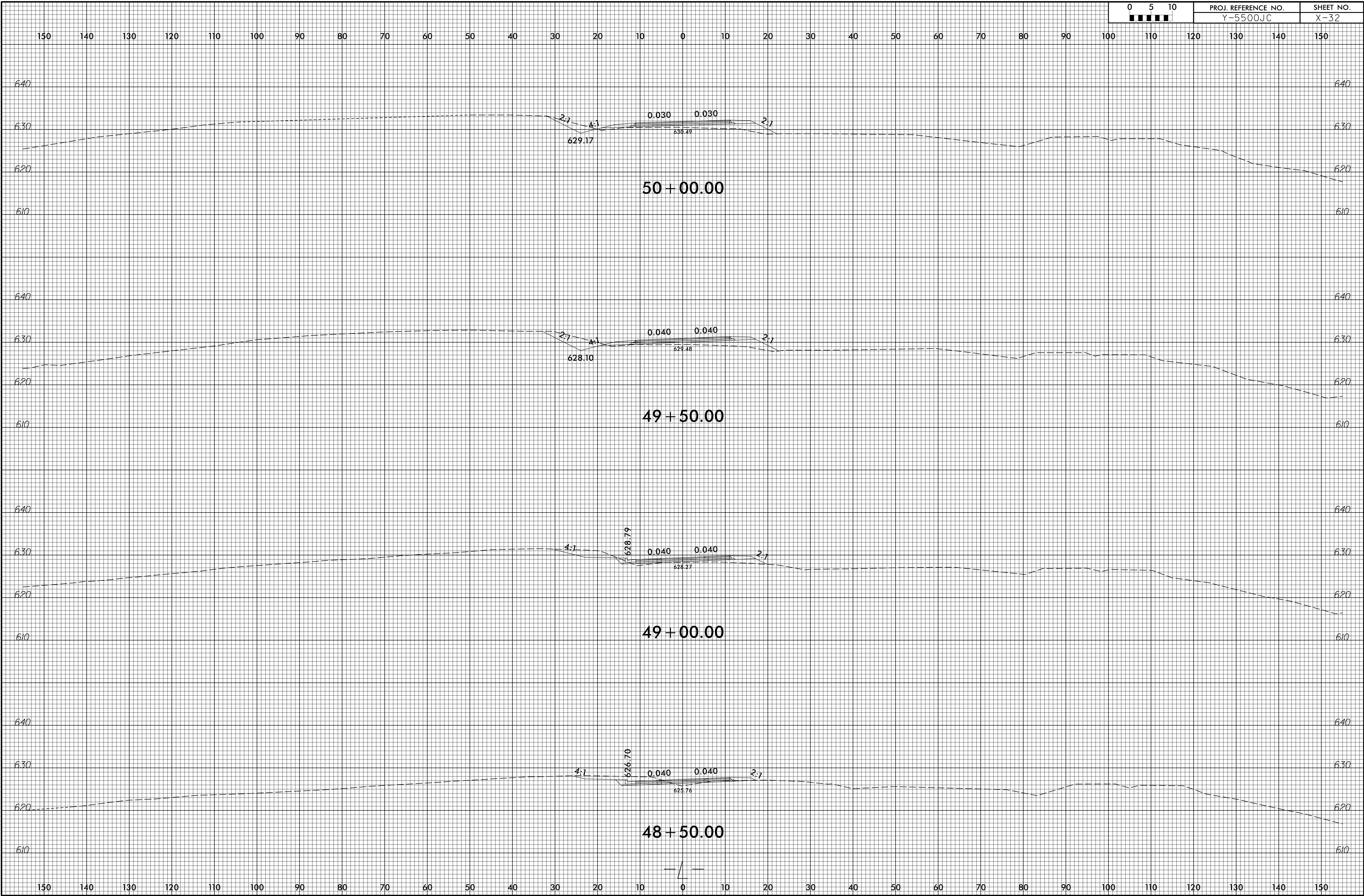

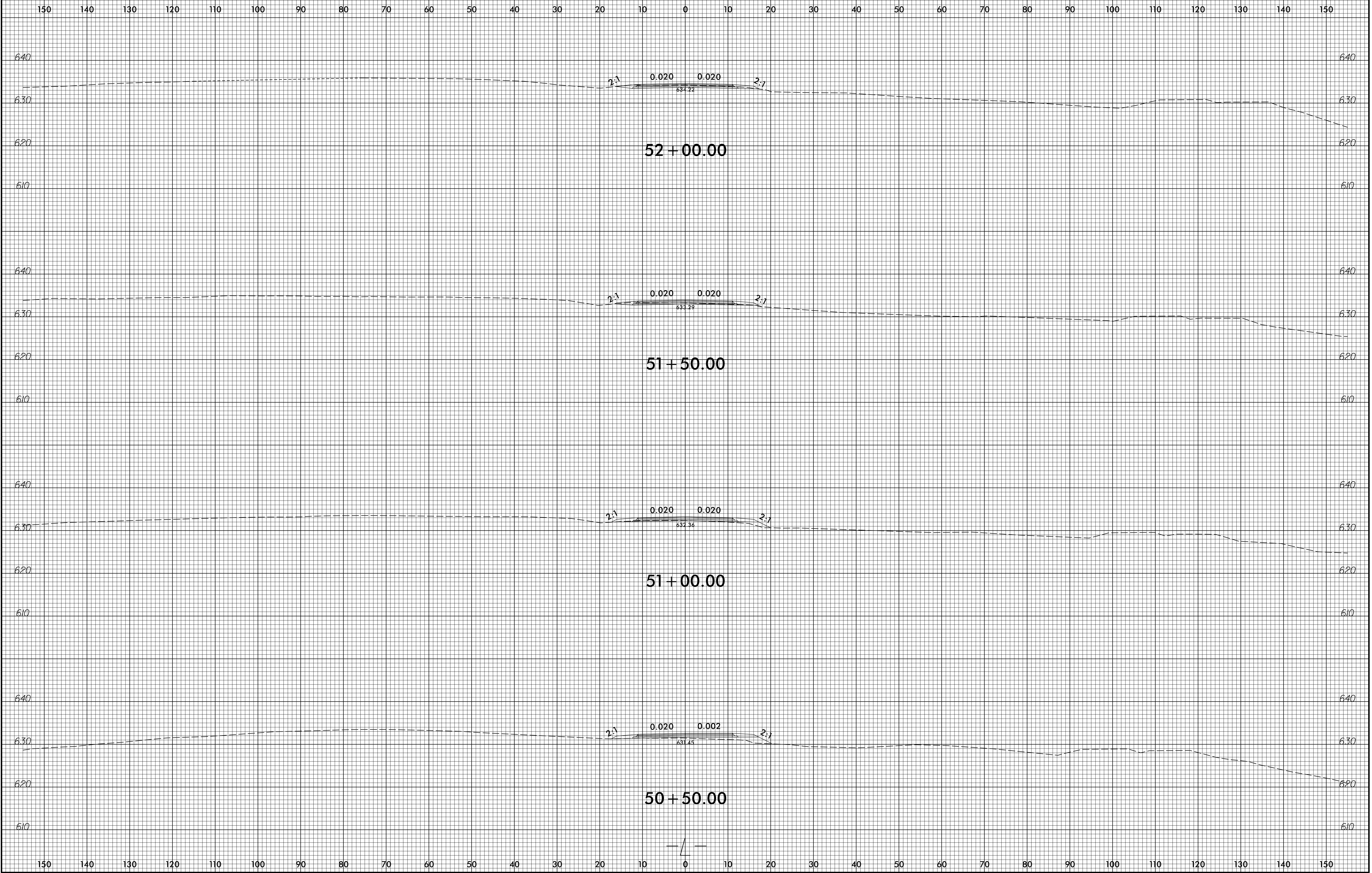

150 140 130 120 110 100 90 80 70 60 50 40 30 20 10 0 10 20 30 40 50 60 70 80 90 100 110 120 130 140 150

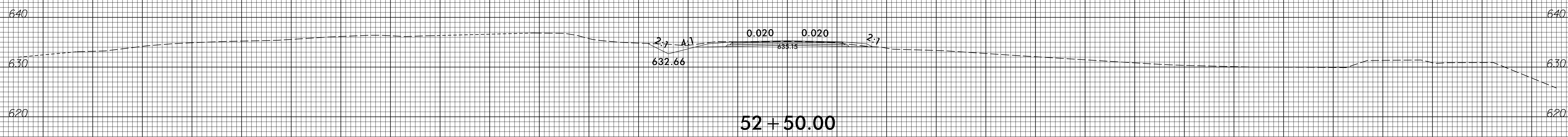
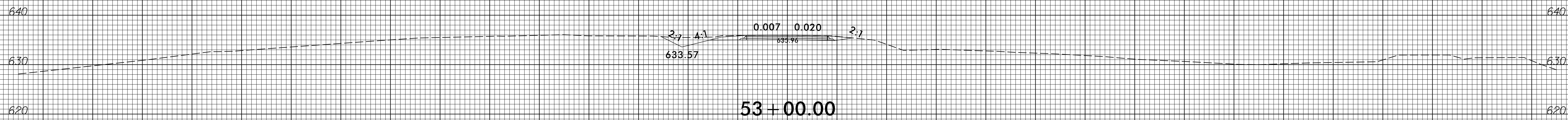
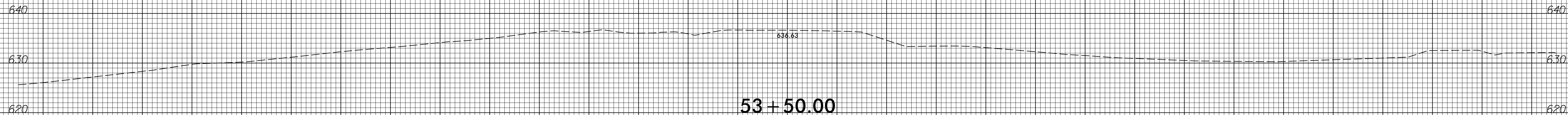

150 140 130 120 110 100 90 80 70 60 50 40 30 20 10 0 10 20 30 40 50 60 70 80 90 100 110 120 130 140 150

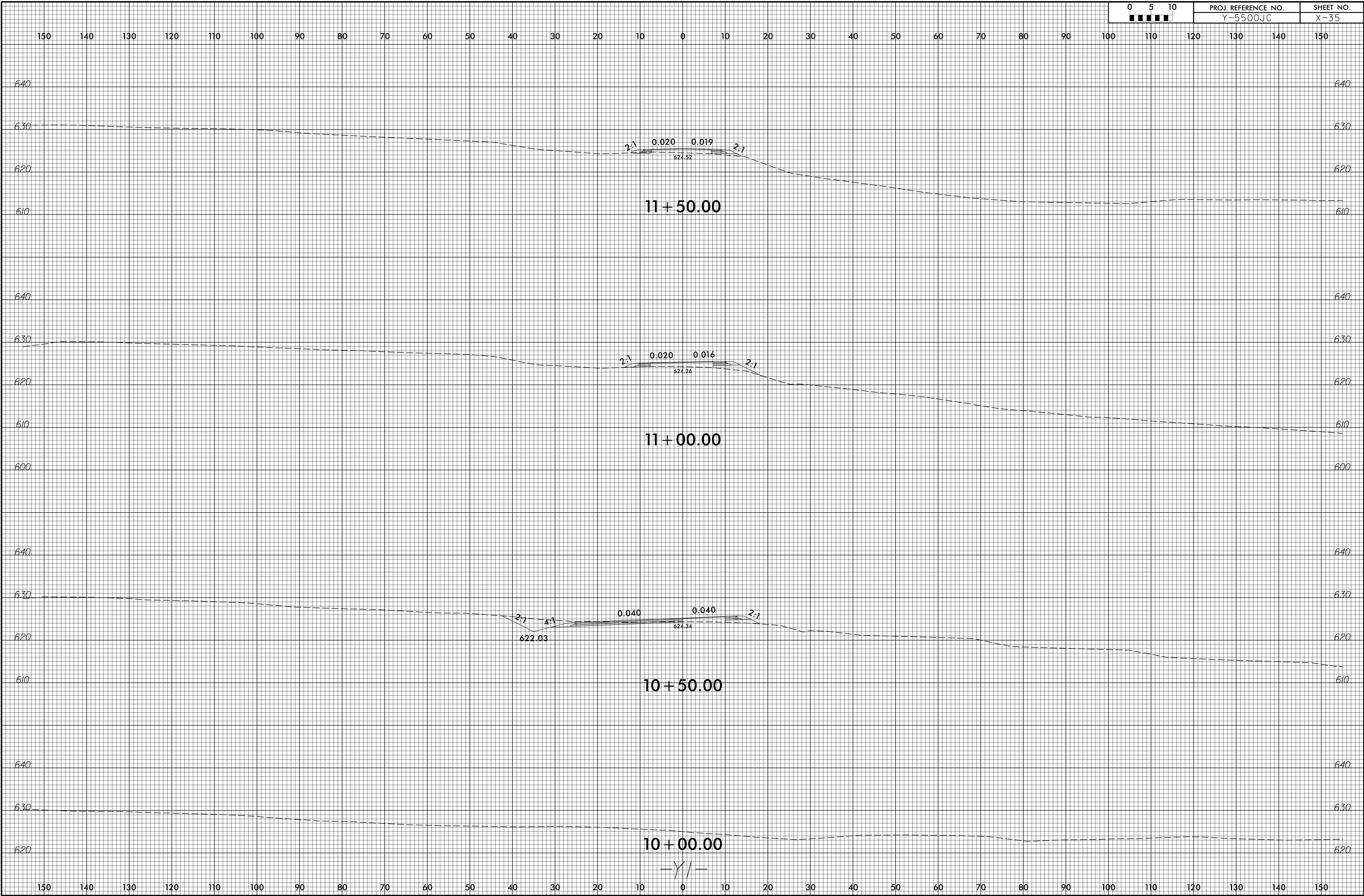

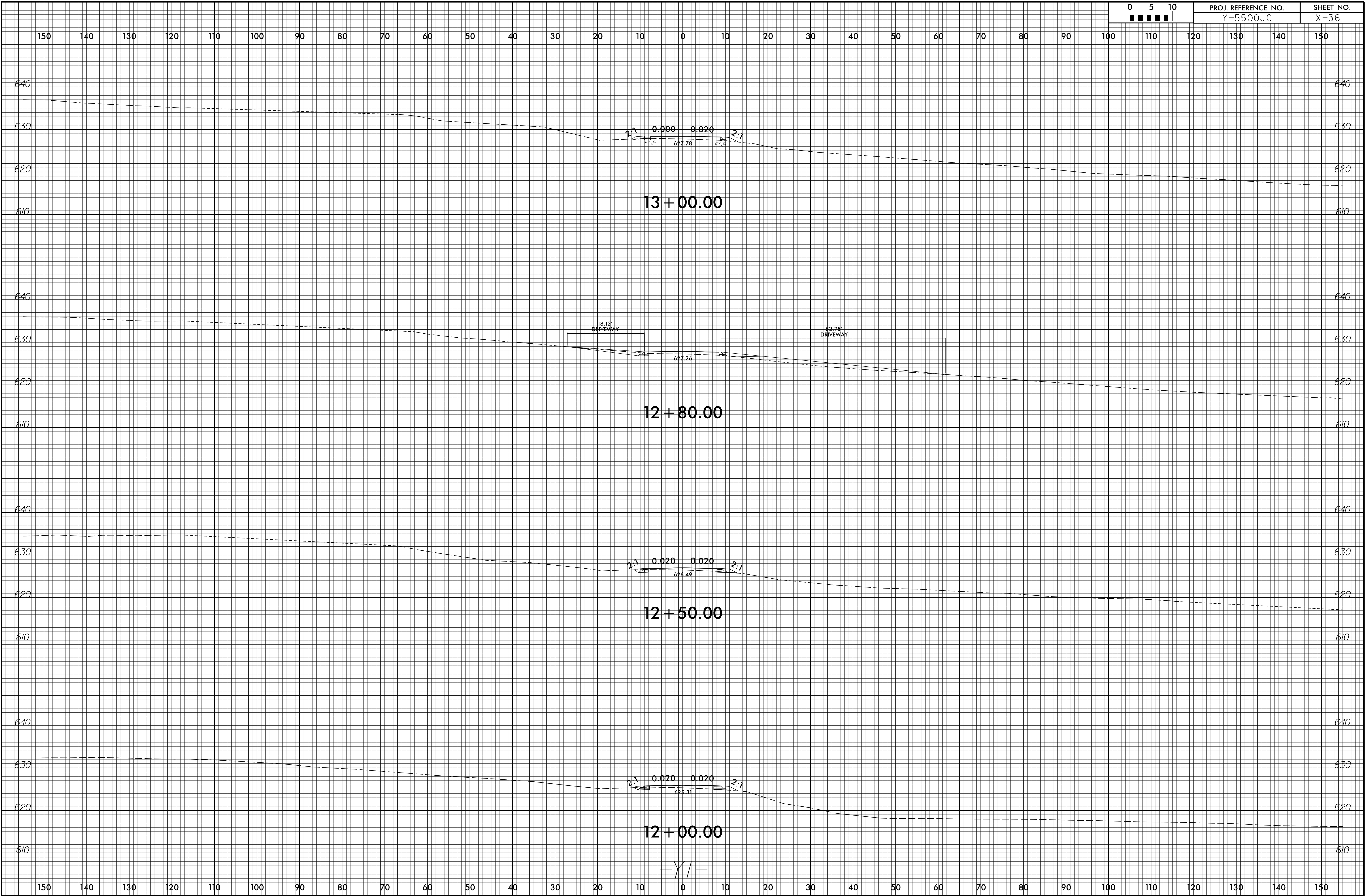

150 140 130 120 110 100 90 80 70 60 50 40 30 20 10 0 10 20 30 40 50 60 70 80 90 100 110 120 130 140 150

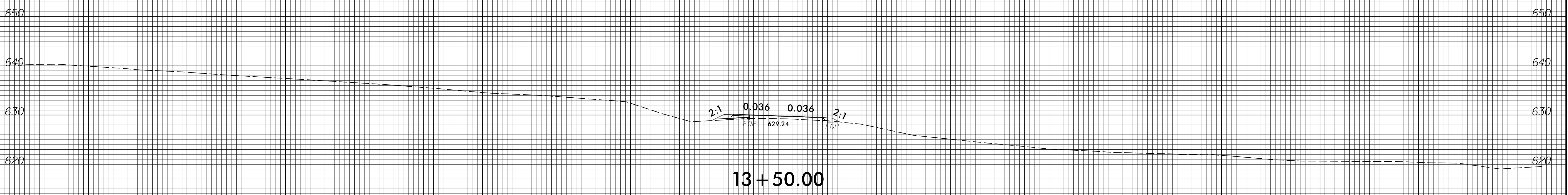
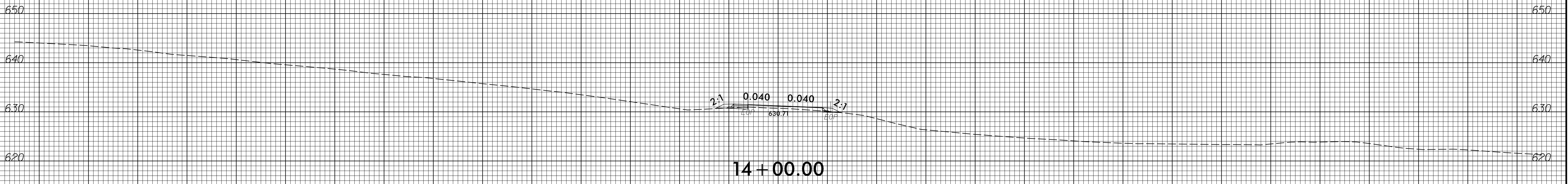
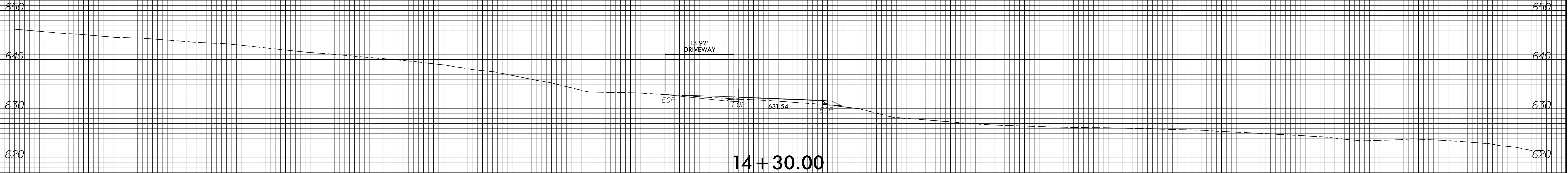

-Y/-

6/23/16

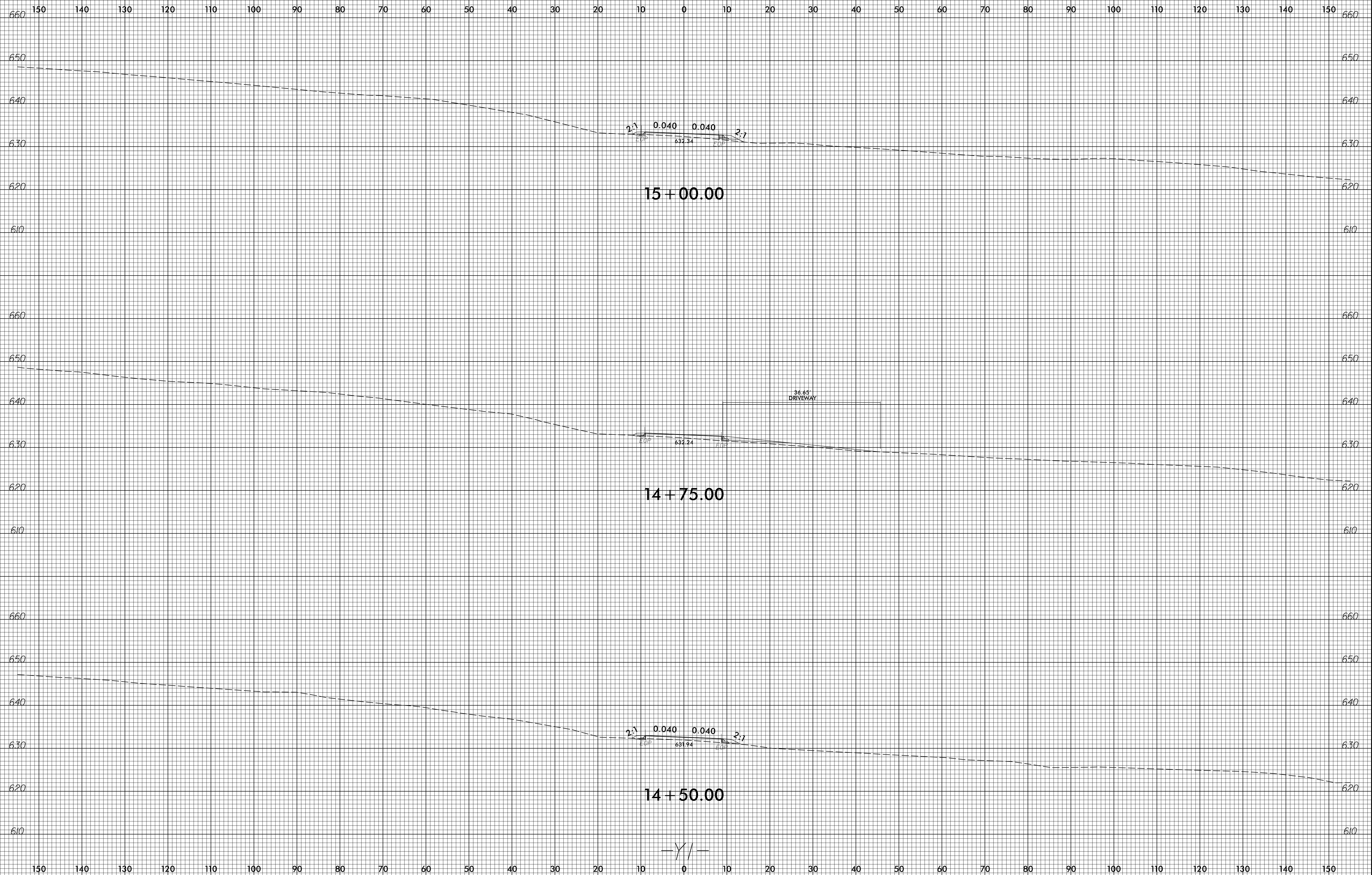

2:28:45 PM  
E:\Projects\14288\14288\_rdy\_XPL\_Y1.dgn  
00062710



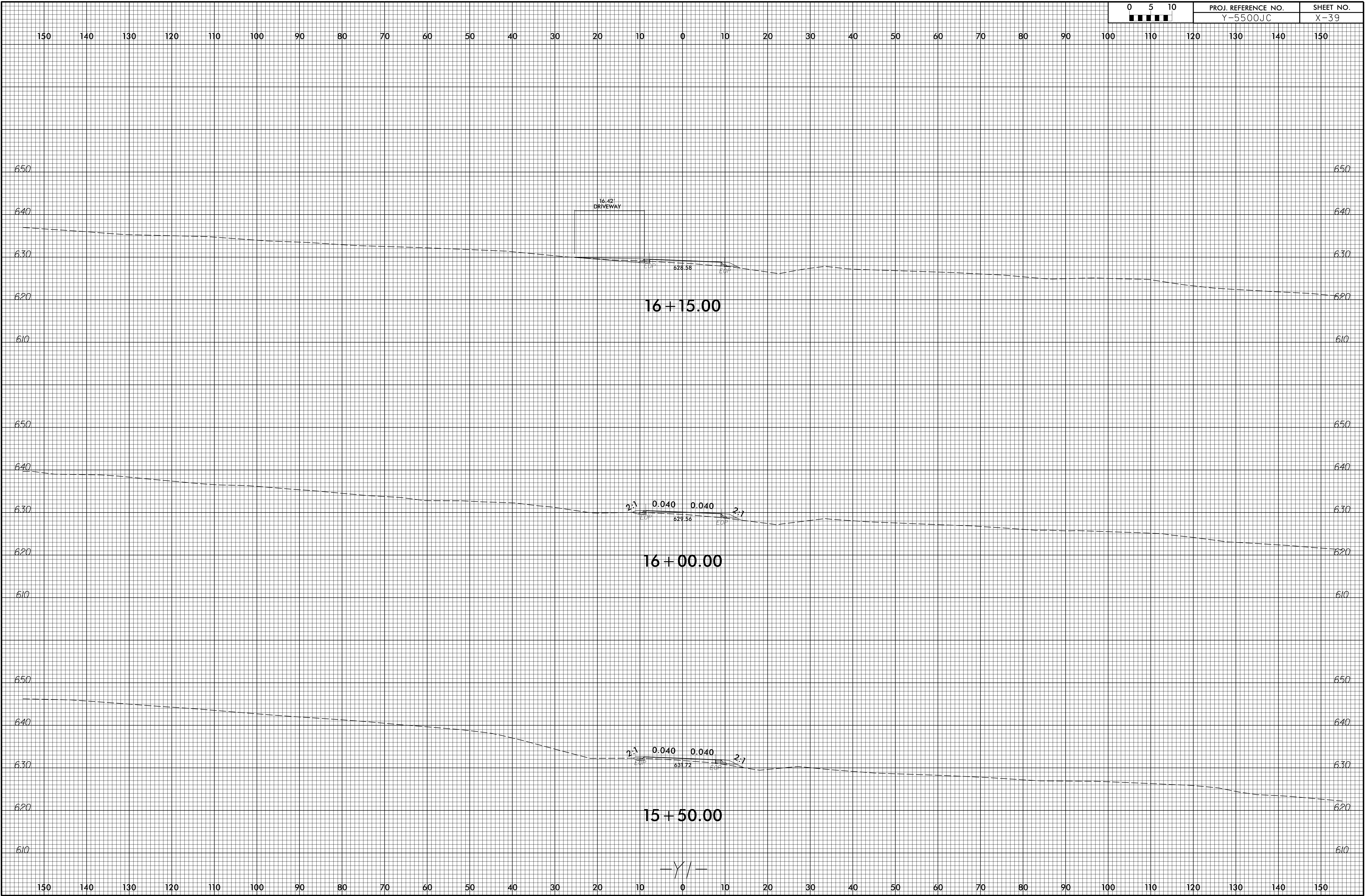

6/23/16

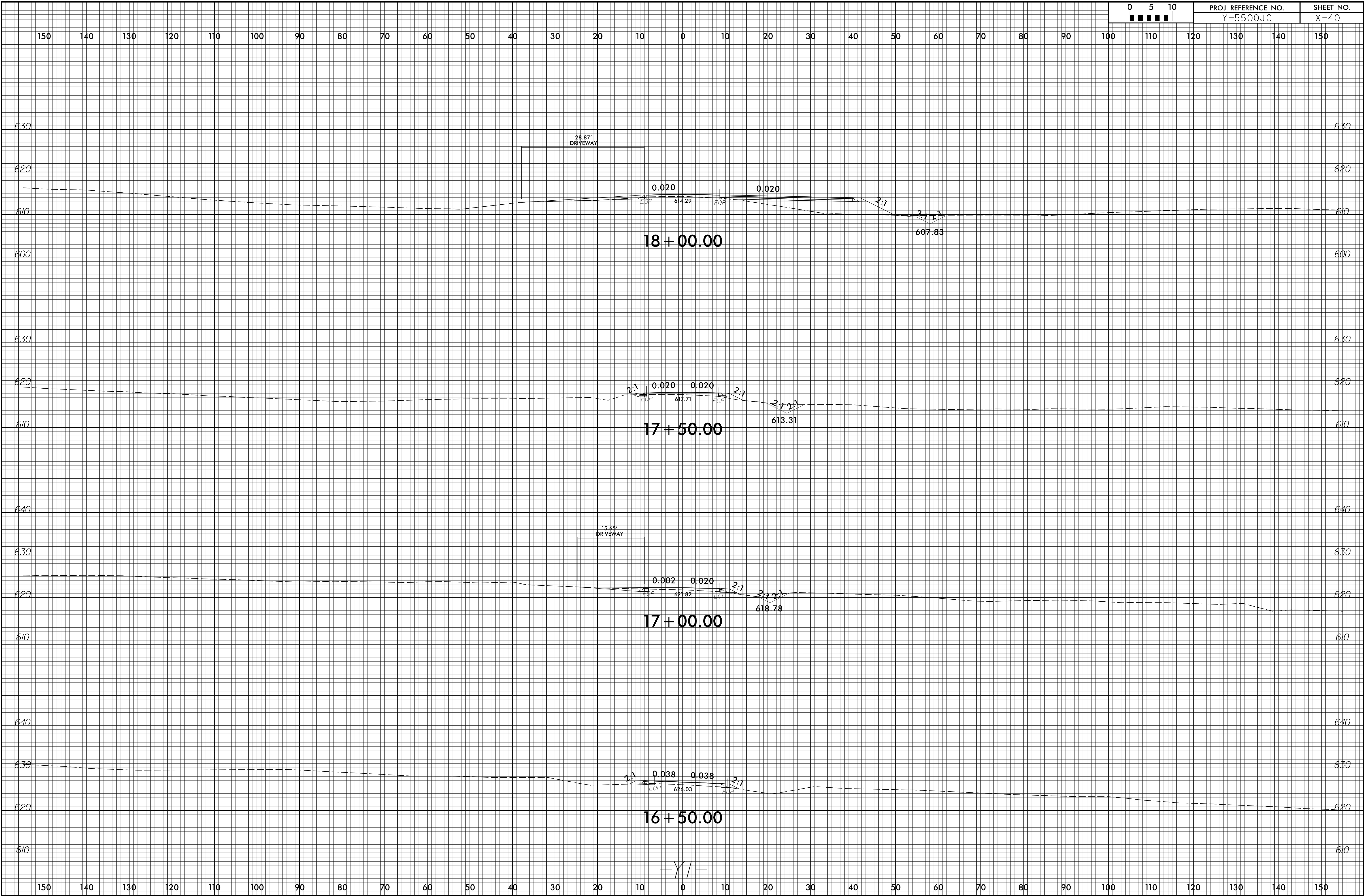

2:28:45 PM  
E:\Projects\14288\14288\_rdu\_XPL\_Y1.dgn  
00062710

6/23/16

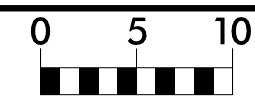

PROJ. REFERENCE NO.  
Y-5500JC

SHEET NO.  
X-41

150 140 130 120 110 100 90 80 70 60 50 40 30 20 10 0 10 20 30 40 50 60 70 80 90 100 110 120 130 140 150

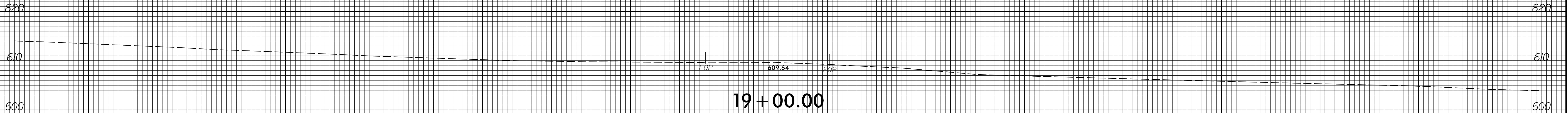

19 + 00.00

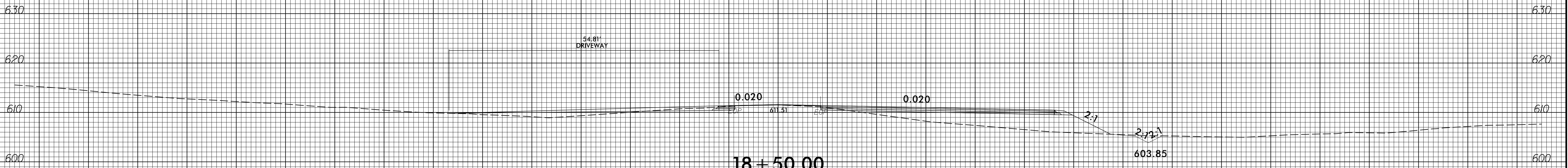
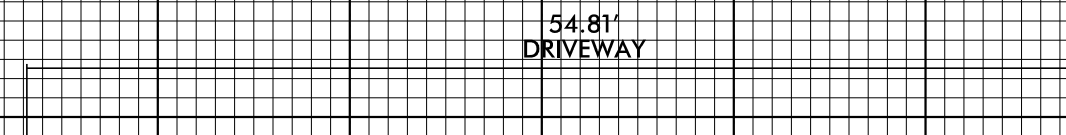

18 + 50.00

-Y/-

150 140 130 120 110 100 90 80 70 60 50 40 30 20 10 0 10 20 30 40 50 60 70 80 90 100 110 120 130 140 150

2:28:46 PM  
E:\Projects\14288\14288\_rdy\_XPL\_Y1.dgn  
0062710

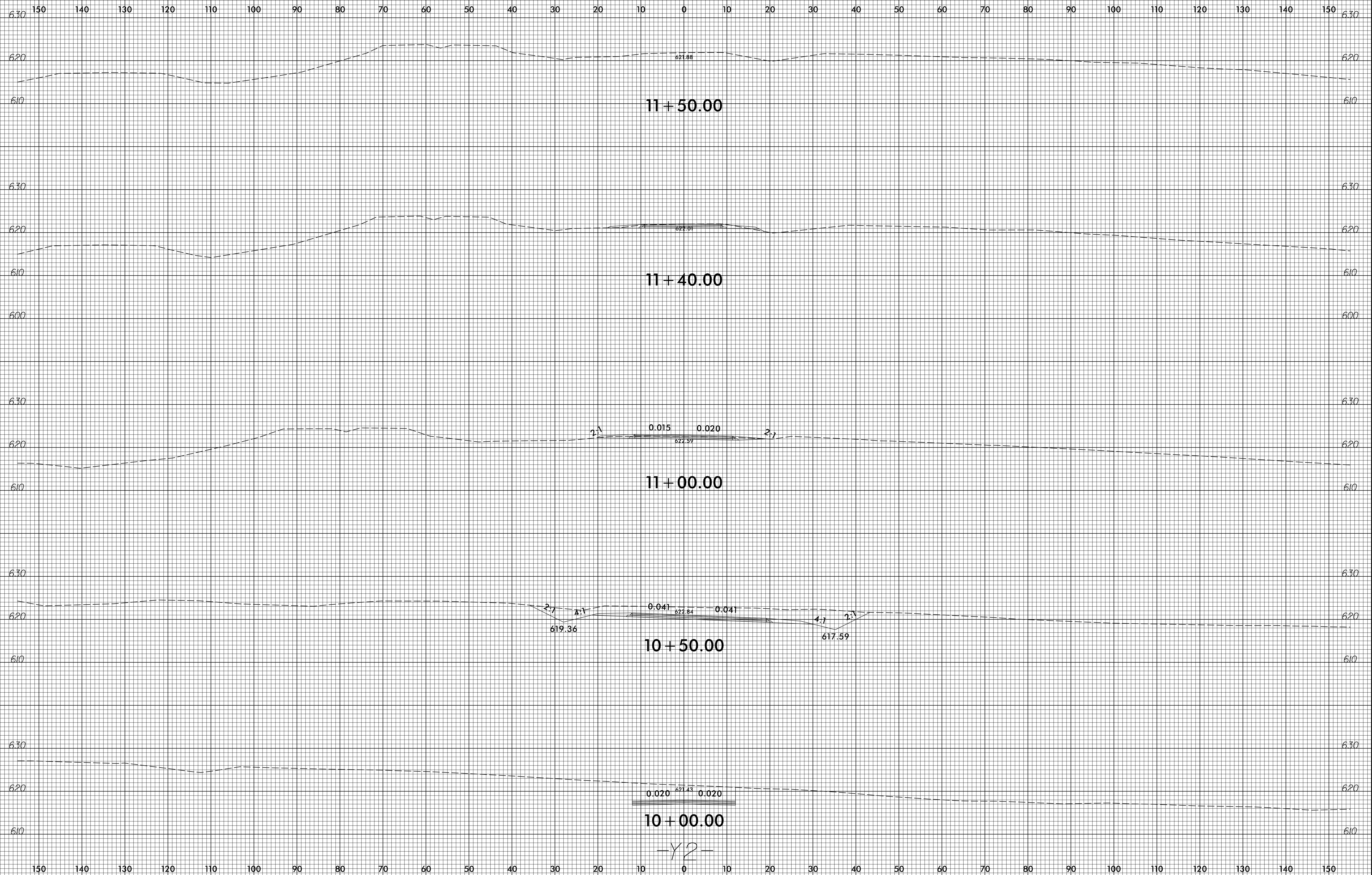

6/23/16

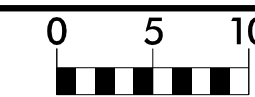

PROJ. REFERENCE NO.	SHEET NO.
Y-5500JC	X-43

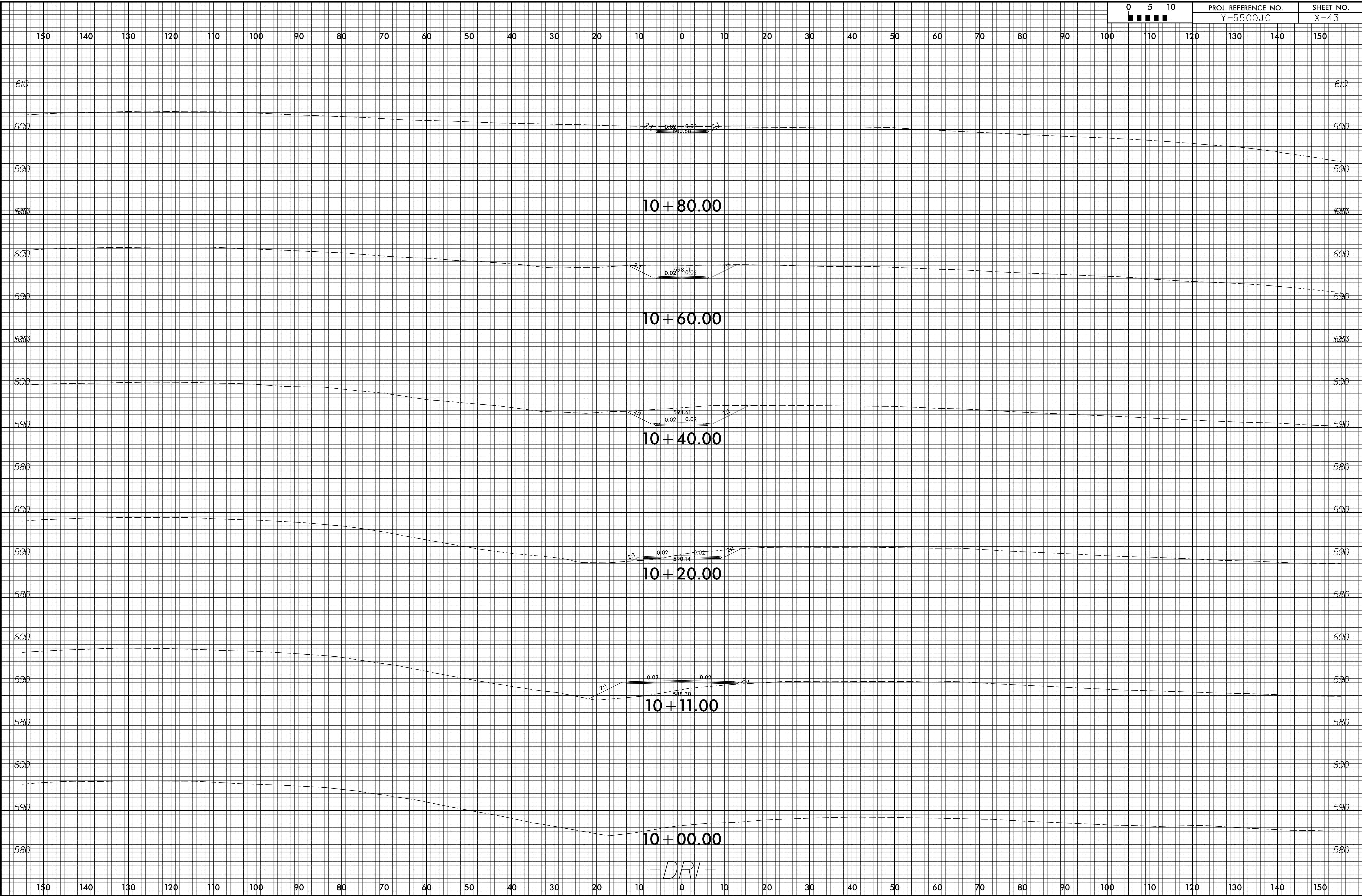

7:07:35 PM  
C:\Users\jgoy\Xsc\Xp\1\F-14288\_r.dwg\_XPL\_DRI.dgn  
000278

6/23/16

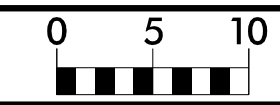

PROJ. REFERENCE NO.	SHEET NO.
Y-5500JC	X-44

150 140 130 120 110 100 90 80 70 60 50 40 30 20 10 0 10 20 30 40 50 60 70 80 90 100 110 120 130 140 150

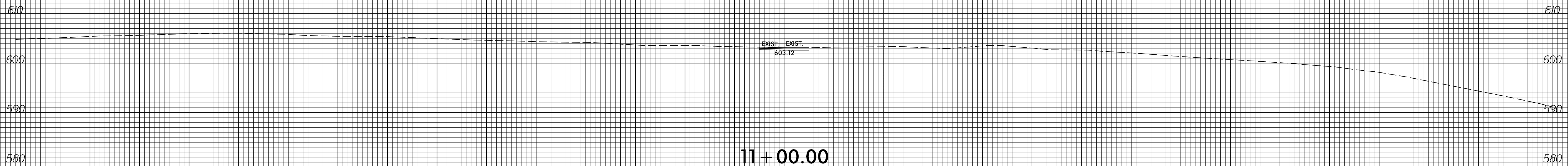

11 + 00.00

-DRI-

7:07:53 PM  
 C:\Users\jguy\Xsc\Xp\1\F-14288\_r.dwg\_XPL\_DRI.dgn  
 0002710