

Stantec
 Stantec Consulting Services Inc.
 801 Jones Franklin Road
 Suite 300
 Raleigh, NC 27606
 Tel. 919.851.6866
 Fax. 919.851.7024
 www.stantec.com
 License No. F-0672

DocuSigned by
 J.W. Woolard, Jr.
 58C02F49E5656C

4/29/2022

**DOCUMENT NOT CONSIDERED FINAL
 UNLESS ALL SIGNATURES COMPLETED**

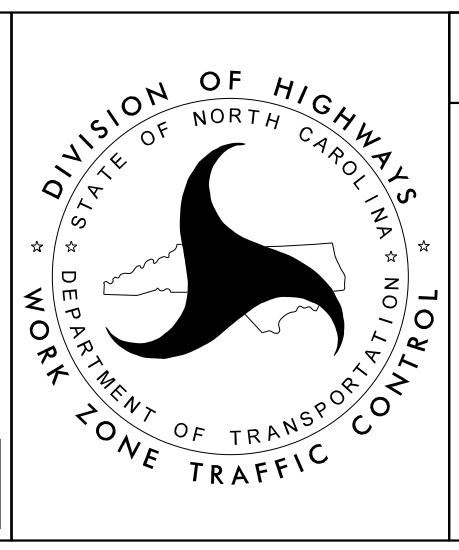

SECTION 2

-L- I-95
 PHASE I
 STEP 1B

3/15/2022
 U:\Traffic\Transportation Management Plan\TCP\PLAN SHEETS\I-5987B_TMP-134G_PHASE I_STEP 1B.dgn
 angood

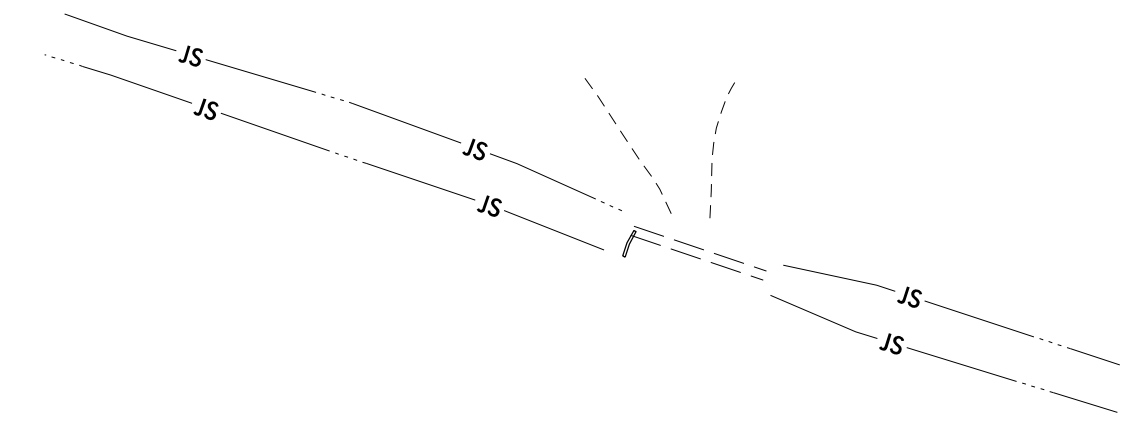
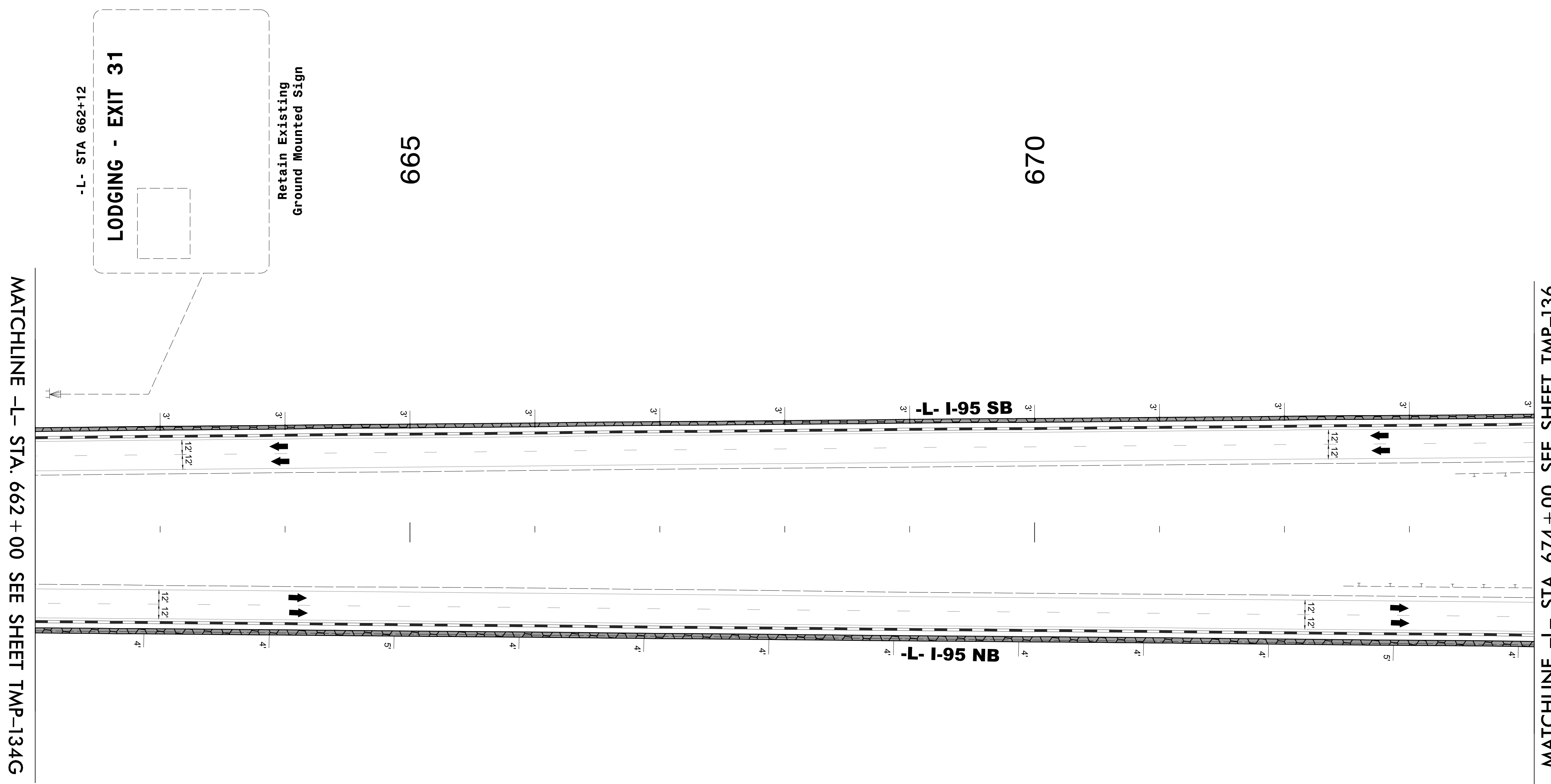

3/15/2022
 U:\Traffic\Transportation Management Plan\TCP\PLAN SHEETS\I-5987B_TMP-135_PHASE I_STEP 1B.dgn
 angood

Stantec Consulting Services Inc.
 801 Jones Franklin Road
 Suite 300
 Raleigh, NC 27606
 Tel. 919.851.6866
 Fax. 919.851.7024
 www.stantec.com
 License No. F-0672

4/29/2022

**DOCUMENT NOT CONSIDERED FINAL
 UNLESS ALL SIGNATURES COMPLETED**

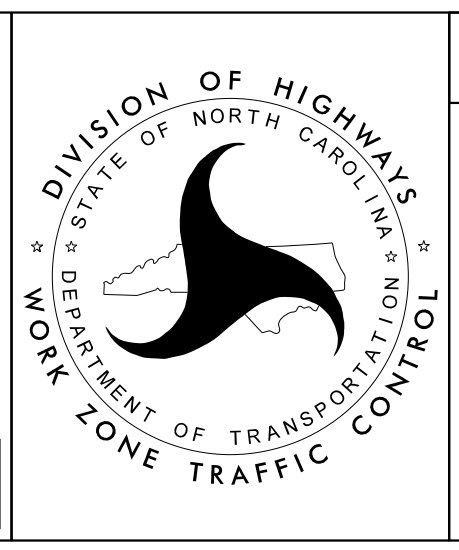

SECTION 2

-L- I-95
 PHASE I
 STEP 1B

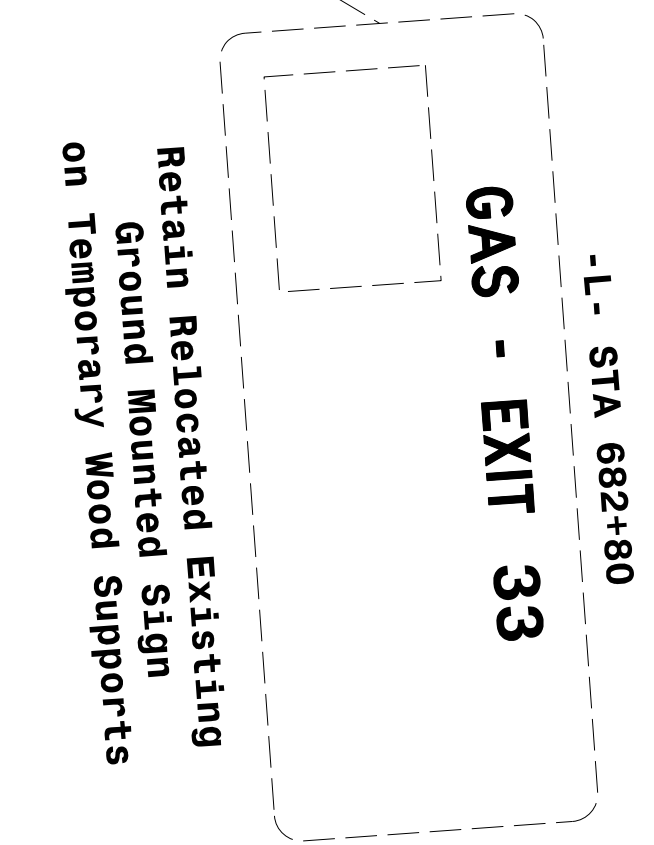
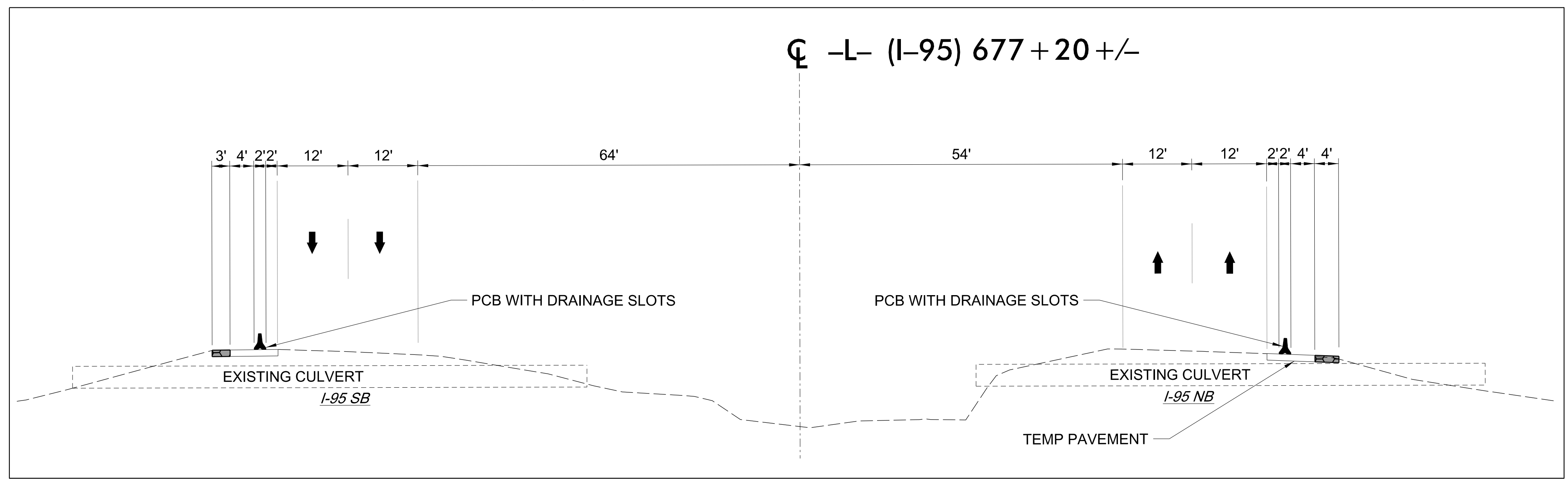
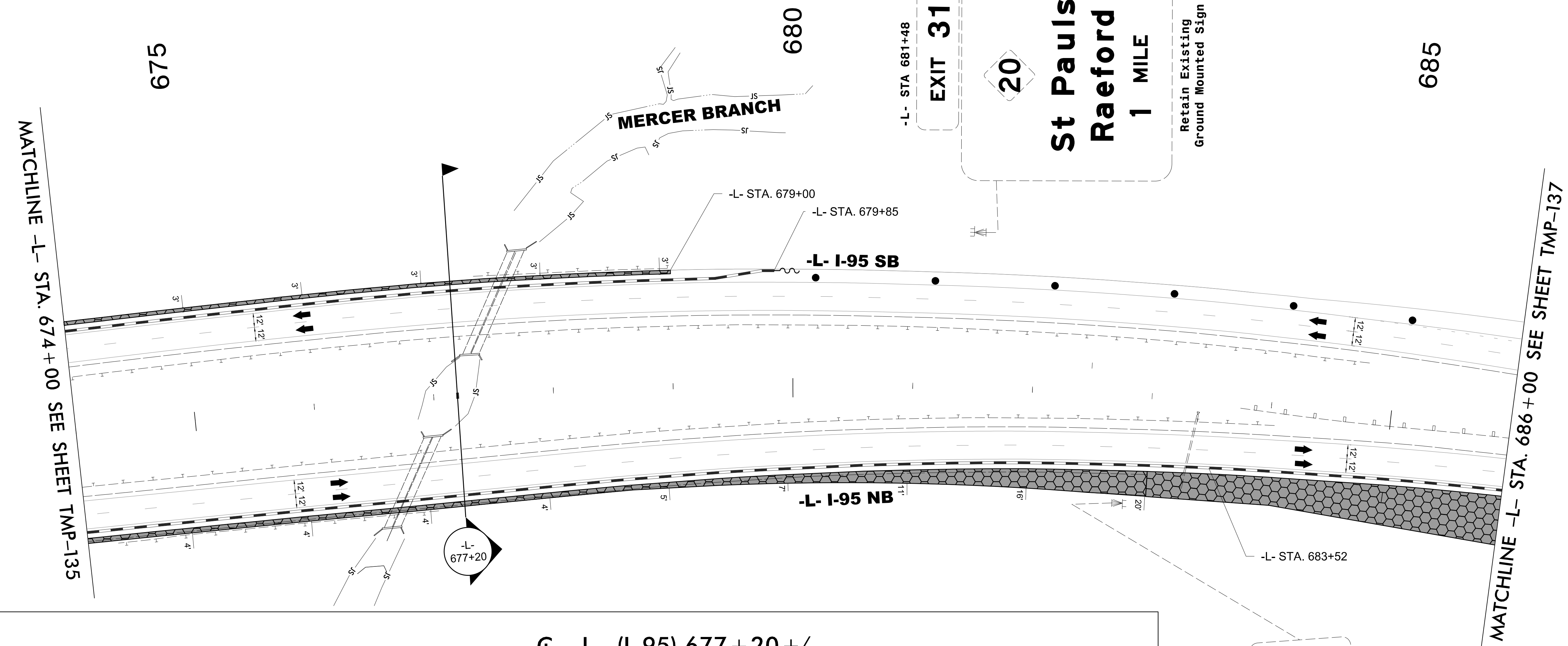

3/15/2022
 U:\Traffic\Transportation Management Plan\TCP\PLAN SHEETS\I-5987B_TMP_136_PHASE_1LSTEP_IB.dgn
 angood

Stantec
 Stantec Consulting Services Inc.
 801 Jones Franklin Road
 Suite 300
 Raleigh, NC 27606
 Tel. 919.851.6866
 Fax. 919.851.7024
 www.stantec.com
 License No. F-0672

DocuSigned by
 J.W. Woolard
 SEAL
 19862
 ENGINEER
 J.W. WOOLARD, JR.
 4/29/2022
**DOCUMENT NOT CONSIDERED FINAL
 UNLESS ALL SIGNATURES COMPLETED**

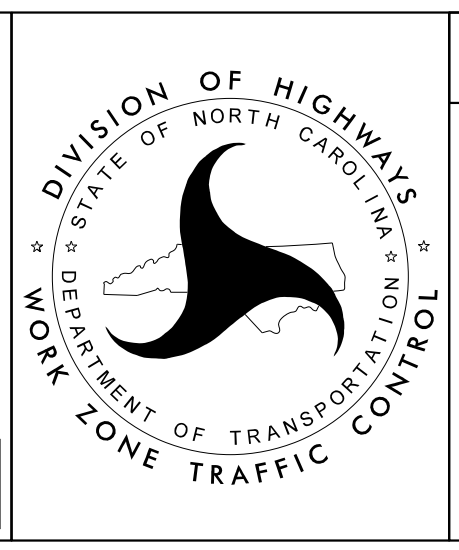

SECTION 2

-L- I-95
 PHASE I
 STEP 1B

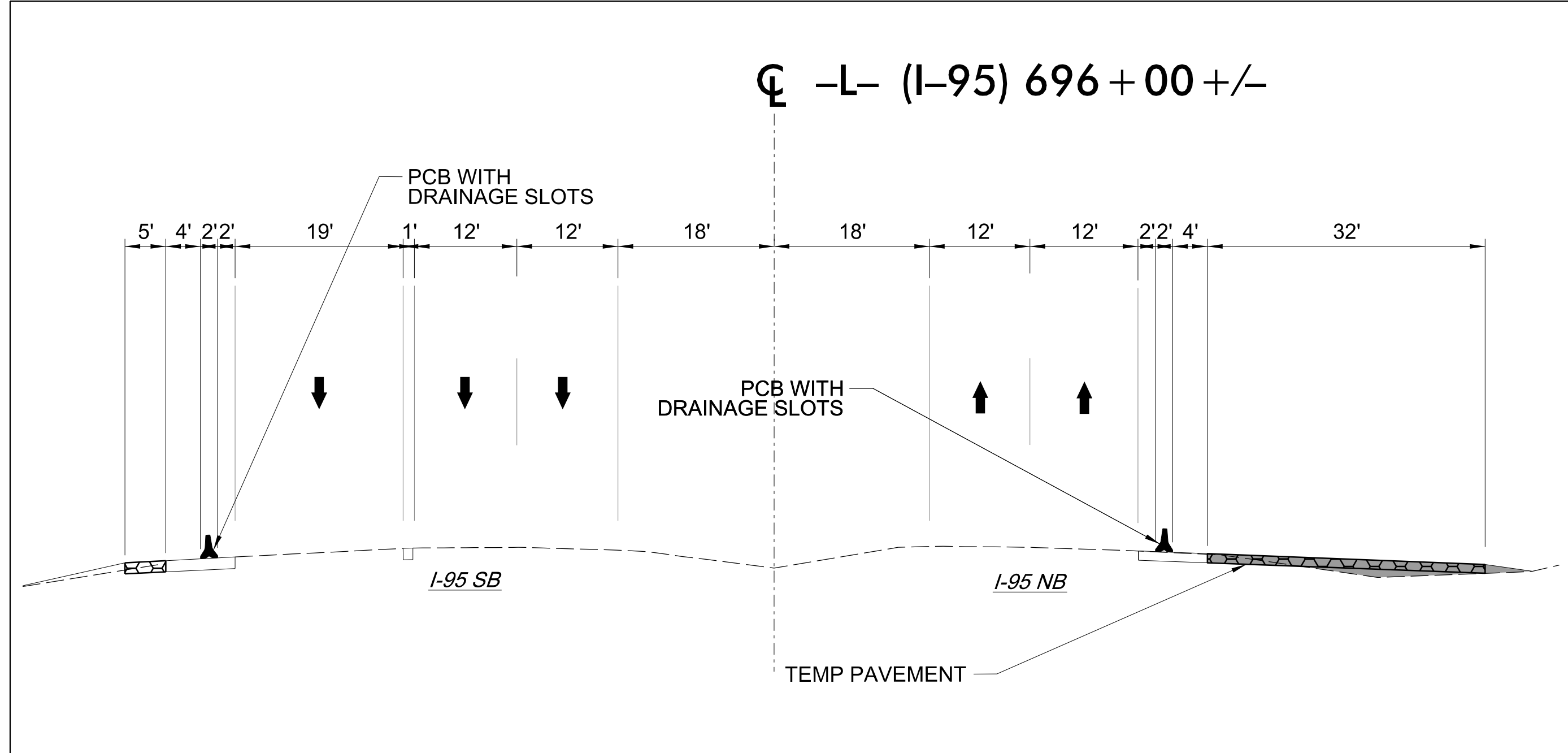
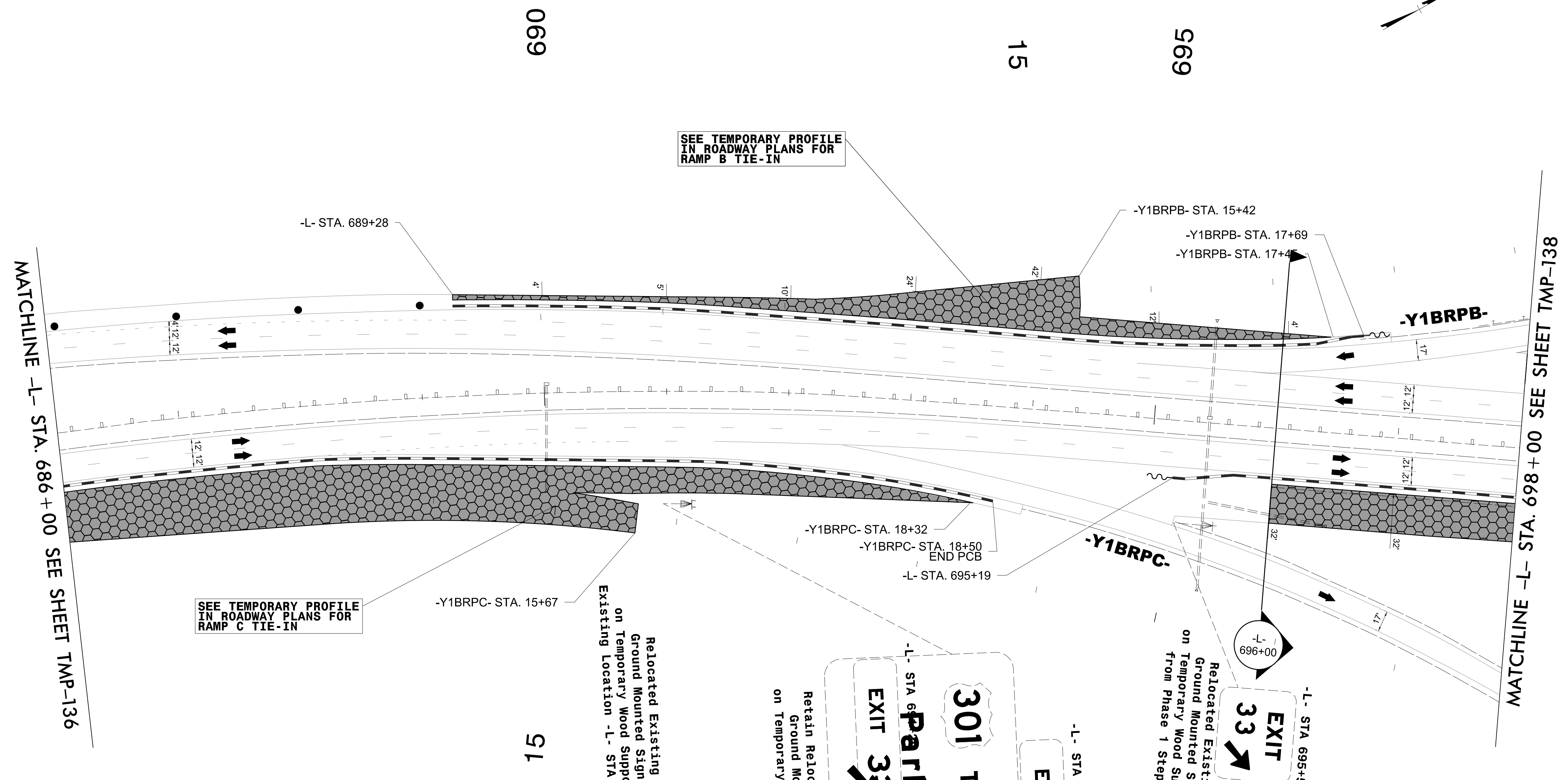

Stantec
 Stantec Consulting Services Inc.
 801 Jones Franklin Road
 Suite 300
 Raleigh, NC 27606
 Tel. 919.851.6866
 Fax. 919.851.7024
 www.stantec.com
 License No. F-0672

DocuSigned by:
 J.W. Woolard
 PROFESSIONAL SEAL
 19862
 ENGINEER
 J.W. WOOLARD, JR.
 4/29/2022
**DOCUMENT NOT CONSIDERED FINAL
 UNLESS ALL SIGNATURES COMPLETED**

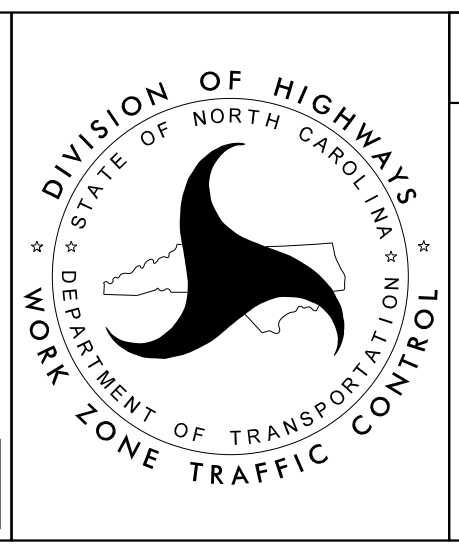

SECTION 2

-L- I-95
 PHASE I
 STEP 1B

3/15/2022
 U:\Traffic\Transportation Management Plan\TCP\PLAN SHEETS\I-5987B_TMP-137_PHASE 1_STEP 1B.dgn
 angood

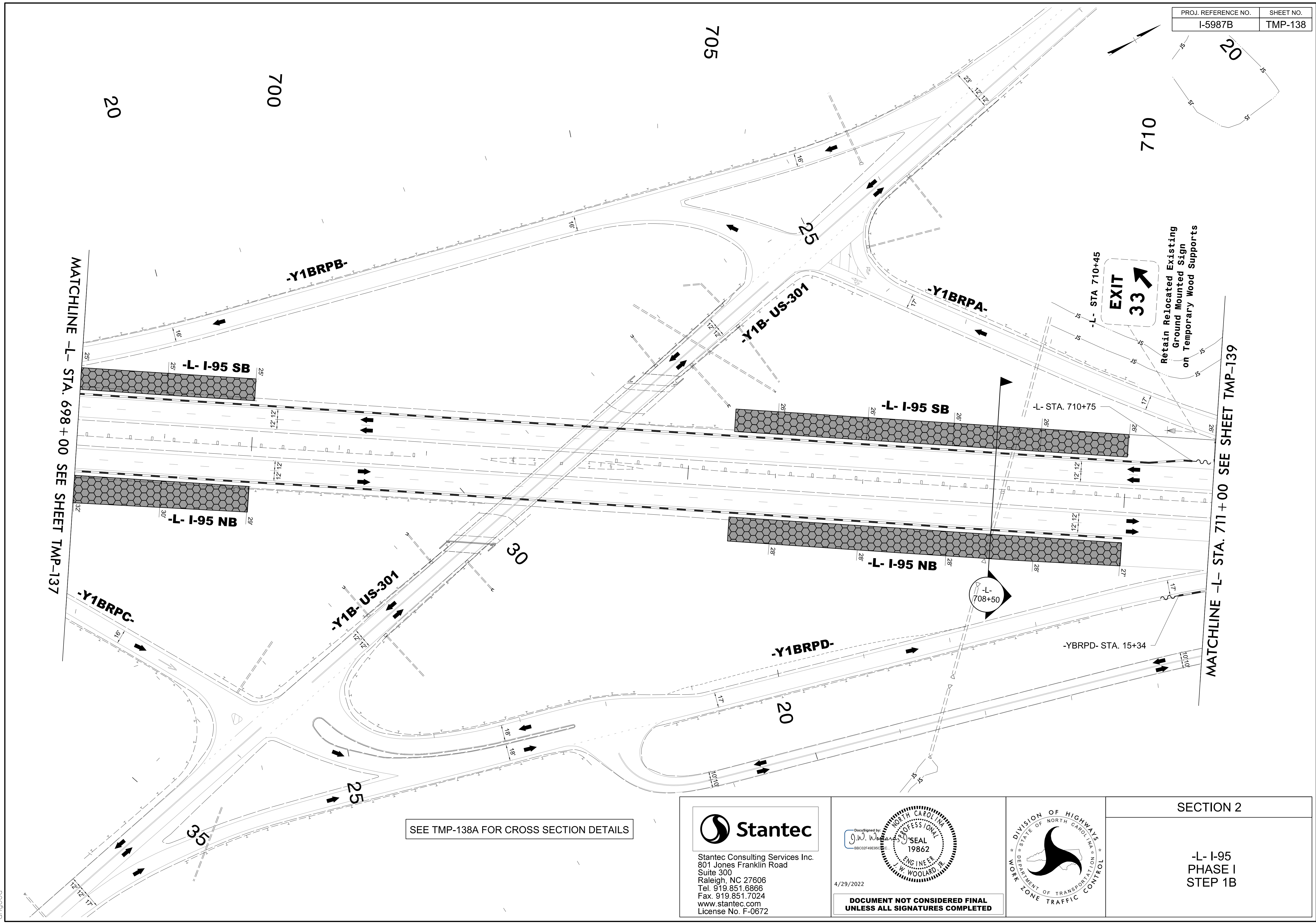

MATCHLINE -L- STA. 698+00 SEE SHEET TMP-137

MATCHLINE -L- STA. 711+00 SEE SHEET TMP-139

SEE TMP-138A FOR CROSS SECTION DETAILS

3/15/2022
U:\Traffic\Transportation Management Plan\TCP\PLAN SHEETS\I-5987B_TMP-138_PHASE 1_STEP 1B.dgn
angood

Stantec
 Stantec Consulting Services Inc.
 801 Jones Franklin Road
 Suite 300
 Raleigh, NC 27606
 Tel. 919.851.6866
 Fax. 919.851.7024
 www.stantec.com
 License No. F-0672

DocuSigned by
 J.W. Woolard
 58BC20F49E56561C

4/29/2022

**DOCUMENT NOT CONSIDERED FINAL
 UNLESS ALL SIGNATURES COMPLETED**

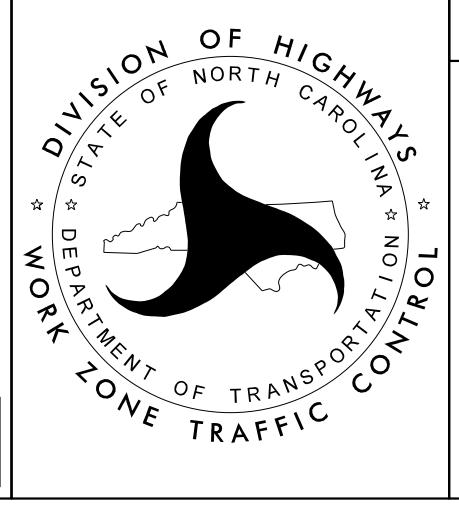
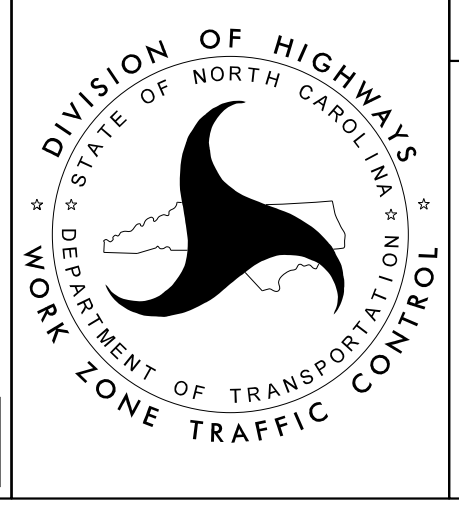

SECTION 2

-L- I-95
 PHASE I
 STEP 1B

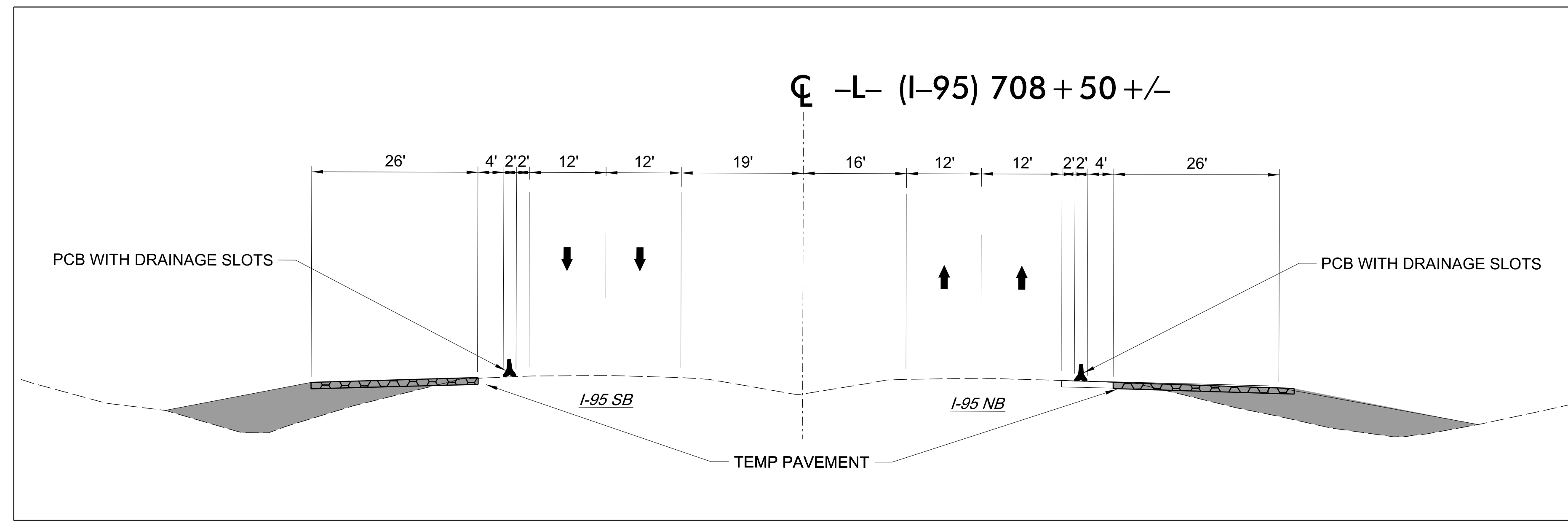

3/15/2022
U:\Traffic\Transportation Management\Plan\TCP\PLAN SHEETS\I-5987B_TMP-138A_PHASE I_STEP 1B.dgn
angood

Stantec
Stantec Consulting Services Inc.
801 Jones Franklin Road
Suite 300
Raleigh, NC 27606
Tel. 919.851.6866
Fax. 919.851.7024
www.stantec.com
License No. F-0672

DocuSigned by:
J.W. Woolard
SBB020F49E565C

4/29/2022

**DOCUMENT NOT CONSIDERED FINAL
UNLESS ALL SIGNATURES COMPLETED**

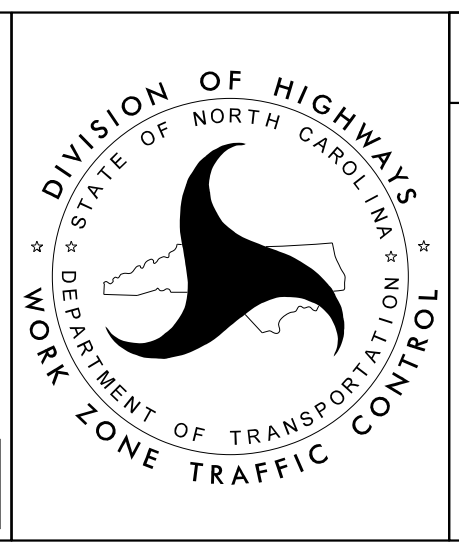

SECTION 2

-L- I-95
PHASE I
STEP 1B
SECTIONS

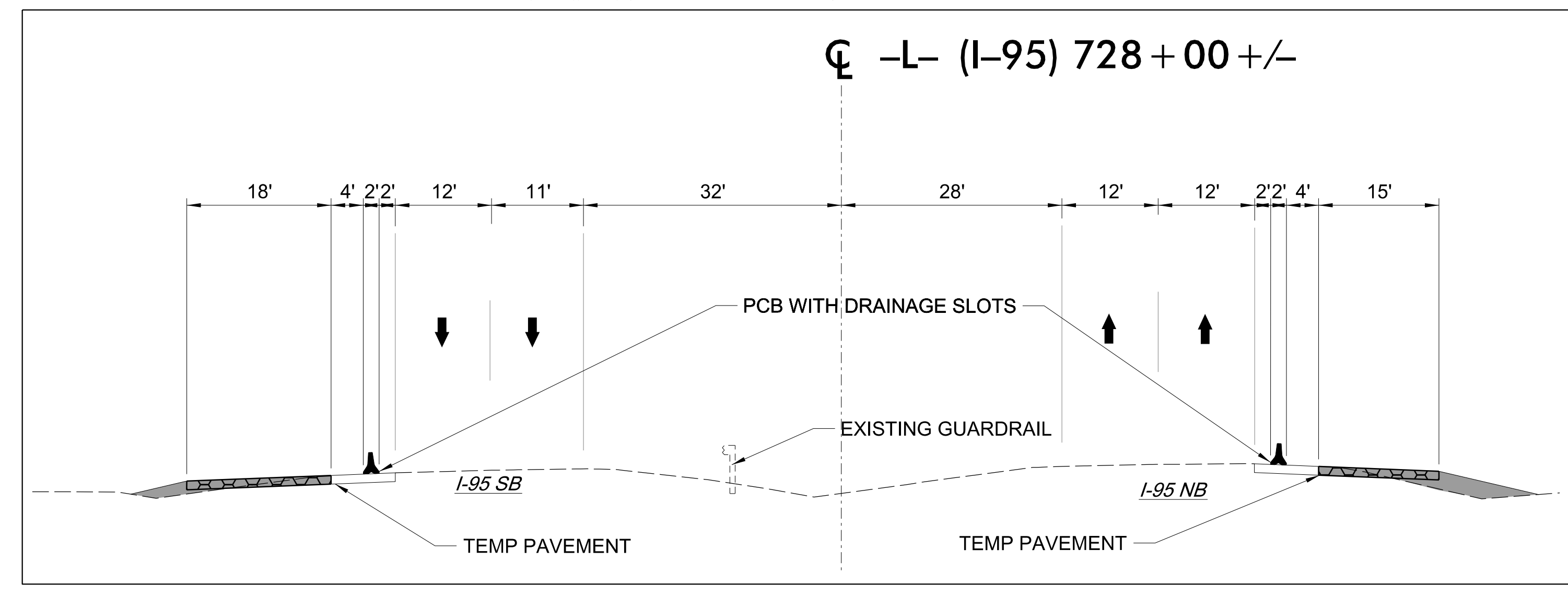
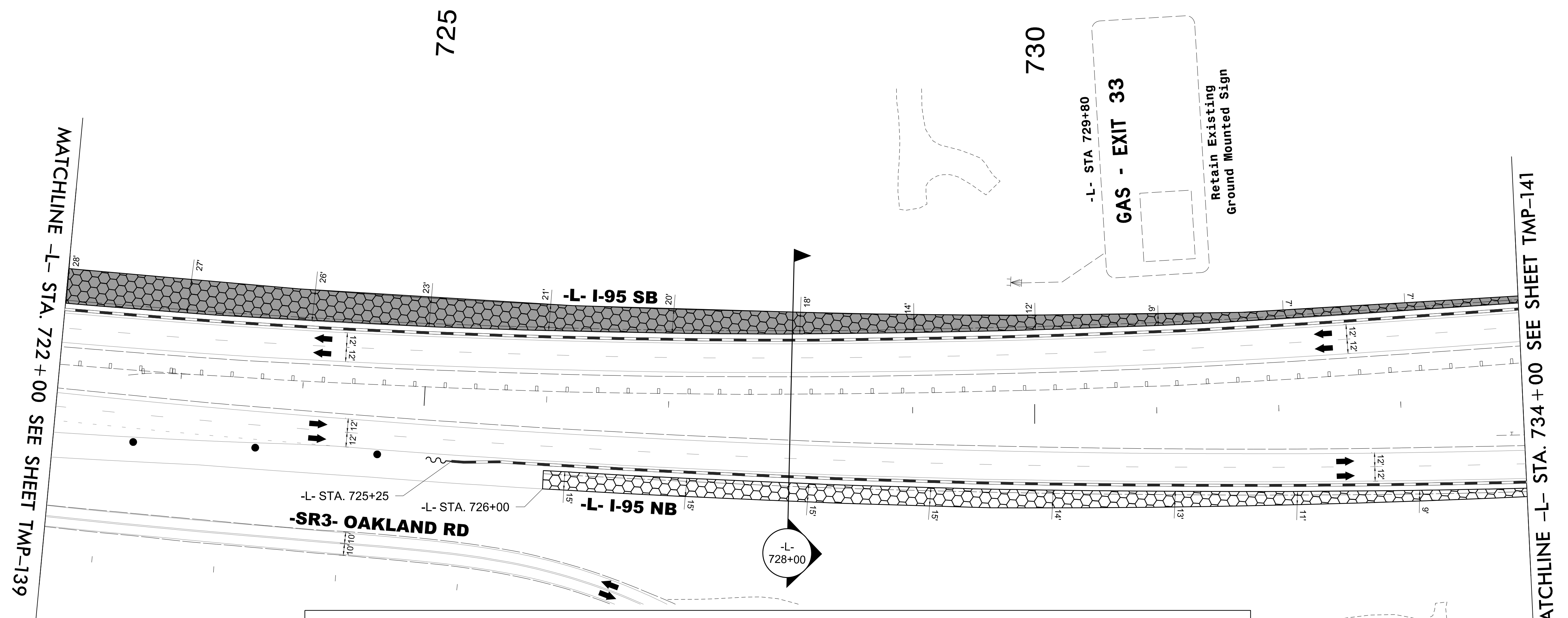
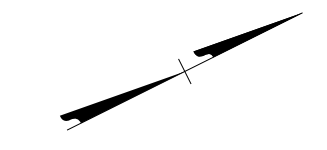

3/15/2022
U:\Traffic\Transportation Management\Plan\TCP\PLAN SHEETS\I-5987B_TMP_140_PHASE_1_LSTEP_IB.dgn
angood

Stantec
 Stantec Consulting Services Inc.
 801 Jones Franklin Road
 Suite 300
 Raleigh, NC 27606
 Tel. 919.851.6866
 Fax. 919.851.7024
 www.stantec.com
 License No. F-0672

DocuSigned by:
 J.W. Woollard
 58C02F49E5656

4/29/2022

**DOCUMENT NOT CONSIDERED FINAL
 UNLESS ALL SIGNATURES COMPLETED**

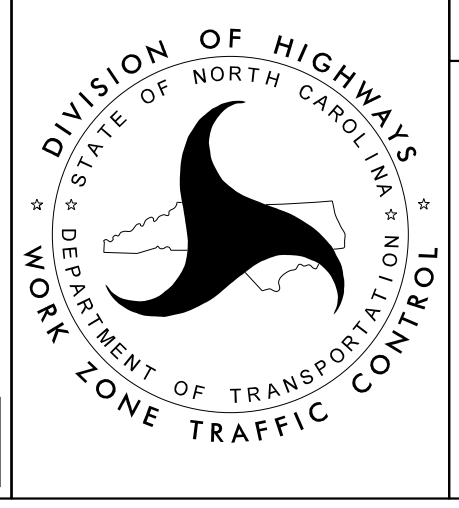

SECTION 2

-L- I-95
 PHASE I
 STEP 1B

PROJ. REFERENCE NO.	SHEET NO.
I-5987B	TMP-141

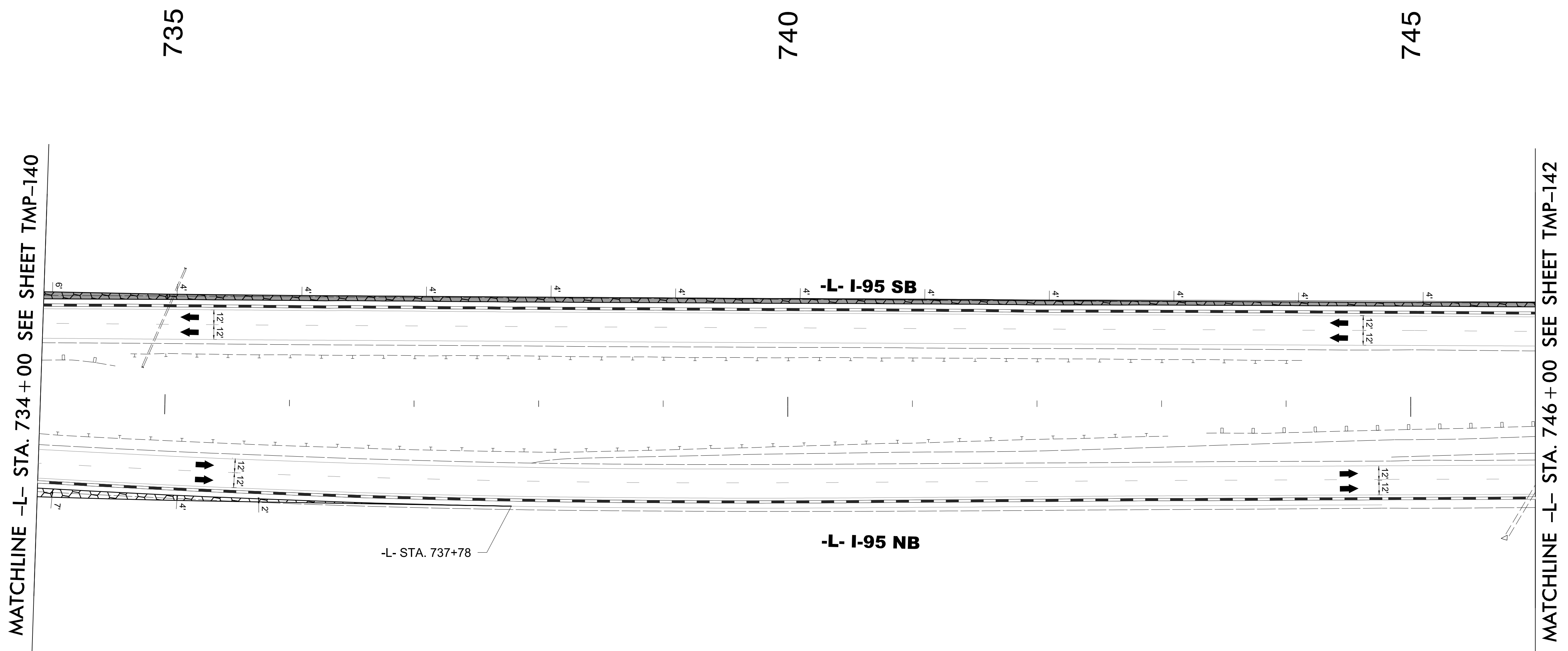
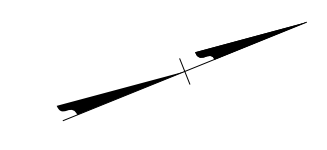

3/15/2022
 U:\Traffic\Transportation Management\Plan\TCP\PLAN SHEETS\I-5987B_TMP-141_PHASE I_STEP 1B.dgn
 angood

Stantec Consulting Services Inc.
 801 Jones Franklin Road
 Suite 300
 Raleigh, NC 27606
 Tel. 919.851.6866
 Fax. 919.851.7024
 www.stantec.com
 License No. F-0672

DocuSigned by
 J.W. Woolard
 58BC20F49E565...

4/29/2022
**DOCUMENT NOT CONSIDERED FINAL
 UNLESS ALL SIGNATURES COMPLETED**

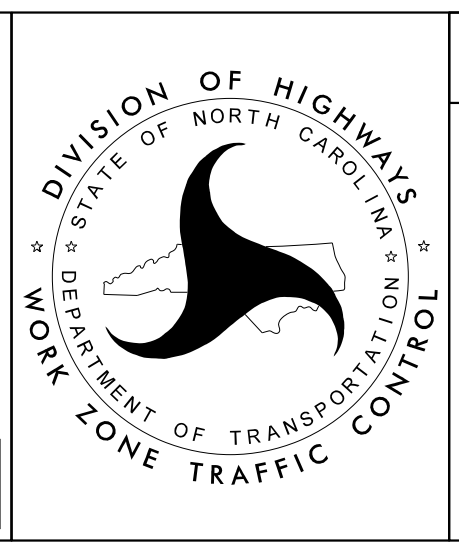

SECTION 2

-L- I-95
 PHASE I
 STEP 1B

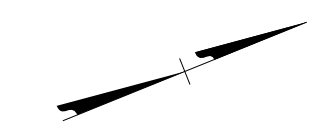

MATCHLINE -L- STA. 746+00 SEE SHEET TMP-141

MATCHLINE -L- STA. 757+00 SEE SHEET TMP-143

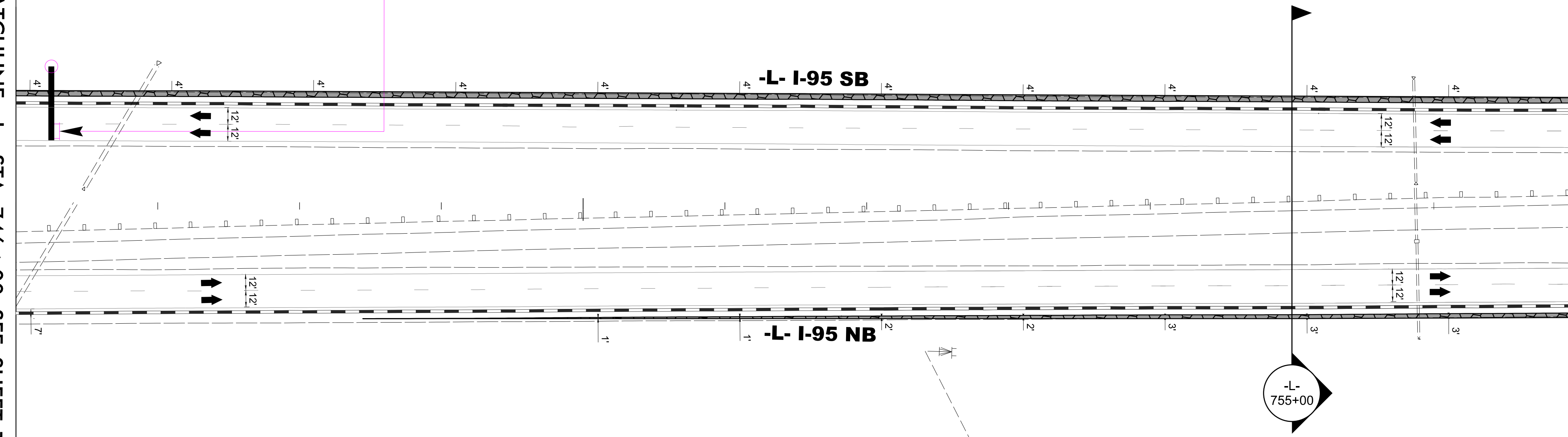

-L- STA. 752+60

Fayetteville	17
Dunn	40
Benson	46

Retain Existing
Ground Mounted Sign

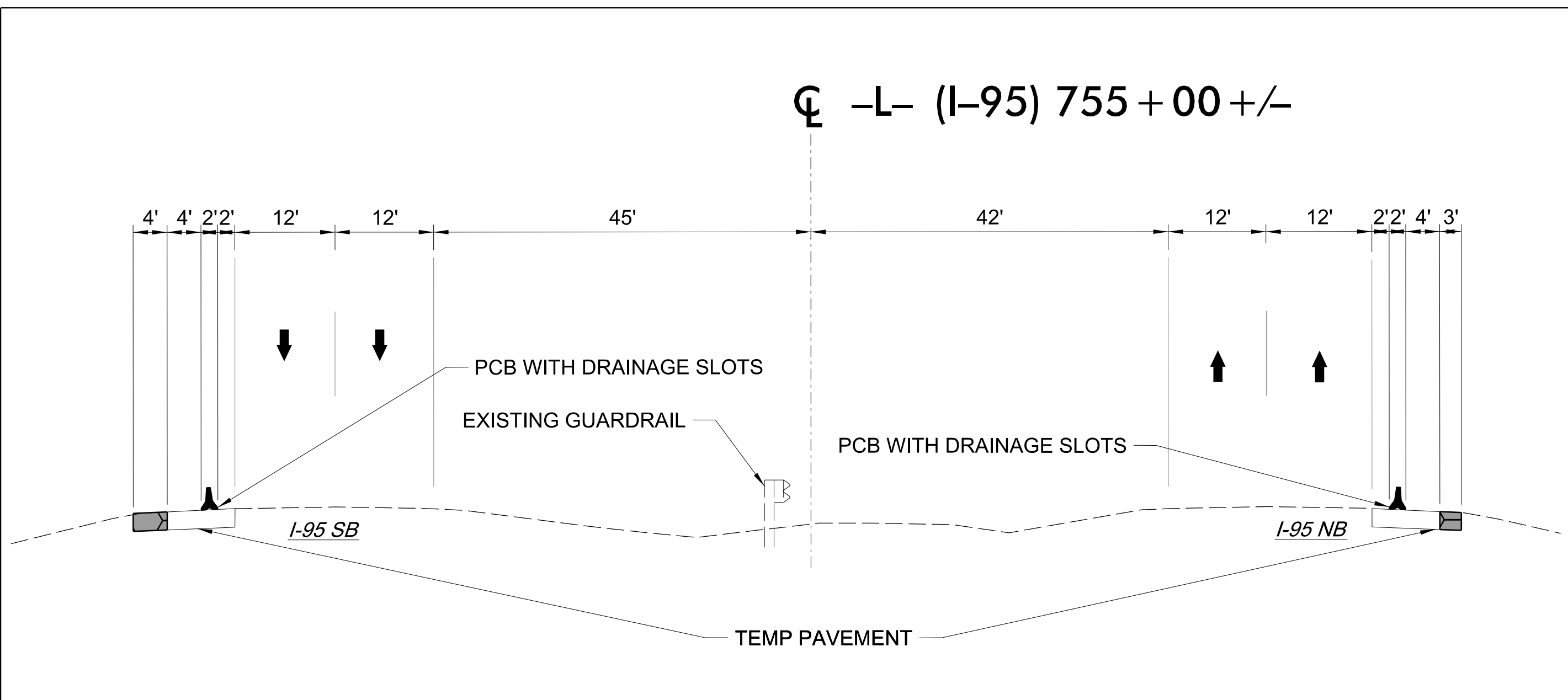
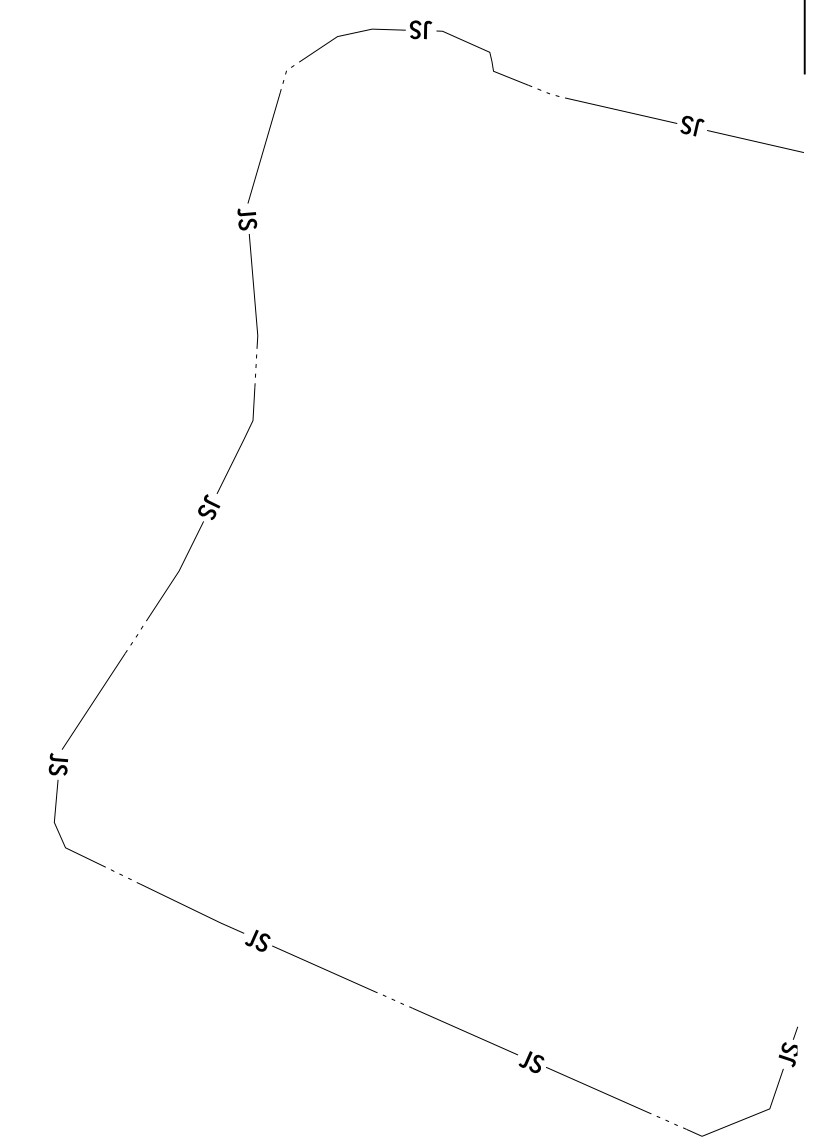
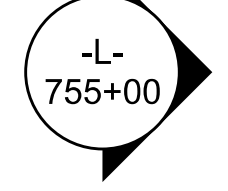

Stantec Consulting Services Inc.
801 Jones Franklin Road
Suite 300
Raleigh, NC 27606
Tel. 919.851.6866
Fax. 919.851.7024
www.stantec.com
License No. F-0672

DocuSigned by
J.W. Woolard
SEAL
19862
ENGINEER
J.W. WOOLARD, JR.

4/29/2022

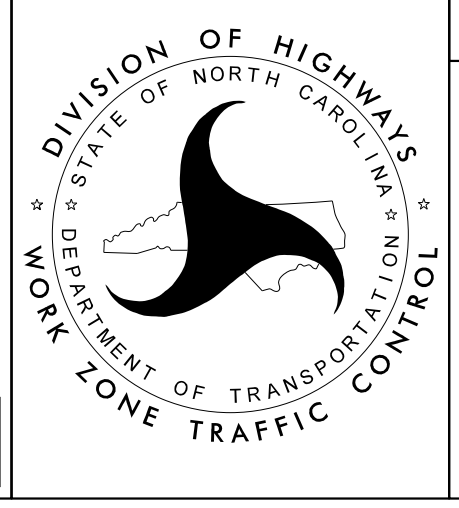

SECTION 2

-L- I-95
PHASE I
STEP 1B



3/15/2022
 U:\Traffic\Transportation Management\Plan\TCP\PLAN SHEETS\I-5987B_TMP_143_PHASE_1_STEP_1B.dgn
 angood

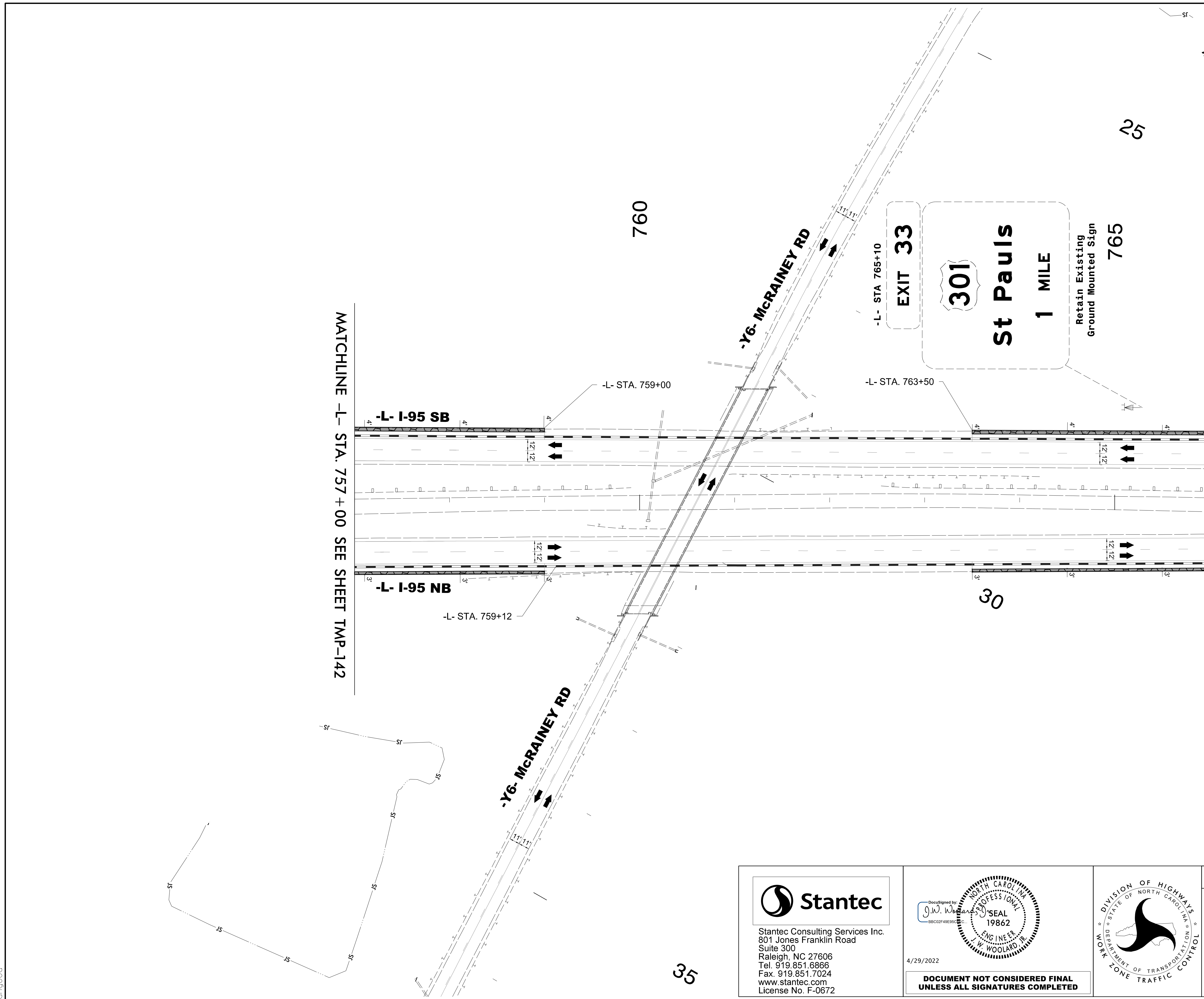

MATCHLINE -L- STA. 757 + 00 SEE SHEET TMP-142

MATCHLINE -L- STA. 766 + 00 SEE SHEET TMP-144

 Stantec Consulting Services Inc.
 801 Jones Franklin Road
 Suite 300
 Raleigh, NC 27606
 Tel. 919.851.6866
 Fax. 919.851.7024
 www.stantec.com
 License No. F-0672

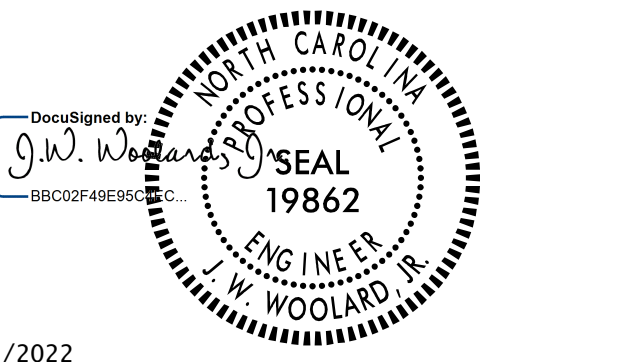
4/29/2022

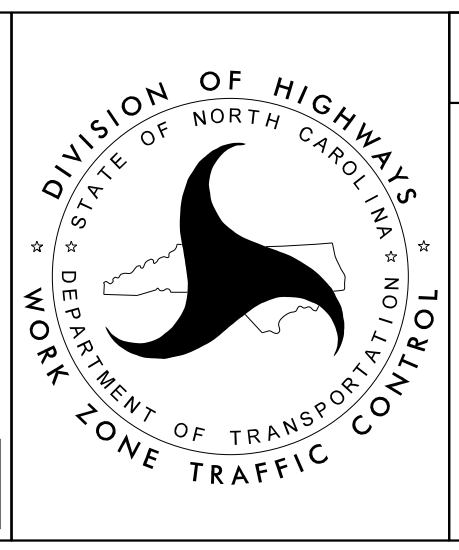
**DOCUMENT NOT CONSIDERED FINAL
 UNLESS ALL SIGNATURES COMPLETED**



SECTION 2

-L- I-95
 PHASE I
 STEP 1B

760

25

EXIT 33

301
 St Pauls
 1 MILE

Retain Existing
 Ground Mounted Sign

765

-L- STA. 759+00

-L- STA. 763+50

-L- I-95 SB

-L- I-95 NB

-L- STA. 759+12

-Y6- McRAINEY RD

30

35

25

770

775

MATCHLINE -L- STA. 766 + 00 SEE SHEET TMP-143

MATCHLINE -L- STA. 777 + 00 SEE SHEET TMP-145

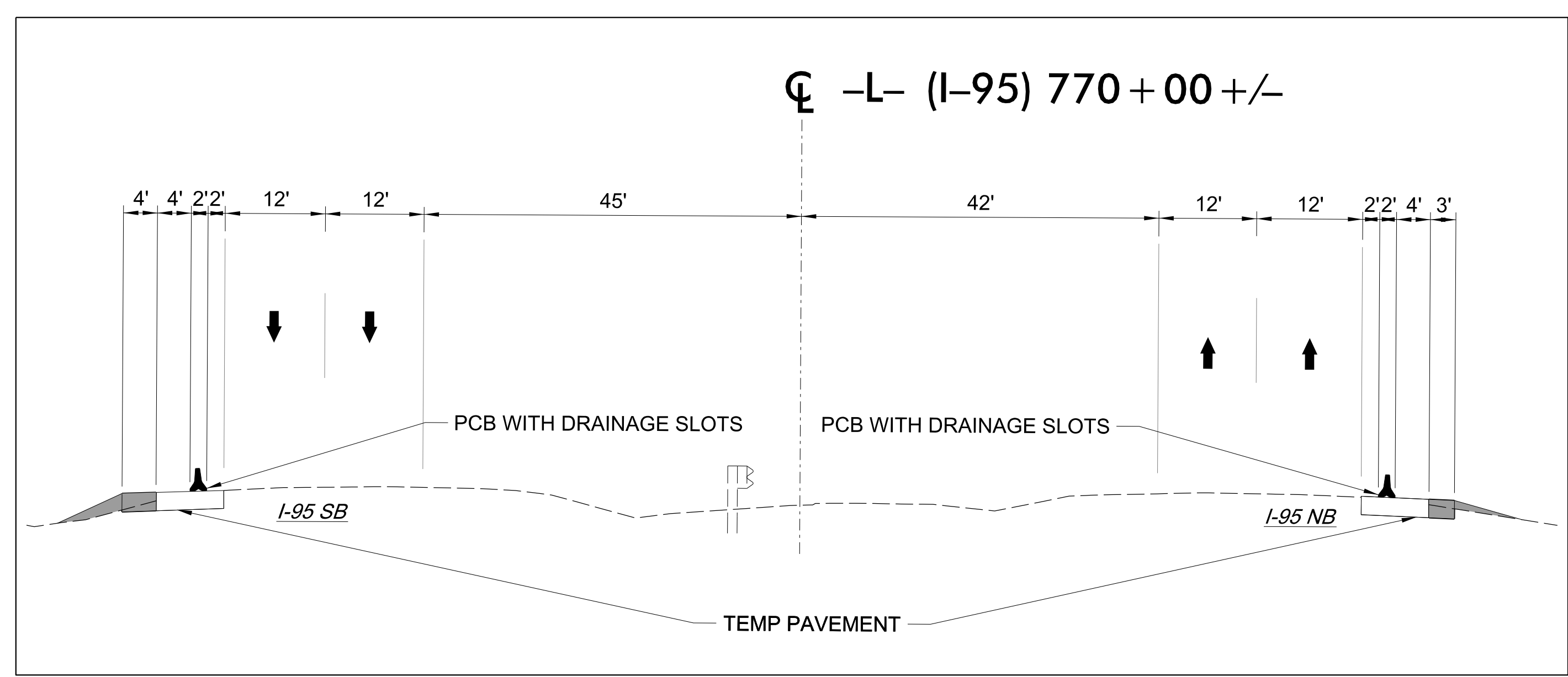
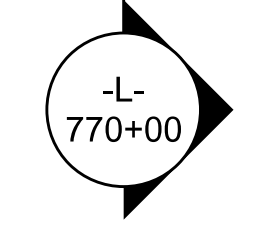
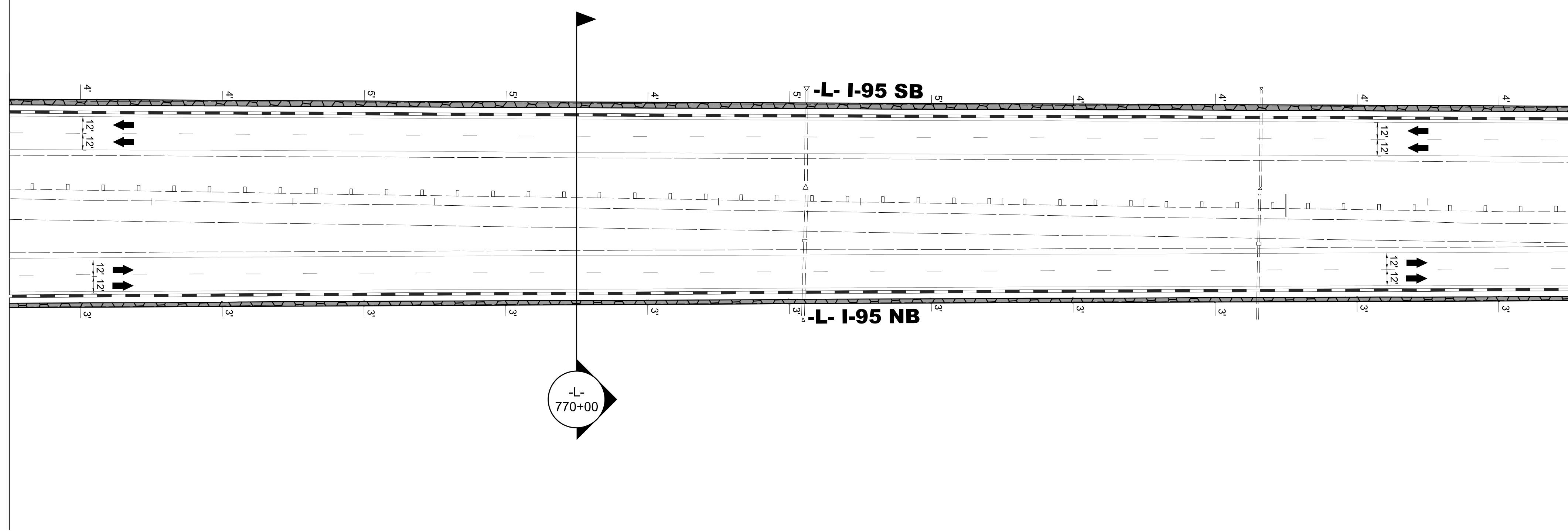

Q -L- (I-95) 770 + 00 +/-

Stantec
 Stantec Consulting Services Inc.
 801 Jones Franklin Road
 Suite 300
 Raleigh, NC 27606
 Tel. 919.851.6866
 Fax. 919.851.7024
 www.stantec.com
 License No. F-0672

DocuSigned by
 J.W. Woollard, Jr.
 SEAL
 19862
 ENGINEER
 J.W. WOOLLARD, JR.
 4/29/2022
**DOCUMENT NOT CONSIDERED FINAL
 UNLESS ALL SIGNATURES COMPLETED**

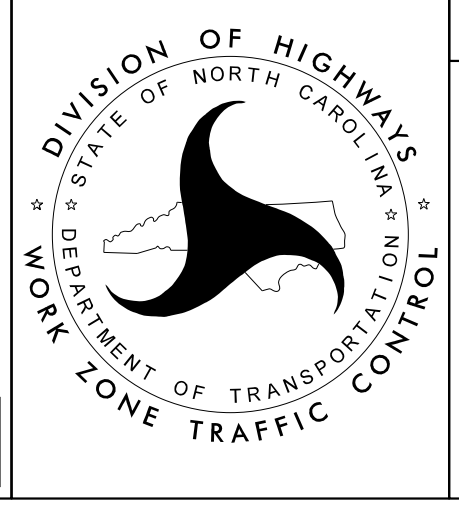

SECTION 2

-L- I-95
 PHASE I
 STEP 1B

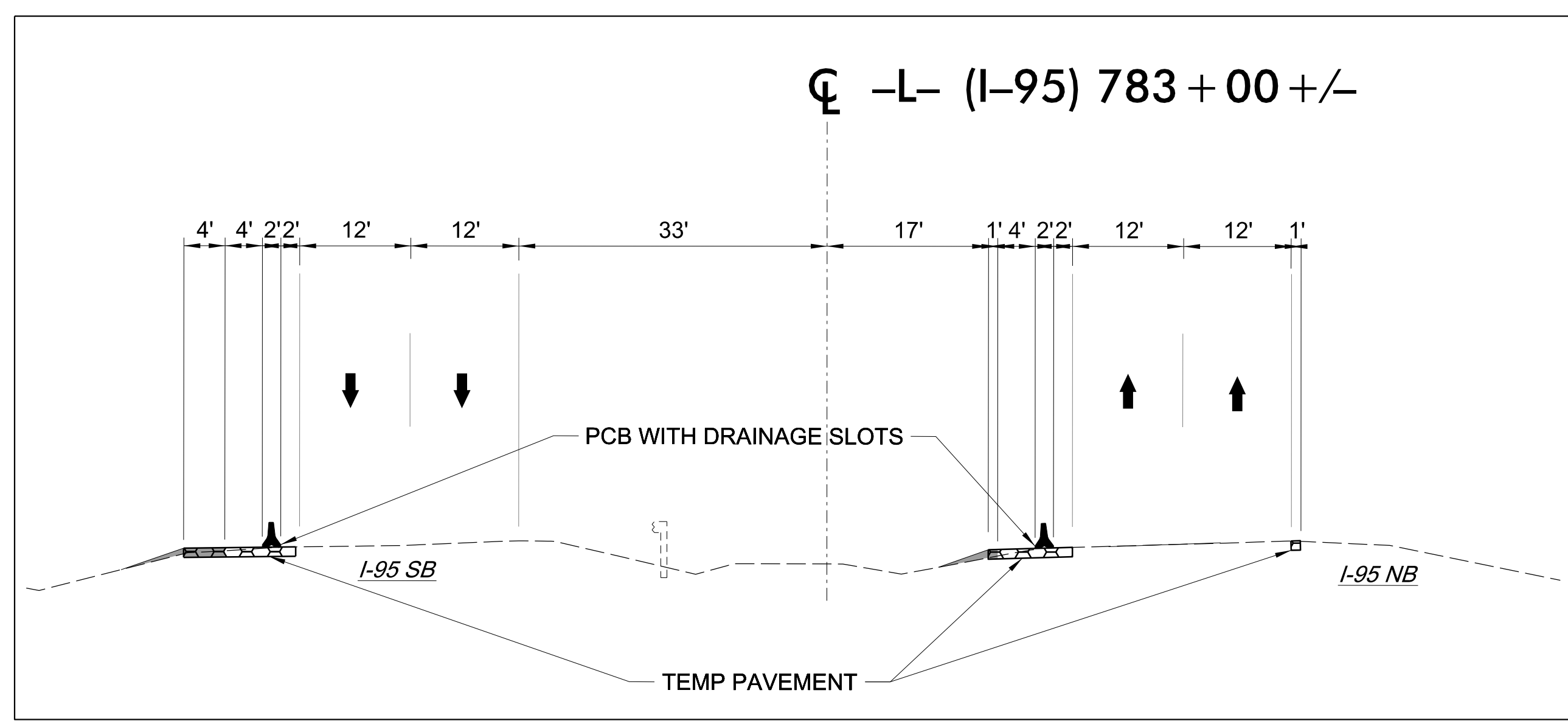
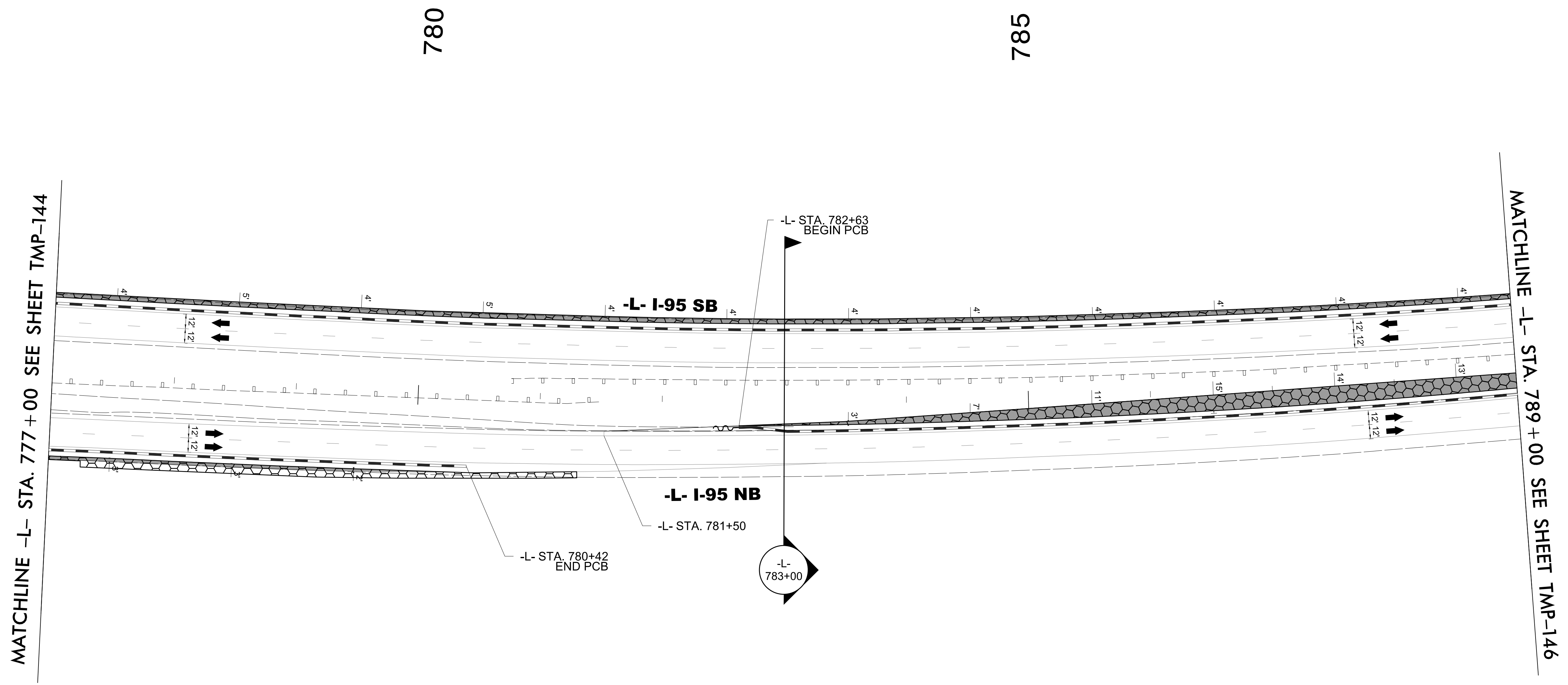
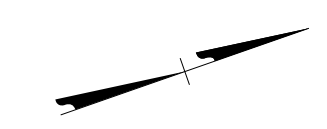

Stantec Consulting Services Inc.
801 Jones Franklin Road
Suite 300
Raleigh, NC 27606
Tel. 919.851.6866
Fax. 919.851.7024
www.stantec.com
License No. F-0672

DocuSigned by
J.W. Woollard
SBBCC2F49E5656C

4/29/2022

**DOCUMENT NOT CONSIDERED FINAL
UNLESS ALL SIGNATURES COMPLETED**

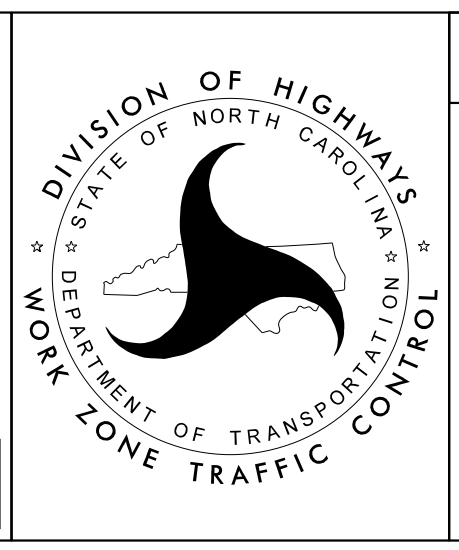

SECTION 2

-L- I-95
PHASE I
STEP 1B

3/15/2022
U:\Traffic\Transportation Management\Plan\TCP\PLAN SHEETS\I-5987B_TMP_145_PHASE_1_STEP_1B.dgn
angood

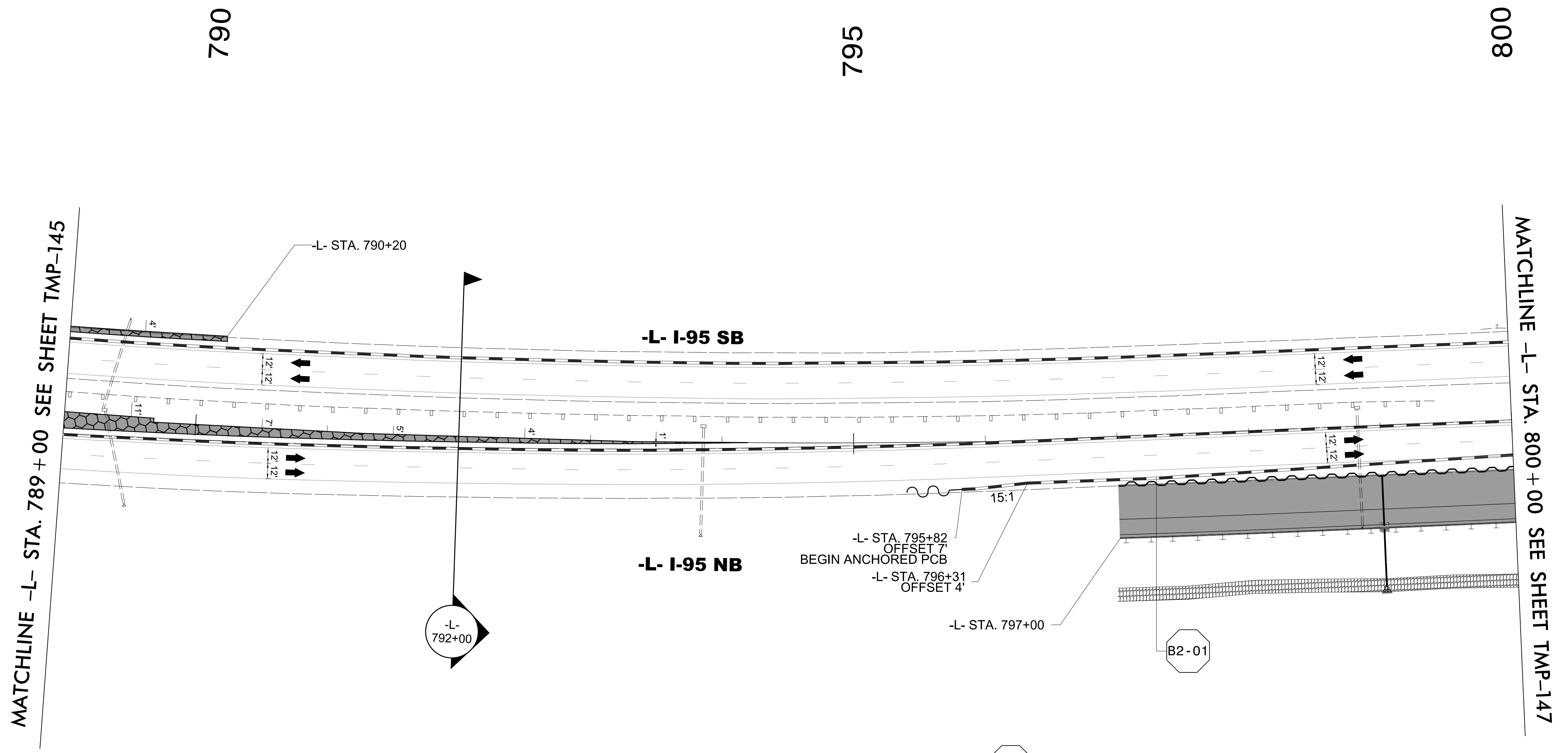

B2-01 QUANTITY = 3510 SF
 TEMPORARY SHORING ON -L-
 FROM 797+00+/- (33'RT) TO 802+40+/- (33'RT)
 (SEE SHEET TMP-2TS8 FOR
 TEMPORARY SHORING NOTES)

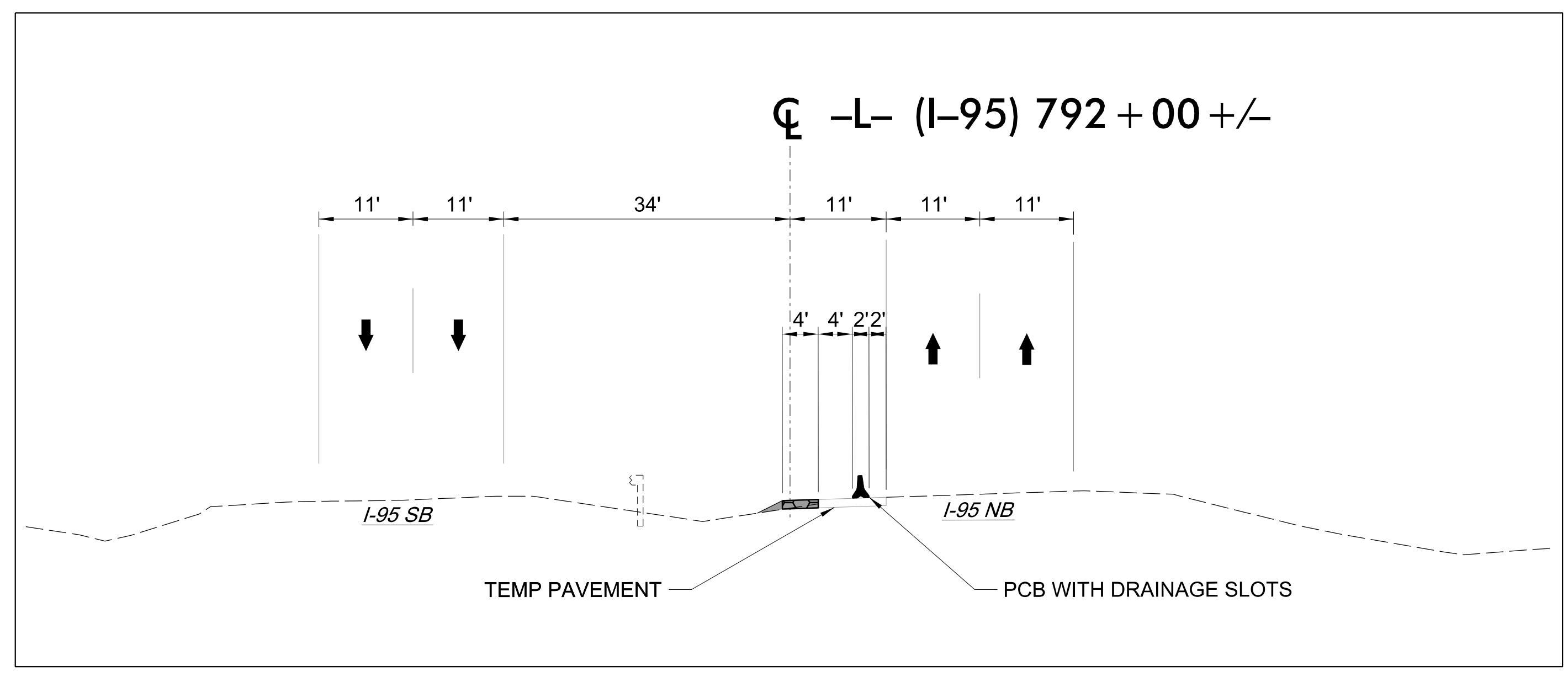

3/15/2022
 U:\Traffic\Transportation Management Plan\TCP\PLAN SHEETS\I-5987B_TMP_146_PHASE_1LSTEP_IB.dgn
 angood

Stantec

Stantec Consulting Services Inc.
 801 Jones Franklin Road
 Suite 300
 Raleigh, NC 27606
 Tel. 919.851.6866
 Fax. 919.851.7024
 www.stantec.com
 License No. F-0672

DocuSigned by
 J.W. Woollard, Jr.
 PROFESSIONAL ENGINEER
 SEAL
 19862
 J.W. WOOLLARD, JR.

4/29/2022

**DOCUMENT NOT CONSIDERED FINAL
 UNLESS ALL SIGNATURES COMPLETED**

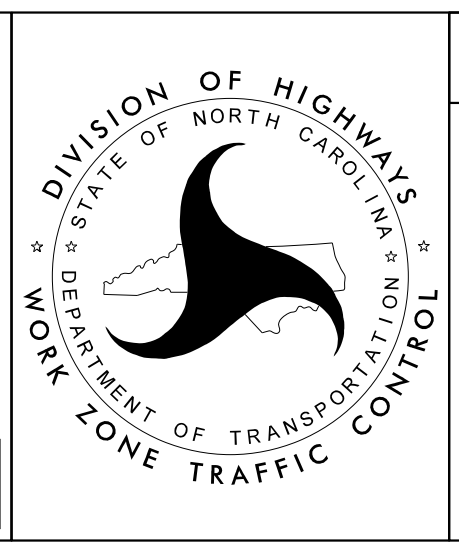

SECTION 2

-L- I-95
 PHASE I
 STEP 1B

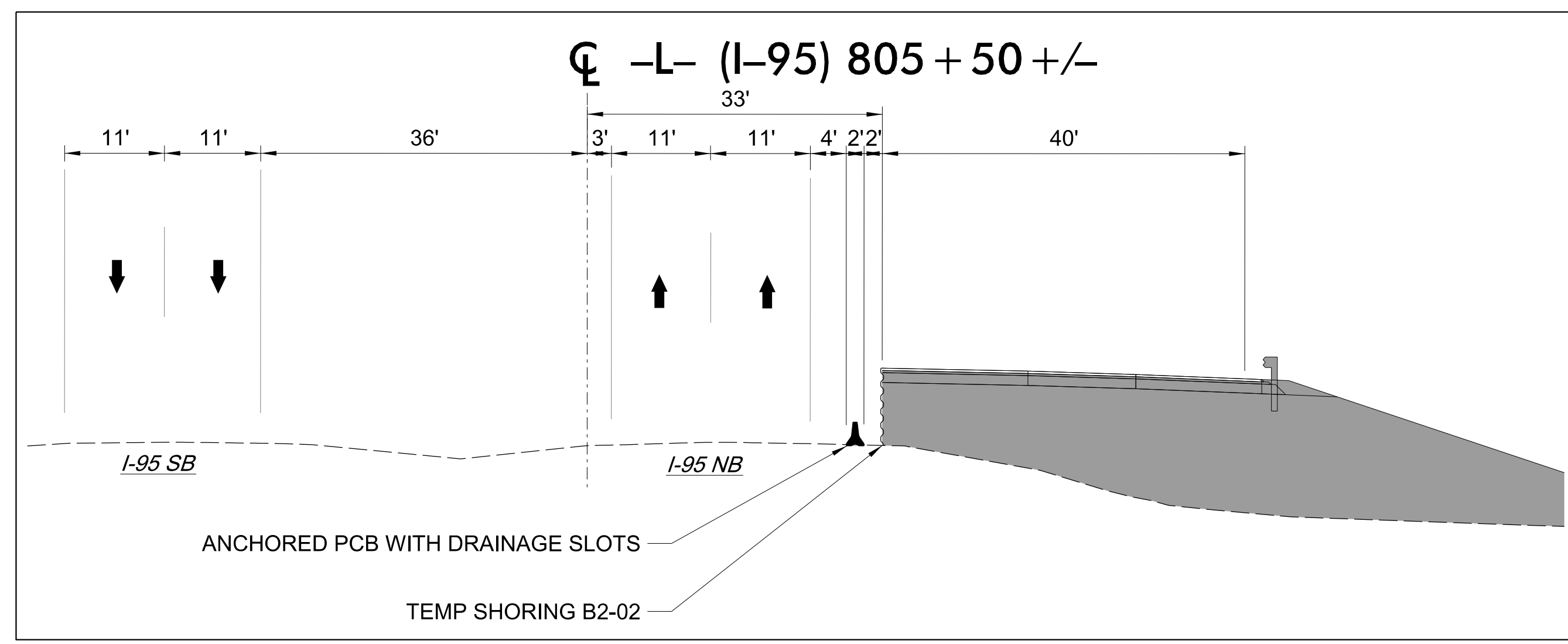
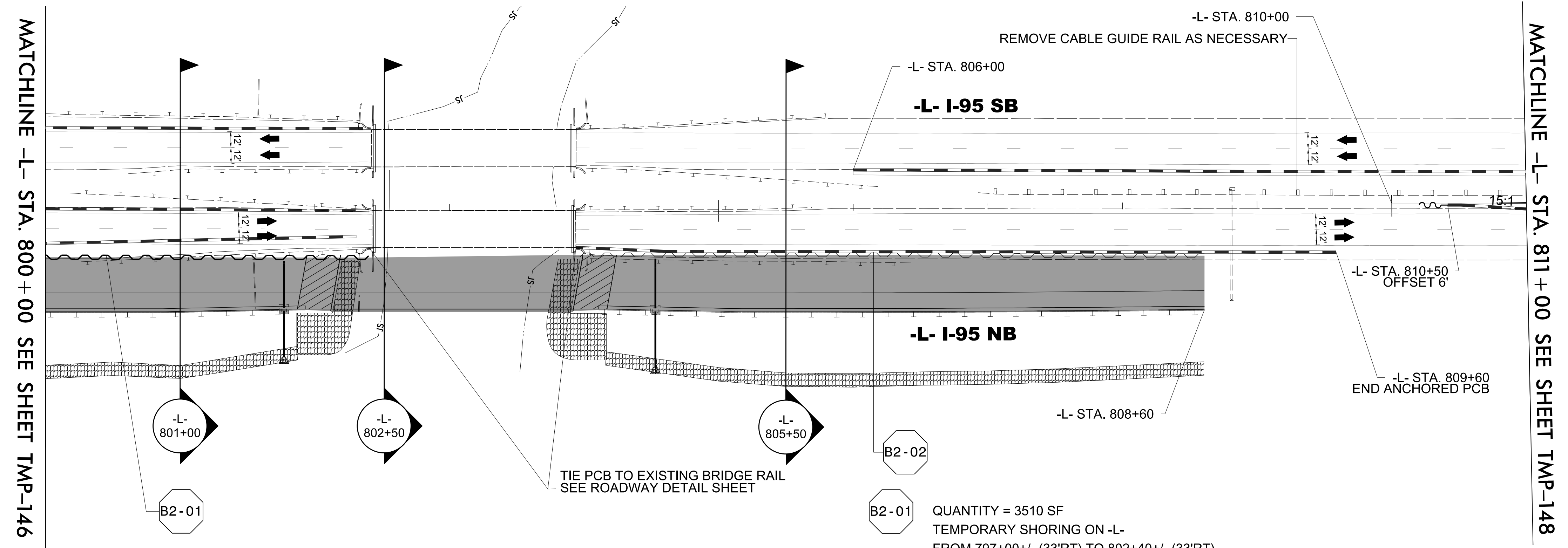
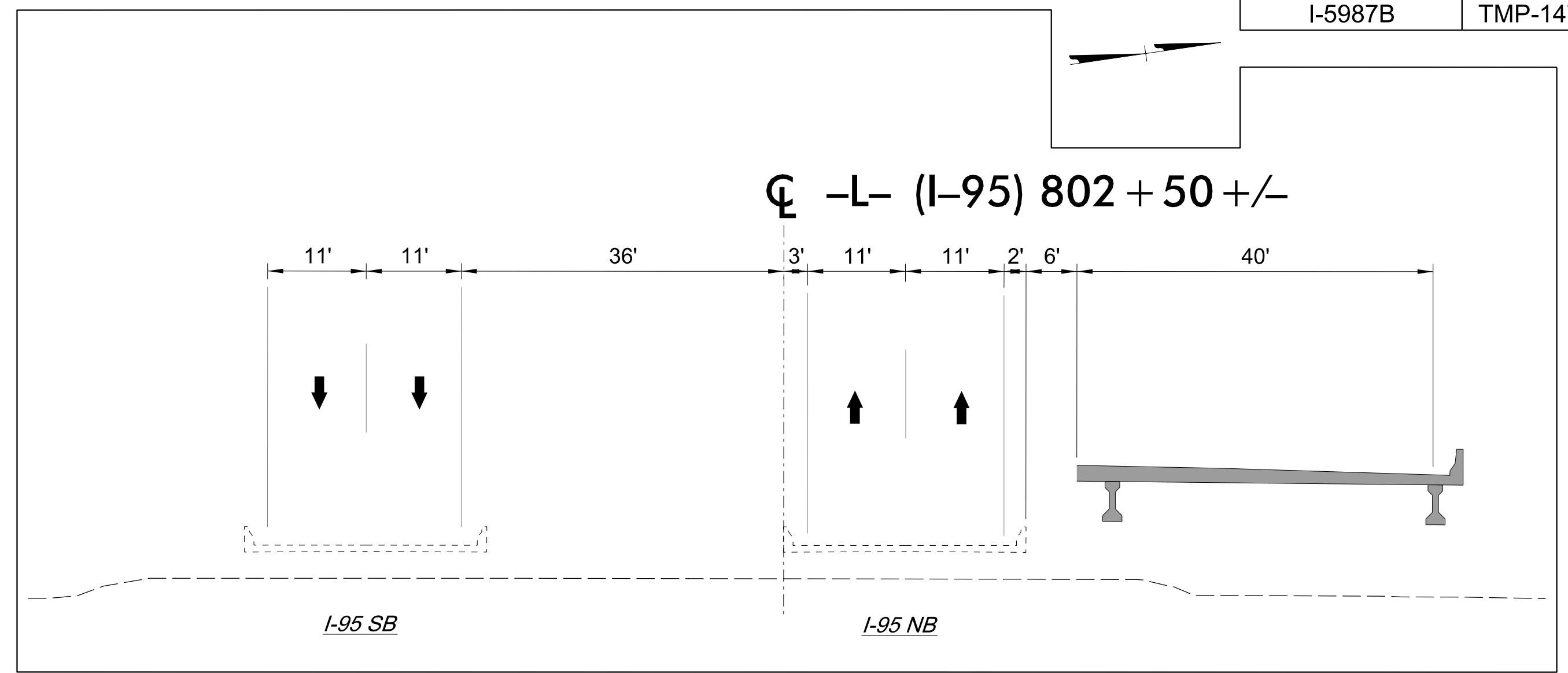
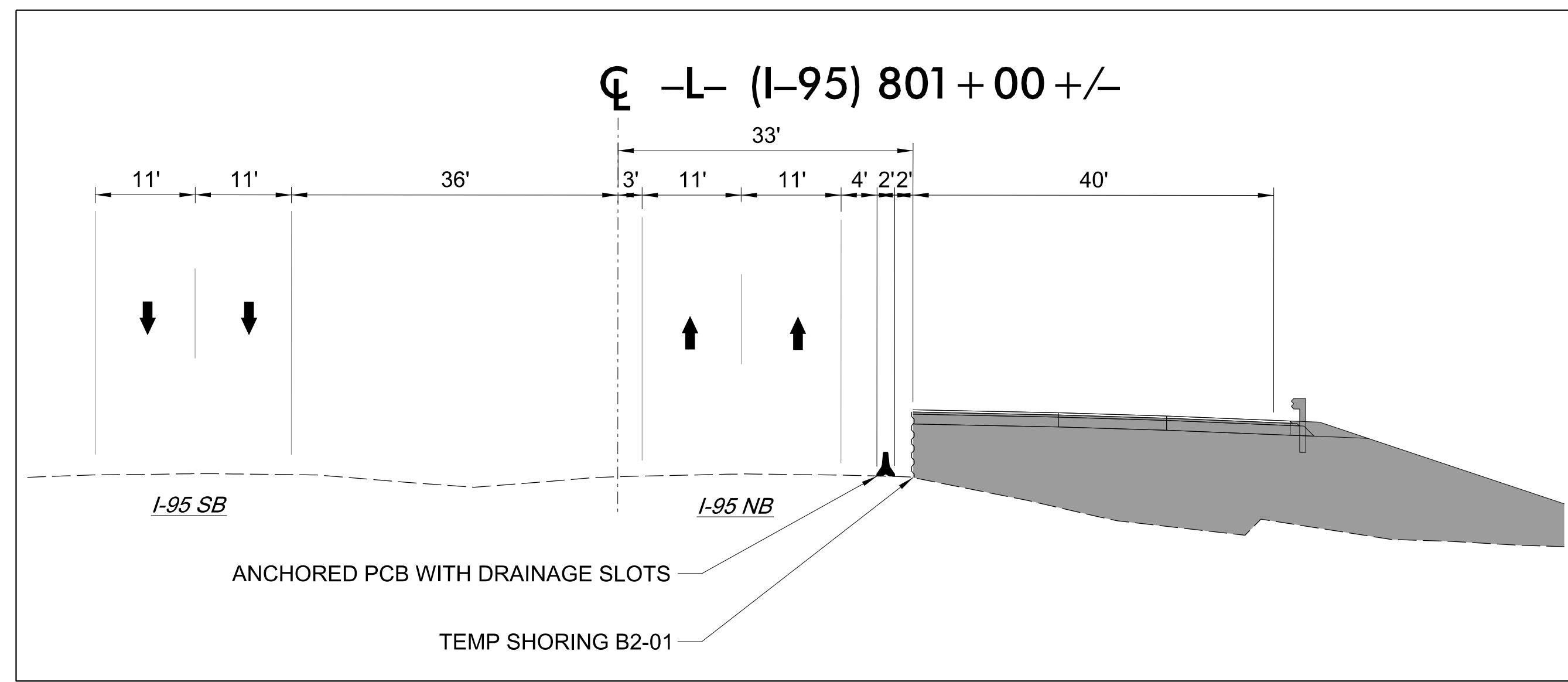

- B2-01 QUANTITY = 3510 SF
TEMPORARY SHORING ON -L- FROM 797+00+/- (33'RT) TO 802+40+/- (33'RT) (SEE SHEET TMP-2TS8 FOR TEMPORARY SHORING NOTES)
- B2-02 QUANTITY = 3791 SF
TEMPORARY SHORING ON -L- FROM 803+92+/- (33'RT) TO 808+60+/- (33'RT) (SEE SHEET TMP-2TS8 FOR TEMPORARY SHORING NOTES)

3/15/2022
L:\Traffic\Transportation Management\Plan\TCP\PLAN SHEETS\I-5987B_TMP_147_PHASE_1_STEP_1B.dgn
angood

Stantec Consulting Services Inc.
801 Jones Franklin Road
Suite 300
Raleigh, NC 27606
Tel. 919.851.6866
Fax. 919.851.7024
www.stantec.com
License No. F-0672

DocuSigned by
J.W. Woolard
SEAL
19862
ENGINEER
J.W. WOOLARD, JR.
4/29/2022

**DOCUMENT NOT CONSIDERED FINAL
UNLESS ALL SIGNATURES COMPLETED**

DIVISION OF HIGHWAYS
STATE OF NORTH CAROLINA
DEPARTMENT OF TRANSPORTATION
WORK ZONE TRAFFIC CONTROL

SECTION 2

-L- I-95
PHASE I
STEP 1B



810

815

820

MATCHLINE -L- STA. 811+00 SEE SHEET TMP-147

MATCHLINE -L- STA. 822+00 SEE SHEET TMP-149

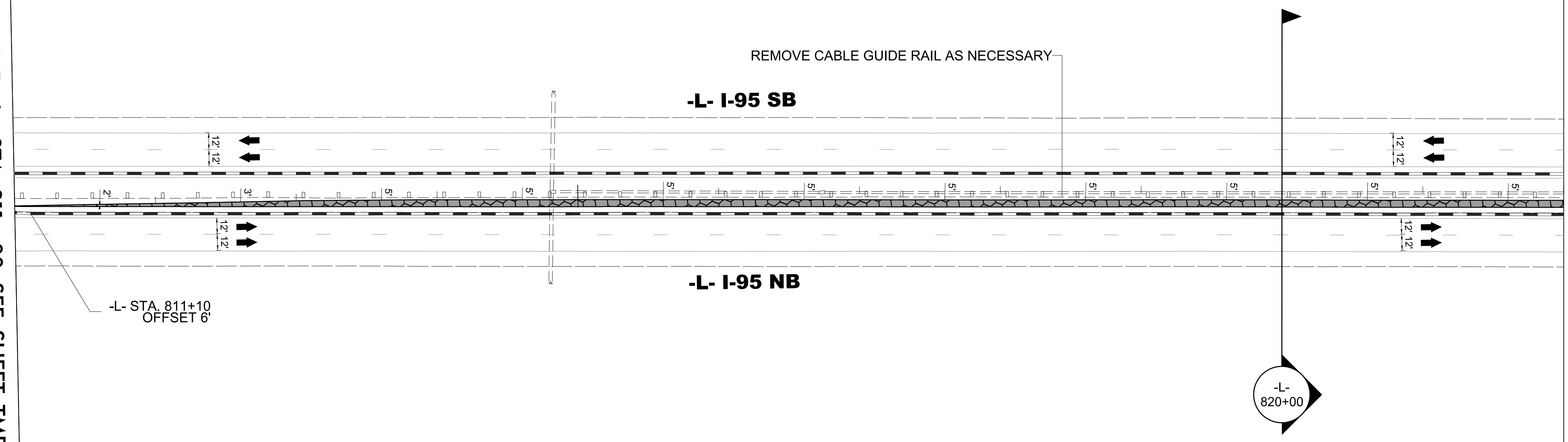

REMOVE CABLE GUIDE RAIL AS NECESSARY

-L- STA. 811+10
OFFSET 6'

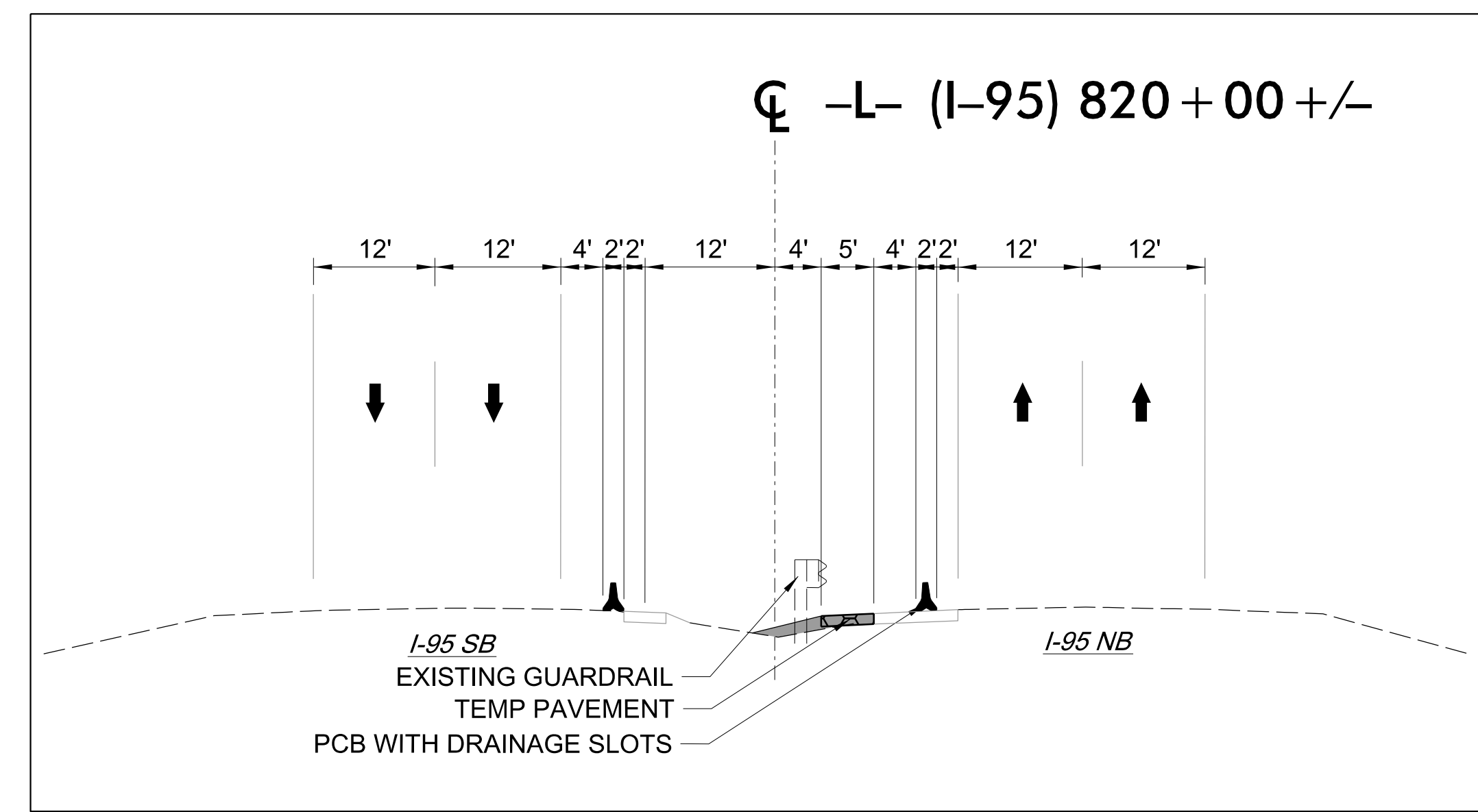
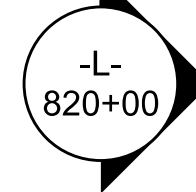

CL -L- (I-95) 820+00 +/-

I-95 SB
EXISTING GUARDRAIL
TEMP PAVEMENT
PCB WITH DRAINAGE SLOTS

I-95 NB

3/15/2022
U:\Traffic\Transportation Management Plan\TCP\PLAN SHEETS\I-5987B_TMP_148_PHASE_1_STEP_1B.dgn
angood

Stantec Consulting Services Inc.
801 Jones Franklin Road
Suite 300
Raleigh, NC 27606
Tel. 919.851.6866
Fax. 919.851.7024
www.stantec.com
License No. F-0672

DocuSigned by
J.W. Woollard
SBC02F49E5656

4/29/2022

**DOCUMENT NOT CONSIDERED FINAL
UNLESS ALL SIGNATURES COMPLETED**

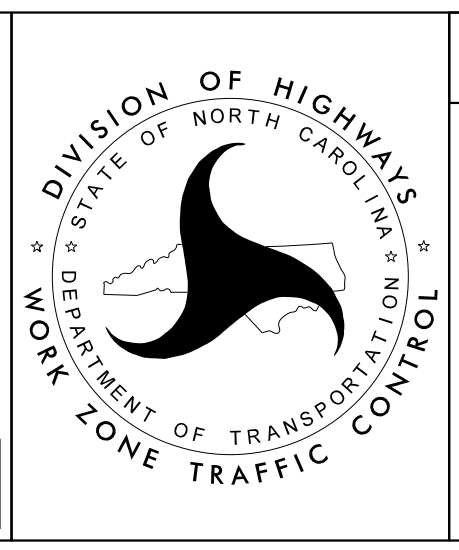

SECTION 2

-L- I-95
PHASE I
STEP 1B

PROJ. REFERENCE NO.	SHEET NO.
I-5987B	TMP-149

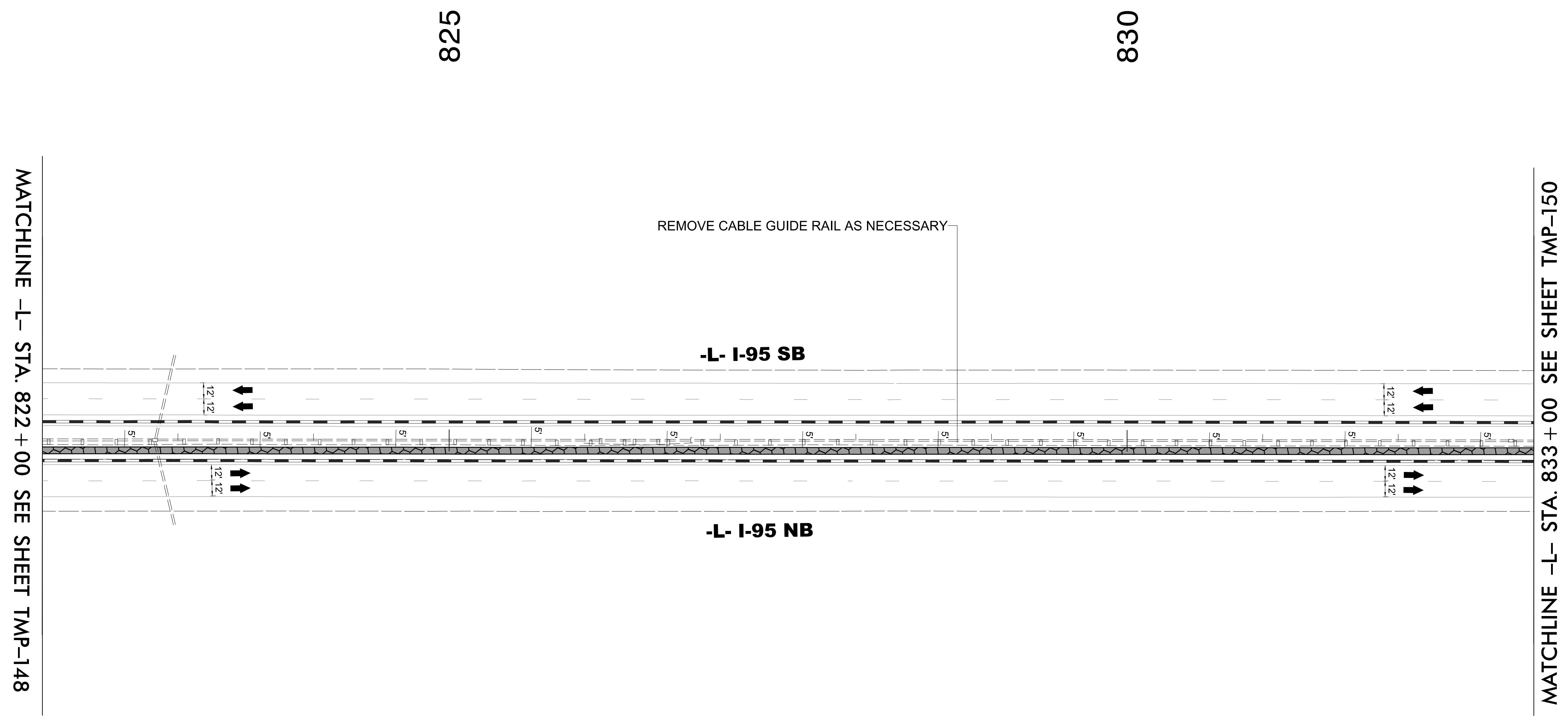

3/15/2022
 U:\Traffic\Transportation Management\Plan\TCP\PLAN SHEETS\I-5987B_TMP_149_PHASE_1_STEP_1B.dgn
 angood

Stantec Consulting Services Inc.
 801 Jones Franklin Road
 Suite 300
 Raleigh, NC 27606
 Tel. 919.851.6866
 Fax. 919.851.7024
 www.stantec.com
 License No. F-0672

DocuSigned by
 J.W. Woolard
 58C02F49E565C

4/29/2022

**DOCUMENT NOT CONSIDERED FINAL
 UNLESS ALL SIGNATURES COMPLETED**

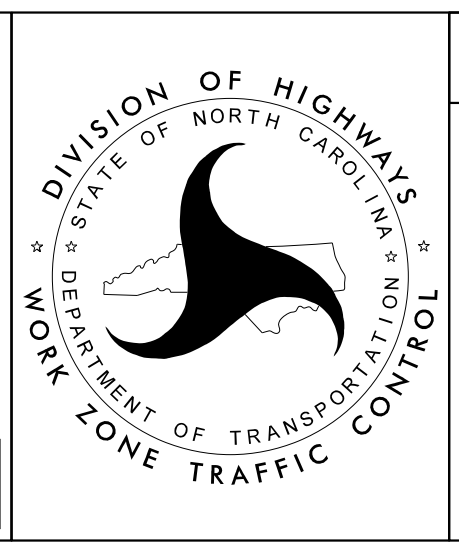

SECTION 2

**-L- I-95
 PHASE I
 STEP 1B**

PROJ. REFERENCE NO.	SHEET NO.
I-5987B	TMP-150

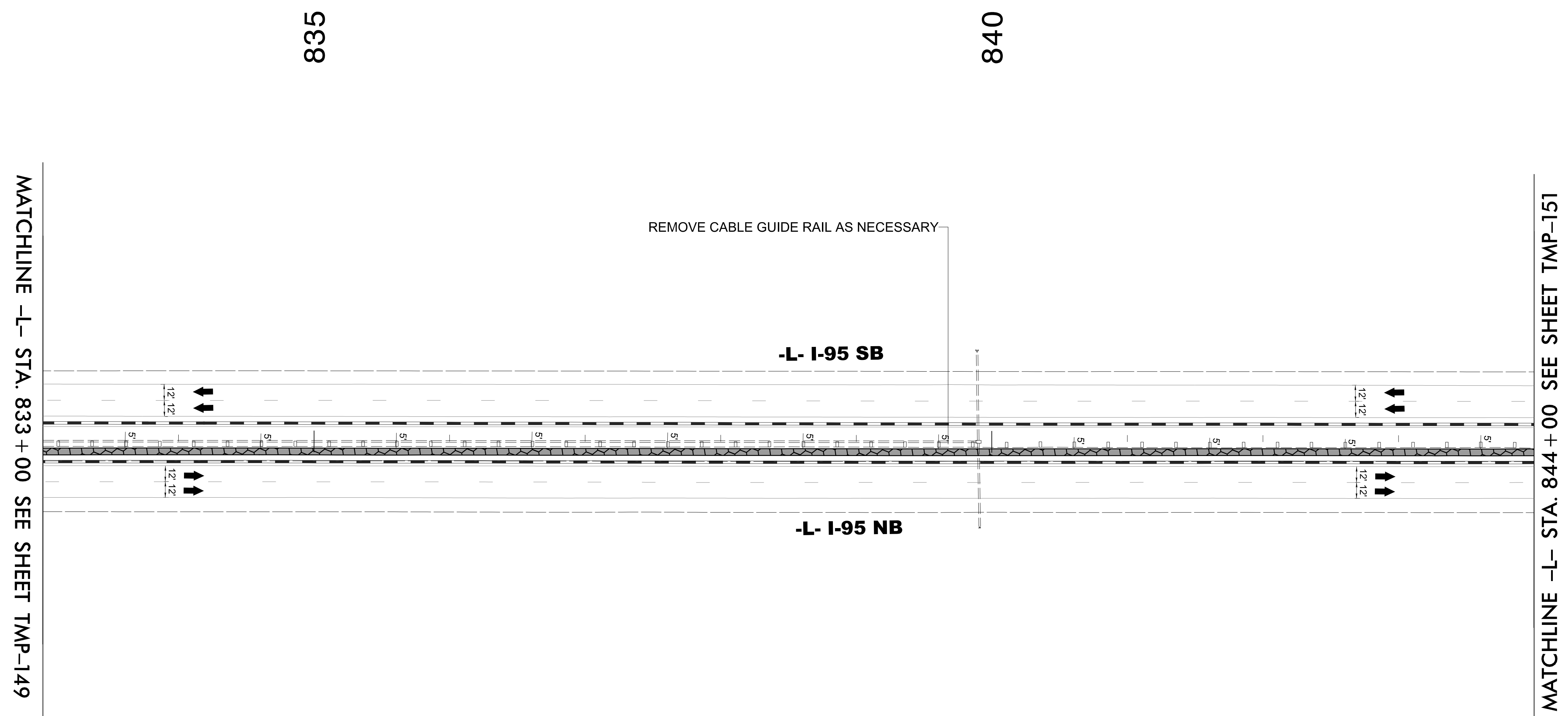

3/15/2022
 U:\Traffic\Transportation Management\Plan\TCP\PLAN SHEETS\I-5987B_TMP_150_PHASE_1_STEP_1B.dgn
 angood

Stantec
 Stantec Consulting Services Inc.
 801 Jones Franklin Road
 Suite 300
 Raleigh, NC 27606
 Tel. 919.851.6866
 Fax. 919.851.7024
 www.stantec.com
 License No. F-0672

DocuSigned by
 J.W. Woolard
 58BC20F49E565C

4/29/2022

**DOCUMENT NOT CONSIDERED FINAL
 UNLESS ALL SIGNATURES COMPLETED**

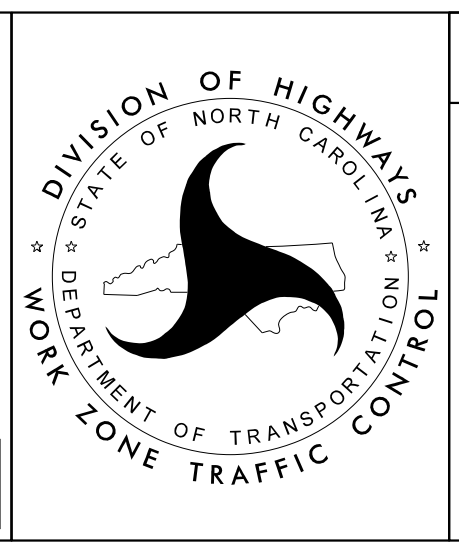

SECTION 2

-L- I-95
 PHASE I
 STEP 1B

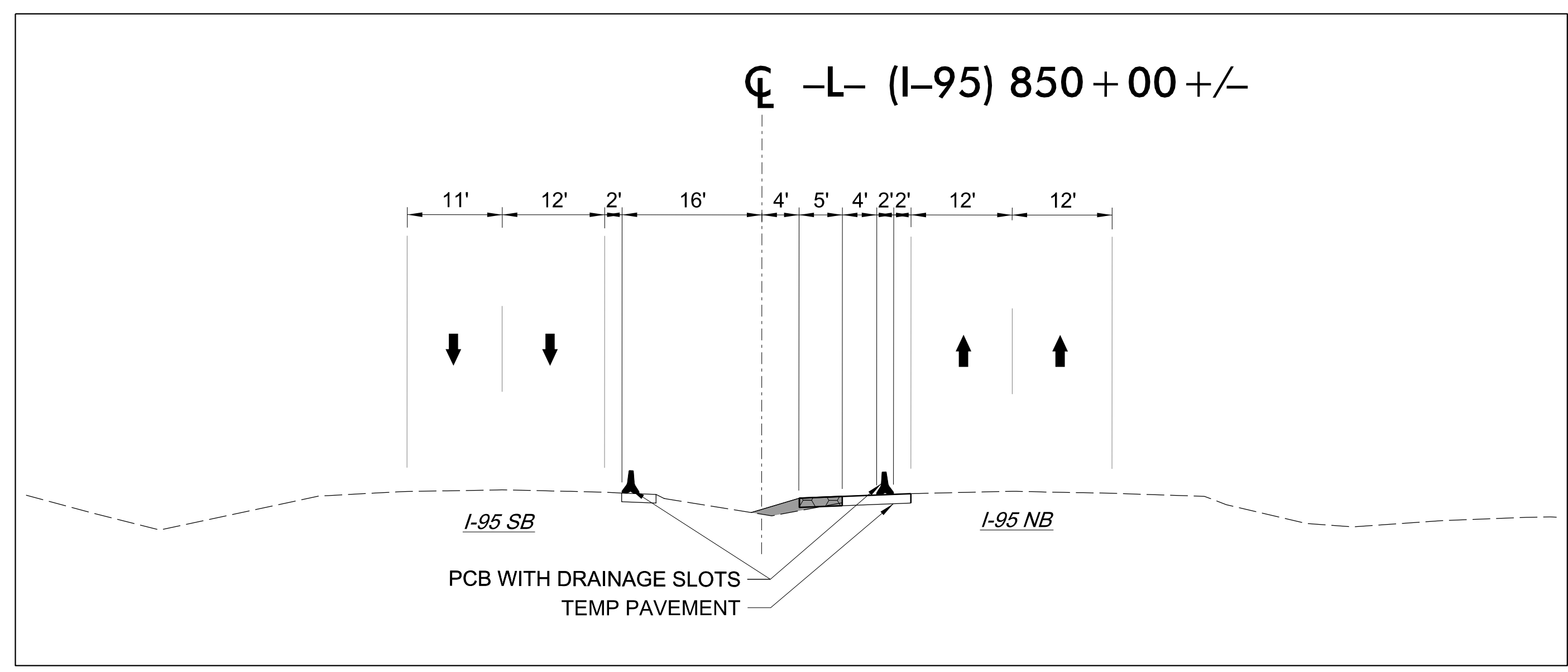

845

855

MATCHLINE -L- STA. 844 + 00 SEE SHEET TMP-150

MATCHLINE -L- STA. 856 + 00 SEE SHEET TMP-152

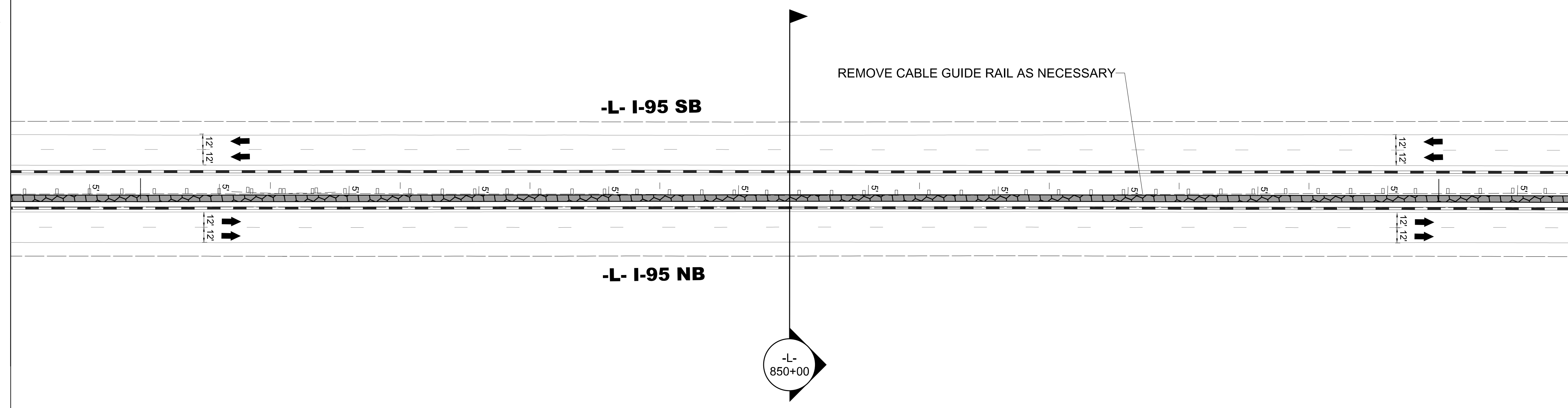

3/15/2022
U:\Traffic\Transportation Management\Plan\TCP\PLAN SHEETS\I-5987B_TMP_ISI_PHASE I_STEP 1B.dgn
angood

Stantec Consulting Services Inc.
801 Jones Franklin Road
Suite 300
Raleigh, NC 27606
Tel. 919.851.6866
Fax. 919.851.7024
www.stantec.com
License No. F-0672

DocuSigned by:
J.W. Woolard
SBB020F49E565C

4/29/2022

**DOCUMENT NOT CONSIDERED FINAL
UNLESS ALL SIGNATURES COMPLETED**

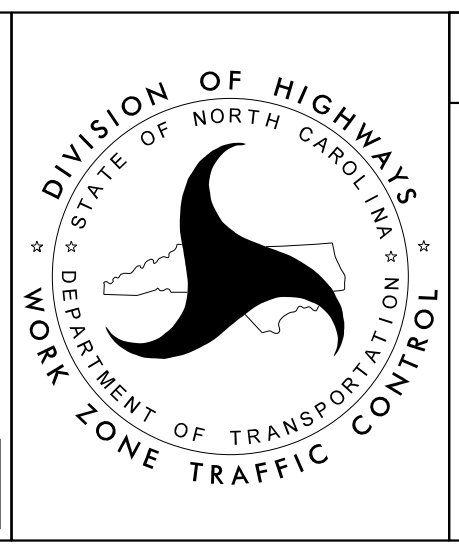

SECTION 2

-L- I-95
PHASE I
STEP 1B

PROJ. REFERENCE NO.	SHEET NO.
I-5987B	TMP-152



MATCHLINE -L- STA. 856 + 00 SEE SHEET TMP-151

860

865

REMOVE CABLE GUIDE RAIL AS NECESSARY

-L- I-95 SB

-L- I-95 NB

MATCHLINE -L- STA. 686 + 00 SEE SHEET TMP-153

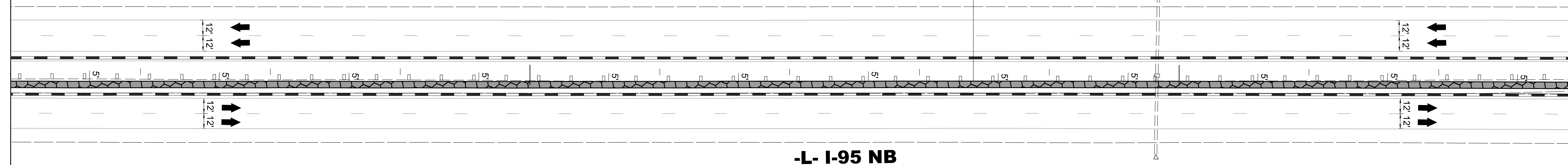

3/15/2022
 U:\Traffic\Transportation Management\Plan\TCP\PLAN SHEETS\I-5987B_TMP_I52_PHASE_1_STEP_1B.dgn
 angood

Stantec Consulting Services Inc.
 801 Jones Franklin Road
 Suite 300
 Raleigh, NC 27606
 Tel. 919.851.6866
 Fax. 919.851.7024
 www.stantec.com
 License No. F-0672

DocuSigned by
 J.W. Woolard
 58C02F49E565C

4/29/2022

**DOCUMENT NOT CONSIDERED FINAL
 UNLESS ALL SIGNATURES COMPLETED**

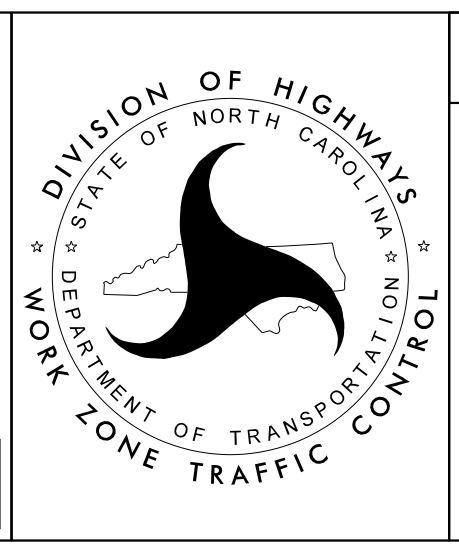

SECTION 2

**-L- I-95
 PHASE I
 STEP 1B**

PROJ. REFERENCE NO.	SHEET NO.
I-5987B	TMP-153

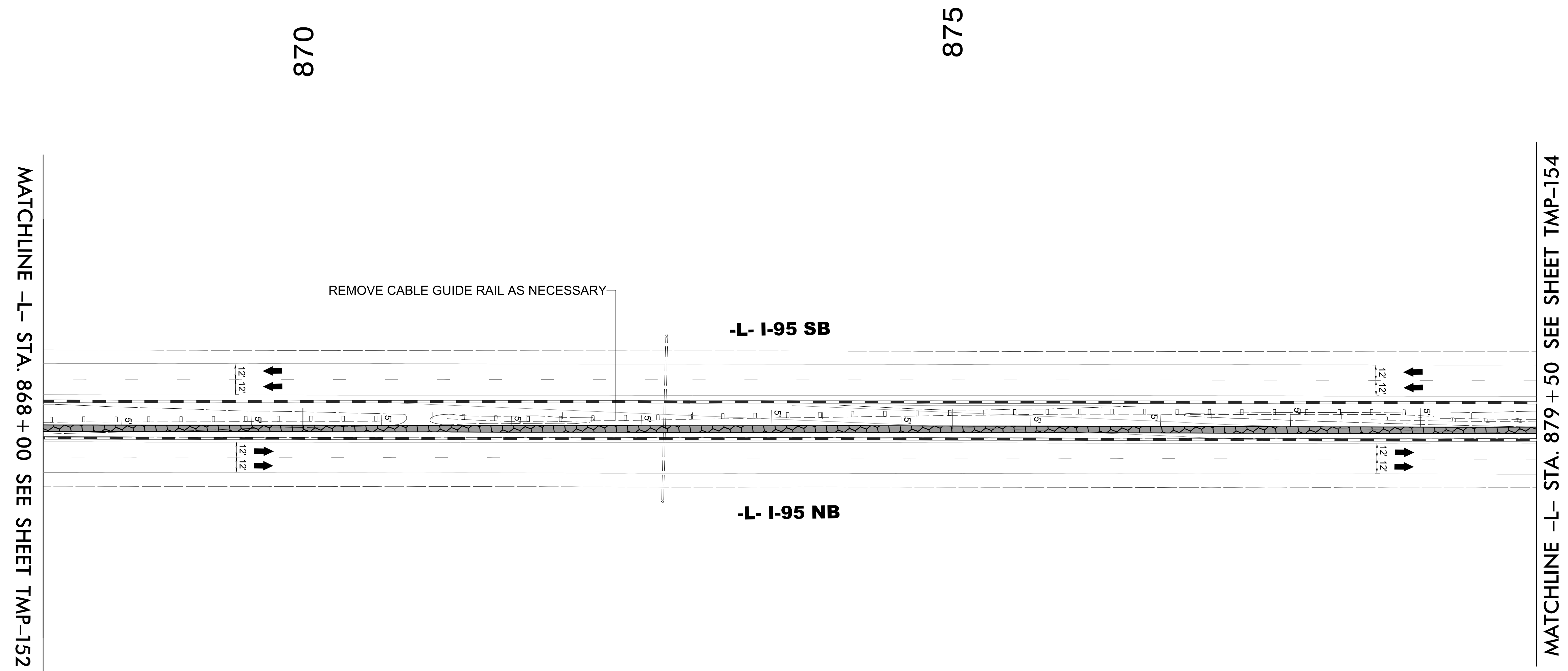

3/15/2022
 U:\Traffic\Transportation Management\Plan\TCP\PLAN SHEETS\I-5987B_TMP-153_PHASE 1_STEP 1B.dgn
 angood

Stantec Consulting Services Inc.
 801 Jones Franklin Road
 Suite 300
 Raleigh, NC 27606
 Tel. 919.851.6866
 Fax. 919.851.7024
 www.stantec.com
 License No. F-0672

DocuSigned by
J.W. Woolard
 5BCC2CF49E565C

4/29/2022

**DOCUMENT NOT CONSIDERED FINAL
 UNLESS ALL SIGNATURES COMPLETED**

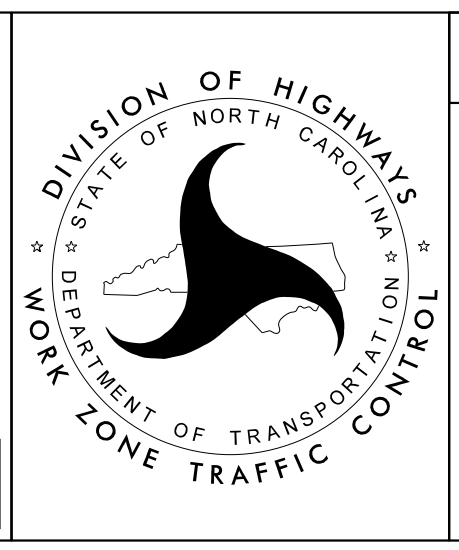

SECTION 2

-L- I-95
 PHASE I
 STEP 1B

PROJ. REFERENCE NO.	SHEET NO.
I-5987B	TMP-154

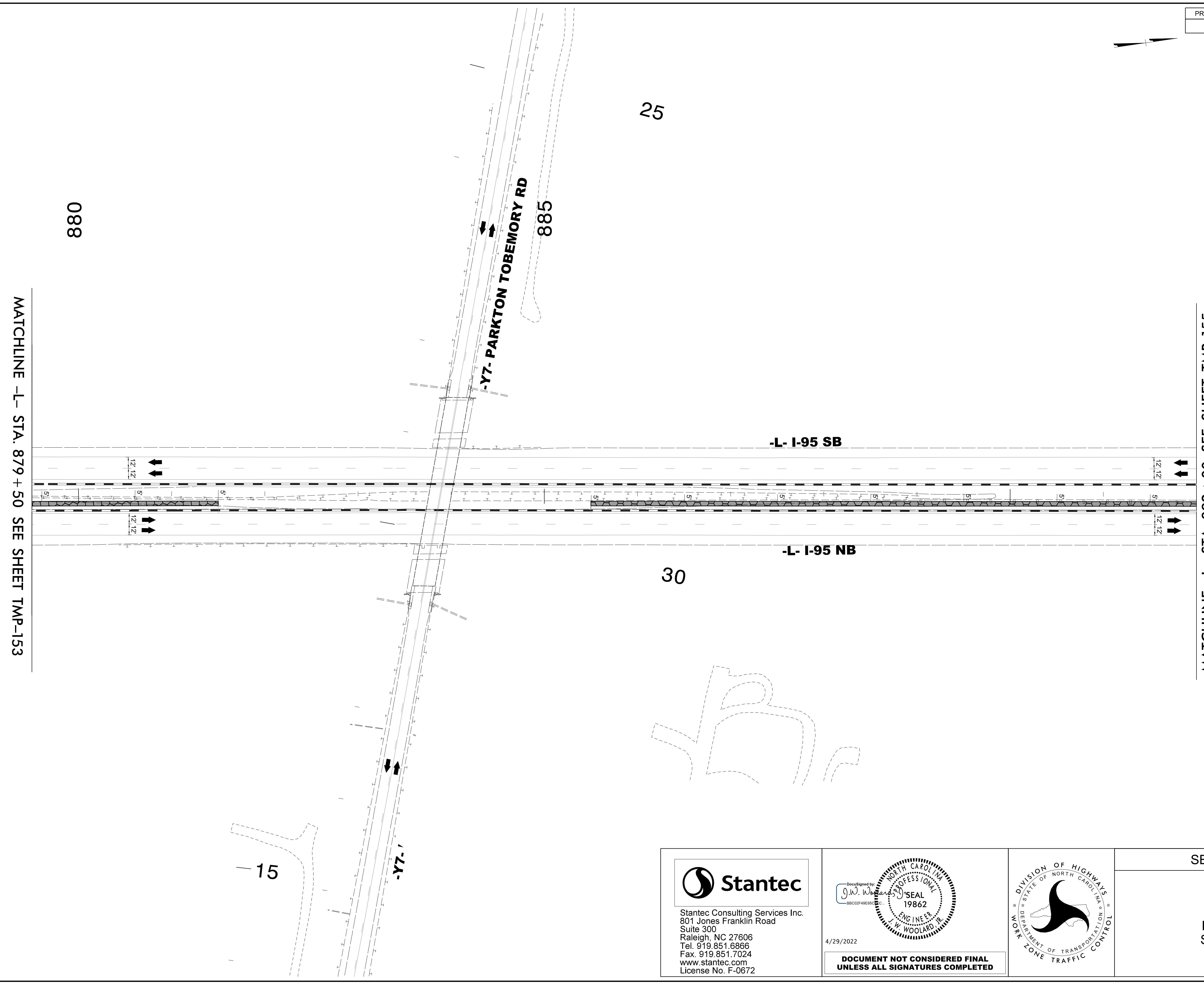

MATCHLINE -L- STA. 879 + 50 SEE SHEET TMP-153

MATCHLINE -L- STA. 892 + 00 SEE SHEET TMP-155

3/15/2022
 U:\Traffic\Transportation Management\Plan\TCP\PLAN SHEETS\I-5987B_TMP_I54_PHASE_1_STEP_1B.dgn
 angood

Stantec Consulting Services Inc.
 801 Jones Franklin Road
 Suite 300
 Raleigh, NC 27606
 Tel. 919.851.6866
 Fax. 919.851.7024
 www.stantec.com
 License No. F-0672

DocuSigned by
 J.W. Woollard
 58C02F49E565C

4/29/2022

**DOCUMENT NOT CONSIDERED FINAL
 UNLESS ALL SIGNATURES COMPLETED**

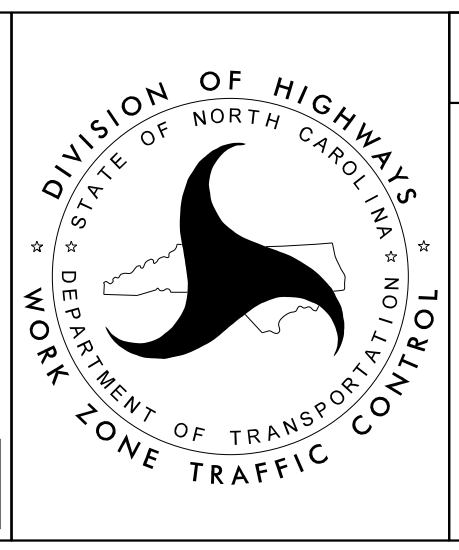

SECTION 2

-L- I-95
 PHASE I
 STEP 1B

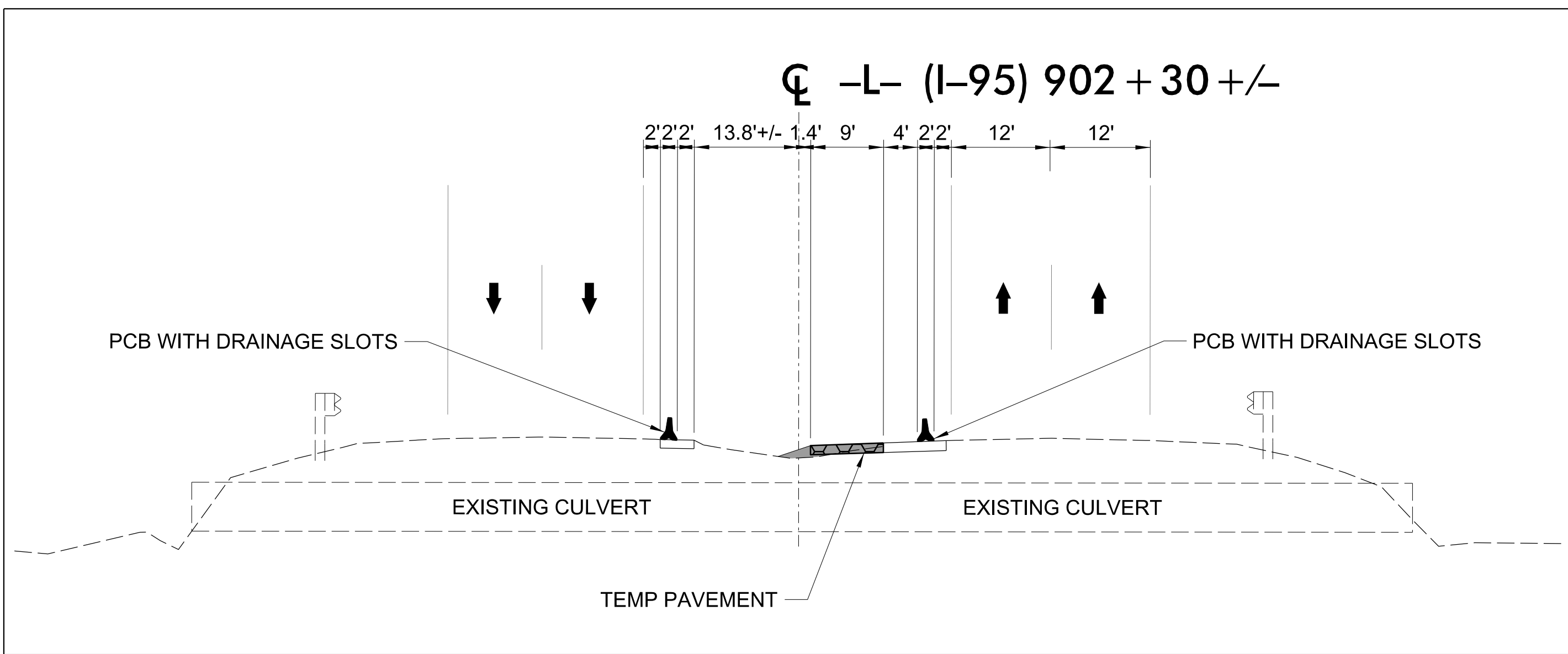
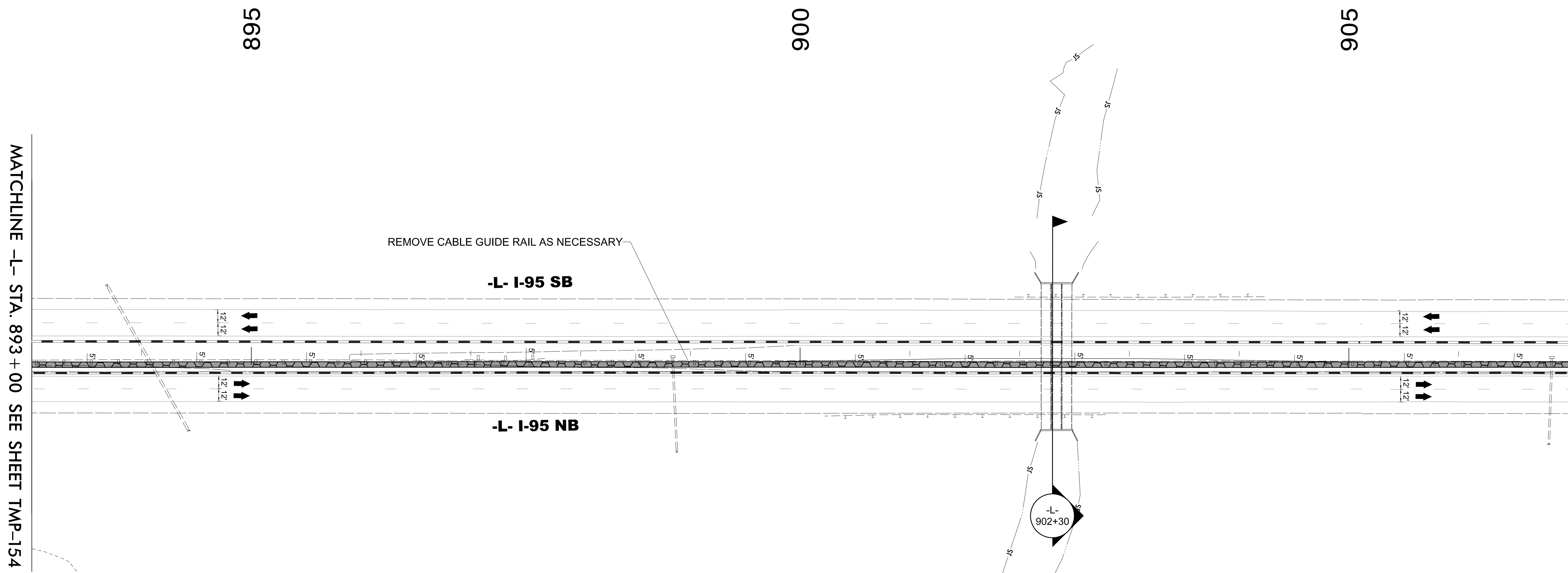

3/15/2022
U:\Traffic\Transportation Management Plan\TCP\PLAN SHEETS\I-5987B_TMP_I55_PHASE_1_STEP_1B.dgn
angood

Stantec Consulting Services Inc.
801 Jones Franklin Road
Suite 300
Raleigh, NC 27606
Tel. 919.851.6866
Fax. 919.851.7024
www.stantec.com
License No. F-0672

DocuSigned by
J.W. Woollard
98C02F49E5656

4/29/2022

**DOCUMENT NOT CONSIDERED FINAL
UNLESS ALL SIGNATURES COMPLETED**

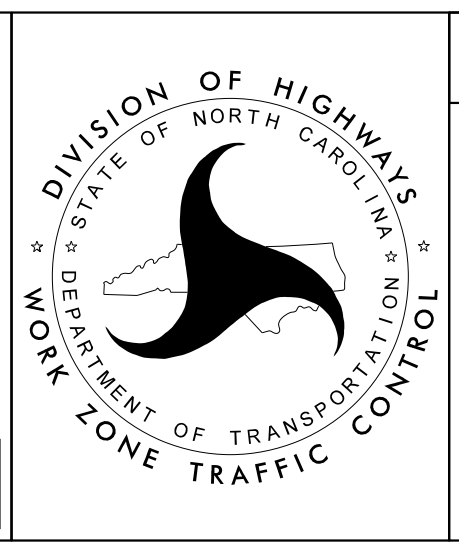

SECTION 2

-L- I-95
PHASE I
STEP 1B

MATCHLINE -L- STA. 745 + 00 SEE SHEET TMP-156

MATCHLINE -L- STA. 893 + 00 SEE SHEET TMP-154



MATCHLINE -L- STA. 907 + 00 SEE SHEET TMP-155

910

915

End TIP Project I-5987B
-L- Sta. 915 + 07.85
Tie to TIP Project U-2519AA
-Y- Sta. 22 + 89.87

CONTRACTOR SHALL COORDINATE CONSTRUCTION WITH U-2519AA CONTRACTOR

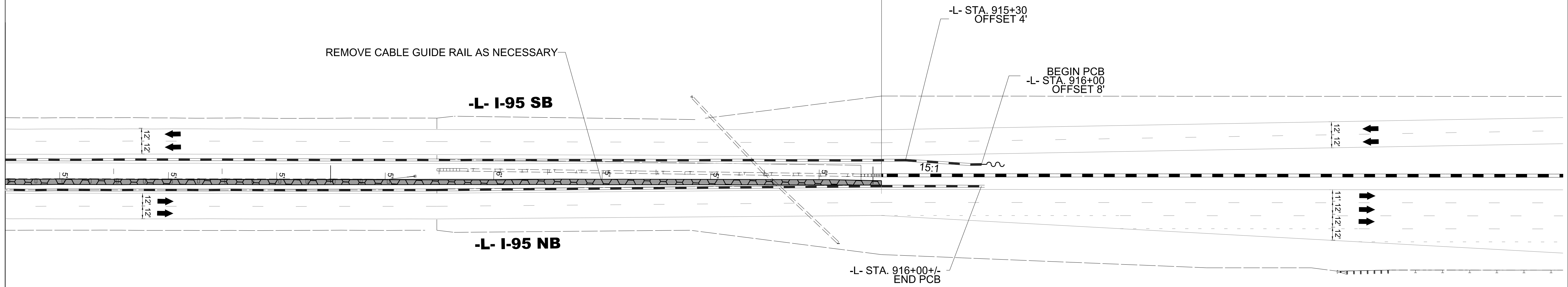

3/15/2022
U:\Traffic\Transportation Management\Plan\TCP\PLAN SHEETS\I-5987B_TMP-156-PHASE 1LSTEP 1B.dgn
angood

Stantec Consulting Services Inc.
 801 Jones Franklin Road
 Suite 300
 Raleigh, NC 27606
 Tel. 919.851.6866
 Fax. 919.851.7024
 www.stantec.com
 License No. F-0672

DocuSigned by
 J.W. Woolard
 58C02F49E565C

4/29/2022

**DOCUMENT NOT CONSIDERED FINAL
 UNLESS ALL SIGNATURES COMPLETED**

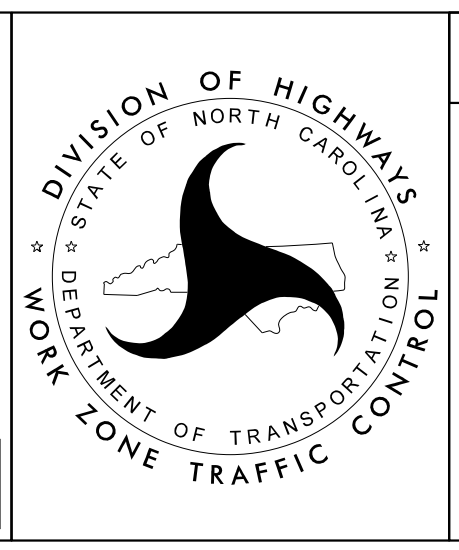

SECTION 2

-L- I-95
 PHASE I
 STEP 1B

B2-03 QUANTITY = 732 SF
 TEMPORARY SHORING ON -Y1B-
 FROM 27+50± (32'LT) TO 28+09± (32'LT)
 (SEE SHEET TMP-2TS8 FOR
 TEMPORARY SHORING NOTES)

B2-04 QUANTITY = 1701 SF
 TEMPORARY SHORING ON -Y1B-
 FROM 26+20± (27'LT) TO 28+09± (27'LT)
 (SEE SHEET TMP-2TS8 FOR
 TEMPORARY SHORING NOTES)

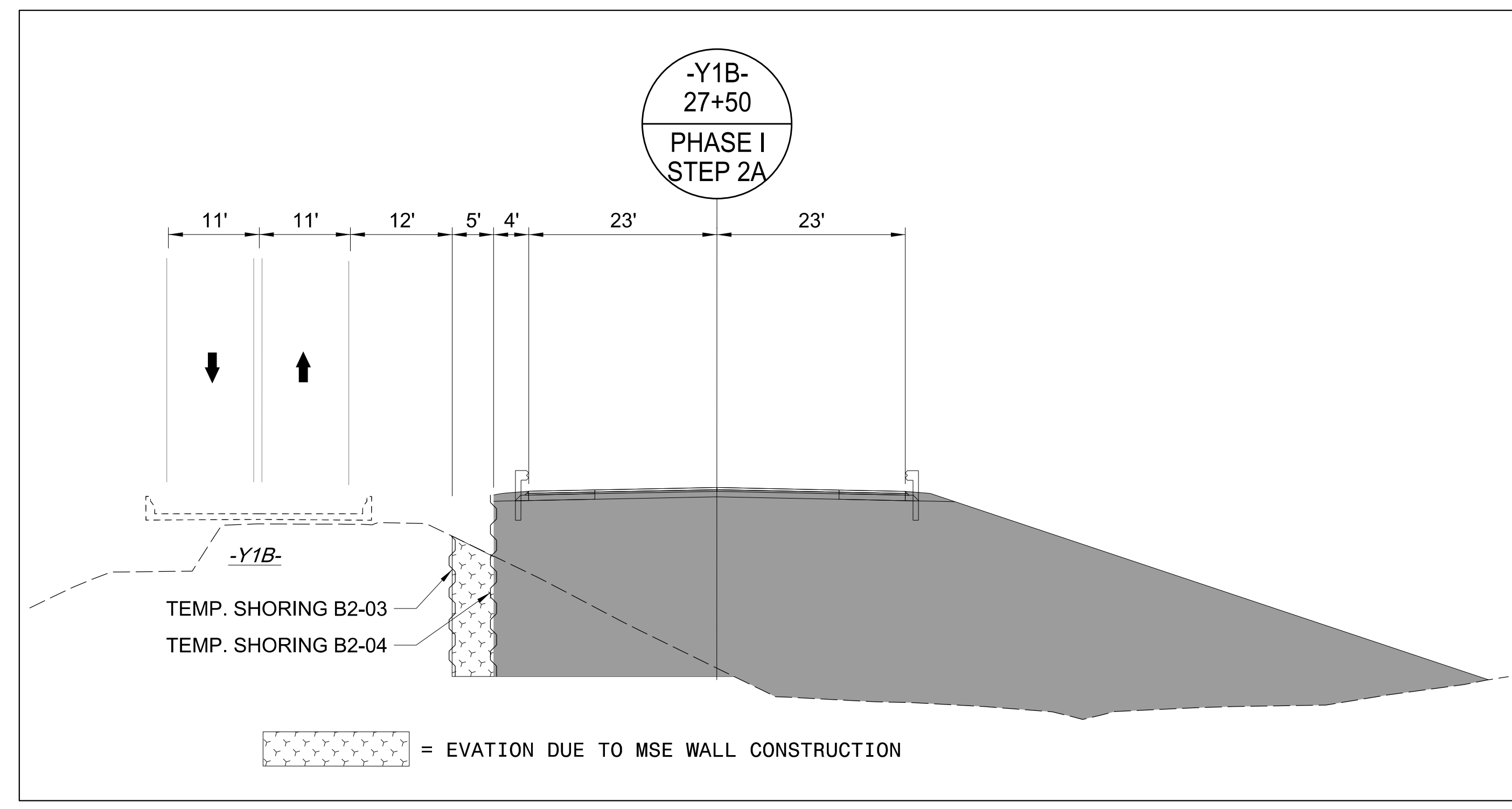
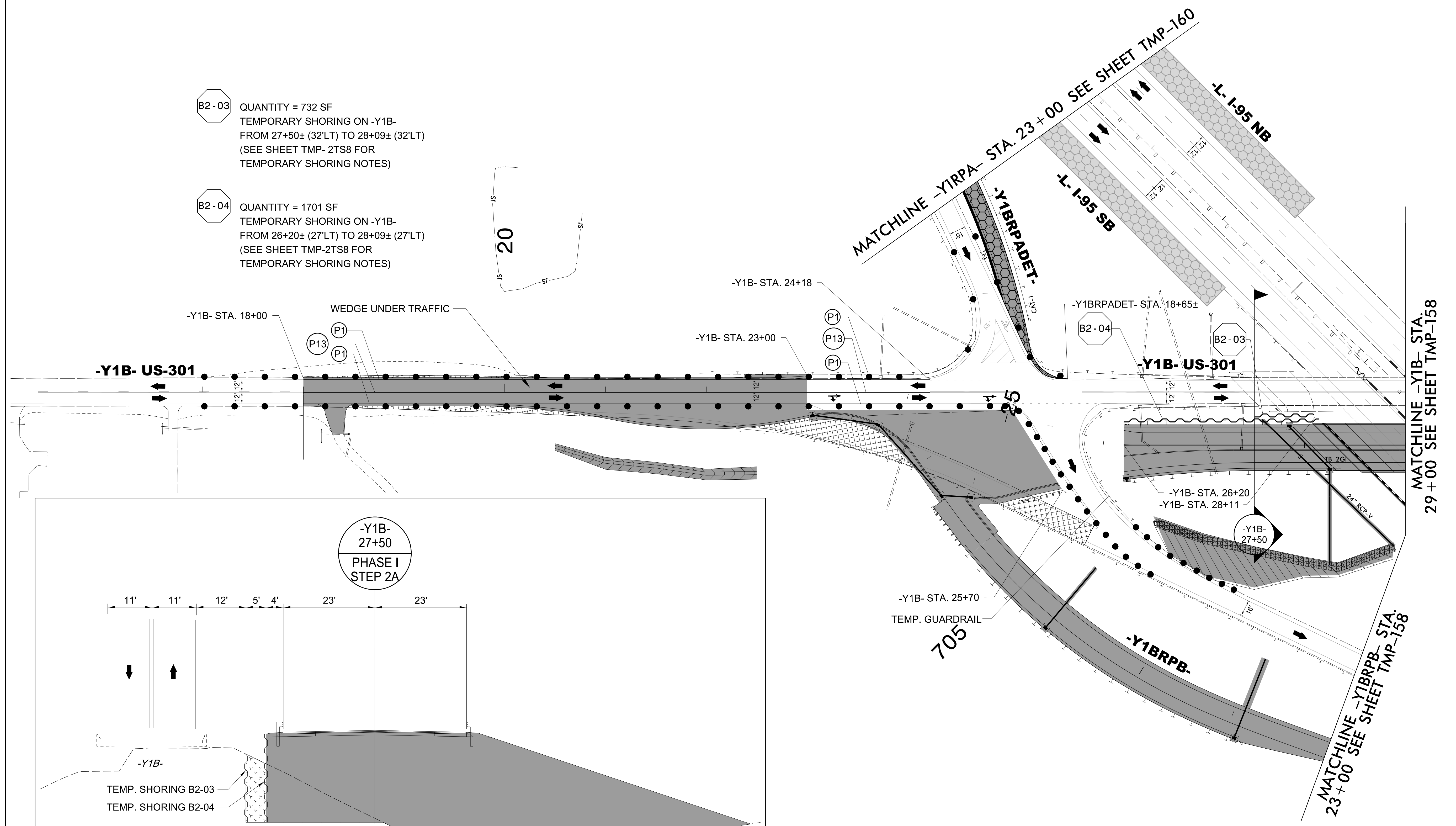

3/15/2022
 U:\Traffic\Transportation Management\Plan\TCP\PLAN SHEETS\I-5987B_TMP_I57_PHASE_I_STEP_2A.dgn
 angood

<p>Stantec Consulting Services Inc. 801 Jones Franklin Road Suite 300 Raleigh, NC 27606 Tel. 919.851.6866 Fax. 919.851.7024 www.stantec.com License No. F-0672</p>	<p>4/29/2022</p> <p>DOCUMENT NOT CONSIDERED FINAL UNLESS ALL SIGNATURES COMPLETED</p>		SECTION 2
			-Y1B- US-301 PHASE I STEP 2A

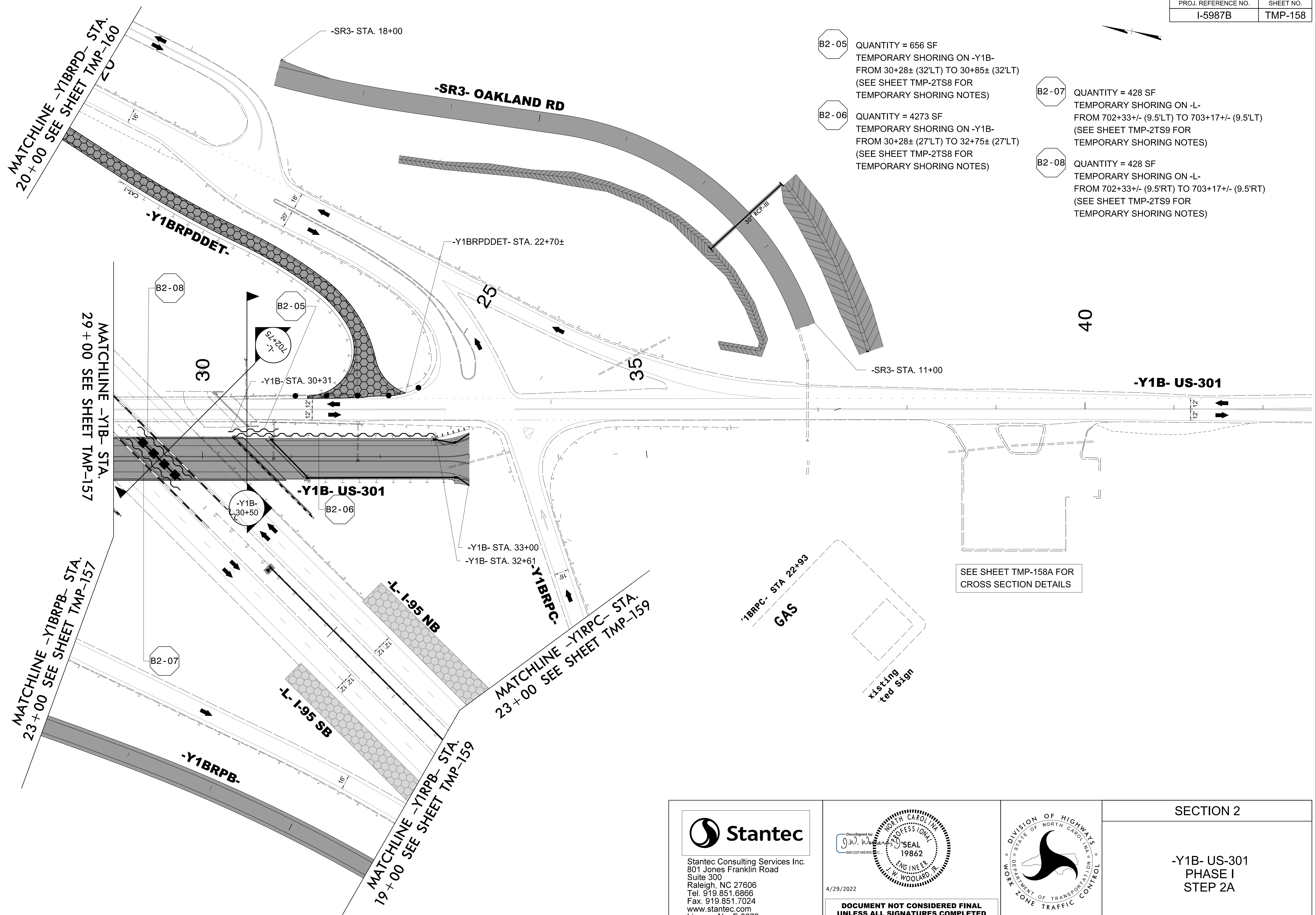

- B2-05 QUANTITY = 656 SF
TEMPORARY SHORING ON -Y1B-
FROM 30+28± (32'LT) TO 30+85± (32'LT)
(SEE SHEET TMP-2TS8 FOR
TEMPORARY SHORING NOTES)
- B2-06 QUANTITY = 4273 SF
TEMPORARY SHORING ON -Y1B-
FROM 30+28± (27'LT) TO 32+75± (27'LT)
(SEE SHEET TMP-2TS8 FOR
TEMPORARY SHORING NOTES)

- B2-07 QUANTITY = 428 SF
TEMPORARY SHORING ON -L-
FROM 702+33+/- (9.5'LT) TO 703+17+/- (9.5'LT)
(SEE SHEET TMP-2TS9 FOR
TEMPORARY SHORING NOTES)
- B2-08 QUANTITY = 428 SF
TEMPORARY SHORING ON -L-
FROM 702+33+/- (9.5'RT) TO 703+17+/- (9.5'RT)
(SEE SHEET TMP-2TS9 FOR
TEMPORARY SHORING NOTES)

3/15/2022
 U:\Traffic\Transportation Management Plan\TCP\PLAN SHEETS\I-5987B_TMP_158_PHASE I_STEP 2A.dgn
 angood

Stantec
 Stantec Consulting Services Inc.
 801 Jones Franklin Road
 Suite 300
 Raleigh, NC 27606
 Tel. 919.851.6866
 Fax. 919.851.7024
 www.stantec.com
 License No. F-0672

4/29/2022

DocuSigned by:
 J.W. Woollard
 SBCC02F49E5656

4/29/2022

**DOCUMENT NOT CONSIDERED FINAL
 UNLESS ALL SIGNATURES COMPLETED**

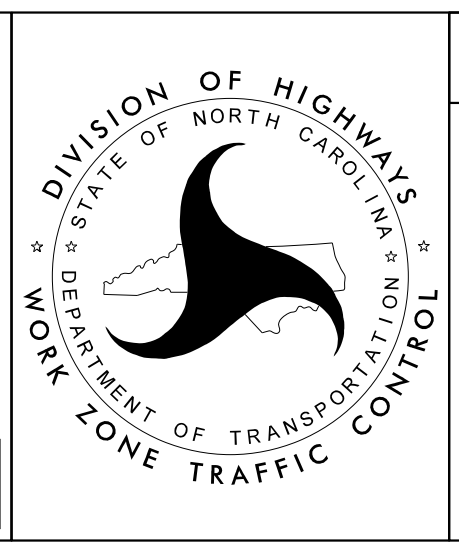

SECTION 2

-Y1B- US-301
 PHASE I
 STEP 2A

SEE SHEET TMP-158A FOR
 CROSS SECTION DETAILS

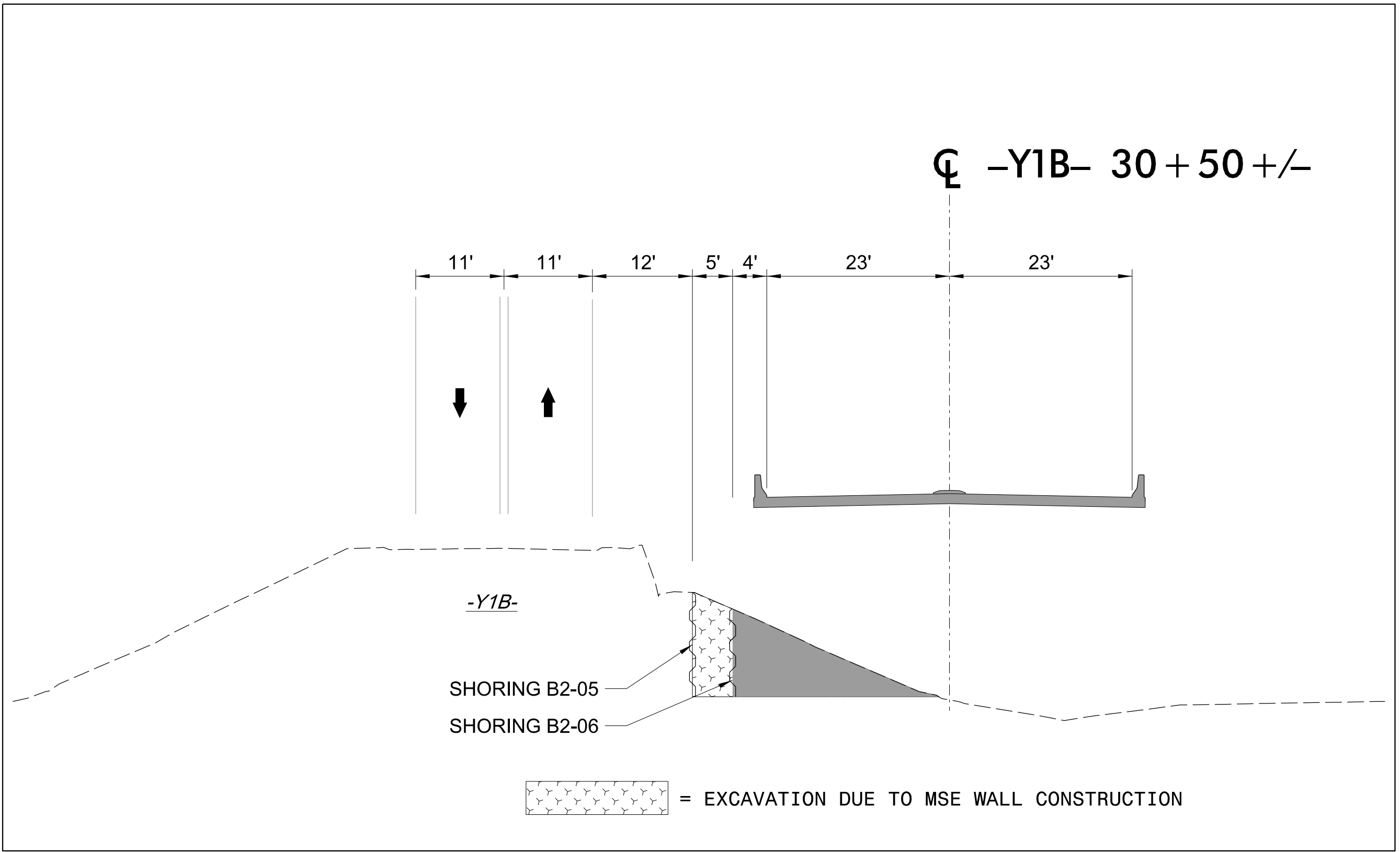
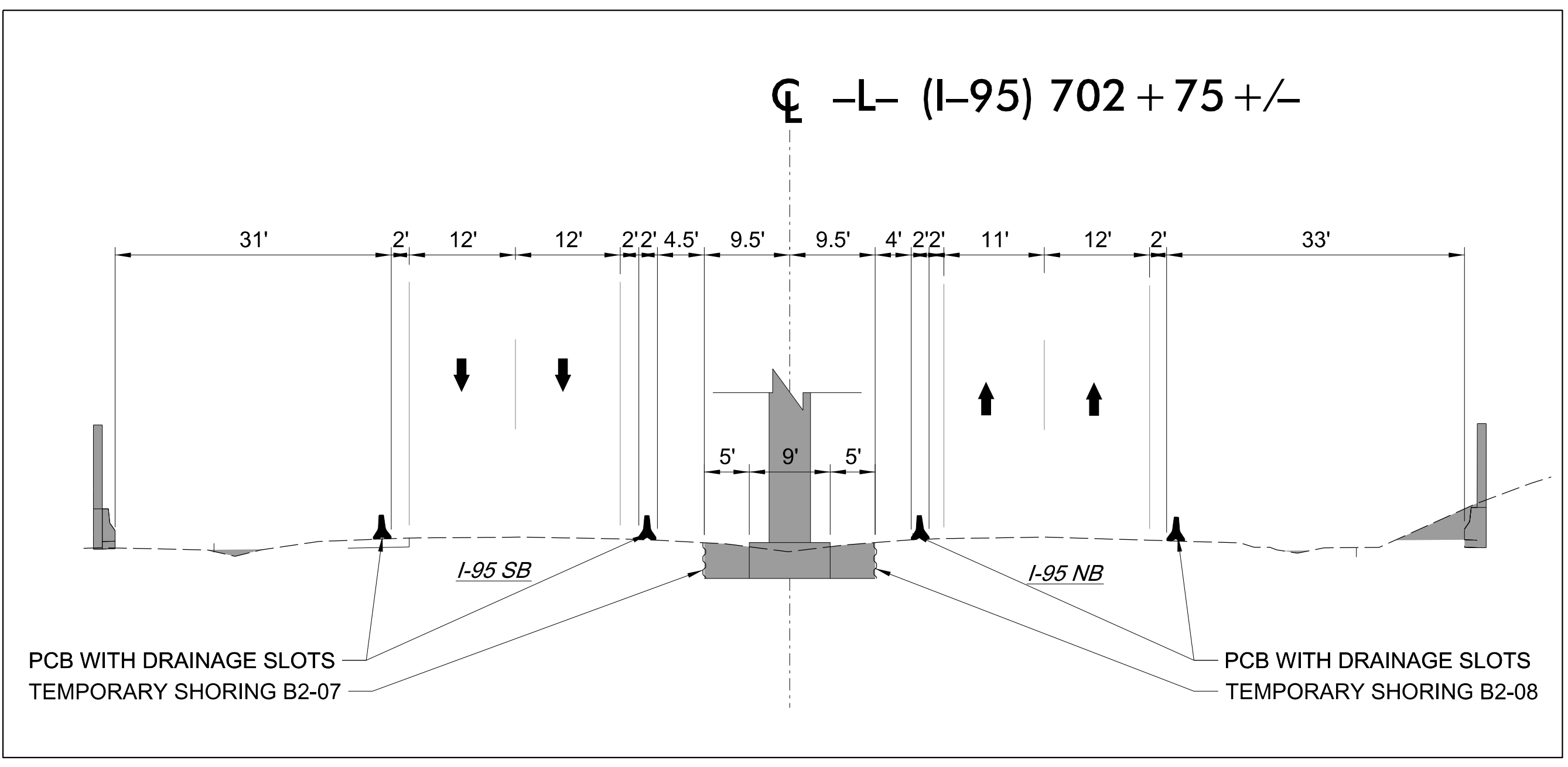

3/15/2022
U:\Traffic\Transportation Management\Plan\TCP\PLAN SHEETS\I-5987B_TMP_I58A_PHASE I_STEP 2A.dgn
angood

Stantec Consulting Services Inc.
801 Jones Franklin Road
Suite 300
Raleigh, NC 27606
Tel. 919.851.6866
Fax. 919.851.7024
www.stantec.com
License No. F-0672

DocuSigned by
J.W. Woolard
4/29/2022

**DOCUMENT NOT CONSIDERED FINAL
UNLESS ALL SIGNATURES COMPLETED**

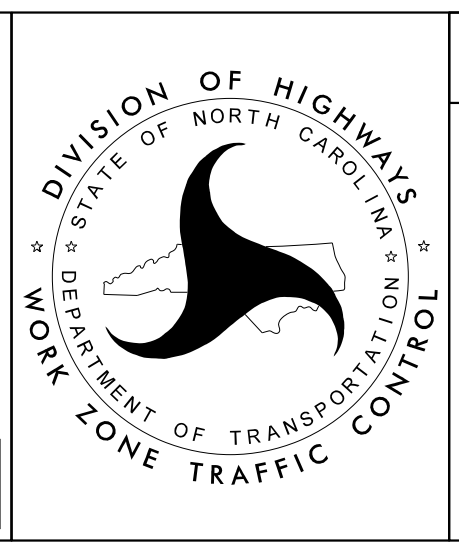

SECTION 2

-Y1B- US-301
PHASE I
STEP 2A

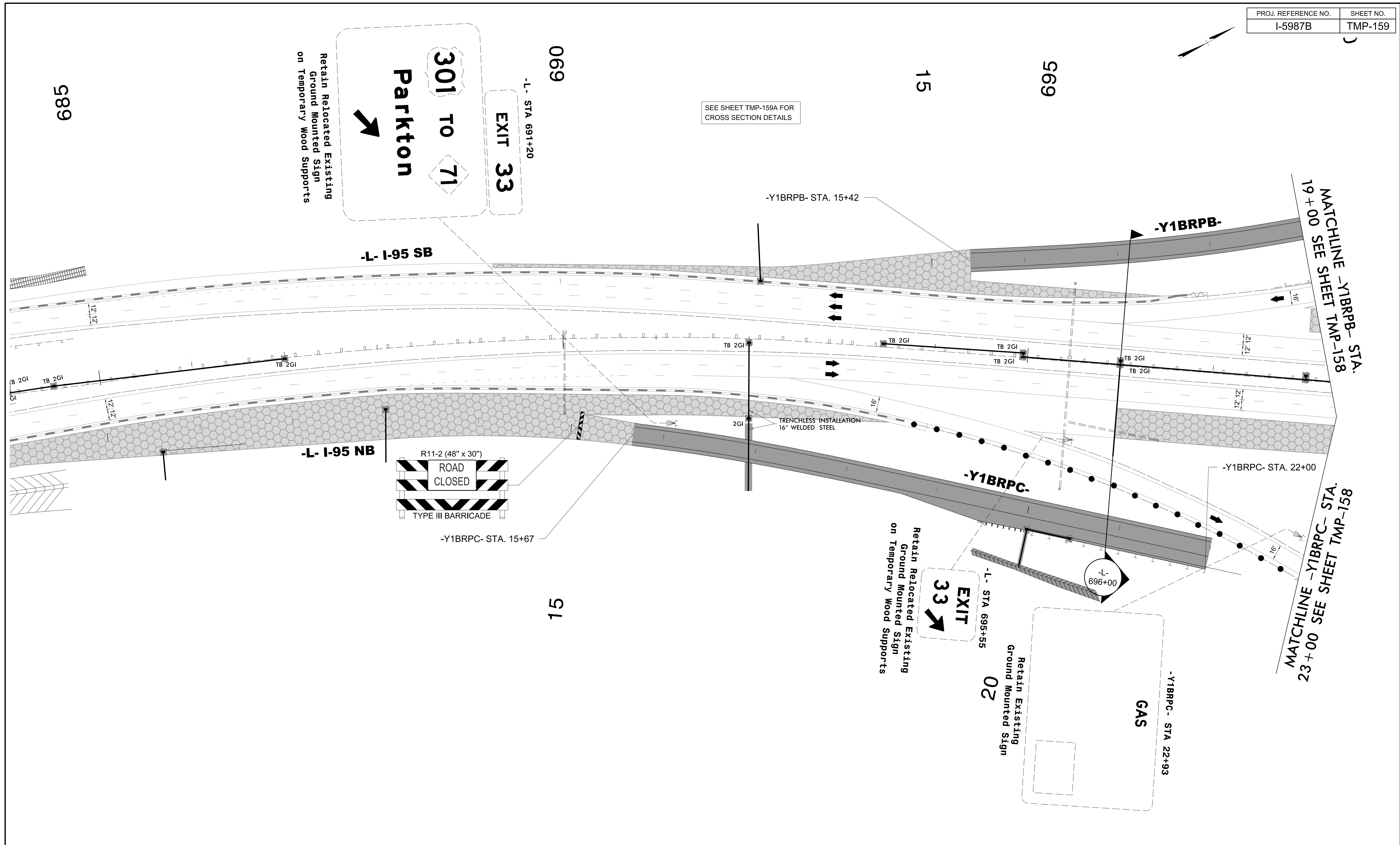

3/15/2022
 U:\Traffic\Transportation Management\Plan\TCP\PLAN SHEETS\I-5987B_TMP_159_PHASE 1_STEP 2A.dgn
 angood

Stantec

Stantec Consulting Services Inc.
 801 Jones Franklin Road
 Suite 300
 Raleigh, NC 27606
 Tel. 919.851.6866
 Fax. 919.851.7024
 www.stantec.com
 License No. F-0672

DocuSigned by
J.W. Woolard
 58BC20F49E5656

4/29/2022

**DOCUMENT NOT CONSIDERED FINAL
 UNLESS ALL SIGNATURES COMPLETED**

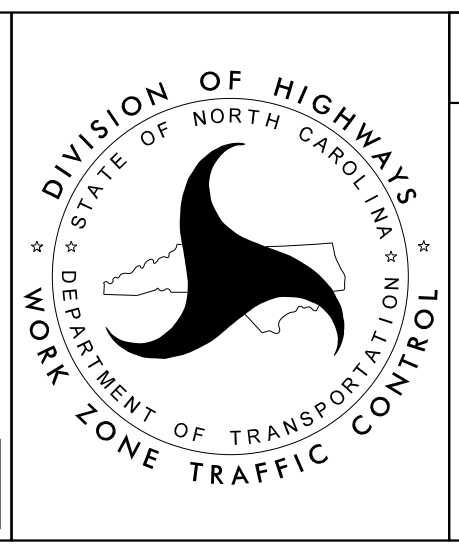

SECTION 2

-Y1B- US-301
 PHASE I
 STEP 2A

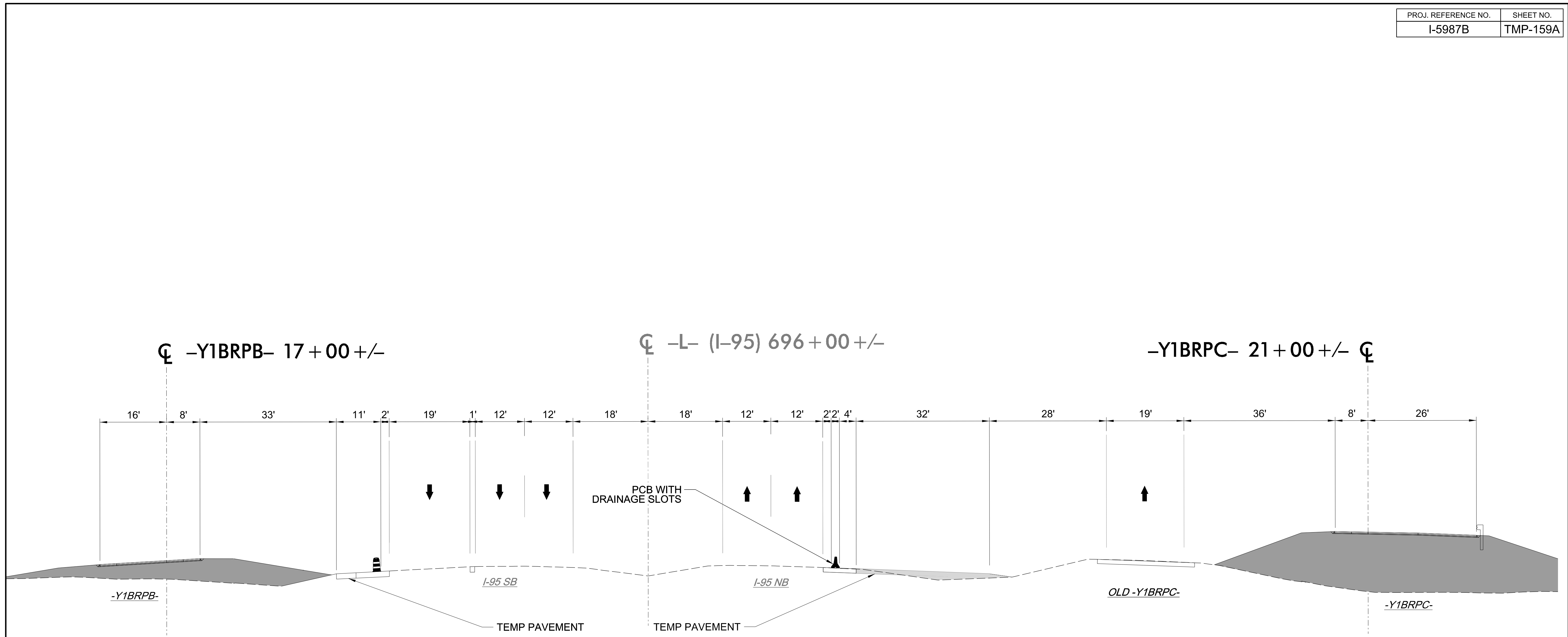

3/15/2022
U:\Traffic\Transportation Management\Plan\TCP\PLAN SHEETS\I-5987B_TMP-I59A_PHASE I_STEP 2A.dgn
angood

Stantec
Stantec Consulting Services Inc.
801 Jones Franklin Road
Suite 300
Raleigh, NC 27606
Tel. 919.851.6866
Fax. 919.851.7024
www.stantec.com
License No. F-0672

DocuSigned by
J.W. Woolard
SBCC02F49E956C

4/29/2022

**DOCUMENT NOT CONSIDERED FINAL
UNLESS ALL SIGNATURES COMPLETED**

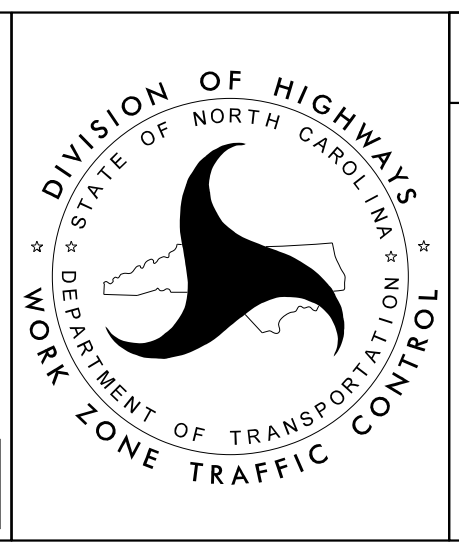

SECTION 2

**-Y1B- US-301
PHASE I
STEP 2A**

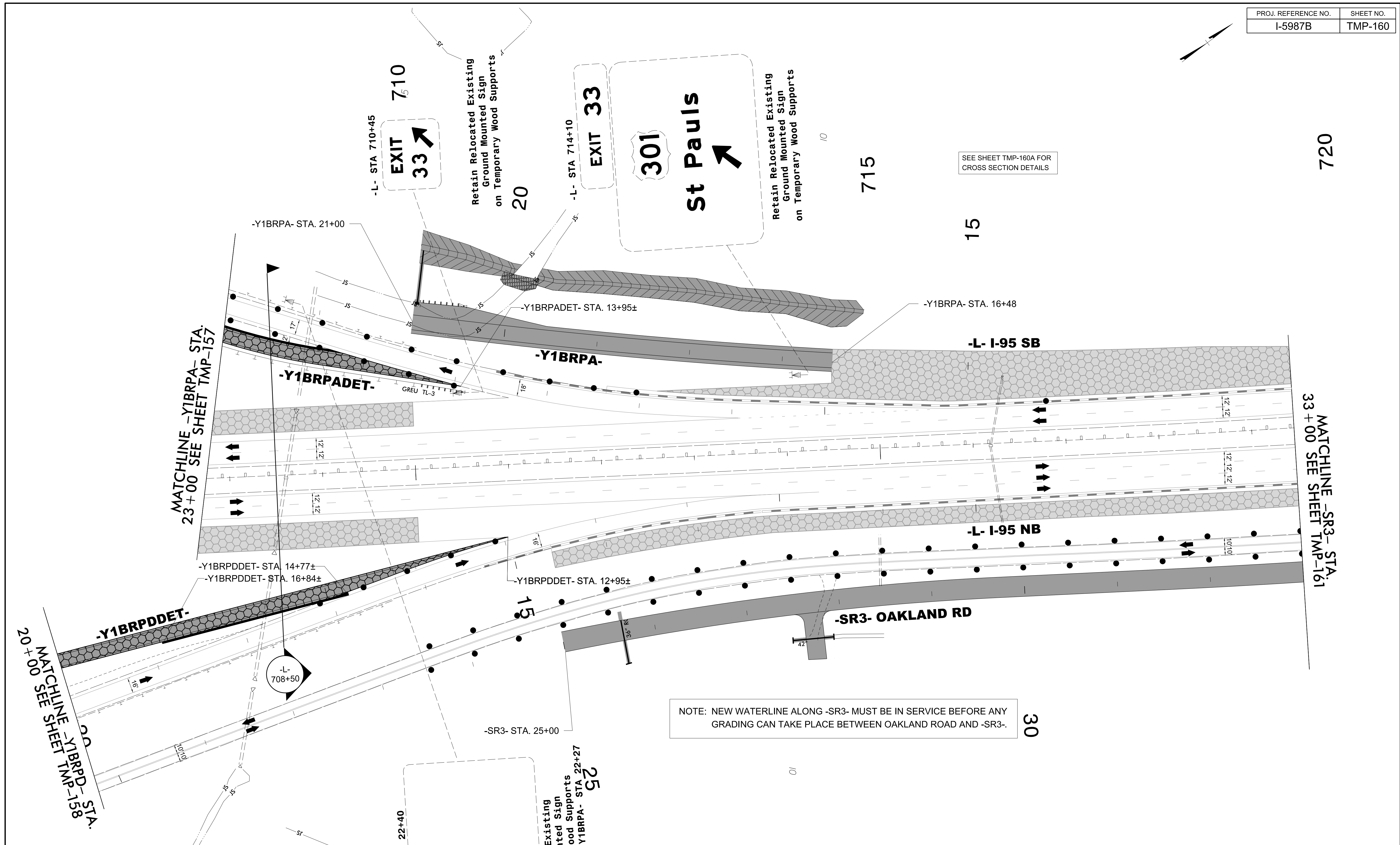

3/15/2022
 U:\Traffic\Transportation Management\Plan\TCP\PLAN SHEETS\I-5987B_TMP_160_PHASE I_STEP 2A.dgn
 angood

NOTE: NEW WATERLINE ALONG -SR3- MUST BE IN SERVICE BEFORE ANY GRADING CAN TAKE PLACE BETWEEN OAKLAND ROAD AND -SR3-

Stantec
 Stantec Consulting Services Inc.
 801 Jones Franklin Road
 Suite 300
 Raleigh, NC 27606
 Tel. 919.851.6866
 Fax. 919.851.7024
 www.stantec.com
 License No. F-0672

4/29/2022

DOCUMENT NOT CONSIDERED FINAL
UNLESS ALL SIGNATURES COMPLETED

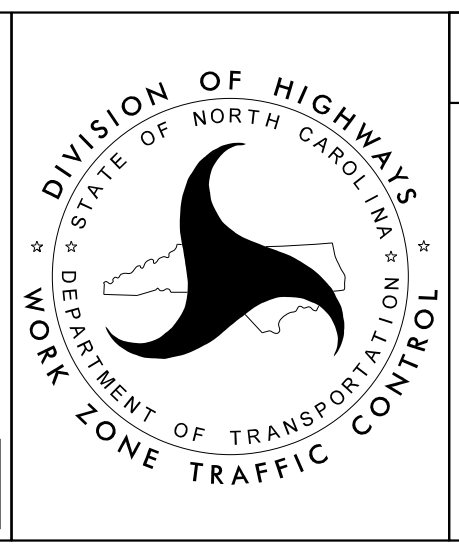

SECTION 2

-Y1B- US-301
 PHASE I
 STEP 2A

3/15/2022

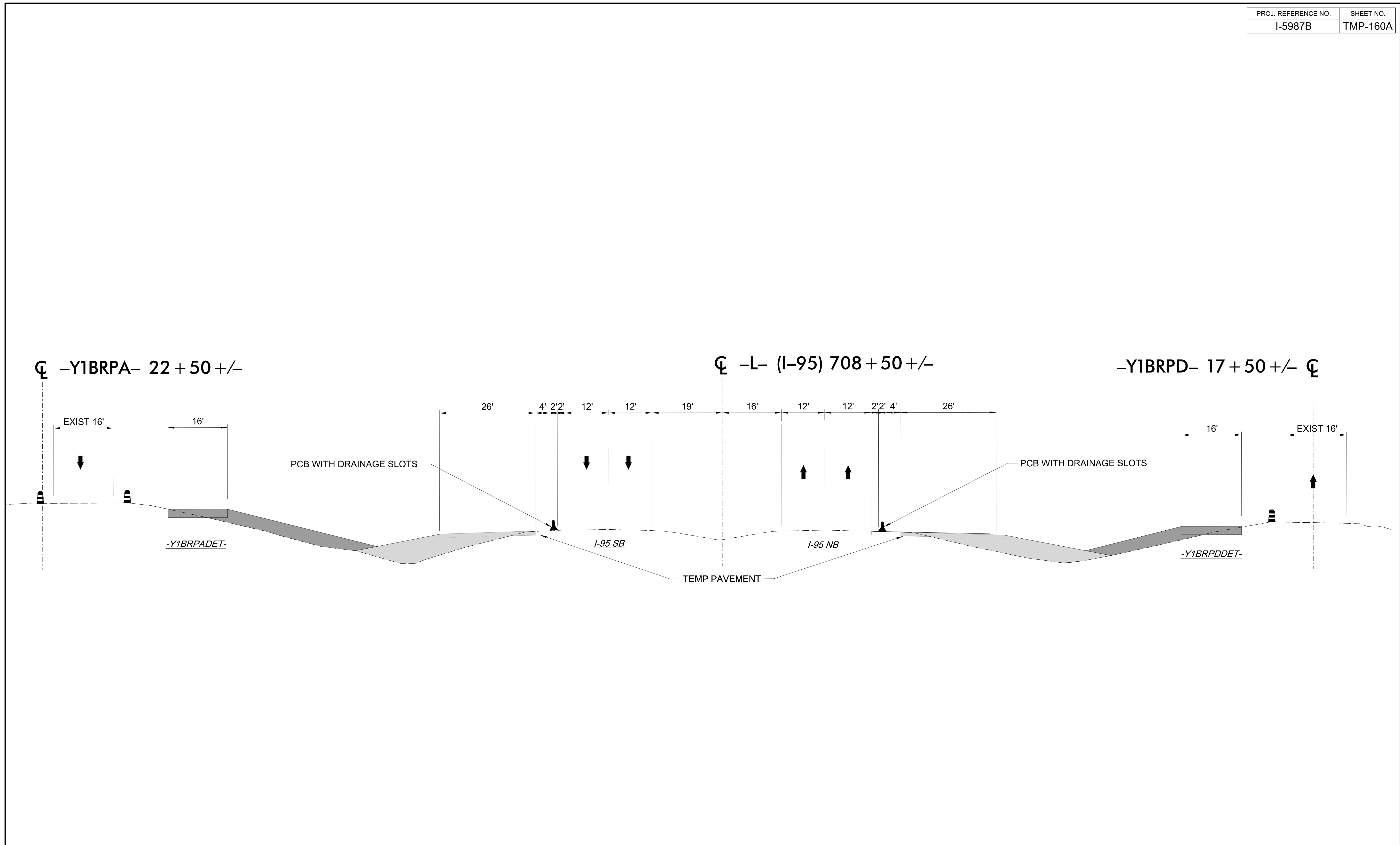

3/15/2022
U:\Traffic\Transportation Management\Plan\TCP\PLAN SHEETS\I-5987B_TMP_160A_PHASE I_STEP 2A.dgn
angood

Stantec
Stantec Consulting Services Inc.
801 Jones Franklin Road
Suite 300
Raleigh, NC 27606
Tel. 919.851.6866
Fax. 919.851.7024
www.stantec.com
License No. F-0672

DocuSigned by:
J.W. Woolard
SBB020F49E565C

4/29/2022

**DOCUMENT NOT CONSIDERED FINAL
UNLESS ALL SIGNATURES COMPLETED**

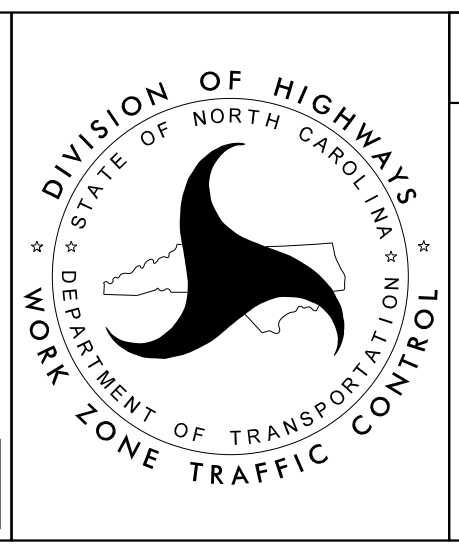

SECTION 2

**-Y1B- US-301
PHASE I
STEP 2A**

PROJ. REFERENCE NO.	SHEET NO.
I-5987B	TMP-161

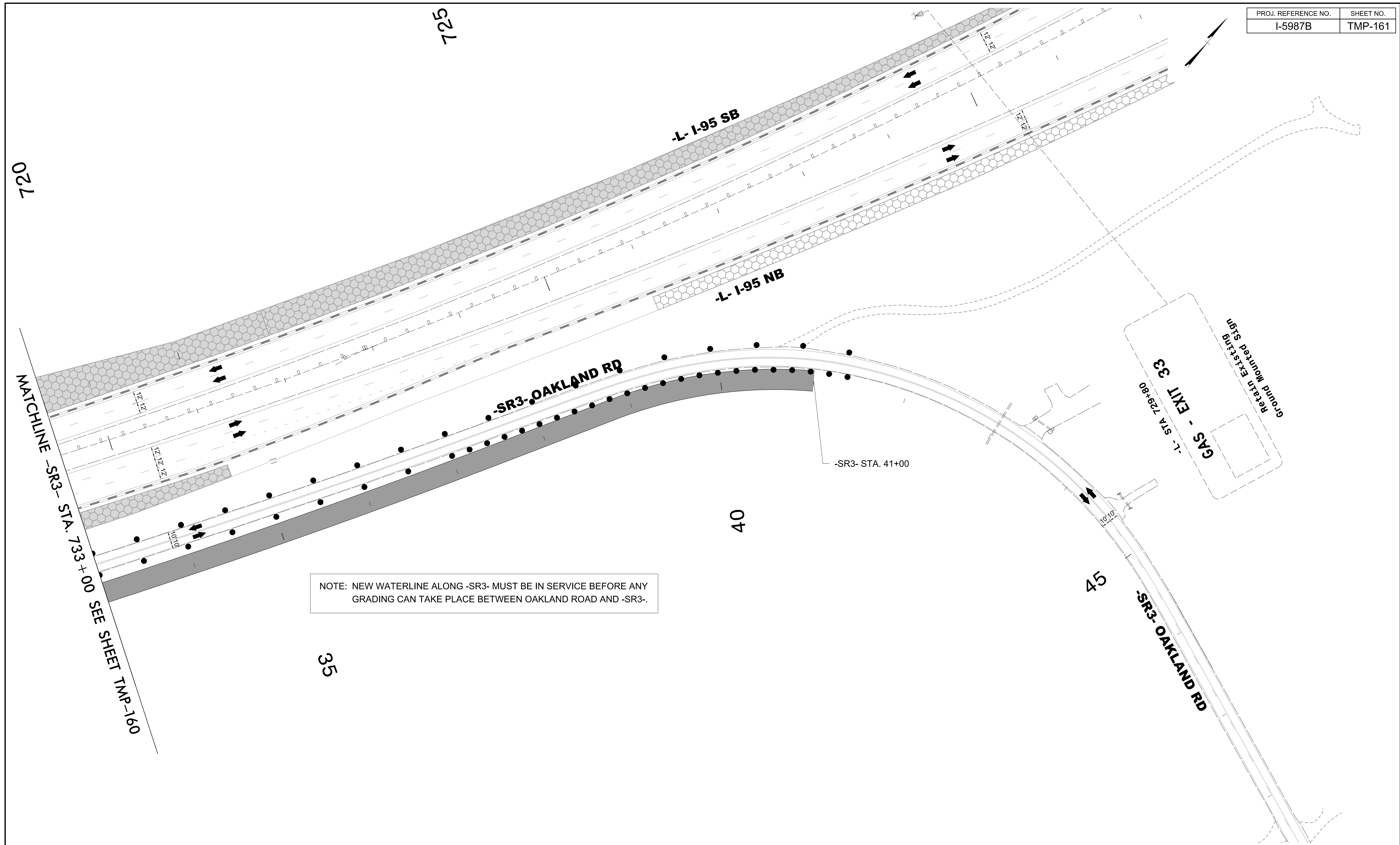

3/15/2022
 U:\Traffic\Transportation Management Plan\TCP\PLAN SHEETS\I-5987B_TMP_161_PHASE I_STEP 2A.dgn
 angood

Stantec
 Stantec Consulting Services Inc.
 801 Jones Franklin Road
 Suite 300
 Raleigh, NC 27606
 Tel. 919.851.6866
 Fax. 919.851.7024
 www.stantec.com
 License No. F-0672

DocuSigned by
 J.W. Woollard
 58C02F49E5656C
 4/29/2022

PROFESSIONAL SEAL
 19862
 ENGINEER
 J.W. WOOLLARD, JR.

**DOCUMENT NOT CONSIDERED FINAL
 UNLESS ALL SIGNATURES COMPLETED**

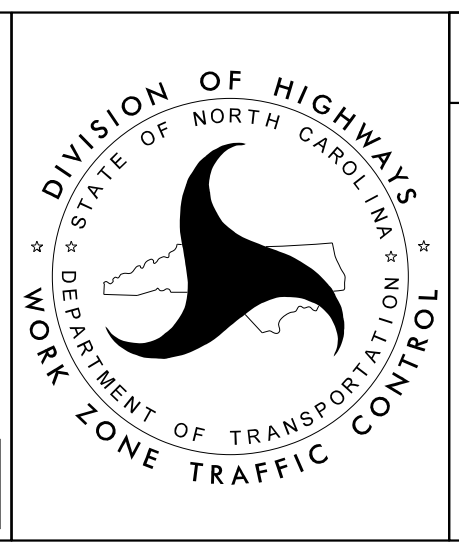

SECTION 2

**-Y1B- US-301
 PHASE I
 STEP 2A**

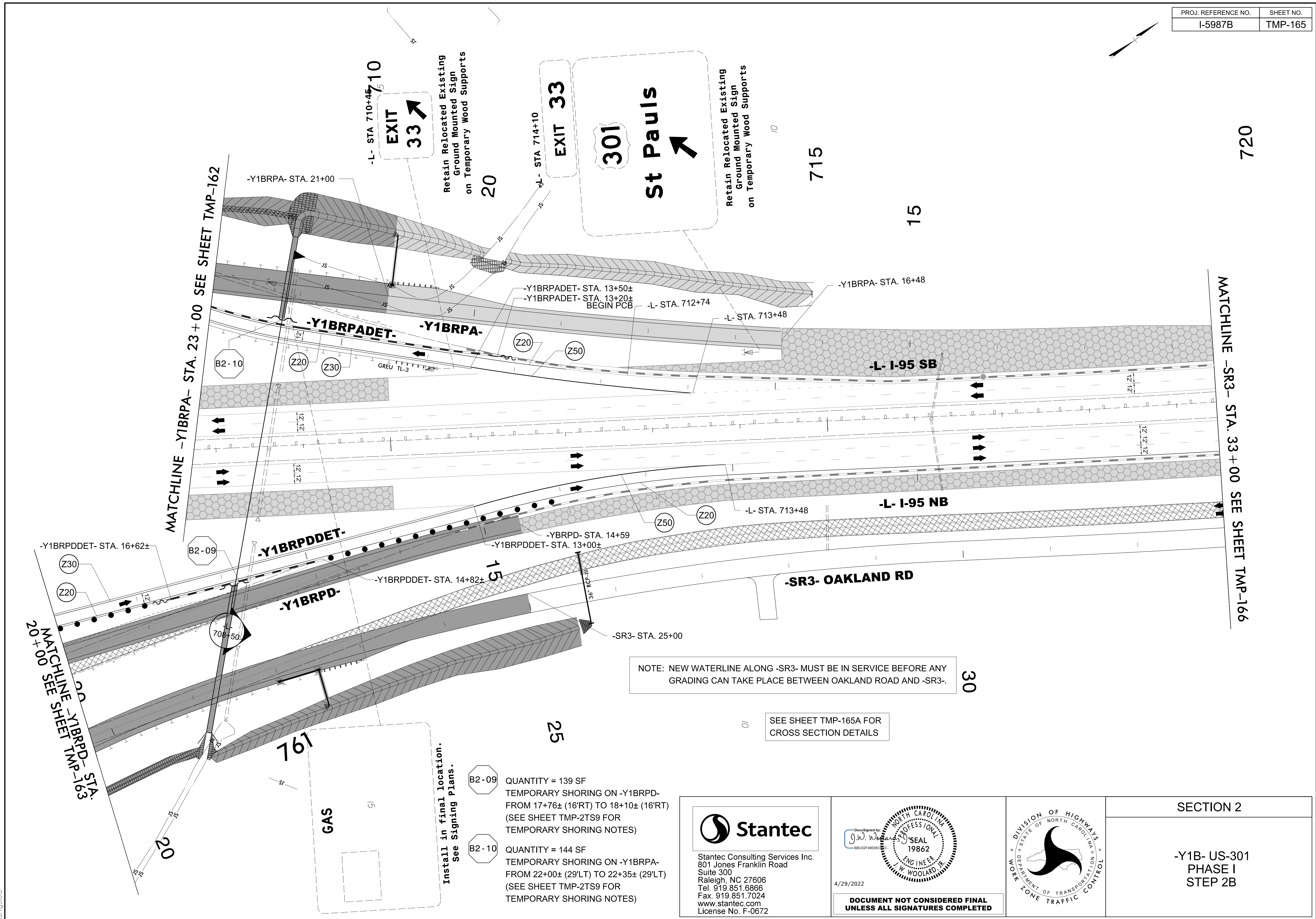

3/15/2022
 U:\Traffic\Transportation Management Plan\TCP\PLAN SHEETS\I-5987B_TMP_165_PHASE_1\STEP_2B.dgn
 angood

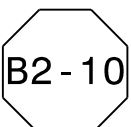
- 
 QUANTITY = 139 SF
 TEMPORARY SHORING ON -Y1BRPD-
 FROM 17+76± (16'RT) TO 18+10± (16'RT)
 (SEE SHEET TMP-2TS9 FOR
 TEMPORARY SHORING NOTES)
- 
 QUANTITY = 144 SF
 TEMPORARY SHORING ON -Y1BRPA-
 FROM 22+00± (29'LT) TO 22+35± (29'LT)
 (SEE SHEET TMP-2TS9 FOR
 TEMPORARY SHORING NOTES)

Install in final location.
 See Signing Plans.

NOTE: NEW WATERLINE ALONG -SR3- MUST BE IN SERVICE BEFORE ANY GRADING CAN TAKE PLACE BETWEEN OAKLAND ROAD AND -SR3-.

SEE SHEET TMP-165A FOR CROSS SECTION DETAILS



Stantec Consulting Services Inc.
 801 Jones Franklin Road
 Suite 300
 Raleigh, NC 27606
 Tel. 919.851.6866
 Fax. 919.851.7024
 www.stantec.com
 License No. F-0672

4/29/2022

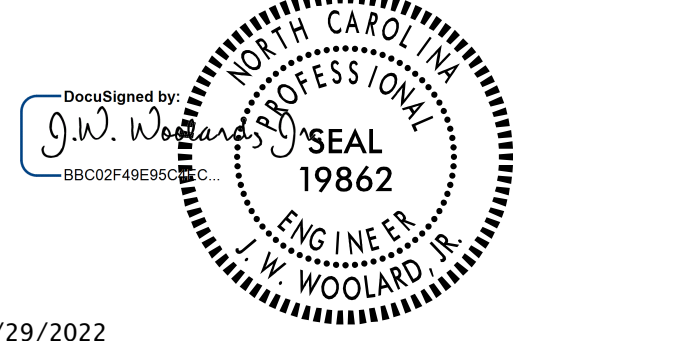

**DOCUMENT NOT CONSIDERED FINAL
 UNLESS ALL SIGNATURES COMPLETED**

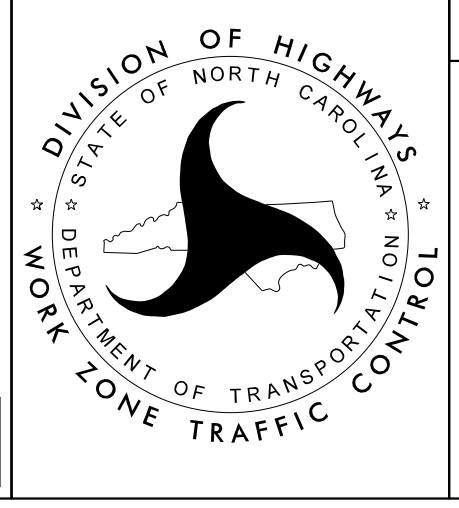

SECTION 2

-Y1B- US-301
 PHASE I
 STEP 2B

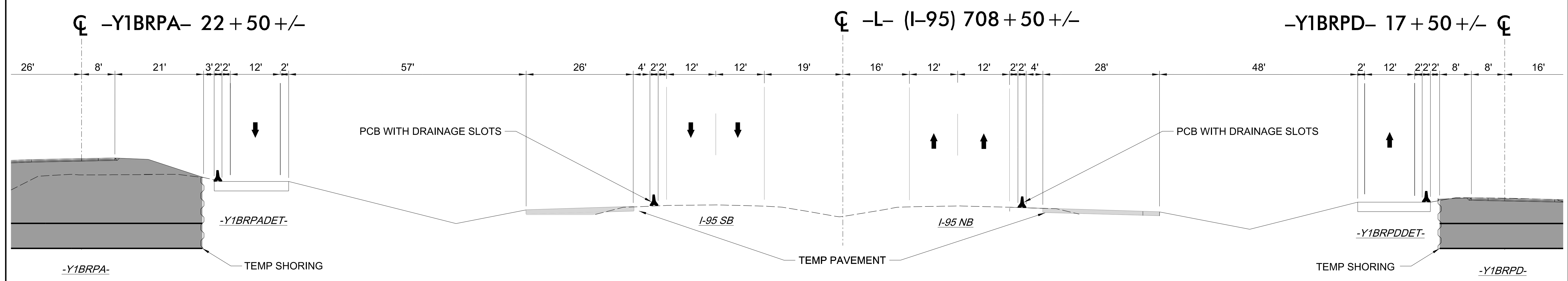

3/15/2022
U:\Traffic\Transportation Management\Plan\TCP\PLAN SHEETS\I-5987B_TMP_165A_PHASE I_STEP 2B.dgn
angood

Stantec Consulting Services Inc.
801 Jones Franklin Road
Suite 300
Raleigh, NC 27606
Tel. 919.851.6866
Fax. 919.851.7024
www.stantec.com
License No. F-0672

DocuSigned by:
J.W. Woollard
SEAL
19862
ENGINEER
J.W. WOOLLARD, P.E.

4/29/2022

**DOCUMENT NOT CONSIDERED FINAL
UNLESS ALL SIGNATURES COMPLETED**

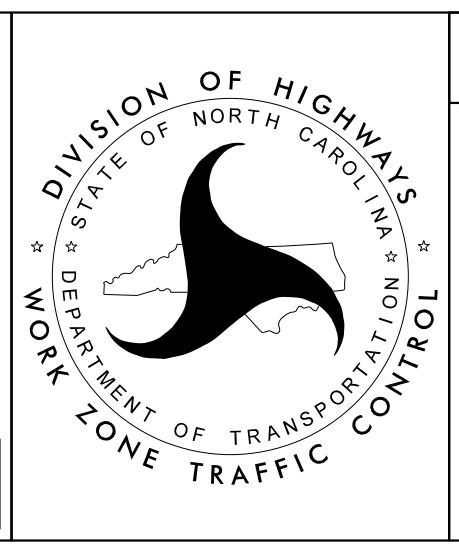

SECTION 2

-Y1B- US-301
PHASE I
STEP 2B

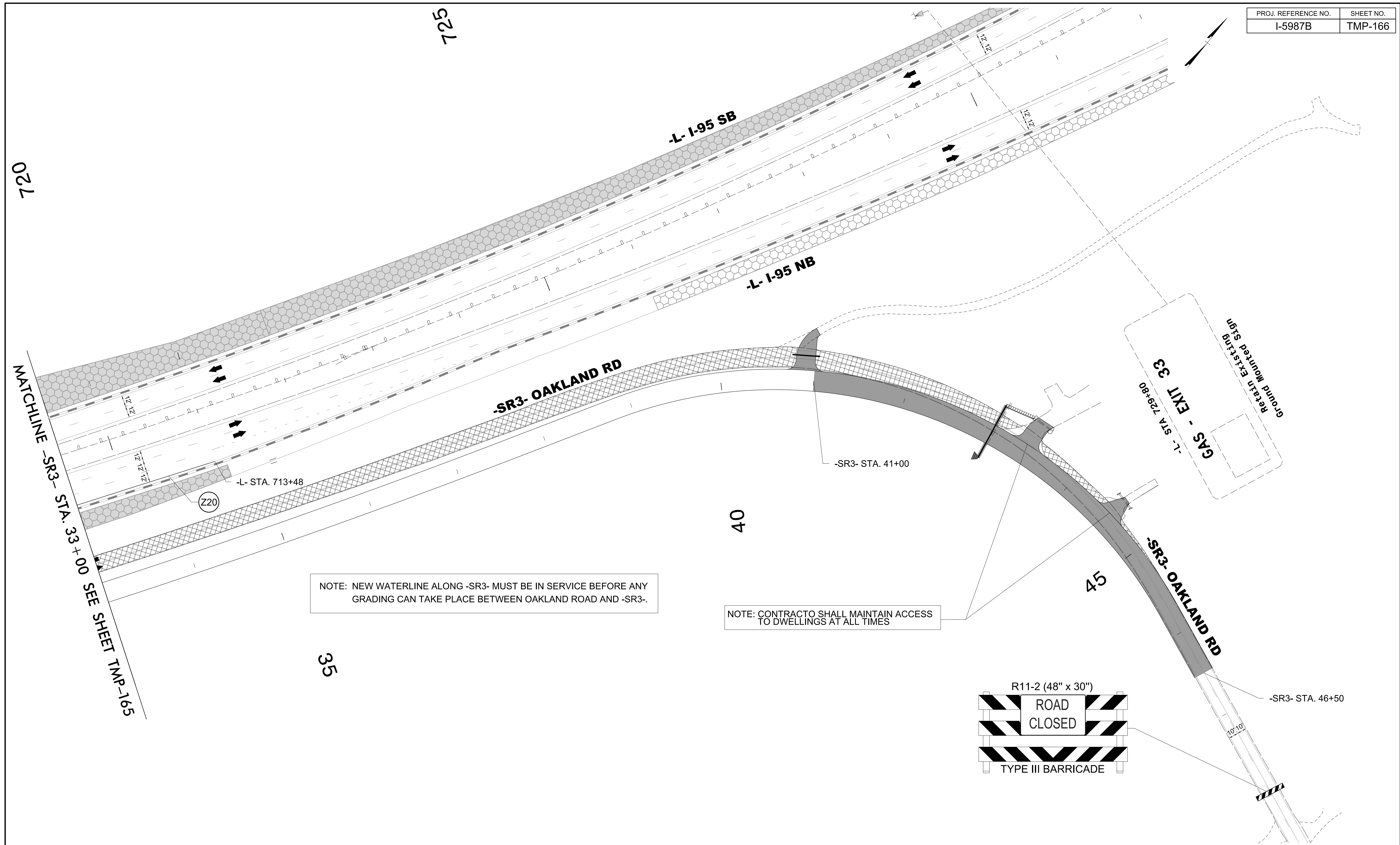

NOTE: NEW WATERLINE ALONG -SR3- MUST BE IN SERVICE BEFORE ANY GRADING CAN TAKE PLACE BETWEEN OAKLAND ROAD AND -SR3-.

NOTE: CONTRACTOR SHALL MAINTAIN ACCESS TO DWELLINGS AT ALL TIMES

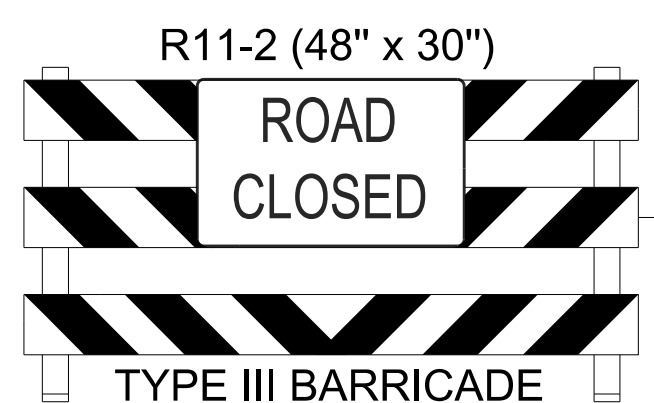

3/15/2022
 U:\Traffic\Transportation Management\Plan\TCP\PLAN SHEETS\I-5987B_TMP_166_PHASE_1_L5STEP_2B.dgn
 angood

Stantec Consulting Services Inc.
 801 Jones Franklin Road
 Suite 300
 Raleigh, NC 27606
 Tel. 919.851.6866
 Fax. 919.851.7024
 www.stantec.com
 License No. F-0672

DocuSigned by
 J.W. Woollard
 58C02F49E564

4/29/2022

**DOCUMENT NOT CONSIDERED FINAL
 UNLESS ALL SIGNATURES COMPLETED**

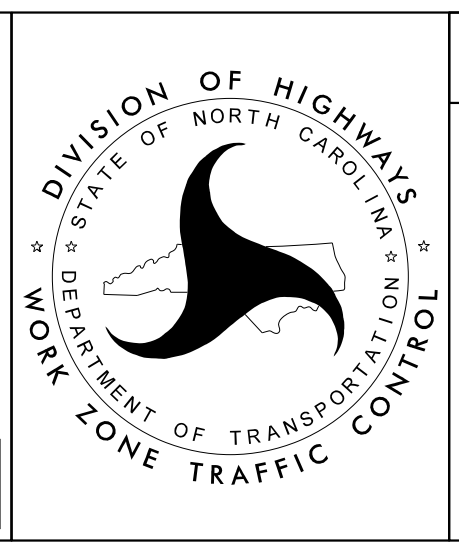

SECTION 2

-Y1B- US-301
 PHASE I
 STEP 2B

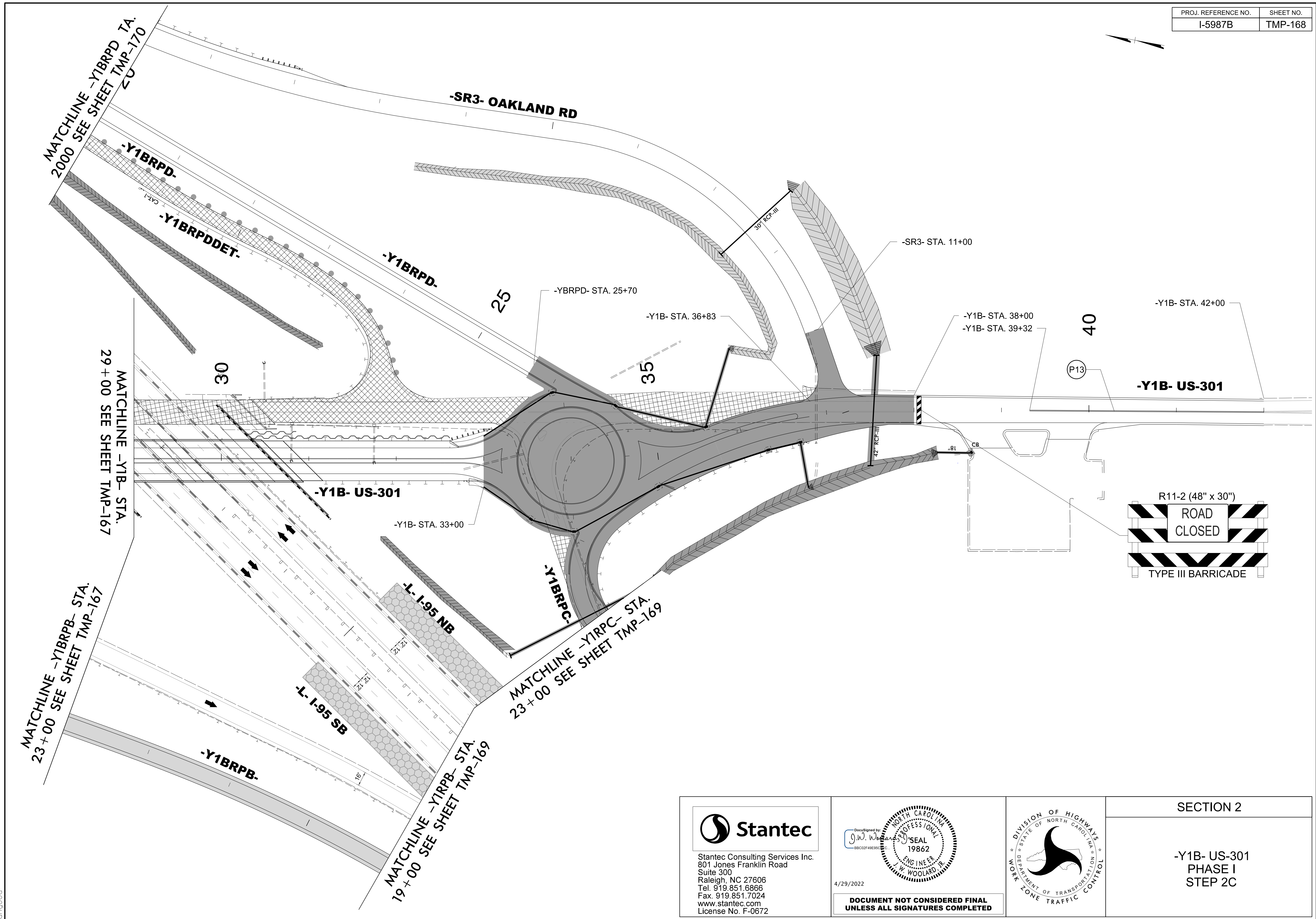

4/21/2022
 U:\Traffic\Transportation Management Plan\TCP\PLAN SHEETS\I-5987B_TMP_168_PHASE_1\STEP_2C.dgn
 angood

Stantec Consulting Services Inc.
 801 Jones Franklin Road
 Suite 300
 Raleigh, NC 27606
 Tel. 919.851.6866
 Fax. 919.851.7024
 www.stantec.com
 License No. F-0672

4/29/2022

**DOCUMENT NOT CONSIDERED FINAL
 UNLESS ALL SIGNATURES COMPLETED**

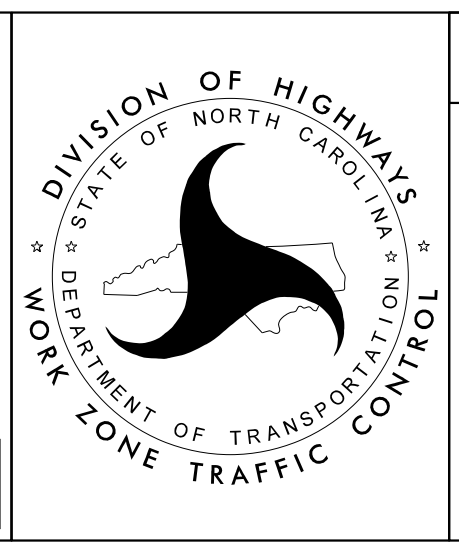

SECTION 2

-Y1B- US-301
 PHASE I
 STEP 2C

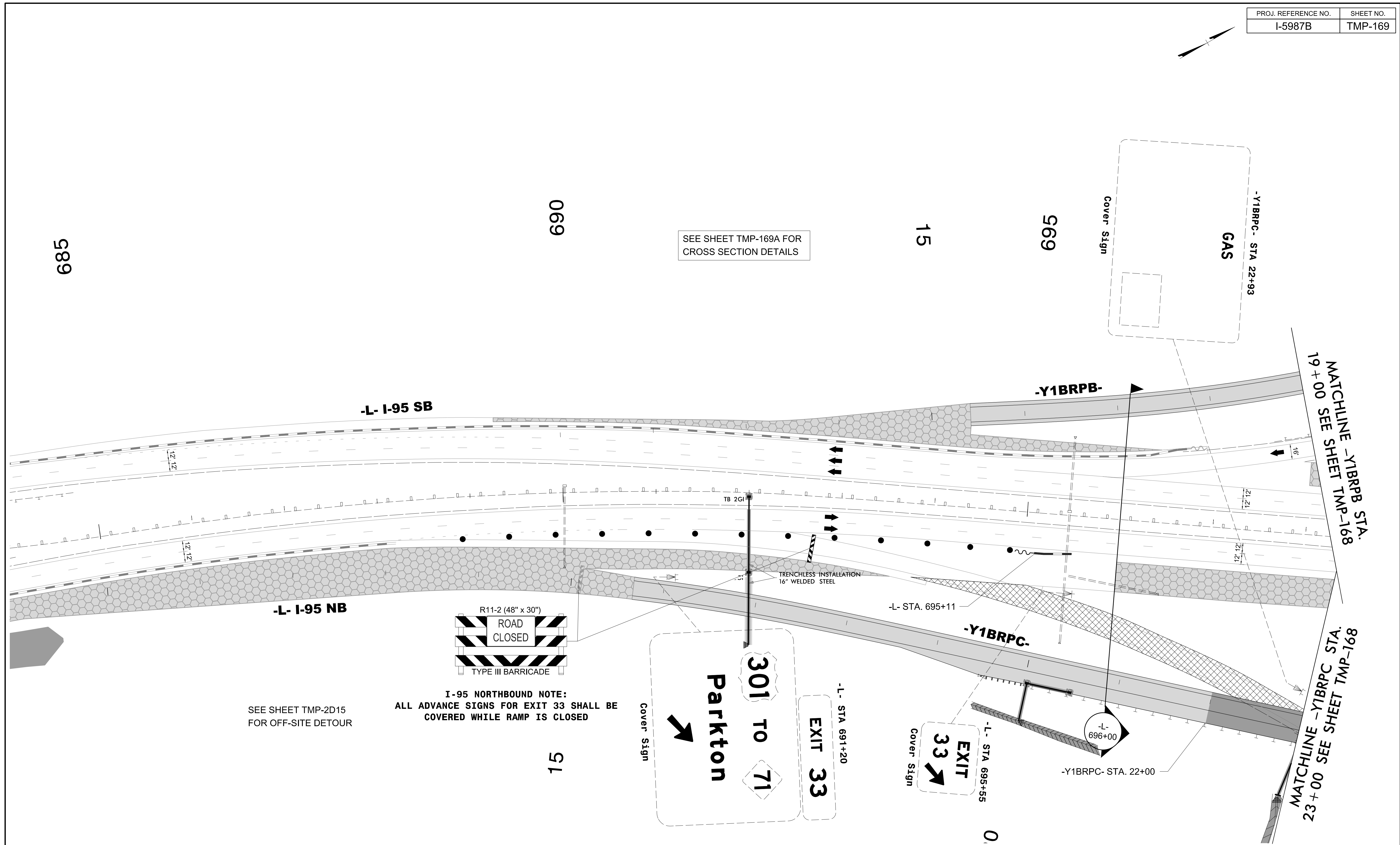
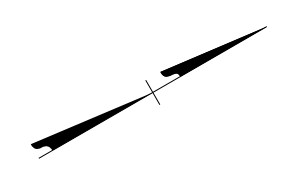

SEE SHEET TMP-169A FOR CROSS SECTION DETAILS

SEE SHEET TMP-2D15 FOR OFF-SITE DETOUR

I-95 NORTHBOUND NOTE:
ALL ADVANCE SIGNS FOR EXIT 33 SHALL BE COVERED WHILE RAMP IS CLOSED

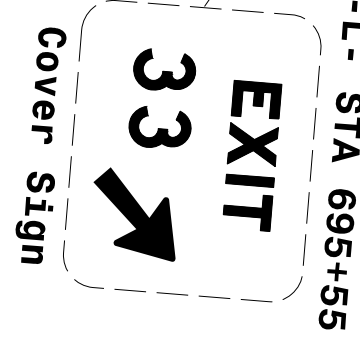
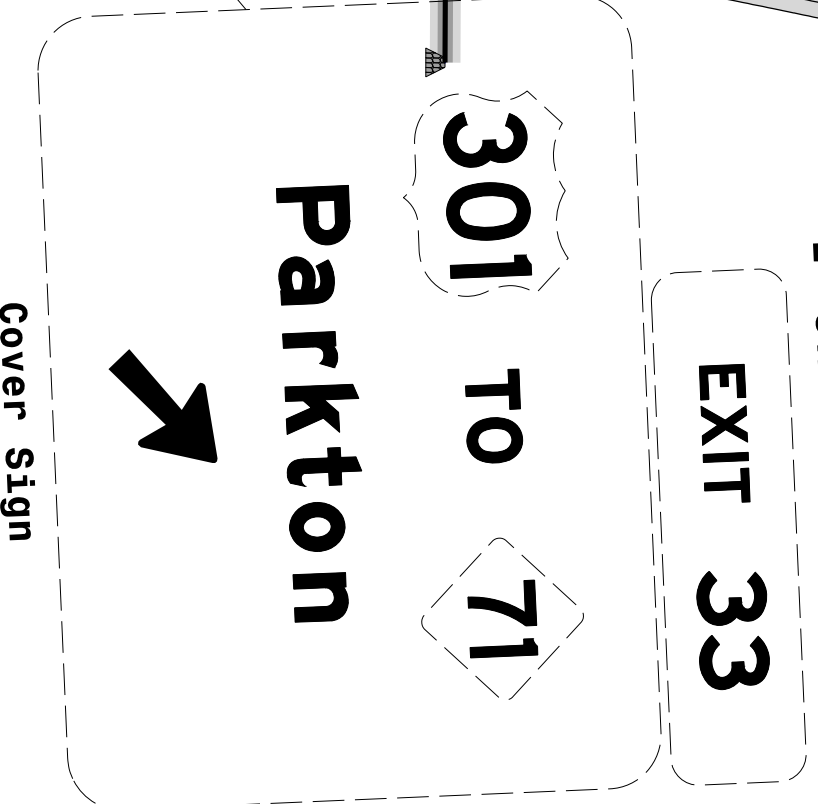
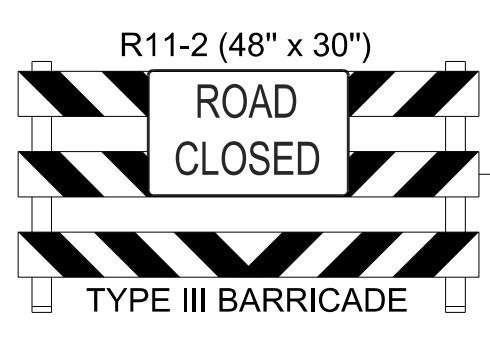

3/15/2022
U:\Traffic\Transportation Management Plan\TCP\PLAN SHEETS\I-5987B_TMP_169_PHASE 1\STEP 2C.dgn
angood

Stantec
Stantec Consulting Services Inc.
801 Jones Franklin Road
Suite 300
Raleigh, NC 27606
Tel. 919.851.6866
Fax. 919.851.7024
www.stantec.com
License No. F-0672

DocuSigned by
J.W. Woolard
SEAL
19862
ENGINEER
J.W. WOOLARD, JR.
4/29/2022
**DOCUMENT NOT CONSIDERED FINAL
UNLESS ALL SIGNATURES COMPLETED**

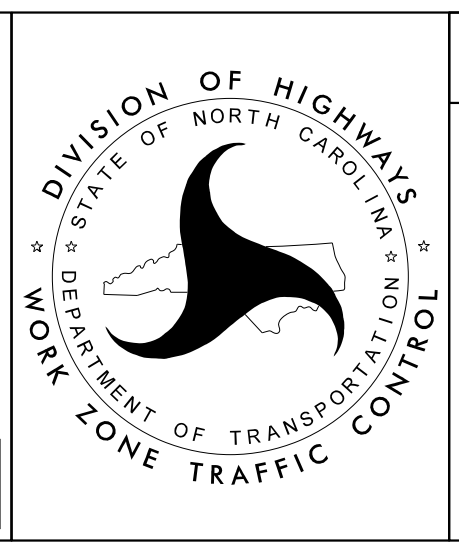

SECTION 2

-Y1B- US-301
PHASE I
STEP 2C

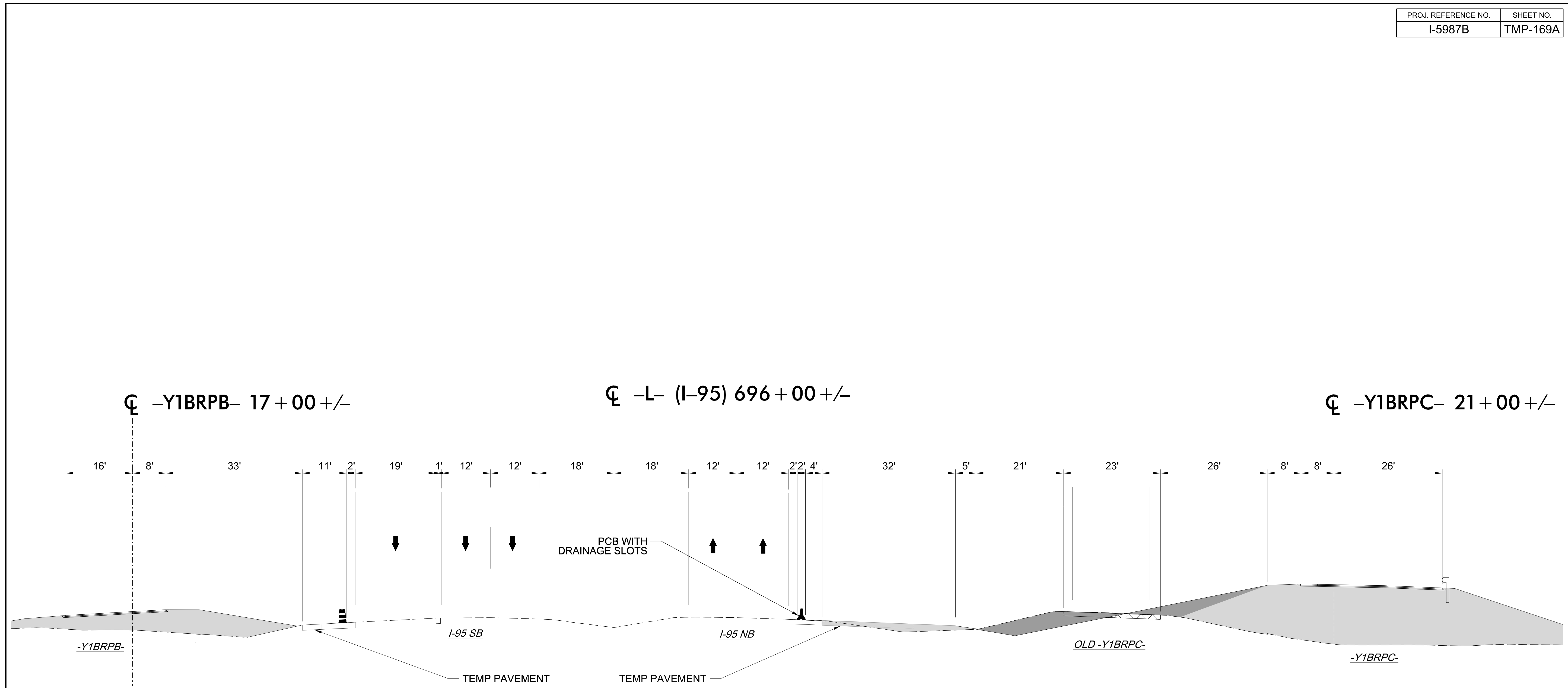

3/15/2022
U:\Traffic\Transportation Management\Plan\TCP\PLAN SHEETS\I-5987B_TMP_169A_PHASE I_STEP 2C.dgn
angood

Stantec
 Stantec Consulting Services Inc.
 801 Jones Franklin Road
 Suite 300
 Raleigh, NC 27606
 Tel. 919.851.6866
 Fax. 919.851.7024
 www.stantec.com
 License No. F-0672

DocuSigned by:
 J.W. Woolard
 5B8C20F49E565C

4/29/2022

**DOCUMENT NOT CONSIDERED FINAL
 UNLESS ALL SIGNATURES COMPLETED**

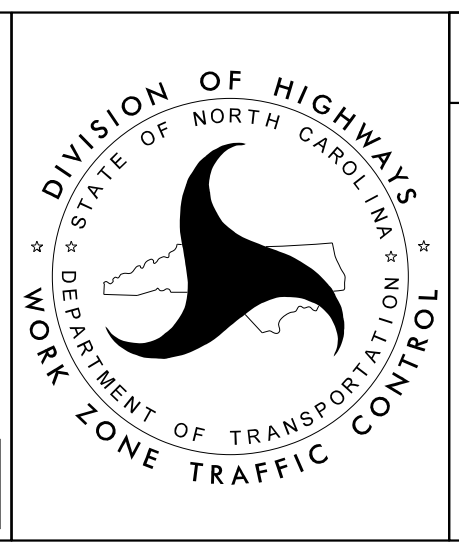

SECTION 2

-Y1B- US-301
 PHASE I
 STEP 2C

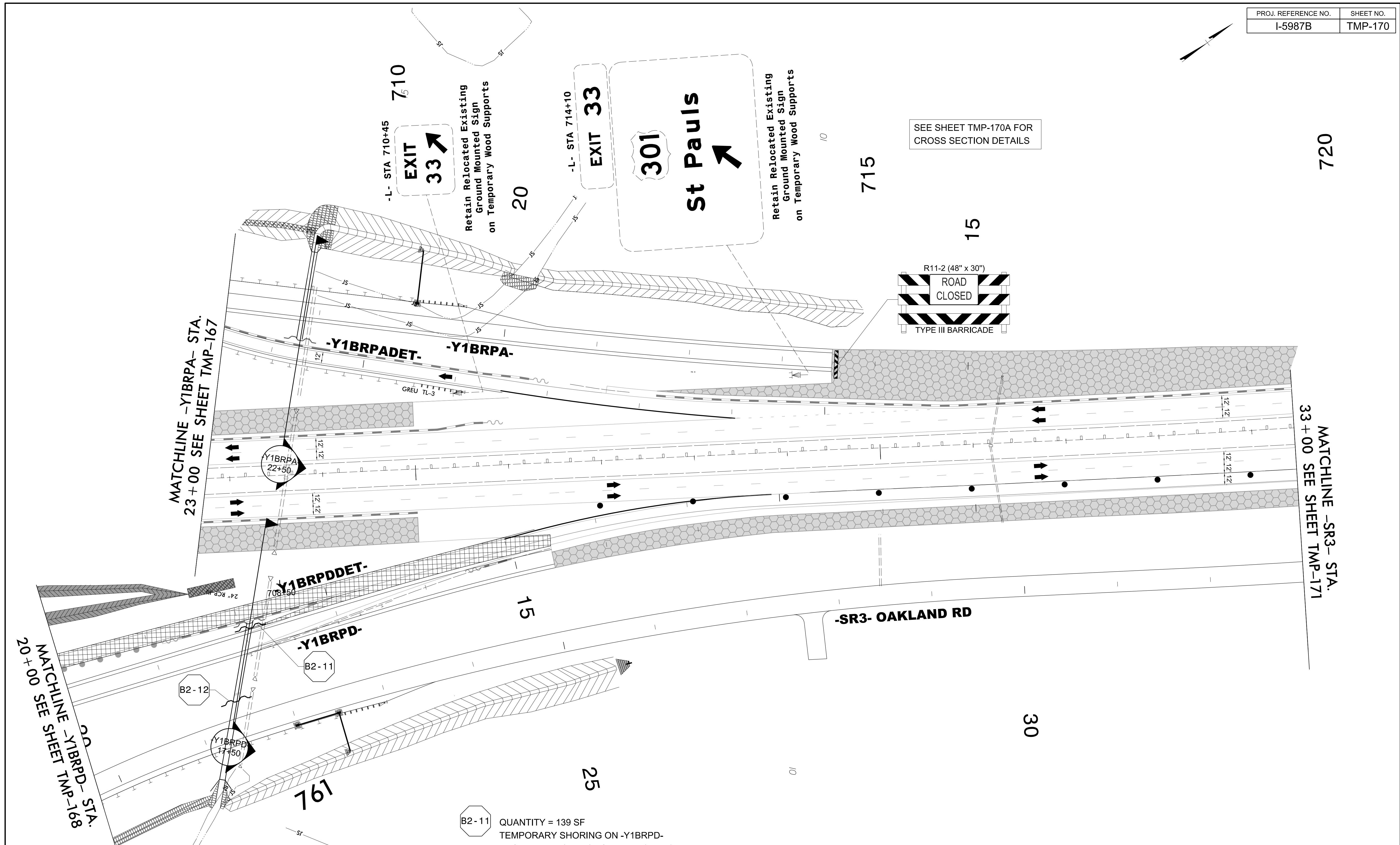

- B2-11** QUANTITY = 139 SF
TEMPORARY SHORING ON -Y1BRPD-
FROM 17+76± (11'RT) TO 18+10± (11'RT)
(SEE SHEET TMP-2TS9 FOR
TEMPORARY SHORING NOTES)
- B2-12** QUANTITY = 139 SF
TEMPORARY SHORING ON -SR3-
FROM 21+29± (30'LT) TO 21+63± (30'LT)
(SEE SHEET TMP-2TS9 FOR
TEMPORARY SHORING NOTES)

Stantec
 Stantec Consulting Services Inc.
 801 Jones Franklin Road
 Suite 300
 Raleigh, NC 27606
 Tel. 919.851.6866
 Fax. 919.851.7024
 www.stantec.com
 License No. F-0672

DocuSigned by
 J.W. Woolard
 PROFESSIONAL
 SEAL
 19862
 ENGINEER
 J.W. WOOLARD, JR.
 4/29/2022
**DOCUMENT NOT CONSIDERED FINAL
 UNLESS ALL SIGNATURES COMPLETED**

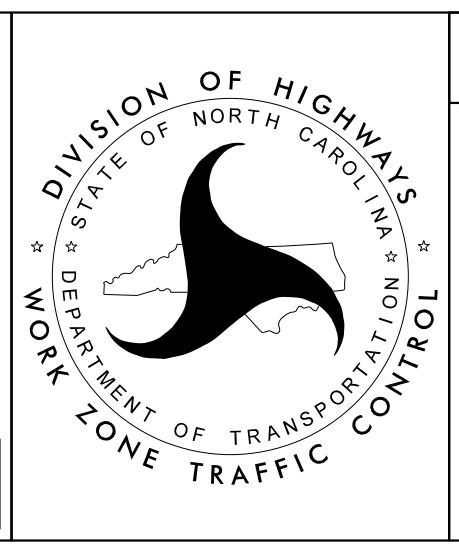

SECTION 2
 -Y1B- US-301
 PHASE I
 STEP 2C

4/21/2022
 U:\Traffic\Transportation Management Plan\TCP\PLAN SHEETS\I-5987B_TMP_I70_PHASE_1\STEP_2C.dgn
 angood

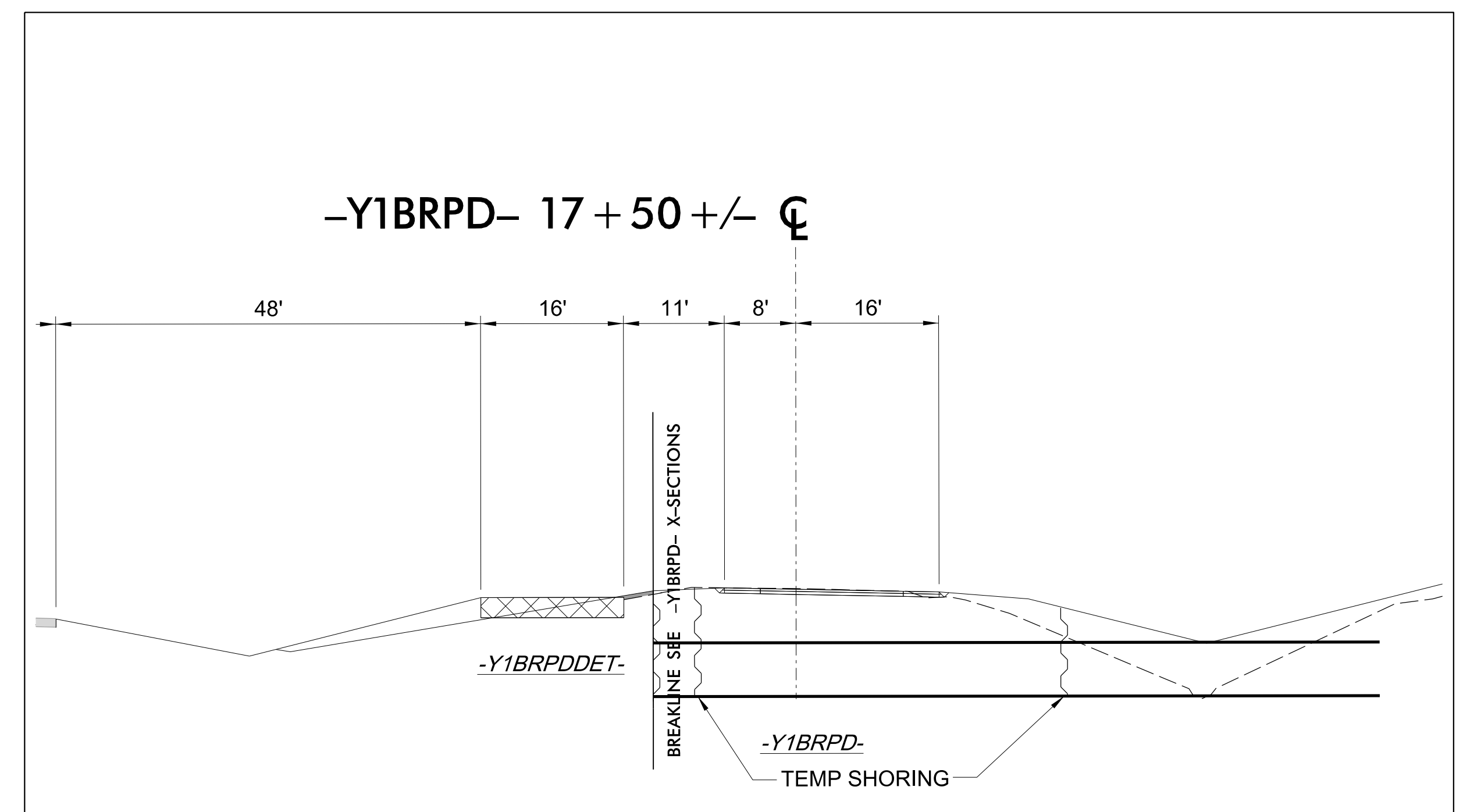
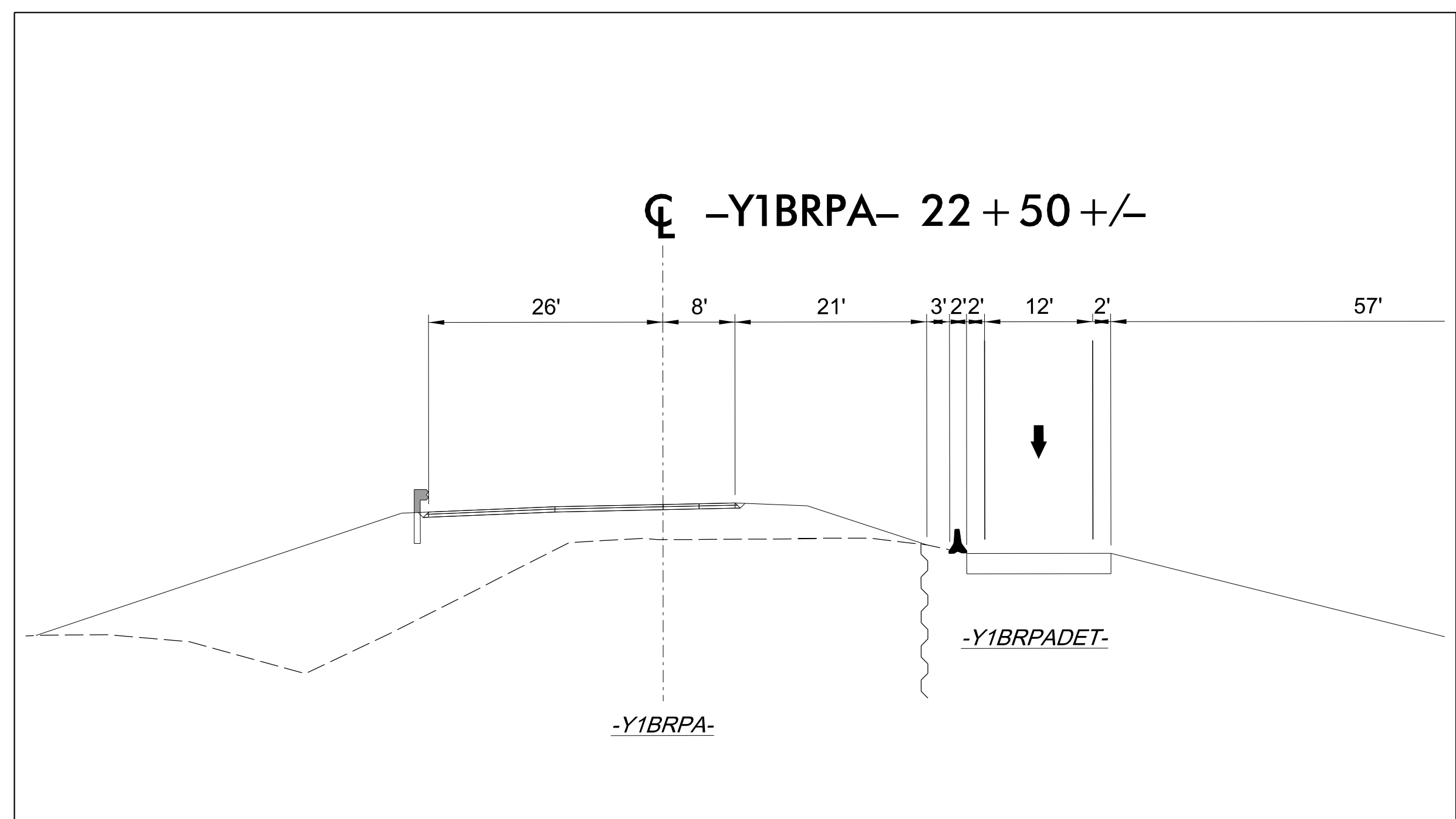

4/21/2022
U:\Traffic\Transportation Management\Plan\TCP\PLAN SHEETS\I-5987B_TMP\I70A_PHASE I_STEP 2C.dgn
angood

Stantec Consulting Services Inc.
801 Jones Franklin Road
Suite 300
Raleigh, NC 27606
Tel. 919.851.6866
Fax. 919.851.7024
www.stantec.com
License No. F-0672

DocuSigned by
J.W. Woolard
SEAL
19862
ENGINEER
J.W. WOOLARD, JR.
4/29/2022
**DOCUMENT NOT CONSIDERED FINAL
UNLESS ALL SIGNATURES COMPLETED**

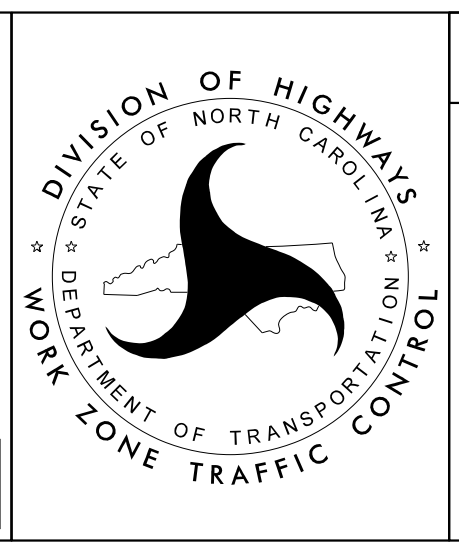

SECTION 2

-Y1B- US-301
PHASE I
STEP 2C

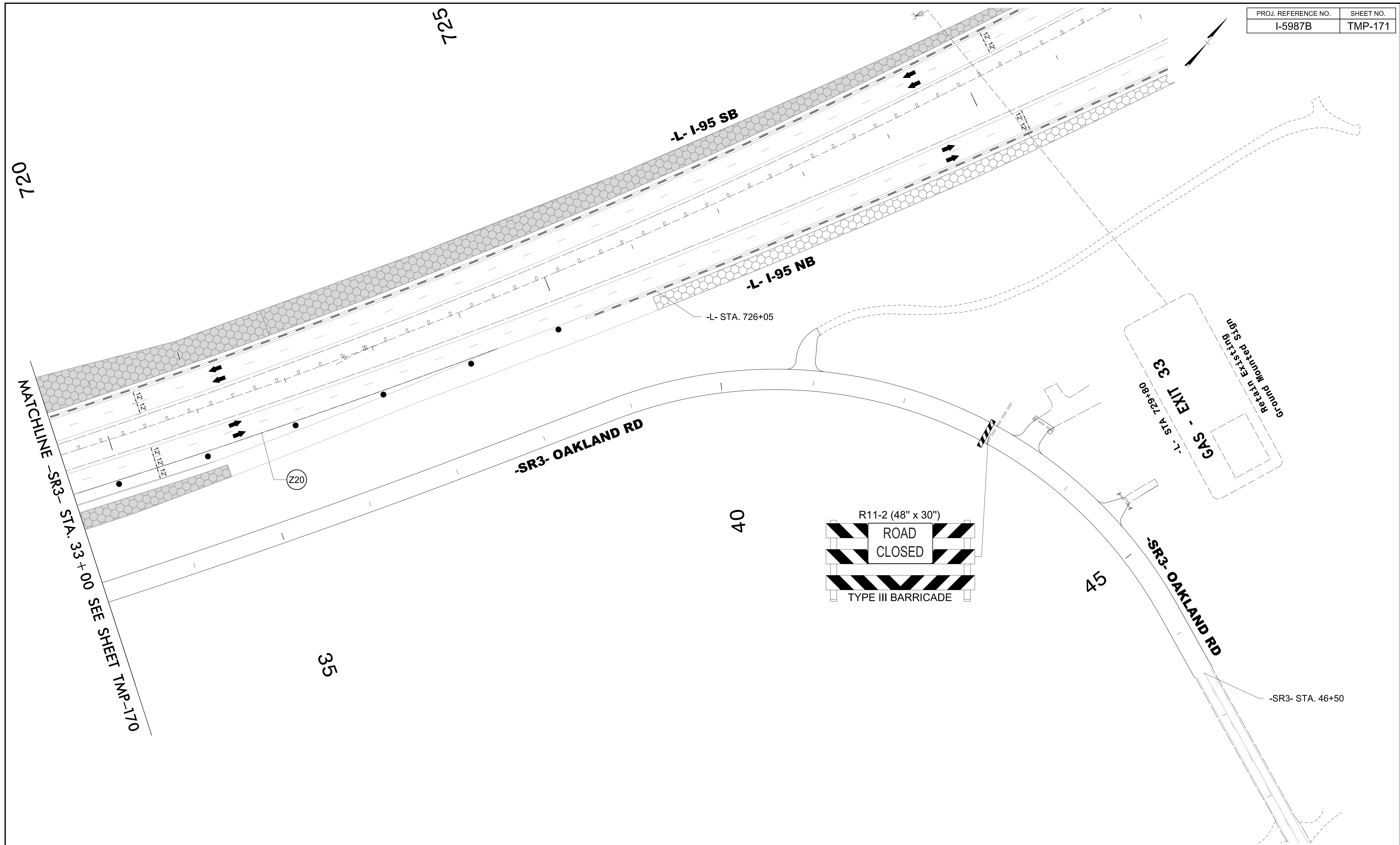

3/15/2022
 U:\Traffic\Transportation Management\Plan\TCP\PLAN SHEETS\I-5987B_TMP-171_PHASE I_STEP 2C.dgn
 angood

 Stantec Consulting Services Inc.
 801 Jones Franklin Road
 Suite 300
 Raleigh, NC 27606
 Tel. 919.851.6866
 Fax. 919.851.7024
 www.stantec.com
 License No. F-0672

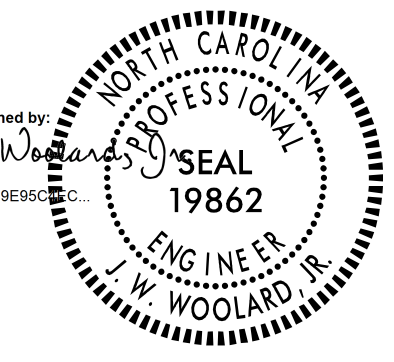
Documented by

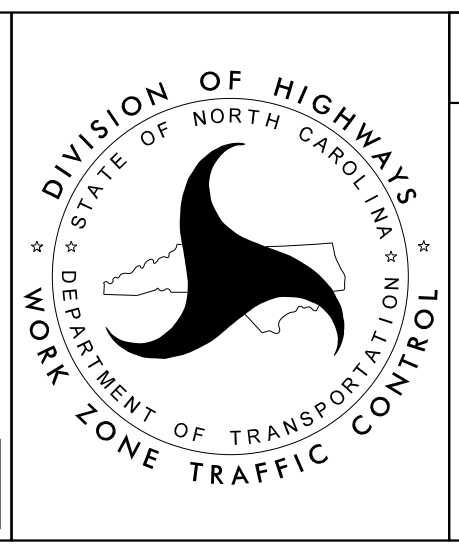
 J.W. WOOLLARD, P.E.
 4/29/2022
**DOCUMENT NOT CONSIDERED FINAL
 UNLESS ALL SIGNATURES COMPLETED**



SECTION 2

 -Y1B- US-301
 PHASE I
 STEP 2C



SEE TMP-2D14 FOR DETOUR ROUTES

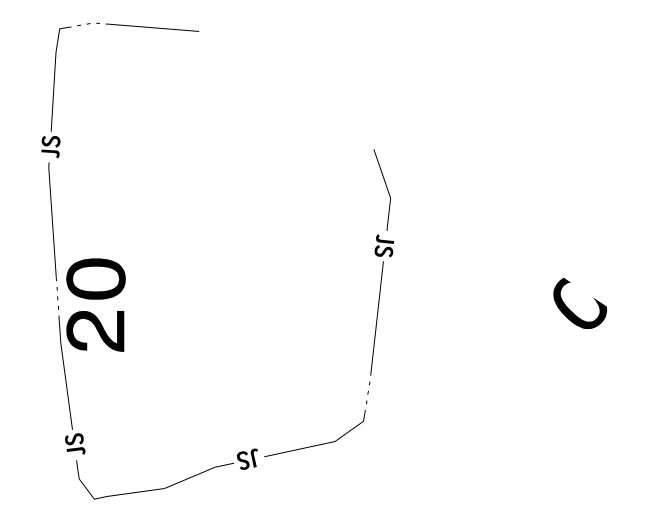
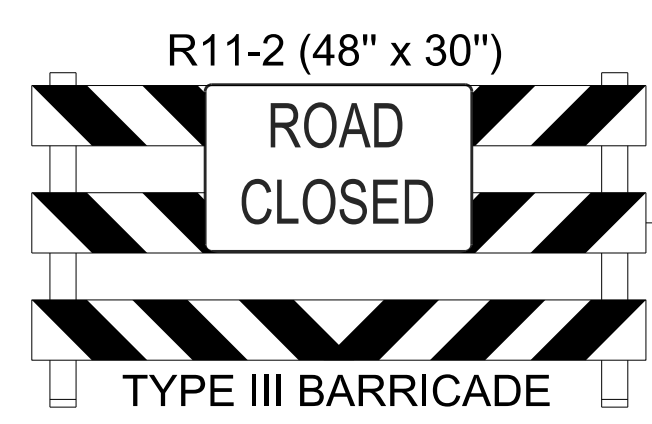
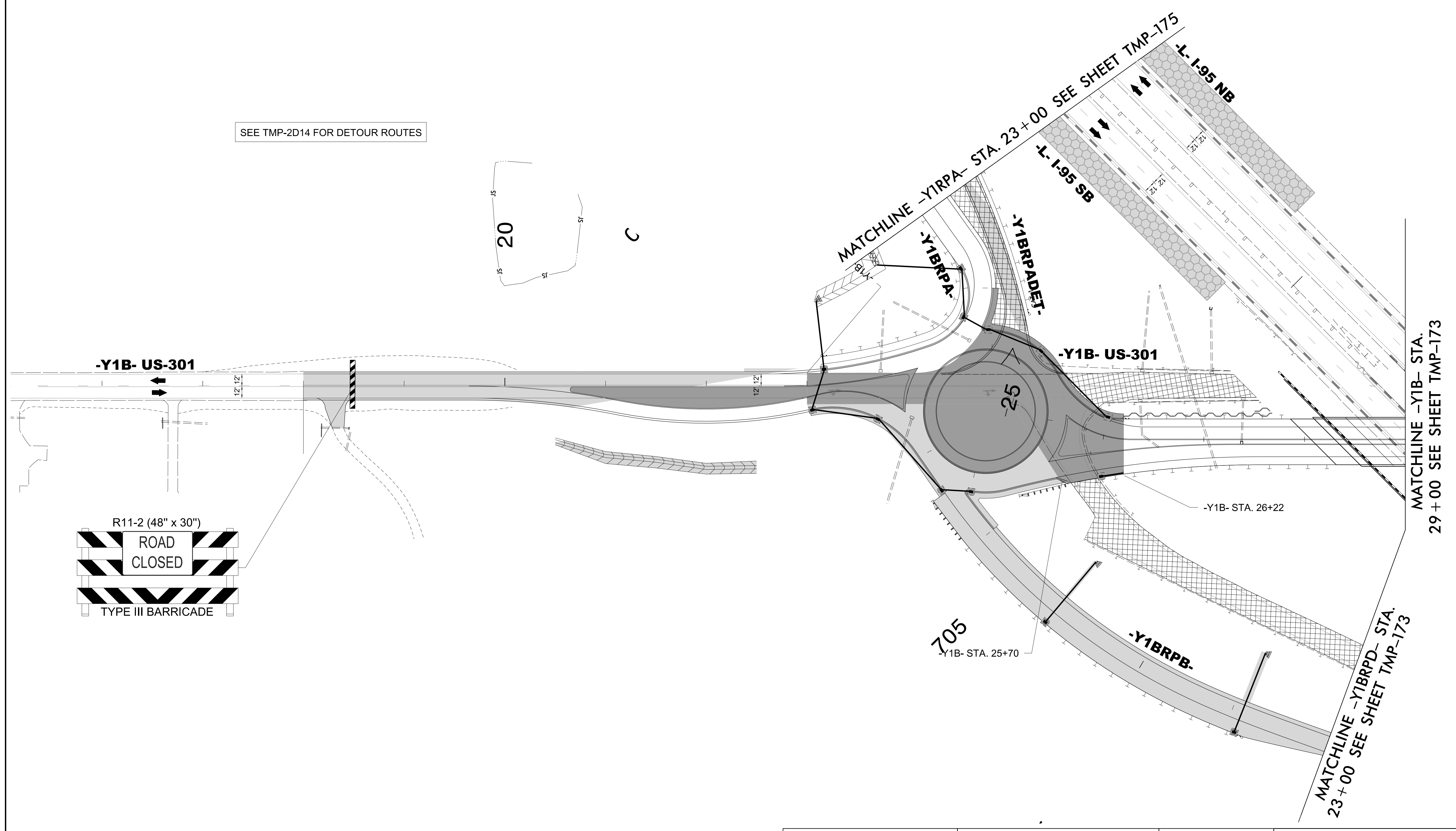

4/21/2022
L:\Traffic\Transportation Management\Plan\TCP\PLAN SHEETS\I-5987B_TMP_172_PHASE 1_STEP 2D.dgn
angood

<p>Stantec Consulting Services Inc. 801 Jones Franklin Road Suite 300 Raleigh, NC 27606 Tel. 919.851.6866 Fax. 919.851.7024 www.stantec.com License No. F-0672</p>	<p>4/29/2022 DOCUMENT NOT CONSIDERED FINAL UNLESS ALL SIGNATURES COMPLETED</p>	<p>DIVISION OF HIGHWAYS DEPARTMENT OF TRANSPORTATION WORK ZONE TRAFFIC CONTROL</p>	<p>SECTION 2</p> <p>-Y1B- US-301 PHASE I STEP 2D</p>
------------------------------------------------------------------------------------------------------------------------------------------------------------------------------------------------	-----------------------------------------------------------------------------------------------	--------------------------------------------------------------------------------------------	--------------------------------------------------------------

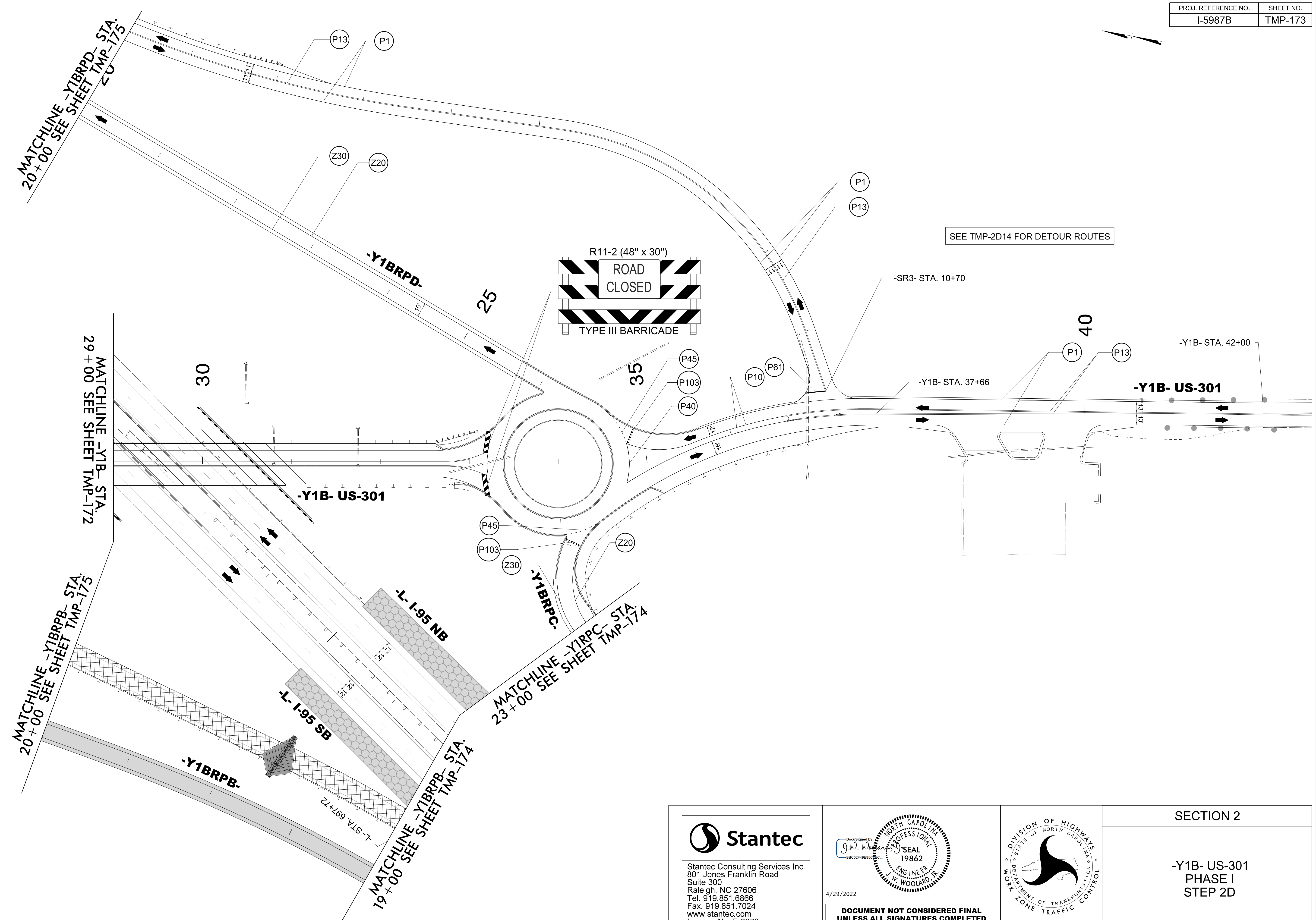

3/15/2022
 U:\Traffic\Transportation Management Plan\TCP\PLAN SHEETS\I-5987B_TMP_IT3_PHASE I_STEP 2D.dgn
 angood

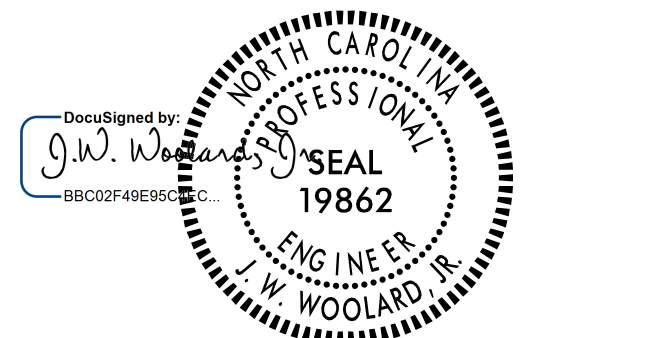

 Stantec Consulting Services Inc.
 801 Jones Franklin Road
 Suite 300
 Raleigh, NC 27606
 Tel. 919.851.6866
 Fax. 919.851.7024
 www.stantec.com
 License No. F-0672

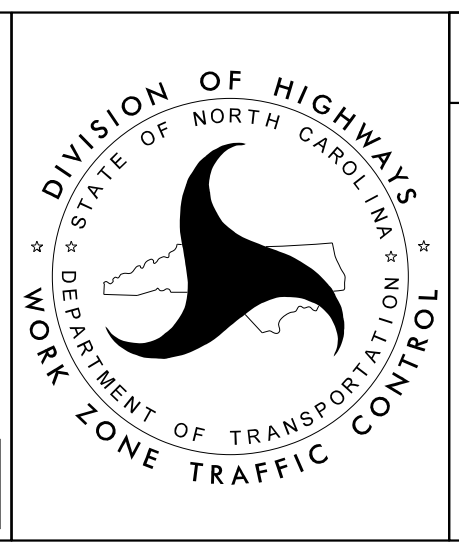
4/29/2022

**DOCUMENT NOT CONSIDERED FINAL
 UNLESS ALL SIGNATURES COMPLETED**

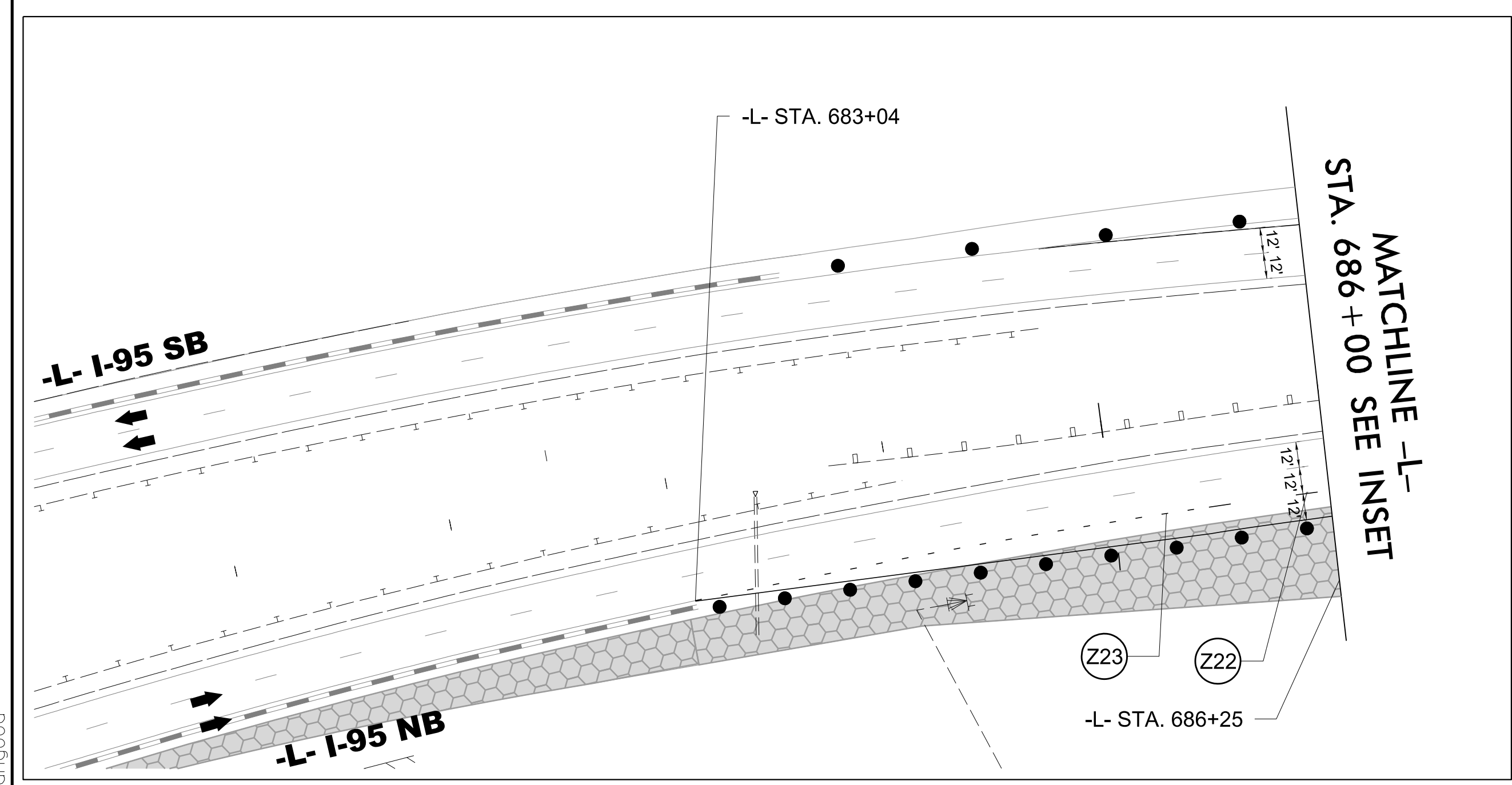
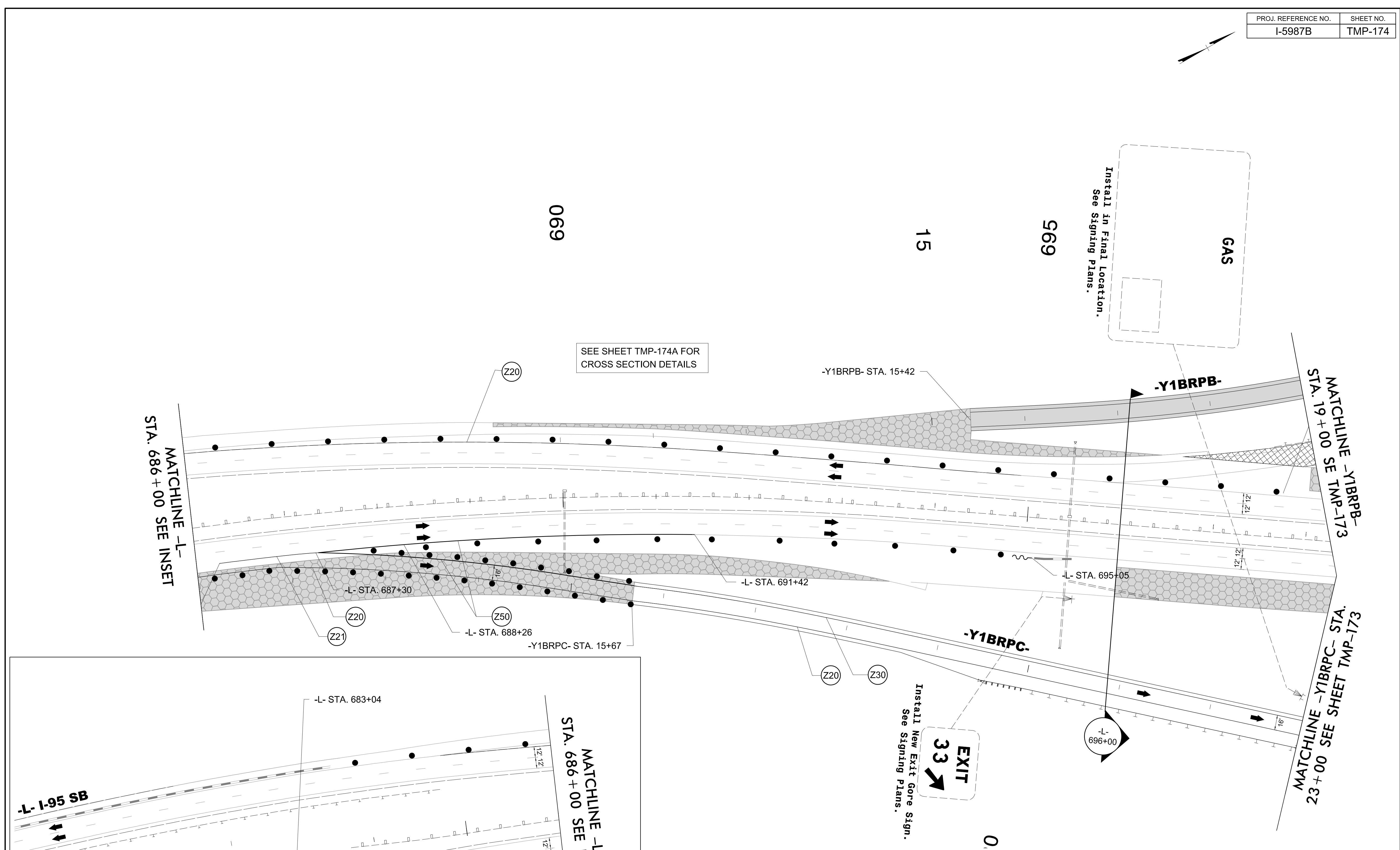
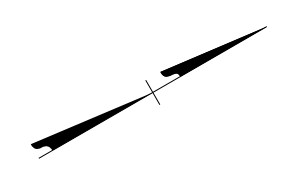

SECTION 2

 -Y1B- US-301
 PHASE I
 STEP 2D



3/15/2022
 U:\Traffic\Transportation Management Plan\TCP\PLAN SHEETS\I-5987B_TMP_174_PHASE 1_STEP 2D.dgn
 angood

Stantec
 Stantec Consulting Services Inc.
 801 Jones Franklin Road
 Suite 300
 Raleigh, NC 27606
 Tel. 919.851.6866
 Fax. 919.851.7024
 www.stantec.com
 License No. F-0672

4/29/2022

DOCUMENT NOT CONSIDERED FINAL
 UNLESS ALL SIGNATURES COMPLETED

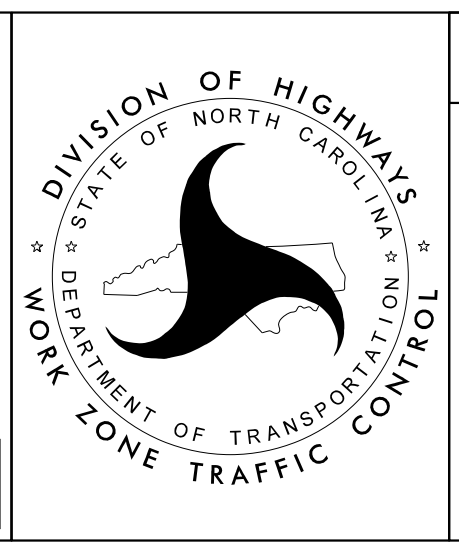

SECTION 2

-Y1B- US-301
 PHASE I
 STEP 2D

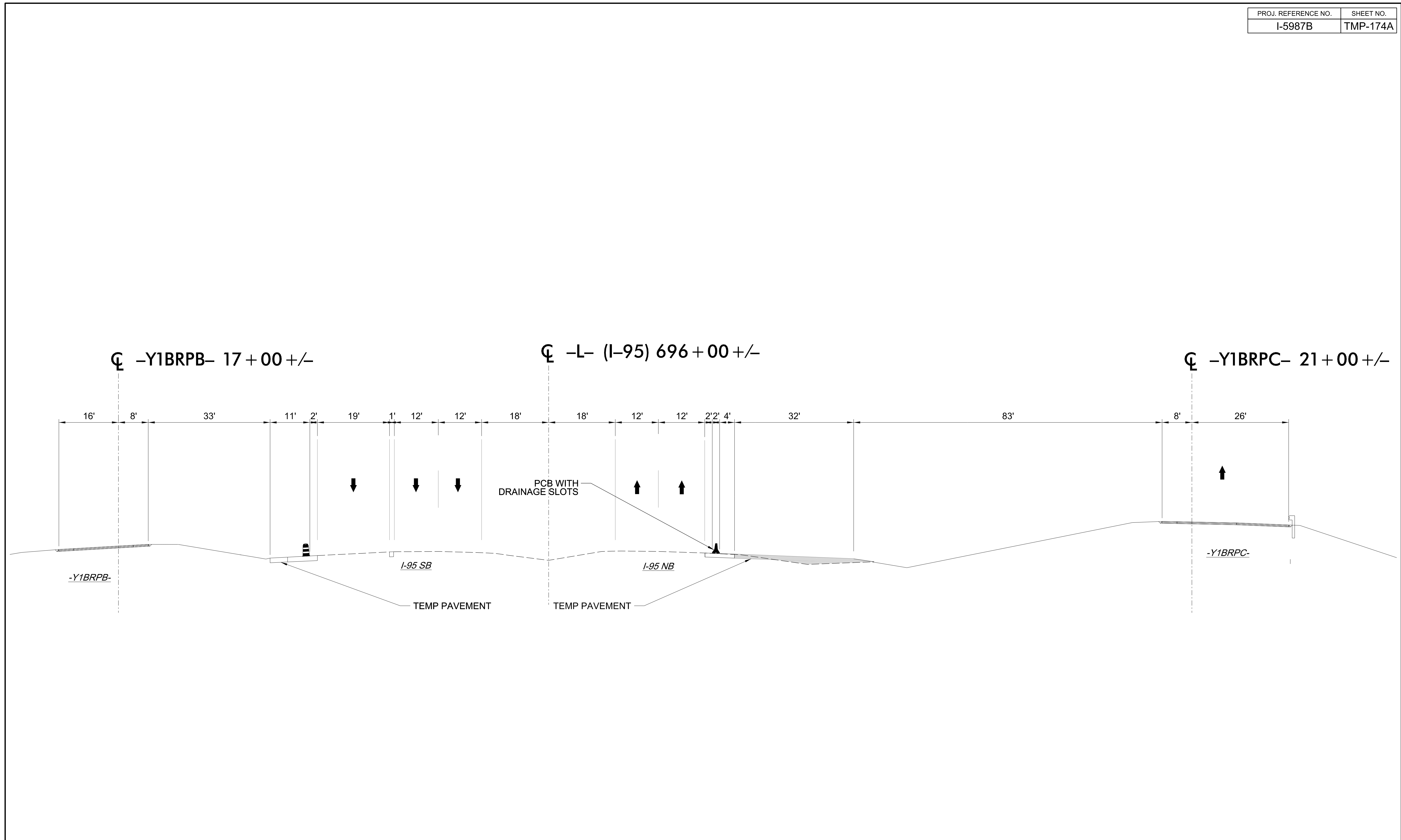

3/15/2022
U:\Traffic\Transportation Management\Plan\TCP\PLAN SHEETS\I-5987B_TMP_I74A_PHASE I_STEP 2D.dgn
angood

Stantec Consulting Services Inc.
801 Jones Franklin Road
Suite 300
Raleigh, NC 27606
Tel. 919.851.6866
Fax. 919.851.7024
www.stantec.com
License No. F-0672

DocuSigned by:
J.W. Woolard
SBB020F49E5656C

4/29/2022

**DOCUMENT NOT CONSIDERED FINAL
UNLESS ALL SIGNATURES COMPLETED**

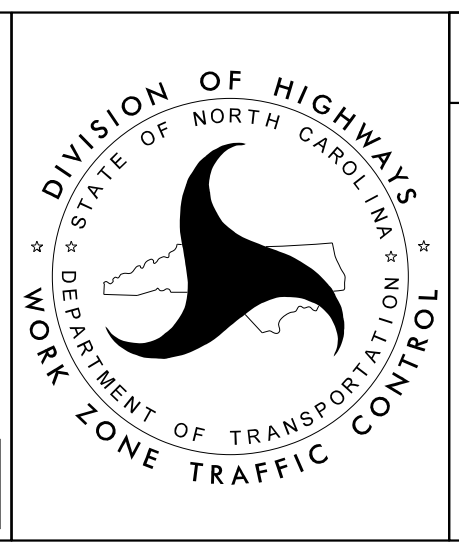

SECTION 2

**-Y1B- US-301
PHASE I
STEP 2D**

I-95 SOUTHBOUND NOTE:
ALL ADVANCE SIGNS FOR EXIT 33 SHALL BE COVERED WHILE RAMP IS CLOSED

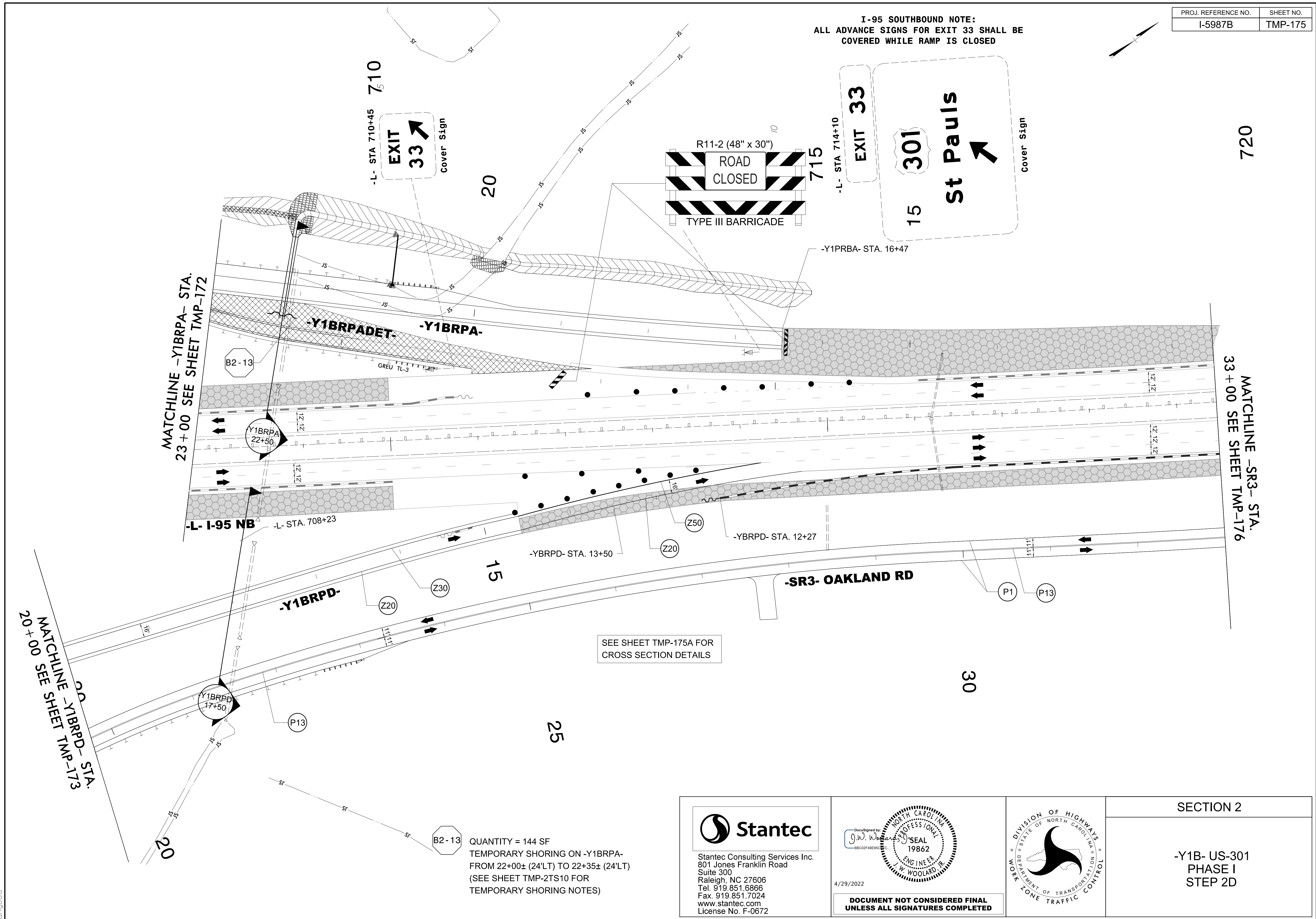

4/21/2022
L:\Traffic\Transportation Management Plan\TCP\PLAN SHEETS\I-5987B_TMP_175_PHASE 1_STEP 2D.dgn
angood

MATCHLINE -Y1BRPD- STA. 20+00 SEE SHEET TMP-173

MATCHLINE -Y1BRPA- STA. 23+00 SEE SHEET TMP-172

MATCHLINE -SR3- STA. 33+00 SEE SHEET TMP-176

B2-13 QUANTITY = 144 SF
TEMPORARY SHORING ON -Y1BRPA-
FROM 22+00± (24'LT) TO 22+35± (24'LT)
(SEE SHEET TMP-2TS10 FOR
TEMPORARY SHORING NOTES)

Stantec
Stantec Consulting Services Inc.
801 Jones Franklin Road
Suite 300
Raleigh, NC 27606
Tel. 919.851.6866
Fax. 919.851.7024
www.stantec.com
License No. F-0672

DocuSigned by
J.W. Woolard
SEAL
19862
ENGINEER
J.W. WOOLARD, JR.
4/29/2022
**DOCUMENT NOT CONSIDERED FINAL
UNLESS ALL SIGNATURES COMPLETED**

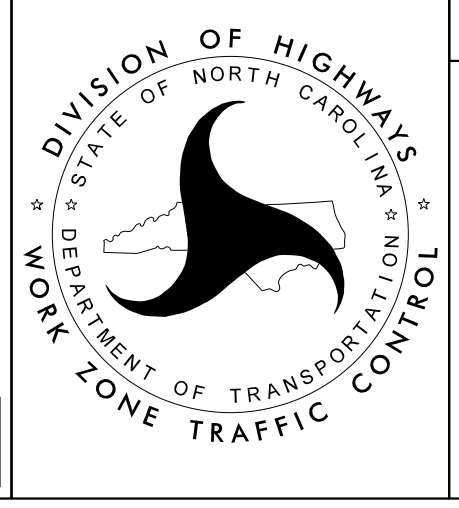

SECTION 2

-Y1B- US-301
PHASE I
STEP 2D

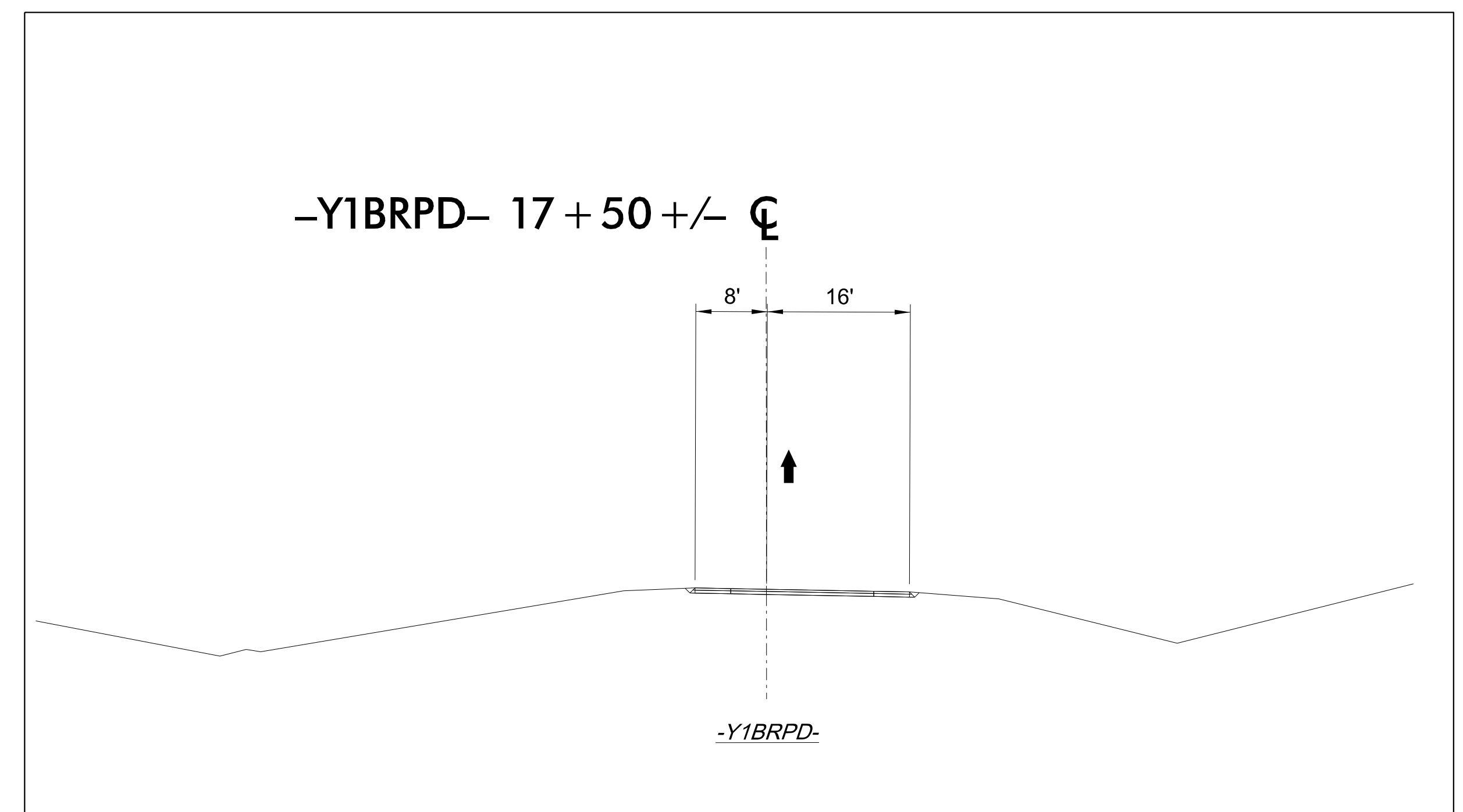
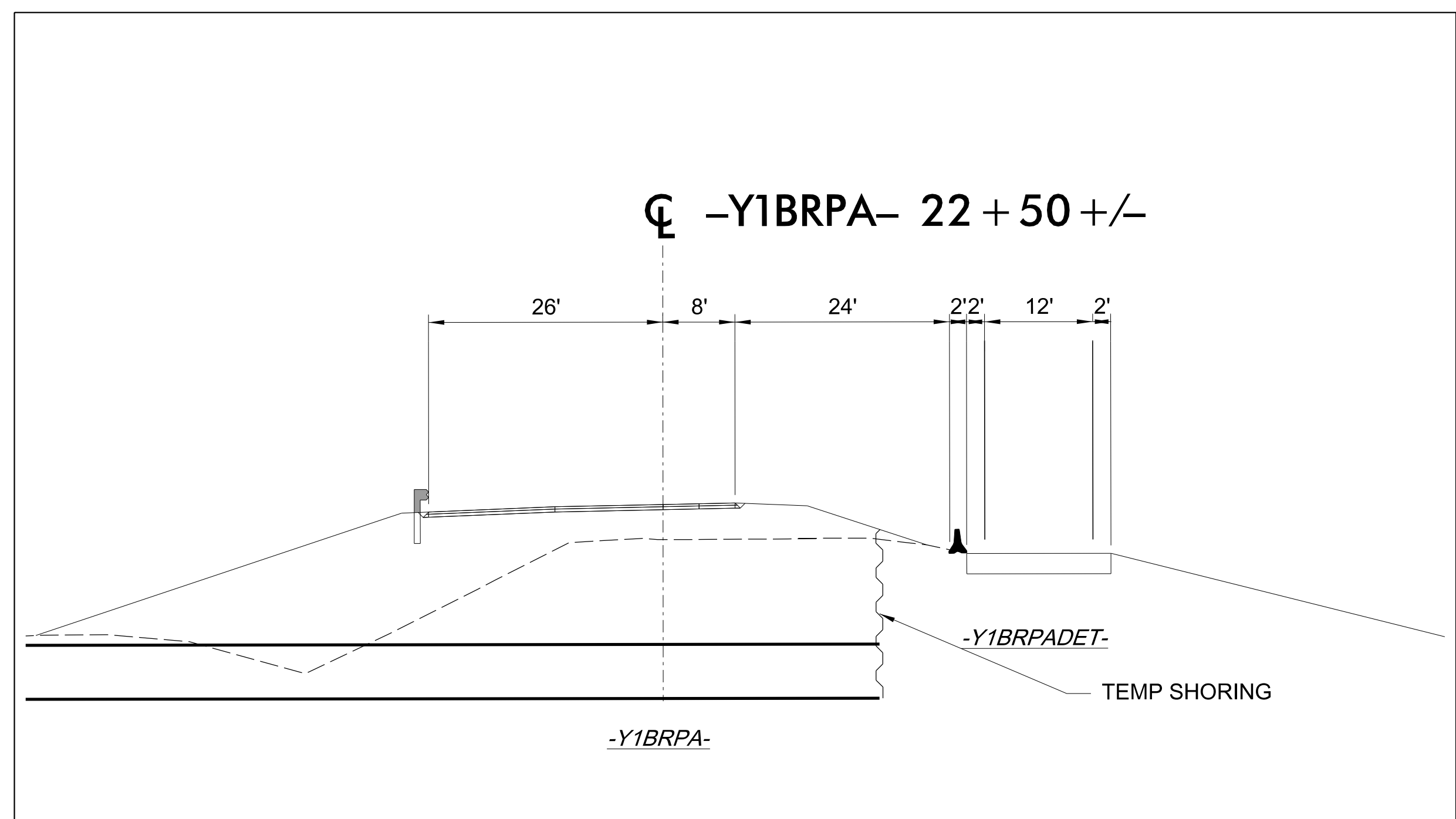

4/21/2022
 U:\Traffic\Transportation Management\Plan\TCP\PLAN SHEETS\I-5987B_TMP_175A_PHASE I_STEP 2D.dgn
 angood

Stantec Consulting Services Inc.
 801 Jones Franklin Road
 Suite 300
 Raleigh, NC 27606
 Tel. 919.851.6866
 Fax. 919.851.7024
 www.stantec.com
 License No. F-0672

DocuSigned by:
 J.W. Woolard
 58C02F49E56C

4/29/2022

**DOCUMENT NOT CONSIDERED FINAL
 UNLESS ALL SIGNATURES COMPLETED**

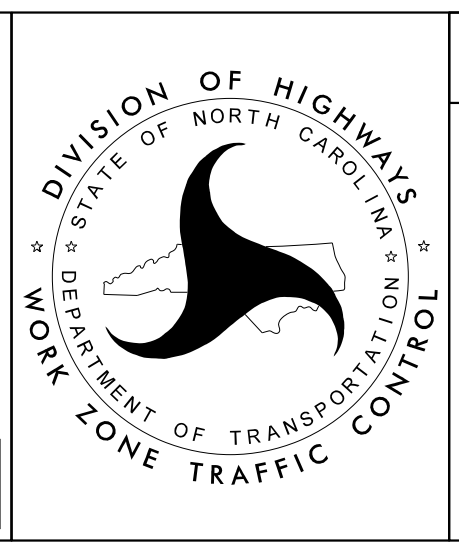

SECTION 2

-Y1B- US-301
 PHASE I
 STEP 2D

PROJ. REFERENCE NO.	SHEET NO.
I-5987B	TMP-176

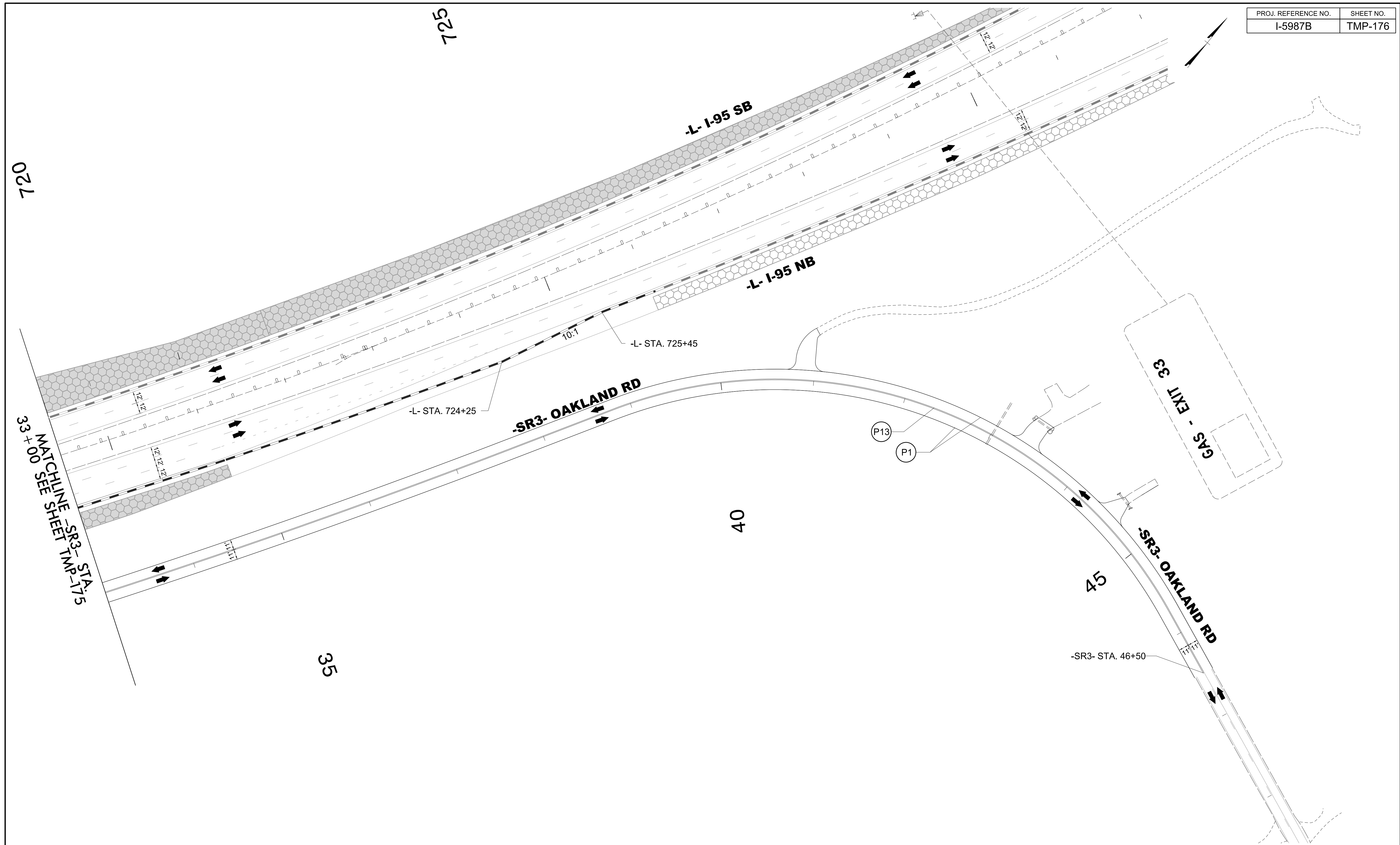

3/15/2022
 U:\Traffic\Transportation Management\Plan\TCP\PLAN SHEETS\I-5987B_TMP_176_PHASE 1_STEP 2D.dgn
 angood

Stantec
 Stantec Consulting Services Inc.
 801 Jones Franklin Road
 Suite 300
 Raleigh, NC 27606
 Tel. 919.851.6866
 Fax. 919.851.7024
 www.stantec.com
 License No. F-0672

DocuSigned by
 J.W. Woollard
 58BC20F49E5656C

4/29/2022

**DOCUMENT NOT CONSIDERED FINAL
 UNLESS ALL SIGNATURES COMPLETED**

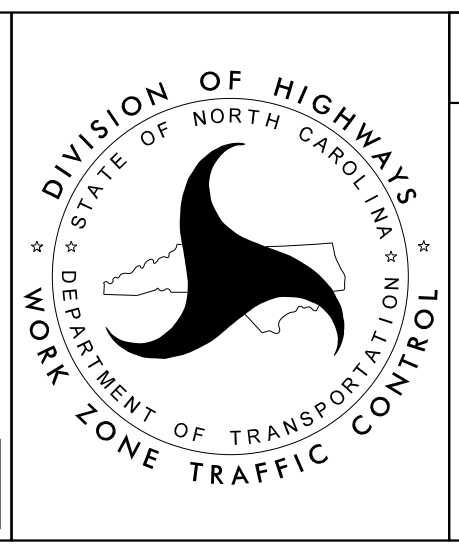

SECTION 2

**-Y1B- US-301
 PHASE I
 STEP 2D**

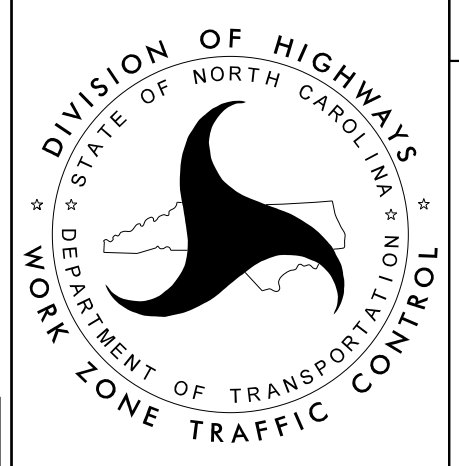

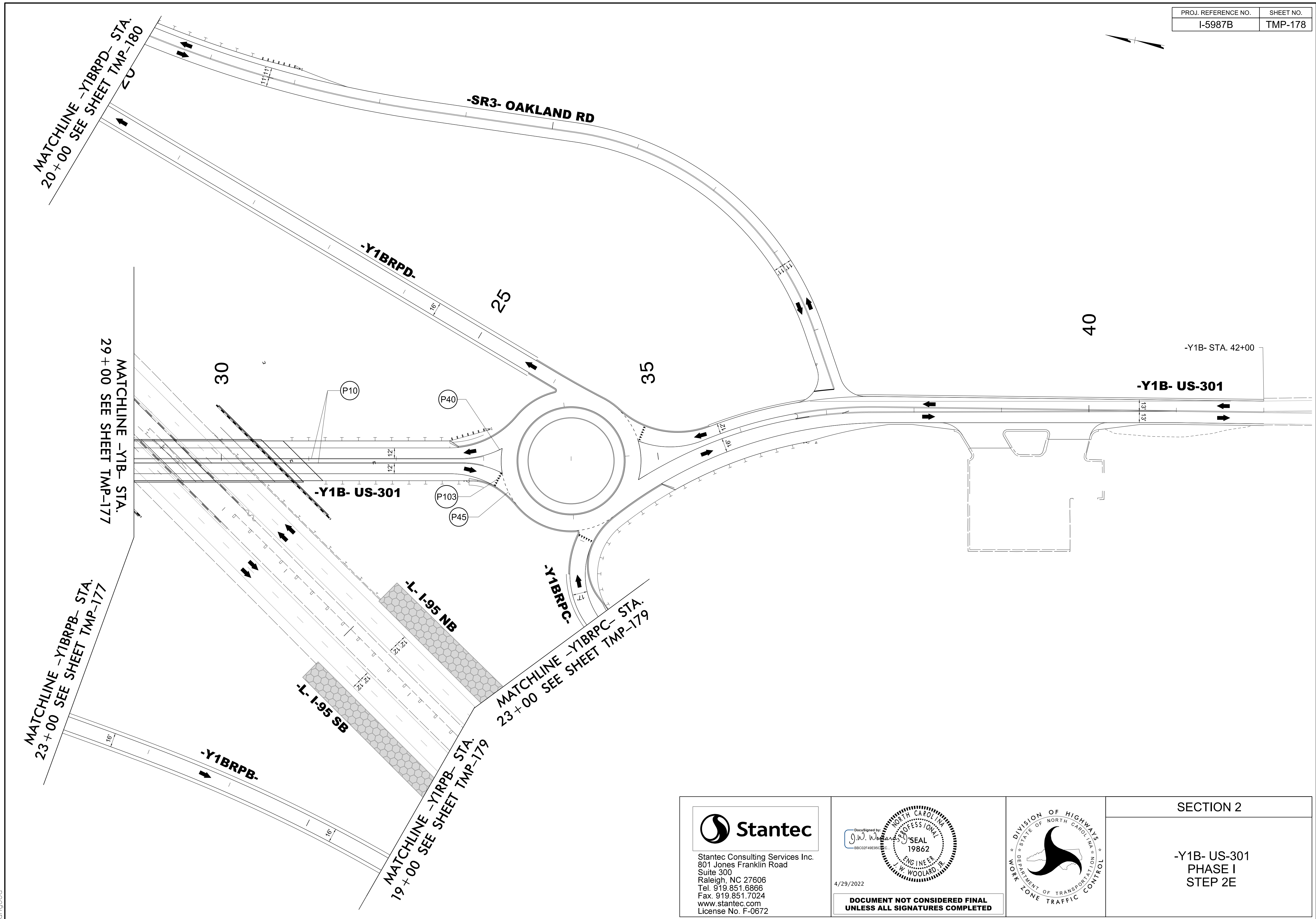

3/15/2022
 U:\Traffic\Transportation Management Plan\TCP\PLAN SHEETS\I-5987B_TMP_178_PHASE 1_STEP 2E.dgn
 angood

Stantec Consulting Services Inc.
 801 Jones Franklin Road
 Suite 300
 Raleigh, NC 27606
 Tel. 919.851.6866
 Fax. 919.851.7024
 www.stantec.com
 License No. F-0672

4/29/2022

**DOCUMENT NOT CONSIDERED FINAL
 UNLESS ALL SIGNATURES COMPLETED**

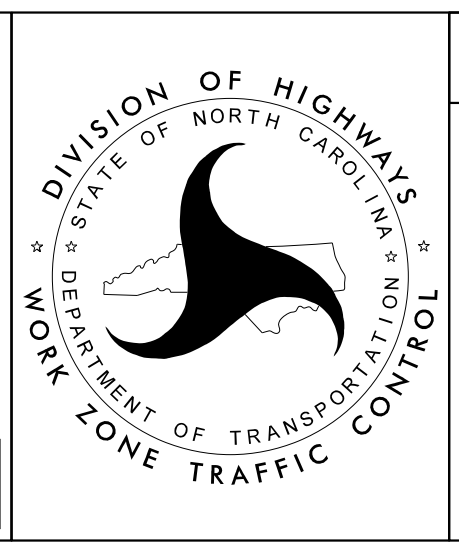

SECTION 2

-Y1B- US-301
 PHASE I
 STEP 2E

20

069

15

665

SEE SHEET TMP-179A FOR CROSS SECTION DETAILS

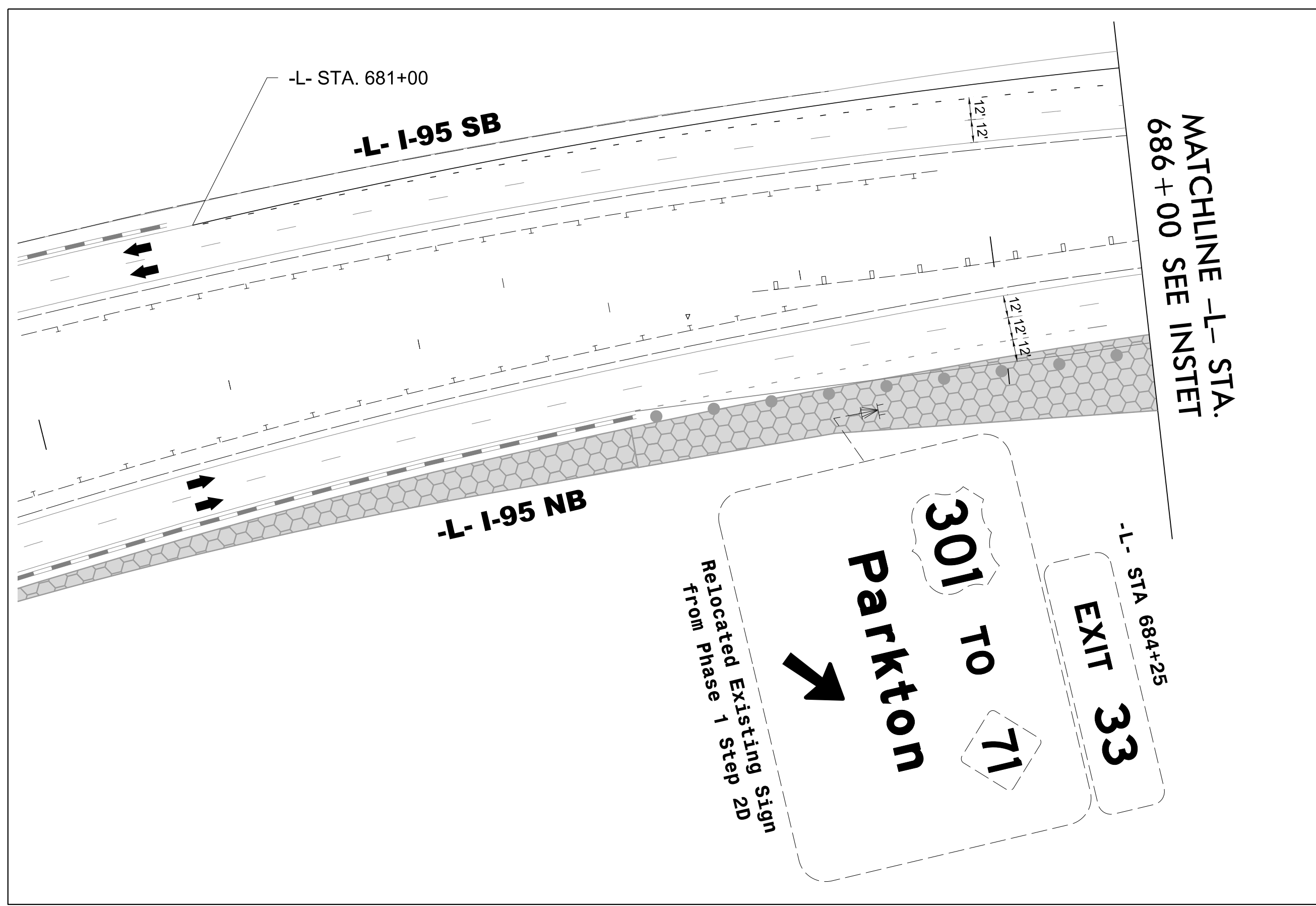
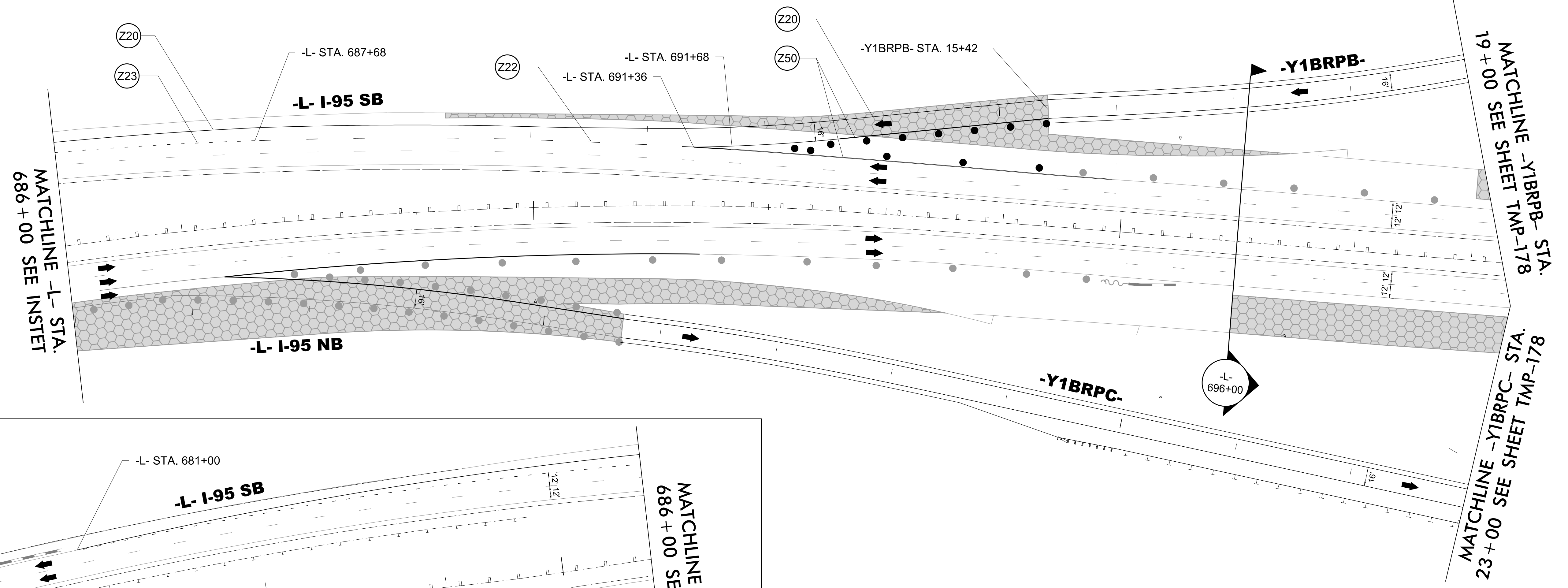

3/15/2022
U:\Traffic\Transportation Management Plan\TCP\PLAN SHEETS\I-5987B_TMP_179_PHASE 1_STEP 2E.dgn
angood

Stantec
 Stantec Consulting Services Inc.
 801 Jones Franklin Road
 Suite 300
 Raleigh, NC 27606
 Tel. 919.851.6866
 Fax. 919.851.7024
 www.stantec.com
 License No. F-0672

DocuSigned by
 J.W. Woolard
 PROFESSIONAL SEAL
 19862
 ENGINEER
 J.W. WOOLARD, JR.
 4/29/2022
**DOCUMENT NOT CONSIDERED FINAL
 UNLESS ALL SIGNATURES COMPLETED**

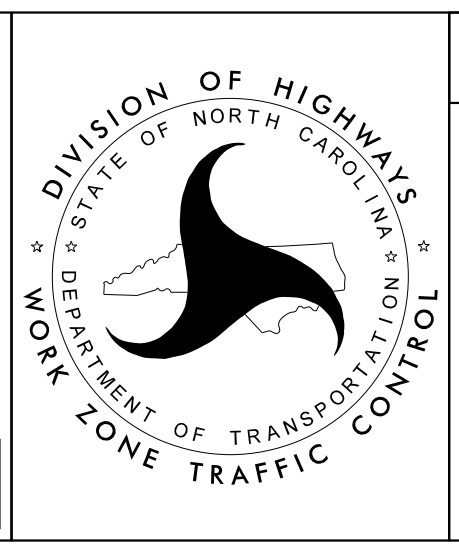

SECTION 2

**-Y1B- US-301
 PHASE I
 STEP 2E**

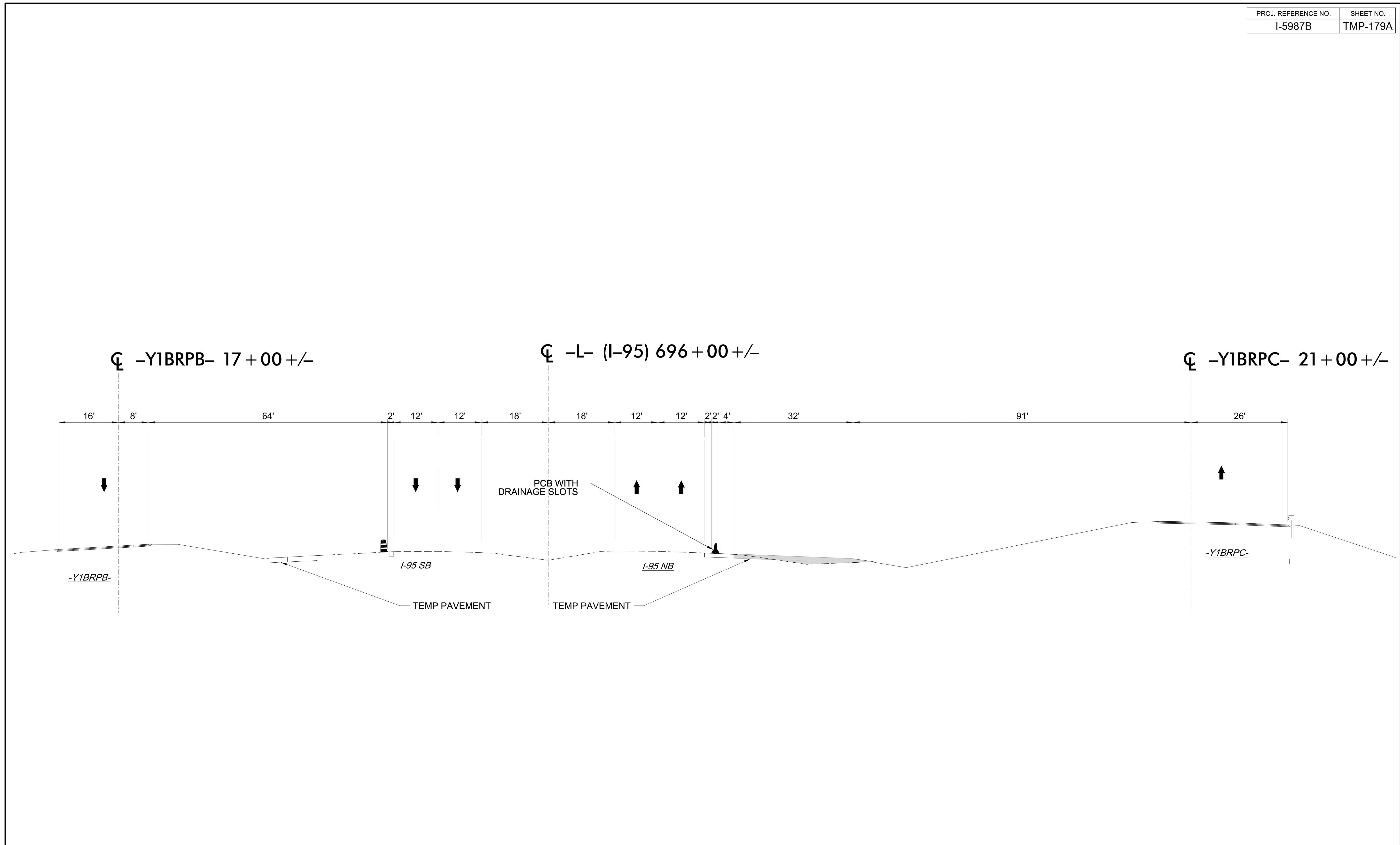

3/15/2022
U:\Traffic\Transportation Management\Plan\TCP\PLAN SHEETS\I-5987B_TMP_179A_PHASE I_STEP 2E.dgn
angood

Stantec
 Stantec Consulting Services Inc.
 801 Jones Franklin Road
 Suite 300
 Raleigh, NC 27606
 Tel. 919.851.6866
 Fax. 919.851.7024
 www.stantec.com
 License No. F-0672

DocuSigned by
 J.W. Woolard
 58C20F49E565C

4/29/2022

**DOCUMENT NOT CONSIDERED FINAL
 UNLESS ALL SIGNATURES COMPLETED**

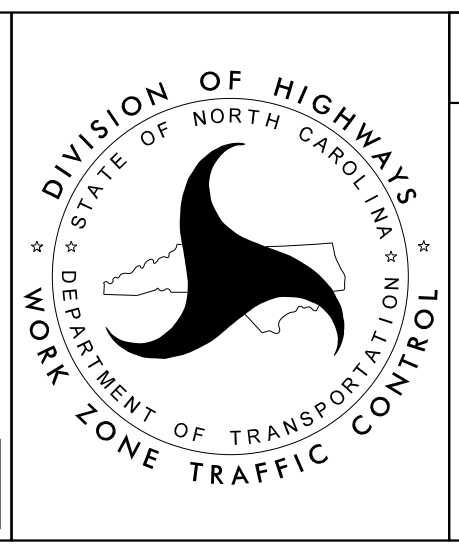

SECTION 2

-Y1B- US-301
 PHASE I
 STEP 2E

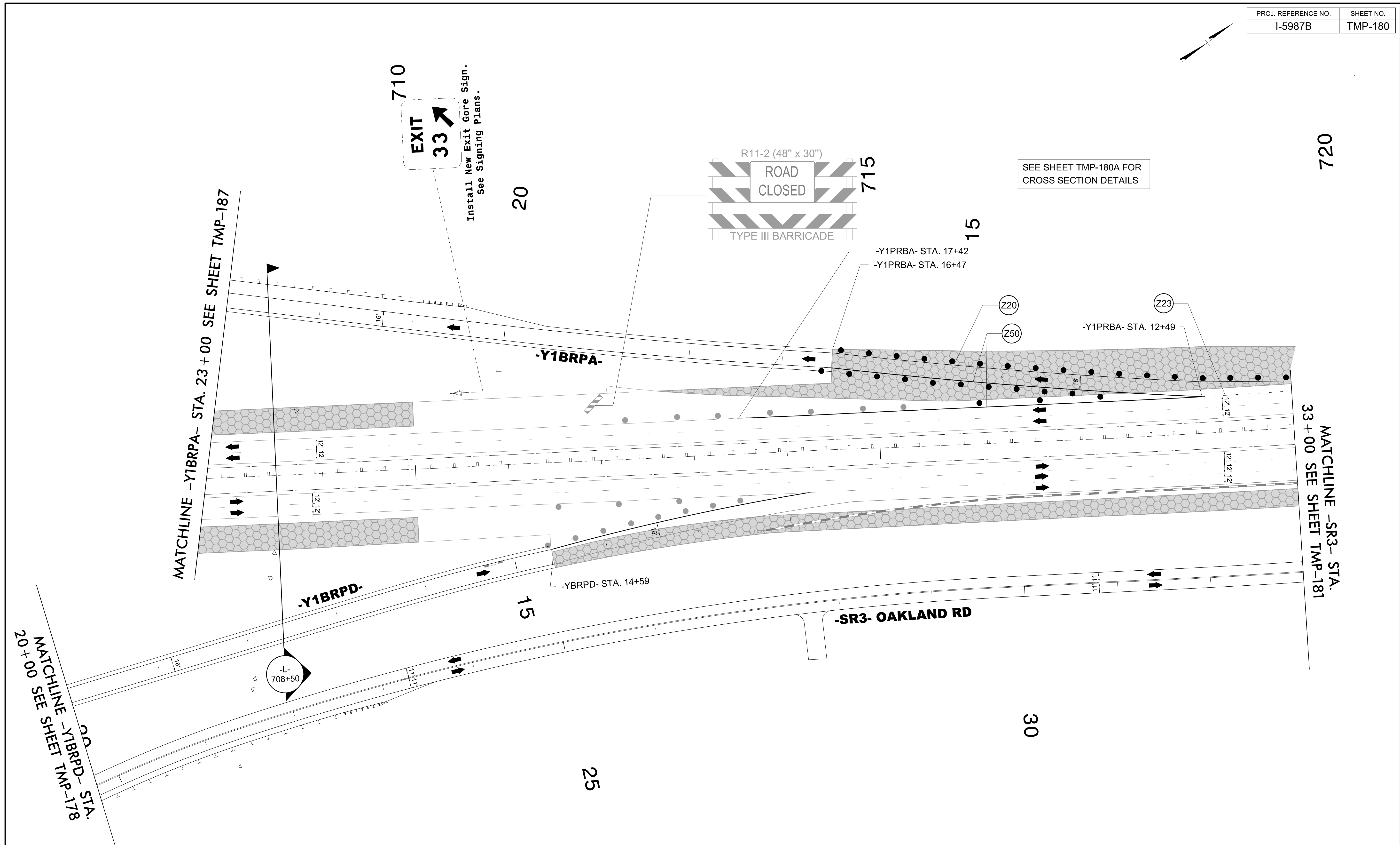
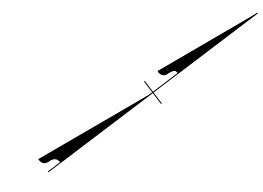

3/15/2022
U:\Traffic\Transportation Management\Plan\TCP\PLAN SHEETS\I-5987B_TMP_180_PHASE_1LSTEP_2E.dgn
angood

 Stantec Consulting Services Inc.
 801 Jones Franklin Road
 Suite 300
 Raleigh, NC 27606
 Tel. 919.851.6866
 Fax. 919.851.7024
 www.stantec.com
 License No. F-0672

DocuSigned by:

 4/29/2022
**DOCUMENT NOT CONSIDERED FINAL
 UNLESS ALL SIGNATURES COMPLETED**

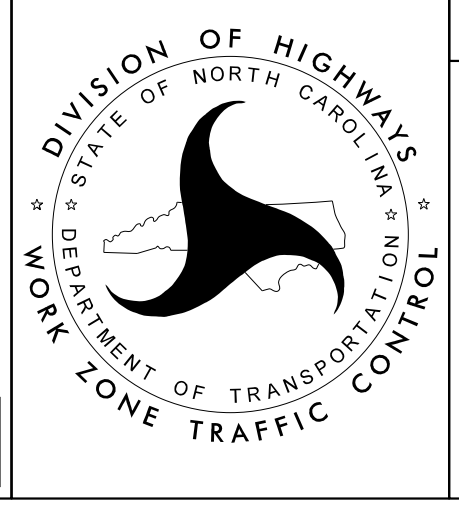

SECTION 2

-Y1B- US-301
 PHASE I
 STEP 2E

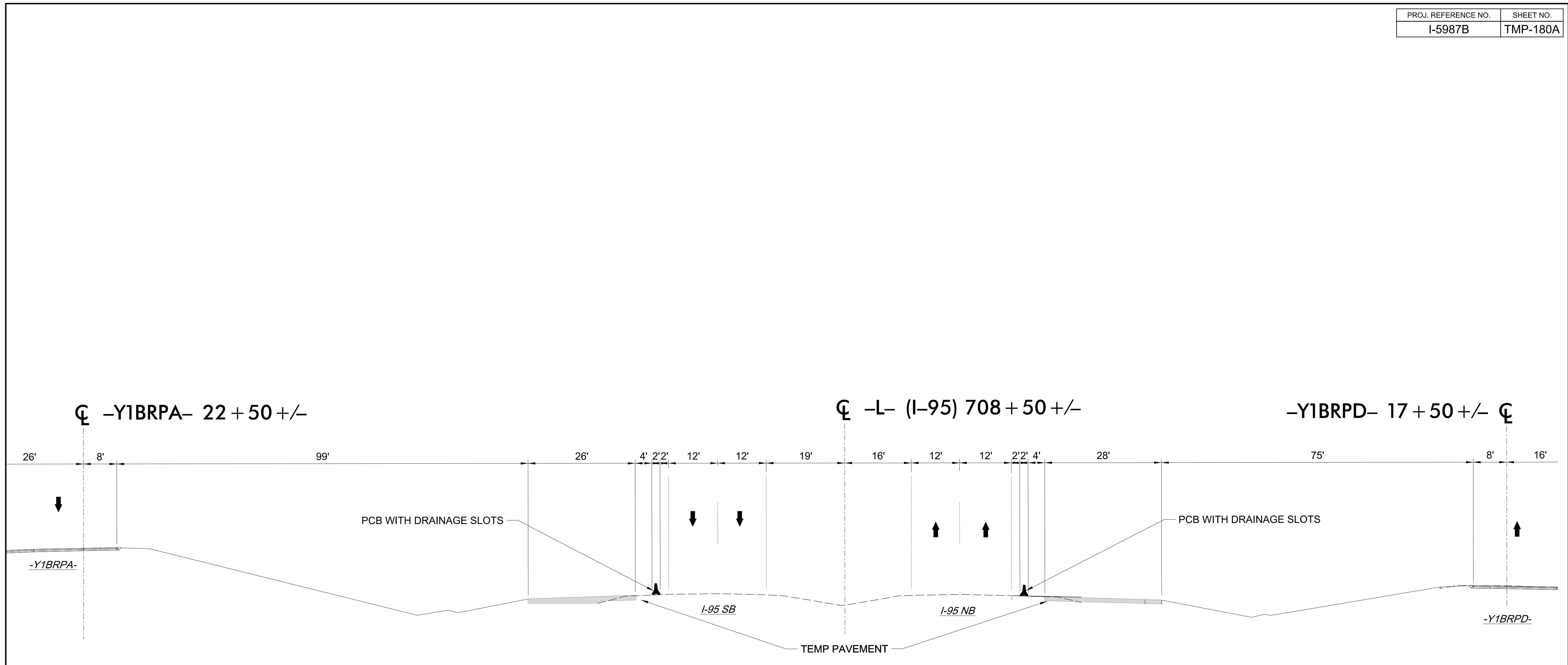

3/15/2022
U:\Traffic\Transportation Management\Plan\TCP\PLAN SHEETS\I-5987B_TMP_180A_PHASE I_STEP 2E.dgn
angood

Stantec
Stantec Consulting Services Inc.
801 Jones Franklin Road
Suite 300
Raleigh, NC 27606
Tel. 919.851.6866
Fax. 919.851.7024
www.stantec.com
License No. F-0672

DocuSigned by
J.W. Woolard
SBB020F49E565C

4/29/2022

**DOCUMENT NOT CONSIDERED FINAL
UNLESS ALL SIGNATURES COMPLETED**

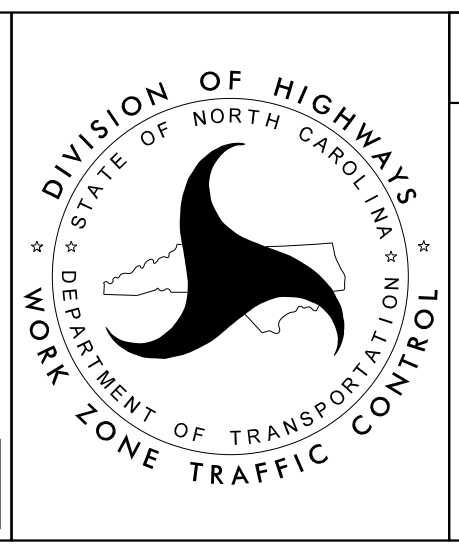

SECTION 2

**-Y1B- US-301
PHASE I
STEP 2E**

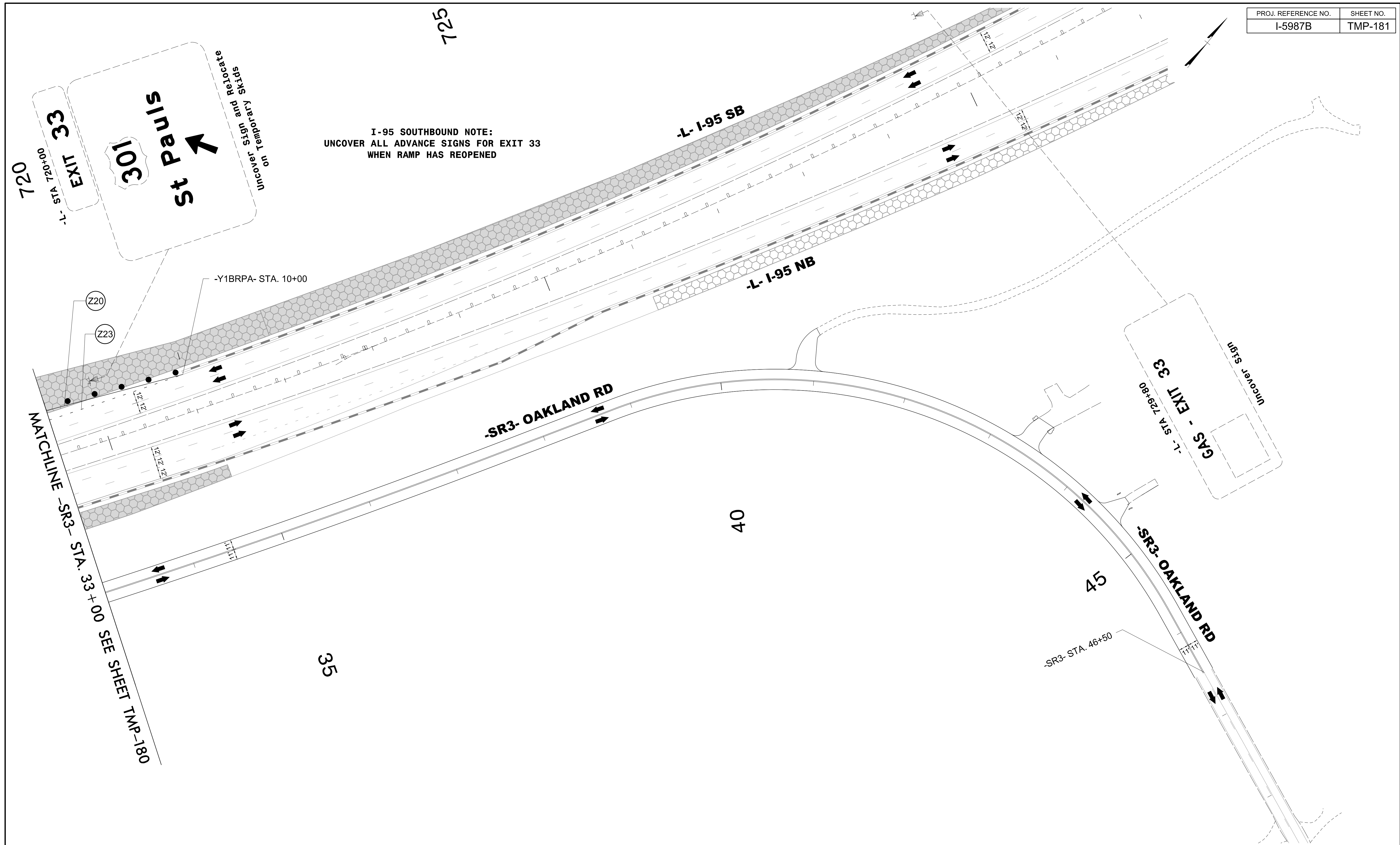

3/15/2022
 U:\Traffic\Transportation Management\Plan\TCP\PLAN SHEETS\I-5987B-TMP-181-PHASE 1-STEP 2E.dgn
 angood

Stantec
 Stantec Consulting Services Inc.
 801 Jones Franklin Road
 Suite 300
 Raleigh, NC 27606
 Tel. 919.851.6866
 Fax. 919.851.7024
 www.stantec.com
 License No. F-0672

DocuSigned by
 J.W. Woollard
 58BC20F49E5656C

4/29/2022

**DOCUMENT NOT CONSIDERED FINAL
 UNLESS ALL SIGNATURES COMPLETED**

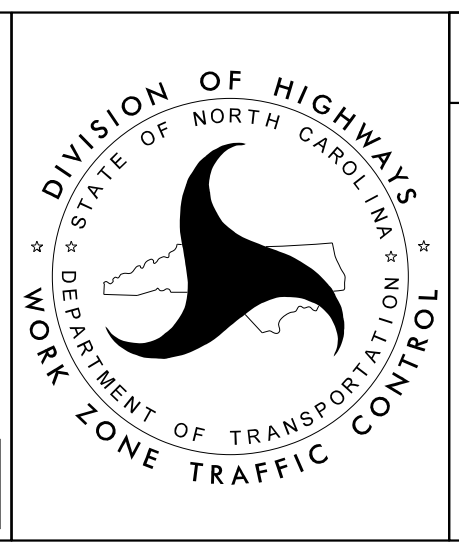

SECTION 2

**-Y1B- US-301
 PHASE I
 STEP 2E**

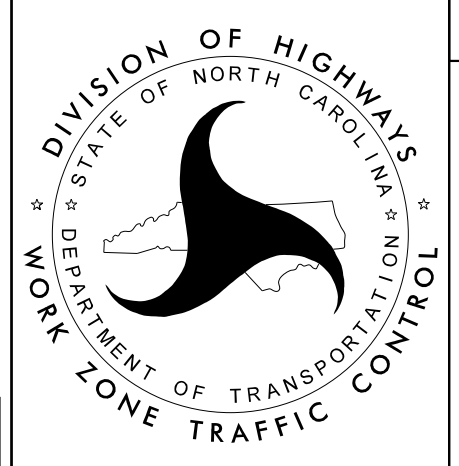

PROJ. REFERENCE NO.	SHEET NO.
I-5987B	TMP-182

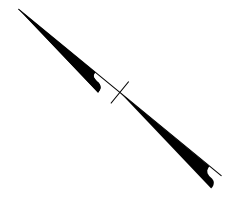

15

25

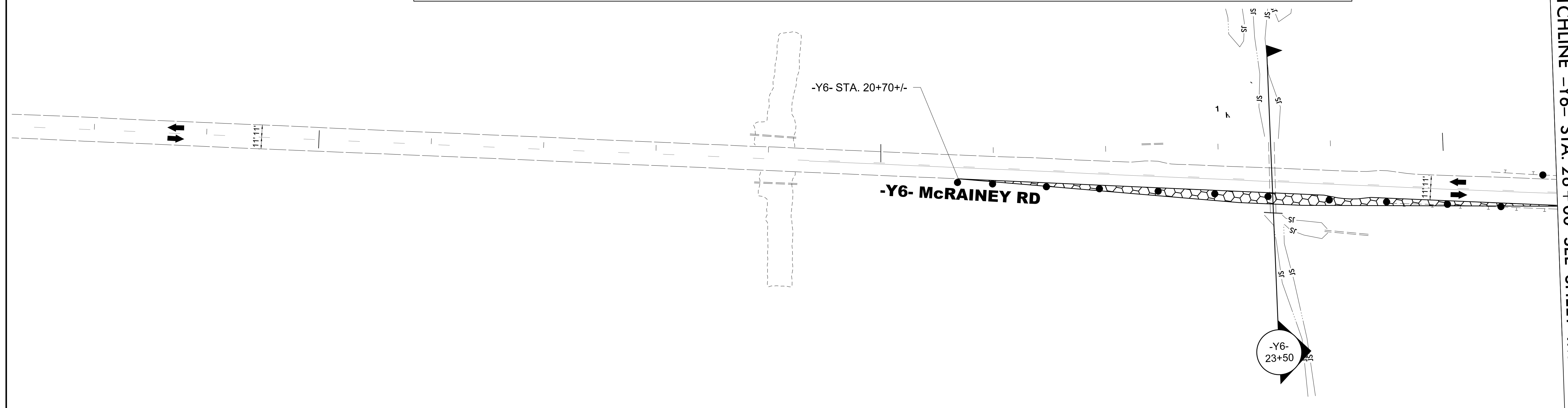
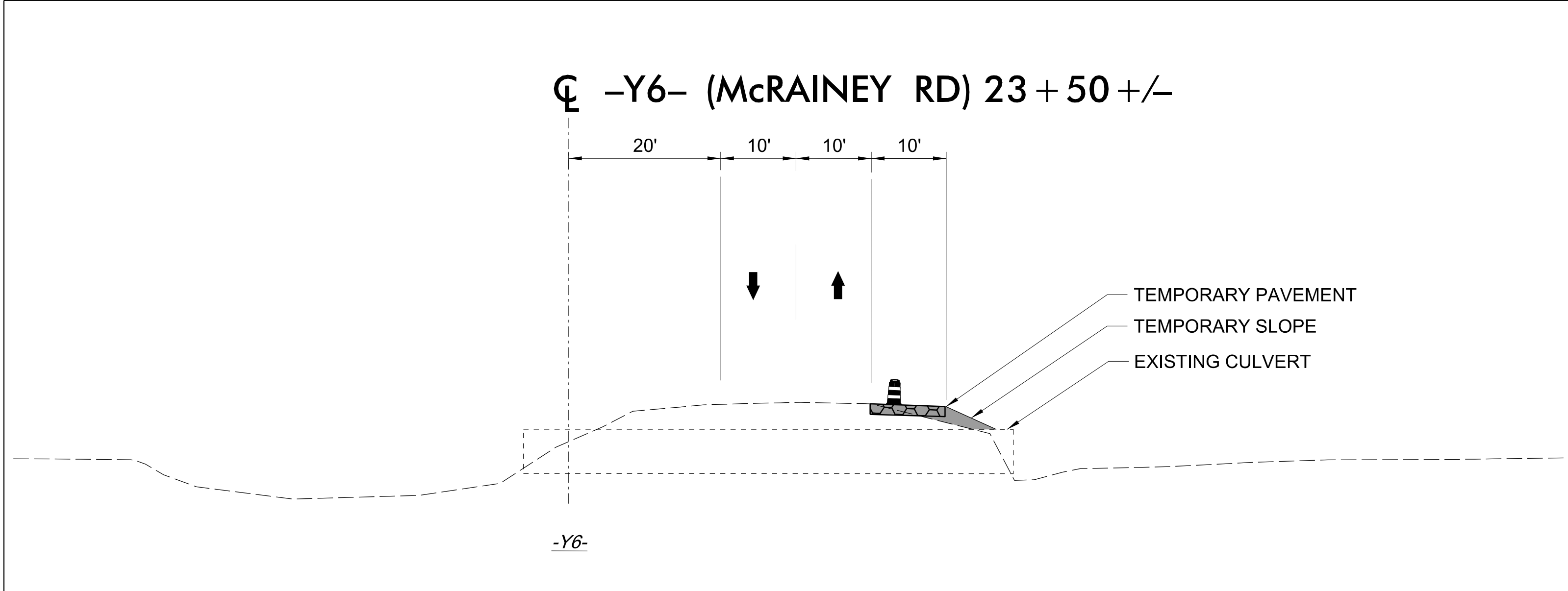

3/15/2022
 U:\Traffic\Transportation Management\Plan\TCP\PLAN SHEETS\I-5987B_TMP_182_PHASE I_STEP 3A.dgn
 angood



Stantec Consulting Services Inc.
 801 Jones Franklin Road
 Suite 300
 Raleigh, NC 27606
 Tel. 919.851.6866
 Fax. 919.851.7024
 www.stantec.com
 License No. F-0672

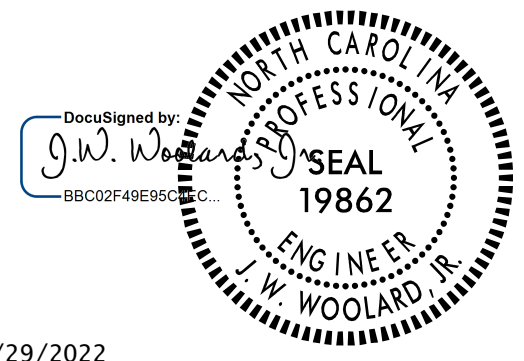

4/29/2022

**DOCUMENT NOT CONSIDERED FINAL
UNLESS ALL SIGNATURES COMPLETED**

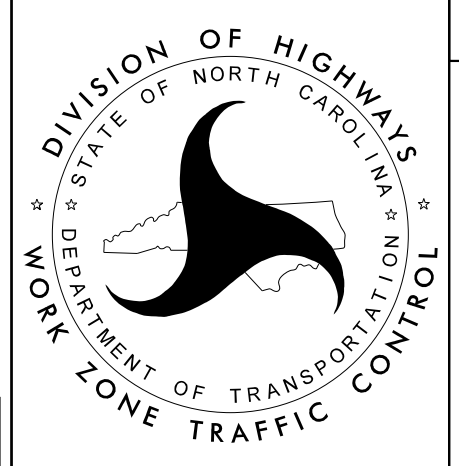

SECTION 2

-Y6- McRAINEY RD
 PHASE I
 STEP 3A

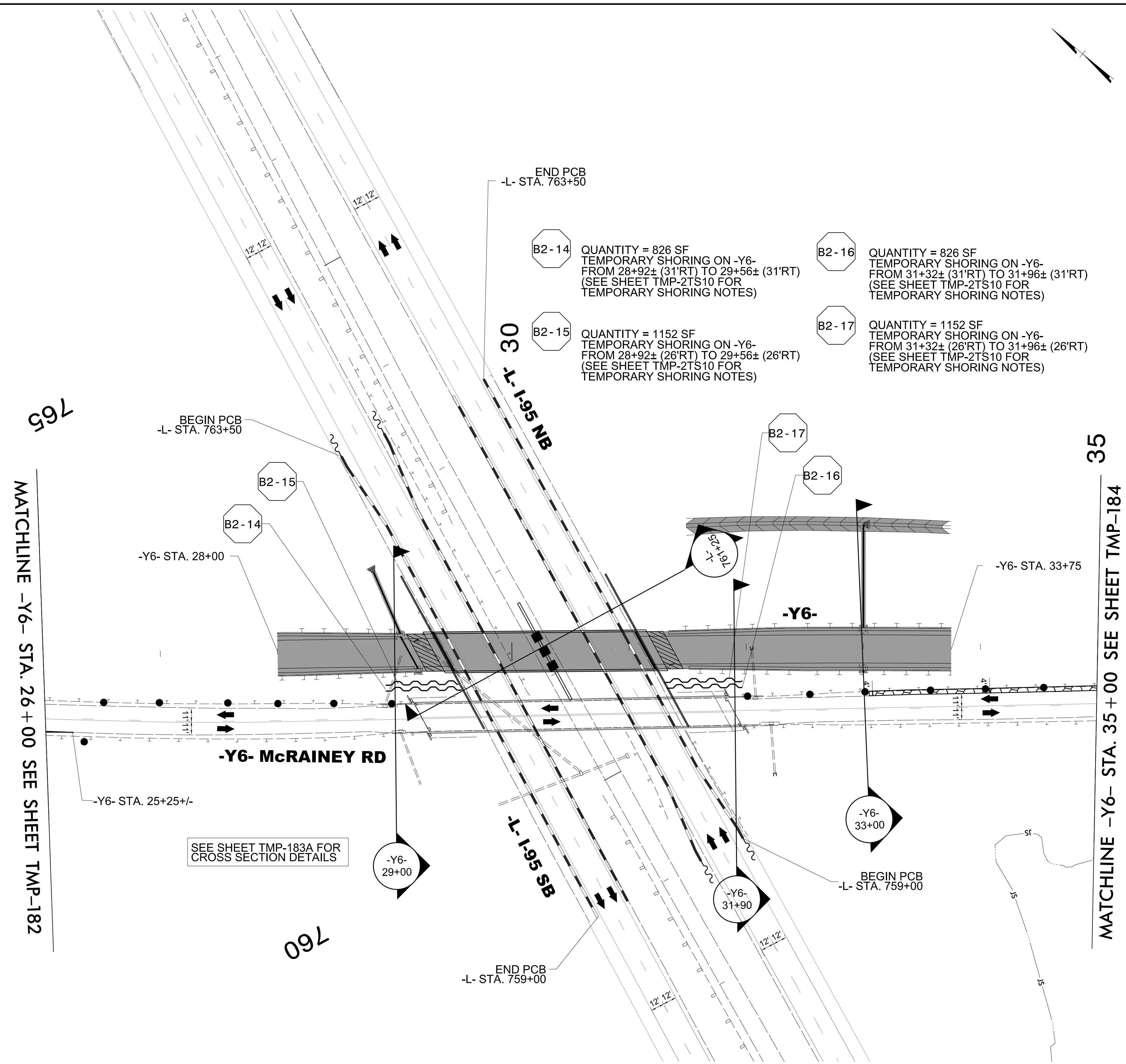

MATCHLINE -Y6- STA. 26 + 00 SEE SHEET TMP-182

MATCHLINE -Y6- STA. 35 + 00 SEE SHEET TMP-184

- B2-14 QUANTITY = 826 SF
TEMPORARY SHORING ON -Y6-
FROM 28+92± (31'RT) TO 29+56± (31'RT)
(SEE SHEET TMP-2TS10 FOR
TEMPORARY SHORING NOTES)
- B2-15 QUANTITY = 1152 SF
TEMPORARY SHORING ON -Y6-
FROM 28+92± (26'RT) TO 29+56± (26'RT)
(SEE SHEET TMP-2TS10 FOR
TEMPORARY SHORING NOTES)
- B2-16 QUANTITY = 826 SF
TEMPORARY SHORING ON -Y6-
FROM 31+32± (31'RT) TO 31+96± (31'RT)
(SEE SHEET TMP-2TS10 FOR
TEMPORARY SHORING NOTES)
- B2-17 QUANTITY = 1152 SF
TEMPORARY SHORING ON -Y6-
FROM 31+32± (26'RT) TO 31+96± (26'RT)
(SEE SHEET TMP-2TS10 FOR
TEMPORARY SHORING NOTES)

SEE SHEET TMP-183A FOR
CROSS SECTION DETAILS

Stantec
 Stantec Consulting Services Inc.
 801 Jones Franklin Road
 Suite 300
 Raleigh, NC 27606
 Tel. 919.851.6866
 Fax. 919.851.7024
 www.stantec.com
 License No. F-0672

DocuSigned by
 J.W. Woolard
 PROFESSIONAL
 SEAL
 19862
 ENGINEER
 J.W. WOOLARD, JR.
 4/29/2022
**DOCUMENT NOT CONSIDERED FINAL
 UNLESS ALL SIGNATURES COMPLETED**

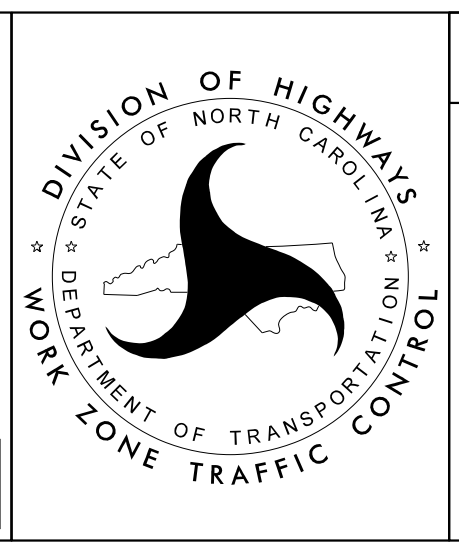

SECTION 2
 -Y6- McRAINEY RD
 PHASE I
 STEP 3A

3/15/2022
 U:\Traffic\Transportation Management\Plan\TCP\PLAN SHEETS\I-5987B_TMP-183_PHASE I_STEP 3A.dgn
 angood

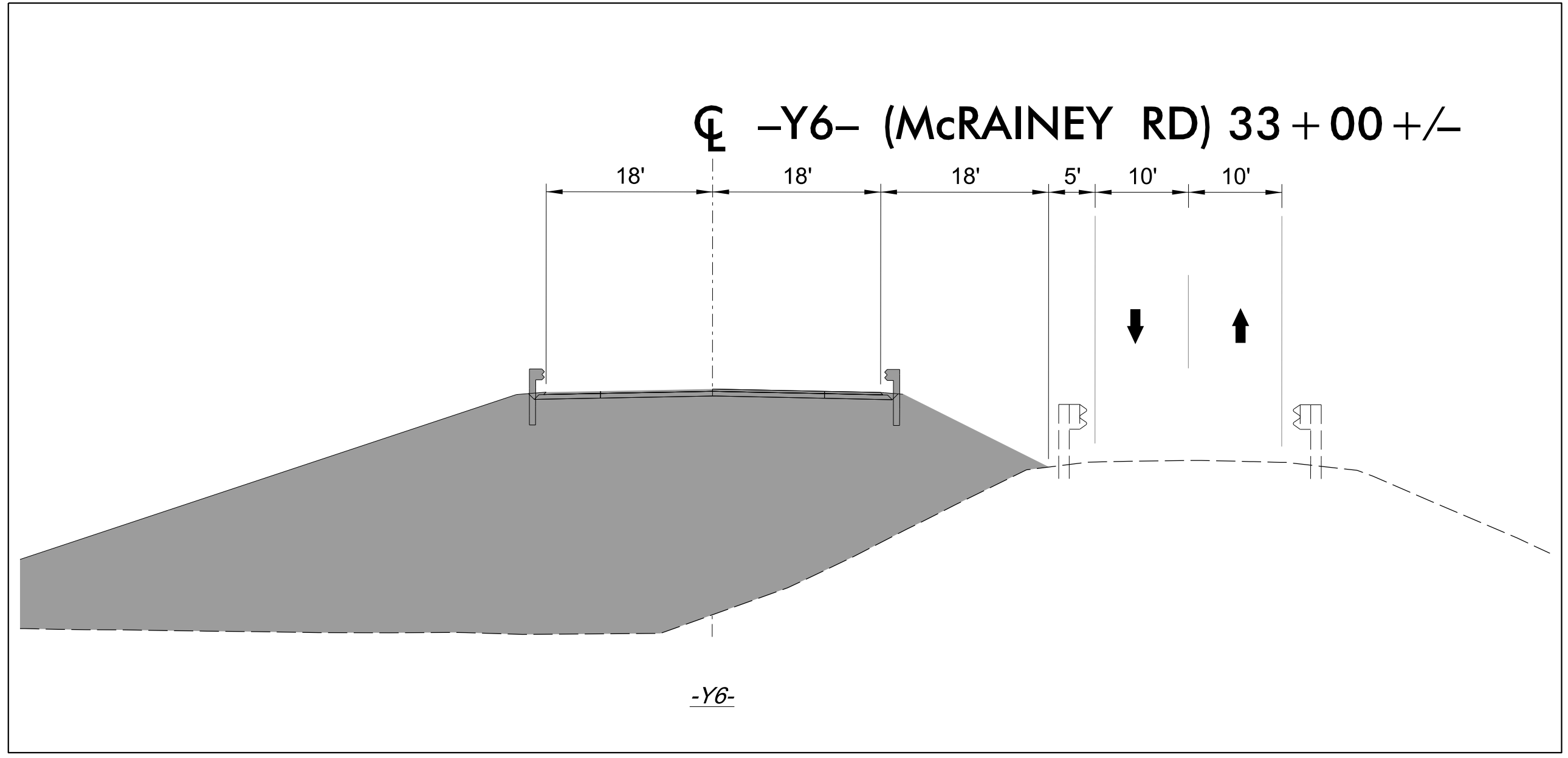
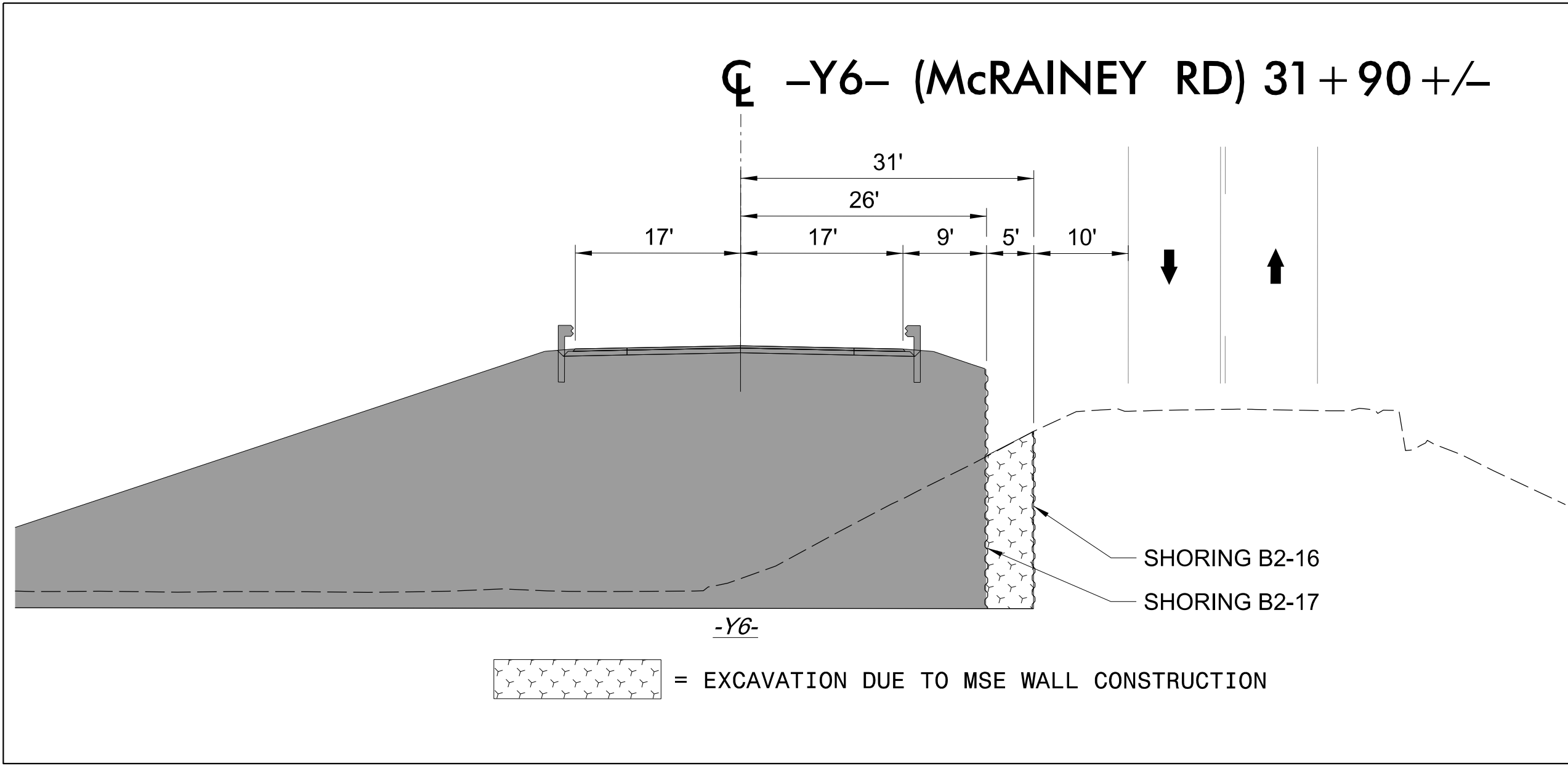
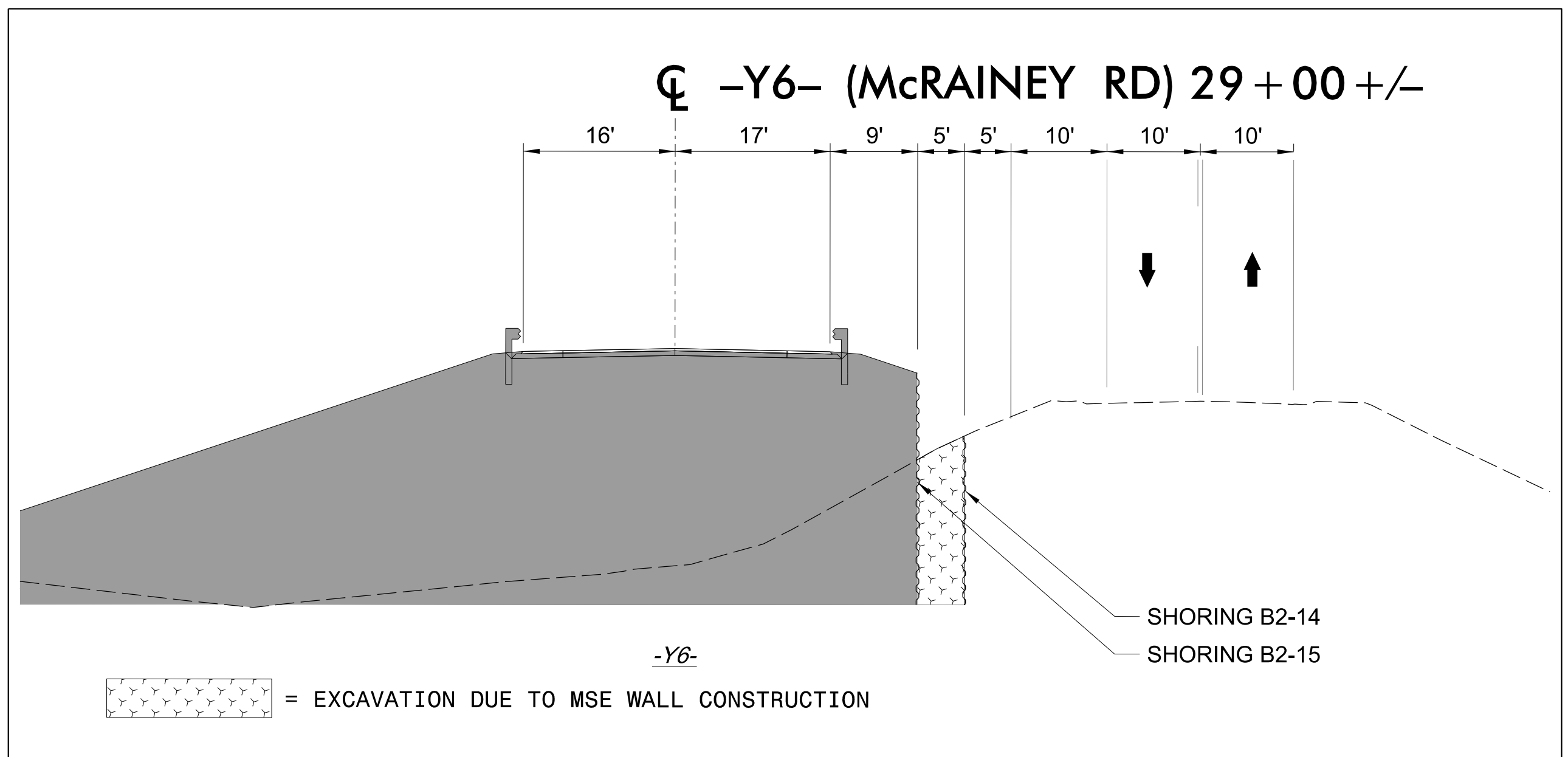
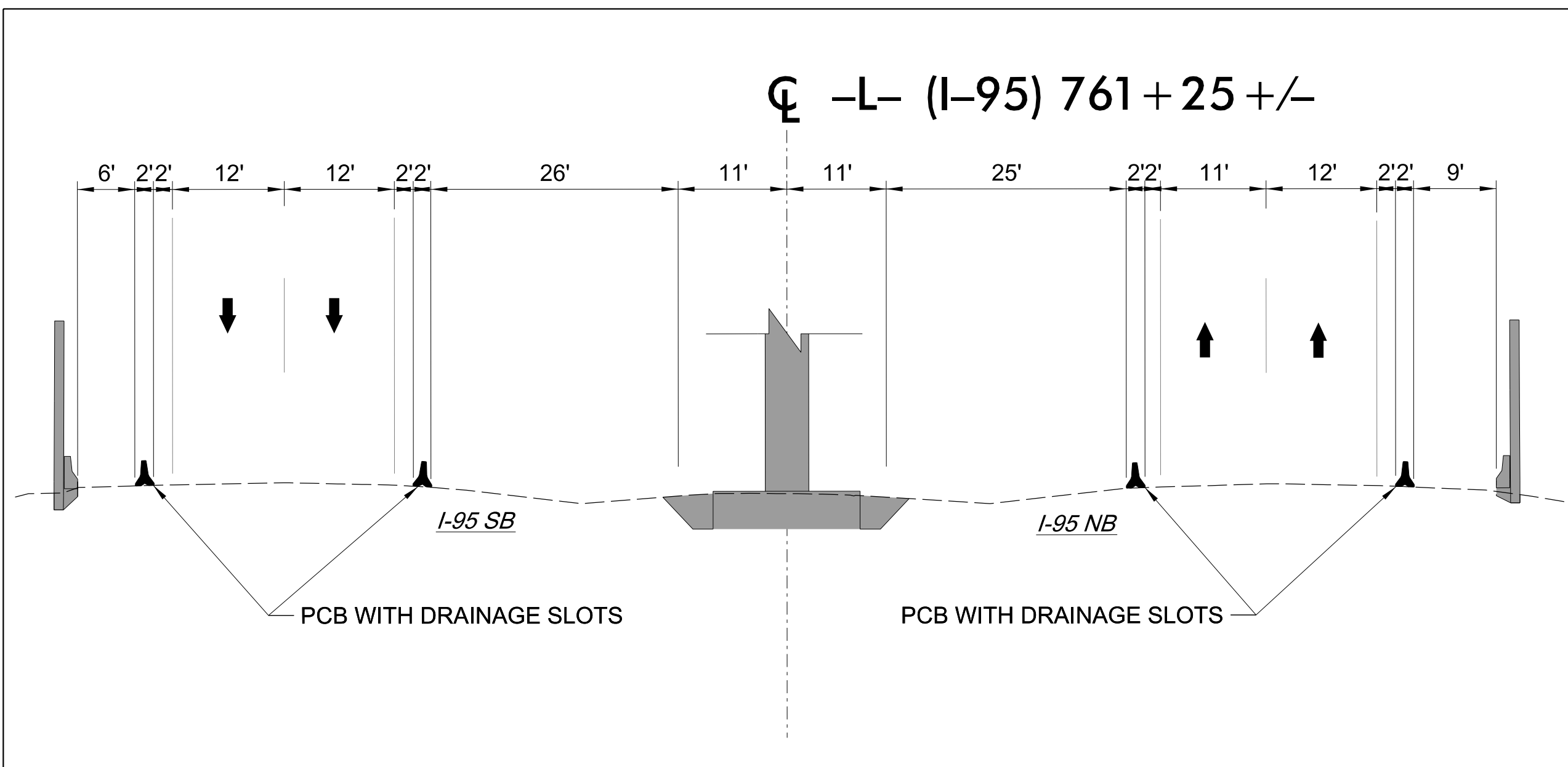

3/15/2022
U:\Traffic\Transportation Management\Plan\TCP\PLAN SHEETS\I-5987B_TMP_183A_PHASE I_STEP 3A.dgn
angood

<p>Stantec Consulting Services Inc. 801 Jones Franklin Road Suite 300 Raleigh, NC 27606 Tel. 919.851.6866 Fax. 919.851.7024 www.stantec.com License No. F-0672</p>	<p>DocuSigned by: J.W. Woollard, Jr. SBC02F49E556</p> <p>4/29/2022</p> <p>DOCUMENT NOT CONSIDERED FINAL UNLESS ALL SIGNATURES COMPLETED</p>	<p>DIVISION OF HIGHWAYS DEPARTMENT OF TRANSPORTATION WORK ZONE TRAFFIC CONTROL</p>	<p>SECTION 2</p> <p>-Y6- McRAINEY RD PHASE I STEP 3A</p>
------------------------------------------------------------------------------------------------------------------------------------------------------------------------------------------------	----------------------------------------------------------------------------------------------------------------------------------------------------------------	--------------------------------------------------------------------------------------------	--------------------------------------------------------------------------------

PROJ. REFERENCE NO.	SHEET NO.
I-5987B	TMP-184

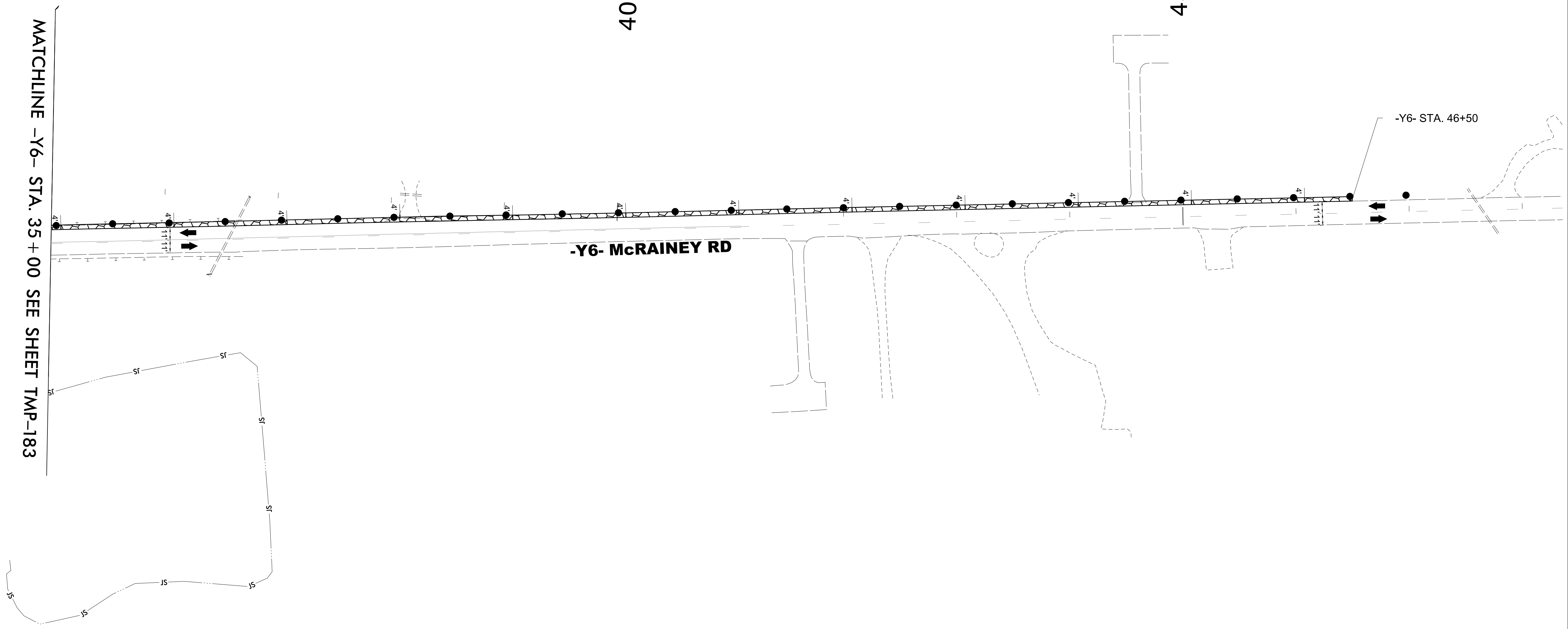
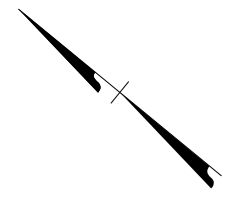

MATCHLINE -Y6- STA. 35+00 SEE SHEET TMP-183

3/15/2022
 U:\Traffic\Transportation Management\Plan\TCP\PLAN SHEETS\I-5987B_TMP-184_PHASE 1_STEP 3A.dgn
 angood

Stantec Consulting Services Inc.
 801 Jones Franklin Road
 Suite 300
 Raleigh, NC 27606
 Tel. 919.851.6866
 Fax. 919.851.7024
 www.stantec.com
 License No. F-0672

DocuSigned by:
 J.W. Woollard
 58C02F49E5656C

4/29/2022

**DOCUMENT NOT CONSIDERED FINAL
 UNLESS ALL SIGNATURES COMPLETED**

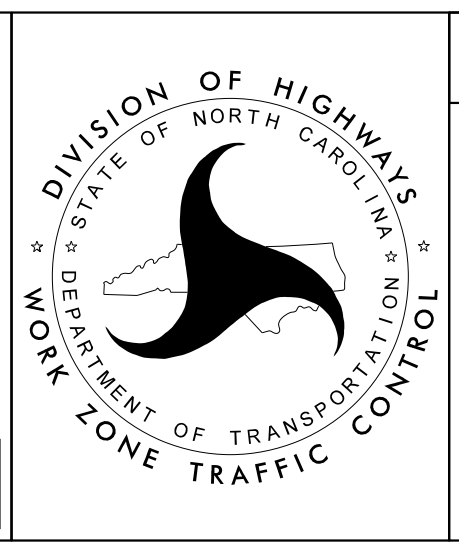

SECTION 2

-Y6- McRAINEY RD
 PHASE I
 STEP 3A

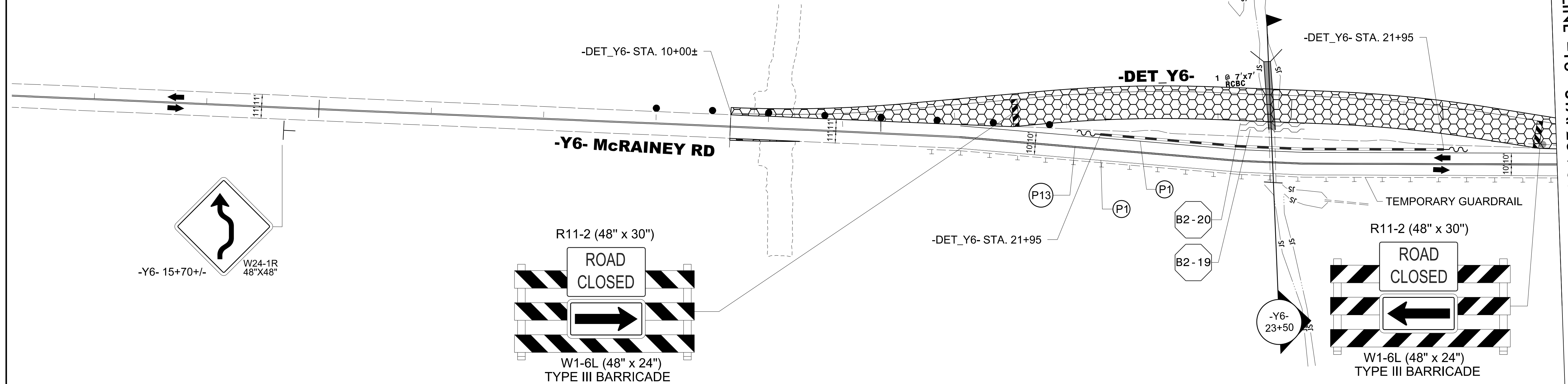
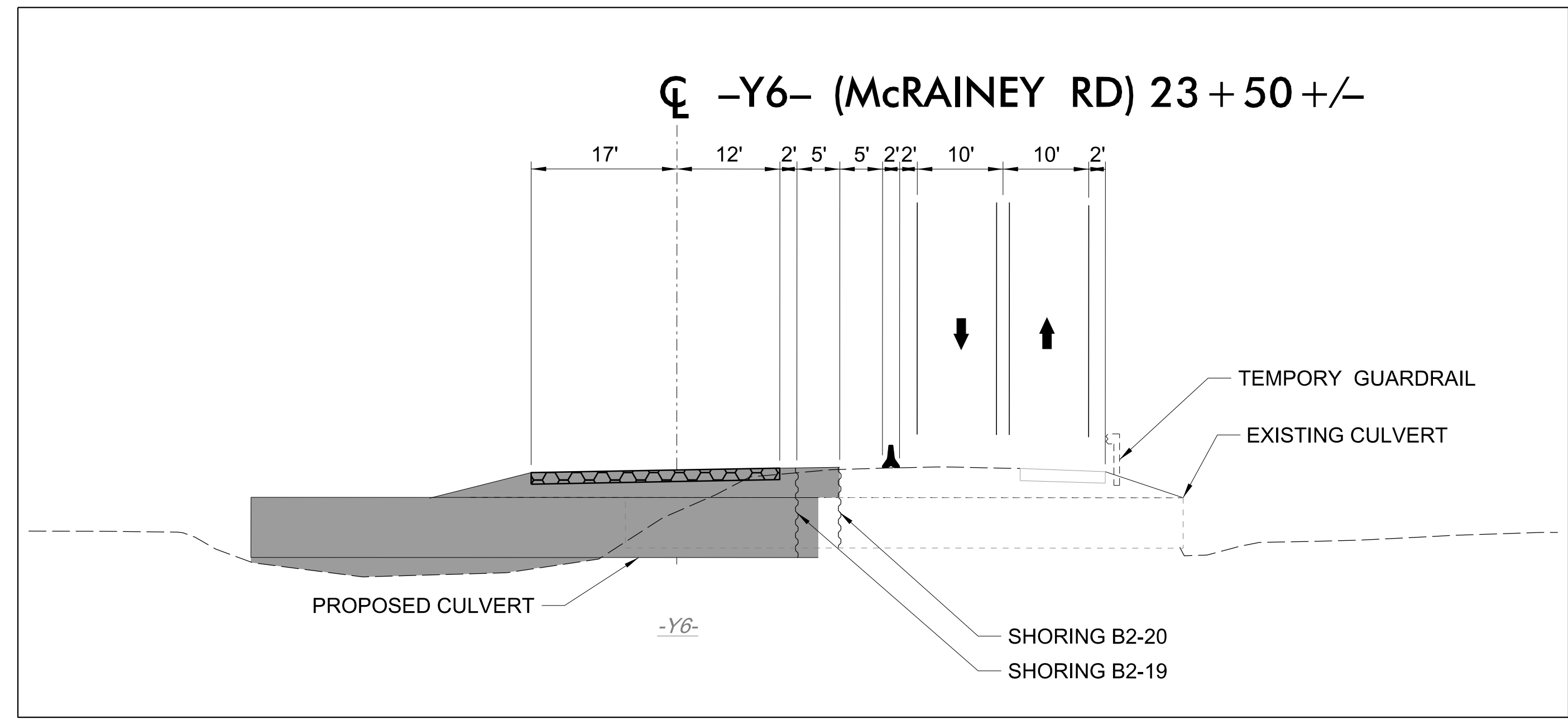

MATCHLINE -Y6- STA. 26 + 00 SEE SHEET TMP-186

B2-19 QUANTITY = 358 SF
 TEMPORARY SHORING ON -Y6-
 FROM 23+20+/- (19'RT) TO 23+76+/- (19'RT)
 (SEE SHEET TMP-2TS11 FOR
 TEMPORARY SHORING NOTES)

B2-20 QUANTITY = 319 SF
 TEMPORARY SHORING ON -Y6-
 FROM 23+20+/- (14'RT) TO 23+76+/- (14'RT)
 (SEE SHEET TMP-2TS11 FOR
 TEMPORARY SHORING NOTES)

3/15/2022
 U:\Traffic\Transportation Management\Plan\TCP\PLAN SHEETS\I-5987B_TMP-185_PHASE I_STEP 3B.dgn
 angood

Stantec
 Stantec Consulting Services Inc.
 801 Jones Franklin Road
 Suite 300
 Raleigh, NC 27606
 Tel. 919.851.6866
 Fax. 919.851.7024
 www.stantec.com
 License No. F-0672

DocuSigned by
 J.W. Woollard
 PROFESSIONAL
 SEAL
 19862
 ENGINEER
 J.W. WOOLLARD, JR.
 4/29/2022
**DOCUMENT NOT CONSIDERED FINAL
 UNLESS ALL SIGNATURES COMPLETED**

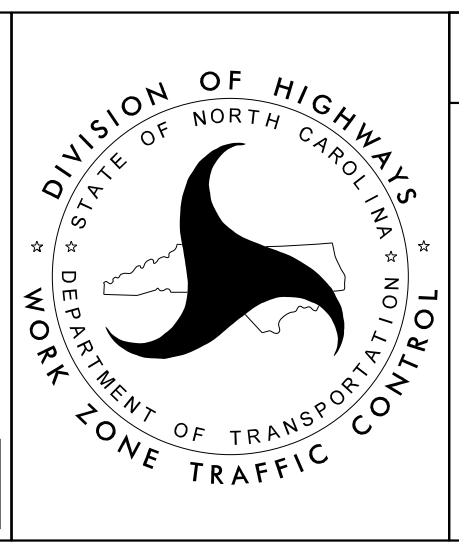

SECTION 2

-Y6- McRAINEY RD
 PHASE I
 STEPS 3B - 3D