

MATCHLINE -L- STA. 892 + 00 SEE SHEET TMP-257

MATCHLINE -L- STA. 7905 + 00 SEE SHEET TMP-259

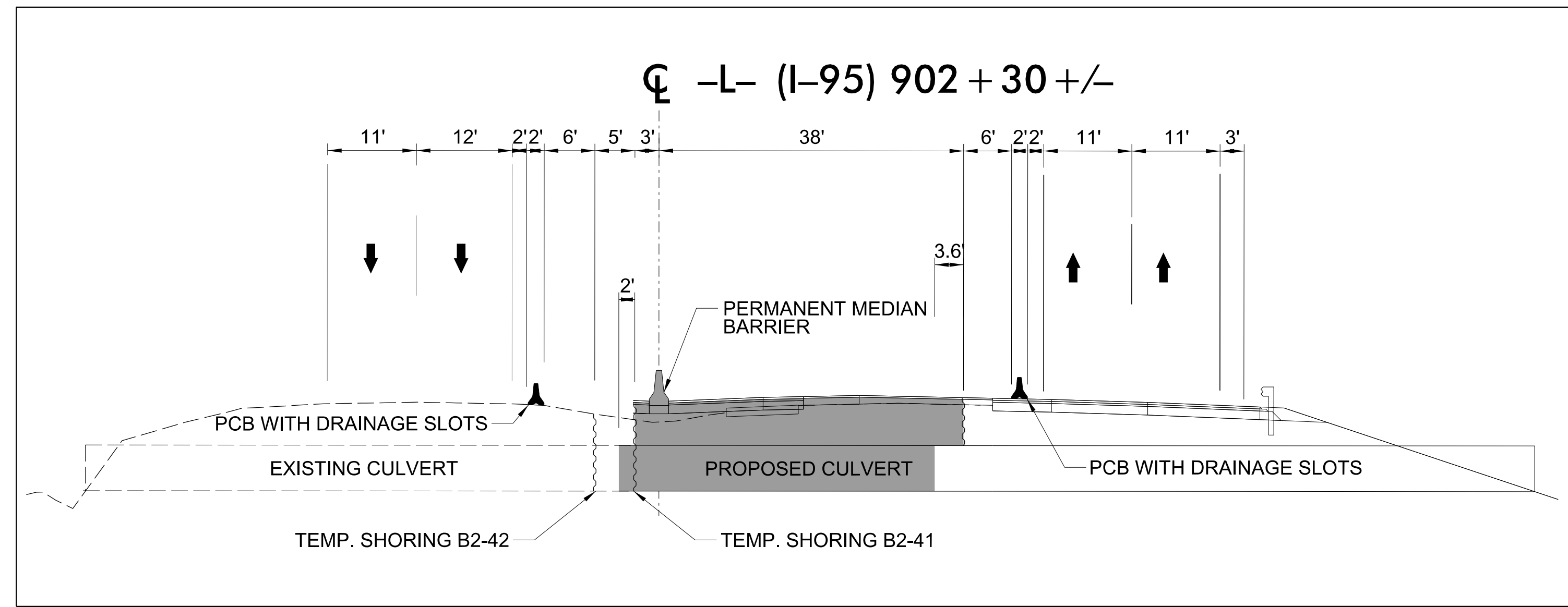

5/9/2022 U:\Traffic\Transportation Management Plan\TCP\PLAN SHEETS\VOL3\I-5987B_TMP-258_PHASE 3.dgn angood

Stantec

Stantec Consulting Services Inc.
801 Jones Franklin Road
Suite 300
Raleigh, NC 27606
Tel. 919.851.6866
Fax. 919.851.7024
www.stantec.com
License No. F-0672

DocuSigned by
J.W. Woollard
PROFESSIONAL
ENGINEER
19862
J.W. WOOLLARD, JR.

5/9/2022

**DOCUMENT NOT CONSIDERED FINAL
UNLESS ALL SIGNATURES COMPLETED**

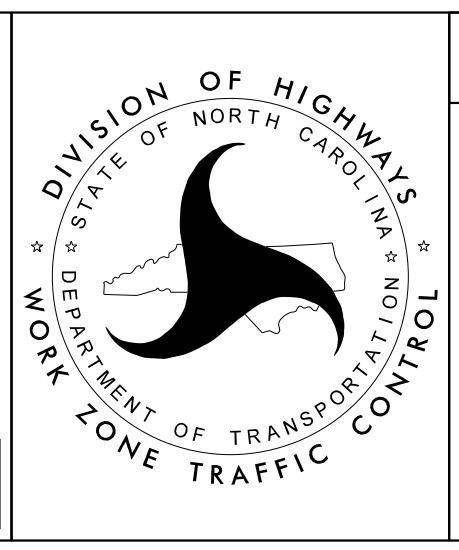

SECTION 2

**-L- I-95
PHASE III
STEPS 1B, 2B, 3**

PROJ. REFERENCE NO.	SHEET NO.
I-5987B	TMP-259



CONTRACTOR SHALL COORDINATE CONSTRUCTION WITH U-2519AA CONTRACTOR

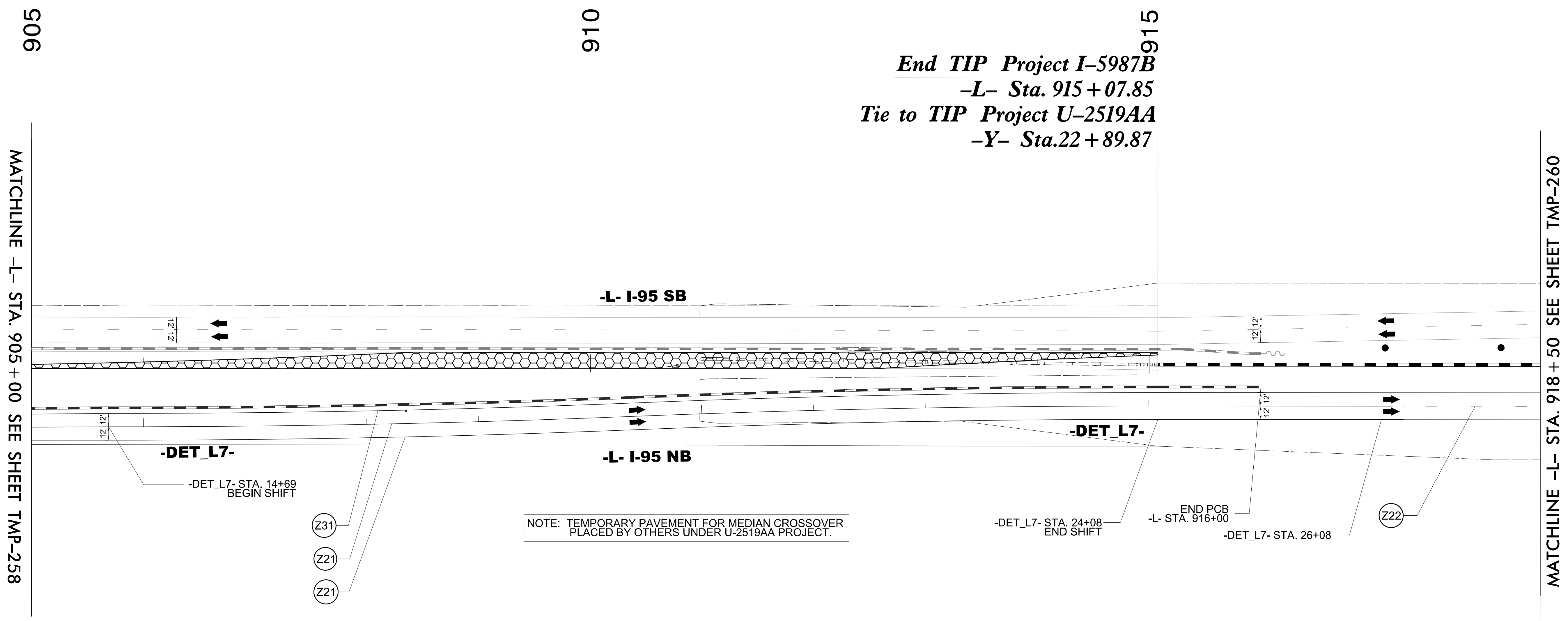

End TIP Project I-5987B
-L- Sta. 915 + 07.85
Tie to TIP Project U-2519AA
-Y- Sta. 22 + 89.87

MATCHLINE -L- STA. 905 + 00 SEE SHEET TMP-258

MATCHLINE -L- STA. 918 + 50 SEE SHEET TMP-260

4/19/2022
 U:\Traffic\Transportation Management\Plan\TCP\PLAN SHEETS\I-5987B_TMP-259_PHASE 3.dgn
 angood

Stantec
 Stantec Consulting Services Inc.
 801 Jones Franklin Road
 Suite 300
 Raleigh, NC 27606
 Tel. 919.851.6866
 Fax. 919.851.7024
 www.stantec.com
 License No. F-0672

DocuSigned by:
 J.W. Williams
 8B02F49E3E5C

4/29/2022

**DOCUMENT NOT CONSIDERED FINAL
 UNLESS ALL SIGNATURES COMPLETED**

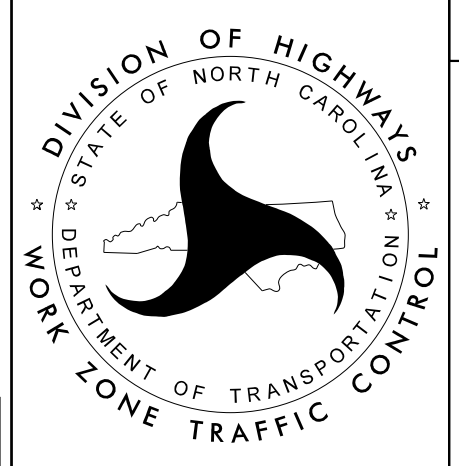
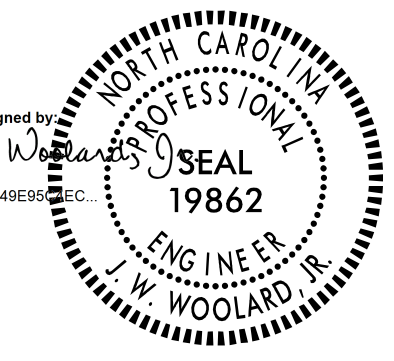

SECTION 2

**-L- I-95
 PHASE III
 STEPS 1B, 2B, 3**

PROJ. REFERENCE NO.	SHEET NO.
I-5987B	TMP-260



MATCHLINE -L- STA. 918 + 50 SEE SHEET TMP-259

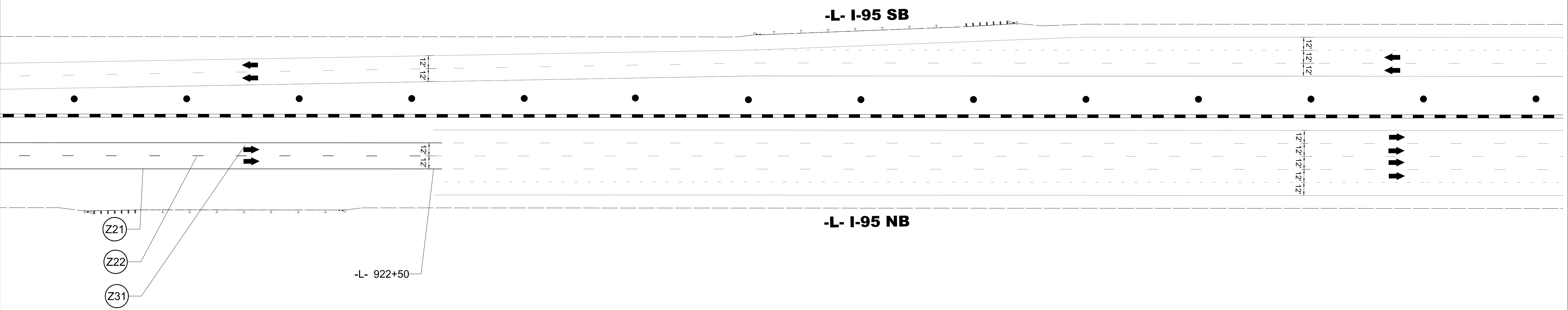

4/19/2022
 U:\Traffic\Transportation Management\Plan\TCP\PLAN SHEETS\I-5987B_TMP-260_PHASE 3.dgn
 angood

Stantec Consulting Services Inc.
 801 Jones Franklin Road
 Suite 300
 Raleigh, NC 27606
 Tel. 919.851.6866
 Fax. 919.851.7024
 www.stantec.com
 License No. F-0672

DocuSigned by:
 J.W. Woolard
 4/29/2022

**DOCUMENT NOT CONSIDERED FINAL
 UNLESS ALL SIGNATURES COMPLETED**

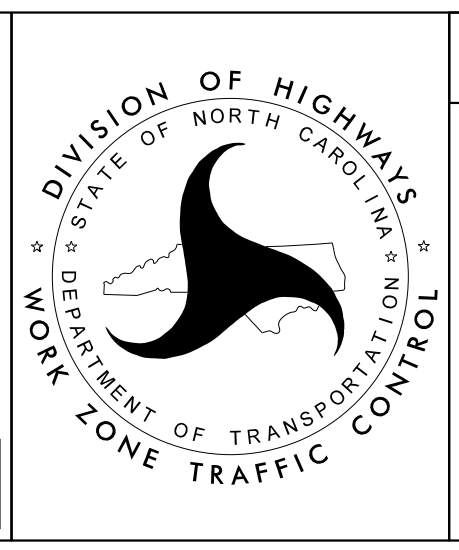

SECTION 2

-L- I-95
 PHASE III

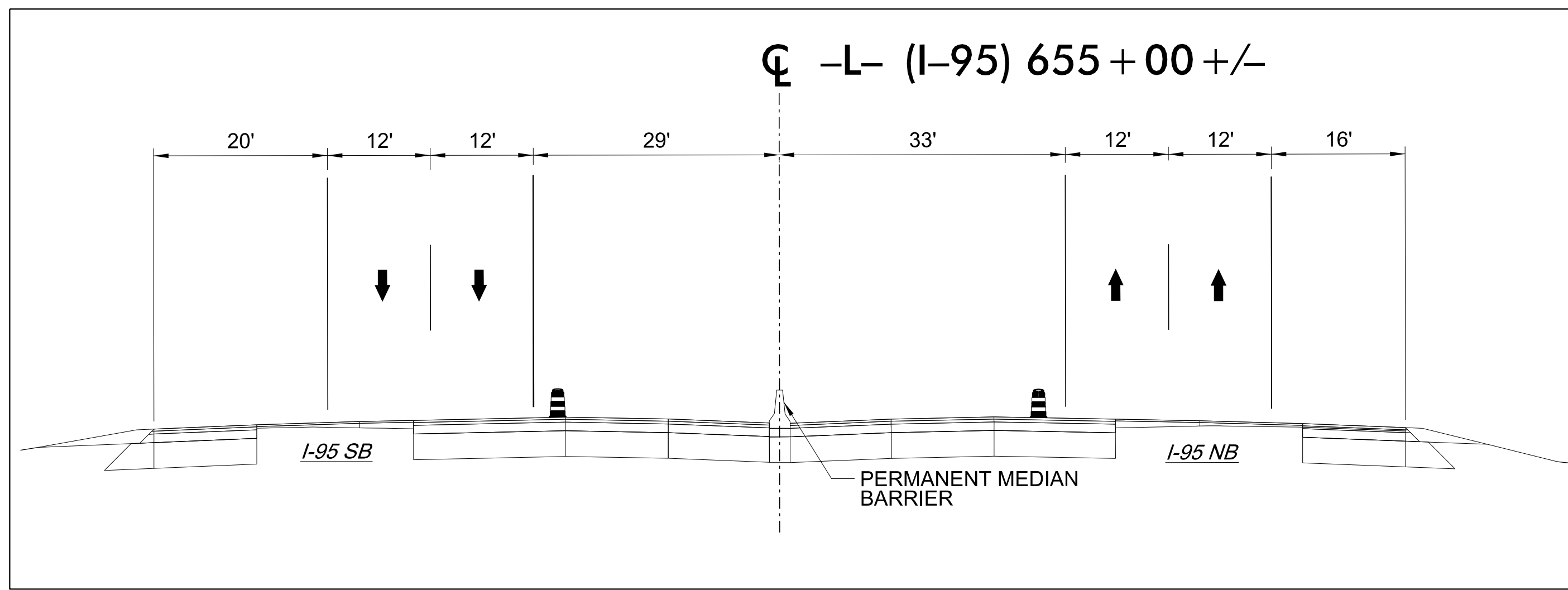

650

660

30

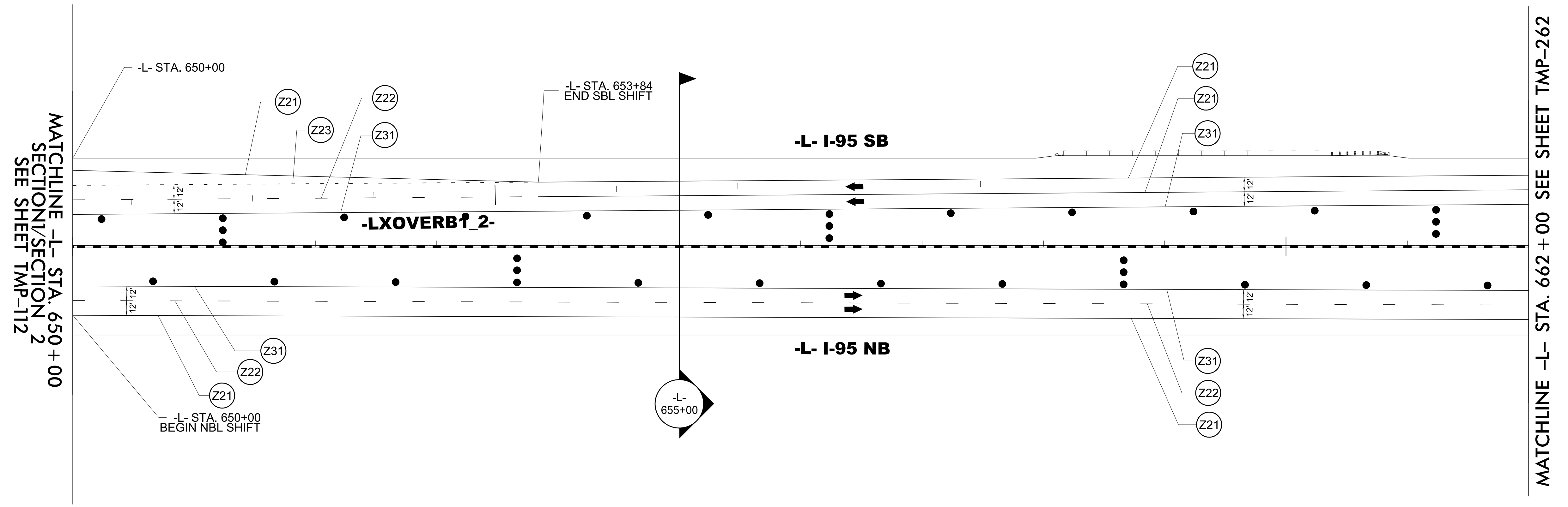

MATCHLINE -L- STA. 650 + 00
 SECTION 1/SECTION 2
 SEE SHEET TMP-112

MATCHLINE -L- STA. 662 + 00 SEE SHEET TMP-262

4/19/2022
 U:\Traffic\Transportation Management Plan\TCP\PLAN SHEETS\I-5987B_TMP-261_PHASE 4.dgn
 angood

Stantec Consulting Services Inc.
 801 Jones Franklin Road
 Suite 300
 Raleigh, NC 27606
 Tel. 919.851.6866
 Fax. 919.851.7024
 www.stantec.com
 License No. F-0672

4/29/2022

**DOCUMENT NOT CONSIDERED FINAL
 UNLESS ALL SIGNATURES COMPLETED**

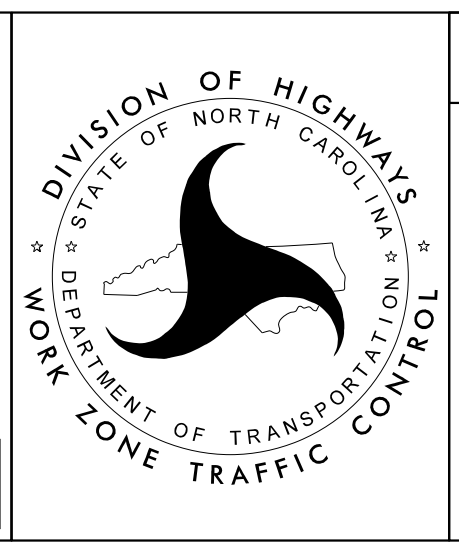

SECTION 2

-L- I-95
PHASE IV

PROJ. REFERENCE NO.	SHEET NO.
I-5987B	TMP-262

MATCHLINE -L- STA. 662 + 00 SEE SHEET TMP-261

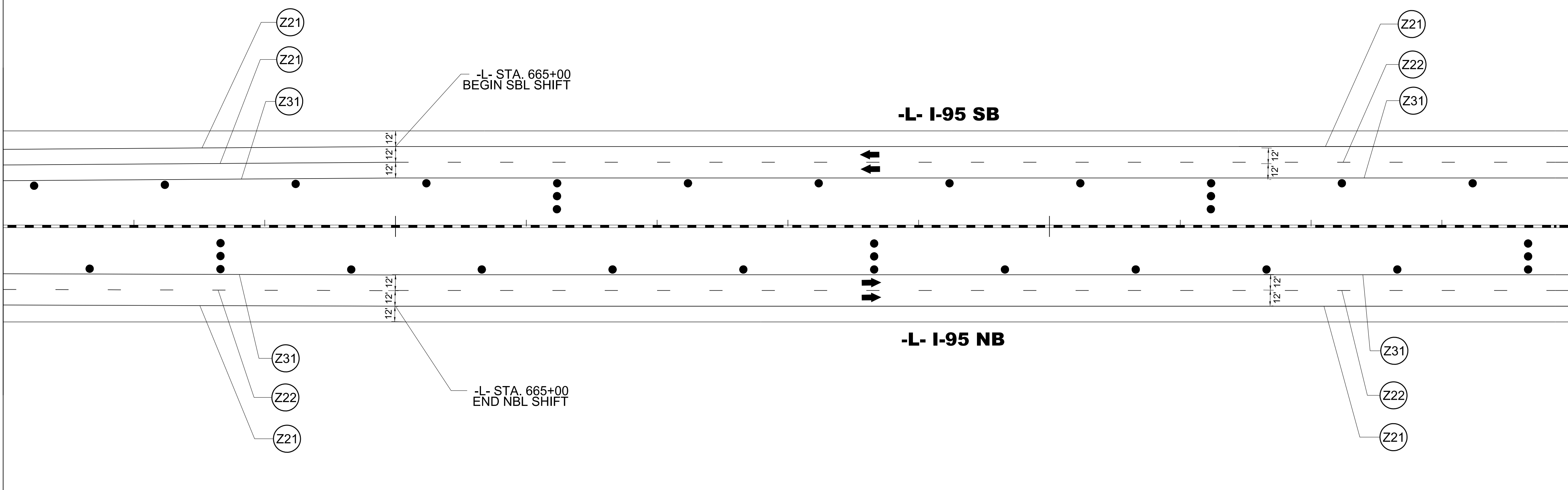

4/19/2022
U:\Traffic\Transportation Management Plan\TCP\PLAN SHEETS\I-5987B_TMP-262_PHASE 4.dgn
angood

Stantec
 Stantec Consulting Services Inc.
 801 Jones Franklin Road
 Suite 300
 Raleigh, NC 27606
 Tel. 919.851.6866
 Fax. 919.851.7024
 www.stantec.com
 License No. F-0672

DocuSigned by:
 J.W. Woolard
 BBO2F49E3E3C

4/29/2022

**DOCUMENT NOT CONSIDERED FINAL
 UNLESS ALL SIGNATURES COMPLETED**

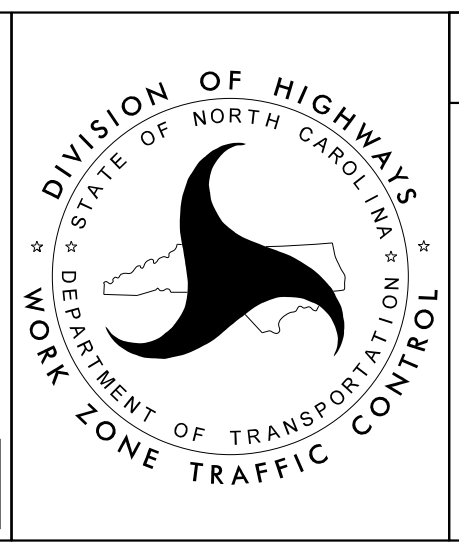

SECTION 2

-L- I-95
 PHASE IV

PROJ. REFERENCE NO.	SHEET NO.
I-5987B	TMP-263

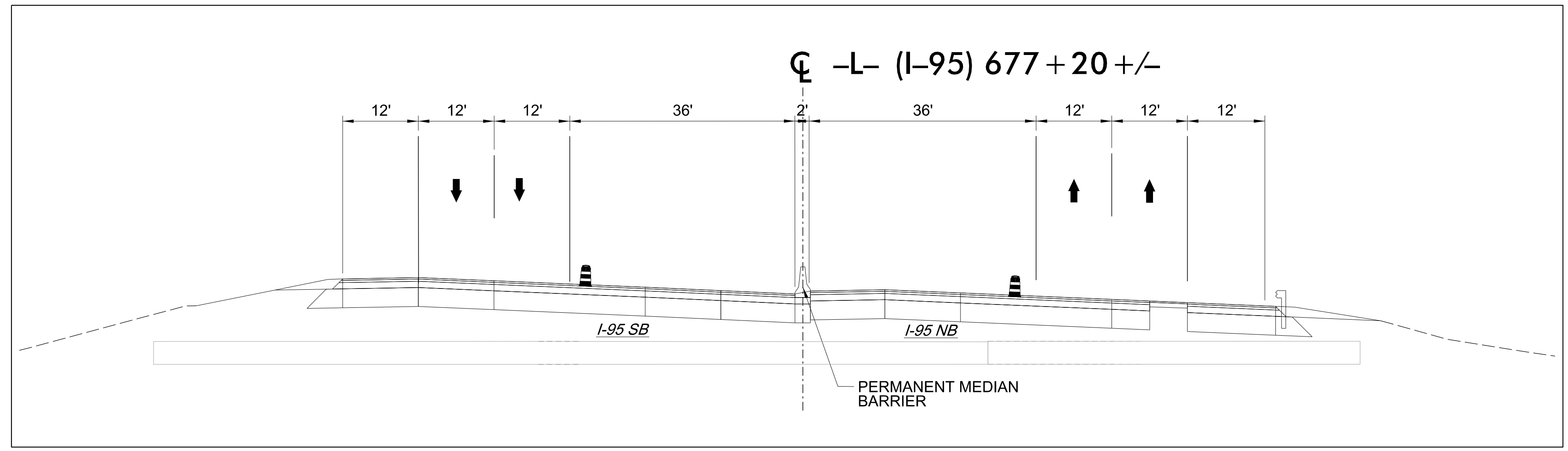

675

680

685

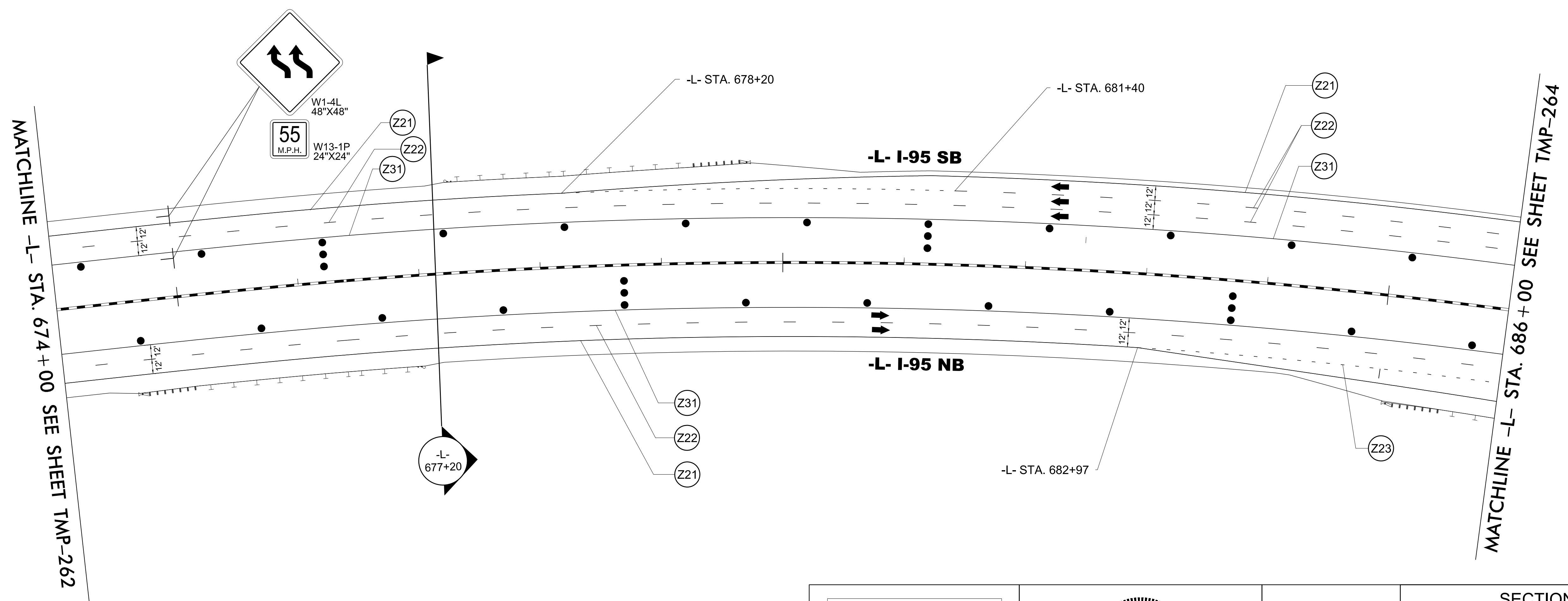

4/19/2022
L:\Traffic\Transportation Management Plan\TCP\PLAN SHEETS\I-5987B_TMP-263_PHASE 4.dgn
angood

Stantec
Stantec Consulting Services Inc.
801 Jones Franklin Road
Suite 300
Raleigh, NC 27606
Tel. 919.851.6866
Fax. 919.851.7024
www.stantec.com
License No. F-0672

DocuSigned by:
J.W. Woolard
4/29/2022

**DOCUMENT NOT CONSIDERED FINAL
UNLESS ALL SIGNATURES COMPLETED**

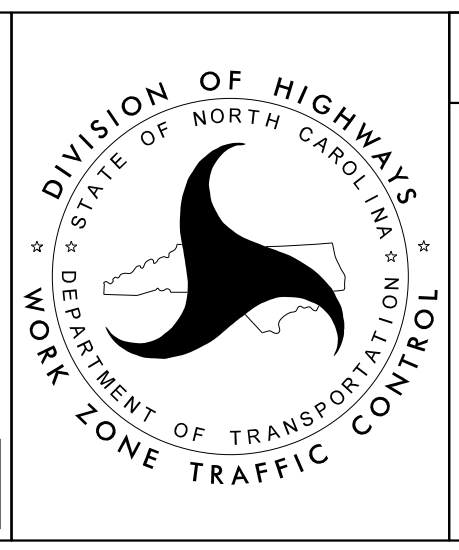

SECTION 2

-L- I-95
PHASE IV

PROJ. REFERENCE NO.	SHEET NO.
I-5987B	TMP-264

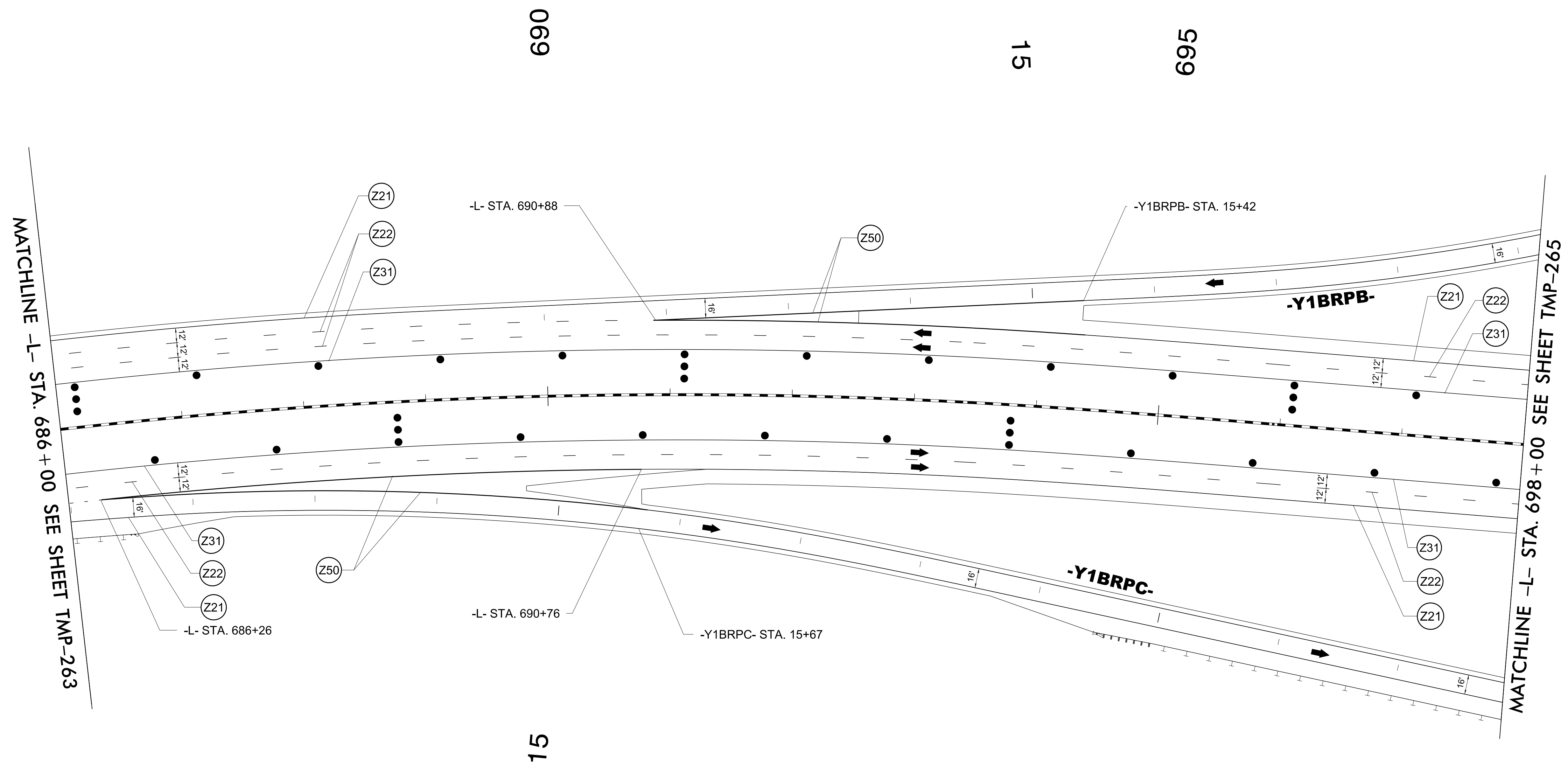
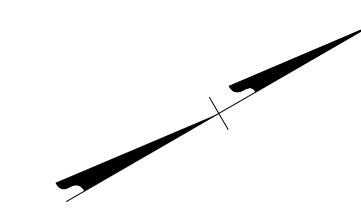

4/19/2022
 U:\Traffic\Transportation Management Plan\TCP\PLAN SHEETS\I-5987B_TMP-264_PHASE 4.dgn
 angood

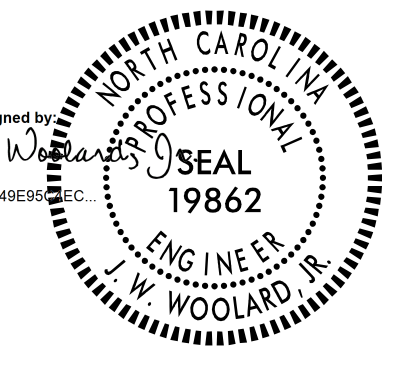

 Stantec Consulting Services Inc.
 801 Jones Franklin Road
 Suite 300
 Raleigh, NC 27606
 Tel. 919.851.6866
 Fax. 919.851.7024
 www.stantec.com
 License No. F-0672

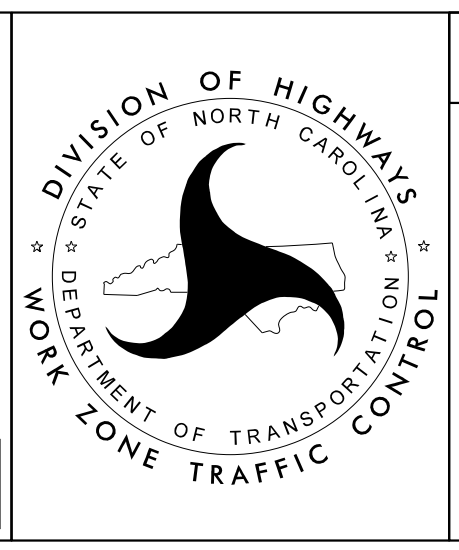
Documented by

 J.W. WOOLARD, P.E.
 4/29/2022
**DOCUMENT NOT CONSIDERED FINAL
 UNLESS ALL SIGNATURES COMPLETED**

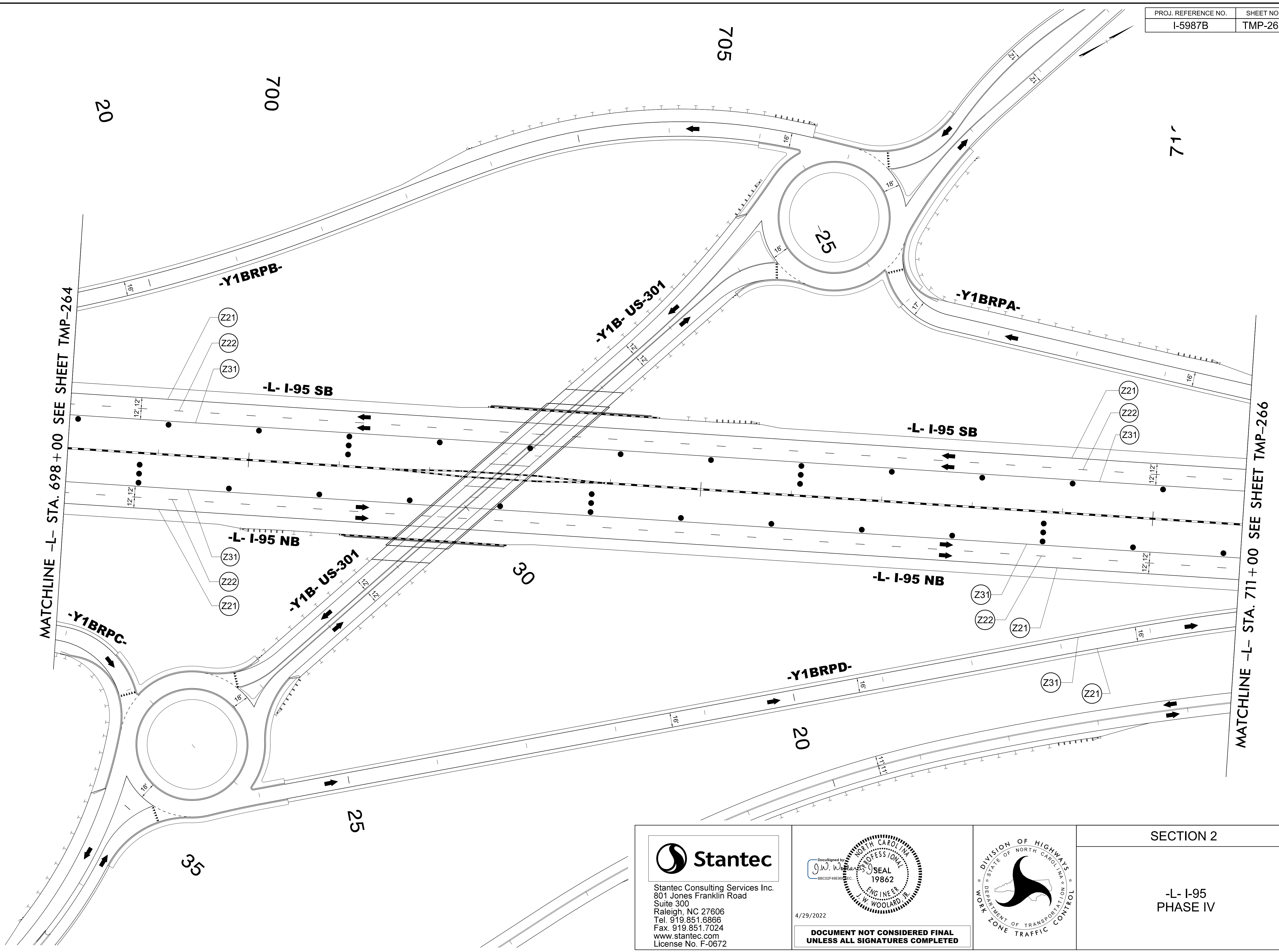

SECTION 2

-L- I-95
PHASE IV



4/19/2022
 U:\Traffic\Transportation Management Plan\TCP\PLAN SHEETS\I-5987B_TMP-265_PHASE 4.dgn
 angood

Stantec
 Stantec Consulting Services Inc.
 801 Jones Franklin Road
 Suite 300
 Raleigh, NC 27606
 Tel. 919.851.6866
 Fax. 919.851.7024
 www.stantec.com
 License No. F-0672

DocuSigned by:
 J.W. Woolard
 BB02F49E8378C

4/29/2022

**DOCUMENT NOT CONSIDERED FINAL
 UNLESS ALL SIGNATURES COMPLETED**

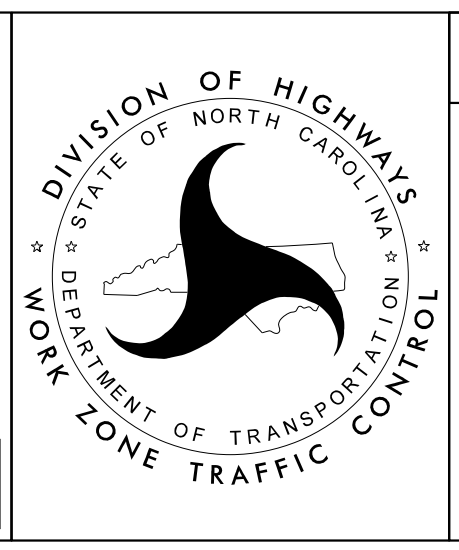

SECTION 2

**-L- I-95
 PHASE IV**

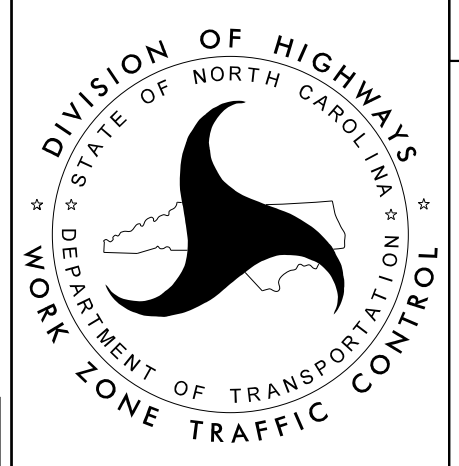

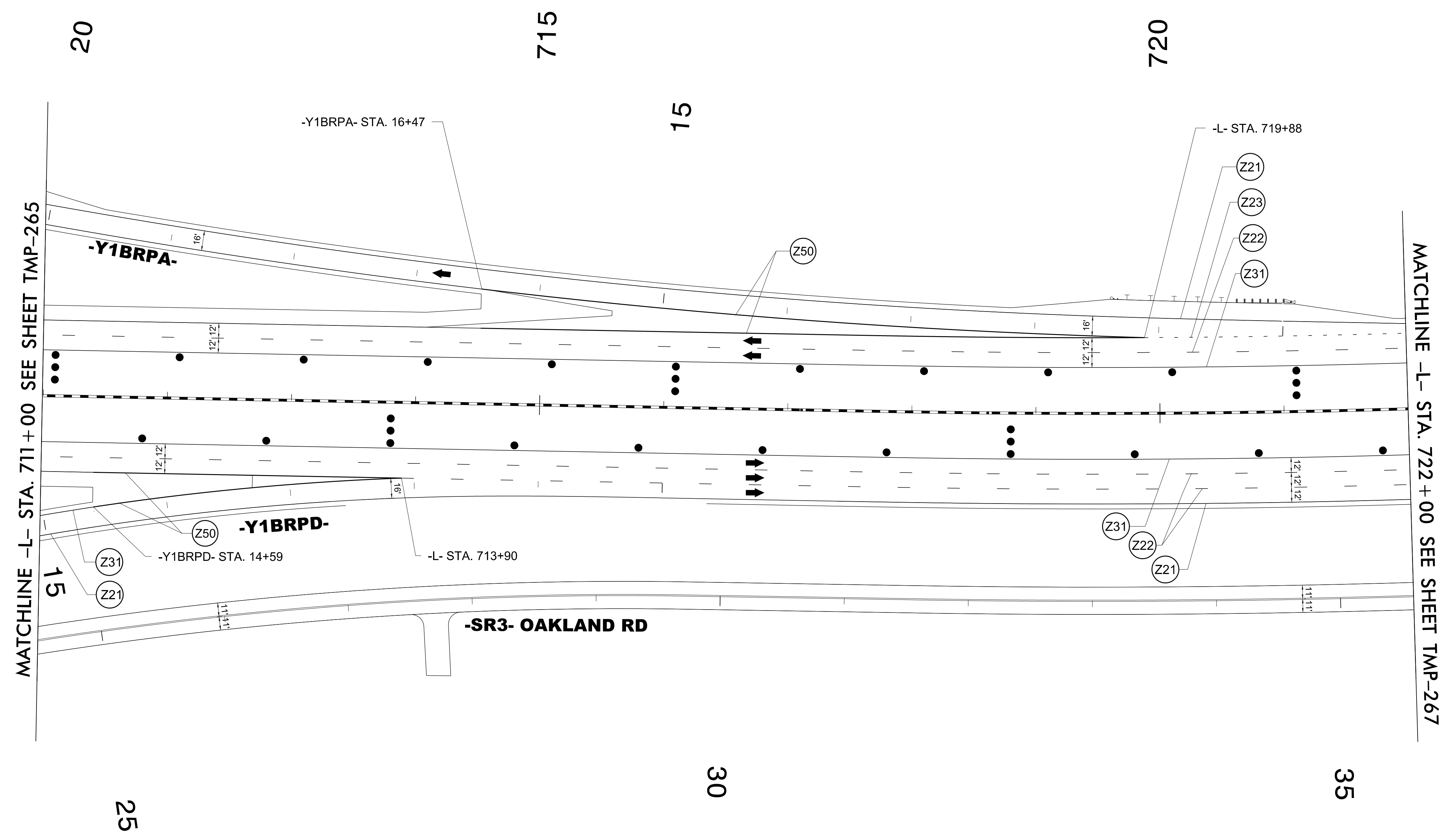
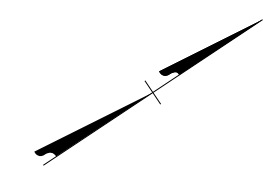

Stantec Consulting Services Inc.
801 Jones Franklin Road
Suite 300
Raleigh, NC 27606
Tel. 919.851.6866
Fax. 919.851.7024
www.stantec.com
License No. F-0672

DocuSigned by:
J.W. Williams
BBOC2F49E93E13C

4/29/2022

**DOCUMENT NOT CONSIDERED FINAL
UNLESS ALL SIGNATURES COMPLETED**

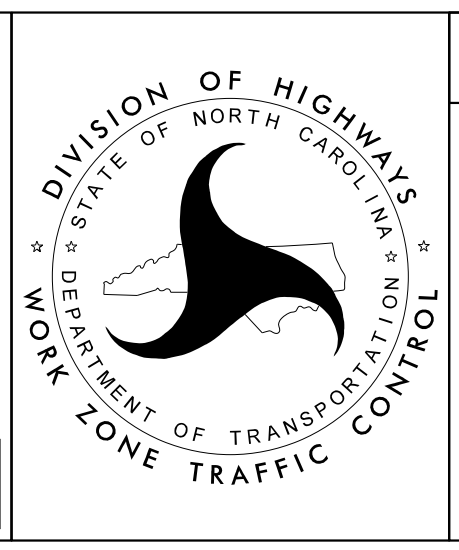

SECTION 2

-L- I-95
PHASE IV

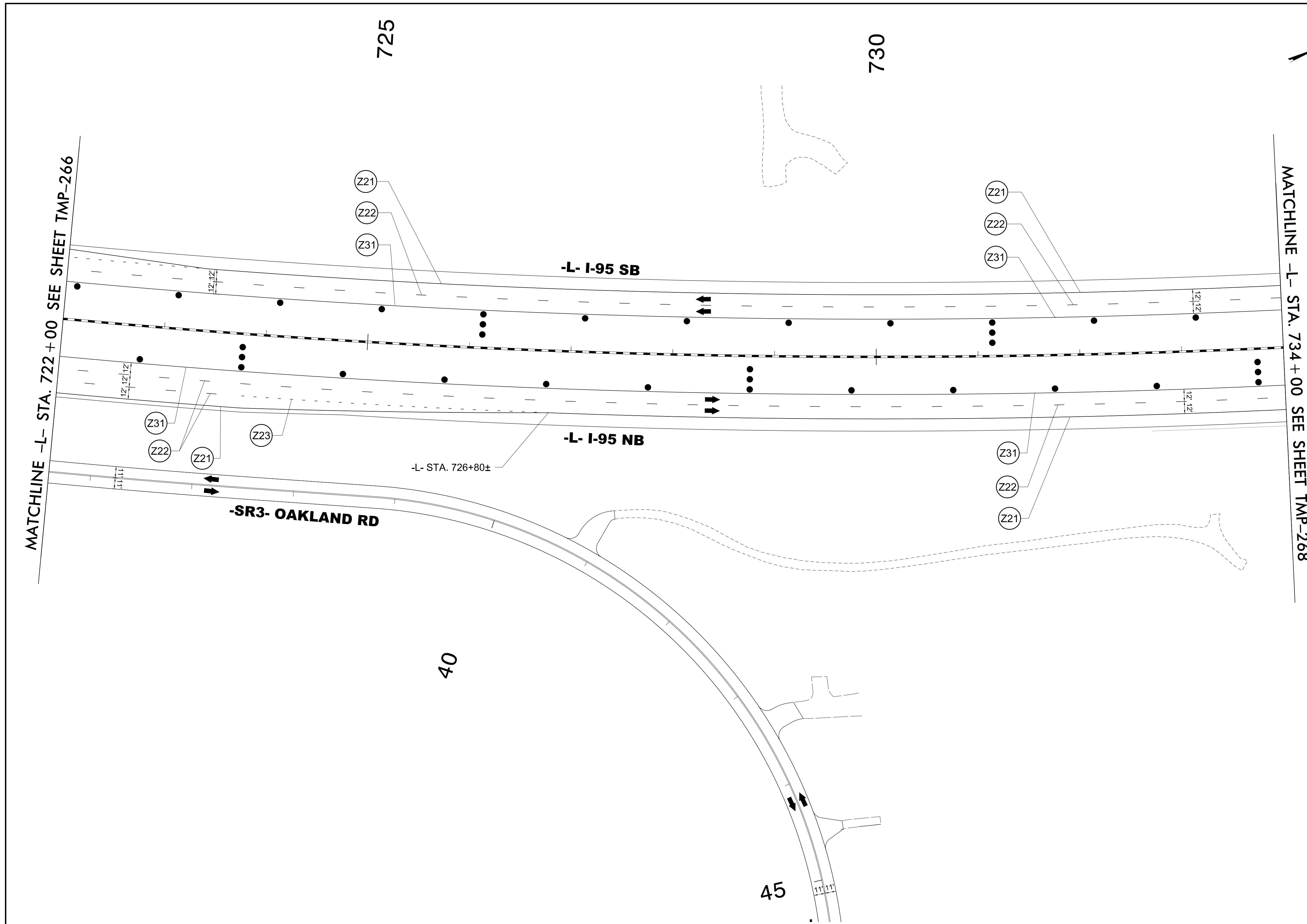
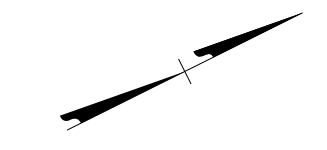

4/19/2022
U:\Traffic\Transportation Management Plan\TCP\PLAN SHEETS\I-5987B_TMP-267_PHASE 4.dgn
angood

Stantec Consulting Services Inc.
801 Jones Franklin Road
Suite 300
Raleigh, NC 27606
Tel. 919.851.6866
Fax. 919.851.7024
www.stantec.com
License No. F-0672

DocuSigned by:
J.W. Woolard
4/29/2022

**DOCUMENT NOT CONSIDERED FINAL
UNLESS ALL SIGNATURES COMPLETED**

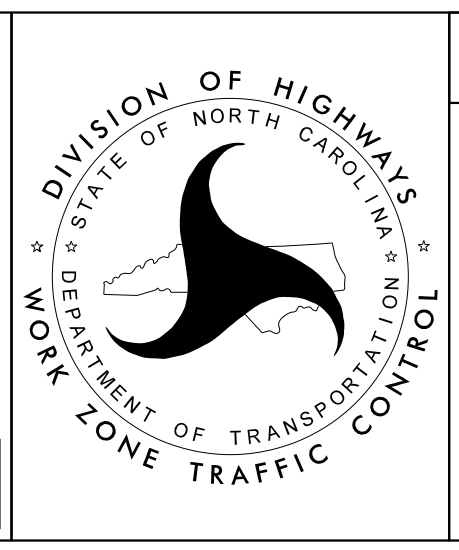

SECTION 2

-L- I-95
PHASE IV

PROJ. REFERENCE NO.	SHEET NO.
I-5987B	TMP-268

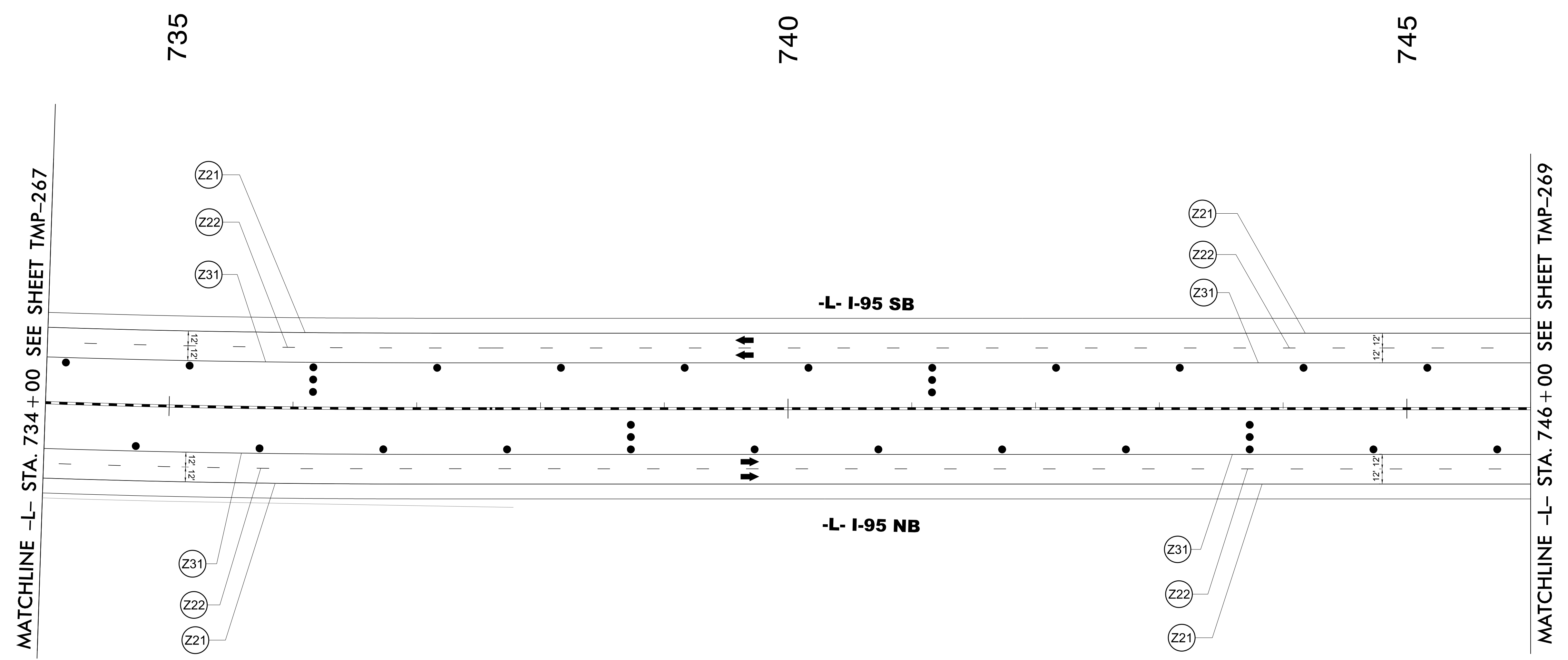
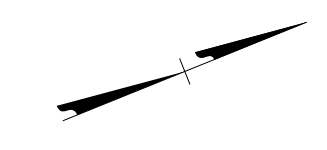

4/19/2022
 U:\Traffic\Transportation Management Plan\TCP\PLAN SHEETS\I-5987B_TMP-268_PHASE 4.dgn
 angood

Stantec Consulting Services Inc.
 801 Jones Franklin Road
 Suite 300
 Raleigh, NC 27606
 Tel. 919.851.6866
 Fax. 919.851.7024
 www.stantec.com
 License No. F-0672

4/29/2022

**DOCUMENT NOT CONSIDERED FINAL
UNLESS ALL SIGNATURES COMPLETED**

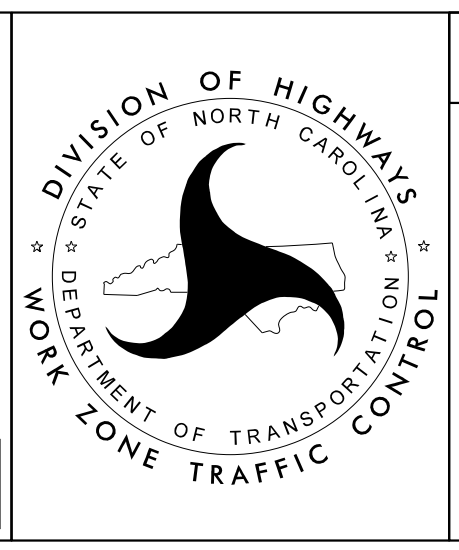

SECTION 2

-L- I-95
PHASE IV

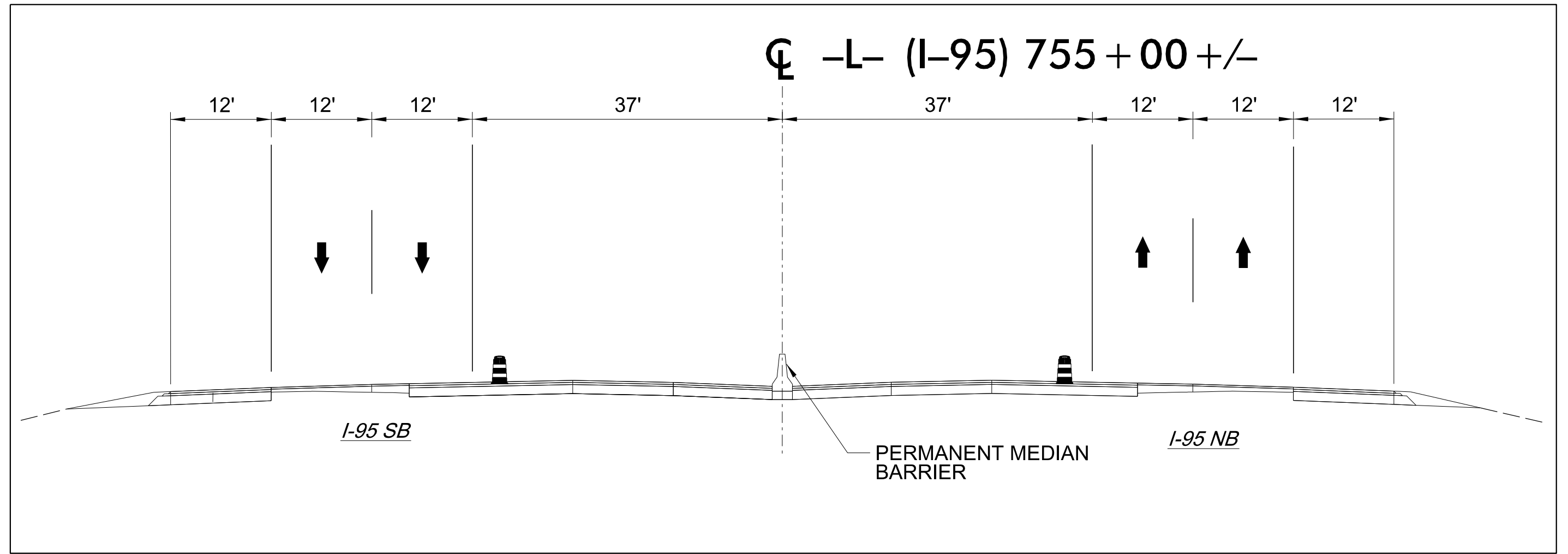
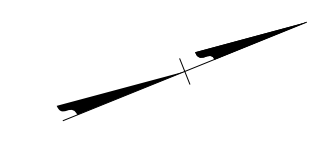

755

MATCHLINE -L- STA. 746 + 00 SEE SHEET TMP-268

MATCHLINE -L- STA. 755 + 00 SEE SHEET TMP-270

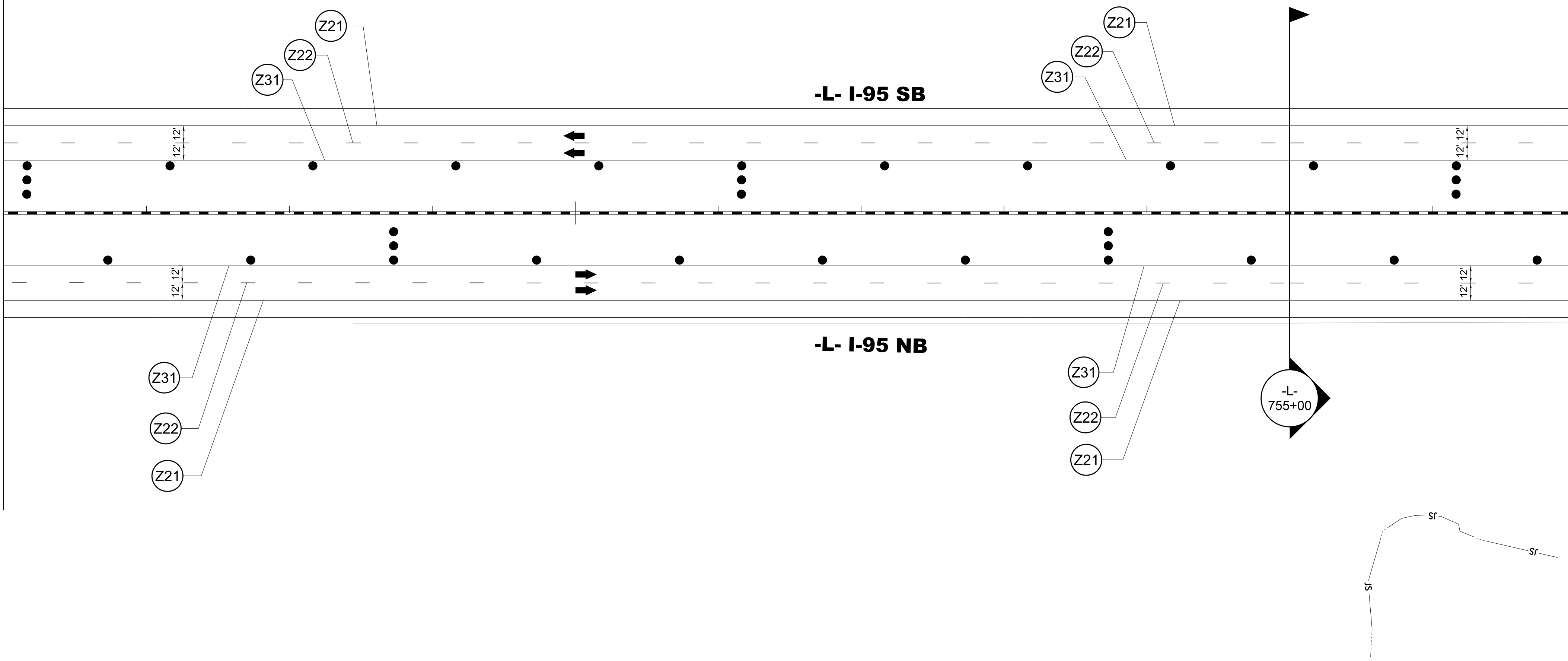

4/19/2022
U:\Traffic\Transportation Management Plan\TCP\PLAN SHEETS\I-5987B_TMP-269_PHASE 4.dgn
angood

Stantec Consulting Services Inc.
801 Jones Franklin Road
Suite 300
Raleigh, NC 27606
Tel. 919.851.6866
Fax. 919.851.7024
www.stantec.com
License No. F-0672

DocuSigned by:
J.W. Woolard
SEAL
19862
ENGINEER
J.W. WOOLARD, JR.
4/29/2022
DOCUMENT NOT CONSIDERED FINAL
UNLESS ALL SIGNATURES COMPLETED

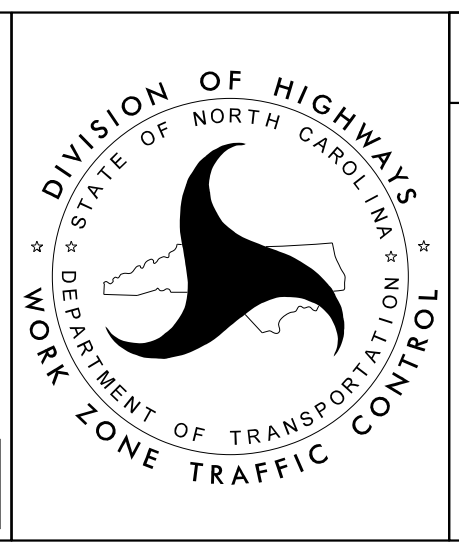

SECTION 2

-L- I-95
PHASE IV

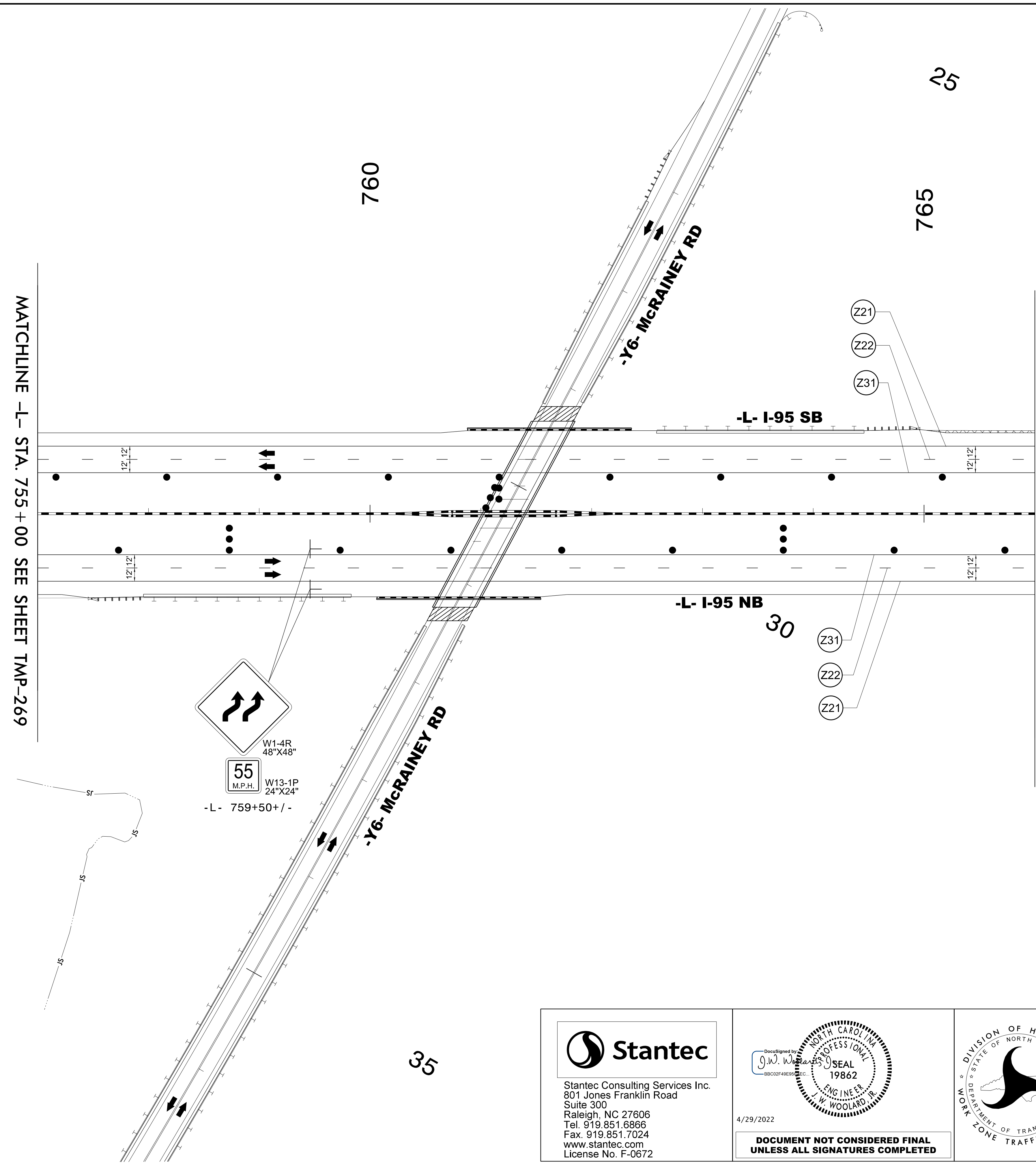
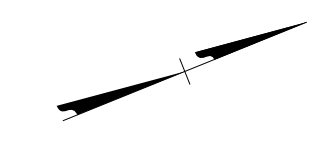

MATCHLINE -L- STA. 755 + 00 SEE SHEET TMP-269

MATCHLINE -L- STA. 766 + 00 SEE SHEET TMP-271

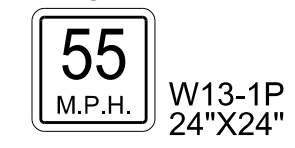
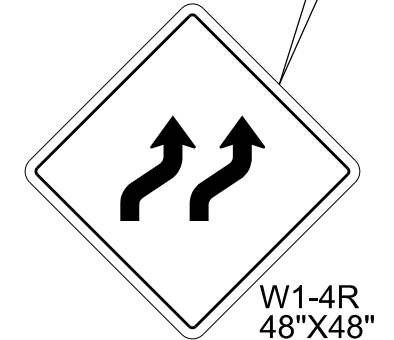

-L- 759+50+/-

4/19/2022
U:\Traffic\Transportation Management\Plan\TCP\PLAN SHEETS\I-5987B_TMP-270_PHASE 4.dgn
angood

Stantec Consulting Services Inc.
801 Jones Franklin Road
Suite 300
Raleigh, NC 27606
Tel. 919.851.6866
Fax. 919.851.7024
www.stantec.com
License No. F-0672

DocuSigned by:
J.W. Woolard
4/29/2022

**DOCUMENT NOT CONSIDERED FINAL
UNLESS ALL SIGNATURES COMPLETED**

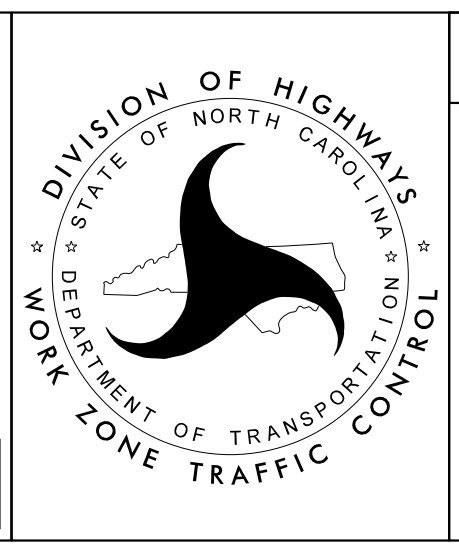

SECTION 2

-L- I-95
PHASE IV

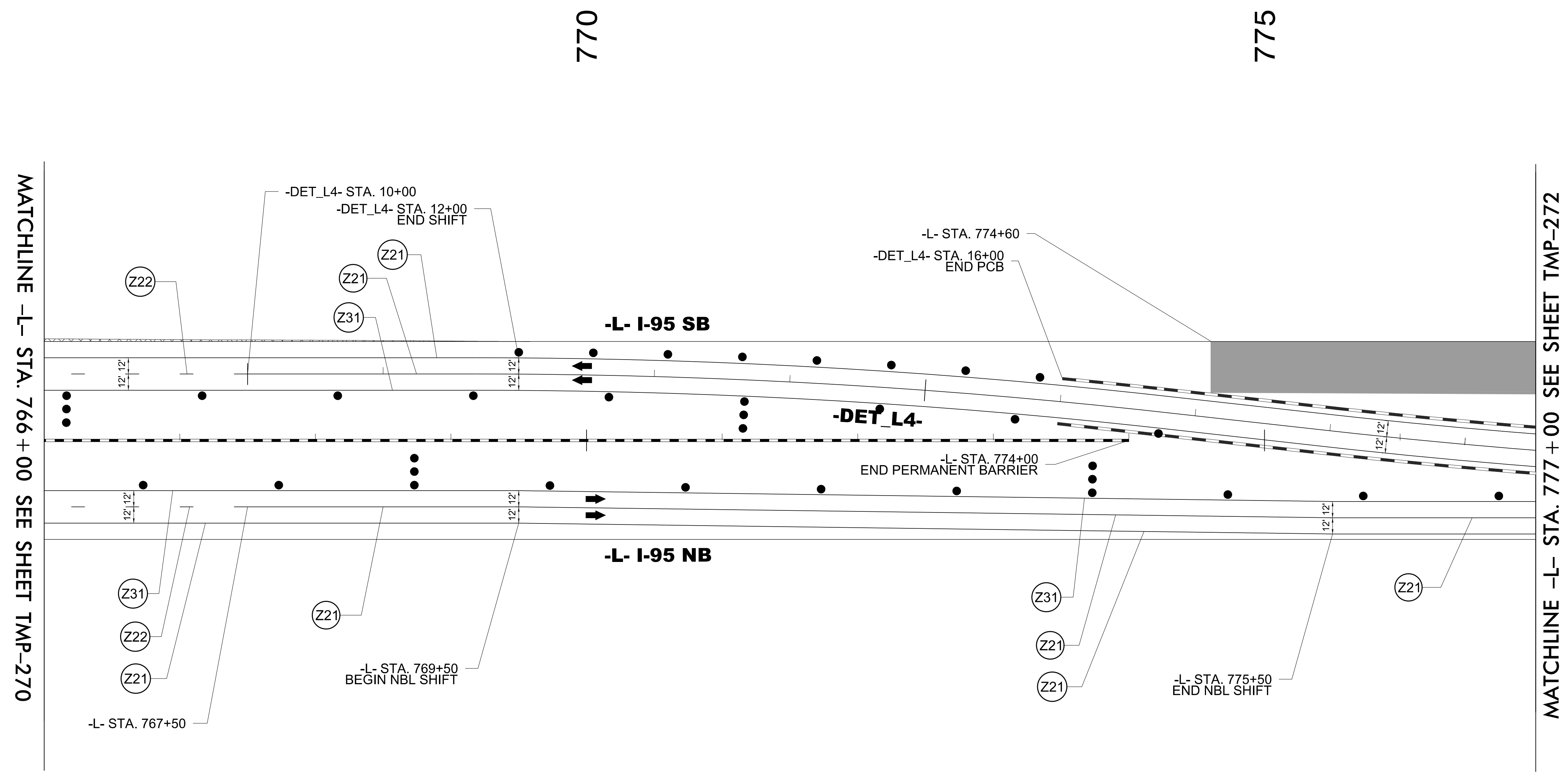

4/19/2022
U:\Traffic\Transportation Management Plan\TCP\PLAN SHEETS\I-5987B_TMP-271_PHASE 4.dgn
angood

Stantec
 Stantec Consulting Services Inc.
 801 Jones Franklin Road
 Suite 300
 Raleigh, NC 27606
 Tel. 919.851.6866
 Fax. 919.851.7024
 www.stantec.com
 License No. F-0672

DocuSigned by:
 J.W. Woolard
 BBOC2F49E93E3C

4/29/2022

**DOCUMENT NOT CONSIDERED FINAL
 UNLESS ALL SIGNATURES COMPLETED**

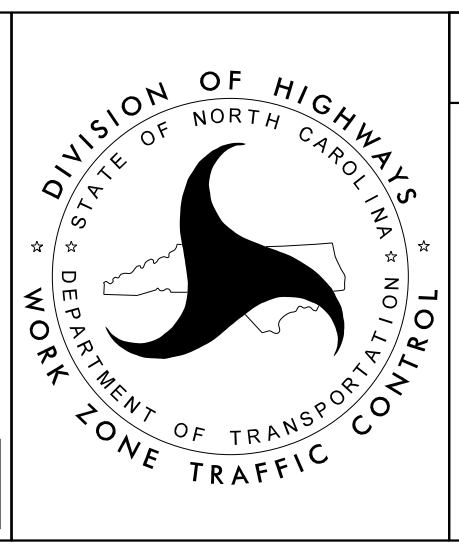

SECTION 2

-L- I-95
 PHASE IV

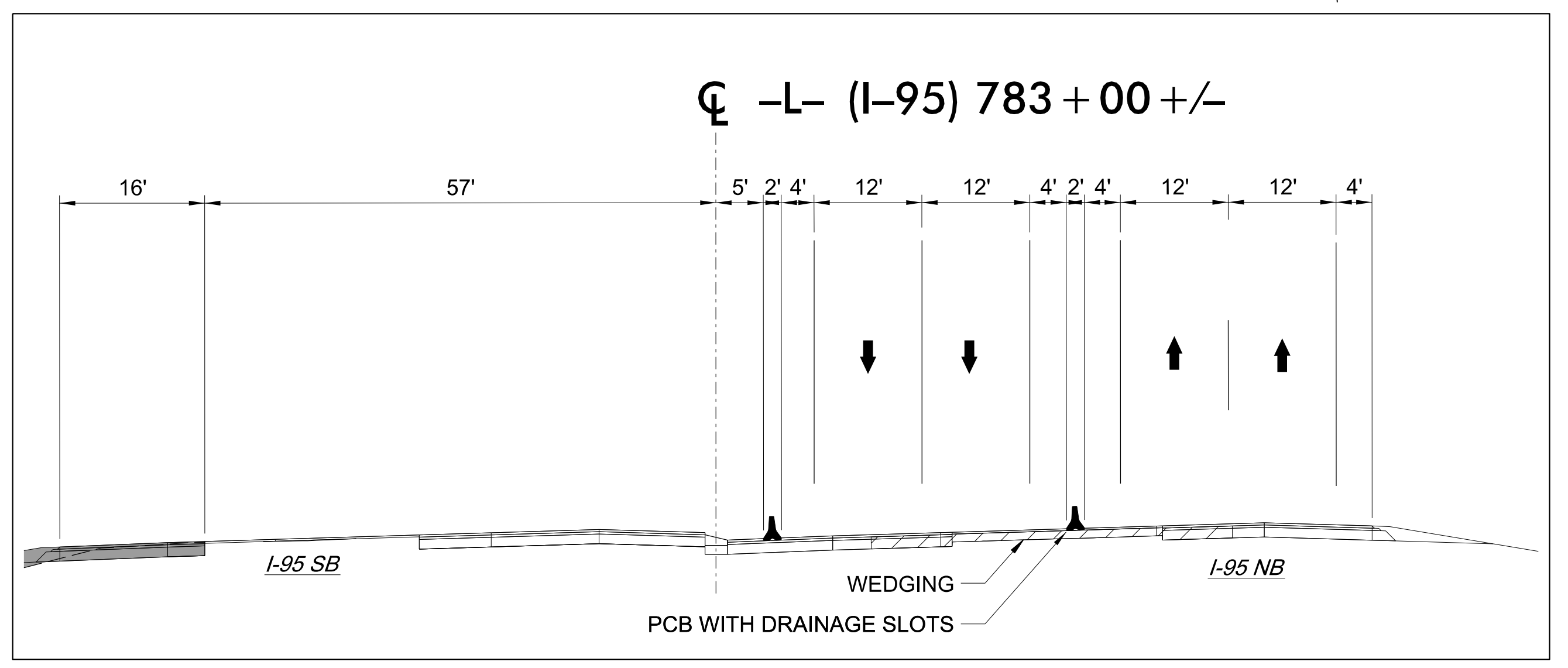
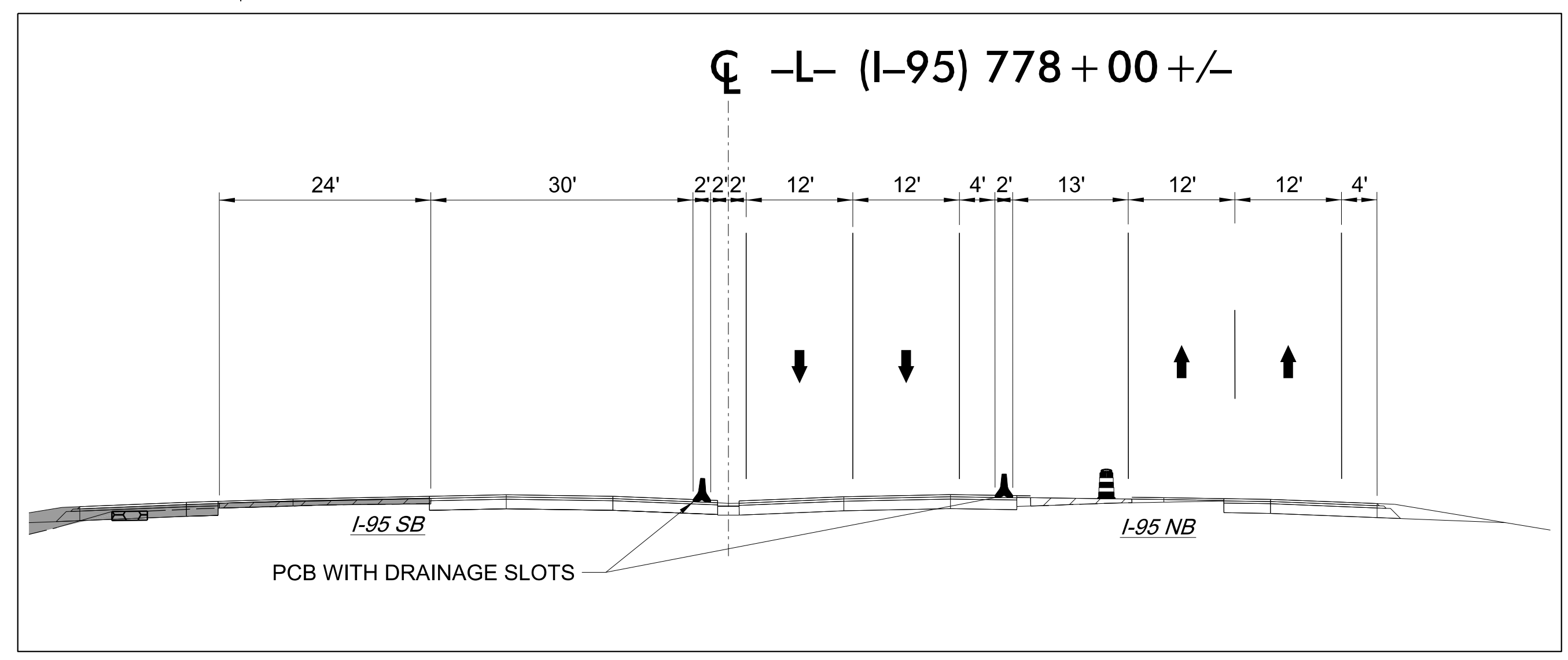
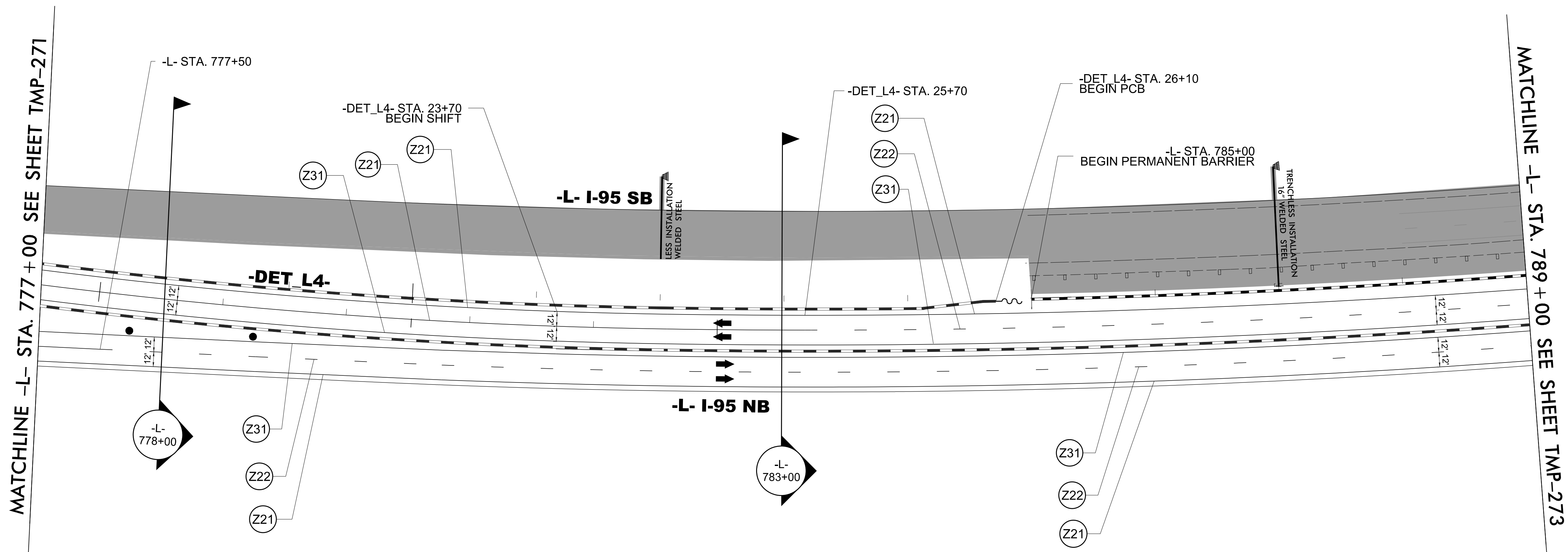

4/19/2022
U:\Traffic\Transportation Management Plan\TCP\PLAN SHEETS\I-5987B_TMP-272_PHASE 4.dgn
angood

Stantec
Stantec Consulting Services Inc.
801 Jones Franklin Road
Suite 300
Raleigh, NC 27606
Tel. 919.851.6866
Fax. 919.851.7024
www.stantec.com
License No. F-0672

DocuSigned by:
J.W. Woollard, Jr.
PROFESSIONAL
SEAL
19862
ENGINEER
J.W. WOOLLARD, JR.

4/29/2022

**DOCUMENT NOT CONSIDERED FINAL
UNLESS ALL SIGNATURES COMPLETED**

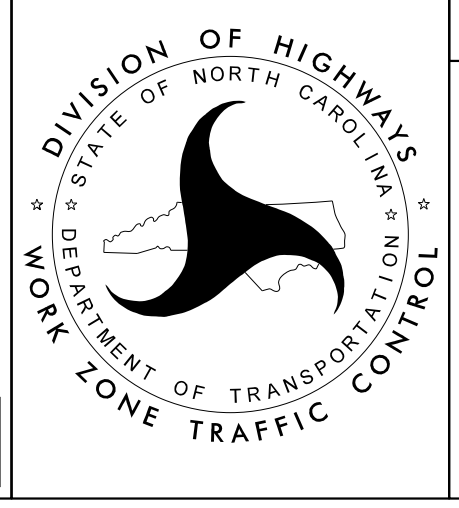

SECTION 2

-L- I-95
PHASE IV

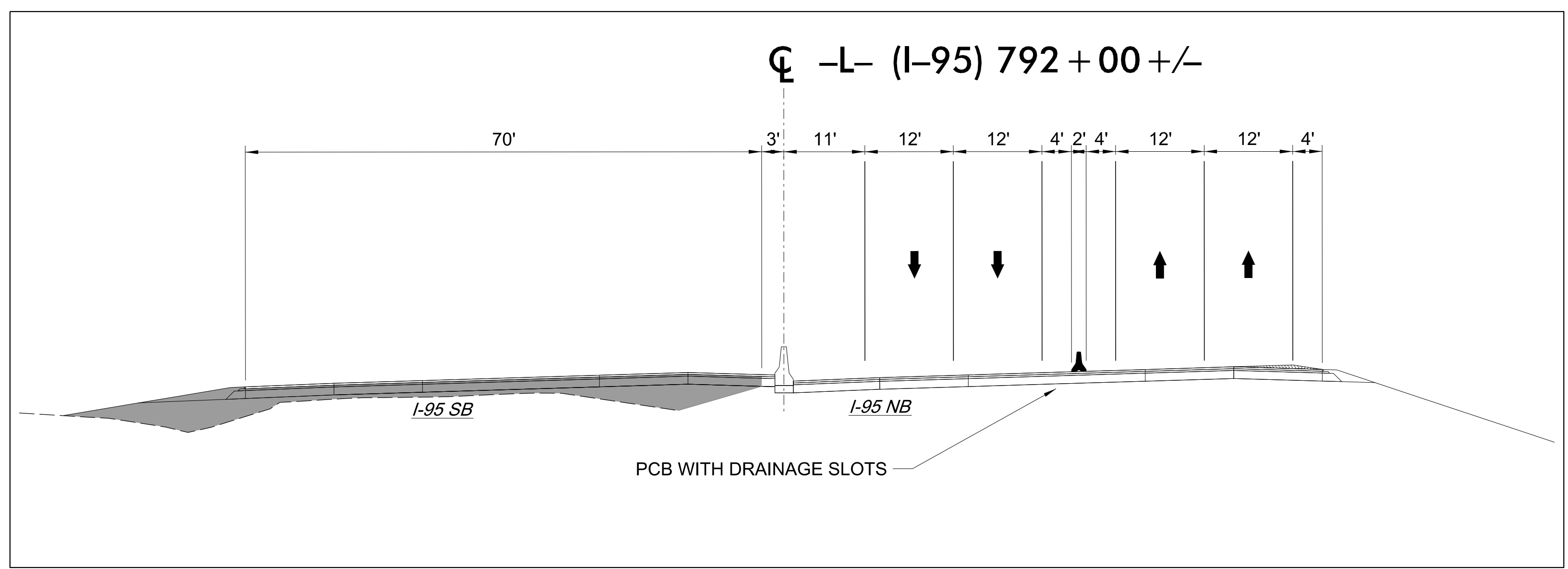
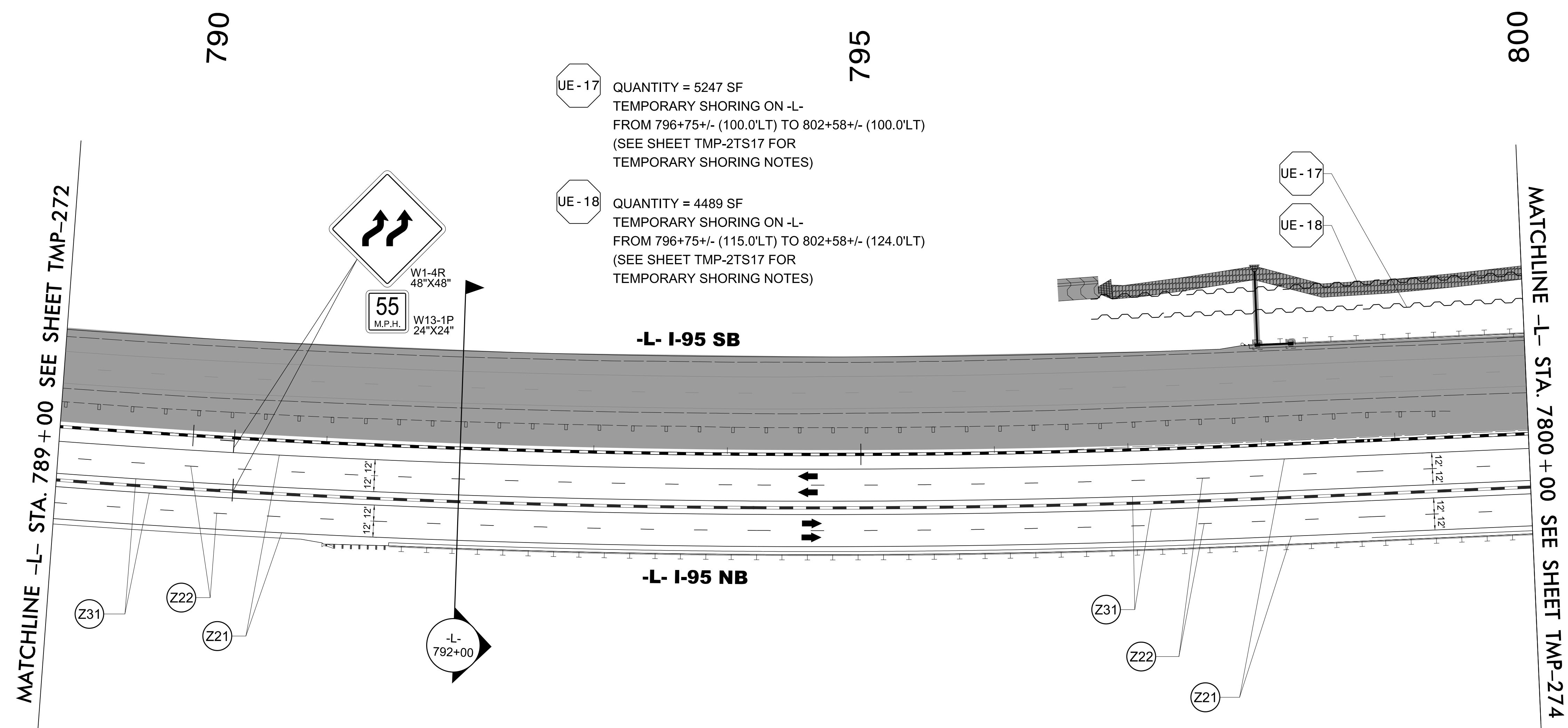

4/19/2022
U:\Traffic\Transportation Management Plan\TCP\PLAN SHEETS\I-5987B_TMP-273_PHASE 4.dgn
angood

Stantec

Stantec Consulting Services Inc.
801 Jones Franklin Road
Suite 300
Raleigh, NC 27606
Tel. 919.851.6866
Fax. 919.851.7024
www.stantec.com
License No. F-0672

DocuSigned by:
J.W. Woollard
BBO2F49E93C

4/29/2022

**DOCUMENT NOT CONSIDERED FINAL
UNLESS ALL SIGNATURES COMPLETED**

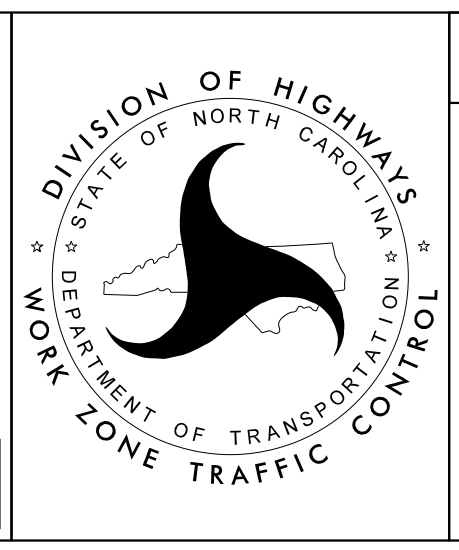

SECTION 2

**-L- I-95
PHASE IV**

008
MATCHLINE -L- STA. 800 + 00 SEE SHEET TMP-273

MATCHLINE -L- STA. 811 + 00 SEE SHEET TMP-275

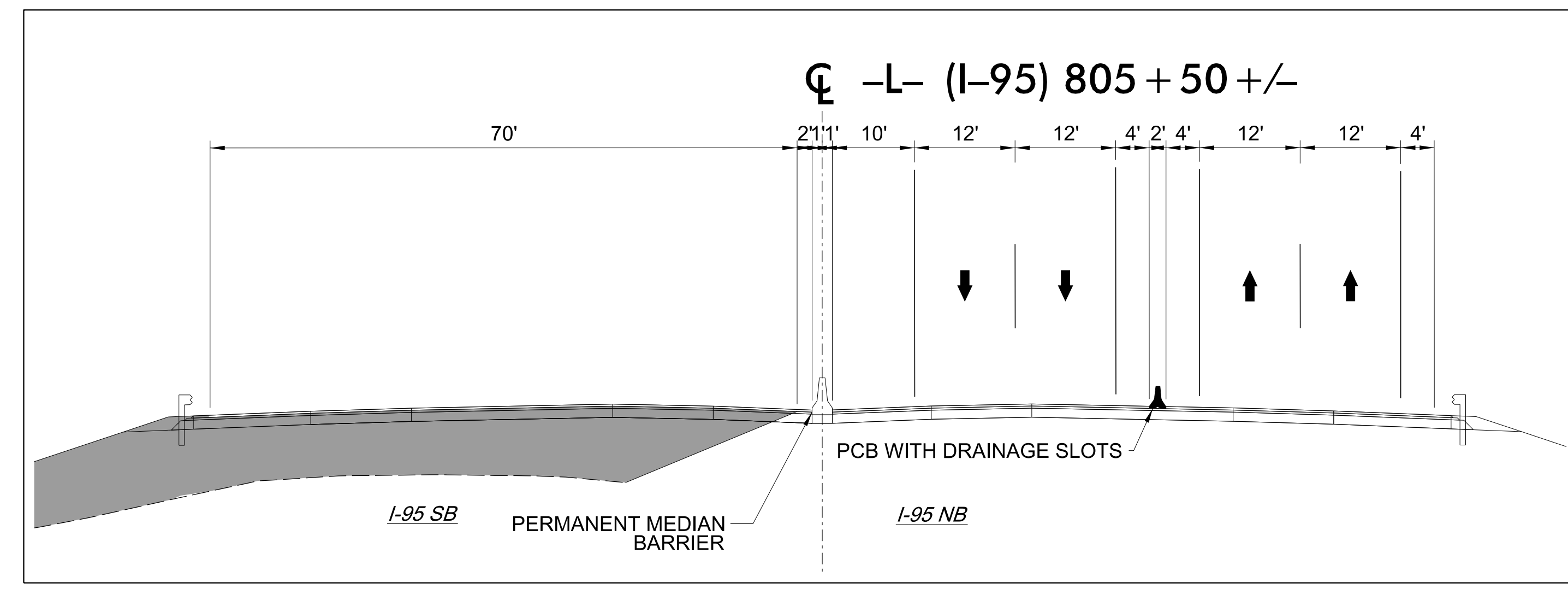
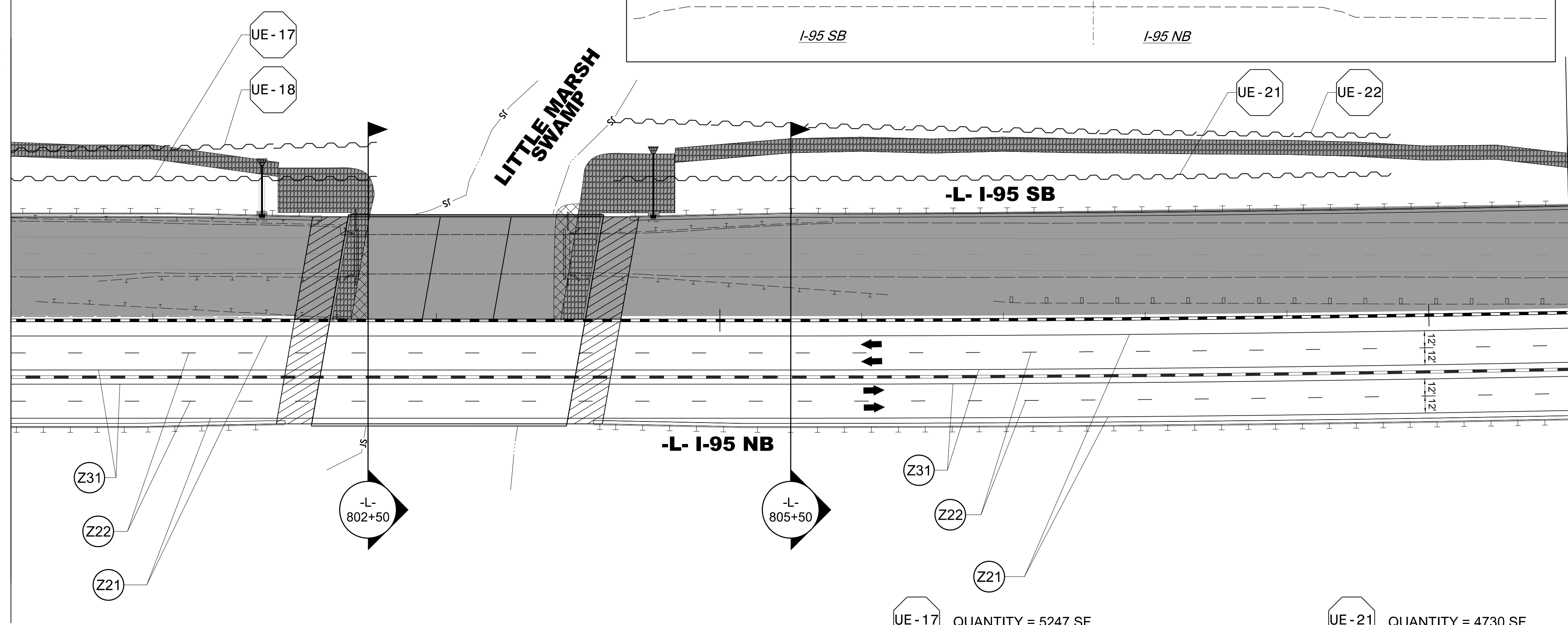
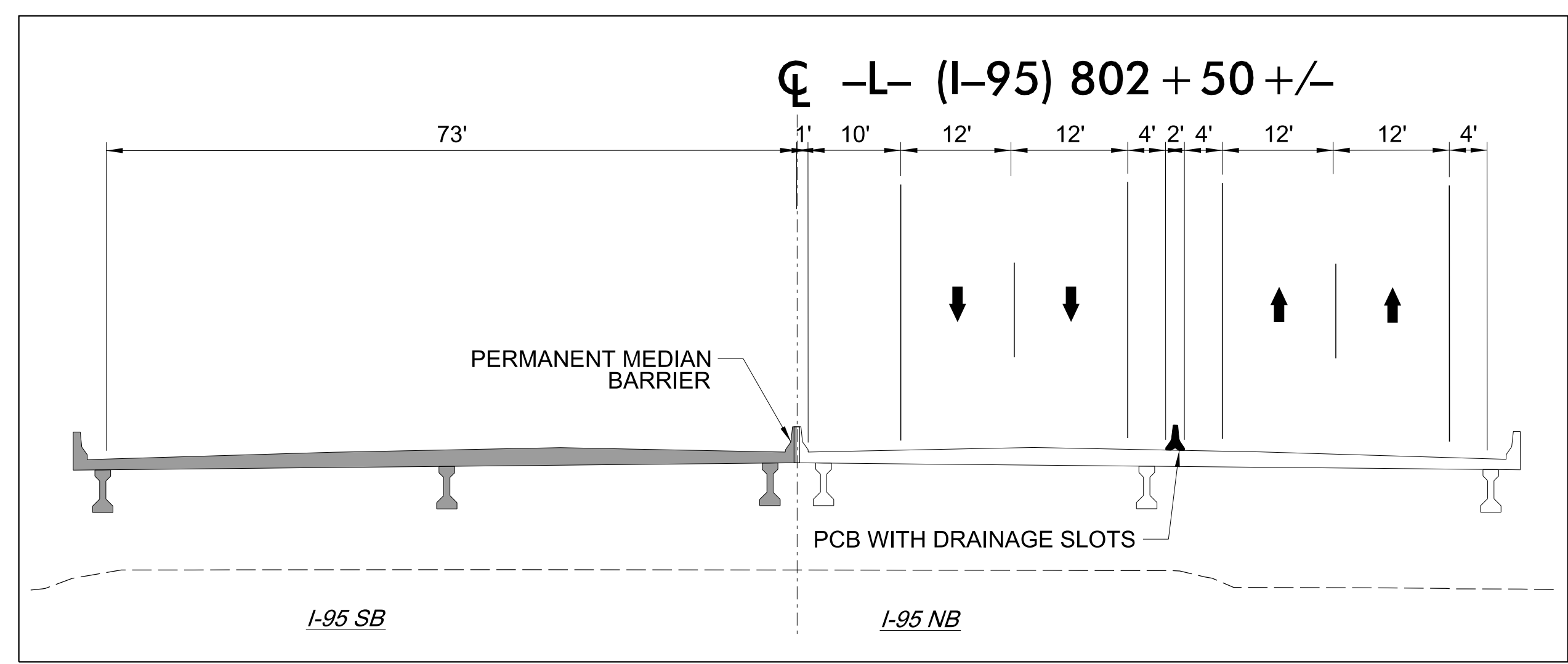

- UE-17** QUANTITY = 5247 SF
 TEMPORARY SHORING ON -L- FROM 796+75+/- (100.0'LT) TO 802+58+/- (100.0'LT) (SEE SHEET TMP-2TS17 FOR TEMPORARY SHORING NOTES)
- UE-21** QUANTITY = 4730 SF
 TEMPORARY SHORING ON -L- FROM 804+25+/- (100.0'LT) TO 809+75+/- (100.0'LT) (SEE SHEET TMP-2TS18 FOR TEMPORARY SHORING NOTES)
- UE-18** QUANTITY = 4489 SF
 TEMPORARY SHORING ON -L- FROM 796+75+/- (115.0'LT) TO 802+58+/- (130.0'LT) (SEE SHEET TMP-2TS17 FOR TEMPORARY SHORING NOTES)
- UE-22** QUANTITY = 4510 SF
 TEMPORARY SHORING ON -L- FROM 804+25+/- (141.0'LT) TO 809+75+/- (127.0'LT) (SEE SHEET TMP-2TS18 FOR TEMPORARY SHORING NOTES)

4/19/2022
 U:\Traffic\Transportation Management Plan\TCP\PLAN SHEETS\I-5987B_TMP-274_PHASE 4.dgn
 angood

<p>Stantec Consulting Services Inc. 801 Jones Franklin Road Suite 300 Raleigh, NC 27606 Tel. 919.851.6866 Fax. 919.851.7024 www.stantec.com License No. F-0672</p>	<p>4/29/2022</p>		SECTION 2
			-L- I-95 PHASE IV

**DOCUMENT NOT CONSIDERED FINAL
 UNLESS ALL SIGNATURES COMPLETED**

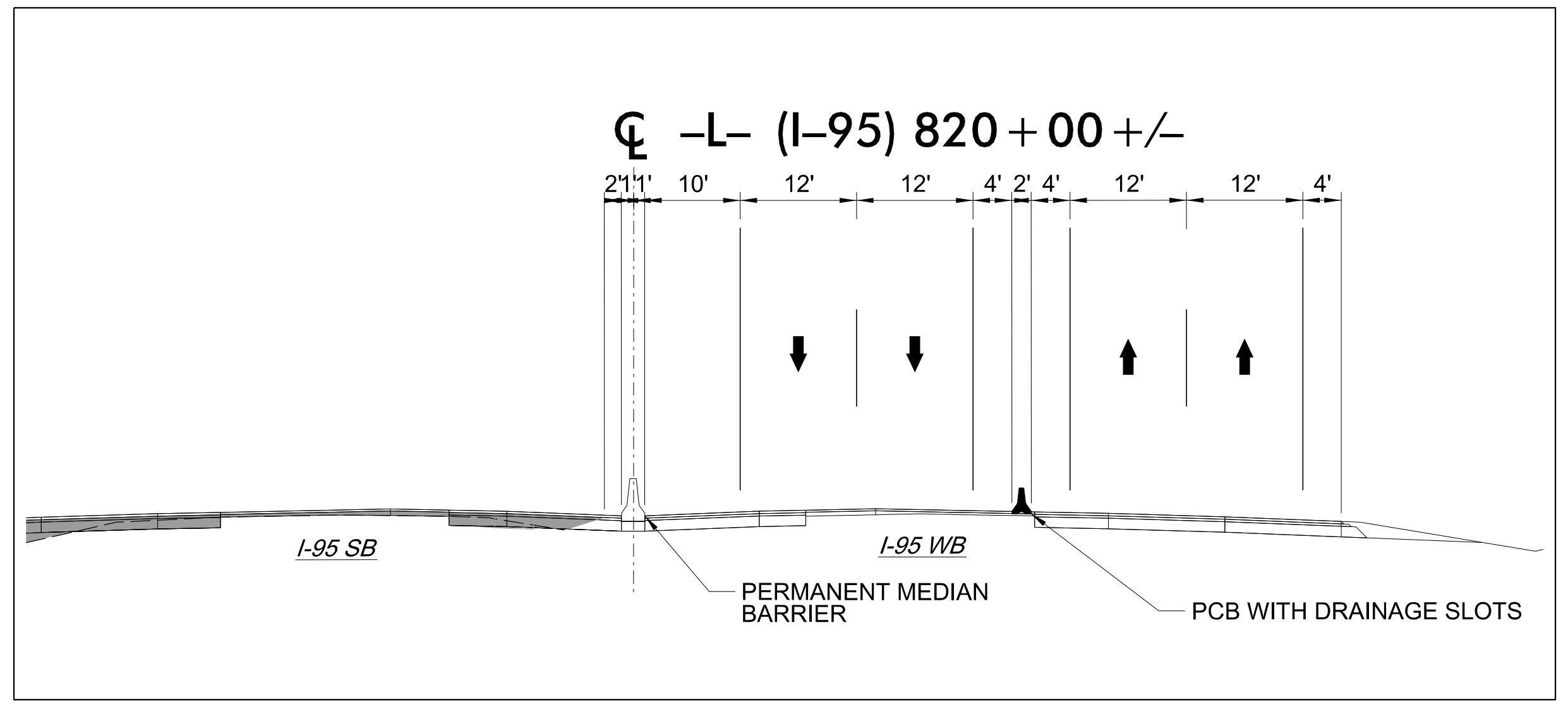

820

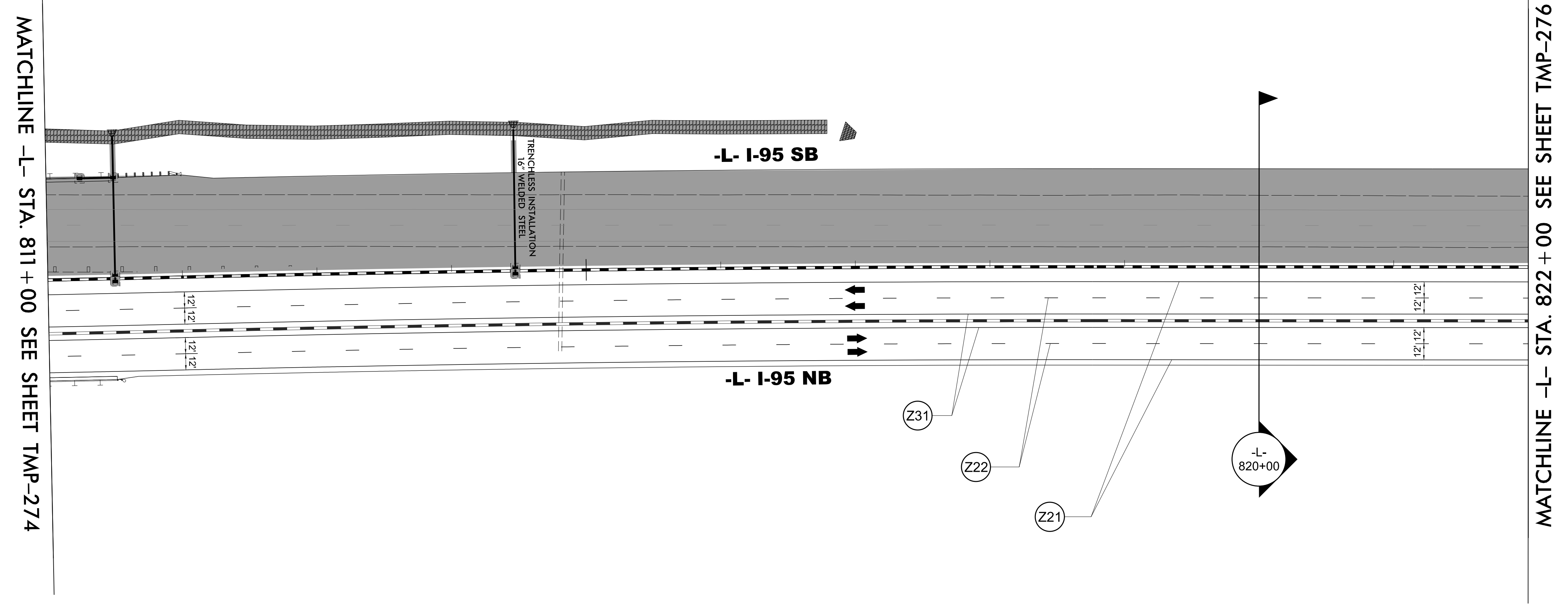

MATCHLINE -L- STA. 811 + 00 SEE SHEET TMP-274

MATCHLINE -L- STA. 822 + 00 SEE SHEET TMP-276

4/19/2022
U:\Traffic\Transportation Management Plan\TCP\PLAN SHEETS\I-5987B_TMP-275_PHASE 4.dgn
angood

Stantec Consulting Services Inc.
801 Jones Franklin Road
Suite 300
Raleigh, NC 27606
Tel. 919.851.6866
Fax. 919.851.7024
www.stantec.com
License No. F-0672

DocuSigned by:
J.W. Woolard, Jr.
SEAL
19862
ENGINEER
J.W. WOOLARD, JR.
4/29/2022

**DOCUMENT NOT CONSIDERED FINAL
UNLESS ALL SIGNATURES COMPLETED**

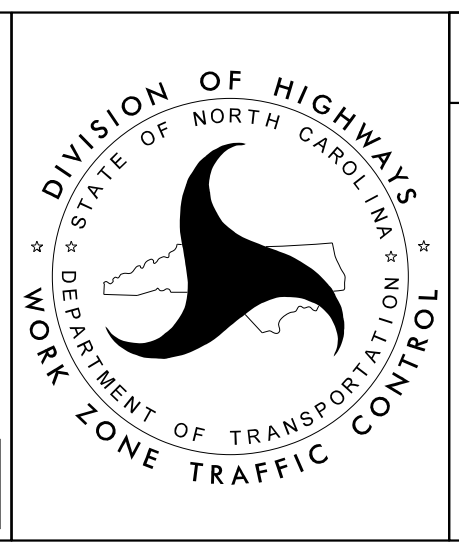

SECTION 2

-L- I-95
PHASE IV

PROJ. REFERENCE NO.	SHEET NO.
I-5987B	TMP-276

MOTORIST PULL OFF AREA REQUIRED
 BETWEEN STATION -L- NB AND SB 820+00+/- AND 840+00+/-
 AS NEEDED TO COMPLETE PAVING OPERATIONS
 SEE TMP-2A-1 FOR DETAIL

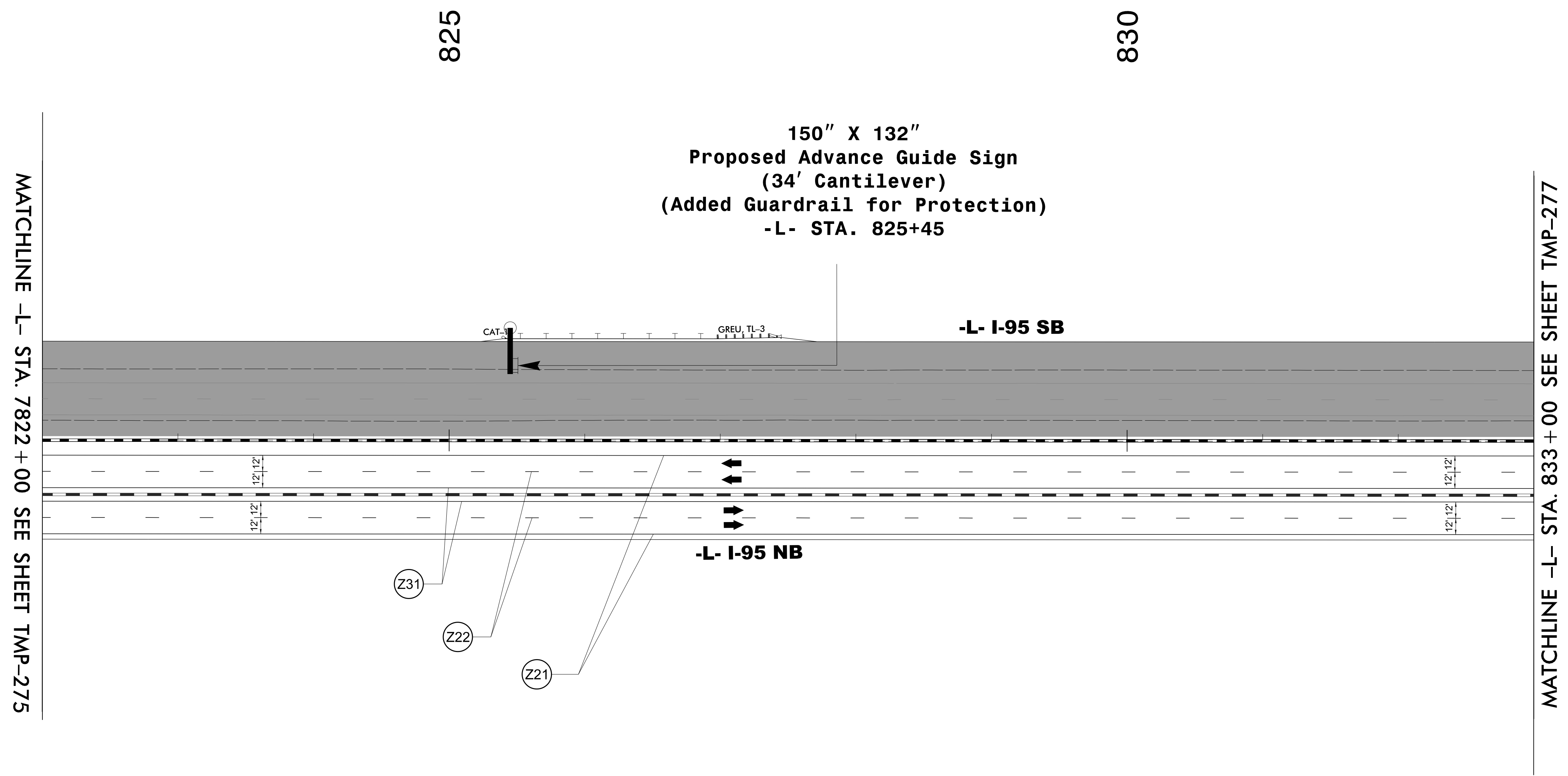

4/19/2022
 U:\Traffic\Transportation Management\Plan\TCP\PLAN SHEETS\I-5987B_TMP-276_PHASE 4.dgn
 angood

Stantec Consulting Services Inc.
 801 Jones Franklin Road
 Suite 300
 Raleigh, NC 27606
 Tel. 919.851.6866
 Fax. 919.851.7024
 www.stantec.com
 License No. F-0672

DocuSigned by:
 J.W. Woolard
 BB02F49E3E3C

4/29/2022

**DOCUMENT NOT CONSIDERED FINAL
 UNLESS ALL SIGNATURES COMPLETED**

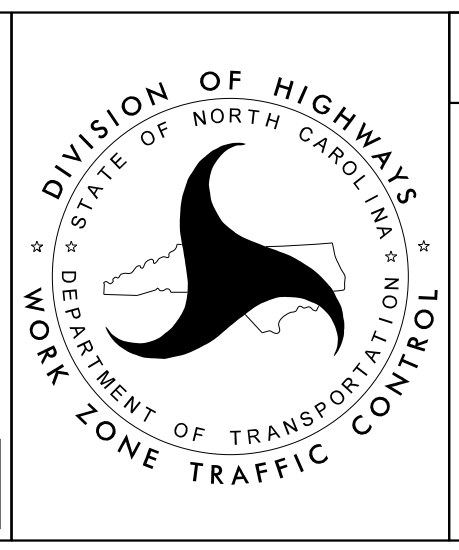

SECTION 2

-L- I-95
 PHASE IV

PROJ. REFERENCE NO.	SHEET NO.
I-5987B	TMP-277

MOTORIST PULL OFF AREA REQUIRED
 BETWEEN STATION -L- NB AND SB 820+00+/- AND 840+00+/-
 AS NEEDED TO COMPLETE PAVING OPERATIONS
 SEE TMP-2A-1 FOR DETAIL

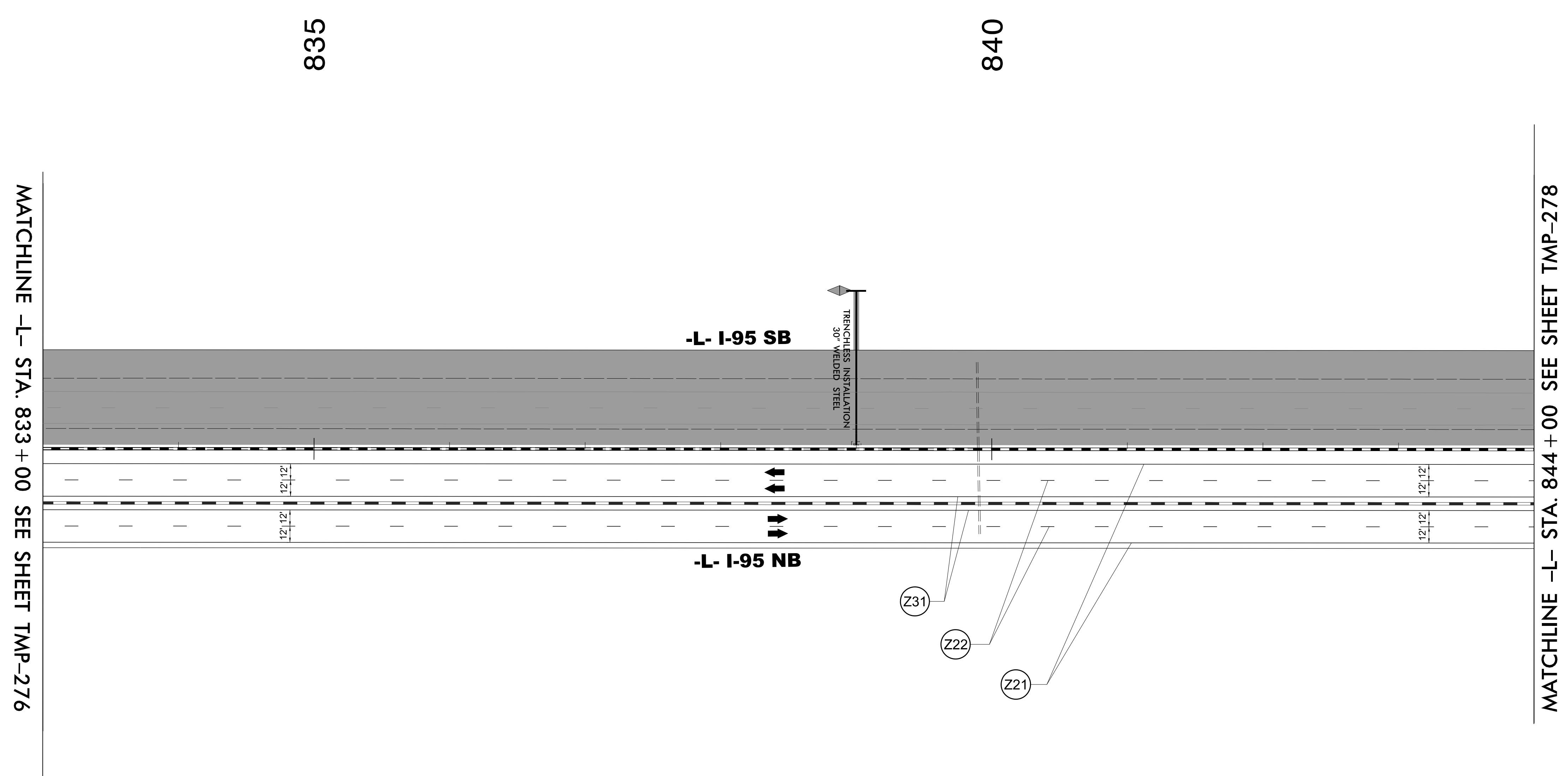

4/19/2022
 U:\Traffic\Transportation Management\Plan\TCP\PLAN SHEETS\I-5987B_TMP-277_PHASE 4.dgn
 angood

Stantec Consulting Services Inc.
 801 Jones Franklin Road
 Suite 300
 Raleigh, NC 27606
 Tel. 919.851.6866
 Fax. 919.851.7024
 www.stantec.com
 License No. F-0672

4/29/2022

**DOCUMENT NOT CONSIDERED FINAL
 UNLESS ALL SIGNATURES COMPLETED**

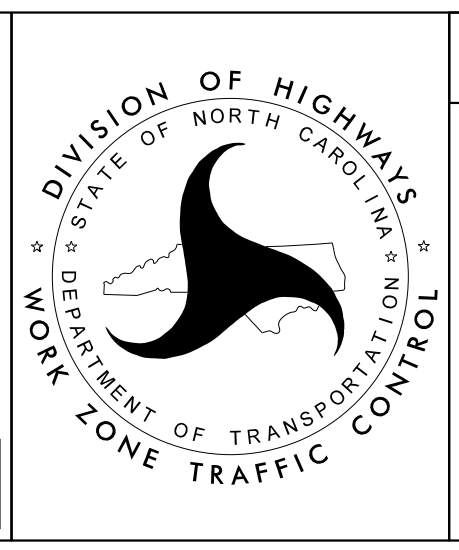

SECTION 2

-L- I-95
 PHASE IV

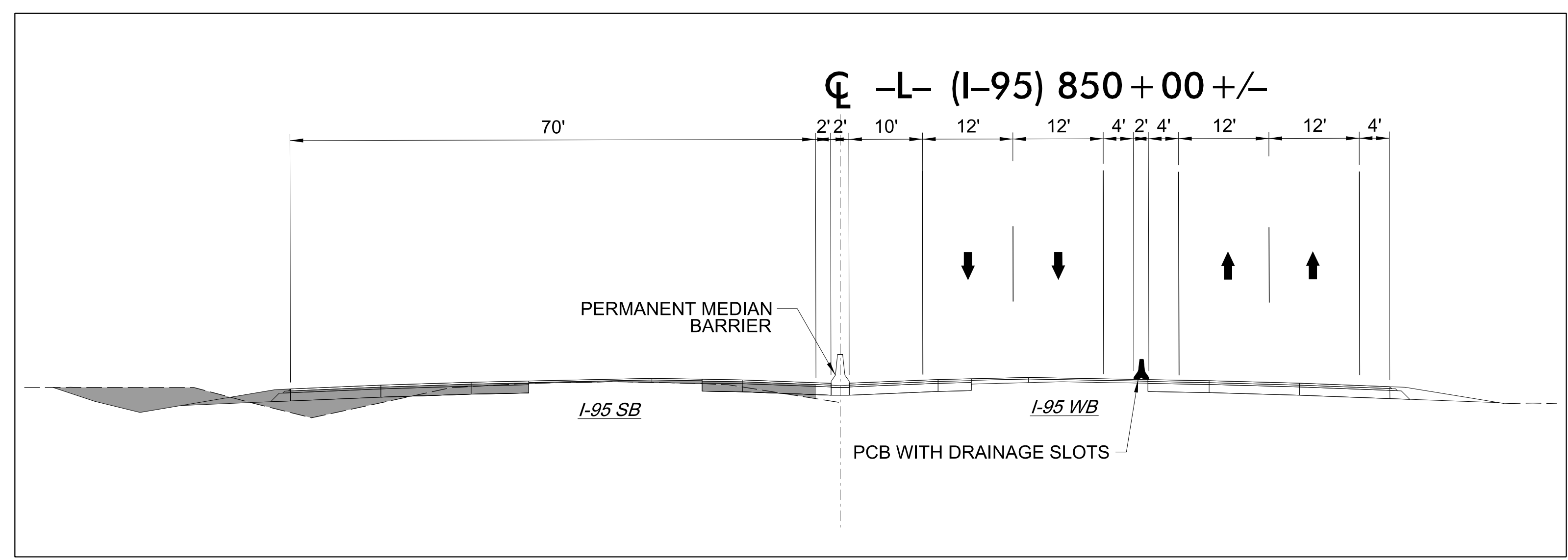

845

855

MATCHLINE -L- STA. 844 + 00 SEE SHEET TMP-227

MATCHLINE -L- STA. 856 + 00 SEE SHEET TMP-279

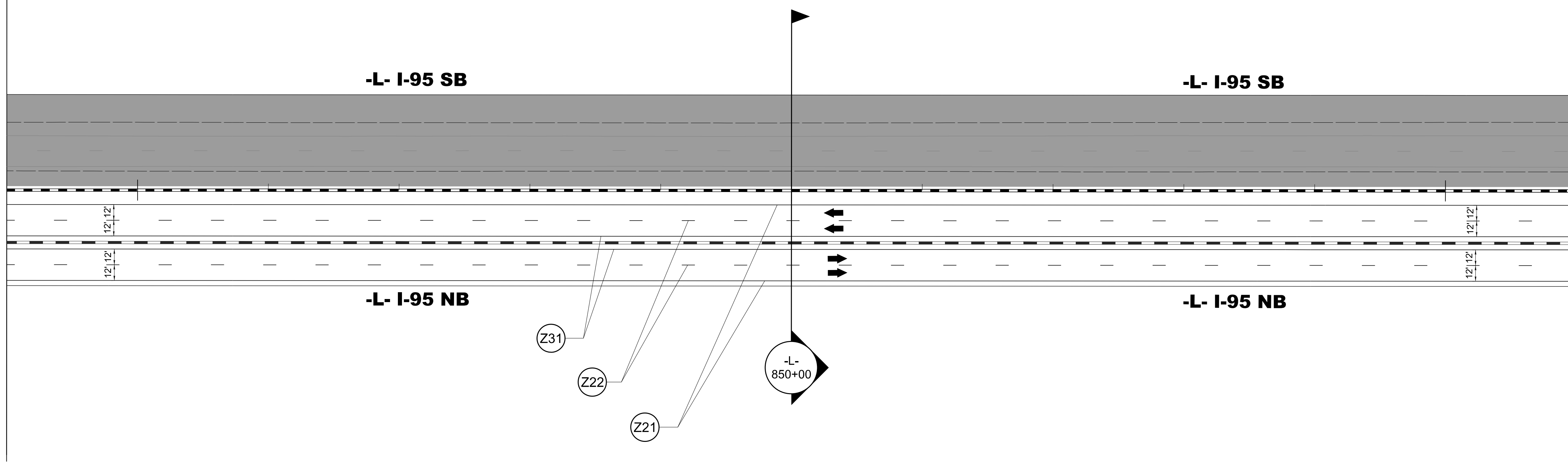

4/19/2022
U:\Traffic\Transportation Management Plan\TCP\PLAN SHEETS\I-5987B_TMP-278_PHASE 4.dgn
angood

Stantec Consulting Services Inc.
801 Jones Franklin Road
Suite 300
Raleigh, NC 27606
Tel. 919.851.6866
Fax. 919.851.7024
www.stantec.com
License No. F-0672

DocuSigned by:
J.W. Woolard
4/29/2022

**DOCUMENT NOT CONSIDERED FINAL
UNLESS ALL SIGNATURES COMPLETED**

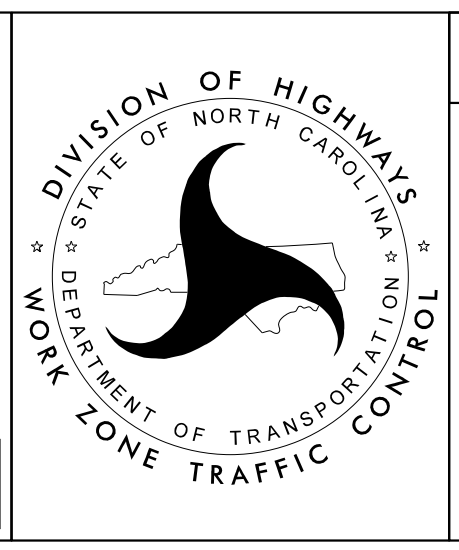

SECTION 2

-L- I-95
PHASE IV

PROJ. REFERENCE NO.	SHEET NO.
I-5987B	TMP-279

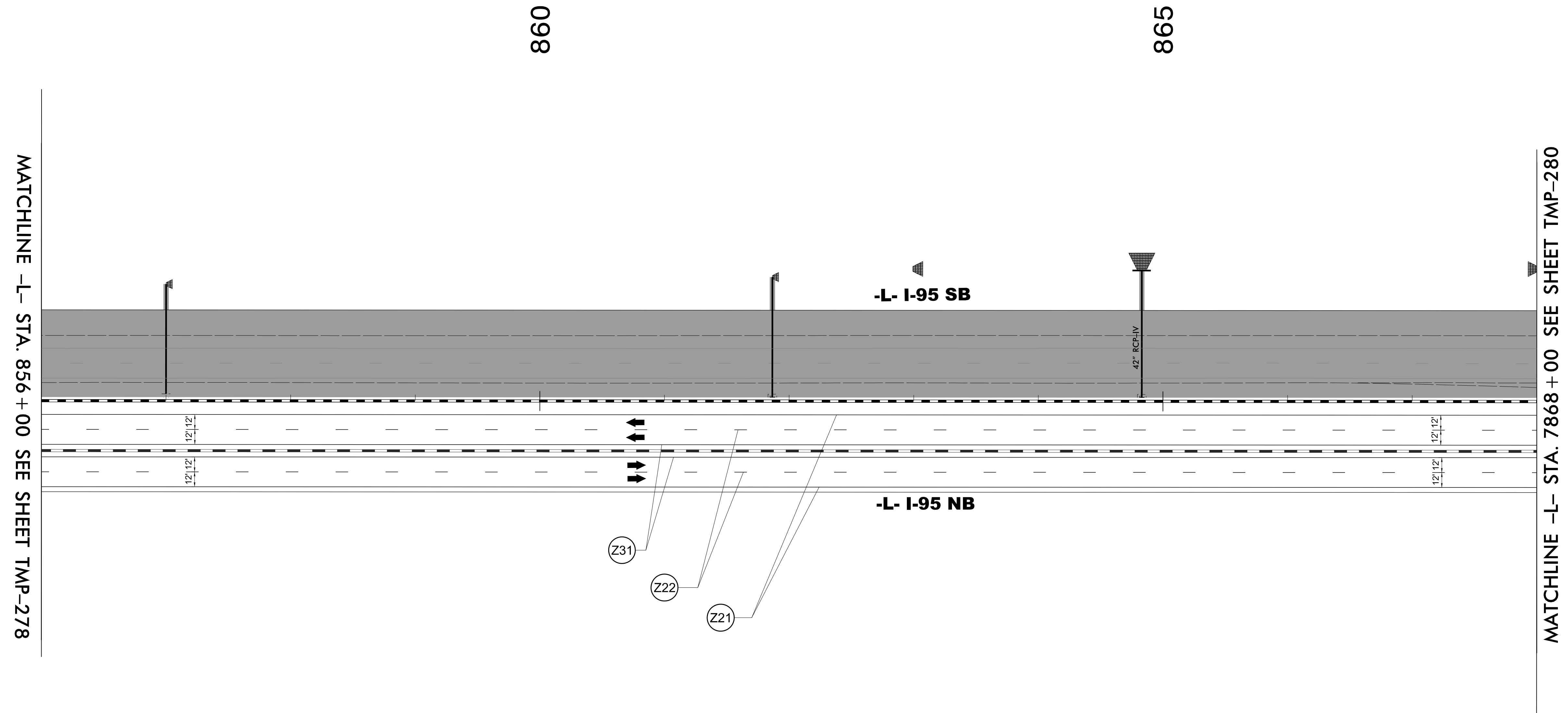

4/19/2022
 U:\Traffic\Transportation Management Plan\TCP\PLAN SHEETS\I-5987B_TMP-279_PHASE 4.dgn
 angood

Stantec Consulting Services Inc.
 801 Jones Franklin Road
 Suite 300
 Raleigh, NC 27606
 Tel. 919.851.6866
 Fax. 919.851.7024
 www.stantec.com
 License No. F-0672

DocuSigned by:
 J.W. Woolard
 BB02F49E3E1EC

4/29/2022

**DOCUMENT NOT CONSIDERED FINAL
 UNLESS ALL SIGNATURES COMPLETED**

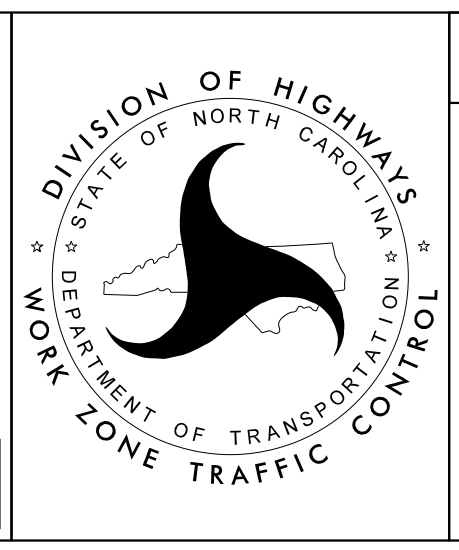

SECTION 2

-L- I-95
 PHASE IV

PROJ. REFERENCE NO.	SHEET NO.
I-5987B	TMP-280

MOTORIST PULL OFF AREA REQUIRED
 BETWEEN STATION -L- NB AND SB 870+00+/- AND 890+00+/-
 AS NEEDED TO COMPLETE PAVING OPERATIONS
 SEE TMP-2A-1 FOR DETAIL

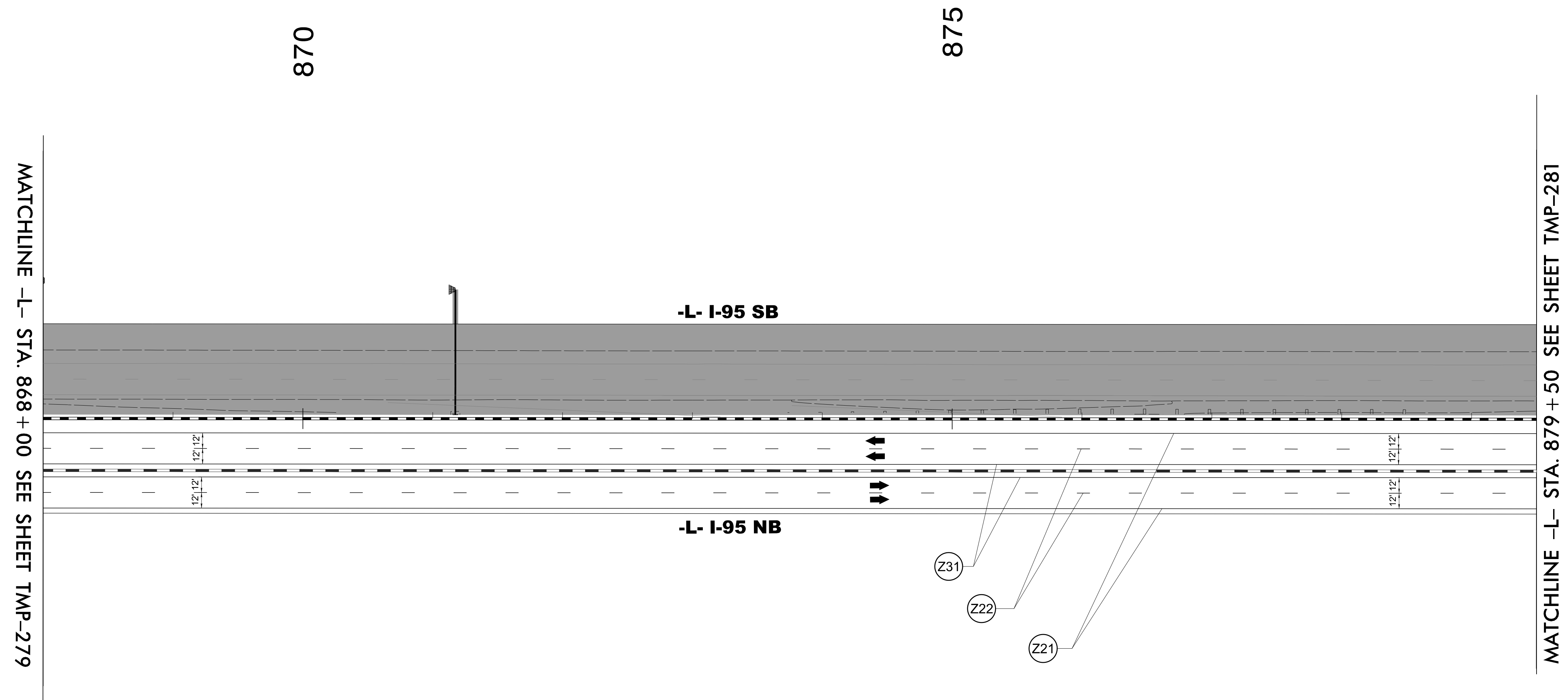

4/19/2022
 U:\Traffic\Transportation Management Plan\TCP\PLAN SHEETS\I-5987B_TMP-280_PHASE 4.dgn
 angood

Stantec Consulting Services Inc.
 801 Jones Franklin Road
 Suite 300
 Raleigh, NC 27606
 Tel. 919.851.6866
 Fax. 919.851.7024
 www.stantec.com
 License No. F-0672

DocuSigned by
 J.W. Woolard
 4/29/2022

**DOCUMENT NOT CONSIDERED FINAL
 UNLESS ALL SIGNATURES COMPLETED**

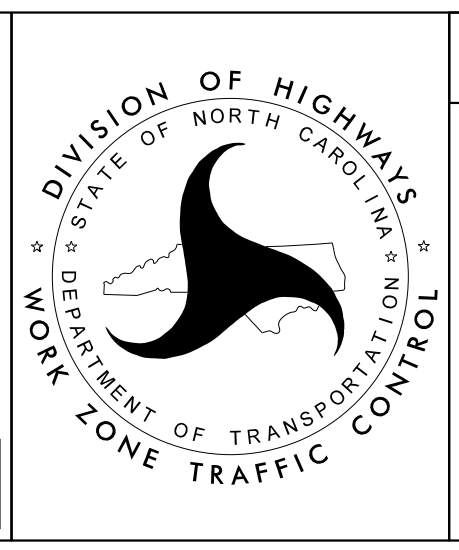

SECTION 2

-L- I-95
 PHASE IV



880

MATCHLINE -L- STA. 879 + 50 SEE SHEET TMP-280

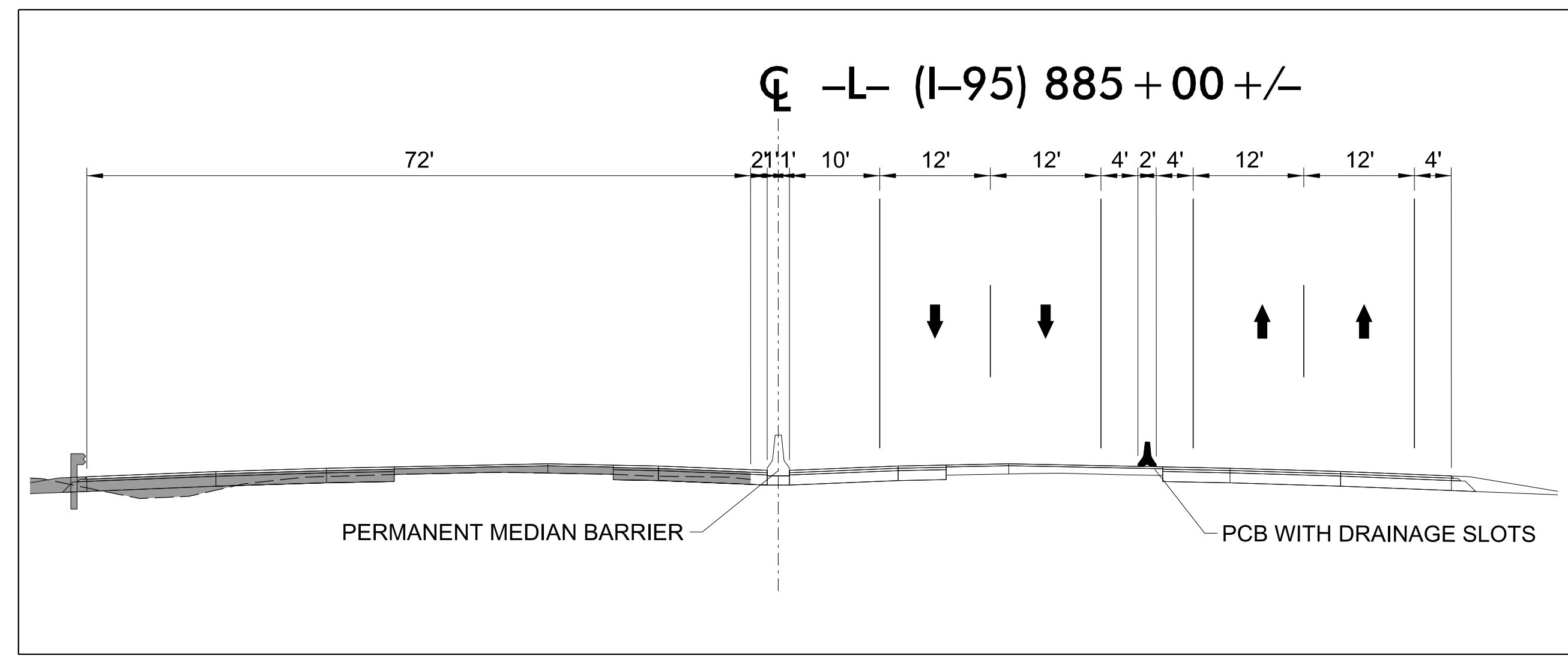
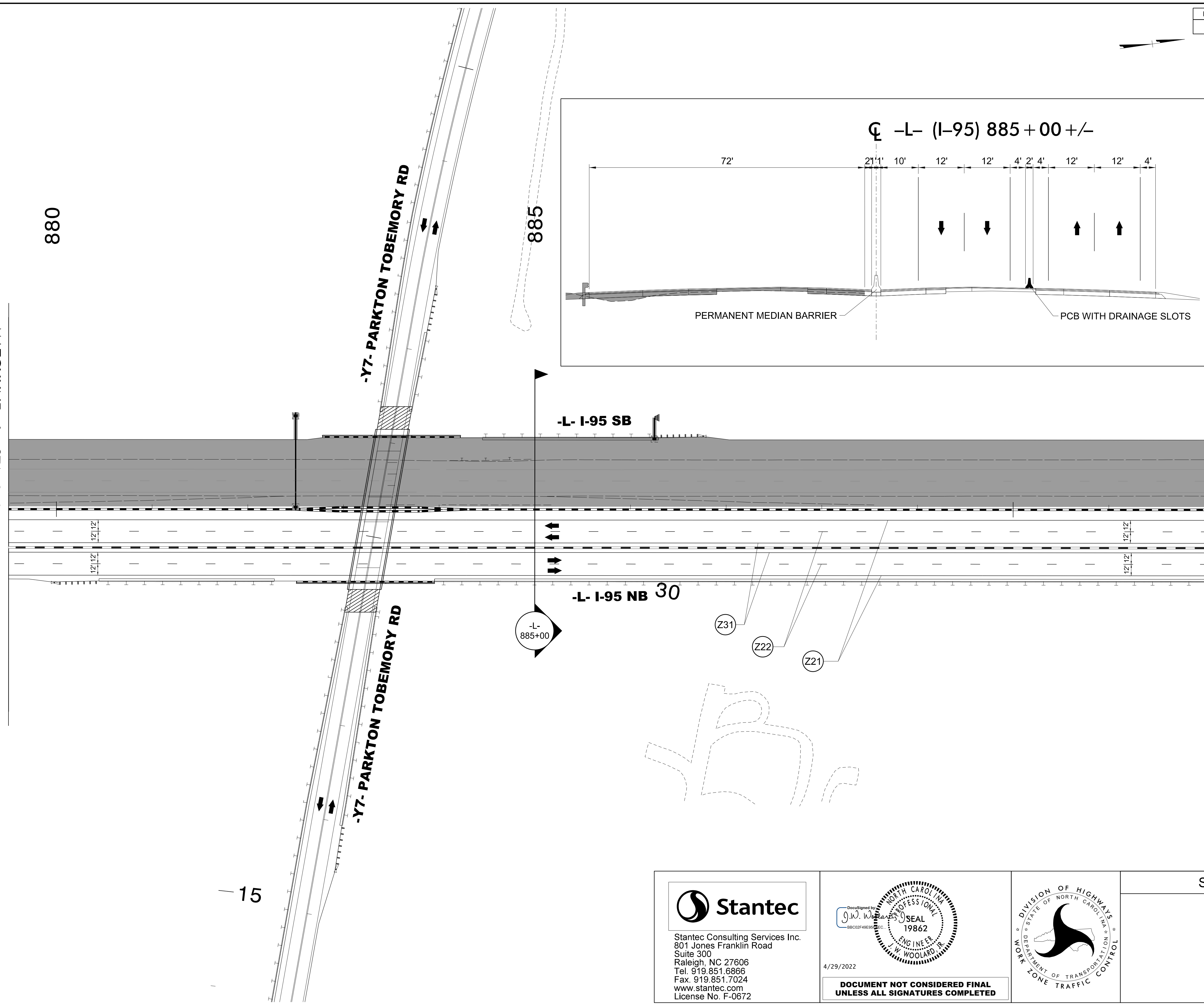

MATCHLINE -L- STA. 892 + 00 SEE SHEET TMP-282

4/19/2022
 U:\Traffic\Transportation Management Plan\TCP\PLAN SHEETS\I-5987B_TMP-281_PHASE 4.dgn
 angood

Stantec
 Stantec Consulting Services Inc.
 801 Jones Franklin Road
 Suite 300
 Raleigh, NC 27606
 Tel. 919.851.6866
 Fax. 919.851.7024
 www.stantec.com
 License No. F-0672

DocuSigned by:
 J.W. Woolard, Jr.
 4/29/2022

PROFESSIONAL SEAL
 19862
 ENGINEER
 J.W. WOOLARD, JR.

**DOCUMENT NOT CONSIDERED FINAL
 UNLESS ALL SIGNATURES COMPLETED**

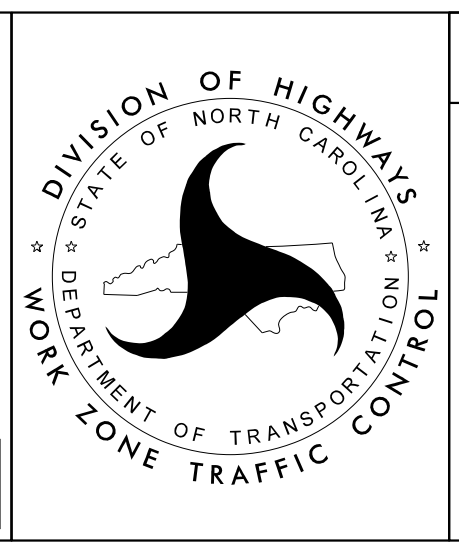

SECTION 2

-L- I-95
 PHASE IV

UE-25 QUANTITY = 720 SF
 TEMPORARY SHORING ON -L-
 FROM 899+25+/- (90.0'LT) TO 900+25+/- (90.0'LT)
 (SEE SHEET TMP-2TS19 FOR
 TEMPORARY SHORING NOTES)

UE-27 QUANTITY = 350 SF
 TEMPORARY SHORING ON -L-
 FROM 901+25+/- (110.0'LT) TO 901+75+/- (110.0'LT)
 (SEE SHEET TMP-2TS19 FOR
 TEMPORARY SHORING NOTES)

UE-26 QUANTITY = 740 SF
 TEMPORARY SHORING ON -L-
 FROM 900+75+/- (90.0'LT) TO 901+75+/- (90.0'LT)
 (SEE SHEET TMP-2TS19 FOR
 TEMPORARY SHORING NOTES)

UE-30 QUANTITY = 405 SF
 TEMPORARY SHORING ON -L-
 FROM 903+25+/- (90.0'LT) TO 903+75+/- (90.0'LT)
 (SEE SHEET TMP-2TS19 FOR
 TEMPORARY SHORING NOTES)

UE-31 QUANTITY = 350 SF
 TEMPORARY SHORING ON -L-
 FROM 903+25+/- (115.0'LT) TO 903+75+/- (115.0'LT)
 (SEE SHEET TMP-2TS20 FOR
 TEMPORARY SHORING NOTES)

MATCHLINE -L- STA. 7892 + 00 SEE SHEET TMP-281

MATCHLINE -L- STA. 904 + 00 SEE SHEET TMP-283

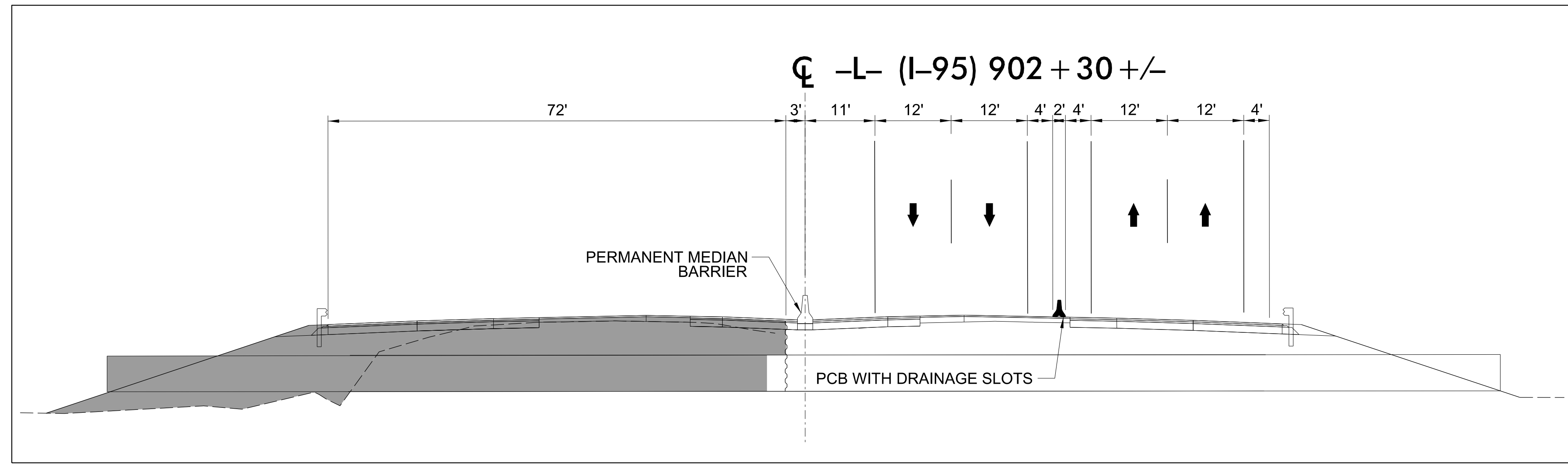
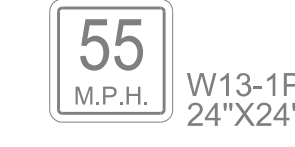
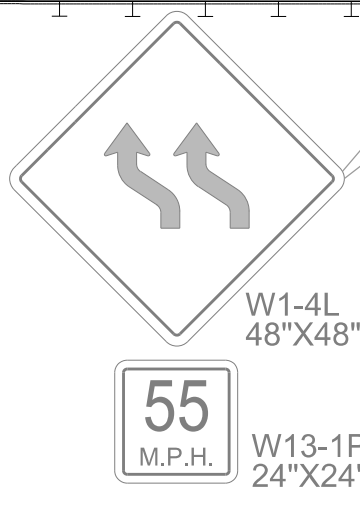
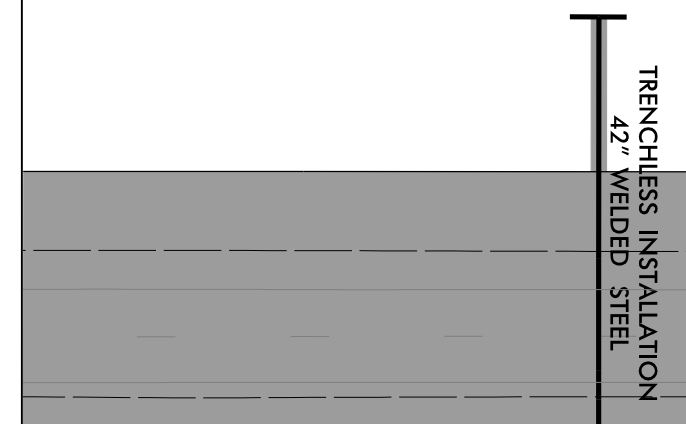
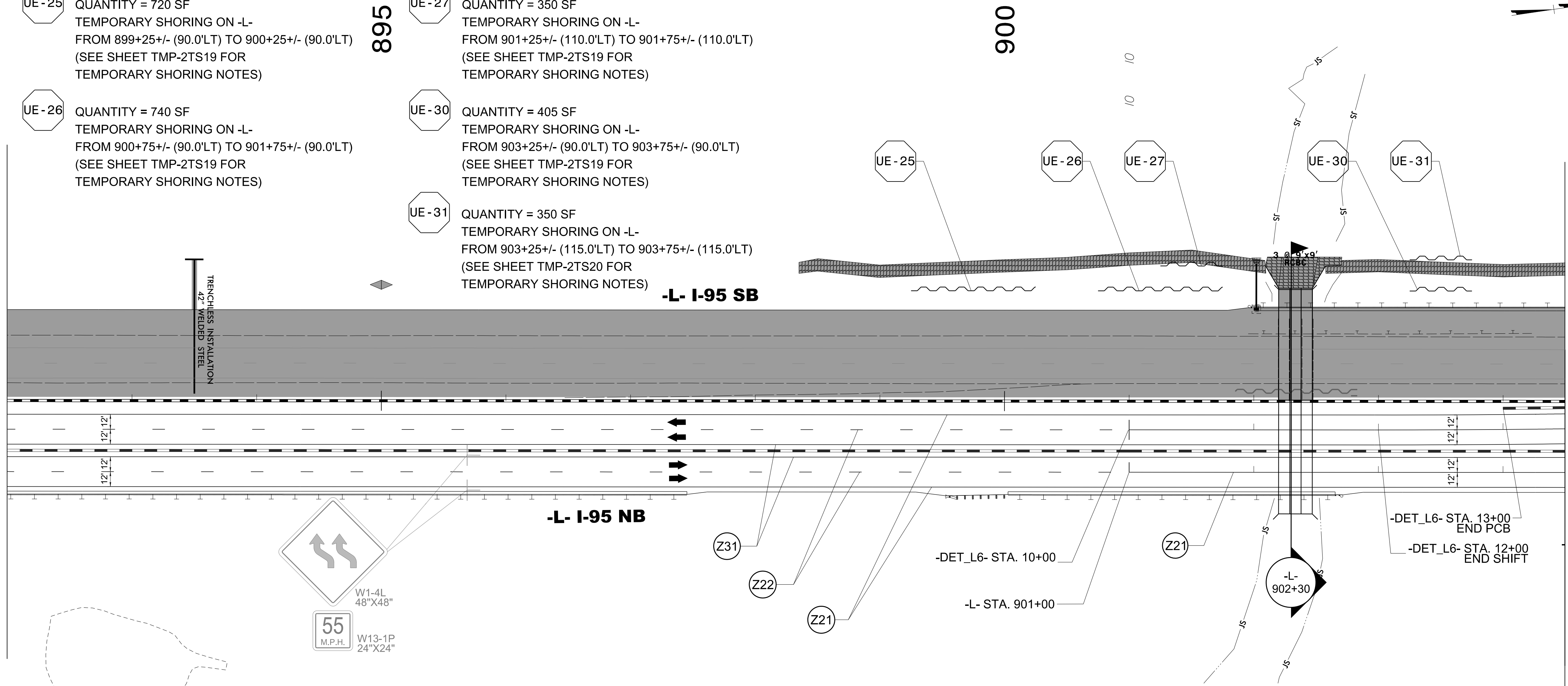

4/19/2022
 U:\Traffic\Transportation Management Plan\TCP\PLAN SHEETS\I-5987B_TMP-282_PHASE 4.dgn
 angood

Stantec
 Stantec Consulting Services Inc.
 801 Jones Franklin Road
 Suite 300
 Raleigh, NC 27606
 Tel. 919.851.6866
 Fax. 919.851.7024
 www.stantec.com
 License No. F-0672

DocuSigned by:
 J.W. Woollard, Jr.
 PROFESSIONAL SEAL
 19862
 ENGINEER
 J.W. WOOLLARD, JR.
 4/29/2022
**DOCUMENT NOT CONSIDERED FINAL
 UNLESS ALL SIGNATURES COMPLETED**

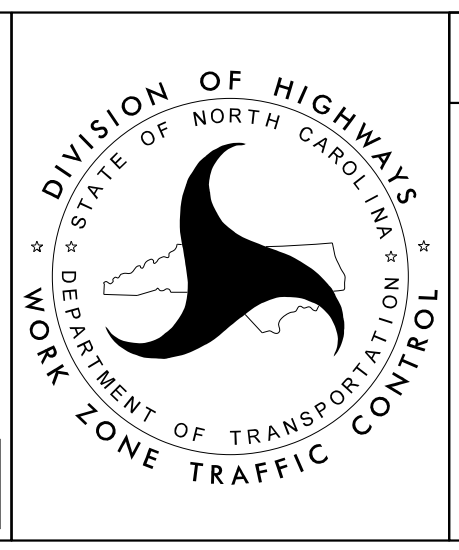

SECTION 2

-L- I-95
 PHASE IV

PROJ. REFERENCE NO.	SHEET NO.
I-5987B	TMP-283



CONTRACTOR SHALL COORDINATE CONSTRUCTION WITH U-2519AA CONTRACTOR

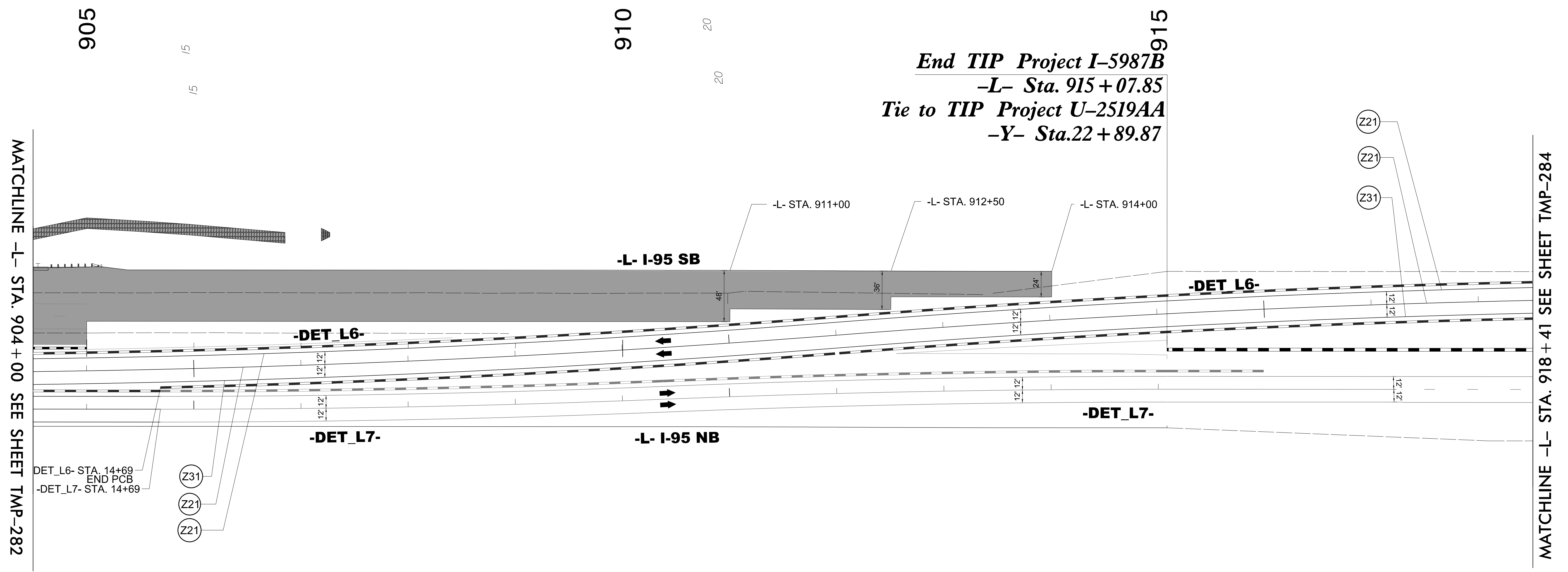

MATCHLINE -L- STA. 904 + 00 SEE SHEET TMP-282

MATCHLINE -L- STA. 918 + 41 SEE SHEET TMP-284

DET_L6- STA. 14+69
END PCB
-DET_L7- STA. 14+69

Z31
Z21
Z21

Z21
Z21
Z31

4/19/2022
U:\Traffic\Transportation Management Plan\TCP\PLAN SHEETS\I-5987B_TMP-283_PHASE 4.dgn
angood

Stantec Consulting Services Inc.
801 Jones Franklin Road
Suite 300
Raleigh, NC 27606
Tel. 919.851.6866
Fax. 919.851.7024
www.stantec.com
License No. F-0672

4/29/2022

**DOCUMENT NOT CONSIDERED FINAL
UNLESS ALL SIGNATURES COMPLETED**

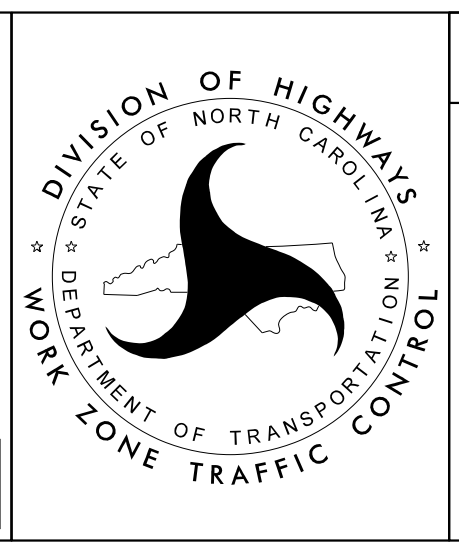

SECTION 2

-L- I-95
PHASE IV



MATCHLINE -L- STA. 918 + 41 SEE SHEET TMP-283

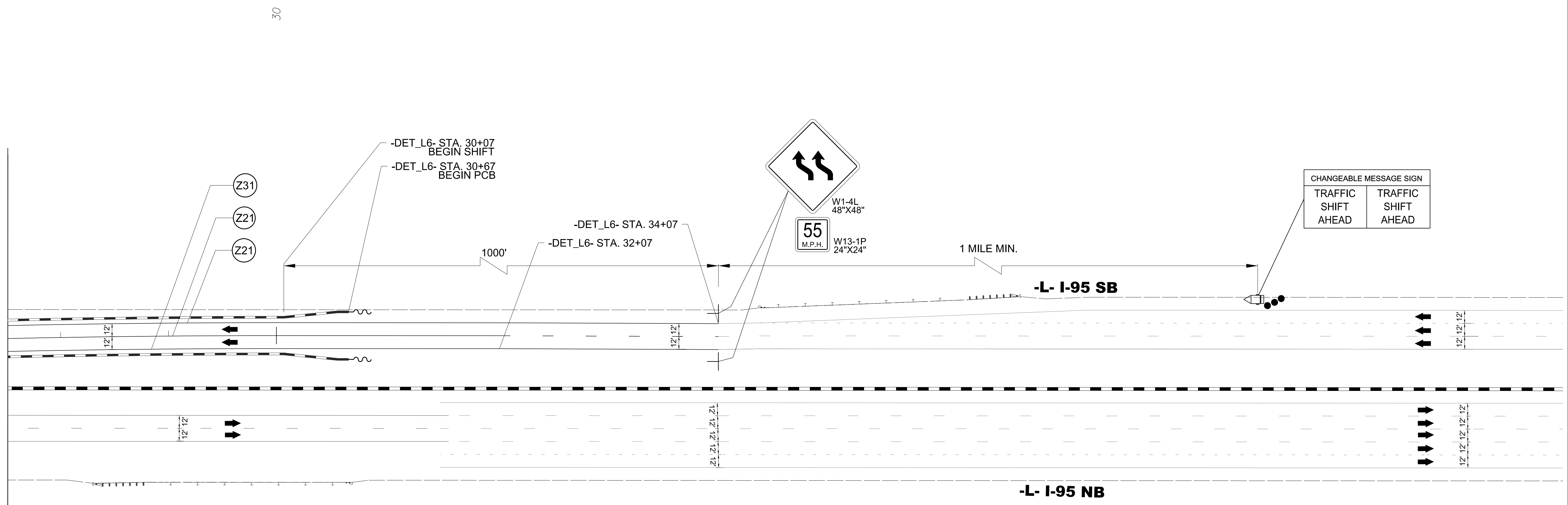

CHANGEABLE MESSAGE SIGN	
TRAFFIC SHIFT AHEAD	TRAFFIC SHIFT AHEAD

4/19/2022
U:\Traffic\Transportation Management Plan\TCP\PLAN SHEETS\I-5987B_TMP-284_PHASE 4.dgn
angood

Stantec Consulting Services Inc.
801 Jones Franklin Road
Suite 300
Raleigh, NC 27606
Tel. 919.851.6866
Fax. 919.851.7024
www.stantec.com
License No. F-0672

DocuSigned by:
J.W. Woolard
BBO2F49E93C

4/29/2022

**DOCUMENT NOT CONSIDERED FINAL
UNLESS ALL SIGNATURES COMPLETED**

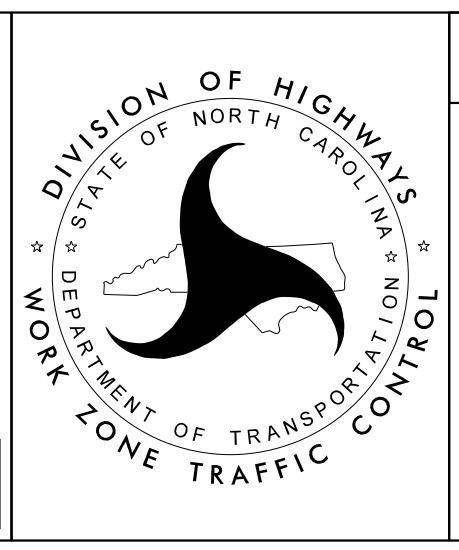

SECTION 2

-L- I-95
PHASE IV

PROJ. REFERENCE NO.	SHEET NO.
I-5987B	TMP-285

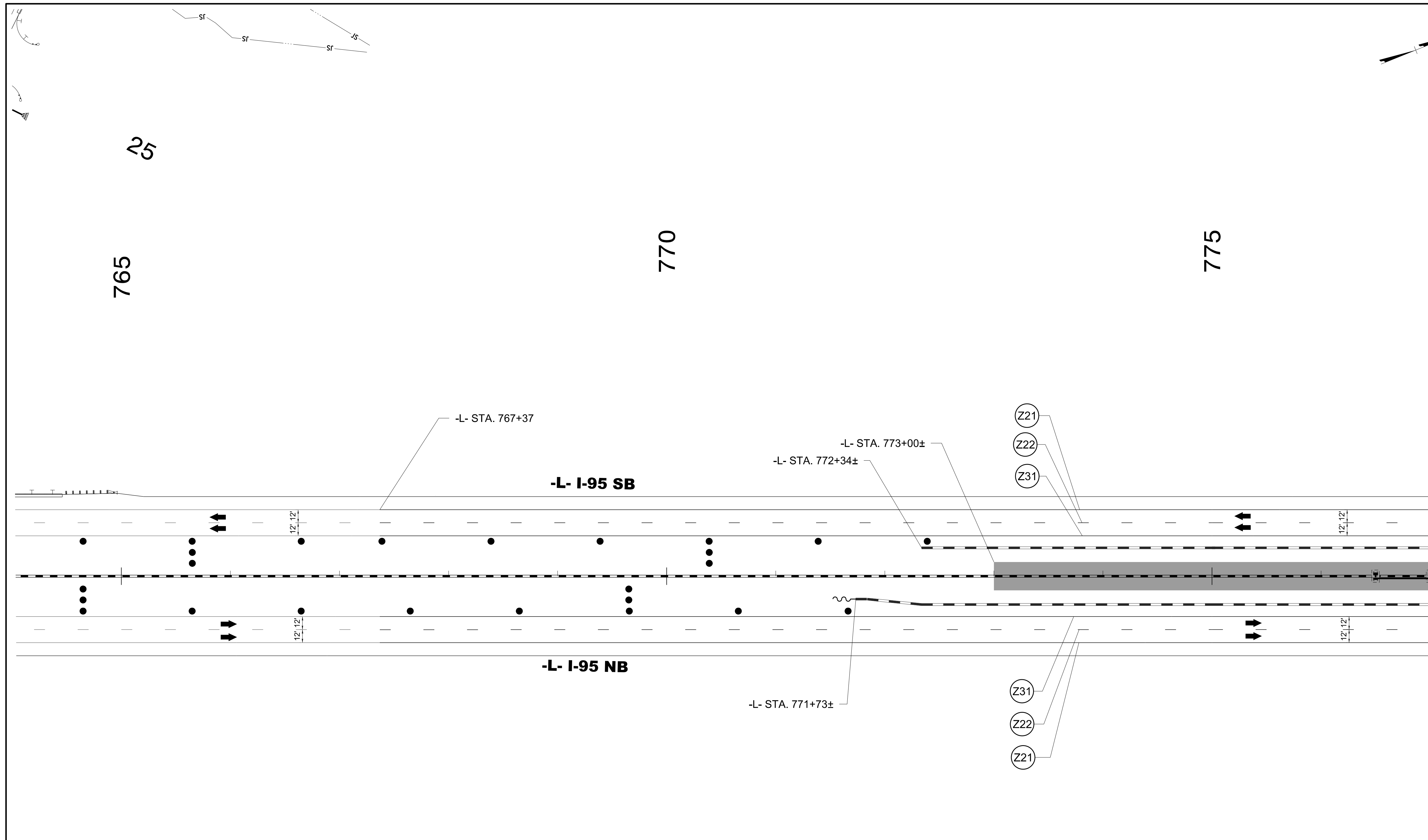

MATCHLINE -L- STA. 777 + 00 SEE SHEET TMP-286

4/19/2022
 U:\Traffic\Transportation Management Plan\TCP\PLAN SHEETS\I-5987B_TMP-285_PHASE 5.dgn
 angood

Stantec
 Stantec Consulting Services Inc.
 801 Jones Franklin Road
 Suite 300
 Raleigh, NC 27606
 Tel. 919.851.6866
 Fax. 919.851.7024
 www.stantec.com
 License No. F-0672

DocuSigned by:
 J.W. Woolard
 4/29/2022

PROFESSIONAL SEAL
 19862
 ENGINEER
 J.W. WOOLARD, JR.

**DOCUMENT NOT CONSIDERED FINAL
 UNLESS ALL SIGNATURES COMPLETED**

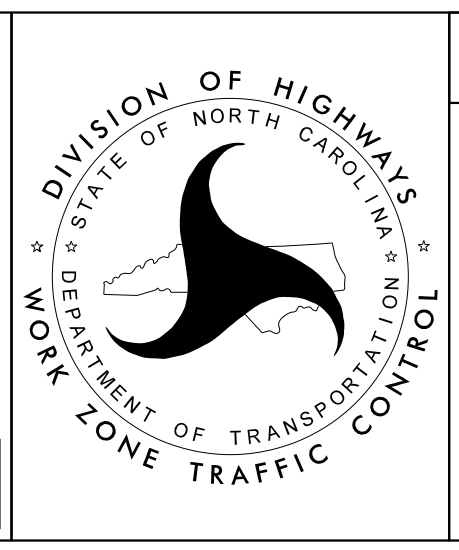

SECTION 2

-L- I-95
 PHASE V

MATCHLINE -L- STA. 777 + 00 SEE SHEET TMP-285

MATCHLINE -L- STA. 789 + 00 SEE SHEET TMP-287

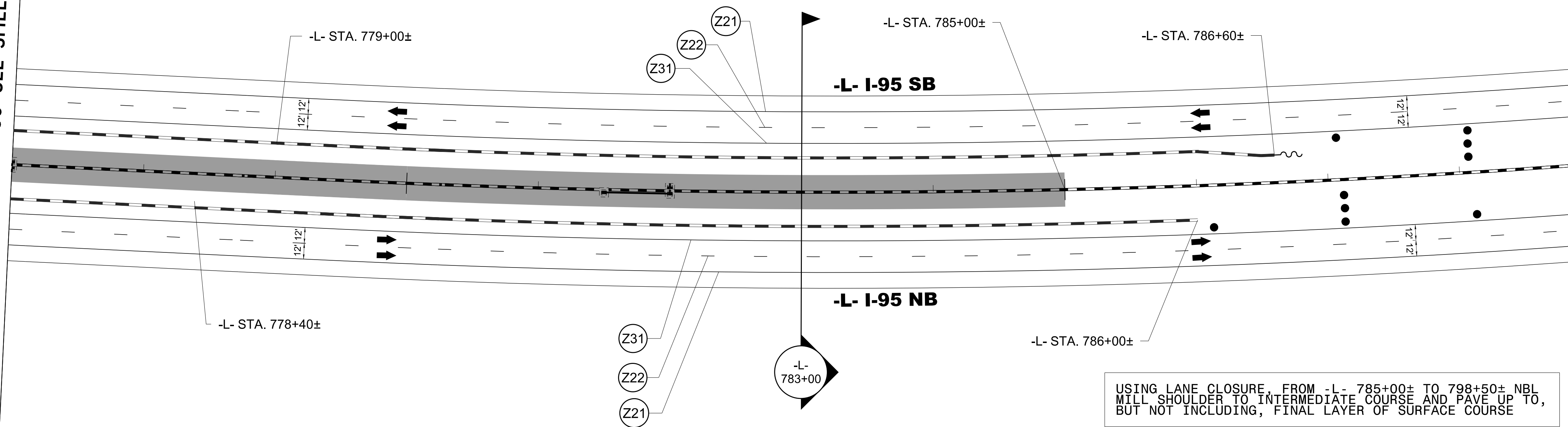

USING LANE CLOSURE, FROM -L- 785+00± TO 788+00± NBL MILL SHOULDER TO INTERMEDIATE COURSE AND PAVE UP TO, BUT NOT INCLUDING, FINAL LAYER OF SURFACE COURSE

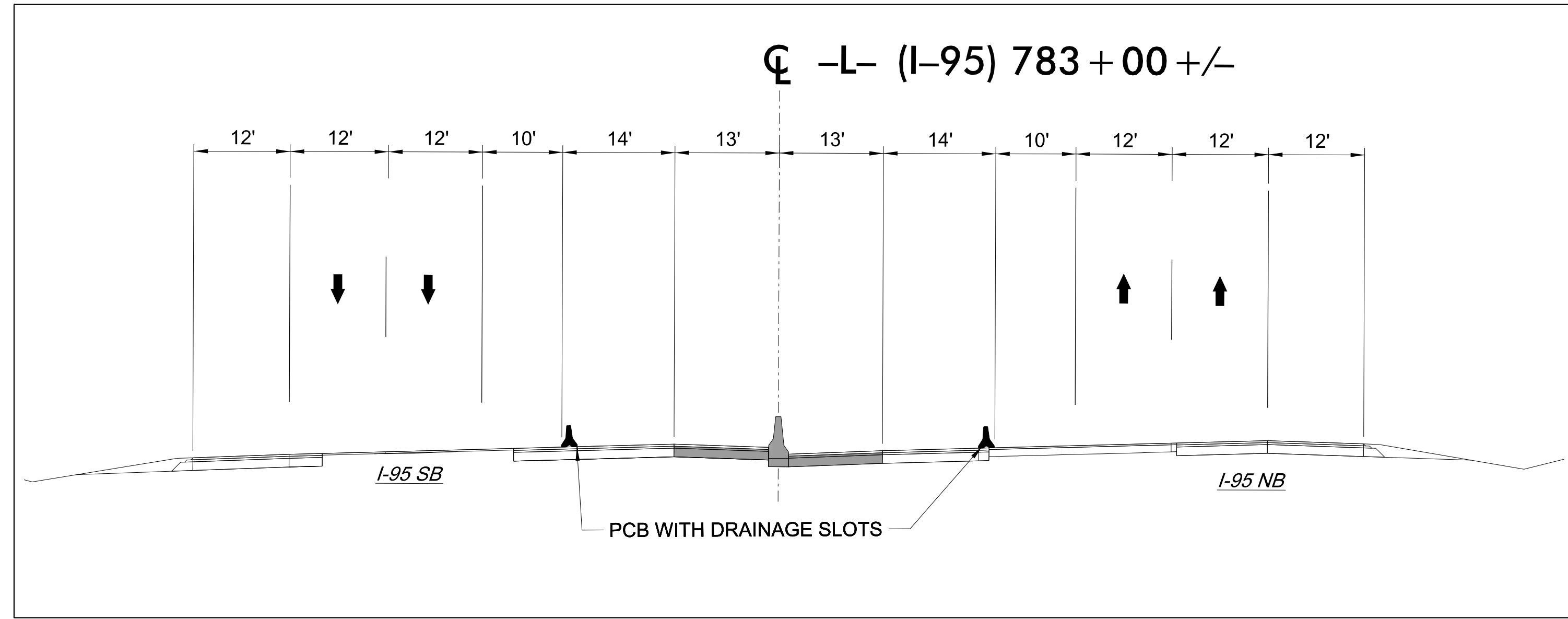

4/19/2022
U:\Traffic\Transportation Management\Plan\TCP\PLAN SHEETS\I-5987B_TMP-286_PHASE 5.dgn
angood

Stantec
Stantec Consulting Services Inc.
801 Jones Franklin Road
Suite 300
Raleigh, NC 27606
Tel. 919.851.6866
Fax. 919.851.7024
www.stantec.com
License No. F-0672

DocuSigned by:
J.W. Woollard, Jr.
PROFESSIONAL ENGINEER
SEAL
19862
J.W. WOOLLARD, JR.
4/29/2022
DOCUMENT NOT CONSIDERED FINAL UNLESS ALL SIGNATURES COMPLETED

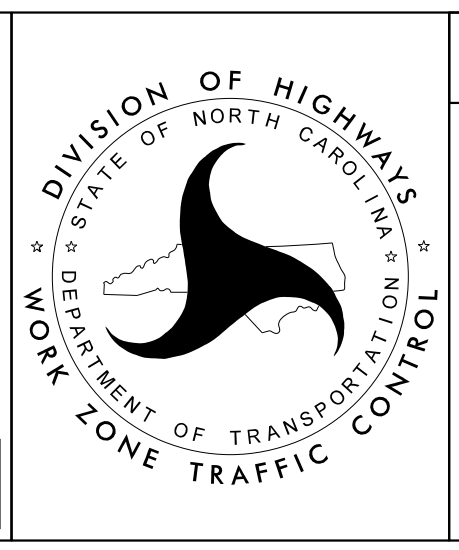

SECTION 2

-L- I-95
PHASE V

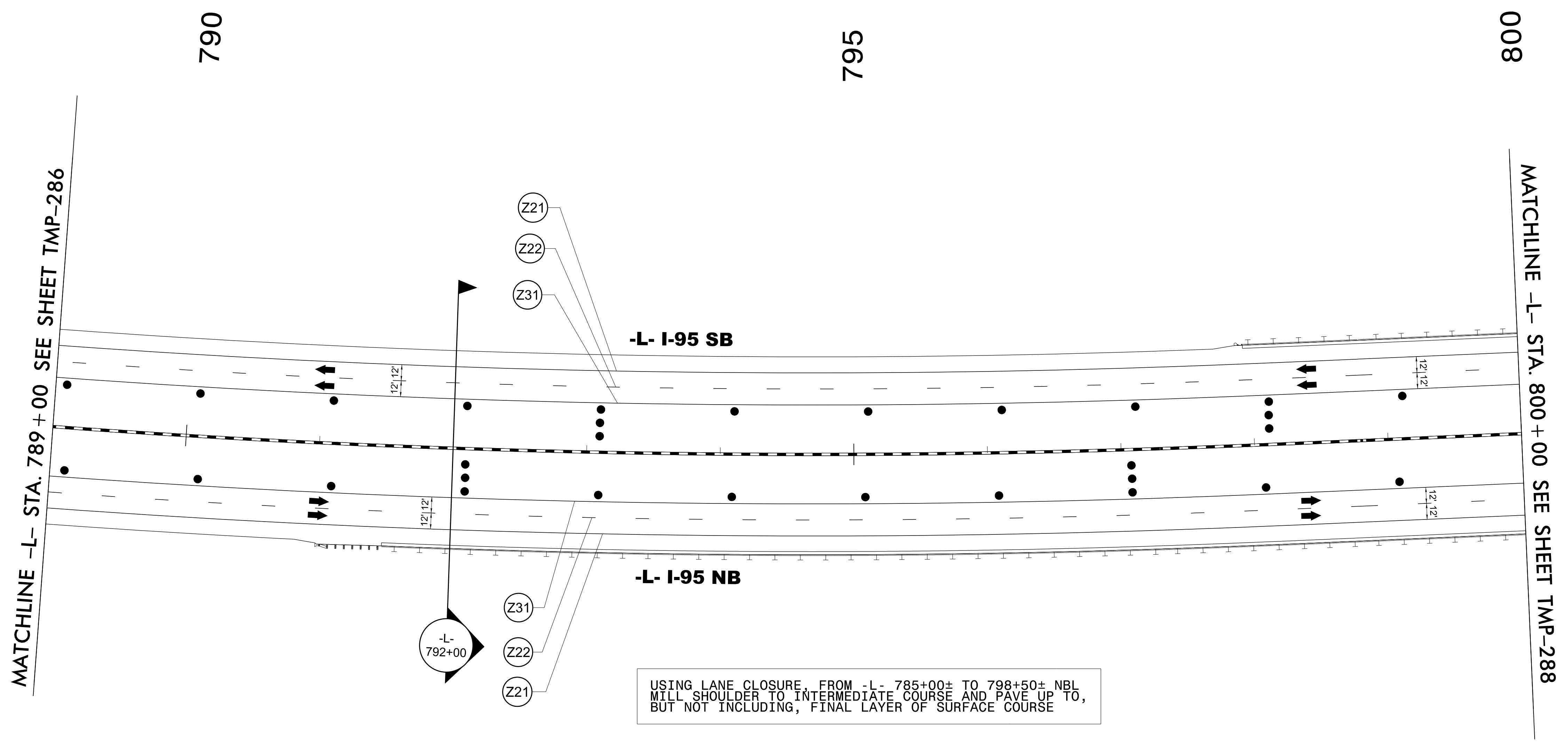

USING LANE CLOSURE FROM -L- 785+00+ TO 798+50+ NBL
MILL SHOULDER TO INTERMEDIATE COURSE AND PAVE UP TO,
BUT NOT INCLUDING, FINAL LAYER OF SURFACE COURSE

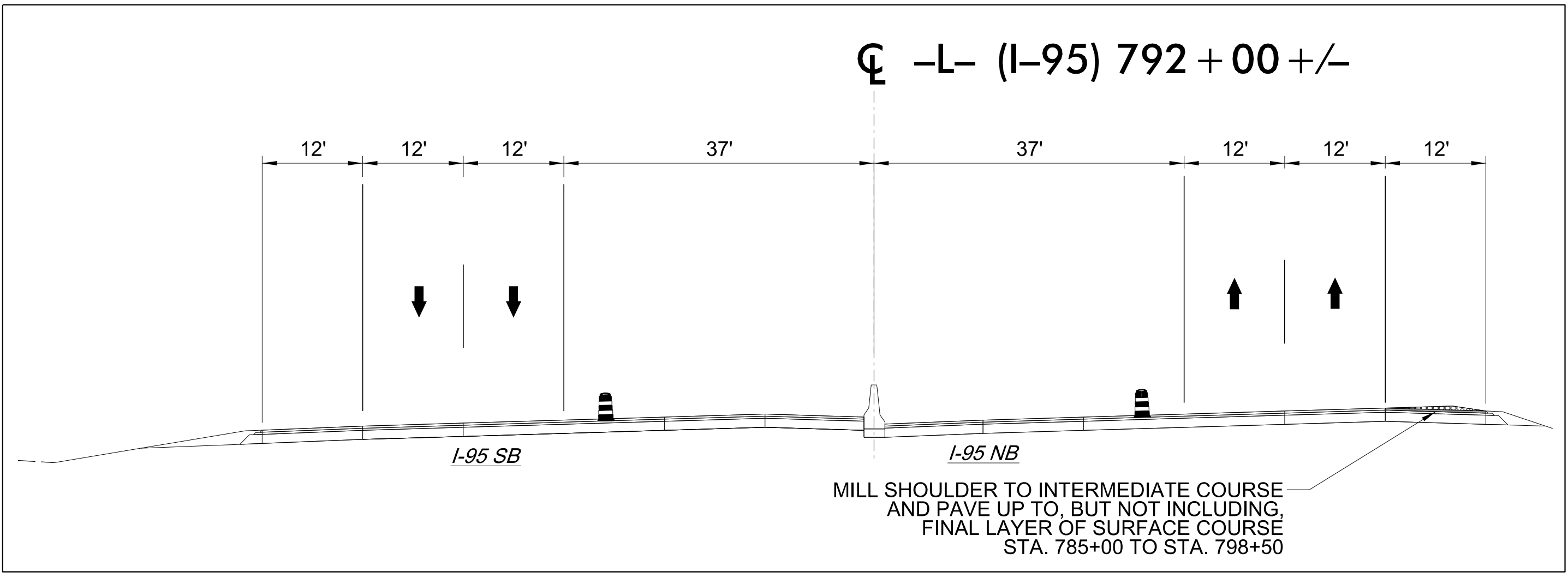

4/19/2022
U:\Traffic\Transportation Management Plan\TCP\PLAN SHEETS\I-5987B_TMP-287_PHASE 5.dgn
angood

Stantec
Stantec Consulting Services Inc.
801 Jones Franklin Road
Suite 300
Raleigh, NC 27606
Tel. 919.851.6866
Fax. 919.851.7024
www.stantec.com
License No. F-0672

DocuSigned by:
J.W. Woollard
Professional Engineer
19862
J.W. WOOLLARD, P.E.
4/29/2022
**DOCUMENT NOT CONSIDERED FINAL
UNLESS ALL SIGNATURES COMPLETED**

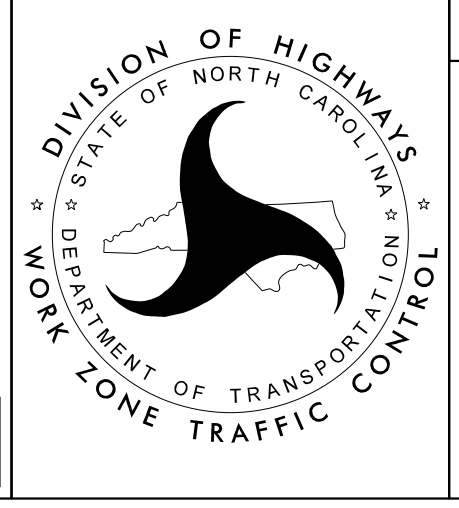

SECTION 2

-L- I-95
PHASE V

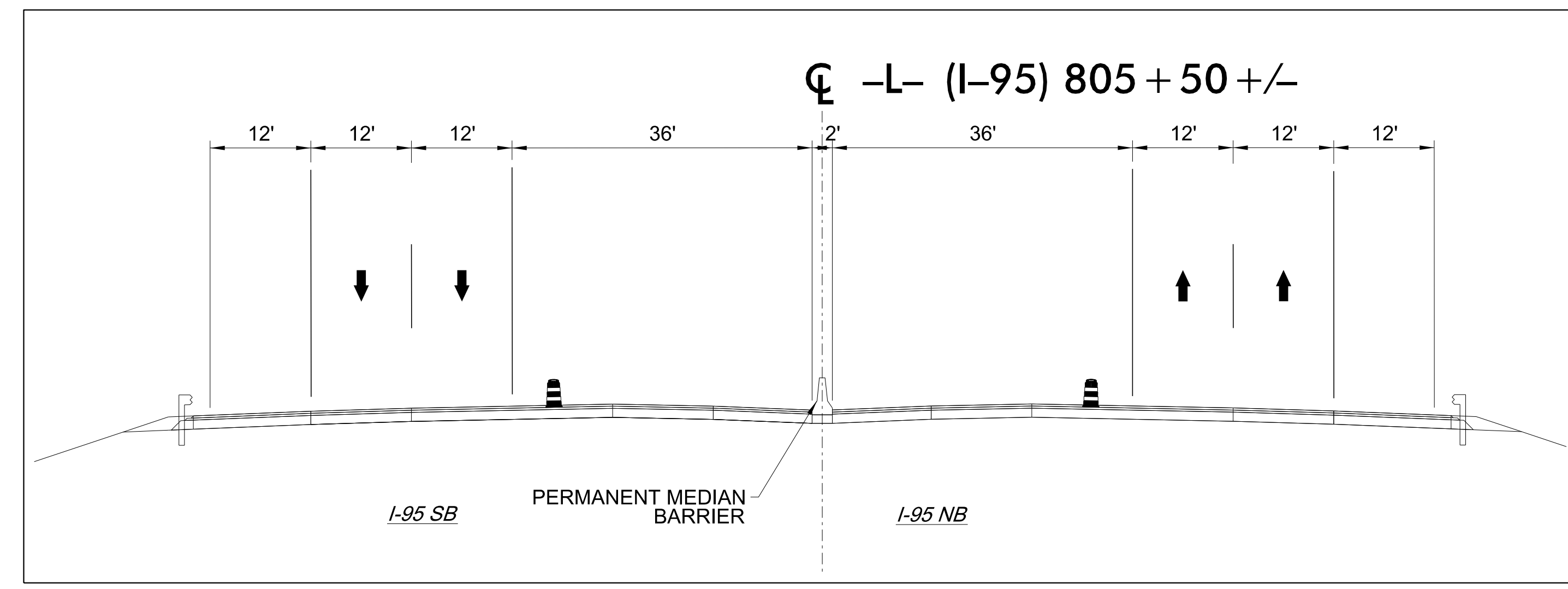
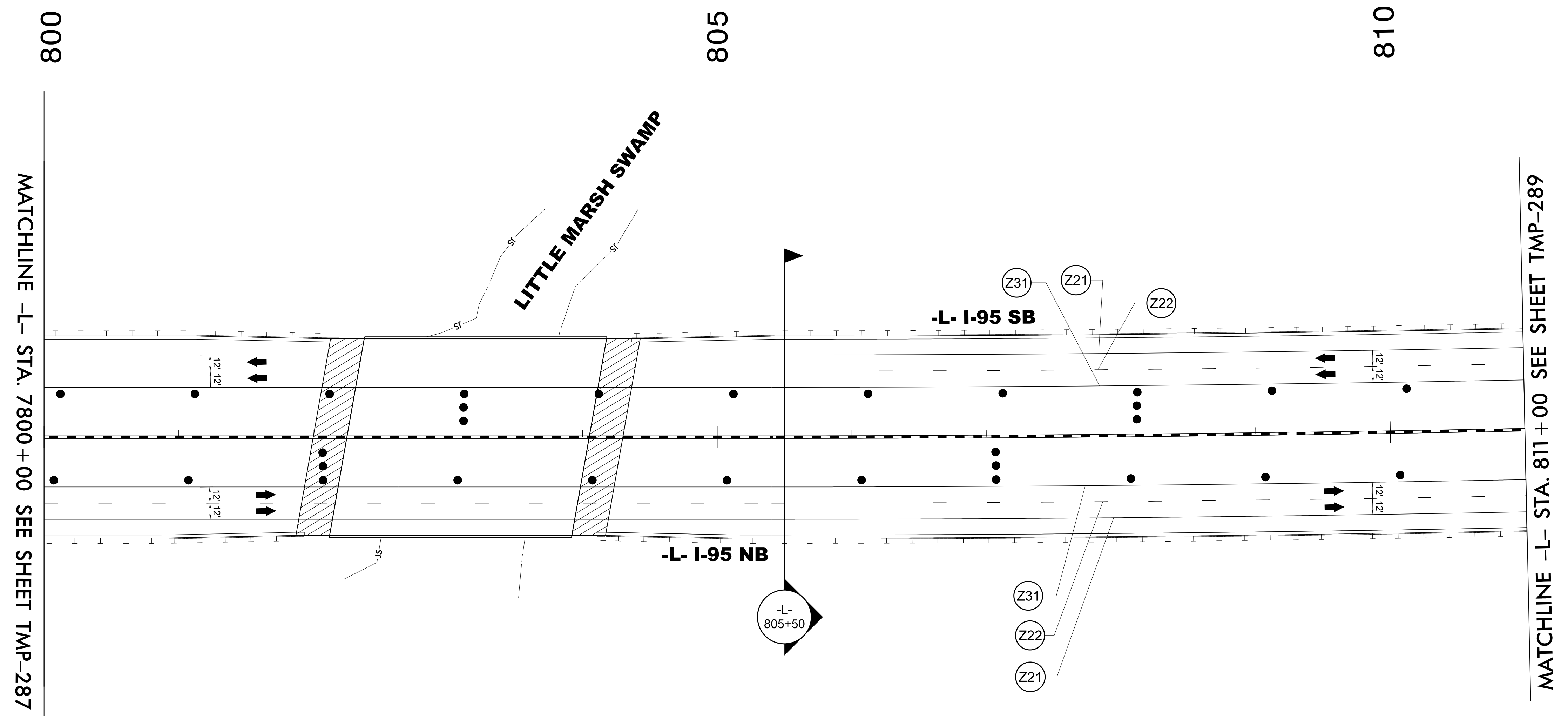

4/19/2022
U:\Traffic\Transportation Management Plan\TCP\PLAN SHEETS\I-5987B_TMP-288_PHASE 5.dgn
angood

Stantec Consulting Services Inc.
801 Jones Franklin Road
Suite 300
Raleigh, NC 27606
Tel. 919.851.6866
Fax. 919.851.7024
www.stantec.com
License No. F-0672

DocuSigned by:
J.W. Williams
BBOC2F49E937EC

4/29/2022

**DOCUMENT NOT CONSIDERED FINAL
UNLESS ALL SIGNATURES COMPLETED**

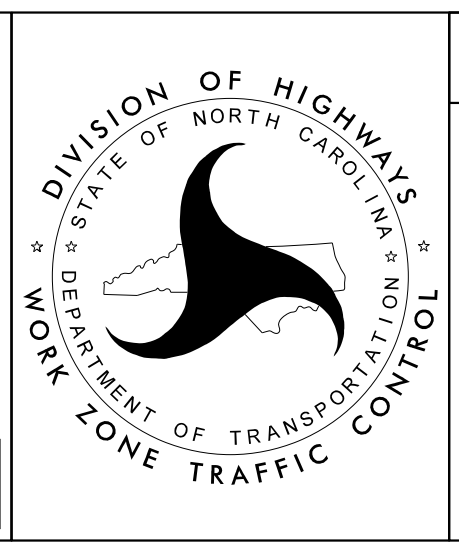

SECTION 2

-L- I-95
PHASE V

PROJ. REFERENCE NO.	SHEET NO.
I-5987B	TMP-289

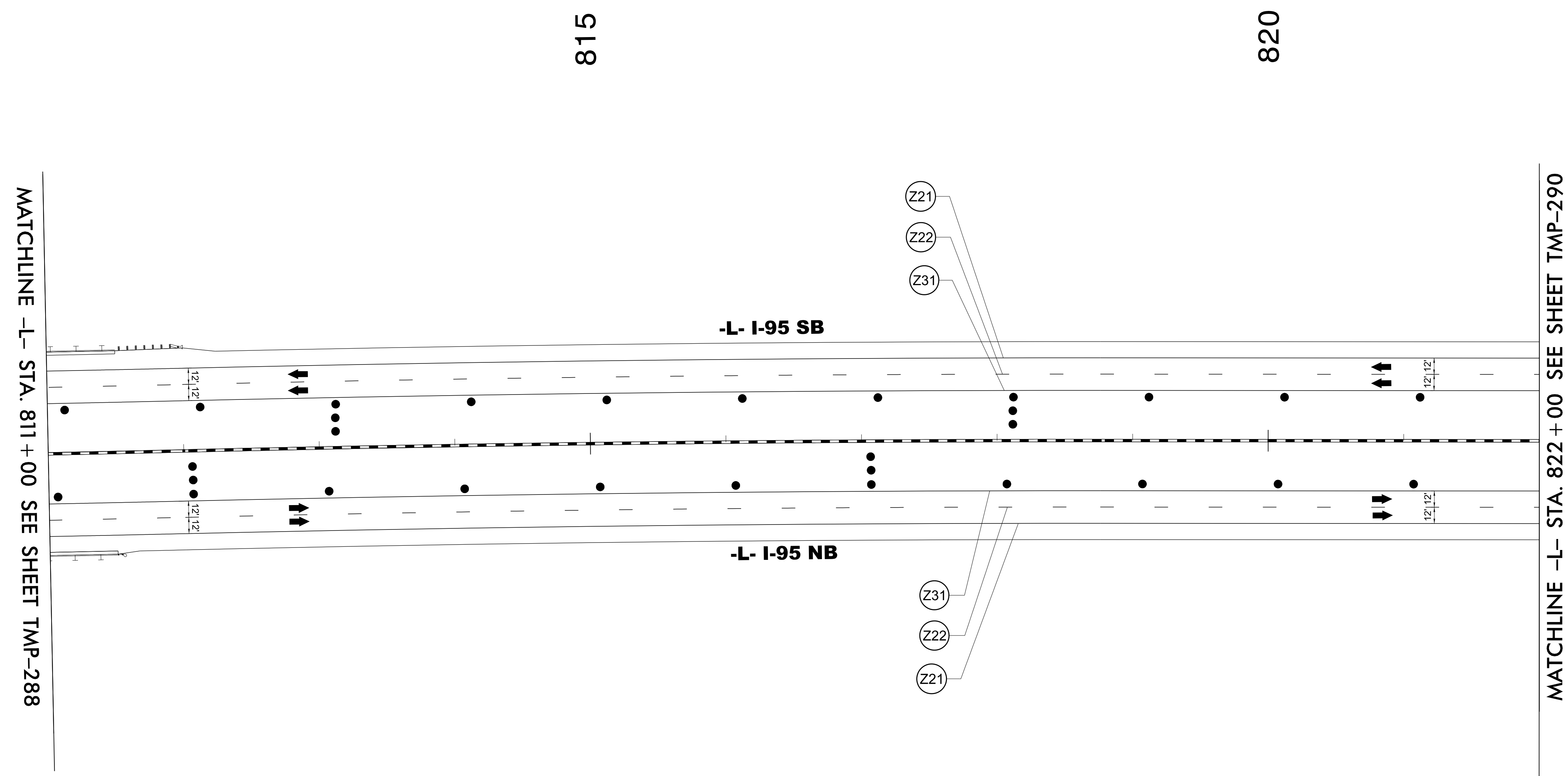

4/19/2022
 U:\Traffic\Transportation Management Plan\TCP\PLAN SHEETS\I-5987B_TMP-289_PHASE 5.dgn
 angood

Stantec Consulting Services Inc.
 801 Jones Franklin Road
 Suite 300
 Raleigh, NC 27606
 Tel. 919.851.6866
 Fax. 919.851.7024
 www.stantec.com
 License No. F-0672

DocuSigned by:
 J.W. Woolard
 4/29/2022

**DOCUMENT NOT CONSIDERED FINAL
 UNLESS ALL SIGNATURES COMPLETED**

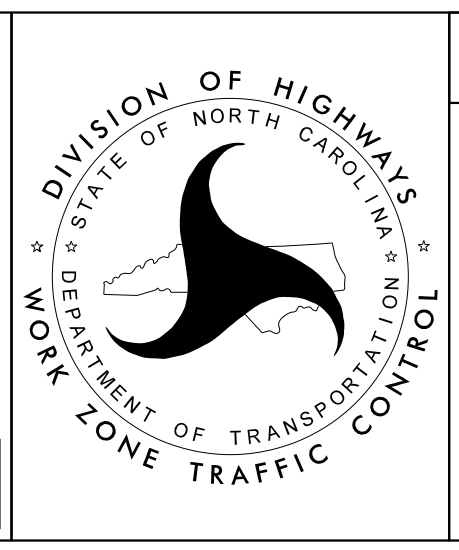

SECTION 2

-L- I-95
 PHASE V

PROJ. REFERENCE NO.	SHEET NO.
I-5987B	TMP-290

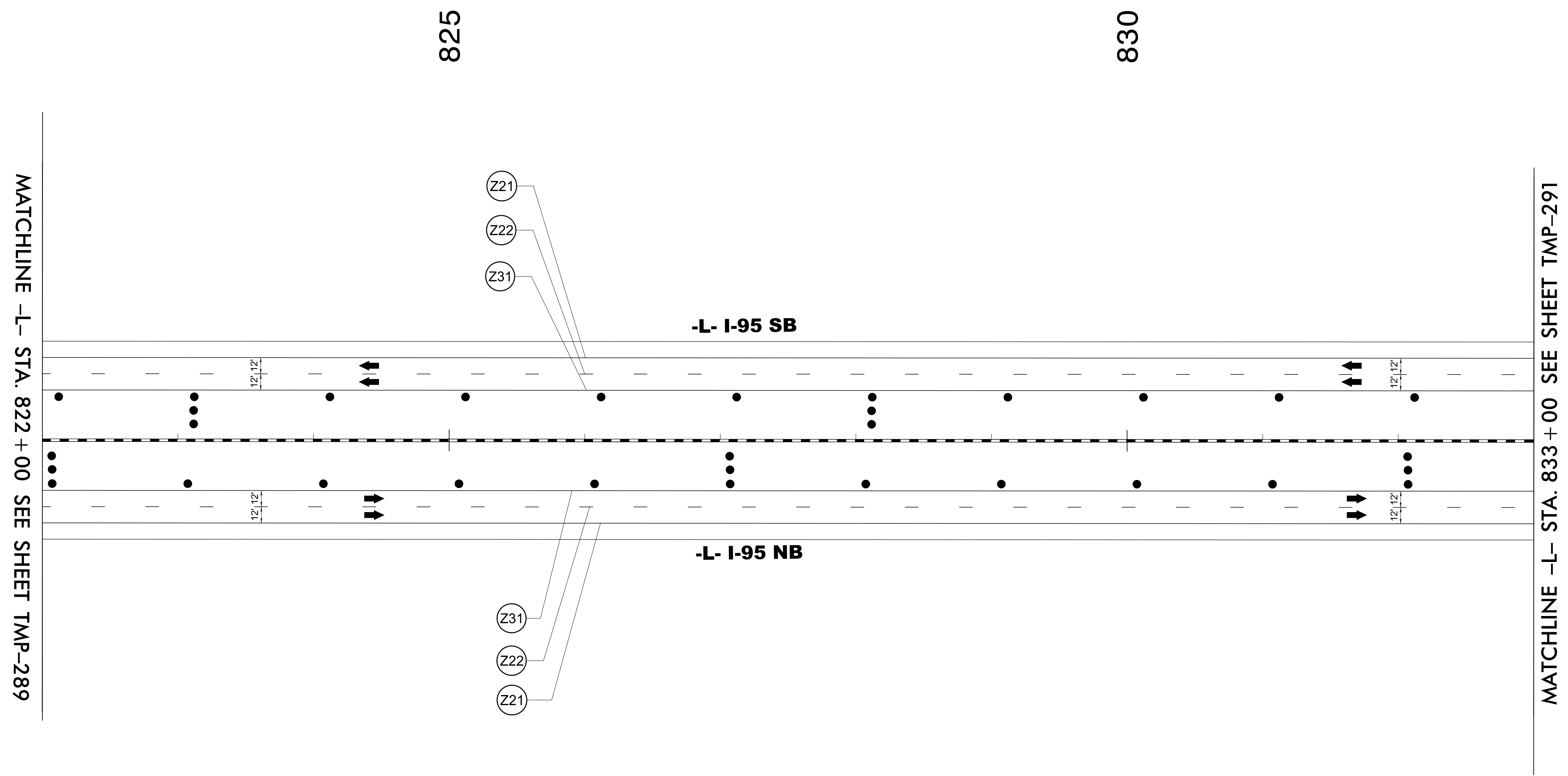

4/19/2022
 U:\Traffic\Transportation Management\Plan\TCP\PLAN SHEETS\I-5987B_TMP-290_PHASE 5.dgn
 angood

Stantec Consulting Services Inc.
 801 Jones Franklin Road
 Suite 300
 Raleigh, NC 27606
 Tel. 919.851.6866
 Fax. 919.851.7024
 www.stantec.com
 License No. F-0672

4/29/2022

**DOCUMENT NOT CONSIDERED FINAL
 UNLESS ALL SIGNATURES COMPLETED**

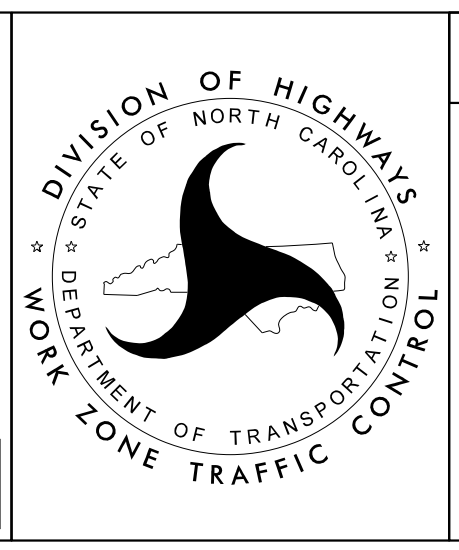

SECTION 2

-L- I-95
PHASE V

PROJ. REFERENCE NO.	SHEET NO.
I-5987B	TMP-291

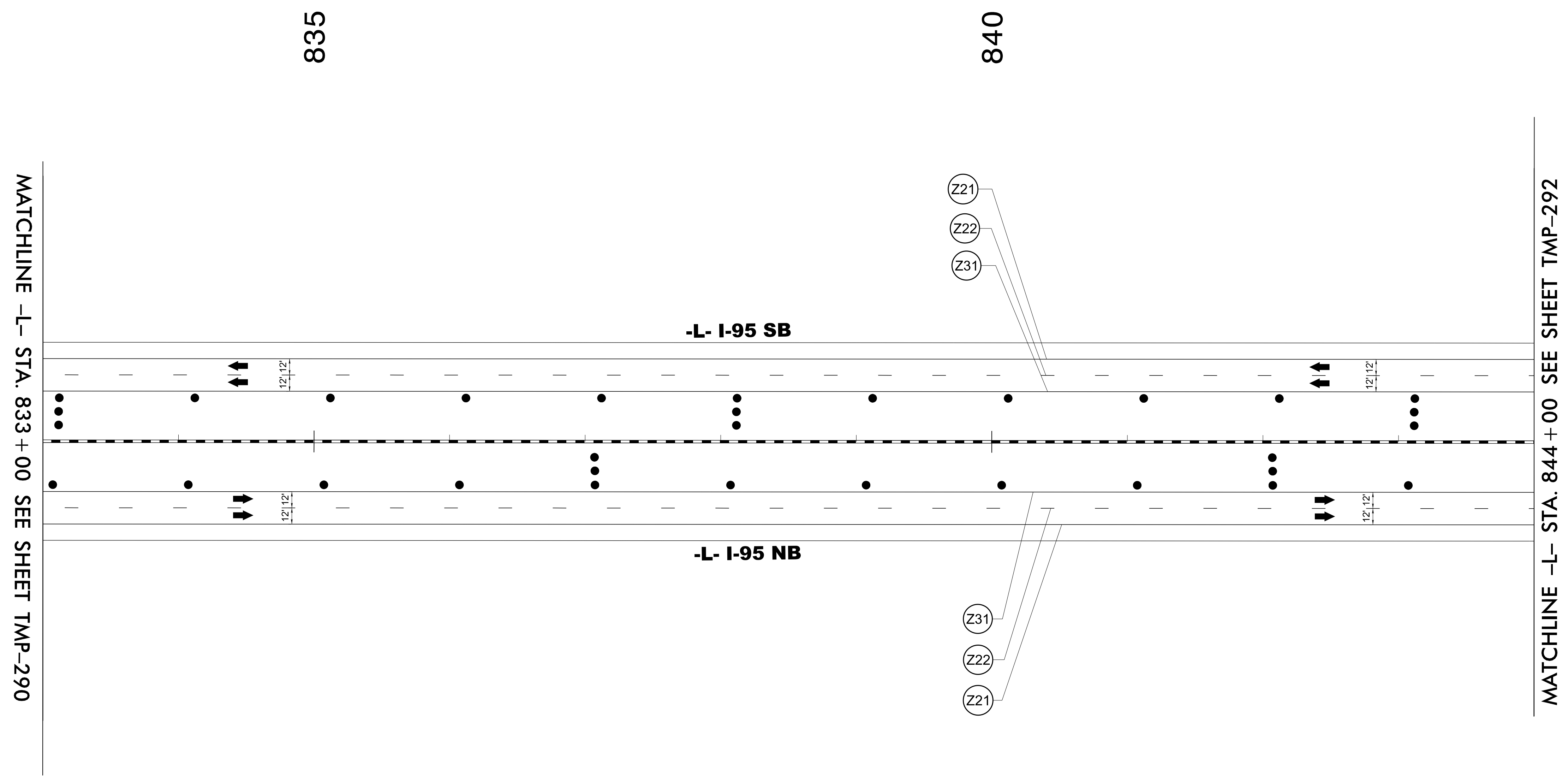

4/19/2022
 U:\Traffic\Transportation Management\Plan\TCP\PLAN SHEETS\I-5987B_TMP-291_PHASE 5.dgn
 angood

Stantec Consulting Services Inc.
 801 Jones Franklin Road
 Suite 300
 Raleigh, NC 27606
 Tel. 919.851.6866
 Fax. 919.851.7024
 www.stantec.com
 License No. F-0672

Documented by
 J.W. Woolard
 PROFESSIONAL SEAL
 19862
 ENGINEER
 J.W. WOOLARD, JR.
 4/29/2022
**DOCUMENT NOT CONSIDERED FINAL
 UNLESS ALL SIGNATURES COMPLETED**

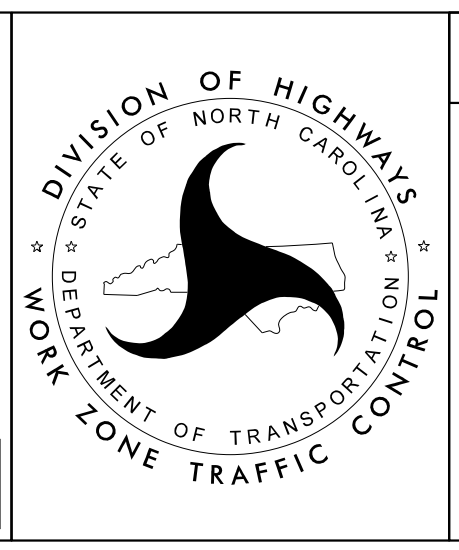

SECTION 2

**-L- I-95
 PHASE V**

PROJ. REFERENCE NO.	SHEET NO.
I-5987B	TMP-292

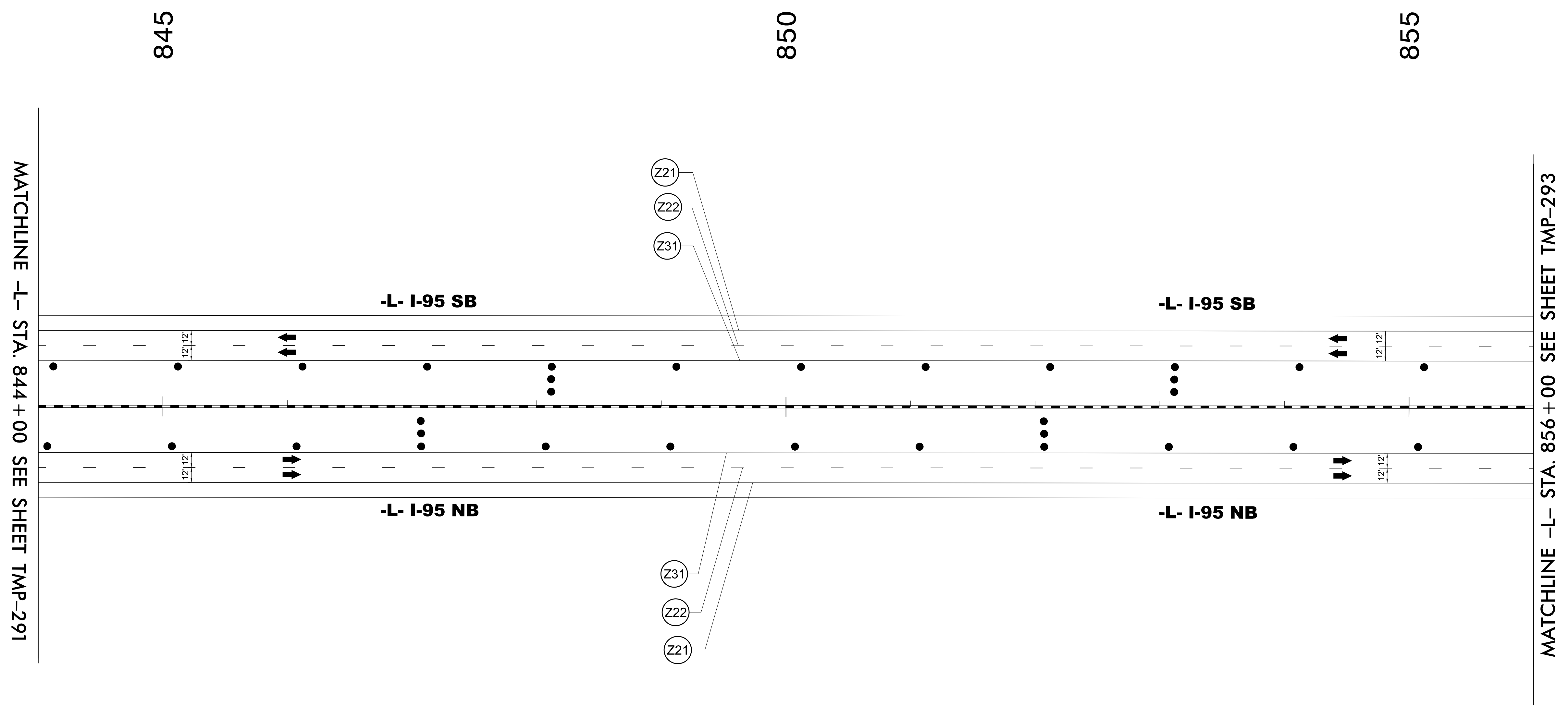

MATCHLINE -L- STA. 844 + 00 SEE SHEET TMP-291

MATCHLINE -L- STA. 856 + 00 SEE SHEET TMP-293

4/19/2022
 U:\Traffic\Transportation Management Plan\TCP\PLAN SHEETS\I-5987B_TMP-292_PHASE 5.dgn
 angood

Stantec Consulting Services Inc.
 801 Jones Franklin Road
 Suite 300
 Raleigh, NC 27606
 Tel. 919.851.6866
 Fax. 919.851.7024
 www.stantec.com
 License No. F-0672

DocuSigned by:
 J.W. Woolard
 4/29/2022

**DOCUMENT NOT CONSIDERED FINAL
 UNLESS ALL SIGNATURES COMPLETED**

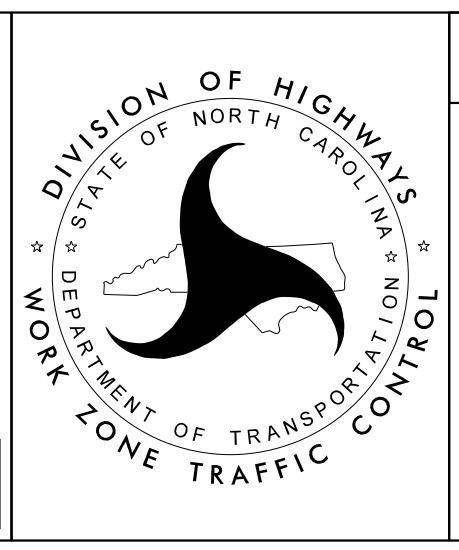

SECTION 2

-L- I-95
 PHASE V

PROJ. REFERENCE NO.	SHEET NO.
I-5987B	TMP-293

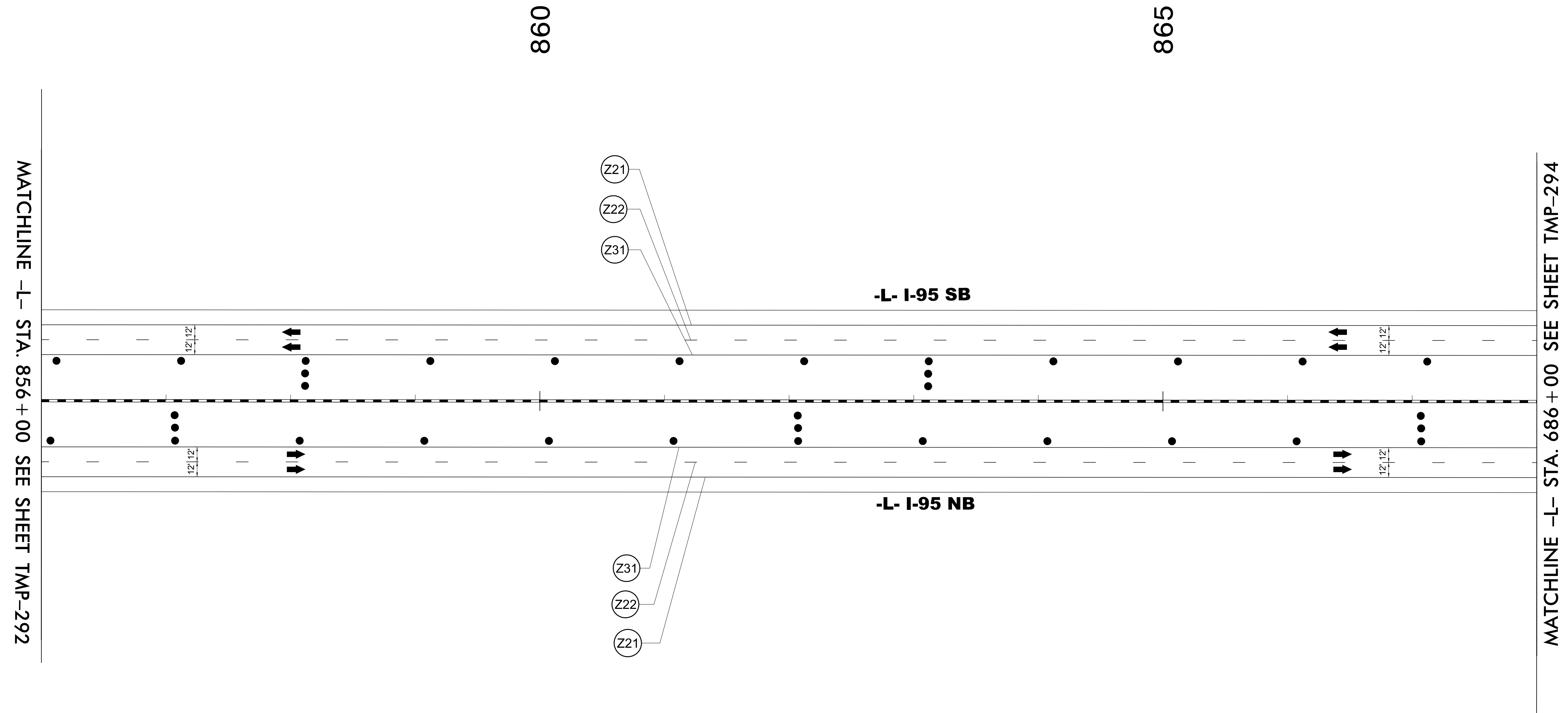

MATCHLINE -L- STA. 856 + 00 SEE SHEET TMP-292

MATCHLINE -L- STA. 686 + 00 SEE SHEET TMP-294

4/19/2022
 U:\Traffic\Transportation Management\Plan\TCP\PLAN SHEETS\I-5987B_TMP-293_PHASE 5.dgn
 angood

Stantec Consulting Services Inc.
 801 Jones Franklin Road
 Suite 300
 Raleigh, NC 27606
 Tel. 919.851.6866
 Fax. 919.851.7024
 www.stantec.com
 License No. F-0672

DocuSigned by:
 J.W. Woolard
 4/29/2022

**DOCUMENT NOT CONSIDERED FINAL
 UNLESS ALL SIGNATURES COMPLETED**

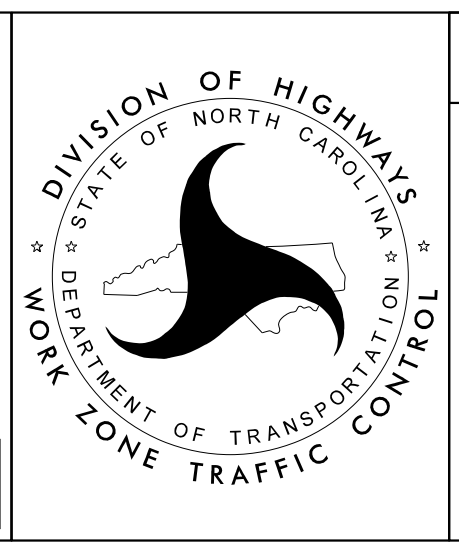

SECTION 2

-L- I-95
 PHASE V

PROJ. REFERENCE NO.	SHEET NO.
I-5987B	TMP-294

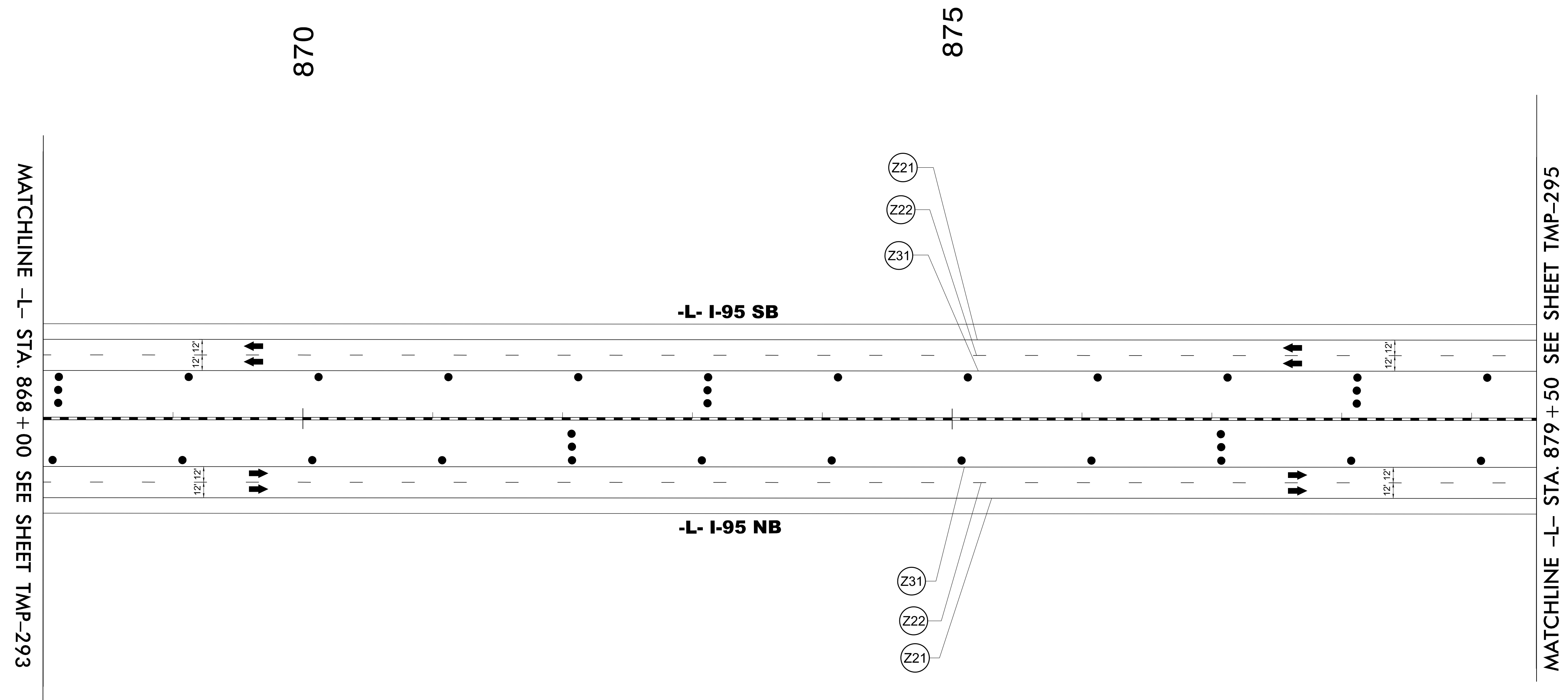

MATCHLINE -L- STA. 868 + 00 SEE SHEET TMP-293

MATCHLINE -L- STA. 879 + 50 SEE SHEET TMP-295

4/19/2022
 U:\Traffic\Transportation Management Plan\TCP\PLAN SHEETS\I-5987B_TMP-294_PHASE 5.dgn
 angood

Stantec Consulting Services Inc.
 801 Jones Franklin Road
 Suite 300
 Raleigh, NC 27606
 Tel. 919.851.6866
 Fax. 919.851.7024
 www.stantec.com
 License No. F-0672

DocuSigned by:
 J.W. Woolard
 4/29/2022

**DOCUMENT NOT CONSIDERED FINAL
 UNLESS ALL SIGNATURES COMPLETED**

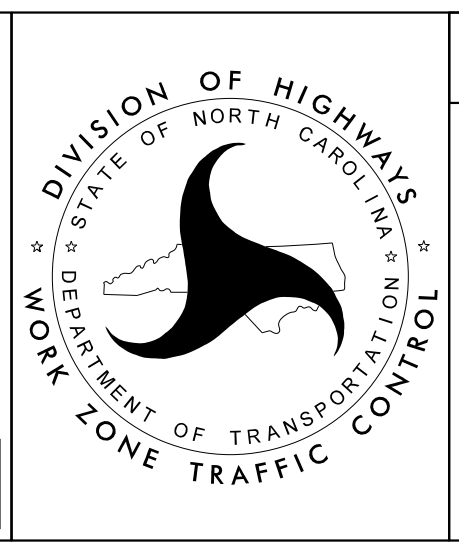

SECTION 2

-L- I-95
 PHASE V

PROJ. REFERENCE NO.	SHEET NO.
I-5987B	TMP-295

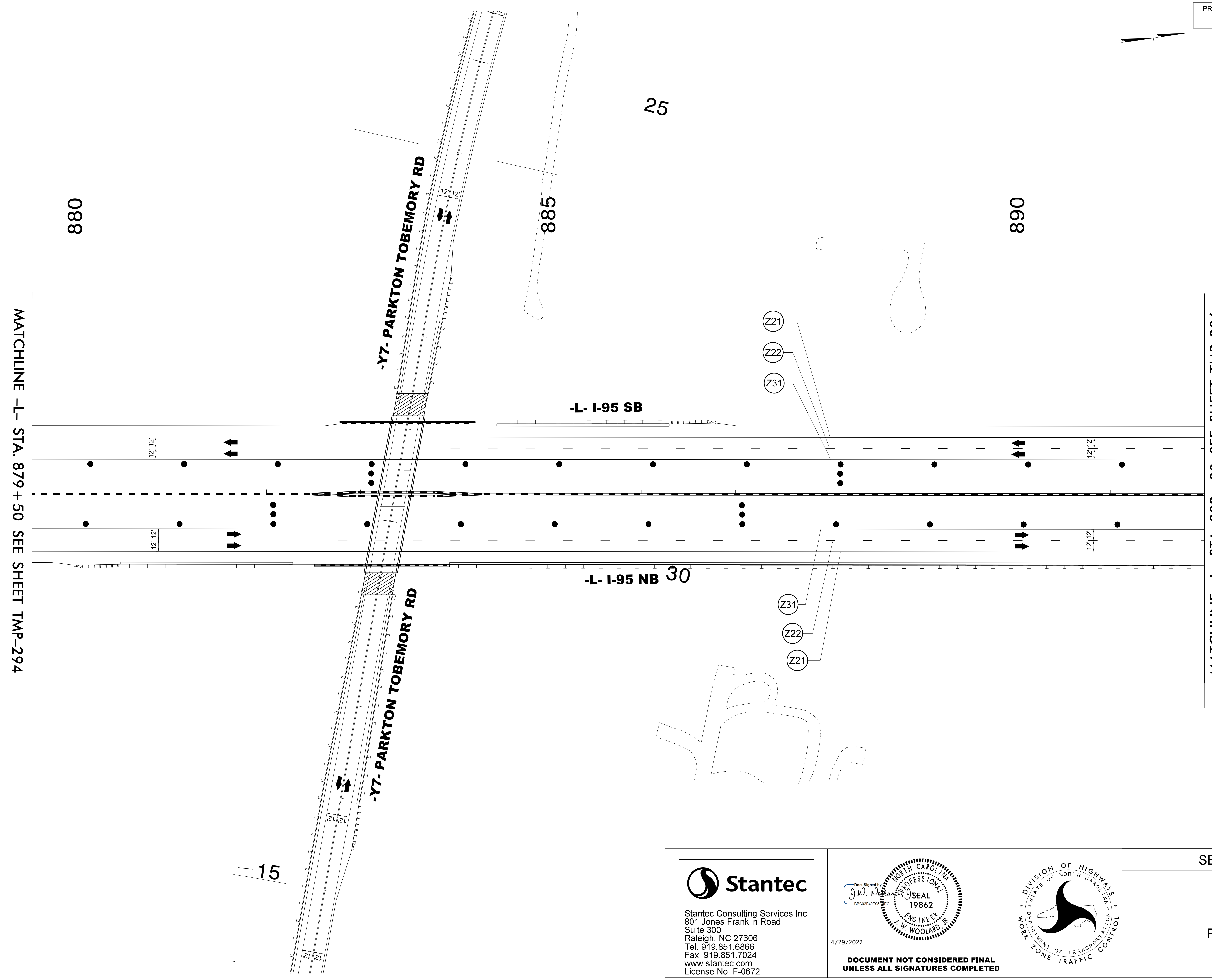

MATCHLINE -L- STA. 879 + 50 SEE SHEET TMP-294

MATCHLINE -L- STA. 892 + 00 SEE SHEET TMP-296

4/19/2022
 U:\Traffic\Transportation Management\Plan\TCP\PLAN SHEETS\I-5987B_TMP-295_PHASE 5.dgn
 angood

Stantec Consulting Services Inc.
 801 Jones Franklin Road
 Suite 300
 Raleigh, NC 27606
 Tel. 919.851.6866
 Fax. 919.851.7024
 www.stantec.com
 License No. F-0672

DocuSigned by:
 J.W. Woollard
 BB02F49E3E3C

4/29/2022

**DOCUMENT NOT CONSIDERED FINAL
 UNLESS ALL SIGNATURES COMPLETED**

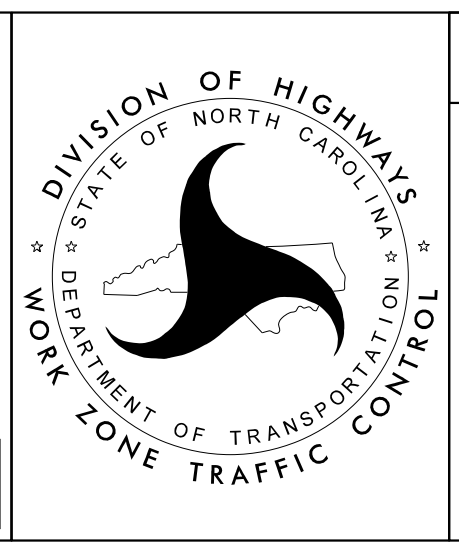

SECTION 2

-L- I-95
 PHASE V



MATCHLINE -L- STA. 892+00 SEE SHEET TMP-295

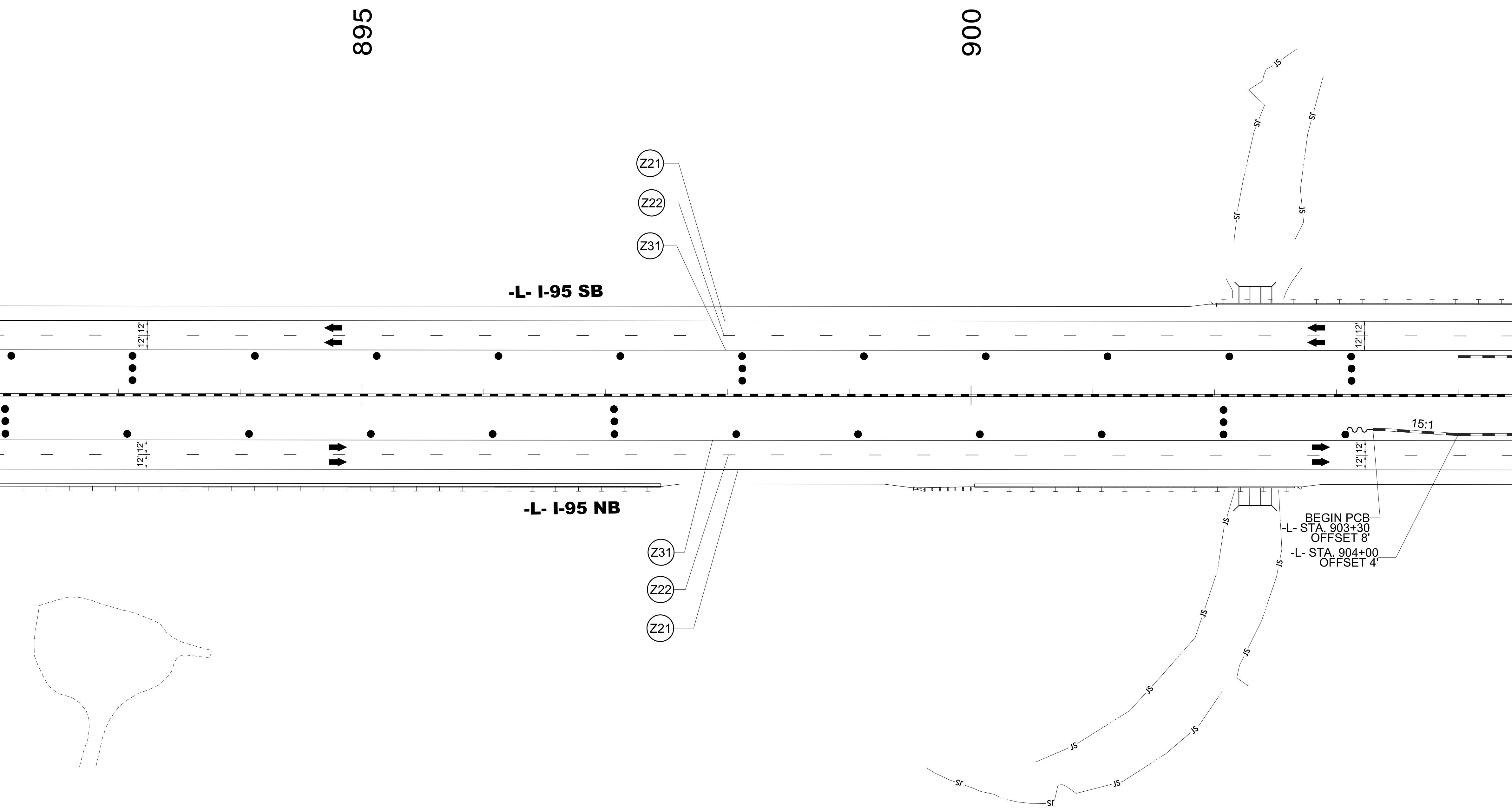

4/19/2022
U:\Traffic\Transportation Management Plan\TCP\PLAN SHEETS\I-5987B_TMP-296_PHASE 5.dgn
angood

Stantec Consulting Services Inc.
801 Jones Franklin Road
Suite 300
Raleigh, NC 27606
Tel. 919.851.6866
Fax. 919.851.7024
www.stantec.com
License No. F-0672

4/29/2022

**DOCUMENT NOT CONSIDERED FINAL
UNLESS ALL SIGNATURES COMPLETED**

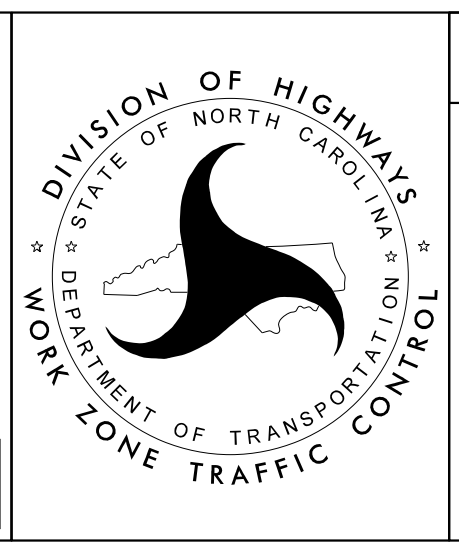

SECTION 2

-L- I-95
PHASE V

CONTRACTOR SHALL COORDINATE CONSTRUCTION WITH U-2519AA CONTRACTOR

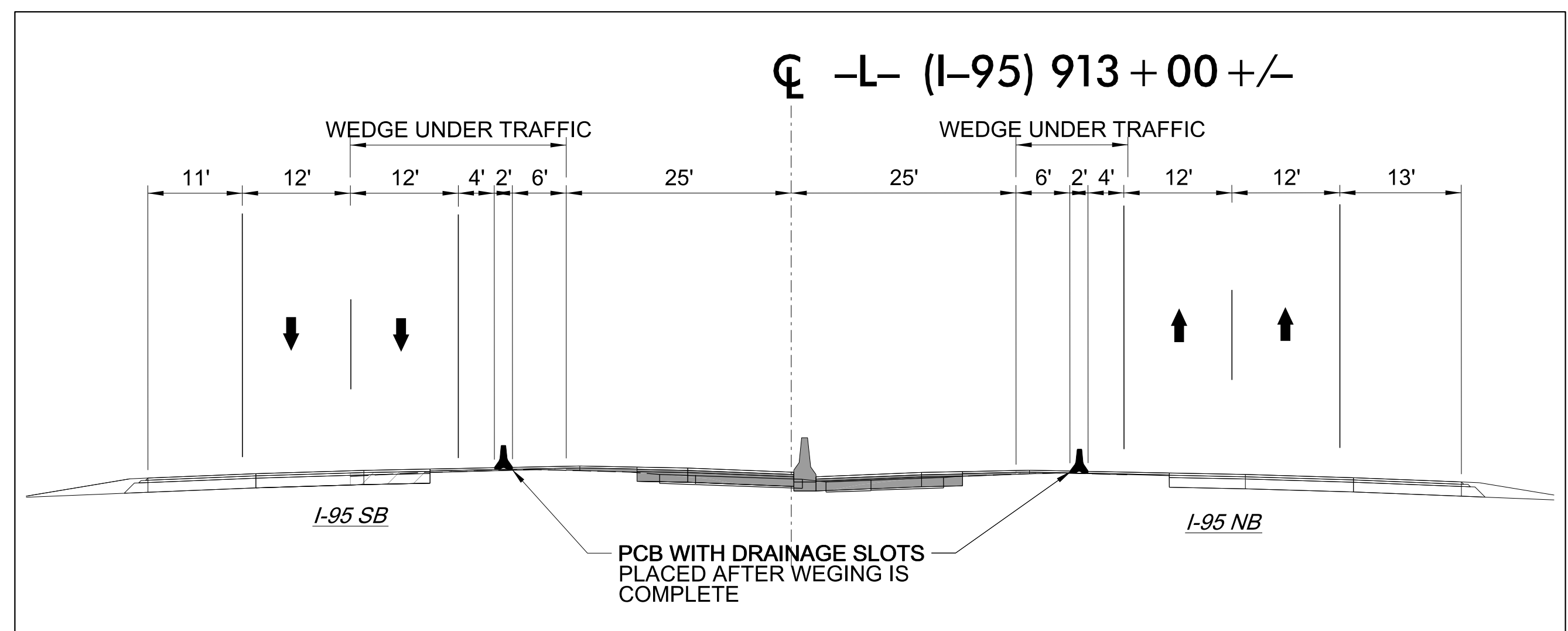
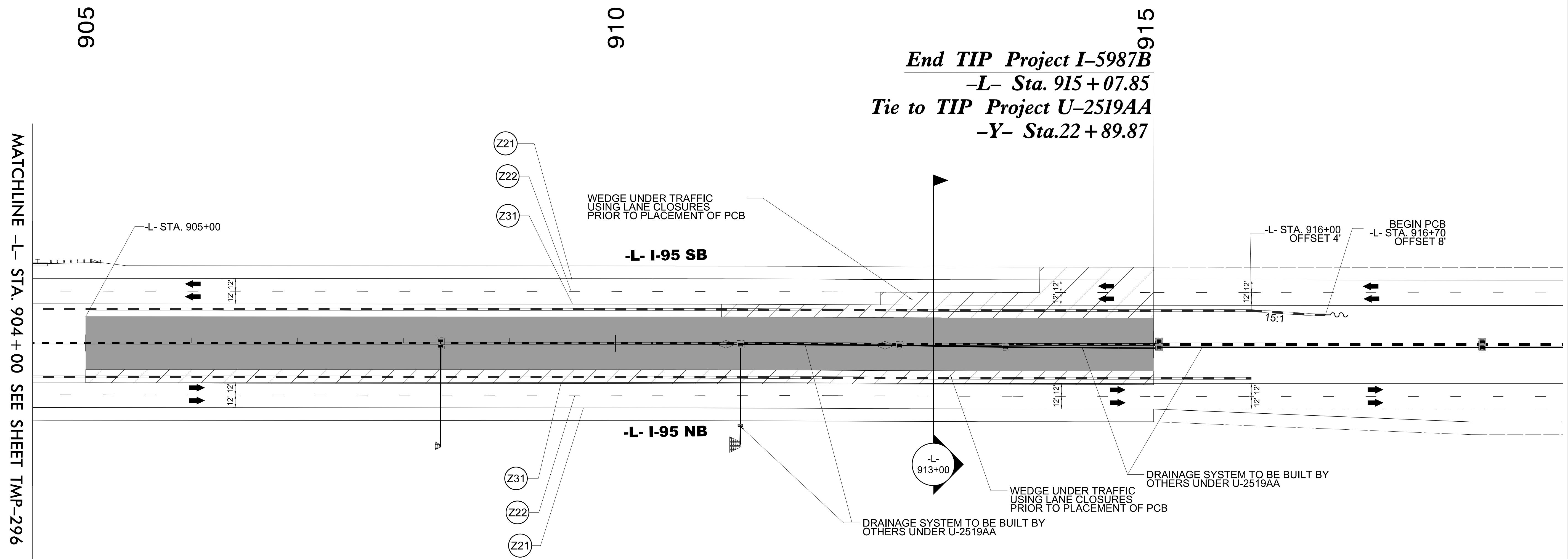

4/19/2022
 U:\Traffic\Transportation Management Plan\TCP\PLAN SHEETS\I-5987B_TMP-297_PHASE 5.dgn
 angood

Stantec Consulting Services Inc.
 801 Jones Franklin Road
 Suite 300
 Raleigh, NC 27606
 Tel. 919.851.6866
 Fax. 919.851.7024
 www.stantec.com
 License No. F-0672

4/29/2022

**DOCUMENT NOT CONSIDERED FINAL
 UNLESS ALL SIGNATURES COMPLETED**

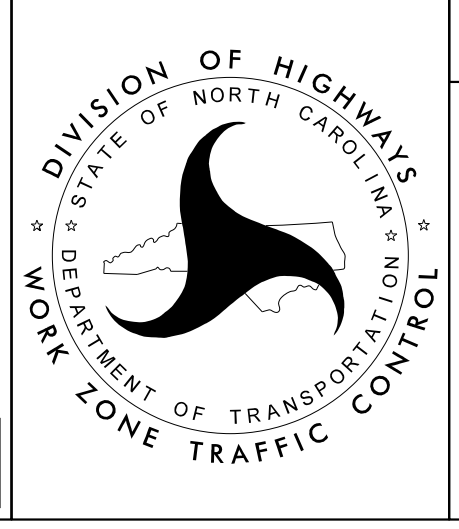

SECTION 2

-L- I-95
 PHASE V