

PROGRAMMING DETAIL

(remove jumpers and set switches as shown)

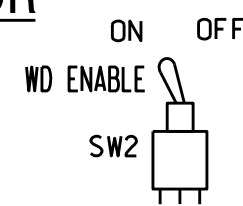

REMOVE DIODE JUMPERS 2-6, 2-9, 2-11, 6-9, 6-11 and 9-11.

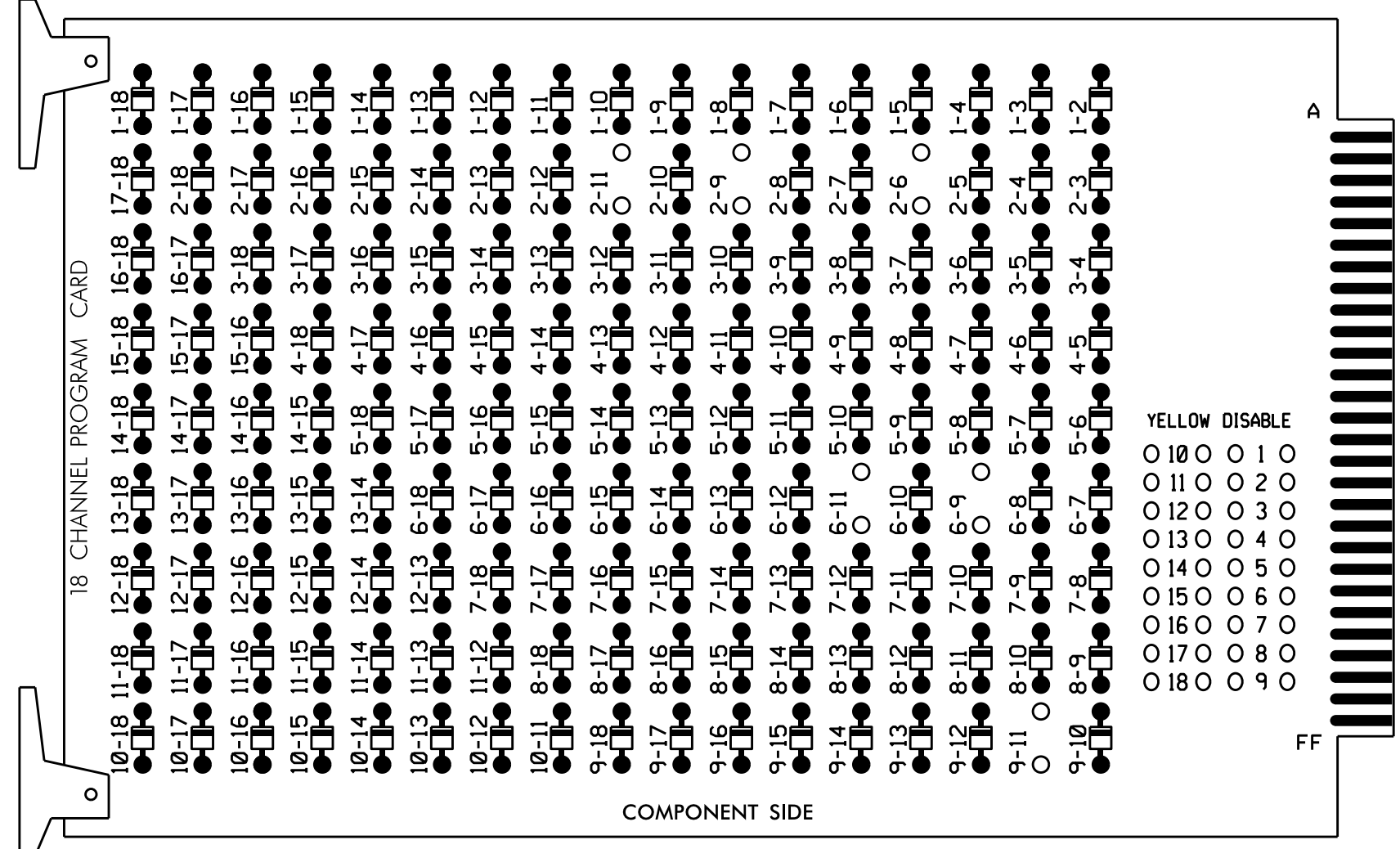

REMOVE JUMPERS AS SHOWN

NOTES:

- Card is provided with all diode jumpers in place. Removal of any jumper allows its channels to run concurrently.
- Ensure jumpers SEL2-SEL5 and SEL9 are present on the monitor board.
- Ensure that Red Enable is active at all times during normal operation.
- Connect serial cable from conflict monitor to comm. port 1 of 2070 controller. Ensure conflict monitor communicates with 2070.

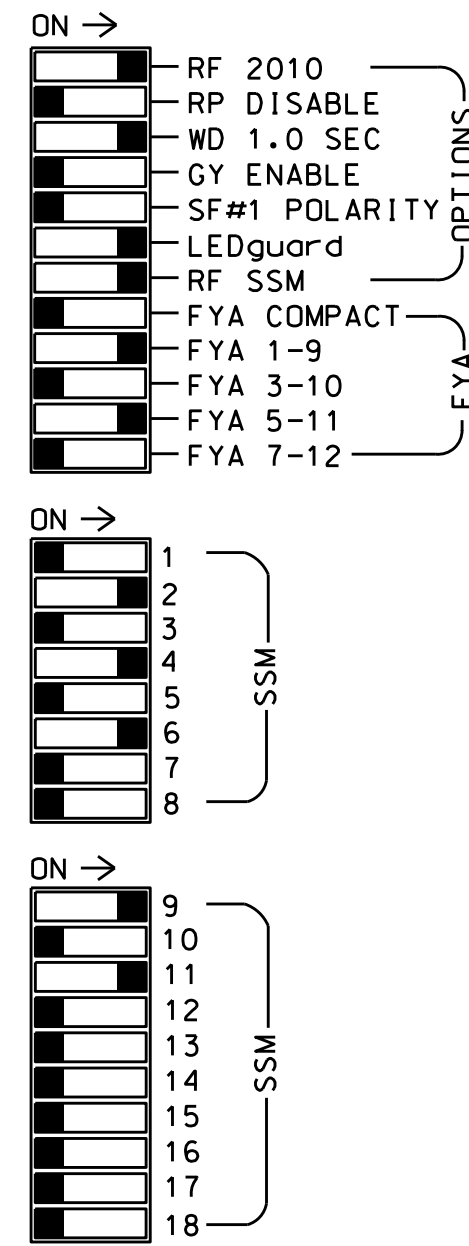

■ = DENOTES POSITION OF SWITCH

NOTES

- To prevent "flash-conflict" problems, insert red flash program blocks for all unused vehicle load switches in the output file. The installer shall verify that signal heads flash in accordance with the Signal Plans.
- Enable Simultaneous Gap-Out for all Phases.
- Program phases 2 and 6 for Variable Initial and Gap Reduction.
- Program phases 2 and 6 for Startup In Green.
- Program phases 2 and 6 for Yellow Flash, and overlap 1 as Wag Overlaps.
- If this signal will be managed by an ATMS software, enable controller and detector logging for all detectors used at this location.
- The cabinet and controller are part of the US 70 Bus.- NC 42 (Clayton) D04-01_Clayton System.

EQUIPMENT INFORMATION

CONTROLLER.....2070
 CABINET.....332 W/ AUX
 SOFTWARE.....ECONOLITE OASIS
 CABINET MOUNT.....BASE
 OUTPUT FILE POSITIONS...18 WITH AUX. OUTPUT FILE
 LOAD SWITCHES USED.....S2,S5,S8,AUX S1,AUX S4
 PHASES USED.....2,4,6
 OVERLAP "A".....2
 OVERLAP "B".....NOT USED
 OVERLAP "C".....6
 OVERLAP "D".....NOT USED

SIGNAL HEAD HOOK-UP CHART

LOAD SWITCH NO.	S1	S2	S3	S4	S5	S6	S7	S8	S9	S10	S11	S12	AUX S1	AUX S2	AUX S3	AUX S4	AUX S5	AUX S6
CMU CHANNEL NO.	1	2	13	3	4	14	5	6	15	7	8	16	9	10	17	11	12	18
PHASE	1	2	2 PED	3	4	4 PED	5	6	6 PED	7	8	8 PED	OLA	OLB	SPARE	OLC	OLD	SPARE
SIGNAL HEAD NO.	NU	22, 23,24	NU	NU	41,42	NU	NU	61, 62,64	NU	NU	NU	NU	63	NU	NU	21	NU	NU
RED		128			101			134					A121					
YELLOW		129			102			135										
GREEN		130			103			136										
RED ARROW																		A114
YELLOW ARROW													A122					A115
FLASHING YELLOW ARROW													A123					A116
GREEN ARROW																		

NU = Not Used

★ See pictorial of head wiring in detail this sheet.

INPUT FILE POSITION LAYOUT

(front view)

FILE "I"	1	2	3	4	5	6	7	8	9	10	11	12	13	14
U	∅ 2	2A	∅ 2	∅ 2	∅ 2	∅ 4	∅ 4	∅ 4	∅ 4	∅ 4	∅ 4	∅ 4	∅ 4	FS
L	∅ 2	2B	∅ 2	∅ 2	∅ 2	∅ 4	∅ 4	∅ 4	∅ 4	∅ 4	∅ 4	∅ 4	∅ 4	DC ISOLATOR
U	∅ 6	6A	∅ 6	∅ 6	∅ 6	∅ 6	∅ 6	∅ 6	∅ 6	∅ 6	∅ 6	∅ 6	∅ 6	DC ISOLATOR
L	NOT USED	NOT USED	NOT USED	NOT USED	NOT USED	NOT USED	NOT USED	NOT USED	NOT USED	NOT USED	NOT USED	NOT USED	NOT USED	NOT USED

EX.: 1A, 2A, ETC. = LOOP NO.'S

FS = FLASH SENSE
 ST = STOP TIME

INPUT FILE CONNECTION & PROGRAMMING CHART

LOOP NO.	LOOP TERMINAL	INPUT FILE POS.	PIN NO.	INPUT ASSIGNMENT NO.	DETECTOR NO.	NEMA PHASE	CALL	EXTEND	FULL TIME DELAY	STRETCH TIME	DELAY TIME
2A	TB2-5,6	I2U	39	1	2	2	Y	Y			
2B	TB2-7,8	I2L	43	5	12	2	Y	Y	Y		3
4A	TB4-9,10	I6U	41	3	4	4	Y	Y			3
4B	TB4-11,12	I6L	45	7	14	4	Y	Y			15
6A	TB3-5,6	J2U	40	2	6	6	Y	Y			

INPUT FILE POSITION LEGEND: J2L

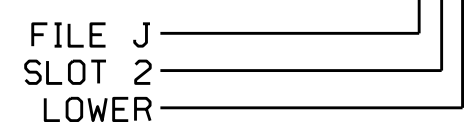

OVERLAP PROGRAMMING DETAIL

(program controller as shown below)

FROM MAIN MENU PRESS '8' (OVERLAPS), THEN '1' (VEHICLE OVERLAP SETTINGS).

PAGE 1: VEHICLE OVERLAP 'A' SETTINGS
 PHASE: ;12345678910111213141516
 VEH OVL PARENTS: ; X
 VEH OVL NOT VEH: ;
 VEH OVL NOT PED: ;
 VEH OVL GRN EXT: ;
 STARTUP COLOR: - RED - YELLOW - GREEN
 FLASH COLORS: - RED - YELLOW X GREEN
 SELECT VEHICLE OVERLAP OPTIONS: (Y/N)
 FLASH YELLOW IN CONTROLLER FLASH?...Y
 GREEN EXTENSION (0-255 SEC).....0
 YELLOW CLEAR (0=PARENT,3-25.5 SEC)...0.0
 RED CLEAR (0=PARENT,0.1-25.5 SEC)...0.0
 OUTPUT AS PHASE # (0=NONE, 1-16)....0

PRESS '+' TWICE

PAGE 1: VEHICLE OVERLAP 'C' SETTINGS
 PHASE: ;12345678910111213141516
 VEH OVL PARENTS: ; X
 VEH OVL NOT VEH: ;
 VEH OVL NOT PED: ;
 VEH OVL GRN EXT: ;
 STARTUP COLOR: - RED - YELLOW - GREEN
 FLASH COLORS: - RED - YELLOW X GREEN
 SELECT VEHICLE OVERLAP OPTIONS: (Y/N)
 FLASH YELLOW IN CONTROLLER FLASH?...Y
 GREEN EXTENSION (0-255 SEC).....0
 YELLOW CLEAR (0=PARENT,3-25.5 SEC)...0.0
 RED CLEAR (0=PARENT,0.1-25.5 SEC)...0.0
 OUTPUT AS PHASE # (0=NONE, 1-16)....0

OVERLAP PROGRAMMING COMPLETE

FYA SIGNAL WIRING DETAIL

(wire signal heads as shown)

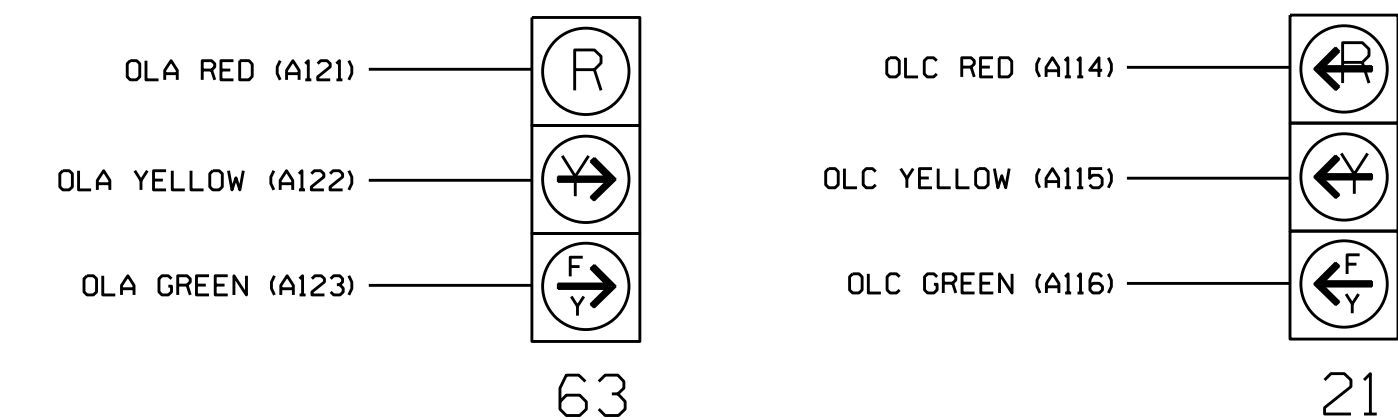

THIS ELECTRICAL DETAIL IS FOR THE SIGNAL DESIGN: 04-1448
 DESIGNED: January 2022
 SEALED: 3/25/2022
 REVISED: N/A

Electrical Detail

ELECTRICAL AND PROGRAMMING DETAILS FOR:

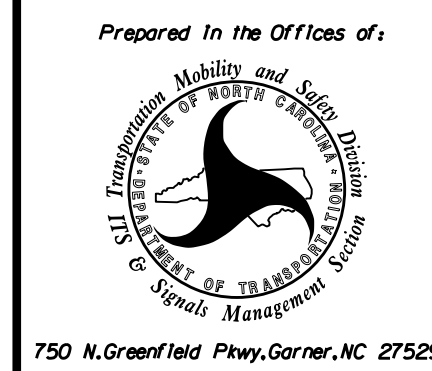

SR 1560 (-L-) at Sr 3769 (-Y2-)

Division 4 Johnston County Clayton

PLAN DATE: March 2022 REVIEWED BY:

PREPARED BY: Zarrar Zafar REVIEWED BY:

REVISIONS INIT. DATE

DOCUMENT NOT CONSIDERED FINAL UNLESS ALL SIGNATURES COMPLETED

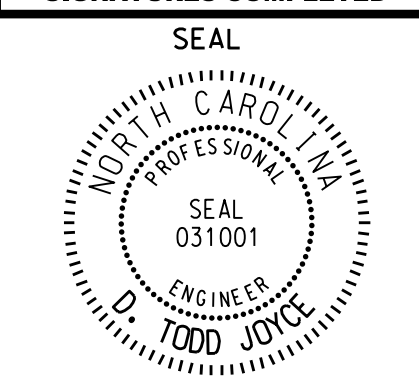

DocSigned by: D. Todd Joyce 03/25/2022

SIG. INVENTORY NO. 04-1448