

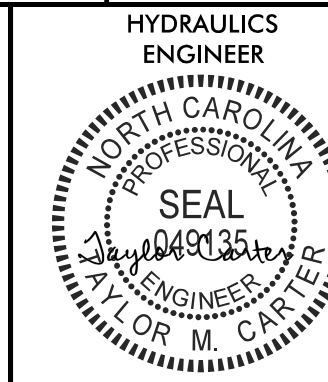

B-17/99

PROJECT REFERENCE NO. B-3186 / B-5898	SHEET NO. 2D-1
HYDRAULICS ENGINEER	
	
3/17/2022	



HDR Engineering, Inc. of the Carolinas
555 Fayetteville St. Suite 900 Raleigh, N.C. 27601
N.C.B.E.L.S. License Number: F-0116

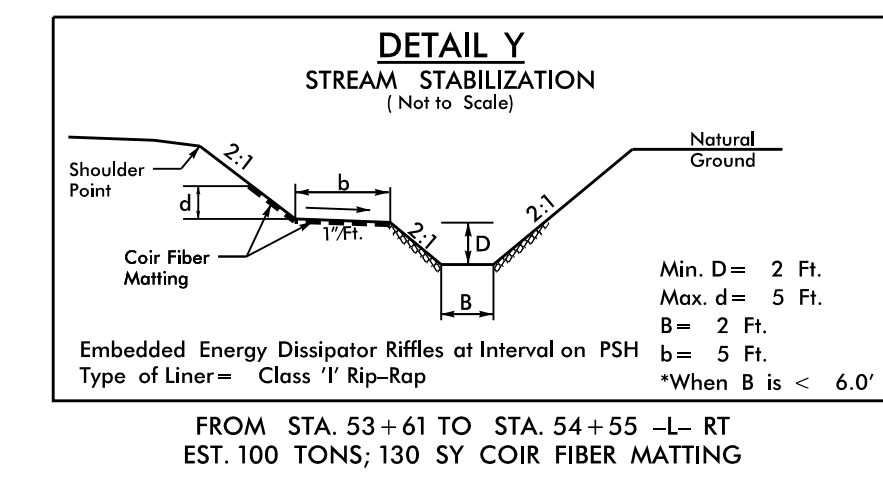
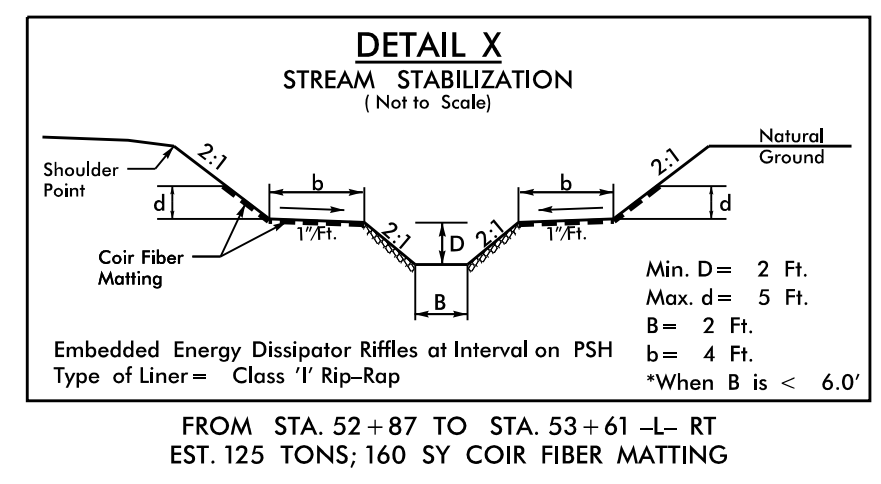
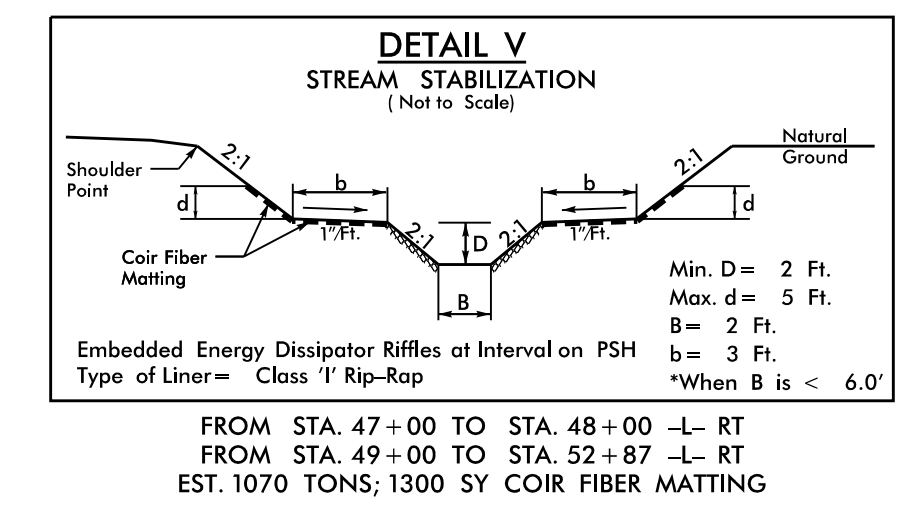
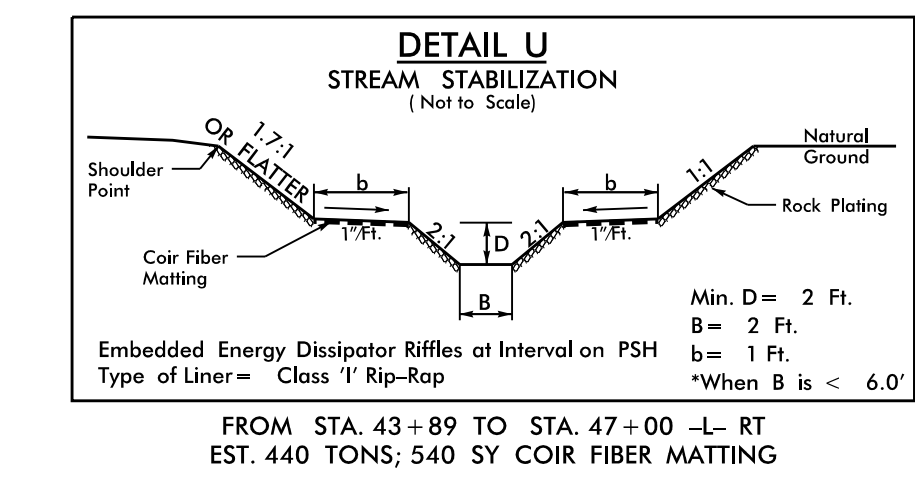
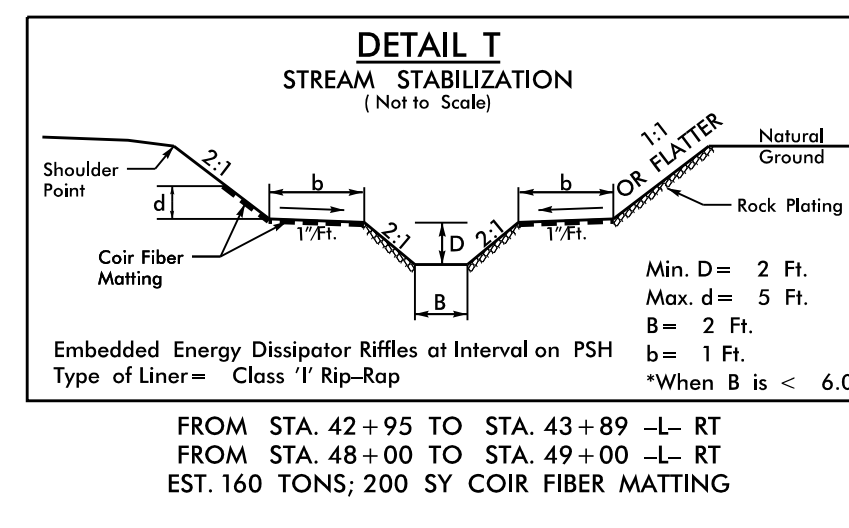
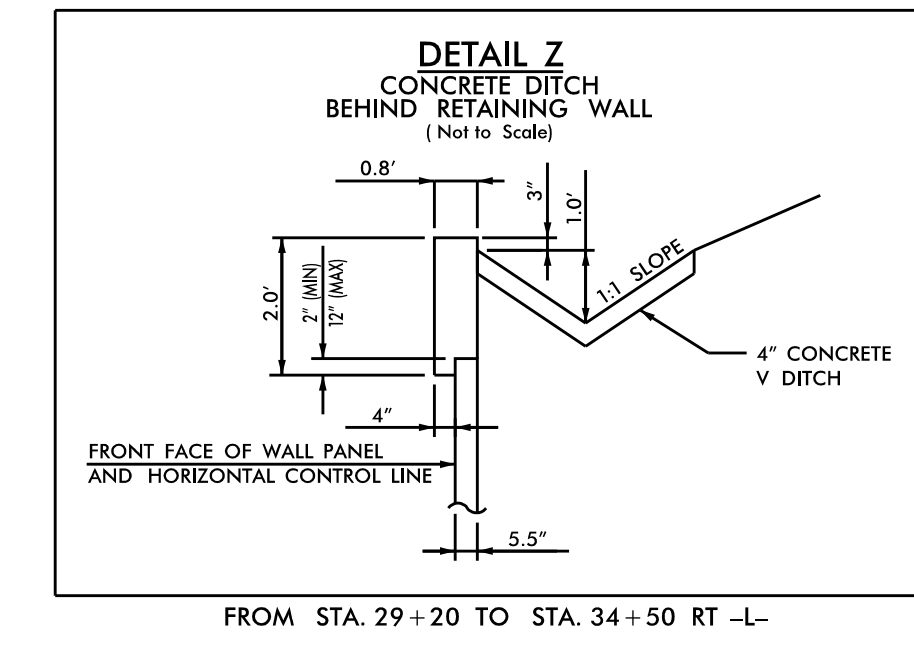
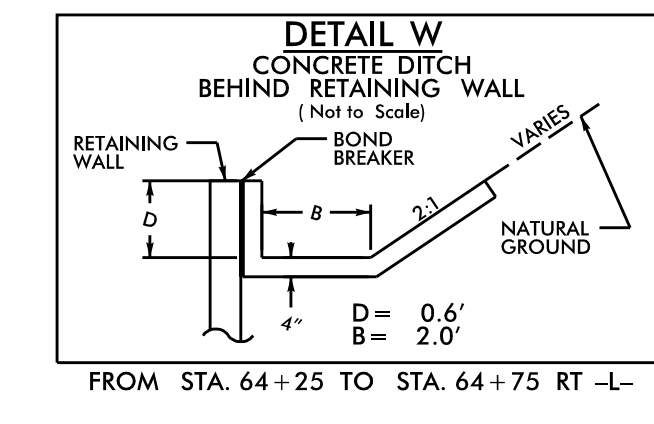
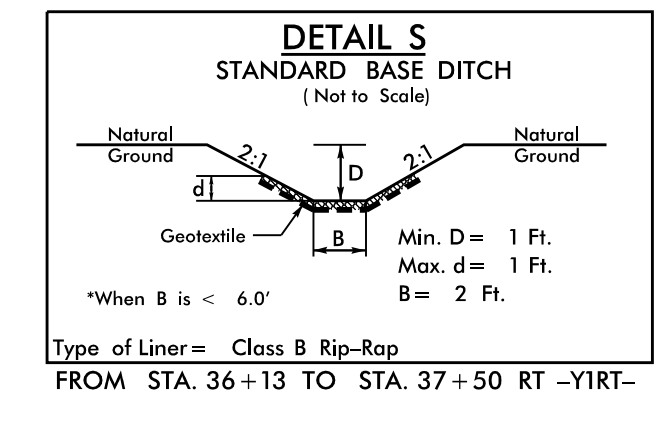
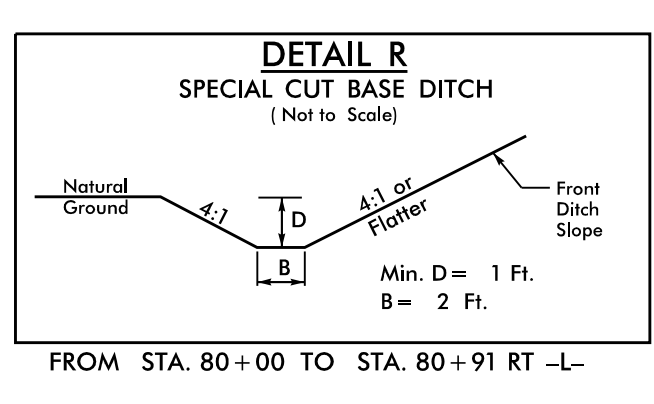
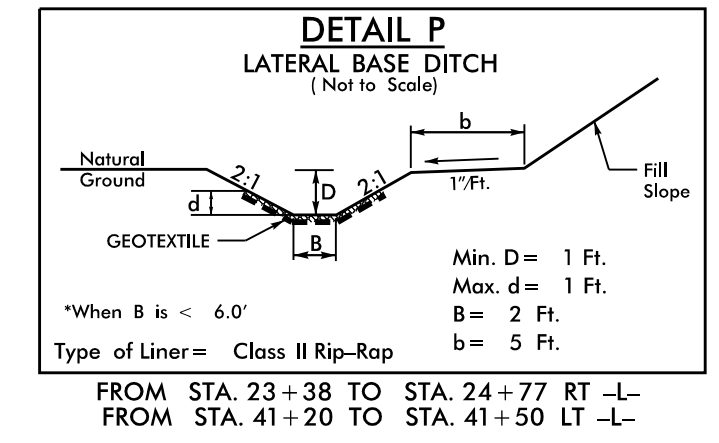
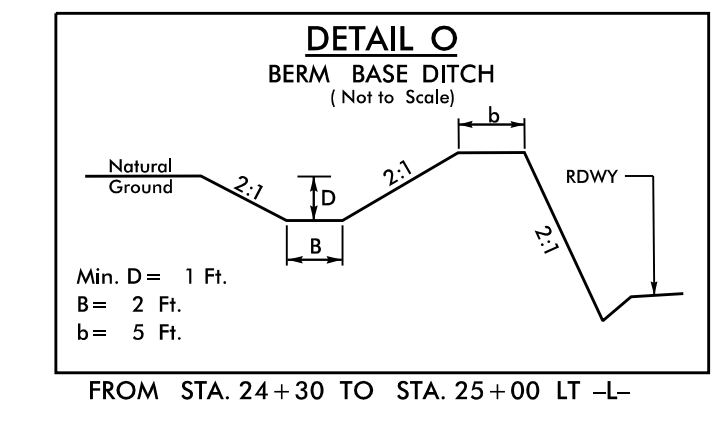
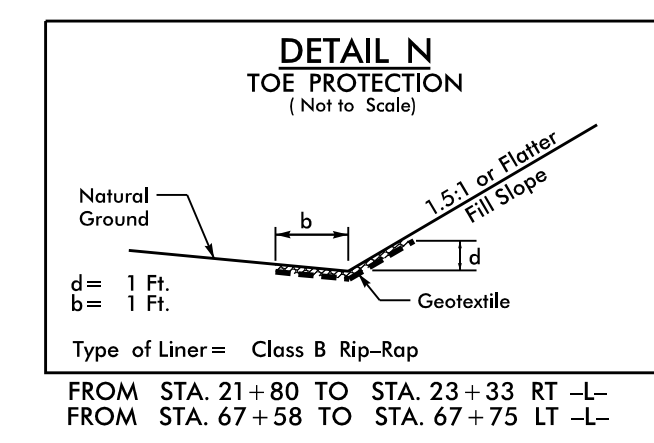
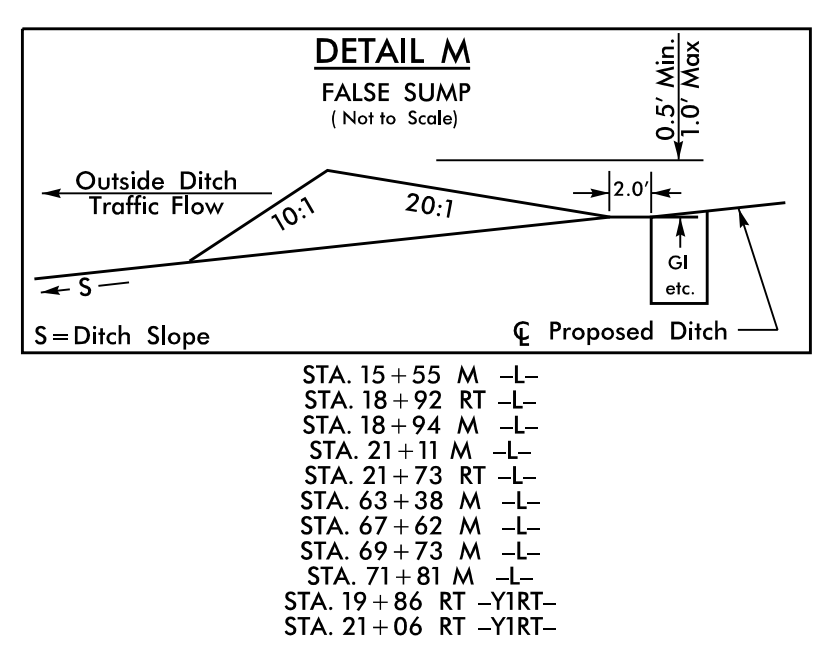
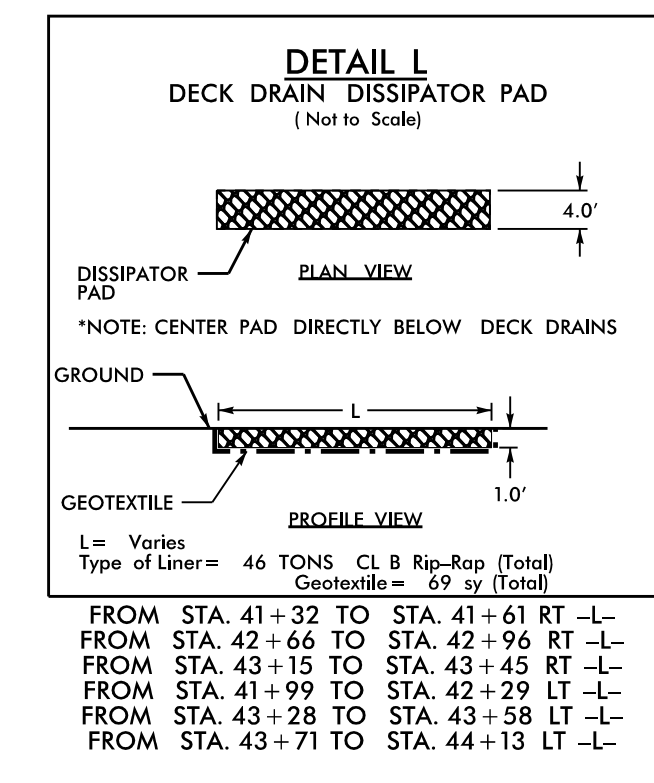
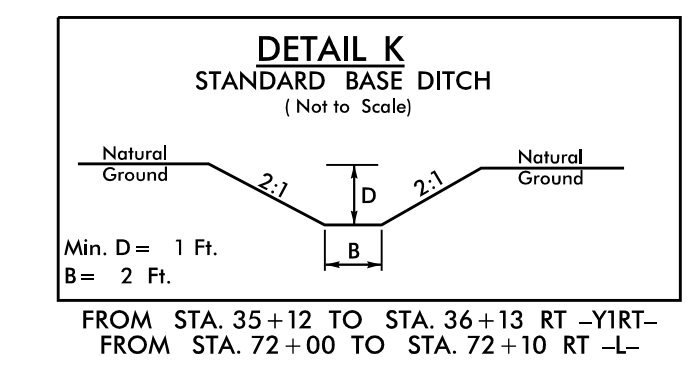
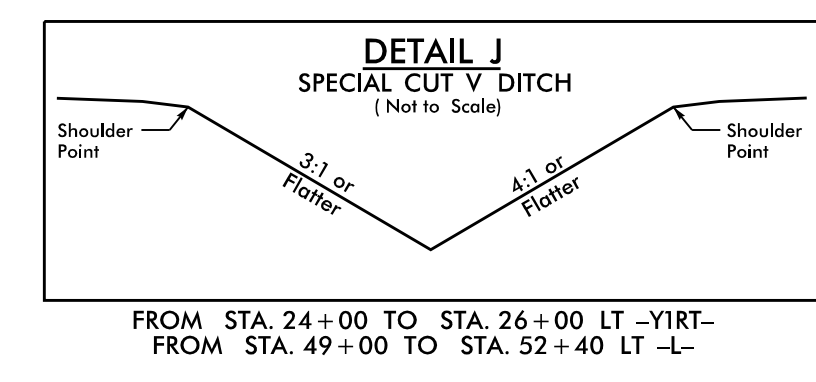
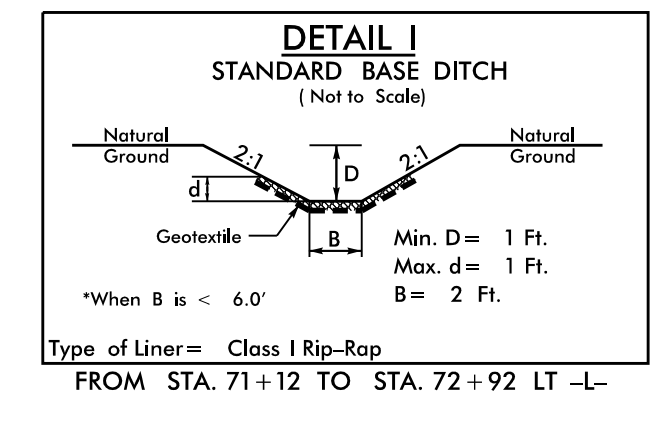
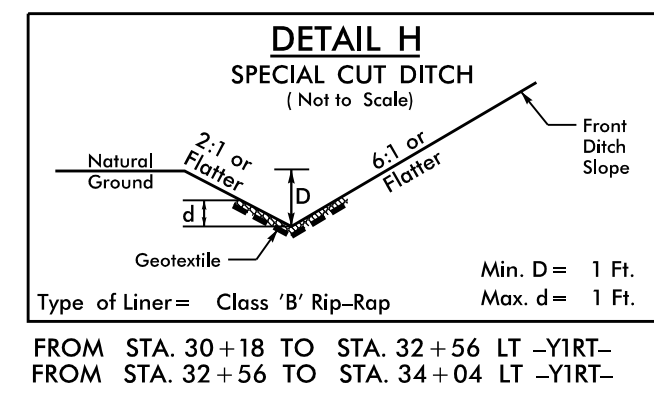
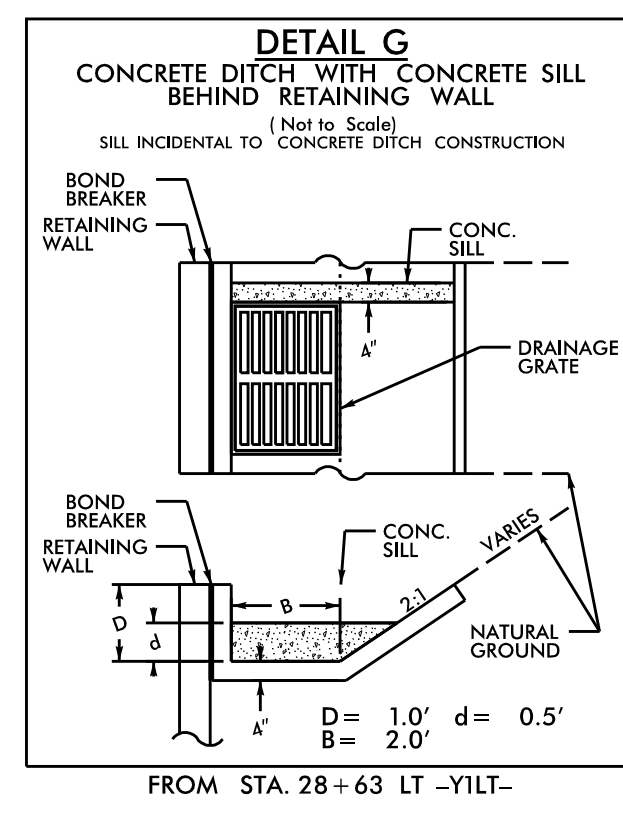
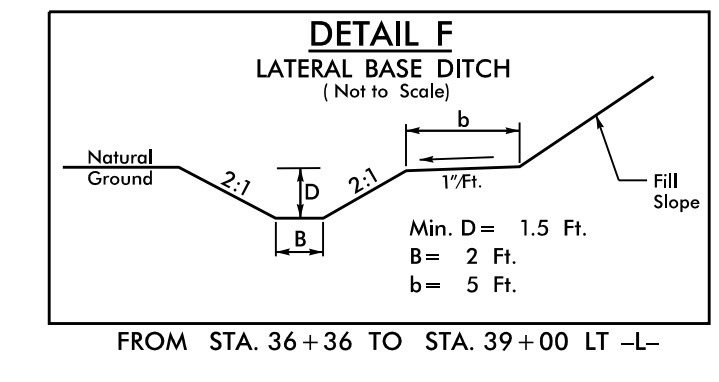
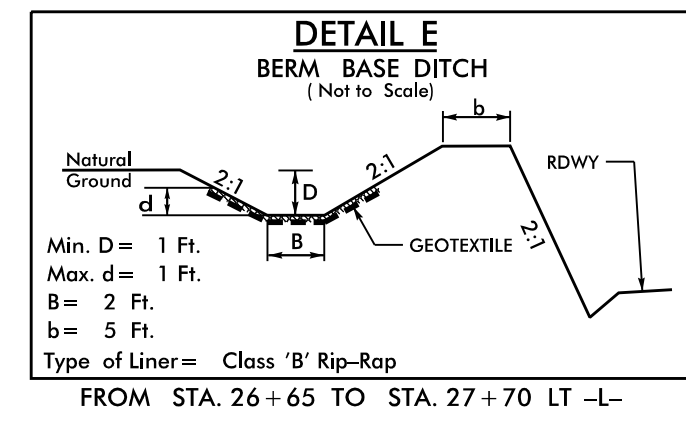
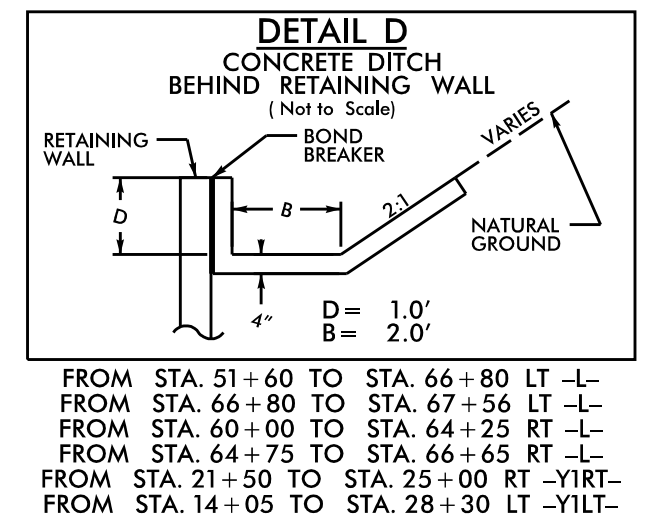
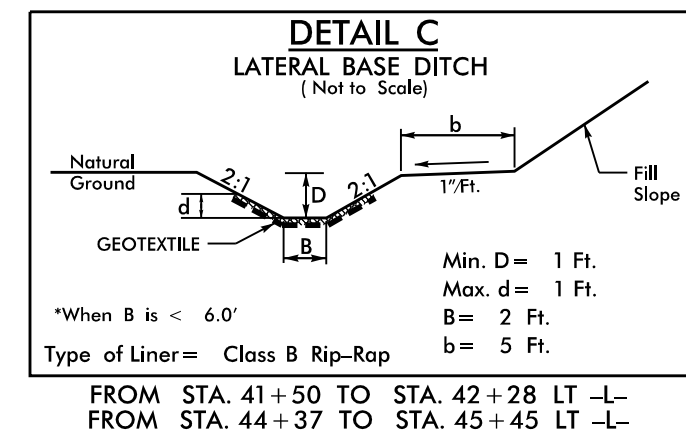
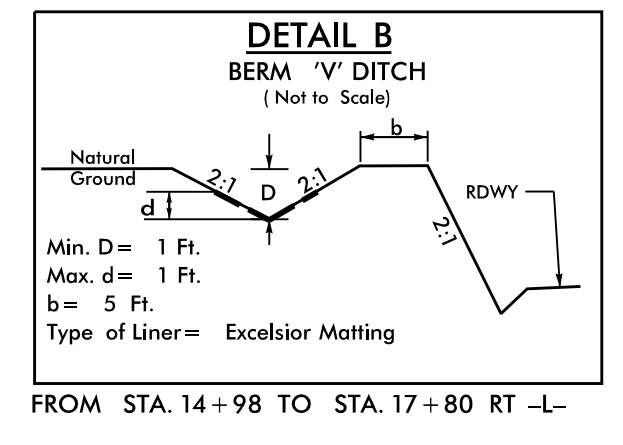
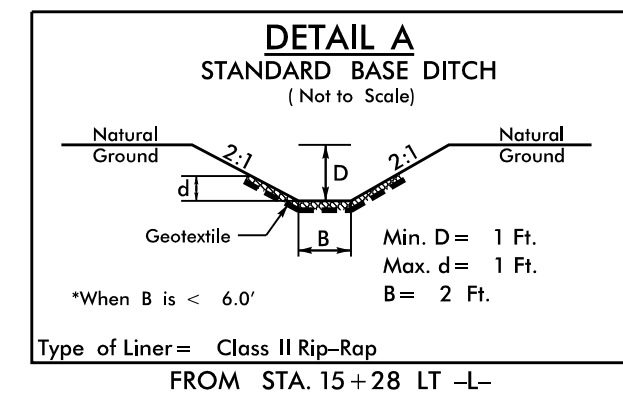

PLOT DRIVER: NCDOT_color_eng_50.plt
 USER: HBARE
 DATE: 2/9/2022
 TIME: 8:56:40 AM
 FILE: NCDOT\NCDOT-B3186-T02.c.\6.0.CAD.BTM.6.2.Work.In.Progress\B-3186-B-5898\Drainage\B3186-B5898-HYD.DETAILS.dgn

REVISIONS