

**This electronic collection of documents is provided
for the convenience of the user
and is Not a Certified Document –**

**The documents contained herein were originally issued
and sealed by the individuals whose names and license
numbers appear on each page, on the dates appearing
with their signature on that page.**

**This file or an individual page
shall not be considered a certified document.**

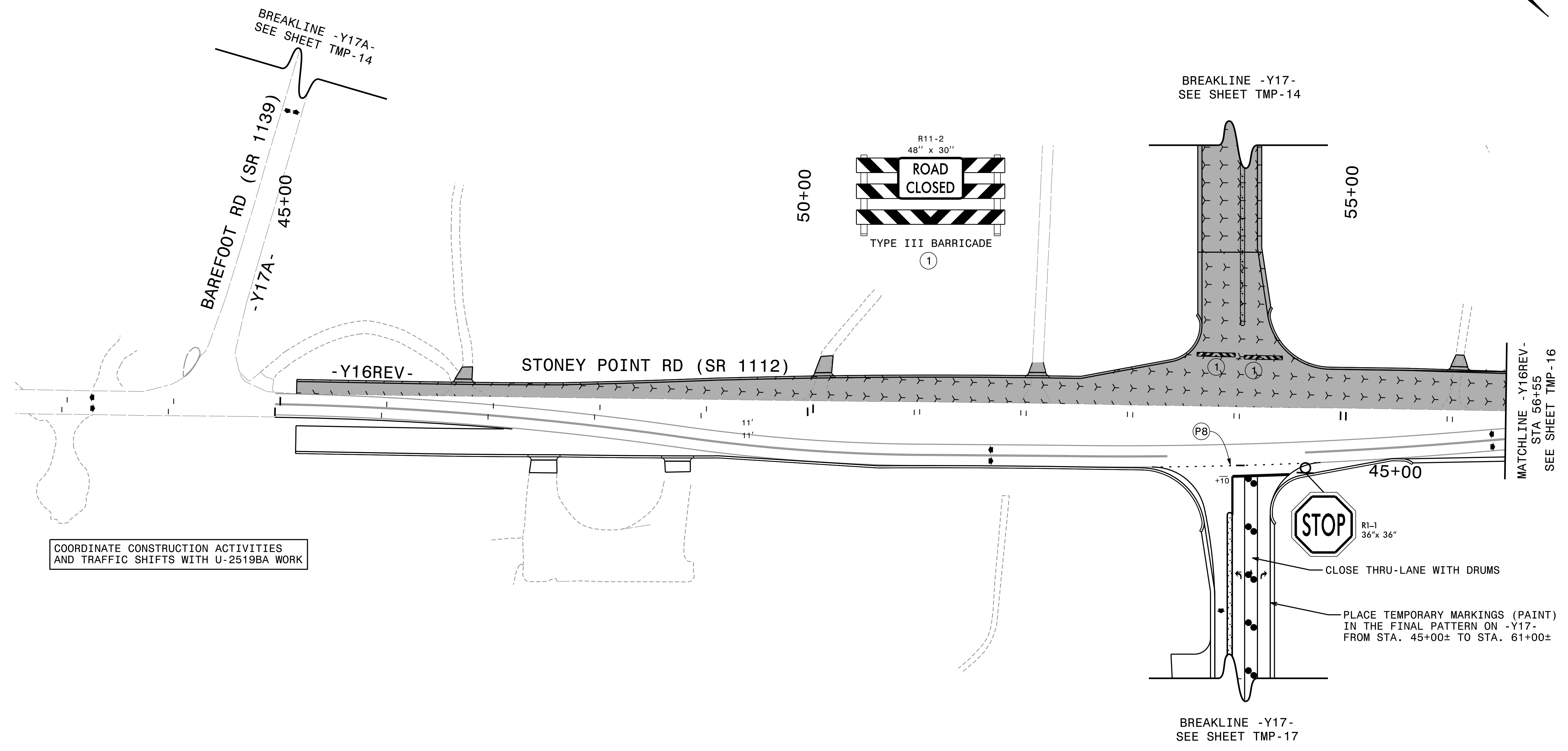
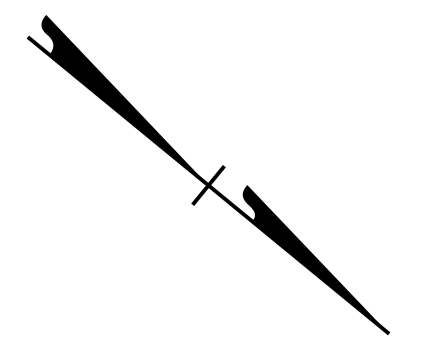

REVISIONS

PLOT DRIVER: NCDOT_paf_mono_eng-50.plt
USER: MRZEPKA
PENTABLE: NCDOT_tcp.tbl
DATE: 2/14/2022
TIME: 9:52:14 AM
FILE: p:\pwhdr\useas01\HDR-US-East_01\Documents\3322\10000297\10049996\6_0_CAD_BIM\6.2_Work_In_Progress\U-2519BB\TrafficControl\TCP\U2519bb_tmp_psh_15.dgn

APPROVED: *Michael T. Rzepka*
DATE: 2/14/2022
SEAL

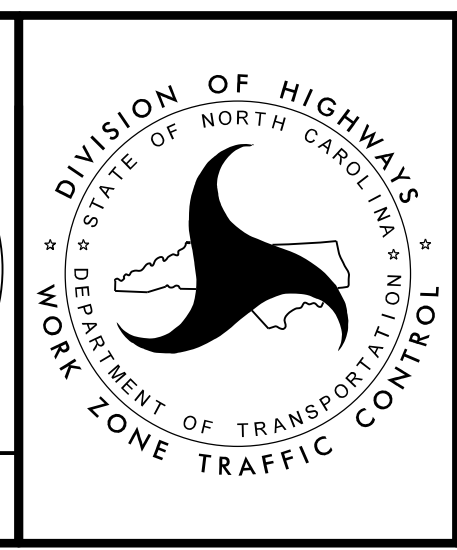

**PHASE II
DETAIL**

DOCUMENT NOT CONSIDERED FINAL
UNLESS ALL SIGNATURES COMPLETED

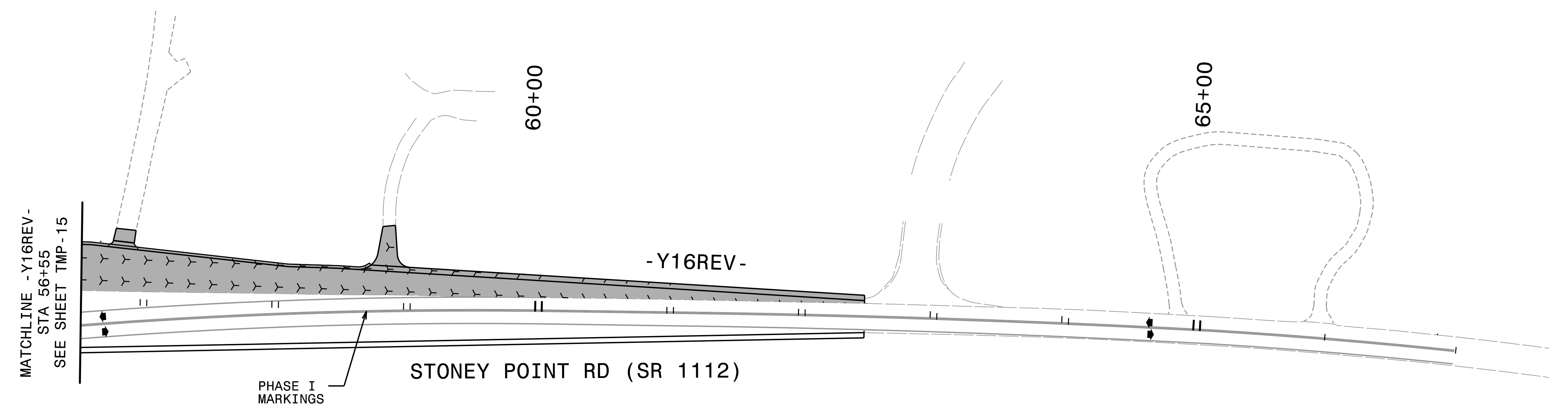
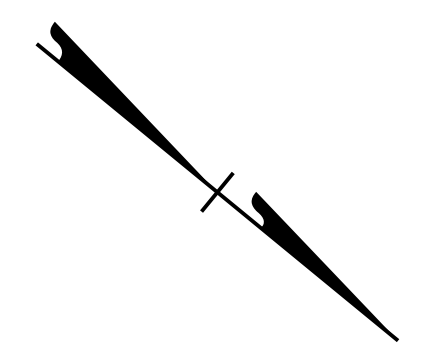

REVISIONS

PLOT DRIVER: NCDOT_paf_mono_eng.50.plt PENTABLE: NCDOT_tcp.tbl
USER: MRZEPKA DATE: 2/14/2022 TIME: 10:00:12 AM
FILE: p:\p\h\users\01\HDR_US_East_01\Documents\3322\10000297\10049996\6_0_CAD_BIM\6.2_Work_In_Progress\U-2519BB_TrafficControl\TCP\U2519bb_tmp_psh_16.dgn

APPROVED: *Michael T. Rzepka*
DATE: 2/14/2022
SEAL

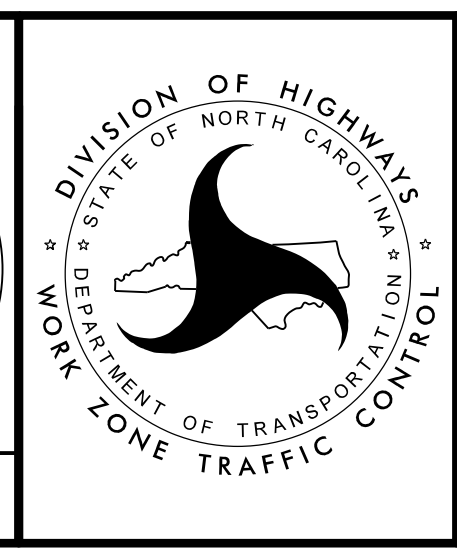

**PHASE II
DETAIL**

**DOCUMENT NOT CONSIDERED FINAL
UNLESS ALL SIGNATURES COMPLETED**

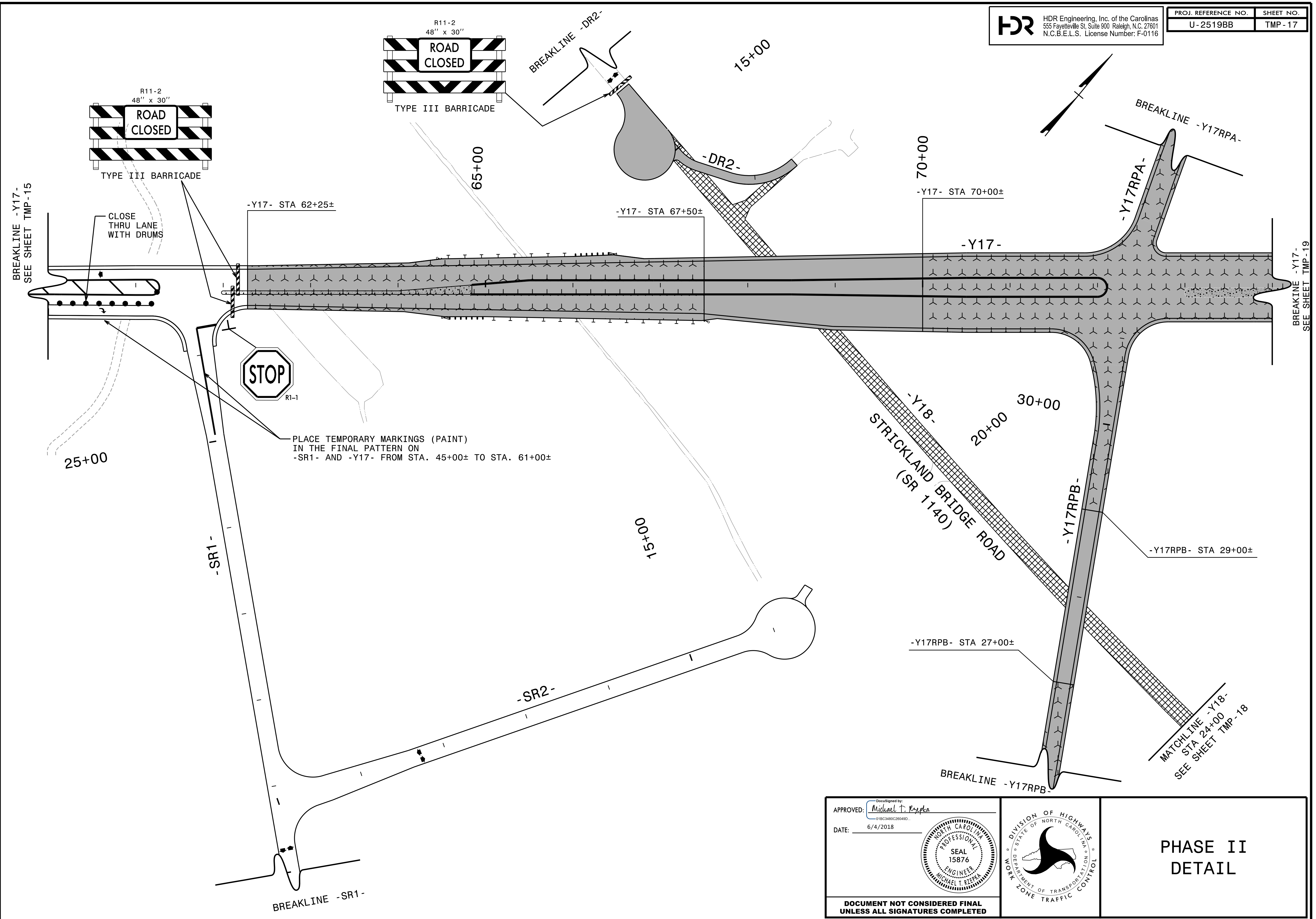

PLOT DRIVER: NCDOT_pdf_color_eng_50.plt
USER: mrzepka
FILE: c:\pwworking\veast01\d0140951\ud2519bb.tmp.psh_17.dgn
PENTABLE: NCDOT_tcp.tbl
DATE: 6/4/2018
TIME: 10:35:20 AM

APPROVED: *Michael T. Repta*
DATE: 6/4/2018

018C3480C28049D...

PROFESSIONAL ENGINEER SEAL 15876
MICHAEL T. REPTA

DOCUMENT NOT CONSIDERED FINAL UNLESS ALL SIGNATURES COMPLETED

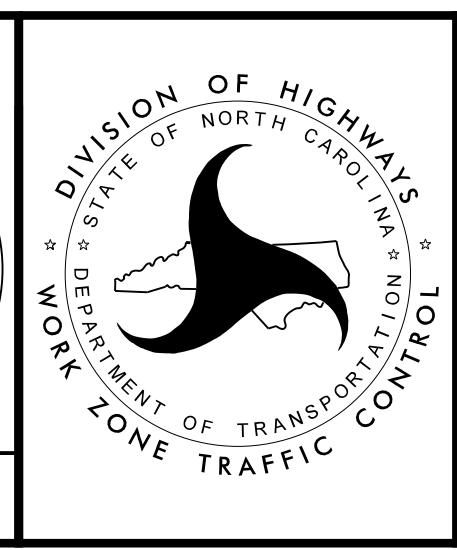

**PHASE II
DETAIL**

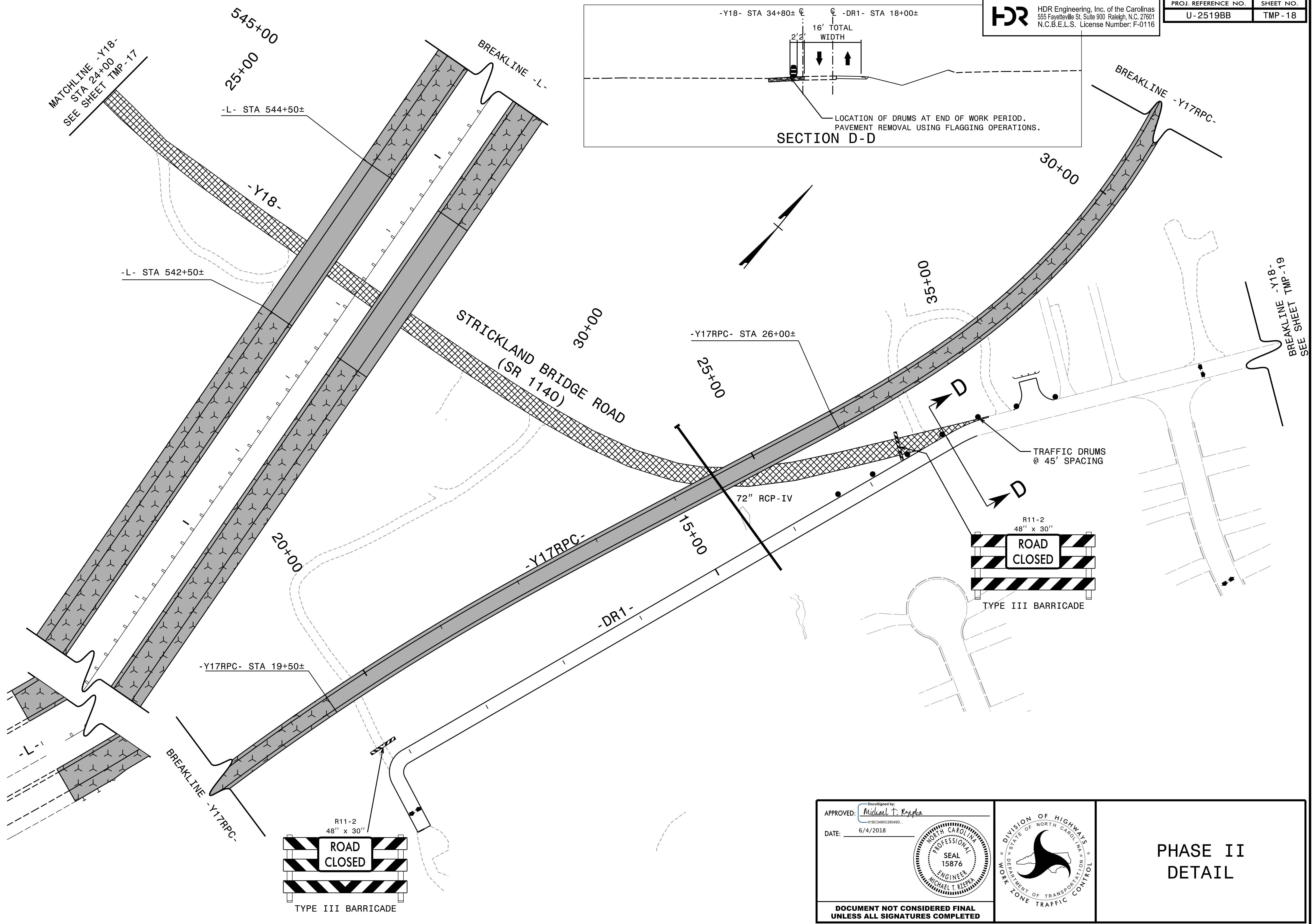

PLOT DRIVER: NCDOT_pdf_color_eng_50.plt
USER: mrzepka
DATE: 6/4/2018
FILE: c:\pwworking\veest01\d0140951\ud2519bb_fm_psh_18.dgn

APPROVED: *Michael T. Krepa*
DATE: 6/4/2018

DocuSigned by:
Michael T. Krepa
01BC3480C26049D...

PROFESSIONAL ENGINEER
SEAL 15876
MICHAEL T. KREPA

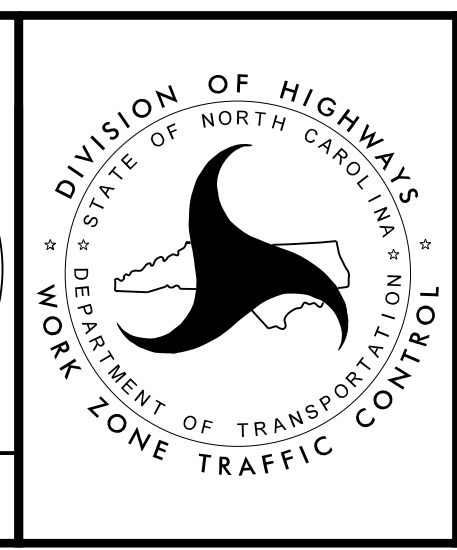

**PHASE II
DETAIL**

DOCUMENT NOT CONSIDERED FINAL
UNLESS ALL SIGNATURES COMPLETED

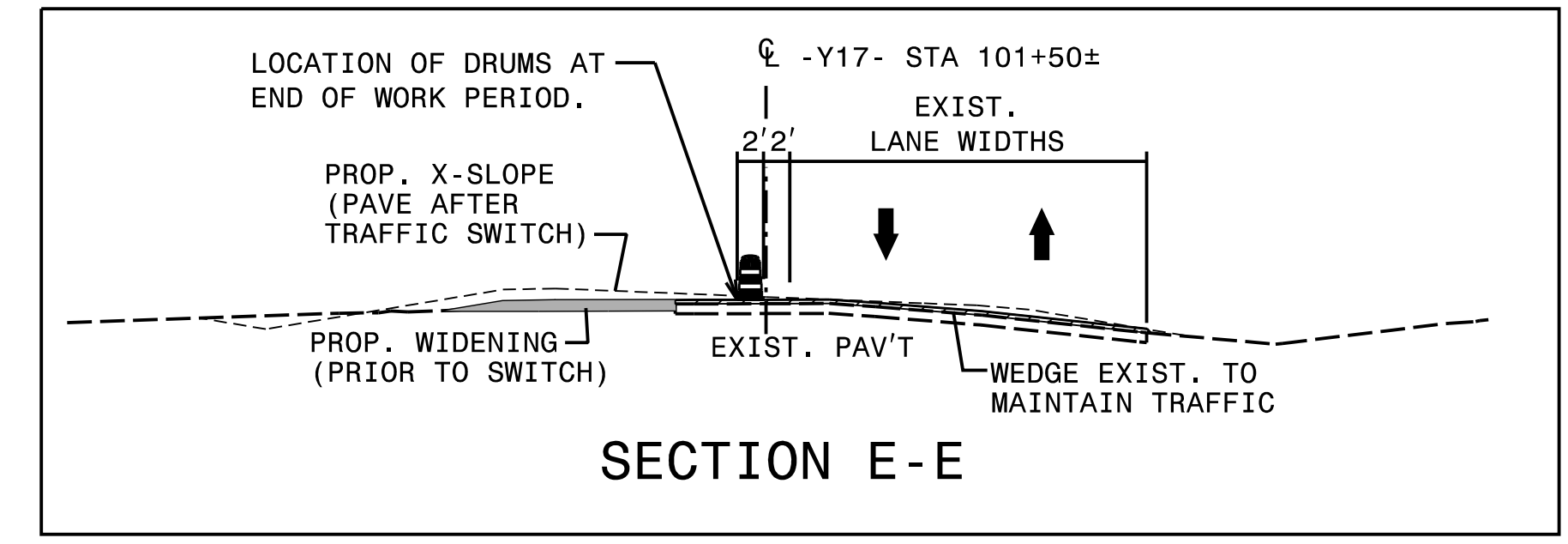
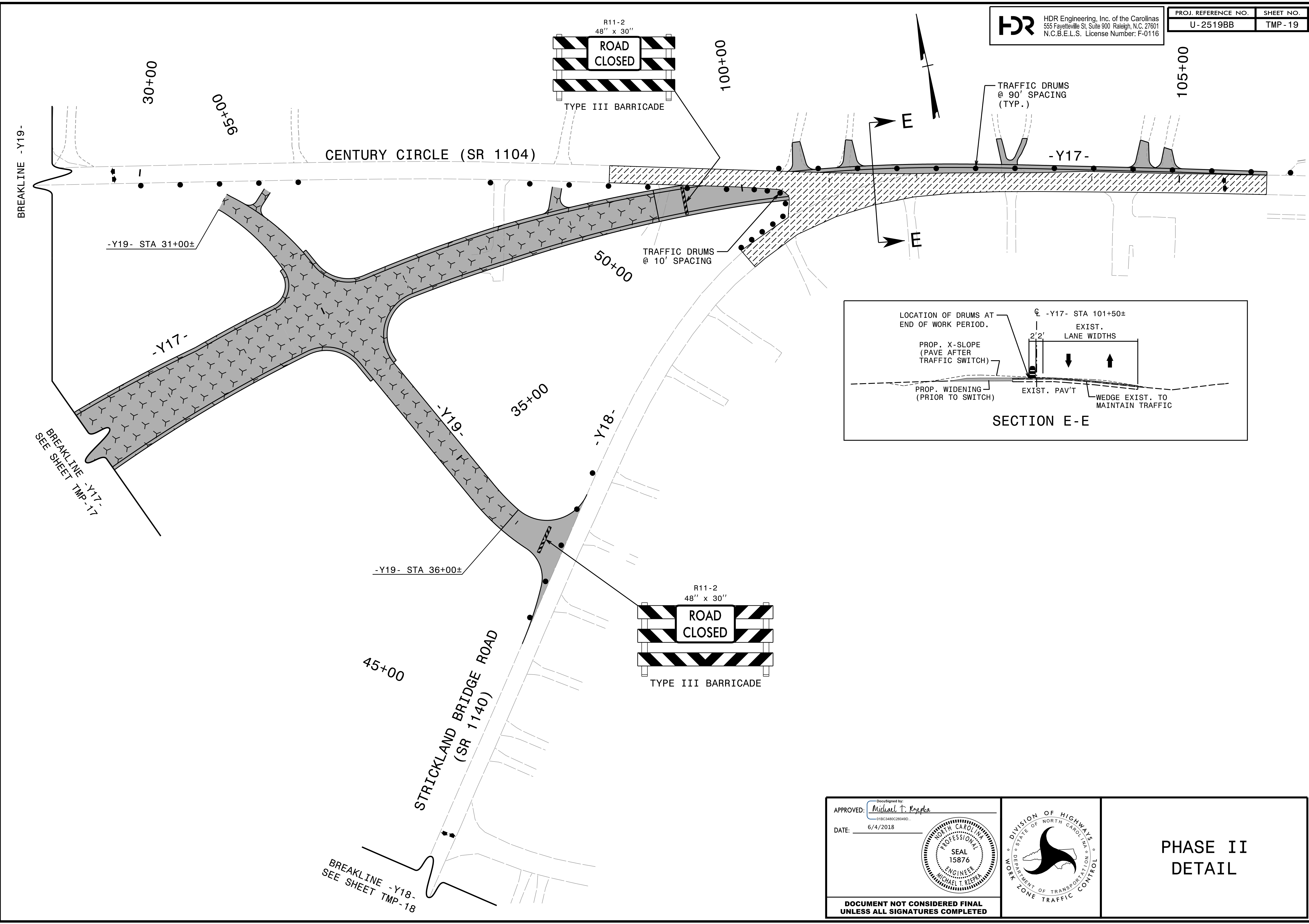

PLOT DRIVER: NCDOT_pdf_color_eng_50.plt
USER: mrzepka
DATE: 6/4/2018
FILE: c:\pwworking\veast01\d0140951\ud2519bb_fm_psh_19.dgn

PENTABLE: NCDOT_tcp.tbl
TIME: 10:35:23 AM

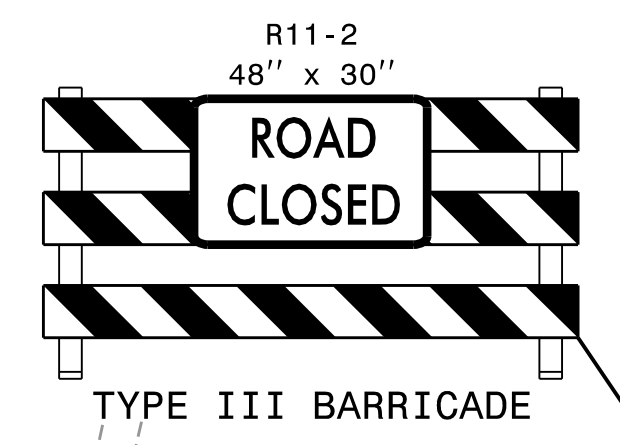
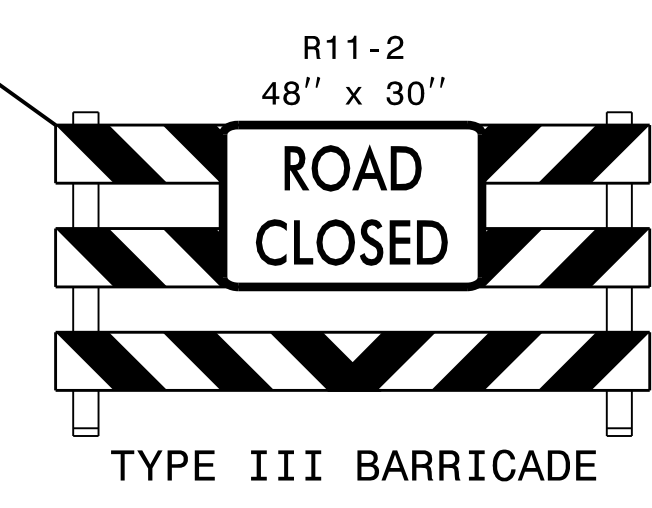

APPROVED: *Michael T. Kiepa*
DATE: 6/4/2018

018C3480C26049D...

PROFESSIONAL SEAL
15876
ENGINEER
MICHAEL T. KIEPA

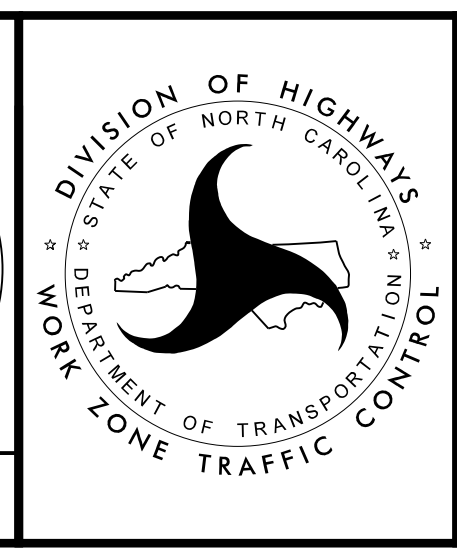

**PHASE II
DETAIL**

**DOCUMENT NOT CONSIDERED FINAL
UNLESS ALL SIGNATURES COMPLETED**

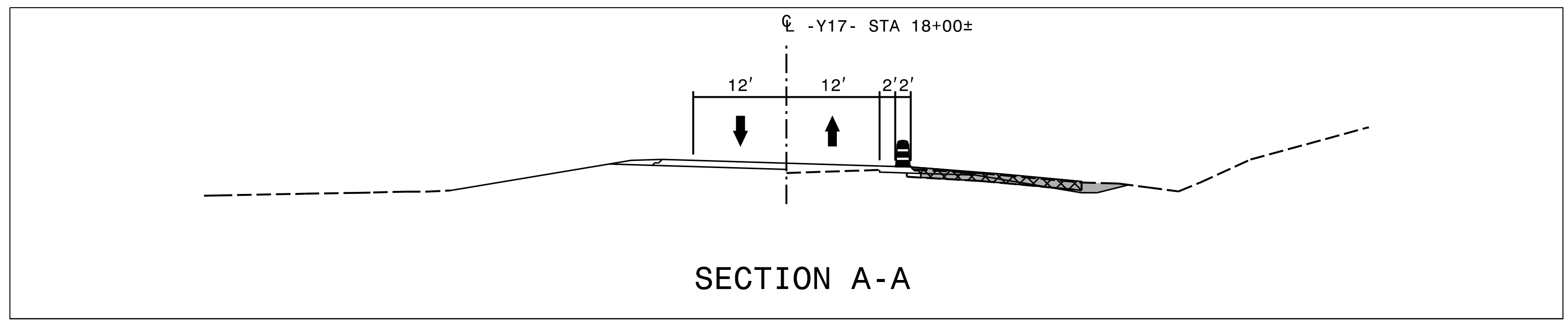
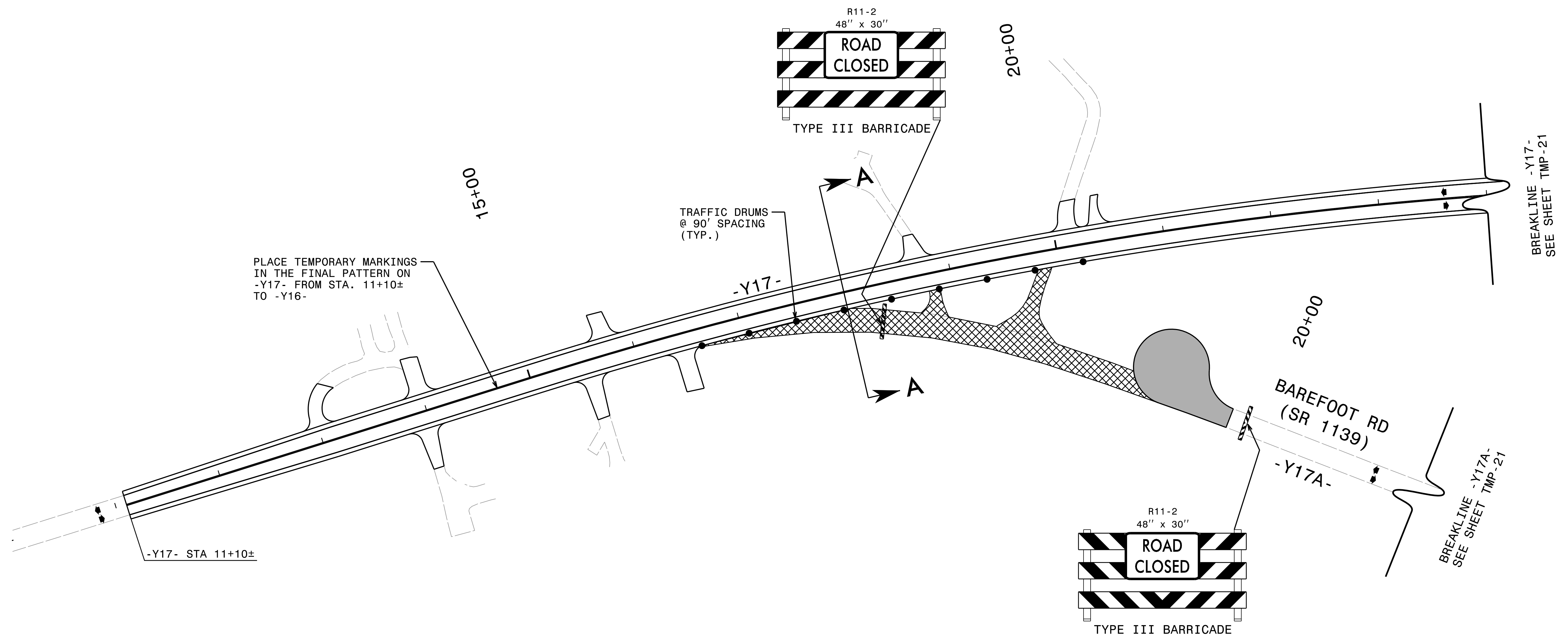
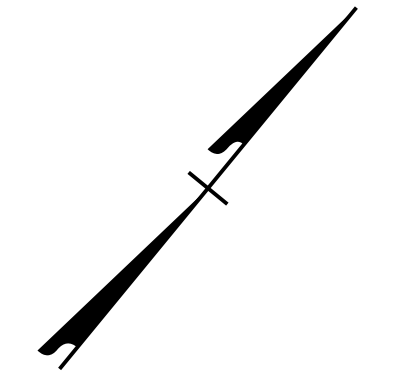

PLOT DRIVER: NCDOT_pdf_color_eng_50.plt
USER: mrzepka
FILE: c:\pwworking\ceast01\0140951\ud2519bb.tmp.psh.20.dgn
PENTABLE: NCDOT_tcp.tbl
DATE: 6/4/2018
TIME: 10:35:25 AM

APPROVED: *Michael T. Krepta*
DATE: 6/4/2018
018C3480C26049D...
NORTH CAROLINA PROFESSIONAL ENGINEER SEAL 15876
MICHAEL T. KREPTA

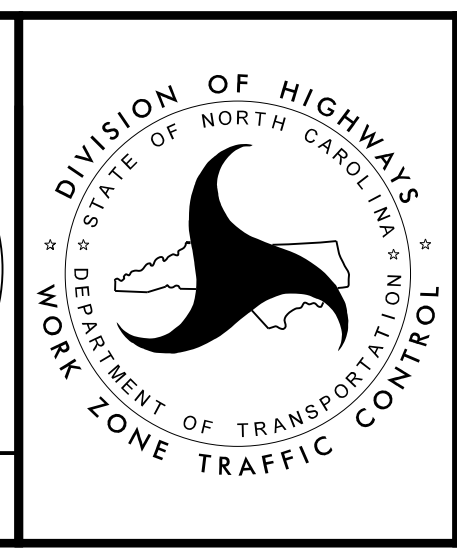

**PHASE III
STEPS 1 & 2
DETAIL**

DOCUMENT NOT CONSIDERED FINAL
UNLESS ALL SIGNATURES COMPLETED

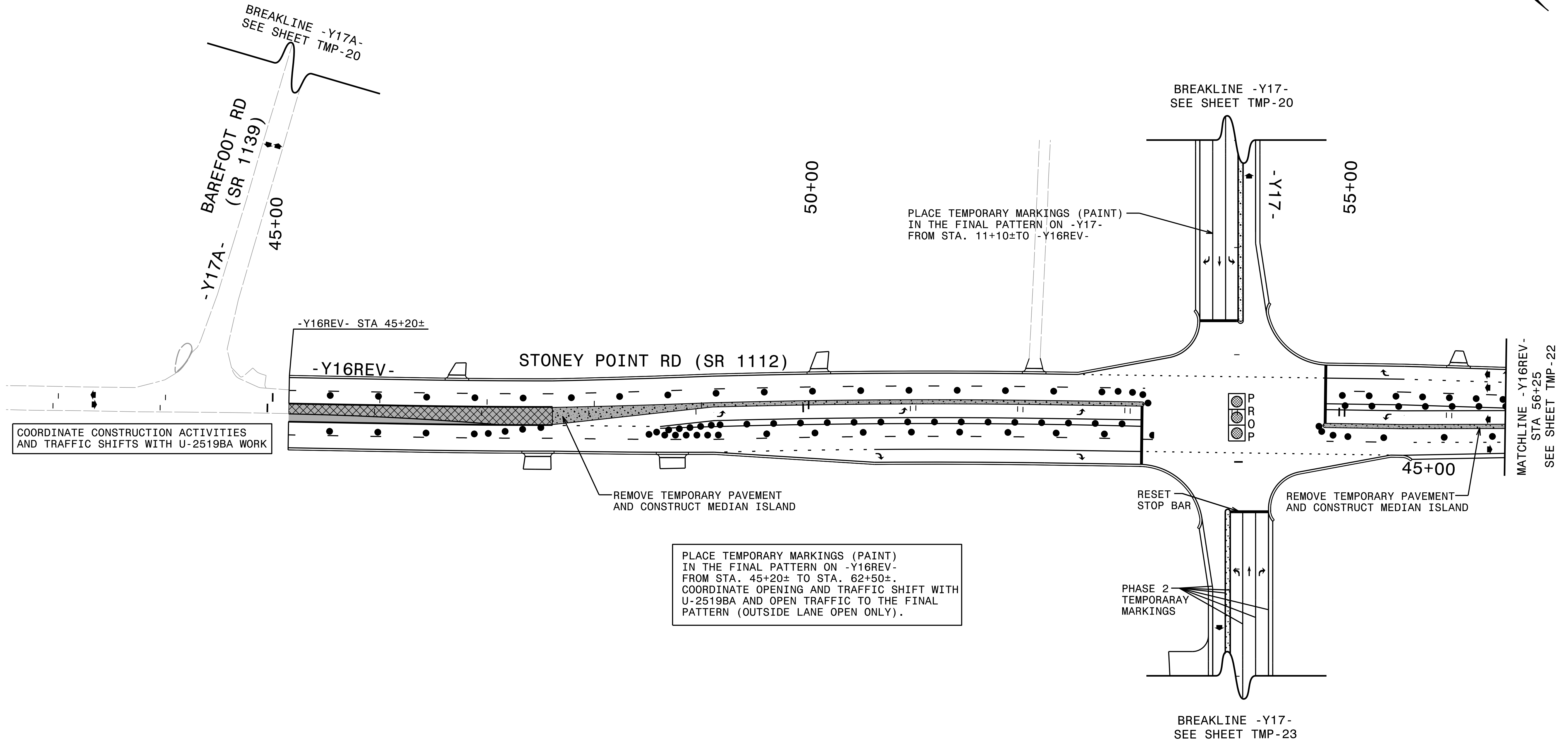
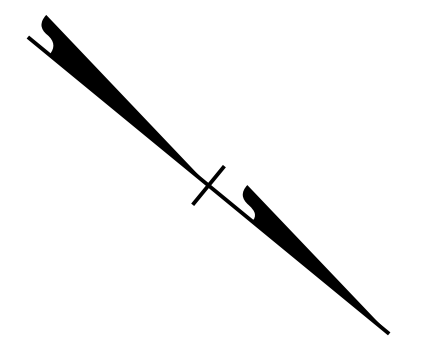

REVISIONS

PLOT DRIVER: NCDOT_paf_mono_eng_50.plt
PENTABLE: NCDOT_tcp.tbl
DATE: 2/14/2022
TIME: 9:53:32 AM
USER: MRZEPKA
FILE: pwa\pwhdr\useas01\HDR-US_East_01\Documents\3322\10000297\10049996\6_0_CAD_BIM\6_2_Work\In_Progress\U-2519BB_TrafficControl\TCP\U2519bb_tmp_psh_21.dgn

APPROVED: *Michael T. Rzepka*
DATE: 2/14/2022

SEAL

DOCUMENT NOT CONSIDERED FINAL
UNLESS ALL SIGNATURES COMPLETED

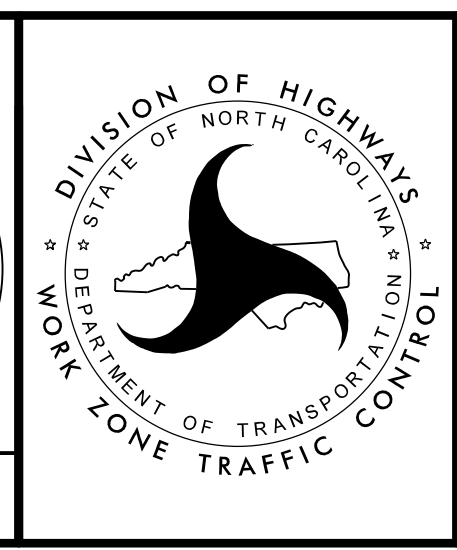

**PHASE III
STEPS 1 & 2
DETAIL**

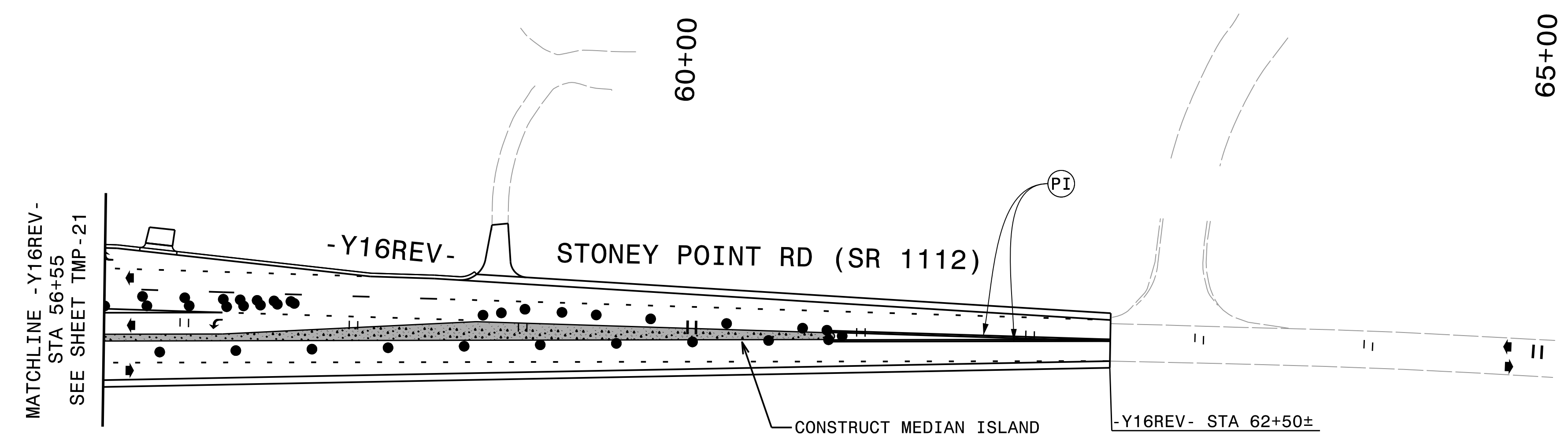
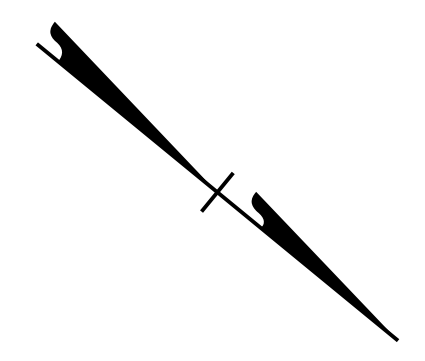

PLACE TEMPORARY MARKINGS (PAINT)
 IN THE FINAL PATTERN ON -Y16REV-
 FROM STA. 45+20± TO STA. 62+50±.
 COORDINATE OPENING AND TRAFFIC SHIFT WITH
 U-2519BA AND OPEN TRAFFIC TO THE FINAL
 PATTERN (OUTSIDE LANE OPEN ONLY).

REVISIONS

PLOT DRIVER: NCDOT_paf_mono_eng_50.plt PENTABLE: NCDOT_tcp.tbl
 USER: MRZEPKA DATE: 2/14/2022 TIME: 9:54:09 AM
 FILE: pwa\pwhdr\useas01\HDR-US_East_01\Documents\3322\10000297\10049996\6_0_CAD_BIM\6.2_Work_In_Progress\U-2519BB_TrafficControl\TCP\U2519bb_tmp_psh_22.dgn

APPROVED: *Michael T. Rzepka*
01BC348C28649D

DATE: 2/14/2022

SEAL

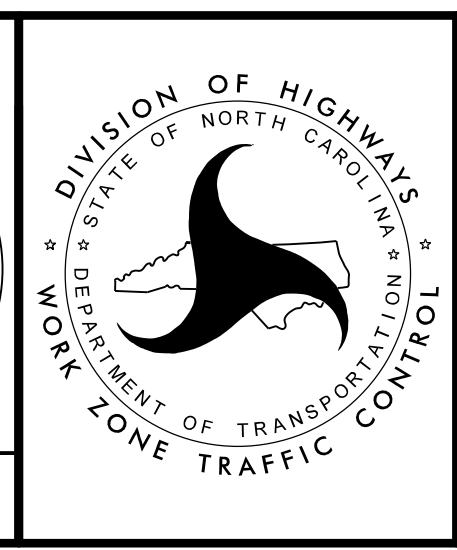

PHASE III
 STEPS 1 & 2
 DETAIL

DOCUMENT NOT CONSIDERED FINAL
 UNLESS ALL SIGNATURES COMPLETED

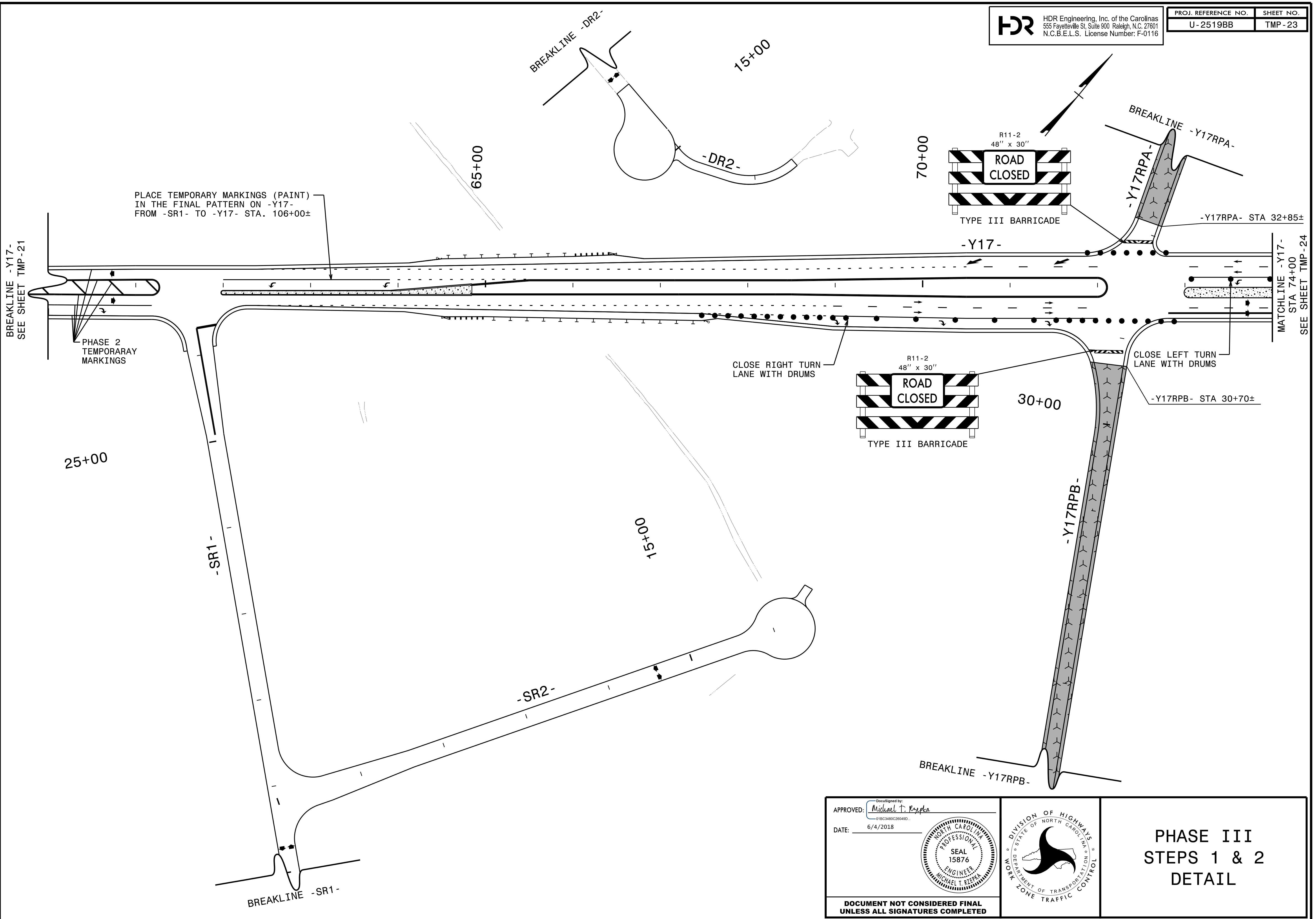

PLOT DRIVER: NCDOT_pdf_color_eng_50.plt
USER: mrzepka
FILE: c:\pwworking\east01\0140951\ud2519bb.tmp.psh.23.dgn
PENTABLE: NCDOT_tcp.tbl
DATE: 6/4/2018
TIME: 10:35:29 AM

APPROVED: *Michael T. Reppa*
DATE: 6/4/2018

018C3480C28049D...

NORTH CAROLINA
PROFESSIONAL
SEAL
15876
ENGINEER
MICHAEL T. REPPA

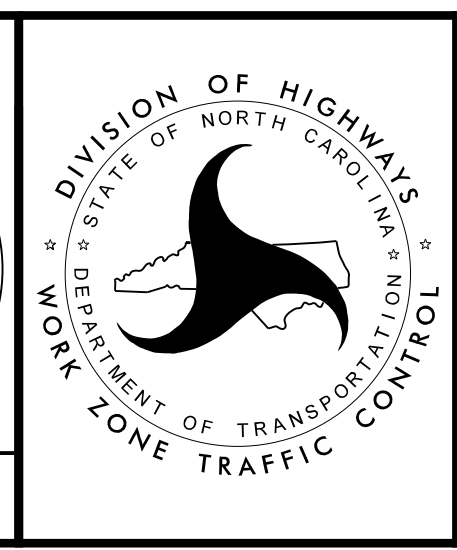

**PHASE III
STEPS 1 & 2
DETAIL**

**DOCUMENT NOT CONSIDERED FINAL
UNLESS ALL SIGNATURES COMPLETED**

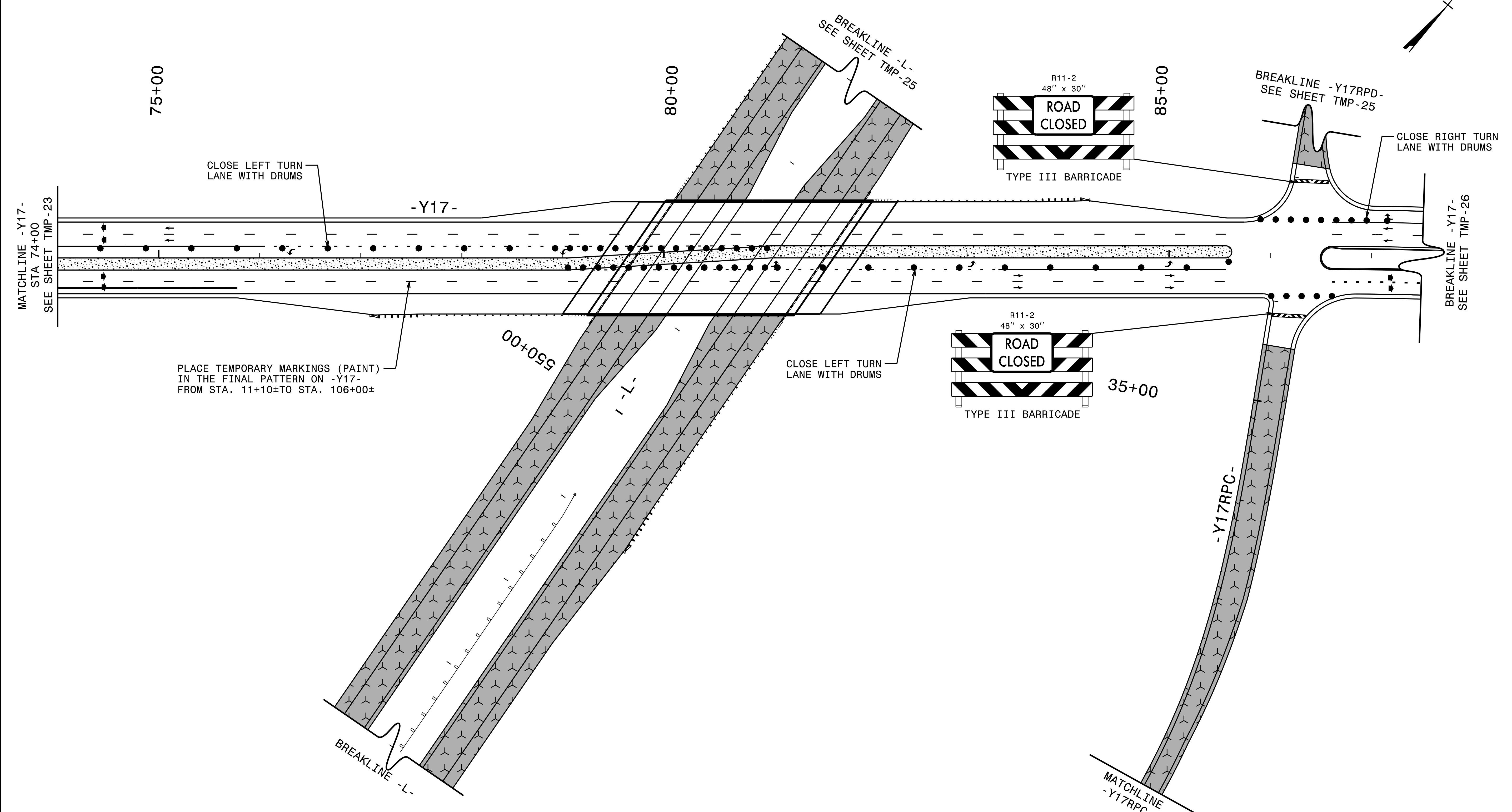
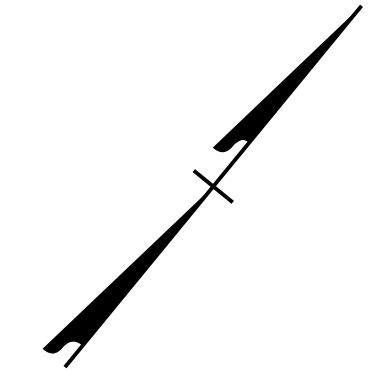

PLOT DRIVER: NCDOT_pdf_color_eng_50.plt
USER: mrzepka
FILE: c:\pwworking\east01\0140951\ud2519bb_tmp.psh_24.dgn
PENTABLE: NCDOT_tcp.tbl
DATE: 6/4/2018
TIME: 10:35:30 AM

APPROVED: *Michael T. Rejzka*
DATE: 6/4/2018
018C3480C28049D...

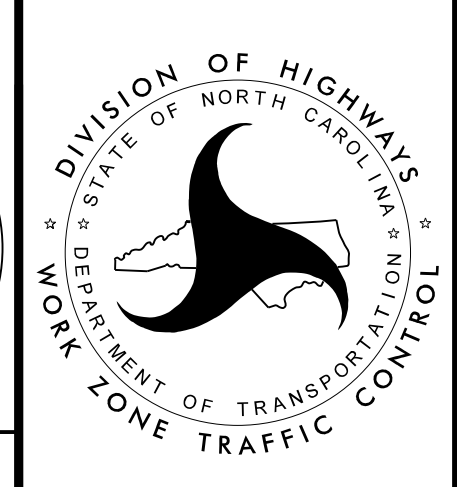
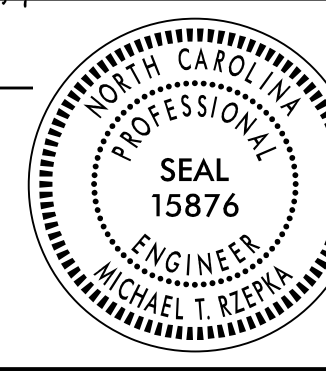

**PHASE III
STEPS 1 & 2
DETAIL**

**DOCUMENT NOT CONSIDERED FINAL
UNLESS ALL SIGNATURES COMPLETED**

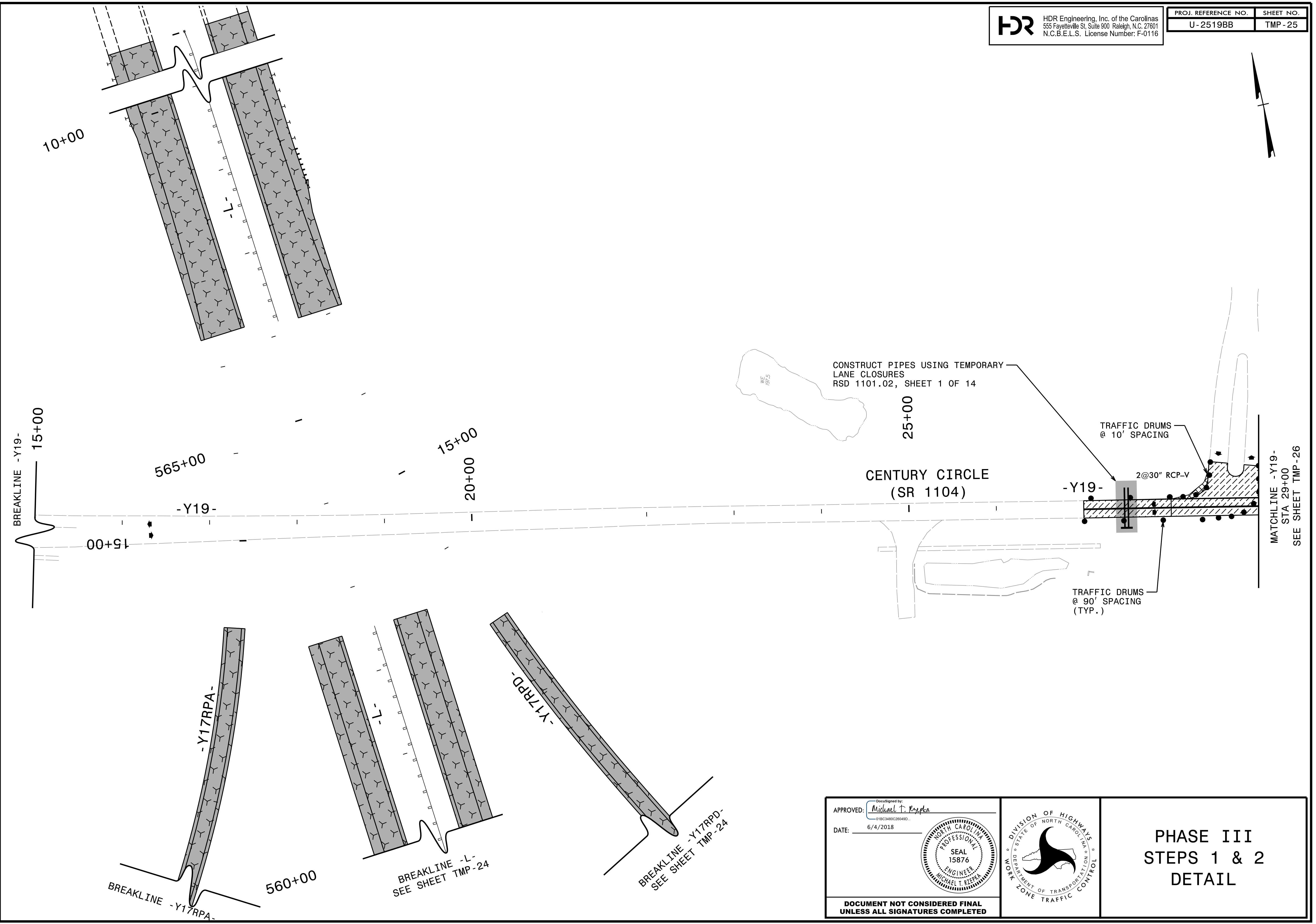
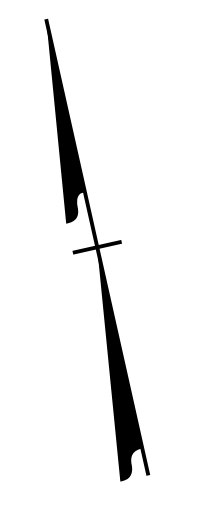

PLOT DRIVER: NCDOT_pdf_color_eng_50.plt
USER: m7zephka
FILE: c:\pwworking\veast01\0140951\ud2519bb_fm.psh_25.dgn
PENTABLE: NCDOT_tcp.tbl
DATE: 6/4/2018
TIME: 10:35:32 AM

APPROVED: *Michael T. Krepka*
DATE: 6/4/2018
NORTH CAROLINA PROFESSIONAL ENGINEER SEAL 15876
MICHAEL T. KREPKA

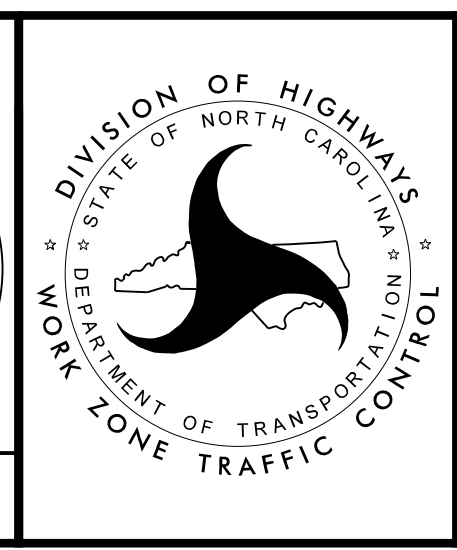

**PHASE III
STEPS 1 & 2
DETAIL**

DOCUMENT NOT CONSIDERED FINAL
UNLESS ALL SIGNATURES COMPLETED

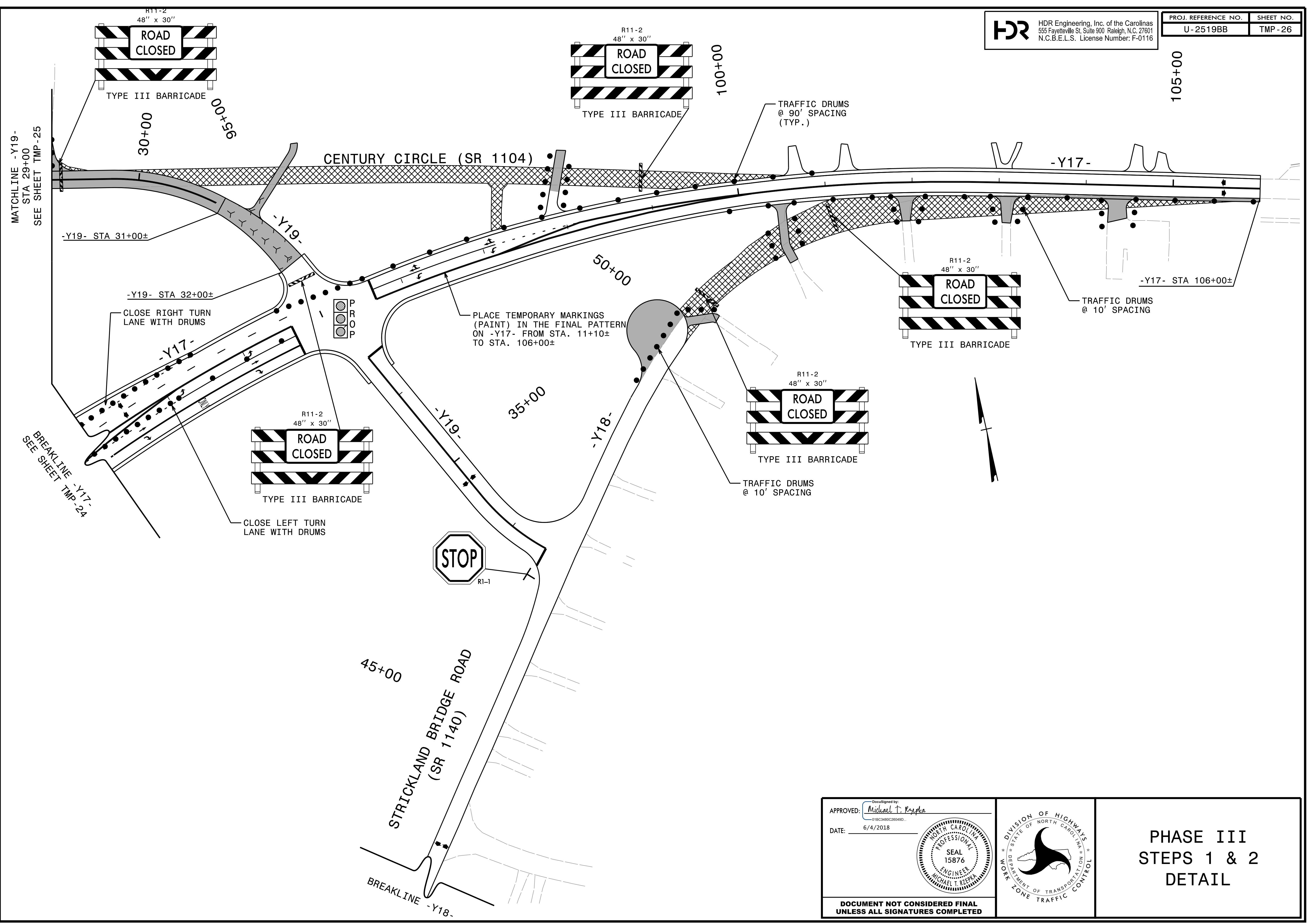

PLOT DRIVER: NCDOT_pdf_color_eng_50.plt
USER: mrzepka
DATE: 6/4/2018
FILE: c:\pwworking\veast01\d0140951\ud2519bb_tmp.psh_26.dgn

APPROVED: *Michael T. Reppa*
018C3480C28049D...
 DATE: 6/4/2018

SEAL
 15876
 ENGINEER
 MICHAEL T. REPPA

**DOCUMENT NOT CONSIDERED FINAL
 UNLESS ALL SIGNATURES COMPLETED**

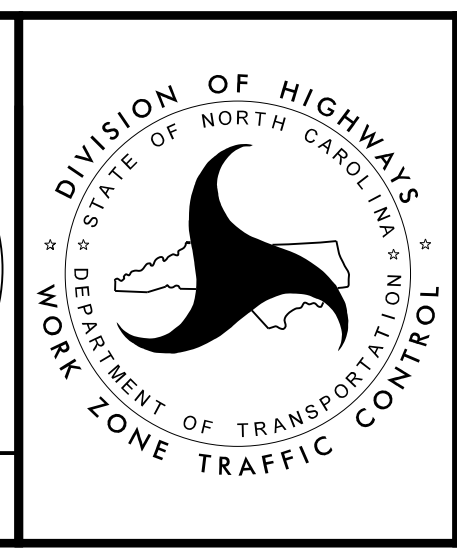

**PHASE III
 STEPS 1 & 2
 DETAIL**

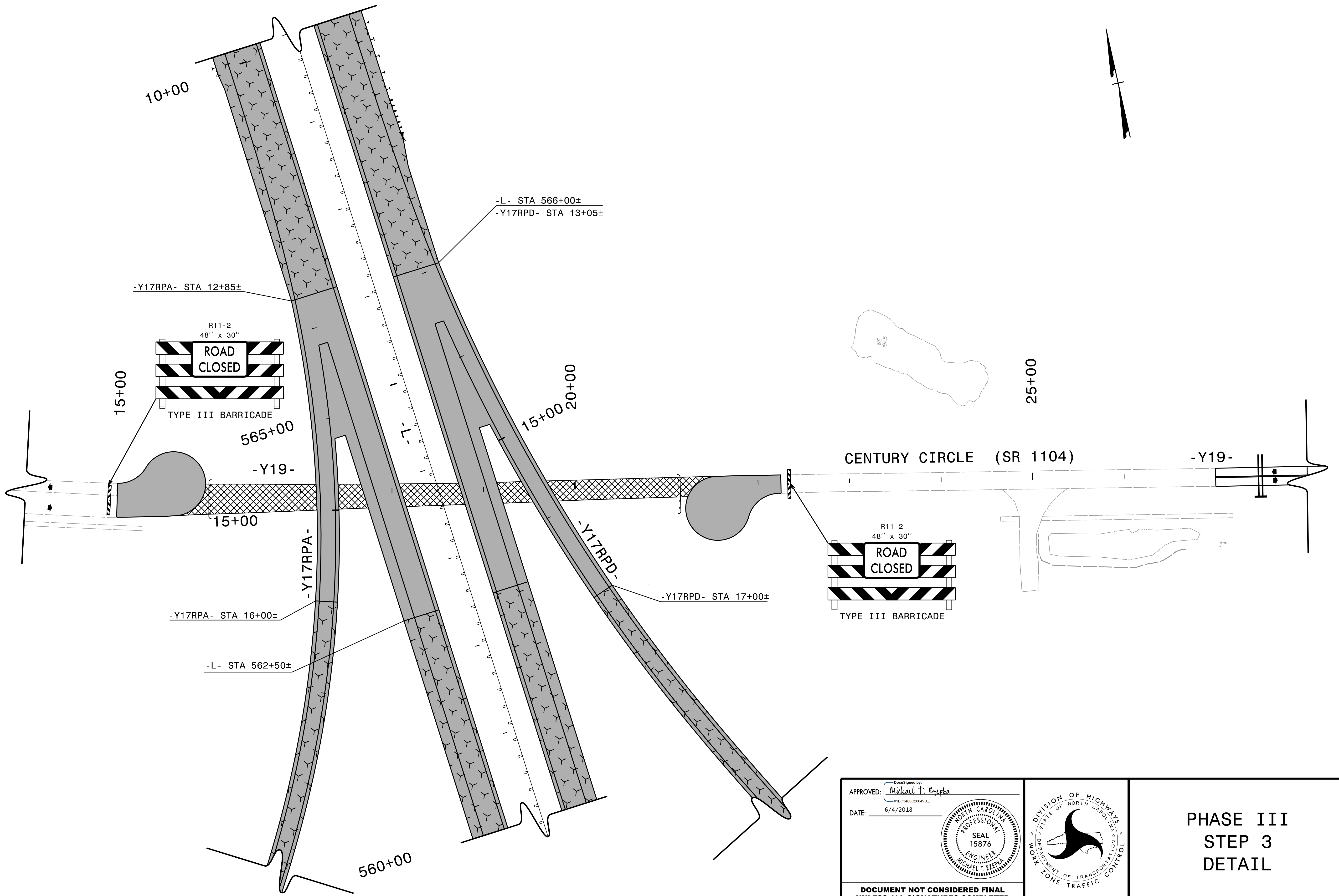

PLOT DRIVER: NCDOT_pdf_color_eng_50.plt
USER: mrzepka
FILE: c:\pwworking\east01\0140951\ud2519bb_fm_psh_27.dgn
PENTABLE: NCDOT_tcp.tbl
DATE: 6/4/2018
TIME: 10:35:35 AM

APPROVED: *Michael T. Reppa*
DATE: 6/4/2018
018C3480C28049D...
NORTH CAROLINA
PROFESSIONAL
SEAL
15876
ENGINEER
MICHAEL T. REPPA

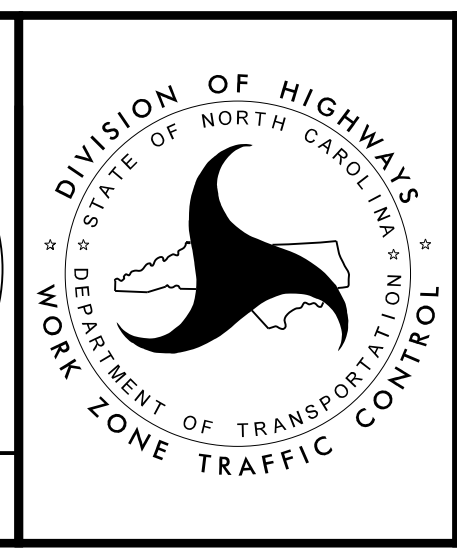

**PHASE III
STEP 3
DETAIL**

**DOCUMENT NOT CONSIDERED FINAL
UNLESS ALL SIGNATURES COMPLETED**