

**STATE OF NORTH CAROLINA  
DEPARTMENT OF TRANSPORTATION**

**SIGNING PLAN  
BEAUFORT & MARTIN COUNTIES**

**LOCATION: US 17 FROM NORTH OF NC 171 TO  
EXISTING MULTI-LANES SOUTH OF WILLIAMSTON**

<small>TIP NO.</small> R-2511	<small>SHEET NO.</small> SIGN-1
<small>APPROVED:</small> <i>David T. Sears</i> <small>DATE:</small> 9/13/2021	
	
<b>DOCUMENT NOT CONSIDERED FINAL UNLESS ALL SIGNATURES COMPLETED</b>	

**T.I.P.: R-2511**

**CONTRACT: C204498**

**ROADWAY STANDARD DRAWING**

THE FOLLOWING ROADWAY STANDARDS AS APPEAR IN "ROADWAY STANDARD DRAWINGS" - PROJECT SERVICES UNIT - N.C. DEPARTMENT OF TRANSPORTATION - RALEIGH, N.C., DATED JANUARY 2018 ARE APPLICABLE TO THIS PROJECT AND BY REFERENCE HEREBY ARE CONSIDERED A PART OF THESE PLANS:

<u>STD. NO.</u>	<u>TITLE</u>
901.50	ARROWS AND SHIELDS
903.20	WOOD SIGN SUPPORTS
904.10	ORIENTATION OF GROUND MOUNTED SIGNS
904.50	MOUNTING OF TYPE D,E & F SIGNS ON U-CHANNEL POSTS
910.30	SIGNING SIGNALIZED AND UNSIGNALIZED SUPERSTREET
910.50	SIGNING FOR SPEED REDUCTION ZONE

**GENERAL NOTES**

- . SIGNS FURNISHED BY STATE
- . CONFIRM IN WRITING AT LEAST 4 MONTHS IN ADVANCE, THE ACTUAL DATE THE DEPARTMENT FURNISHED SIGNS WILL BE REQUIRED.
- . ALL TYPE 'D' SIGNS SHALL BE MOUNTED ON WOOD POSTS UNLESS OTHERWISE INDICATED ON THE PLANS.
- . IF REMOVAL OR RELOCATION OF SIGNS ON PRIVATE STREET (NON-STATE MAINTAINED) IS REQUIRED DUE TO CONSTRUCTION, THE CONTRACTOR SHALL INFORM THE ENGINEER. THE WORK WILL BE COMPLETED BY OTHERS.
- . WHEN NOT STATIONED OR DIMENSIONED ON PLANS, ALL 'E' AND 'F' SIGNS SHALL BE FIELD LOCATED BY THE ENGINEER
- . ALL EXISTING SIGNS ON WOOD POST WITHIN THE PROJECT LIMITS SHALL BE REMOVED AND DISPOSED OF UNLESS OTHERWISE NOTED ON PLANS.
- . WHEN EXISTING SIGNS ARE REMOVED AND INSTALLED ON NEW SUPPORTS, THE RE-ERECTION SHALL IMMEDIATELY FOLLOW THE REMOVAL.
- . THE BACKGROUND FOR TYPE E & F SIGNS SHALL BE TYPE C REFLECTIVE SHEETING.
- . SEE ROADWAY PLANS FOR GUARD/GUIDE RAIL DETAILS.

**SUMMARY OF QUANTITIES**

ITEM NO.		ITEM DESCRIPTION	QUANTITY	UNIT
DESC. NO.	SECT. NO.			
4072000000	903	SUPPORTS, 3 LB STEEL U-CHANNEL	206	L.F.
4082000000	903	SUPPORTS, WOOD	3868	L.F.
4096000000	904	SIGN ERECTION, TYPE D	16	EA.
4102000000	904	SIGN ERECTION, TYPE E	149	EA.
4108000000	904	SIGN ERECTION, TYPE F	54	EA.
4116100000	904	SIGN ERECTION, RELOCATE SIGN TYPE D (GROUND MOUNTED)	3	EA.
4116100000	904	SIGN ERECTION, RELOCATE SIGN TYPE E (GROUND MOUNTED)	3	EA.
4141000000	907	DISPOSAL OF SUPPORT, WOOD	6	EA.
4158000000	907	DISPOSAL OF SIGN SYSTEM, WOOD	91	EA.

**RFC SIGNING PLANS**

**INDEX**

<u>SHEET NO.</u>	<u>DESCRIPTION</u>
SIGN-1	TITLE SHEET
SIGN-3	E AND F SIGNS
SIGN-3A-3E	SIGN DESIGNS
SIGN-4-25	SIGNING PLAN SHEETS

**PLAN SUBMITTED TO:**

*Ayman Alqudwah, PE* Signing & Delineation Regional Engineer  
*David M. Eaton, PE* Signing & Delineation Project Design Engineer  
*Jason Davidson* Division 1 Traffic Engineer  
*Steven Hamilton, PE, CPM* Division 2 Traffic Engineer

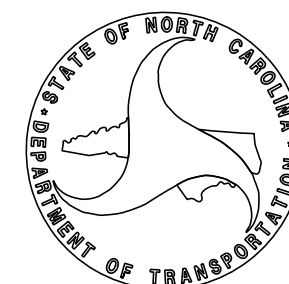

**PLAN PREPARED BY:**

*David Sears, PE, PTOE* Project Engineer  
*Allen Tutt* Sr. Designer



P: (919) 878-9560  
 8601 Six Forks Road, Forum 1, Suite 700  
 Raleigh, North Carolina 27615-3960  
 NC License No. F-0112

Engineers | Construction Managers | Planners | Scientists  
 www.rkk.com

Responsive People | Creative Solutions

PROJECT REFERENCE NO. R-2511	SHEET NO. SIGN-3
APPROVED: <i>David J. Sease</i> 9/13/2021	
SEAL 	
DOCUMENT NOT CONSIDERED FINAL UNLESS ALL SIGNATURES COMPLETED	

401 QUANTITY REQ'D 5

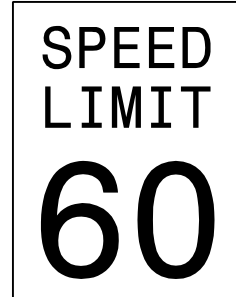

R2-1  
30"X 36"

ONE WOOD POST PER SIGN

402 QUANTITY REQ'D 43

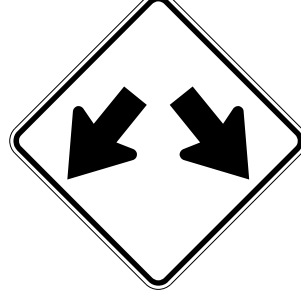

W12-1  
30"X 30"

ONE WOOD POST PER SIGN

403 QUANTITY REQ'D 13



R6-1R  
36"X 12"

MOUNT ABOVE SIGN 404  
IN 13 INSTALLATIONS

404 QUANTITY REQ'D 17

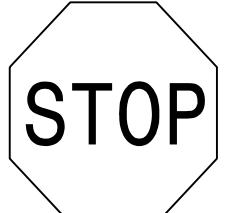

R1-1  
36"X 36"

ONE WOOD POST PER SIGN

405 QUANTITY REQ'D 1

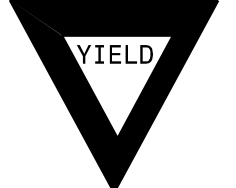

R1-2  
36"X36"X36"

ONE WOOD POST

406 QUANTITY REQ'D 1



W14-1  
30"X 30"

ONE WOOD POST

407 QUANTITY REQ'D 6

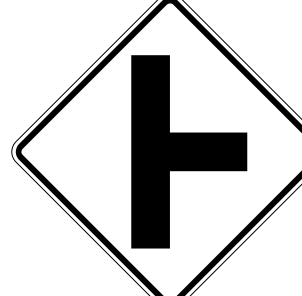

W2-2  
30"X 30"

ONE WOOD POST PER SIGN

408 QUANTITY REQ'D 30



R6-1L  
54"X 18"

TWO WOOD POSTS PER SIGN

409 QUANTITY REQ'D 12



R4-7  
24"X 30"

ONE WOOD POST PER SIGN

410 QUANTITY REQ'D 4

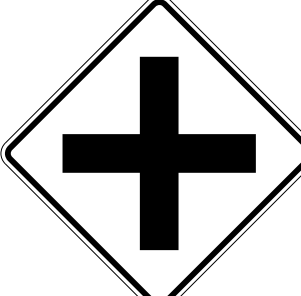

W2-1  
30"X 30"

ONE WOOD POST PER SIGN

411 QUANTITY REQ'D 2

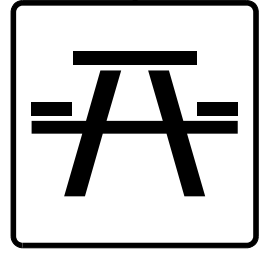

RS-044  
24"X 24"

COLOR: BROWN

ONE WOOD POST PER SIGN

412 QUANTITY REQ'D 2

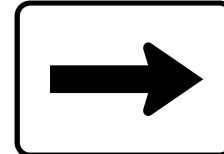

M6-1  
21"X 15"

COLOR: BLUE

MOUNT BELOW SIGN 413  
IN TWO INSTALLATIONS

413 QUANTITY REQ'D 2



D9-3  
24"X 24"

COLOR: BLUE

MOUNT BELOW SIGN 314  
IN ONE INSTALLATION  
MOUNT BELOW SIGN 315  
IN ONE INSTALLATION

414 QUANTITY REQ'D 1

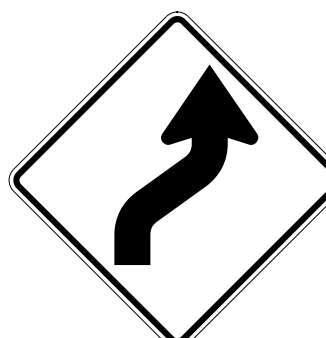

W1-4R  
30"X 30"

ONE WOOD POST

415 QUANTITY REQ'D 1



W13-1P  
18"X 18"

MOUNT BELOW SIGN-414  
IN ONE INSTALLATION

416 QUANTITY REQ'D 2

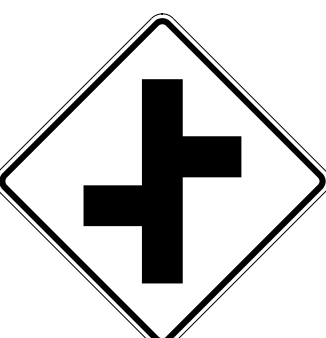

W2-7L  
30"X 30"

ONE WOOD POST PER SIGN

417 QUANTITY REQ'D 1

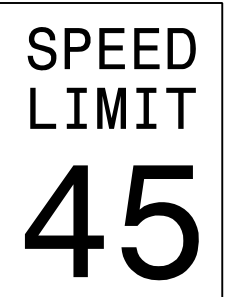

R2-1  
24"X 30"

ONE WOOD POST

418 QUANTITY REQ'D 1

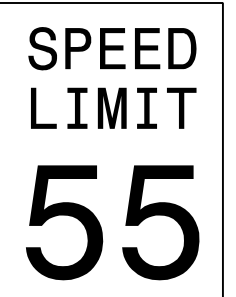

R2-1  
30"X 36"

ONE WOOD POST

419 QUANTITY REQ'D 1

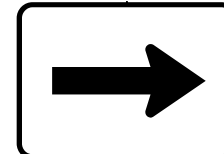

M6-1  
21"X 15"

COLOR: BROWN

MOUNT BELOW SIGN 411  
IN ONE INSTALLATION

420 QUANTITY REQ'D 1

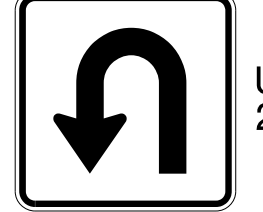

U-TURN  
21"X21"

COLOR: BROWN

MOUNT BELOW SIGN 411  
IN ONE INSTALLATION  
SEE SHEET SIGN-3E  
FOR ARROW DETAIL

421 QUANTITY REQ'D 1



W3-5  
36"X 36"

ONE WOOD POST

422 QUANTITY REQ'D 2

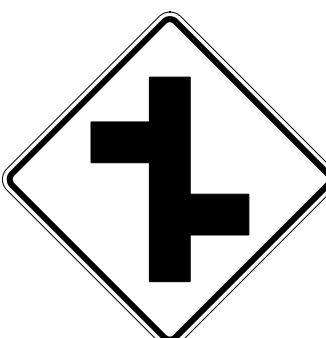

W2-7R  
30"X 30"

ONE WOOD POST PER SIGN



P: (919) 878-9560  
8601 Six Forks Road, Forum 1, Suite 700  
Raleigh, North Carolina 27615-3960  
NC License No. F-0112

Engineers | Construction Managers | Planners | Scientists  
www.rkk.com  
Responsive People | Creative Solutions

502 507 510 514 518 524  
528 532 536 542 546 551



M3-3  
24"X 12"



M1-4  
24"X 24"

ONE WOOD POST PER SIGN

505 508 512 517 521 525  
529 533 539 543 549 554



M3-1  
24"X 12"



M1-4  
24"X 24"

ONE WOOD POST PER SIGN

501 504 506 511 515 520  
523 527 531 535 538 541  
545 548  
552



M3-3  
24"X 12"



M1-4  
24"X 24"

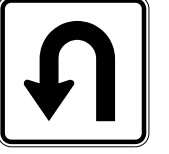

U-TURN  
21"X 21"

MOUNT 515 BELOW SIGN 305.  
OTHERS ONE WOOD POST PER SIGN

503 509 513 516 519 522  
526 530 534 537 540 544  
547 550  
553



M3-1  
24"X 12"



M1-4  
24"X 24"

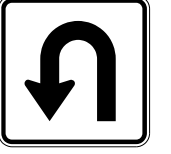

U-TURN  
21"X 21"

ONE WOOD POST PER SIGN

TYPE "E" & "F" SIGNS

09/13/2021 10:51:51 AM



APPROVED: *David T. Sears*  
069183F28E741E  
 DATE: 9/13/2021

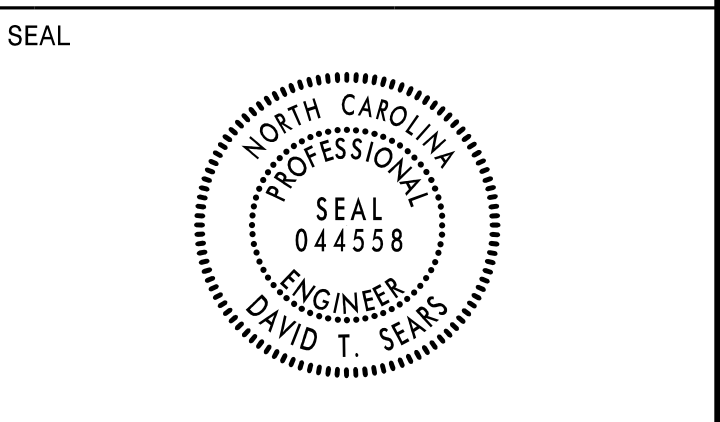

**DOCUMENT NOT CONSIDERED FINAL  
 UNLESS ALL SIGNATURES COMPLETED**

**SIGN NUMBER: 301**      **BACKG COLOR: Green**      **DESIGN BY: A. TUTT**      **CHECKED BY: D. SEARS**      **Jul 13, 2021**  
**TYPE: D**      **COPY COLOR: White**      **PROJECT ID: R-2511**      **LOCATION: -L- STA. 37+50**      **DIV: 1,2**

**QUANTITY: 1**

SYMBOL	X	Y	WID	HT

**SIGN WIDTH: 6'-0"**  
**HEIGHT: 2'-6"**  
**TOTAL AREA: 15.0 Sq.Ft.**

**BORDER TYPE: FLUSH**  
**RECESS: 0"**  
**WIDTH: 0.75"**  
**RADII: 3.75"**

**MAT'L: 0.125" (3.2 mm) ALUMINUM**

**NO. Z BARS: LENGTH:**

**USE NOTES: 1,2**

- Legend and border(except those that are colored black) shall be direct applied Grade C sheeting.
- Background shall be Grade C reflective sheeting.
- Shields: A, B, and C type arrows shall be on 0.032" (0.8mm) aluminum and demountable.

Spacing Factor is 1 unless specified otherwise

**LETTER POSITIONS**

Letter spacings are to start of next letter													Series/Size
													Text Length
6	5.8	4.2	3.6	4.7	2.2	4.4	4.3	2.8	4.6	3.5	25.8		D 2000
													40.1
													D 2000
													4.1
													D 2000
													37.5
													D 2000
													9.8

FILENAME: P2511\_SGN      NORTH CAROLINA D.O.T. SIGN DETAIL

**SIGN NUMBER: 302**      **BACKG COLOR: Green**      **DESIGN BY: A. TUTT**      **CHECKED BY: D. SEARS**      **Jul 13, 2021**  
**TYPE: D**      **COPY COLOR: White**      **PROJECT ID: R-2511**      **LOCATION: -L- STA. 77+00**      **DIV: 1,2**

**QUANTITY: 1**

SYMBOL	X	Y	WID	HT

**SIGN WIDTH: 5'-6"**  
**HEIGHT: 1'-6"**  
**TOTAL AREA: 8.3 Sq.Ft.**

**BORDER TYPE: FLUSH**  
**RECESS: 0"**  
**WIDTH: 0.75"**  
**RADII: 2.25"**

**MAT'L: 0.125" (3.2 mm) ALUMINUM**

**NO. Z BARS: LENGTH:**

**USE NOTES: 1,2**

- Legend and border(except those that are colored black) shall be direct applied Grade C sheeting.
- Background shall be Grade C reflective sheeting.
- Shields: A, B, and C type arrows shall be on 0.032" (0.8mm) aluminum and demountable.

Spacing Factor is 1 unless specified otherwise

**LETTER POSITIONS**

Letter spacings are to start of next letter													Series/Size
													Text Length
6	6.1	2.2	2.2	1.9	4.6	6.7	3.1	2.8	4.6	3.5	20.2		D 2000
													39.8
													D 2000
													6.8

FILENAME: P2511\_SGN      NORTH CAROLINA D.O.T. SIGN DETAIL

**SIGN NUMBER: 303**      **BACKG COLOR: Green**      **DESIGN BY: A. TUTT**      **CHECKED BY: D. SEARS**      **Jan 12, 2021**  
**TYPE: D**      **COPY COLOR: White**      **PROJECT ID: R-2511**      **LOCATION: -L- STA. 158+00**      **DIV: 1,2**

**QUANTITY: 1**

SYMBOL	X	Y	WID	HT
AR_Type D	6	4.5	6	9

**SIGN WIDTH: 5'-6"**  
**HEIGHT: 1'-6"**  
**TOTAL AREA: 8.3 Sq.Ft.**

**BORDER TYPE: FLUSH**  
**RECESS: 0"**  
**WIDTH: 0.75"**  
**RADII: 2.25"**

**MAT'L: 0.125" (3.2 mm) ALUMINUM**

**NO. Z BARS: LENGTH:**

**USE NOTES: 1,2**

- Legend and border(except those that are colored black) shall be direct applied Grade C sheeting.
- Background shall be Grade C reflective sheeting.
- Shields: A, B, and C type arrows shall be on 0.032" (0.8mm) aluminum and demountable.

Spacing Factor is 1 unless specified otherwise

**LETTER POSITIONS**

Letter spacings are to start of next letter													Series/Size
													Text Length
18	5.9	4.4	4.6	1.9	4.6	2.8	3.6	6	4.7	3.6	6		D 2000
													42

FILENAME: P2511\_SGN      NORTH CAROLINA D.O.T. SIGN DETAIL

**SIGN NUMBER: 304**      **BACKG COLOR: Green**      **DESIGN BY: A. TUTT**      **CHECKED BY: D. SEARS**      **Jul 13, 2021**  
**TYPE: D**      **COPY COLOR: White**      **PROJECT ID: R-2511**      **LOCATION: -L- STA. 171+50**      **DIV: 1,2**

**QUANTITY: 1**

SYMBOL	X	Y	WID	HT

**SIGN WIDTH: 6'-0"**  
**HEIGHT: 2'-6"**  
**TOTAL AREA: 15.0 Sq.Ft.**

**BORDER TYPE: FLUSH**  
**RECESS: 0"**  
**WIDTH: 0.75"**  
**RADII: 3.75"**

**MAT'L: 0.125" (3.2 mm) ALUMINUM**

**NO. Z BARS: LENGTH:**

**USE NOTES: 1,2**

- Legend and border(except those that are colored black) shall be direct applied Grade C sheeting.
- Background shall be Grade C reflective sheeting.
- Shields: A, B, and C type arrows shall be on 0.032" (0.8mm) aluminum and demountable.

Spacing Factor is 1 unless specified otherwise

**LETTER POSITIONS**

Letter spacings are to start of next letter													Series/Size
													Text Length
6	5.8	4.2	3.6	4.7	2.2	4.4	4.3	2.8	4.6	3.5	25.9		D 2000
													40.1
													D 2000
													4.3
													D 2000
													37.5
													D 2000
													9.9

FILENAME: P2511\_SGN      NORTH CAROLINA D.O.T. SIGN DETAIL

P:\2021\30N-DESIGNS\_PSH03A.dgn

**RK&K**  
 P: (919) 878-9560  
 8601 Six Forks Road, Forum 1, Suite 700  
 Raleigh, North Carolina 27615-3960  
 NC License No. F-0112

Engineers | Construction Managers | Planners | Scientists  
 www.rkk.com

Responsive People | Creative Solutions

SIGN DESIGNS

APPROVED: *David T. Sears*  
0691837282741E  
 DATE: 9/13/2021

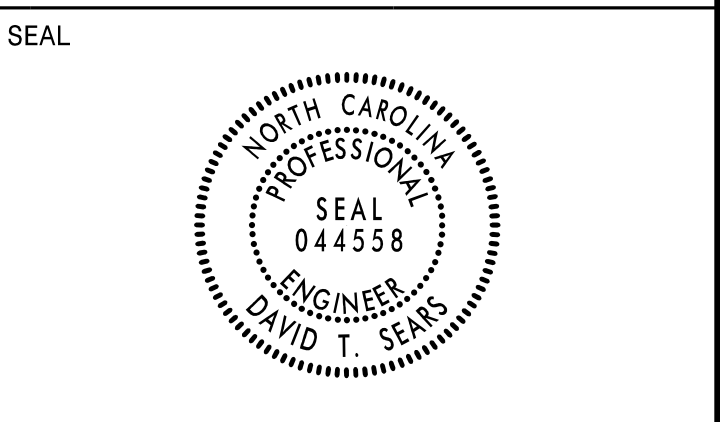

**DOCUMENT NOT CONSIDERED FINAL  
 UNLESS ALL SIGNATURES COMPLETED**

SIGN NUMBER: 305 TYPE: D QUANTITY: 1  
 SIGN WIDTH: 6'-0" HEIGHT: 1'-6" TOTAL AREA: 9.0 Sq.Ft.  
 BORDER TYPE: FLUSH RECESS: 0" WIDTH: 0.75" RADII: 2.25"  
 NO. Z BARS: LENGTH: MAT'L: 0.125" (3.2 mm) ALUMINUM

BACKG COLOR: Green COPY COLOR: White

SYMBOL	X	Y	WID	HT
u arrow	6.9	3.4	10.2	11.1

DESIGN BY: A. TUTT CHECKED BY: D. SEARS  
 PROJECT ID: R-2511 LOCATION: 173+12 Jan 12, 2021 DIV: 1,2

USE NOTES: 1,2  
 1. Legend and border(except those that are colored black) shall be direct applied Grade C sheeting.  
 2. Background shall be Grade C reflective sheeting.  
 3. Shields; A, B, and C type arrows shall be on 0.032" (0.8mm) aluminum and demountable.

LETTER POSITIONS

Letter spacings are to start of next letter													Series/Size Text Length
W	o	o	l	a	r	d		R	d				D 2000
23.1	5.9	4.4	4.6	1.9	4.6	2.8	3.6	6	4.7	3.6	6.9		42

FILENAME: p2511\_SGN NORTH CAROLINA D.O.T. SIGN DETAIL

SIGN NUMBER: 306 TYPE: D QUANTITY: 1  
 SIGN WIDTH: 5'-6" HEIGHT: 1'-6" TOTAL AREA: 8.3 Sq.Ft.  
 BORDER TYPE: FLUSH RECESS: 0" WIDTH: 0.75" RADII: 2.25"  
 NO. Z BARS: LENGTH: MAT'L: 0.125" (3.2 mm) ALUMINUM

BACKG COLOR: Green COPY COLOR: White

SYMBOL	X	Y	WID	HT

DESIGN BY: A. TUTT CHECKED BY: D. SEARS  
 PROJECT ID: R-2511 LOCATION: -L- STA. 217+00 Jan 12, 2021 DIV: 1,2

USE NOTES: 1,2  
 1. Legend and border(except those that are colored black) shall be direct applied Grade C sheeting.  
 2. Background shall be Grade C reflective sheeting.  
 3. Shields; A, B, and C type arrows shall be on 0.032" (0.8mm) aluminum and demountable.

LETTER POSITIONS

Letter spacings are to start of next letter													Series/Size Text Length
W	i	l	i	a	m	s	t	o	n				D 2000
6	6.1	2.2	2.2	2.2	1.9	4.6	6.7	3.1	2.8	4.6	3.5	20.2	39.8
		1	2										D 2000
53.1	2.8	4.1	6										6.9

FILENAME: p2511\_SGN NORTH CAROLINA D.O.T. SIGN DETAIL

SIGN NUMBER: 307 TYPE: D QUANTITY: 1  
 SIGN WIDTH: 6'-0" HEIGHT: 3'-0" TOTAL AREA: 18.0 Sq.Ft.  
 BORDER TYPE: FLUSH RECESS: 0" WIDTH: 1" RADII: 4.5"  
 NO. Z BARS: LENGTH: MAT'L: 0.125" (3.2 mm) ALUMINUM

BACKG COLOR: Green COPY COLOR: White

SYMBOL	X	Y	WID	HT

DESIGN BY: A. TUTT CHECKED BY: D. SEARS  
 PROJECT ID: R-2511 LOCATION: -L- STA. 231+00 Jul 13, 2021 DIV: 1,2

USE NOTES: 1,2  
 1. Legend and border(except those that are colored black) shall be direct applied Grade C sheeting.  
 2. Background shall be Grade C reflective sheeting.  
 3. Shields; A, B, and C type arrows shall be on 0.032" (0.8mm) aluminum and demountable.

LETTER POSITIONS

Letter spacings are to start of next letter													Series/Size Text Length
W	e	l	c	o	m	e		T	o				EM 2000
8.4	7.3	5.8	3.1	5.3	5.9	8.5	4	6	5.3	4.1	8.4		55.2
													E 2000
19.8	6.7	7.1	5.5	5.5	2.6	4.9	19.8						32.3
													E 2000
18.1	6.1	6.4	6.4	5.9	5	6.1	18.1						35.9

FILENAME: p2511\_SGN NORTH CAROLINA D.O.T. SIGN DETAIL

SIGN NUMBER: 308 TYPE: D QUANTITY: 1  
 SIGN WIDTH: 6'-0" HEIGHT: 3'-0" TOTAL AREA: 18.0 Sq.Ft.  
 BORDER TYPE: FLUSH RECESS: 0" WIDTH: 1" RADII: 4.5"  
 NO. Z BARS: LENGTH: MAT'L: 0.125" (3.2 mm) ALUMINUM

BACKG COLOR: Green COPY COLOR: White

SYMBOL	X	Y	WID	HT

DESIGN BY: A. TUTT CHECKED BY: D. SEARS  
 PROJECT ID: R-2511 LOCATION: -L- STA. 231+00 Jul 13, 2021 DIV: 1,2

USE NOTES: 1,2  
 1. Legend and border(except those that are colored black) shall be direct applied Grade C sheeting.  
 2. Background shall be Grade C reflective sheeting.  
 3. Shields; A, B, and C type arrows shall be on 0.032" (0.8mm) aluminum and demountable.

LETTER POSITIONS

Letter spacings are to start of next letter													Series/Size Text Length
W	e	l	c	o	m	e		T	o				EM 2000
8.4	7.3	5.8	3.1	5.3	5.9	8.5	4	6	5.3	4.1	8.4		55.2
													E 2000
12.7	6.1	5.2	7.1	6.4	5.3	6.4	5.5	4.5	12.7				46.6
													E 2000
18.1	6.1	6.4	6.4	5.9	5	6.1	18.1						35.9

FILENAME: p2511\_SGN NORTH CAROLINA D.O.T. SIGN DETAIL

P:\2021\30N-DESIGNS\_PSH\03A.dgn

**RK&K**  
 P: (919) 878-9560  
 8601 Six Forks Road, Forum 1, Suite 700  
 Raleigh, North Carolina 27615-3960  
 NC License No. F-0112

Engineers | Construction Managers | Planners | Scientists  
 www.rkk.com

Responsive People | Creative Solutions

**SIGN DESIGNS**



APPROVED: *David T. Sears*  
0691837282741E  
 DATE: 9/13/2021

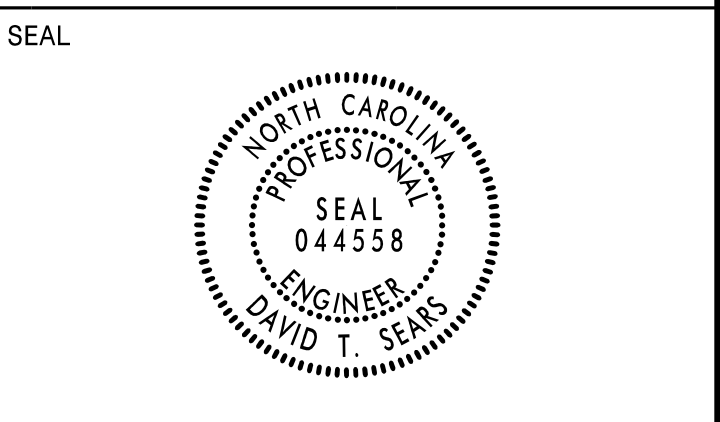

**DOCUMENT NOT CONSIDERED FINAL  
 UNLESS ALL SIGNATURES COMPLETED**

SIGN NUMBER: 309      BACKG COLOR: Green      DESIGN BY: A. TUTT      CHECKED BY: D. SEARS      Jul 13, 2021  
 TYPE: D      COPY COLOR: White      PROJECT ID: R-2511      LOCATION: -L- STA. 251+50      DIV: 1,2

QUANTITY: 1

SYMBOL	X	Y	WID	HT

SIGN WIDTH: 4'-6"  
 HEIGHT: 2'-6"  
 TOTAL AREA: 11.3 Sq.Ft.

BORDER TYPE: FLUSH  
 RECESS: 0"  
 WIDTH: 0.75"  
 RADII: 3.75"

NO. Z BARS:      MAT'L: 0.125" (3.2 mm) ALUMINUM  
 LENGTH:

USE NOTES: 1,2

- Legend and border (except those that are colored black) shall be direct applied Grade C sheeting.
- Background shall be Grade C reflective sheeting.
- Shields: A, B, and C type arrows shall be on 0.032" (0.8mm) aluminum and demountable.

Spacing Factor is 1 unless specified otherwise

LETTER POSITIONS

Letter spacings are to start of next letter													Series/Size
													Text Length
E	N	T	E	R	I	N	G						D 2000
15	3.2	3.3	3.1	3.2	3.4	1.6	3.6	2.7	15				24
T	A	R	-	P	A	M	L	I	C	O			D 2000
5.9	3.4	5	3.8	2.5	3.7	5	5.1	3.8	1.9	4.4	3.6	5.9	42.2
R	I	V	E	R	B	A	S	I	N				D 2000
6.6	4.2	1.5	4.5	3.9	3.4	5	3.8	4.6	4.2	2	3.4	6.6	40.8

FILENAME: P2511\_SGN      NORTH CAROLINA D.O.T. SIGN DETAIL

SIGN NUMBER: 310      BACKG COLOR: Green      DESIGN BY: A. TUTT      CHECKED BY: D. SEARS      Jul 13, 2021  
 TYPE: D      COPY COLOR: White      PROJECT ID: R-2511      LOCATION: -L- STA. 253+50      DIV: 1,2

QUANTITY: 1

SYMBOL	X	Y	WID	HT

SIGN WIDTH: 4'-6"  
 HEIGHT: 2'-6"  
 TOTAL AREA: 11.3 Sq.Ft.

BORDER TYPE: FLUSH  
 RECESS: 0"  
 WIDTH: 0.75"  
 RADII: 3.75"

NO. Z BARS:      MAT'L: 0.125" (3.2 mm) ALUMINUM  
 LENGTH:

USE NOTES: 1,2

- Legend and border (except those that are colored black) shall be direct applied Grade C sheeting.
- Background shall be Grade C reflective sheeting.
- Shields: A, B, and C type arrows shall be on 0.032" (0.8mm) aluminum and demountable.

Spacing Factor is 1 unless specified otherwise

LETTER POSITIONS

Letter spacings are to start of next letter													Series/Size
													Text Length
E	N	T	E	R	I	N	G						D 2000
15	3.2	3.3	3.1	3.2	3.4	1.6	3.6	2.7	15				24
R	O	A	N	O	K	E							D 2000
12	4.1	4.2	5	4.5	4.6	4.3	3.1	12					30
R	I	V	E	R	B	A	S	I	N				D 2000
6.6	4.2	1.5	4.5	3.9	3.4	5	3.8	4.6	4.2	2	3.4	6.6	40.8

FILENAME: P2511\_SGN      NORTH CAROLINA D.O.T. SIGN DETAIL

SIGN NUMBER: 311      BACKG COLOR: Green      DESIGN BY: A. TUTT      CHECKED BY: D. SEARS      Jul 13, 2021  
 TYPE: D      COPY COLOR: White      PROJECT ID: R-2511      LOCATION: -L- STA. 371+00      DIV: 1,2

QUANTITY: 1

SYMBOL	X	Y	WID	HT

SIGN WIDTH: 6'-0"  
 HEIGHT: 2'-6"  
 TOTAL AREA: 15.0 Sq.Ft.

BORDER TYPE: FLUSH  
 RECESS: 0"  
 WIDTH: 0.75"  
 RADII: 3.75"

NO. Z BARS:      MAT'L: 0.125" (3.2 mm) ALUMINUM  
 LENGTH:

USE NOTES: 1,2

- Legend and border (except those that are colored black) shall be direct applied Grade C sheeting.
- Background shall be Grade C reflective sheeting.
- Shields: A, B, and C type arrows shall be on 0.032" (0.8mm) aluminum and demountable.

Spacing Factor is 1 unless specified otherwise

LETTER POSITIONS

Letter spacings are to start of next letter													Series/Size
													Text Length
W	a	s	h	i	n	g	t	o	n				D 2000
6	5.8	4.2	3.6	4.7	2.2	4.4	4.3	2.8	4.6	3.5	25.9		40.1
1	4												D 2000
59.2	2.3	4.5	6										6.8
N	e	w		B	e	r	n						D 2000
6	5.2	3.9	6.8	6	4.7	4.4	3	3.5	28.5				37.5
5	0												D 2000
56.5	5.3	4.3	6										9.5

FILENAME: P2511\_SGN      NORTH CAROLINA D.O.T. SIGN DETAIL

SIGN NUMBER: 312      BACKG COLOR: Green      DESIGN BY: A. TUTT      CHECKED BY: D. SEARS      Jan 12, 2021  
 TYPE: D      COPY COLOR: White      PROJECT ID: R-2511      LOCATION: -L- STA. 417+00      DIV: 1,2

QUANTITY: 1

SYMBOL	X	Y	WID	HT

SIGN WIDTH: 5'-6"  
 HEIGHT: 1'-6"  
 TOTAL AREA: 8.3 Sq.Ft.

BORDER TYPE: FLUSH  
 RECESS: 0"  
 WIDTH: 0.75"  
 RADII: 2.25"

NO. Z BARS:      MAT'L: 0.125" (3.2 mm) ALUMINUM  
 LENGTH:

USE NOTES: 1,2

- Legend and border (except those that are colored black) shall be direct applied Grade C sheeting.
- Background shall be Grade C reflective sheeting.
- Shields: A, B, and C type arrows shall be on 0.032" (0.8mm) aluminum and demountable.

Spacing Factor is 1 unless specified otherwise

LETTER POSITIONS

Letter spacings are to start of next letter													Series/Size
													Text Length
W	i	l	i	a	m	s	t	o	n				D 2000
6	6.1	2.2	2.2	2.2	1.9	4.6	6.7	3.1	2.8	4.6	3.5	20.2	39.8
8													D 2000
55.9	4.1	6											4.1

FILENAME: P2511\_SGN      NORTH CAROLINA D.O.T. SIGN DETAIL

P:\017\30N-DESIGNS\_PSH\03A.dgn  
 RKK

**RK&K**  
 P: (919) 878-9560  
 8601 Six Forks Road, Forum 1, Suite 700  
 Raleigh, North Carolina 27615-3960  
 NC License No. F-0112

Engineers | Construction Managers | Planners | Scientists  
 www.rkk.com

Responsive People | Creative Solutions

**SIGN DESIGNS**

APPROVED: *David T. Sears*  
 DATE: 9/13/2021

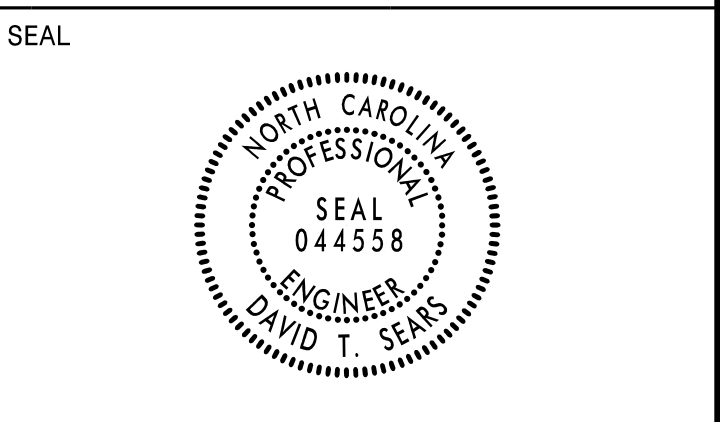

**DOCUMENT NOT CONSIDERED FINAL  
 UNLESS ALL SIGNATURES COMPLETED**

SIGN NUMBER: 313 TYPE: D QUANTITY: 1  
 SIGN WIDTH: 6'-0" HEIGHT: 2'-6" TOTAL AREA: 15.0 Sq.Ft.  
 BORDER TYPE: FLUSH RECESS: 0" WIDTH: 0.75" RADIUS: 3.75"  
 NO. Z BARS: LENGTH:

BACKG COLOR: Green COPY COLOR: White

SYMBOL	X	Y	WID	HT
AR_Type D	23.2	3.5	5	7.5

MAT'L: 0.125" (3.2 mm) ALUMINUM

DESIGN BY: A. TUTT CHECKED BY: D. SEARS Jul 14, 2021  
 PROJECT ID: R-2511 LOCATION: -L- STA. 481+50 DIV: 1,2

USE NOTES: 1,2

- Legend and border (except those that are colored black) shall be direct applied Grade C sheeting.
- Background shall be Grade C reflective sheeting.
- Shields: A, B, and C type arrows shall be on 0.032" (0.8mm) aluminum and demountable.

LETTER POSITIONS

Letter spacings are to start of next letter

Series/Size	Text Length
D 2000	40.1
D 2000	6.7
D 2000	37.5
D 2000	9.4

FILENAME: p2511\_SGN NORTH CAROLINA D.O.T. SIGN DETAIL

SIGN NUMBER: 314 TYPE: D QUANTITY: 1  
 SIGN WIDTH: 4'-6" HEIGHT: 3'-0" TOTAL AREA: 13.5 Sq.Ft.  
 BORDER TYPE: FLUSH RECESS: 0" WIDTH: 0.75" RADIUS: 4.5"  
 NO. Z BARS: LENGTH:

BACKG COLOR: Green COPY COLOR: White

SYMBOL	X	Y	WID	HT
AR_Type D	23.2	3.5	5	7.5

MAT'L: 0.125" (3.2 mm) ALUMINUM

DESIGN BY: A. TUTT CHECKED BY: D. SEARS Sep 13, 2021  
 PROJECT ID: R-2511 LOCATION: -L- STA. 526+00 DIV: 1,2

USE NOTES: 1,2

- Legend and border (except those that are colored black) shall be direct applied Grade C sheeting.
- Background shall be Grade C reflective sheeting.
- Shields: A, B, and C type arrows shall be on 0.032" (0.8mm) aluminum and demountable.

LETTER POSITIONS

Letter spacings are to start of next letter

Series/Size	Text Length
D 2000	29
D 2000	41.5
D 2000	25.5

FILENAME: p2511\_SGN NORTH CAROLINA D.O.T. SIGN DETAIL

SIGN NUMBER: 315 TYPE: D QUANTITY: 1  
 SIGN WIDTH: 4'-6" HEIGHT: 3'-0" TOTAL AREA: 13.5 Sq.Ft.  
 BORDER TYPE: FLUSH RECESS: 0" WIDTH: 0.75" RADIUS: 4.5"  
 NO. Z BARS: LENGTH:

BACKG COLOR: Green COPY COLOR: White

SYMBOL	X	Y	WID	HT
AR_Type D	23.4	3.5	5	7.5

MAT'L: 0.125" (3.2 mm) ALUMINUM

DESIGN BY: A. TUTT CHECKED BY: D. SEARS Sep 13, 2021  
 PROJECT ID: R-2511 LOCATION: -L- STA. 539+00 DIV: 1,2

USE NOTES: 1,2

- Legend and border (except those that are colored black) shall be direct applied Grade C sheeting.
- Background shall be Grade C reflective sheeting.
- Shields: A, B, and C type arrows shall be on 0.032" (0.8mm) aluminum and demountable.

LETTER POSITIONS

Letter spacings are to start of next letter

Series/Size	Text Length
D 2000	29
D 2000	41.5
D 2000	25.5

FILENAME: p2511\_SGN NORTH CAROLINA D.O.T. SIGN DETAIL

SIGN NUMBER: 316 TYPE: D QUANTITY: 1  
 SIGN WIDTH: 5'-6" HEIGHT: 1'-6" TOTAL AREA: 8.3 Sq.Ft.  
 BORDER TYPE: FLUSH RECESS: 0" WIDTH: 0.75" RADIUS: 2.25"  
 NO. Z BARS: LENGTH:

BACKG COLOR: Green COPY COLOR: White

SYMBOL	X	Y	WID	HT
AR_Type D	23.4	3.5	5	7.5

MAT'L: 0.125" (3.2 mm) ALUMINUM

DESIGN BY: A. TUTT CHECKED BY: D. SEARS Jan 12, 2021  
 PROJECT ID: R-2511 LOCATION: -L- STA. 557+00 DIV: 1,2

USE NOTES: 1,2

- Legend and border (except those that are colored black) shall be direct applied Grade C sheeting.
- Background shall be Grade C reflective sheeting.
- Shields: A, B, and C type arrows shall be on 0.032" (0.8mm) aluminum and demountable.

LETTER POSITIONS

Letter spacings are to start of next letter

Series/Size	Text Length
D 2000	39.8
D 2000	4.1

FILENAME: p2511\_SGN NORTH CAROLINA D.O.T. SIGN DETAIL

09/17/2021 SIGN\_DESIGN\_PSH03A.dgn

**RK&K**  
 P: (919) 878-9560  
 8601 Six Forks Road, Forum 1, Suite 700  
 Raleigh, North Carolina 27615-3960  
 NC License No. F-0112

Engineers | Construction Managers | Planners | Scientists  
 www.rkk.com

Responsive People | Creative Solutions

**SIGN DESIGNS**



APPROVED: *David T. Seaks*  
DocuSigned by:  
 069183F28E5741E  
 DATE: 9/13/2021

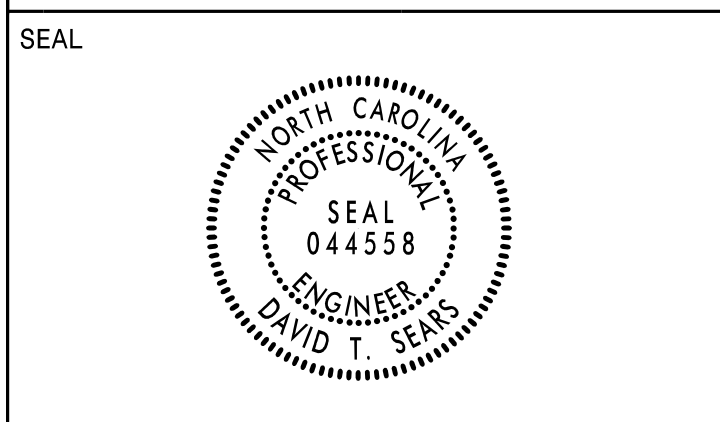

**DOCUMENT NOT CONSIDERED FINAL  
 UNLESS ALL SIGNATURES COMPLETED**

SIGN NUMR: **VAR.**      BACKG. COLOR: White      DESIGN BY:      CHK BY:      STD #:      N. C. DEPARTMENT OF TRANSPORTATION  
 TYPE: F Ground      COPY COLOR: Black      PROJECT ID:      DIV:      DATE:      DIVISION OF HIGHWAYS  
 QUANTITY: **31**      TRANSPORTATION MOBILITY & SAFETY  
 SIGNING & DELINEATION UNIT

SIGN WIDTH: 1'-9"  
 HEIGHT: 1'-9"  
 TOTAL AREA: 3.1 Sq.Ft.

SYMBOL	X	Y	WID	HT
u arrow	3.7	3.5	12.7	13.9

MAT'L: 0.063" ALUMINUM  
 BORDER TYPE: RECESSED  
 RECESS: 0.38"  
 WIDTH: 0.63"  
 RADII: 1.5"  
 NO. Z BARS:  
 LENGTH:

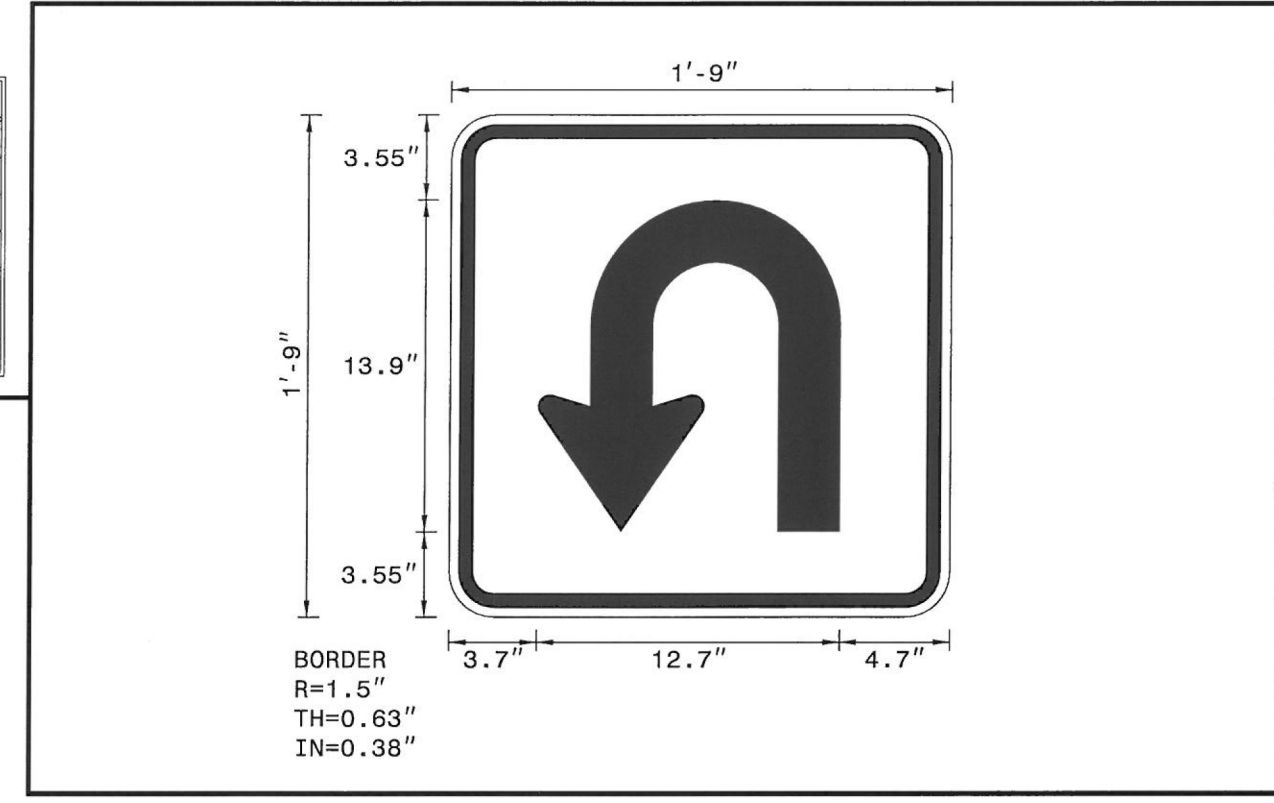

NOTES:

- Legend and border shall be direct applied Non-reflective sheeting.
- Background shall be Grade C reflective sheeting.

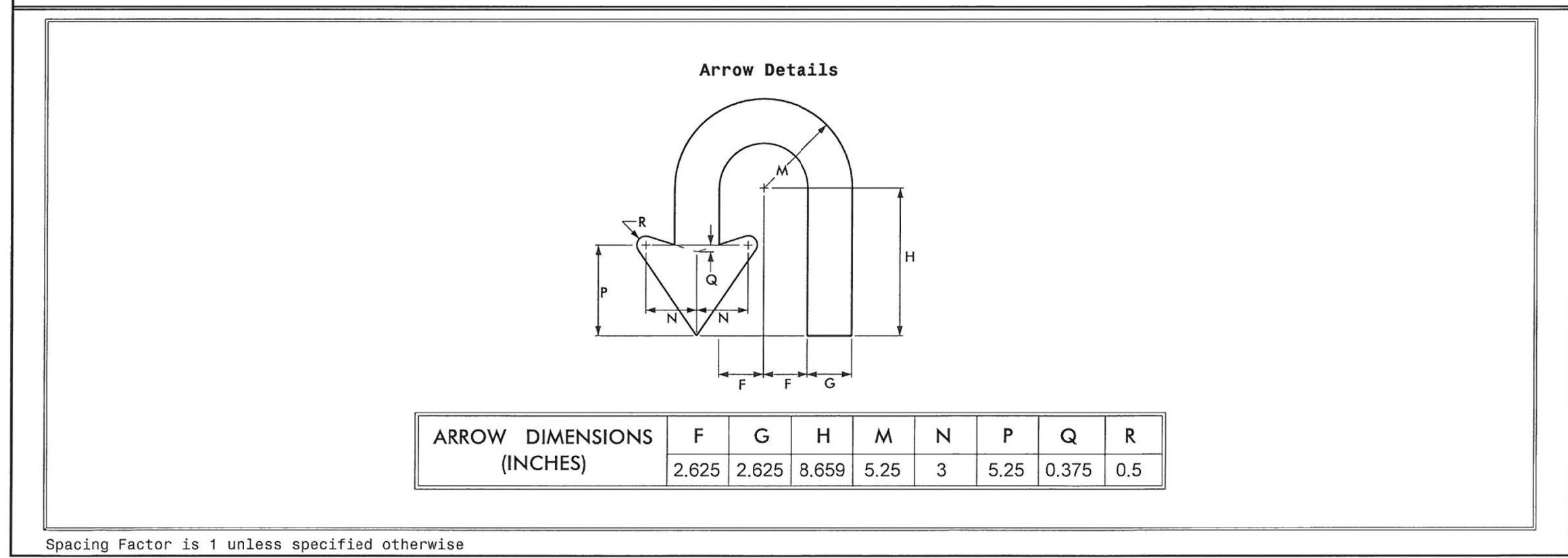

08/13/21 R2511\_SIGN\_DESIGN\_PSH03A.dgn

P: (919) 878-9560  
 8601 Six Forks Road, Forum 1, Suite 700  
 Raleigh, North Carolina 27815-3960  
 NC License No. F-0112

Engineers | Construction Managers | Planners | Scientists  
 www.rkk.com  
 Responsive People | Creative Solutions

SIGN DESIGNS

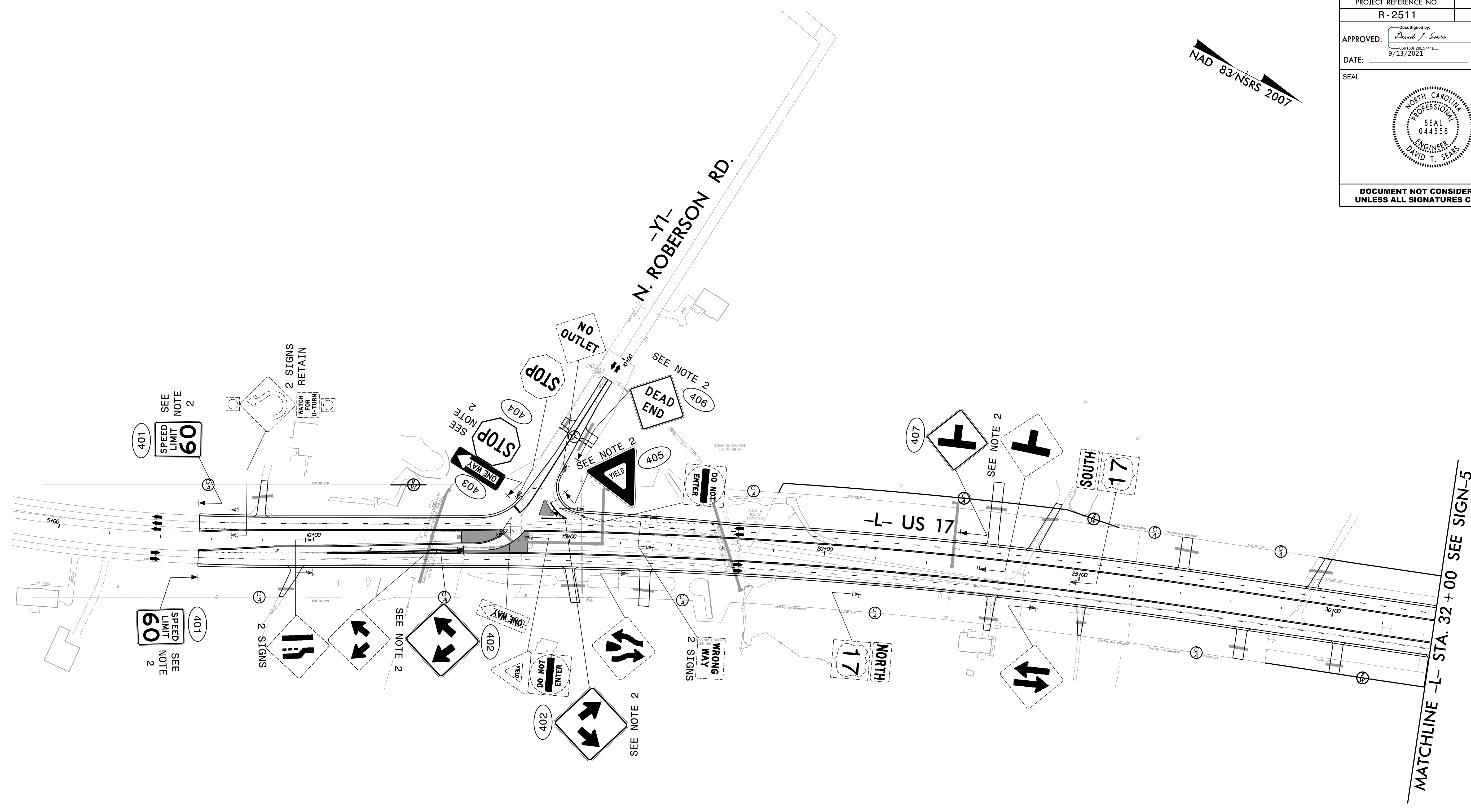
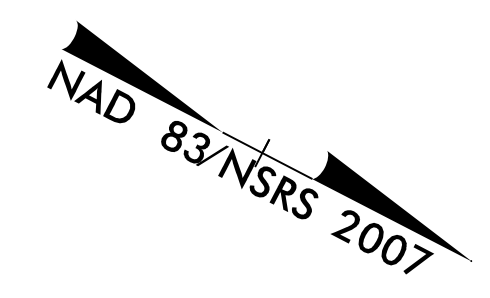

**PROJECT NOTES**

- 1 DISPOSAL OF SUPPORT, WOOD
- 2 SIGN ERECTION, TYPE D, E, AND F
- 3 SIGN ERECTION, RELOCATE SIGN TYPE D
- 4 SIGN ERECTION, RELOCATE SIGN TYPE E

**EXISTING AND PROPOSED SIGNS**

09/13/21 3:56N ipsh04.dgn  
 F:\Projects



NAD 83/NSRS 2007

MATCHLINE -L- STA. 32 + 00 SEE SIGN-4

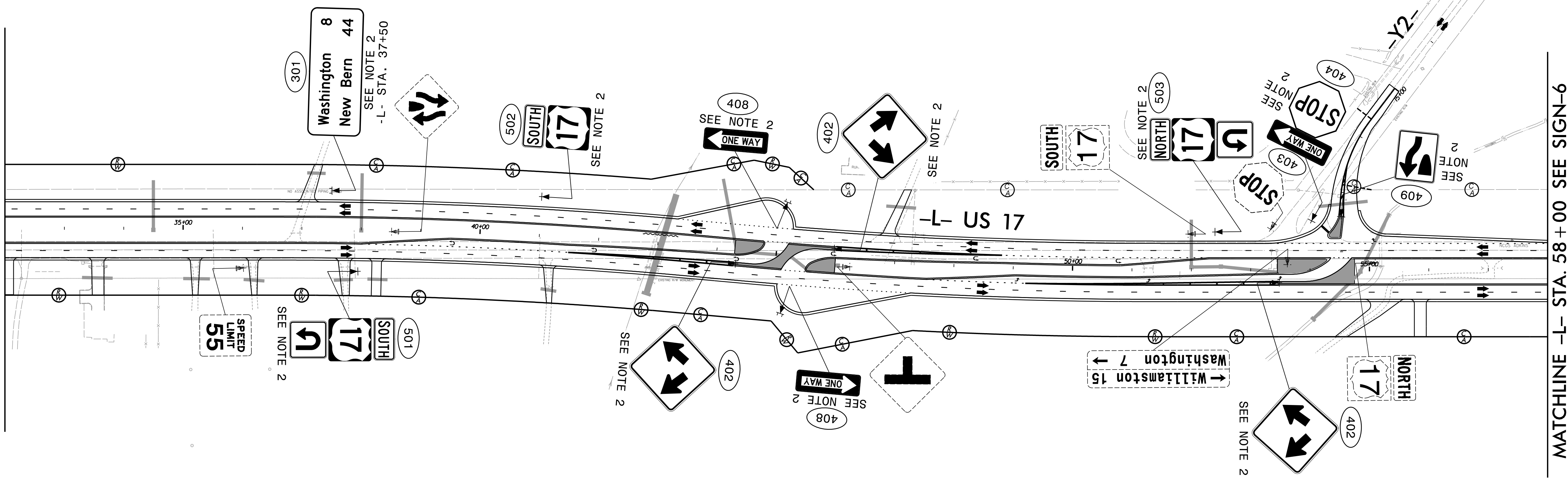

MATCHLINE -L- STA. 58 + 00 SEE SIGN-6

**PROJECT NOTES**

- 1 DISPOSAL OF SUPPORT, WOOD
- 2 SIGN ERECTION, TYPE D, E, AND F
- 3 SIGN ERECTION, RELOCATE SIGN TYPE D
- 4 SIGN ERECTION, RELOCATE SIGN TYPE E

**EXISTING AND PROPOSED SIGNS**

NAD 83/NSRS 2007

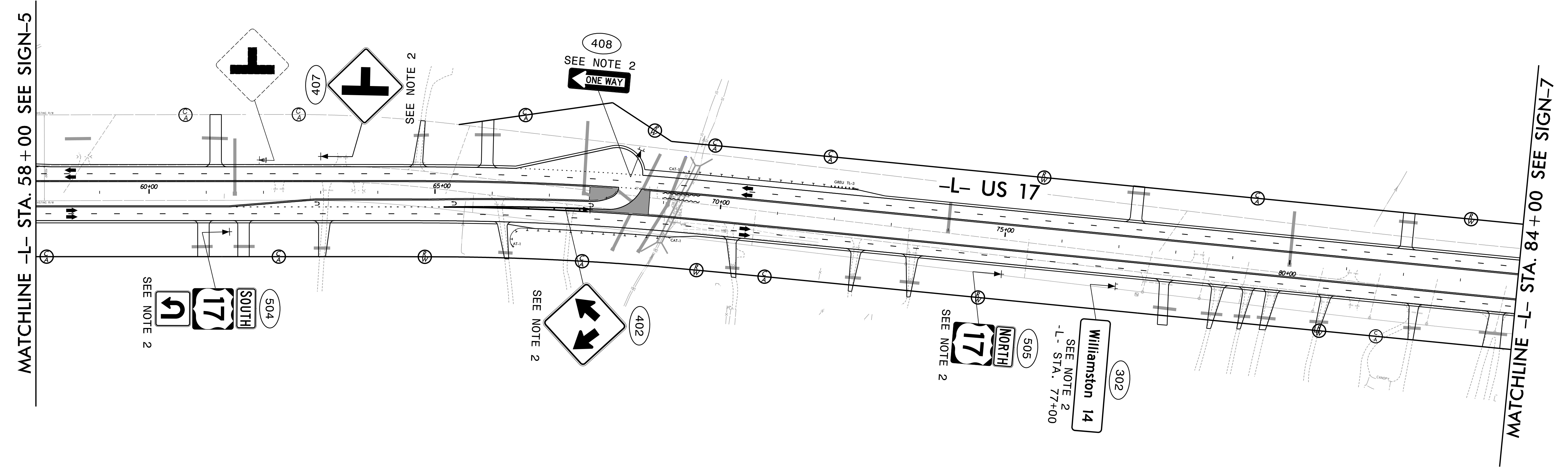

**PROJECT NOTES**

- 1 DISPOSAL OF SUPPORT, WOOD
- 2 SIGN ERECTION, TYPE D, E, AND F
- 3 SIGN ERECTION, RELOCATE SIGN TYPE D
- 4 SIGN ERECTION, RELOCATE SIGN TYPE E

**EXISTING AND PROPOSED SIGNS**

09/13/21 3:56N\_psh06.dgn



NAD 83/NSRS 2007

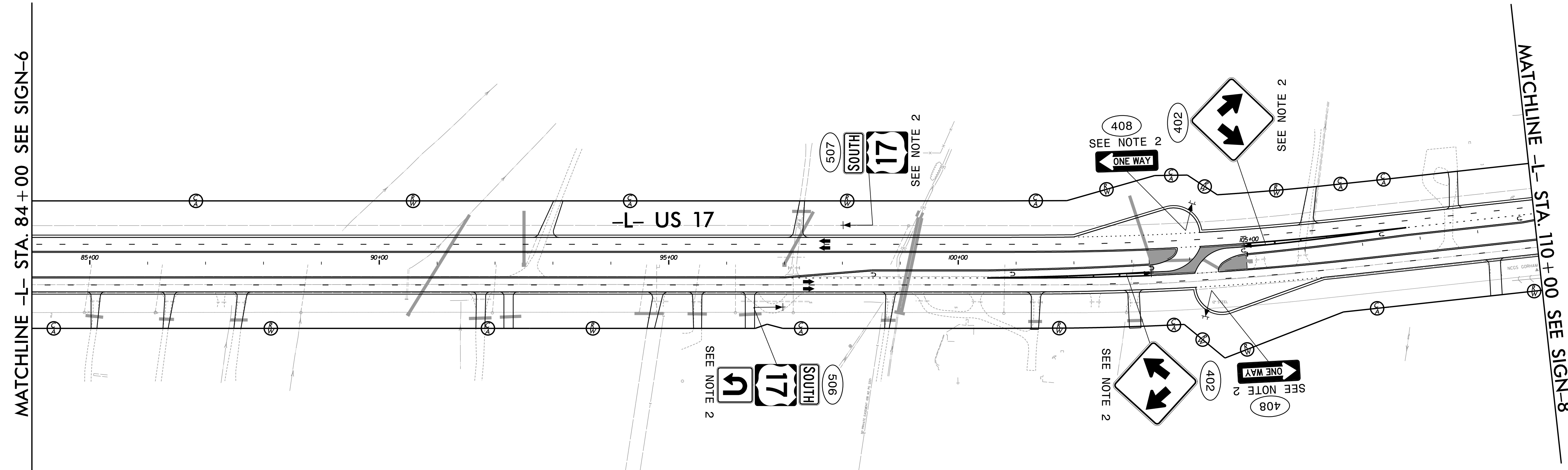

**PROJECT NOTES**

- 1 DISPOSAL OF SUPPORT, WOOD
- 2 SIGN ERECTION, TYPE D, E, AND F
- 3 SIGN ERECTION, RELOCATE SIGN TYPE D
- 4 SIGN ERECTION, RELOCATE SIGN TYPE E

**PROPOSED SIGNS**

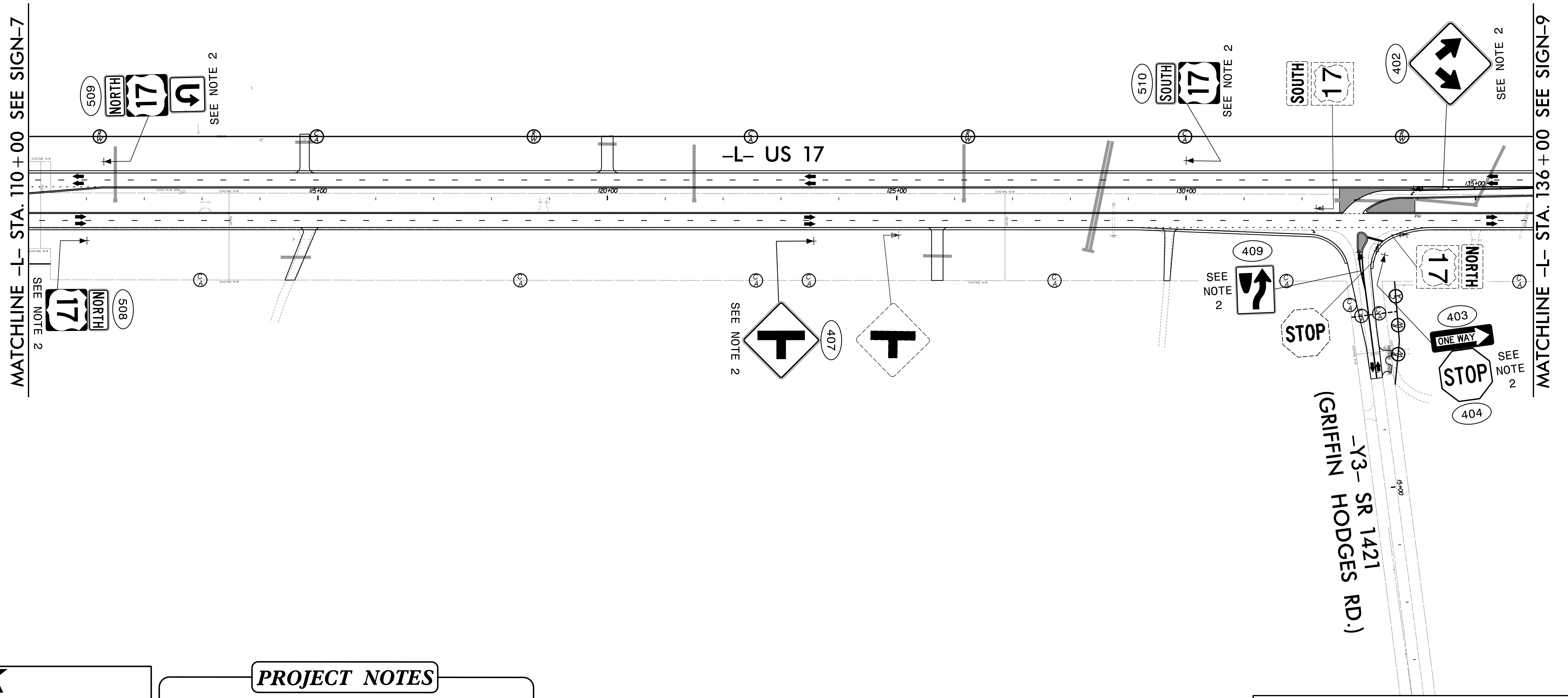
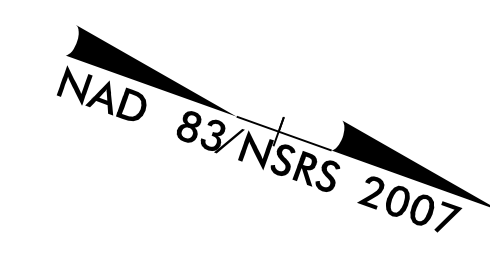

**PROJECT NOTES**

- 1 DISPOSAL OF SUPPORT, WOOD
- 2 SIGN ERECTION, TYPE D, E, AND F
- 3 SIGN ERECTION, RELOCATE SIGN TYPE D
- 4 SIGN ERECTION, RELOCATE SIGN TYPE E

**EXISTING AND PROPOSED SIGNS**

09/13/21 3:56N ipsh08.dgn



MATCHLINE -L- STA. 136+00 SEE SIGN-8

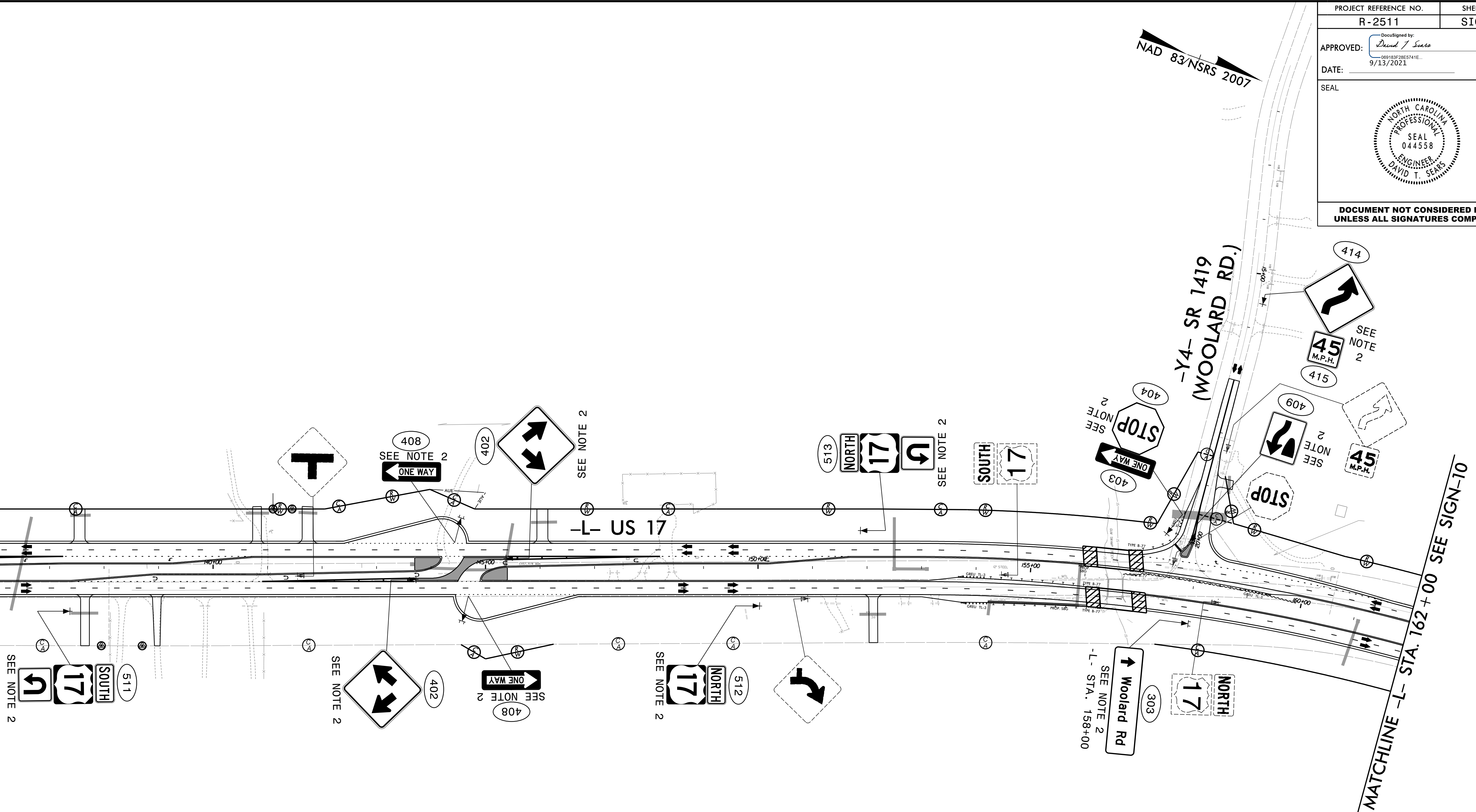

**PROJECT NOTES**

- 1 DISPOSAL OF SUPPORT, WOOD
- 2 SIGN ERECTION, TYPE D, E, AND F
- 3 SIGN ERECTION, RELOCATE SIGN TYPE D
- 4 SIGN ERECTION, RELOCATE SIGN TYPE E

EXISTING AND PROPOSED SIGNS

NAD 83/NSRS 2007

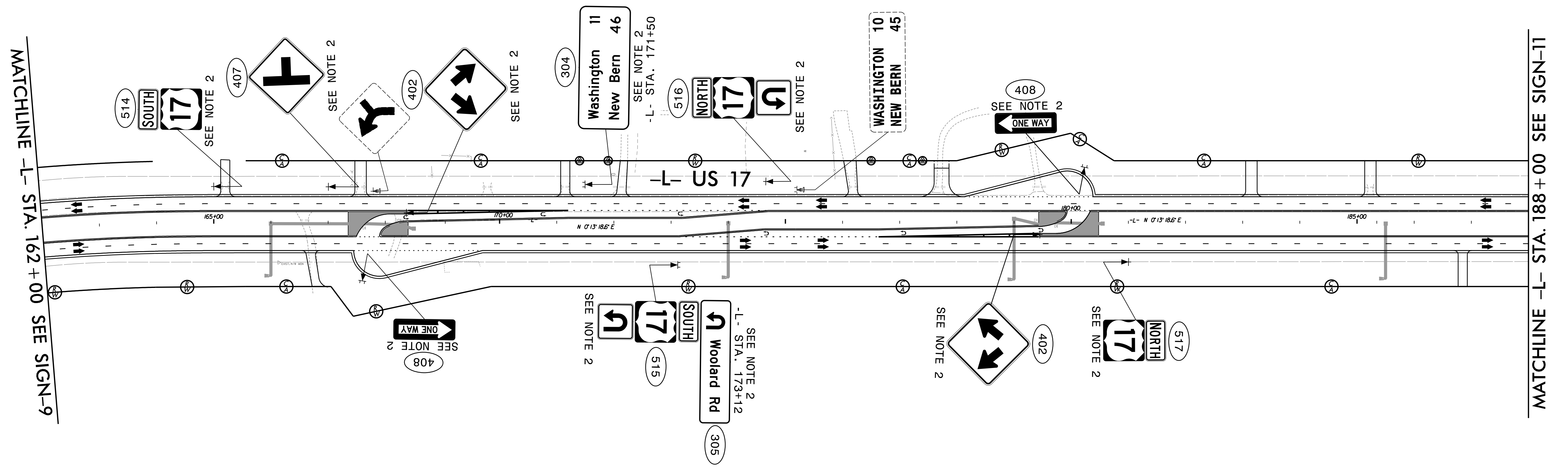

**PROJECT NOTES**

- 1 DISPOSAL OF SUPPORT, WOOD
- 2 SIGN ERECTION, TYPE D, E, AND F
- 3 SIGN ERECTION, RELOCATE SIGN TYPE D
- 4 SIGN ERECTION, RELOCATE SIGN TYPE E

EXISTING AND PROPOSED SIGNS



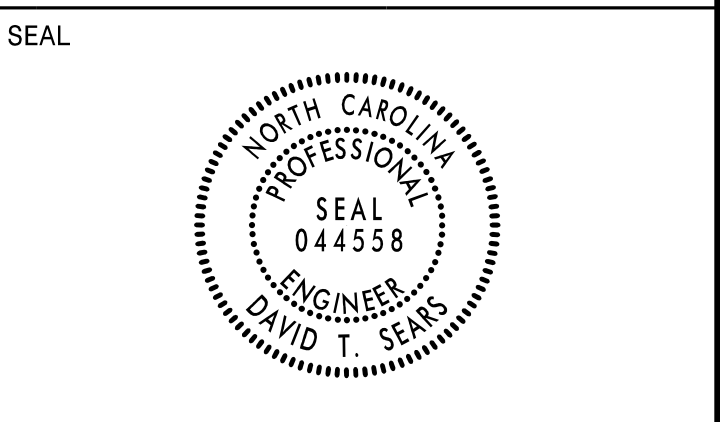

**DOCUMENT NOT CONSIDERED FINAL  
 UNLESS ALL SIGNATURES COMPLETED**

NAD 83/NSRS 2007

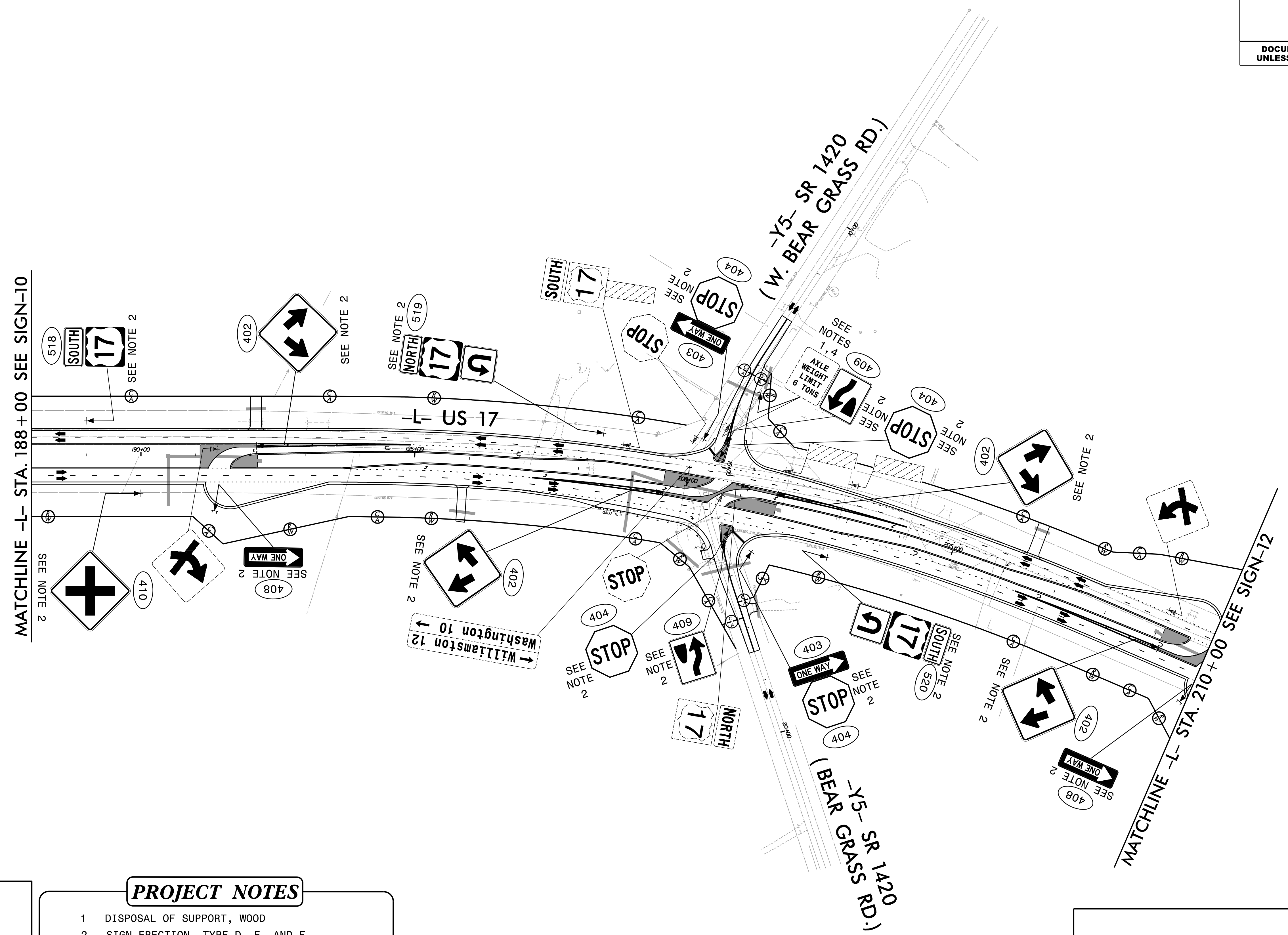

**PROJECT NOTES**

- 1 DISPOSAL OF SUPPORT, WOOD
- 2 SIGN ERECTION, TYPE D, E, AND F
- 3 SIGN ERECTION, RELOCATE SIGN TYPE D
- 4 SIGN ERECTION, RELOCATE SIGN TYPE E

**EXISTING AND PROPOSED SIGNS**

09/13/21 3:56 PM ipsh011.dgn

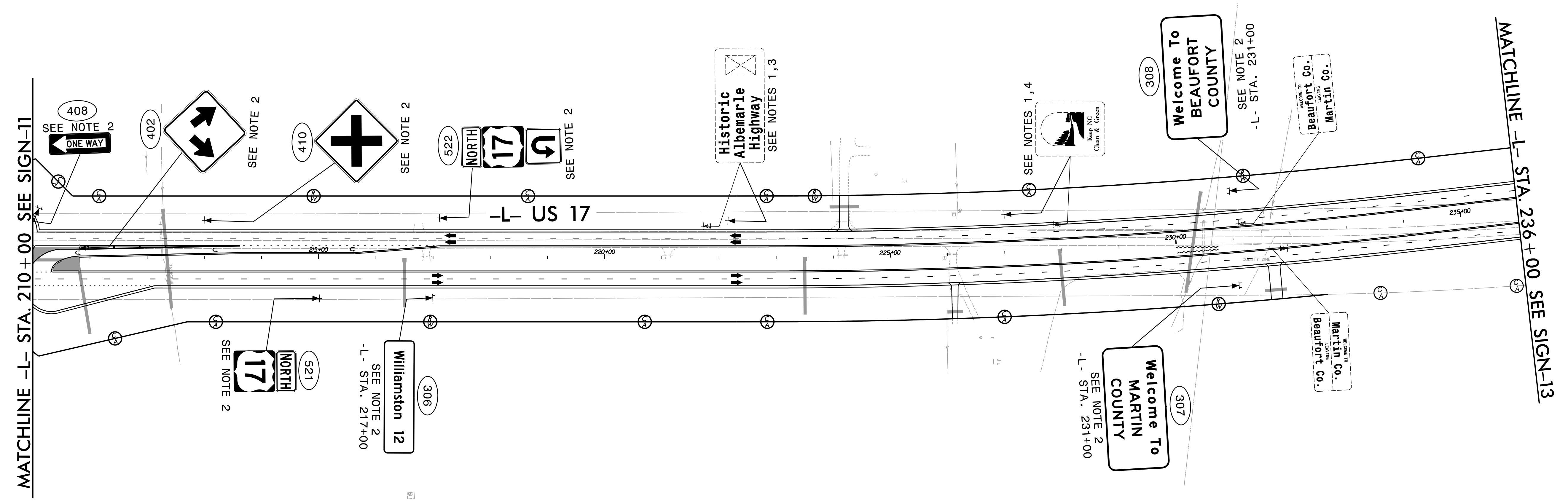
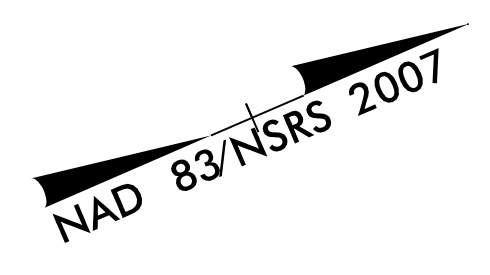

**PROJECT NOTES**

- 1 DISPOSAL OF SUPPORT, WOOD
- 2 SIGN ERECTION, TYPE D, E, AND F
- 3 SIGN ERECTION, RELOCATE SIGN TYPE D
- 4 SIGN ERECTION, RELOCATE SIGN TYPE E

**EXISTING AND PROPOSED SIGNS**



NAD 83/NSRS 2007

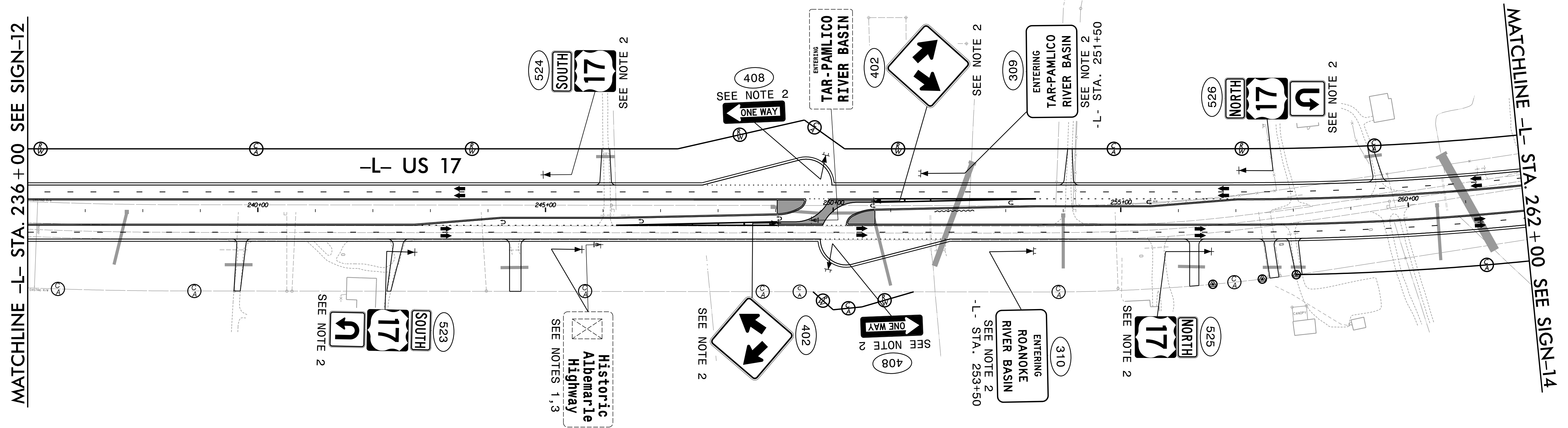

**PROJECT NOTES**

- 1 DISPOSAL OF SUPPORT, WOOD
- 2 SIGN ERECTION, TYPE D, E, AND F
- 3 SIGN ERECTION, RELOCATE SIGN TYPE D
- 4 SIGN ERECTION, RELOCATE SIGN TYPE E

EXISTING AND PROPOSED SIGNS

NAD 83/NSRS 2007

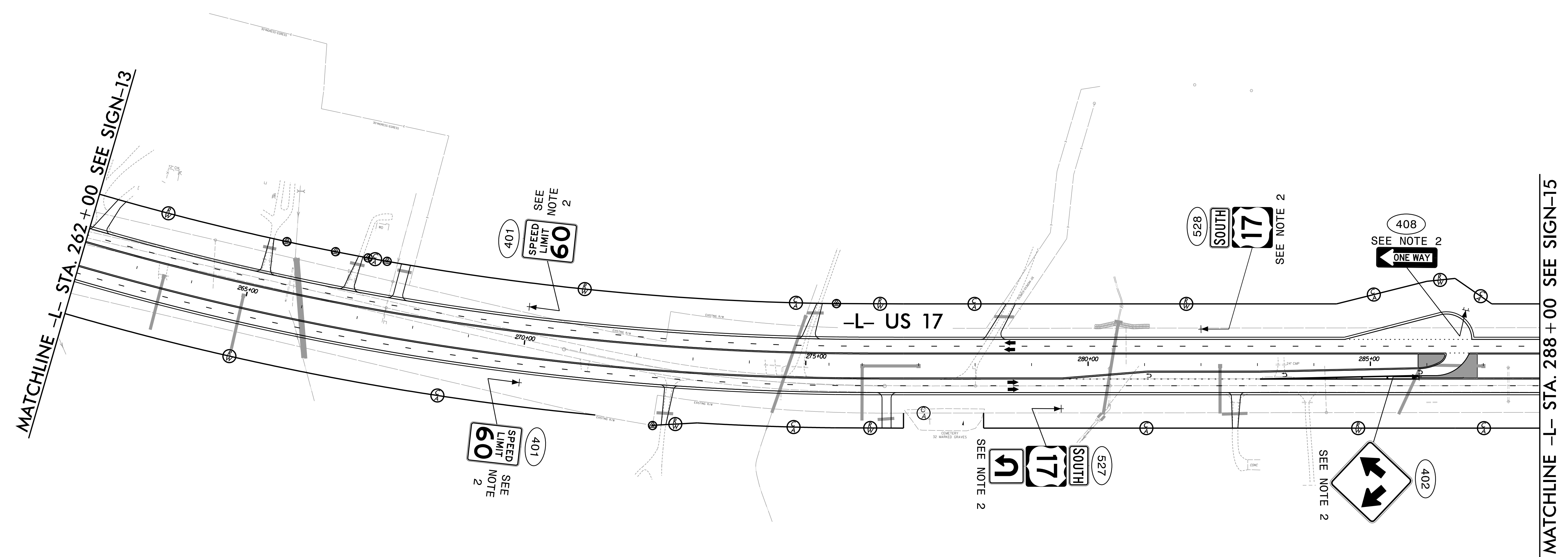

**PROJECT NOTES**

- 1 DISPOSAL OF SUPPORT, WOOD
- 2 SIGN ERECTION, TYPE D, E, AND F
- 3 SIGN ERECTION, RELOCATE SIGN TYPE D
- 4 SIGN ERECTION, RELOCATE SIGN TYPE E

**PROPOSED SIGNS**



NAD 83/NSRS 2007

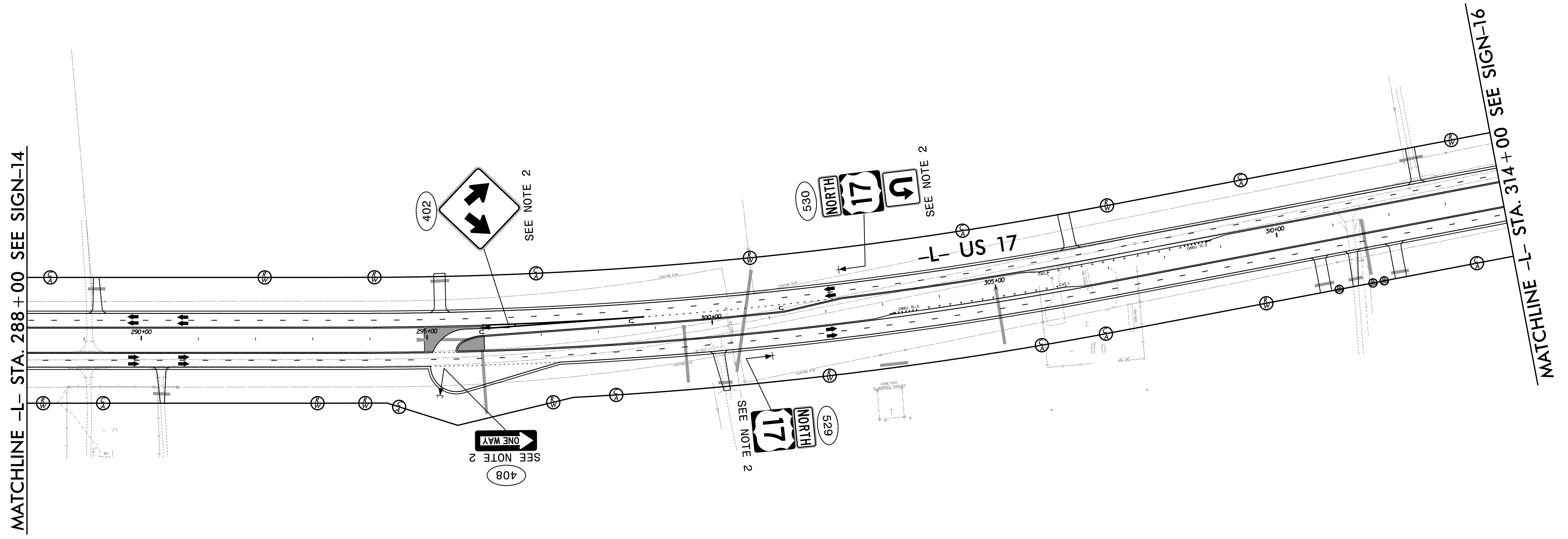

**PROJECT NOTES**

- 1 DISPOSAL OF SUPPORT, WOOD
- 2 SIGN ERECTION, TYPE D, E, AND F
- 3 SIGN ERECTION, RELOCATE SIGN TYPE D
- 4 SIGN ERECTION, RELOCATE SIGN TYPE E

PROPOSED SIGNS

PROJECT REFERENCE NO. R-2511	SHEET NO. SIGN-16
APPROVED: <i>David T. Sears</i> 069183F28E6741E 9/13/2021	
DATE: 9/13/2021	
SEAL	
	
DOCUMENT NOT CONSIDERED FINAL UNLESS ALL SIGNATURES COMPLETED	

NAD 83/NSRS 2007

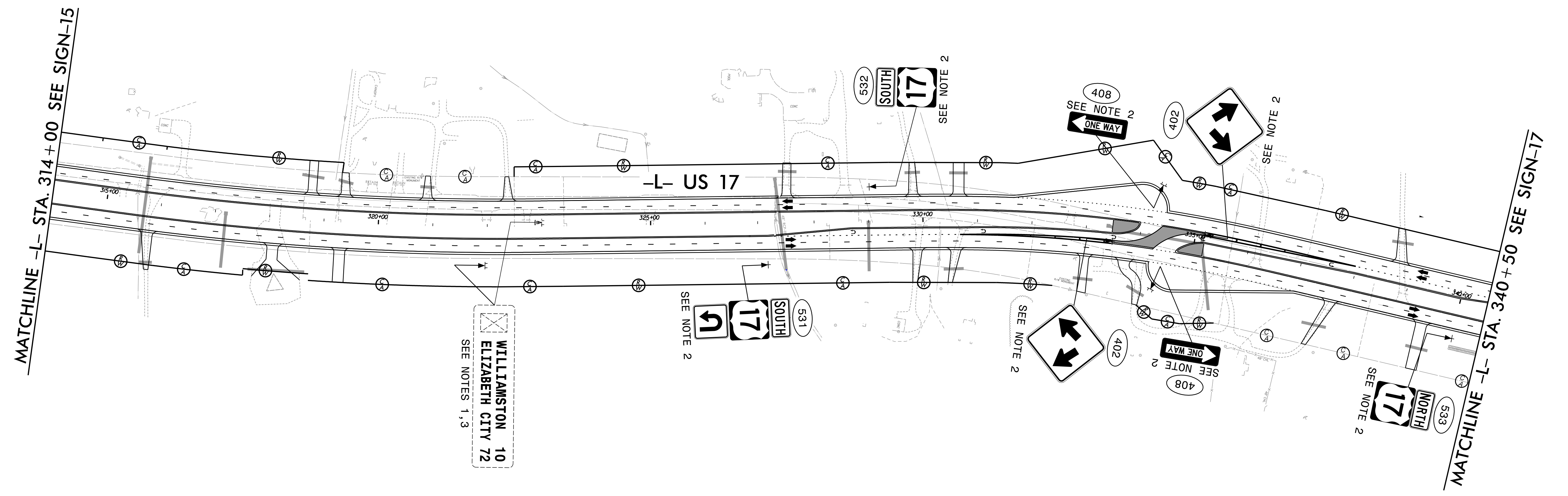

**PROJECT NOTES**

- 1 DISPOSAL OF SUPPORT, WOOD
- 2 SIGN ERECTION, TYPE D, E, AND F
- 3 SIGN ERECTION, RELOCATE SIGN TYPE D
- 4 SIGN ERECTION, RELOCATE SIGN TYPE E

EXISTING AND PROPOSED SIGNS

**RK&K**  
P: (919) 878-9560  
8601 Six Forks Road, Forum 1, Suite 700  
Raleigh, North Carolina 27615-3960  
NC License No. F-0112  
Engineers | Construction Managers | Planners | Scientists  
www.rkk.com  
Responsive People | Creative Solutions

09/13/2021 3:56 PM ipsh016.dgn



PROJECT REFERENCE NO. R-2511	SHEET NO. SIGN-17
APPROVED: <i>David T. Sears</i> -0691837282741E- 9/13/2021	
DATE: 9/13/2021	
SEAL	
	
DOCUMENT NOT CONSIDERED FINAL UNLESS ALL SIGNATURES COMPLETED	

NAD 83/NSRS 2007

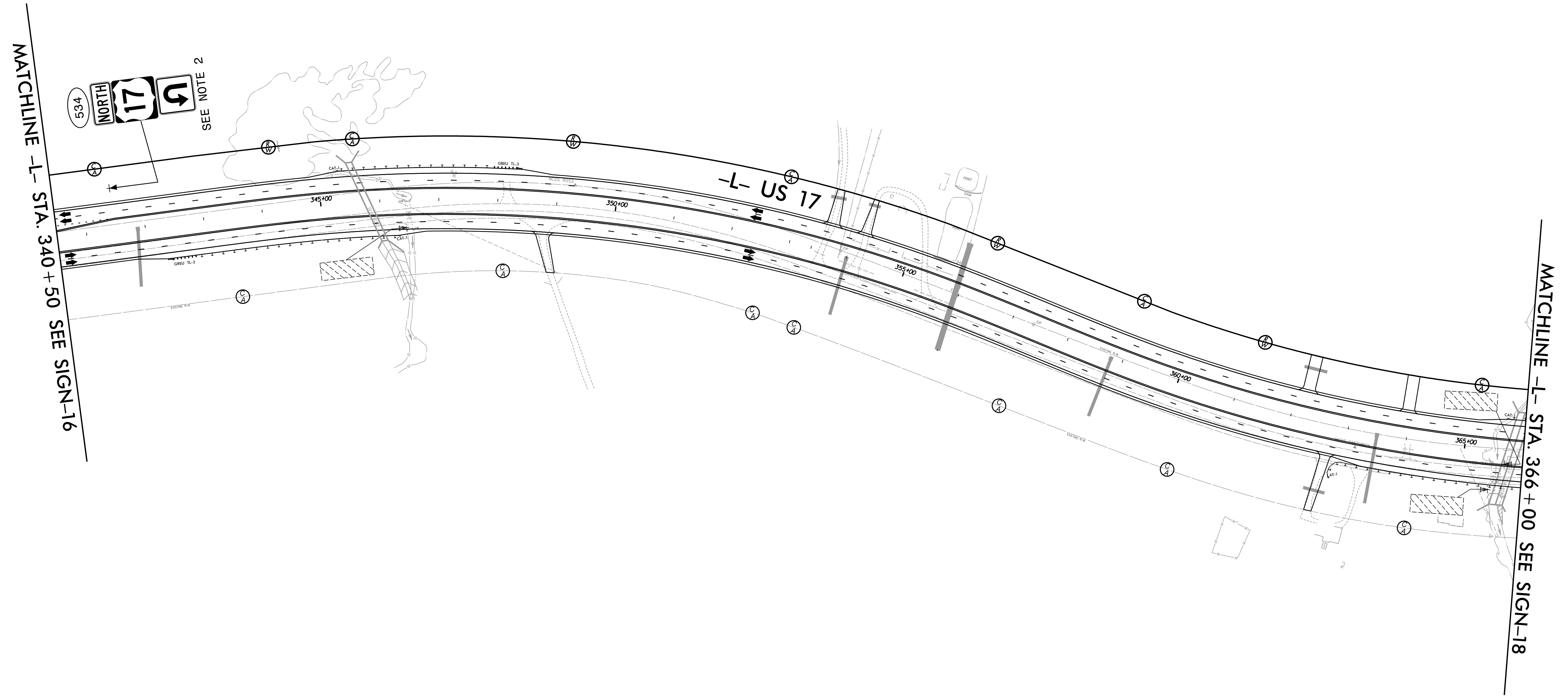

**PROJECT NOTES**

- 1 DISPOSAL OF SUPPORT, WOOD
- 2 SIGN ERECTION, TYPE D, E, AND F
- 3 SIGN ERECTION, RELOCATE SIGN TYPE D
- 4 SIGN ERECTION, RELOCATE SIGN TYPE E

EXISTING AND PROPOSED SIGNS

**RK&K**  
P: (919) 878-9560  
8601 Six Forks Road, Forum 1, Suite 700  
Raleigh, North Carolina 27615-3960  
NC License No. F-0112  
Engineers | Construction Managers | Planners | Scientists  
www.rkk.com  
Responsive People | Creative Solutions

09/13/21 3:56N ipsh017.dgn

NAD 83/NSRS 2007

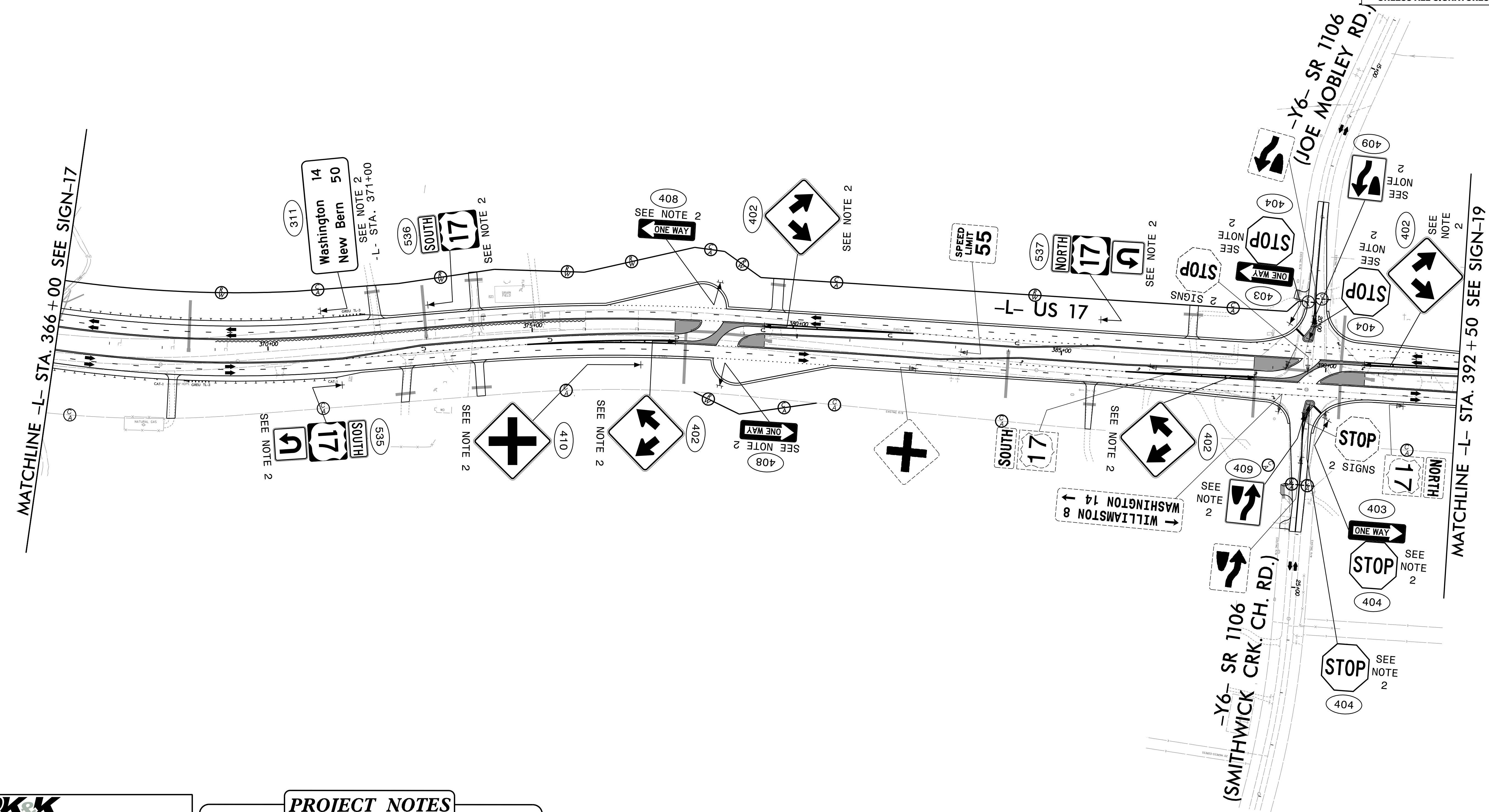

**PROJECT NOTES**

- 1 DISPOSAL OF SUPPORT, WOOD
- 2 SIGN ERECTION, TYPE D, E, AND F
- 3 SIGN ERECTION, RELOCATE SIGN TYPE D
- 4 SIGN ERECTION, RELOCATE SIGN TYPE E

EXISTING AND PROPOSED SIGNS



NAD 83/NSRS 2007

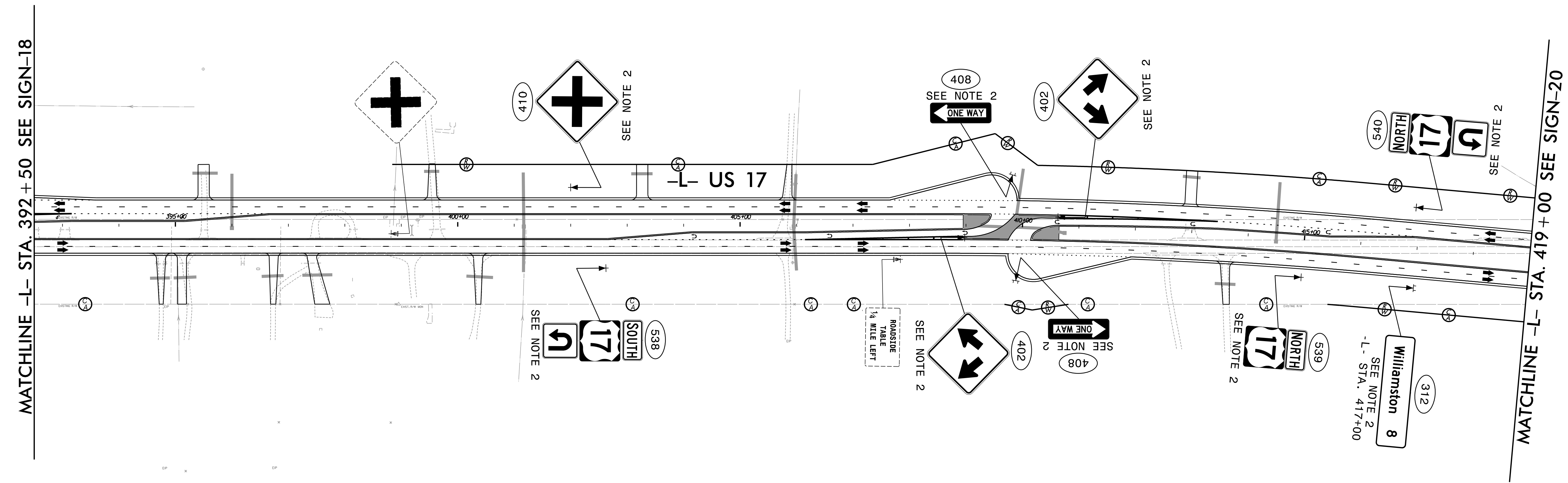

**PROJECT NOTES**

- 1 DISPOSAL OF SUPPORT, WOOD
- 2 SIGN ERECTION, TYPE D, E, AND F
- 3 SIGN ERECTION, RELOCATE SIGN TYPE D
- 4 SIGN ERECTION, RELOCATE SIGN TYPE E

**EXISTING AND PROPOSED SIGNS**

NAD 83/NSRS 2007

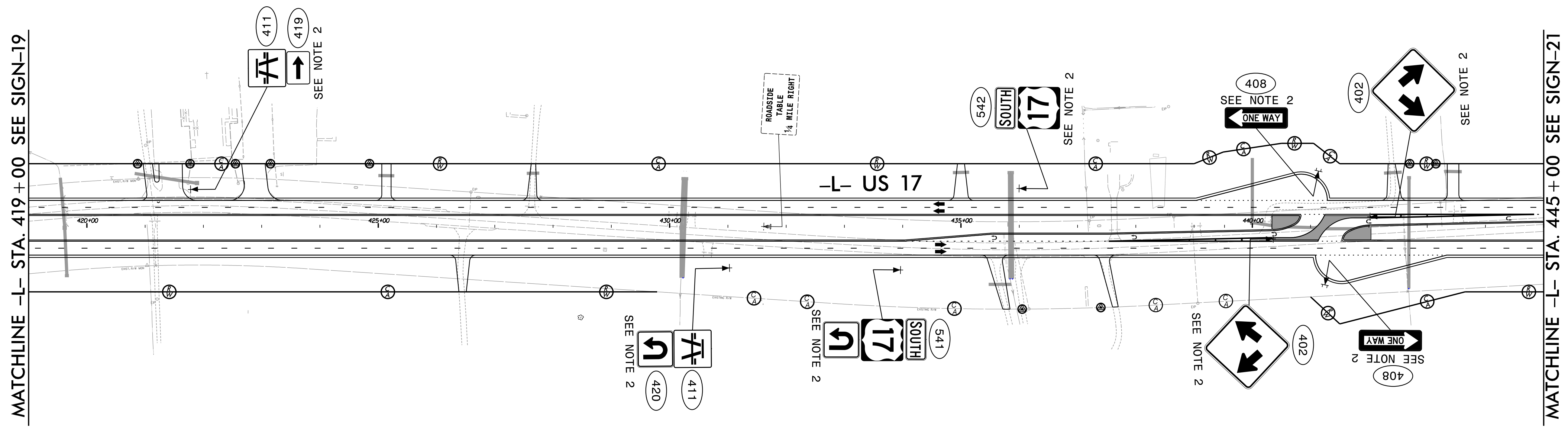

**PROJECT NOTES**

- 1 DISPOSAL OF SUPPORT, WOOD
- 2 SIGN ERECTION, TYPE D, E, AND F
- 3 SIGN ERECTION, RELOCATE SIGN TYPE D
- 4 SIGN ERECTION, RELOCATE SIGN TYPE E

**EXISTING AND PROPOSED SIGNS**



PROJECT REFERENCE NO. R-2511	SHEET NO. SIGN-21
APPROVED: <i>David T. Sears</i> 0691837282741E 9/13/2021	
DATE: 9/13/2021	
SEAL	
	
DOCUMENT NOT CONSIDERED FINAL UNLESS ALL SIGNATURES COMPLETED	

NAD 83/NSRS 2007

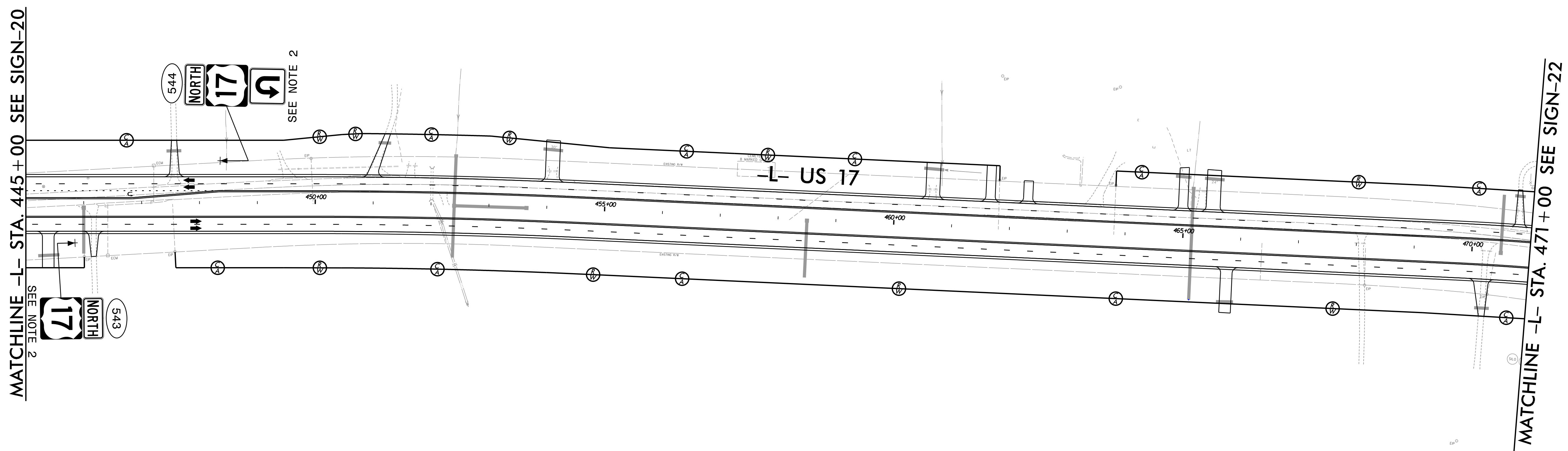

**PROJECT NOTES**

- 1 DISPOSAL OF SUPPORT, WOOD
- 2 SIGN ERECTION, TYPE D, E, AND F
- 3 SIGN ERECTION, RELOCATE SIGN TYPE D
- 4 SIGN ERECTION, RELOCATE SIGN TYPE E

PROPOSED SIGNS

**RK&K**  
 P: (919) 878-9560  
 8601 Six Forks Road, Forum 1, Suite 700  
 Raleigh, North Carolina 27615-3960  
 NC License No. F-0112  
 Engineers | Construction Managers | Planners | Scientists  
 www.rkk.com  
 Responsive People | Creative Solutions

09/13/21 3:56 PM ipsh021.dgn

NAD 83/NSRS 2007

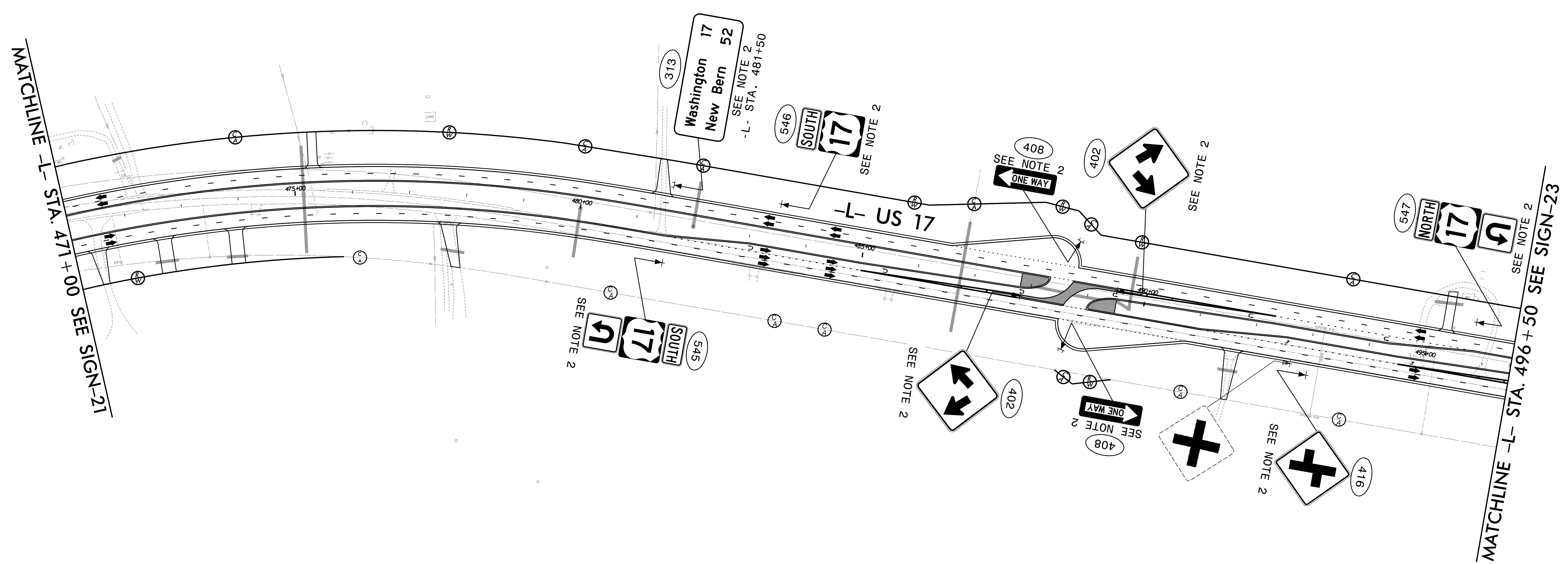

**PROJECT NOTES**

- 1 DISPOSAL OF SUPPORT, WOOD
- 2 SIGN ERECTION, TYPE D, E, AND F
- 3 SIGN ERECTION, RELOCATE SIGN TYPE D
- 4 SIGN ERECTION, RELOCATE SIGN TYPE E

EXISTING AND PROPOSED SIGNS



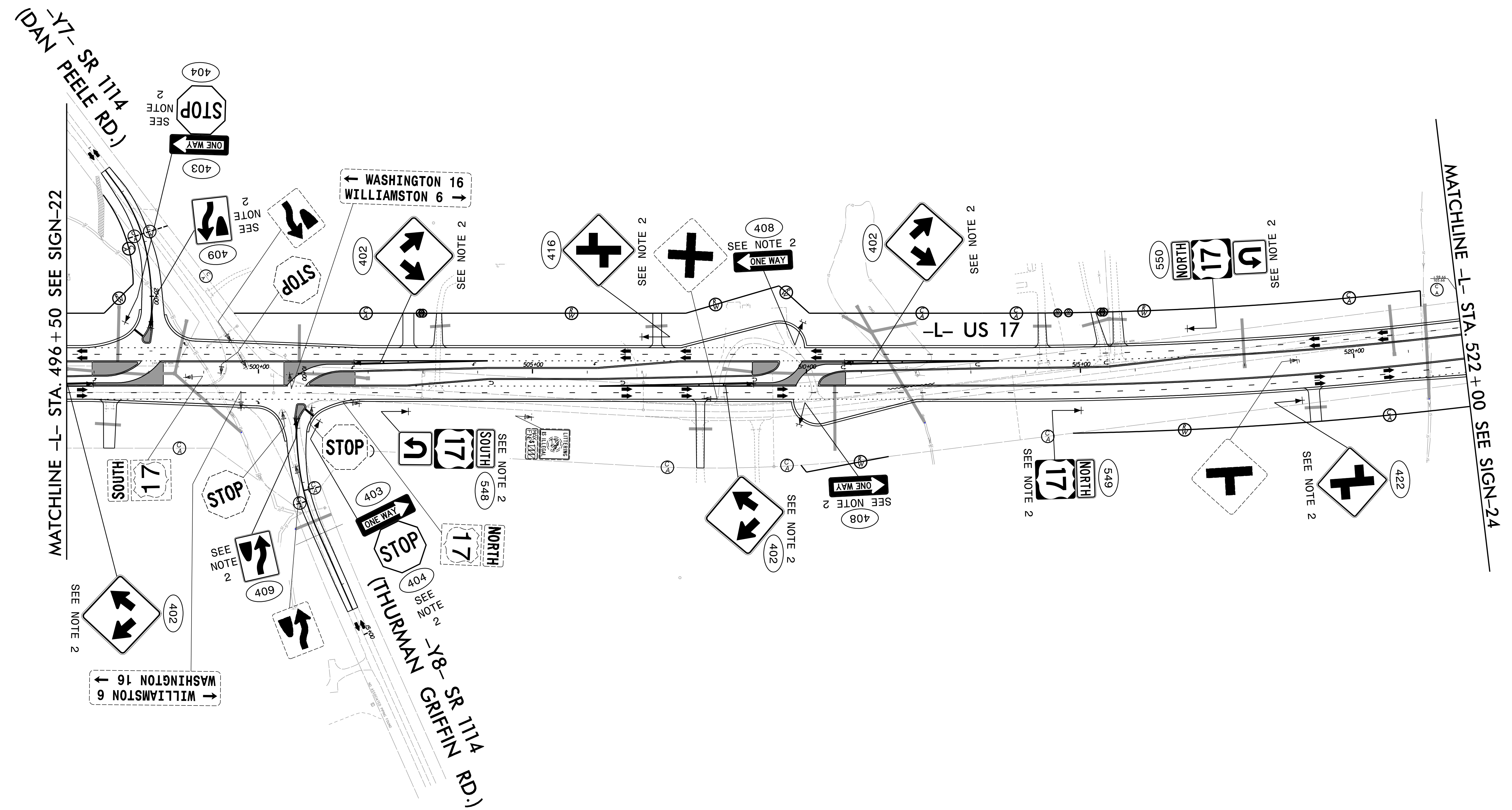
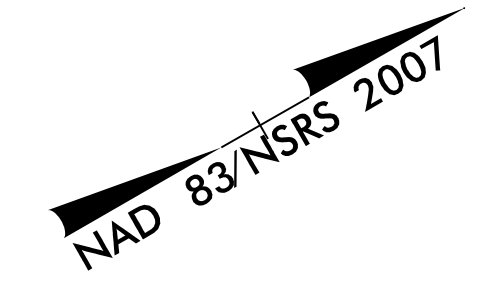

**PROJECT NOTES**

- 1 DISPOSAL OF SUPPORT, WOOD
- 2 SIGN ERECTION, TYPE D, E, AND F
- 3 SIGN ERECTION, RELOCATE SIGN TYPE D
- 4 SIGN ERECTION, RELOCATE SIGN TYPE E

EXISTING AND PROPOSED SIGNS

09/13/21 3:56 PM ipsh023.dgn



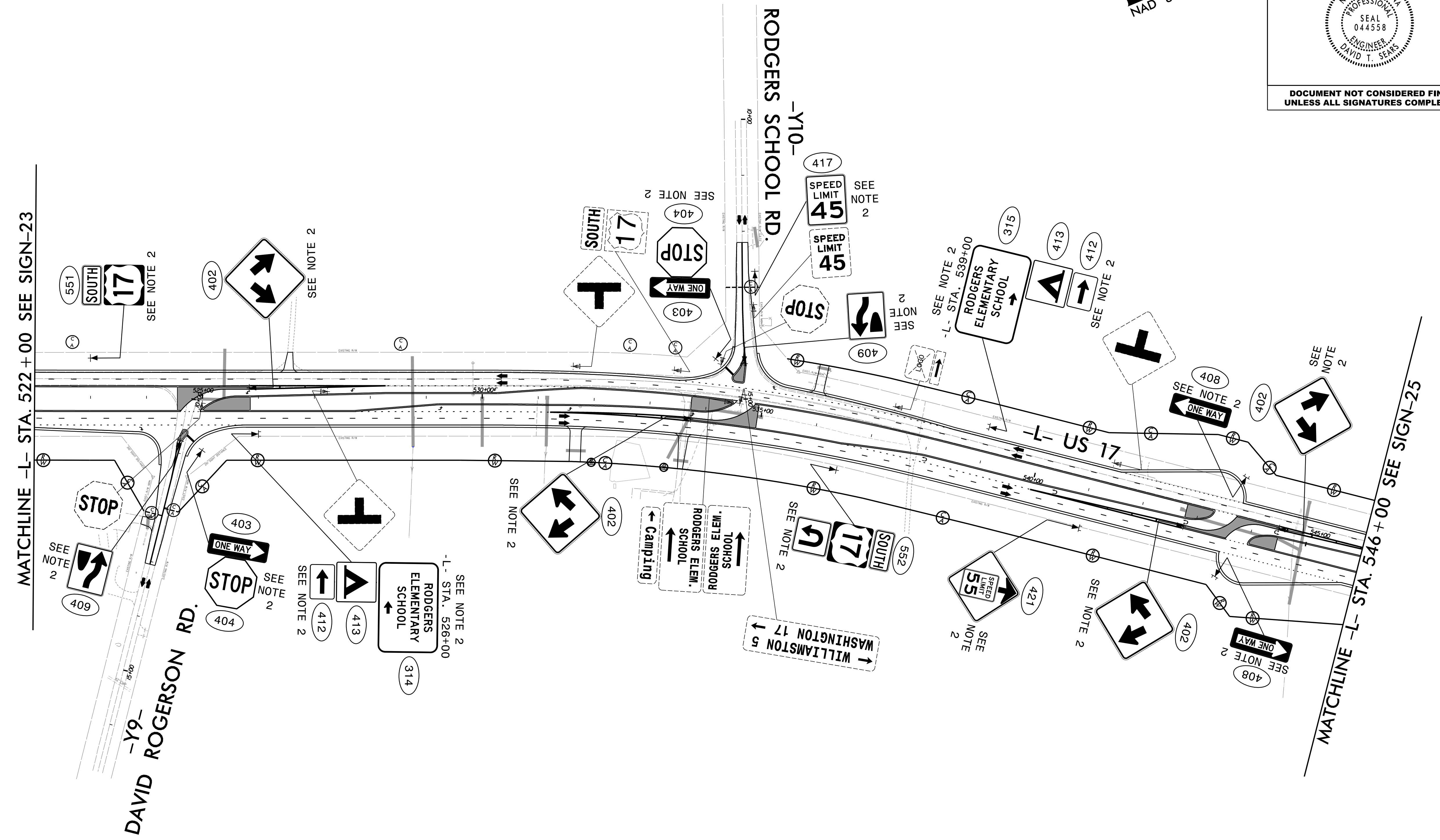
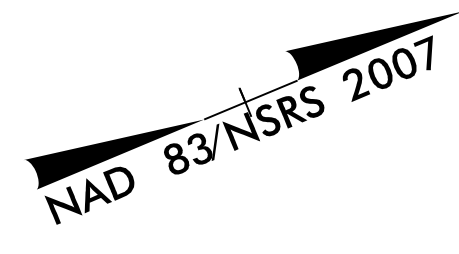

**PROJECT NOTES**

- 1 DISPOSAL OF SUPPORT, WOOD
- 2 SIGN ERECTION, TYPE D, E, AND F
- 3 SIGN ERECTION, RELOCATE SIGN TYPE D
- 4 SIGN ERECTION, RELOCATE SIGN TYPE E

**EXISTING AND PROPOSED SIGNS**

09/13/21 3:01 PM ipsh024.dgn  
 E:\Projects\2021\09\13\01\ipsh024.dgn



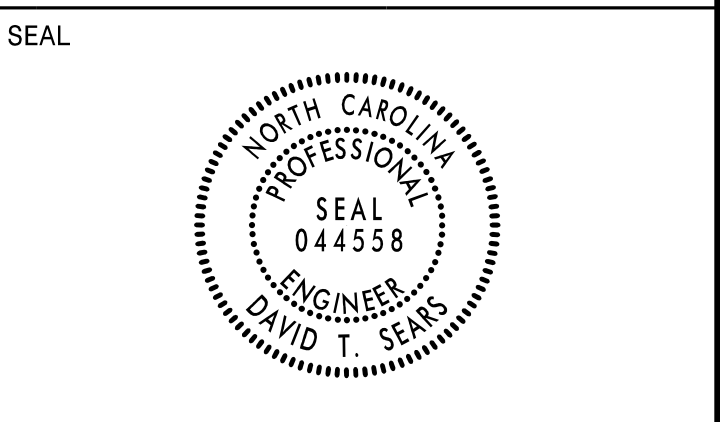

**DOCUMENT NOT CONSIDERED FINAL  
UNLESS ALL SIGNATURES COMPLETED**

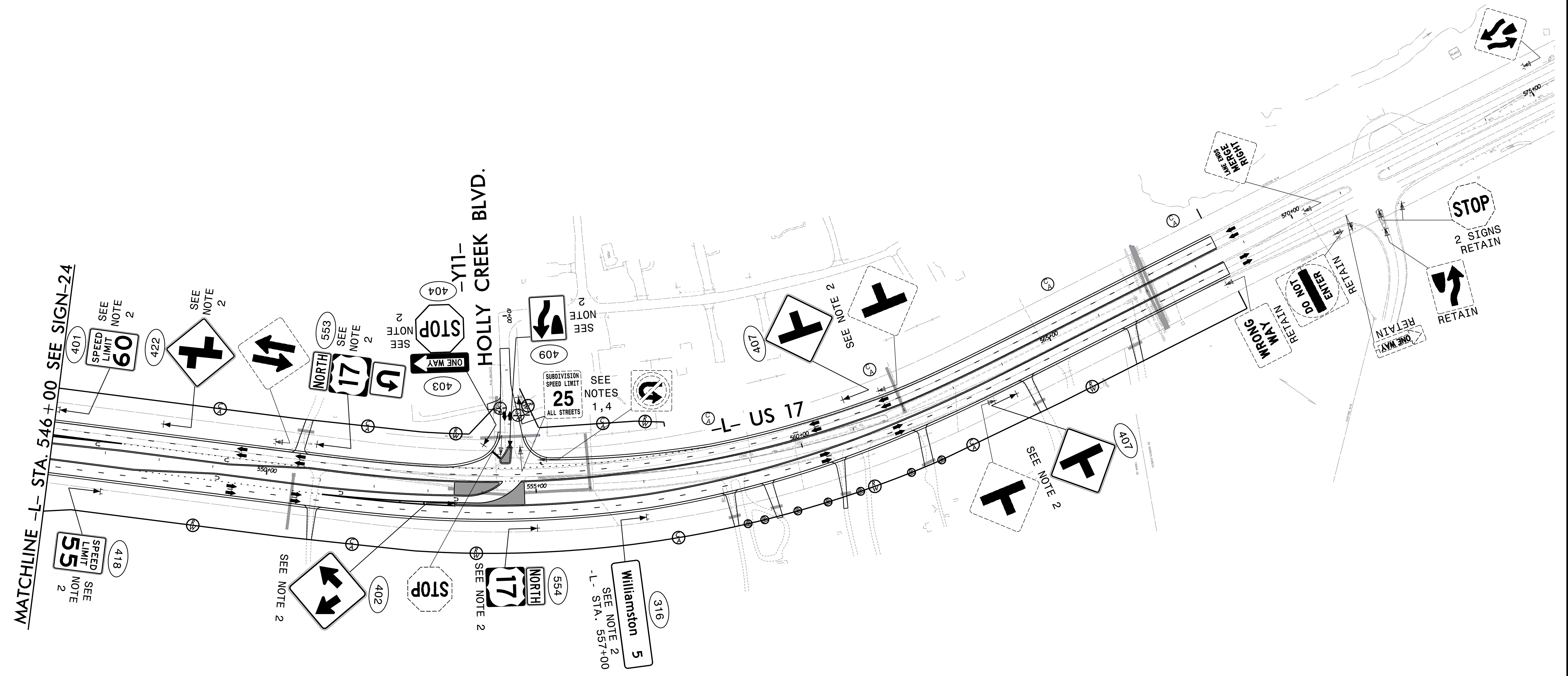
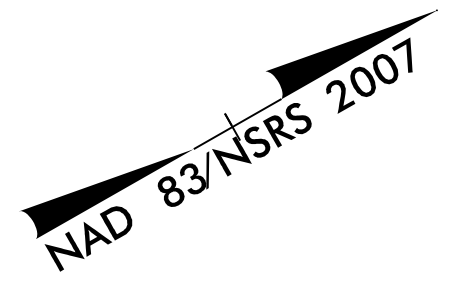

**PROJECT NOTES**

- 1 DISPOSAL OF SUPPORT, WOOD
- 2 SIGN ERECTION, TYPE D, E, AND F
- 3 SIGN ERECTION, RELOCATE SIGN TYPE D
- 4 SIGN ERECTION, RELOCATE SIGN TYPE E

**EXISTING AND PROPOSED SIGNS**

**RK&K**  
 P: (919) 878-9560  
 8601 Six Forks Road, Forum 1, Suite 700  
 Raleigh, North Carolina 27615-3960  
 NC License No. F-0112

Engineers | Construction Managers | Planners | Scientists  
 www.rkk.com

Responsive People | Creative Solutions

09/13/21 3:56 PM ipsh025.dgn