

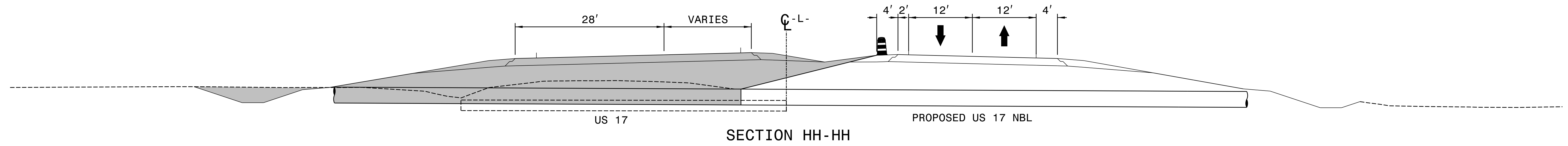



PROJ. REFERENCE NO.	SHEET NO.
R-2511	TMP-23A

RKK
 P: (919) 878-8560
 8601 Six Forks Road, Forum 1, Suite 700
 Raleigh, North Carolina 27615-3960
 NC License No. F-0112
 Engineers | Construction Managers | Planners | Scientists
 www.rkk.com
 Responsive People | Creative Solutions

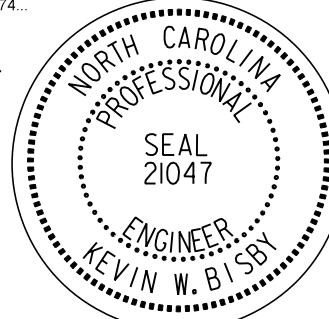

10/1/2021
 R2511_TMP_PSH23A.dgn
 KWS/bl

APPROVED:  DATE: 10/1/2021 SEAL			<p>PHASE I DETAIL DRAWING</p>
<p>DOCUMENT NOT CONSIDERED FINAL UNLESS ALL SIGNATURES COMPLETED</p>			

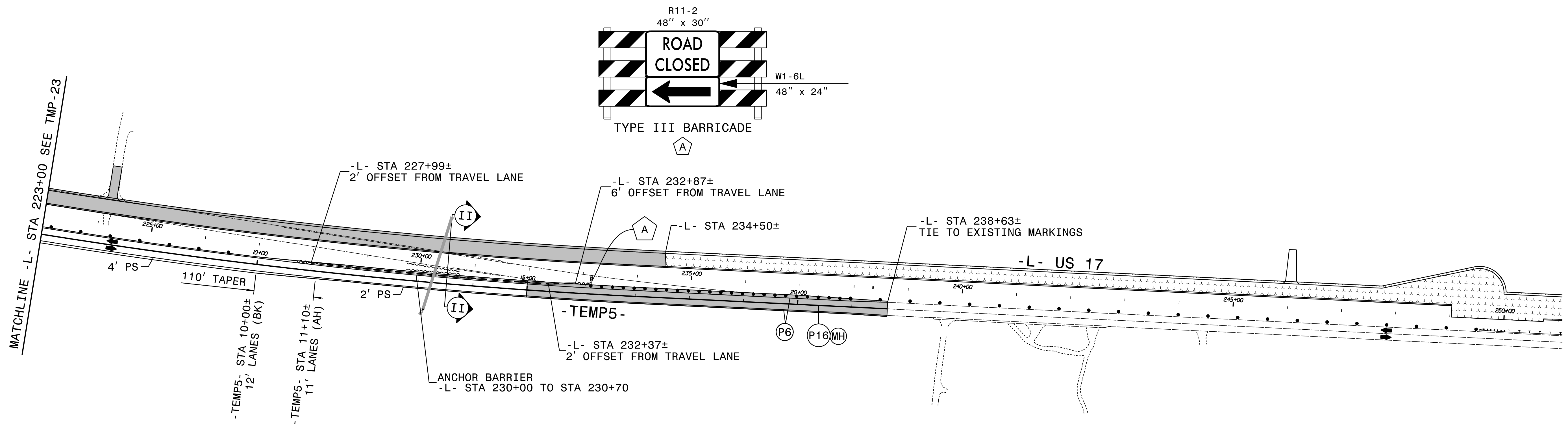
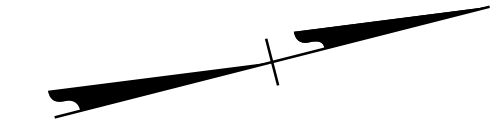

10/1/2021
 R2511-TMP-PSH24.dgn
 ksb

SEE TMP-24A FOR SECTION VIEW.

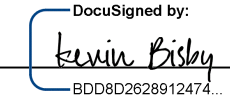
APPROVED: 
 DATE: 10/1/2021

SEAL

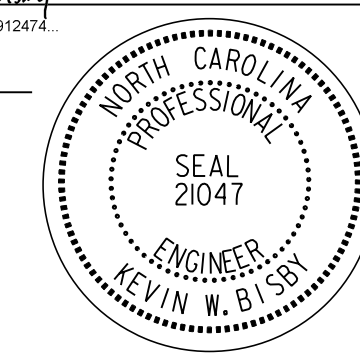
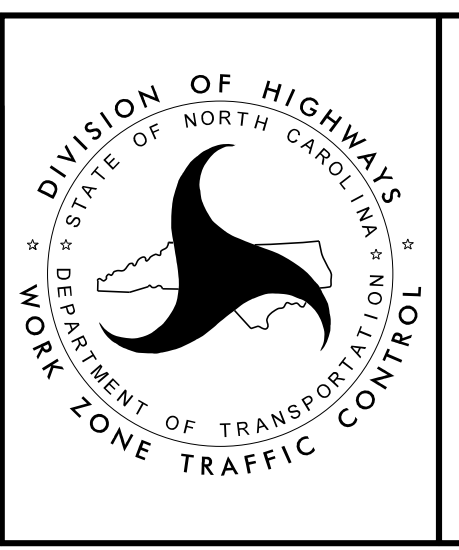
PHASE I
 DETAIL DRAWING

DOCUMENT NOT CONSIDERED FINAL
 UNLESS ALL SIGNATURES COMPLETED

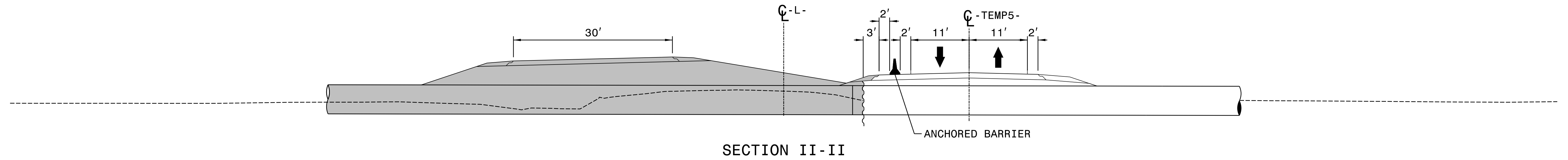

SECTION II-II

APPROVED: *Kevin Bisby*
DocuSigned by: Kevin Bisby BDD8028298912474

DATE: 10/1/2021

SEAL

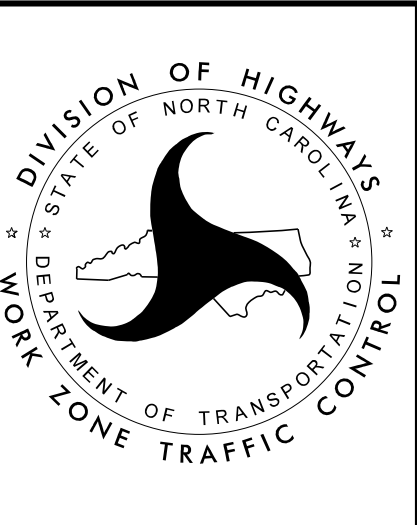

PHASE I
 DETAIL DRAWING

DOCUMENT NOT CONSIDERED FINAL
 UNLESS ALL SIGNATURES COMPLETED

PROJ. REFERENCE NO.	SHEET NO.
R-2511	TMP-25

RKK
 P: (919) 878-8560
 8601 Six Forks Road, Forum 1, Suite 700
 Raleigh, North Carolina 27615-3960
 NC License No. F-0112
 Engineers | Construction Managers | Planners | Scientists
 www.rkk.com
 Responsive People | Creative Solutions

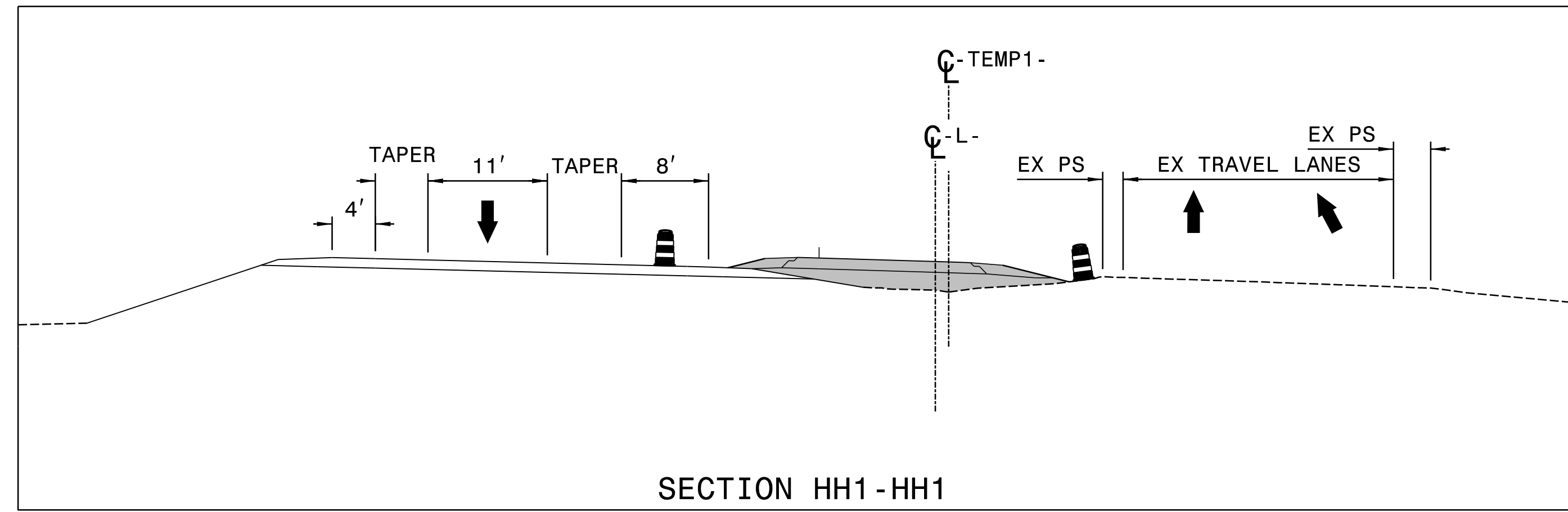
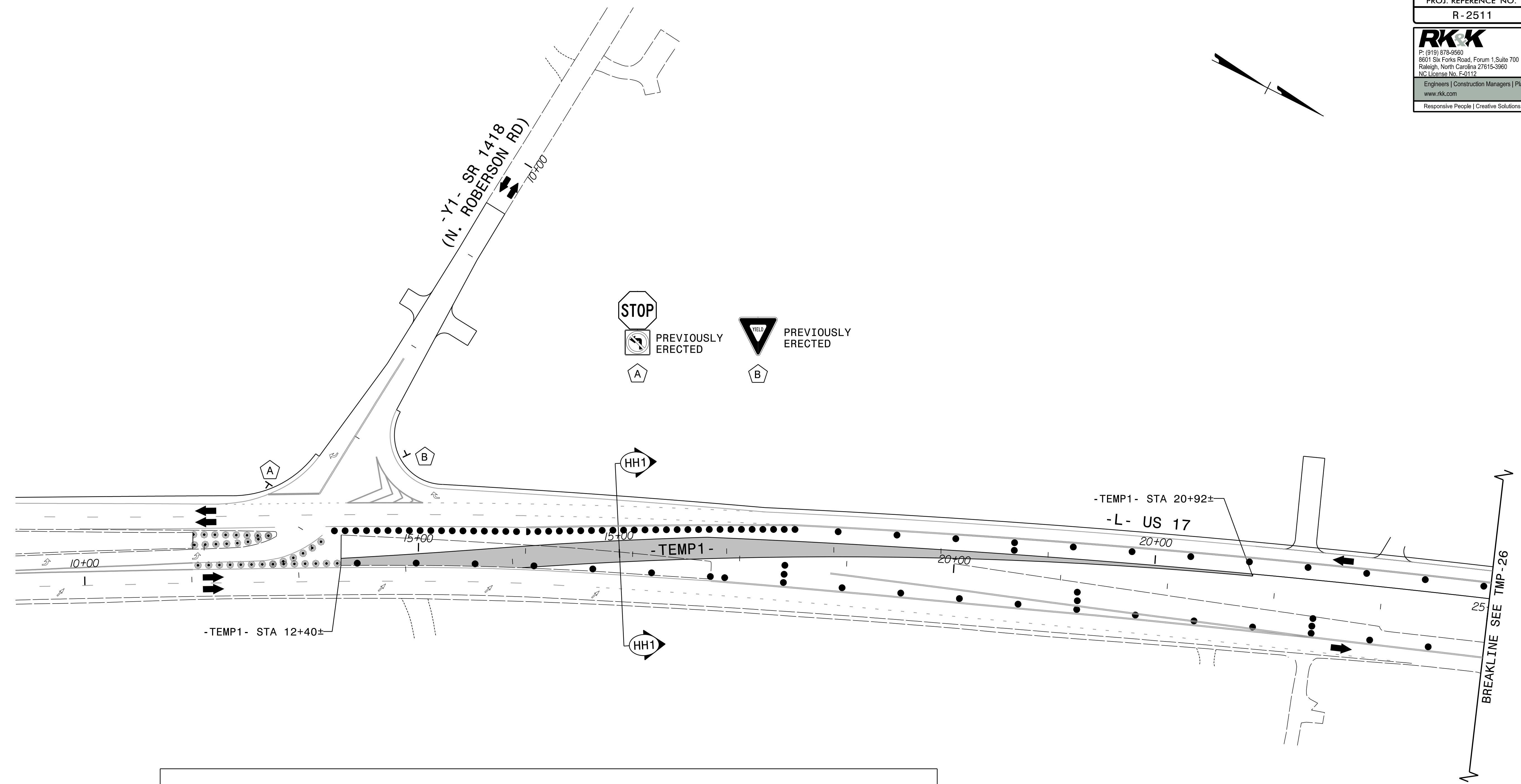

SECTION HH1-HH1

APPROVED: *Kevin Bisby*
 DATE: 10/1/2021
 SEAL
 NORTH CAROLINA PROFESSIONAL SEAL 21047
 ENGINEER KEVIN W. BISBY

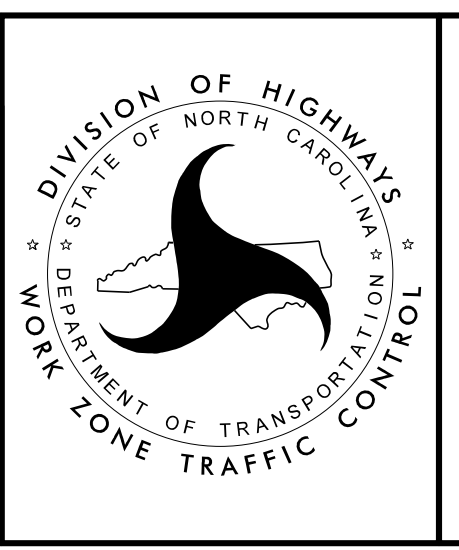

PHASE I
 DETAIL DRAWING

DOCUMENT NOT CONSIDERED FINAL
 UNLESS ALL SIGNATURES COMPLETED

10/1/2021 R2511-TMP-PSH25.dgn kws/bbl

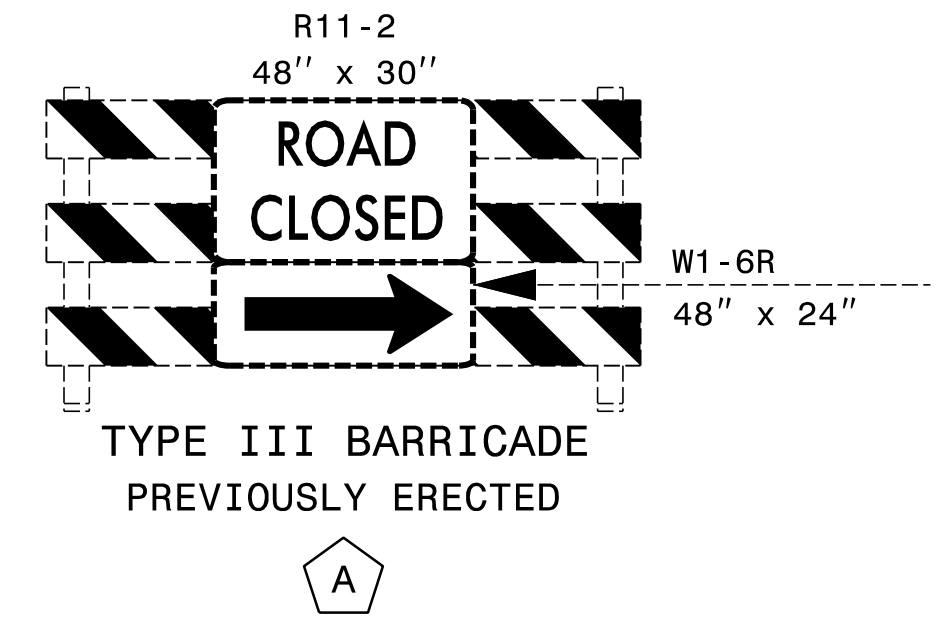
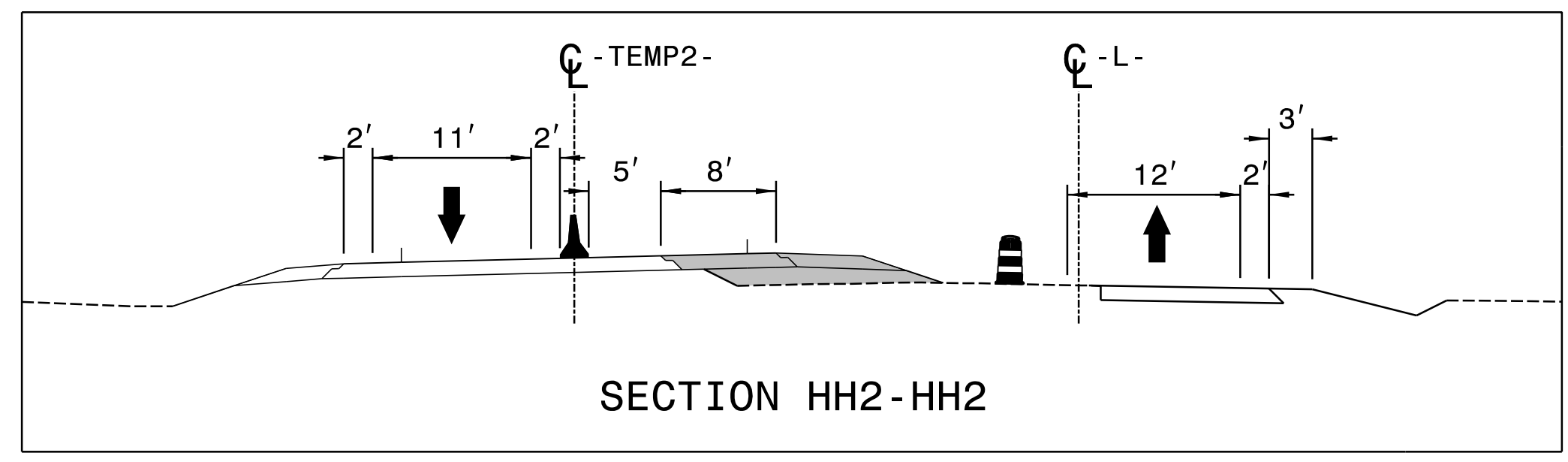
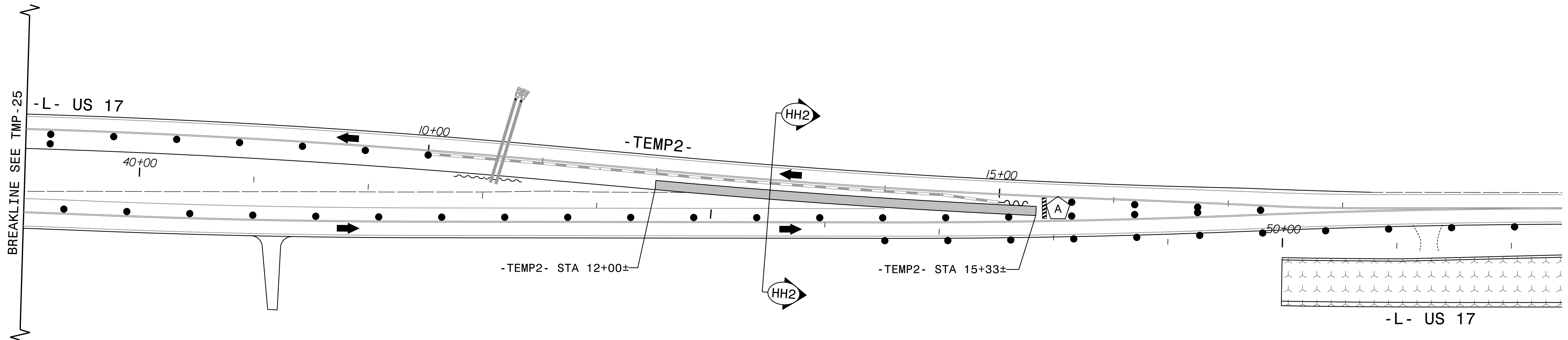
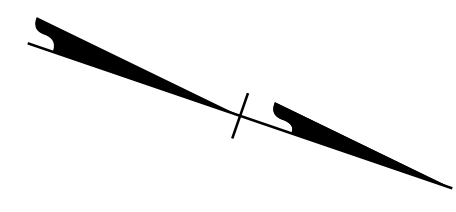

10/1/2021
 R2511_TMP_PSH26.dgn
 ksb1

APPROVED: *Kevin Bisby*
 DATE: 10/1/2021

SEAL

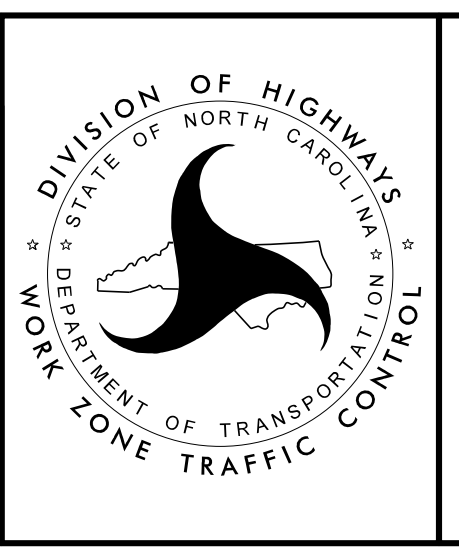

**PHASE I
 DETAIL DRAWING**

**DOCUMENT NOT CONSIDERED FINAL
 UNLESS ALL SIGNATURES COMPLETED**

PROJ. REFERENCE NO.	SHEET NO.
R-2511	TMP-27

RKK
 P: (919) 878-8560
 8601 Six Forks Road, Forum 1, Suite 700
 Raleigh, North Carolina 27615-3960
 NC License No. F-0112
 Engineers | Construction Managers | Planners | Scientists
 www.rkk.com
 Responsive People | Creative Solutions

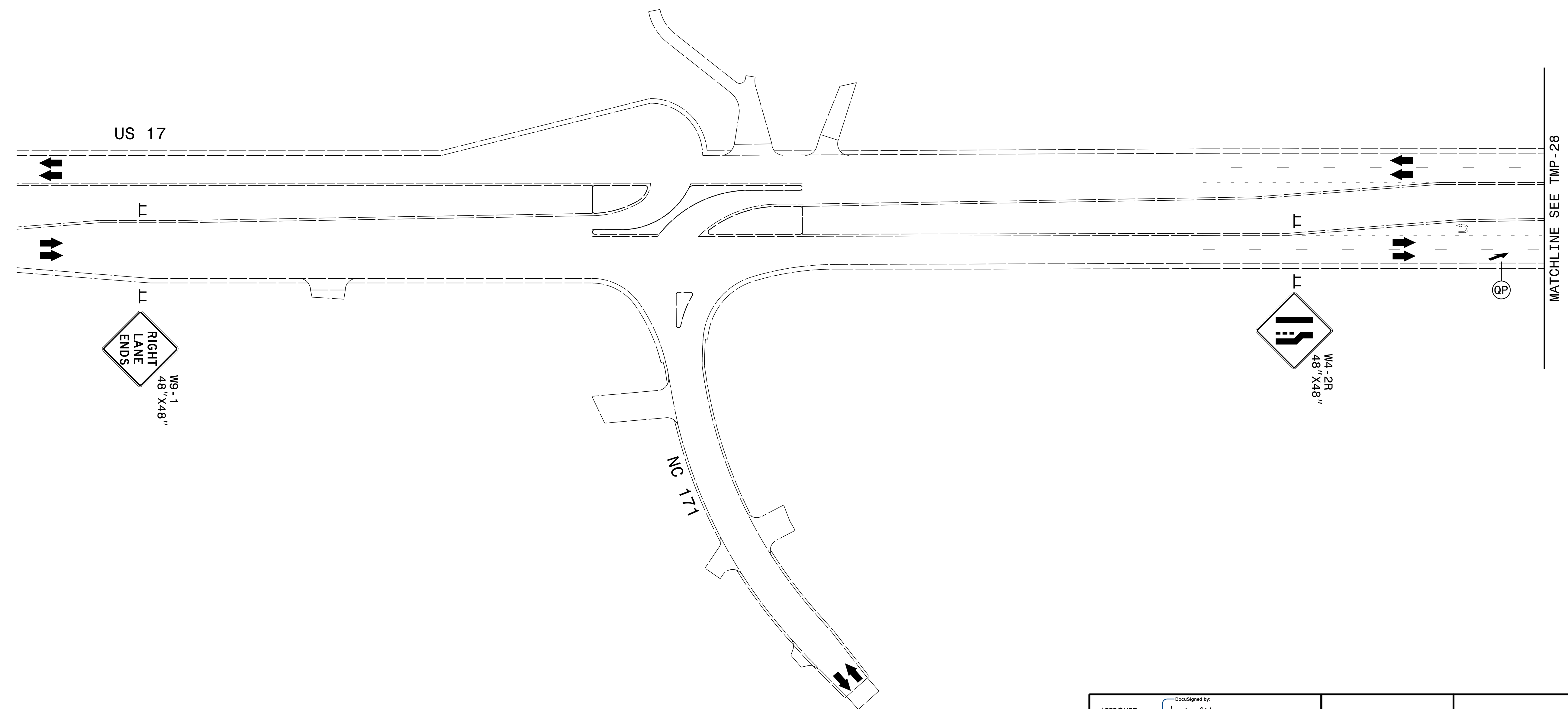
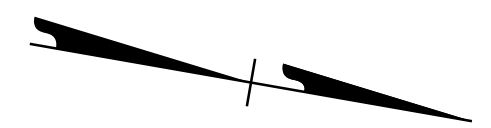

USE RDWY STD 1205.13 FOR LANE REDUCTION SIGN SPACING AND PAVEMENT MARKING REQUIREMENTS.

APPROVED: 
 DATE: 10/1/2021

SEAL

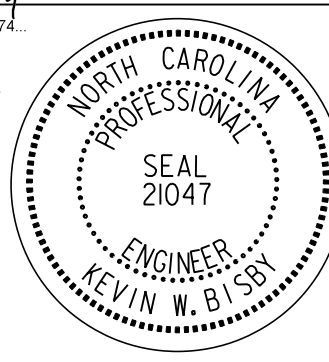
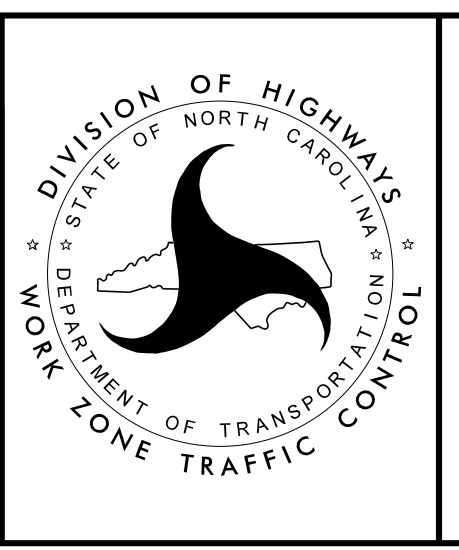
PHASE II
 DETAIL DRAWING

10/1/2021
 R2511_TMP_PSH27.dgn
 kbisbi

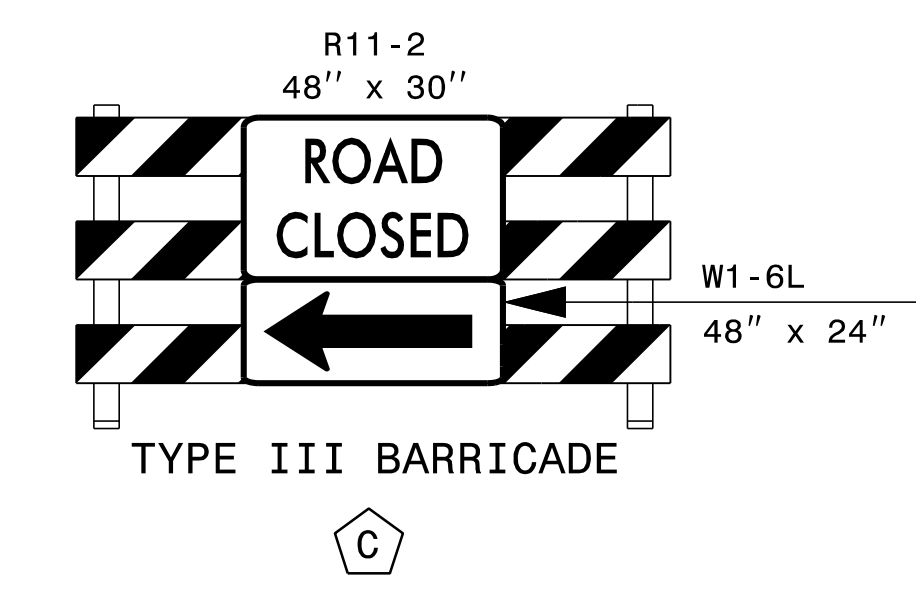
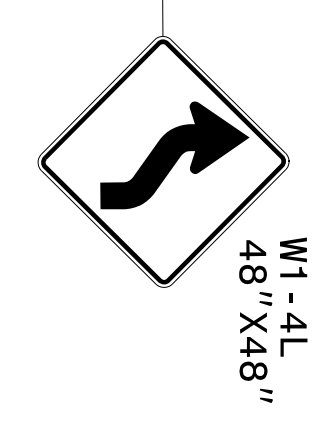
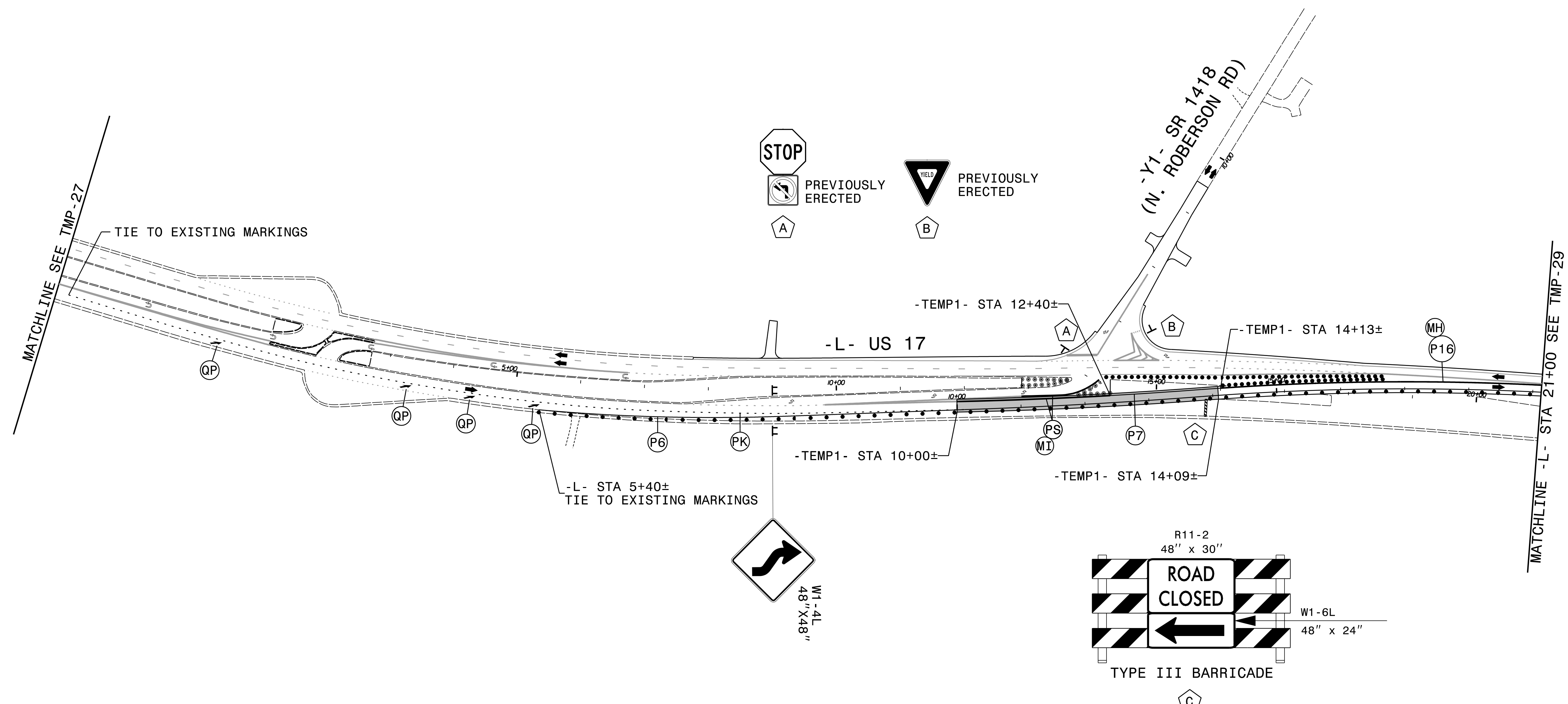
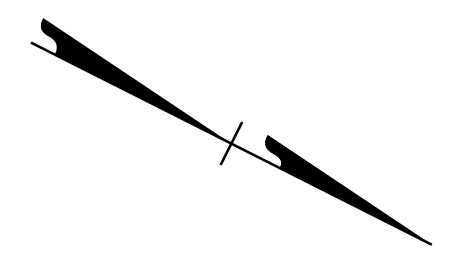

USE RDWY STD 1205.13 FOR LANE REDUCTION SIGN SPACING AND PAVEMENT MARKING REQUIREMENTS.

APPROVED: *Kevin Bisby*
 DATE: 10/1/2021

SEAL

PHASE II
 DETAIL DRAWING

10/1/2021 R2511_TMP_PSH28.dgn ksb

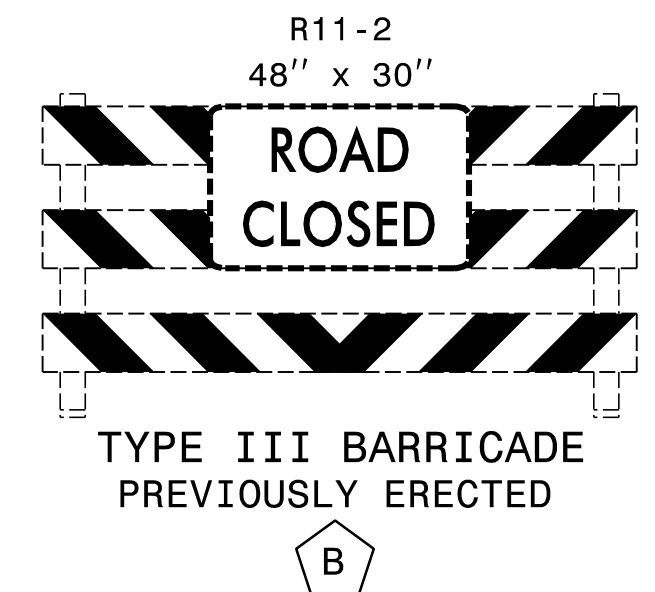
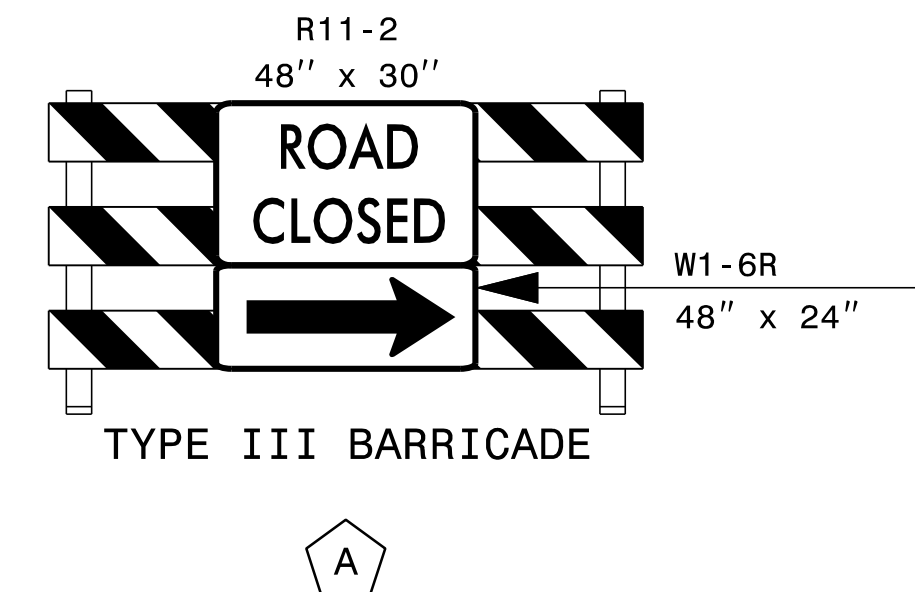
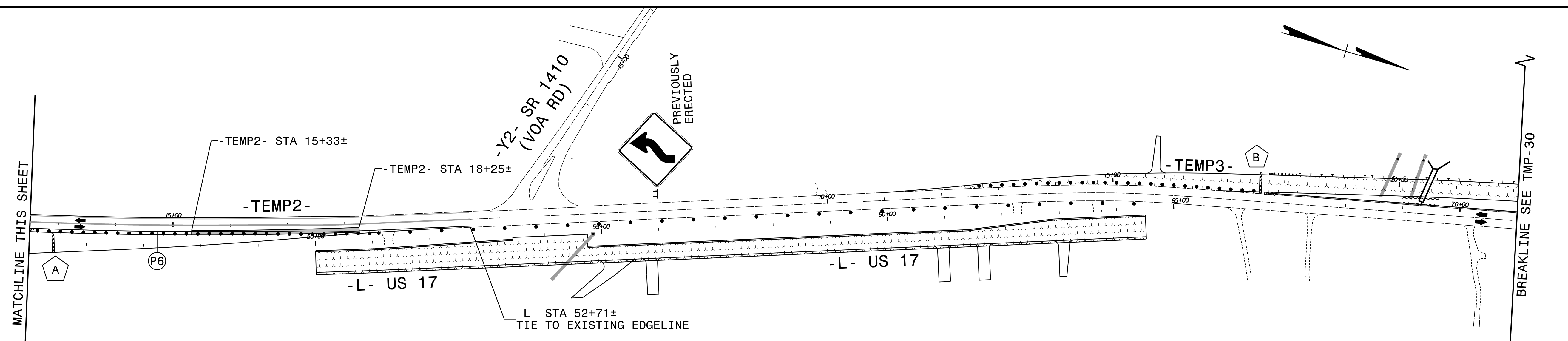
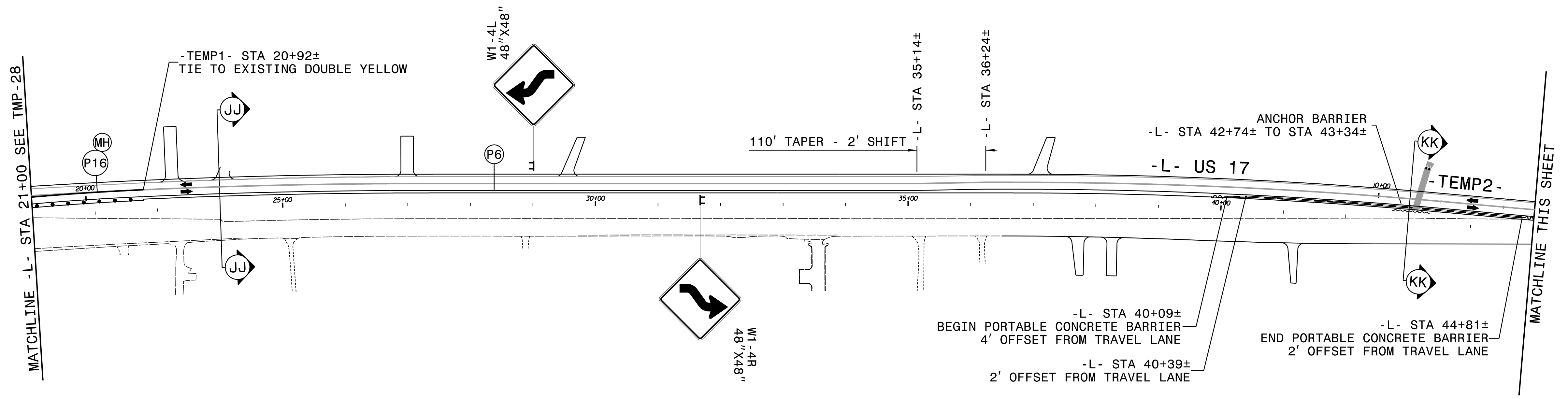

SEE TMP-29A FOR SECTION VIEWS.
 11' LANE WIDTHS UNLESS OTHERWISE INDICATED.

APPROVED: *Kevin Bisby*
 DATE: 10/1/2021
 SEAL
 NORTH CAROLINA PROFESSIONAL ENGINEER
 KEVIN W. BISBY
 SEAL 21047
 BDD0802529912474

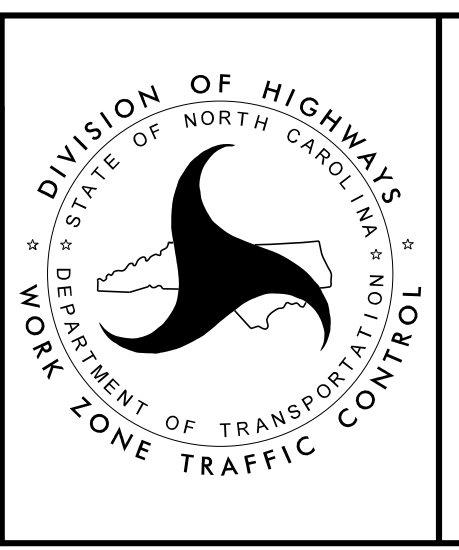

PHASE II
 DETAIL DRAWING

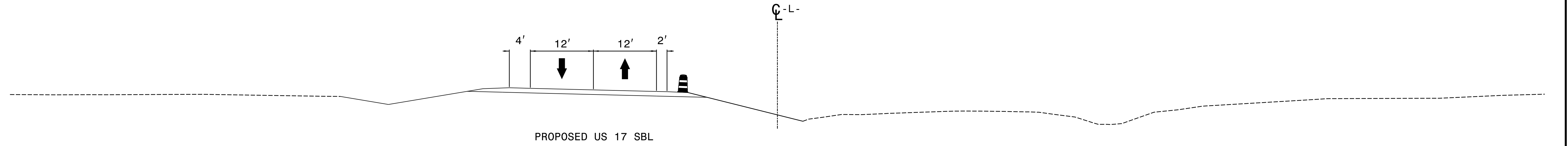

PROPOSED US 17 SBL

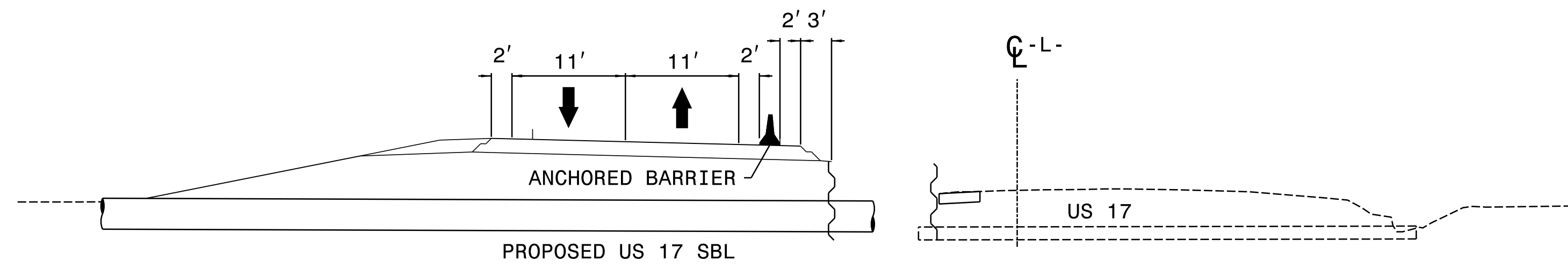

SECTION JJ-JJ



PROPOSED US 17 SBL

SECTION KK-KK

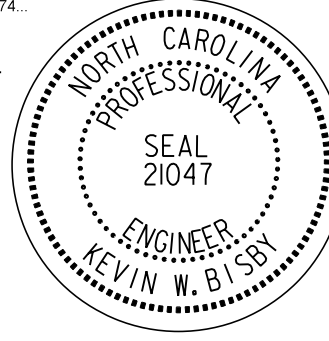
10/1/2021
R2511_TMP_PSH29A.dgn
ksf/bbl

<p>APPROVED:  DATE: 10/1/2021</p> <p>SEAL</p> 		<p style="text-align: center;">PHASE II DETAIL DRAWING</p>
<p>DOCUMENT NOT CONSIDERED FINAL UNLESS ALL SIGNATURES COMPLETED</p>		

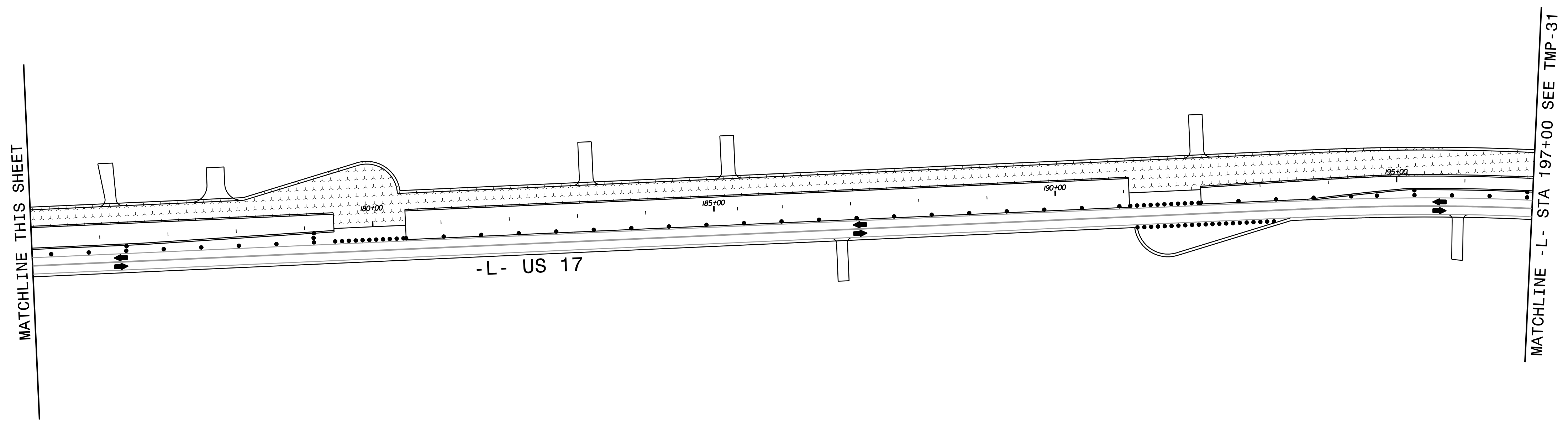
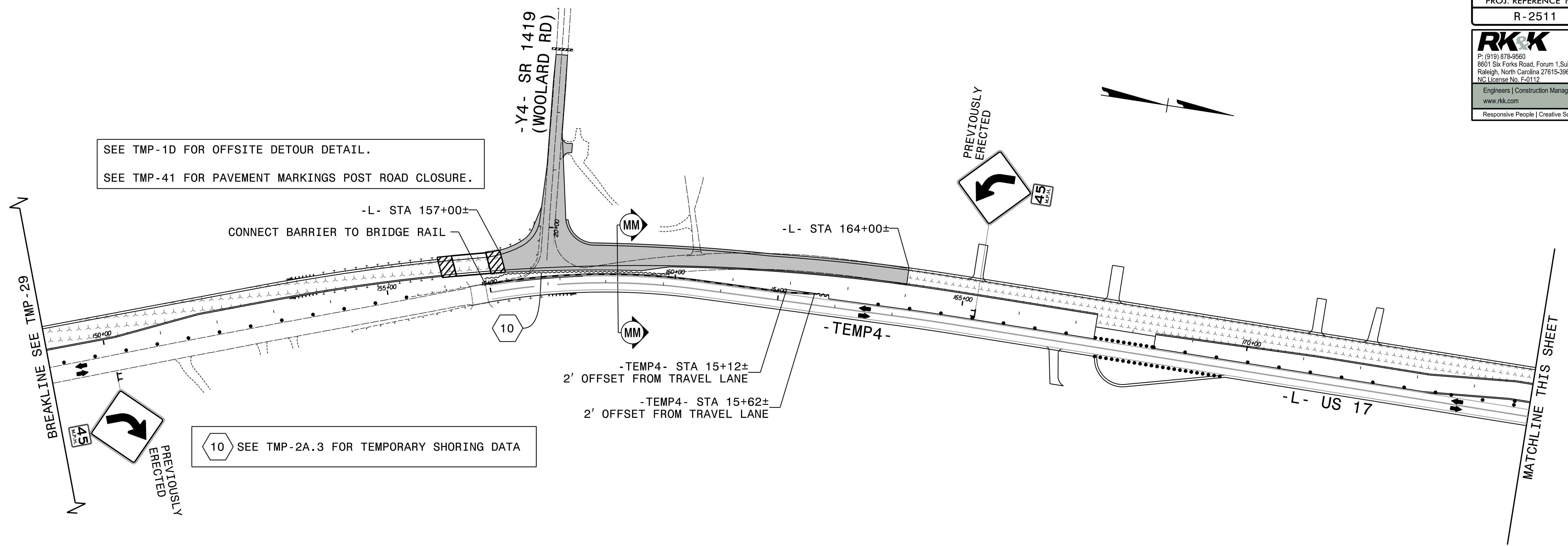

SEE TMP-30A FOR SECTION VIEW.

APPROVED: *Kevin Esley*
 DATE: 1/12/2022

SEAL

SEAL 21047
 ENGINEER
 KEVIN W. BISSBY

DOCUMENT NOT CONSIDERED FINAL
 UNLESS ALL SIGNATURES COMPLETED

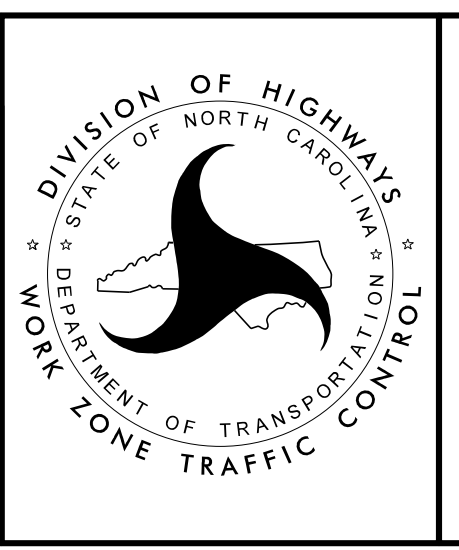

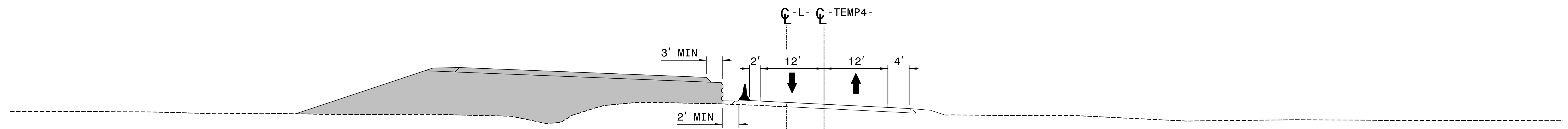

DIVISION OF HIGHWAYS
 STATE OF NORTH CAROLINA
 DEPARTMENT OF TRANSPORTATION
 WORK ZONE TRAFFIC CONTROL

PHASE II
 DETAIL DRAWING

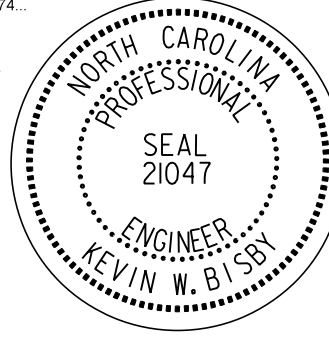

SECTION MM-MM

10/1/2021
 R2511_TMP_PSH30A.dgn
 kbs/bbl

<p>APPROVED:  <small>DocuSigned by: Kevin Bisby BDD802829812474</small></p> <p>DATE: 10/1/2021</p> <p>SEAL</p> 		<p style="text-align: center;">PHASE II DETAIL DRAWING</p>
<p style="text-align: center;">DOCUMENT NOT CONSIDERED FINAL UNLESS ALL SIGNATURES COMPLETED</p>		

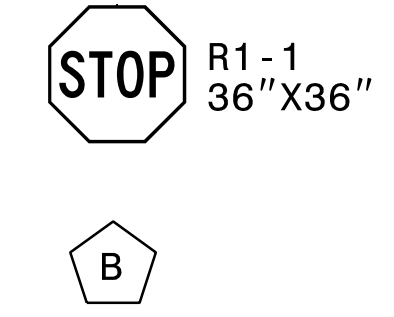
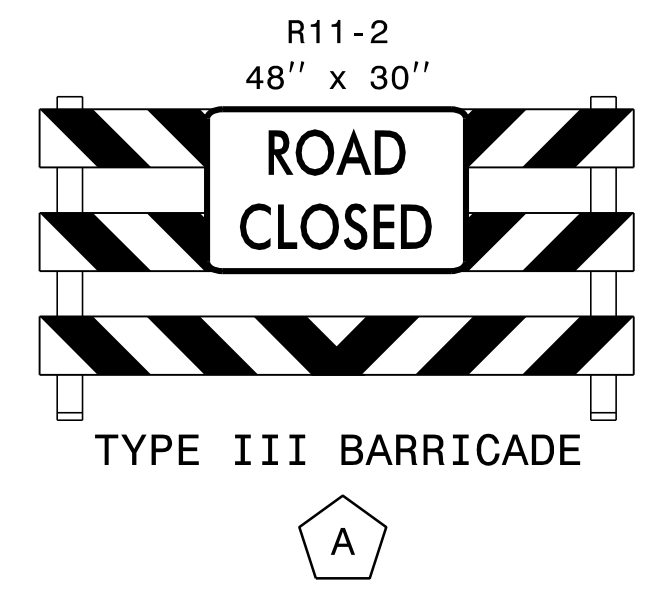
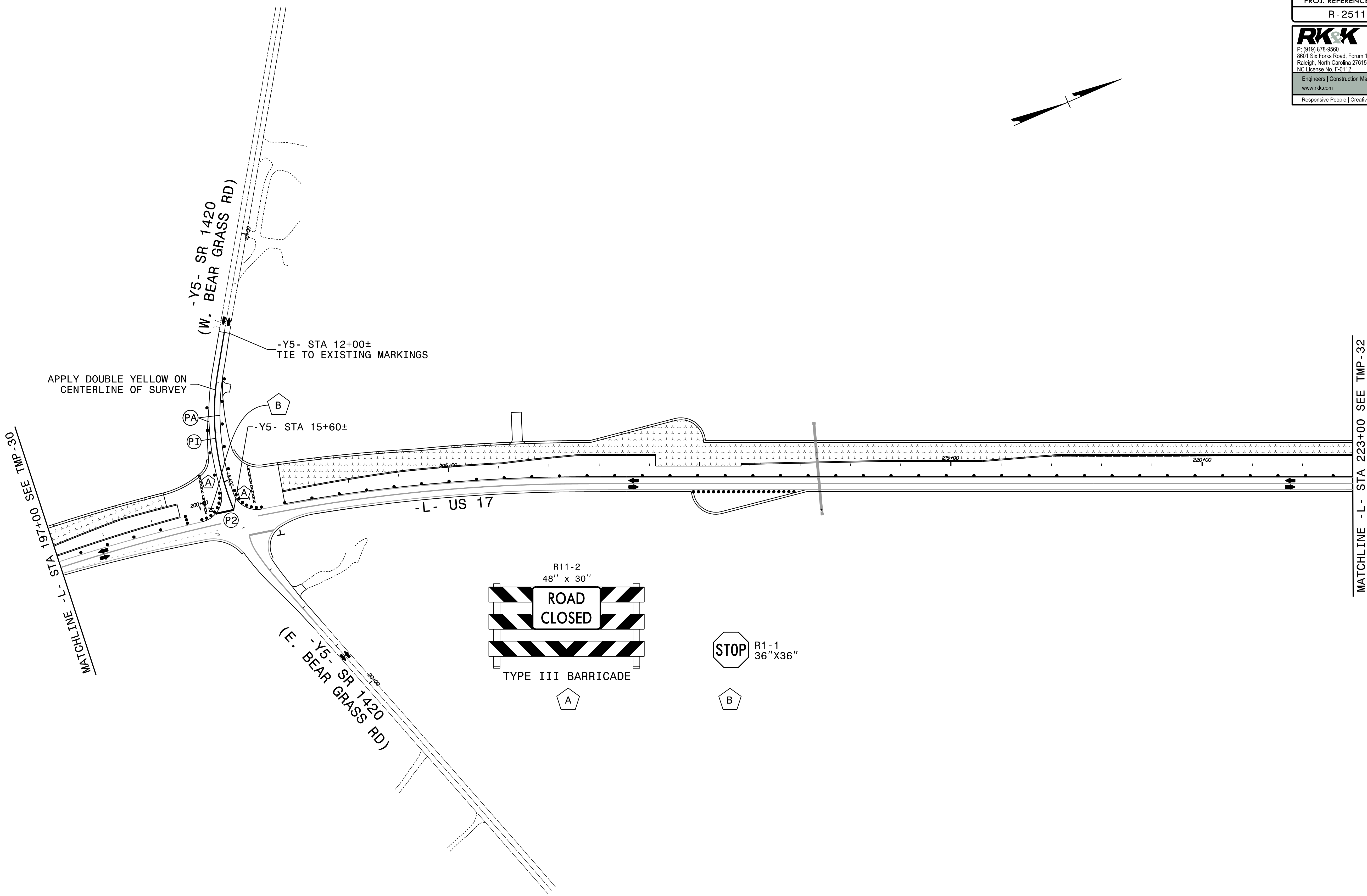
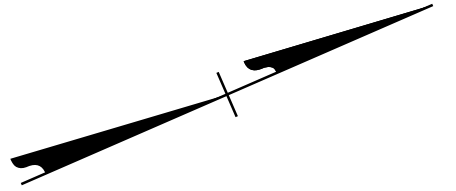

10/1/2021
 R2511_TMP_PSH31.dgn
 KSB

APPROVED: Kevin Bisby
 DATE: 10/1/2021

SEAL

**DOCUMENT NOT CONSIDERED FINAL
 UNLESS ALL SIGNATURES COMPLETED**

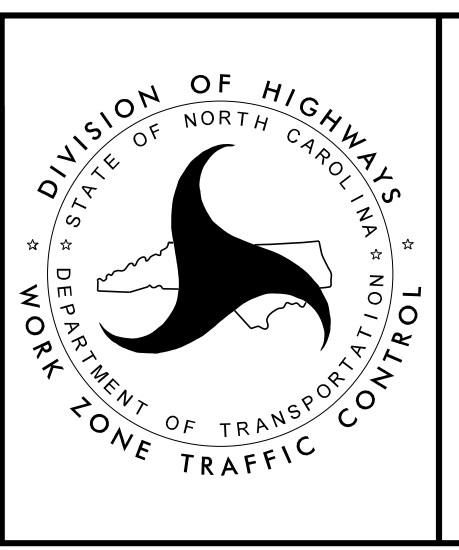

**PHASE II
 DETAIL DRAWING**

MATCHLINE - L - STA 223+00 SEE TMP-32

MATCHLINE - L - STA 197+00 SEE TMP-30

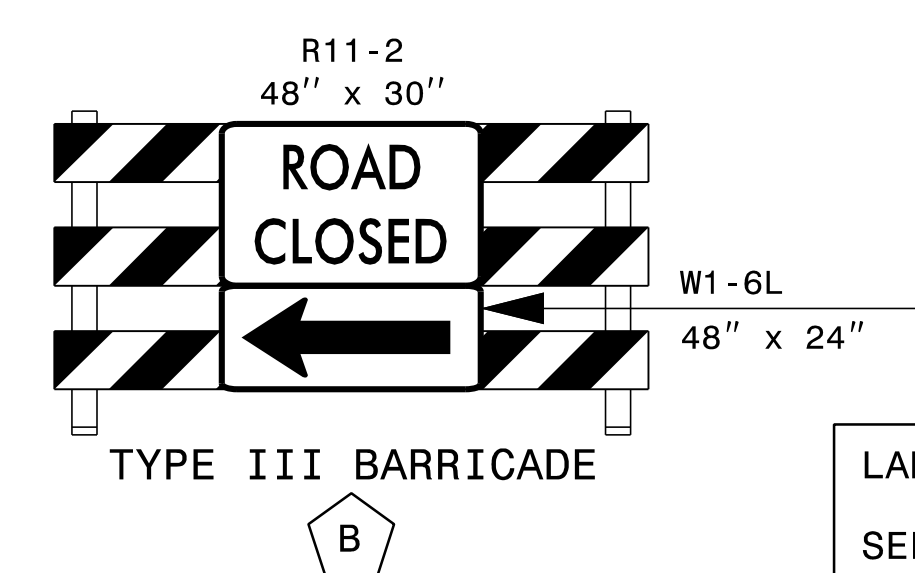
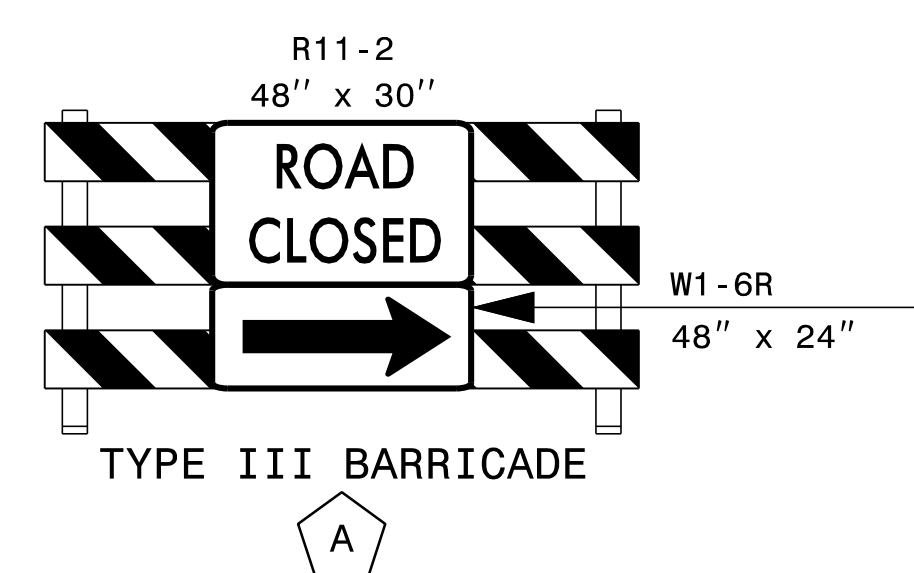
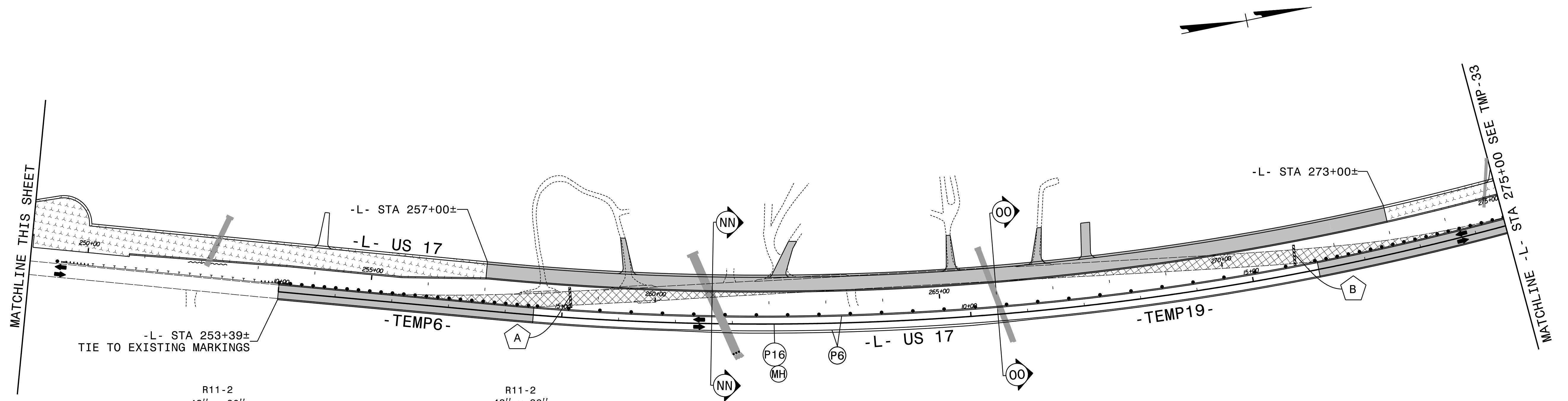
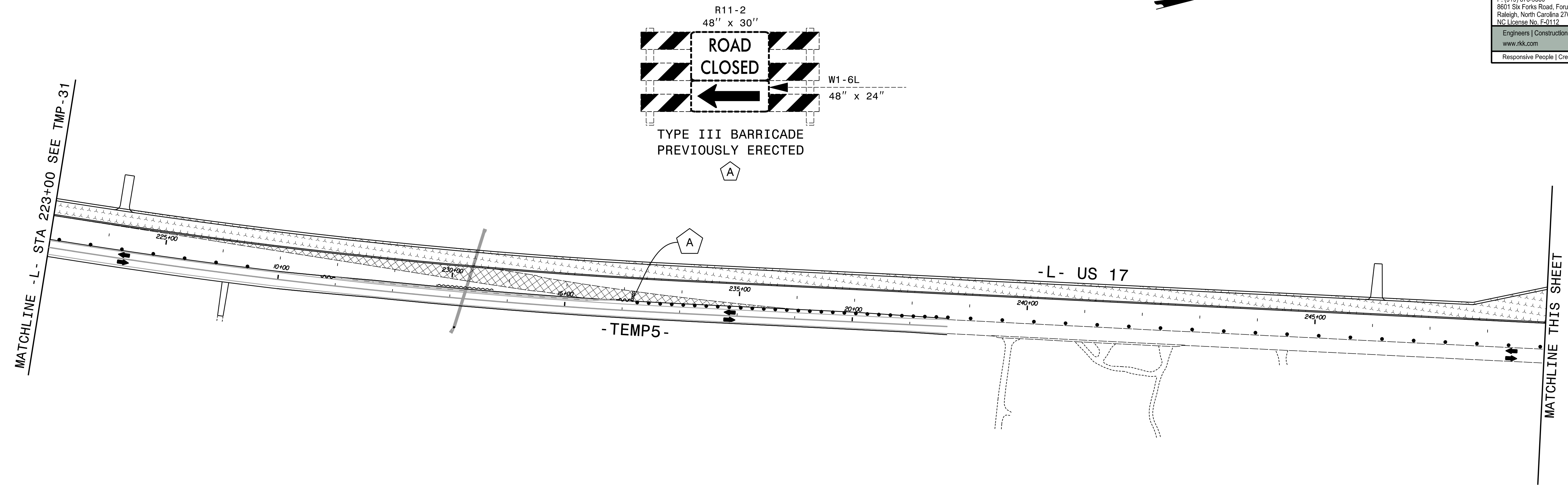

LANE WIDTHS 12' UNLESS OTHERWISE INDICATED.
 SEE TMP-32A FOR SECTION VIEWS.

APPROVED: *Kevin Bisby*
 DATE: 10/1/2021
 SEAL
 DOCUMENT NOT CONSIDERED FINAL
 UNLESS ALL SIGNATURES COMPLETED

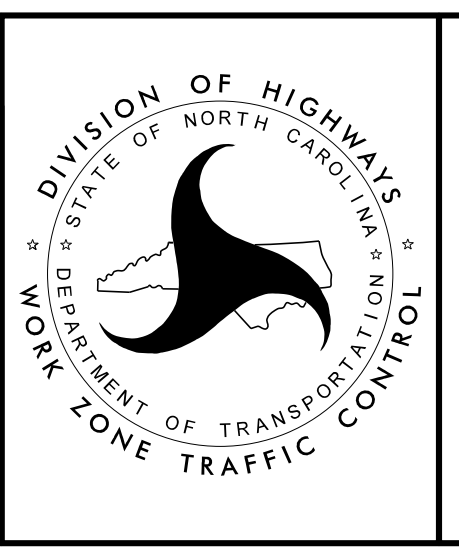

PHASE II
 DETAIL DRAWING

10/1/2021
 R2511-TMP-PSH132.dgn
 kws/bbl

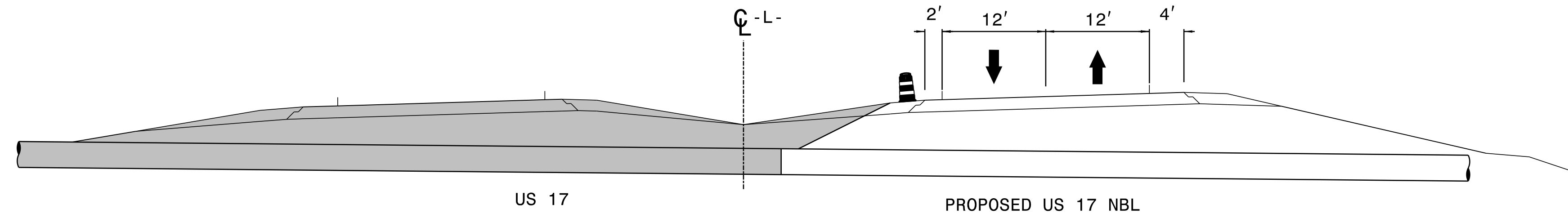

SECTION NN-NN

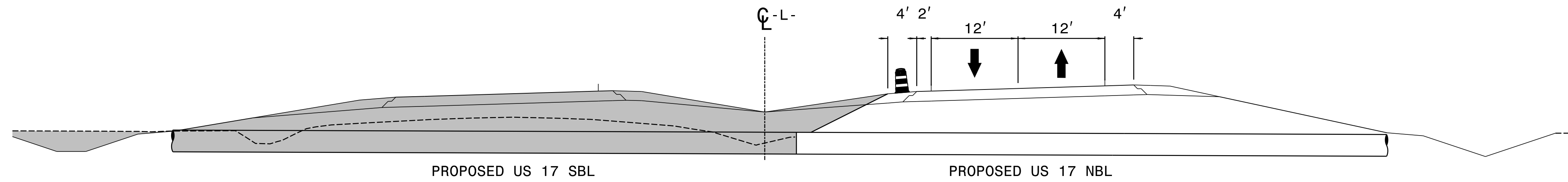

SECTION 00-00

APPROVED: *Kevin Bisby*
 DATE: 10/1/2021

SEAL

DOCUMENT NOT CONSIDERED FINAL
 UNLESS ALL SIGNATURES COMPLETED

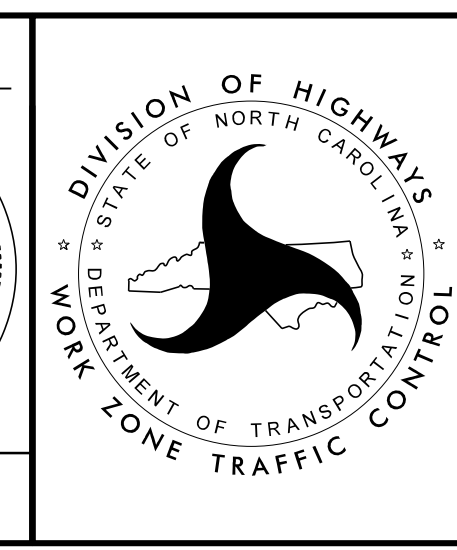

PHASE II
 DETAIL DRAWING

10/1/2021
 R2511_TMP_PSH32A.dgn
 kws/bbl

PROJ. REFERENCE NO.	SHEET NO.
R-2511	TMP-33

RKK
 P: (919) 878-8560
 8601 Six Forks Road, Forum 1, Suite 700
 Raleigh, North Carolina 27615-3960
 NC License No. F-0112
 Engineers | Construction Managers | Planners | Scientists
 www.rkk.com
 Responsive People | Creative Solutions

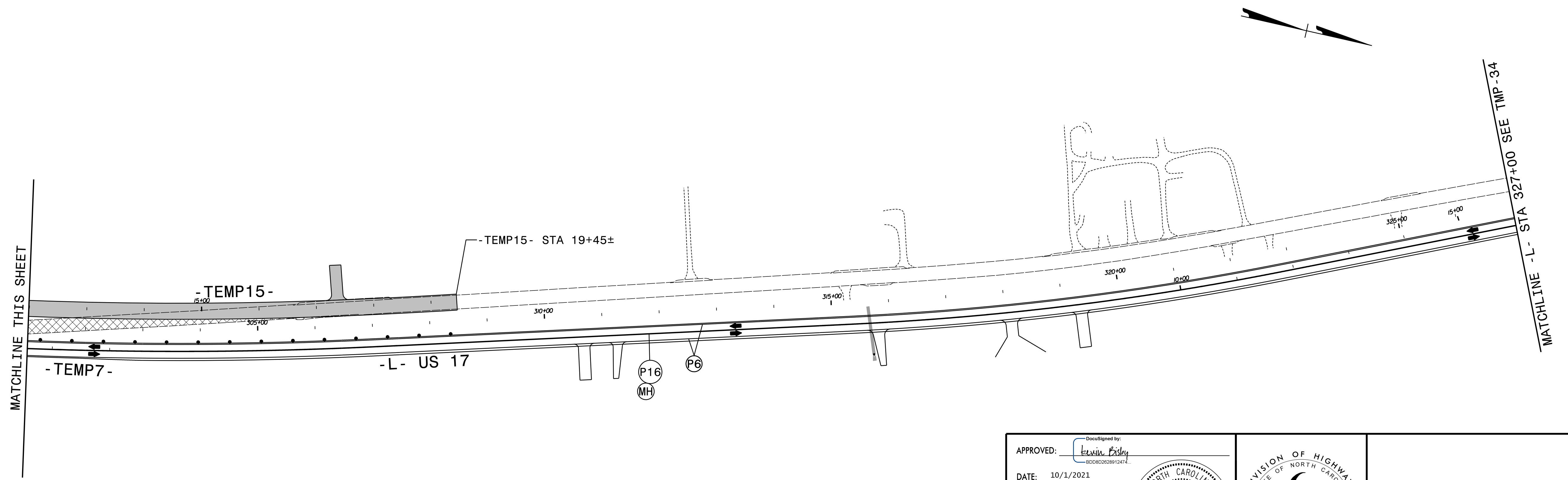
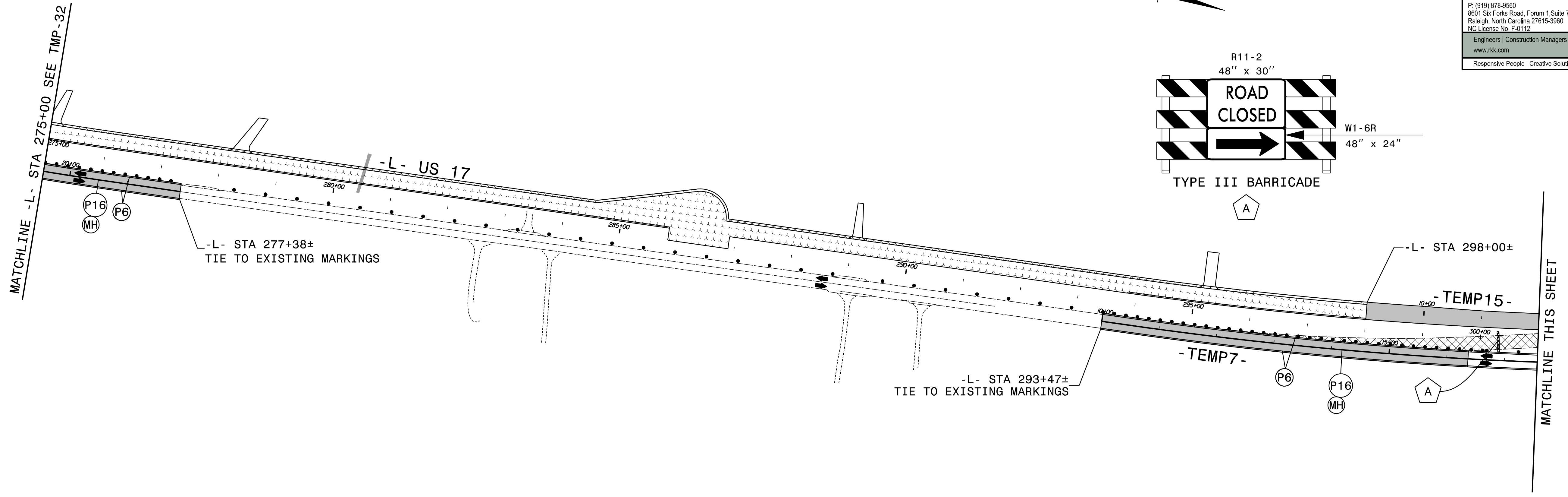

LANE WIDTHS 12' UNLESS OTHERWISE INDICATED.

APPROVED: *Kevin Bisby*
 DATE: 10/1/2021

SEAL

SEAL
 21047
 ENGINEER
 KEVIN W. BISBY

DOCUMENT NOT CONSIDERED FINAL
 UNLESS ALL SIGNATURES COMPLETED

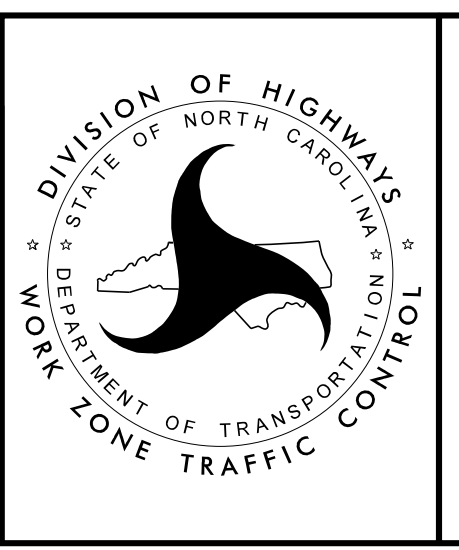

PHASE II
 DETAIL DRAWING

10/1/2021 R2511-TMP-PSH33.dgn

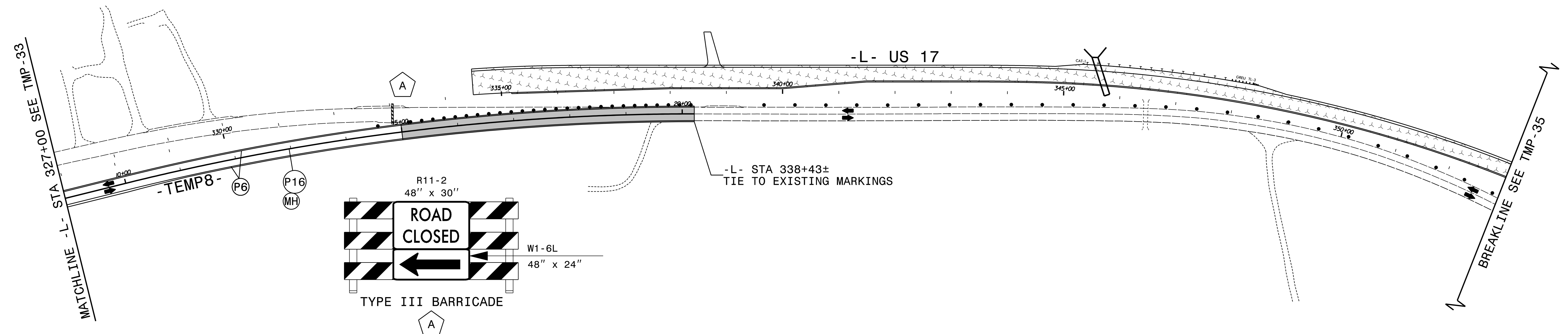
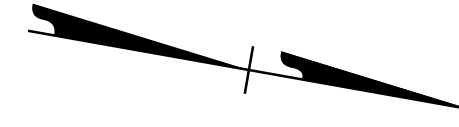

LANE WIDTHS 12' UNLESS OTHERWISE INDICATED.

APPROVED: *Kevin Bisby*
 DATE: 10/1/2021

SEAL

DOCUMENT NOT CONSIDERED FINAL
 UNLESS ALL SIGNATURES COMPLETED

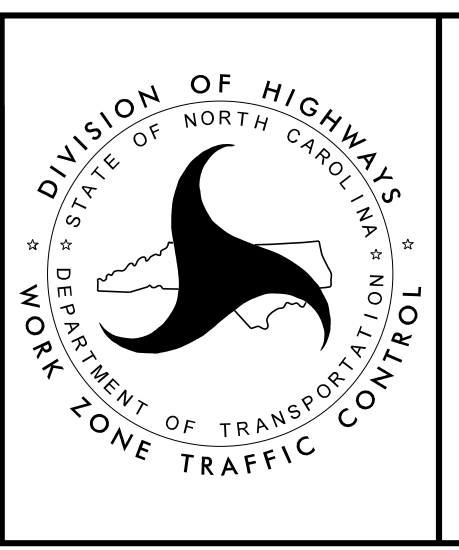

PHASE II
 DETAIL DRAWING

10/1/2021
 R2511-TMP-PSH34.dgn
 ksb1

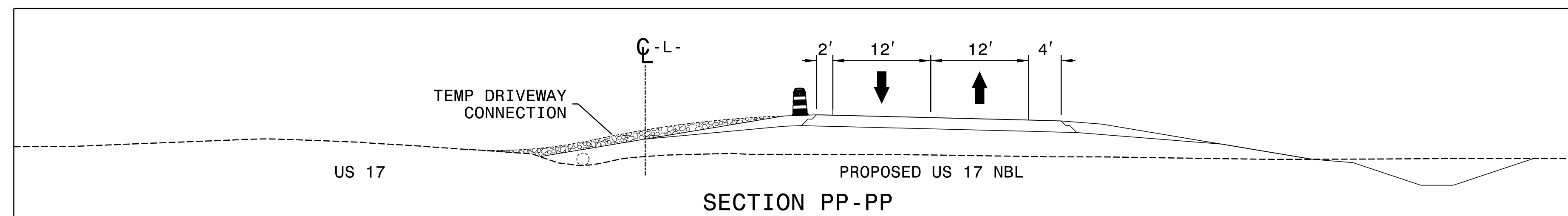
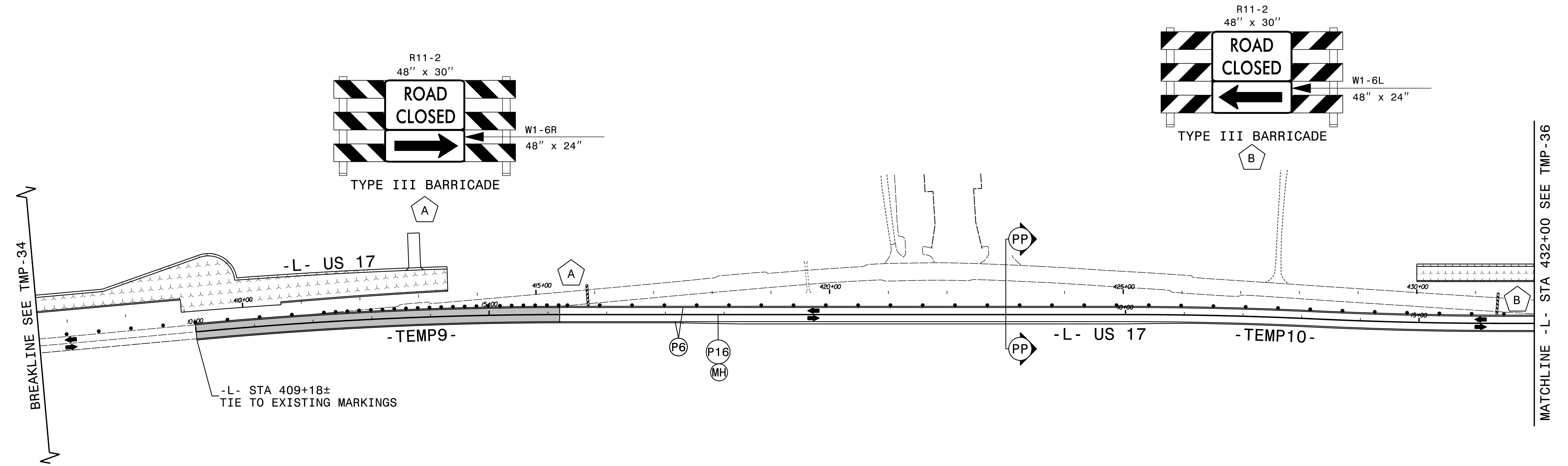
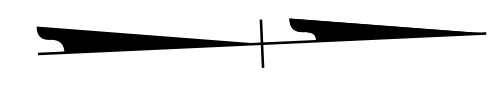

LANE WIDTHS 12' UNLESS OTHERWISE INDICATED.

APPROVED: *Kevin Bisby*
 DATE: 10/1/2021

SEAL

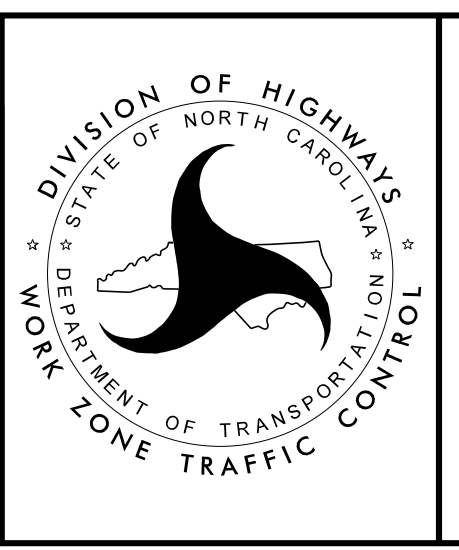

PHASE II
 DETAIL DRAWING

10/1/2021
 R2511-TMP-PSH35.dgn
 kbs/bbl

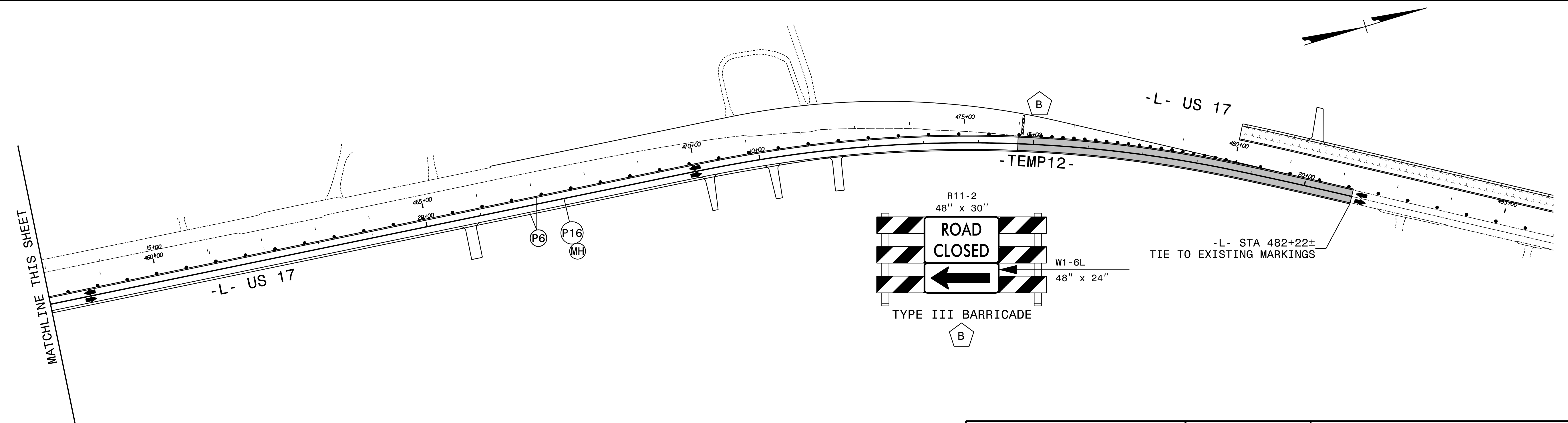
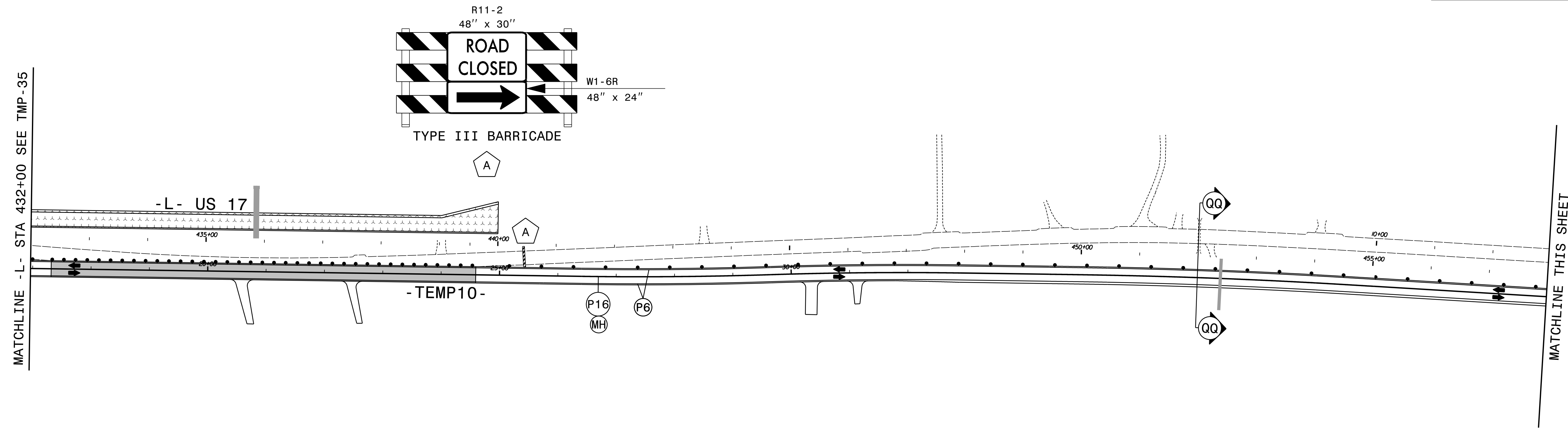

LANE WIDTHS 12' UNLESS OTHERWISE INDICATED.
 SEE TMP-36A FOR SECTION VIEW.

APPROVED: *Kevin Bisby*
 DATE: 10/1/2021

SEAL

DOCUMENT NOT CONSIDERED FINAL
 UNLESS ALL SIGNATURES COMPLETED

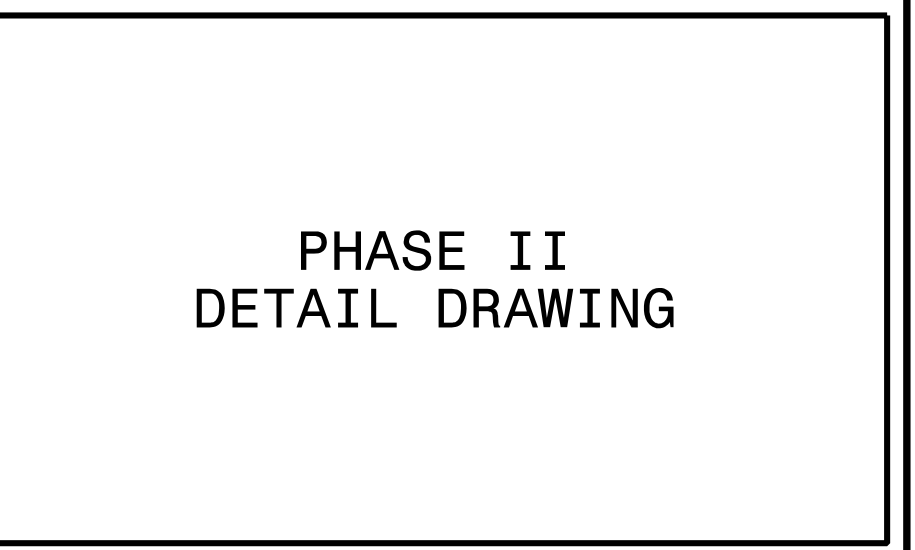
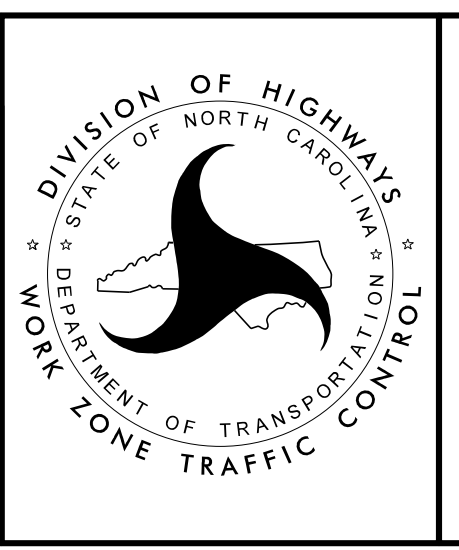

10/1/2021
 R2511_TMP_PSH36.dgn
 ksb

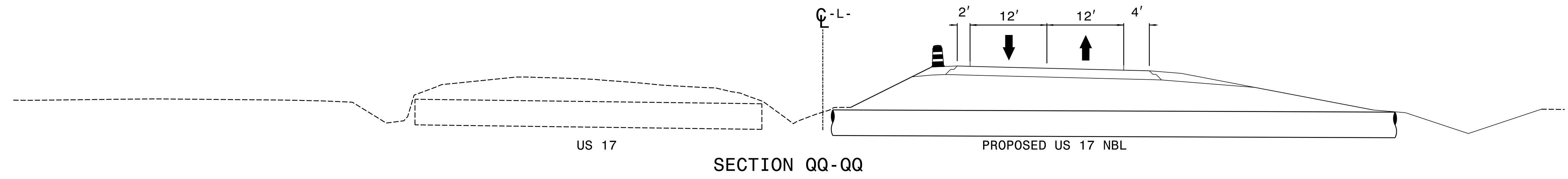

10/1/2021
 R2511_TMP_PSH36A.dgn
 KWB

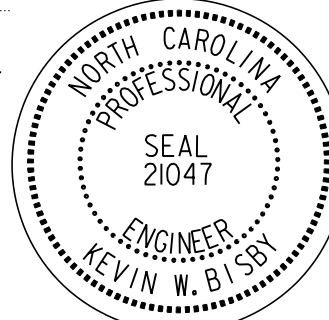
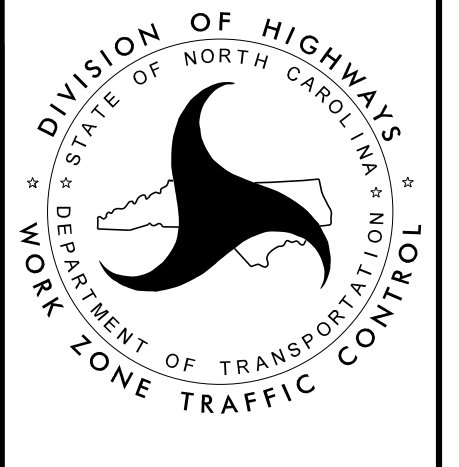
<p>APPROVED:  <small>DocuSigned by: Kevin Bisby BDC802928912474</small></p> <p>DATE: 10/1/2021</p> <p>SEAL</p> 		<p style="text-align: center;">PHASE II DETAIL DRAWING</p>
<p style="text-align: center;">DOCUMENT NOT CONSIDERED FINAL UNLESS ALL SIGNATURES COMPLETED</p>		

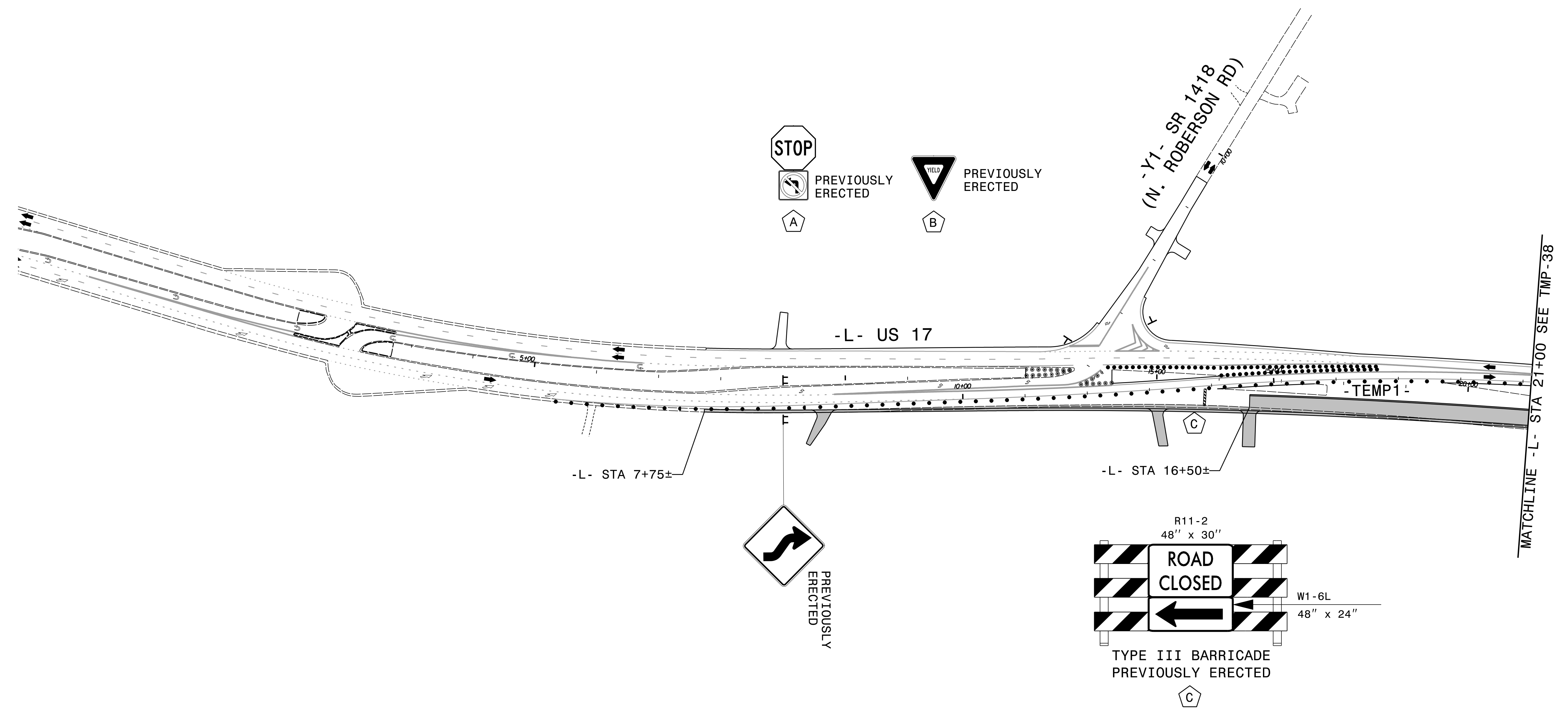

10/1/2021
 R2511_TMP_PSH37.dgn
 KSB

APPROVED: *Kevin Bisby*
 DATE: 10/1/2021

SEAL

DOCUMENT NOT CONSIDERED FINAL
 UNLESS ALL SIGNATURES COMPLETED

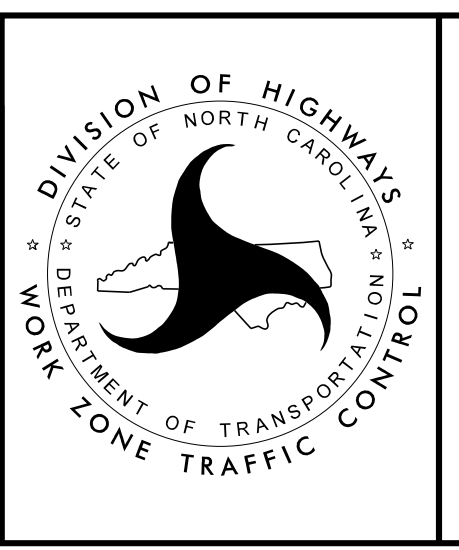

DIVISION OF HIGHWAYS
 DEPARTMENT OF TRANSPORTATION
 WORK ZONE TRAFFIC CONTROL

PHASE II
 DETAIL DRAWING

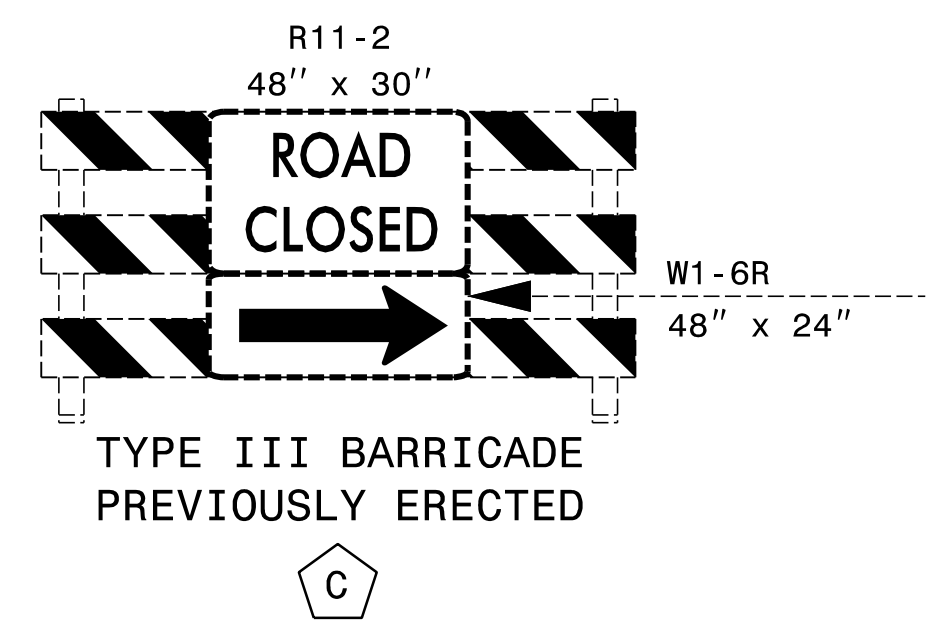
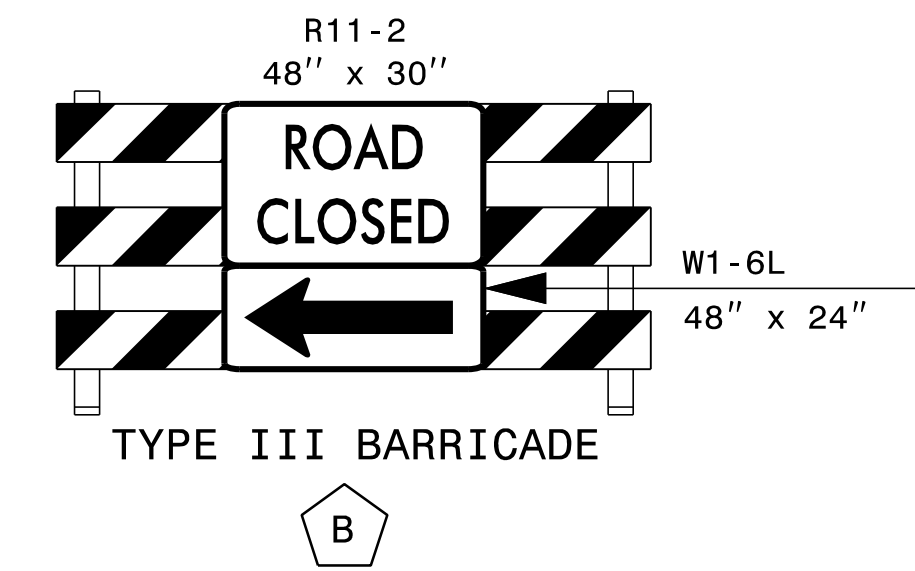
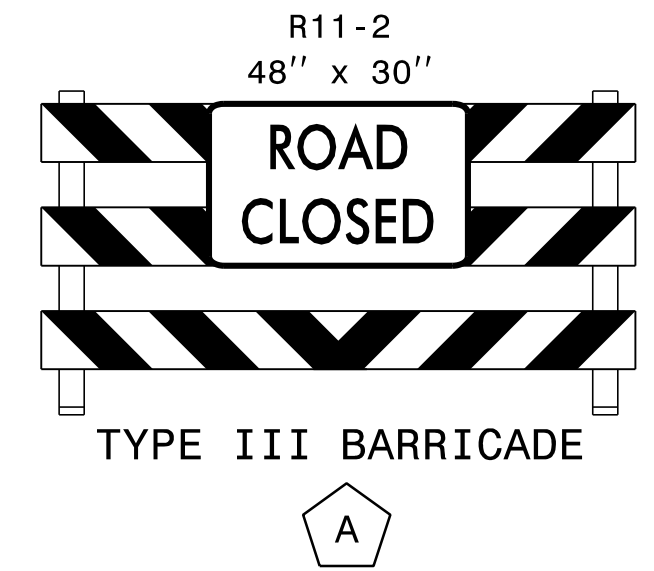
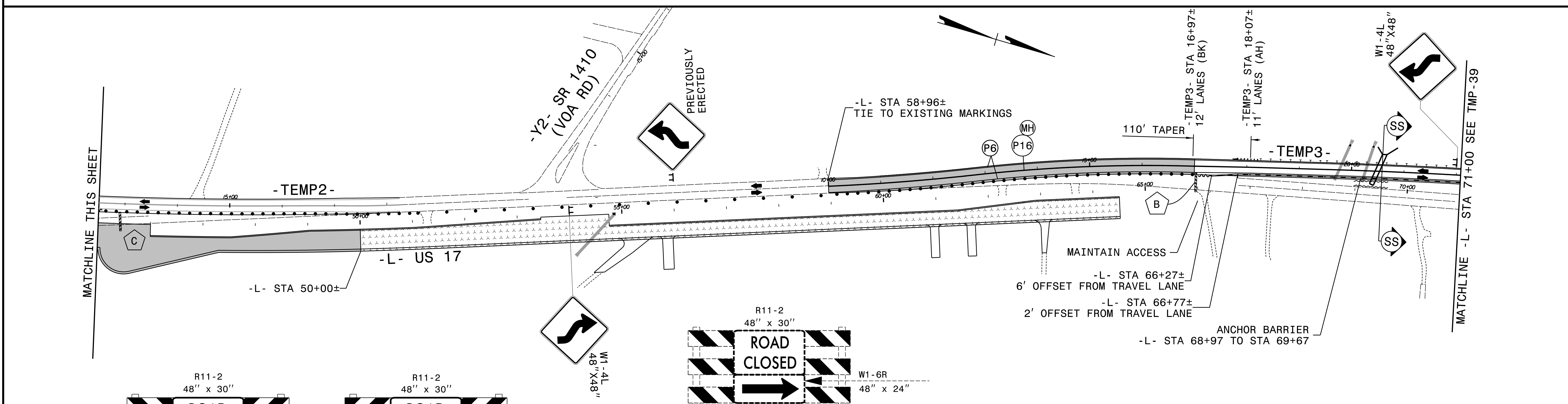
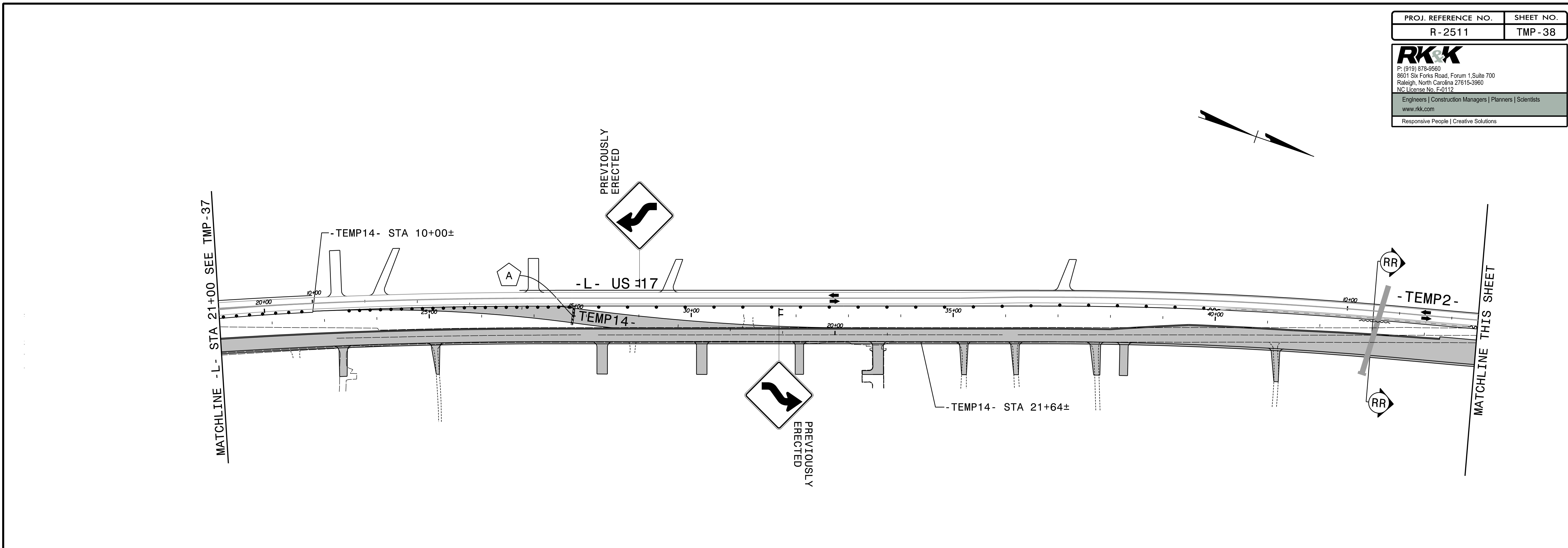

LANE WIDTHS 12' UNLESS OTHERWISE INDICATED.
 SEE TMP-38A FOR SECTION VIEWS.

APPROVED: *Kevin Bisby*
 DATE: 10/1/2021

SEAL

SEAL

DOCUMENT NOT CONSIDERED FINAL
 UNLESS ALL SIGNATURES COMPLETED

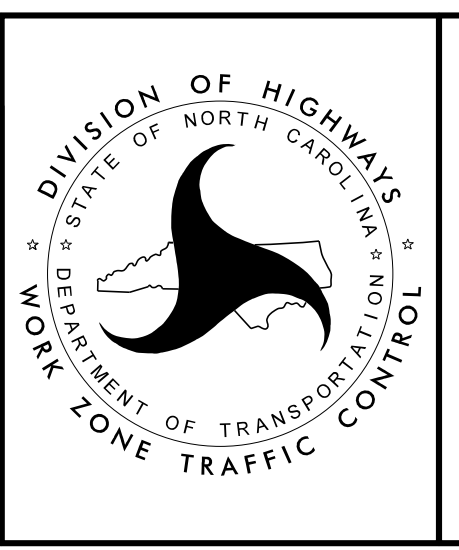

DIVISION OF HIGHWAYS
 STATE OF NORTH CAROLINA
 DEPARTMENT OF TRANSPORTATION
 TRAFFIC CONTROL

PHASE II
 DETAIL DRAWING

10/1/2021
 R2511-TMP-PSH38.dgn
 ksb1

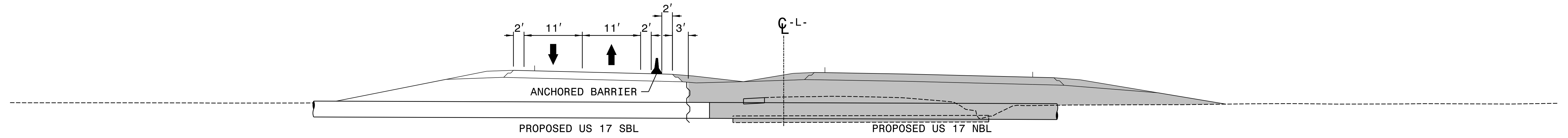

SECTION RR-RR

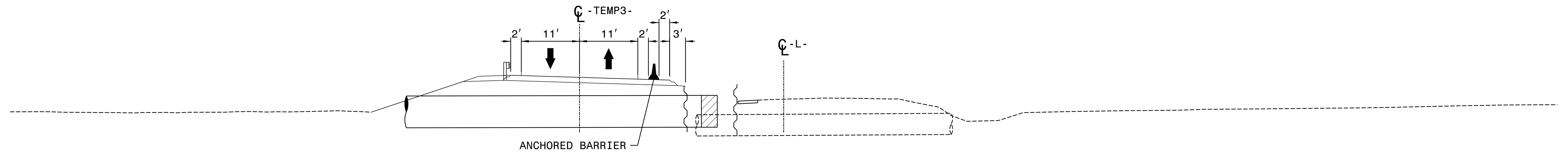

SECTION SS-SS

10/1/2021
R2511_TMP_PSH38A.dgn
KWB

APPROVED: *Kevin Bisby*
 DATE: 10/1/2021

SEAL

DOCUMENT NOT CONSIDERED FINAL
UNLESS ALL SIGNATURES COMPLETED

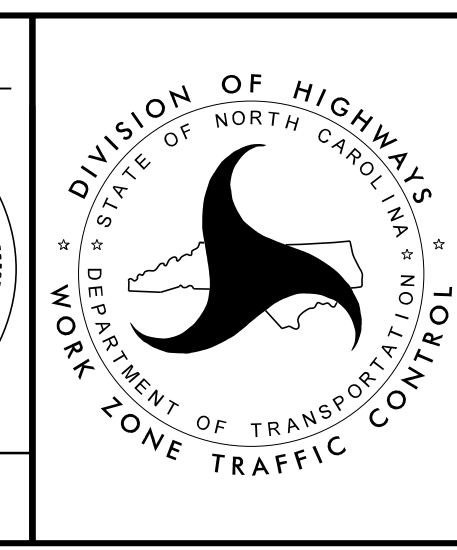

PHASE II
DETAIL DRAWING

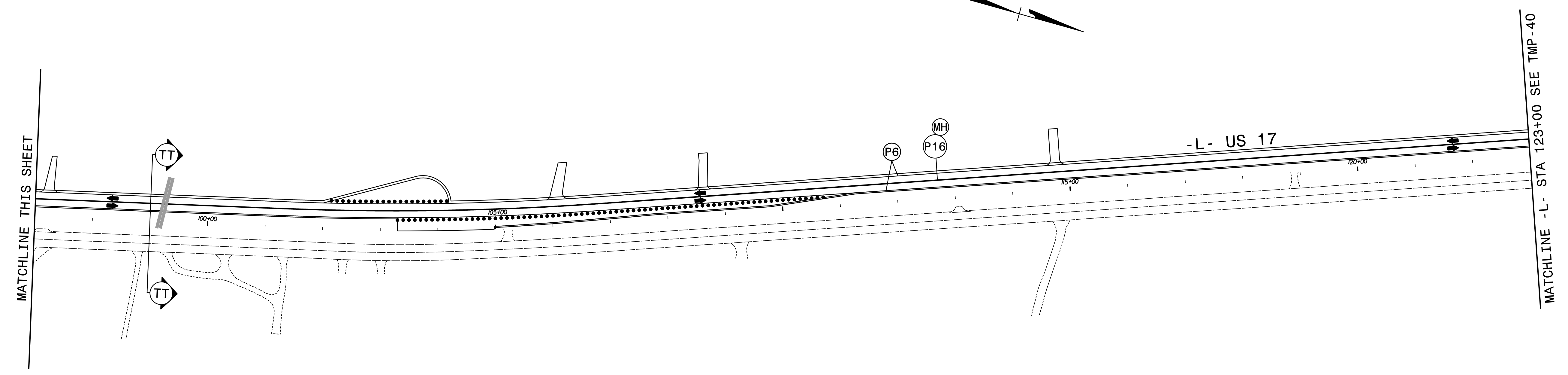
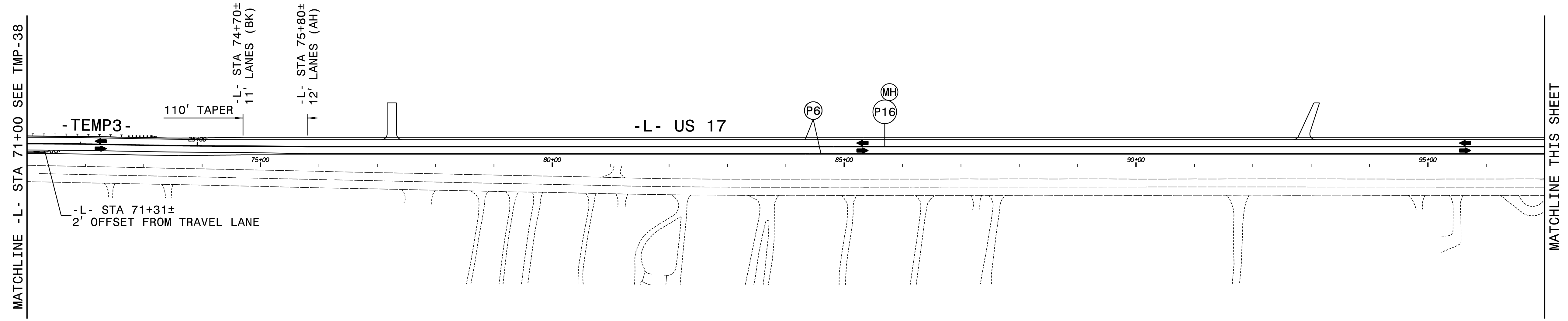

LANE WIDTHS 12' UNLESS OTHERWISE INDICATED.
 SEE TMP-39A FOR SECTION VIEW.

APPROVED: *Kevin Bisby*
 DATE: 10/1/2021

SEAL

DOCUMENT NOT CONSIDERED FINAL
 UNLESS ALL SIGNATURES COMPLETED

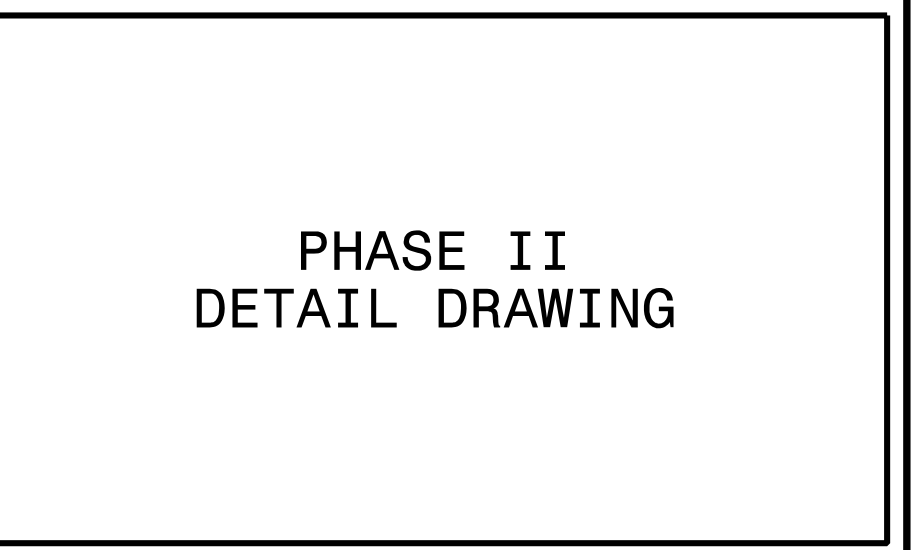
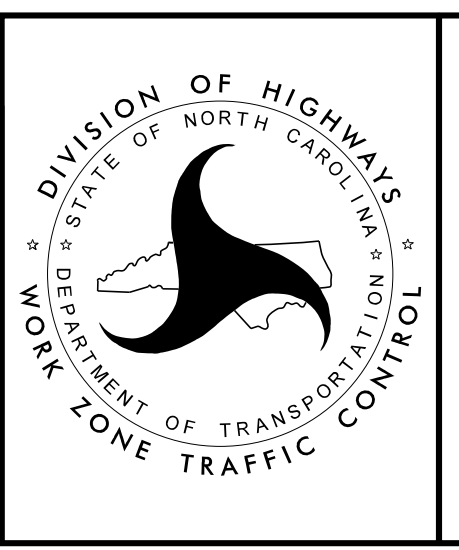

PHASE II
 DETAIL DRAWING

PROJ. REFERENCE NO.	SHEET NO.
R-2511	TMP-39A

RKK
 P: (919) 878-8560
 8601 Six Forks Road, Forum 1, Suite 700
 Raleigh, North Carolina 27615-3960
 NC License No. F-0112
 Engineers | Construction Managers | Planners | Scientists
 www.rkk.com
 Responsive People | Creative Solutions

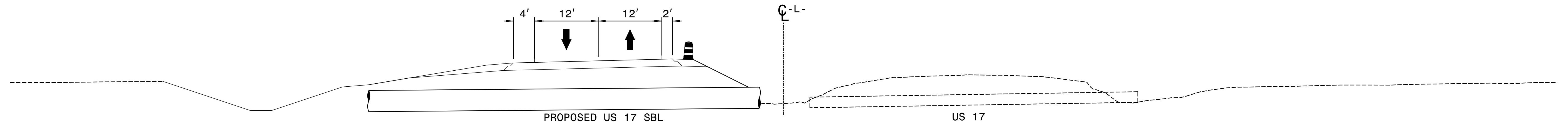

PROPOSED US 70 SBL

US 17

SECTION TT-TT

10/1/2021
 R2511_TMP_PSH39A.dgn
 kshb

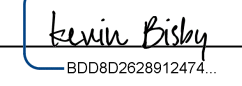
APPROVED: 
DocuSigned by: Kevin Bisby
 BDC802928912474

DATE: 10/1/2021

SEAL

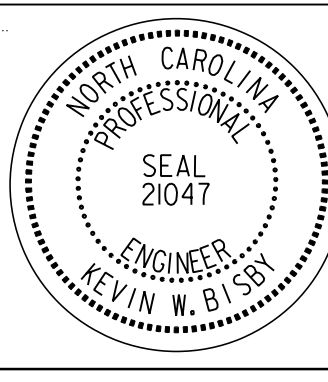
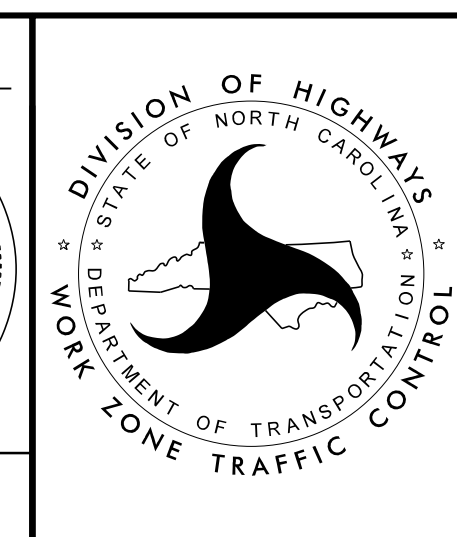
PHASE II
 DETAIL DRAWING

**DOCUMENT NOT CONSIDERED FINAL
 UNLESS ALL SIGNATURES COMPLETED**

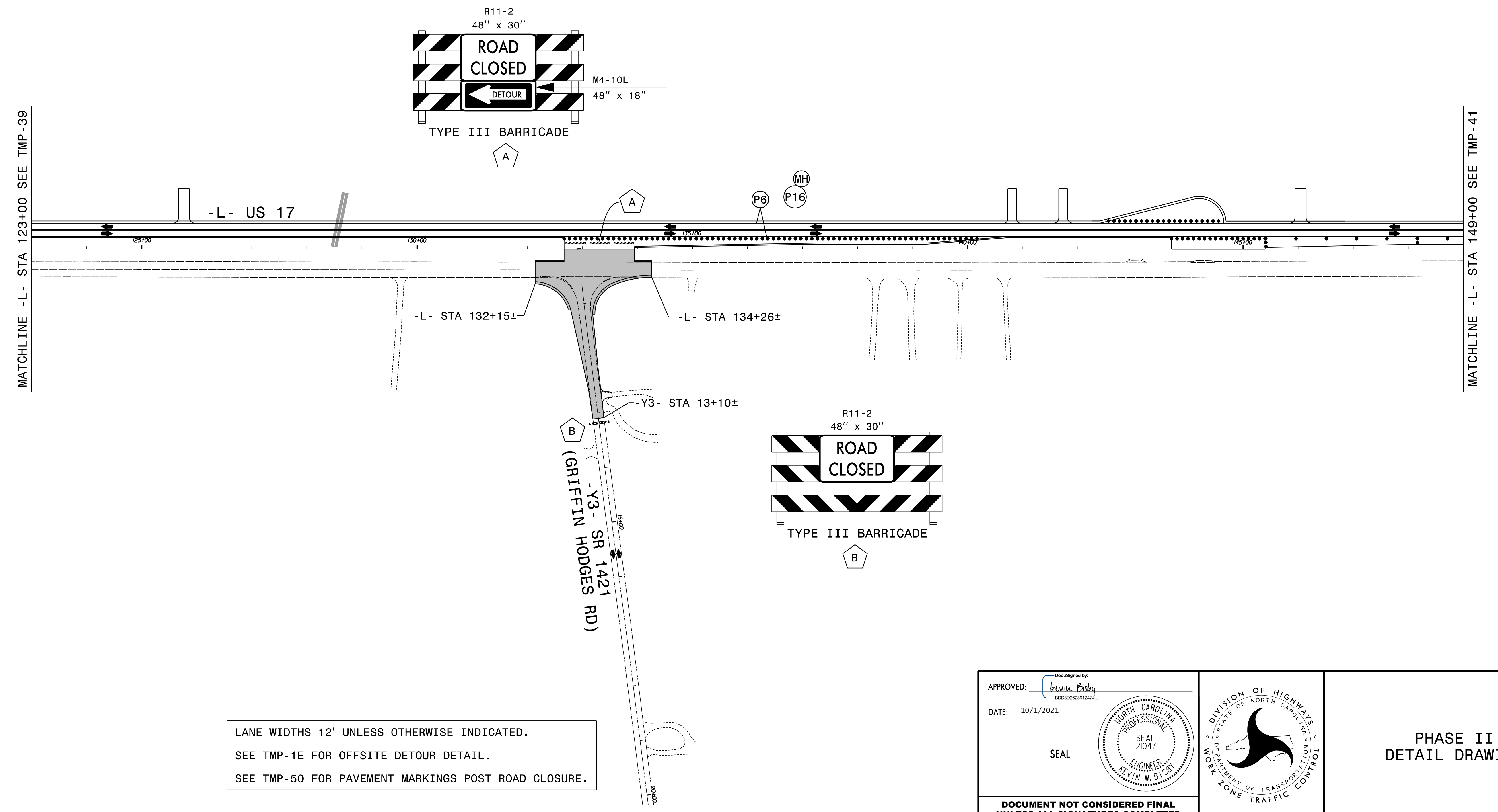
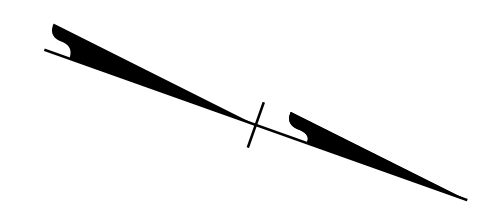

LANE WIDTHS 12' UNLESS OTHERWISE INDICATED.
 SEE TMP-1E FOR OFFSITE DETOUR DETAIL.
 SEE TMP-50 FOR PAVEMENT MARKINGS POST ROAD CLOSURE.

APPROVED: *Kevin Bisby*
 DATE: 10/1/2021

SEAL

**DOCUMENT NOT CONSIDERED FINAL
 UNLESS ALL SIGNATURES COMPLETED**

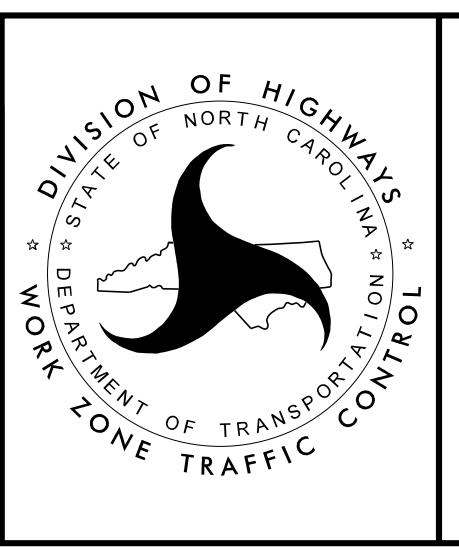

**PHASE II
 DETAIL DRAWING**

10/1/2021
 R2511-TMP_PSH40.dgn
 ksb1b1

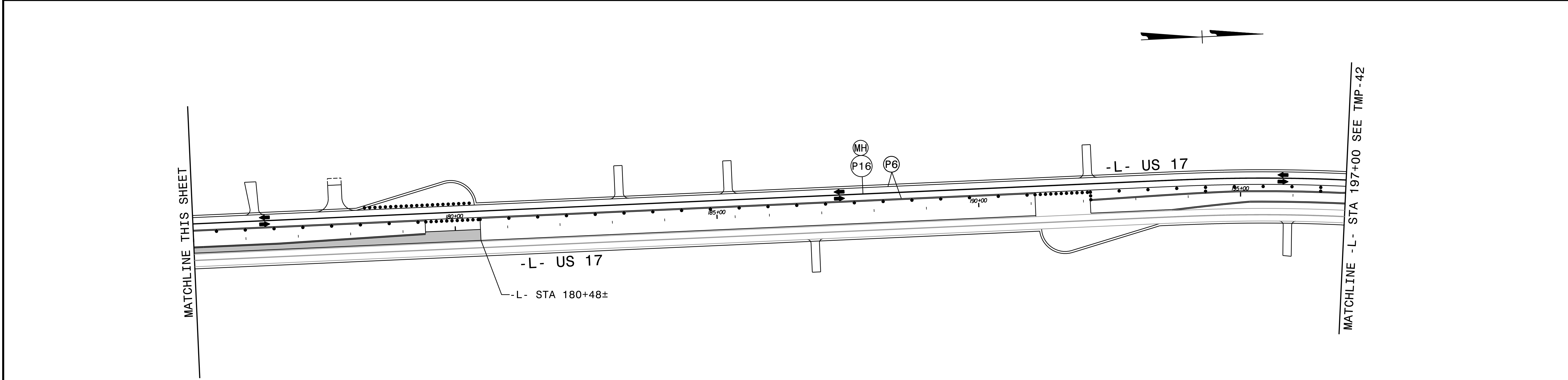
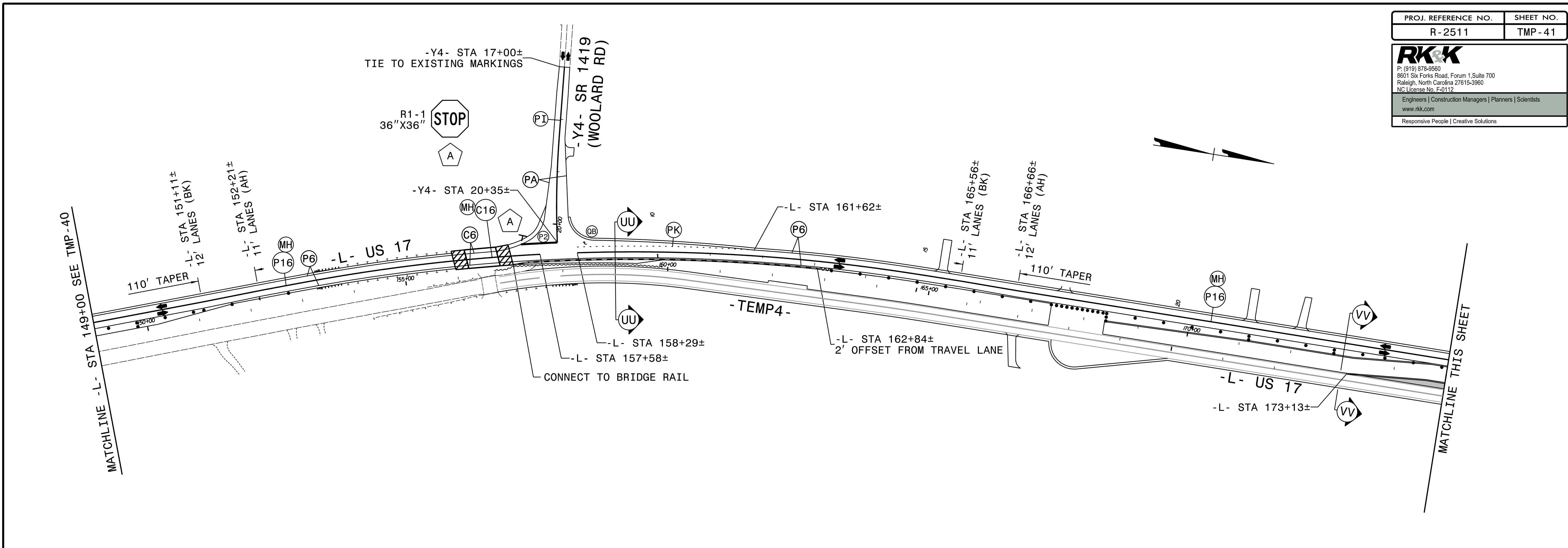

LANE WIDTHS 12' UNLESS OTHERWISE INDICATED.
 SEE TMP-41A FOR SECTION VIEW.

APPROVED: *Kevin Bisby*
 DATE: 10/1/2021

SEAL

**DOCUMENT NOT CONSIDERED FINAL
 UNLESS ALL SIGNATURES COMPLETED**

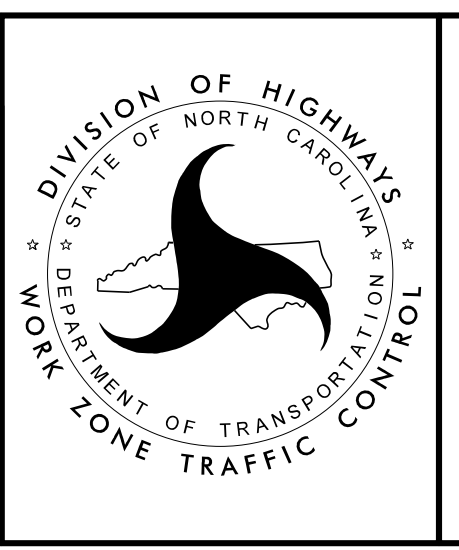

**PHASE II
 DETAIL DRAWING**

10/1/2021
 R2511_TMP_PSH41.dgn
 ksb

PROJ. REFERENCE NO.	SHEET NO.
R-2511	TMP-41A

RKK
 P: (919) 878-8560
 8601 Six Forks Road, Forum 1, Suite 700
 Raleigh, North Carolina 27615-3960
 NC License No. F-0112
 Engineers | Construction Managers | Planners | Scientists
 www.rkk.com
 Responsive People | Creative Solutions

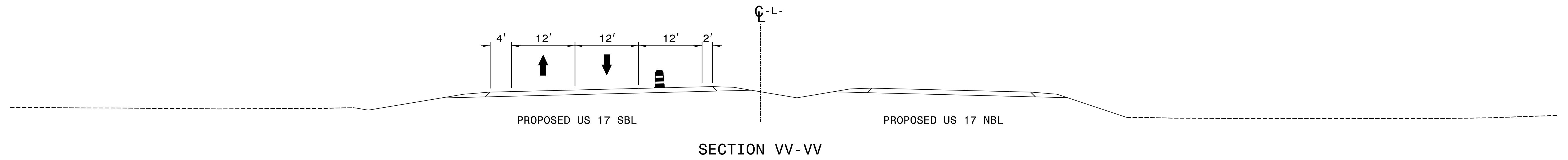
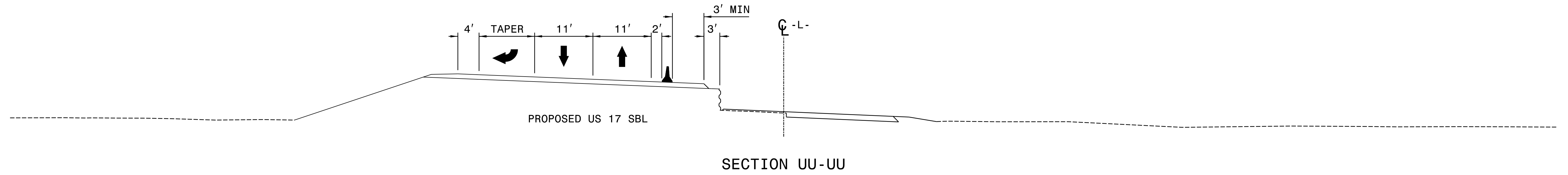

10/1/2021
R2511_TMP_PSH41A.dgn
ksf

APPROVED: 
DocuSigned by: Kevin Bisby
B0C802928912474

DATE: 10/1/2021

SEAL

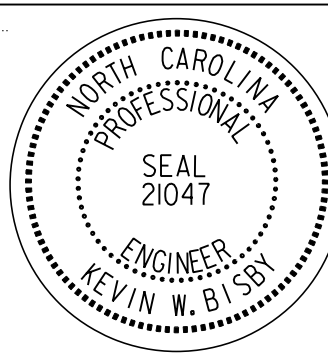
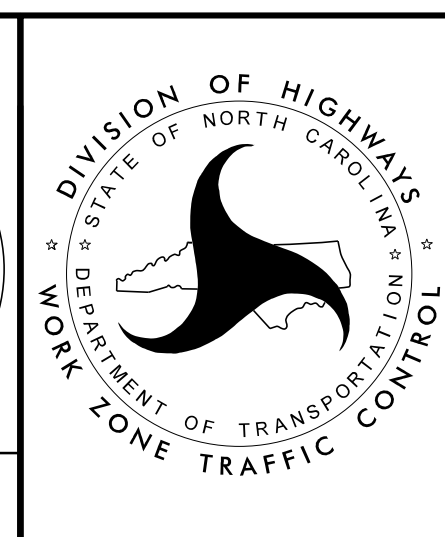
**PHASE II
DETAIL DRAWING**

**DOCUMENT NOT CONSIDERED FINAL
UNLESS ALL SIGNATURES COMPLETED**

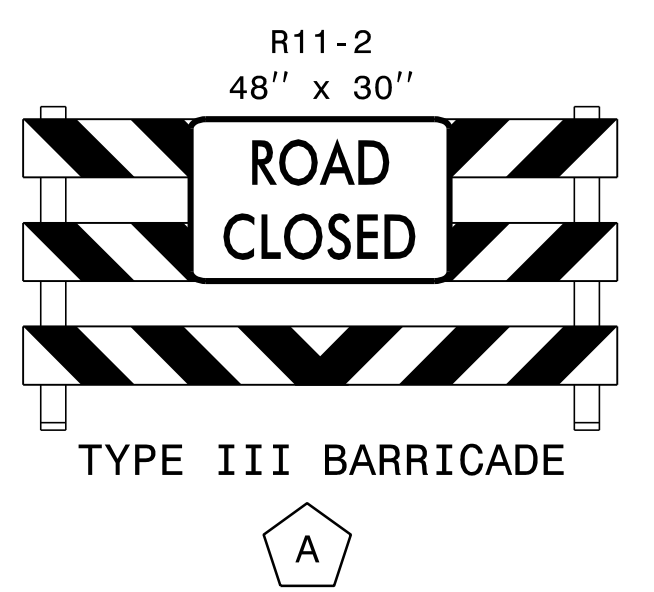
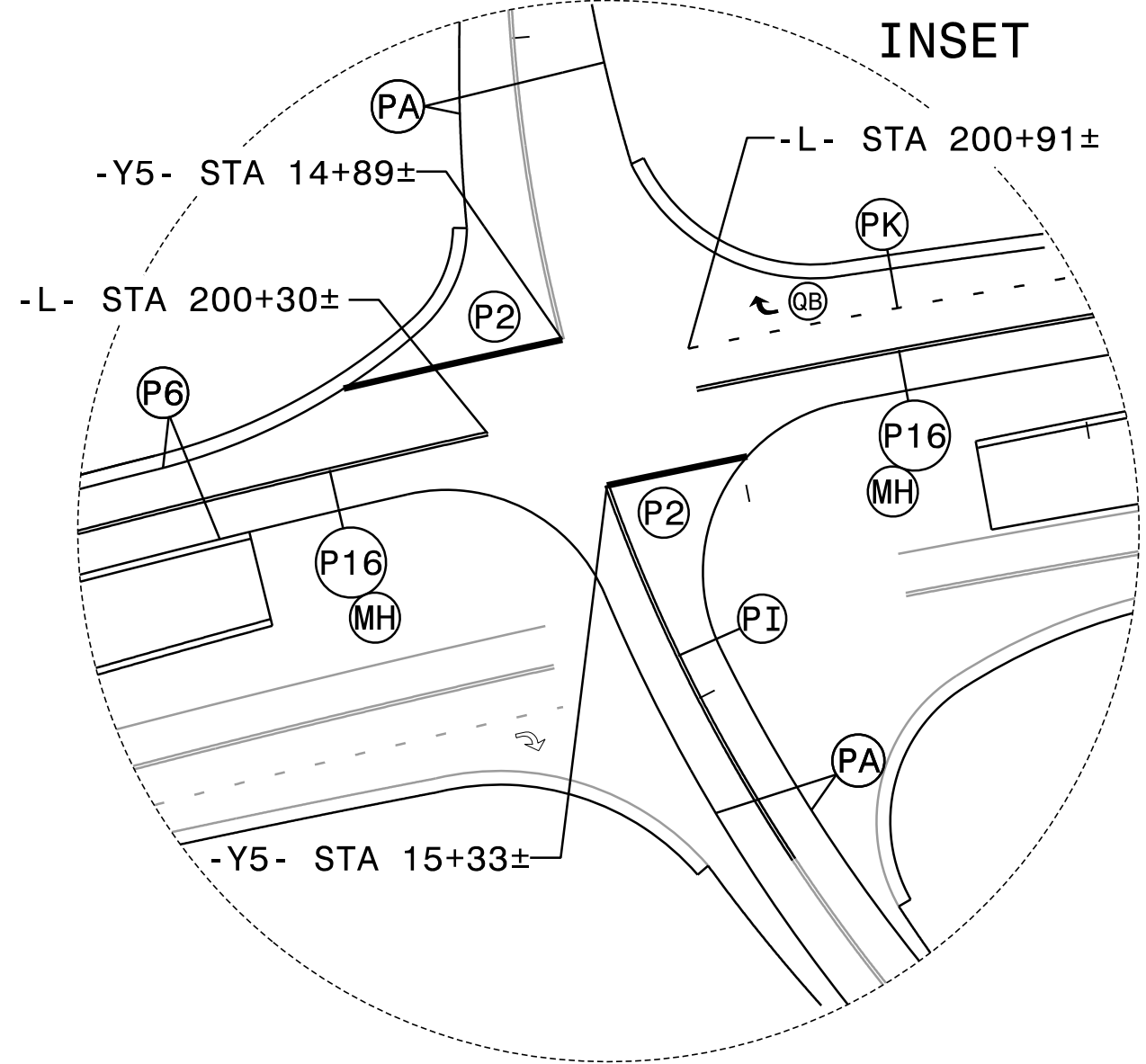
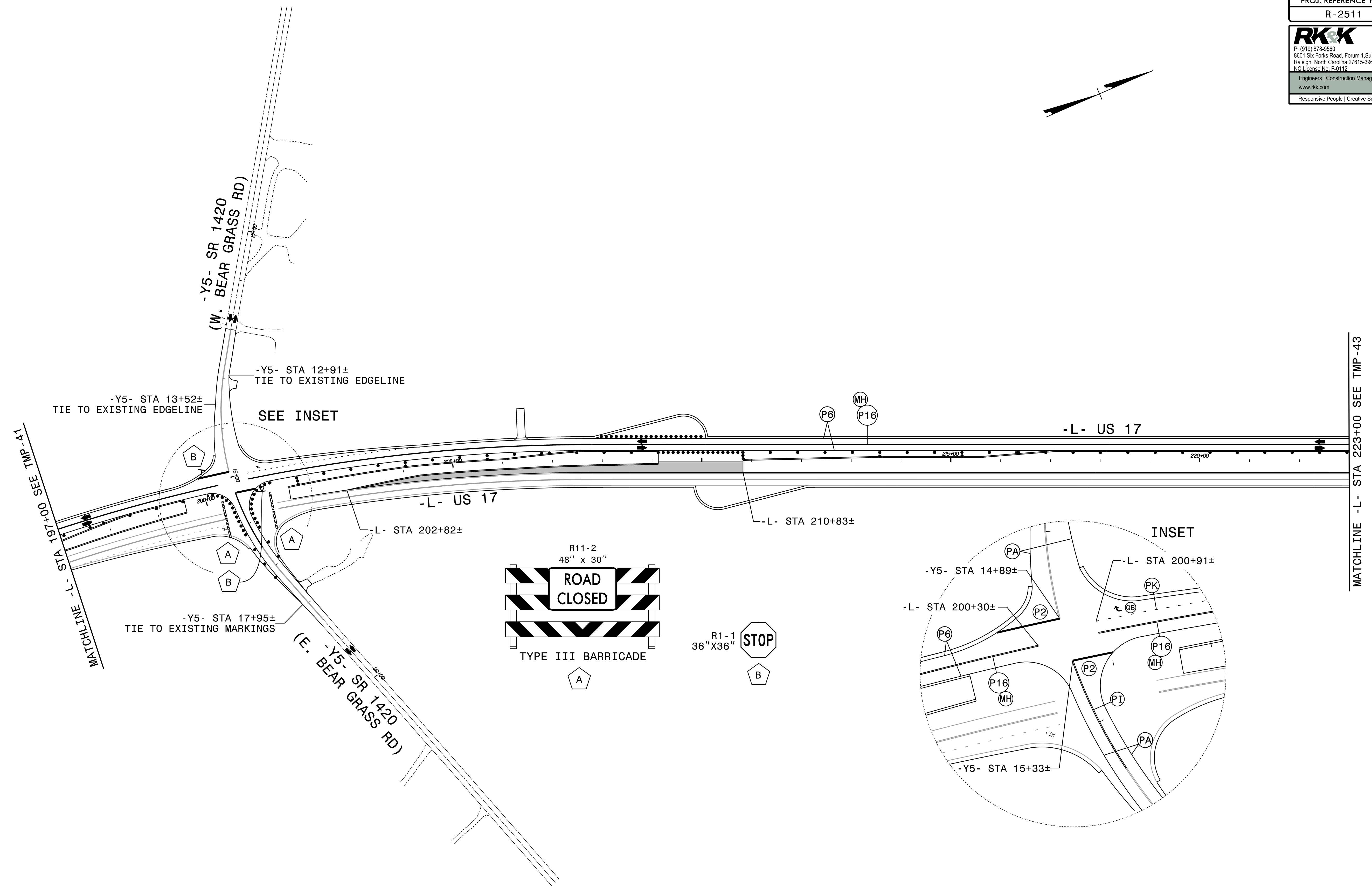
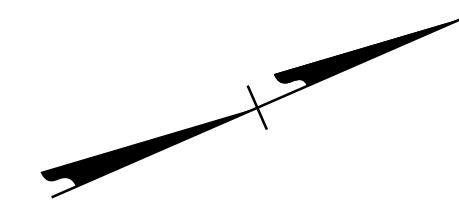

LANE WIDTHS 12' UNLESS OTHERWISE INDICATED.

APPROVED: *Kevin Bisby*
 DATE: 10/1/2021
 SEAL
 NORTH CAROLINA PROFESSIONAL ENGINEER
 SEAL 21047
 KEVIN W. BISBY

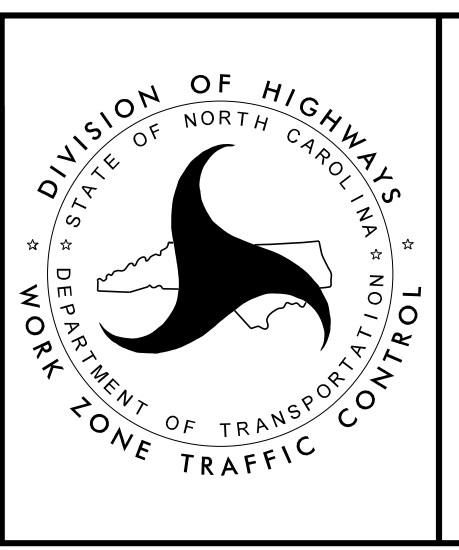

PHASE II
 DETAIL DRAWING

10/1/2021 R2511-TMP-PSH42.dgn KSB

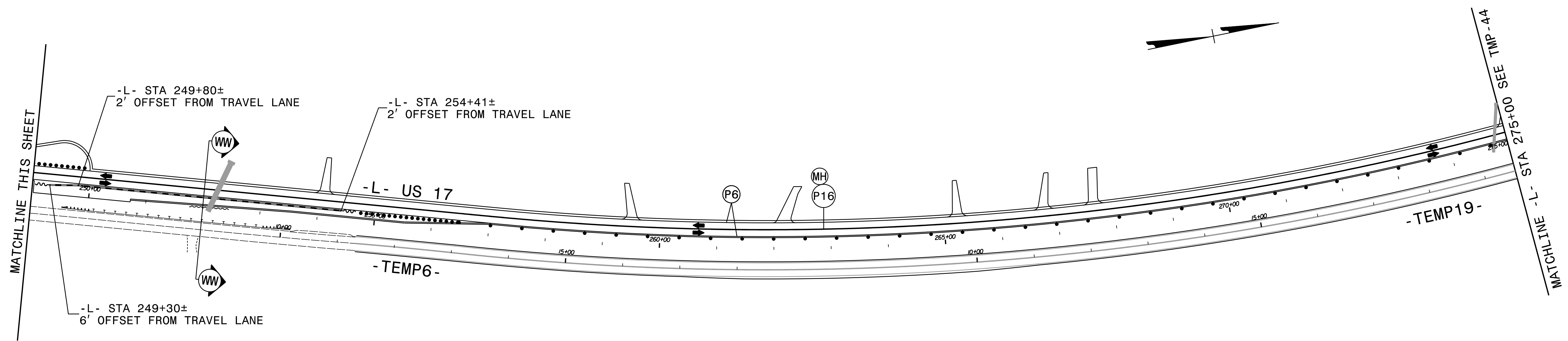
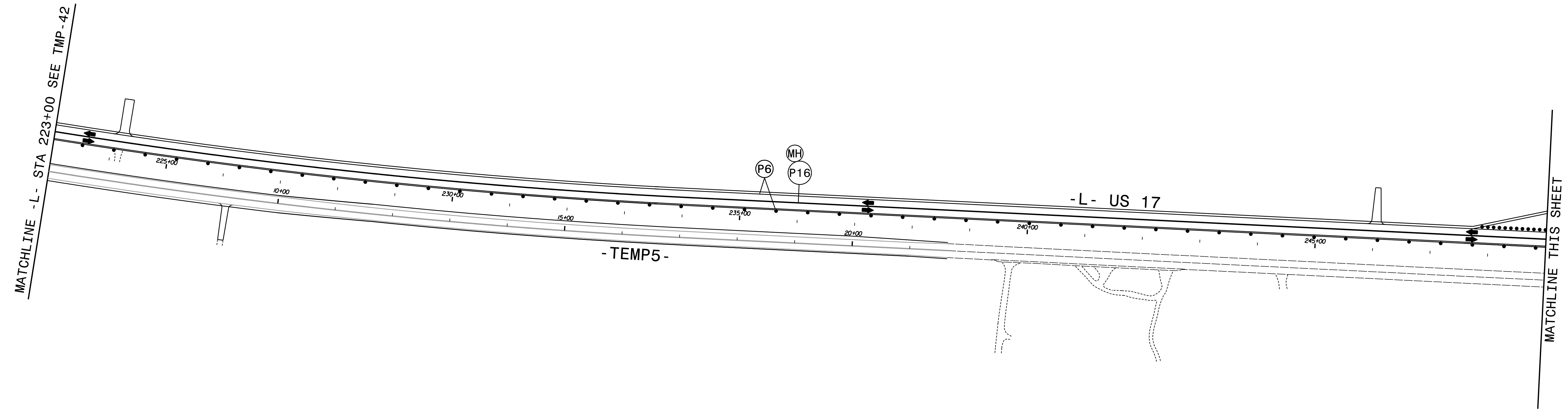

LANE WIDTHS 12' UNLESS OTHERWISE INDICATED.
 SEE TMP-43A FOR SECTION VIEW.

APPROVED: *Kevin Bisby*
DocuSigned by: Kevin Bisby
 B0C802928912474

DATE: 10/1/2021

SEAL

PROFESSIONAL ENGINEER
 KEVIN W. BISBY
 SEAL 21047
 NORTH CAROLINA

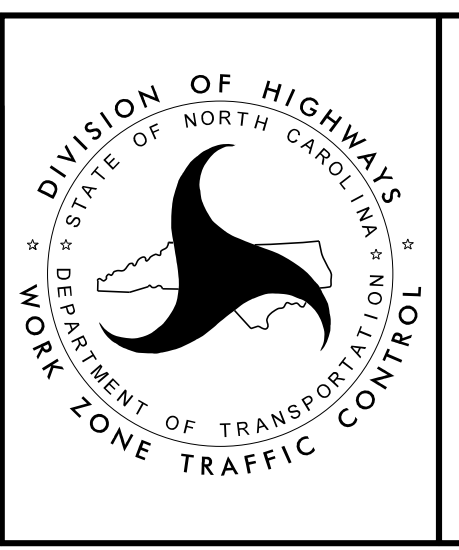

**DOCUMENT NOT CONSIDERED FINAL
 UNLESS ALL SIGNATURES COMPLETED**

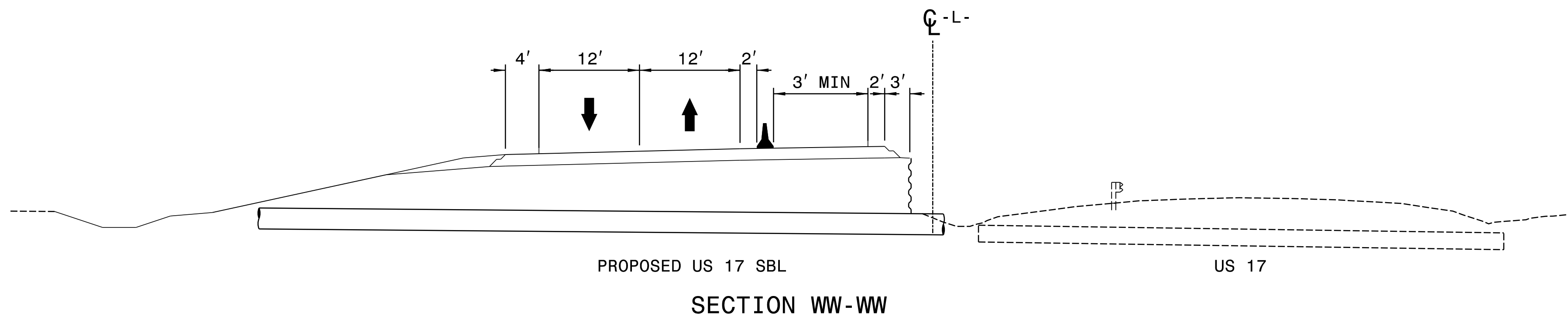

**PHASE II
 DETAIL DRAWING**

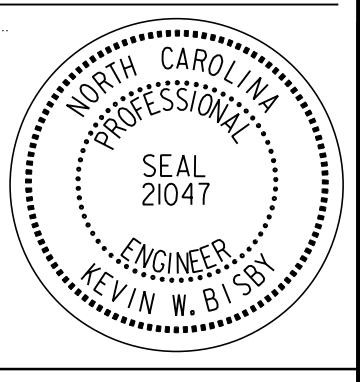

10/1/2021
R2511_TMP_PSH43A.dgn
ksf/bj

APPROVED:  DATE: 10/1/2021	SEAL 		PHASE II DETAIL DRAWING
DOCUMENT NOT CONSIDERED FINAL UNLESS ALL SIGNATURES COMPLETED			

PROJ. REFERENCE NO.	SHEET NO.
R-2511	TMP-44

RKK
 P: (919) 878-8560
 8601 Six Forks Road, Forum 1, Suite 700
 Raleigh, North Carolina 27615-3960
 NC License No. F-0112
 Engineers | Construction Managers | Planners | Scientists
 www.rkk.com
 Responsive People | Creative Solutions

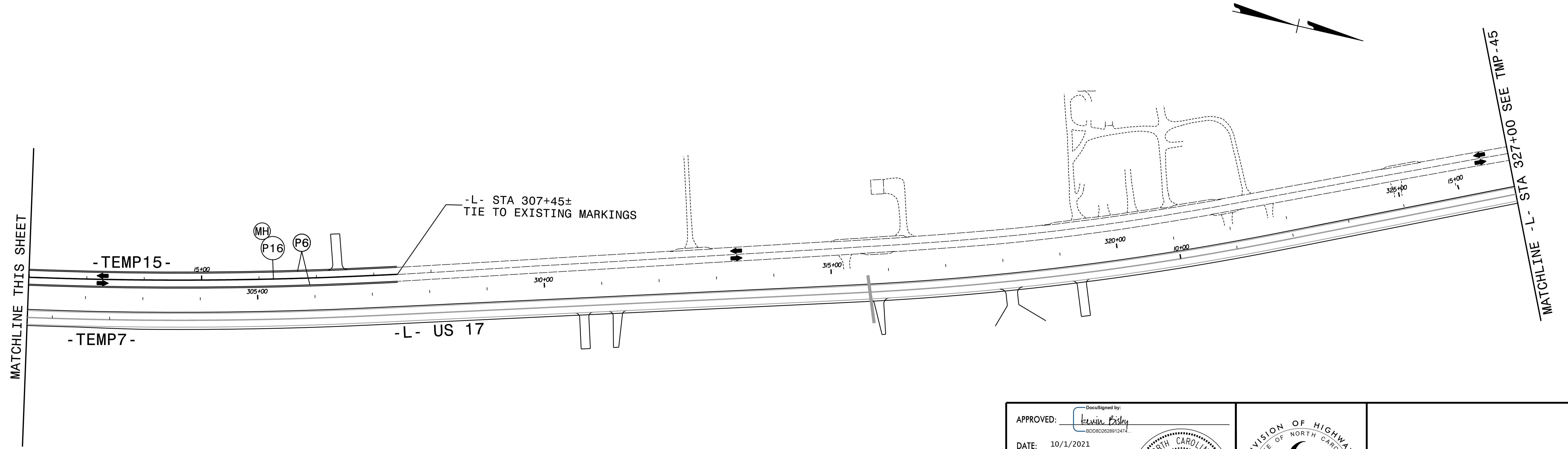
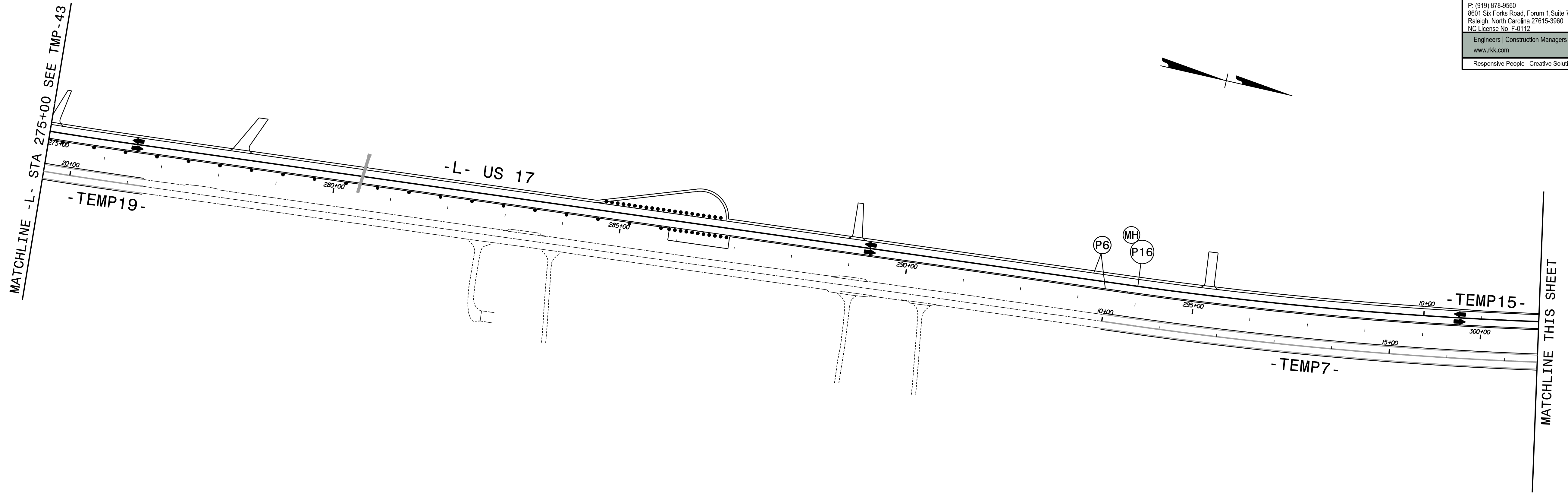

LANE WIDTHS 12' UNLESS OTHERWISE INDICATED.

APPROVED: *Kevin Bisby*
 DATE: 10/1/2021

SEAL

PROFESSIONAL ENGINEER
 SEAL 21047
 KEVIN W. BISBY

DOCUMENT NOT CONSIDERED FINAL
 UNLESS ALL SIGNATURES COMPLETED

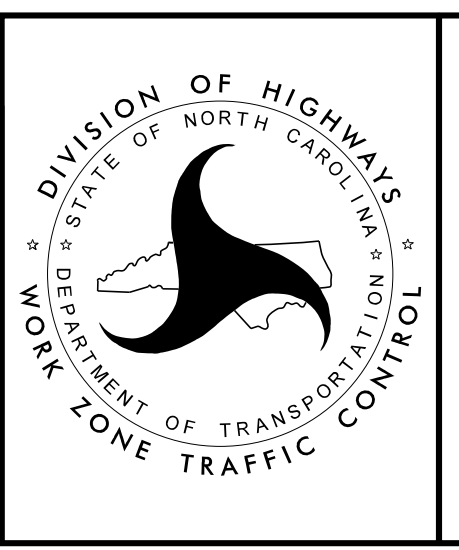

PHASE II
 DETAIL DRAWING

10/1/2021
 R2511_TMP_PSH44.dgn
 kws/bbl

PROJ. REFERENCE NO.	SHEET NO.
R-2511	TMP-45

RKK
 P: (919) 878-8560
 8601 Six Forks Road, Forum 1, Suite 700
 Raleigh, North Carolina 27615-3960
 NC License No. F-0112
 Engineers | Construction Managers | Planners | Scientists
 www.rkk.com
 Responsive People | Creative Solutions

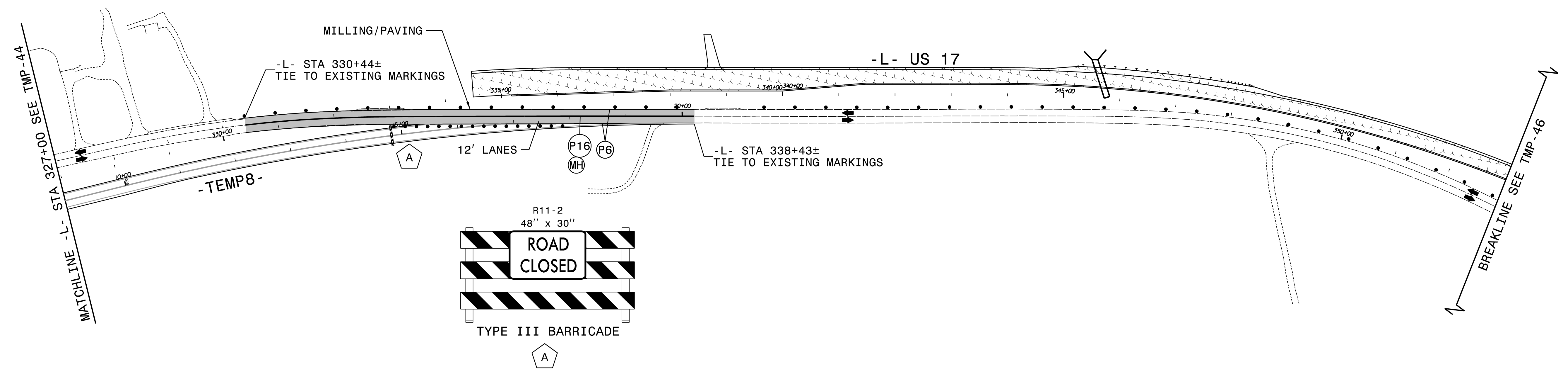

10/1/2021
 R2511_TMP_PSH45.dgn
 ksb

APPROVED: *Kevin Bisby*
 DATE: 10/1/2021

SEAL

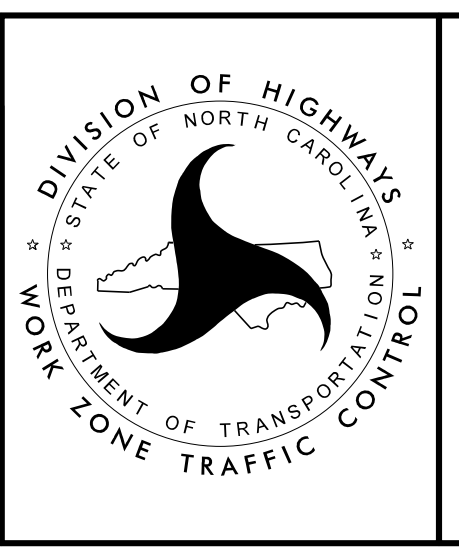

**DOCUMENT NOT CONSIDERED FINAL
 UNLESS ALL SIGNATURES COMPLETED**

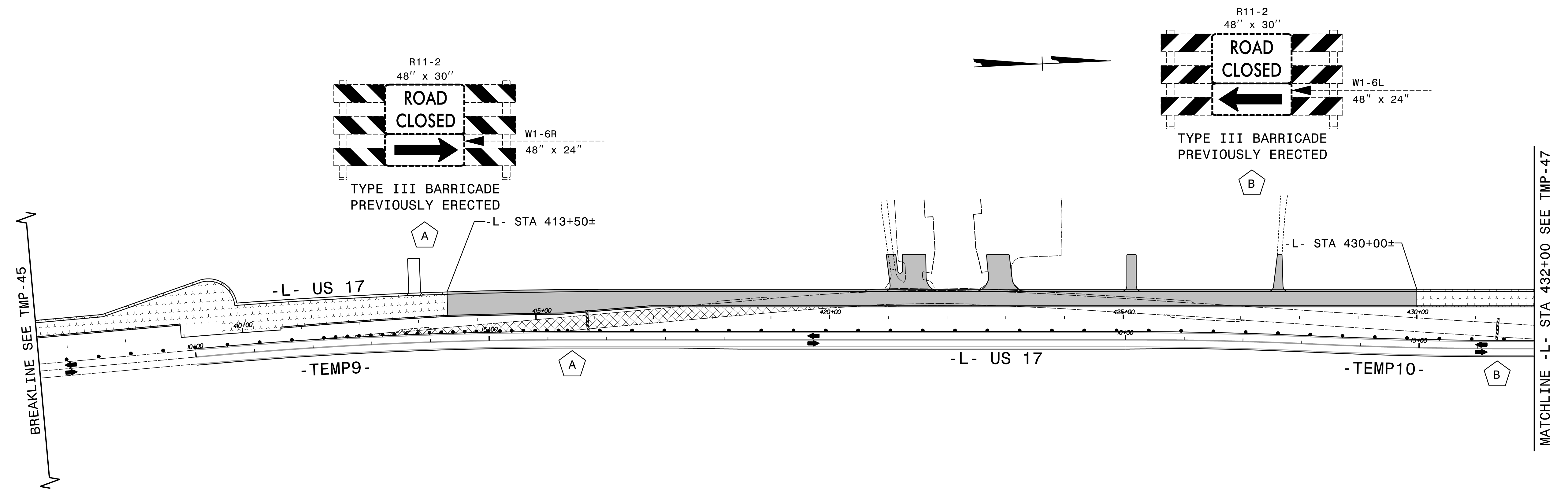

**PHASE II
 DETAIL DRAWING**

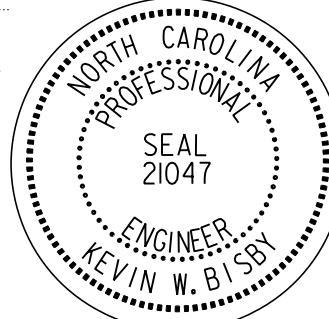

10/1/2021
R2511_TMP_PSH46.dgn
KWB

<p>APPROVED:  <small>DocuSigned by: Kevin Bisby BDC802928912474</small></p> <p>DATE: 10/1/2021</p> <p>SEAL</p> 		<p>PHASE II DETAIL DRAWING</p>
<p>DOCUMENT NOT CONSIDERED FINAL UNLESS ALL SIGNATURES COMPLETED</p>		

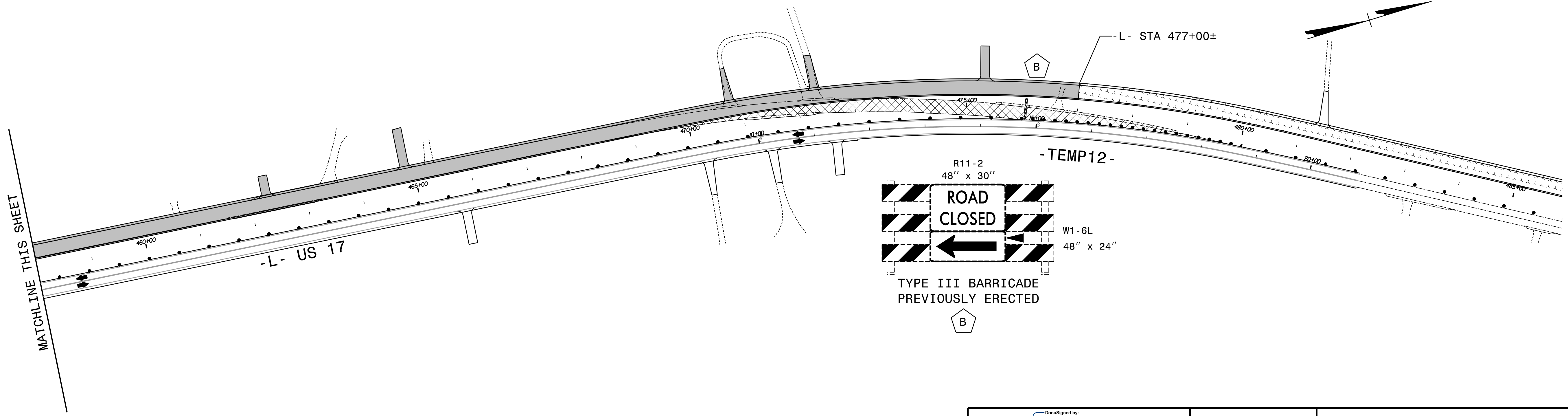
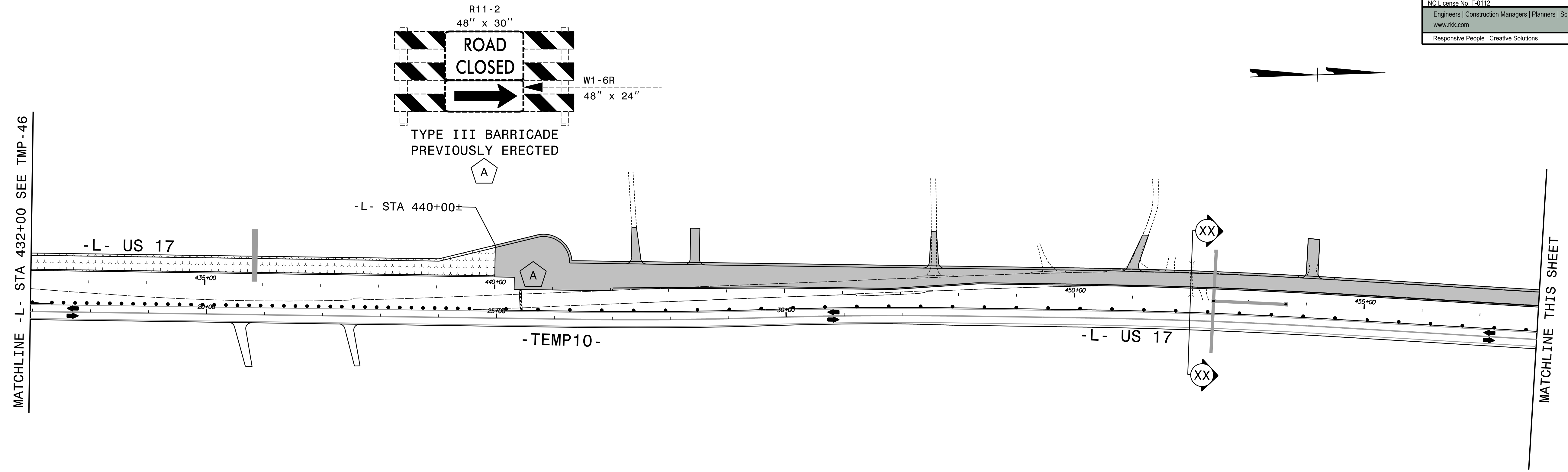

SEE TMP-47A FOR SECTION VIEW.

APPROVED: *Kevin Bisby*
 DATE: 10/1/2021

SEAL

DOCUMENT NOT CONSIDERED FINAL
 UNLESS ALL SIGNATURES COMPLETED

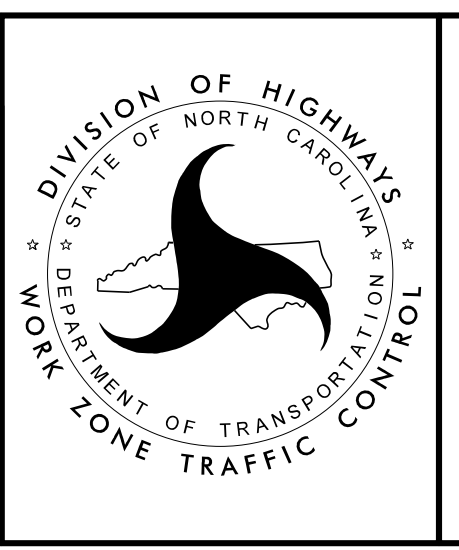

DIVISION OF HIGHWAYS
 DEPARTMENT OF TRANSPORTATION
 WORK ZONE TRAFFIC CONTROL

PHASE II
 DETAIL DRAWING

PROJ. REFERENCE NO.	SHEET NO.
R-2511	TMP-47A

RKK
 P: (919) 878-8560
 8601 Six Forks Road, Forum 1, Suite 700
 Raleigh, North Carolina 27615-3960
 NC License No. F-0112
 Engineers | Construction Managers | Planners | Scientists
 www.rkk.com
 Responsive People | Creative Solutions

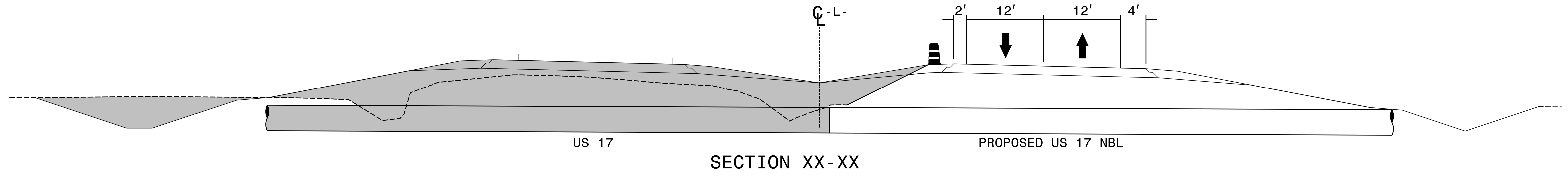

10/1/2021
 R2511_TMP_PSH47A.dgn
 KWS/BJL

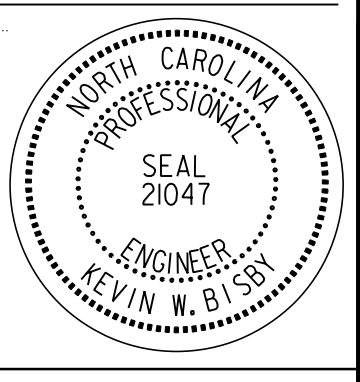
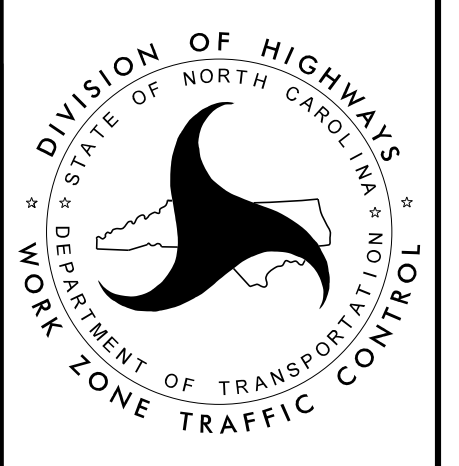
APPROVED:  <small>DocuSigned by: Kevin Blisby B0C802928912474</small> DATE: 10/1/2021	SEAL 		<h2 style="margin: 0;">PHASE II DETAIL DRAWING</h2>
DOCUMENT NOT CONSIDERED FINAL UNLESS ALL SIGNATURES COMPLETED			

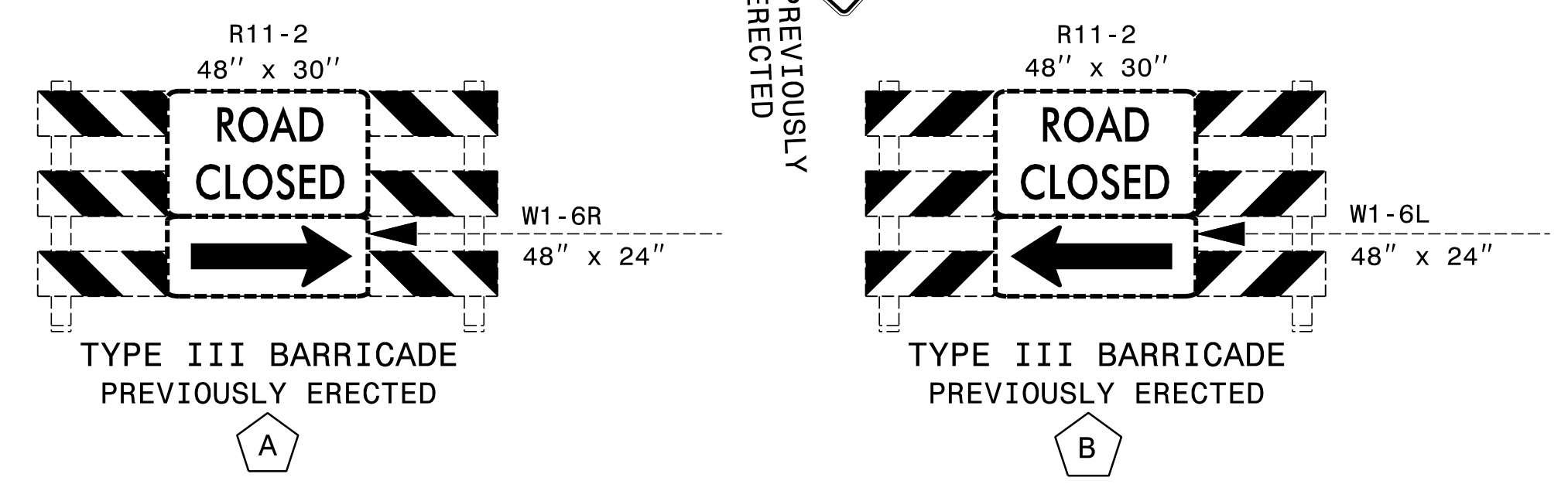
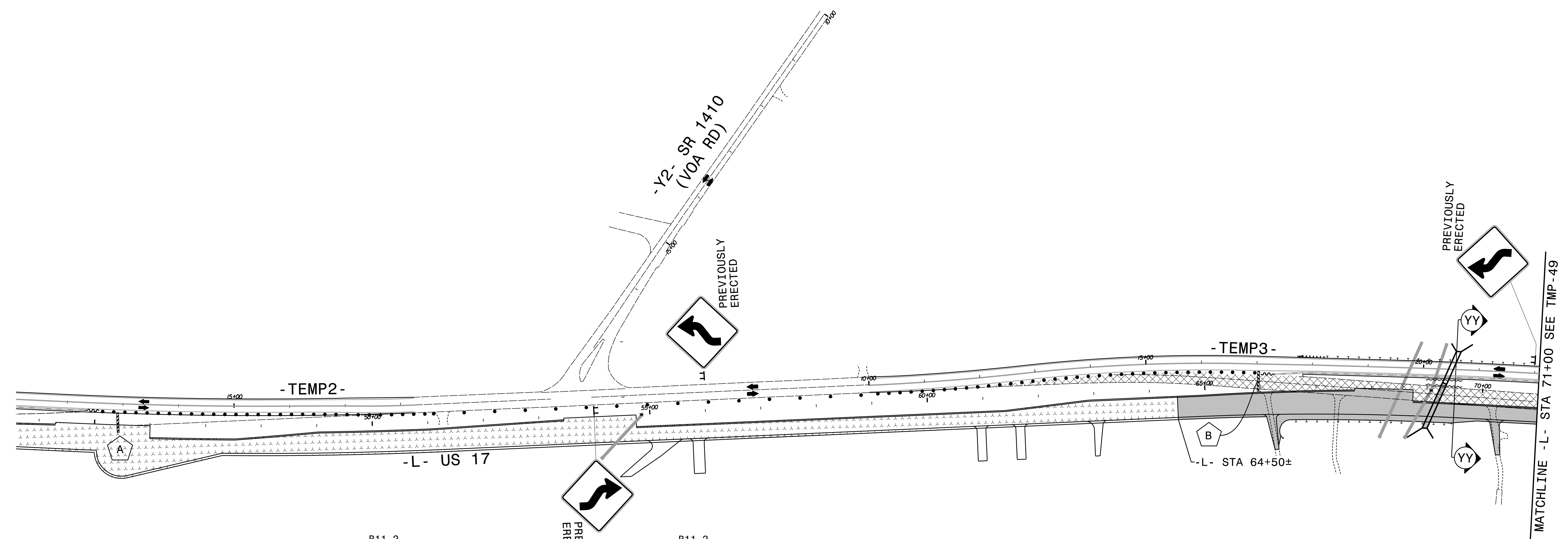
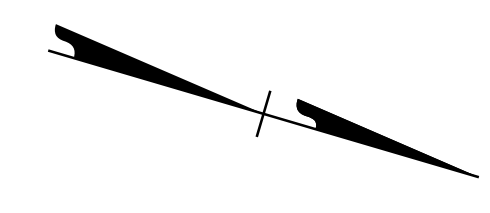

SEE TMP-48A FOR SECTION VIEW.

APPROVED: *Kevin Bisby*
 DATE: 10/1/2021
 SEAL
 NORTH CAROLINA PROFESSIONAL ENGINEER
 SEAL 21047
 KEVIN W. BISBY

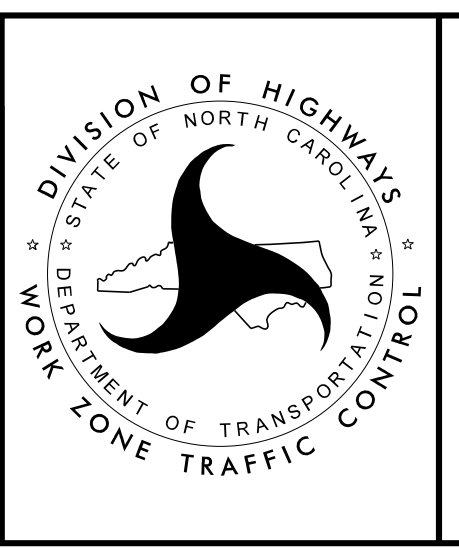

PHASE III
 DETAIL DRAWING



10/1/2021
 R2511_TMP_PSH48.dgn
 ksb

PROJ. REFERENCE NO.	SHEET NO.
R-2511	TMP-48A

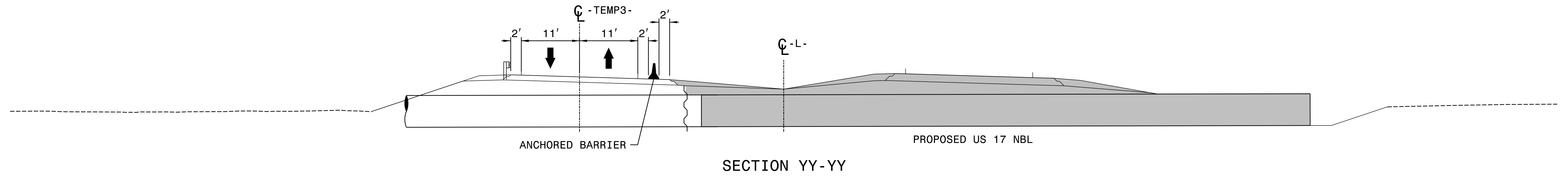
RKK
 P: (919) 878-8560
 8601 Six Forks Road, Forum 1, Suite 700
 Raleigh, North Carolina 27615-3960
 NC License No. F-0112
 Engineers | Construction Managers | Planners | Scientists
 www.rkk.com
 Responsive People | Creative Solutions



10/1/2021
R2511_TMP_PSH48A.dgn
KWB

<p>APPROVED:  <small>DocuSigned by: Kevin W. Bisby B0C802928912474</small></p> <p>DATE: 10/1/2021</p> <p>SEAL</p>		 <p style="text-align: center;">PHASE III DETAIL DRAWING</p>
<p style="text-align: center;">DOCUMENT NOT CONSIDERED FINAL UNLESS ALL SIGNATURES COMPLETED</p>		

PROJ. REFERENCE NO.	SHEET NO.
R - 2511	TMP - 49

RKK
 P: (919) 878-8560
 8601 Six Forks Road, Forum 1, Suite 700
 Raleigh, North Carolina 27615-3960
 NC License No. F-0112
 Engineers | Construction Managers | Planners | Scientists
 www.rkk.com
 Responsive People | Creative Solutions

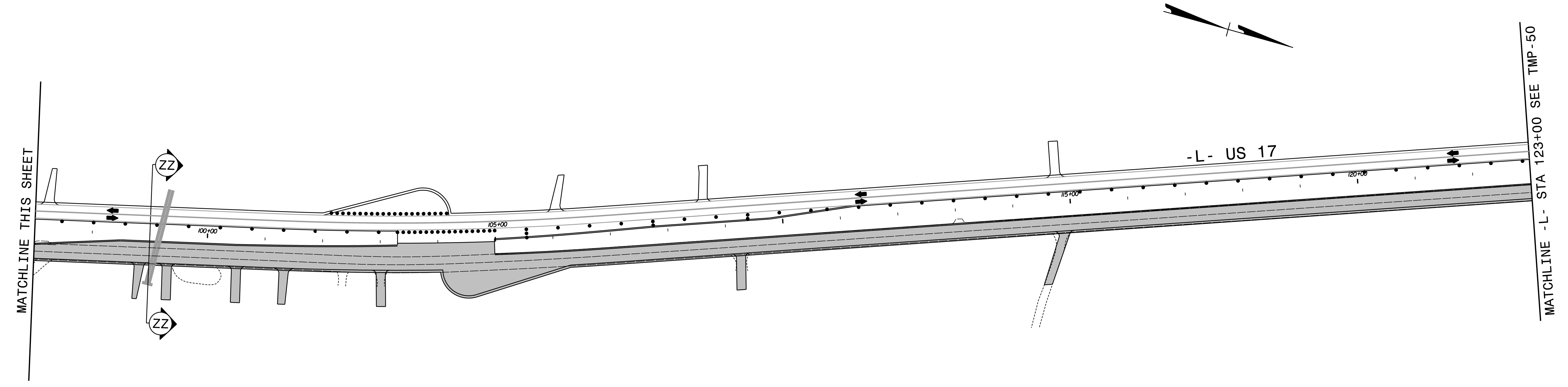
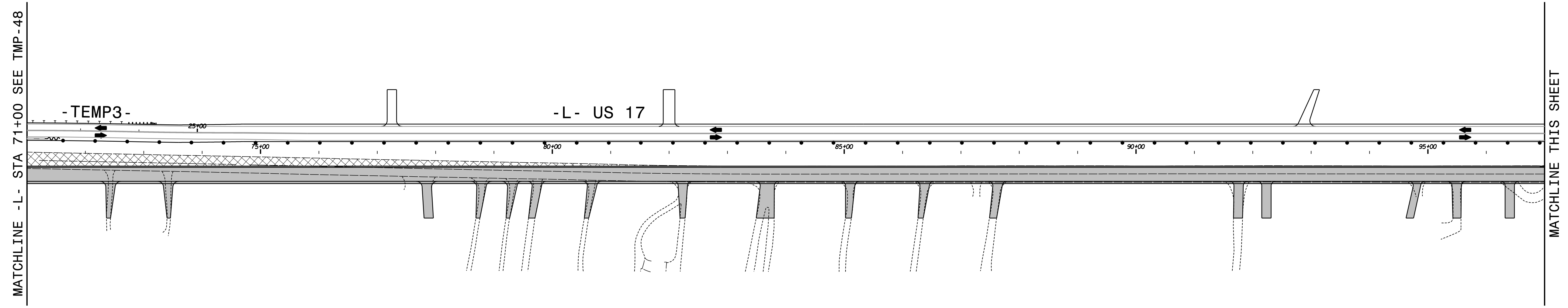

SEE TMP-49A FOR SECTION VIEW.

APPROVED: *Kevin Bisby*
DocuSigned by: Kevin Bisby
 BDC802928912474

DATE: 10/1/2021

SEAL

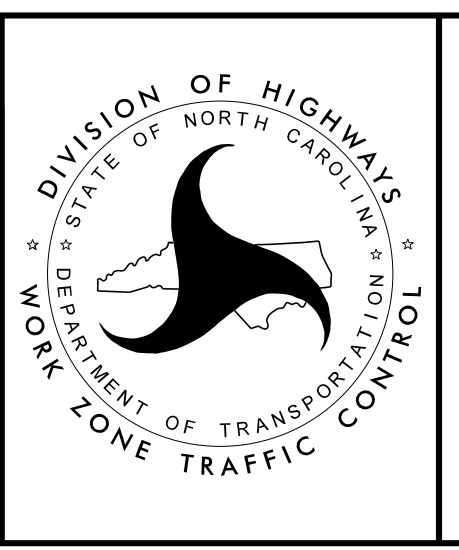

PHASE III
 DETAIL DRAWING



10/1/2021
 R2511_TMP_PSH49.dgn
 ksb

PROJ. REFERENCE NO.	SHEET NO.
R-2511	TMP-49A

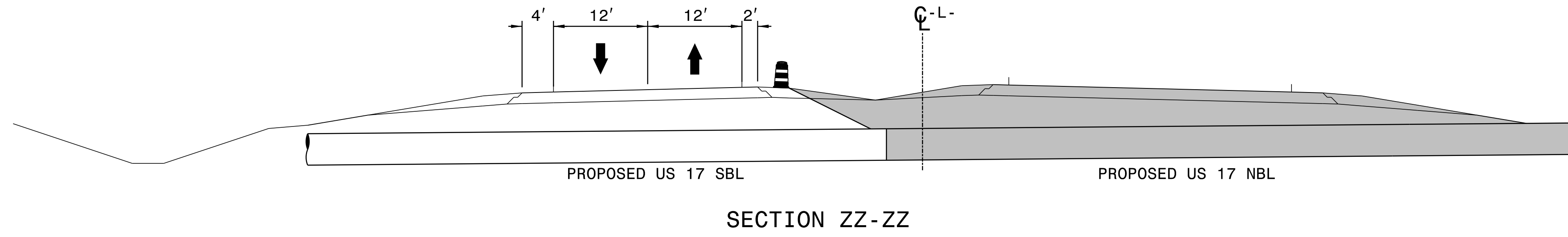
RKK
 P: (919) 878-8560
 8601 Six Forks Road, Forum 1, Suite 700
 Raleigh, North Carolina 27615-3960
 NC License No. F-0112
 Engineers | Construction Managers | Planners | Scientists
 www.rkk.com
 Responsive People | Creative Solutions



10/1/2021
 R2511_TMP_PSH49A.dgn
 KWS/bl

<p>APPROVED:  <small>DocuSigned by: Kevin W. Bisby BDC802928912474</small></p> <p>DATE: 10/1/2021</p> <p>SEAL</p>		 <p>PHASE III DETAIL DRAWING</p>
<p>DOCUMENT NOT CONSIDERED FINAL UNLESS ALL SIGNATURES COMPLETED</p>		

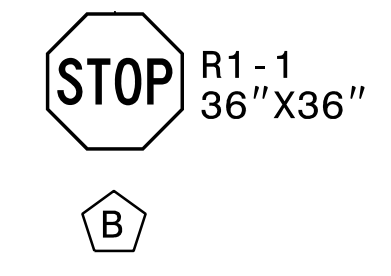
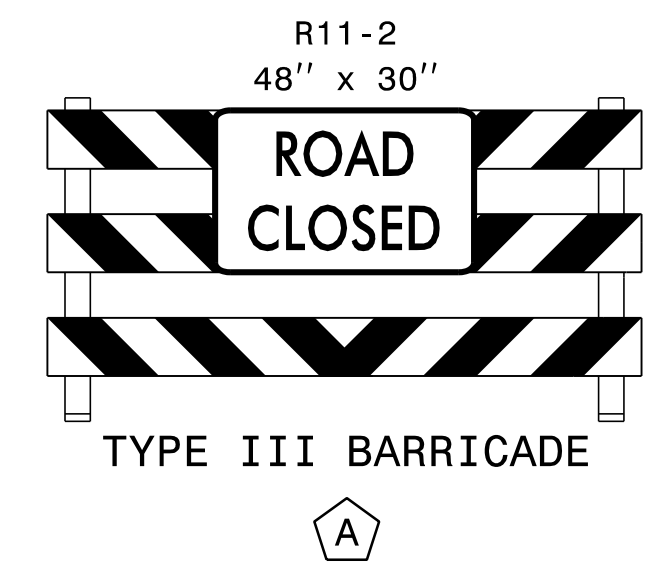
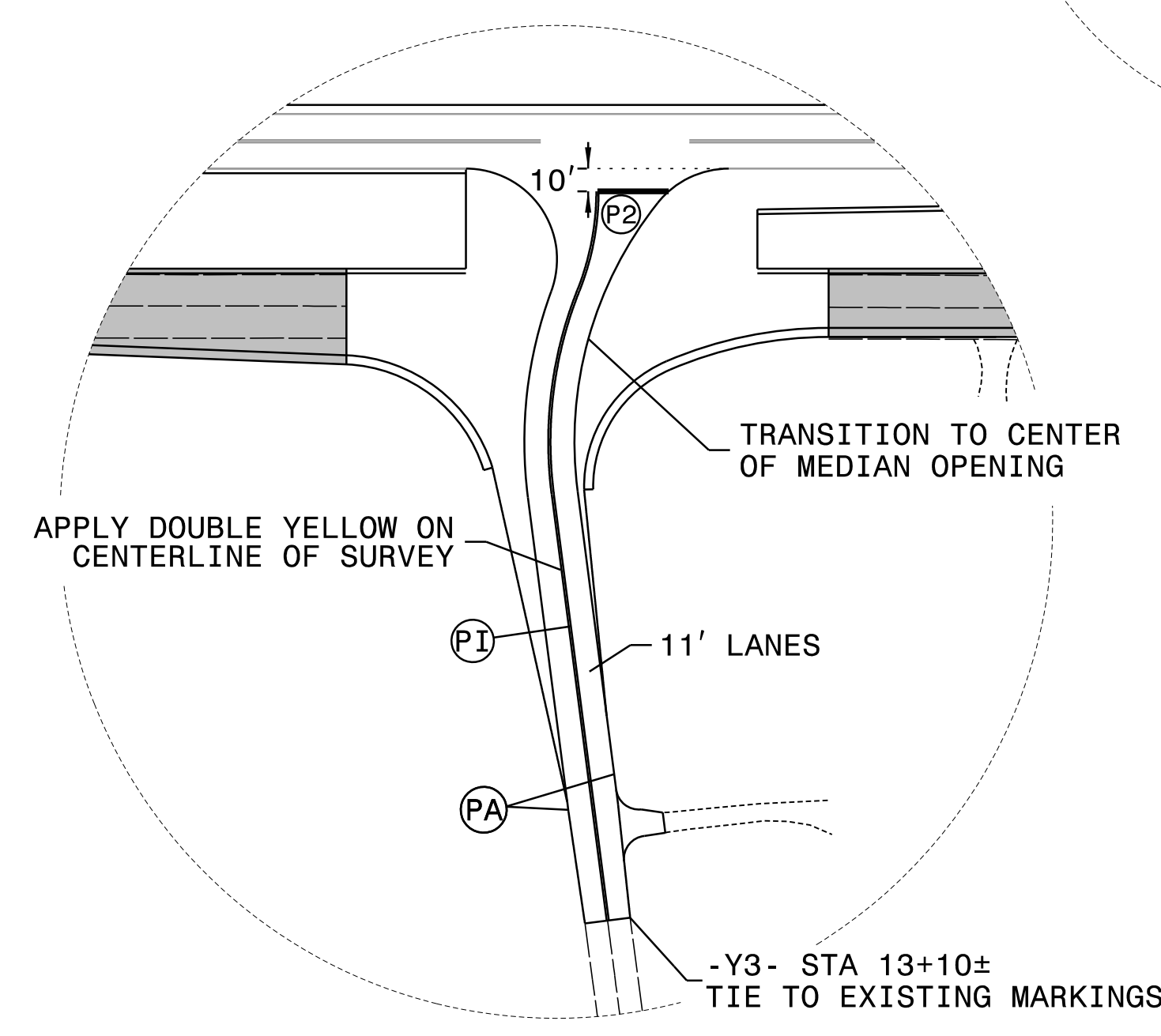
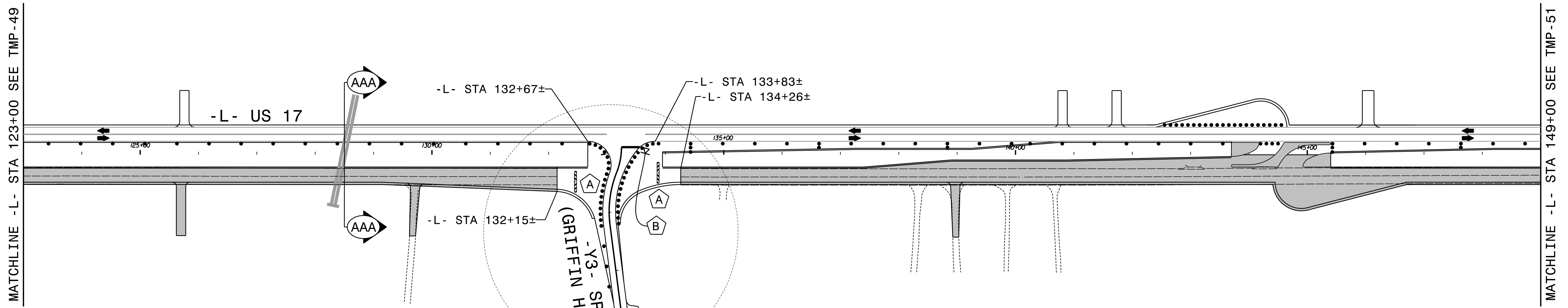
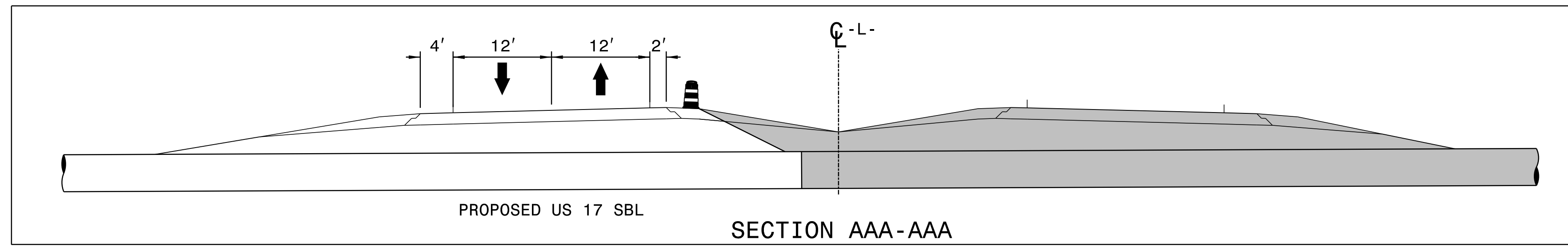
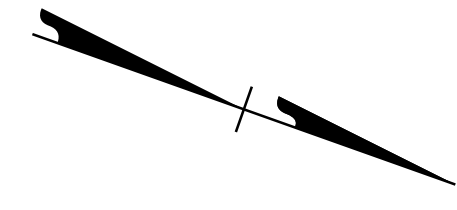

APPROVED: *Kevin Bisby*
 DATE: 10/1/2021

SEAL

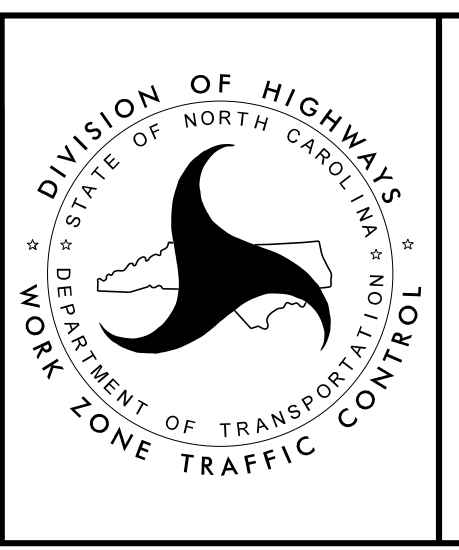

PHASE III
 DETAIL DRAWING

10/1/2021
 R2511_TMP_PSH50.dgn
 KSB

DOCUMENT NOT CONSIDERED FINAL
 UNLESS ALL SIGNATURES COMPLETED

PROJ. REFERENCE NO.	SHEET NO.
R-2511	TMP-51

RKK
 P: (919) 878-8560
 8601 Six Forks Road, Forum 1, Suite 700
 Raleigh, North Carolina 27615-3960
 NC License No. F-0112
 Engineers | Construction Managers | Planners | Scientists
 www.rkk.com
 Responsive People | Creative Solutions

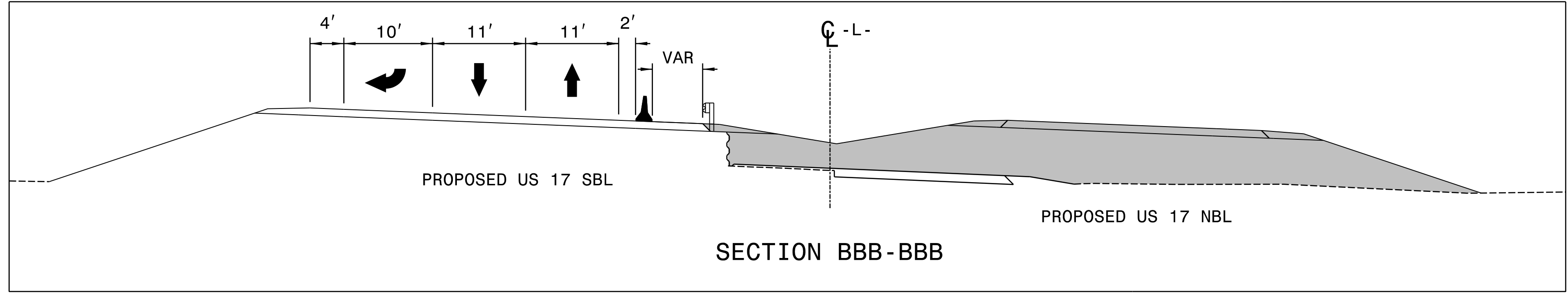
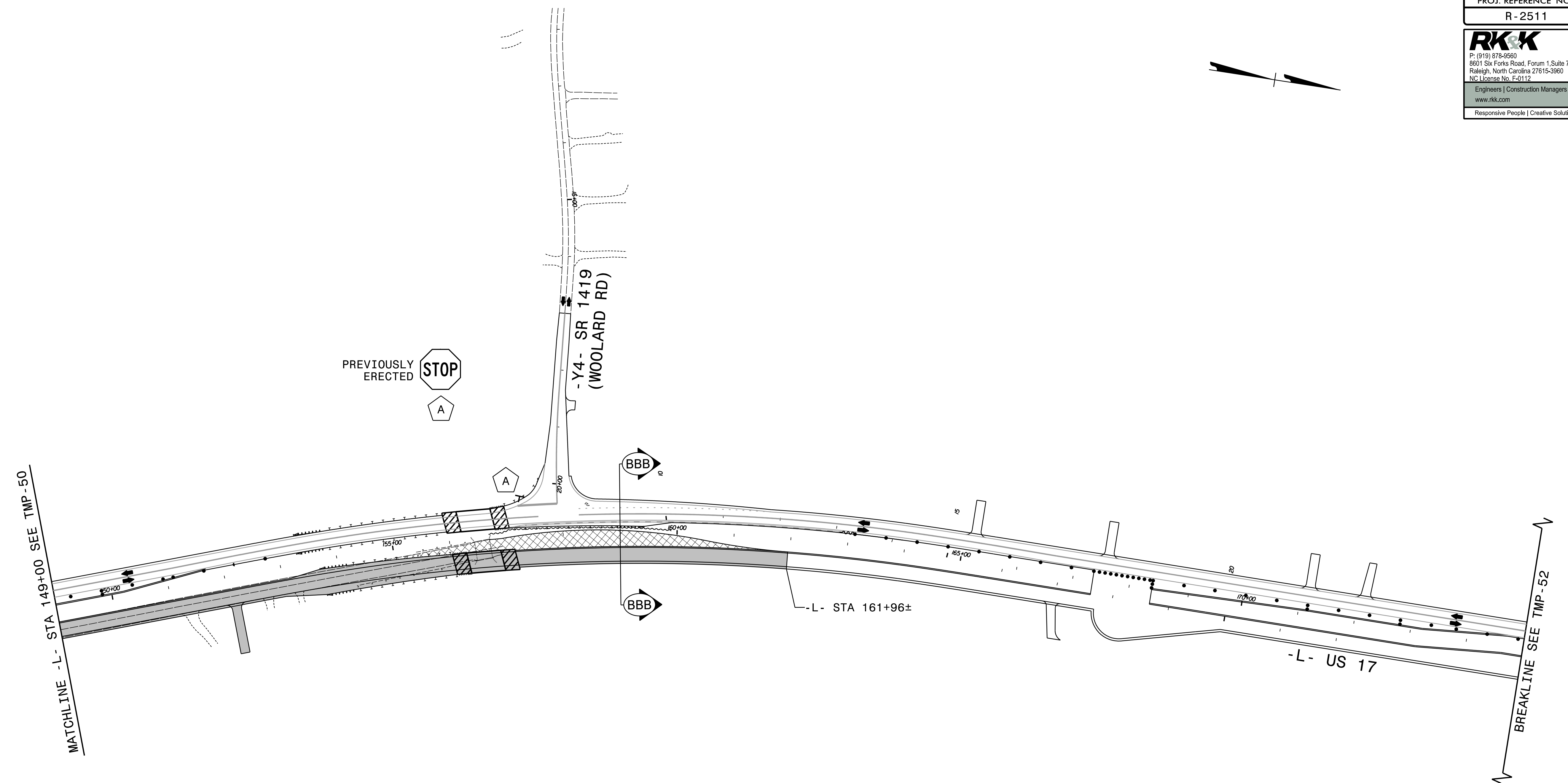

10/1/2021
R2511_TMP_PSH51.dgn
KSH

APPROVED: 
DocuSigned by: Kevin Bisby
BDD802928912474

DATE: 10/1/2021

SEAL

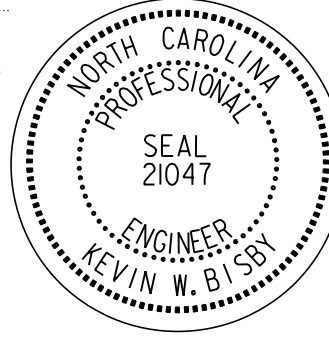
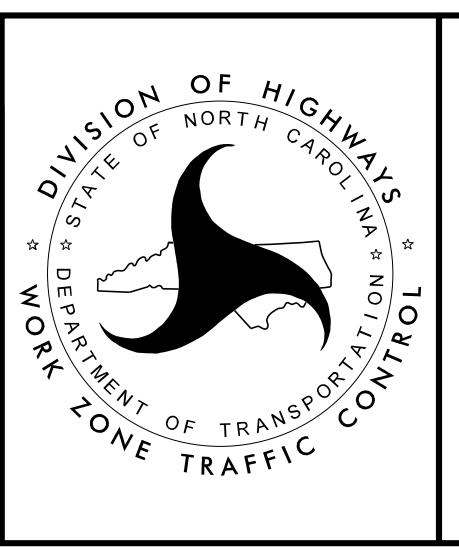



**PHASE III
DETAIL DRAWING**

**DOCUMENT NOT CONSIDERED FINAL
UNLESS ALL SIGNATURES COMPLETED**

PROJ. REFERENCE NO.	SHEET NO.
R-2511	TMP-52

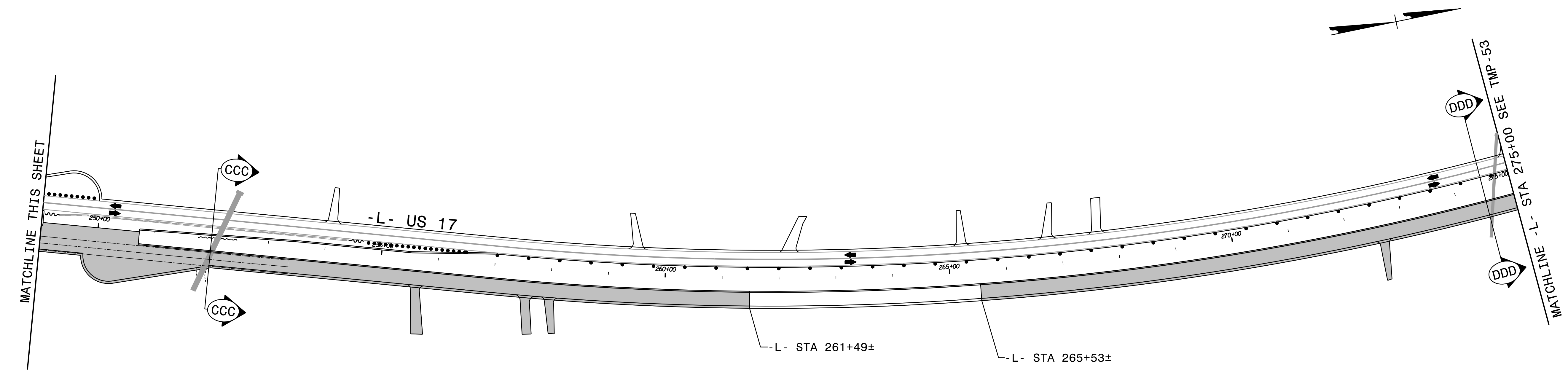
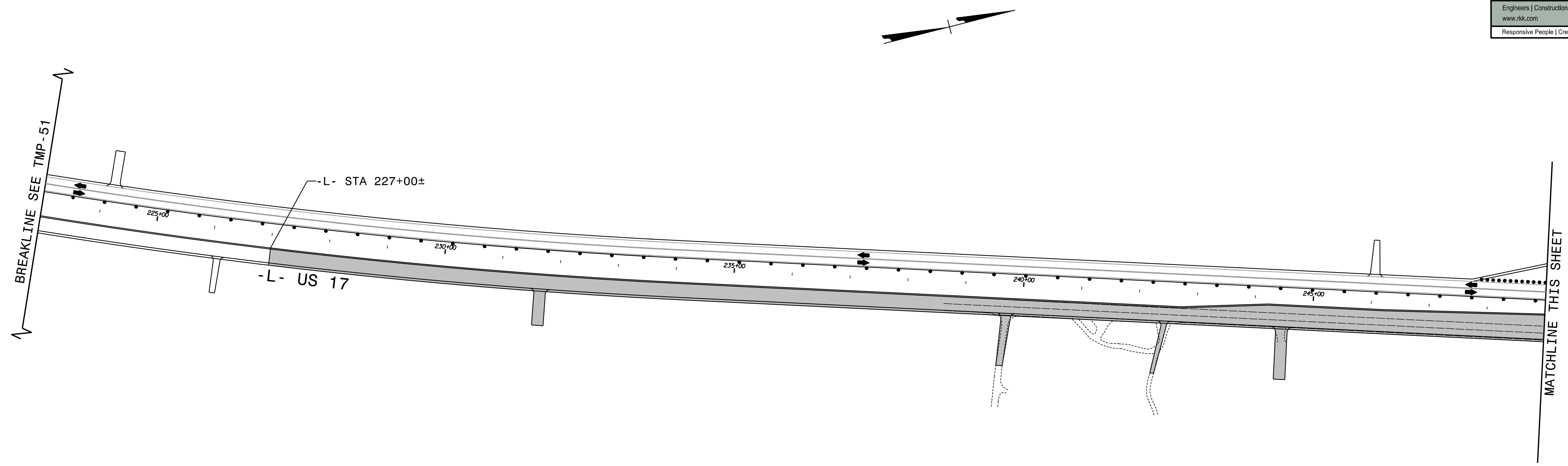
RKK
 P: (919) 878-8560
 8601 Six Forks Road, Forum 1, Suite 700
 Raleigh, North Carolina 27615-3960
 NC License No. F-0112
 Engineers | Construction Managers | Planners | Scientists
 www.rkk.com
 Responsive People | Creative Solutions



SEE TMP-52A FOR SECTION VIEWS.

APPROVED: *Kevin Bisby*
 DATE: 10/1/2021

SEAL

DOCUMENT NOT CONSIDERED FINAL
 UNLESS ALL SIGNATURES COMPLETED

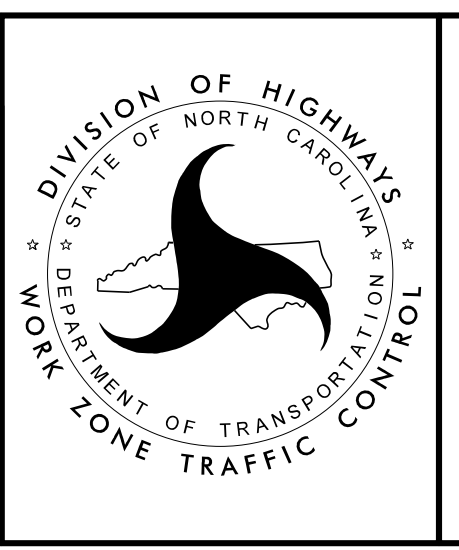



DIVISION OF HIGHWAYS
 NORTH CAROLINA
 DEPARTMENT OF TRANSPORTATION
 WORK ZONE TRAFFIC CONTROL

PHASE III
 DETAIL DRAWING

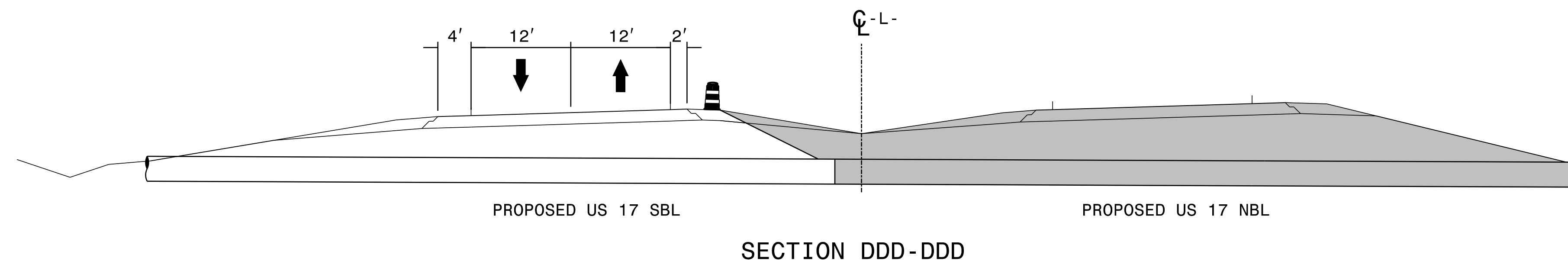
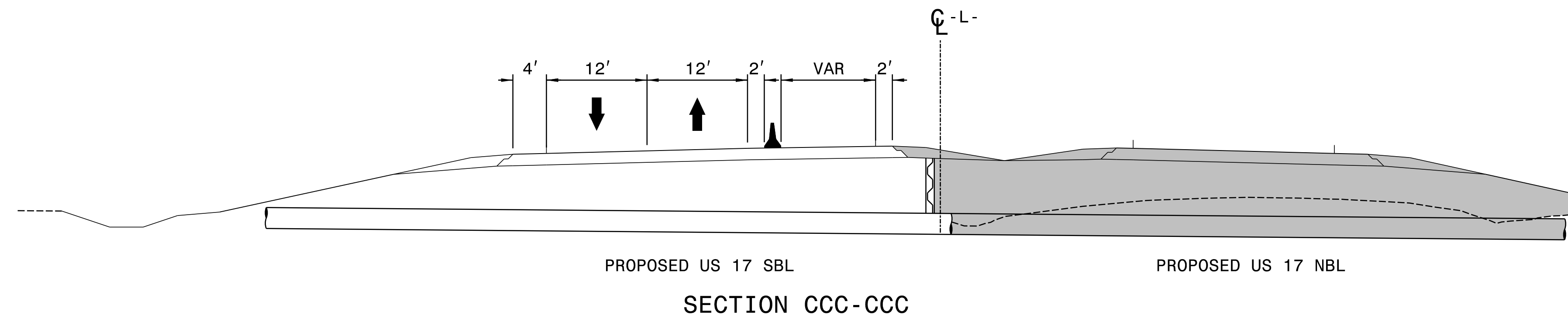
10/1/2021
 R2511_TMP_PSH52.dgn
 KB/BJB

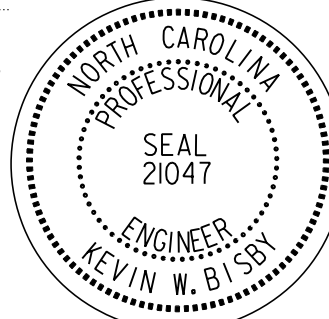

10/1/2021
R2511_TMP_PSH52A.dgn
ksb

<p>APPROVED: <i>Kevin Bisby</i> <small>DocuSigned by: Kevin Bisby 80C802928912474</small></p> <p>DATE: 10/1/2021</p> <p>SEAL</p> 		<p>PHASE III DETAIL DRAWING</p>
<p>DOCUMENT NOT CONSIDERED FINAL UNLESS ALL SIGNATURES COMPLETED</p>		

PROJ. REFERENCE NO.	SHEET NO.
R-2511	TMP-53

RKK
 P: (919) 878-8560
 8601 Six Forks Road, Forum 1, Suite 700
 Raleigh, North Carolina 27615-3960
 NC License No. F-0112
 Engineers | Construction Managers | Planners | Scientists
 www.rkk.com
 Responsive People | Creative Solutions

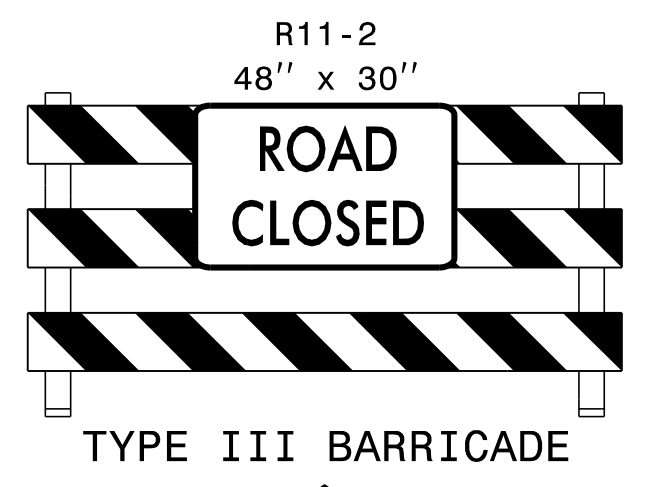
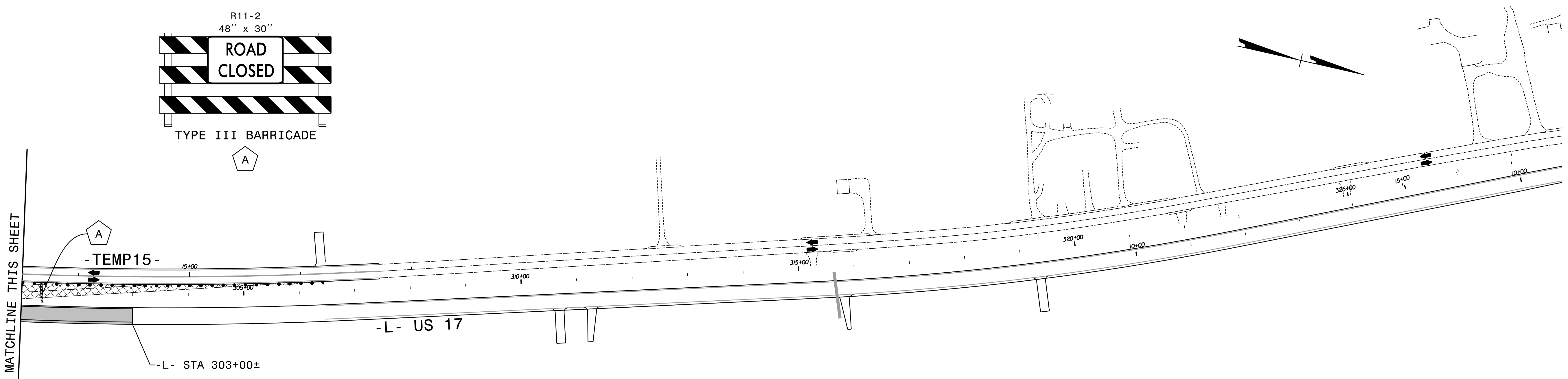
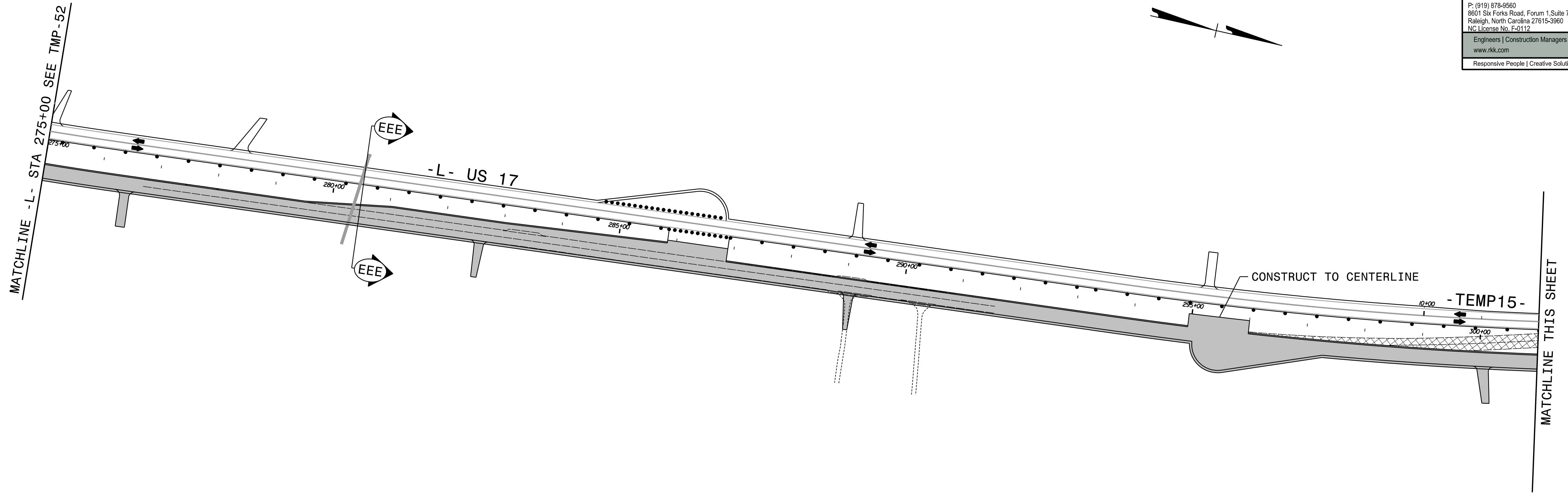

SEE TMP-53A FOR SECTION VIEW.

APPROVED: *Kevin Bisby*
 DATE: 10/1/2021

SEAL

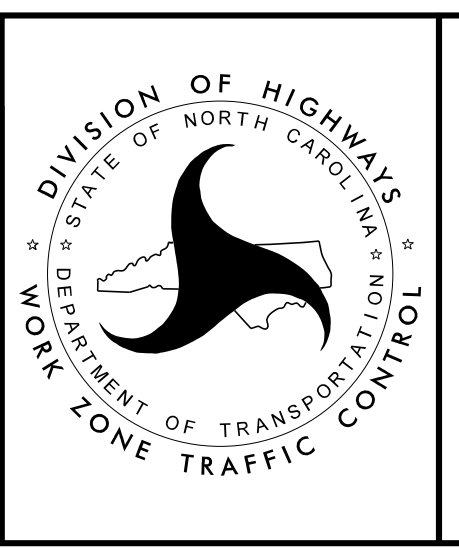

PHASE III
 DETAIL DRAWING

10/1/2021
 R2511_TMP_PSH53.dgn
 ksb

PROJ. REFERENCE NO.	SHEET NO.
R-2511	TMP-53A

RKK
 P: (919) 878-8560
 8601 Six Forks Road, Forum 1, Suite 700
 Raleigh, North Carolina 27615-3960
 NC License No. F-0112
 Engineers | Construction Managers | Planners | Scientists
 www.rkk.com
 Responsive People | Creative Solutions

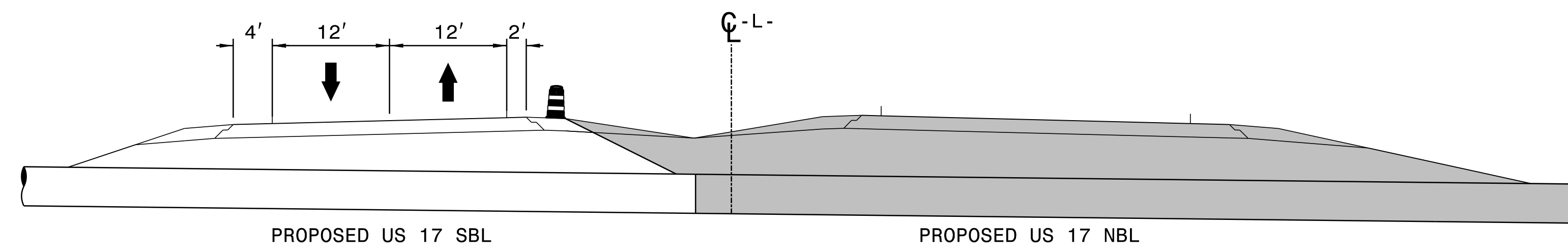

SECTION EEE-EEE

10/1/2021
R2511-TMP_PSH53A.dgn
KWB

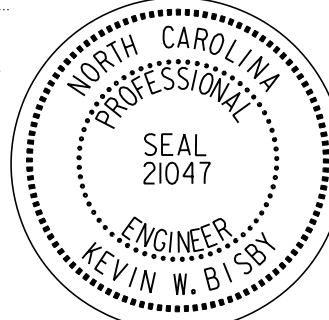
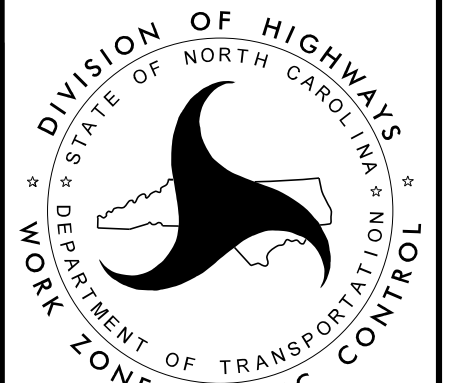
<p>APPROVED:  <small>DocuSigned by: Kevin Bisby B0C802928912474</small></p> <p>DATE: 10/1/2021</p> <p>SEAL</p> 		<p>PHASE III DETAIL DRAWING</p>
<p>DOCUMENT NOT CONSIDERED FINAL UNLESS ALL SIGNATURES COMPLETED</p>		

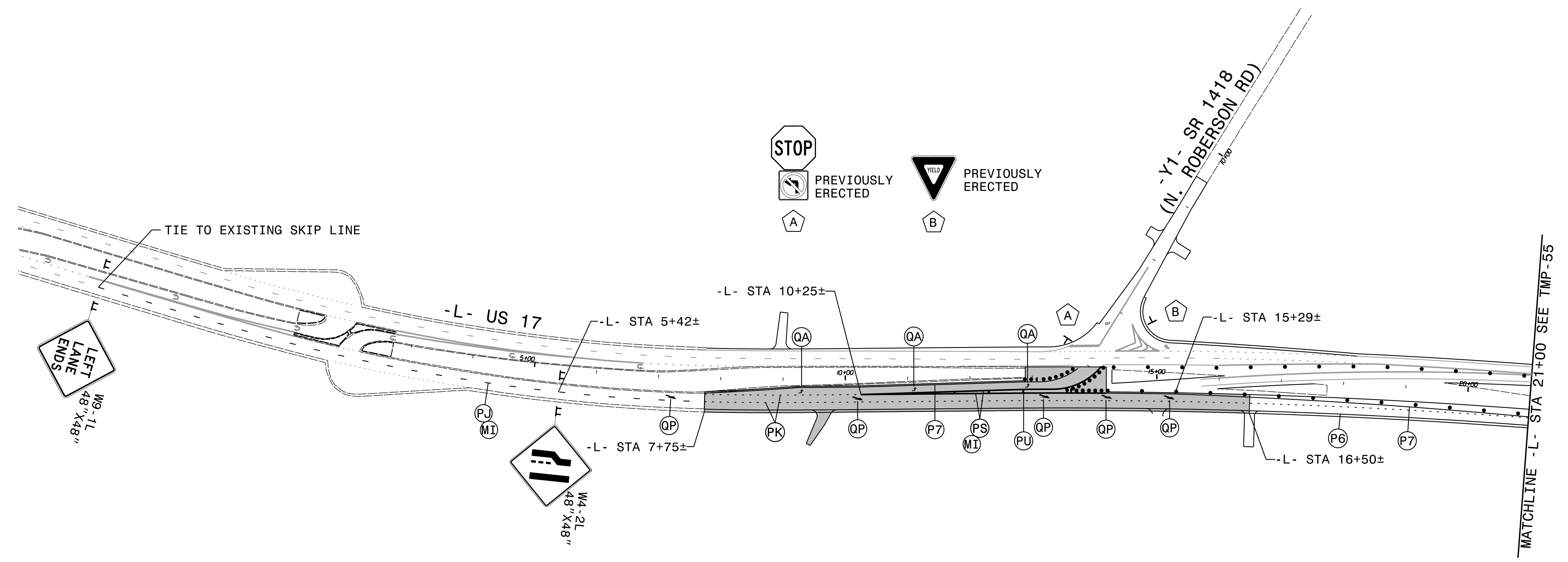
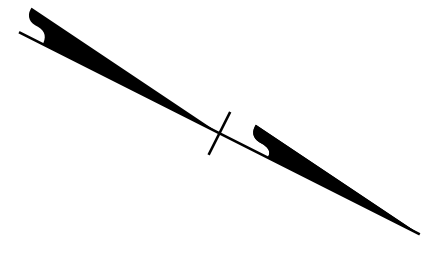

LANE WIDTHS 12' UNLESS OTHERWISE INDICATED.

APPROVED: *Kevin Bisby*
 DATE: 10/1/2021

SEAL

**DOCUMENT NOT CONSIDERED FINAL
 UNLESS ALL SIGNATURES COMPLETED**

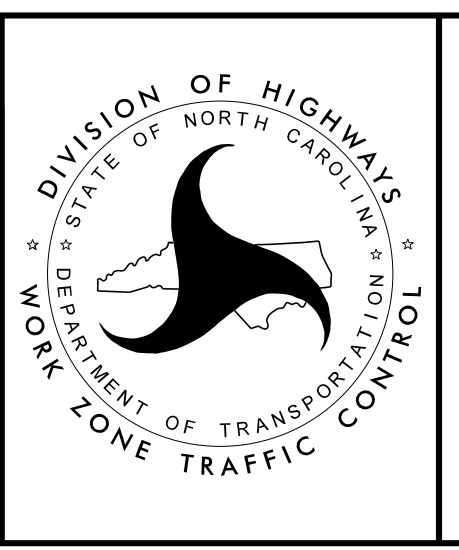

**PHASE III
 DETAIL DRAWING**

10/1/2021
 R2511_TMP_PSH54.dgn
 ksb

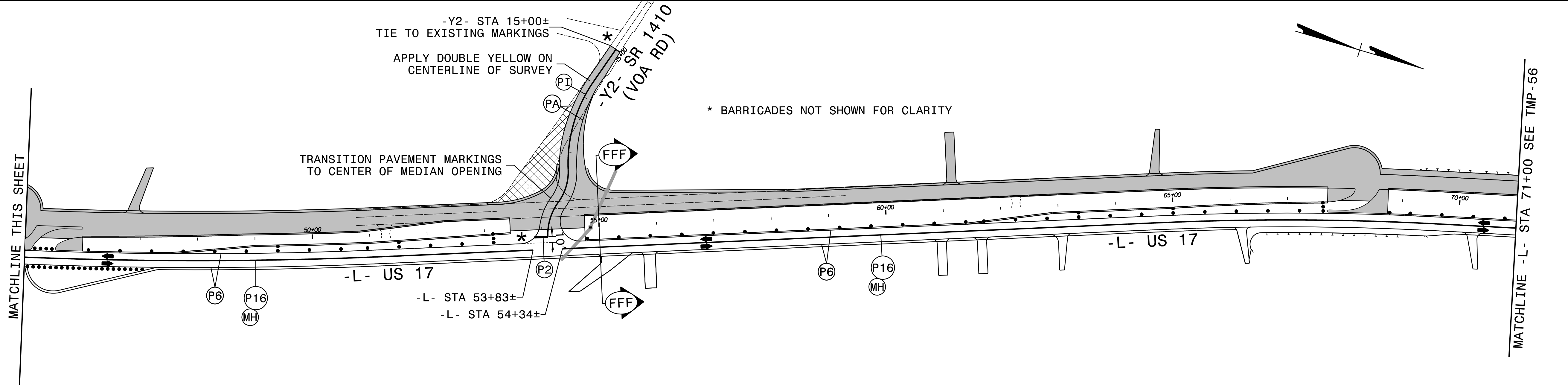
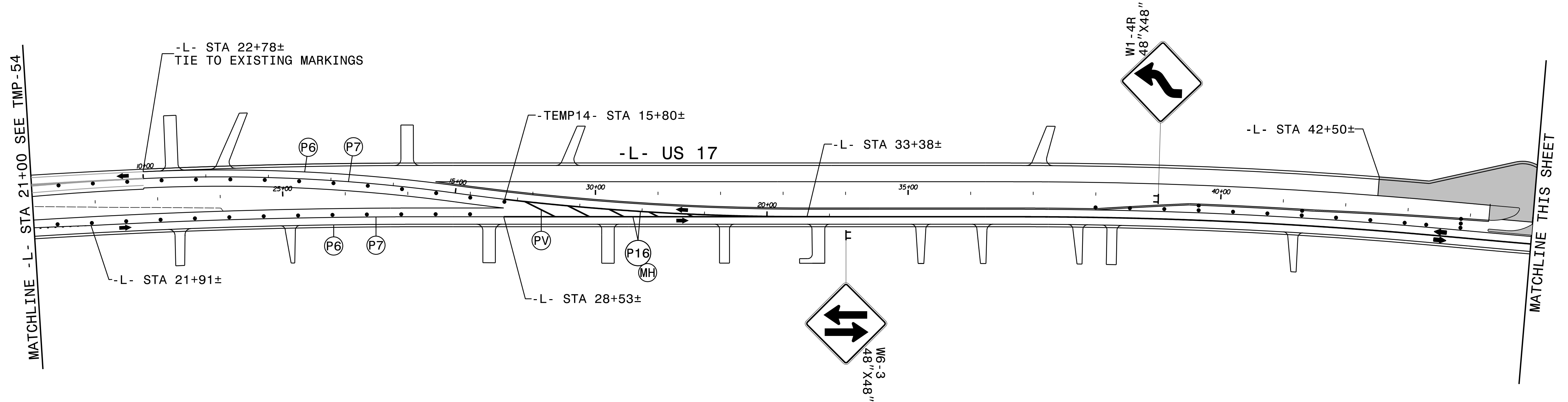

LANE WIDTHS 12' UNLESS OTHERWISE INDICATED.
 SEE TMP-1F FOR OFFSITE DETOUR DETAIL
 SEE TMP-55A FOR SECTION VIEW.

APPROVED: *Kevin Bisby*
 DATE: 10/1/2021

SEAL

DOCUMENT NOT CONSIDERED FINAL
 UNLESS ALL SIGNATURES COMPLETED

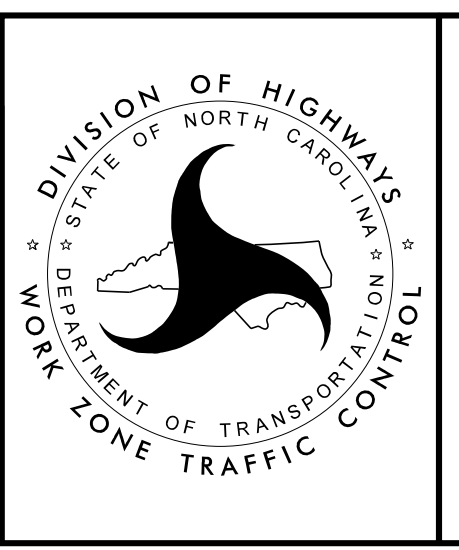

PHASE III
 DETAIL DRAWING

PROJ. REFERENCE NO.	SHEET NO.
R-2511	TMP-55A

RKK
 P: (919) 878-8560
 8601 Six Forks Road, Forum 1, Suite 700
 Raleigh, North Carolina 27615-3960
 NC License No. F-0112
 Engineers | Construction Managers | Planners | Scientists
 www.rkk.com
 Responsive People | Creative Solutions

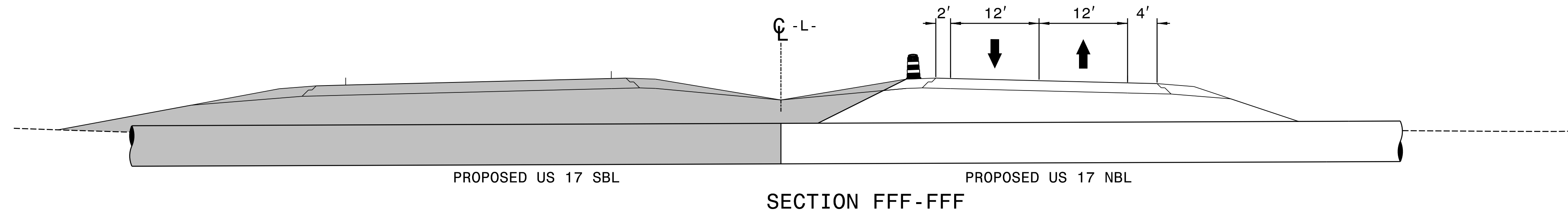

10/1/2021
 R2511_TMP_PSH55A.dgn
 KWB

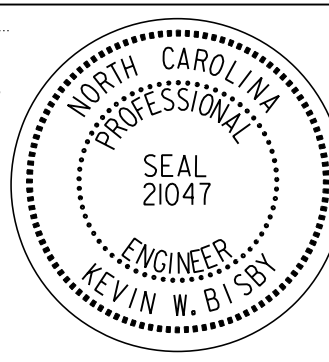
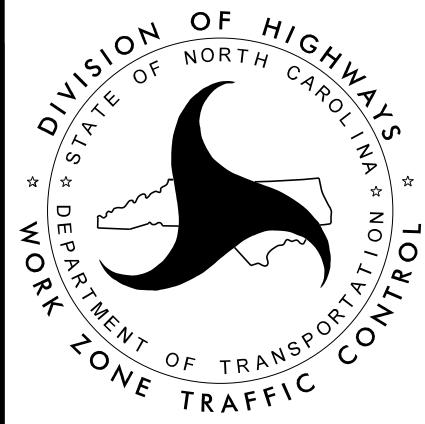
<p>APPROVED:  <small>DocuSigned by: Kevin Bisby B0C802928912474</small></p> <p>DATE: 10/1/2021</p> <p>SEAL</p>	 	<p>PHASE III DETAIL DRAWING</p>
<p>DOCUMENT NOT CONSIDERED FINAL UNLESS ALL SIGNATURES COMPLETED</p>		

PROJ. REFERENCE NO. R-2511	SHEET NO. TMP-56
-------------------------------	---------------------

RKK
 P: (919) 878-8560
 8601 Six Forks Road, Forum 1, Suite 700
 Raleigh, North Carolina 27615-3960
 NC License No. F-0112
 Engineers | Construction Managers | Planners | Scientists
 www.rkk.com
 Responsive People | Creative Solutions

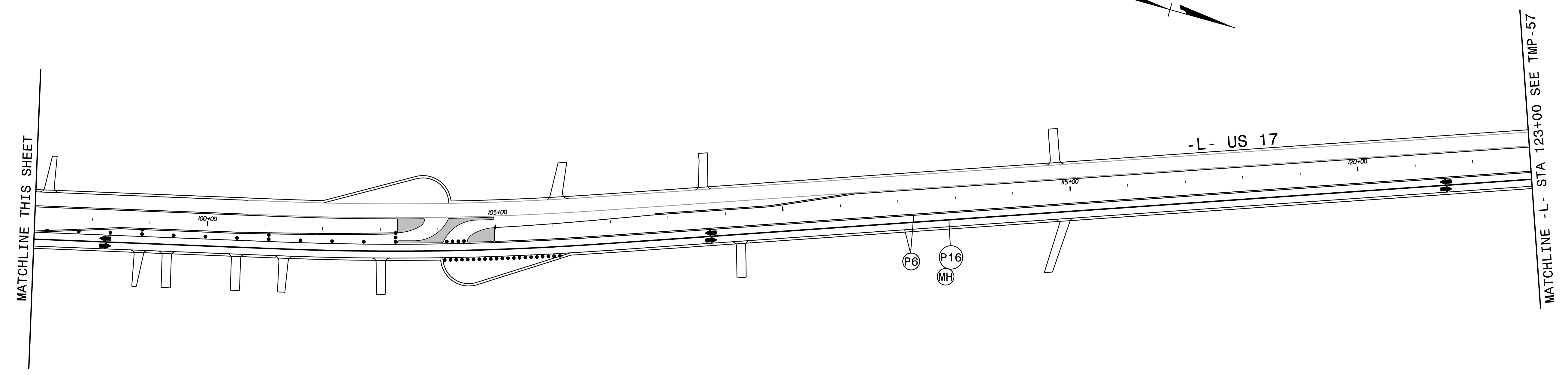
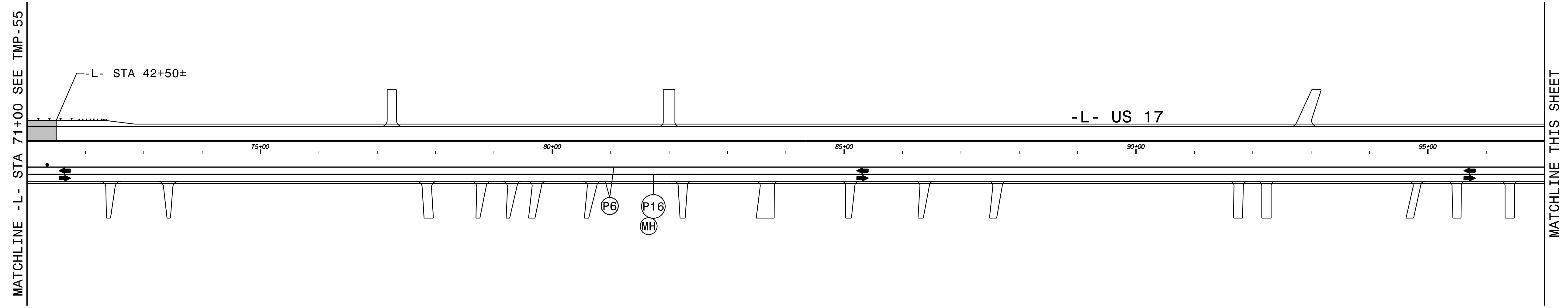

LANE WIDTHS 12' UNLESS OTHERWISE INDICATED.

APPROVED: *Kevin Bissby*
 DATE: 10/1/2021

SEAL

PROFESSIONAL ENGINEER
 KEVIN W. BISSBY
 SEAL 21047

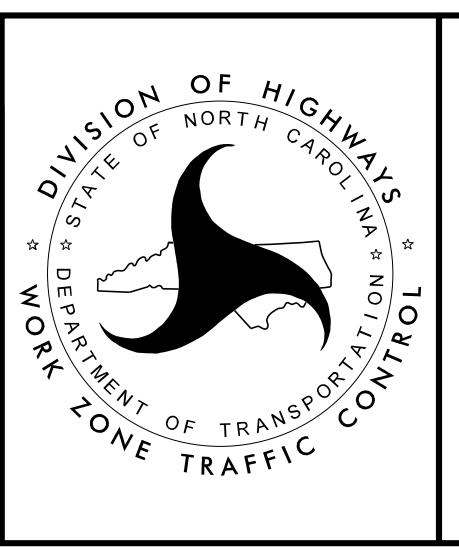

PHASE III
 DETAIL DRAWING

10/1/2021
 R2511_TMP_PSH56.dgn
 KWB/bbl

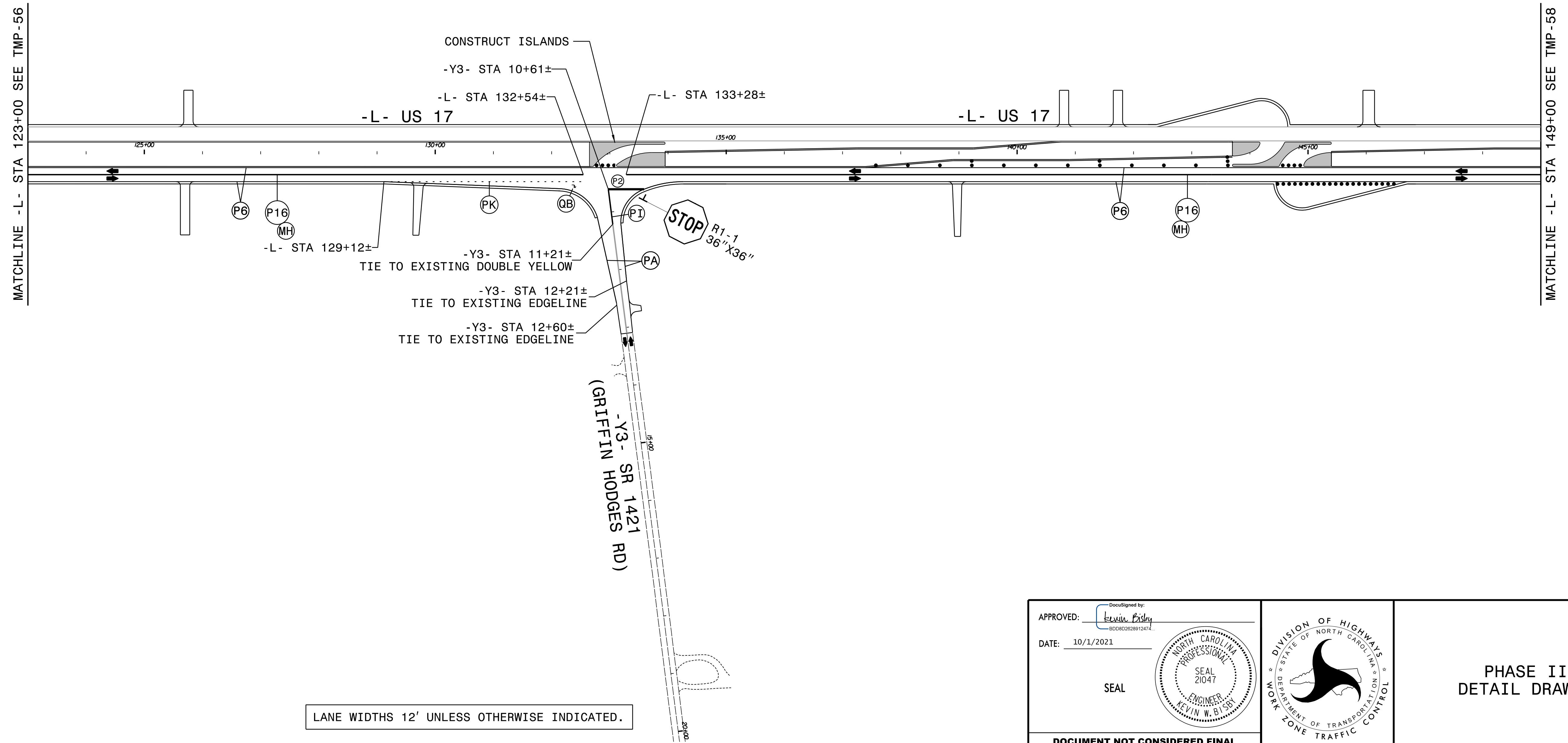

LANE WIDTHS 12' UNLESS OTHERWISE INDICATED.

APPROVED: *Kevin Bisby*
 DATE: 10/1/2021

SEAL

SEAL 21047
 ENGINEER
 KEVIN W. BISBY

DOCUMENT NOT CONSIDERED FINAL
 UNLESS ALL SIGNATURES COMPLETED

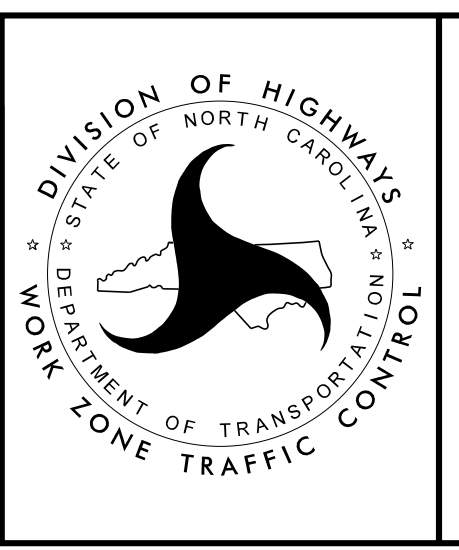

PHASE III
 DETAIL DRAWING

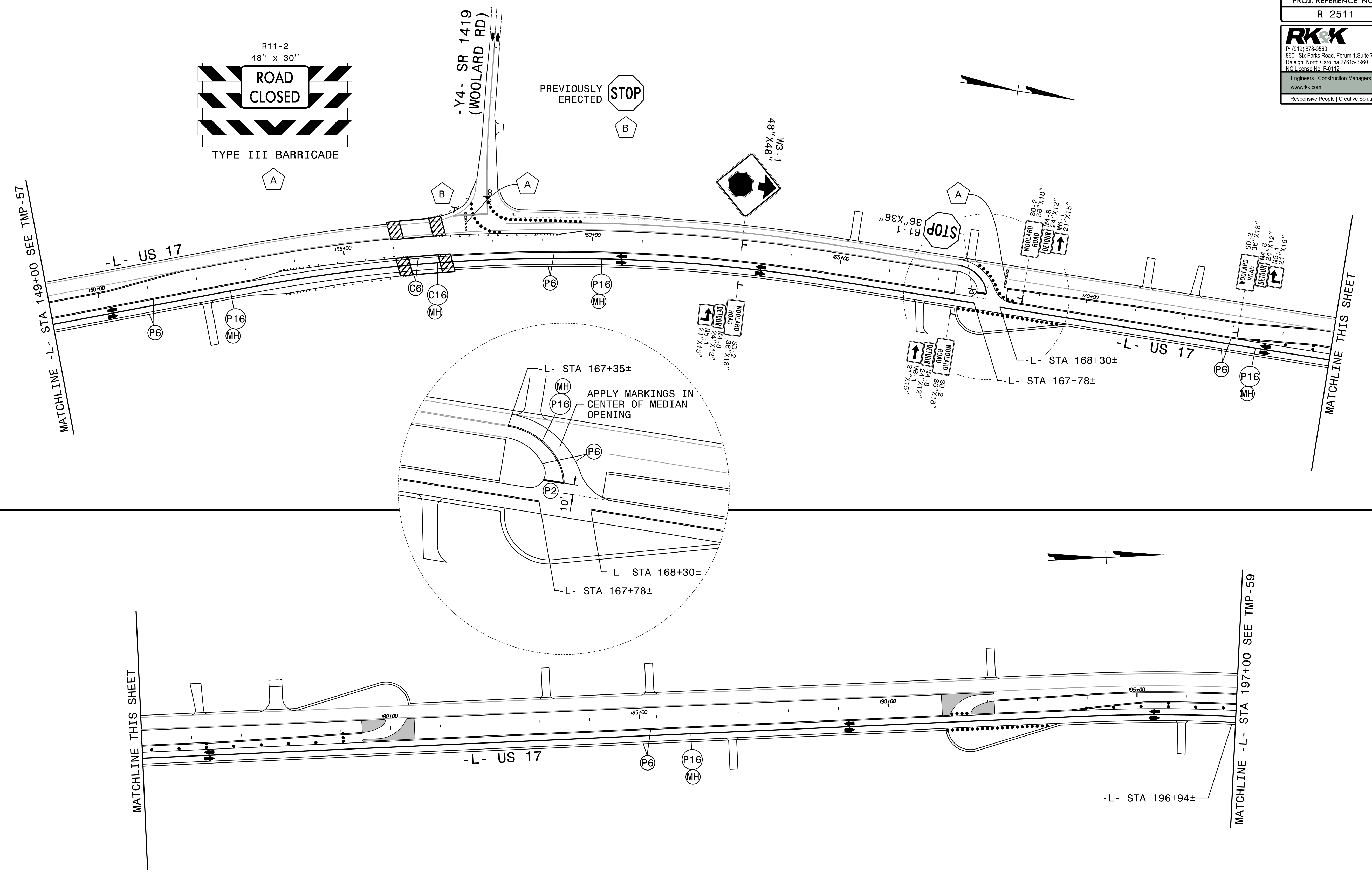

LANE WIDTHS 12' UNLESS OTHERWISE INDICATED.

APPROVED: *Kevin Bisy*
 DATE: 10/1/2021

SEAL

DOCUMENT NOT CONSIDERED FINAL
 UNLESS ALL SIGNATURES COMPLETED

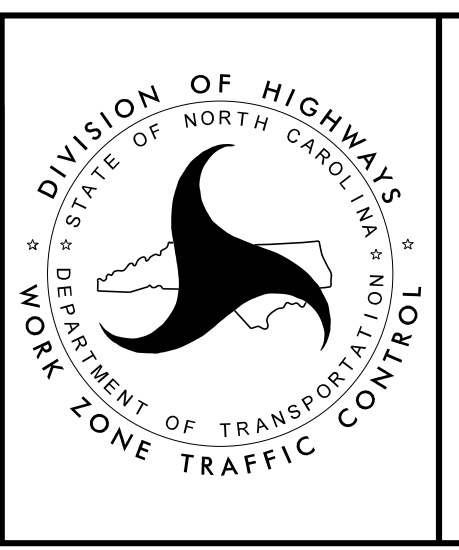

DIVISION OF HIGHWAYS
 DEPARTMENT OF TRANSPORTATION
 ORK ZONE TRAFFIC CONTROL

PHASE III
 DETAIL DRAWING

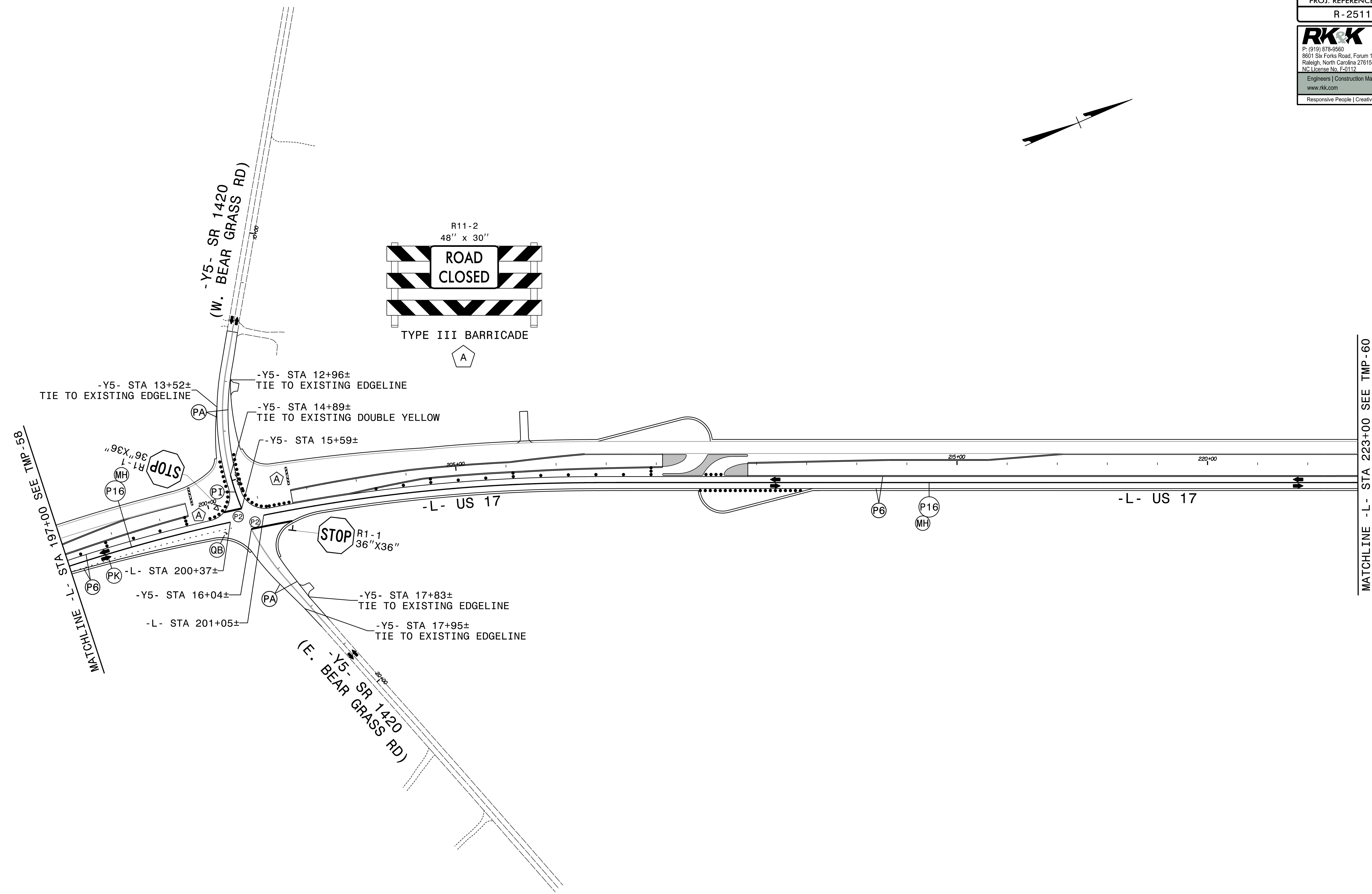
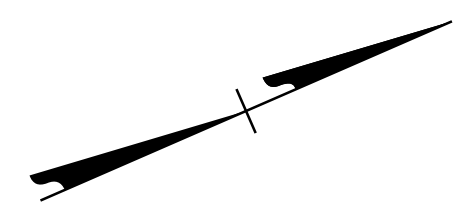

LANE WIDTHS 12' UNLESS OTHERWISE INDICATED.

APPROVED: 
 DATE: 10/1/2021

SEAL

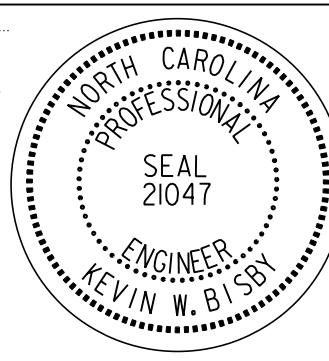
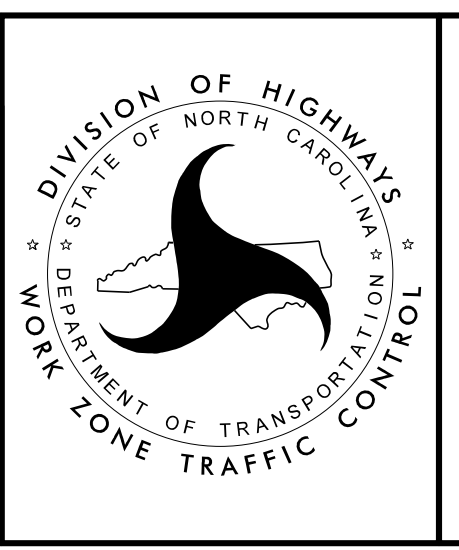
PHASE III
 DETAIL DRAWING

DOCUMENT NOT CONSIDERED FINAL
 UNLESS ALL SIGNATURES COMPLETED

10/1/2021
 R2511-TMP-PSH59.dgn
 ksb

PROJ. REFERENCE NO.	SHEET NO.
R - 2511	TMP - 60

RKK
 P: (919) 878-8560
 8601 Six Forks Road, Forum 1, Suite 700
 Raleigh, North Carolina 27615-3960
 NC License No. F-0112
 Engineers | Construction Managers | Planners | Scientists
 www.rkk.com
 Responsive People | Creative Solutions

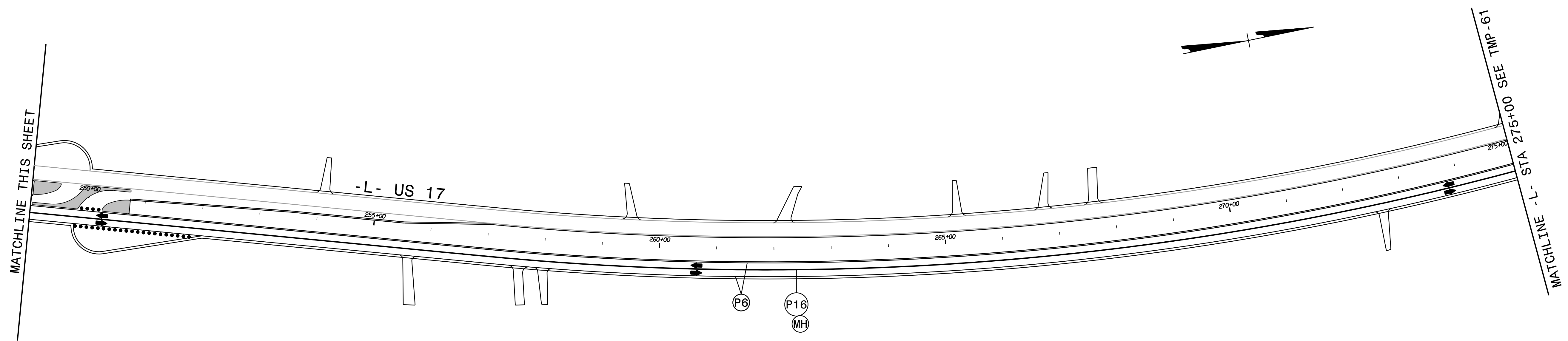
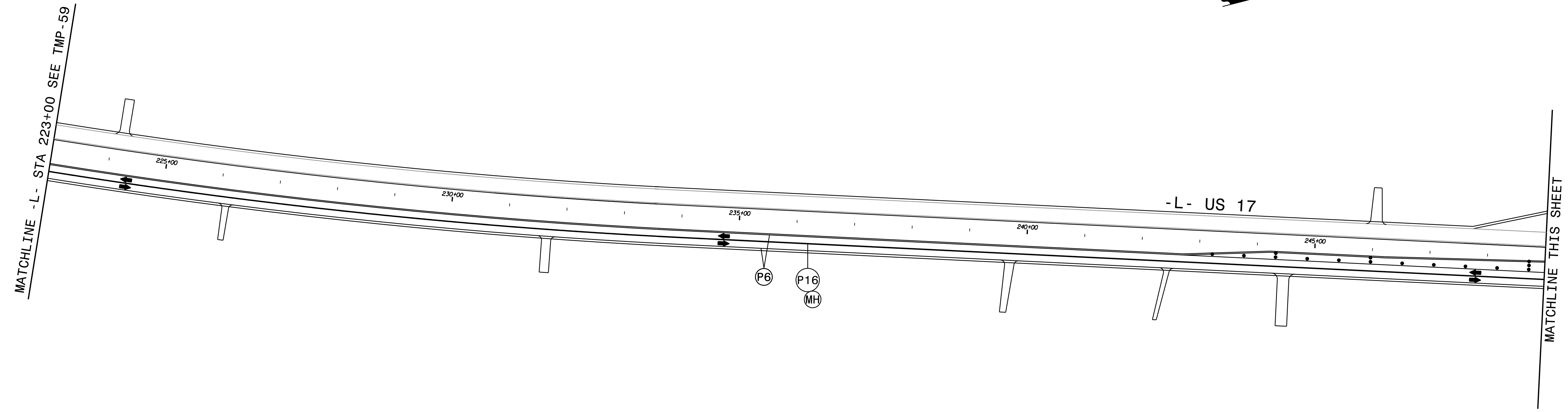

LANE WIDTHS 12' UNLESS OTHERWISE INDICATED.

APPROVED: *Kevin Bisby*
 DATE: 10/1/2021

SEAL

DOCUMENT NOT CONSIDERED FINAL
 UNLESS ALL SIGNATURES COMPLETED

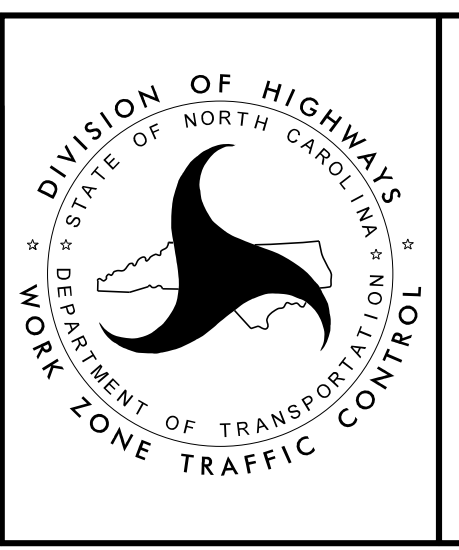

PHASE III
 DETAIL DRAWING

10/1/2021
 R2511_TMP_PSH60.dgn
 kwb

PROJ. REFERENCE NO.	SHEET NO.
R - 2511	TMP - 61

RKK
 P: (919) 878-8560
 8601 Six Forks Road, Forum 1, Suite 700
 Raleigh, North Carolina 27615-3960
 NC License No. F-0112
 Engineers | Construction Managers | Planners | Scientists
 www.rkk.com
 Responsive People | Creative Solutions

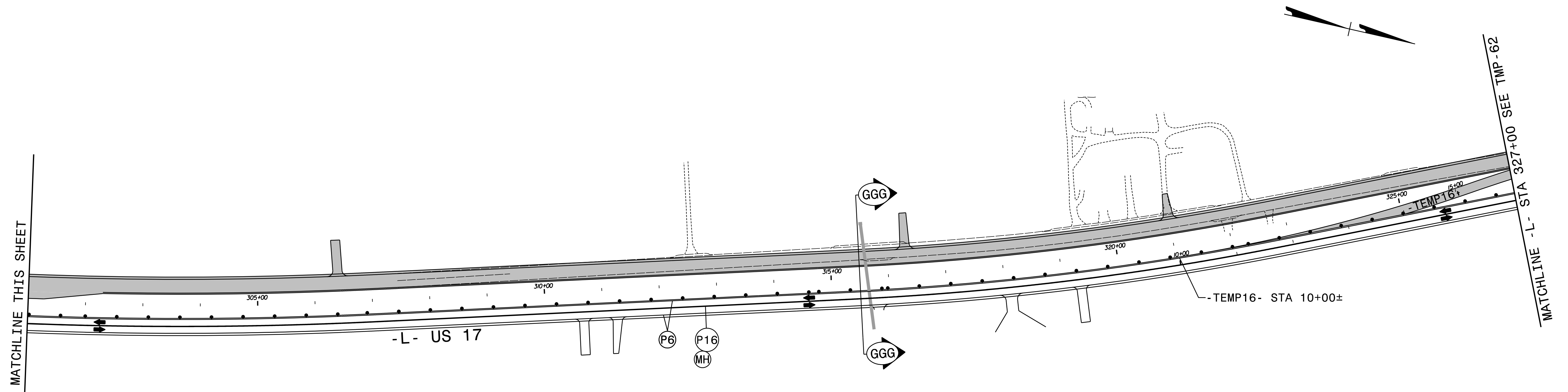
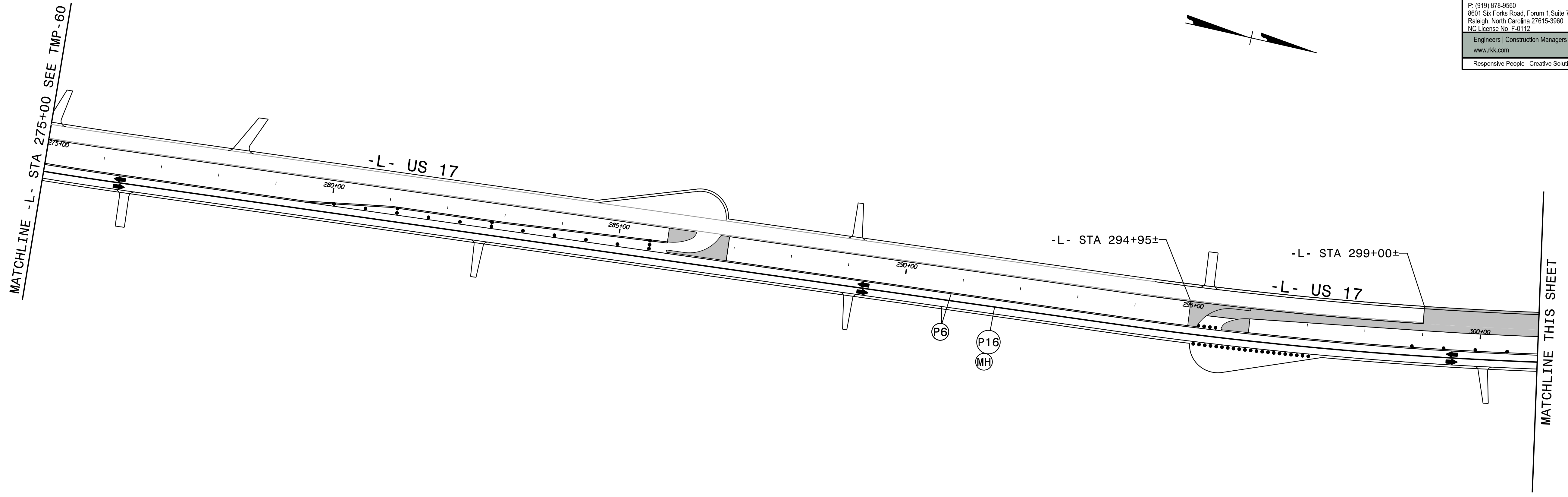

LANE WIDTHS 12' UNLESS OTHERWISE INDICATED.
 SEE TMP-61A FOR SECTION VIEW.

APPROVED: *Kevin Bisby*
 DATE: 10/1/2021

SEAL

DOCUMENT NOT CONSIDERED FINAL
 UNLESS ALL SIGNATURES COMPLETED

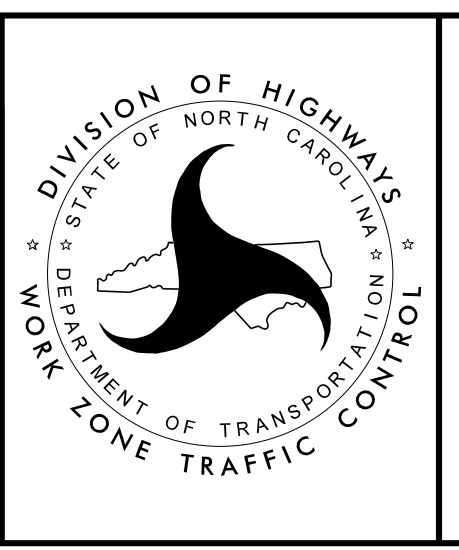

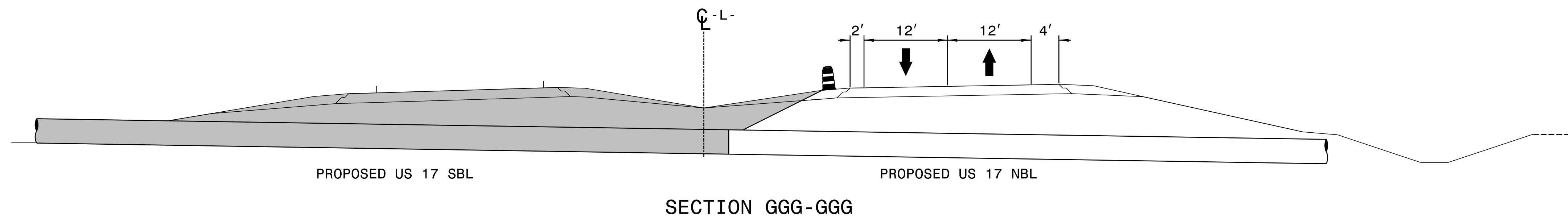

PHASE III
 DETAIL DRAWING

10/1/2021
 R2511_TMP_PSH61.dgn
 ksb

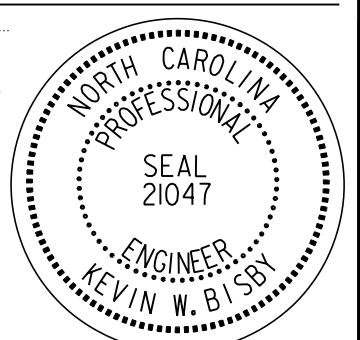

10/1/2021
 R2511_TMP_PSH61A.dgn
 KWB

APPROVED:  DATE: 10/1/2021 SEAL			<p>PHASE III DETAIL DRAWING</p>
<p>DOCUMENT NOT CONSIDERED FINAL UNLESS ALL SIGNATURES COMPLETED</p>			

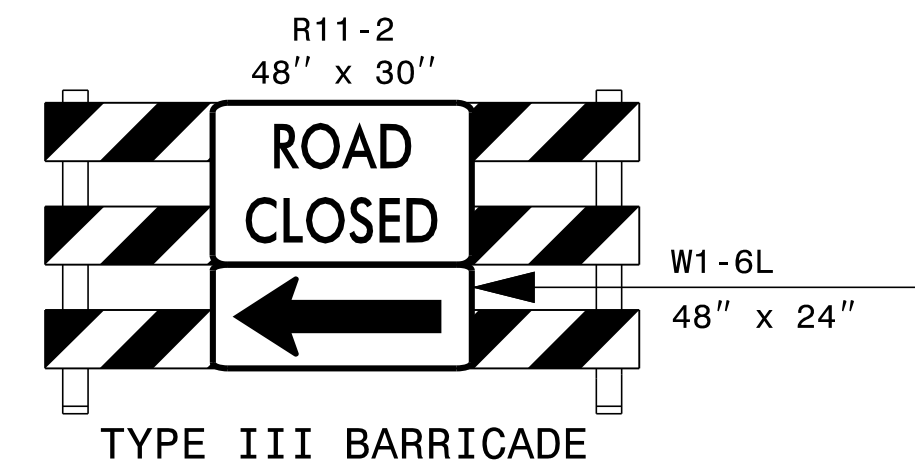
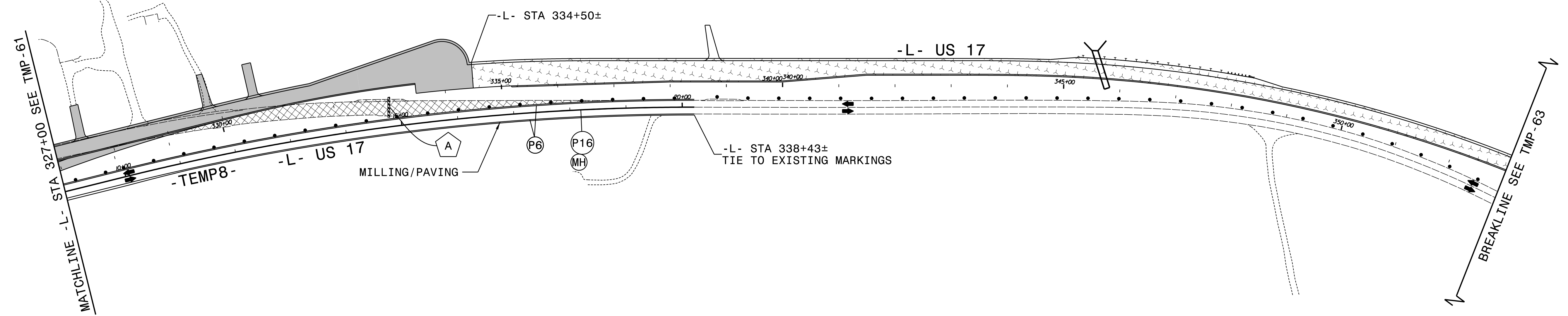

LANE WIDTHS 12' UNLESS OTHERWISE INDICATED.

APPROVED: *Kevin Bisby*
 DATE: 10/1/2021
 SEAL
 NORTH CAROLINA PROFESSIONAL ENGINEER
 SEAL 21047
 KEVIN W. BISBY

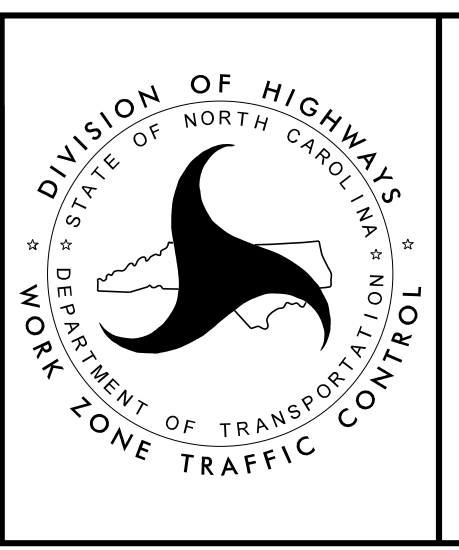

**PHASE III
 DETAIL DRAWING**

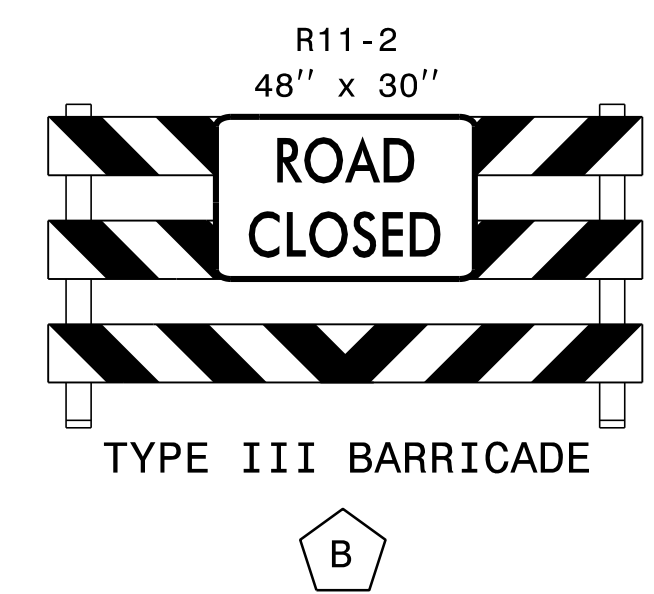
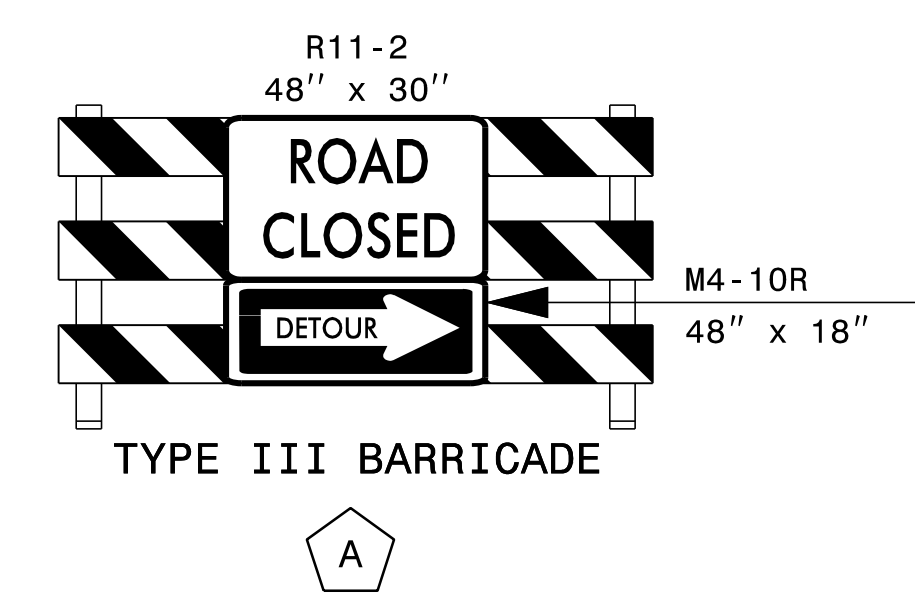
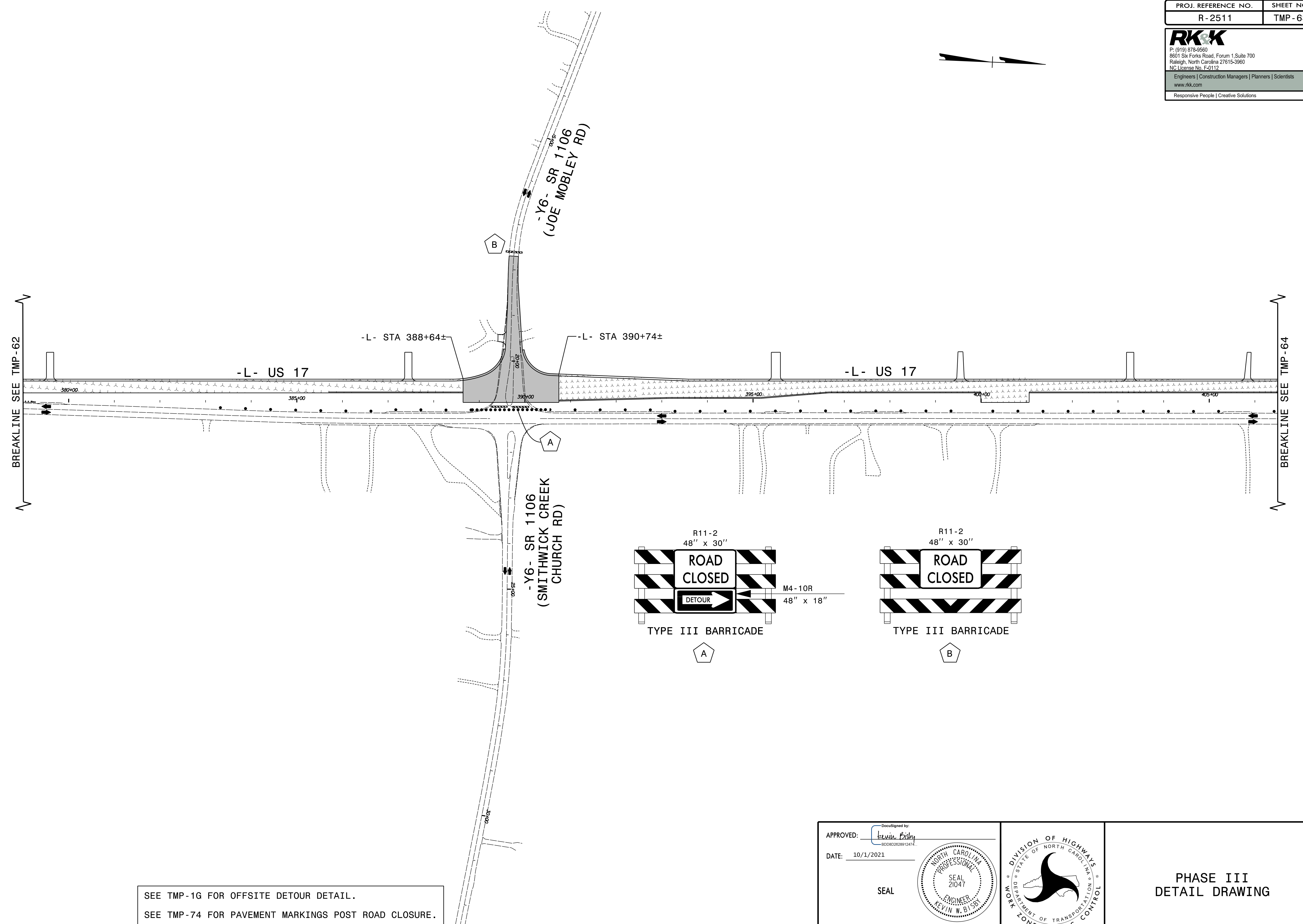
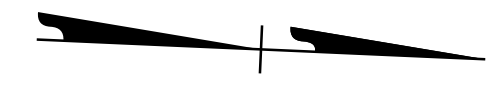

SEE TMP-1G FOR OFFSITE DETOUR DETAIL.
 SEE TMP-74 FOR PAVEMENT MARKINGS POST ROAD CLOSURE.

APPROVED: *Kevin Bisby*
 DATE: 10/1/2021

SEAL

**DOCUMENT NOT CONSIDERED FINAL
 UNLESS ALL SIGNATURES COMPLETED**

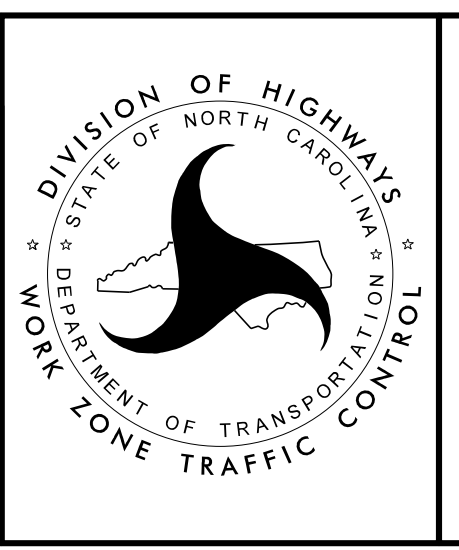

**PHASE III
 DETAIL DRAWING**

10/1/2021
 R2511-TMP-PSH63.dgn
 ksb

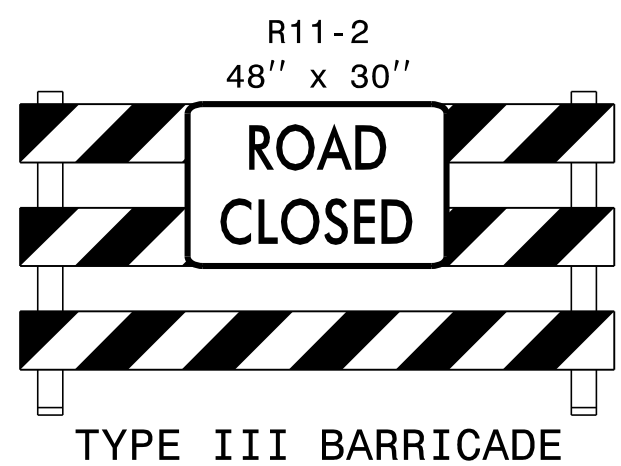
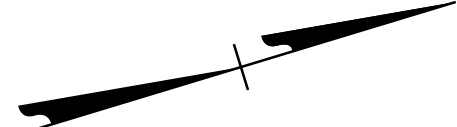
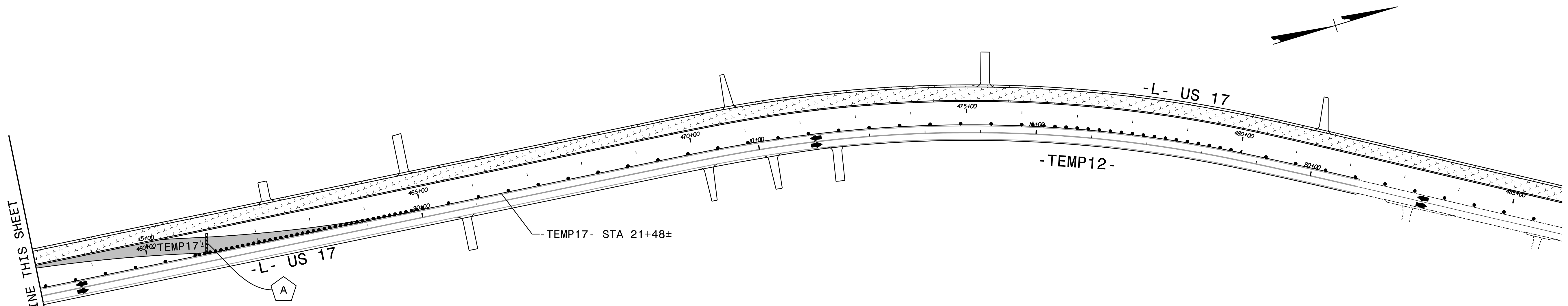
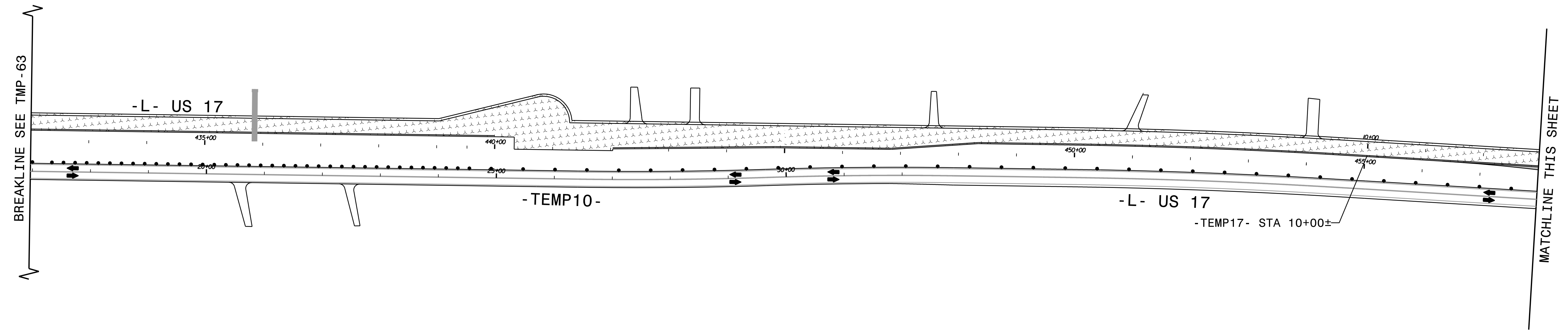

APPROVED: *Kevin Bisby*
DocuSigned by: Kevin Bisby
B0C802928912474

DATE: 10/1/2021

SEAL

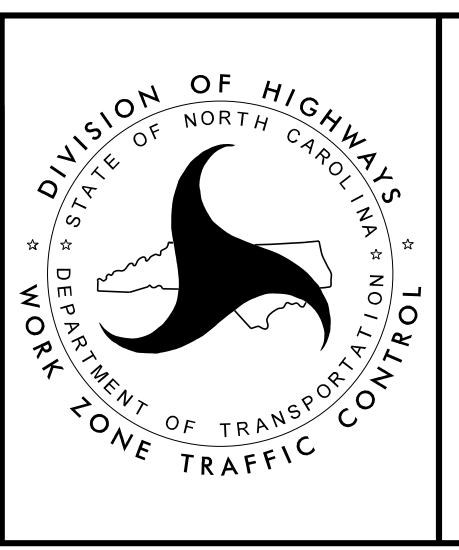

PHASE III
DETAIL DRAWING

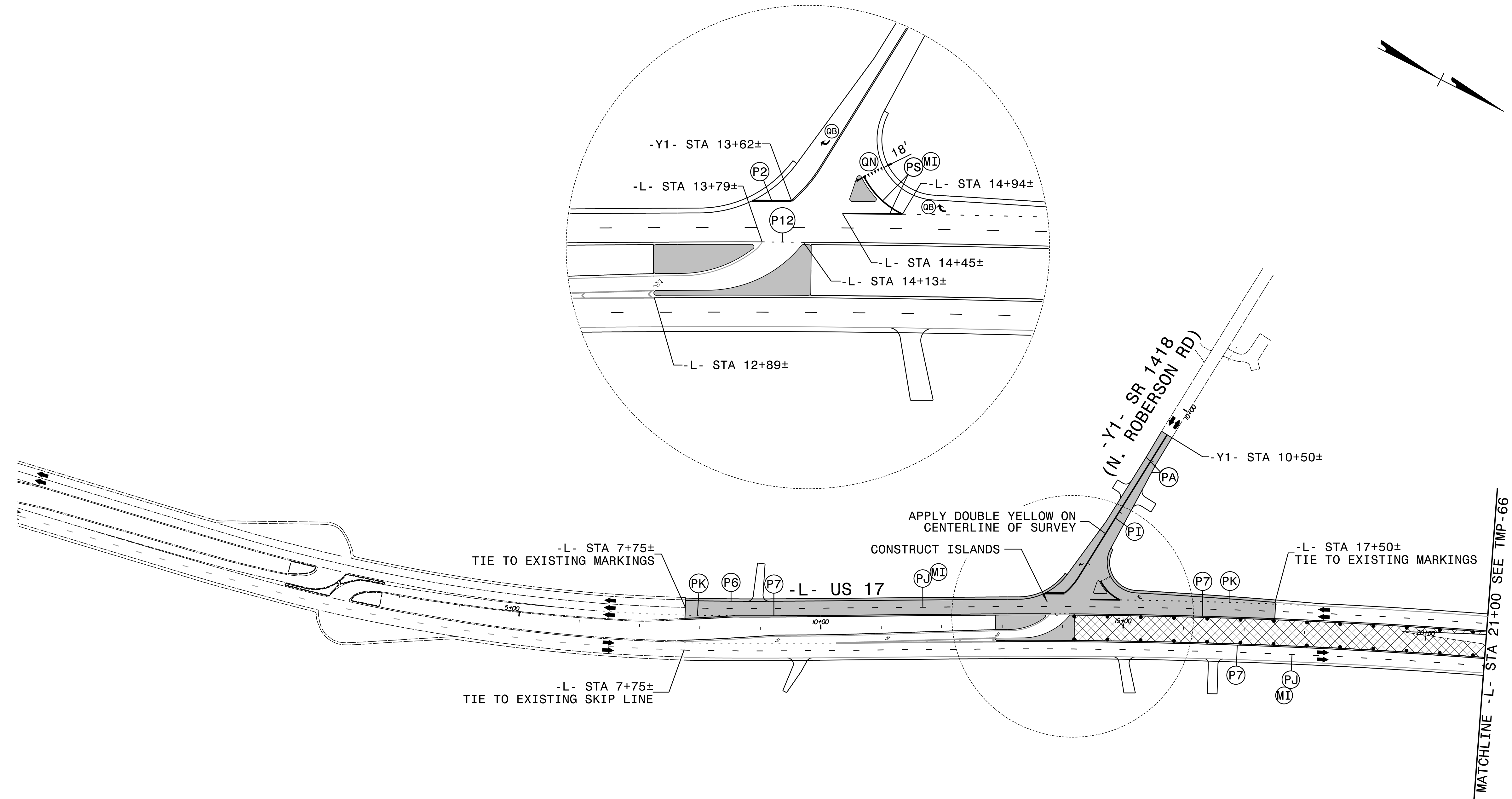
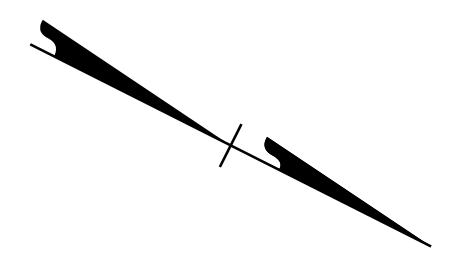

-L- STA 7+75±
TIE TO EXISTING MARKINGS

-L- STA 7+75±
TIE TO EXISTING SKIP LINE

APPLY DOUBLE YELLOW ON
CENTERLINE OF SURVEY

CONSTRUCT ISLANDS

-L- STA 17+50±
TIE TO EXISTING MARKINGS

MATCHLINE -L- STA 21+00 SEE TMP-66

LANE WIDTHS 12' UNLESS OTHERWISE INDICATED.

APPROVED: 
 DATE: 10/1/2021

SEAL

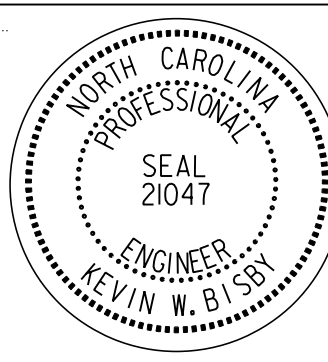

**DOCUMENT NOT CONSIDERED FINAL
UNLESS ALL SIGNATURES COMPLETED**

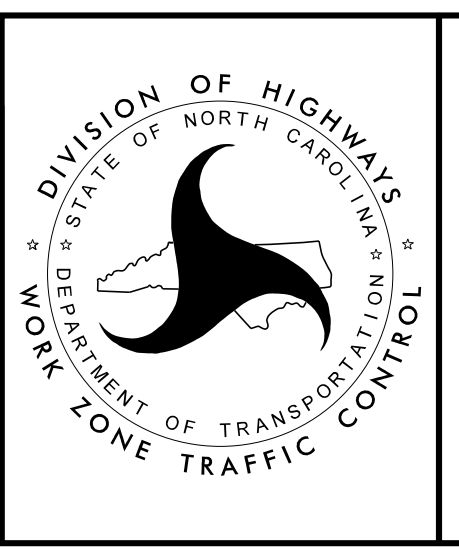

PHASE IV
DETAIL DRAWING

10/1/2021
R2511-TMP-PSH65.dgn
ksf

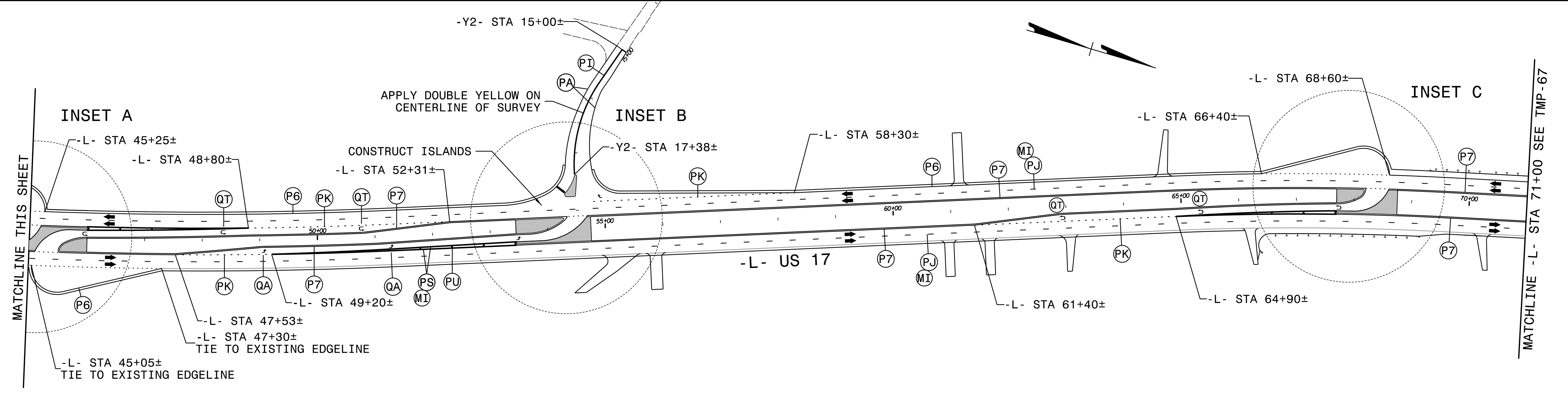
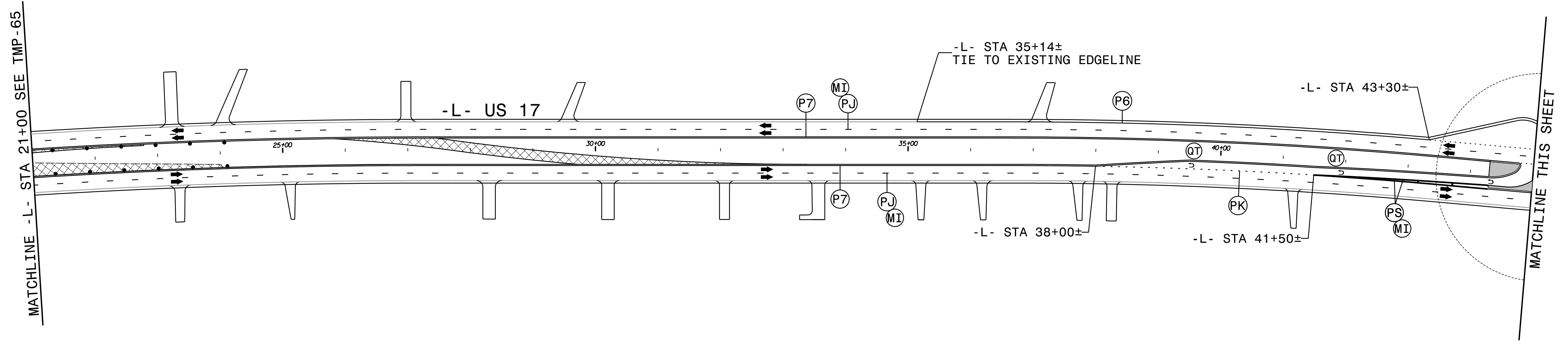

LANE WIDTHS 12' UNLESS OTHERWISE INDICATED.
SEE TMP-66A FOR PAVEMENT MARKING INSETS.

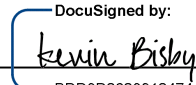
APPROVED: 
DATE: 10/1/2021

SEAL

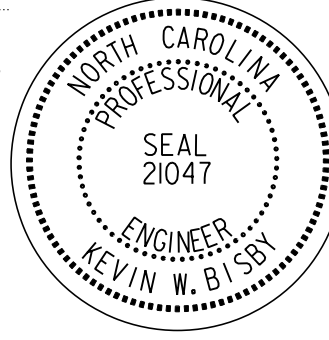

DOCUMENT NOT CONSIDERED FINAL
UNLESS ALL SIGNATURES COMPLETED

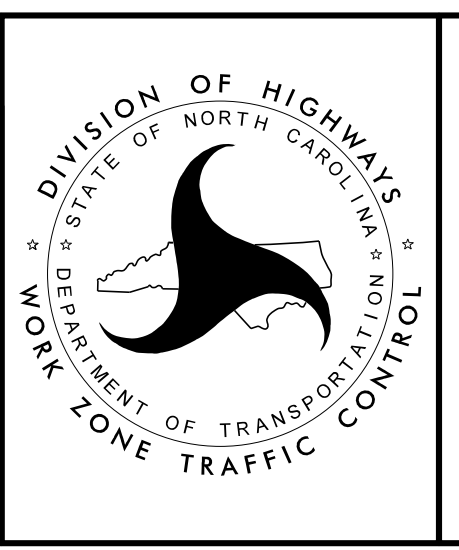

PHASE IV
DETAIL DRAWING

10/1/2021
R2511_TMP_PSH66.dgn
ksb:bl

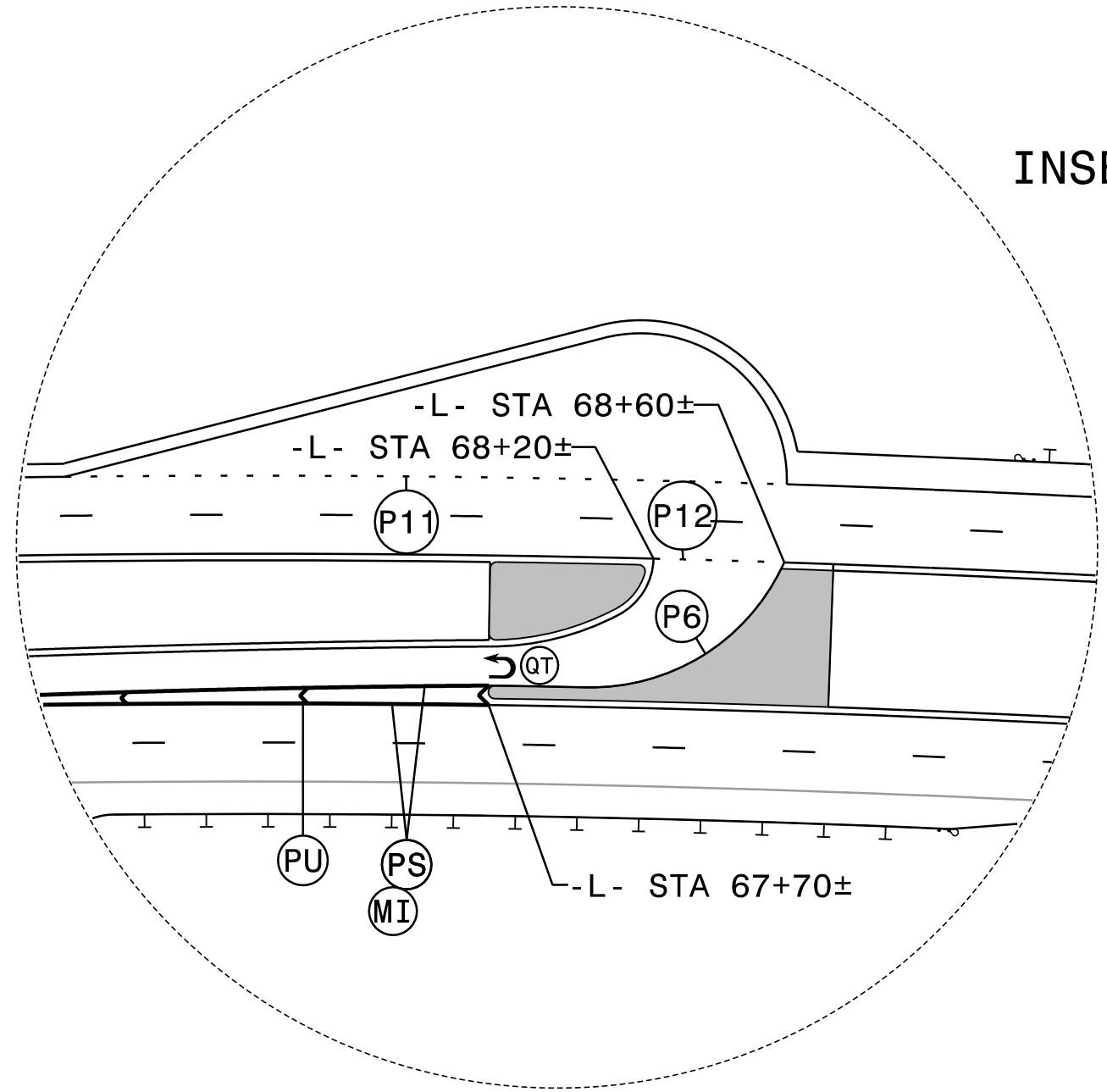
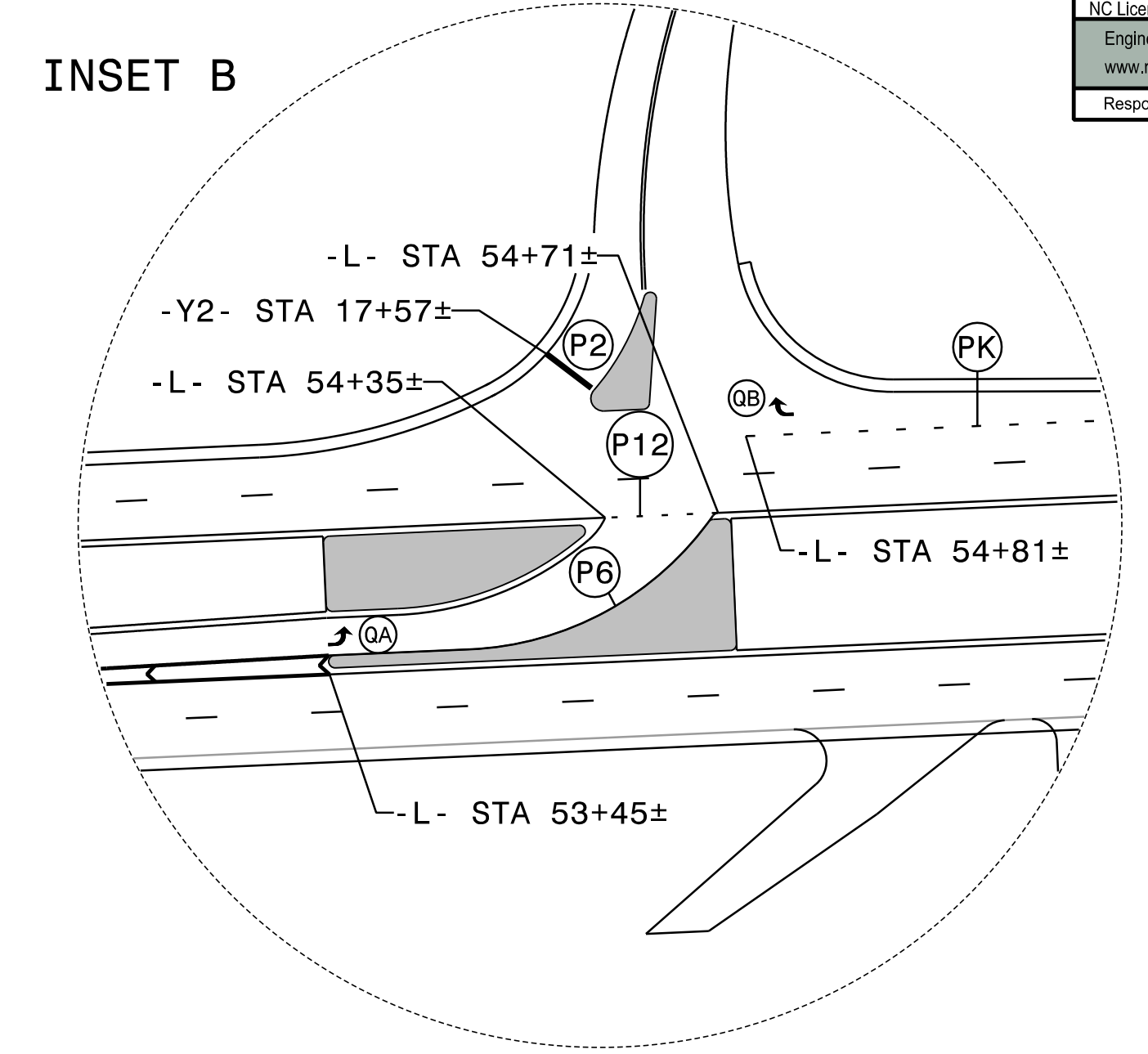
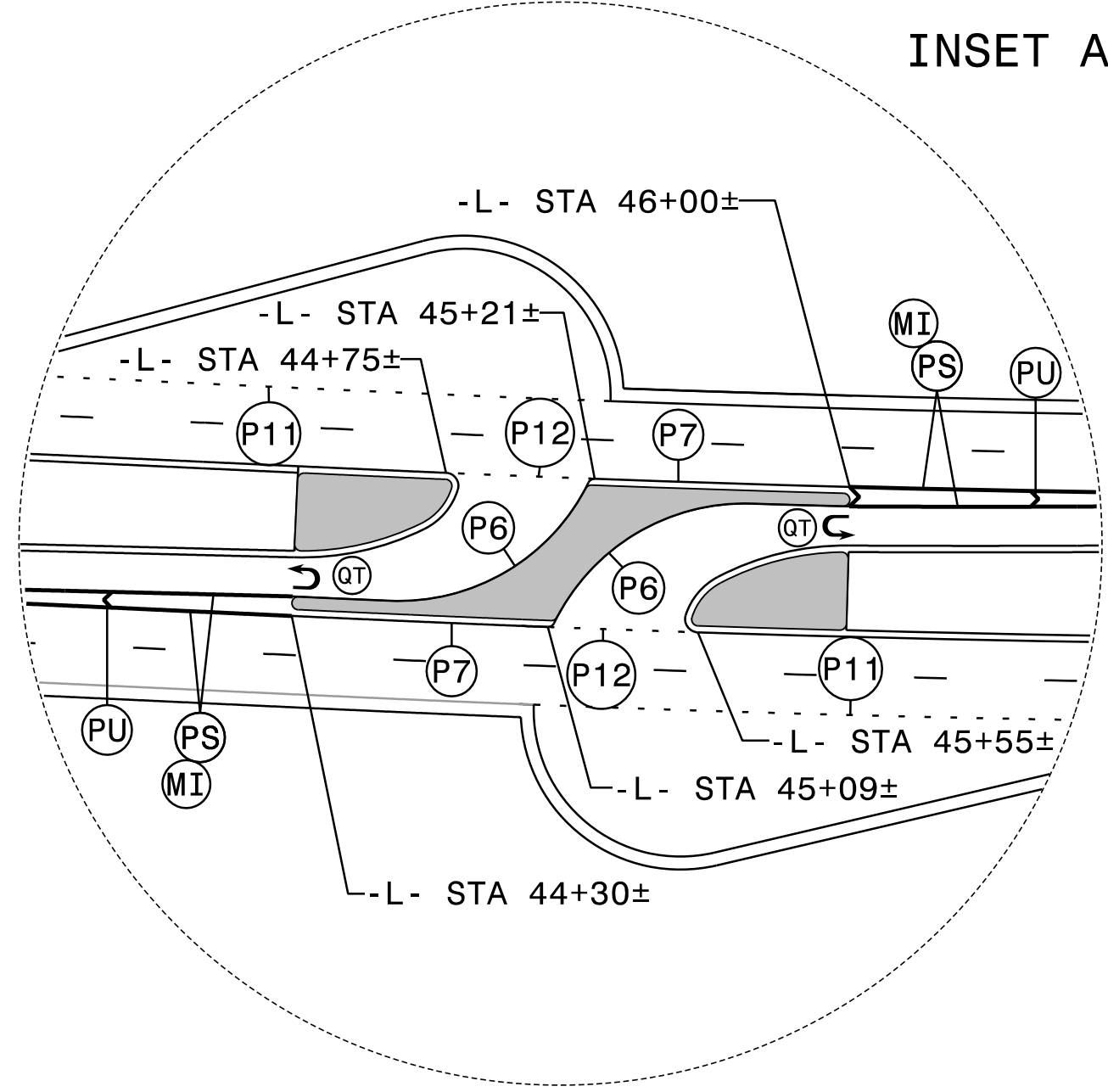

10/1/2021
R2511_TMP_PSH66A.dgn
ksf/bbl

APPROVED: *Kevin Bisby*
DocuSigned by: Kevin Bisby
BDD802928912474

DATE: 10/1/2021

SEAL

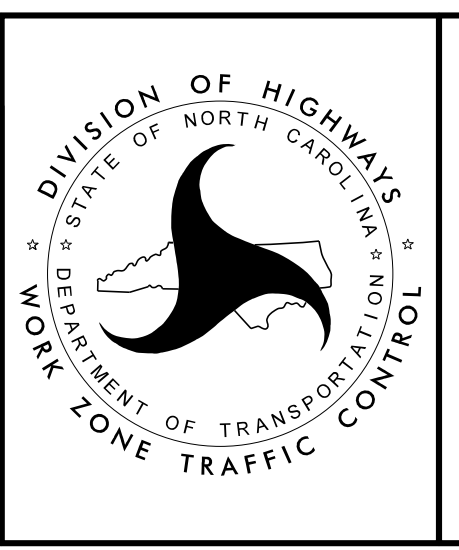

**PHASE IV
DETAIL DRAWING**

**DOCUMENT NOT CONSIDERED FINAL
UNLESS ALL SIGNATURES COMPLETED**

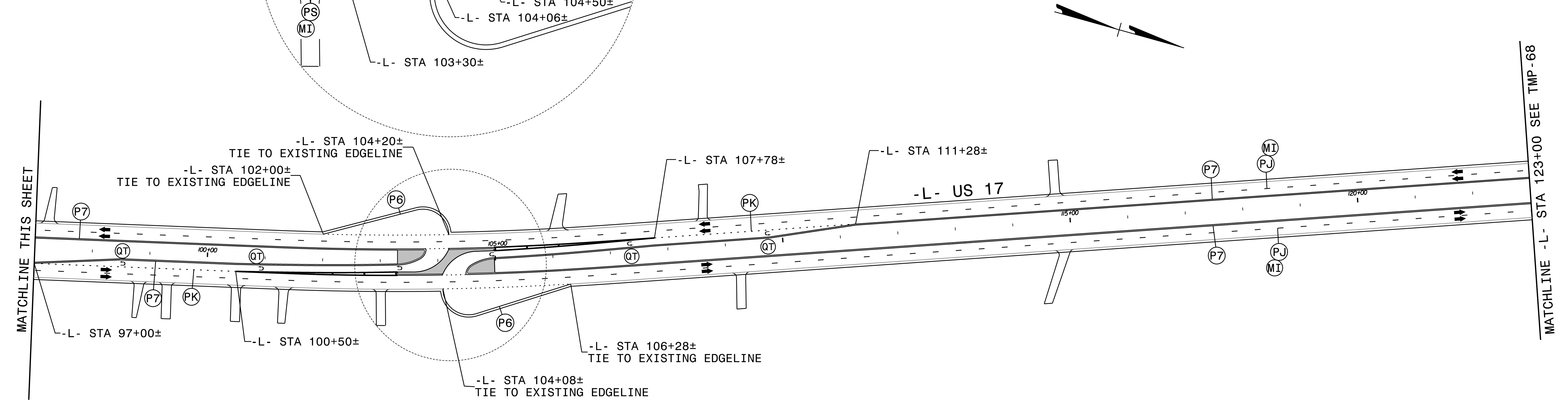
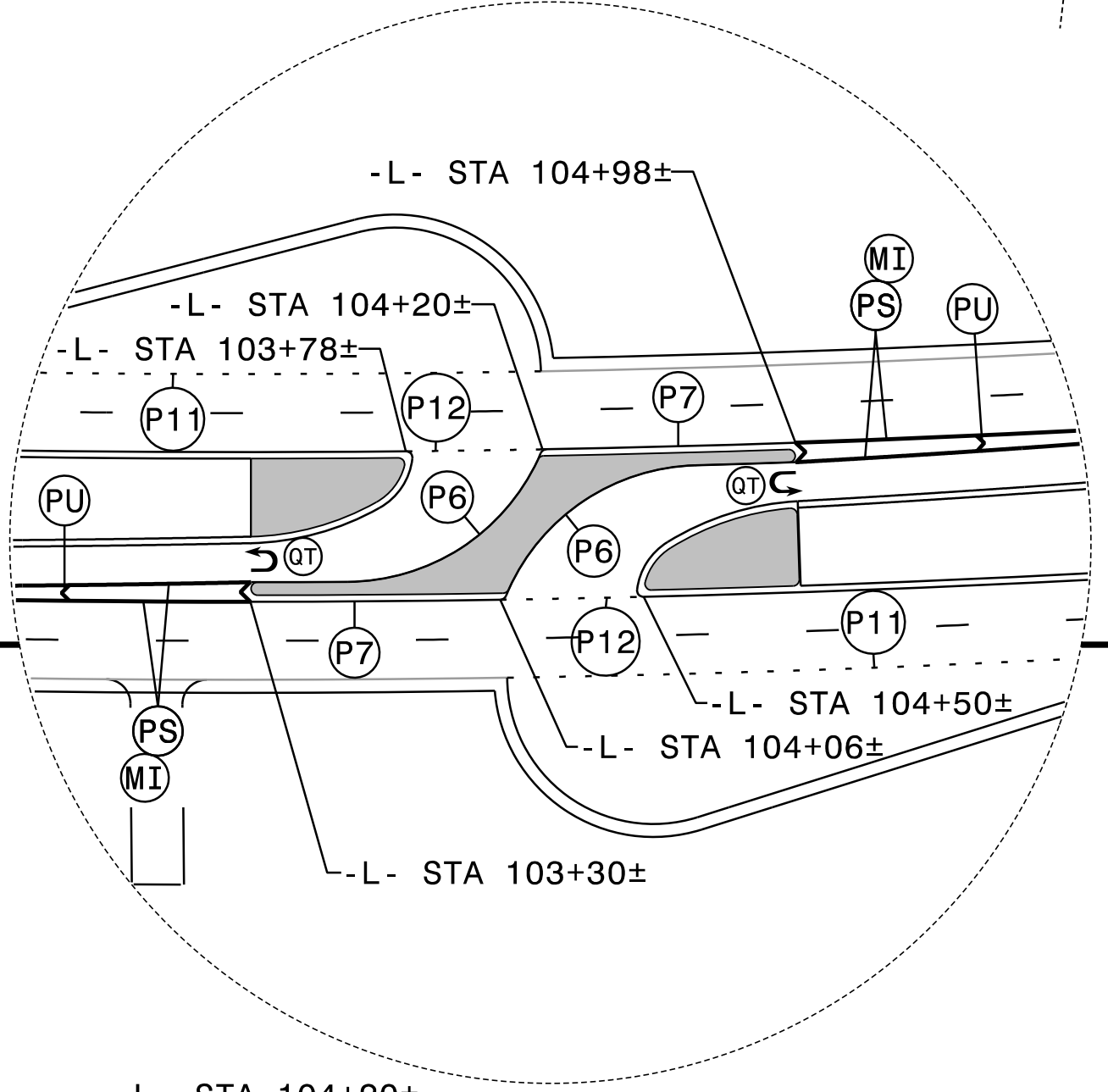
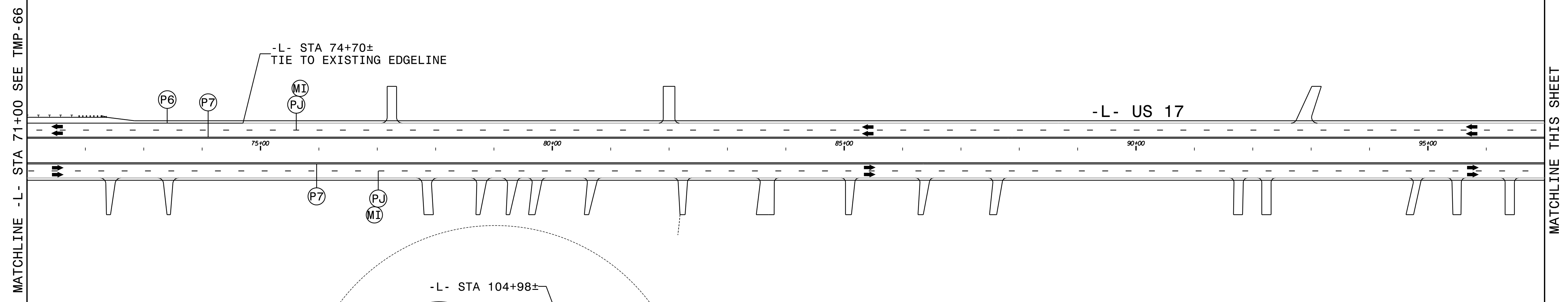

LANE WIDTHS 12' UNLESS OTHERWISE INDICATED.

APPROVED: *Kevin Bisby*
 DATE: 10/1/2021

SEAL

DOCUMENT NOT CONSIDERED FINAL
UNLESS ALL SIGNATURES COMPLETED

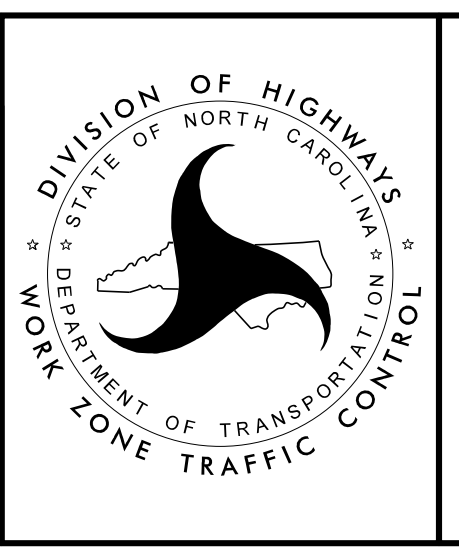

PHASE IV
DETAIL DRAWING

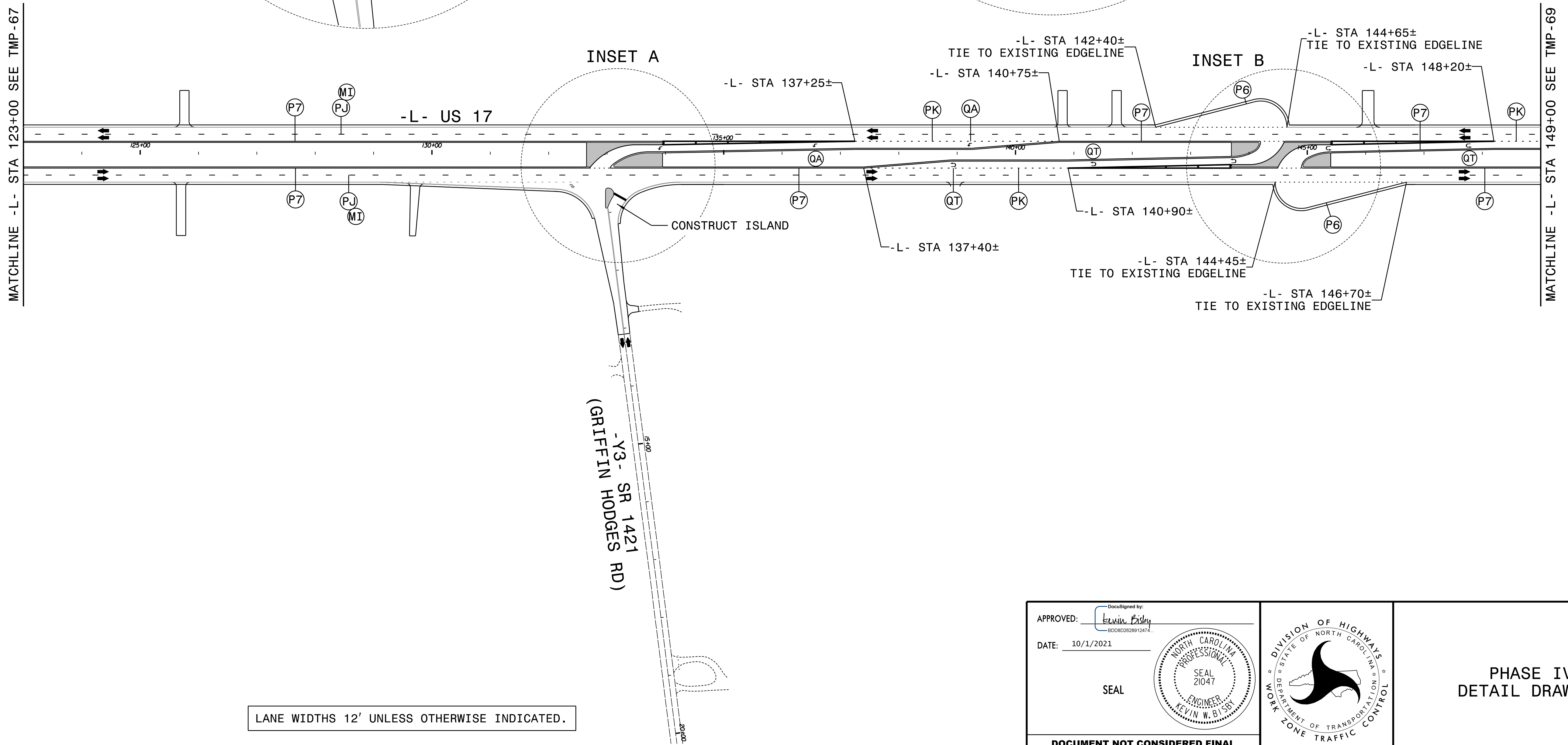
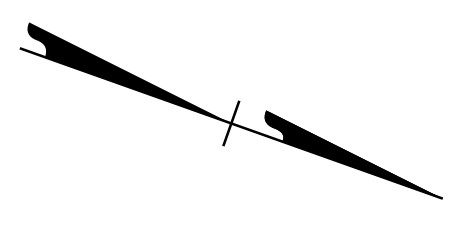
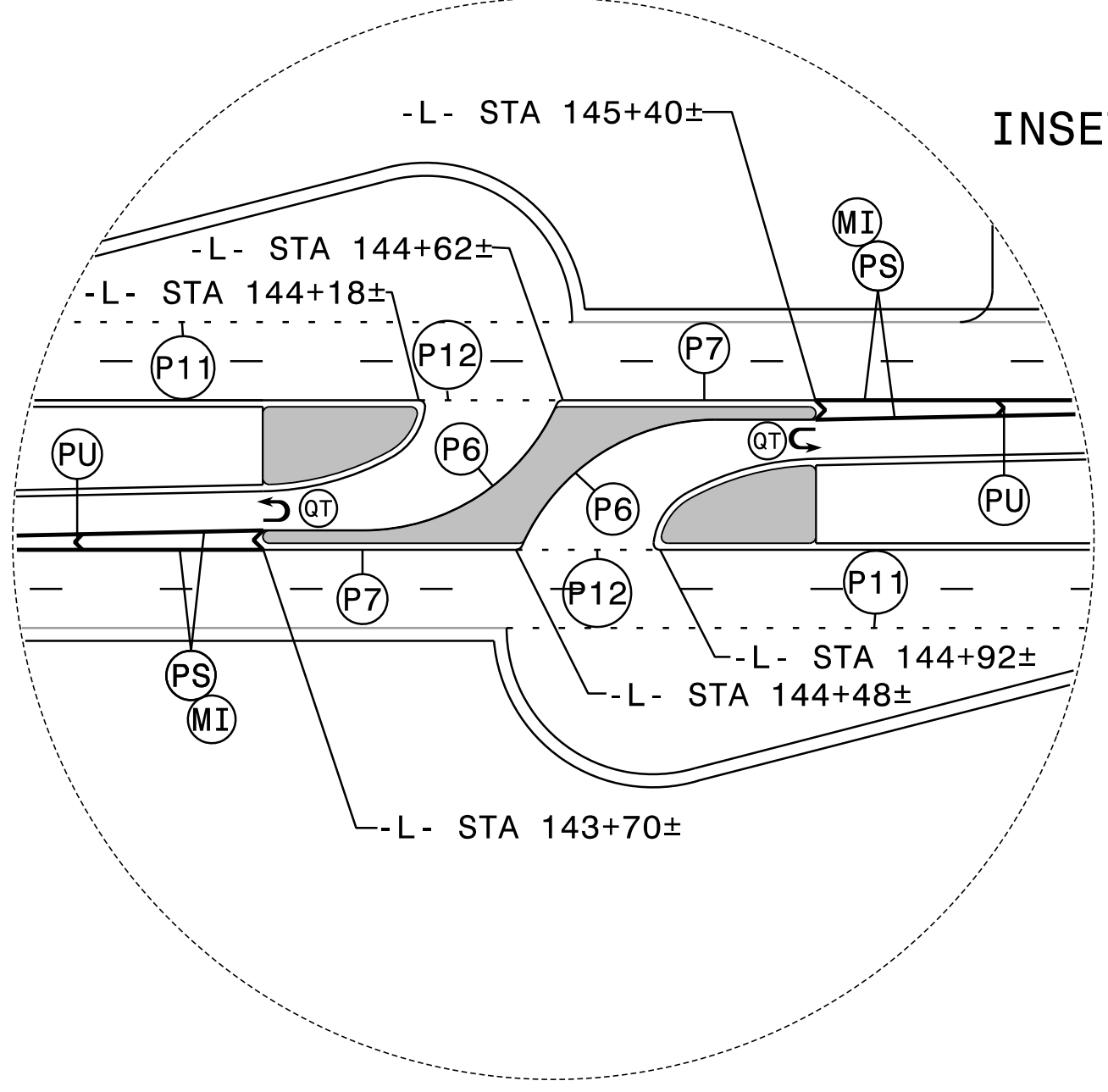
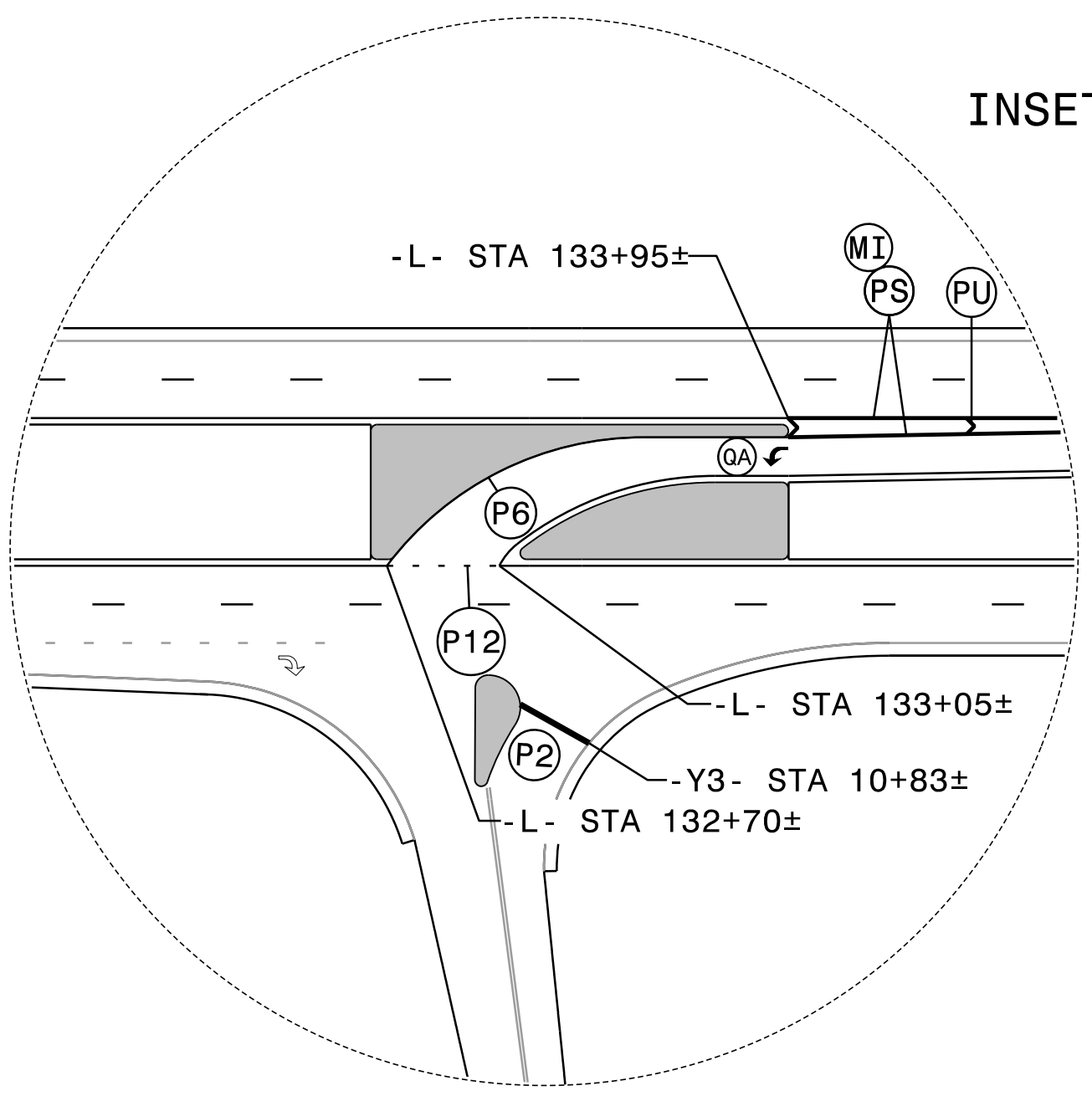

LANE WIDTHS 12' UNLESS OTHERWISE INDICATED.

APPROVED: *Kevin Bisby*
 DATE: 10/1/2021

SEAL

DOCUMENT NOT CONSIDERED FINAL
 UNLESS ALL SIGNATURES COMPLETED

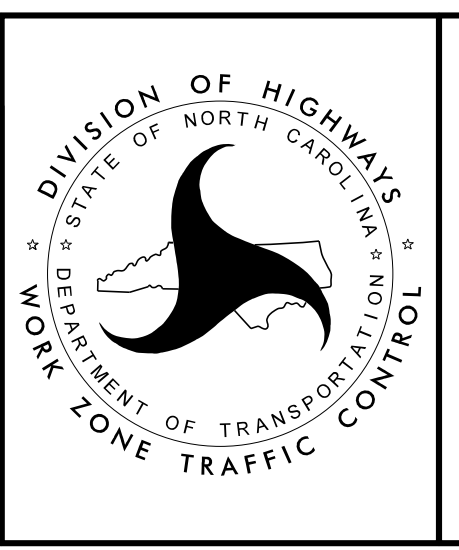

DIVISION OF HIGHWAYS
 NORTH CAROLINA
 DEPARTMENT OF TRANSPORTATION
 WORK ZONE TRAFFIC CONTROL

PHASE IV
 DETAIL DRAWING

10/1/2021
 R2511_TMP_PSH68.dgn
 ksb

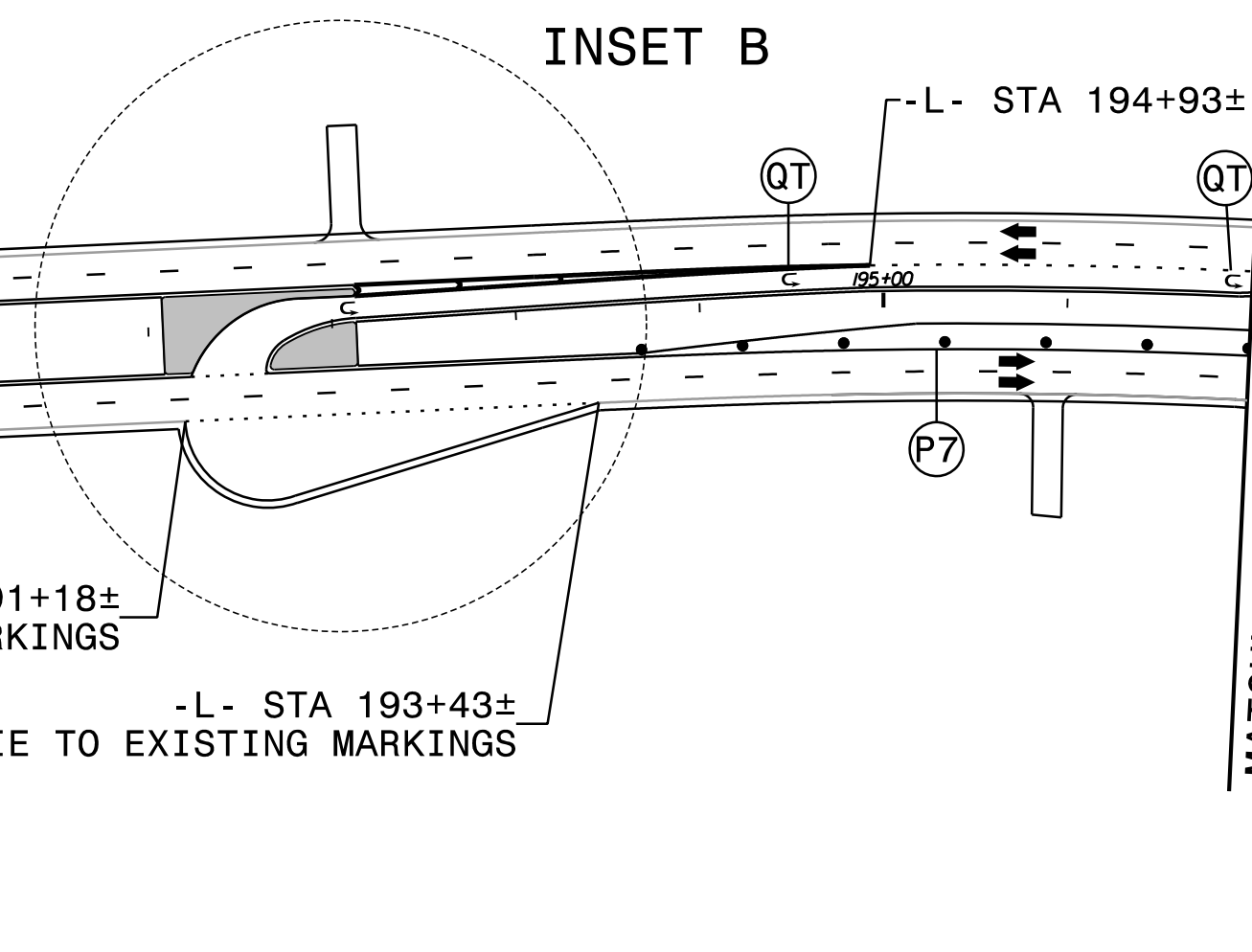
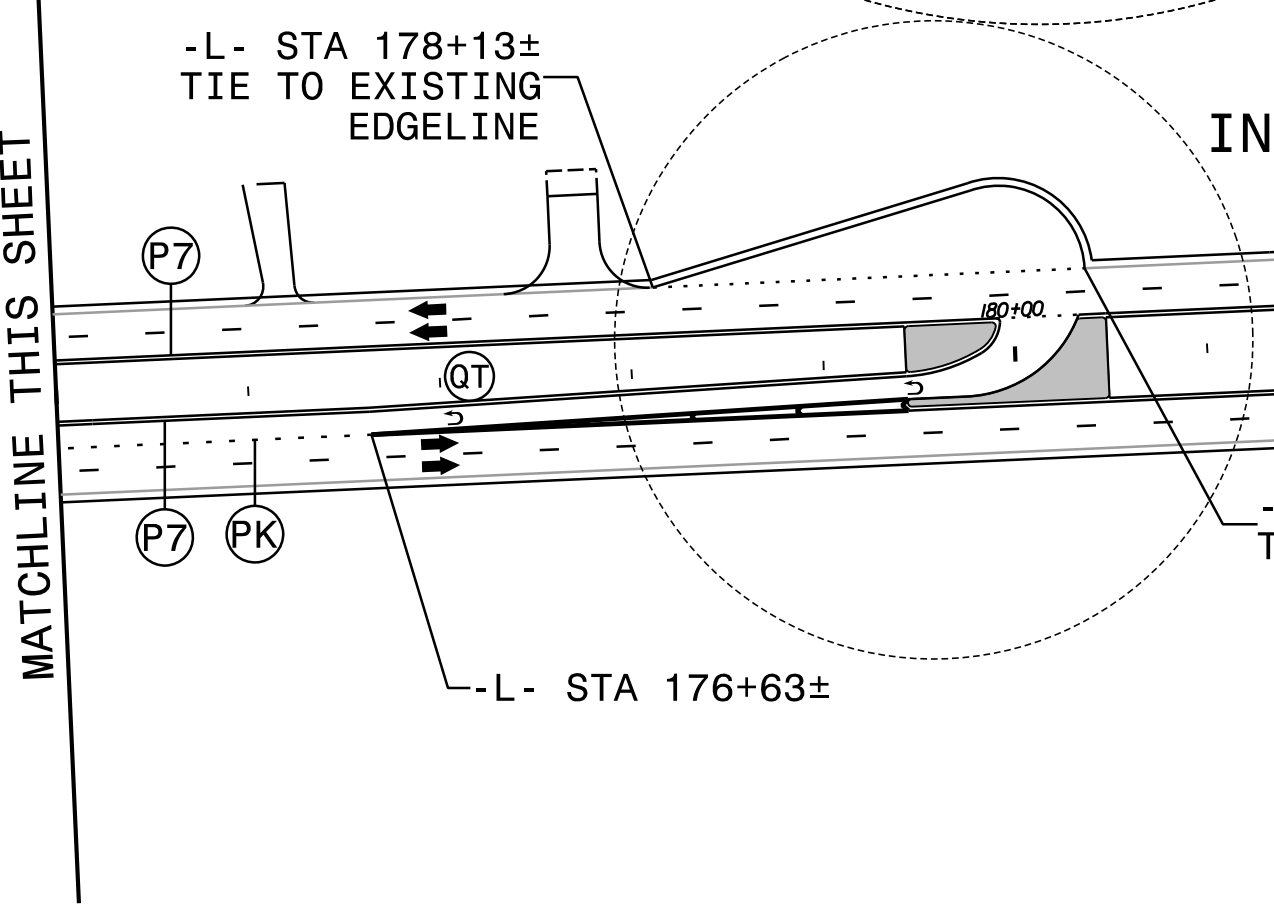
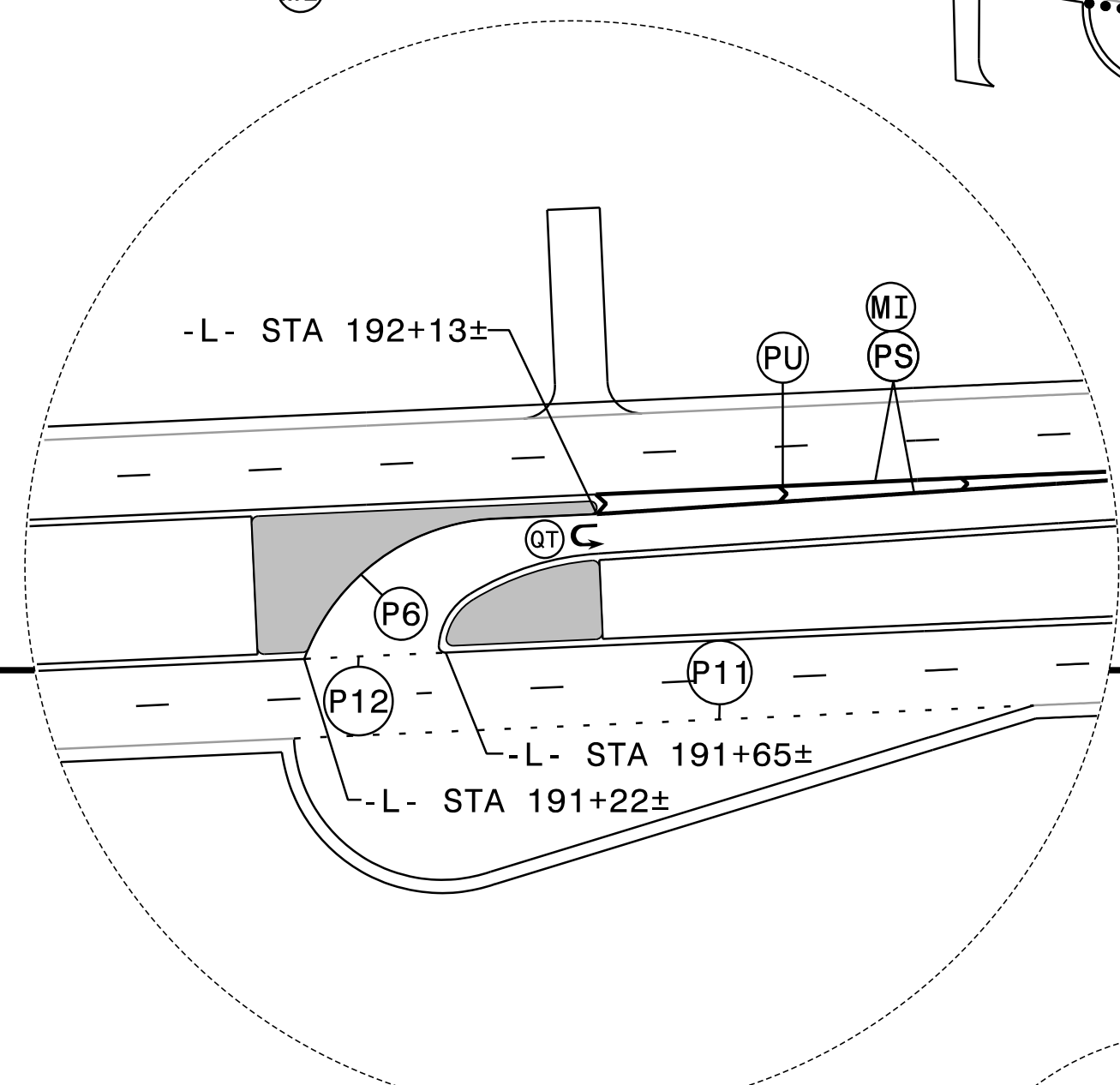
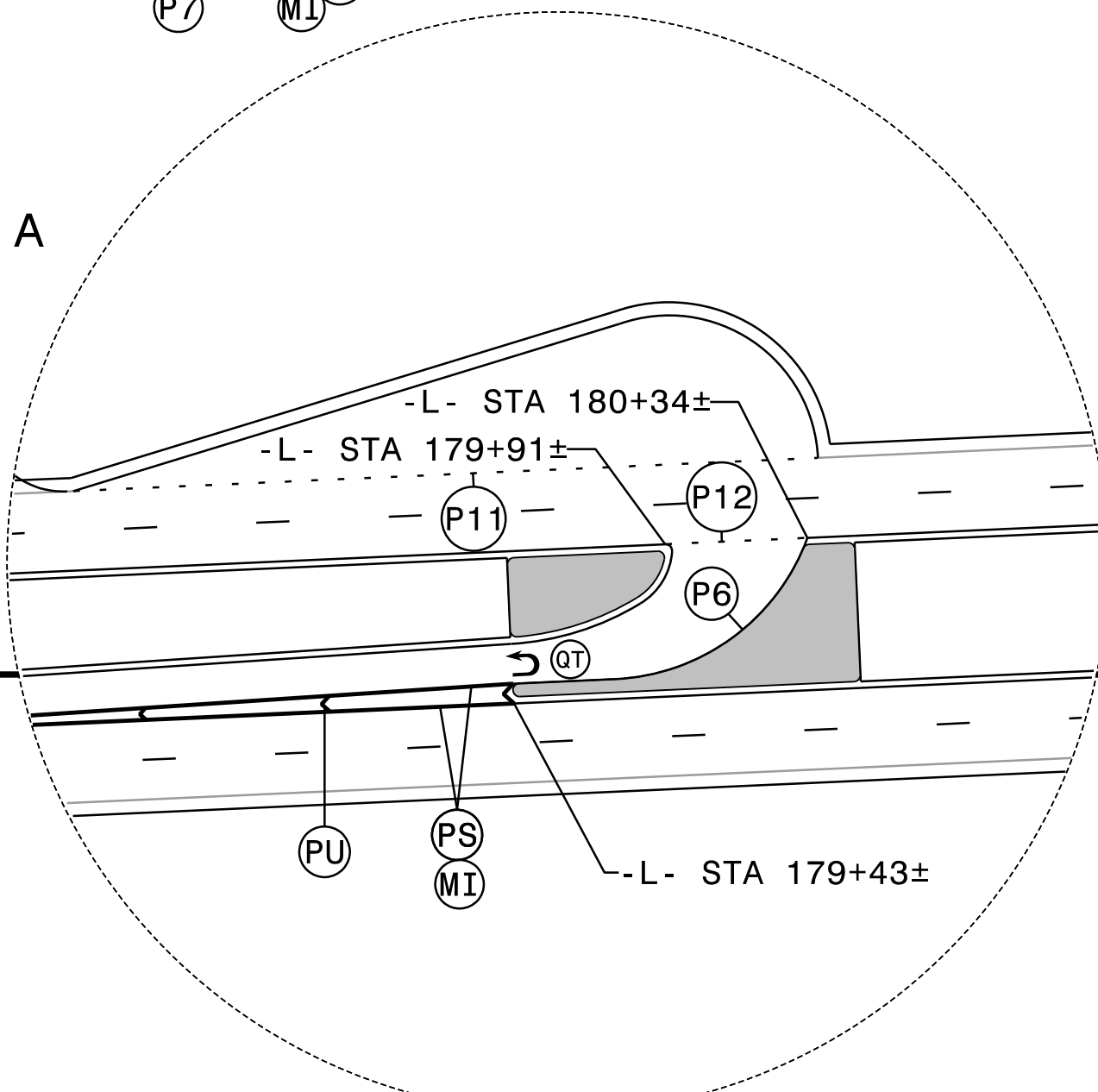
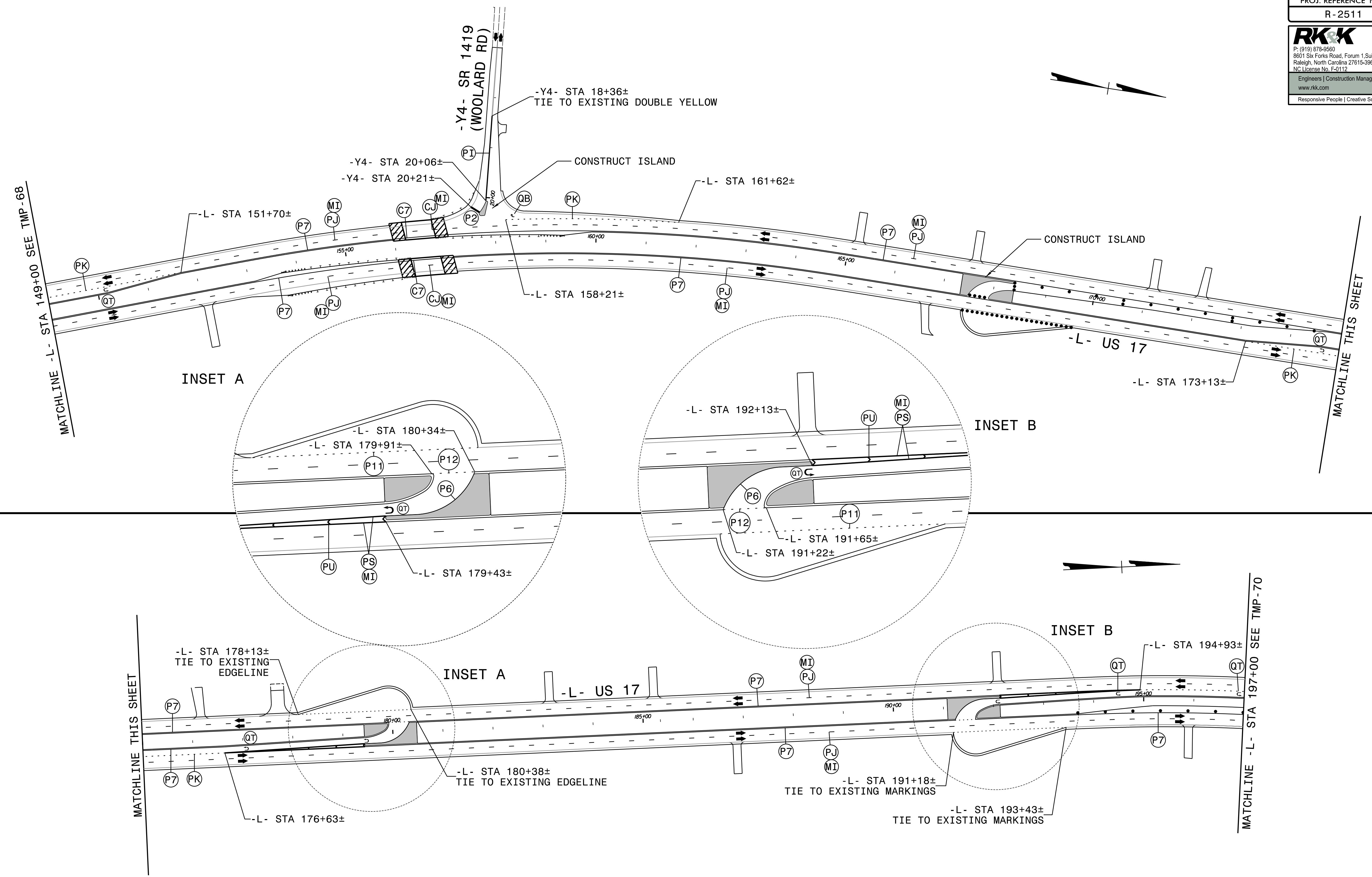

LANE WIDTHS 12' UNLESS OTHERWISE INDICATED.

APPROVED: *Kevin Bisby*
 DATE: 10/1/2021

SEAL

DOCUMENT NOT CONSIDERED FINAL
 UNLESS ALL SIGNATURES COMPLETED

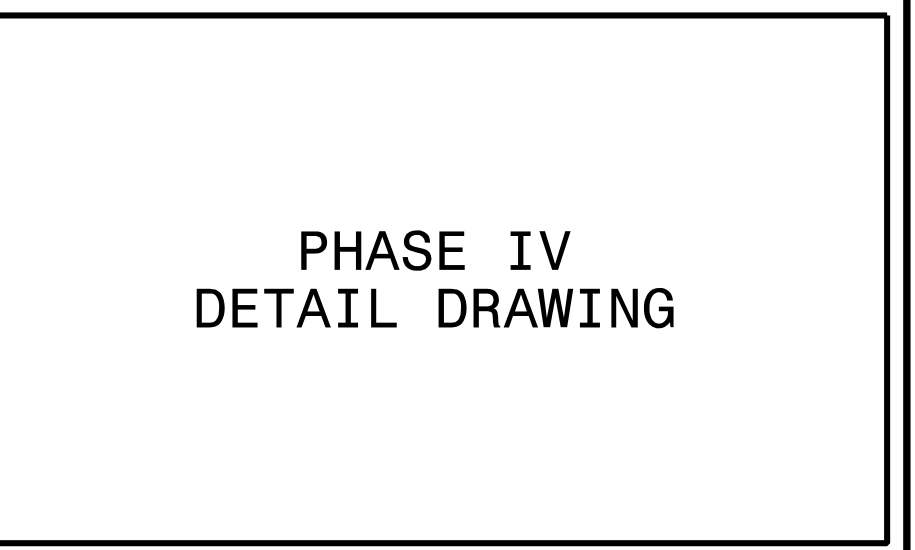
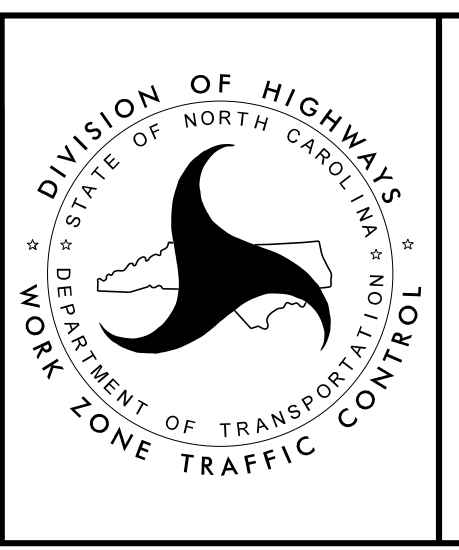

PHASE IV
 DETAIL DRAWING

10/1/2021
 R2511-TMP-PSH69.dgn
 ksb

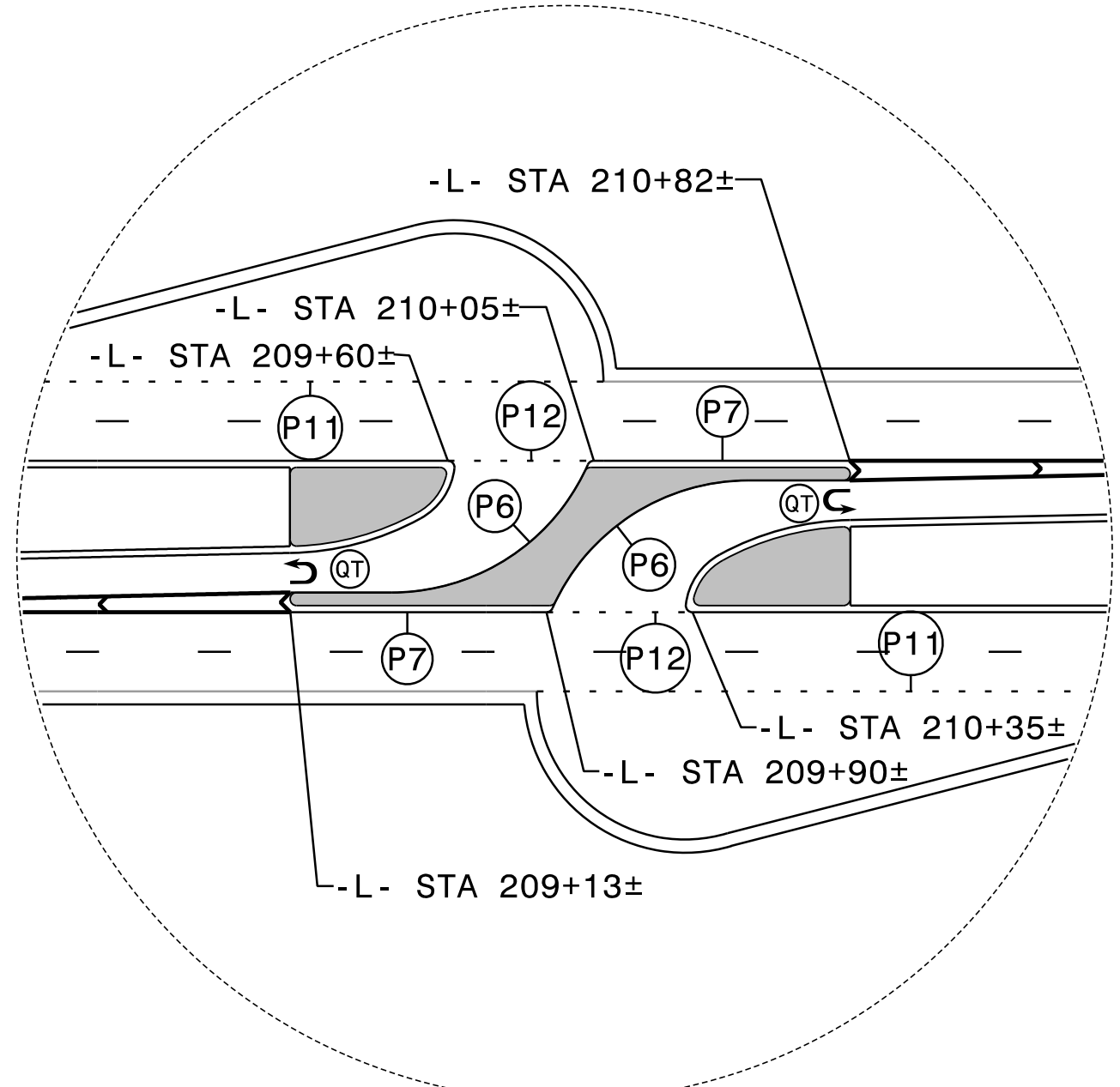
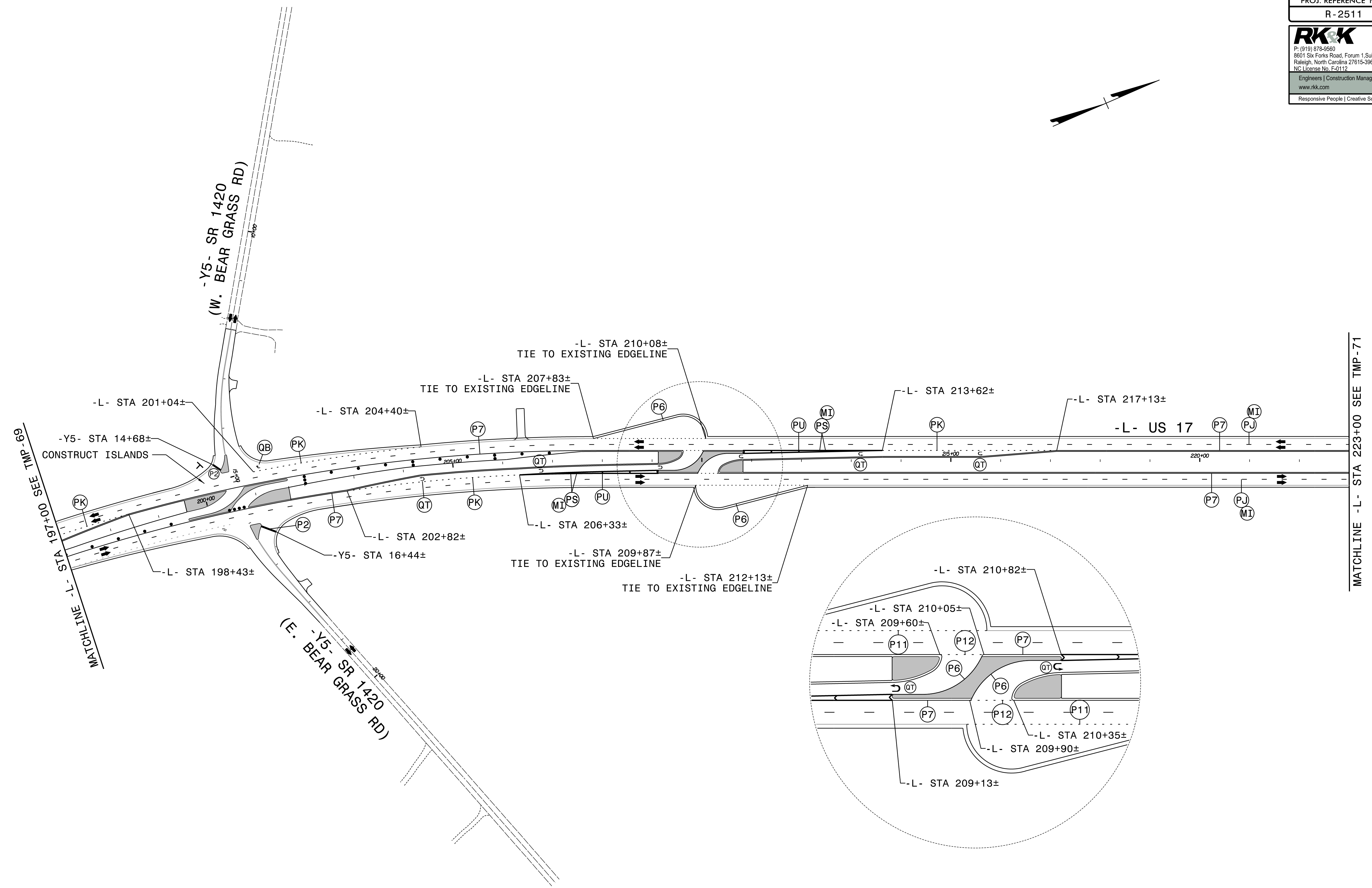
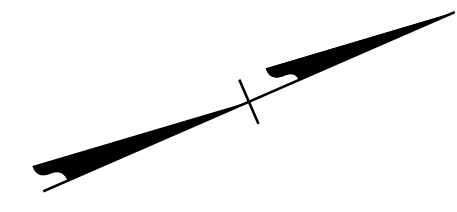

MATCHLINE - L- STA 197+00 SEE TMP-69

MATCHLINE - L- STA 223+00 SEE TMP-71

10/1/2021
R2511-TMP_PSH70.dgn
KSB

LANE WIDTHS 12' UNLESS OTHERWISE INDICATED.

APPROVED: 
 DATE: 10/1/2021

SEAL

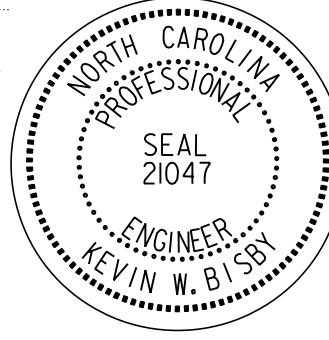

**DOCUMENT NOT CONSIDERED FINAL
UNLESS ALL SIGNATURES COMPLETED**

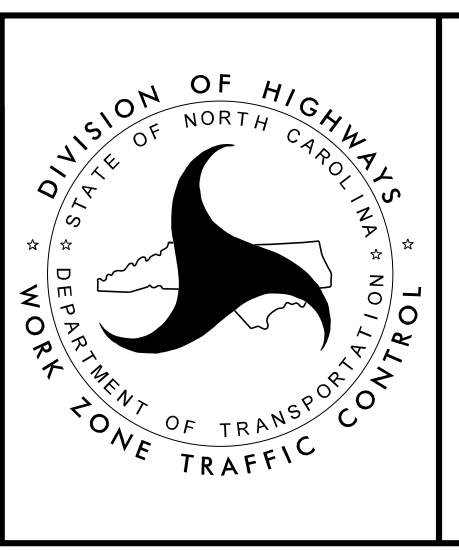

**PHASE IV
DETAIL DRAWING**

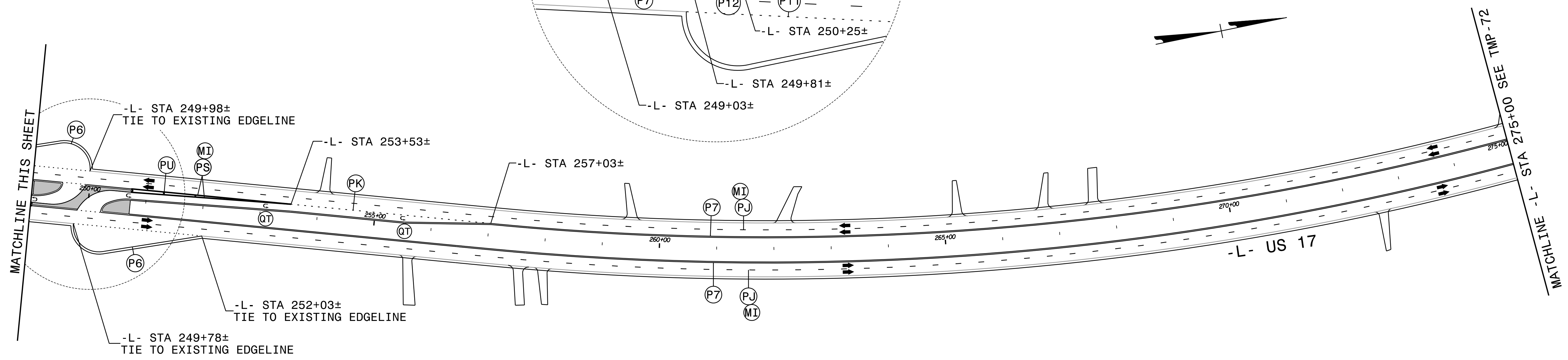
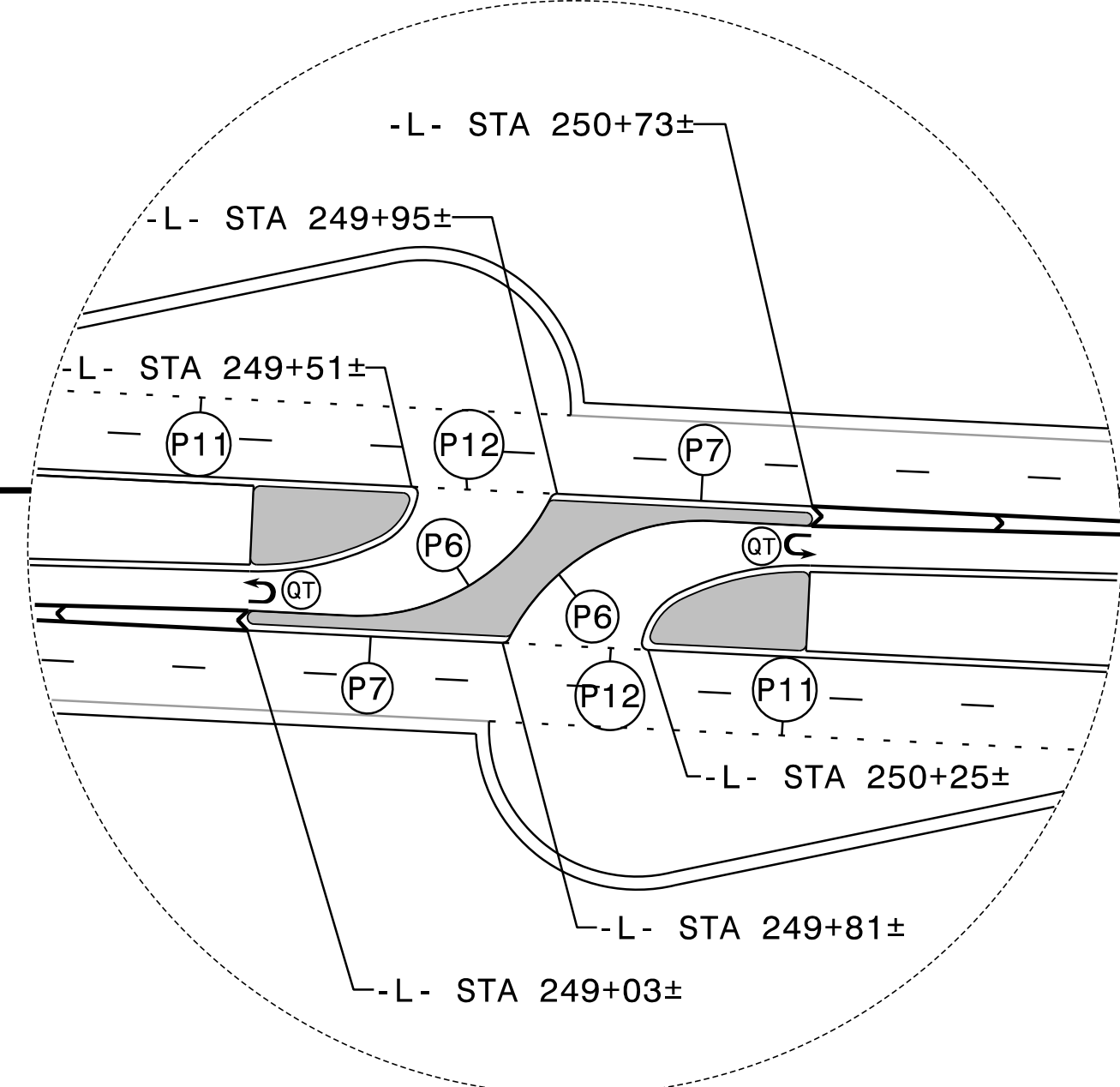
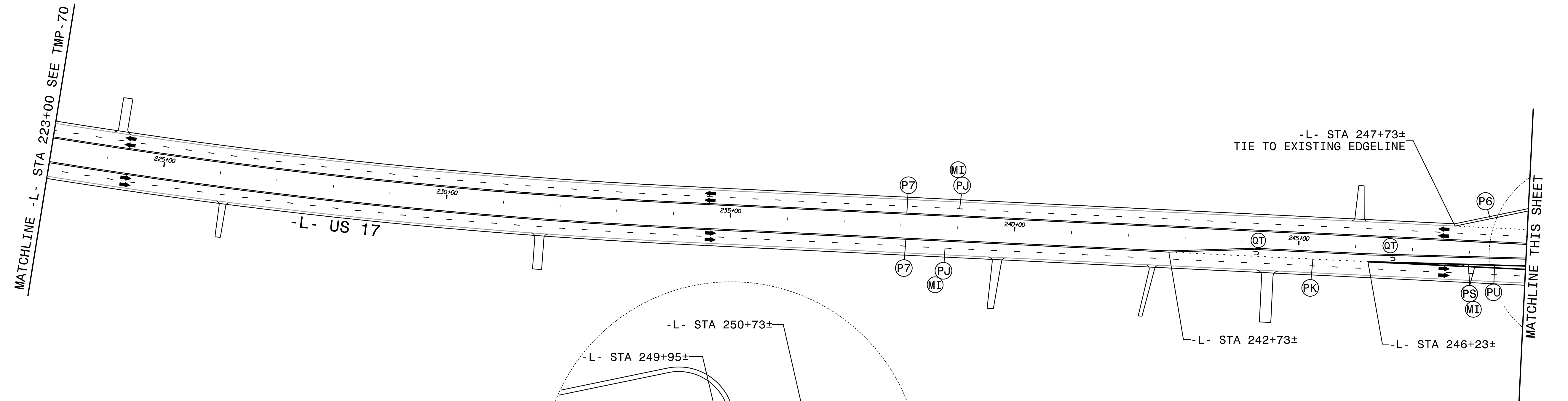

LANE WIDTHS 12' UNLESS OTHERWISE INDICATED.

APPROVED: *Kevin Bisby*
 DATE: 10/1/2021

SEAL

PROFESSIONAL ENGINEER
 SEAL 21047
 KEVIN W. BISBY

DOCUMENT NOT CONSIDERED FINAL
 UNLESS ALL SIGNATURES COMPLETED

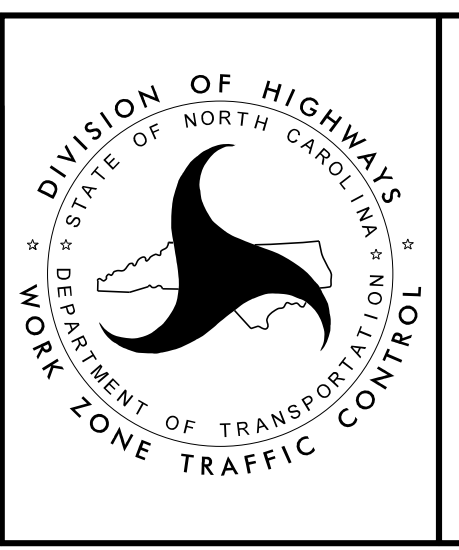

PHASE IV
 DETAIL DRAWING

10/1/2021 R2511-TMP_PSH71.dgn ksb

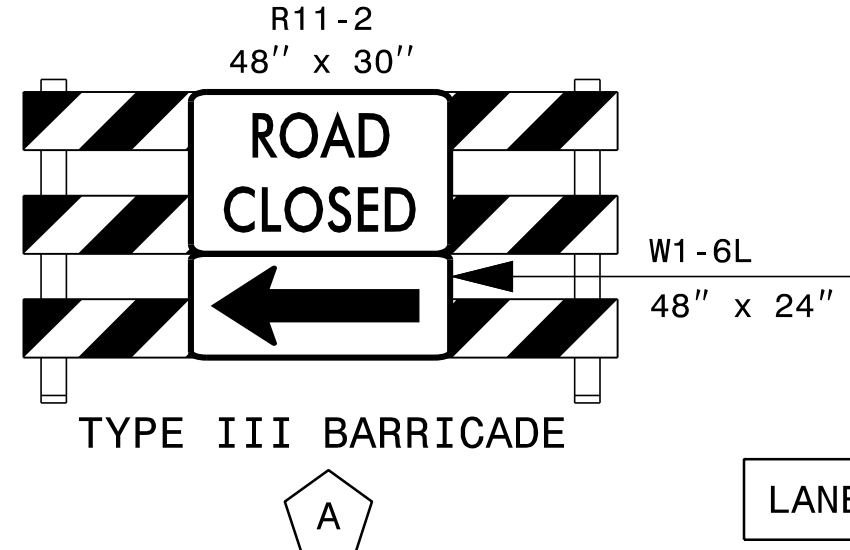
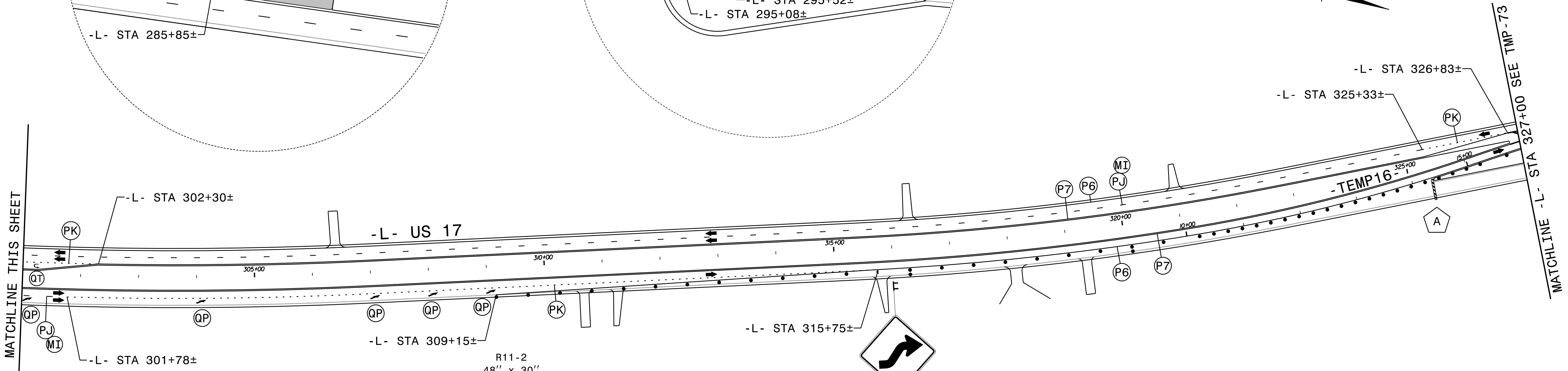
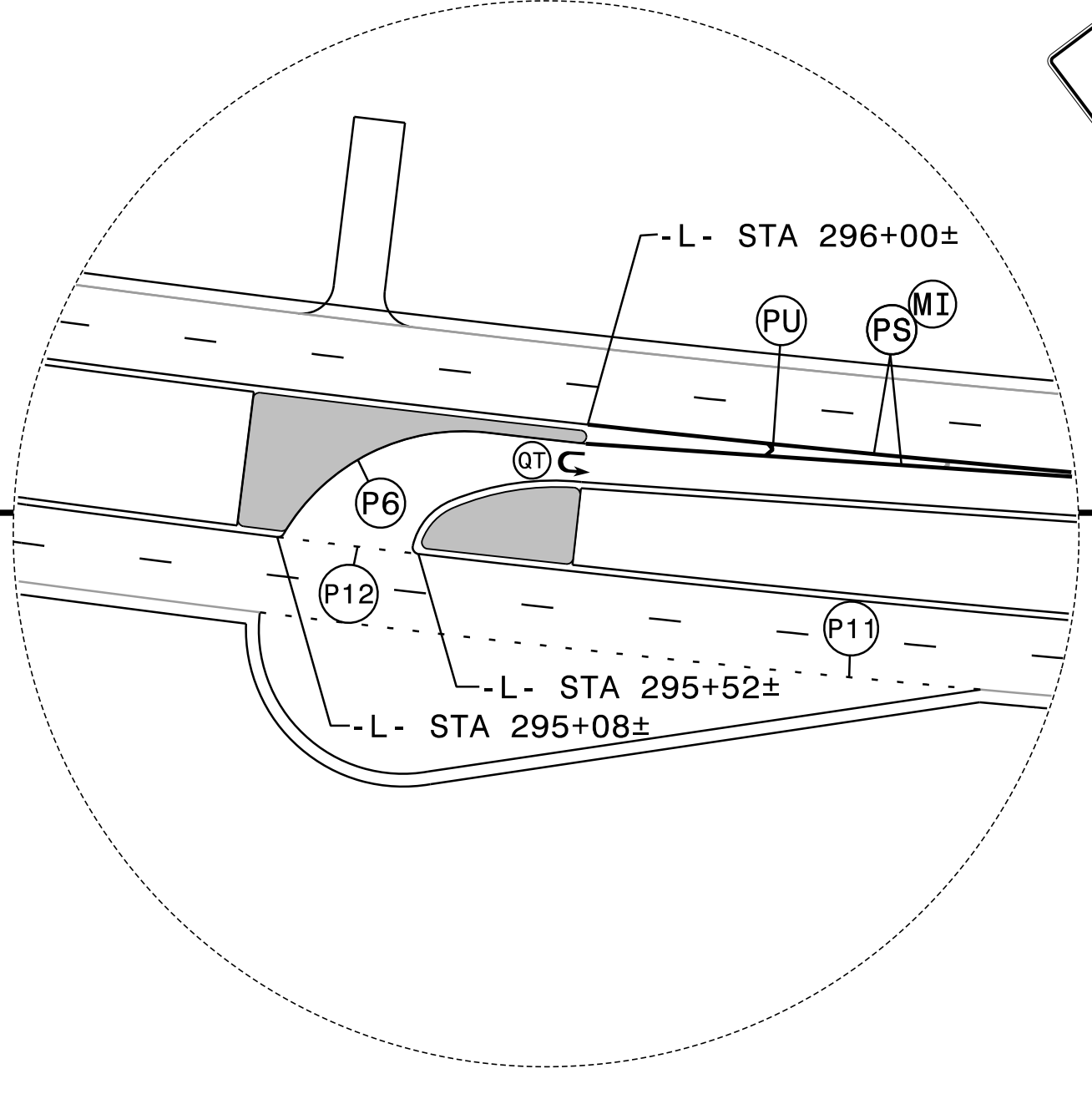
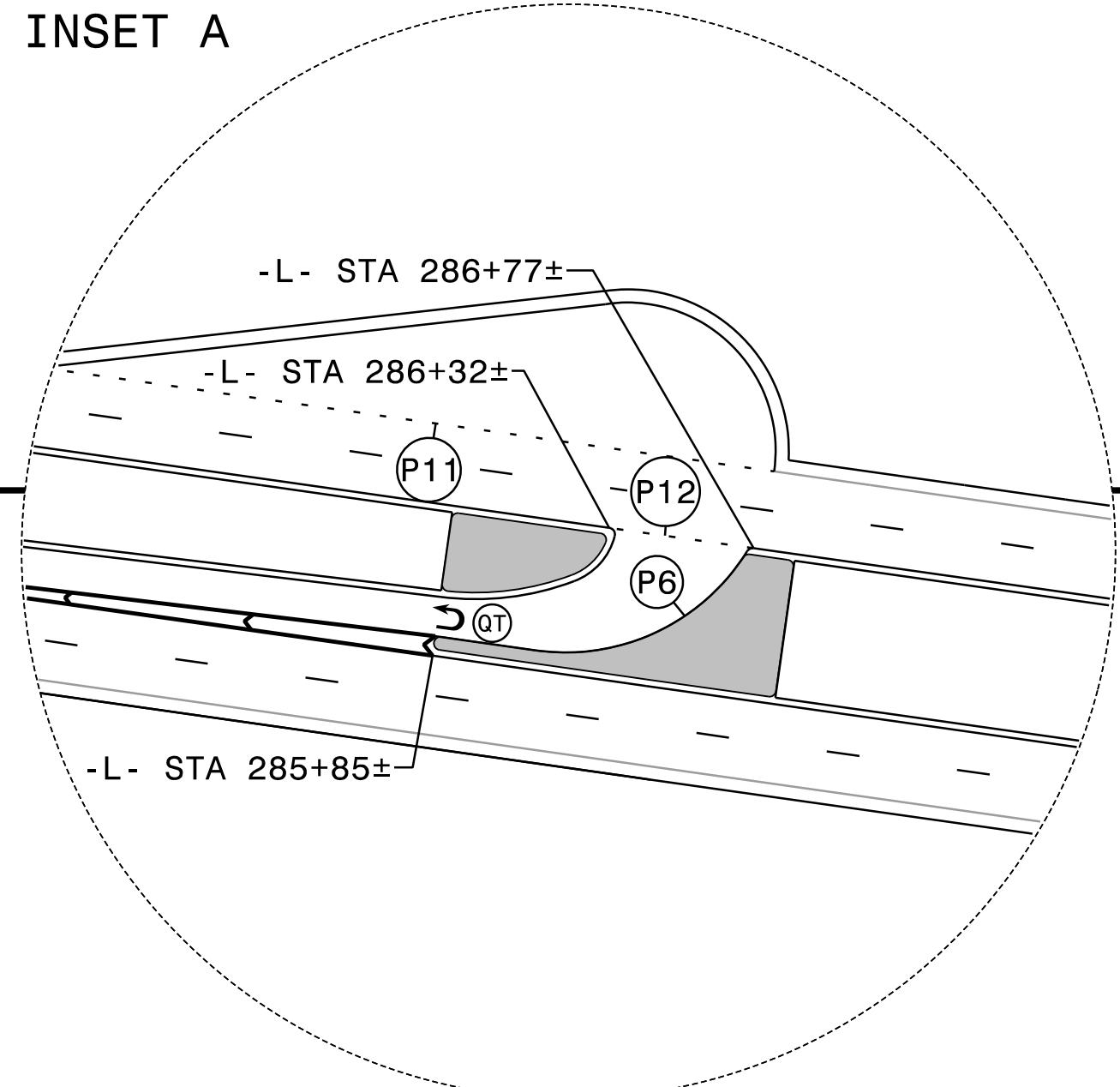
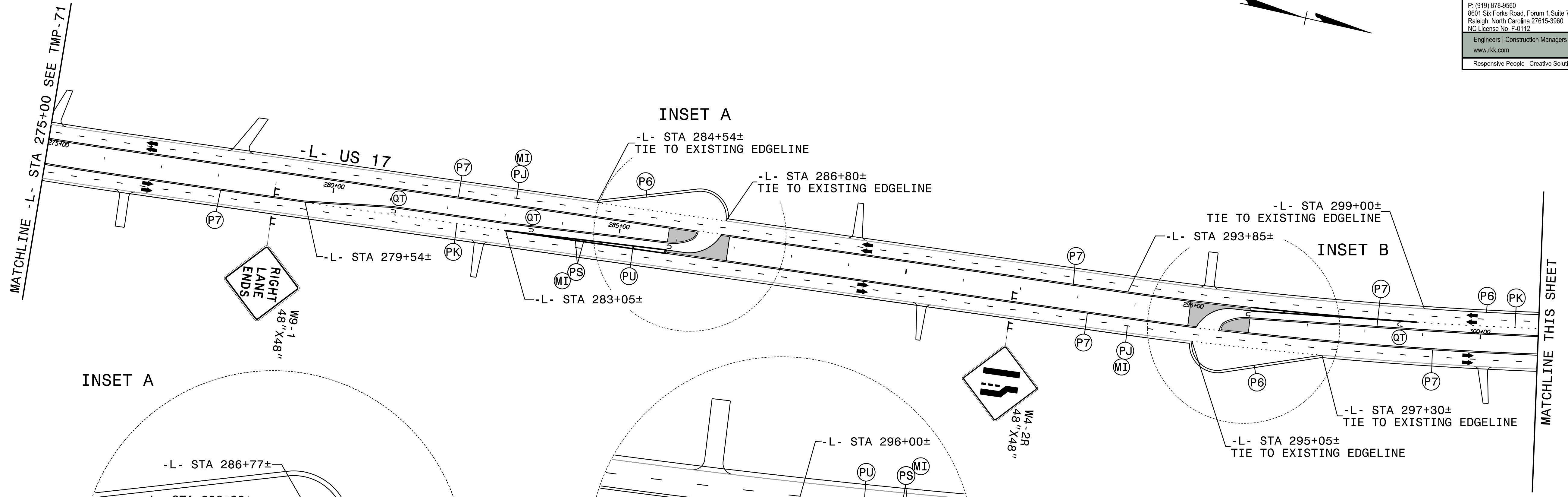

LANE WIDTHS 12' UNLESS OTHERWISE INDICATED.

APPROVED: *Kevin Bisby*
 DATE: 10/1/2021

SEAL

DOCUMENT NOT CONSIDERED FINAL
 UNLESS ALL SIGNATURES COMPLETED

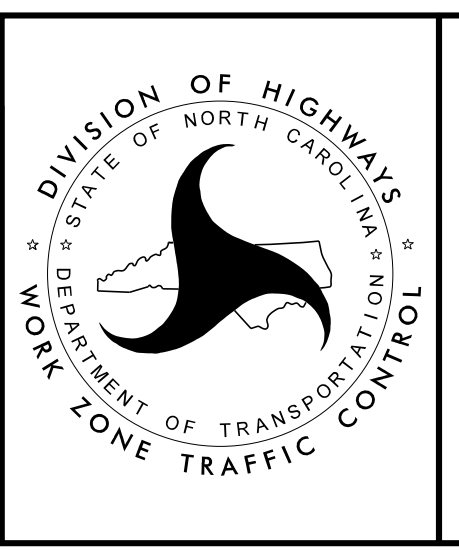

DIVISION OF HIGHWAYS
 STATE OF NORTH CAROLINA
 DEPARTMENT OF TRANSPORTATION
 WORK ZONE TRAFFIC CONTROL

PHASE IV
 DETAIL DRAWING

10/1/2021 R2511-TMP-PSH72.dgn

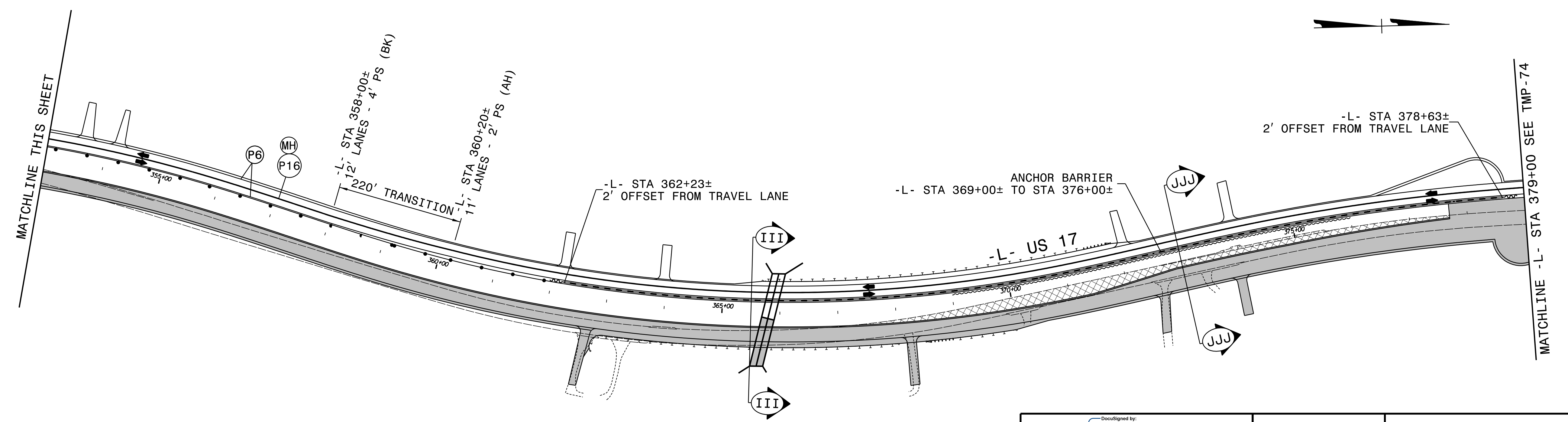
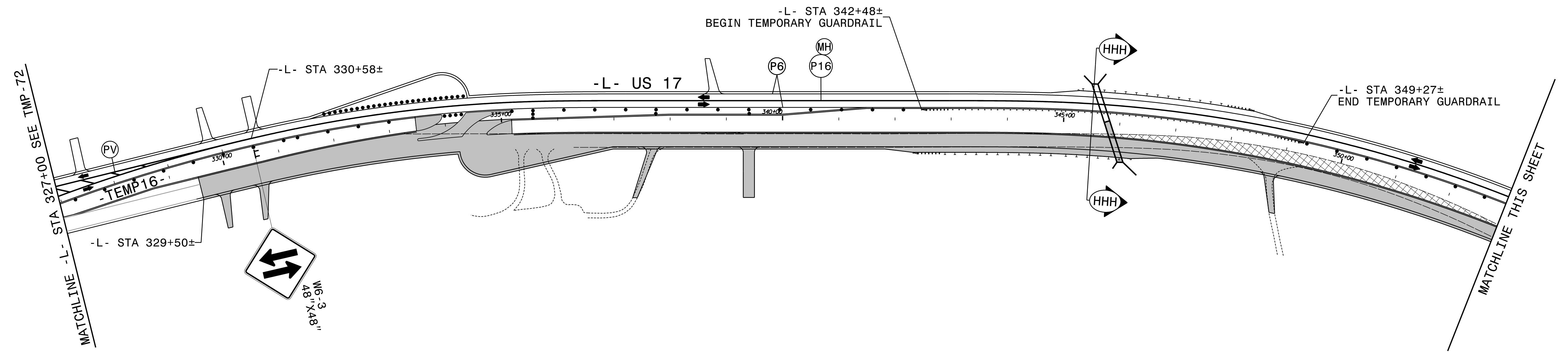

LANE WIDTHS 12' UNLESS OTHERWISE INDICATED.
 SEE TMP-73A FOR SECTION VIEWS.

APPROVED: *Kevin Bisby*
 DATE: 10/1/2021

SEAL

DOCUMENT NOT CONSIDERED FINAL
 UNLESS ALL SIGNATURES COMPLETED

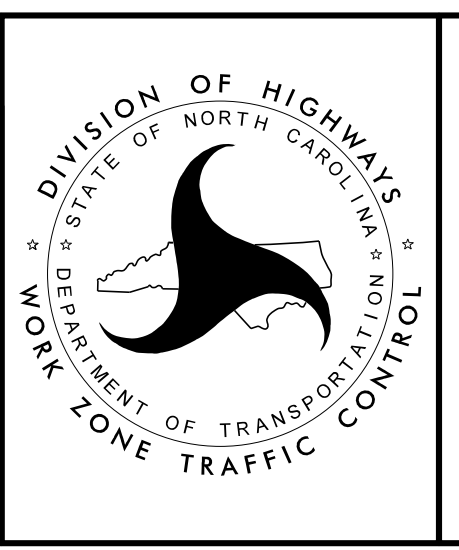

PHASE IV
 DETAIL DRAWING

10/1/2021
 R2511-TMP-PSH73.dgn
 KWB

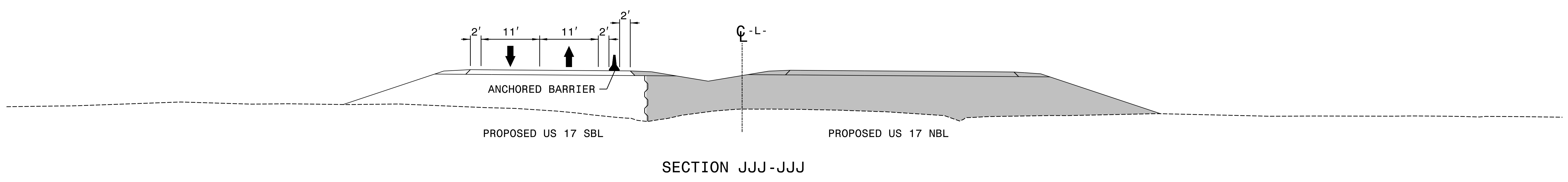
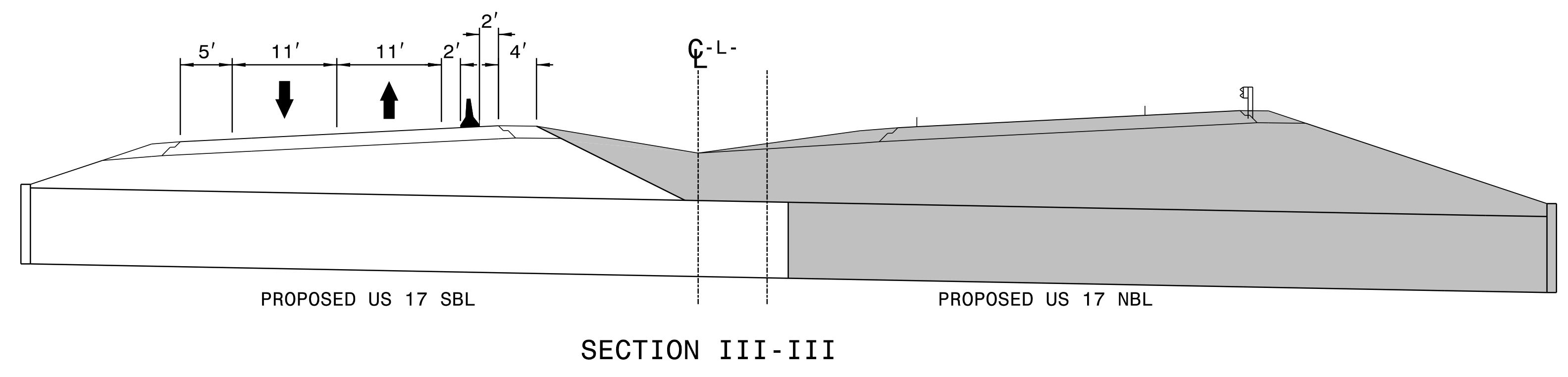
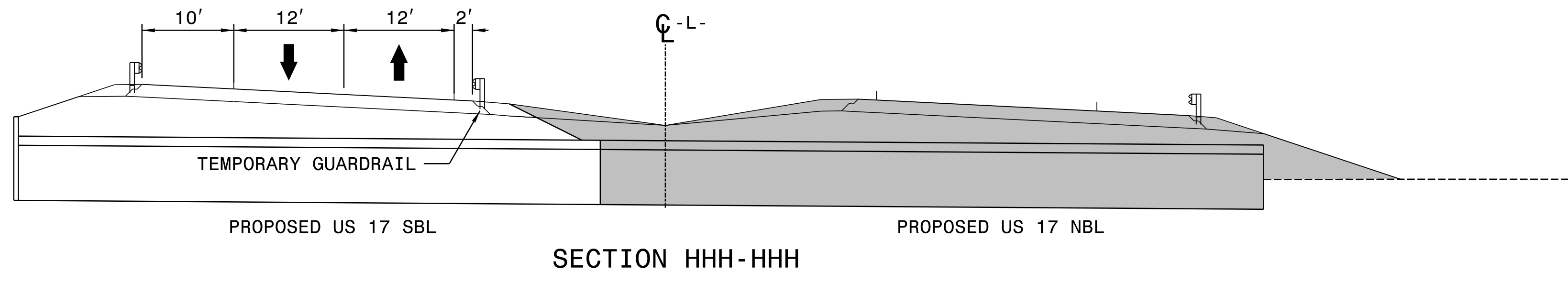

10/1/2021
R2511-TMP_PSH73A.dgn
ksf/bbl

APPROVED: *Kevin Bisby*
DocuSigned by: Kevin Bisby
BDC082928912474

DATE: 10/1/2021

SEAL

**DOCUMENT NOT CONSIDERED FINAL
UNLESS ALL SIGNATURES COMPLETED**

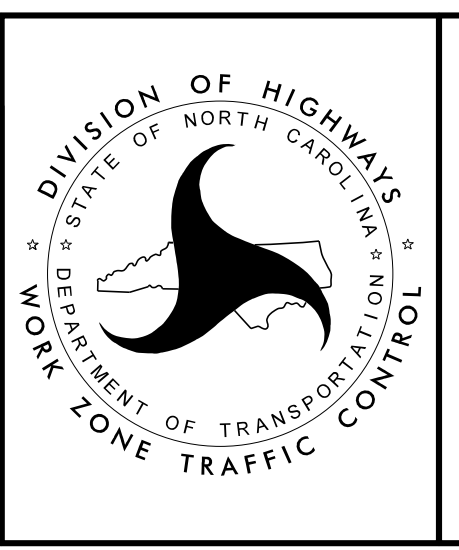

**PHASE IV
DETAIL DRAWING**

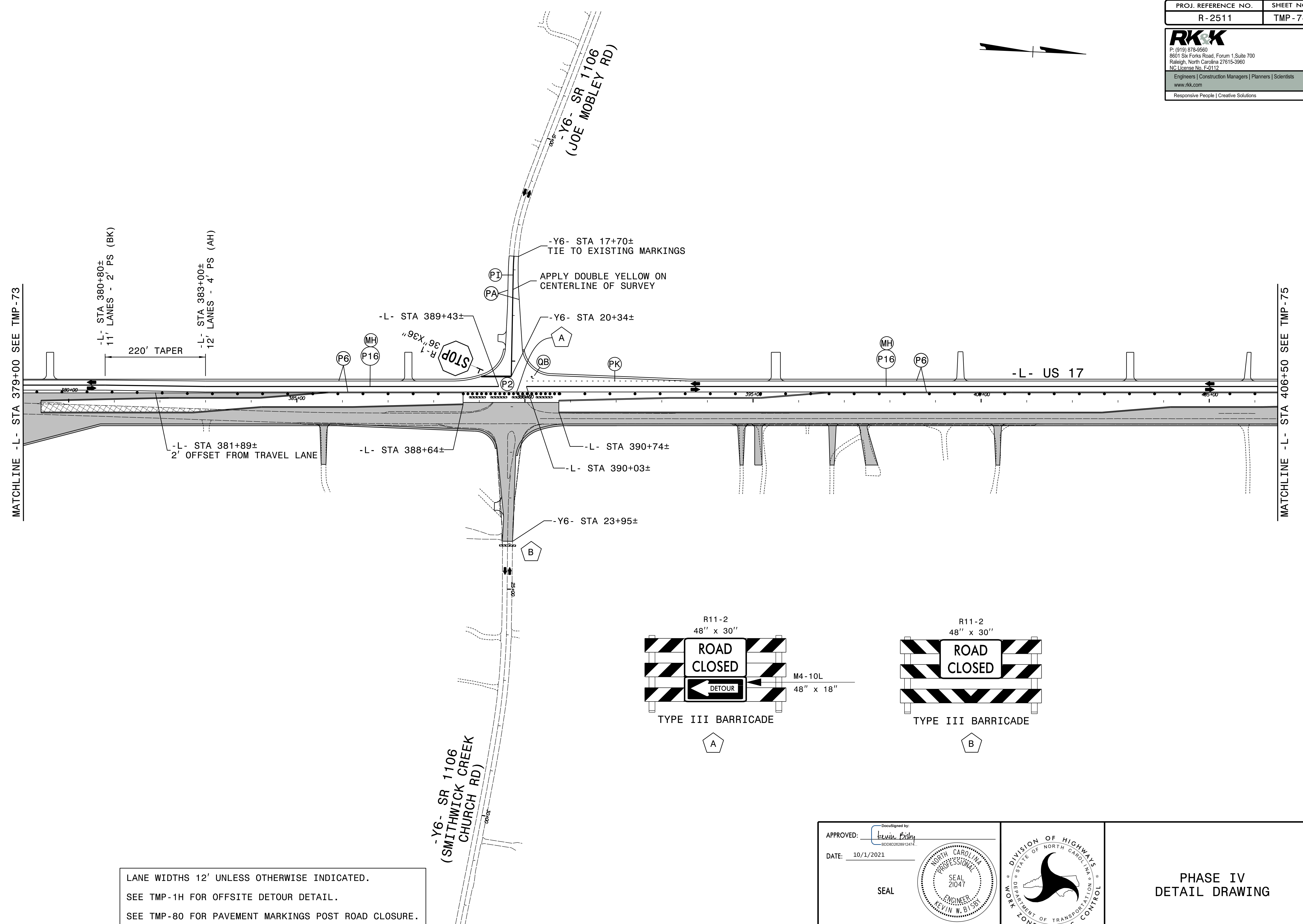
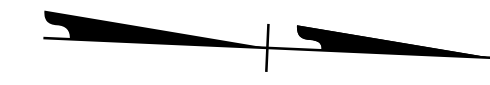

MATCHLINE -L- STA 379+00 SEE TMP-73

MATCHLINE -L- STA 406+50 SEE TMP-75

LANE WIDTHS 12' UNLESS OTHERWISE INDICATED.
 SEE TMP-1H FOR OFFSITE DETOUR DETAIL.
 SEE TMP-80 FOR PAVEMENT MARKINGS POST ROAD CLOSURE.

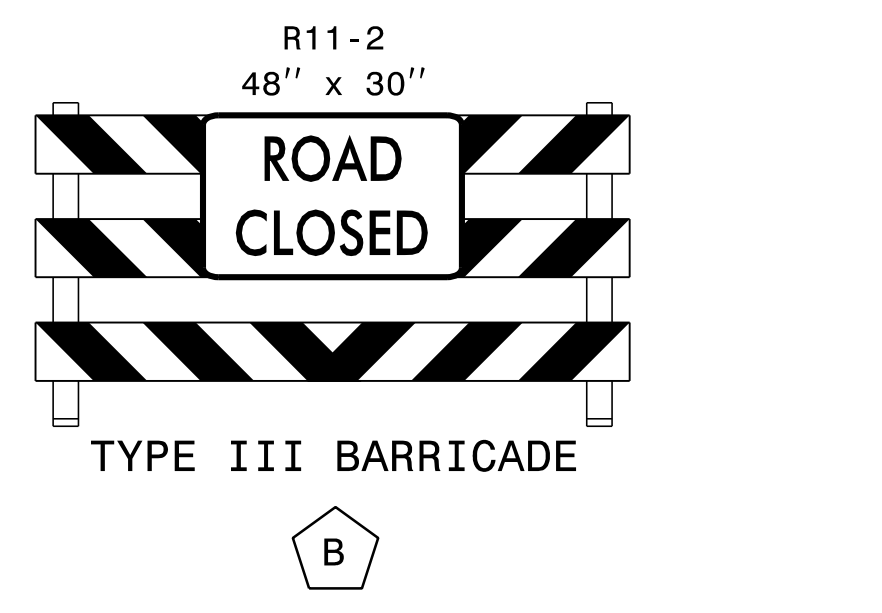
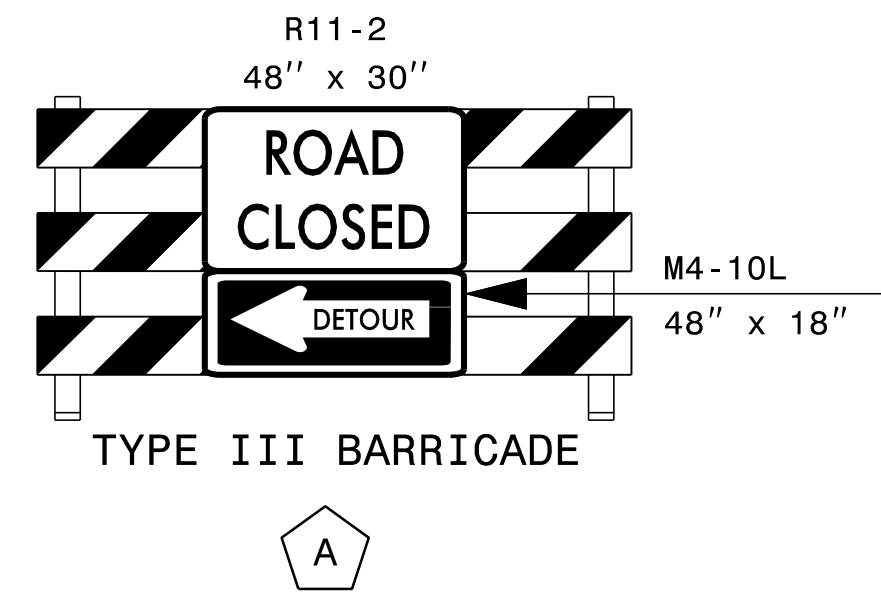

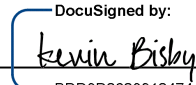
APPROVED: 
 DATE: 10/1/2021

SEAL

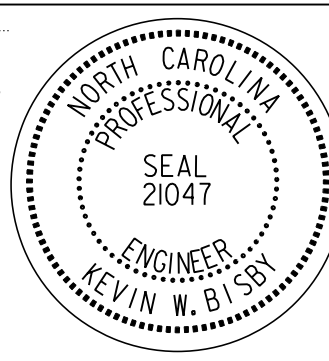
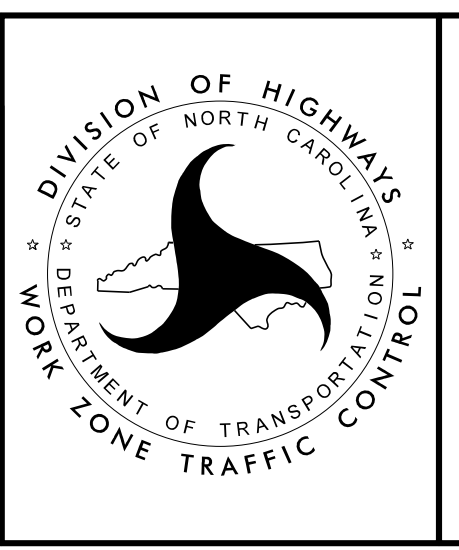



PHASE IV
 DETAIL DRAWING

10/1/2021
 R2511-TMP-PSH74.dgn
 ksb

PROJ. REFERENCE NO.	SHEET NO.
R-2511	TMP-75

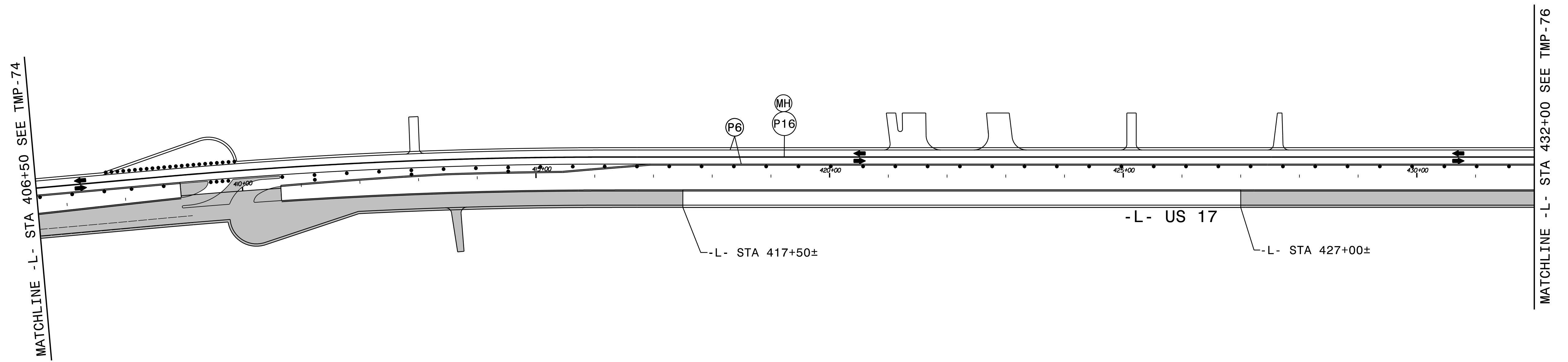
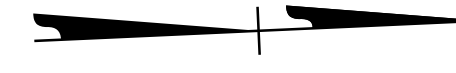
RKX
 P: (919) 878-8560
 8601 Six Forks Road, Forum 1, Suite 700
 Raleigh, North Carolina 27615-3960
 NC License No. F-0112
 Engineers | Construction Managers | Planners | Scientists
 www.rkx.com
 Responsive People | Creative Solutions

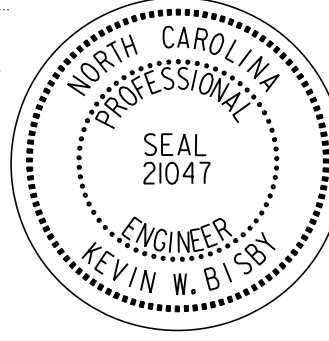
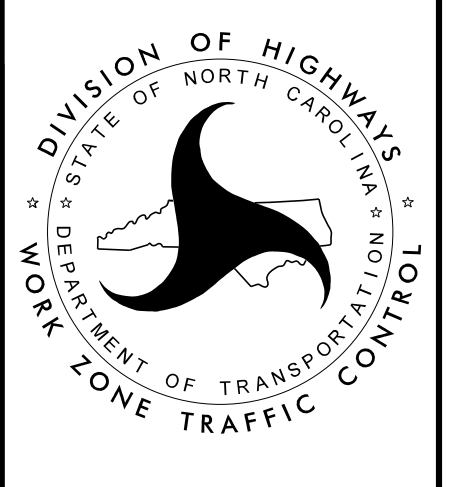

LANE WIDTHS 12' UNLESS OTHERWISE INDICATED.

<p>APPROVED:  <small>DocuSigned by: Kevin Bisby B0C802928912474</small></p> <p>DATE: 10/1/2021</p> <p>SEAL</p> 		<p>PHASE IV DETAIL DRAWING</p>
<p>DOCUMENT NOT CONSIDERED FINAL UNLESS ALL SIGNATURES COMPLETED</p>		

10/1/2021
 R2511_TMP_PSH75.dgn
 kbisbi

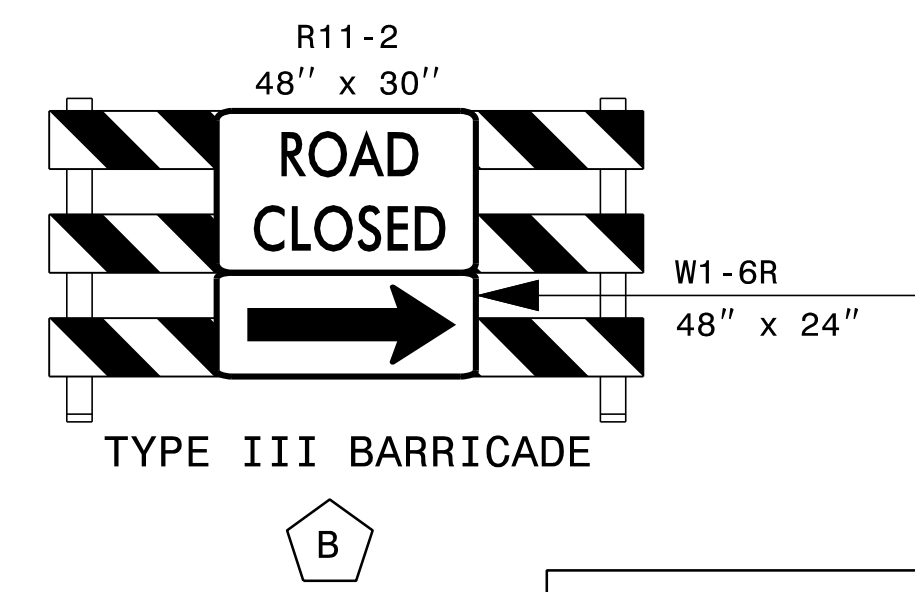
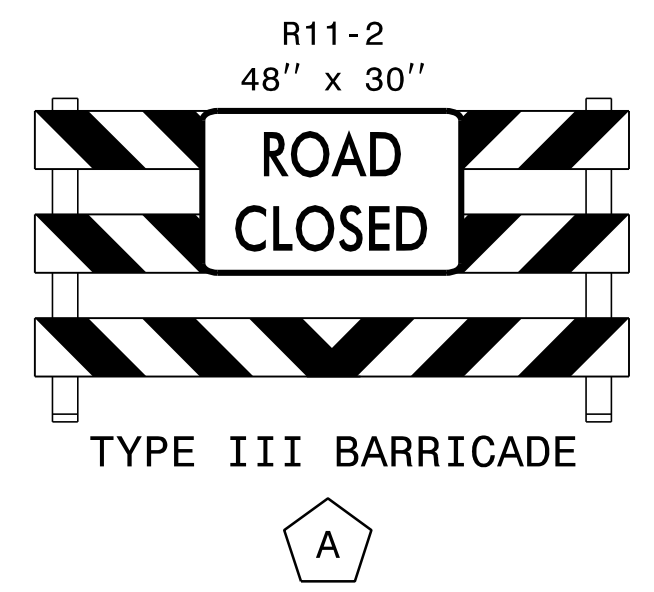
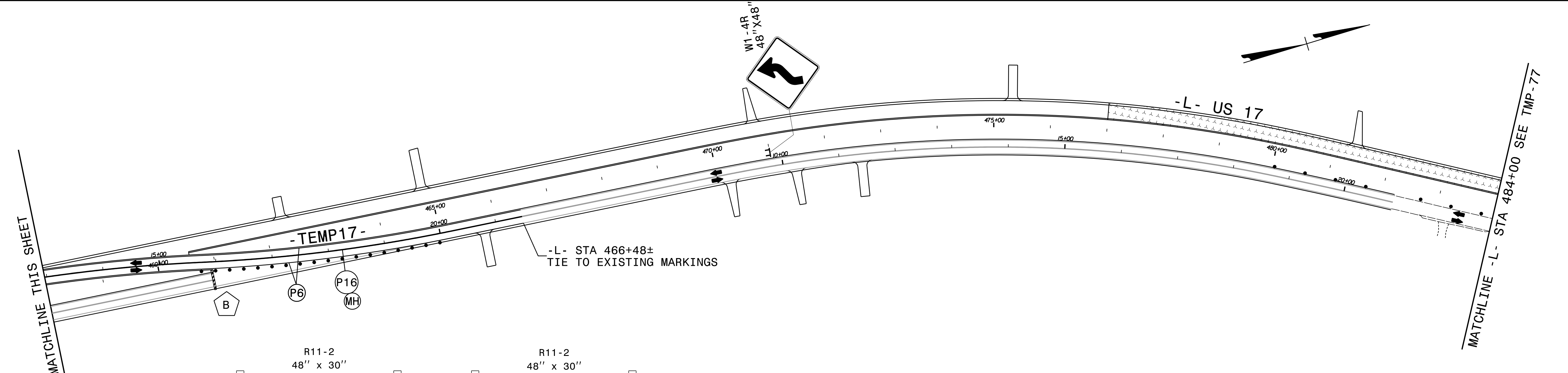
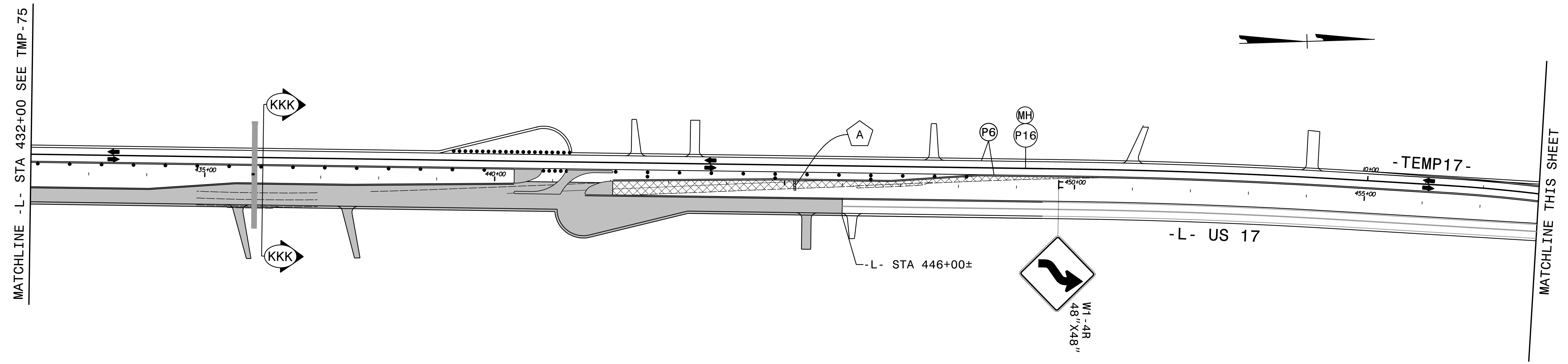

LANE WIDTHS 12' UNLESS OTHERWISE INDICATED.
SEE TMP-76A FOR SECTION VIEW.

APPROVED: *Kevin Bisby*
DocuSigned by: Kevin Bisby
B0C802928912474

DATE: 10/1/2021

SEAL

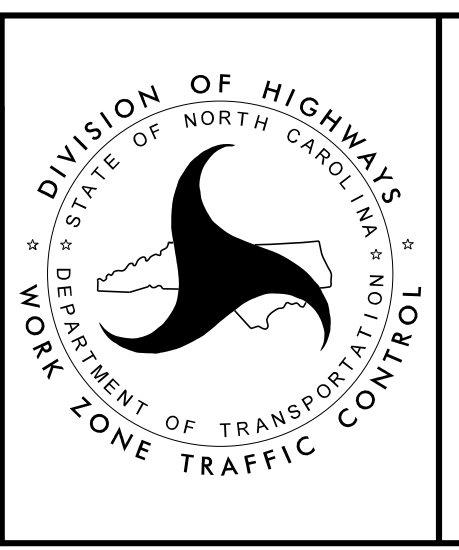

PHASE IV
DETAIL DRAWING

PROJ. REFERENCE NO.	SHEET NO.
R-2511	TMP-76A

RKK
 P: (919) 878-8560
 8601 Six Forks Road, Forum 1, Suite 700
 Raleigh, North Carolina 27615-3960
 NC License No. F-0112
 Engineers | Construction Managers | Planners | Scientists
 www.rkk.com
 Responsive People | Creative Solutions

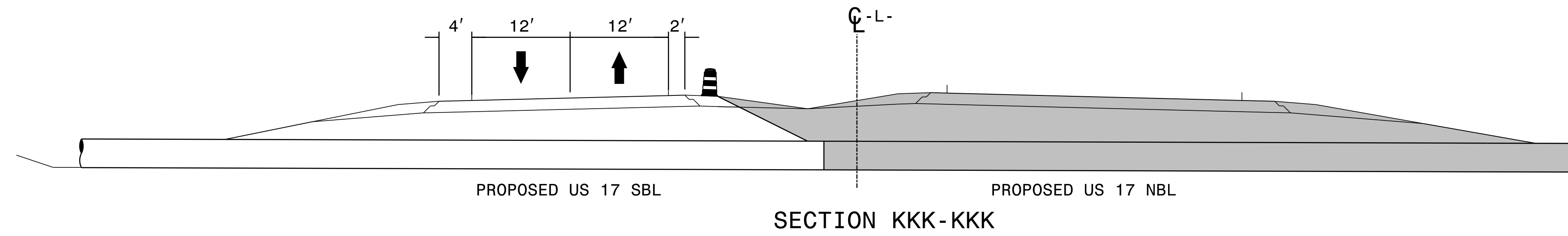

10/1/2021
 R2511_TMP_PSH76A.dgn
 kbsbl

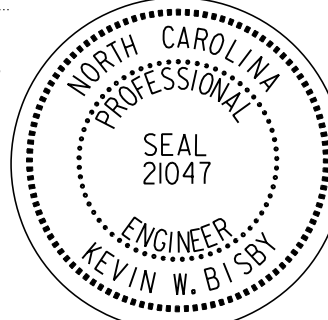
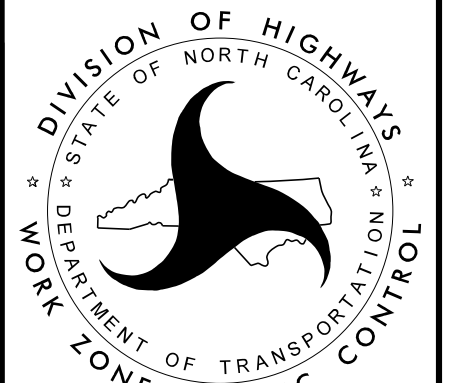
<p>APPROVED:  <small>DocuSigned by: Kevin Bisby B0C802928912474</small></p> <p>DATE: 10/1/2021</p> <p>SEAL</p> 		<p>PHASE IV DETAIL DRAWING</p>
<p>DOCUMENT NOT CONSIDERED FINAL UNLESS ALL SIGNATURES COMPLETED</p>		

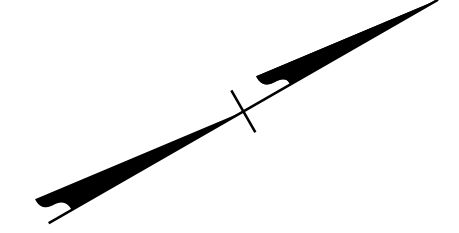

MATCHLINE - L - STA 484+00 SEE TMP-76

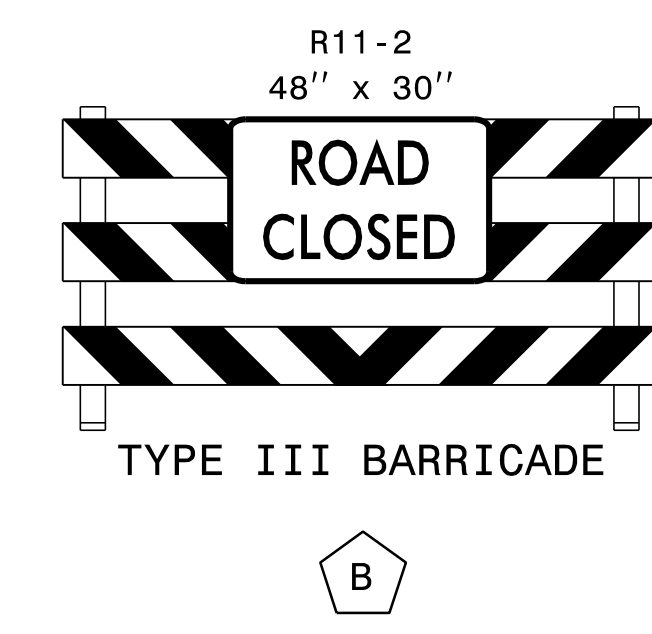
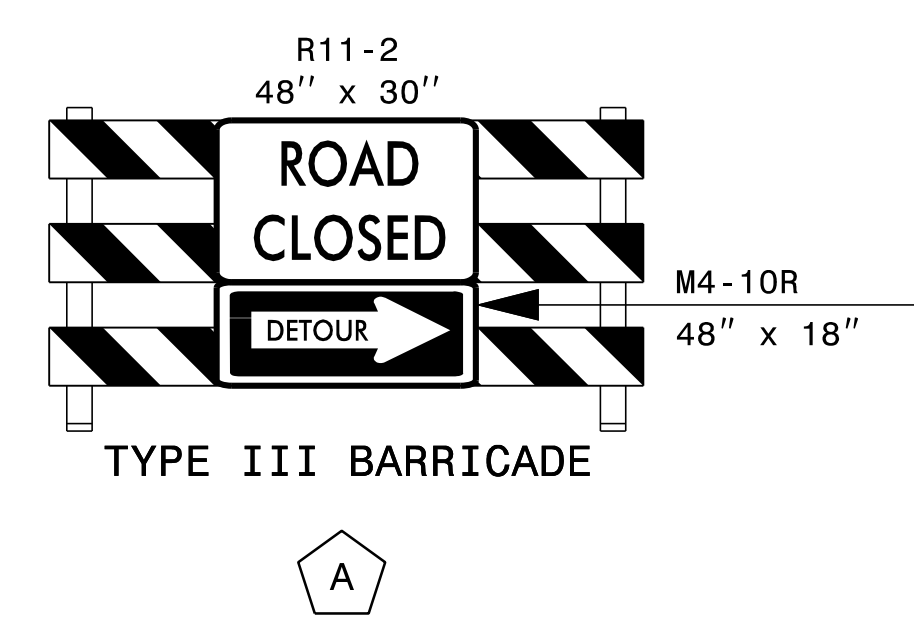
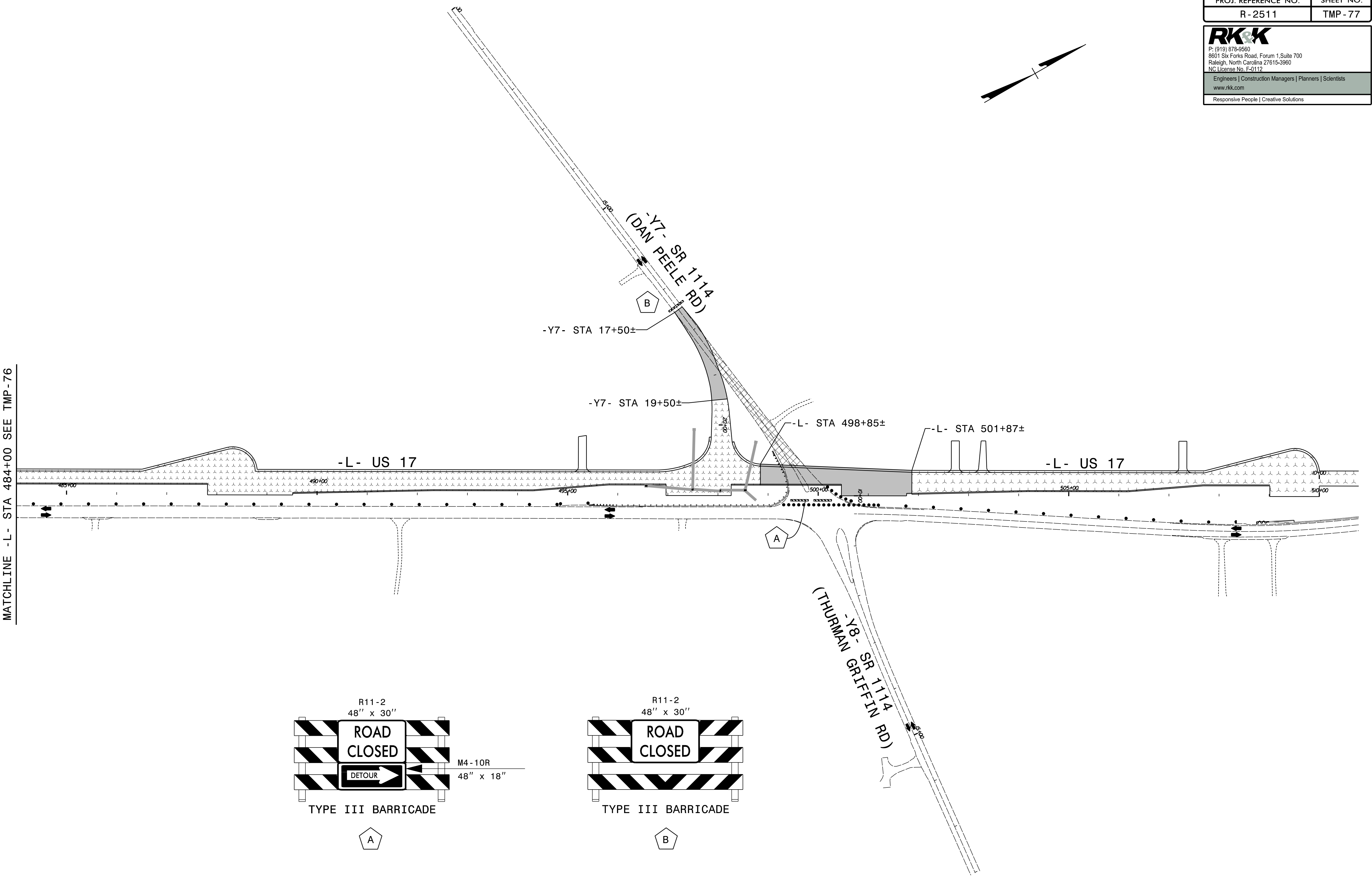

SEE TMP-11 FOR OFFSITE DETOUR DETAIL.
SEE TMP-82 FOR PAVEMENT MARKINGS POST ROAD CLOSURE.

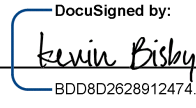
APPROVED: 
DATE: 10/1/2021

SEAL

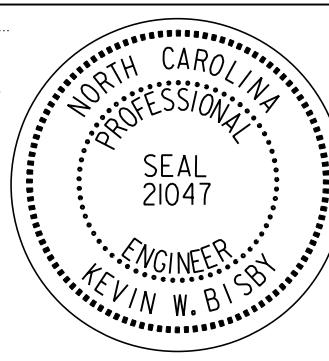

**DOCUMENT NOT CONSIDERED FINAL
UNLESS ALL SIGNATURES COMPLETED**

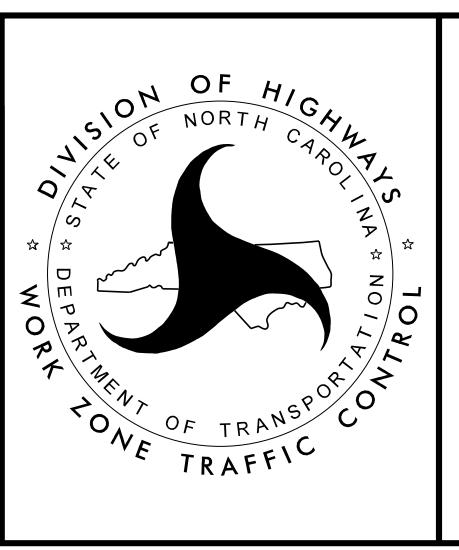

**PHASE IV
DETAIL DRAWING**

PROJ. REFERENCE NO.	SHEET NO.
R-2511	TMP-78

RKK
 P: (919) 878-8560
 8601 Six Forks Road, Forum 1, Suite 700
 Raleigh, North Carolina 27615-3960
 NC License No. F-0112
 Engineers | Construction Managers | Planners | Scientists
 www.rkk.com
 Responsive People | Creative Solutions

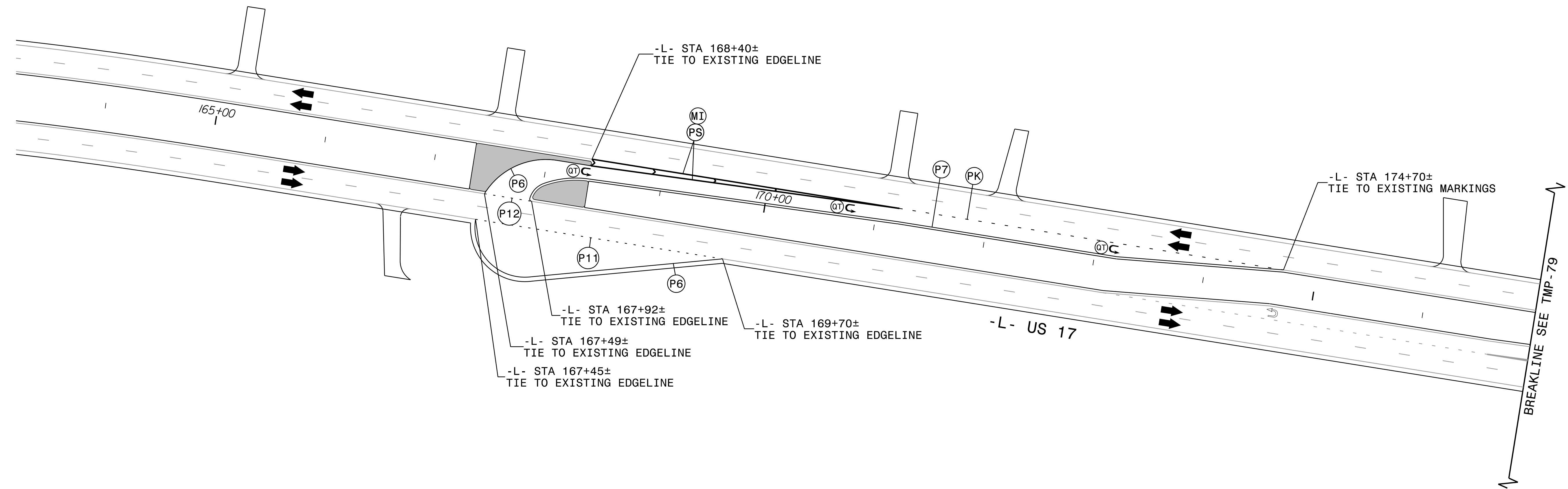
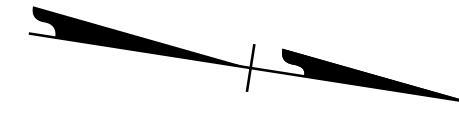

LANE WIDTHS 12' UNLESS OTHERWISE INDICATED.

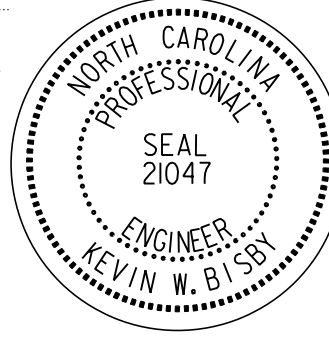
APPROVED: 
 DATE: 10/1/2021
 SEAL

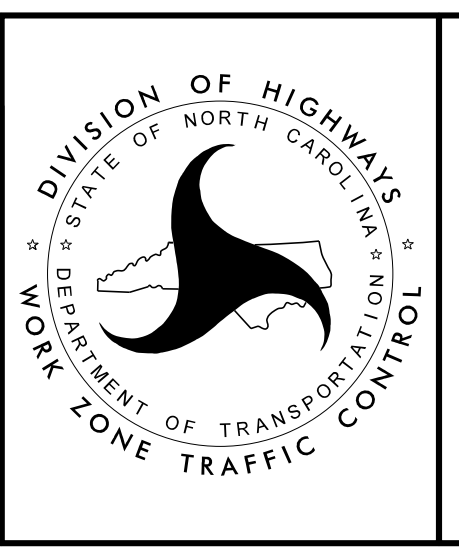
 DOCUMENT NOT CONSIDERED FINAL
 UNLESS ALL SIGNATURES COMPLETED



PHASE V
 DETAIL DRAWING

10/1/2021
 R2511_TMP_PSH78.dgn
 kbisbi

PROJ. REFERENCE NO.	SHEET NO.
R-2511	TMP-79

RKK
 P: (919) 878-8560
 8601 Six Forks Road, Forum 1, Suite 700
 Raleigh, North Carolina 27615-3960
 NC License No. F-0112
 Engineers | Construction Managers | Planners | Scientists
 www.rkk.com
 Responsive People | Creative Solutions

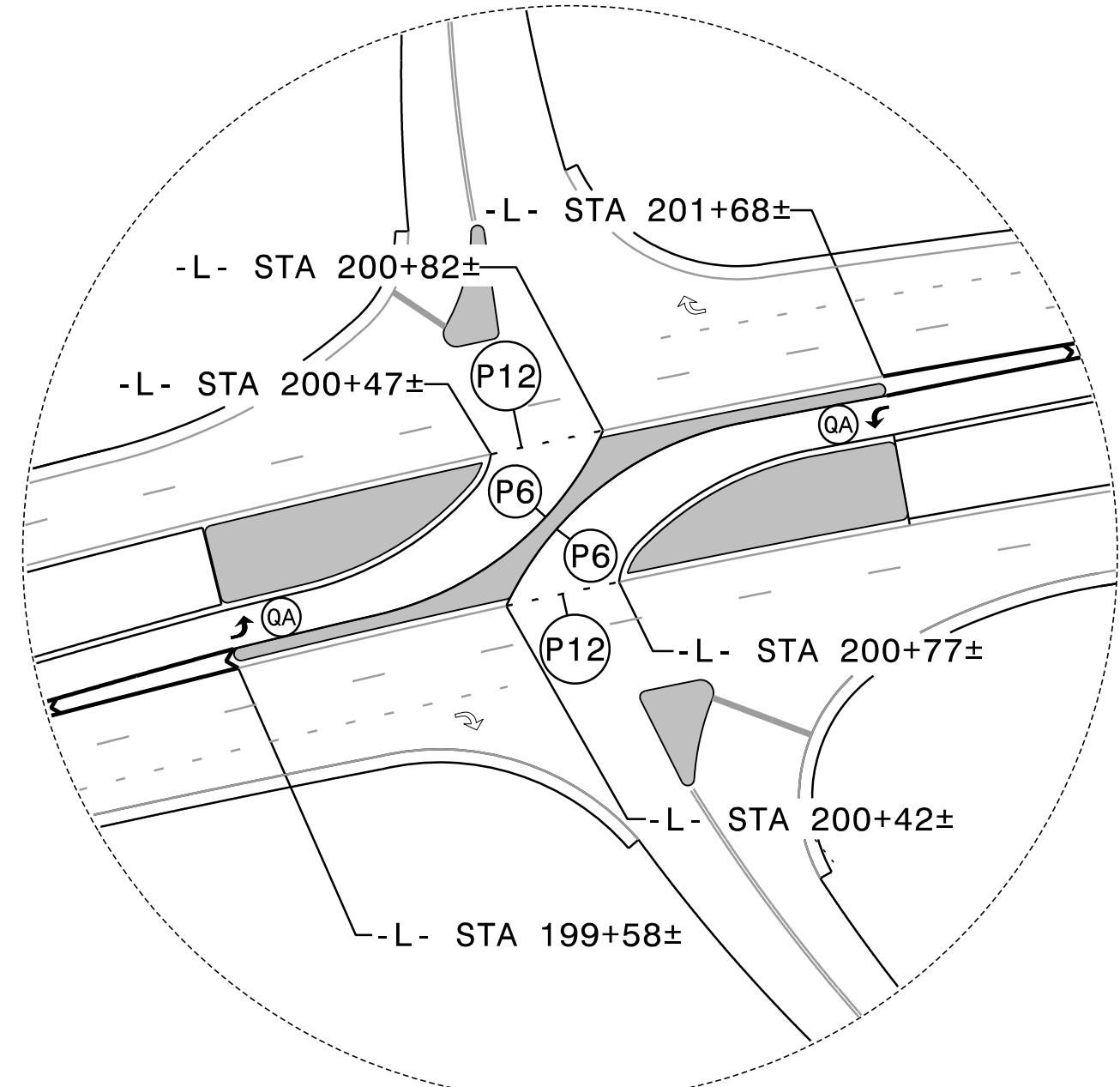
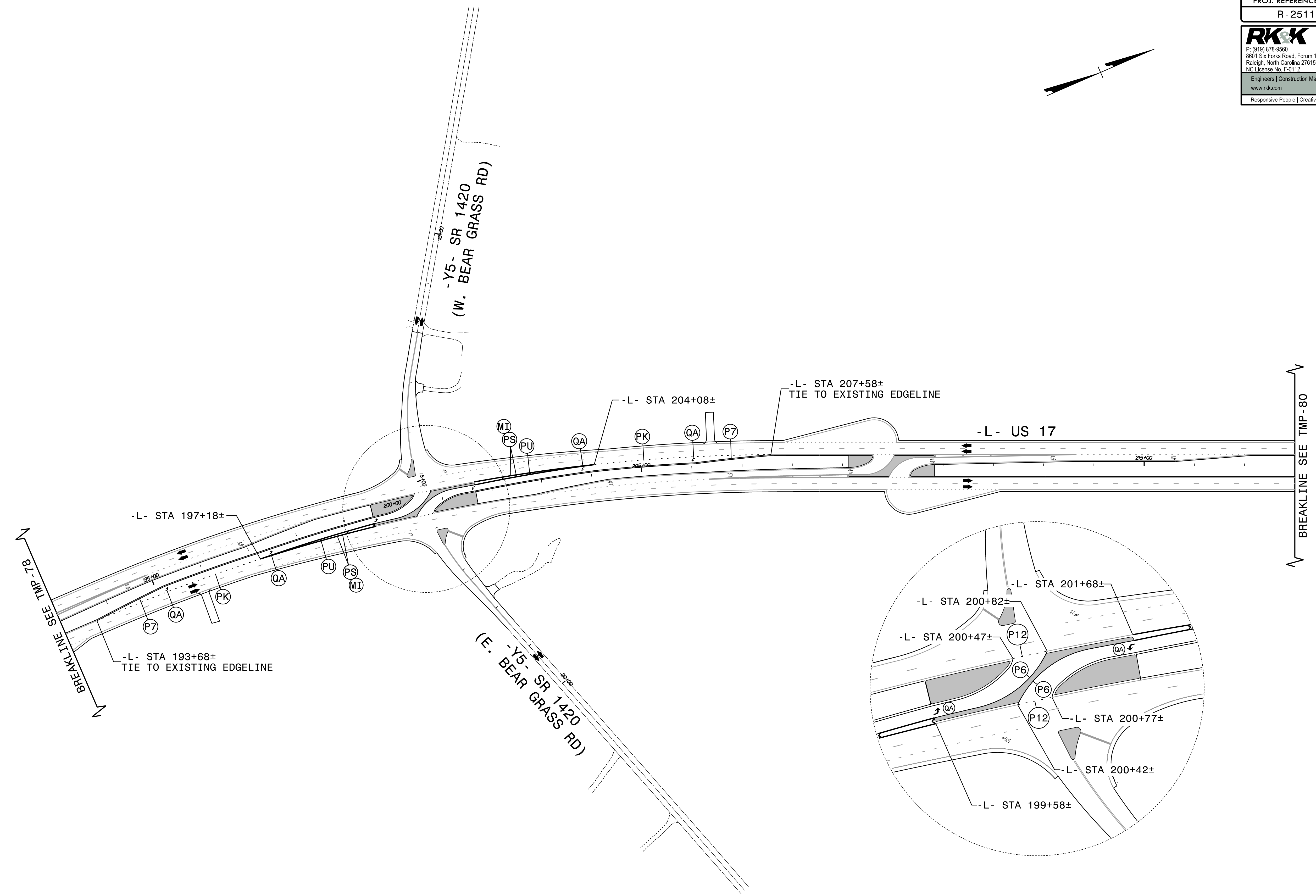
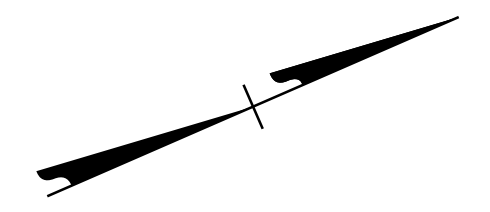

LANE WIDTHS 12' UNLESS OTHERWISE INDICATED.

10/1/2021
R2511-TMP_PSH79.dgn
K5151

APPROVED: 
 DATE: 10/1/2021

SEAL

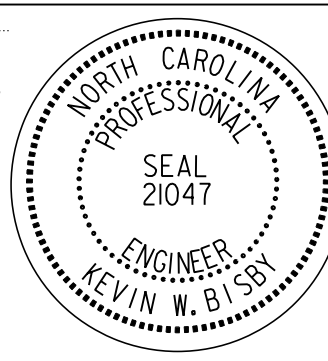

**DOCUMENT NOT CONSIDERED FINAL
UNLESS ALL SIGNATURES COMPLETED**

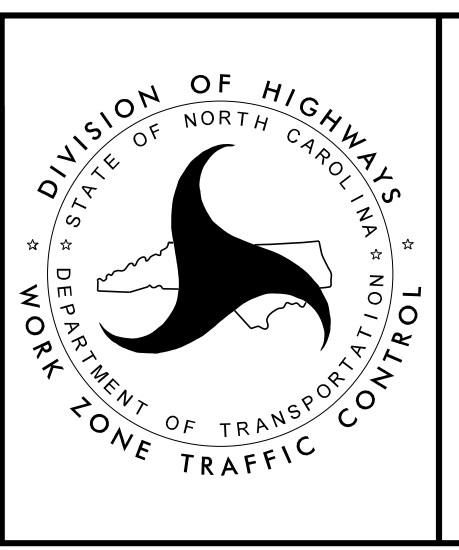

**PHASE V
DETAIL DRAWING**

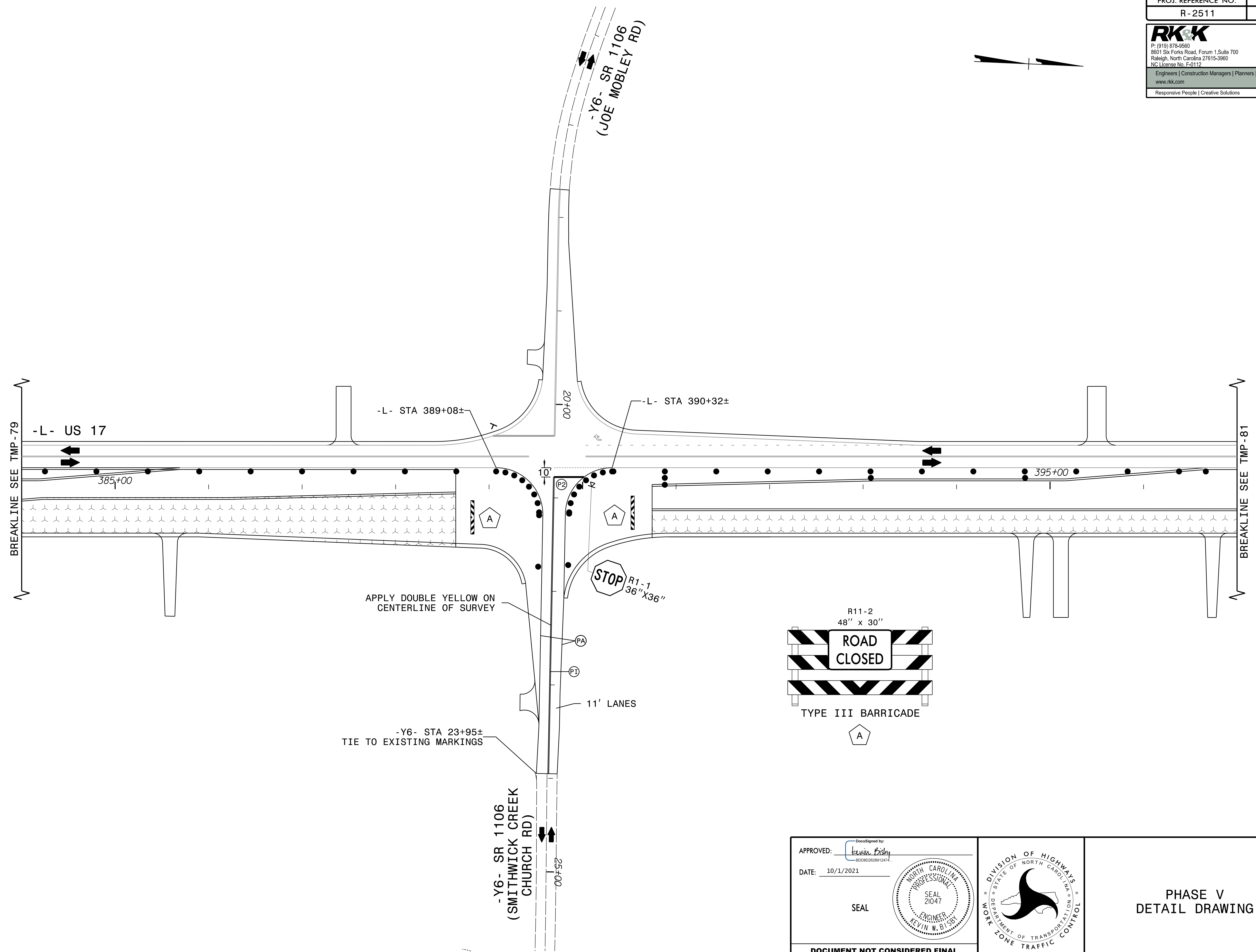

10/1/2021
 R2511-TMP_PSH80.dgn
 KSB

APPROVED: 
 DATE: 10/1/2021

SEAL

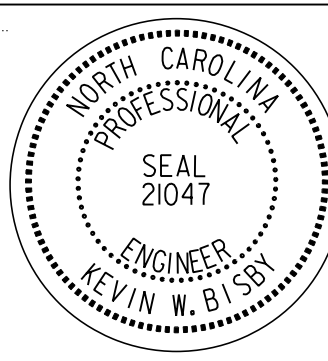

**DOCUMENT NOT CONSIDERED FINAL
 UNLESS ALL SIGNATURES COMPLETED**

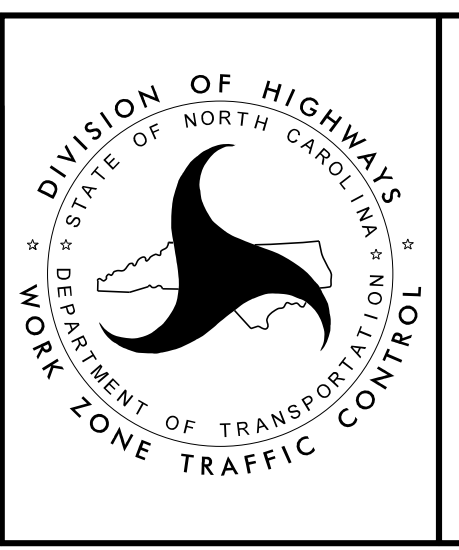

**PHASE V
 DETAIL DRAWING**

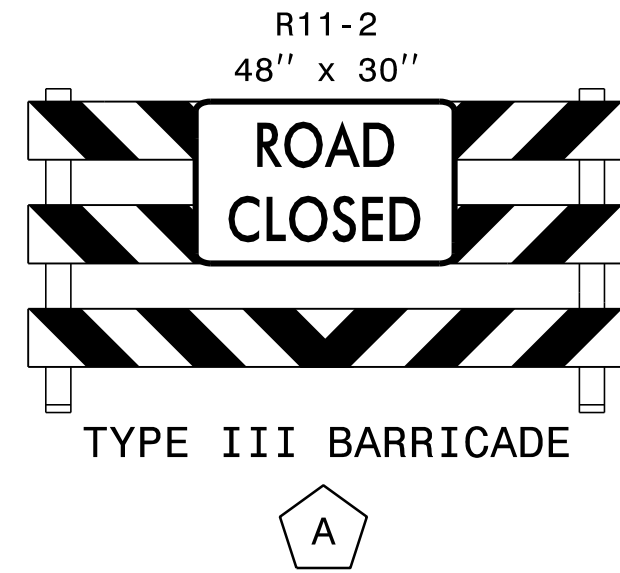
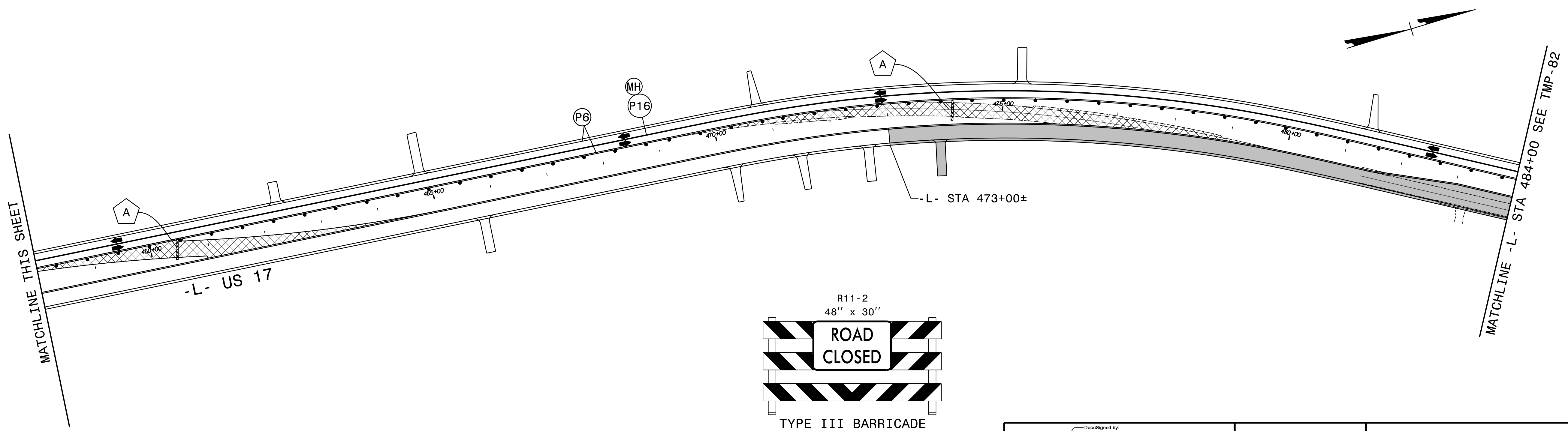
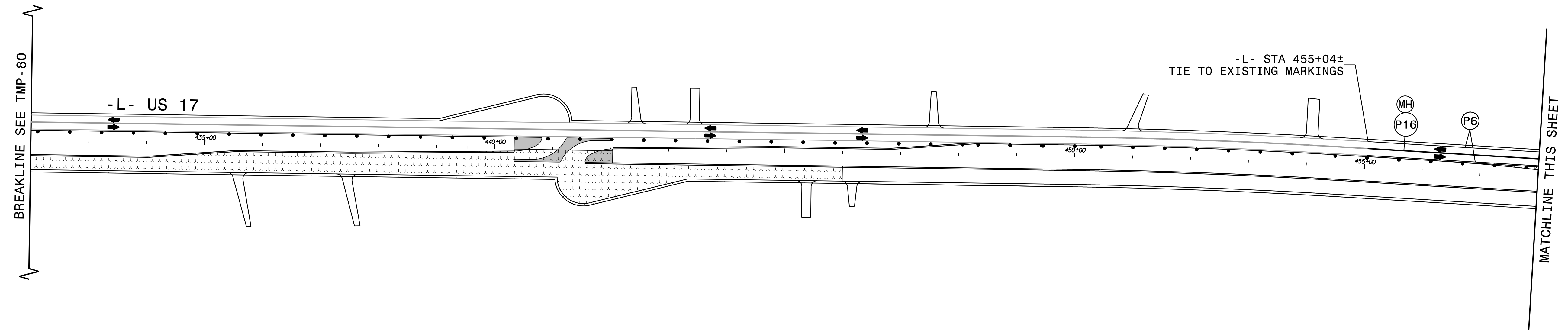
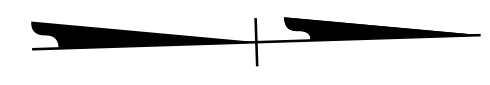

APPROVED: *Kevin Blisby*
 DATE: 10/1/2021

SEAL

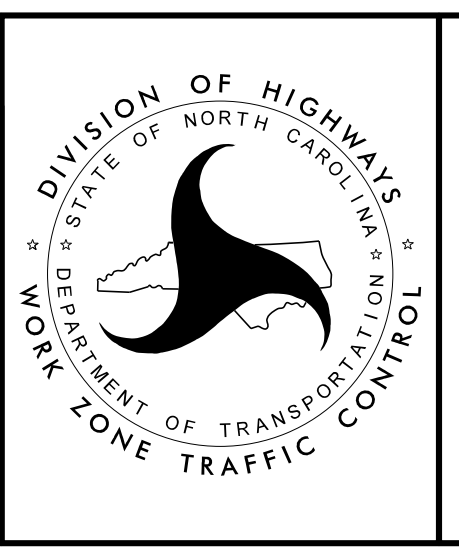

PHASE V
 DETAIL DRAWING

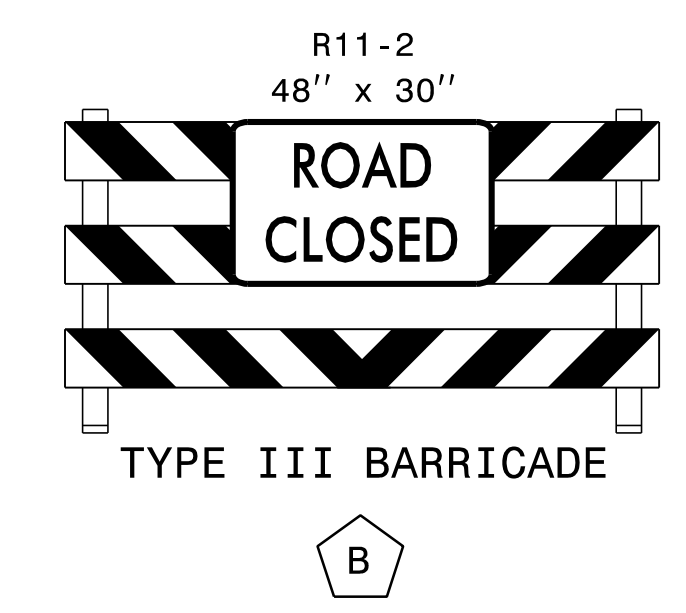
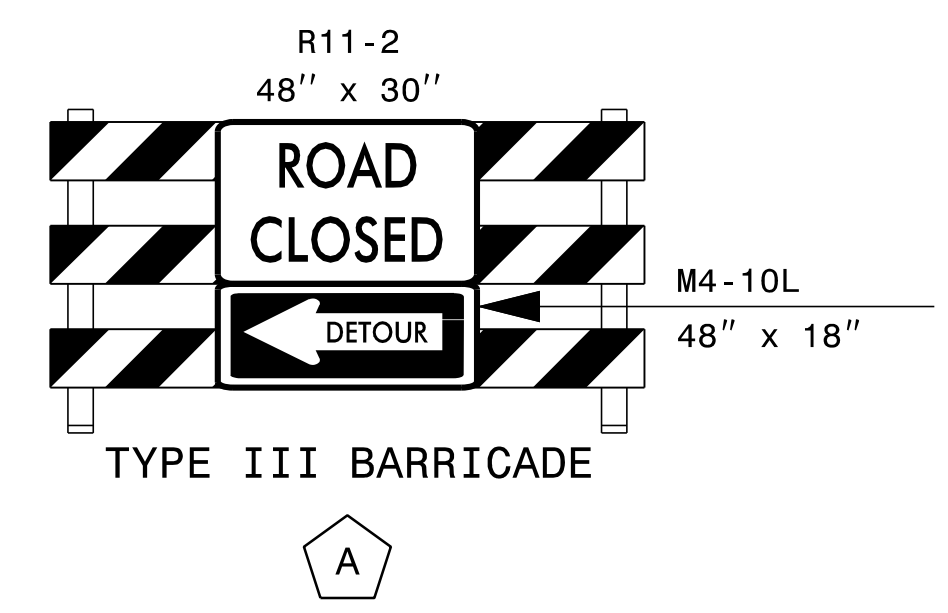
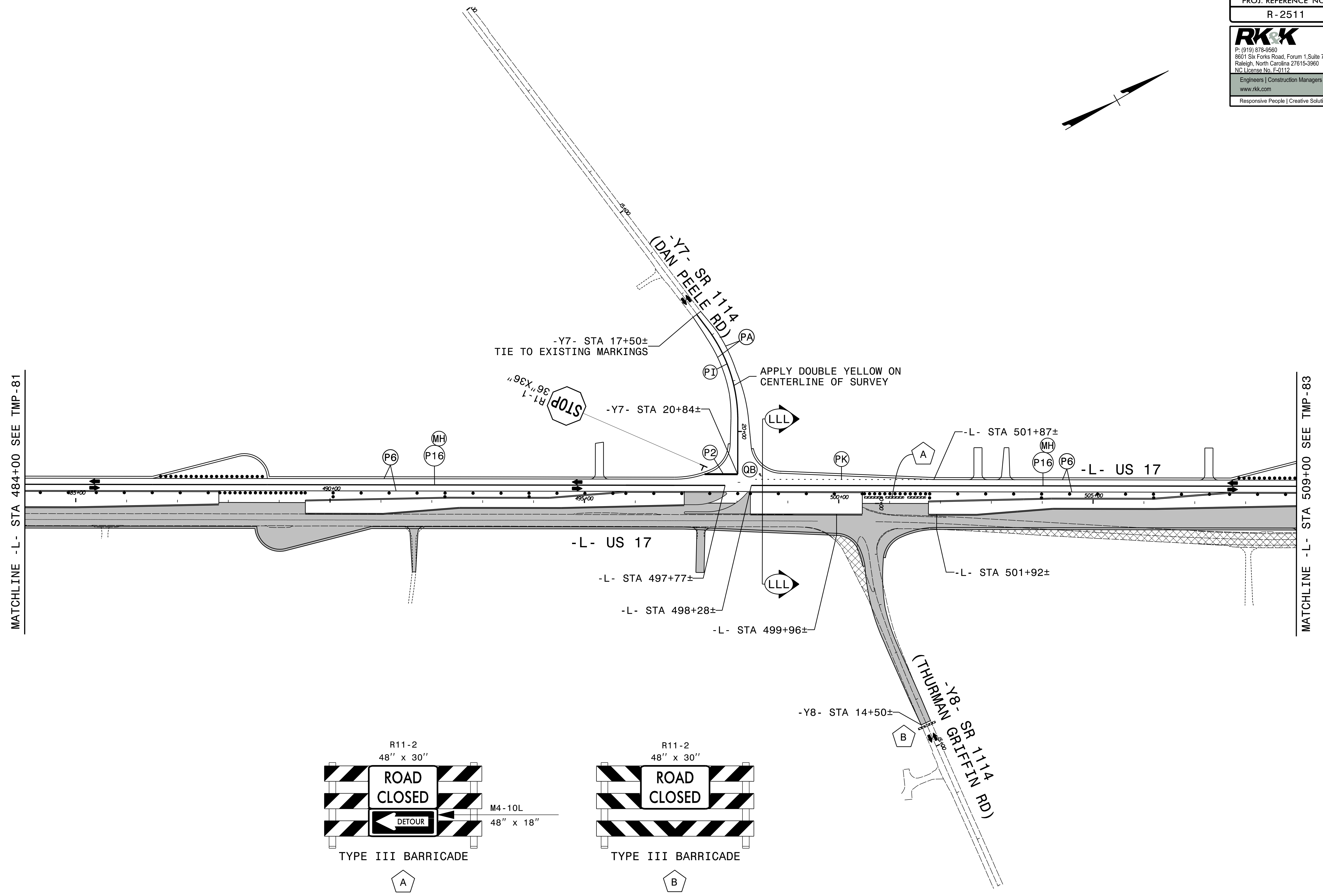
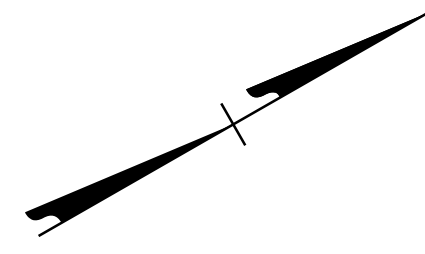

LANE WIDTHS 12' UNLESS OTHERWISE INDICATED.
 SEE TMP-1J FOR OFFSITE DETOUR DETAIL
 SEE TMP-82A FOR SECTION VIEW.
 SEE TMP-84 FOR PAVEMENT MARKINGS POST ROAD CLOSURE.

APPROVED: *Kevin Bisby*
 DATE: 10/1/2021

SEAL

DOCUMENT NOT CONSIDERED FINAL
 UNLESS ALL SIGNATURES COMPLETED

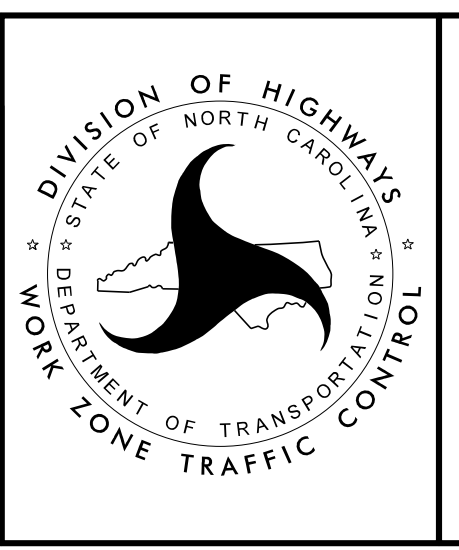

PHASE V
 DETAIL DRAWING

PROJ. REFERENCE NO.	SHEET NO.
R-2511	TMP-82A

RKK
 P: (919) 878-8560
 8601 Six Forks Road, Forum 1, Suite 700
 Raleigh, North Carolina 27615-3960
 NC License No. F-0112
 Engineers | Construction Managers | Planners | Scientists
 www.rkk.com
 Responsive People | Creative Solutions

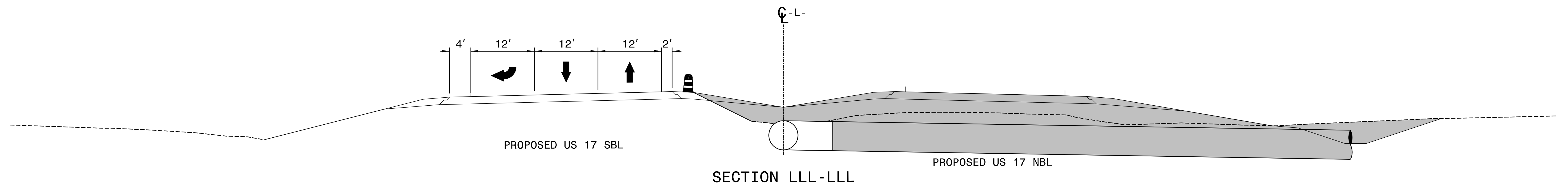

10/1/2021
 R2511_TMP_PSH82A.dgn
 ksb

<p>APPROVED: <i>Kevin Bisby</i> <small>DocuSigned by: Kevin Bisby BDC802928912474</small></p> <p>DATE: 10/1/2021</p> <p>SEAL</p>		<p>PHASE V DETAIL DRAWING</p>
<p>DOCUMENT NOT CONSIDERED FINAL UNLESS ALL SIGNATURES COMPLETED</p>		

PROJ. REFERENCE NO. R-2511	SHEET NO. TMP-83
-------------------------------	---------------------

RKK
 P: (919) 578-8560
 8601 Six Forks Road, Forum 1, Suite 700
 Raleigh, North Carolina 27615-3960
 NC License No. F-0112
 Engineers | Construction Managers | Planners | Scientists
 www.rkk.com
 Responsive People | Creative Solutions

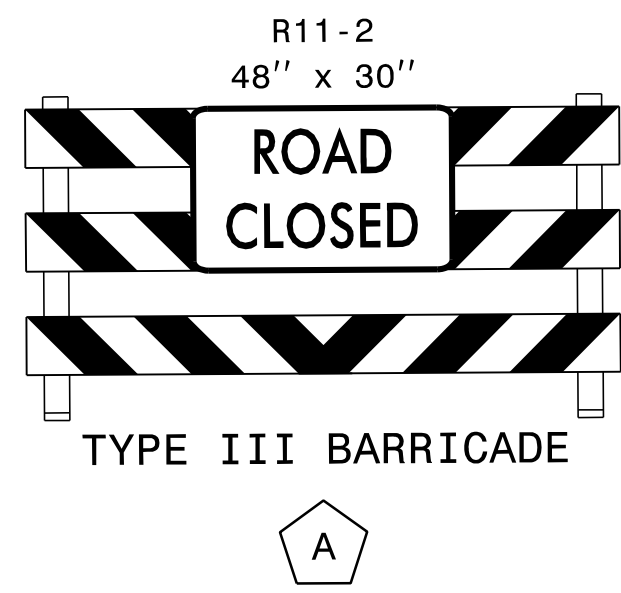
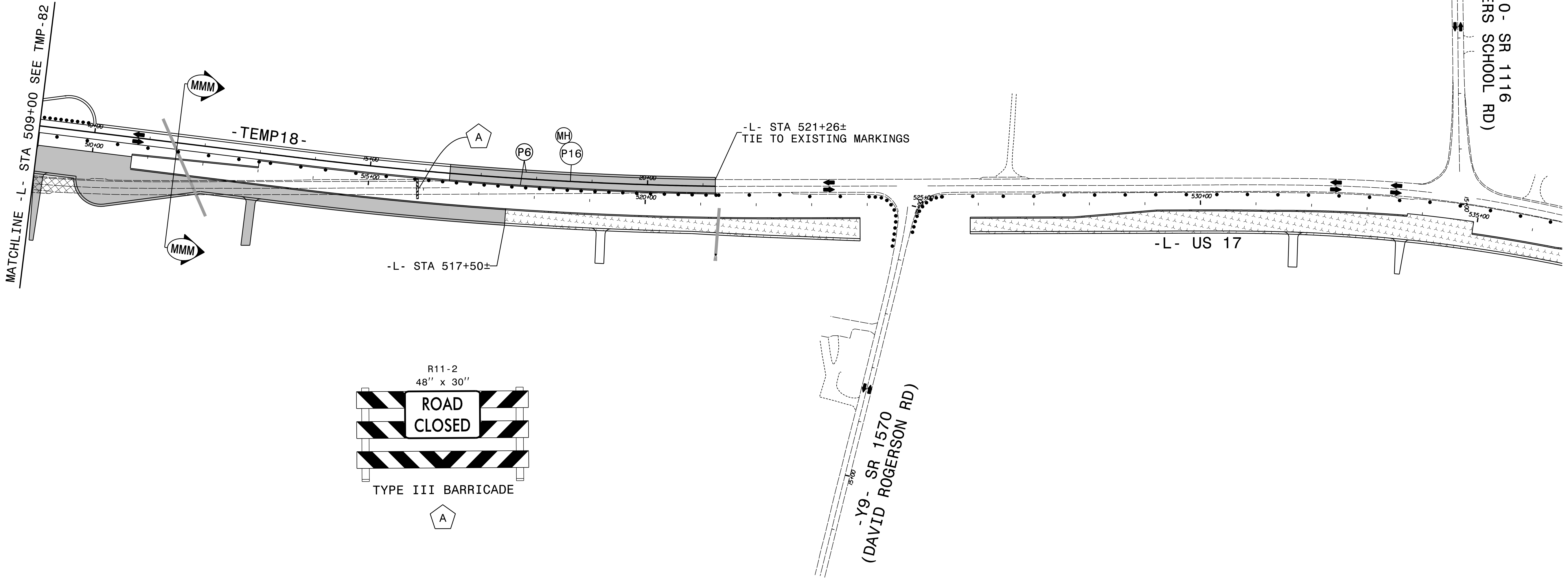
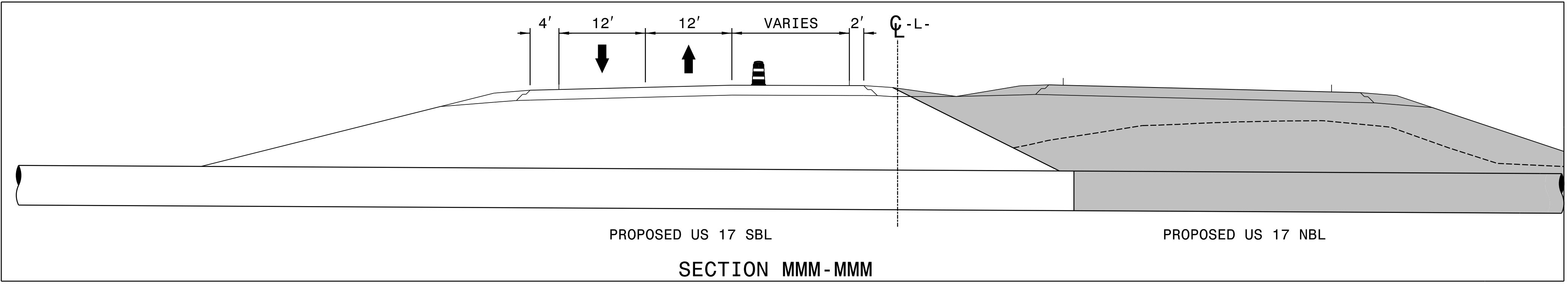
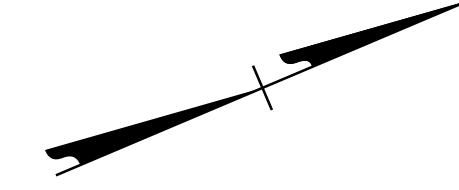

LANE WIDTHS 12' UNLESS OTHERWISE INDICATED.

APPROVED: *Kevin Bisby*
 DATE: 10/1/2021

SEAL

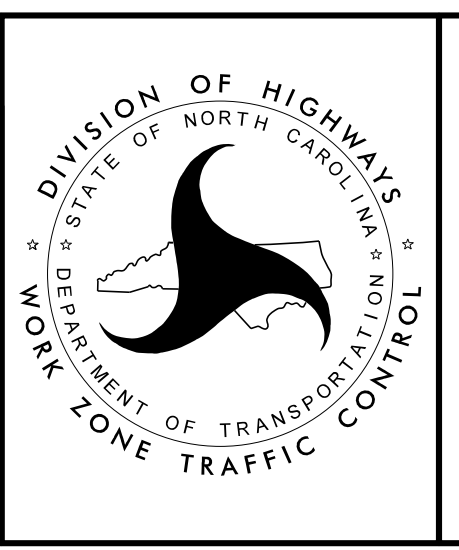

PHASE V
 DETAIL DRAWING

10/1/2021
 R2511-TMP-PSH83.dgn
 ksb

PROJ. REFERENCE NO.	SHEET NO.
R-2511	TMP-84

RKK
 P: (919) 878-8560
 8601 Six Forks Road, Forum 1, Suite 700
 Raleigh, North Carolina 27615-3960
 NC License No. F-0112
 Engineers | Construction Managers | Planners | Scientists
 www.rkk.com
 Responsive People | Creative Solutions

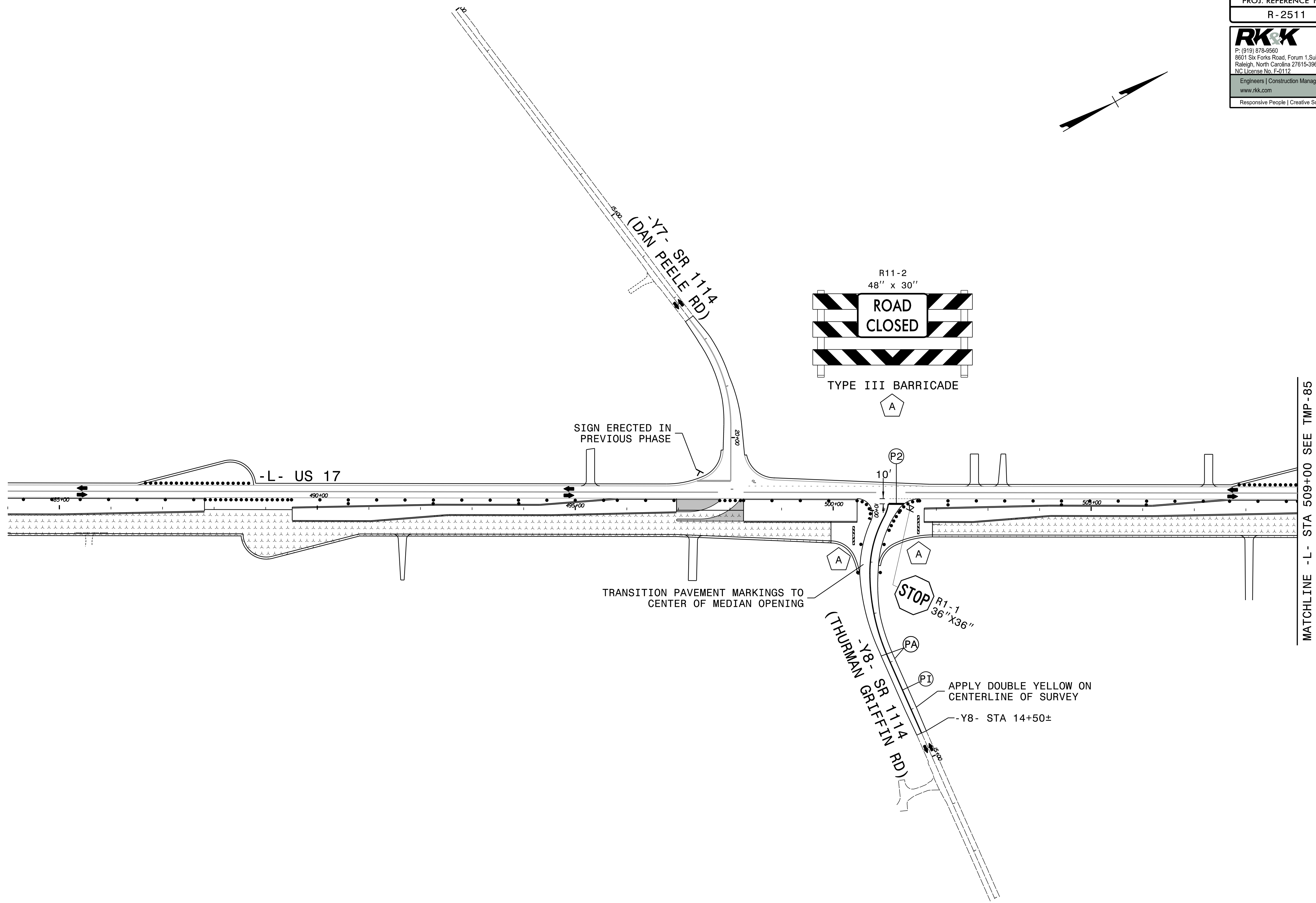
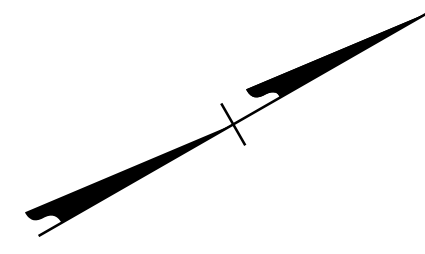

10/1/2021
R2511-TMP-PSH84.dgn
KSB

APPROVED: *Kevin Bisby*
 DATE: 10/1/2021

SEAL

DOCUMENT NOT CONSIDERED FINAL
UNLESS ALL SIGNATURES COMPLETED

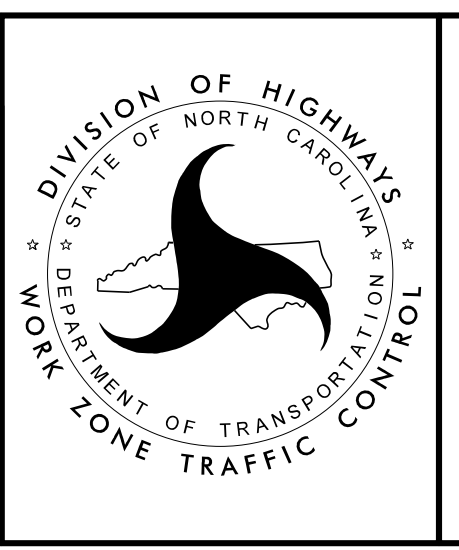

DIVISION OF HIGHWAYS
 STATE OF NORTH CAROLINA
 DEPARTMENT OF TRANSPORTATION
 WORK ZONE TRAFFIC CONTROL

PHASE V
 DETAIL DRAWING

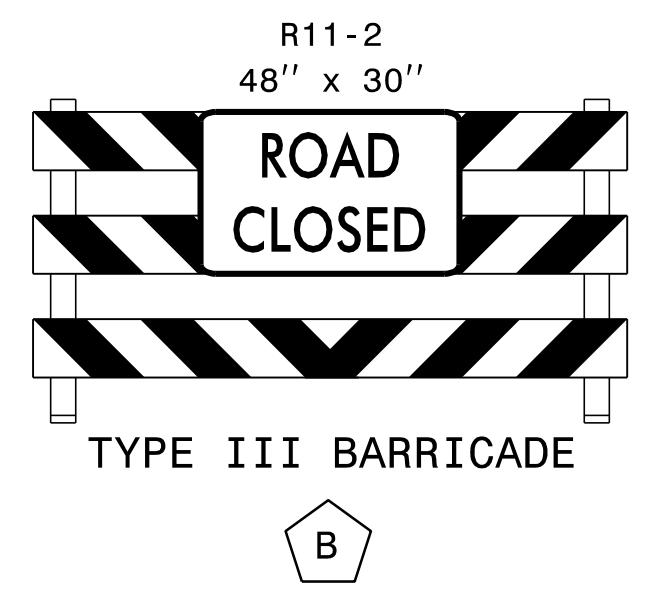
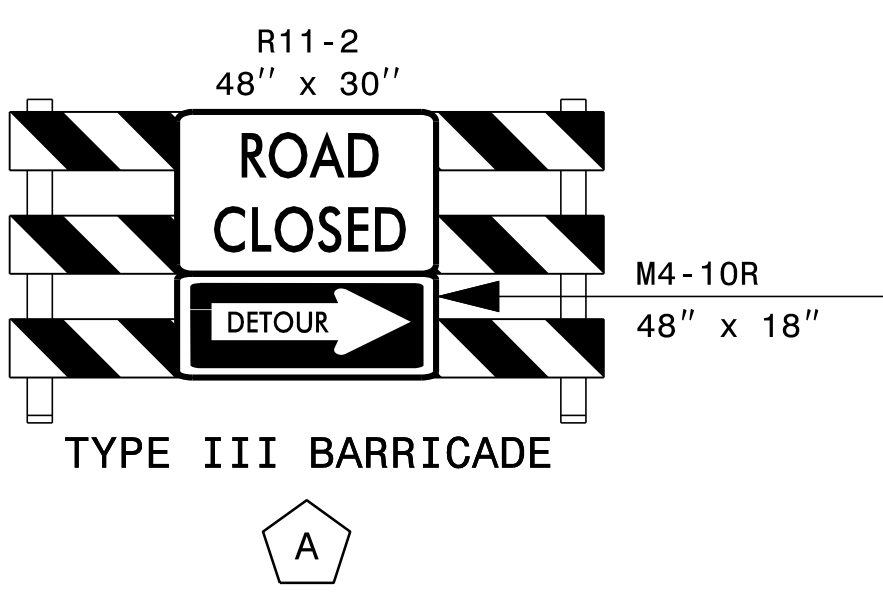
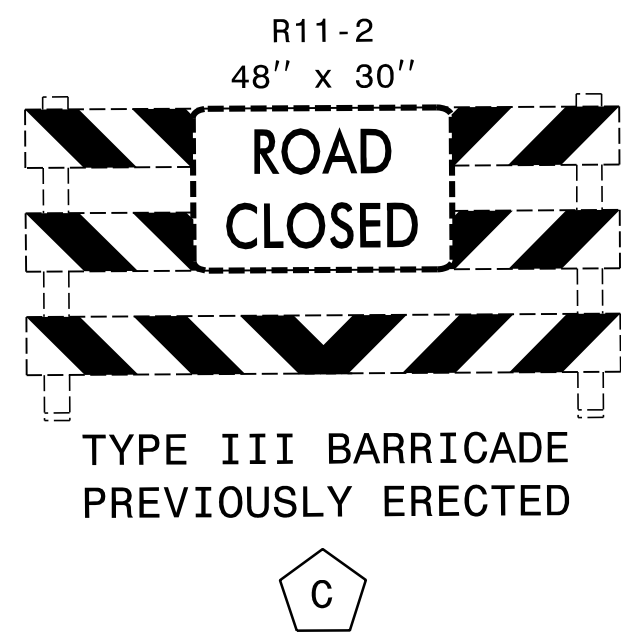
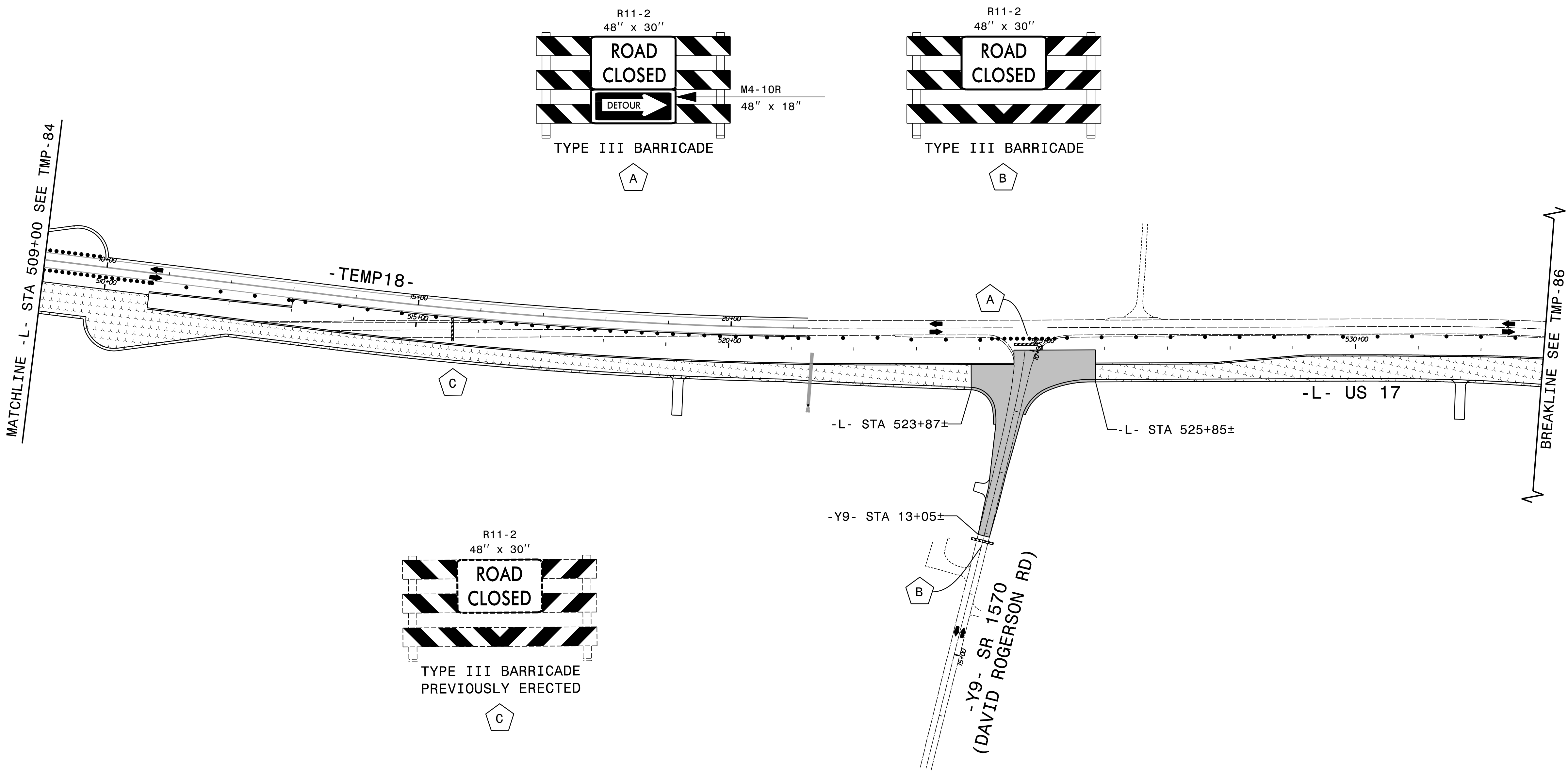
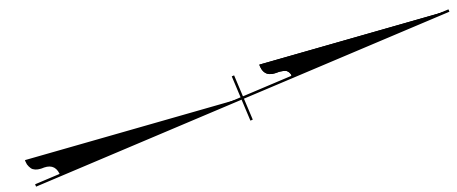

SEE TMP-1K FOR OFFSITE DETOUR DETAIL.
 SEE TMP-93 FOR PAVEMENT MARKINGS POST ROAD CLOSURE.

APPROVED: *Kevin Bisby*
 DATE: 10/1/2021

SEAL

**DOCUMENT NOT CONSIDERED FINAL
 UNLESS ALL SIGNATURES COMPLETED**

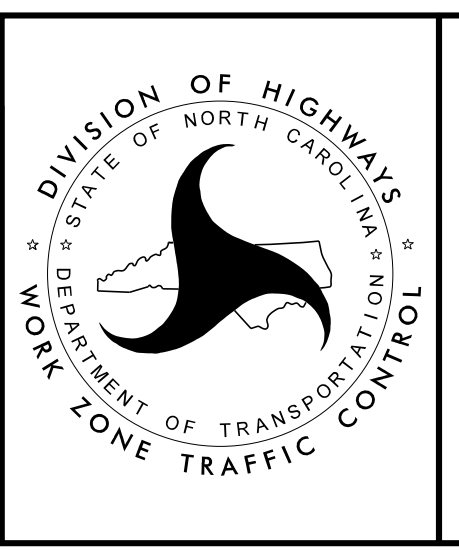

**PHASE V
 DETAIL DRAWING**

PROJ. REFERENCE NO.	SHEET NO.
R-2511	TMP-86

RKK
 P: (919) 878-8560
 8601 Six Forks Road, Forum 1, Suite 700
 Raleigh, North Carolina 27615-3960
 NC License No. F-0112
 Engineers | Construction Managers | Planners | Scientists
 www.rkk.com
 Responsive People | Creative Solutions

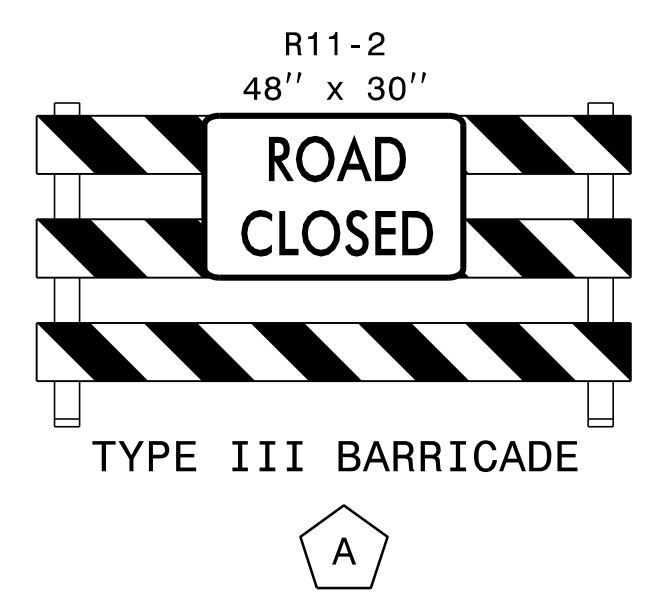
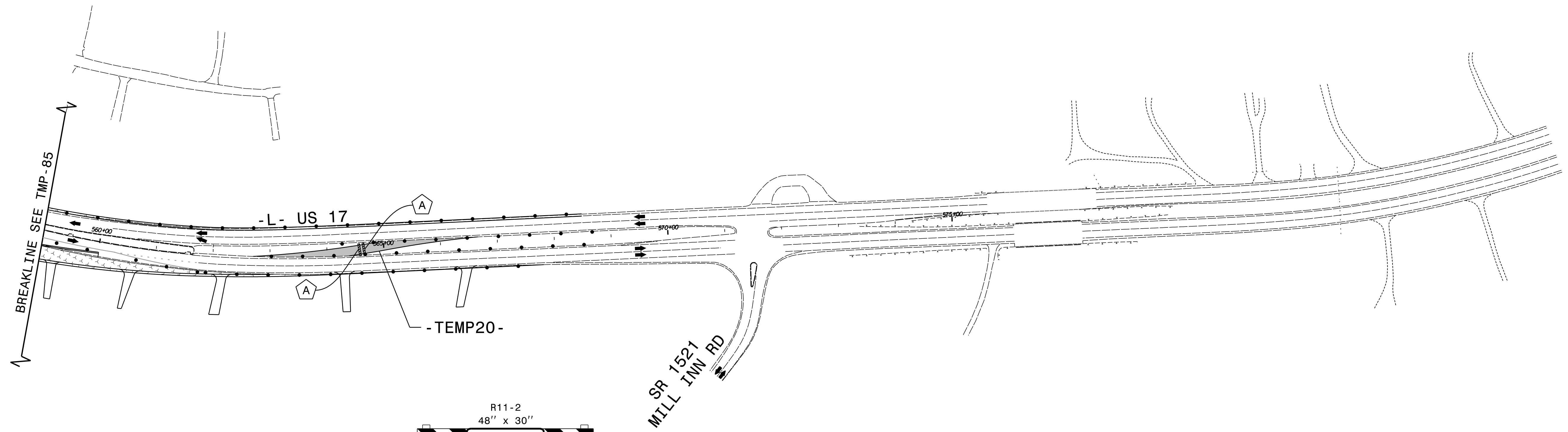

APPROVED: *Kevin Bisby*
DocuSigned by: Kevin Bisby
BDD802928912474

DATE: 10/1/2021

SEAL

**DOCUMENT NOT CONSIDERED FINAL
UNLESS ALL SIGNATURES COMPLETED**

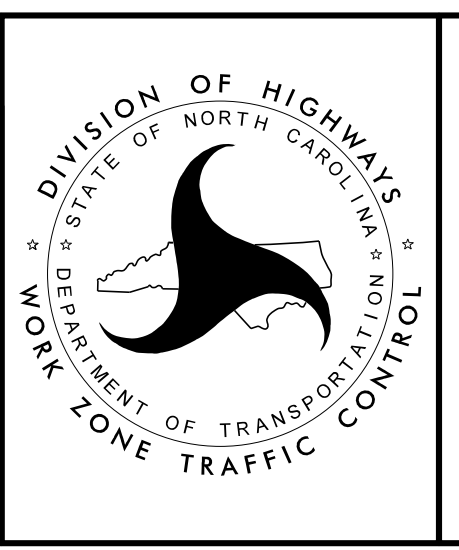

PHASE V
DETAIL DRAWING

10/1/2021
R2511_TMP_PSH86.dgn
KSB

PROJ. REFERENCE NO.	SHEET NO.
R-2511	TMP-87

RKK
 P: (919) 878-8560
 8601 Six Forks Road, Forum 1, Suite 700
 Raleigh, North Carolina 27615-3960
 NC License No. F-0112
 Engineers | Construction Managers | Planners | Scientists
 www.rkk.com
 Responsive People | Creative Solutions

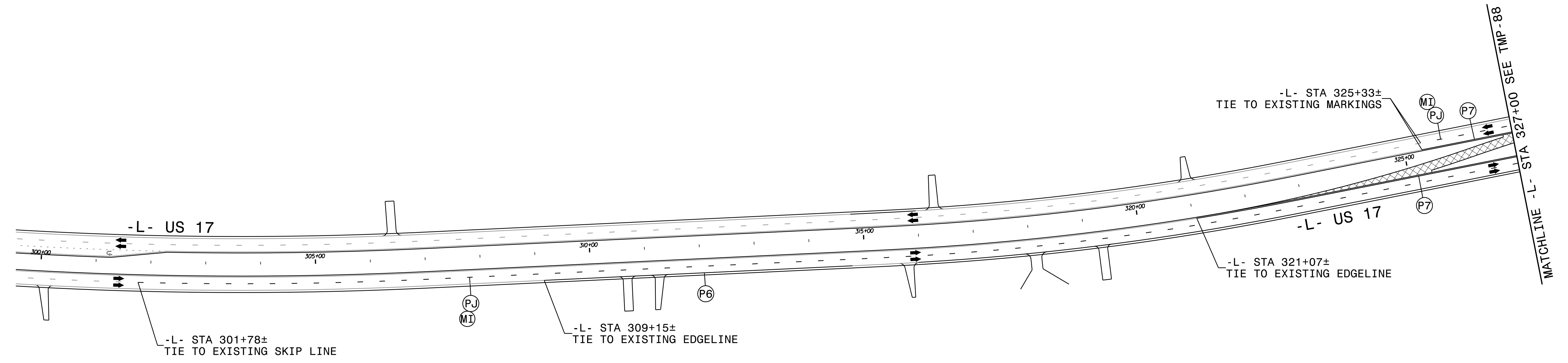
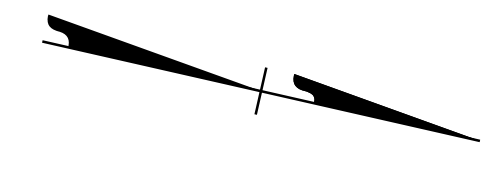

10/1/2021
 R2511-TMP-PSH87.dgn
 KSB

12' LANES UNLESS OTHERWISE INDICATED.

APPROVED: DATE: 10/1/2021 SEAL 		<p style="text-align: center;">PHASE VI DETAIL DRAWING</p>
<p style="text-align: center;">DOCUMENT NOT CONSIDERED FINAL UNLESS ALL SIGNATURES COMPLETED</p>		

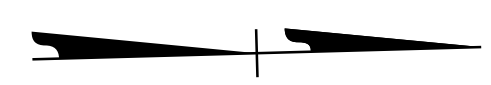
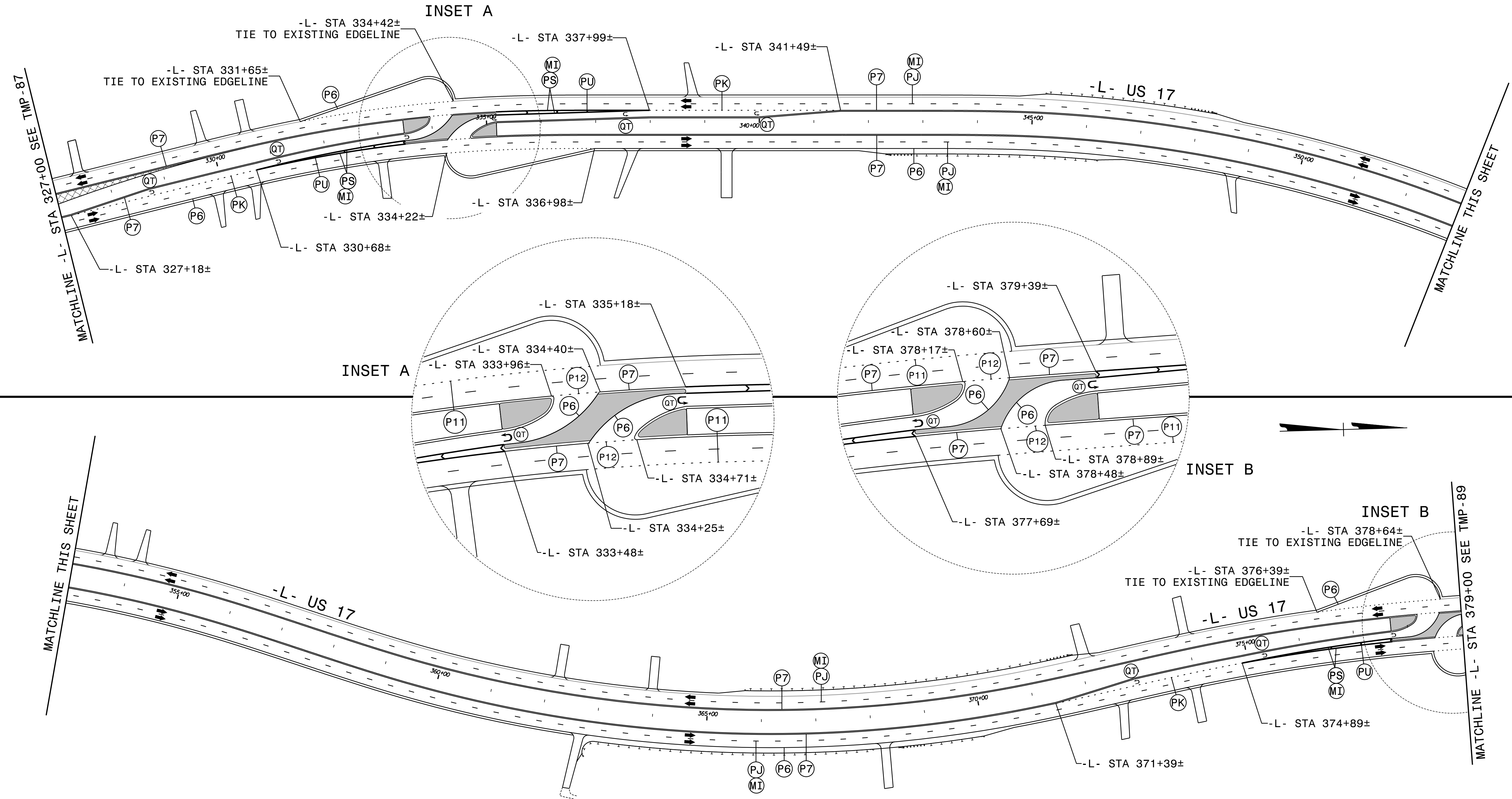

MATCHLINE THIS SHEET

MATCHLINE -L- STA 379+00 SEE TMP-89

12' LANES UNLESS OTHERWISE INDICATED.

APPROVED: *Kevin Bisby*
 DATE: 10/1/2021

SEAL

DOCUMENT NOT CONSIDERED FINAL
 UNLESS ALL SIGNATURES COMPLETED

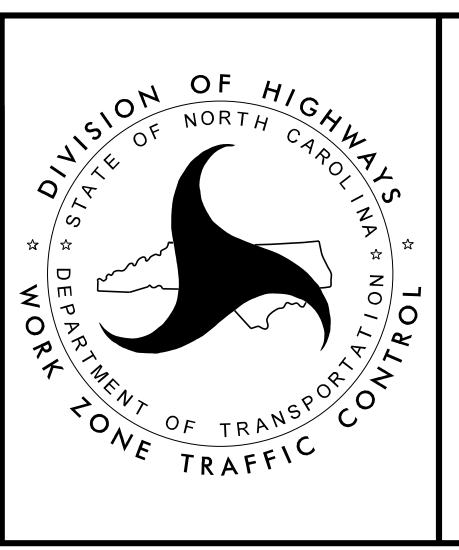

PHASE VI
 DETAIL DRAWING

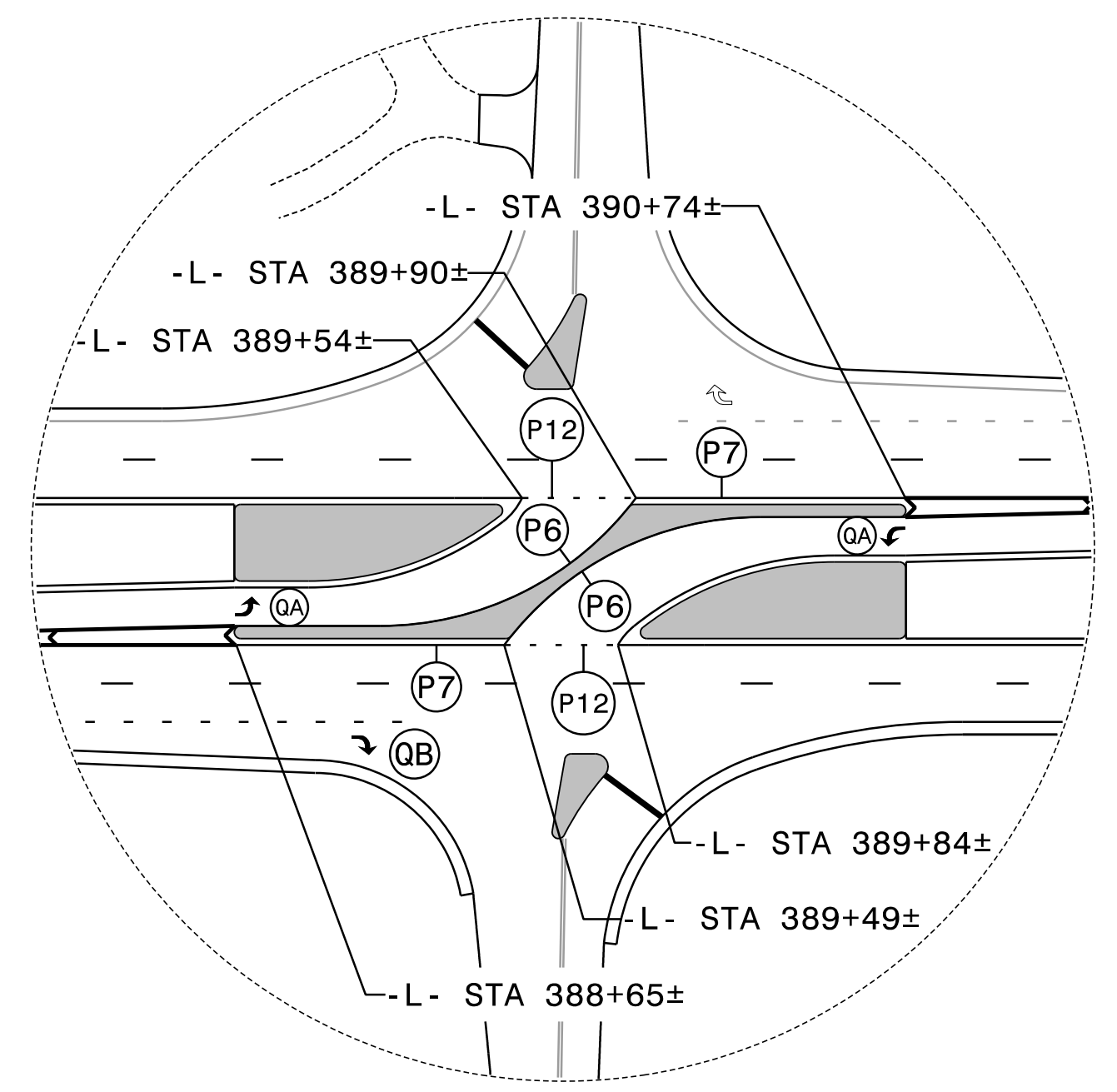
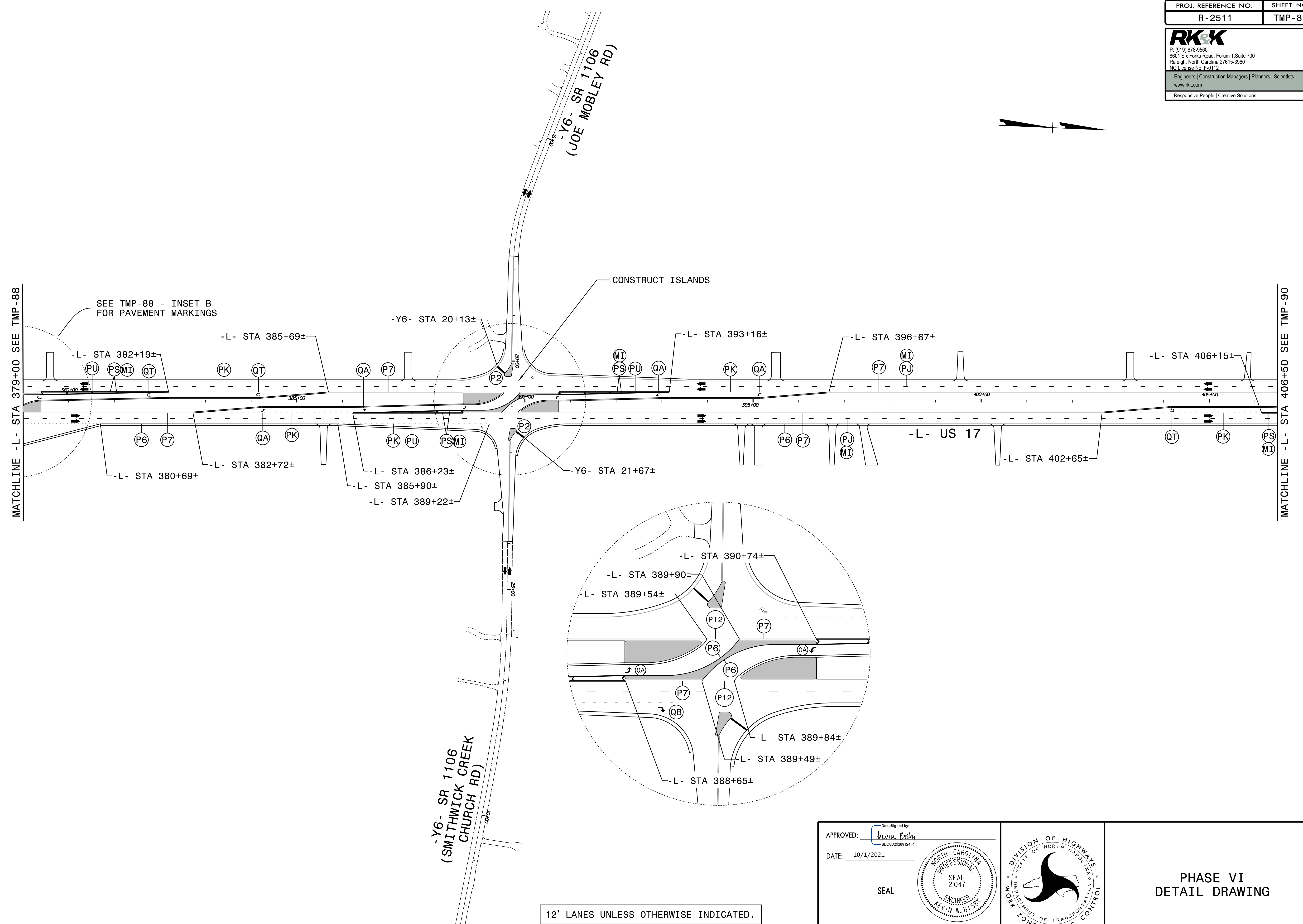
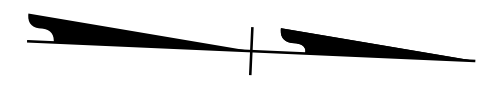

12' LANES UNLESS OTHERWISE INDICATED.

10/1/2021
R2511-TMP_PSH89.dgn
ksf/bbl

APPROVED: 
 DATE: 10/1/2021

SEAL

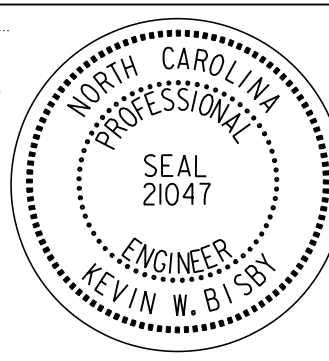

**DOCUMENT NOT CONSIDERED FINAL
UNLESS ALL SIGNATURES COMPLETED**

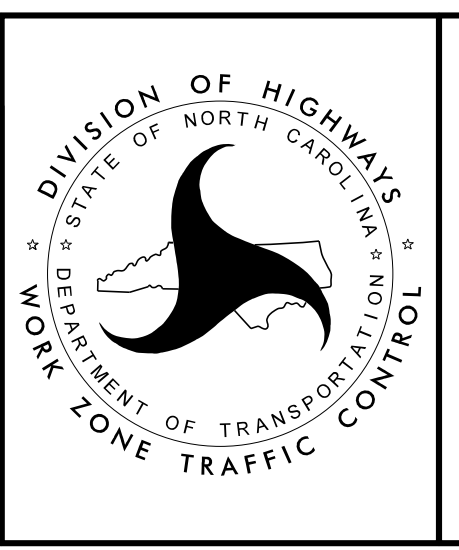

**PHASE VI
DETAIL DRAWING**

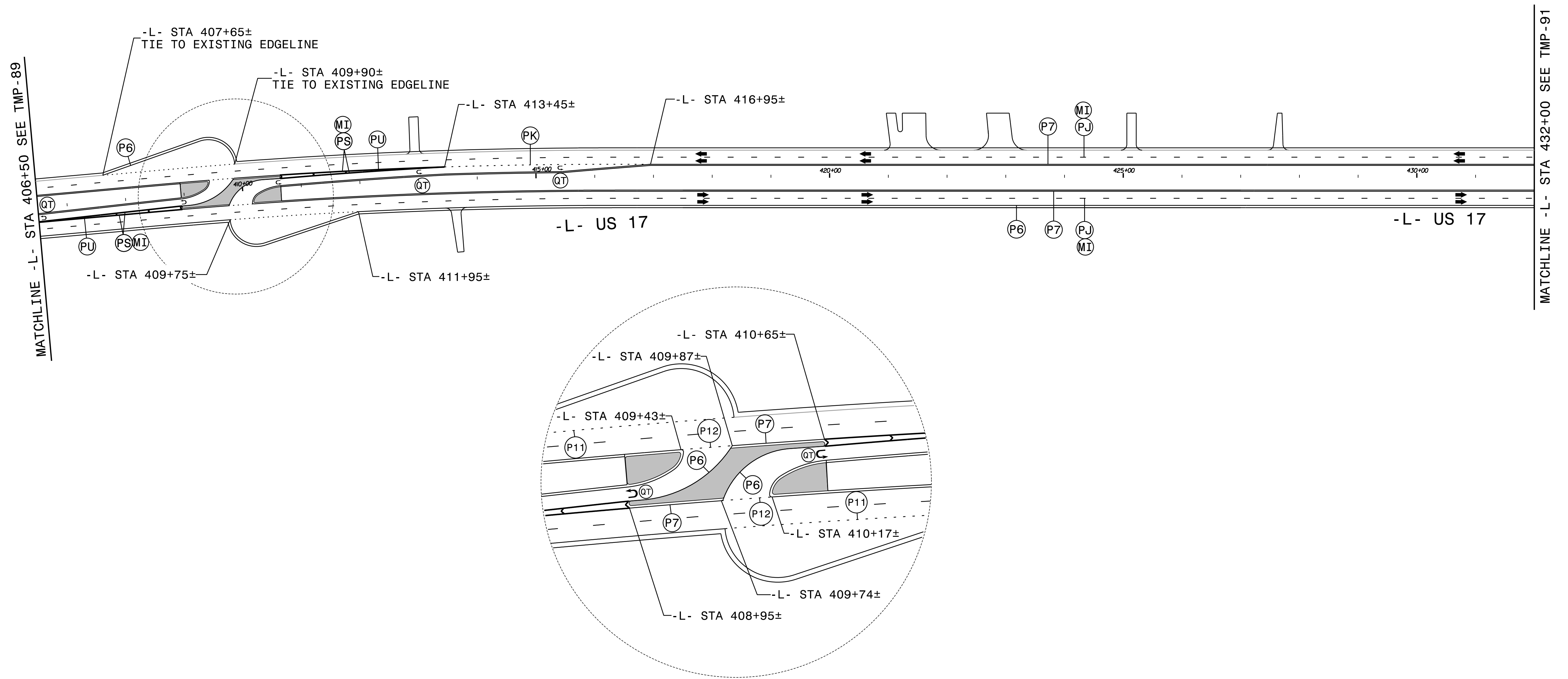
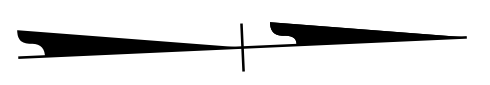

12' LANES UNLESS OTHERWISE INDICATED.

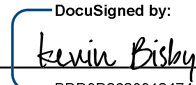
APPROVED: 
 DATE: 10/1/2021

SEAL



DOCUMENT NOT CONSIDERED FINAL
UNLESS ALL SIGNATURES COMPLETED

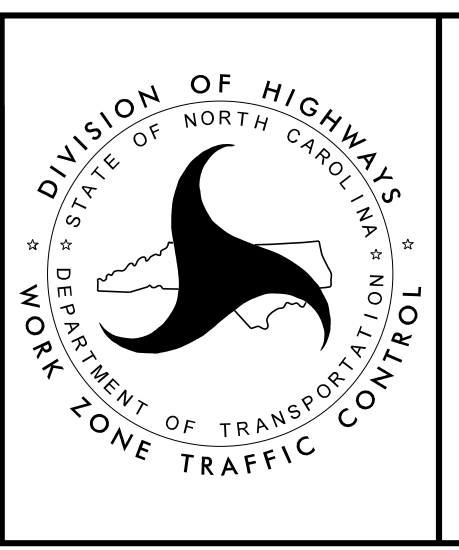

PHASE VI
DETAIL DRAWING

10/1/2021
R2511_TMP_PSH90.dgn
K15151

