

**This electronic collection of documents is provided  
for the convenience of the user  
and is Not a Certified Document –**

**The documents contained herein were originally issued  
and sealed by the individuals whose names and license  
numbers appear on each page, on the dates appearing  
with their signature on that page.**

**This file or an individual page  
shall not be considered a certified document.**

STATE	STATE PROJECT REFERENCE NO.	SHEET NO.	TOTAL SHEETS
N.C.	U-6010	X-1A	37
STATE PROJ. NO.	F.A. PROJ. NO.	DESCRIPTION	
47145.1.1	N/A	PE	
47145.2.1	N/A	ROWUTIL	
47145.3.1	N/A	CONST	

STATE OF NORTH CAROLINA  
 DIVISION OF HIGHWAYS

**CROSS - SECTIONS**

**SECTIONS**  
 CROSS-SECTION TITLE SHEET  
 CROSS-SECTION SUMMARY  
 STA. 7+50.00 -L- TO STA. 54+15.00 -L-  
 STA. 10+00.00 -Y- TO STA. 21+72.00 -Y-  
 STA. 10+32.75 -Y1- TO STA. 10+72.75 -Y1-  
 STA. 10+00.00 -Y2- TO STA. 10+68.47 -Y2-  
 STA. 10+00.00 -Y3- TO STA. 10+71.75 -Y3-  
 STA. 10+28.09 -Y4- TO STA. 11+12.36 -Y4-

**SHEET NO's.**  
 X-1A  
 X-1B  
 X-1 THRU X-24  
 X-25 THRU X-31  
 X-32  
 X-33  
 X-34  
 X-35

7/2/99

27 JAN 2002 18:14  
 C:\U-6010\XSC-U-6010-PDY-XPL-1A.dgn  
 \$\$\$\$USE FOR PLOTTING\$\$\$\$

**CONTRACT: C204572 TIP PROJECT: U-6010**

Approximate quantities only. Unclassified excavation, borrow excavation, fine grading, clearing and grubbing and removal of existing pavement will be paid for at the lump sum price for "Grading".

STATE OF NORTH CAROLINA  
DIVISION OF HIGHWAYS

CROSS-SECTION SUMMARY

PROJ. REFERENCE NO.	SHEET NO.
U-6010	X-1B

Station	Uncl. Exc.	Embt	Station	Uncl. Exc.	Embt	Station	Uncl. Exc.	Embt	Station	Uncl. Exc.	Embt	Station	Uncl. Exc.	Embt	Station	Uncl. Exc.	Embt
L	(cu. yd.)	(cu. yd.)	L	(cu. yd.)	(cu. yd.)	L	(cu. yd.)	(cu. yd.)	L	(cu. yd.)	(cu. yd.)	L	(cu. yd.)	(cu. yd.)	Y	(cu. yd.)	(cu. yd.)
7+50.00	0	0	10+00.00	6	1	25+50.00	83	21	52+00.00	1	47	30+50.00	1	399	10+00.00	0	0
8+00.00	10	1	10+50.00	6	2	26+00.00	106	18	52+50.00	4	34	31+00.00	1	291	10+50.00	17	5
8+50.00	16	4	11+00.00	6	3	26+50.00	83	23	53+00.00	3	14	31+50.00	1	181	11+00.00	15	13
9+00.00	40	6	11+50.00	6	1	27+00.00	43	31	53+50.00	0	0	32+00.00	1	95	11+50.00	13	21
9+50.00	81	5	12+00.00	5	0	27+50.00	21	37	54+00.00	17	4	32+50.00	2	64	12+00.00	13	27
10+00.00	80	8	12+50.00	2	6	28+00.00	52	37	54+15.00	12	1	33+00.00	3	99	12+50.00	13	25
10+50.00	49	8	13+00.00	0	26	28+50.00	70	44				33+50.00	2	164	13+00.00	15	17
11+00.00	35	1	13+50.00	0	33	29+00.00	40	44	Station	Uncl. Exc.	Embt	34+00.00	2	145	13+50.00	28	6
11+50.00	19	0	14+00.00	0	26	29+50.00	25	35	Y	(cu. yd.)	(cu. yd.)	34+50.00	1	106	14+00.00	48	0
12+00.00	31	0	14+50.00	0	23	30+00.00	21	20				35+00.00	0	130	14+50.00	61	0
12+50.00	60	0	15+50.00	0	72	30+50.00	28	3	18+00.00	0	0	35+50.00	2	79	15+00.00	68	0
13+00.00	78	1	16+00.00	0	57	31+00.00	17	0	18+50.00	30	0	36+00.00	2	44	15+50.00	71	0
13+50.00	46	16	16+50.00	2	54	31+50.00	22	0	19+00.00	39	0	36+50.00	0	114	16+00.00	53	4
14+00.00	6	29	17+00.00	5	45	32+00.00	81	0	19+50.00	30	0	37+00.00	0	143	16+50.00	23	13
14+50.00	6	25	17+50.00	16	46	32+50.00	112	0	20+00.00	35	1	37+50.00	2	110	17+00.00	8	15
15+50.00	6	37	18+00.00	44	49	33+00.00	70	0	20+50.00	38	2	38+00.00	6	56			
16+00.00	4	14	18+50.00	41	38	33+50.00	19	28	21+00.00	32	2	38+50.00	10	35	Station	Uncl. Exc.	Embt
16+50.00	7	15	19+00.00	10	79	34+00.00	3	71	21+50.00	26	3	39+00.00	6	16	Y2	(cu. yd.)	(cu. yd.)
17+00.00	8	15	19+50.00	0	417	34+50.00	3	80	21+72.00	12	2	39+50.00	5	17			
17+50.00	6	16	20+00.00	0	584	35+00.00	3	67				40+00.00	8	39	10+00.00	0	0
18+00.00	4	62	20+50.00	0	235	35+50.00	6	50	Station	Uncl. Exc.	Embt	40+50.00	7	70	10+50.00	30	43
18+50.00	1	176	21+00.00	0	34	36+00.00	31	22	Y1	(cu. yd.)	(cu. yd.)	41+00.00	6	106	10+68.47	1	23
19+00.00	0	257	21+50.00	0	70	36+50.00	59	5				41+50.00	3	144			
19+50.00	0	321	22+00.00	0	37	37+00.00	72	5	10+32.75	0	0	42+00.00	2	242	Station	Uncl. Exc.	Embt
20+00.00	0	297	22+50.00	0	1	37+50.00	94	4	10+50.00	32	4	42+50.00	1	235	Y3	(cu. yd.)	(cu. yd.)
20+50.00	0	191	23+00.00	0	0	38+00.00	124	2	10+72.75	30	0	43+00.00	0	102			
21+00.00	0	152				38+50.00	120	1				43+50.00	5	29	10+00.00	0	0
21+50.00	0	106	Station	Uncl. Exc.	Embt	39+00.00	106	0	Station	Uncl. Exc.	Embt	44+00.00	22	8	10+50.00	68	20
22+00.00	7	35	Y	(cu. yd.)	(cu. yd.)	39+50.00	95	0	Y4	(cu. yd.)	(cu. yd.)	44+50.00	24	6	10+71.75	11	15
22+50.00	7	1				40+00.00	61	0				45+00.00	6	31			
23+00.00	0	0	10+00.00	0	0	40+50.00	33	1	10+28.0900	0	0	45+50.00	0	45			
			10+50.00	2	25	41+00.00	14	21	10+50.0000	8	8	46+00.00	0	44			
Station	Uncl. Exc.	Embt	11+00.00	5	43	41+50.00	2	34	11+00.0000	17	29	46+50.00	1	65			
Y	(cu. yd.)	(cu. yd.)	11+50.00	6	50	42+00.00	1	35	11+12.3600	2	8	47+00.00	1	75			
			12+00.00	10	42	42+50.00	0	52				47+50.00	1	83			
18+00.00	0	0	12+50.00	13	21	43+00.00	0	72	Station	Uncl. Exc.	Embt	48+00.00	1	166			
18+50.00	18	11	13+00.00	13	16	43+50.00	0	78	L	(cu. yd.)	(cu. yd.)	48+50.00	0	199			
19+00.00	19	5	13+50.00	14	9	44+00.00	0	81				49+00.00	0	156			
19+50.00	19	2	14+00.00	16	64	44+50.00	0	73	23+00.00	0	0	49+50.00	0	170			
20+00.00	20	2	14+50.00	16	131	45+00.00	0	43	23+50.00	1	1	50+00.00	1	159			
20+50.00	23	1	15+00.00	15	89	45+50.00	3	20	24+00.00	33	5	50+50.00	2	133			
21+00.00	21	0	15+50.00	15	36	46+00.00	11	11	24+50.00	38	25	51+00.00	2	98			
21+50.00	15	1	16+00.00	15	31	46+50.00	8	15	25+00.00	6	62	51+50.00	1	65			
21+72.00	5	1	16+50.00	10	44	47+00.00	0	27	25+50.00	2	82	52+00.00	2	43			
			17+00.00	3	31	47+50.00	1	32	26+00.00	3	90	52+50.00	5	16			
Station	Uncl. Exc.	Embt				48+00.00	2	50	26+50.00	3	116	53+00.00	6	12			
L	(cu. yd.)	(cu. yd.)	Station	Uncl. Exc.	Embt	48+50.00	3	57	27+00.00	2	171	53+50.00	6	8			
						49+00.00	4	54	27+50.00	1	231	54+00.00	7	6			
7+50.00	0	0	L	(cu. yd.)	(cu. yd.)	49+50.00	4	70	28+00.00	2	331	54+15.00	2	2			
8+00.00	33	0	23+50.00	1	0	50+00.00	4	56	28+50.00	3	458						
8+50.00	65	0	24+00.00	23	0	50+50.00	2	44	29+00.00	3	494						
9+00.00	49	0	24+50.00	56	1	51+00.00	2	69	29+50.00	2	489						
9+50.00	18	1	25+00.00	68	14	51+50.00	2	67	30+00.00	1	482						

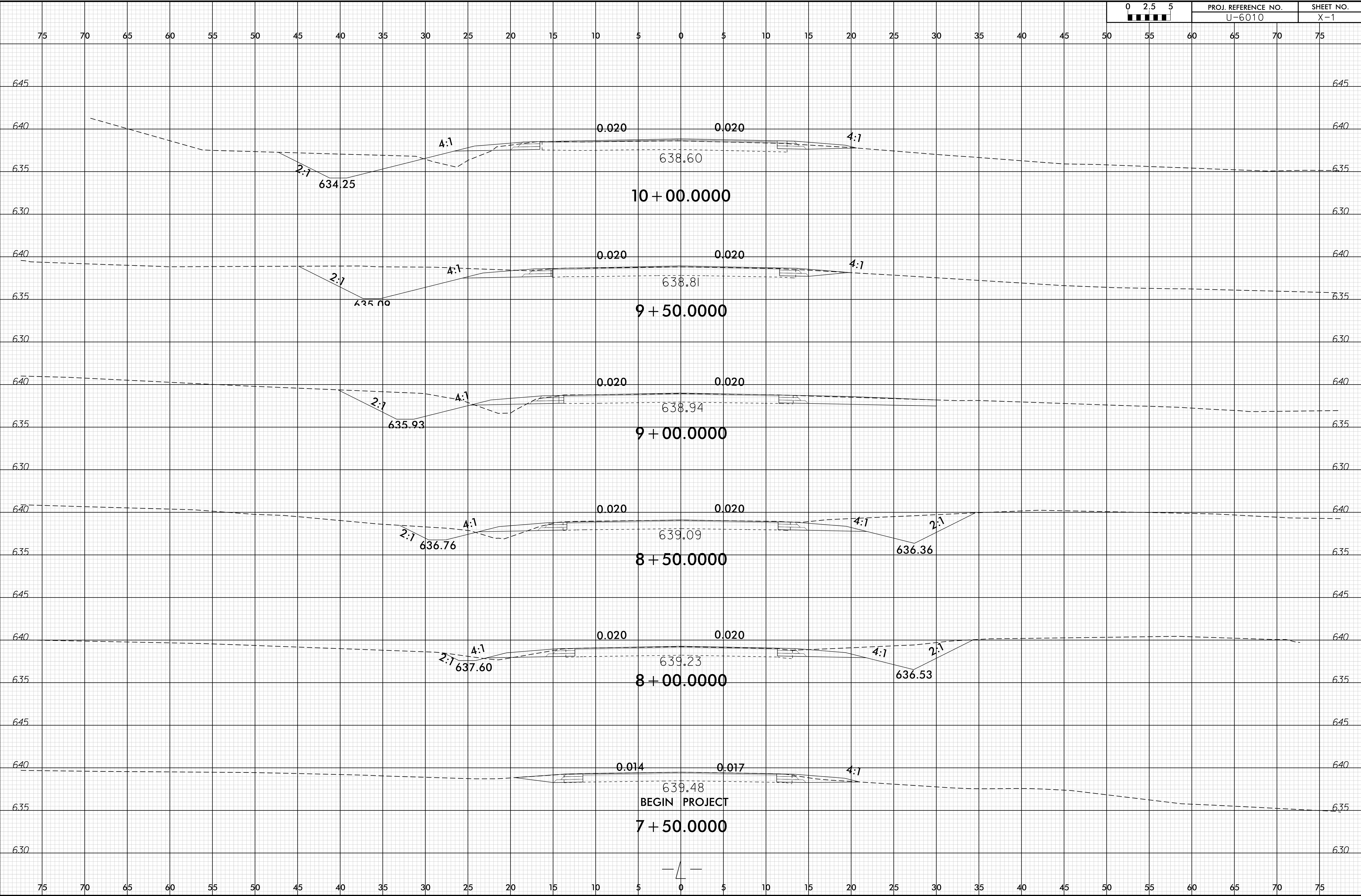





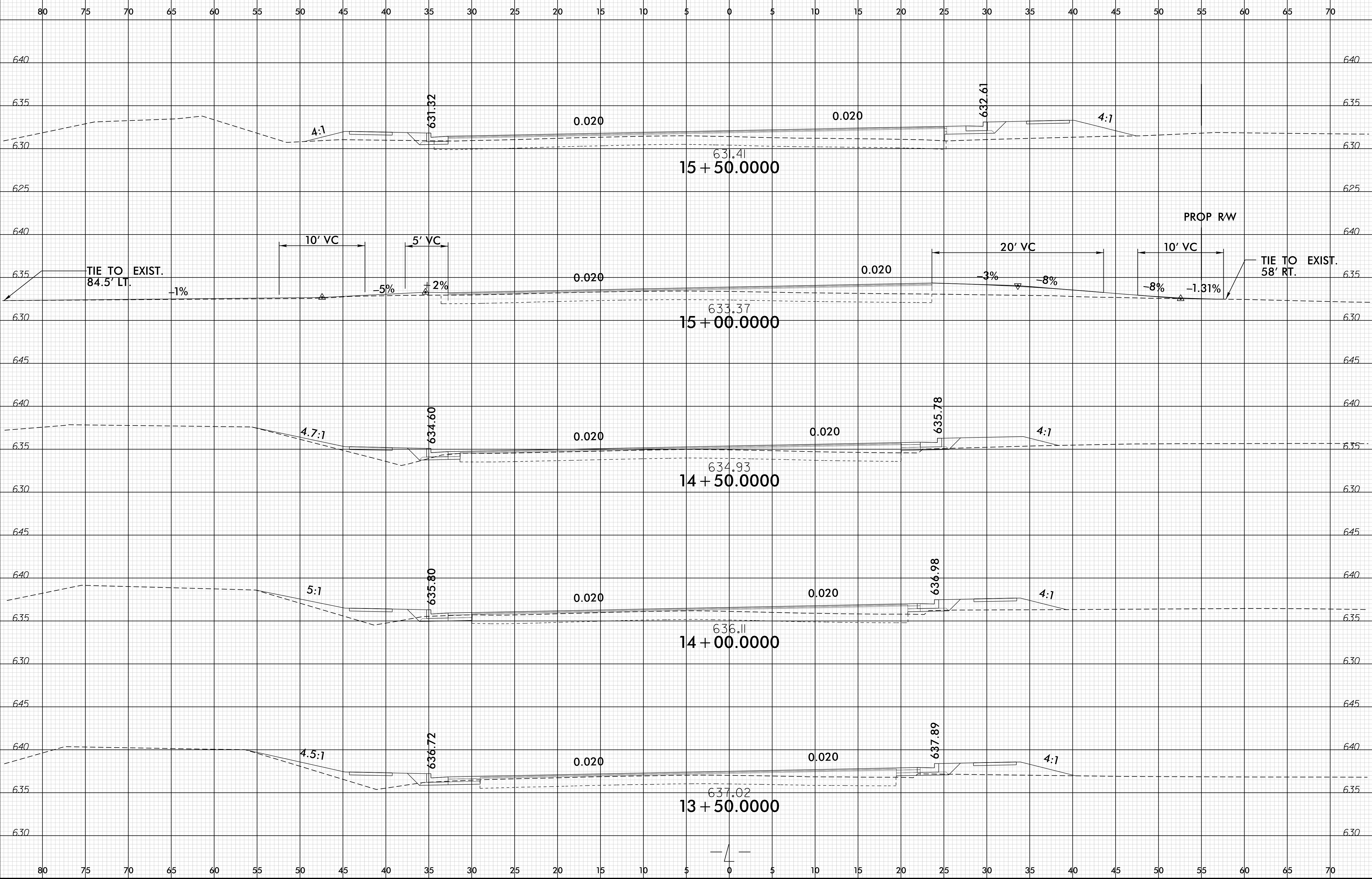
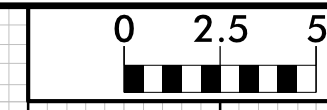

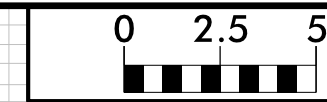

75 70 65 60 55 50 45 40 35 30 25 20 15 10 5 0 5 10 15 20 25 30 35 40 45 50 55 60 65 70 75

SHALLOW UNDERCUT

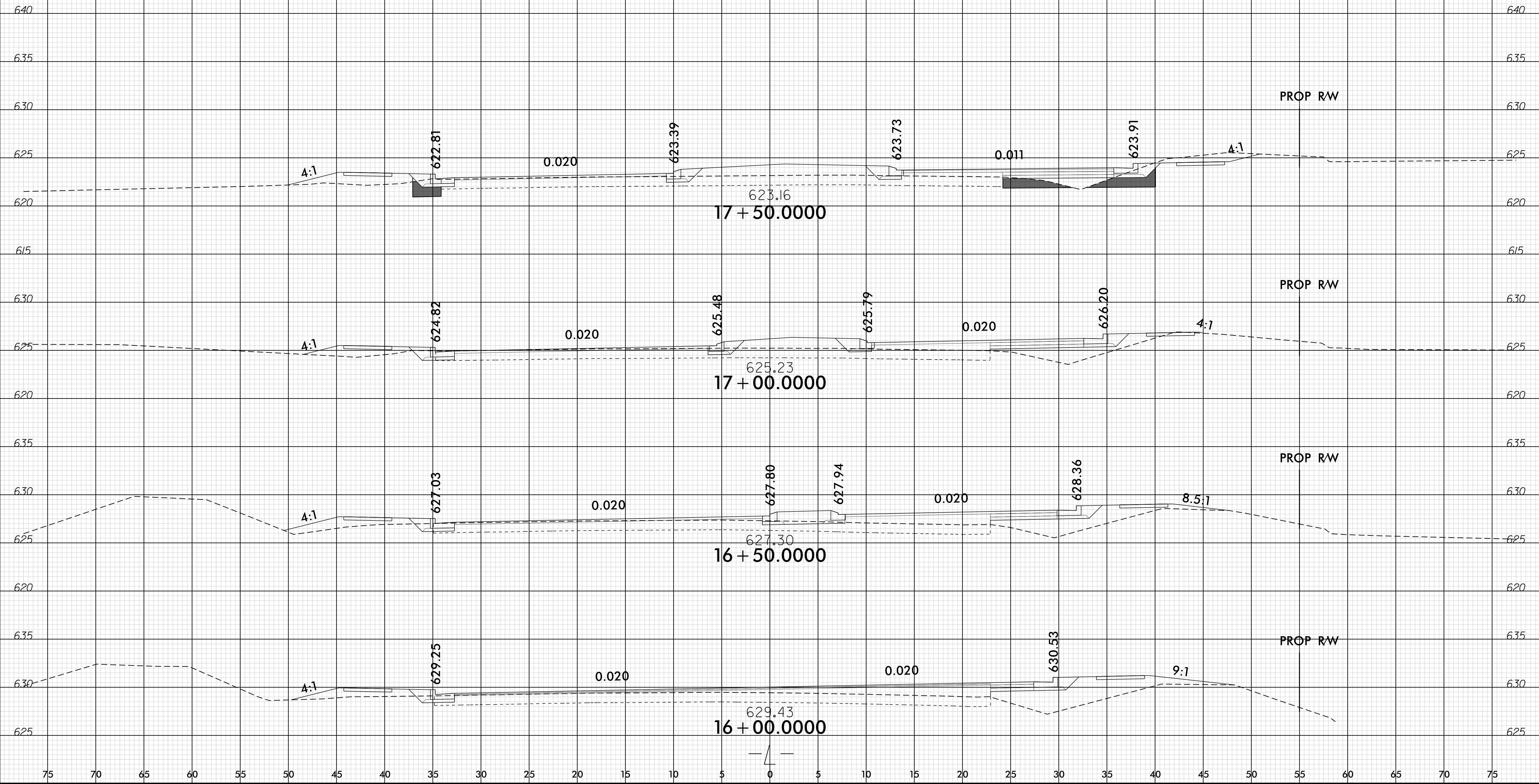

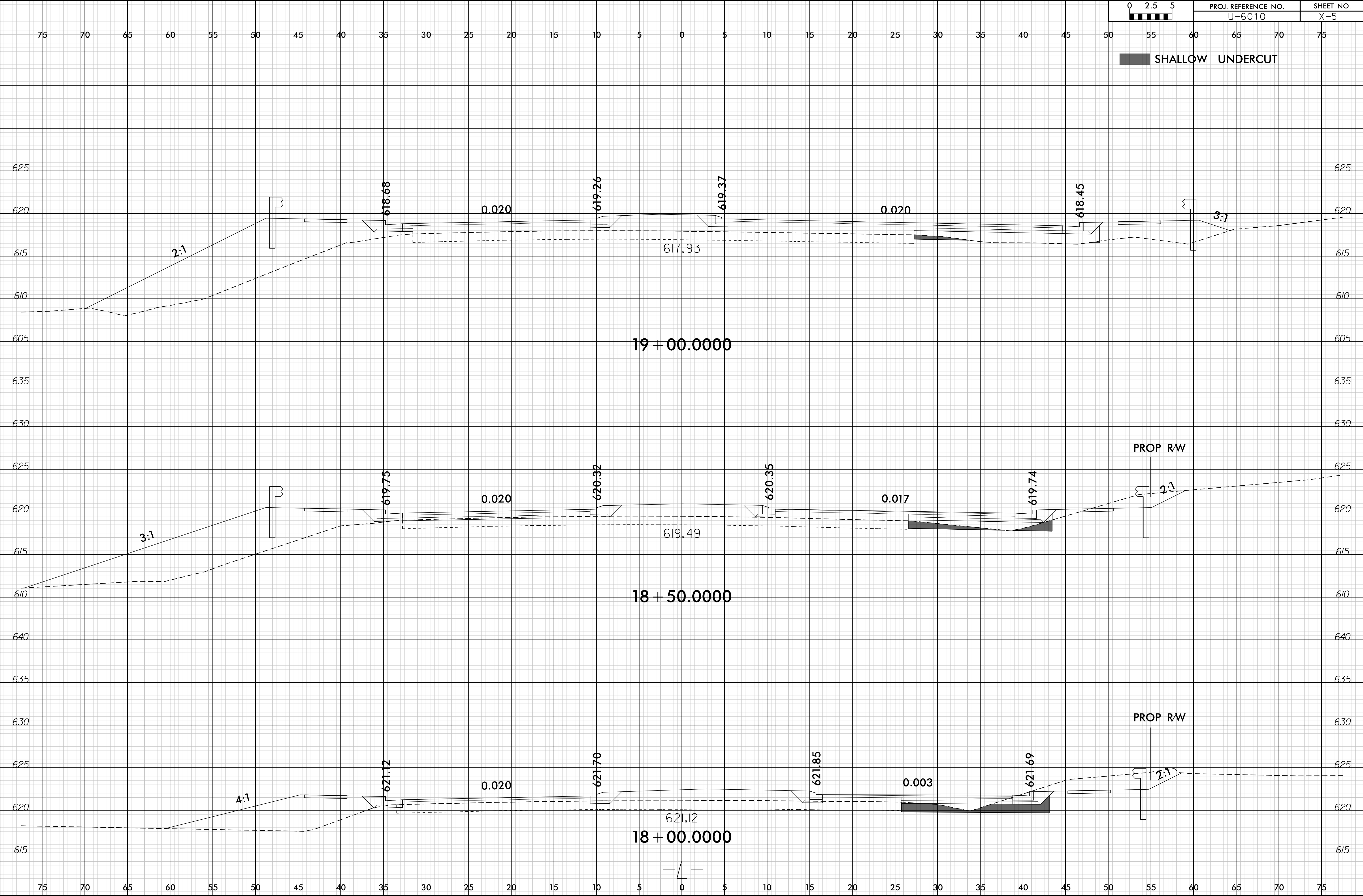





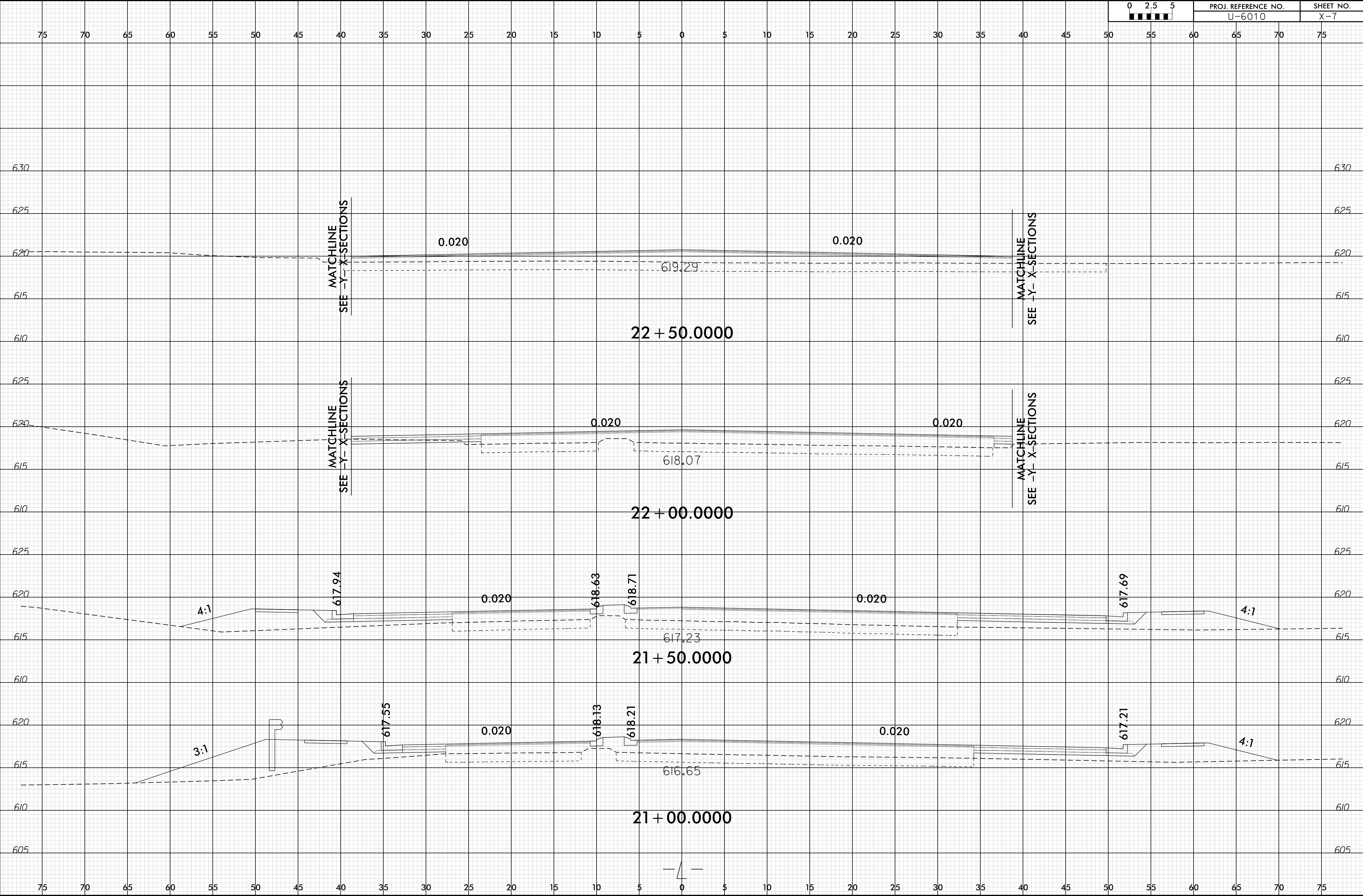
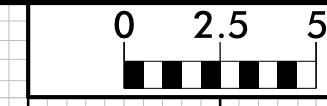

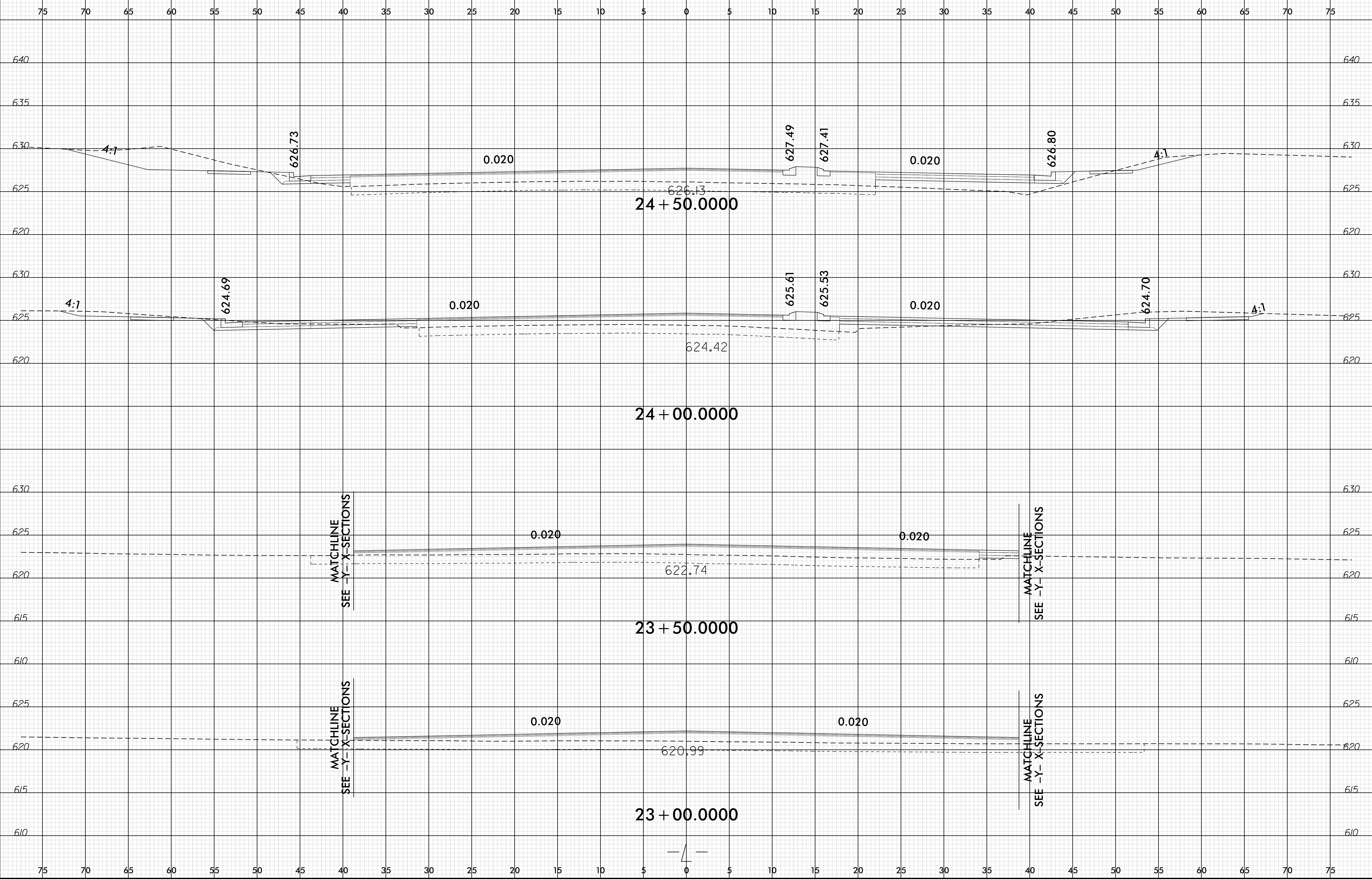
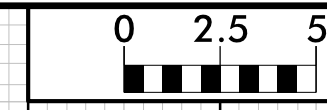

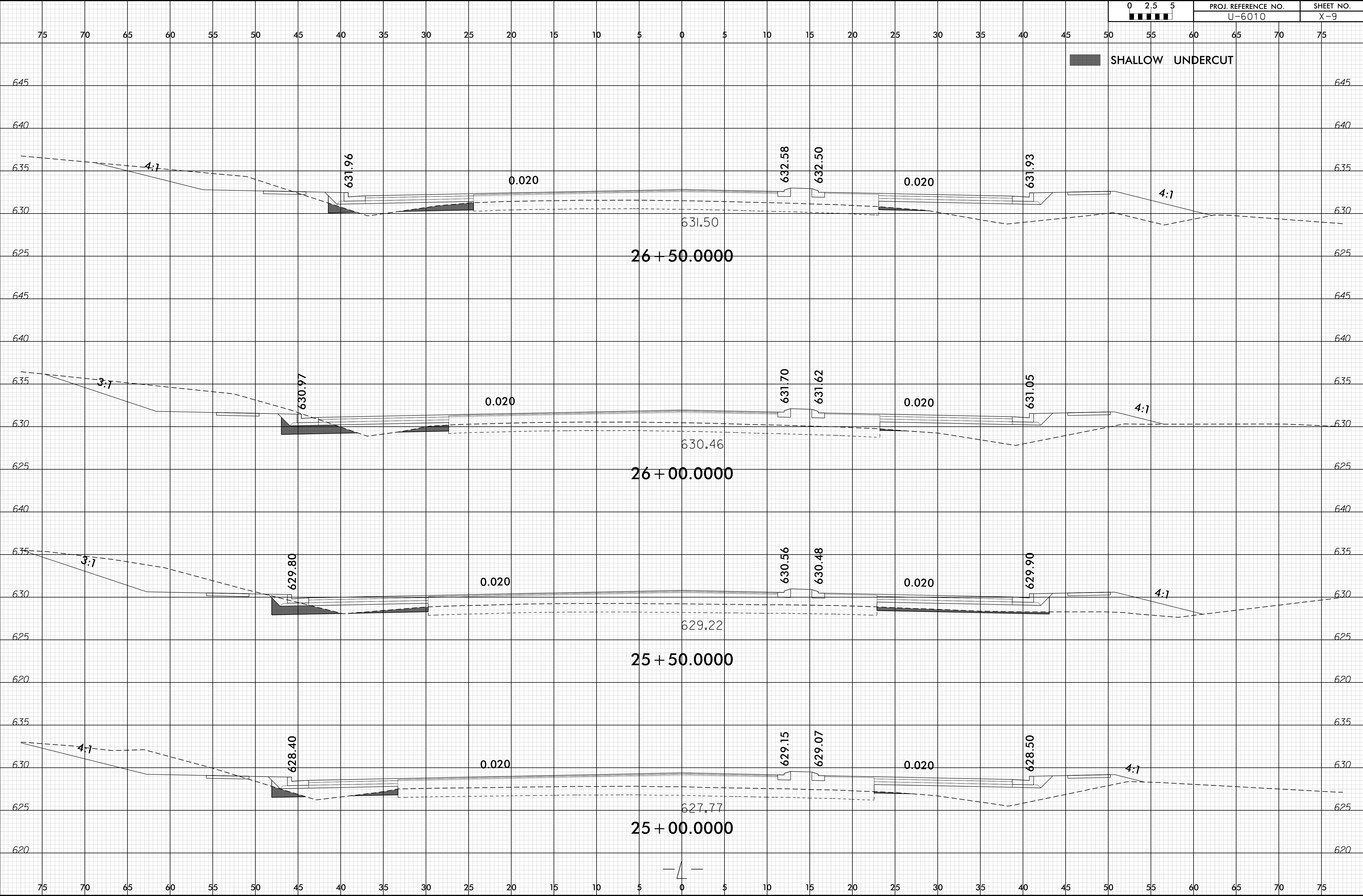
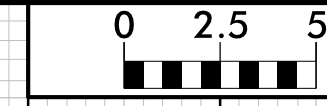



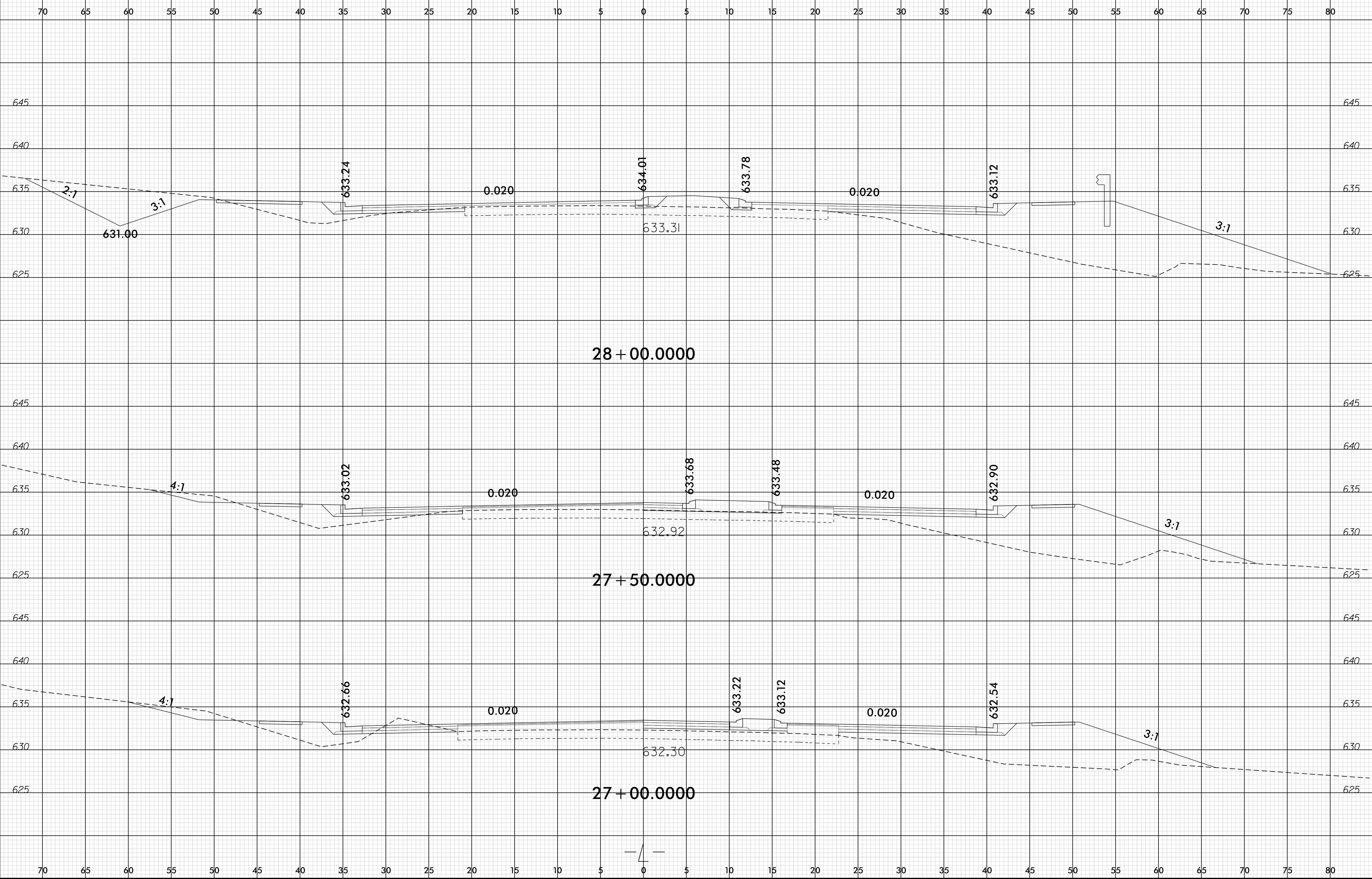
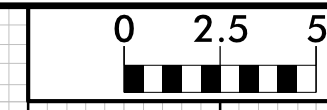



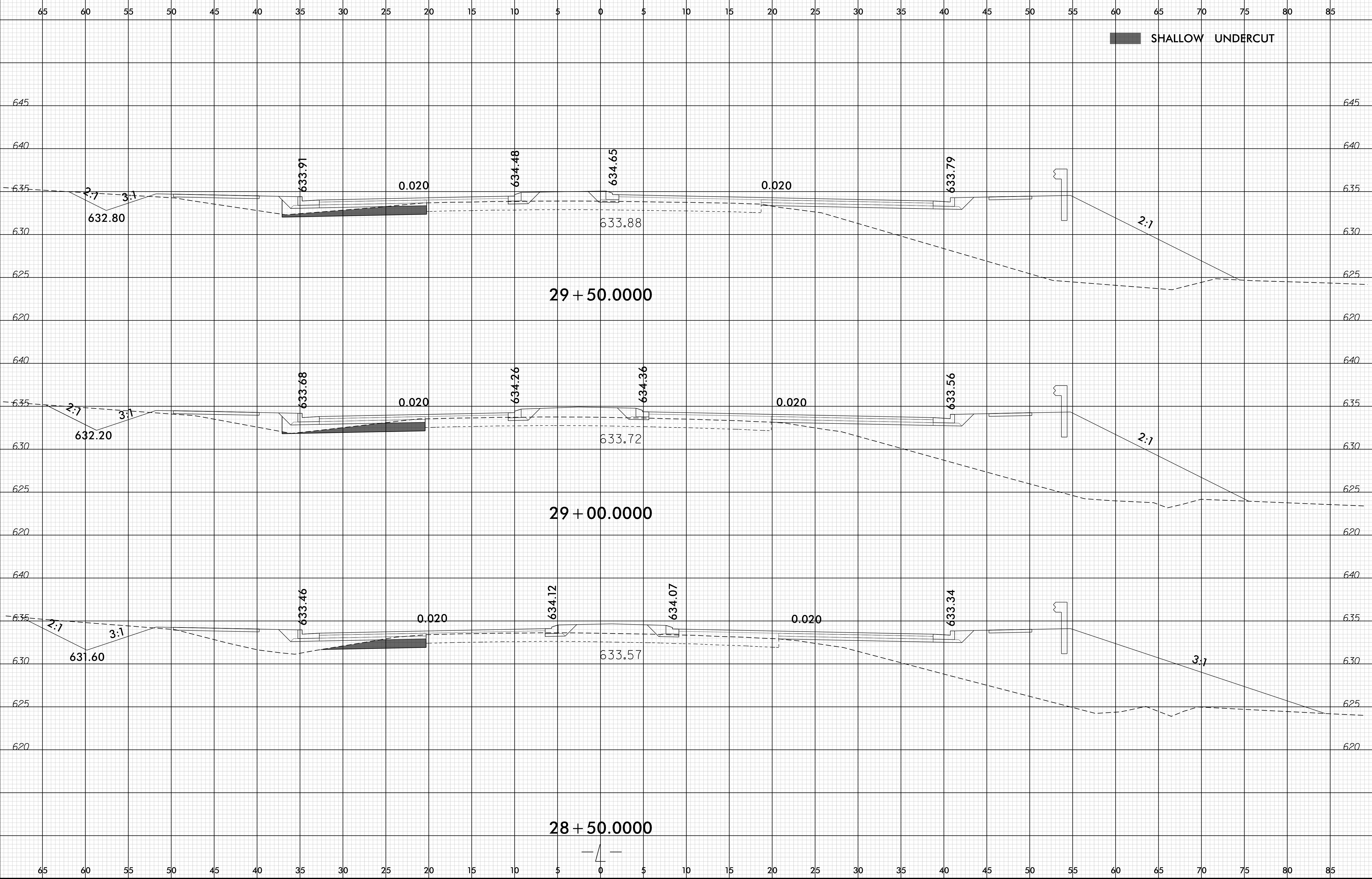
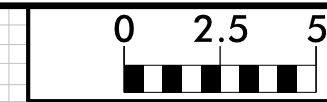

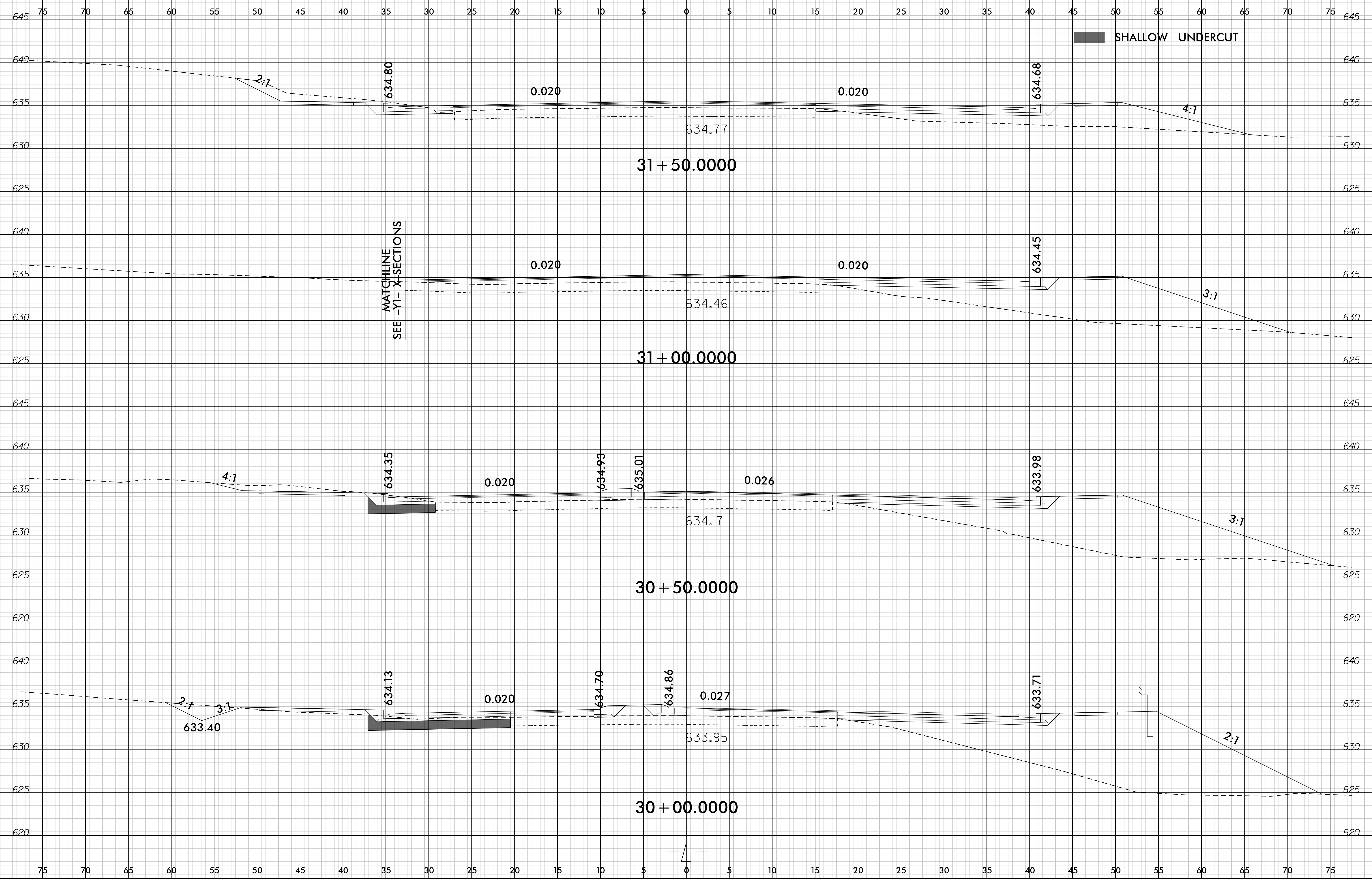
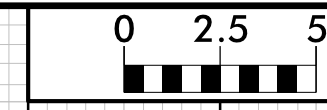

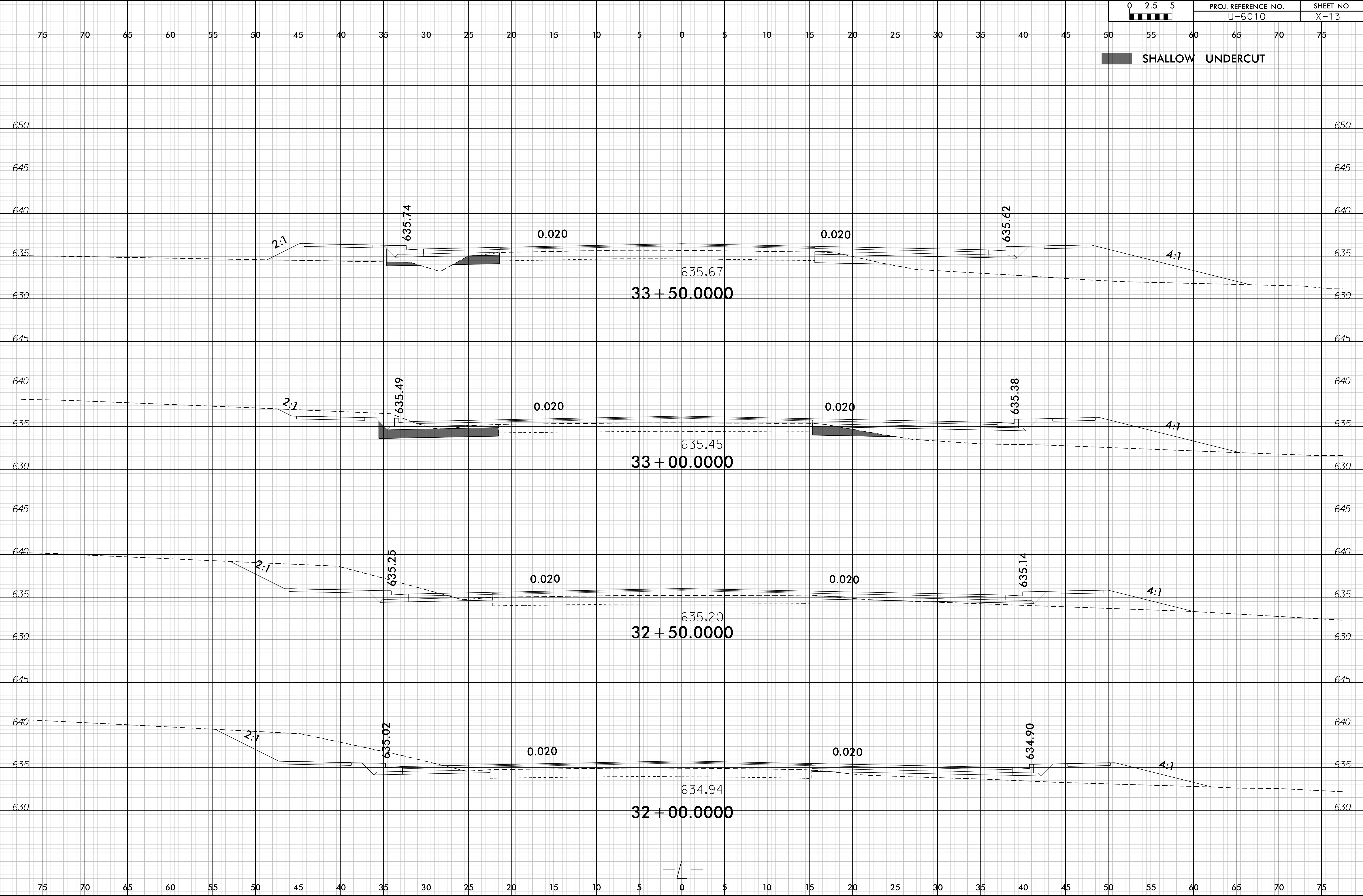
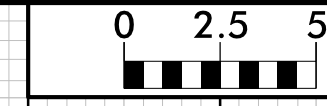

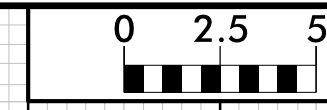

75 70 65 60 55 50 45 40 35 30 25 20 15 10 5 0 5 10 15 20 25 30 35 40 45 50 55 60 65 70 75

SHALLOW UNDERCUT

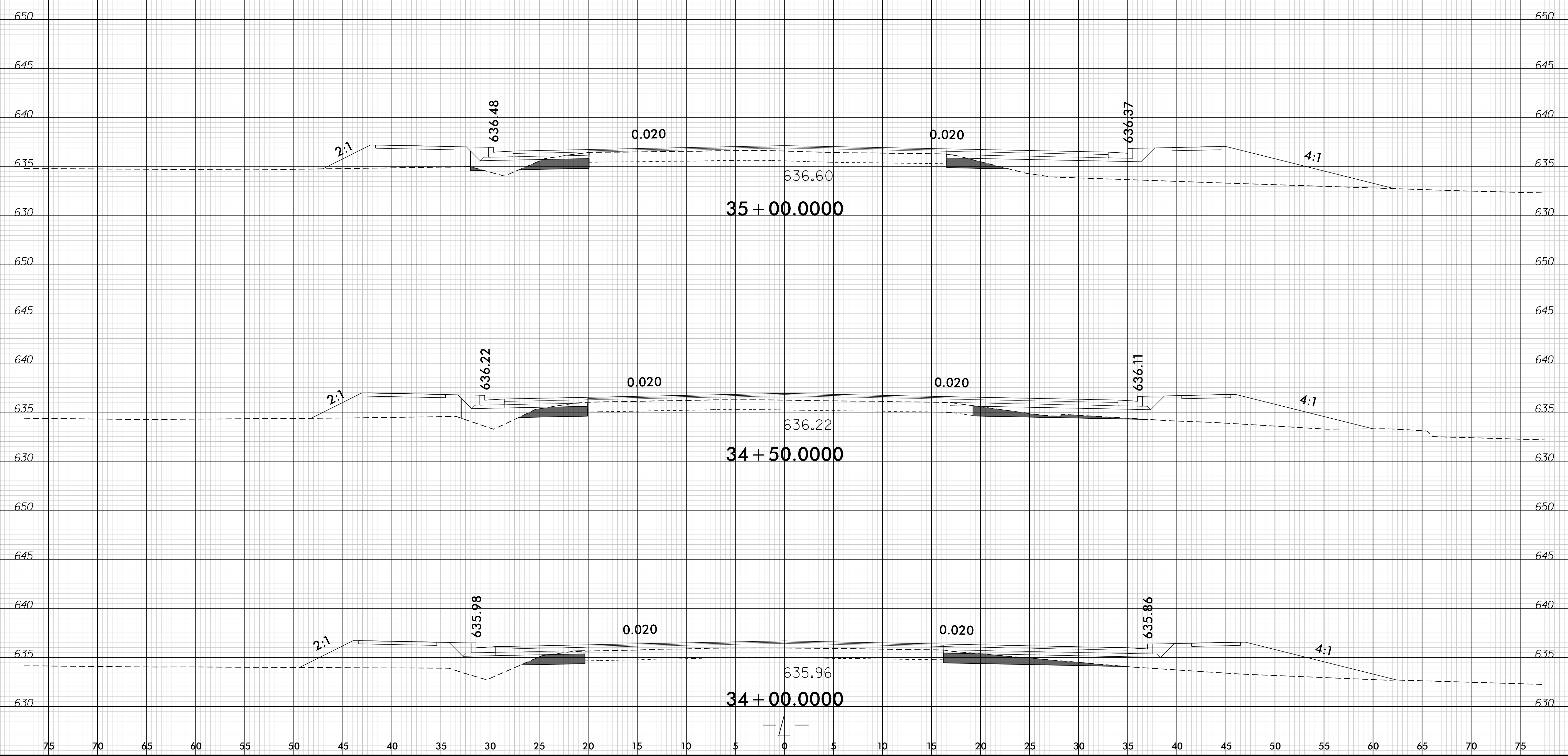

75 70 65 60 55 50 45 40 35 30 25 20 15 10 5 0 5 10 15 20 25 30 35 40 45 50 55 60 65 70 75



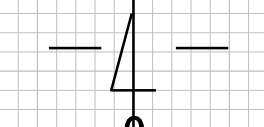
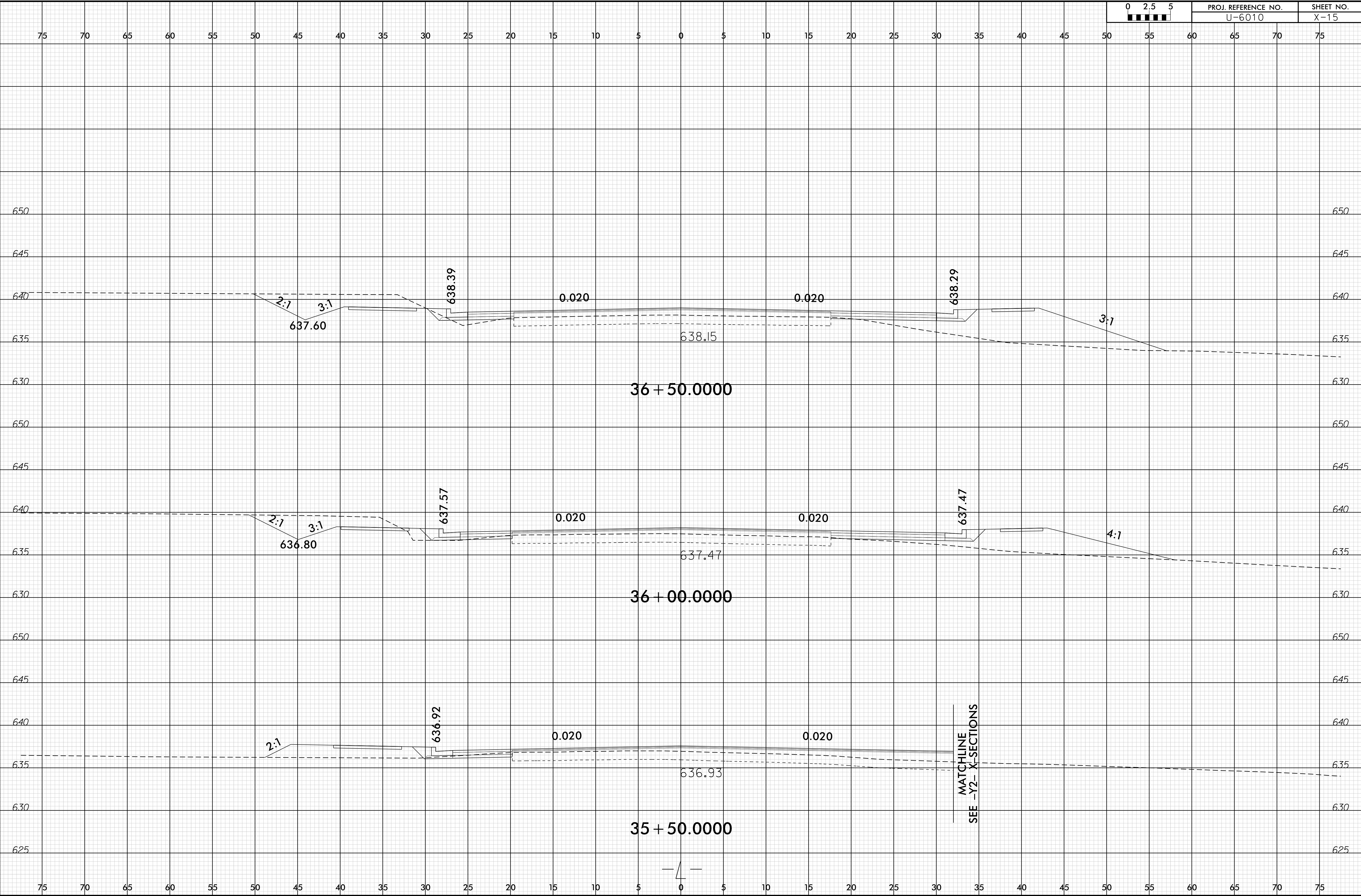
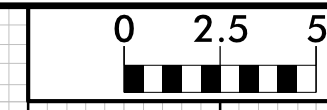



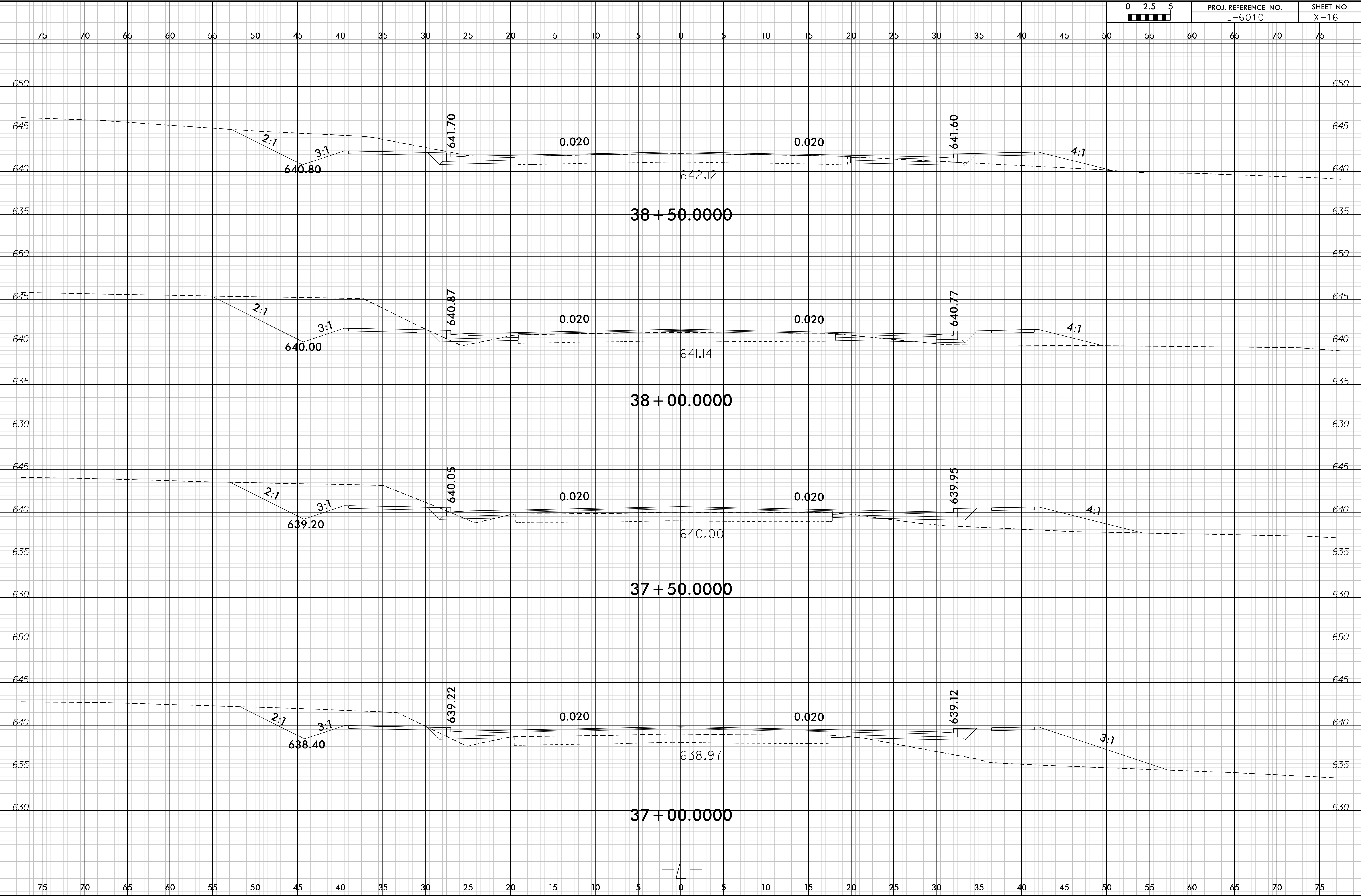
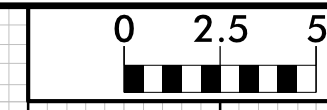

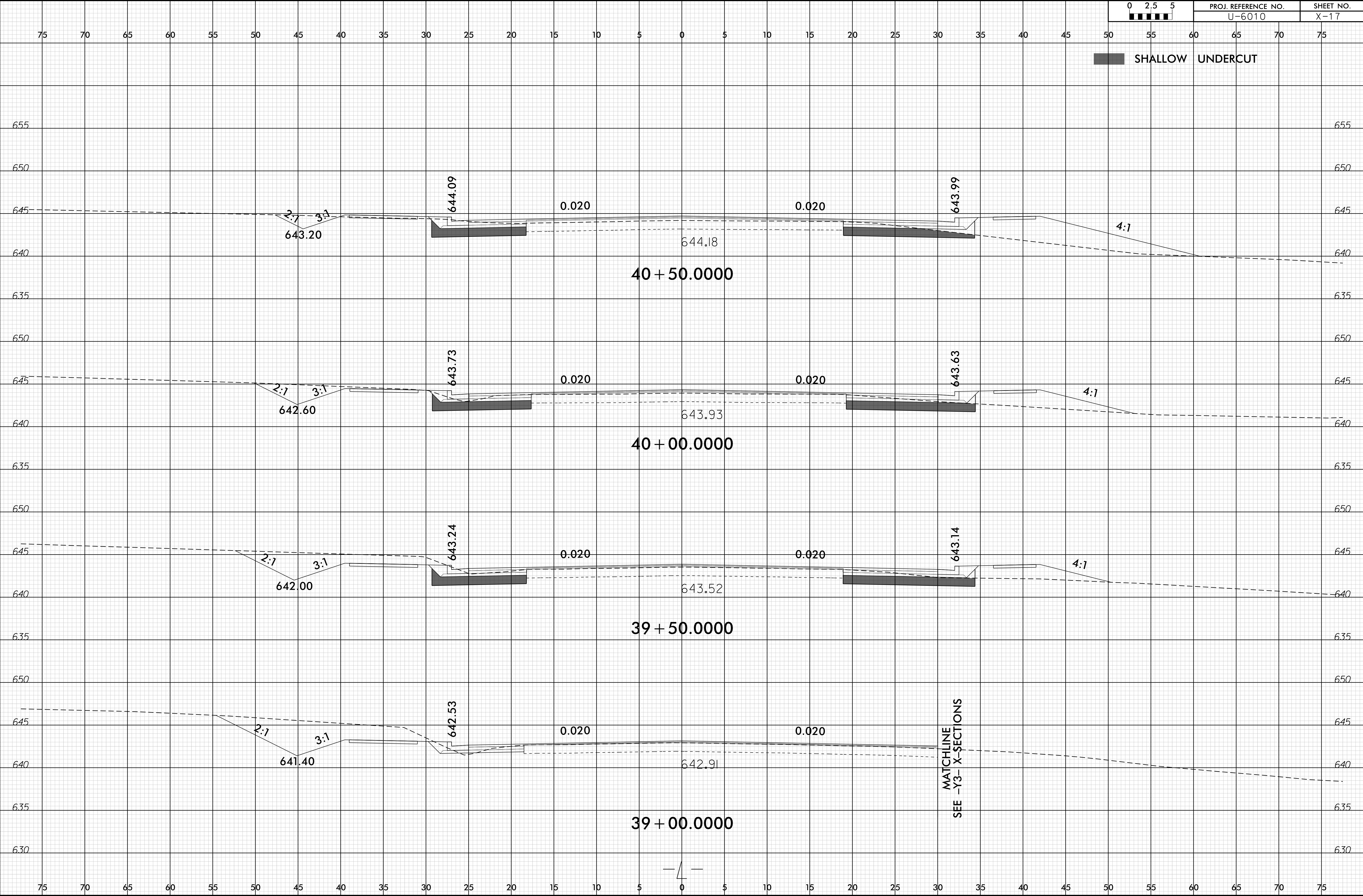
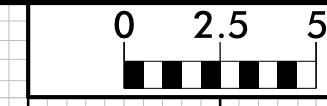

MATCHLINE  
SEE -Y3- X-SECTIONS

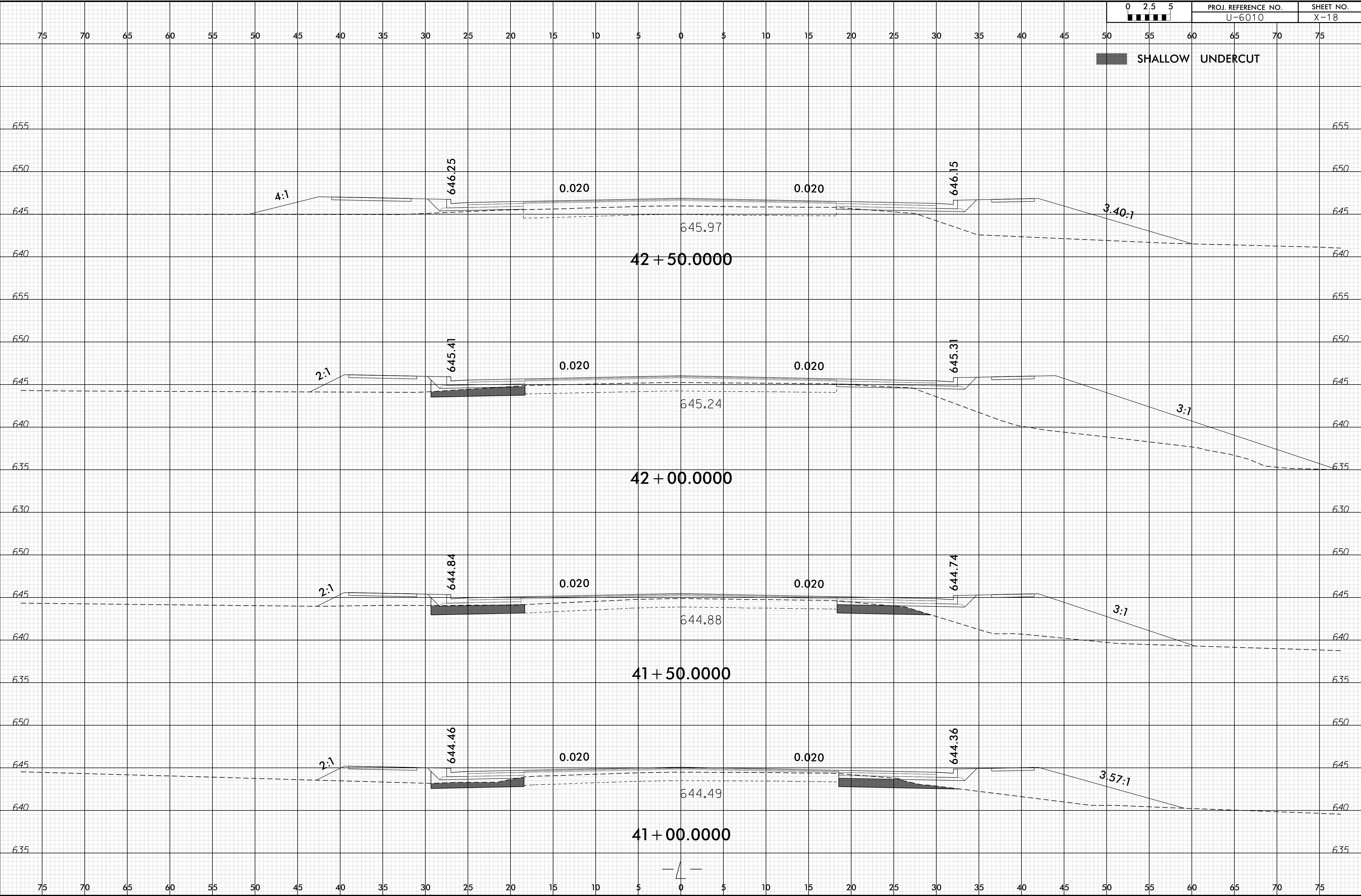
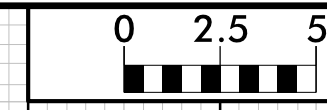

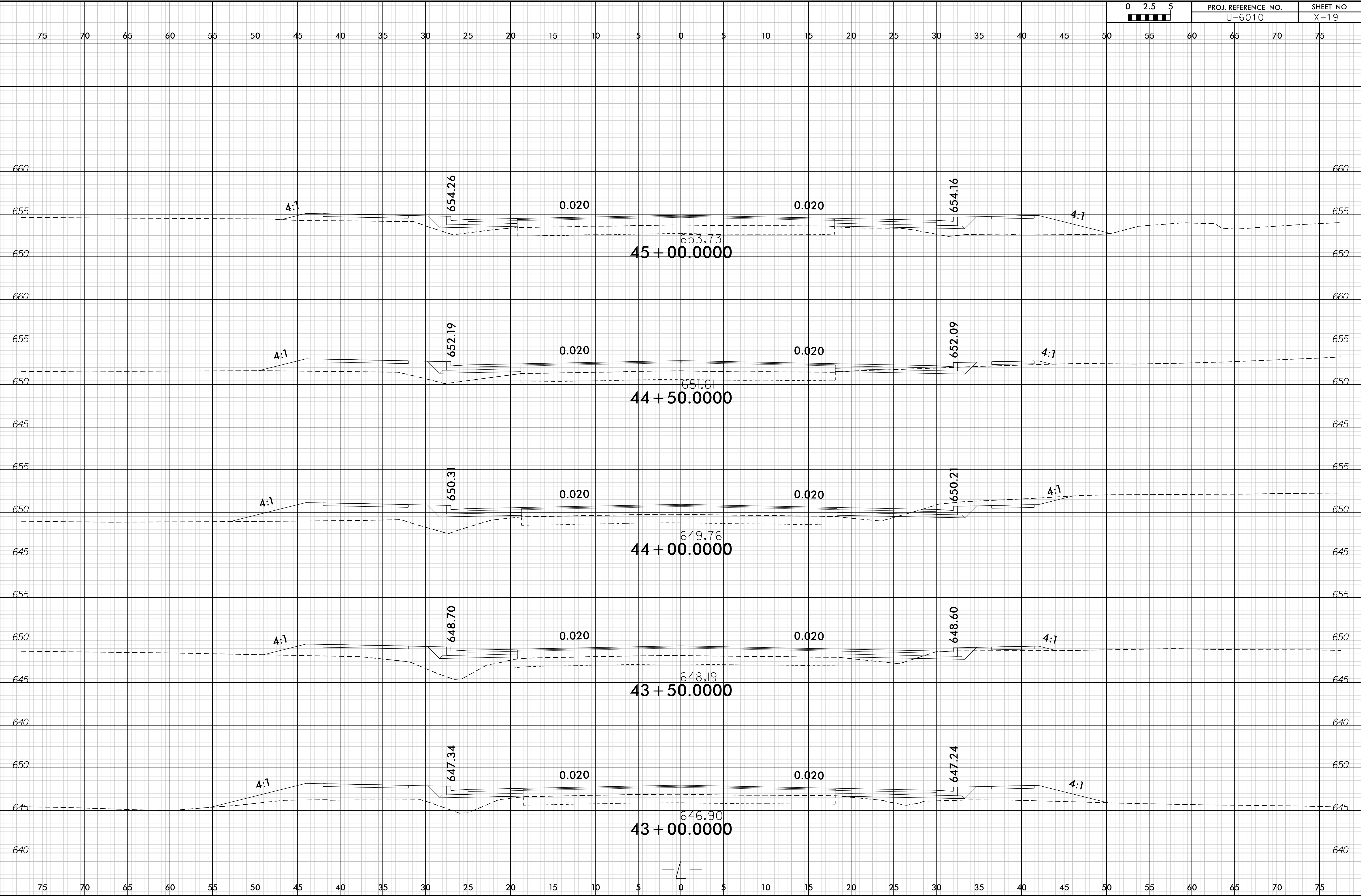
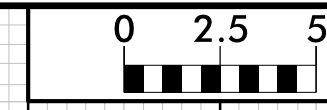



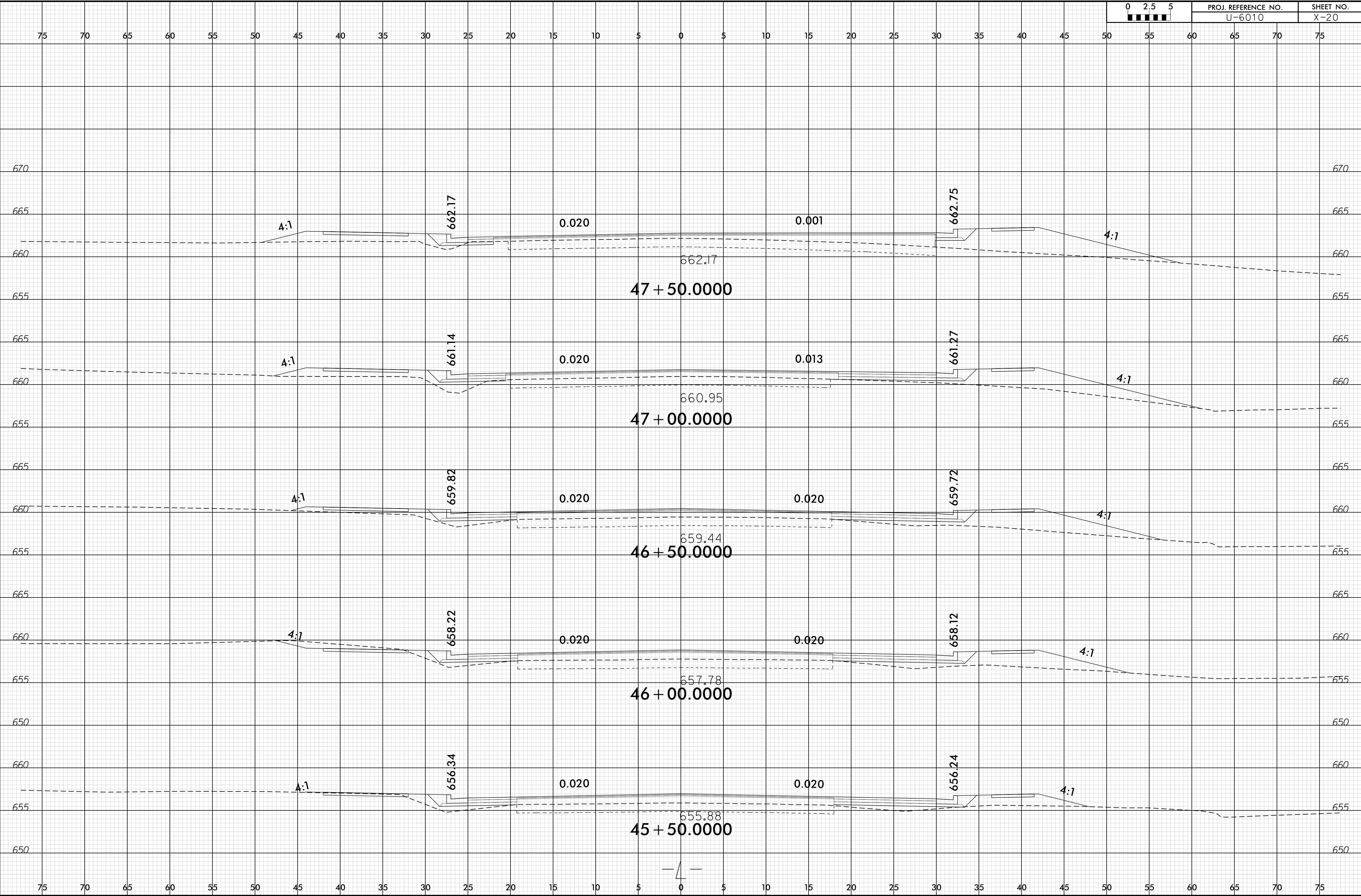
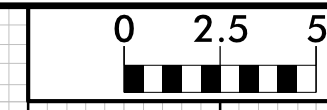





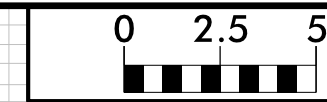

75 70 65 60 55 50 45 40 35 30 25 20 15 10 5 0 5 10 15 20 25 30 35 40 45 50 55 60 65 70 75

SHALLOW UNDERCUT

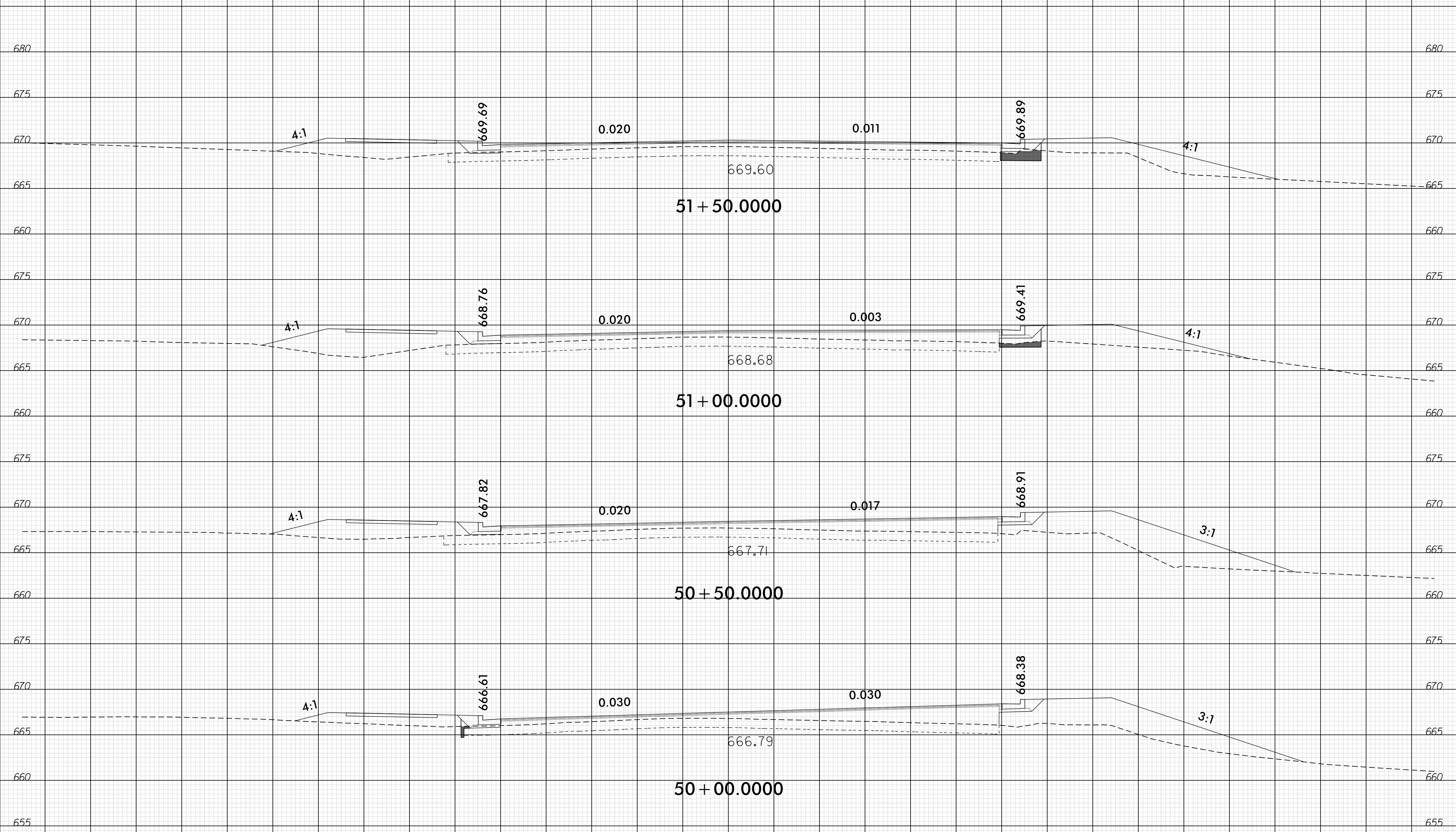

75 70 65 60 55 50 45 40 35 30 25 20 15 10 5 0 5 10 15 20 25 30 35 40 45 50 55 60 65 70 75

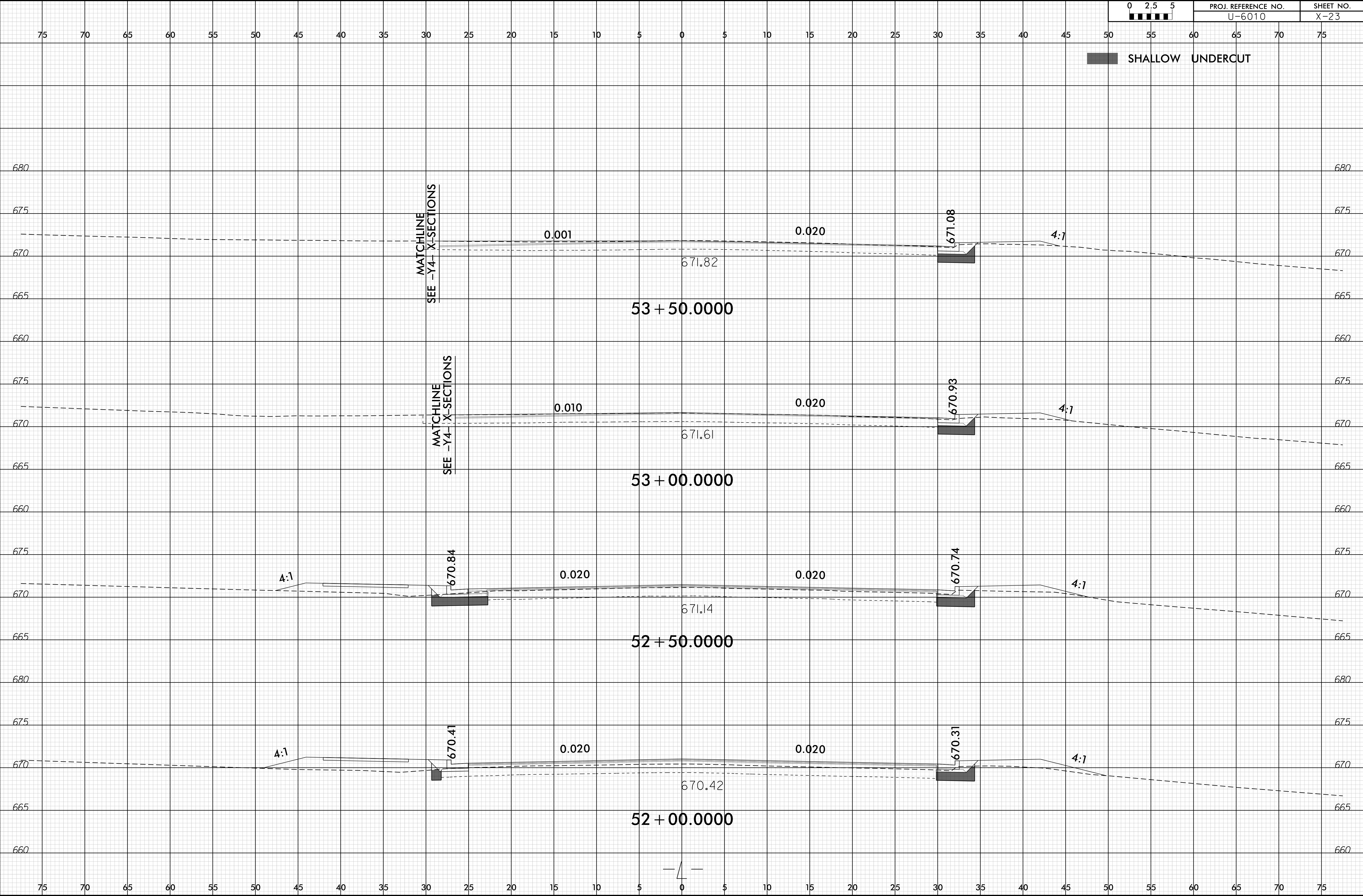
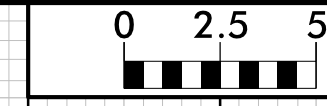

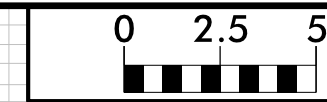

75 70 65 60 55 50 45 40 35 30 25 20 15 10 5 0 5 10 15 20 25 30 35 40 45 50 55 60 65 70 75

SHALLOW UNDERCUT

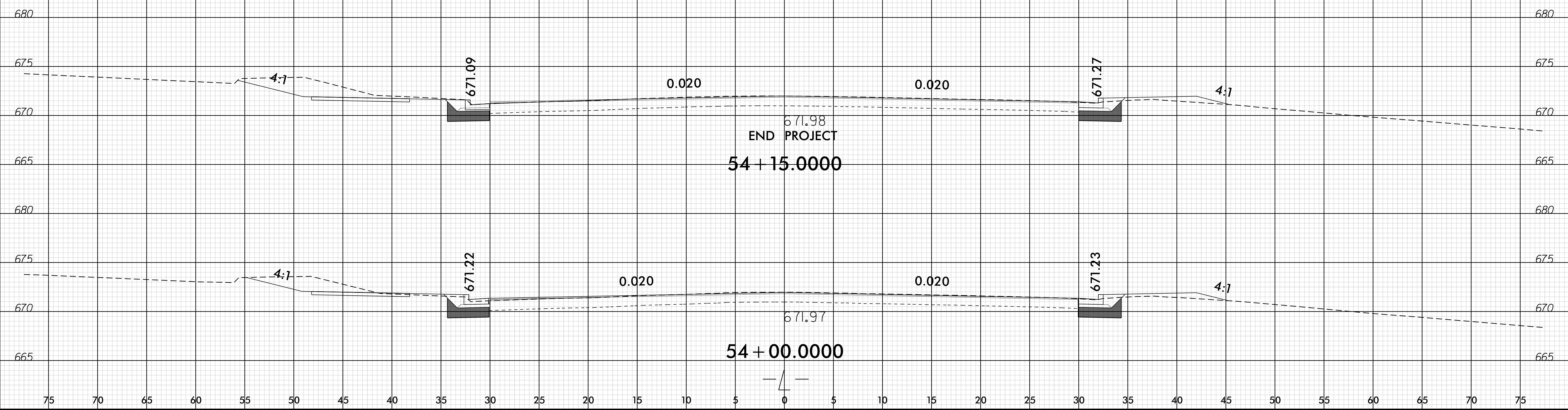

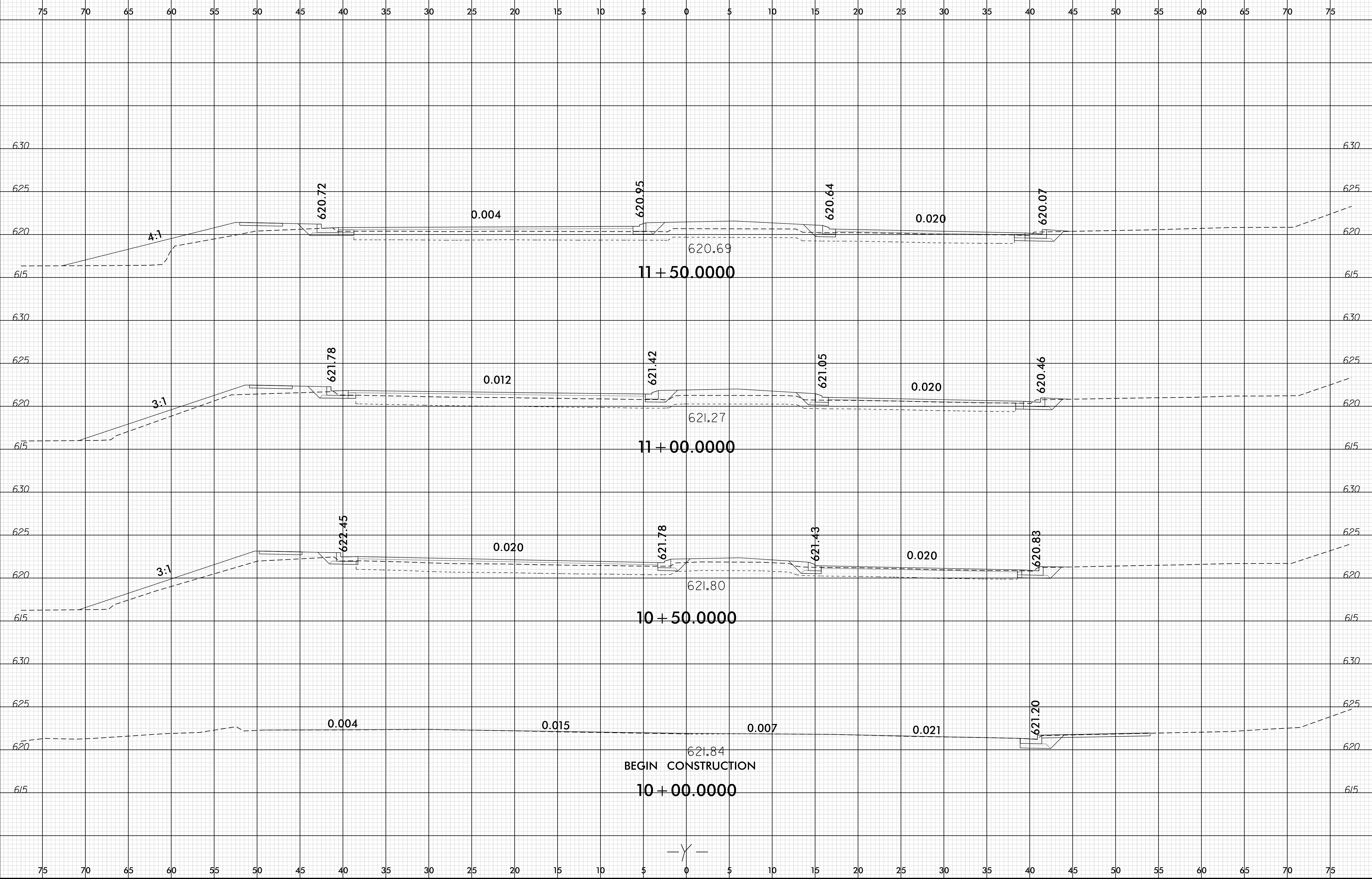
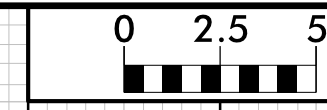

BEGIN CONSTRUCTION





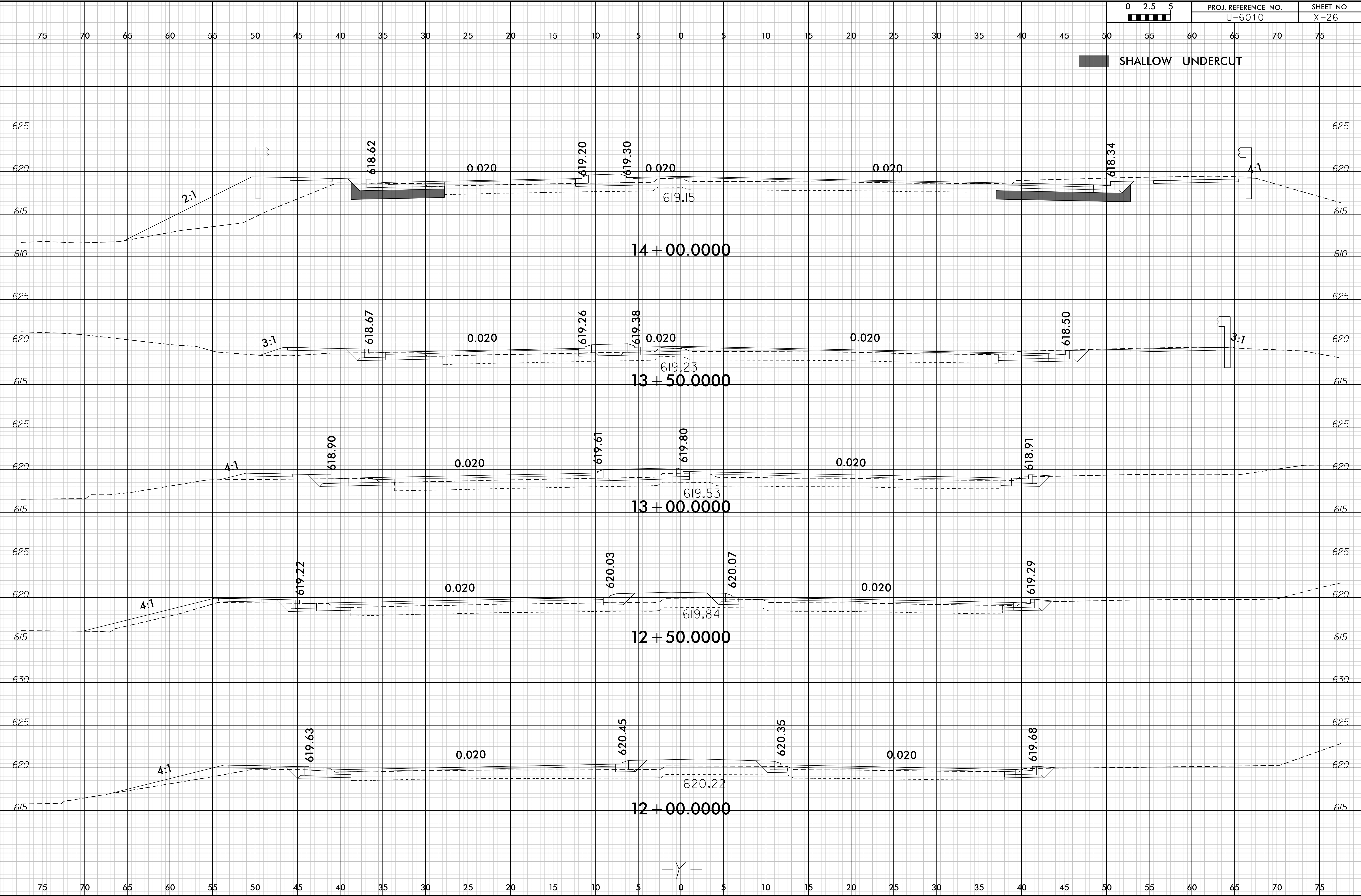
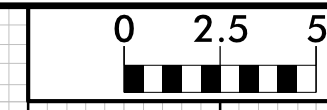

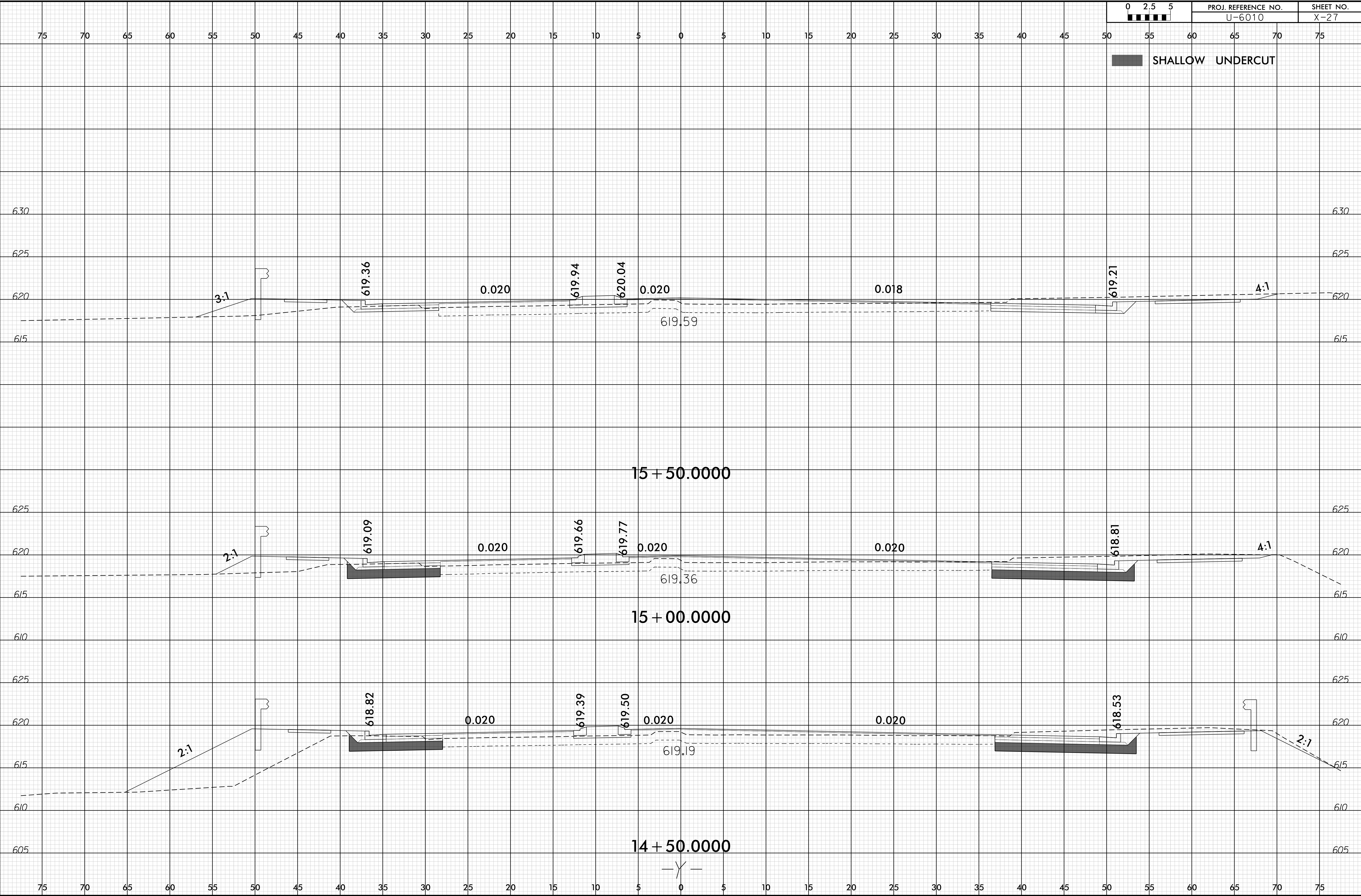
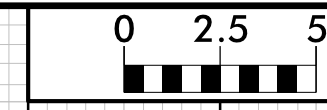

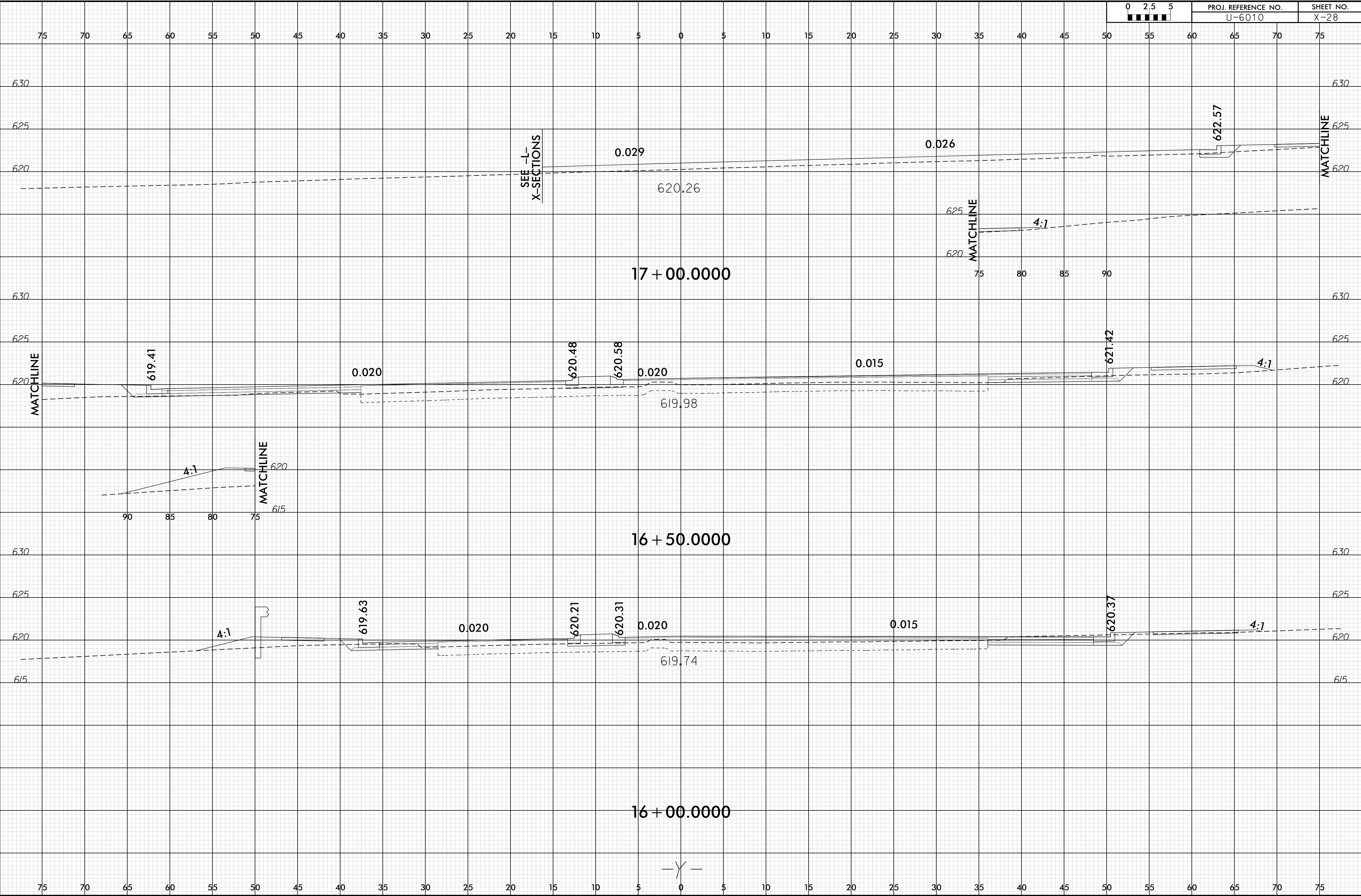
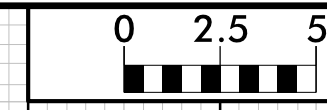

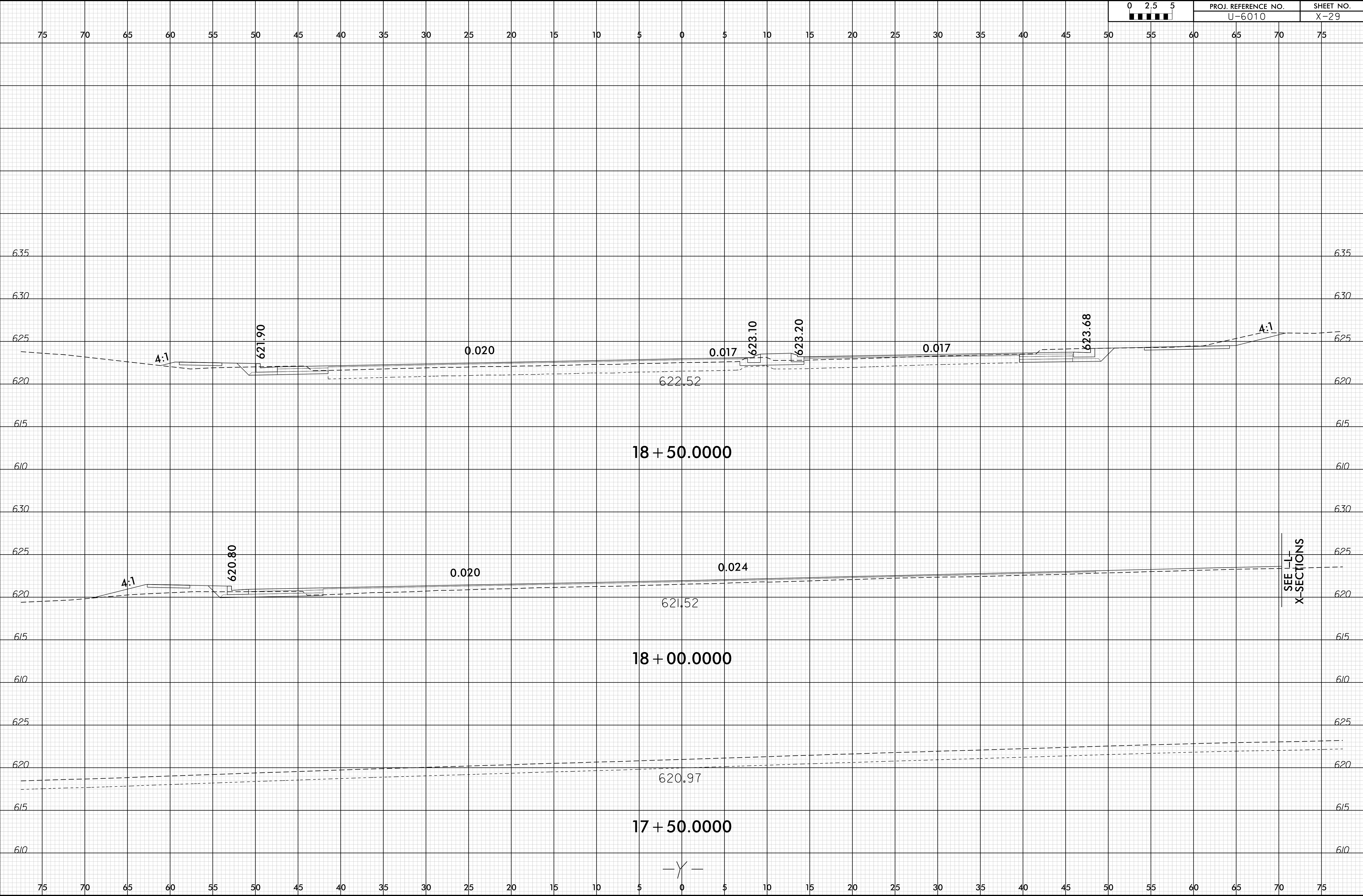
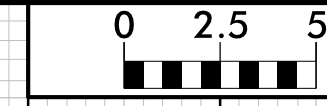

SEE 'L'-  
X-SECTIONS



6/23/16

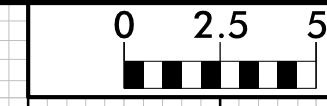

PROJ. REFERENCE NO.	SHEET NO.
U-6010	X-30

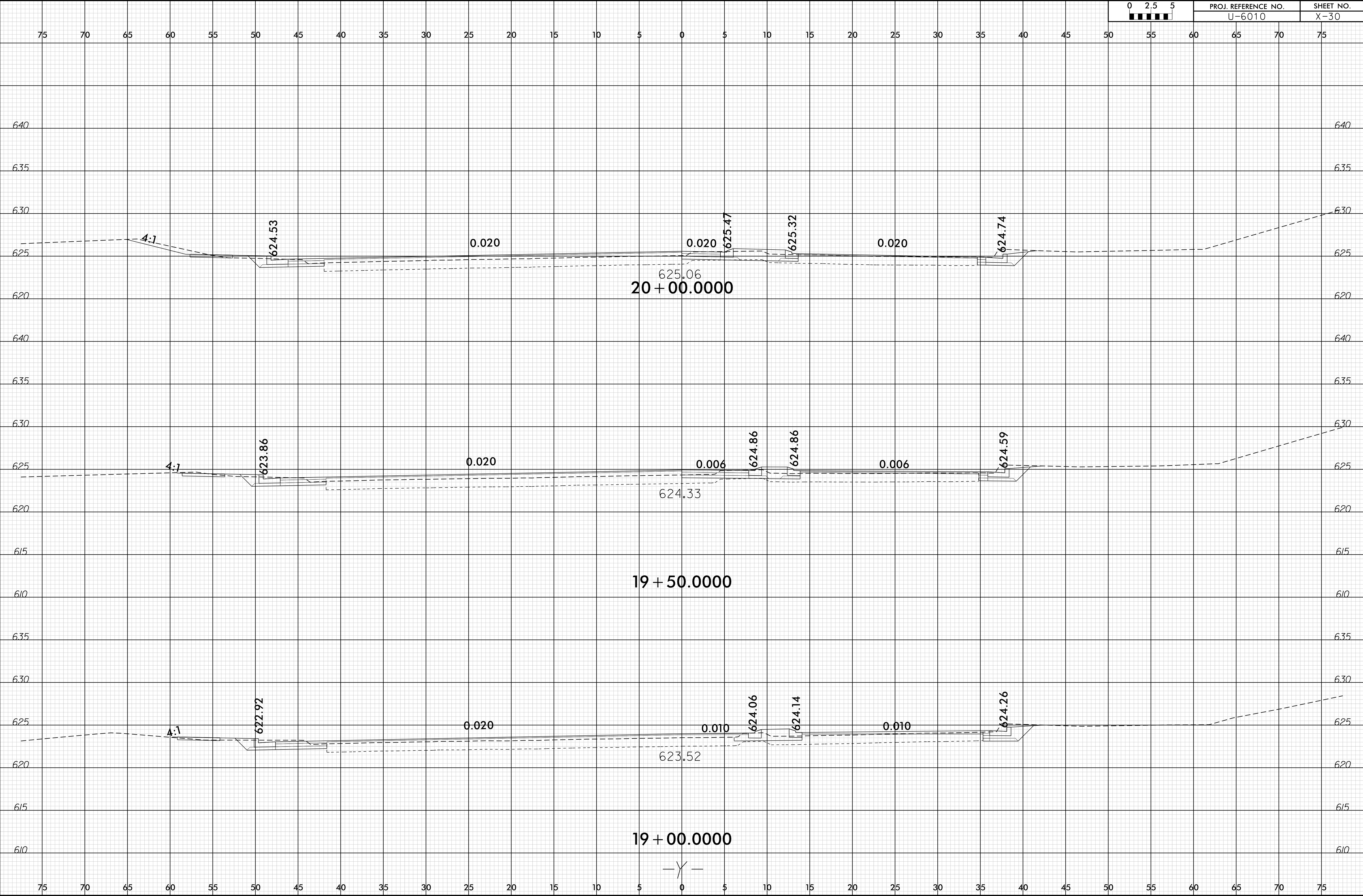

27-JAN-2022 18:16  
 \\s01\work\2022\U-6010-XSC\U-6010-Rd.dwg  
 USER:R...



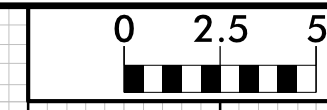

75 70 65 60 55 50 45 40 35 30 25 20 15 10 5 0 5 10 15 20 25 30 35 40 45 50 55 60 65 70 75

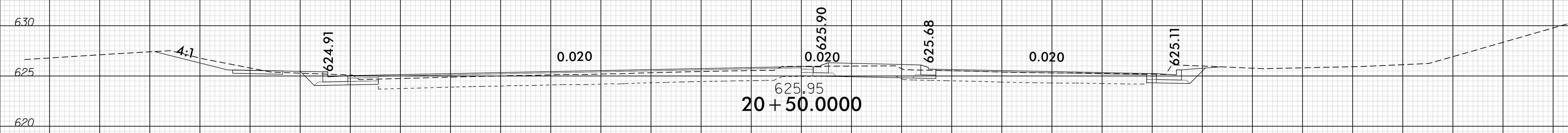
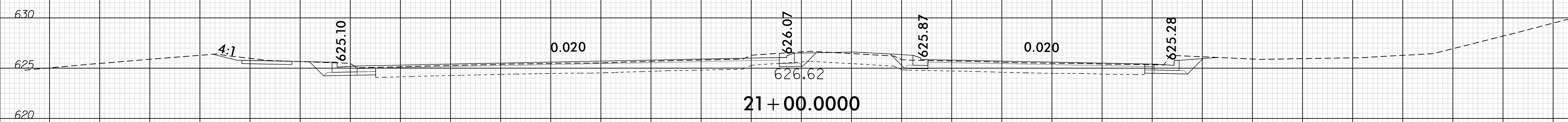
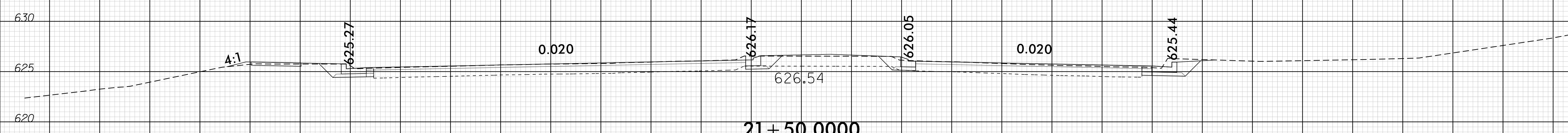
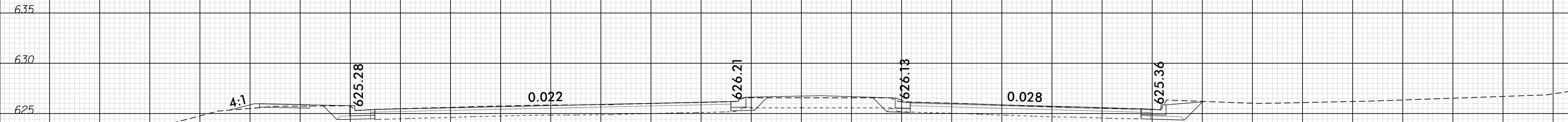

75 70 65 60 55 50 45 40 35 30 25 20 15 10 5 0 5 10 15 20 25 30 35 40 45 50 55 60 65 70 75

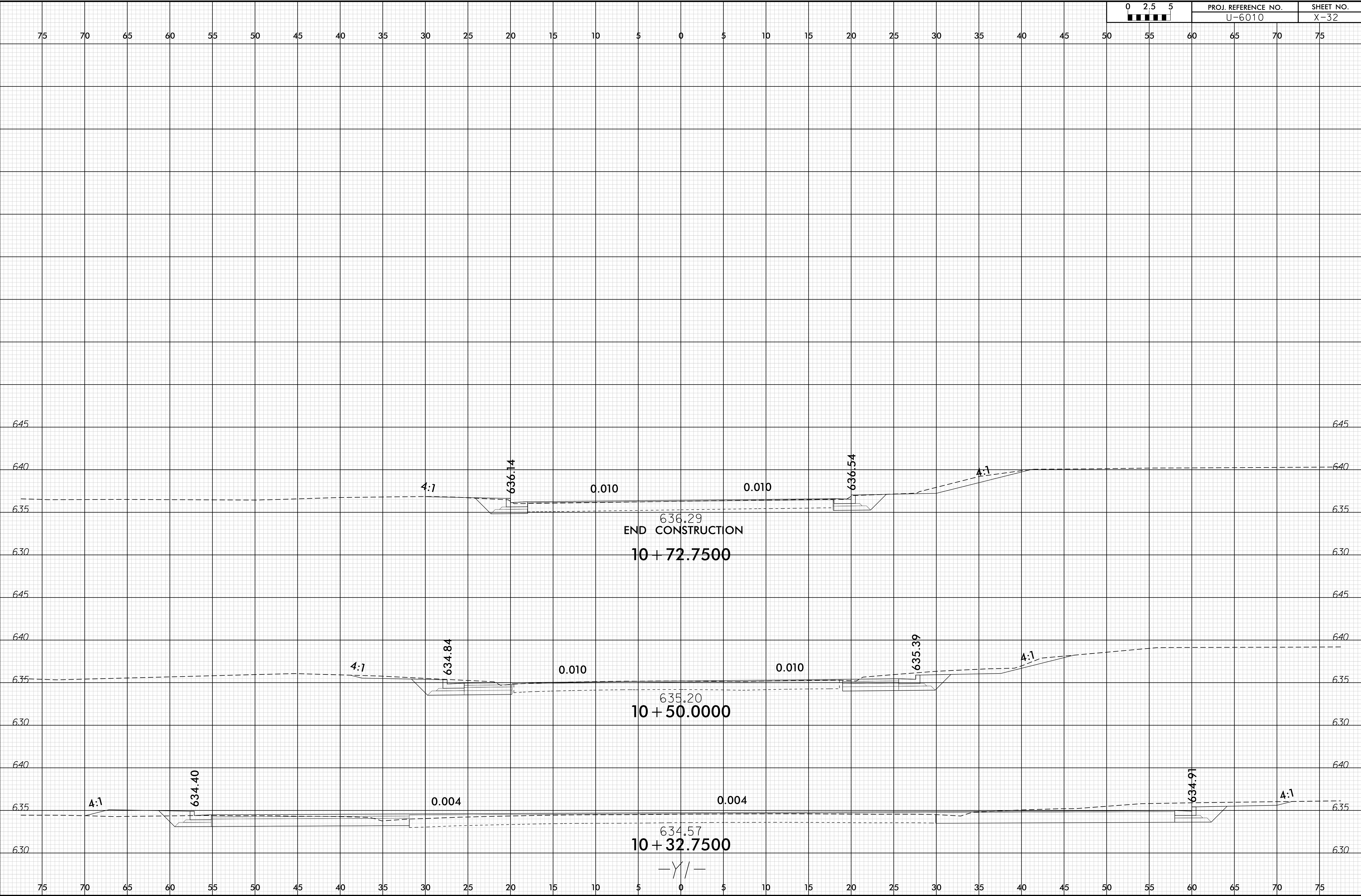

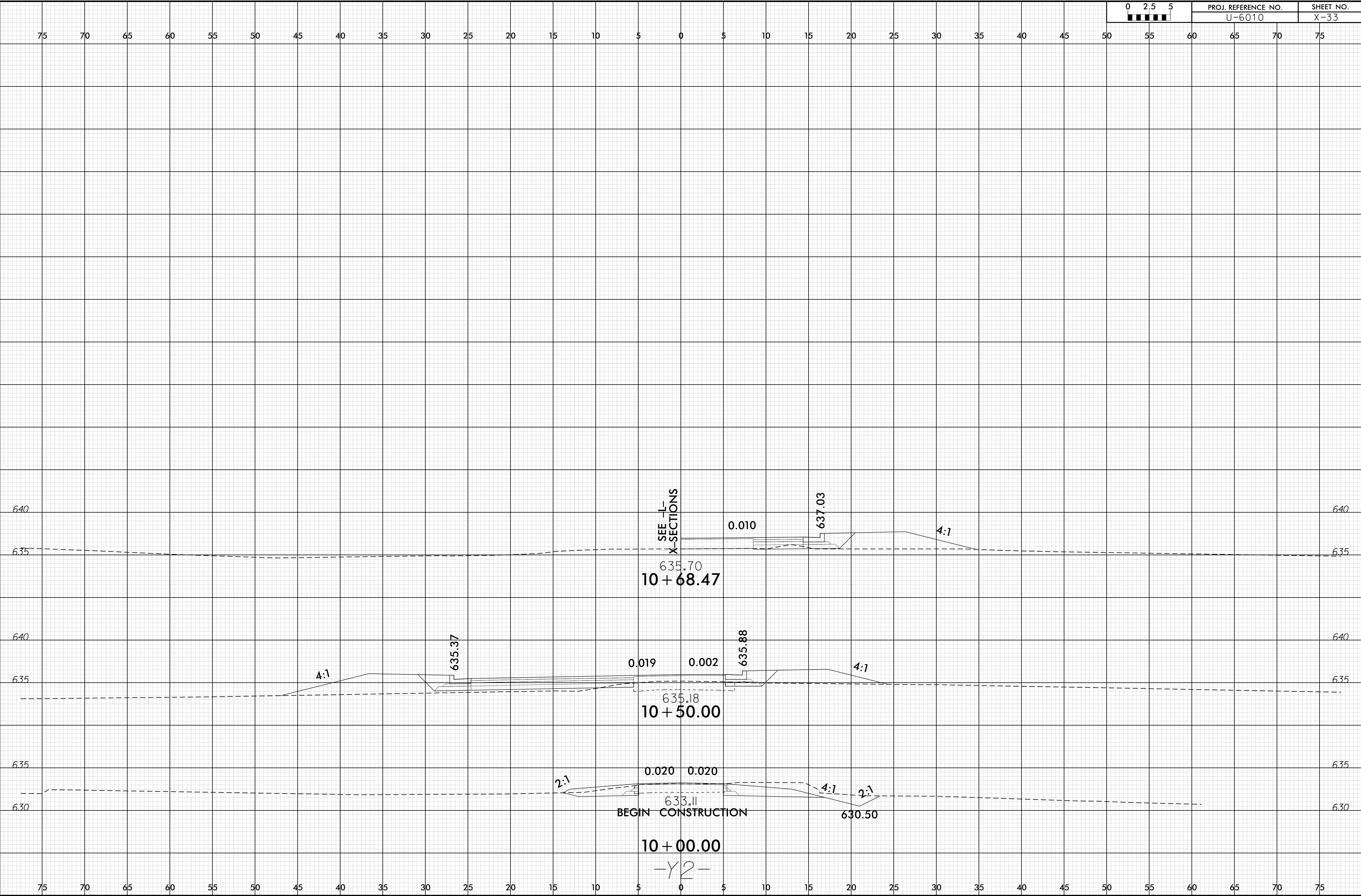

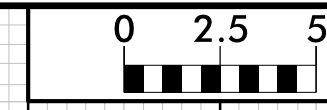

75 70 65 60 55 50 45 40 35 30 25 20 15 10 5 0 5 10 15 20 25 30 35 40 45 50 55 60 65 70 75

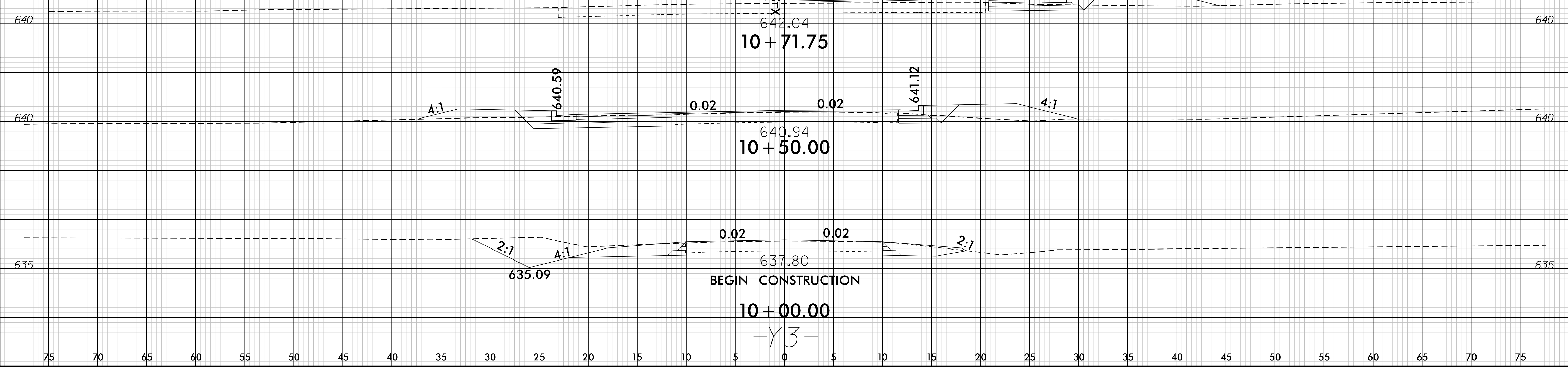

SEE L-X SECTIONS

10 + 50.00

10 + 00.00

-Y3-

BEGIN CONSTRUCTION

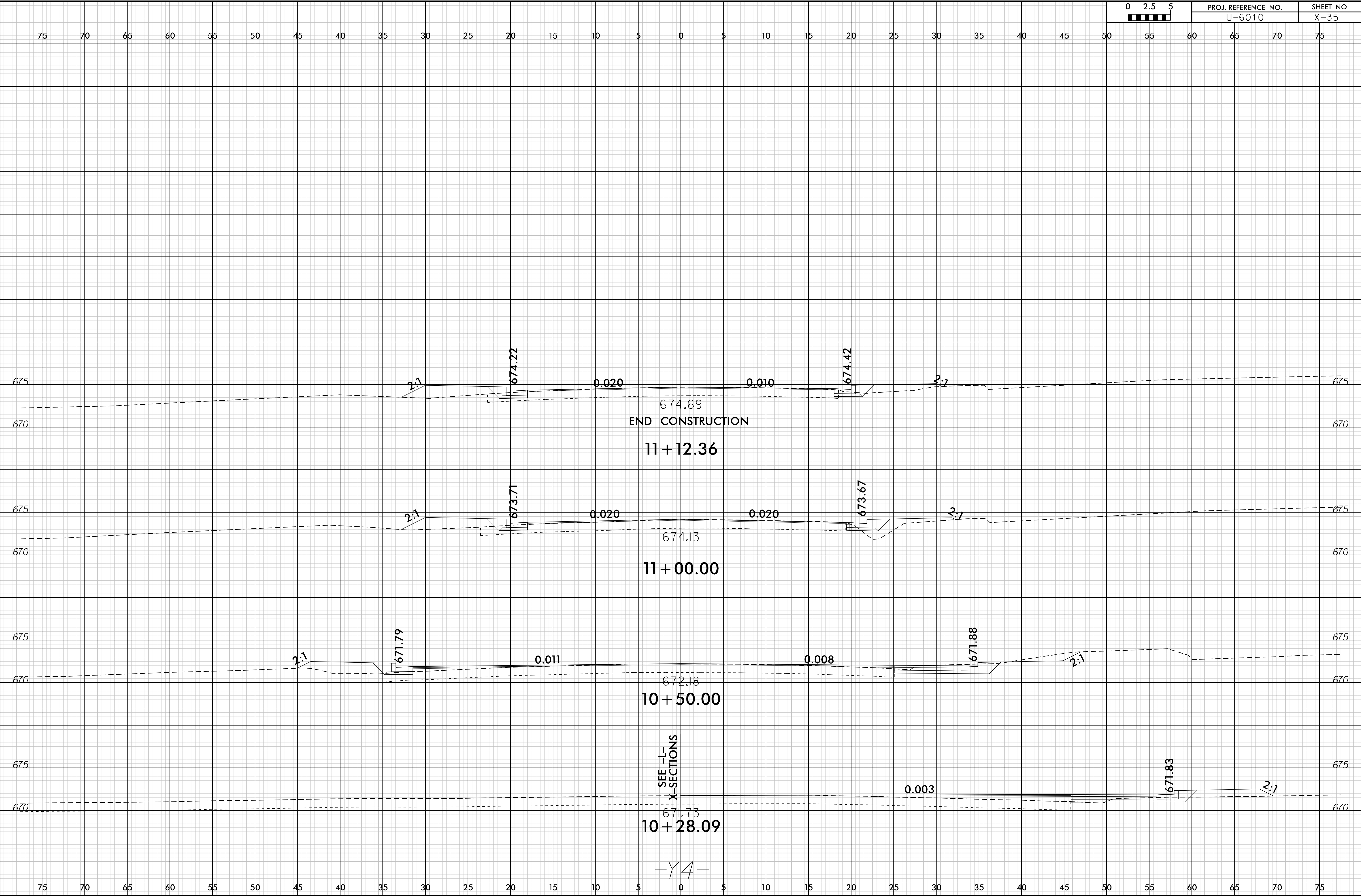
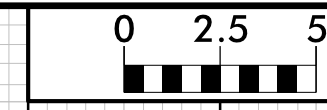

674.69  
 END CONSTRUCTION  
 11 + 12.36

674.13  
 11 + 00.00

672.18  
 10 + 50.00

671.73  
 10 + 28.09

-Y4-

SEE -L-  
 X-SECTIONS