

TIP NO. R-2233BB	SHEET NO. SIGN - 4I
APPROVED: _____	
DATE: _____	
SEAL 	
<b>DOCUMENT NOT CONSIDERED FINAL UNLESS ALL SIGNATURES COMPLETED</b>	
05/02/2022 ADDED RRFB'S AND ADVANCE WARNING FLASHING BEACONS JTB	

435 QUANTITY REQ'D 14

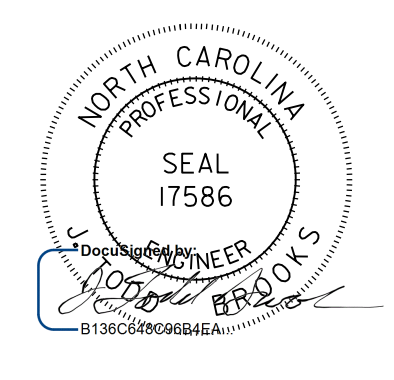
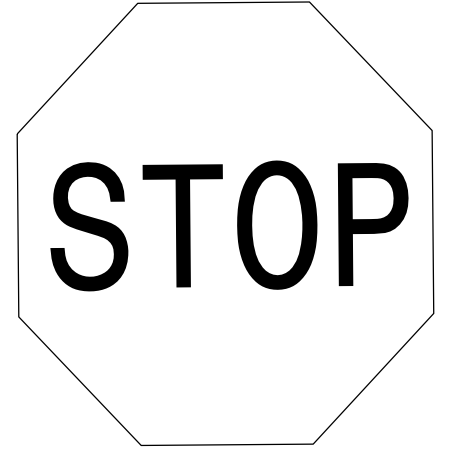

30 X 30  
R1-1

ONE "U" POST PER SIGN

436 QUANTITY REQ'D 5

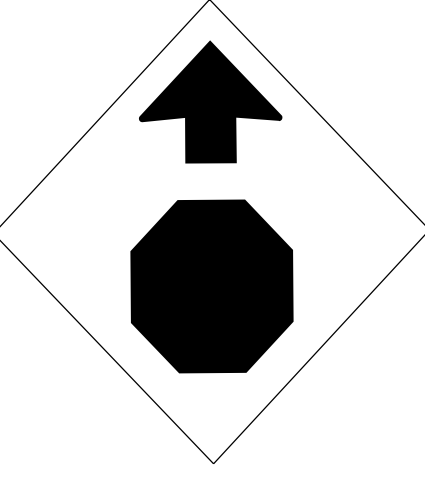

30 X 30  
W3-1

ONE "U" POST PER SIGN

437 QUANTITY REQ'D 1

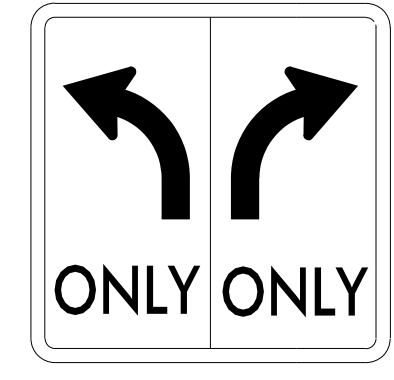

36 X 30  
R3-8MOD

ONE "U" POST PER SIGN

438 QUANTITY REQ'D 2



24 X 30  
R2-1

ONE "U" POST PER SIGN

439 QUANTITY REQ'D 2



30 X 36  
R2-1

ONE "U" POST PER SIGN

440 QUANTITY REQ'D 1

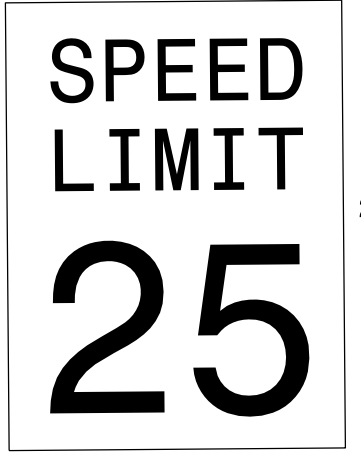

24 X 30  
R2-1

ONE "U" POST PER SIGN

441 QUANTITY REQ'D 2

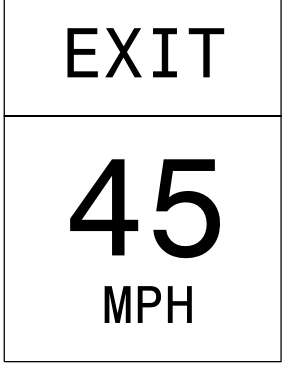

36 X 48  
W13-2

TWO "U" POSTS PER SIGN

442 QUANTITY REQ'D 2



18 X 6  
R1-3P

MOUNT BELOW SIGN 435  
IN 2 INSTALLATIONS

443 QUANTITY REQ'D 8

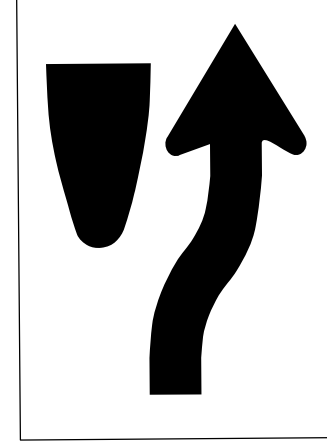

18 X 30  
R4-7C

ONE "U" POSTS PER SIGN

444 QUANTITY REQ'D 1

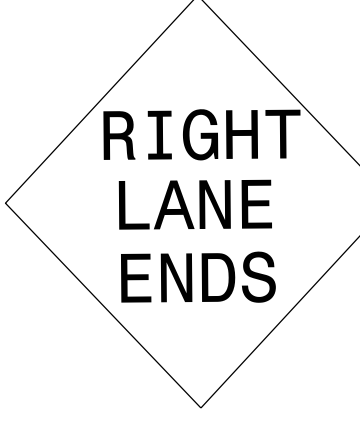

36 X 36  
W9-2(R)

TWO "U" POSTS PER SIGN

445 QUANTITY REQ'D 1

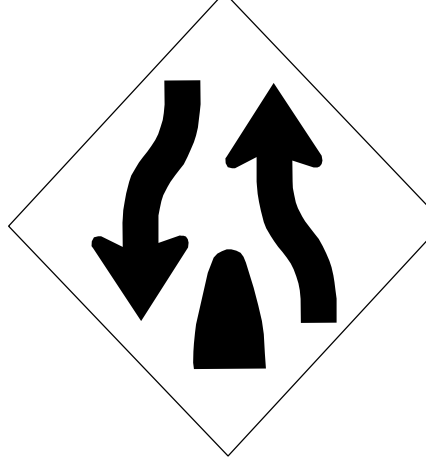

36 X 36  
W6-2

ONE "U" POST PER SIGN

446 QUANTITY REQ'D 7

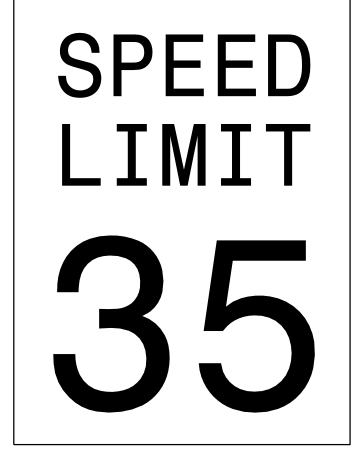

24 X 30  
R2-1

ONE "U" POST PER SIGN

447 QUANTITY REQ'D 1

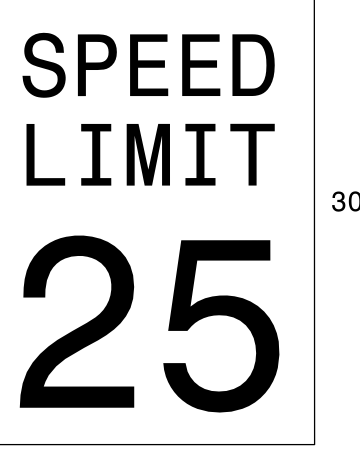

30 X 36  
R2-1

ONE "U" POST PER SIGN

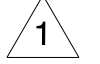
448 QUANTITY REQ'D 4 

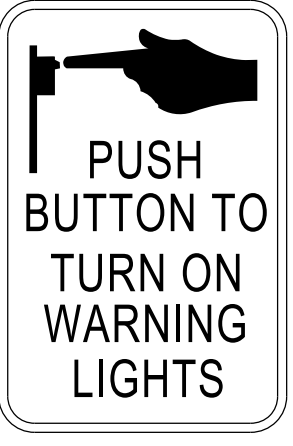



9 X 12  
R10-25

MOUNT ABOVE PUSHBUTTON  
ON TYPE II PEDESTAL

449 QUANTITY REQ'D 

LEFT BLANK  
INTENTIONALLY

450 QUANTITY REQ'D 3 



24 X 12  
W16-9p

YELLOW/GREEN REFLECTIVE SHEETING  
MOUNT BELOW SIGNS 421  
AND 457 IN 3 INSTALLATIONS 

451 QUANTITY REQ'D 3

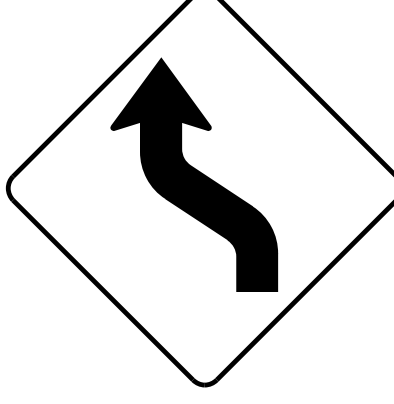

30 X 30  
W1-4L

ONE "U" POST PER SIGN

452 QUANTITY REQ'D 1

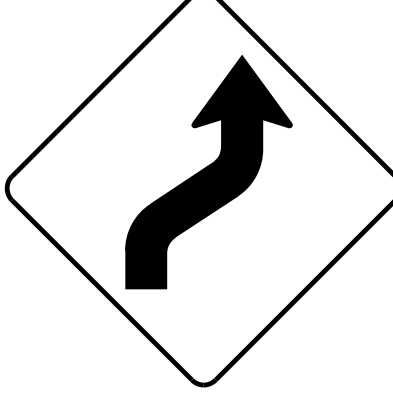

30 X 30  
W1-4R

ONE "U" POST PER SIGN

453 QUANTITY REQ'D 7



36 X 12  
R6-1 (R)

MOUNT ABOVE SIGN 418  
IN 7 INSTALLATIONS

454 QUANTITY REQ'D 7



36 X 12  
R6-1 (L)

MOUNT BACK-TO-BACK WITH  
SIGN 453 IN 7 INSTALLATIONS

455 QUANTITY REQ'D 2

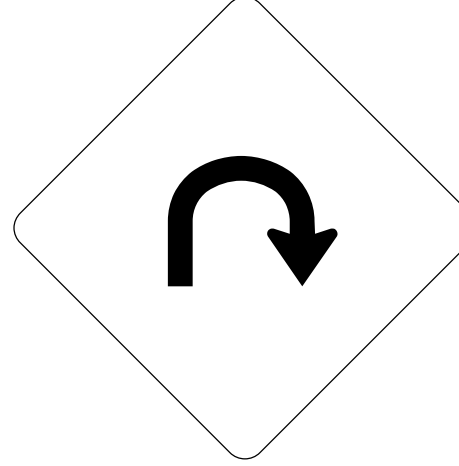

36 X 36  
W1-11

TWO "U" POSTS PER SIGN

456 QUANTITY REQ'D 2



24 X 24  
W13-1P

MOUNT BELOW SIGN 455  
IN 2 INSTALLATIONS

457 QUANTITY REQ'D 1 



30 X 30  
W11-15

YELLOW/GREEN REFLECTIVE SHEETING  
ONE "U" POST PER SIGN

458 QUANTITY REQ'D

LEFT BLANK  
INTENTIONALLY

459 QUANTITY REQ'D 1

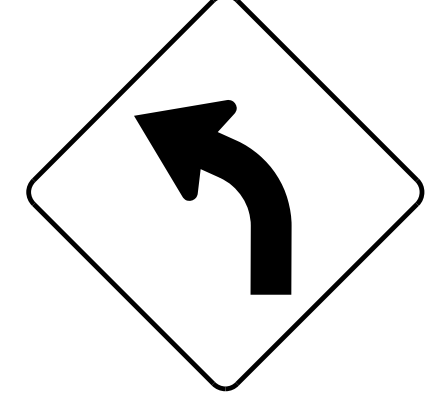

30 X 30  
W1-2L

ONE "U" POST PER SIGN

460 QUANTITY REQ'D 1

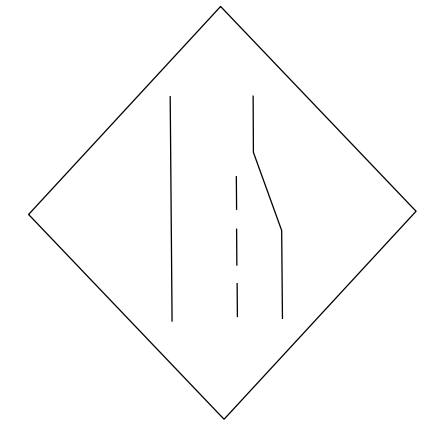

30 X 30  
W4-2(R)

TWO "U" POSTS PER SIGN

461 QUANTITY REQ'D 2



30 X 30  
R3-7

TWO "U" POSTS PER SIGN

02-MAY-2022 16:54  
C:\Users\jrb\OneDrive\Documents\Traffic\Signing\Plans\2233BB-SIGN-4I.dgn  
obshears AT R00KBAV4



2610 WYCLIFF ROAD  
RALEIGH, NC 27607  
SUITE 410  
PHONE: 919.881.9939  
NC COA No. F-0929

TYPE E SIGNS