

01-MAR-2018 07:39
 S:\Contracts\Projects\Special Details\stand\840d17 Extra Depth 2GI.dgn
 J:\over ton AT_CSD-292595

STATE OF NORTH CAROLINA
DEPT. OF TRANSPORTATION
DIVISION OF HIGHWAYS
RALEIGH, N.C.

ENGLISH DETAIL DRAWING FOR
CONCRETE MEDIAN DROP INLET TYPE 'A'
EXTRA DEPTH OVER 12' TO 25'
12" THRU 72" PIPE

SHEET 1 OF 2
840D17

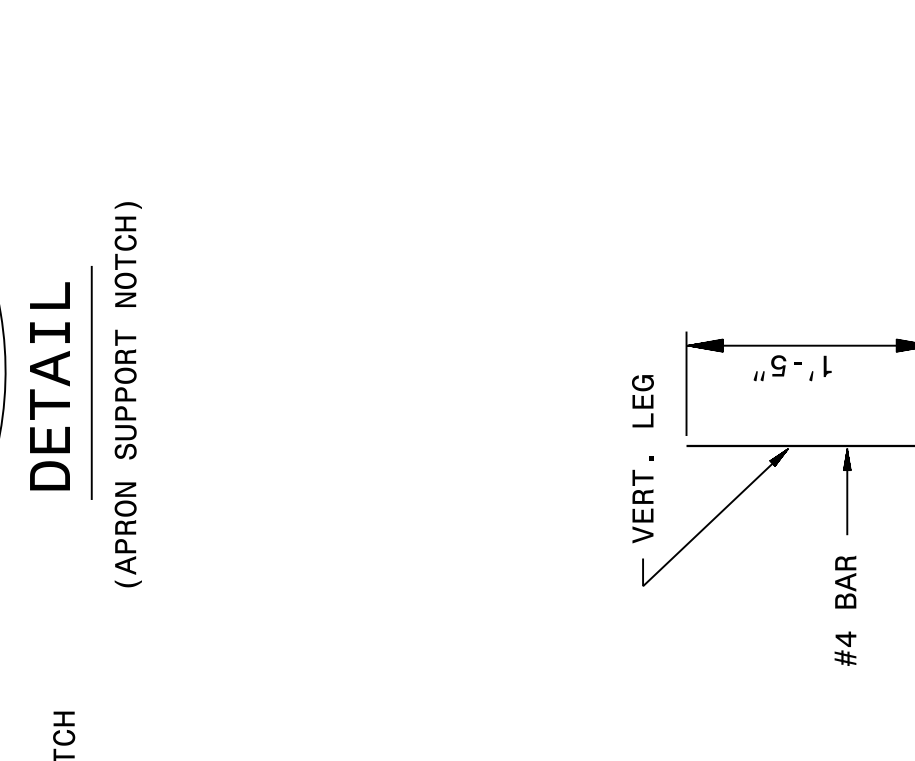
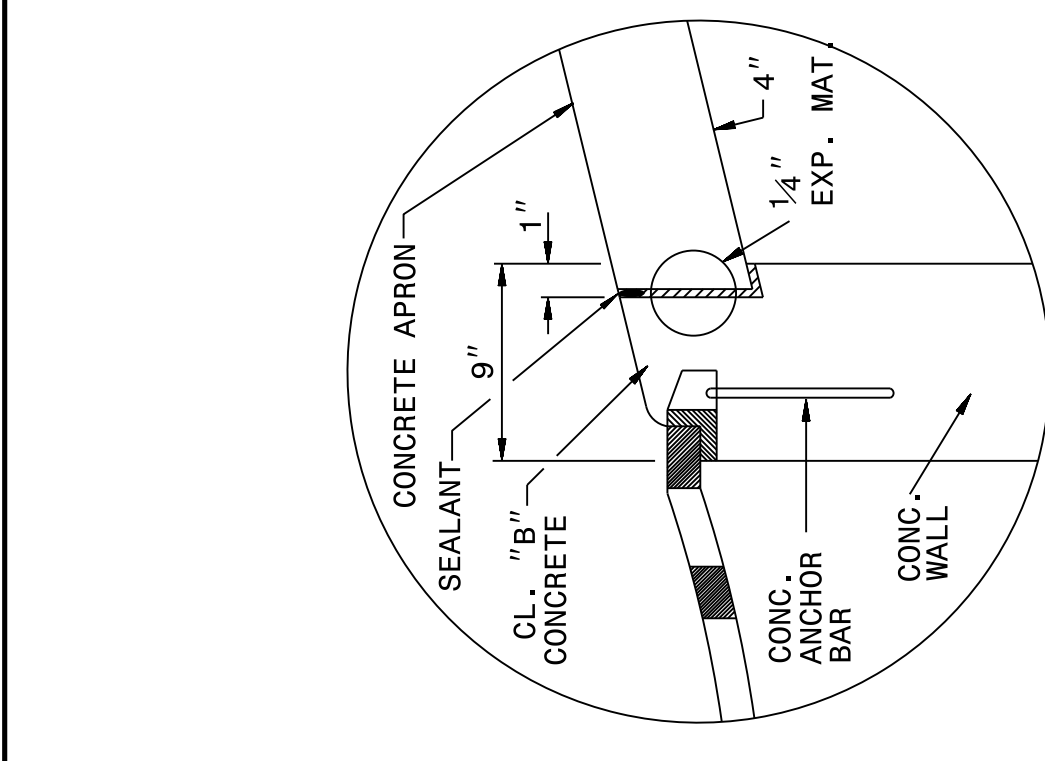
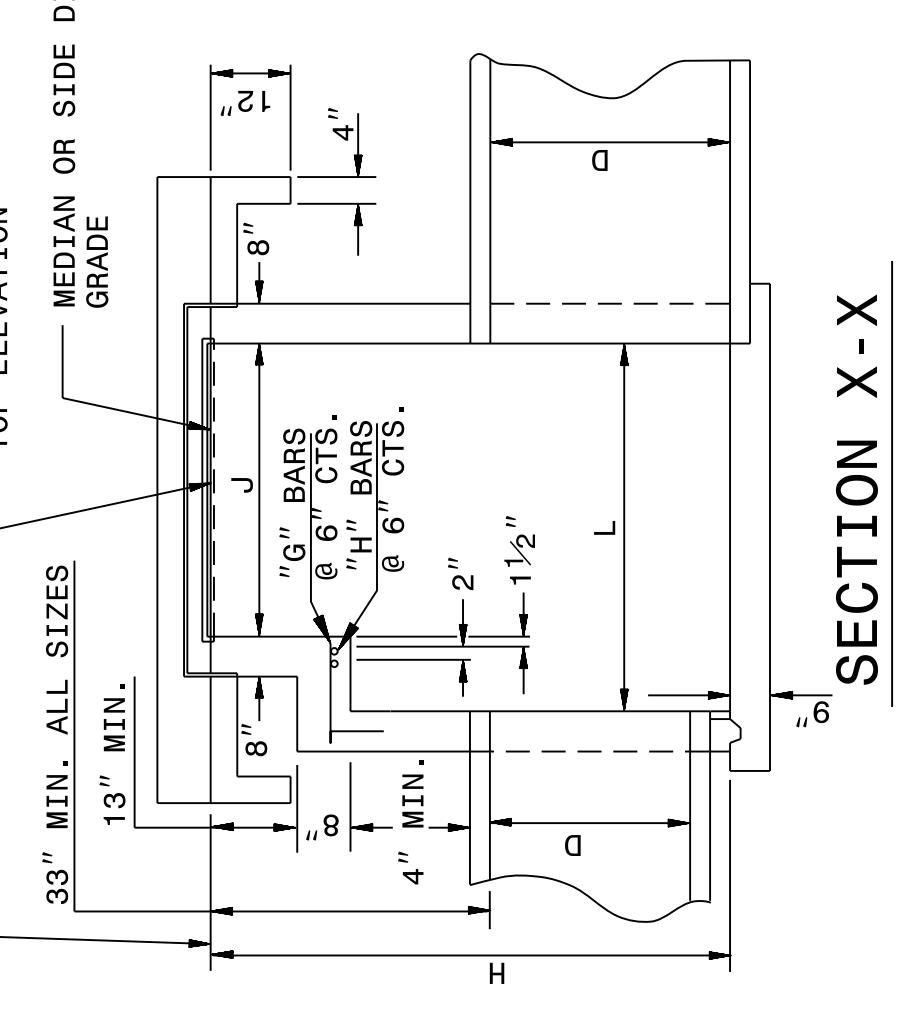
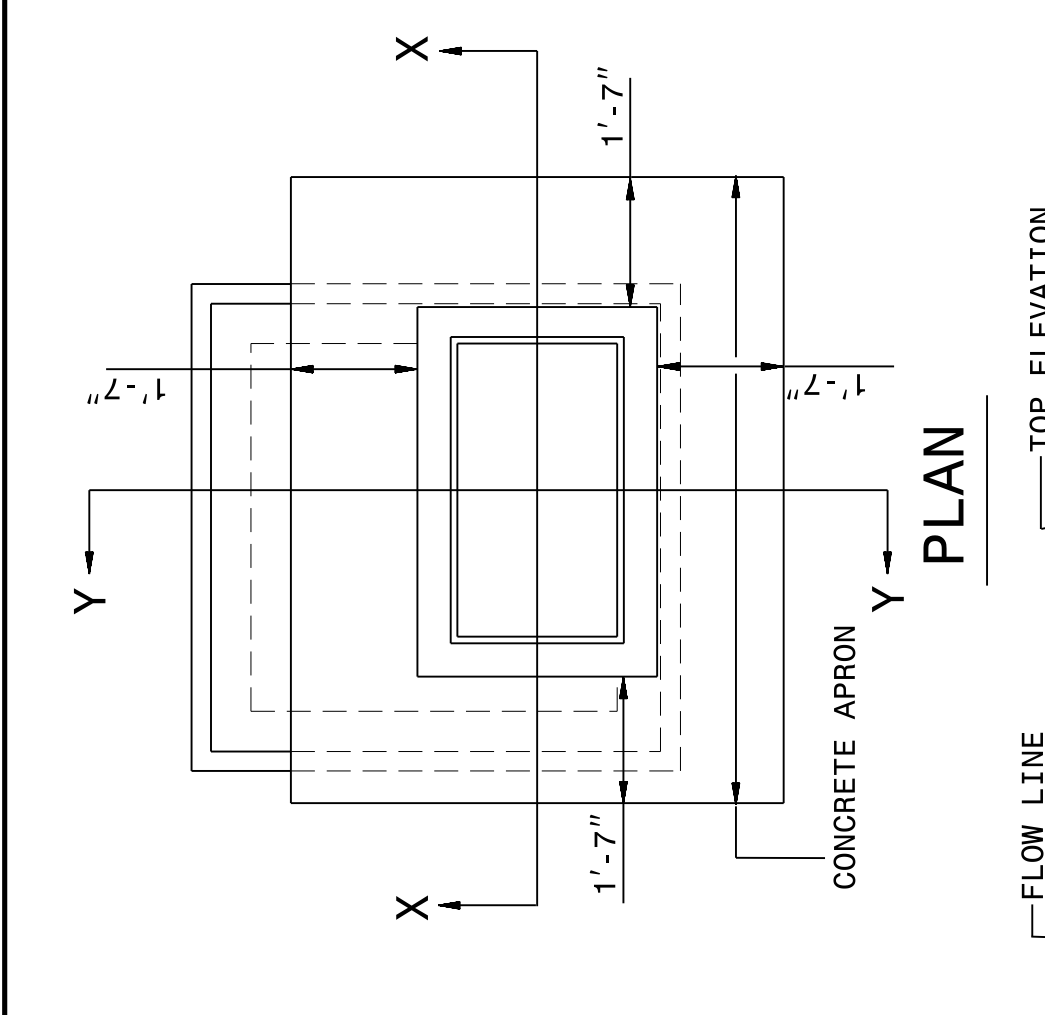

GENERAL NOTES:
 USE CLASS "B" CONCRETE THROUGHOUT.
 PROVIDE DROP INLETS WITH STEPS 12" ON CENTER. USE STEPS WHICH COMPLY WITH STD. DRAWING 840.66.
 OPTIONAL CONSTRUCTION - MONOLITHIC POUR, 2" KEYWAY, OR #4 BAR DOWELS AT 12" CENTERS AS DIRECTED BY THE ENGINEER.
 USE FORMS FOR THE CONSTRUCTION OF THE BOTTOM SLAB.
 IF REINFORCED CONCRETE PIPE IS SET IN BOTTOM SLAB OF BOX, ADD TO SLAB AS SHOWN ON STD. NO. 840.00.
 WHEN PAYMENT FOR THE DROP INLET IS MADE ON A PER EACH BASIS, THE CONCRETE APRON WILL BE CONSIDERED PART OF THE DROP INLET.
 CONSTRUCT WITH PIPE CROWNS MATCHING.
 USE STANDARD FRAMES AND GRATES 840.22 (SHOWN), 840.24 (SHOWN), 840.20, 840.29, AND 840.33.
 SEE STANDARD DRAWING 840.25 FOR ATTACHMENT OF FRAMES AND GRATES NOT SHOWN.
 CHAMFER ALL EXPOSED CORNERS 1".
 DRAWING NOT TO SCALE.
 MAX. DEPTH OF THIS STRUCTURE FROM TOP OF BOTTOM SLAB TO TOP ELEVATION IS 25 FEET.

ENGLISH DETAIL DRAWING FOR
CONCRETE MEDIAN DROP INLET TYPE 'A'
EXTRA DEPTH OVER 12' TO 25'
12" THRU 72" PIPE

SHEET 1 OF 2
840D17

STATE OF NORTH CAROLINA
DEPT. OF TRANSPORTATION
DIVISION OF HIGHWAYS
RALEIGH, N.C.

ENGLISH DETAIL DRAWING FOR
CONCRETE MEDIAN DROP INLET TYPE 'A'
EXTRA DEPTH OVER 12' TO 25'
12" THRU 72" PIPE

SHEET 1 OF 2
840D17

STATE OF NORTH CAROLINA
DEPT. OF TRANSPORTATION
DIVISION OF HIGHWAYS
RALEIGH, N.C.

ENGLISH DETAIL DRAWING FOR
CONCRETE MEDIAN DROP INLET TYPE 'A'
EXTRA DEPTH OVER 12' TO 25'
12" THRU 72" PIPE

SHEET 2 OF 2
840D17

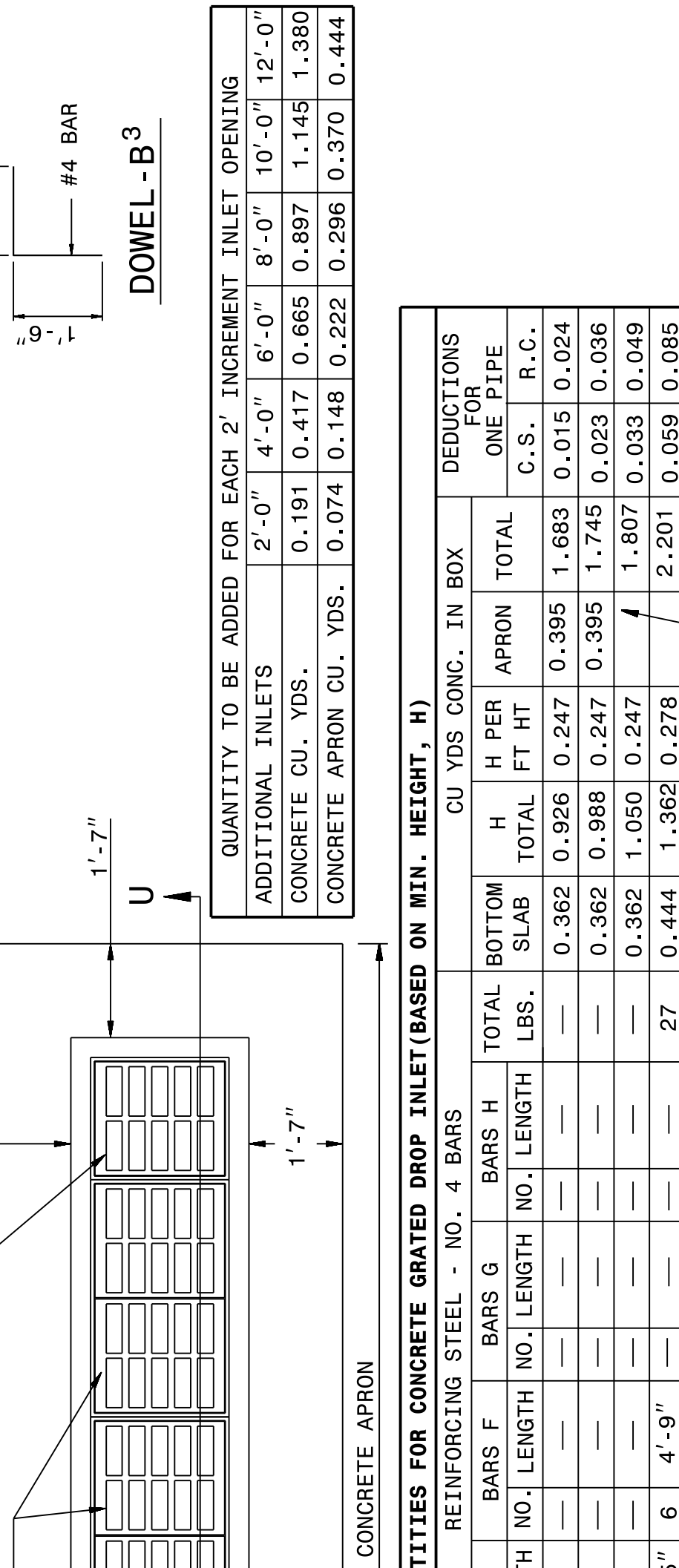
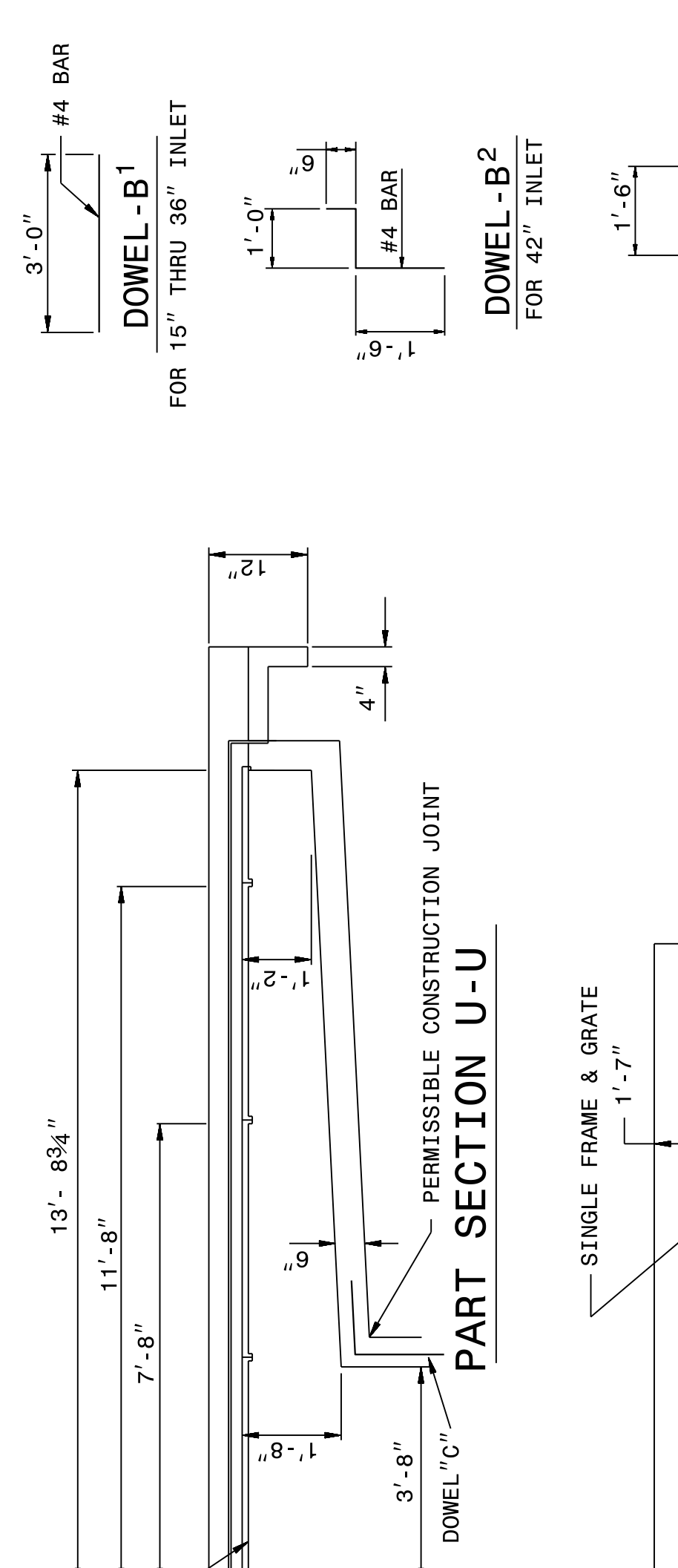
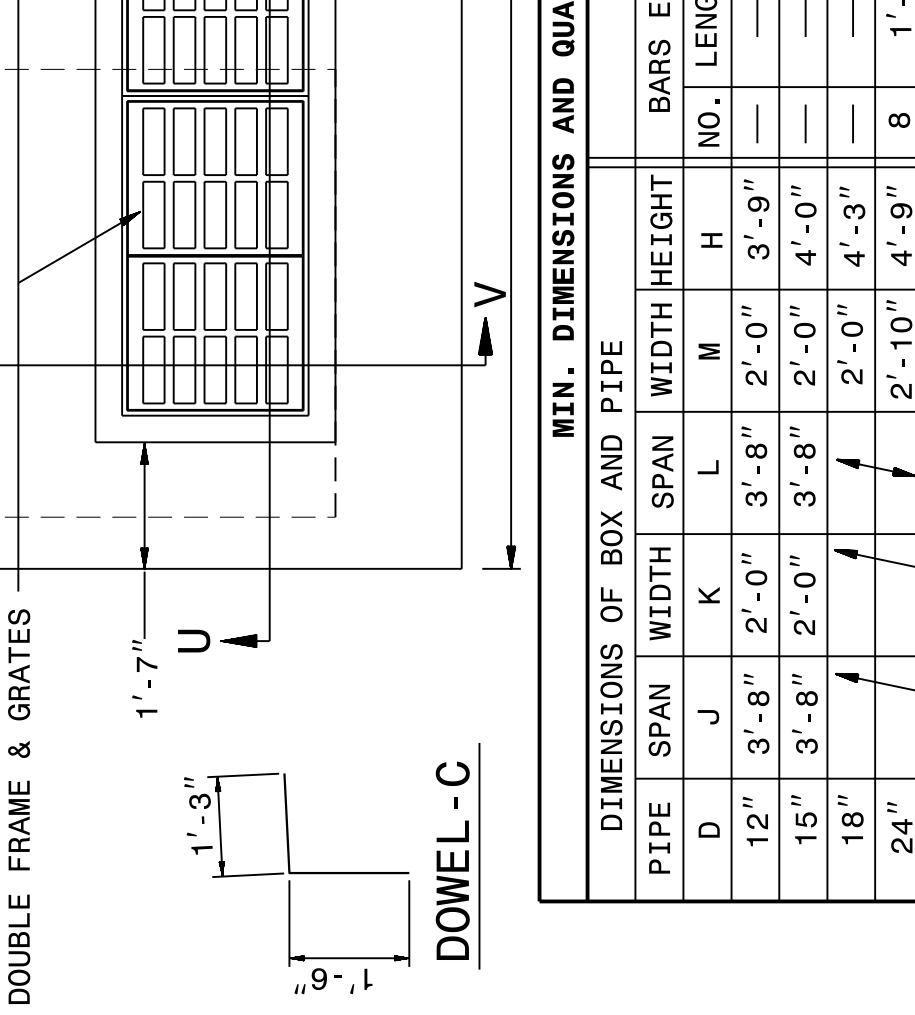
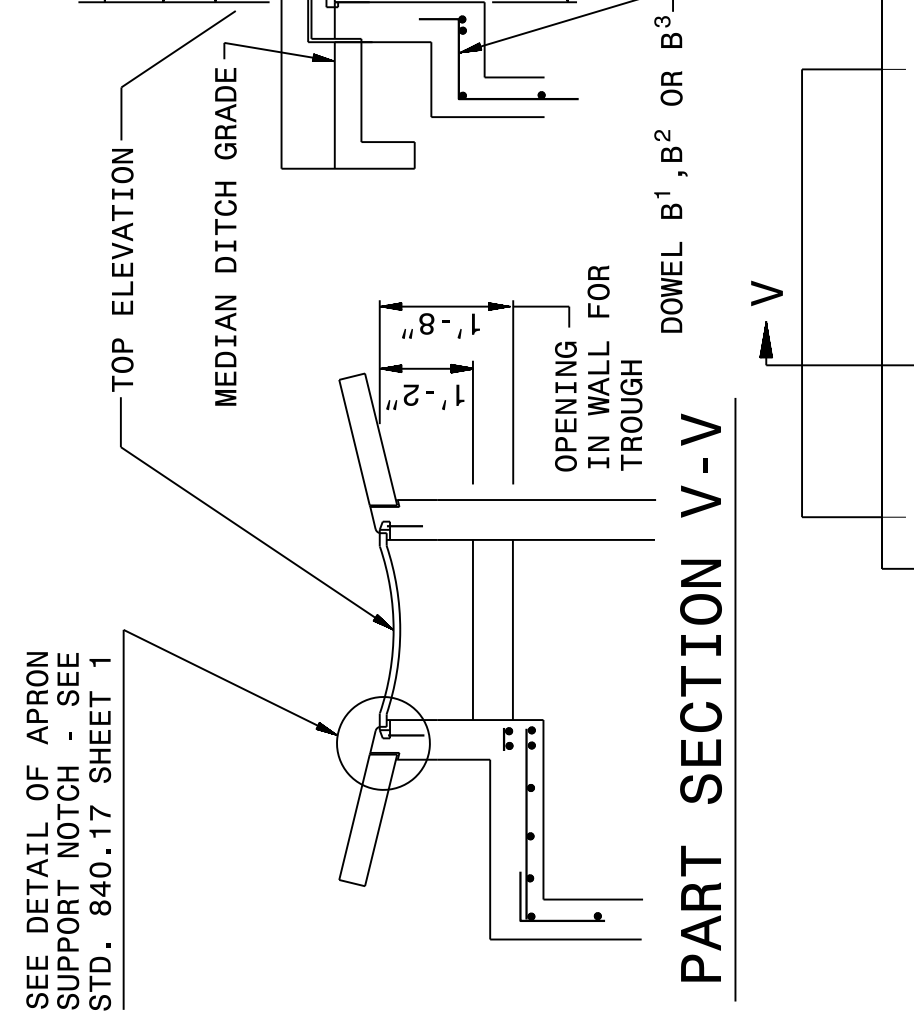

STATE OF NORTH CAROLINA
DEPT. OF TRANSPORTATION
DIVISION OF HIGHWAYS
RALEIGH, N.C.

ENGLISH DETAIL DRAWING FOR
CONCRETE MEDIAN DROP INLET TYPE 'A'
EXTRA DEPTH OVER 12' TO 25'
12" THRU 72" PIPE

SHEET 2 OF 2
840D17

QUANTITY TO BE ADDED FOR EACH 2' INCREMENT INLET OPENING

ADDITIONAL INLETS	2'-0"	4'-0"	6'-0"	8'-0"	10'-0"	12'-0"
CONCRETE CU. YDS.	0.191	0.417	0.665	0.897	1.145	1.380
CONCRETE APRON CU. YDS.	0.074	0.148	0.222	0.296	0.370	0.444

PIPE	DIMENSIONS OF BOX AND PIPE			REINFORCING STEEL - NO. 4 BARS				MIN. DIMENSIONS AND QUANTITIES FOR CONCRETE GRATED DROP INLET (BASED ON MIN. HEIGHT, H)			DEDUCTIONS FOR ONE PIPE			
	SPAN	WIDTH	DEPTH	NO.	LENGTH	NO.	LENGTH	NO.	LENGTH	H	H PER FT	APRON	TOTAL	
12"	3'-8"	2'-0"	3'-8"	8	1'-5"	6	4'-9"	27	0.444	1.362	0.278	2.201	0.059	0.085
15"	3'-8"	2'-0"	4'-0"	8	1'-5"	6	4'-9"	27	0.444	1.362	0.278	2.201	0.059	0.085
18"	3'-8"	2'-0"	4'-3"	8	1'-5"	6	4'-9"	27	0.444	1.362	0.278	2.201	0.059	0.085
24"	3'-8"	2'-0"	5'-3"	8	1'-5"	6	4'-9"	27	0.444	1.362	0.278	2.201	0.059	0.085
30"	4'-0"	2'-0"	6'-3"	8	1'-5"	6	4'-9"	27	0.444	1.362	0.278	2.201	0.059	0.085
36"	4'-0"	2'-0"	7'-3"	8	1'-5"	6	4'-9"	27	0.444	1.362	0.278	2.201	0.059	0.085
42"	4'-0"	2'-0"	8'-3"	8	1'-5"	6	4'-9"	27	0.444	1.362	0.278	2.201	0.059	0.085
48"	4'-0"	2'-0"	9'-3"	8	1'-5"	6	4'-9"	27	0.444	1.362	0.278	2.201	0.059	0.085
54"	4'-0"	2'-0"	10'-3"	8	1'-5"	6	4'-9"	27	0.444	1.362	0.278	2.201	0.059	0.085
60"	4'-0"	2'-0"	11'-3"	8	1'-5"	6	4'-9"	27	0.444	1.362	0.278	2.201	0.059	0.085
66"	4'-0"	2'-0"	12'-3"	8	1'-5"	6	4'-9"	27	0.444	1.362	0.278	2.201	0.059	0.085
72"	4'-0"	2'-0"	13'-3"	8	1'-5"	6	4'-9"	27	0.444	1.362	0.278	2.201	0.059	0.085

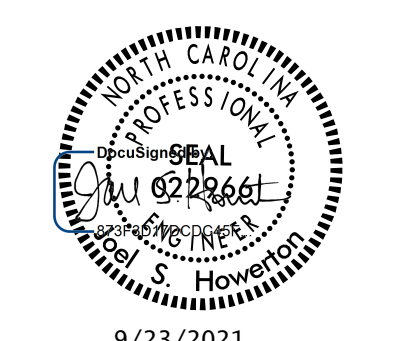

9/23/2021

DOCUMENT NOT CONSIDERED FINAL
UNLESS ALL SIGNATURES COMPLETED

CONTRACT STANDARDS AND DEVELOPMENT UNIT
Office 919-707-6950 FAX 919-250-4119

SEE PLATE FOR TITLE

ORIGINAL BY: 2002 STD.840.1 DATE: _____
 MODIFIED BY: K.A. KEMPF DATE: 07-06-09
 CHECKED BY: _____ DATE: _____
 FILE SPEC.: /stand/840d17 Extra Depth 2GI.dgn