

150 140 130 120 110 100 90 80 70 60 50 40 30 20 10 0 10 20 30 40 50 60 70 80 90 100 110 120 130 140 150

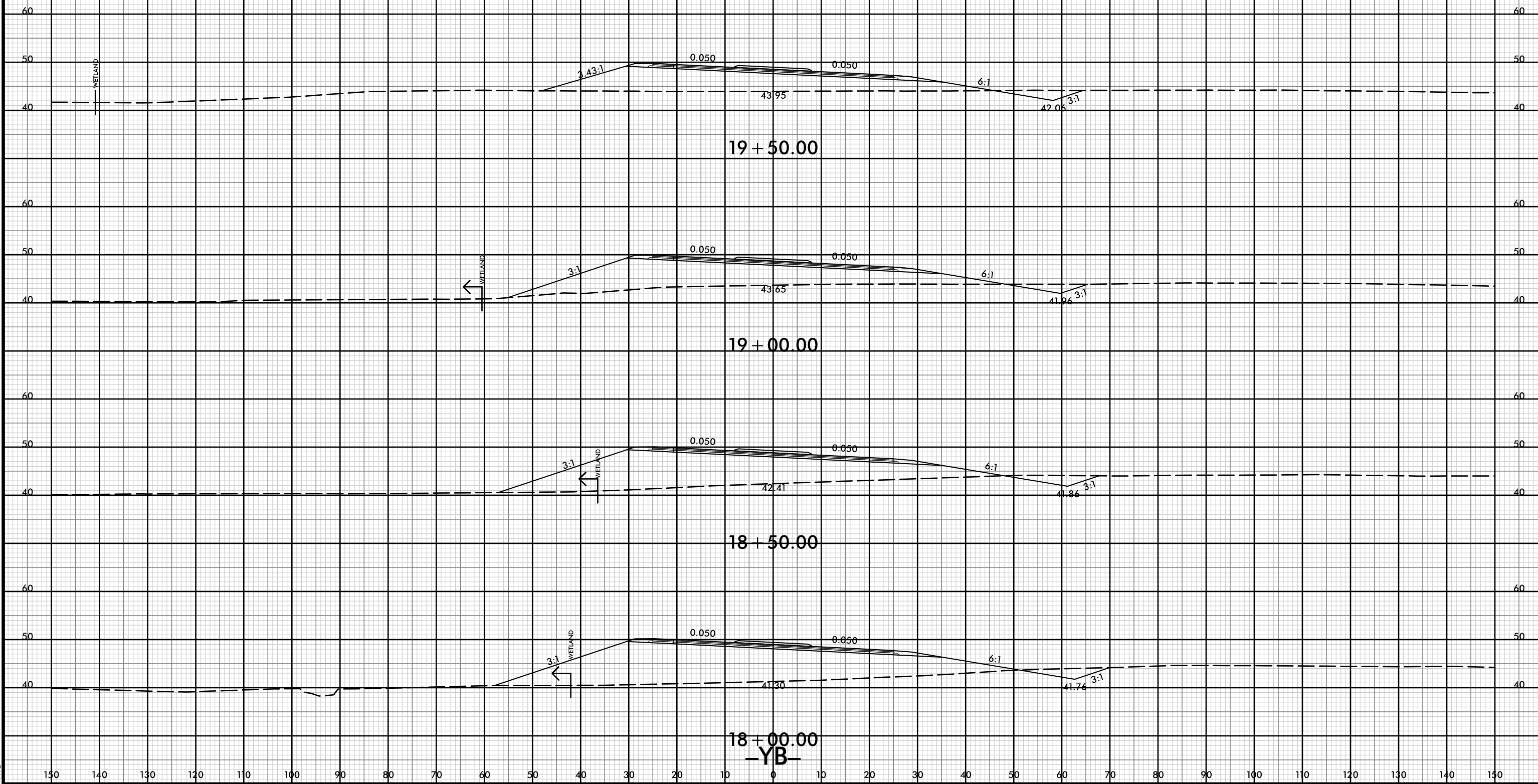

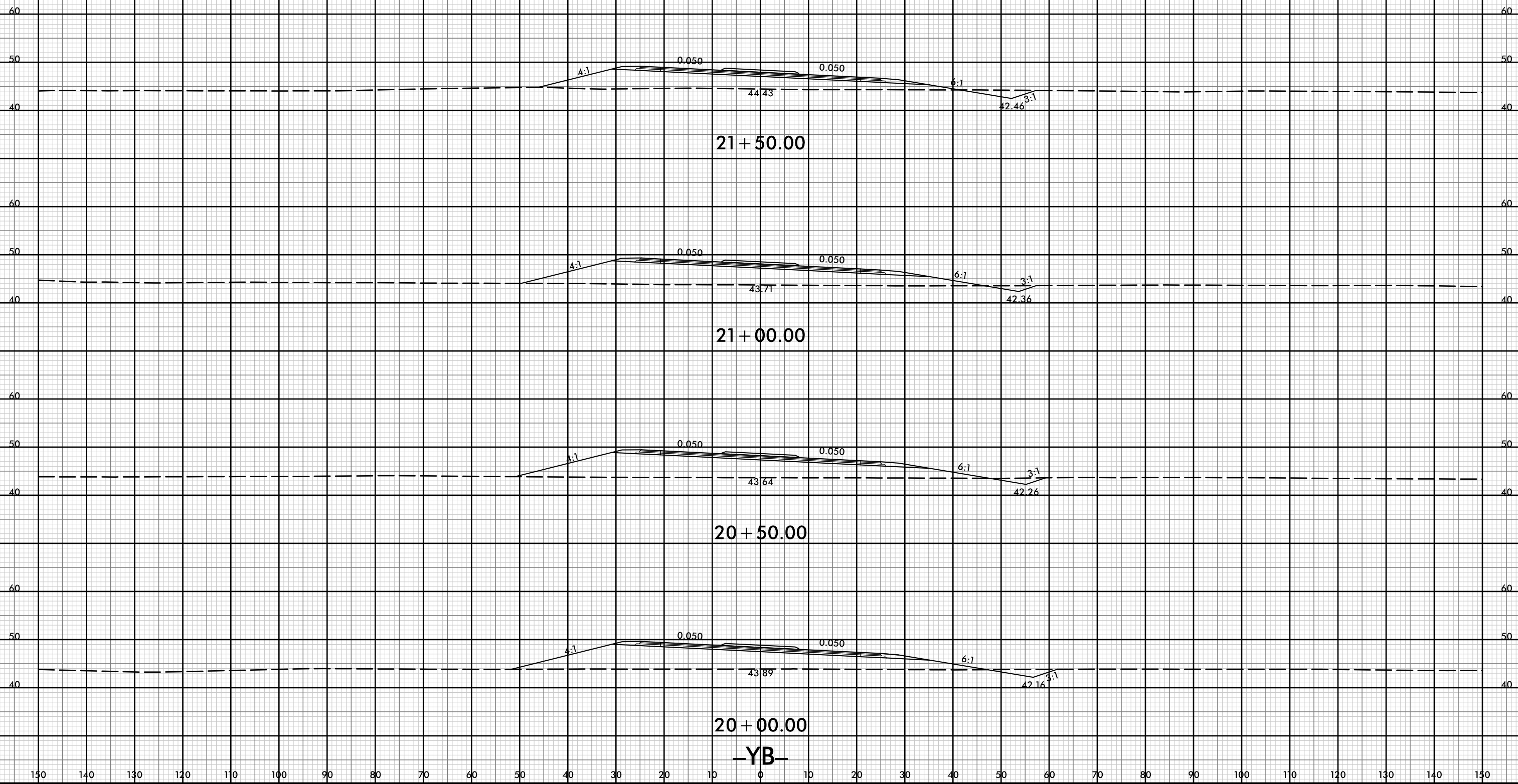

150 140 130 120 110 100 90 80 70 60 50 40 30 20 10 0 10 20 30 40 50 60 70 80 90 100 110 120 130 140 150



150 140 130 120 110 100 90 80 70 60 50 40 30 20 10 0 10 20 30 40 50 60 70 80 90 100 110 120 130 140 150

-YB-



150 140 130 120 110 100 90 80 70 60 50 40 30 20 10 0 10 20 30 40 50 60 70 80 90 100 110 120 130 140 150

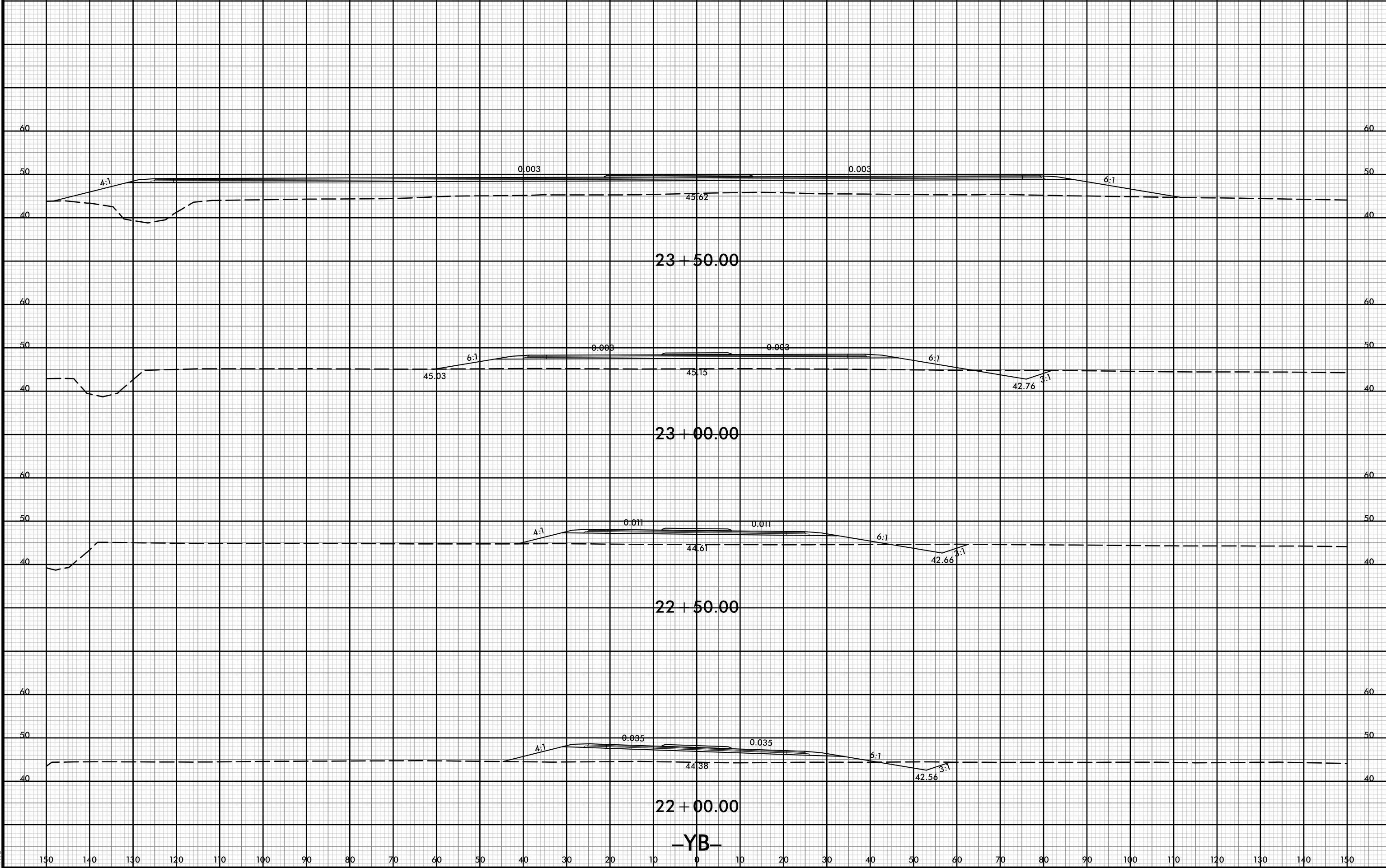

23 + 50.00

23 + 00.00

22 + 50.00

22 + 00.00

-YB-



150 140 130 120 110 100 90 80 70 60 50 40 30 20 10 0 10 20 30 40 50 60 70 80 90 100 110 120 130 140 150

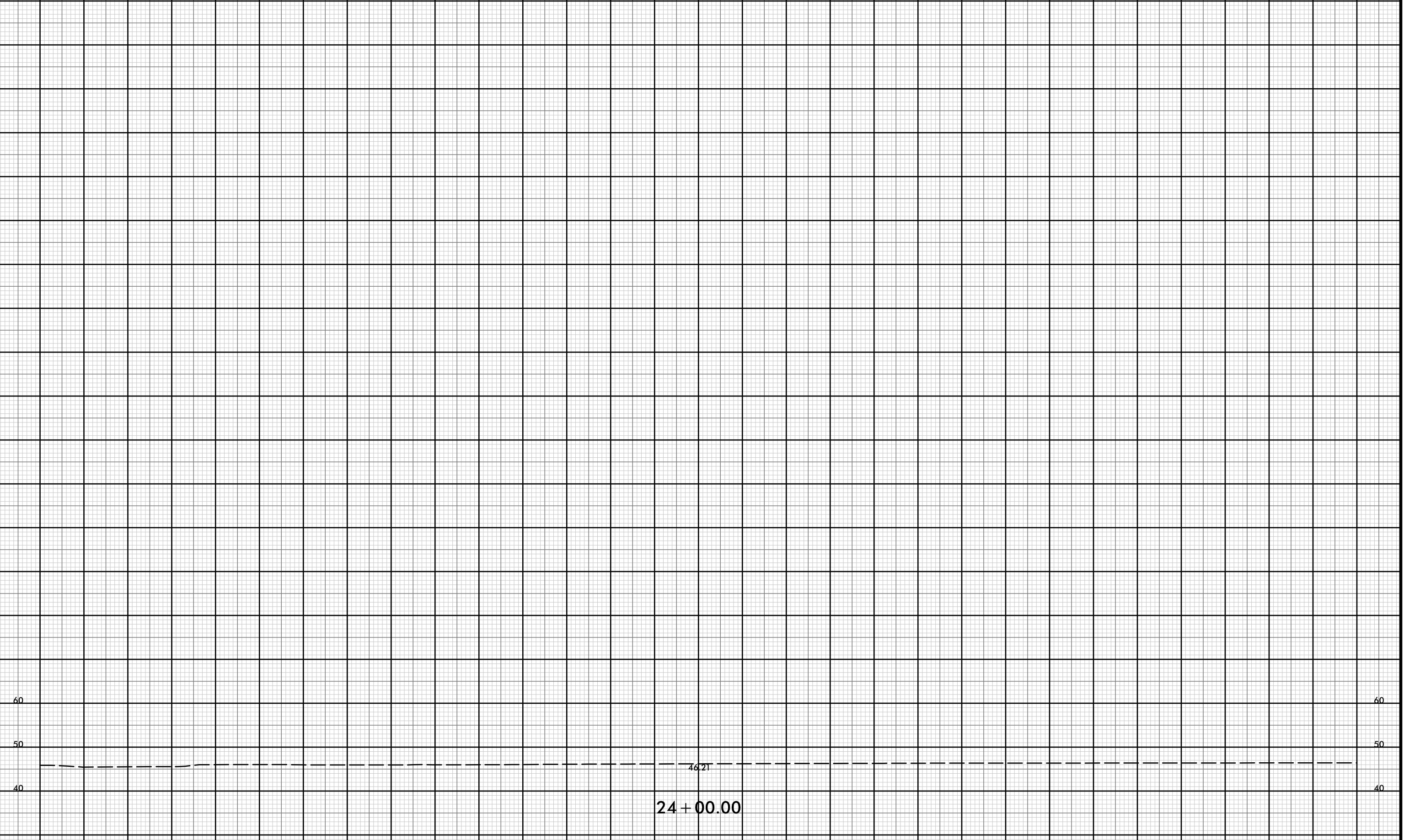

60 60

50 50

40 40

24 + 00.00

-YB-

150 140 130 120 110 100 90 80 70 60 50 40 30 20 10 0 10 20 30 40 50 60 70 80 90 100 110 120 130 140 150

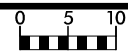

150 140 130 120 110 100 90 80 70 60 50 40 30 20 10 0 10 20 30 40 50 60 70 80 90 100 110 120 130 140 150

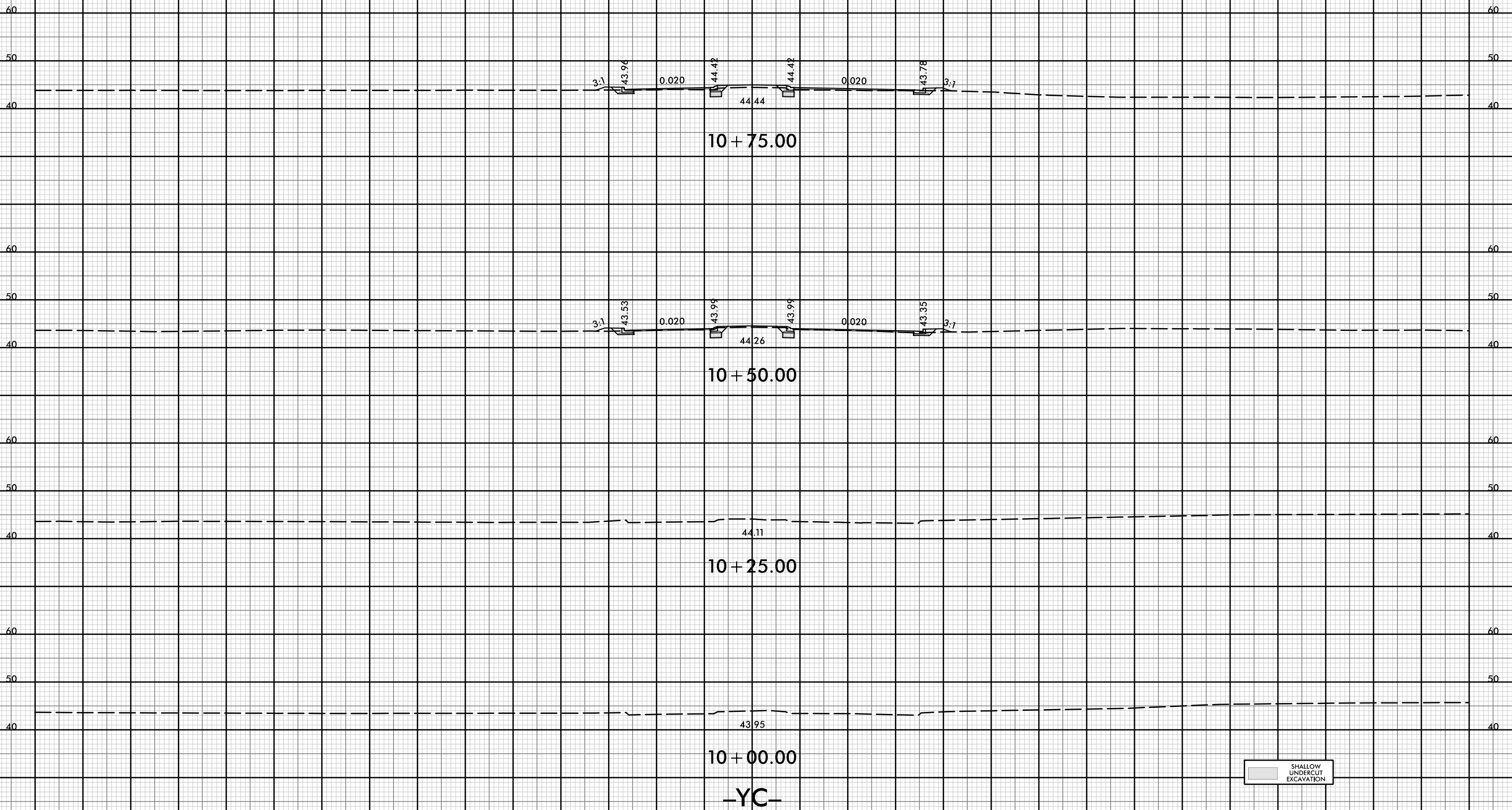

10 + 75.00

10 + 50.00

10 + 25.00

10 + 00.00

-YC-

SHALLOW UNDERCUT EXCAVATION



150 140 130 120 110 100 90 80 70 60 50 40 30 20 10 0 10 20 30 40 50 60 70 80 90 100 110 120 130 140 150

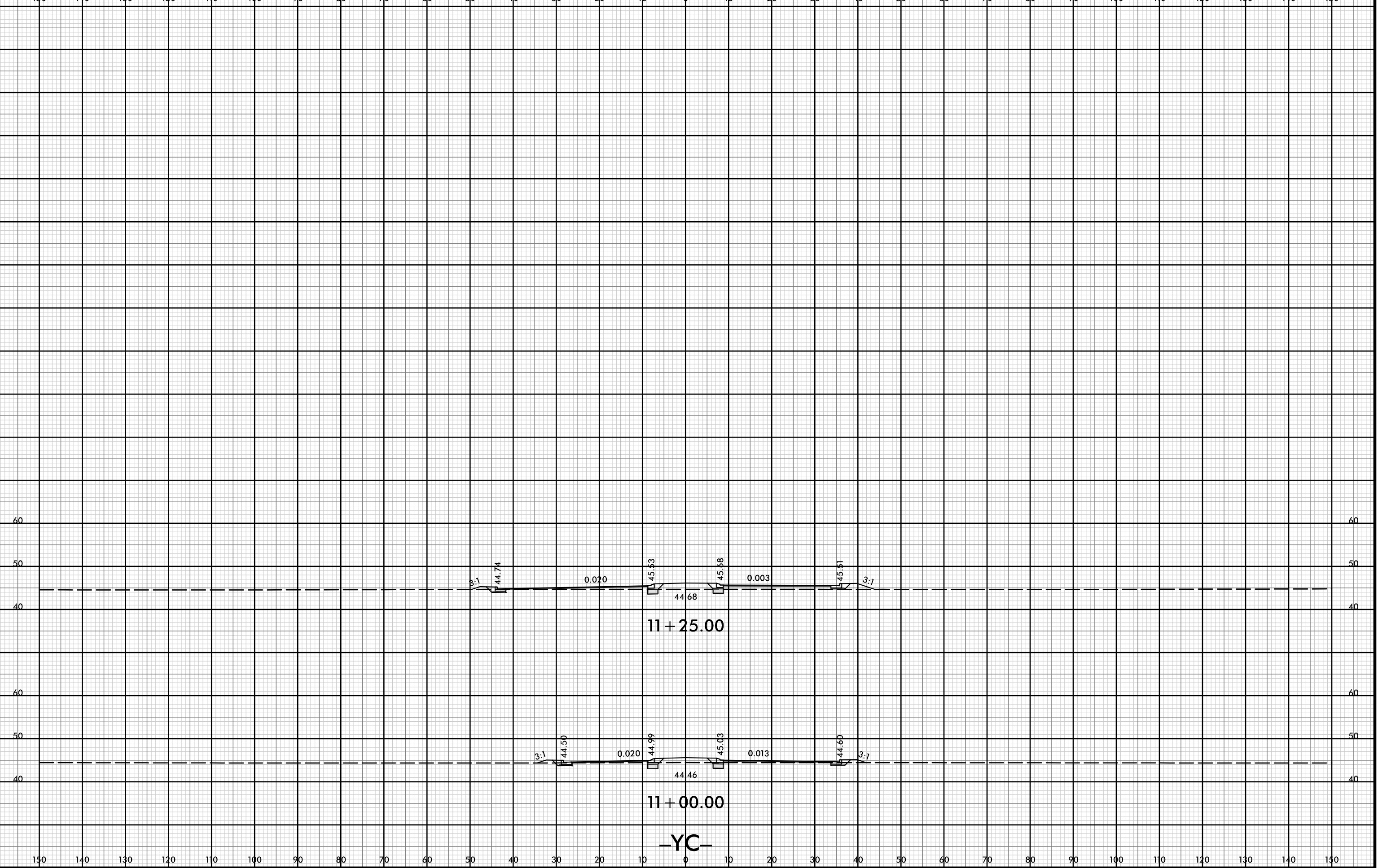

150 140 130 120 110 100 90 80 70 60 50 40 30 20 10 0 10 20 30 40 50 60 70 80 90 100 110 120 130 140 150



150 140 130 120 110 100 90 80 70 60 50 40 30 20 10 0 10 20 30 40 50 60 70 80 90 100 110 120 130 140 150

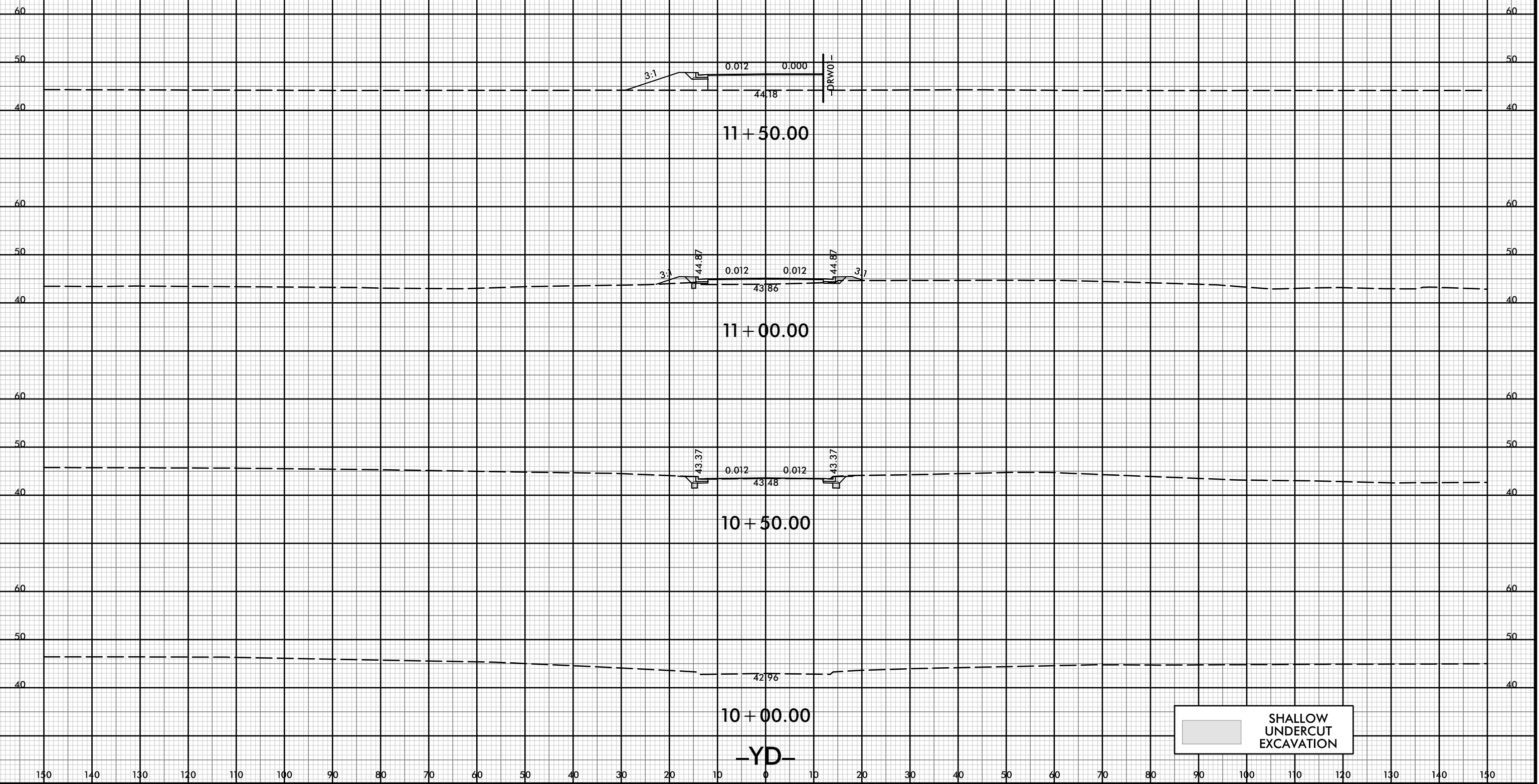

SHALLOW UNDERCUT EXCAVATION



150 140 130 120 110 100 90 80 70 60 50 40 30 20 10 0 10 20 30 40 50 60 70 80 90 100 110 120 130 140 150

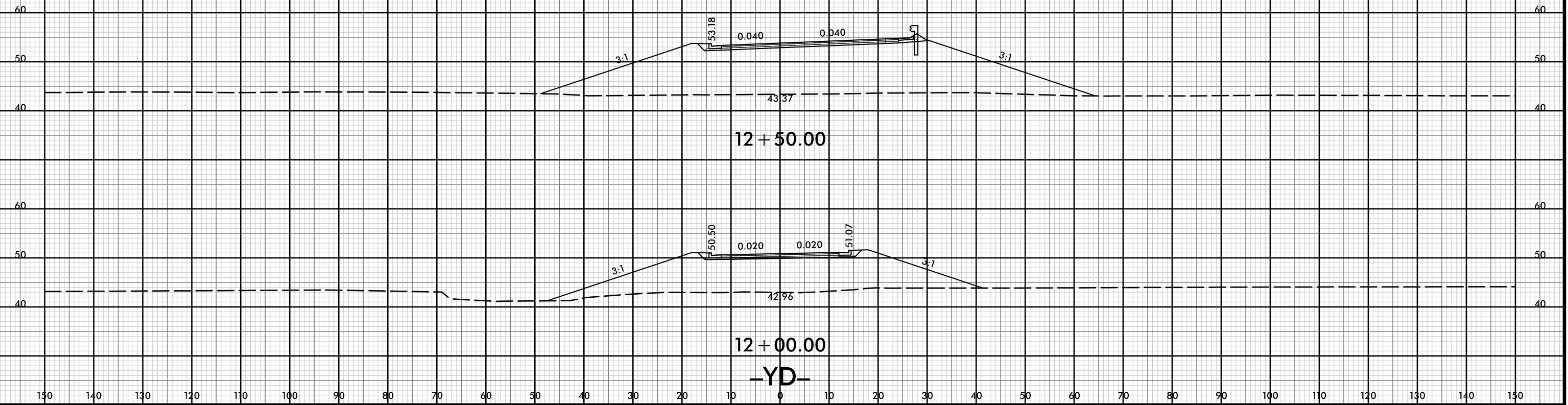

150 140 130 120 110 100 90 80 70 60 50 40 30 20 10 0 10 20 30 40 50 60 70 80 90 100 110 120 130 140 150



150 140 130 120 110 100 90 80 70 60 50 40 30 20 10 0 10 20 30 40 50 60 70 80 90 100 110 120 130 140 150

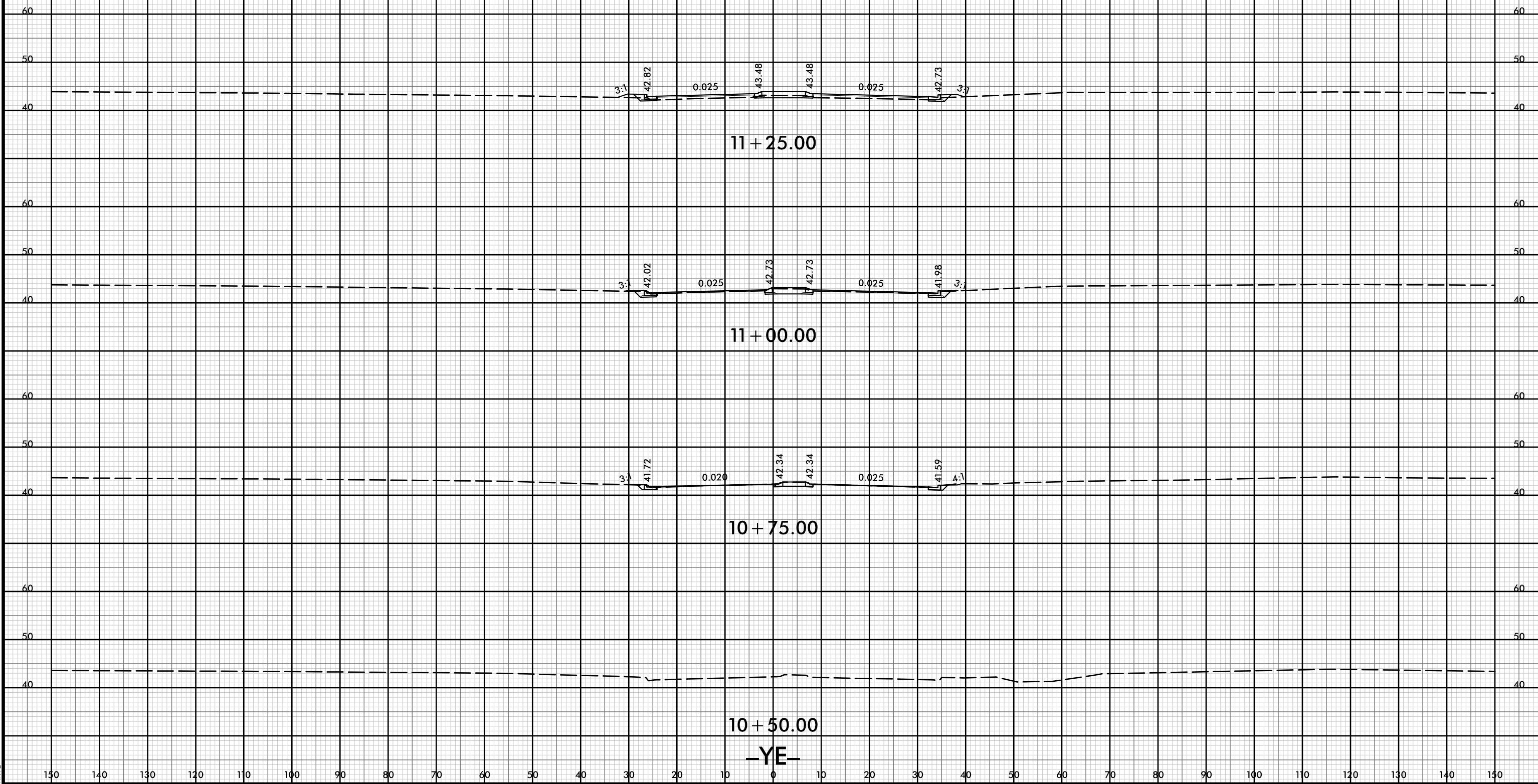

11+25.00

11+00.00

10+75.00

10+50.00

-YE-

8/23/99



PROJ. REFERENCE NO.
R-5021

SHEET NO.
X-247

150 140 130 120 110 100 90 80 70 60 50 40 30 20 10 0 10 20 30 40 50 60 70 80 90 100 110 120 130 140 150

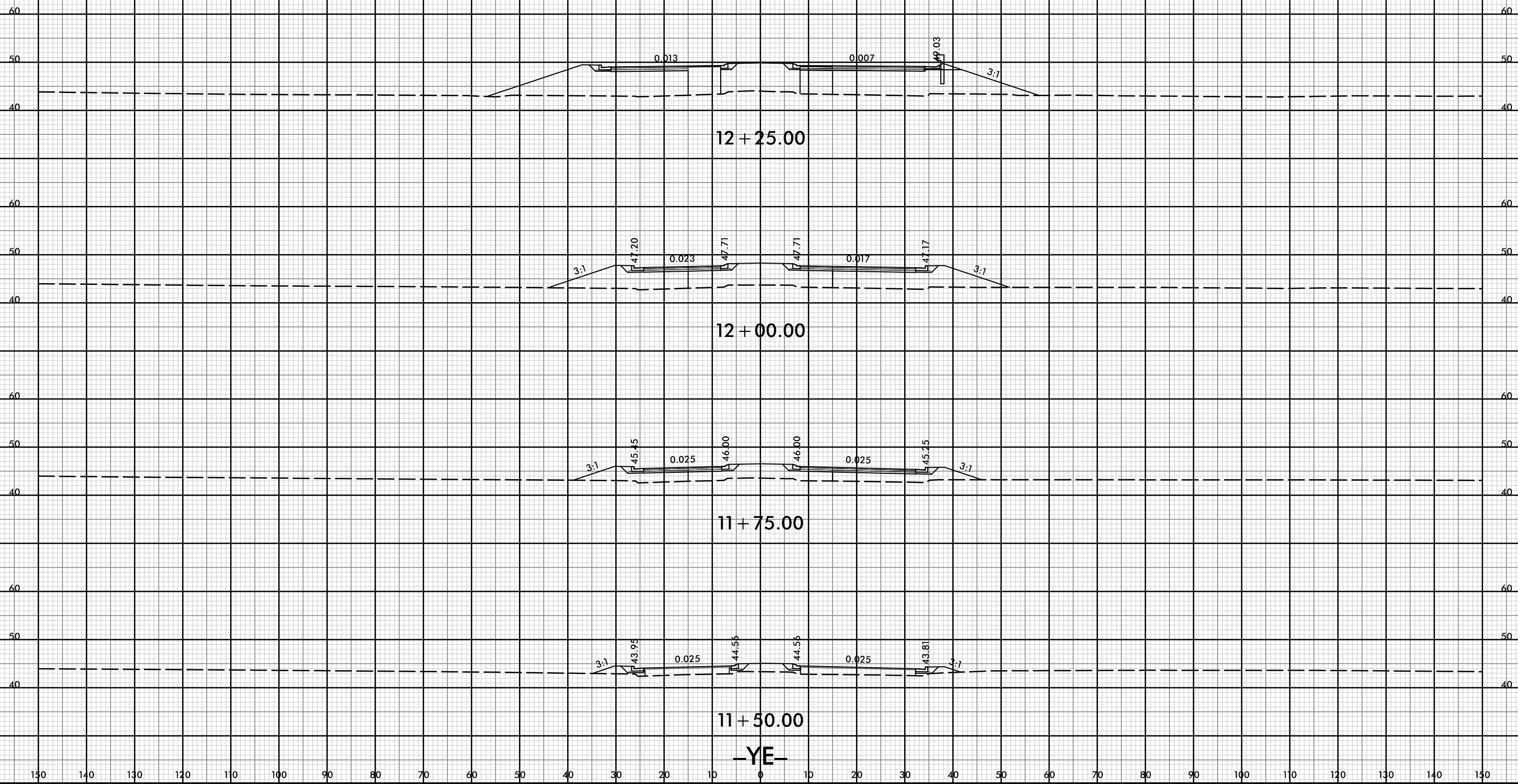

21-Jul-2021 10:37
 R:\p\dawej\XSC\1-5021-rdy-xp-1-YE.dgn
 HNTB

-YE-



150 140 130 120 110 100 90 80 70 60 50 40 30 20 10 0 10 20 30 40 50 60 70 80 90 100 110 120 130 140 150

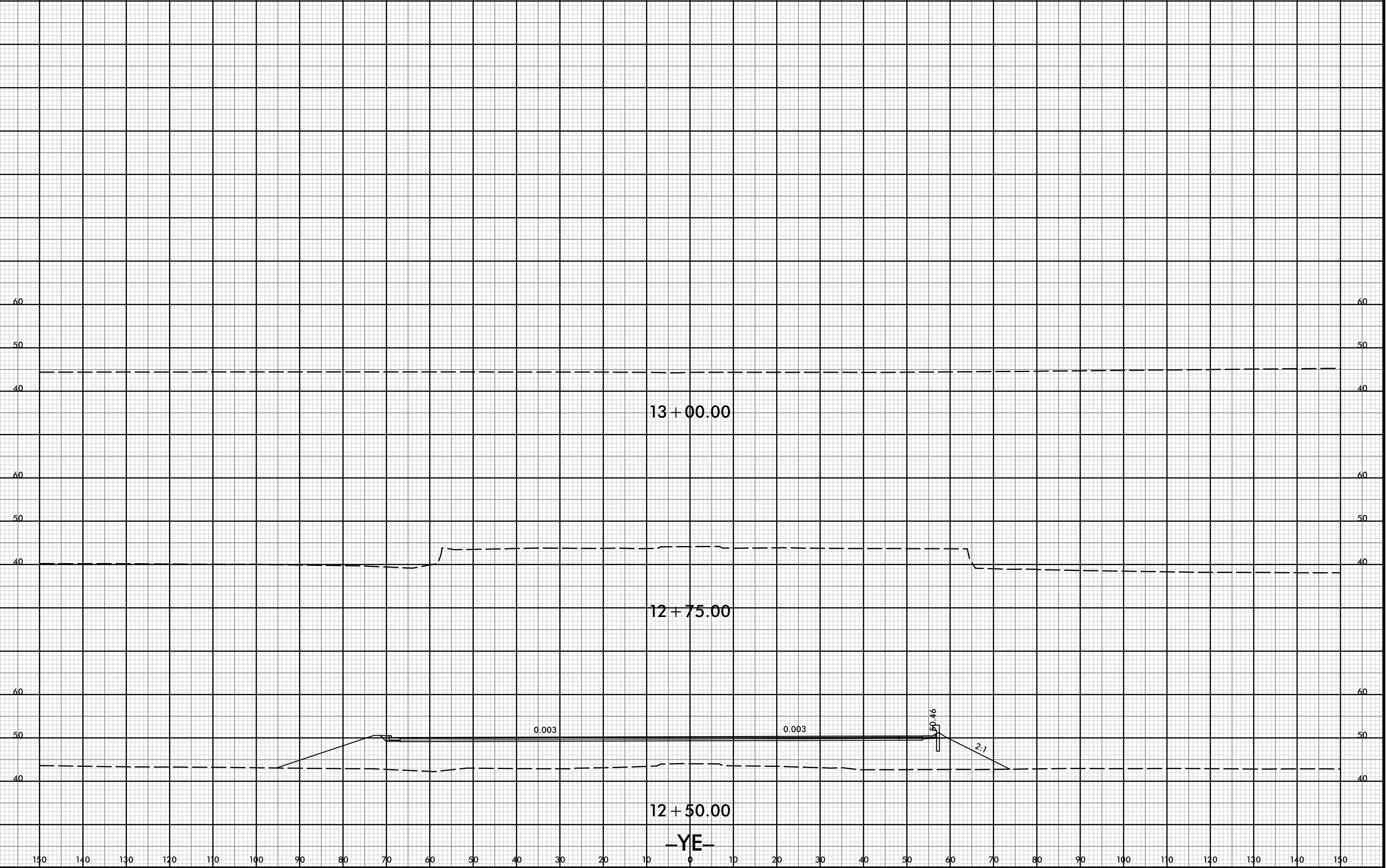

150 140 130 120 110 100 90 80 70 60 50 40 30 20 10 0 10 20 30 40 50 60 70 80 90 100 110 120 130 140 150

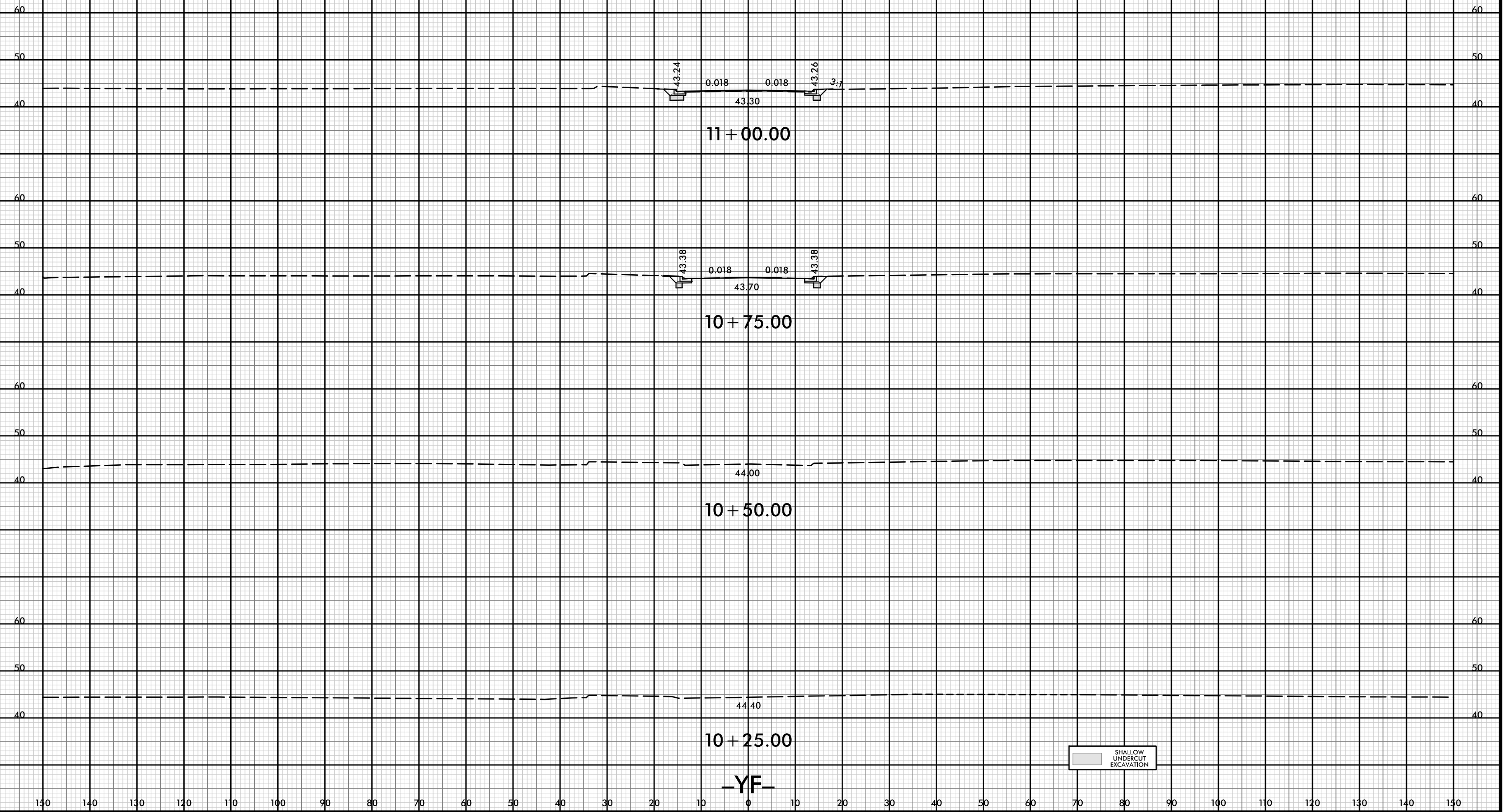

SHALLOW UNDERCUT EXCAVATION

-YF-

150 140 130 120 110 100 90 80 70 60 50 40 30 20 10 0 10 20 30 40 50 60 70 80 90 100 110 120 130 140 150

60 60

50 50

40 40

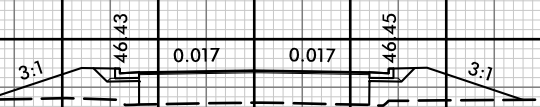

12 + 00.00

60 60

50 50

40 40

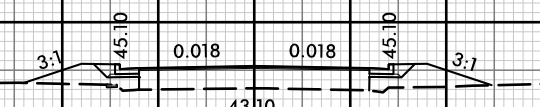

11 + 75.00

60 60

50 50

40 40

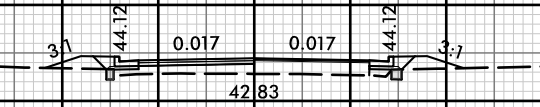

11 + 50.00

60 60

50 50

40 40

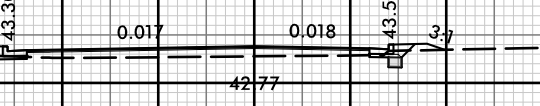

11 + 25.00

-YF-

SHALLOW UNDERCUT EXCAVATION

150 140 130 120 110 100 90 80 70 60 50 40 30 20 10 0 10 20 30 40 50 60 70 80 90 100 110 120 130 140 150

8/23/99



PROJ. REFERENCE NO.
R-5021

SHEET NO.
X-251

150 140 130 120 110 100 90 80 70 60 50 40 30 20 10 0 10 20 30 40 50 60 70 80 90 100 110 120 130 140 150

60 60

50 50

40 40

45.38
13 + 00.00

60 60

50 50

40 40

44.24
12 + 75.00

60 60

50 50

40 40

43.91
12 + 50.00

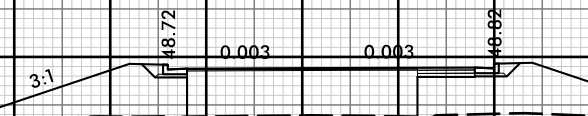

60 60

50 50

40 40

43.65
12 + 25.00

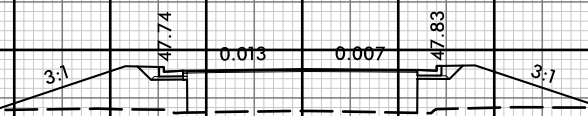

-YF-

150 140 130 120 110 100 90 80 70 60 50 40 30 20 10 0 10 20 30 40 50 60 70 80 90 100 110 120 130 140 150

21-Jul-2021 10:47
R:\p\dawej\XSC\1-5021-rdy-xl-YF.dgn
HTB



150 140 130 120 110 100 90 80 70 60 50 40 30 20 10 0 10 20 30 40 50 60 70 80 90 100 110 120 130 140 150

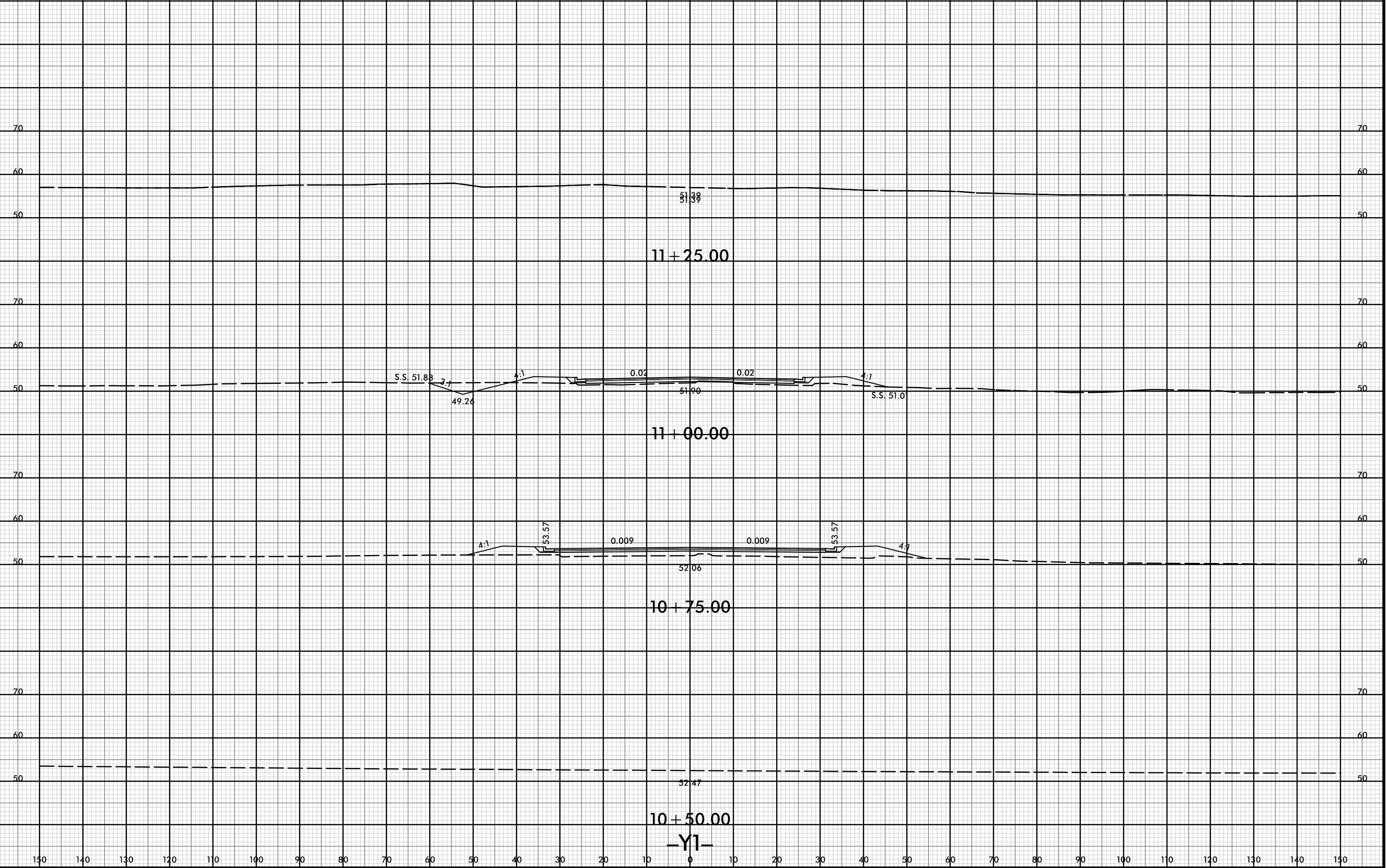

150 140 130 120 110 100 90 80 70 60 50 40 30 20 10 0 10 20 30 40 50 60 70 80 90 100 110 120 130 140 150



150 140 130 120 110 100 90 80 70 60 50 40 30 20 10 0 10 20 30 40 50 60 70 80 90 100 110 120 130 140 150

70 70

60 60

50 50

3:1 51.77 0.019 0.019 52.29 3:1

10 + 50.00

70 70

60 60

50 50

3:1 51.79 0.018 0.018 52.31 3:1

10 + 45.00

70 70

60 60

50 50

49.76

10 + 25.00

70 70

60 60

50 50

49.06

10 + 00.00

-YIA-

150 140 130 120 110 100 90 80 70 60 50 40 30 20 10 0 10 20 30 40 50 60 70 80 90 100 110 120 130 140 150



150 140 130 120 110 100 90 80 70 60 50 40 30 20 10 0 10 20 30 40 50 60 70 80 90 100 110 120 130 140 150

70 70

60 60

50 50

11 + 50.00

11 + 25.00

11 + 00.00

10 + 75.00

-Y1A-

51.24

51.48

51.75

51.93

55.86

54.30

52.80

52.00

55.93

54.65

53.36

52.56

0.002

0.002

0.012

0.012

0.020

0.020

3:1

3:1

3:1

3:1

3:1

3:1



150 140 130 120 110 100 90 80 70 60 50 40 30 20 10 0 10 20 30 40 50 60 70 80 90 100 110 120 130 140 150

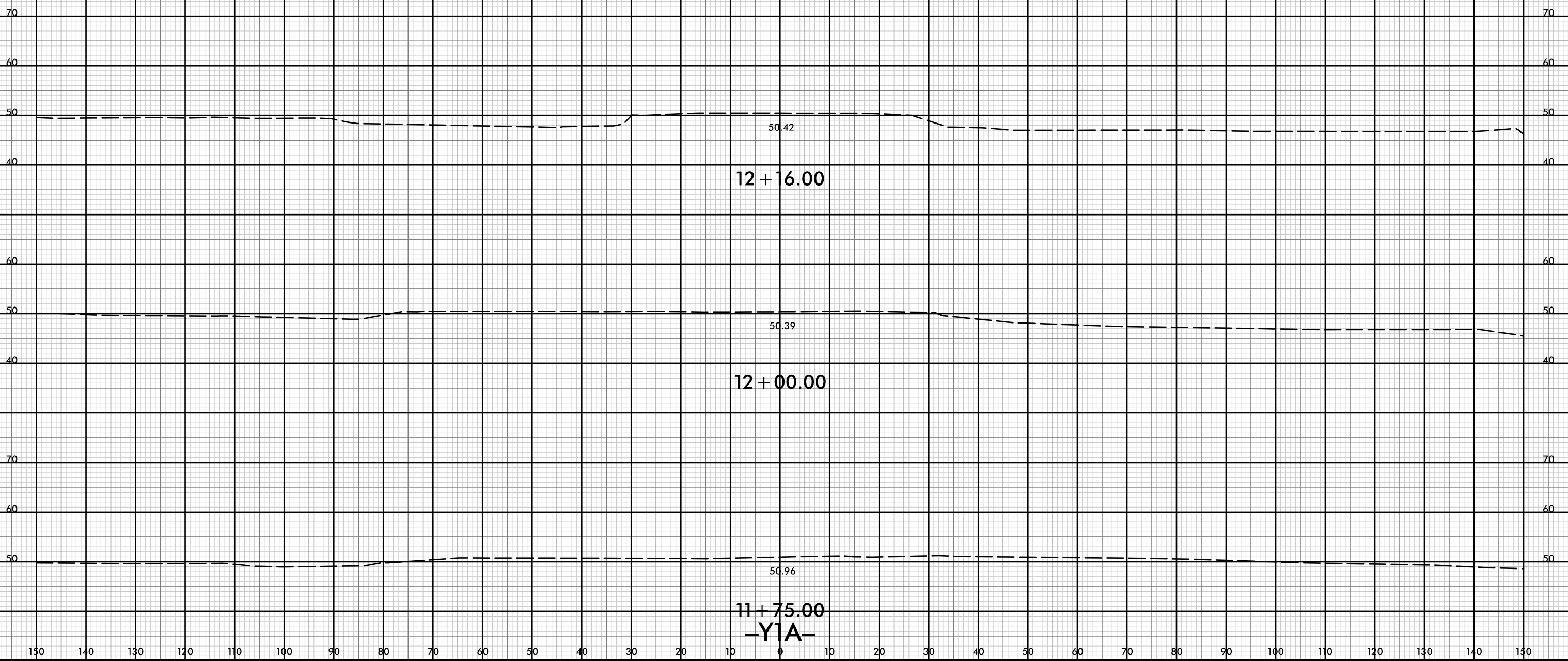

8/23/99



PROJ. REFERENCE NO.
R-5021

SHEET NO.
X-256

150 140 130 120 110 100 90 80 70 60 50 40 30 20 10 0 10 20 30 40 50 60 70 80 90 100 110 120 130 140 150

70 70

60 60



10 + 75.00

70 70

60 60

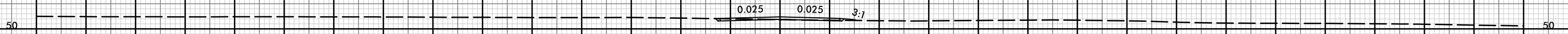

10 + 50.00

70 70

60 60

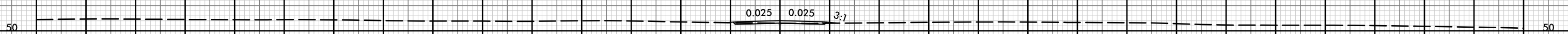

10 + 25.00

70 70

60 60

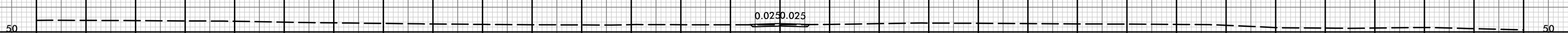

10 + 00.00

-YIC-

150 140 130 120 110 100 90 80 70 60 50 40 30 20 10 0 10 20 30 40 50 60 70 80 90 100 110 120 130 140 150

21-Jul-2021 10:38
R:\pawej\XSCA\5021-rdy-yp-l-YIC.dgn
HTB

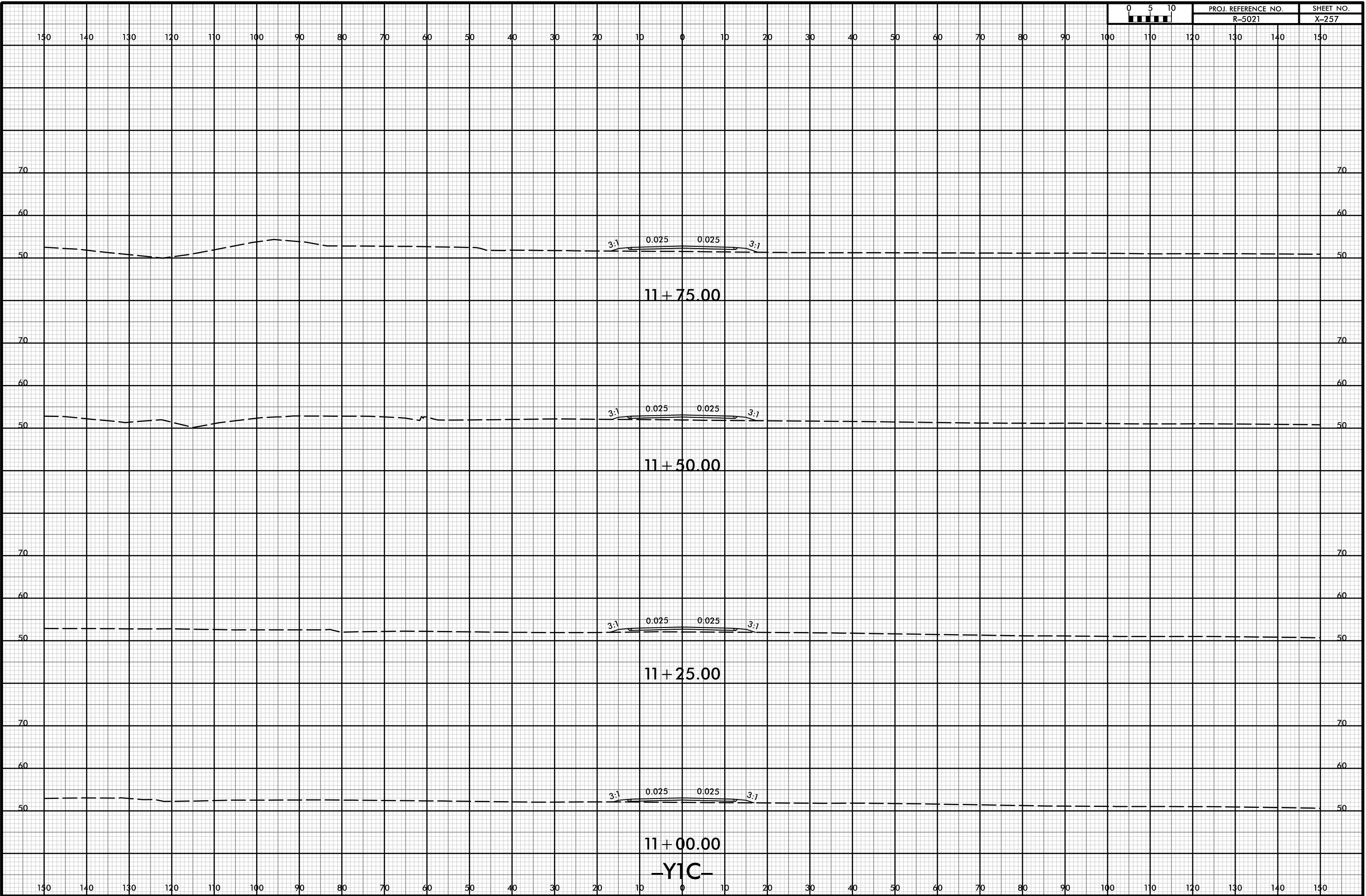



150 140 130 120 110 100 90 80 70 60 50 40 30 20 10 0 10 20 30 40 50 60 70 80 90 100 110 120 130 140 150

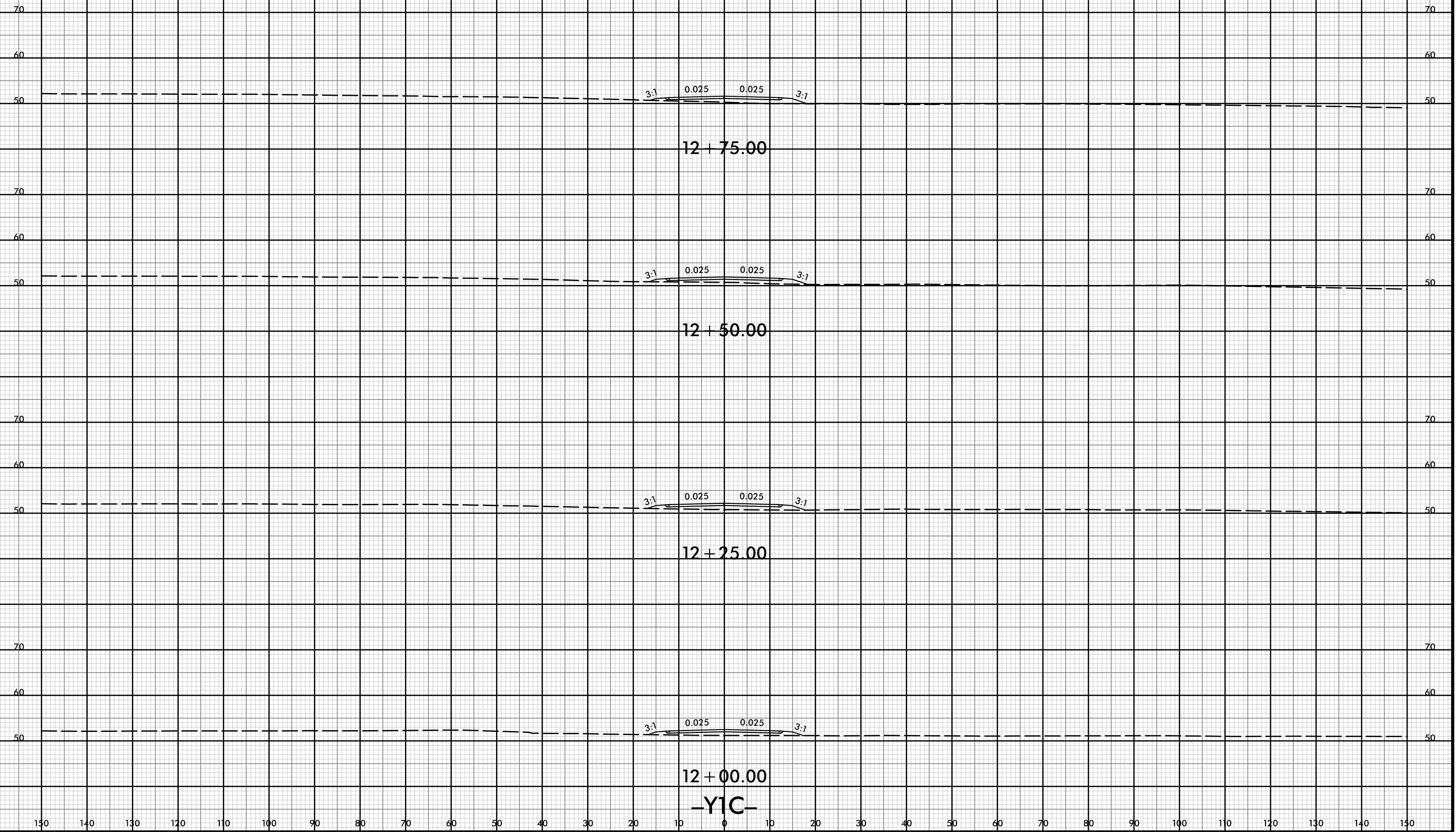

150 140 130 120 110 100 90 80 70 60 50 40 30 20 10 0 10 20 30 40 50 60 70 80 90 100 110 120 130 140 150

12 + 00.00
-Y1C-

8/23/99



PROJ. REFERENCE NO.
R-5021

SHEET NO.
X-259

150 140 130 120 110 100 90 80 70 60 50 40 30 20 10 0 10 20 30 40 50 60 70 80 90 100 110 120 130 140 150

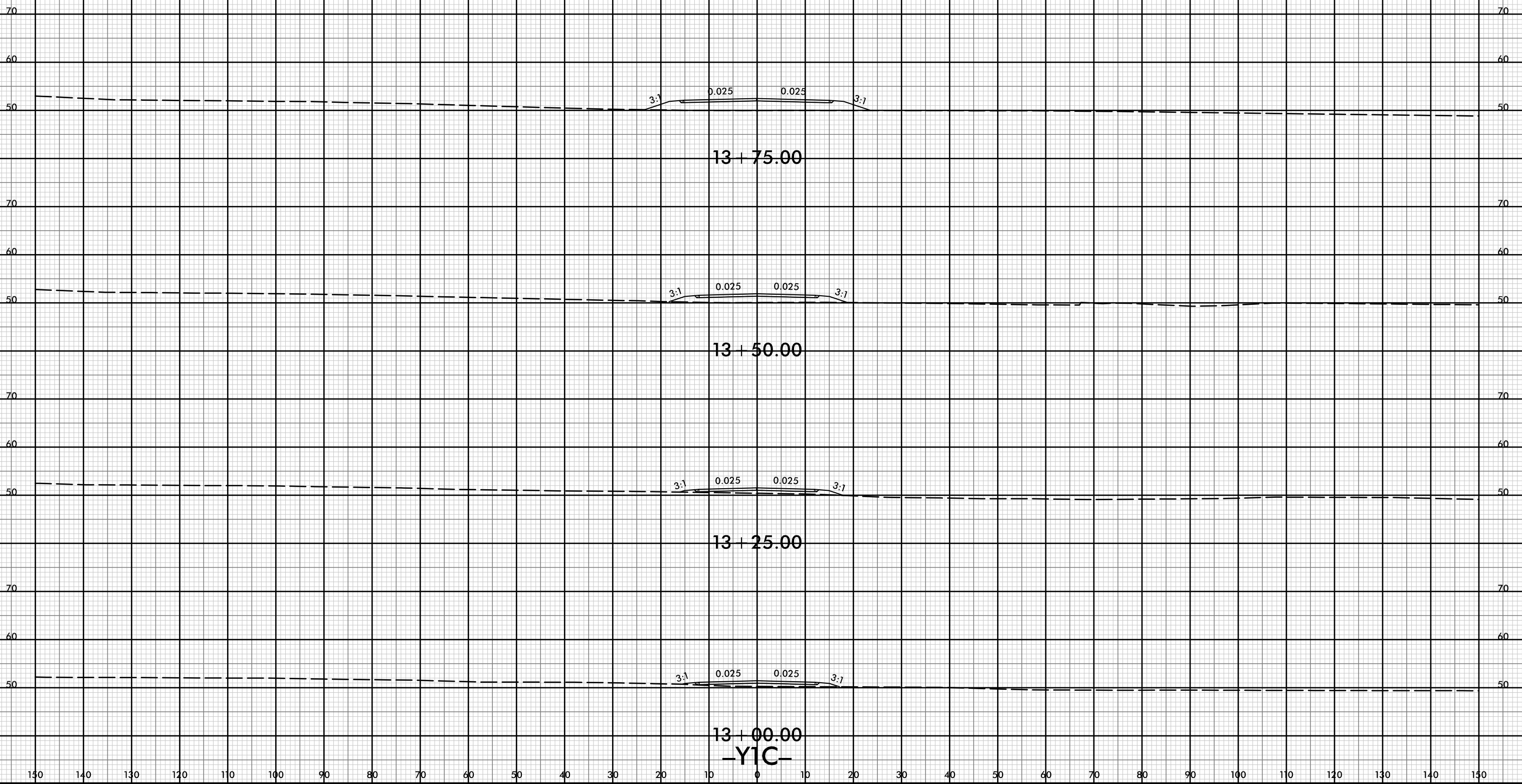

150 140 130 120 110 100 90 80 70 60 50 40 30 20 10 0 10 20 30 40 50 60 70 80 90 100 110 120 130 140 150

21-Jul-2021 10:38
R:\p\dawej\XSCA\5021-rdy-yp-l-YIC.dgn
HTB



150 140 130 120 110 100 90 80 70 60 50 40 30 20 10 0 10 20 30 40 50 60 70 80 90 100 110 120 130 140 150

70 70

60 60

50 50

14 + 75.00

70 70

60 60

50 50

14 + 50.00

70 70

60 60

50 50

14 + 25.00

70 70

60 60

50 50

14 + 00.00

-YIC-

150 140 130 120 110 100 90 80 70 60 50 40 30 20 10 0 10 20 30 40 50 60 70 80 90 100 110 120 130 140 150

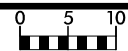

150 140 130 120 110 100 90 80 70 60 50 40 30 20 10 0 10 20 30 40 50 60 70 80 90 100 110 120 130 140 150

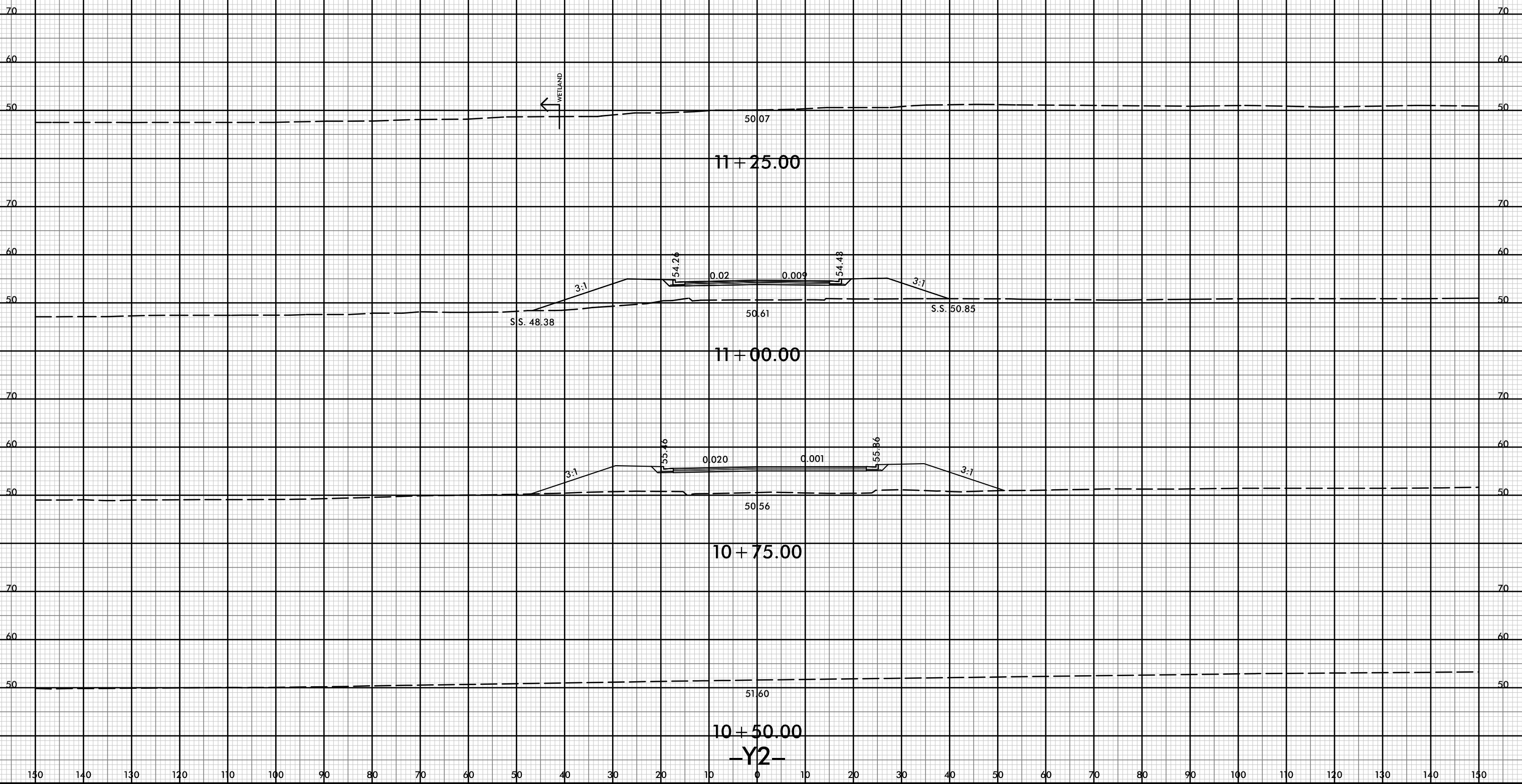

WETLAND

11+25.00

11+00.00

10+75.00

10+50.00

-Y2-

50.07

50.61

50.56

51.60

S.S. 48.38

S.S. 50.85

3:1

3:1

3:1

3:1

54.26

0.02

0.009

54.43

55.46

0.020

0.001

55.36



150 140 130 120 110 100 90 80 70 60 50 40 30 20 10 0 10 20 30 40 50 60 70 80 90 100 110 120 130 140 150

70 70

60 60

50 50

40 40

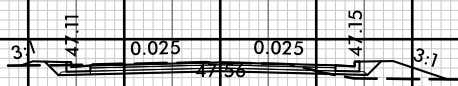

10 + 75.00

60 60

50 50

40 40

45.55

10 + 50.00

60 60

50 50

40 40

45.79

10 + 25.00

60 60

50 50

40 40

46.48

10 + 00.00

-Y2A-

150 140 130 120 110 100 90 80 70 60 50 40 30 20 10 0 10 20 30 40 50 60 70 80 90 100 110 120 130 140 150

8/23/99



PROJ. REFERENCE NO.
R-5021

SHEET NO.
X-263

150 140 130 120 110 100 90 80 70 60 50 40 30 20 10 0 10 20 30 40 50 60 70 80 90 100 110 120 130 140 150

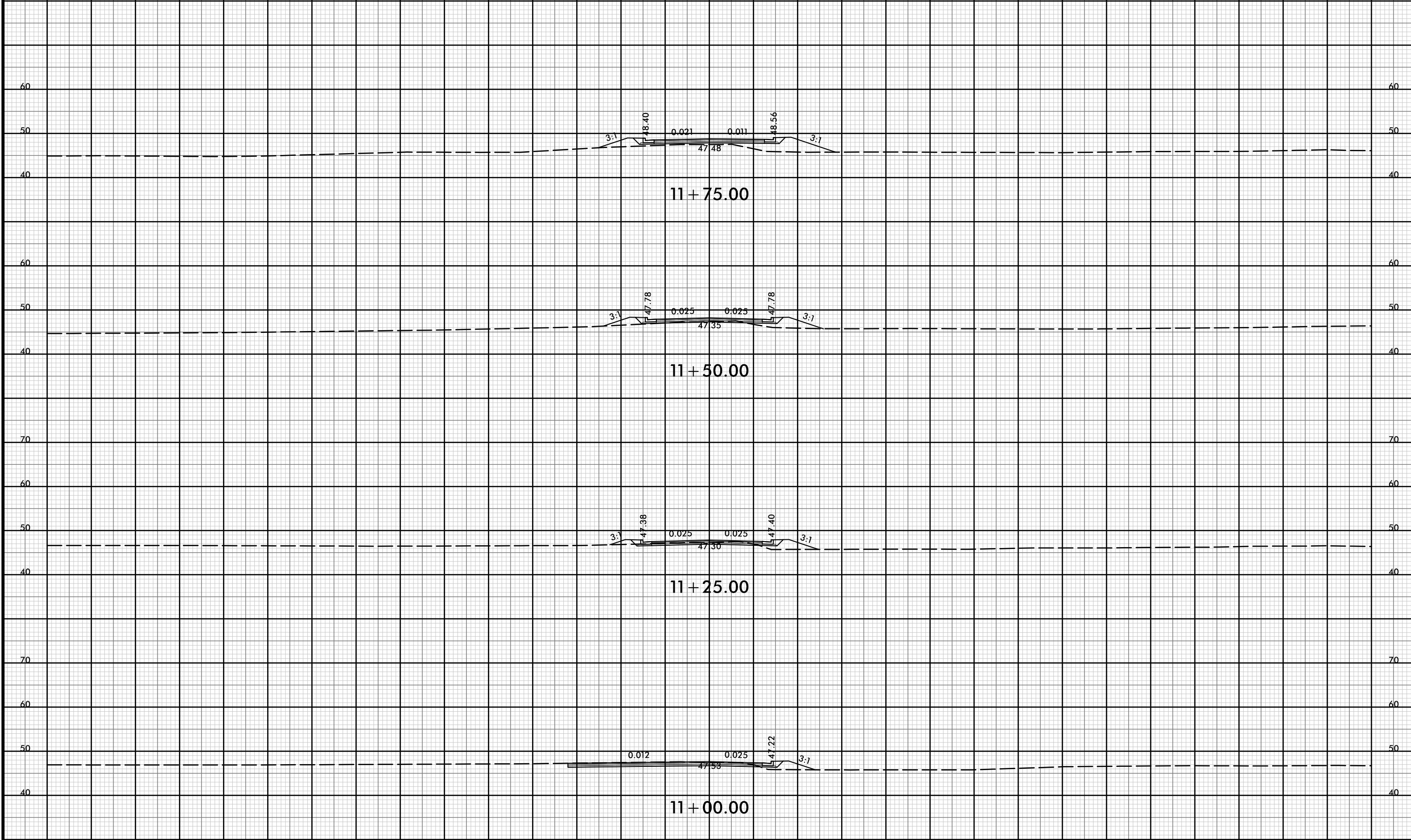

11+75.00

11+50.00

11+25.00

11+00.00

-Y2A-

21-Jul-2021 10:38
 R:\p\dawej\XSCA\5021-rdy-yp1-Y2A.dgn
 HNTB



150 140 130 120 110 100 90 80 70 60 50 40 30 20 10 0 10 20 30 40 50 60 70 80 90 100 110 120 130 140 150

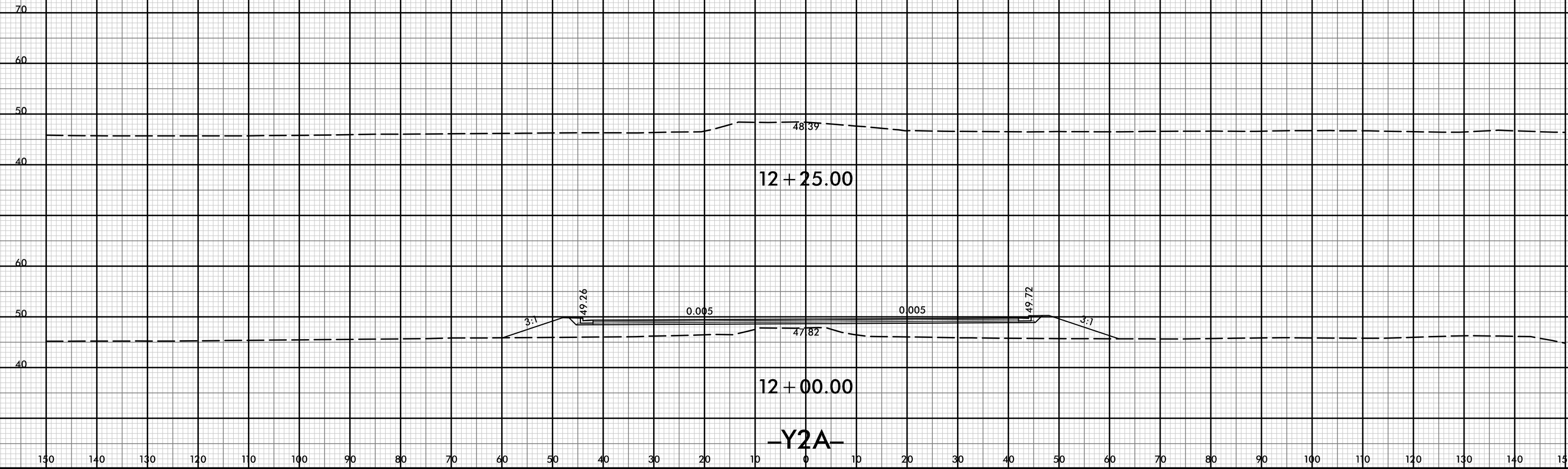



150 140 130 120 110 100 90 80 70 60 50 40 30 20 10 0 10 20 30 40 50 60 70 80 90 100 110 120 130 140 150

60 60

50 50

40 40

0.010 45.61 0.010

10 + 00.00

60 60

50 50

40 40

45.57

9 + 75.00

60 60

50 50

40 40

45.81

9 + 50.00

60 60

50 50

40 40

45.47

9 + 25.00

-Y3-

150 140 130 120 110 100 90 80 70 60 50 40 30 20 10 0 10 20 30 40 50 60 70 80 90 100 110 120 130 140 150

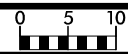

150 140 130 120 110 100 90 80 70 60 50 40 30 20 10 0 10 20 30 40 50 60 70 80 90 100 110 120 130 140 150

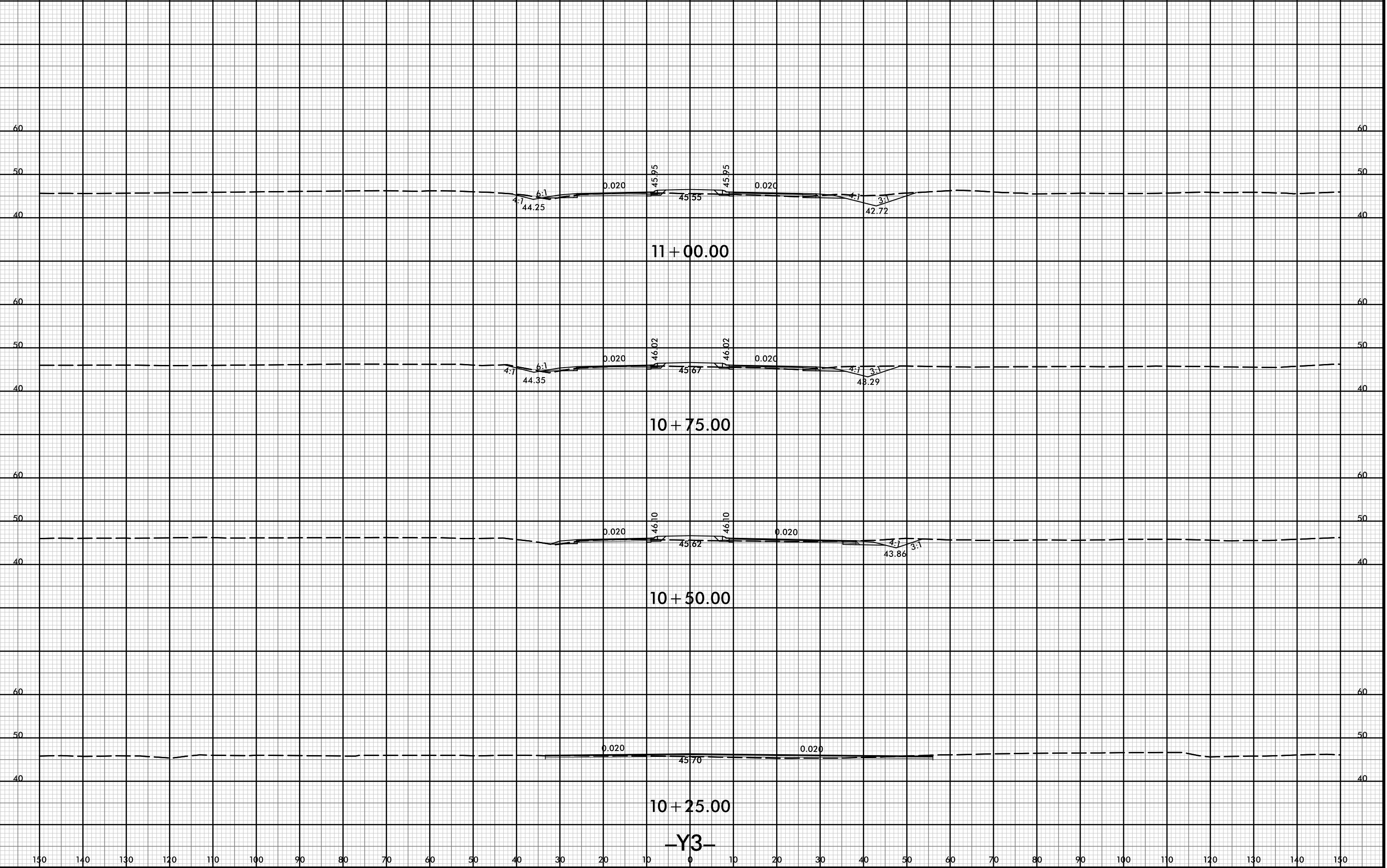

11 + 00.00

10 + 75.00

10 + 50.00

10 + 25.00

-Y3-



150 140 130 120 110 100 90 80 70 60 50 40 30 20 10 0 10 20 30 40 50 60 70 80 90 100 110 120 130 140 150

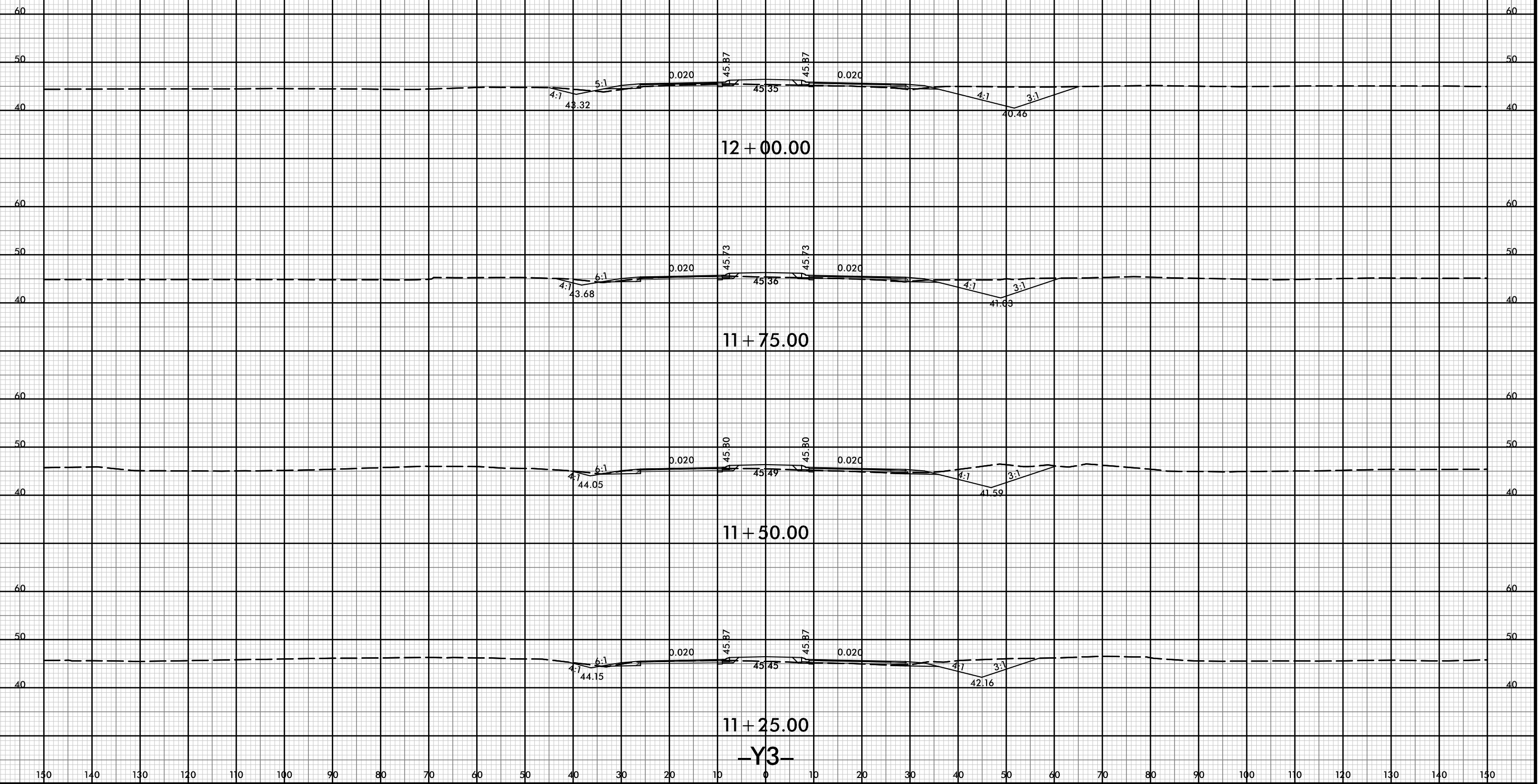

12 + 00.00

11 + 75.00

11 + 50.00

11 + 25.00

-Y3-

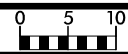

150 140 130 120 110 100 90 80 70 60 50 40 30 20 10 0 10 20 30 40 50 60 70 80 90 100 110 120 130 140 150

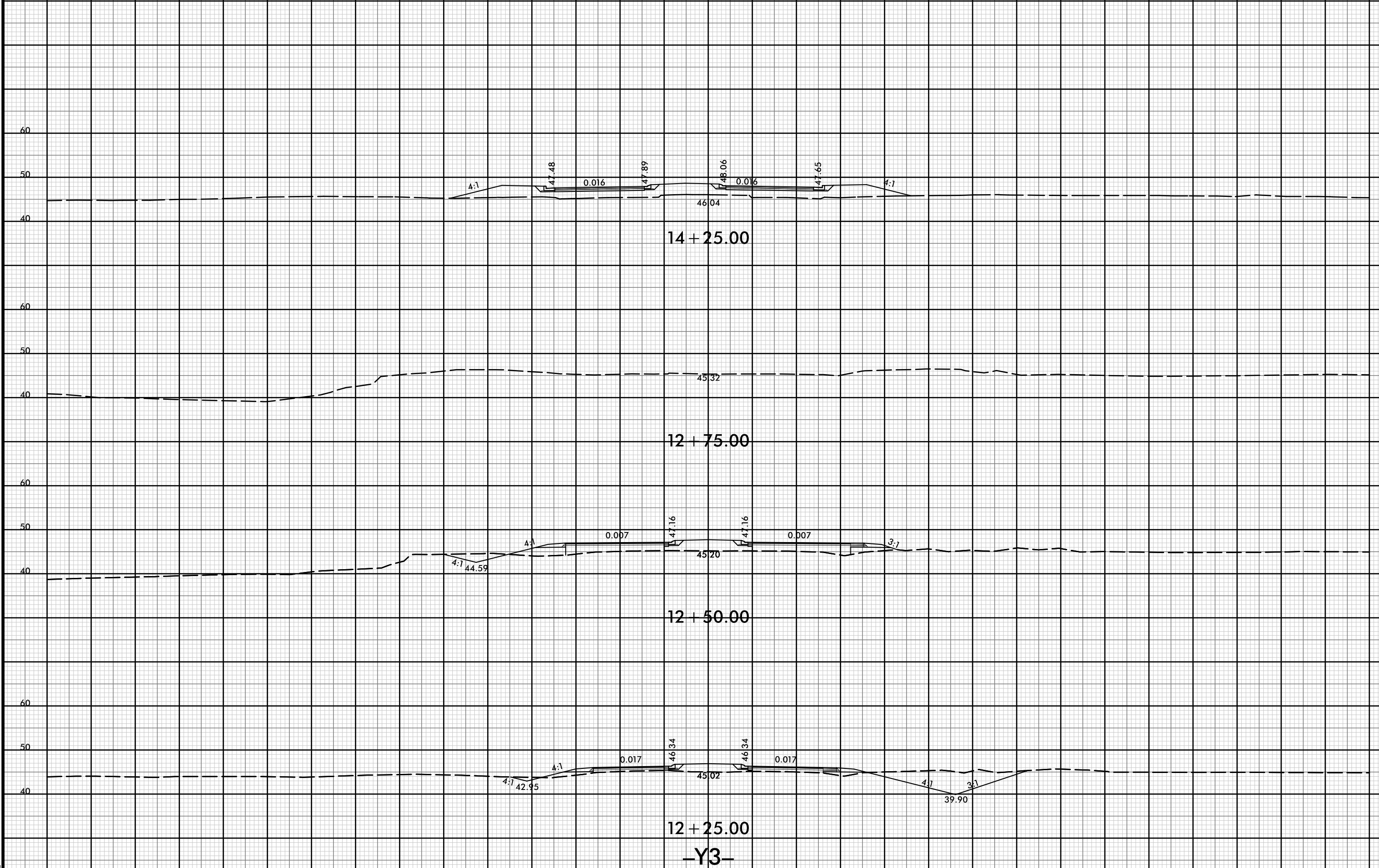

14 + 25.00

12 + 75.00

12 + 50.00

12 + 25.00

-Y3-

4:1 47.48 0.016 47.89 48.06 0.016 47.65 4:1 46.04

4:1 44.59 4:1 47.16 0.007 45.70 47.16 0.007 3:1 45.32

4:1 42.95 4:1 46.34 0.017 45.02 46.34 0.017 4:1 39.90 3:1

150 140 130 120 110 100 90 80 70 60 50 40 30 20 10 0 10 20 30 40 50 60 70 80 90 100 110 120 130 140 150

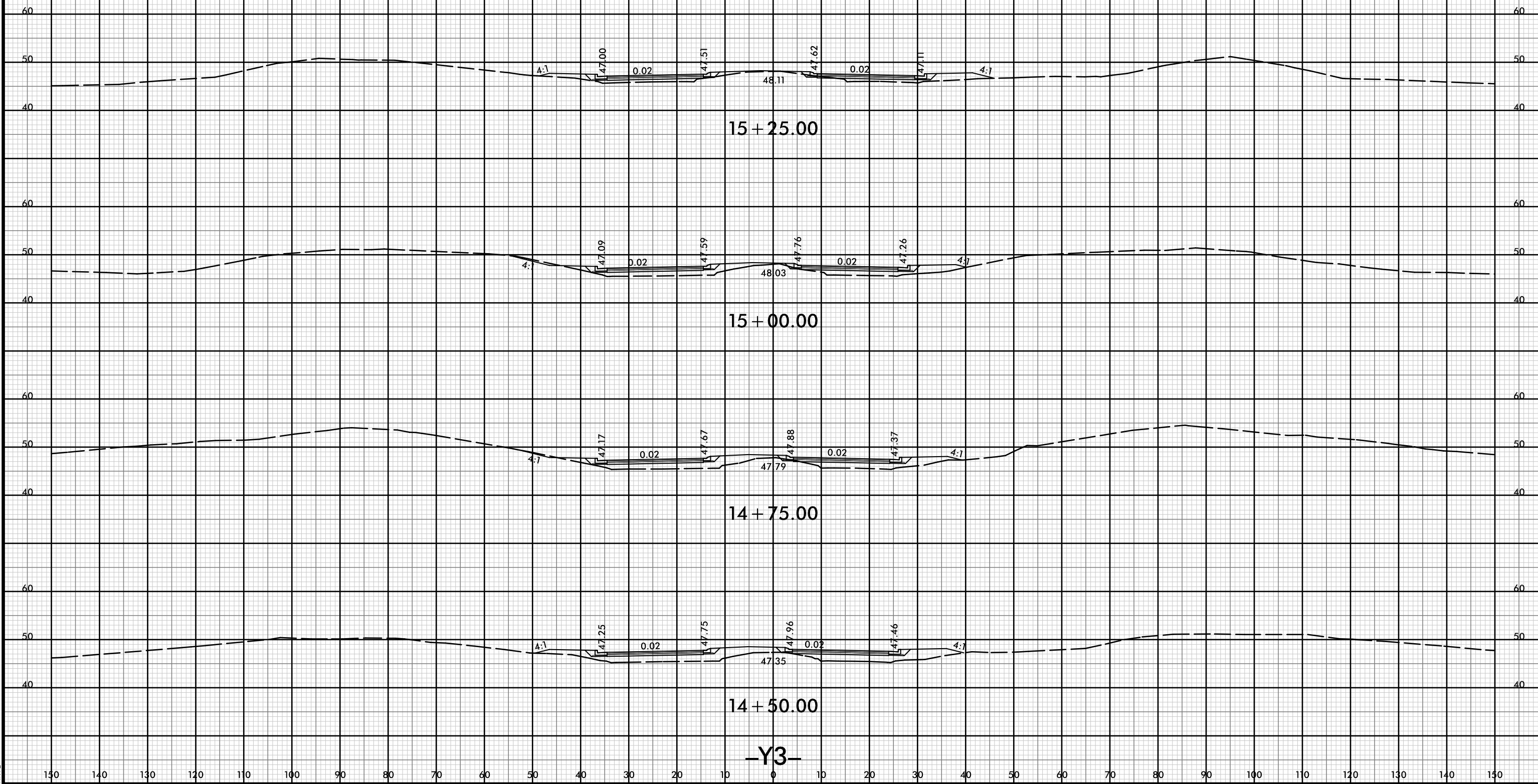

15+25.00

15+00.00

14+75.00

14+50.00

-Y3-

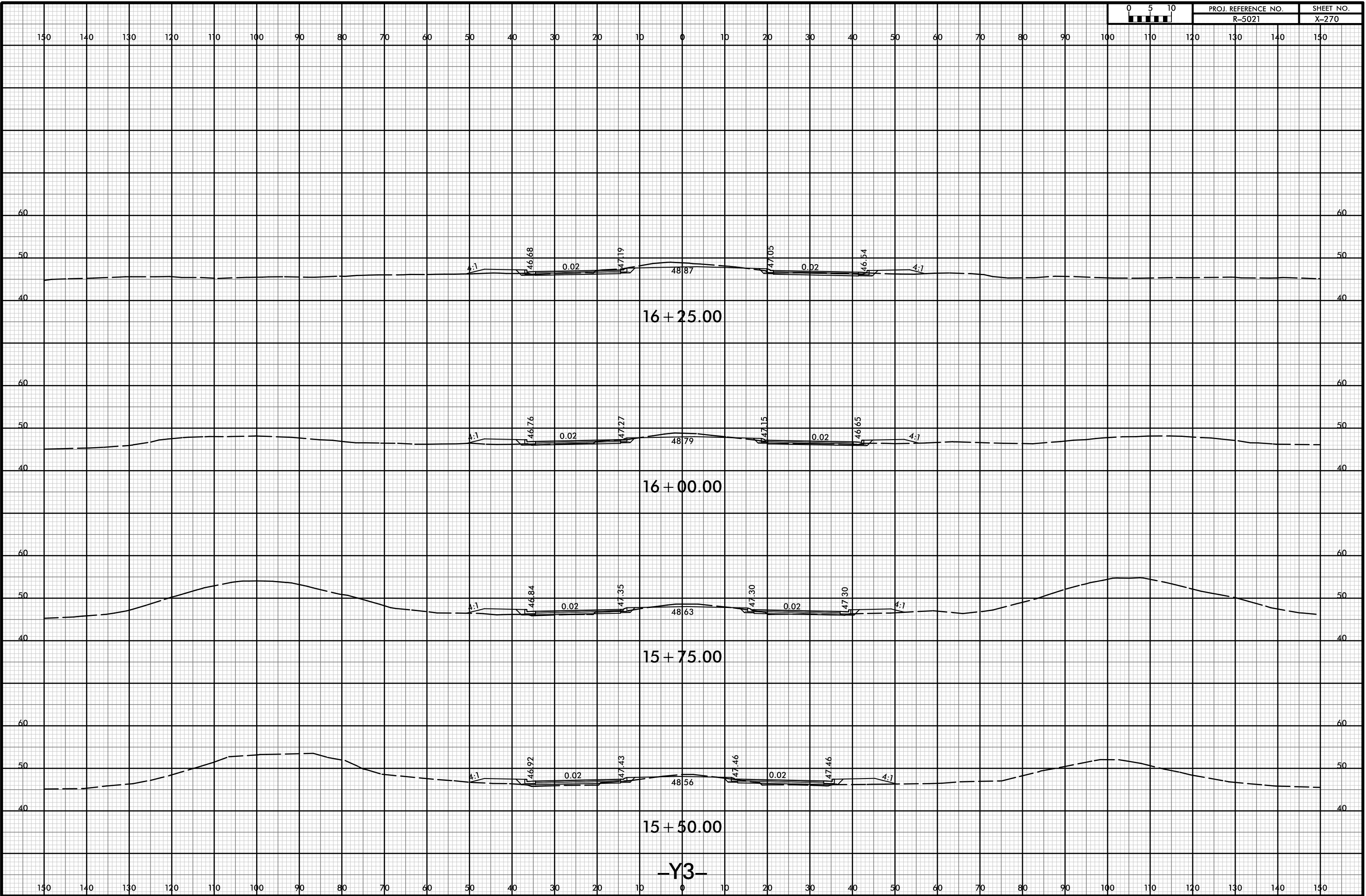

-Y3-

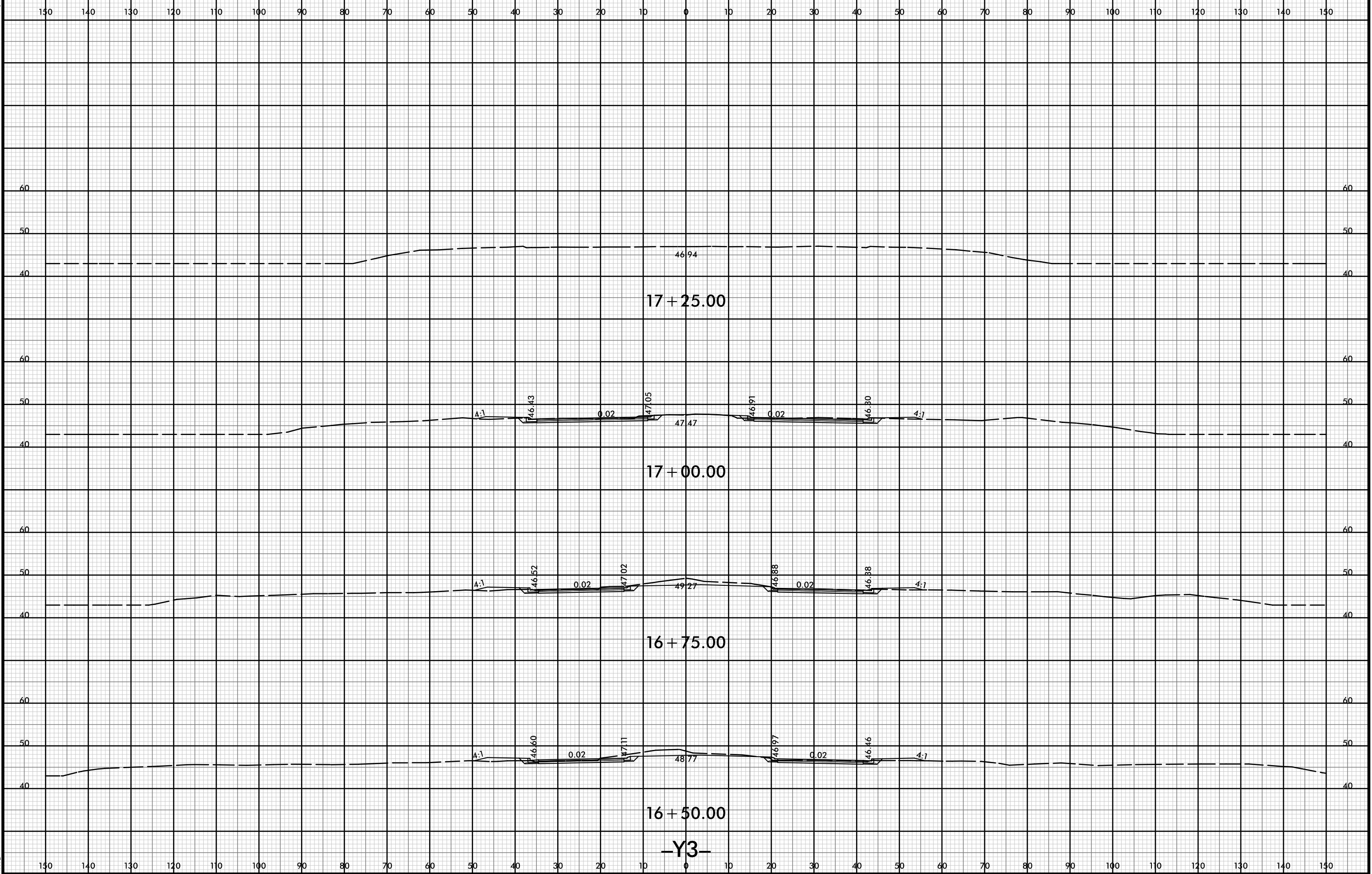



150 140 130 120 110 100 90 80 70 60 50 40 30 20 10 0 10 20 30 40 50 60 70 80 90 100 110 120 130 140 150

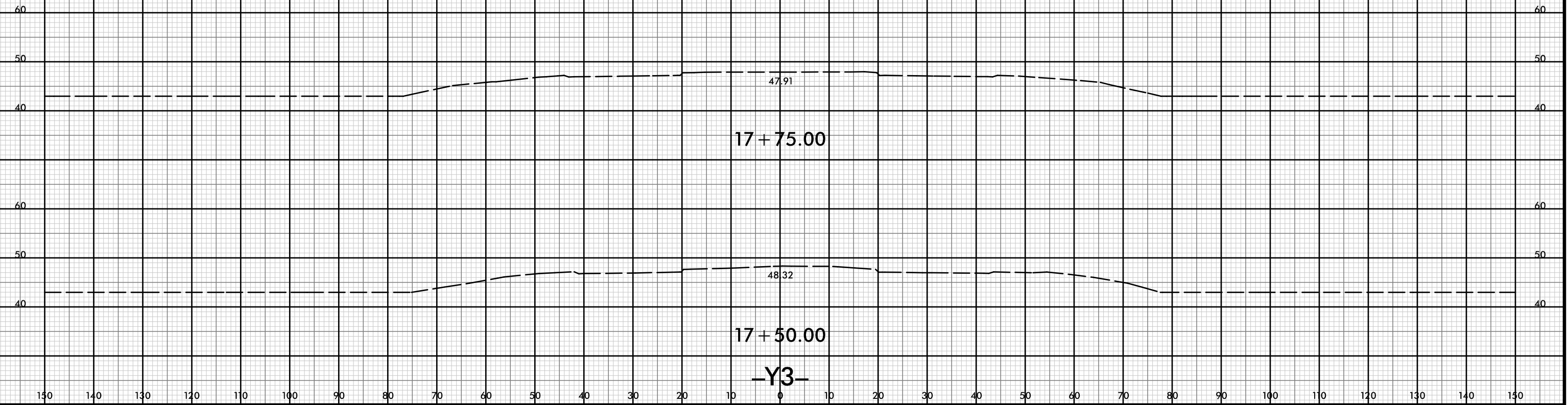

-Y3-

8/23/99



| | |
|---------------------|-----------|
| PROJ. REFERENCE NO. | SHEET NO. |
| R-5021 | X-273 |

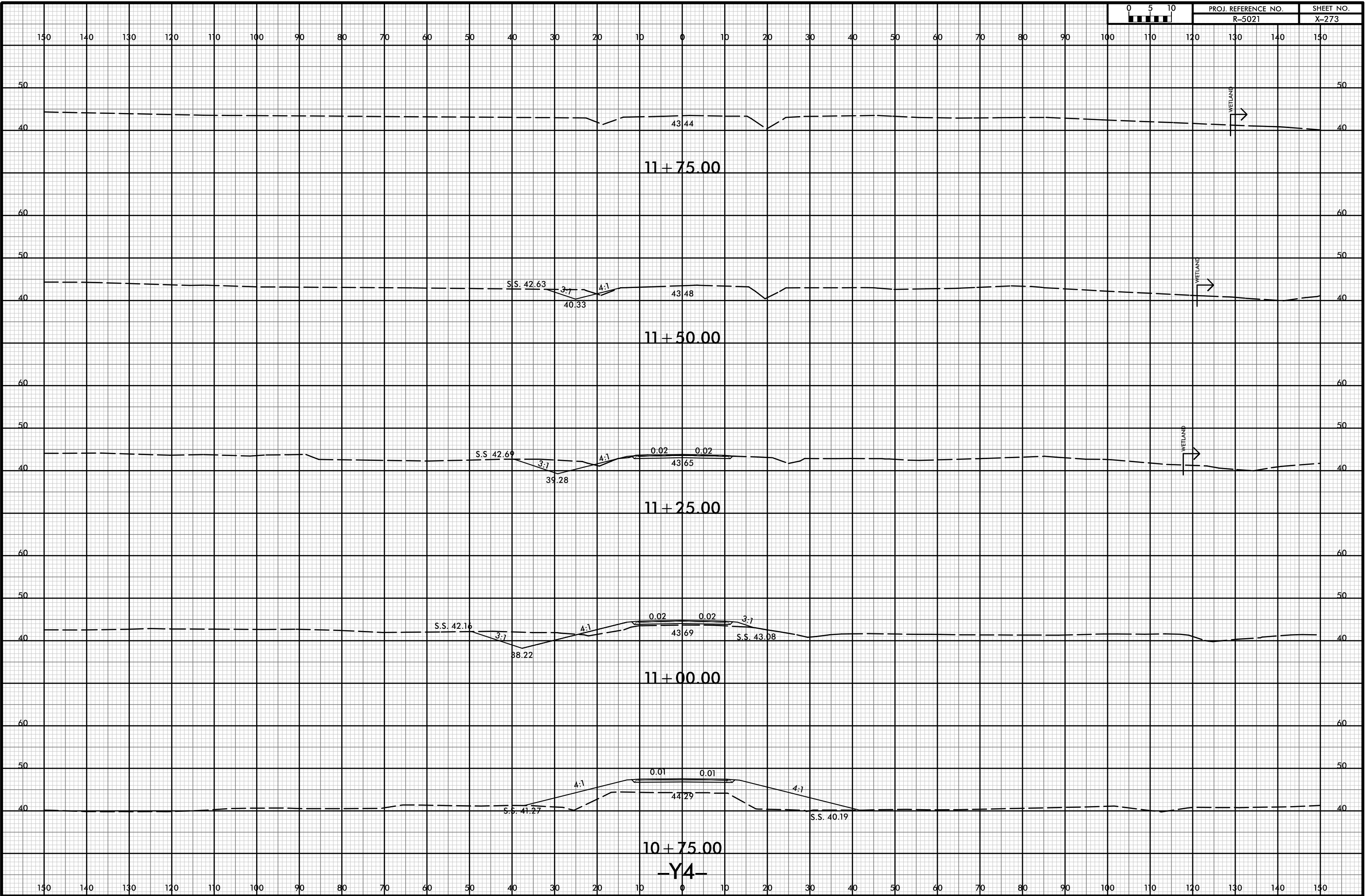

11+75.00

11+50.00

11+25.00

11+00.00

10+75.00

-Y4-

21-Jul-2021 10:38
R:\p\dawej\XSCA\5021-rdy-yp-l-y4.dgn
HTB

150 140 130 120 110 100 90 80 70 60 50 40 30 20 10 0 10 20 30 40 50 60 70 80 90 100 110 120 130 140 150

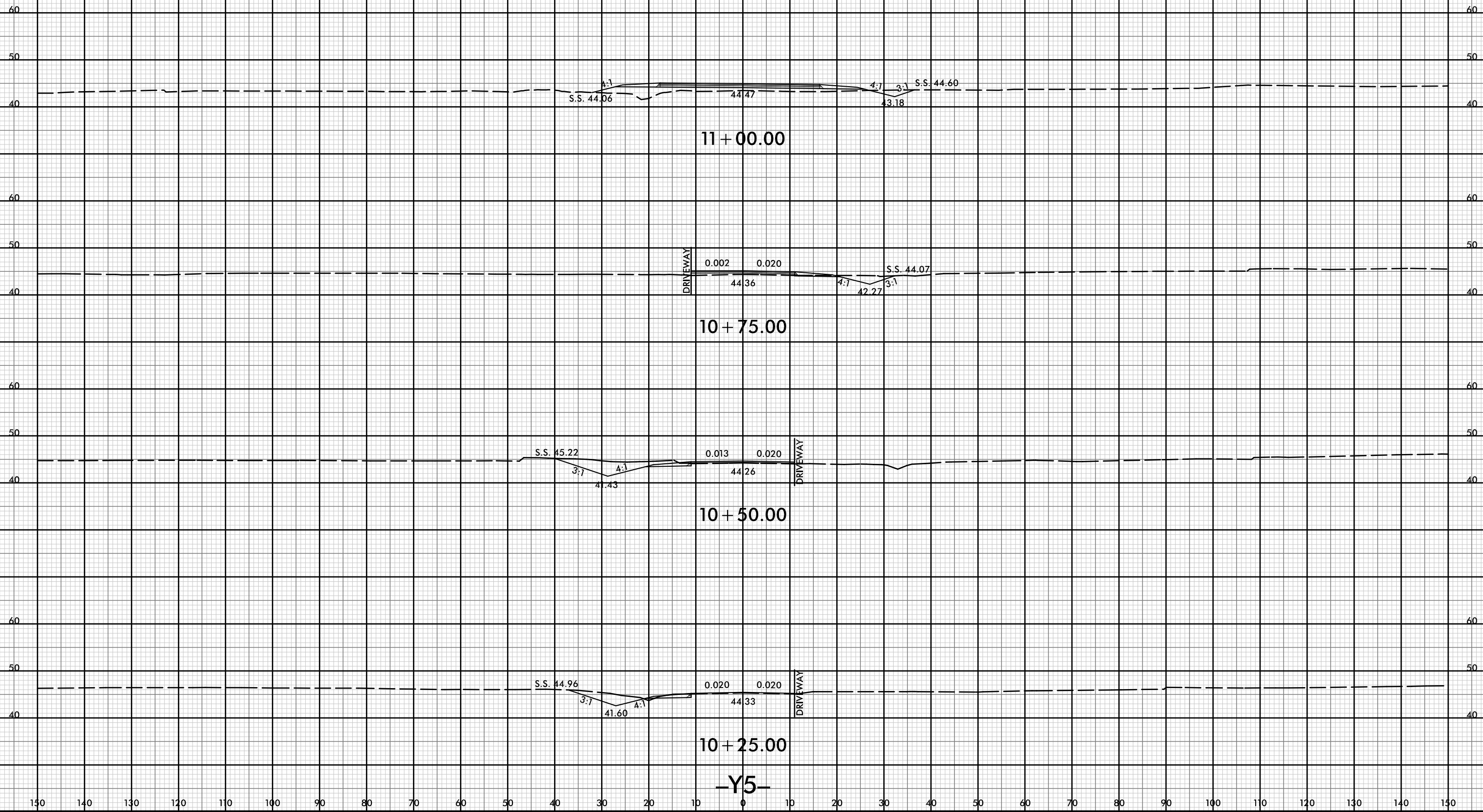

8/23/99



PROJ. REFERENCE NO.
R-5021

SHEET NO.
X-275

150 140 130 120 110 100 90 80 70 60 50 40 30 20 10 0 10 20 30 40 50 60 70 80 90 100 110 120 130 140 150

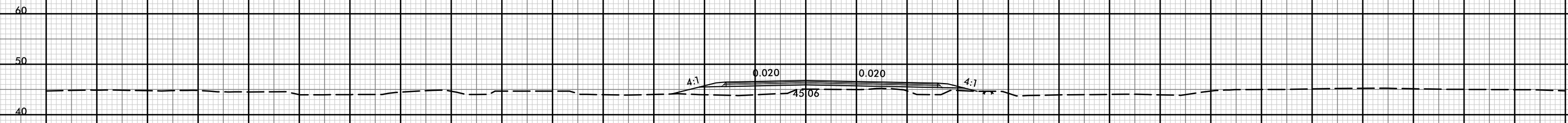

10 + 75.00

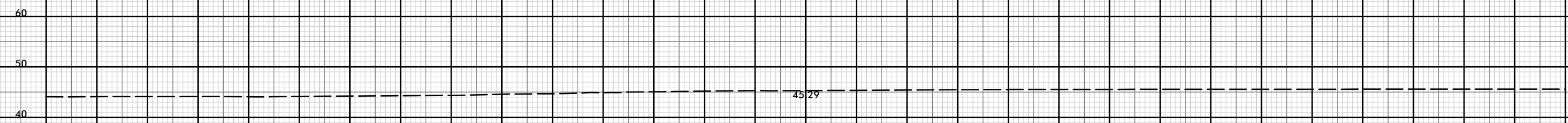

10 + 50.00

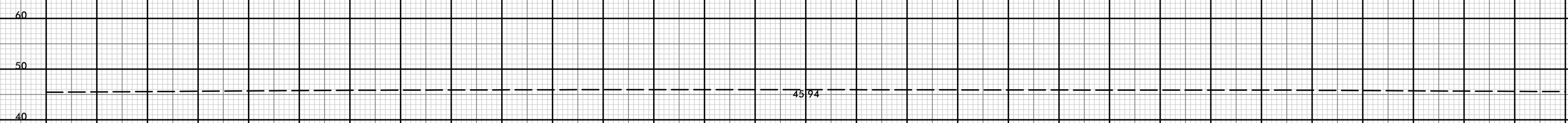

10 + 25.00

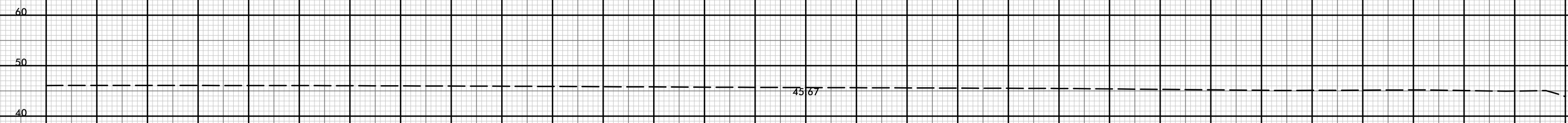

10 + 00.00

-Y5A-

150 140 130 120 110 100 90 80 70 60 50 40 30 20 10 0 10 20 30 40 50 60 70 80 90 100 110 120 130 140 150

21-Jul-2021 10:38
 \\P01dweu\XSCA\5021-rdy-xl-Y5A.dgn
 HNTB

8/23/99



PROJ. REFERENCE NO.
R-5021

SHEET NO.
X-276

150 140 130 120 110 100 90 80 70 60 50 40 30 20 10 0 10 20 30 40 50 60 70 80 90 100 110 120 130 140 150

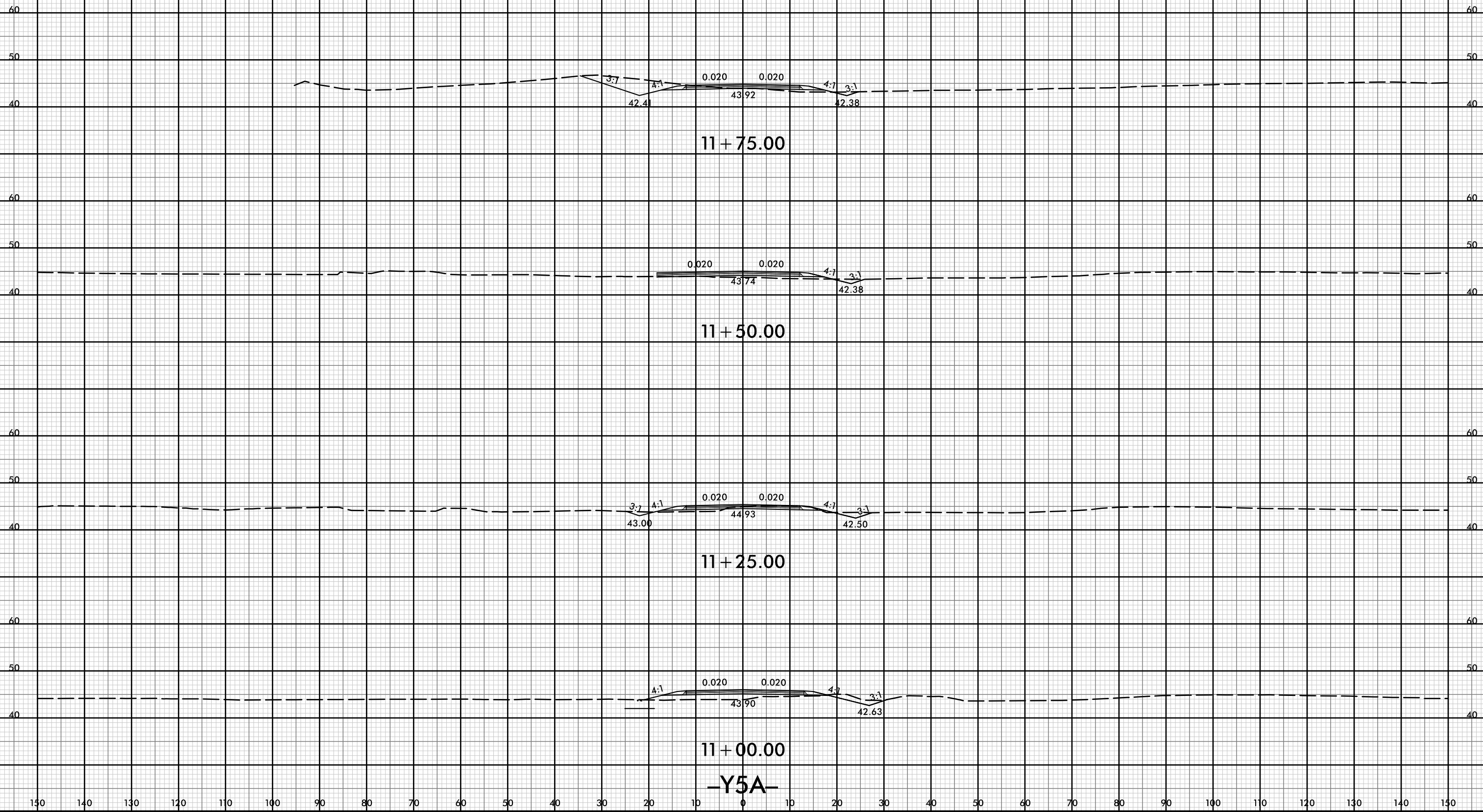

-Y5A-

21-JUL-2021 10:38
\\P01dweu\XSCA\5021-rdy-xl-Y5A.dgn
HTB

8/23/99



PROJ. REFERENCE NO.
R-5021

SHEET NO.
X-277

150 140 130 120 110 100 90 80 70 60 50 40 30 20 10 0 10 20 30 40 50 60 70 80 90 100 110 120 130 140 150

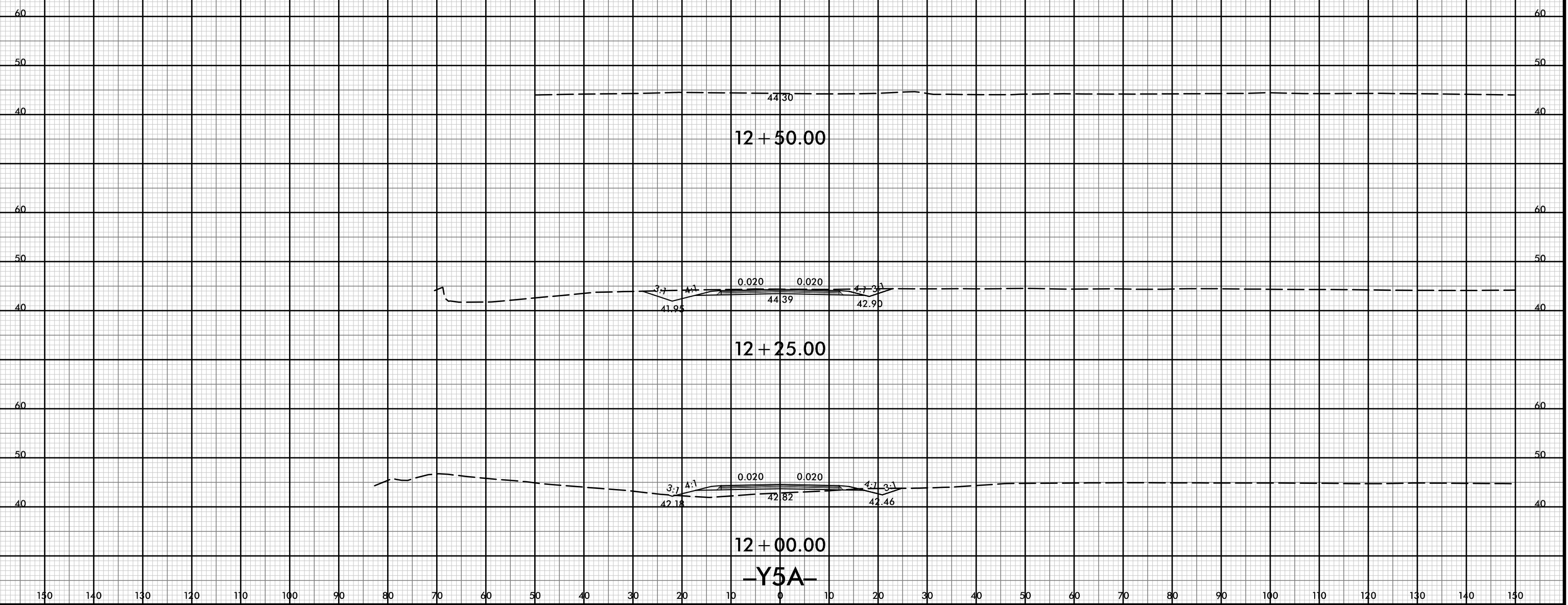

21-Jul-2021 10:38
R:\pawej\XSCA\5021-rdy-yp-l-Y5A.dgn
HTB

8/23/99



PROJ. REFERENCE NO.
R-5021

SHEET NO.
X-278

150 140 130 120 110 100 90 80 70 60 50 40 30 20 10 0 10 20 30 40 50 60 70 80 90 100 110 120 130 140 150

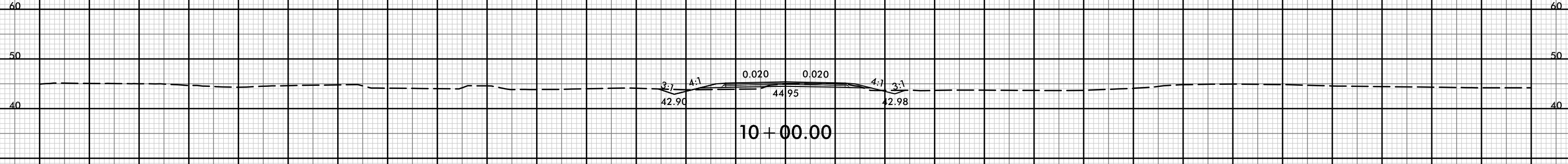
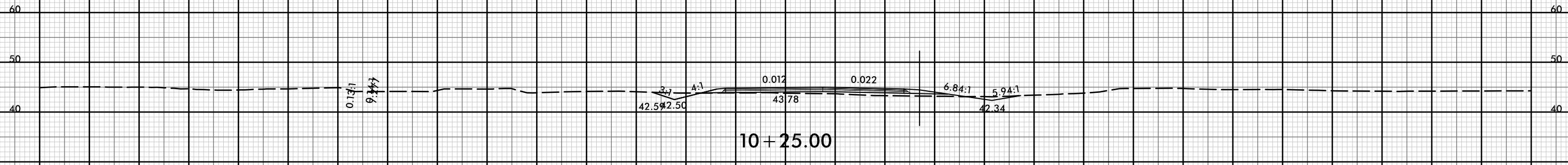
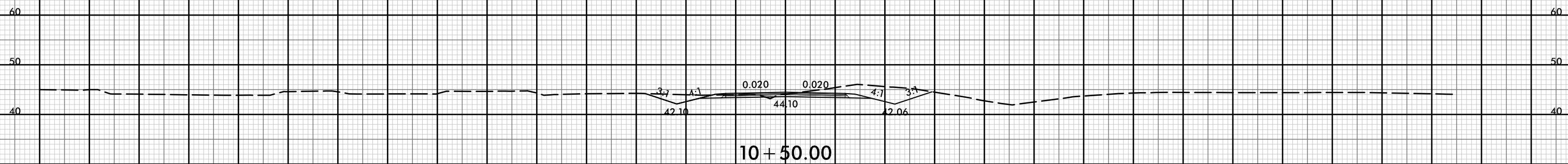
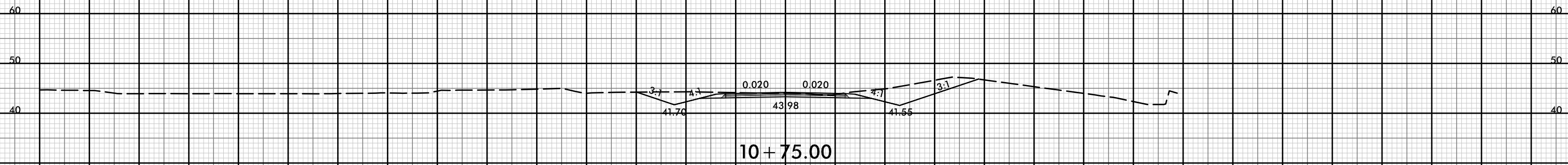

150 140 130 120 110 100 90 80 70 60 50 40 30 20 10 0 10 20 30 40 50 60 70 80 90 100 110 120 130 140 150

-Y5B-

21-Jul-2021 10:38
R:\p\dawej\XSCA\5021-rdy-yp-l-Y5B.dgn
HTB

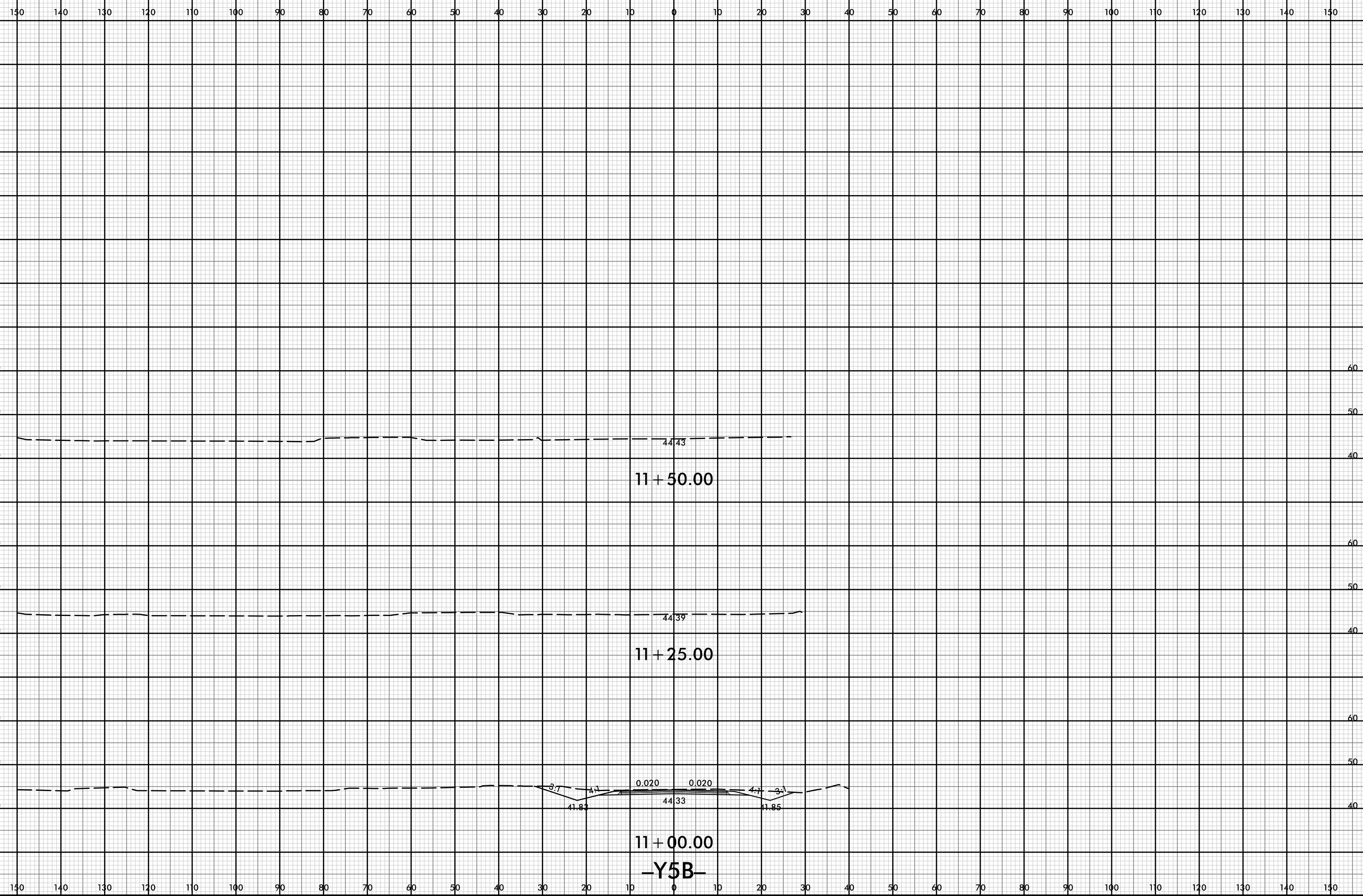

8/23/99



PROJ. REFERENCE NO.
R-5021

SHEET NO.
X-280

150 140 130 120 110 100 90 80 70 60 50 40 30 20 10 0 10 20 30 40 50 60 70 80 90 100 110 120 130 140 150

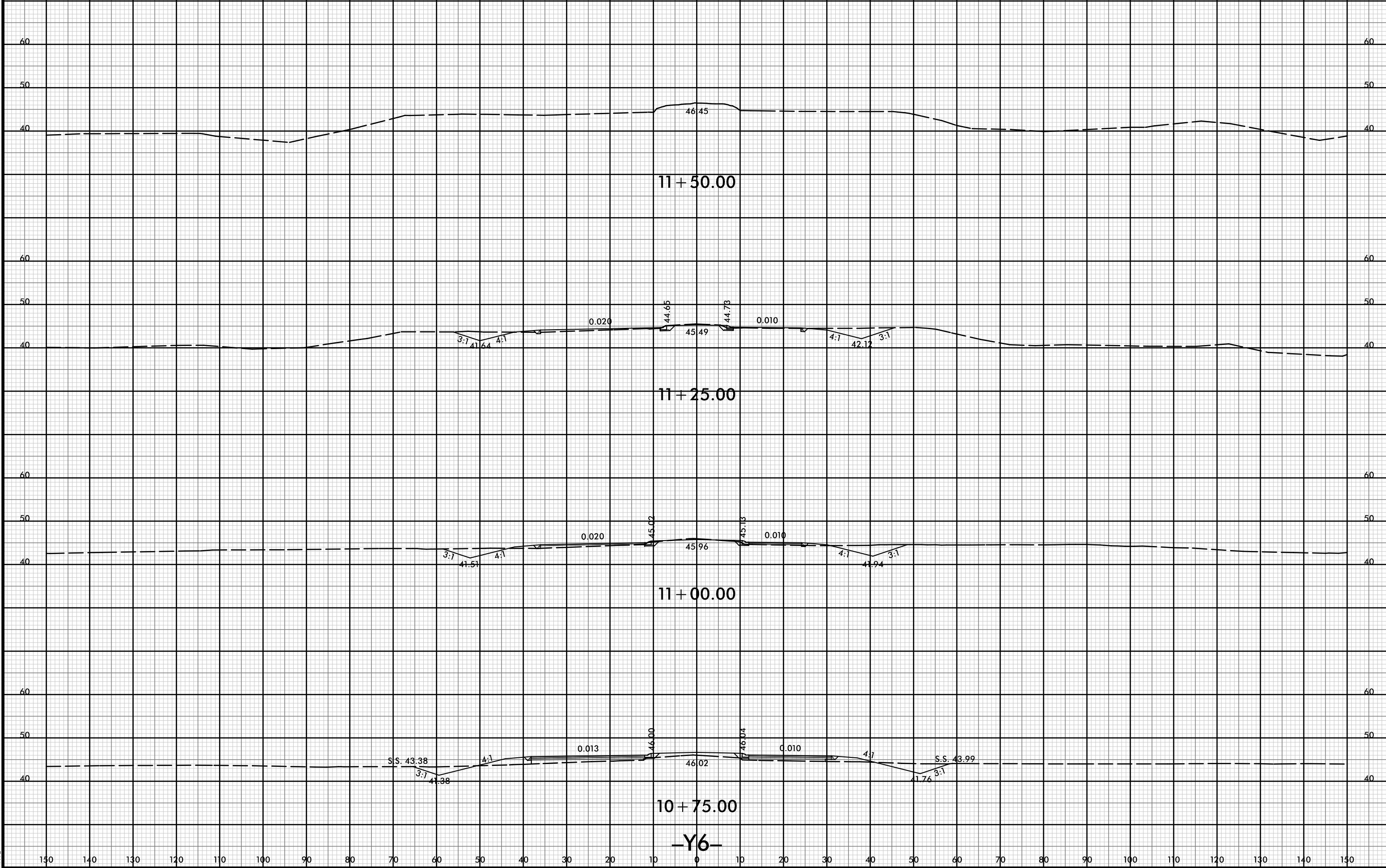

11 + 50.00

11 + 25.00

11 + 00.00

10 + 75.00

-Y6-

46.45

44.65

45.02

46.00

44.78

45.49

45.96

46.02

42.12

42.12

41.94

41.76

3:1

4:1

4:1

4:1

4:1

4:1

4:1

3:1

3:1

3:1

4:1

4:1

4:1

4:1

4:1

4:1

3:1

3:1

S.S. 43.38

41.38

4:1

4:1

4:1

4:1

4:1

4:1

4:1

4:1

3:1

S.S. 43.99

41.76

3:1

0.020

0.020

0.013

0.010

0.010

0.010

21-Jul-2021 10:38
R:\pawej\XSC\5021-rdy-xl-Y6.dgn
HTB



150 140 130 120 110 100 90 80 70 60 50 40 30 20 10 0 10 20 30 40 50 60 70 80 90 100 110 120 130 140 150

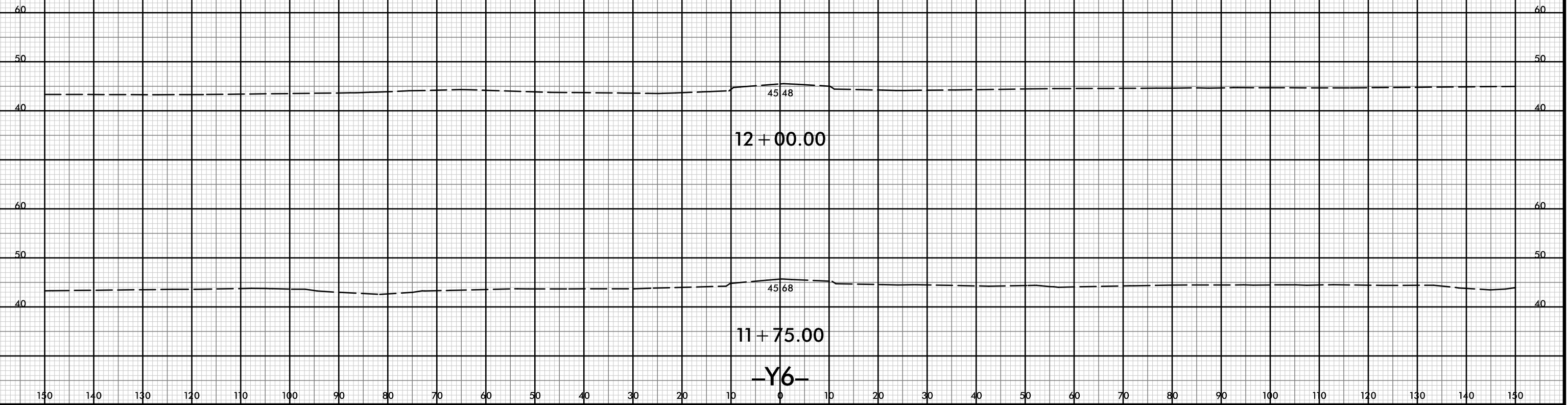

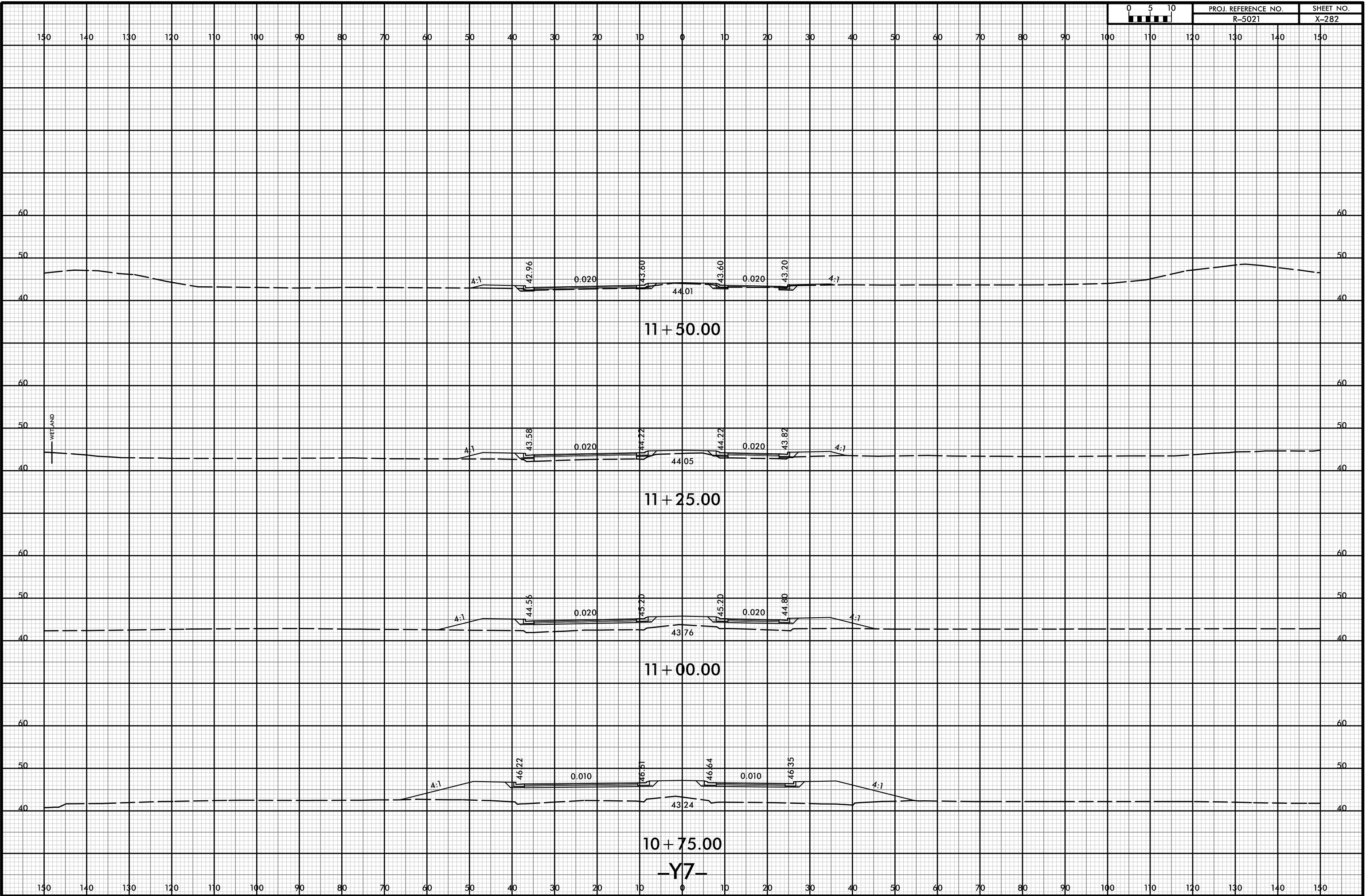



150 140 130 120 110 100 90 80 70 60 50 40 30 20 10 0 10 20 30 40 50 60 70 80 90 100 110 120 130 140 150

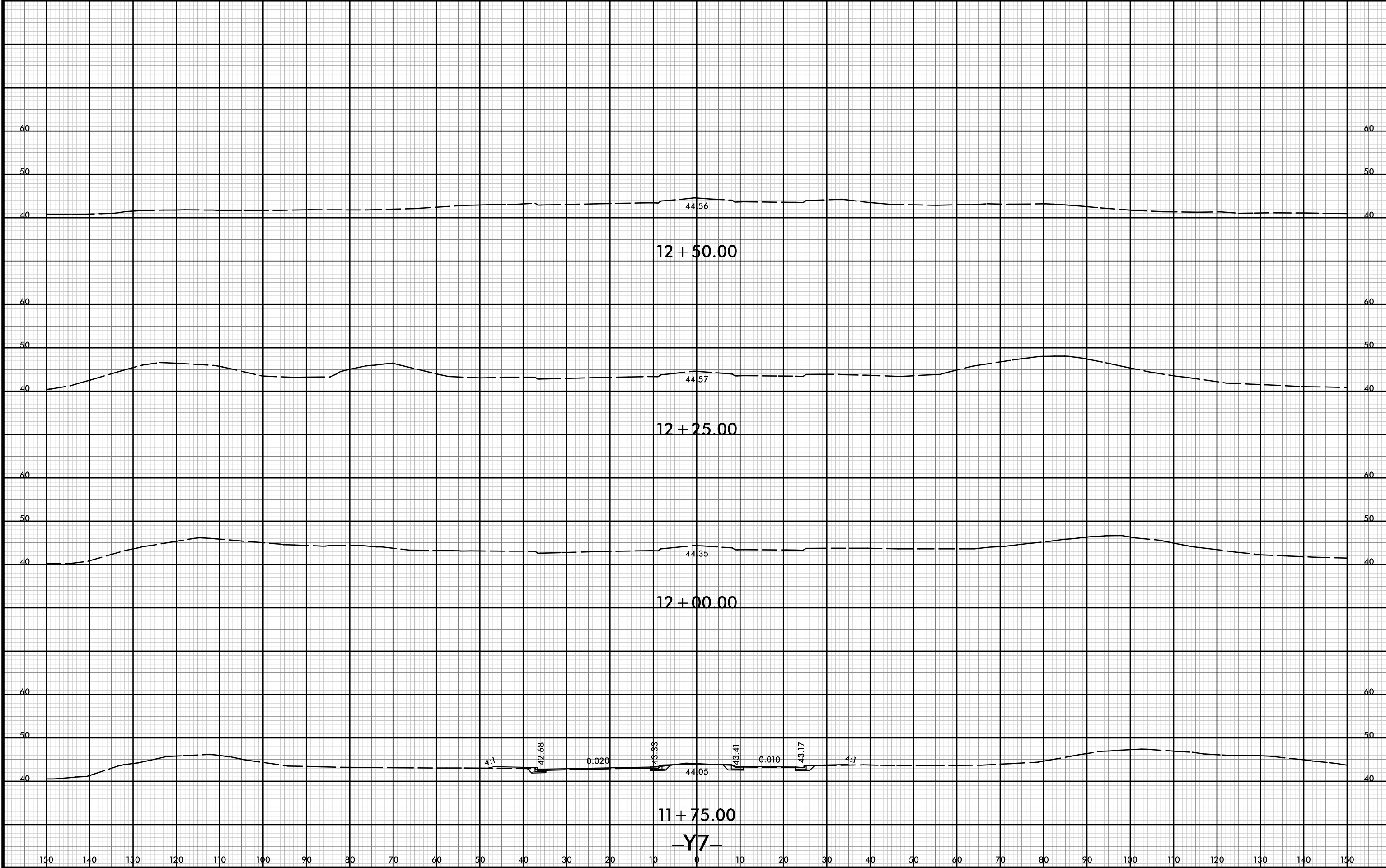

-Y7-

150 140 130 120 110 100 90 80 70 60 50 40 30 20 10 0 10 20 30 40 50 60 70 80 90 100 110 120 130 140 150

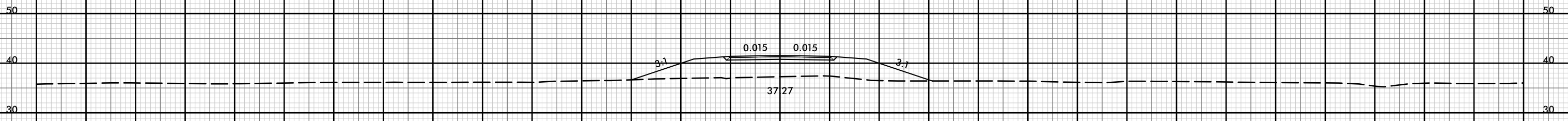

10 + 75.00

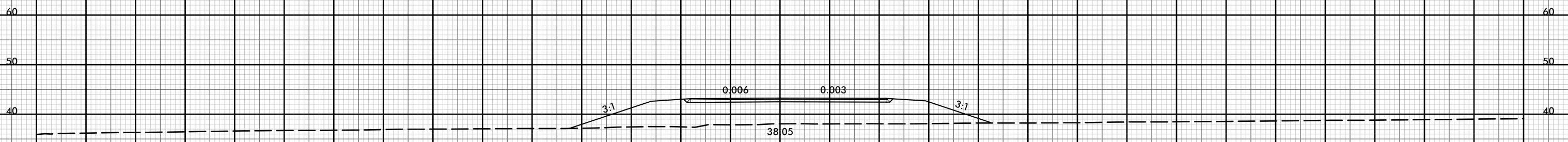

10 + 50.00

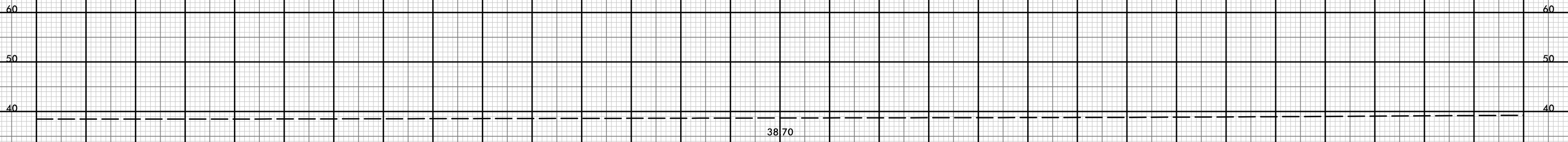

10 + 25.00

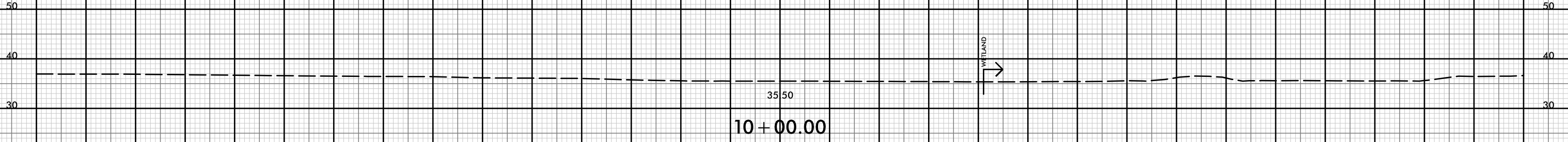

10 + 00.00

-Y8-

150 140 130 120 110 100 90 80 70 60 50 40 30 20 10 0 10 20 30 40 50 60 70 80 90 100 110 120 130 140 150



150 140 130 120 110 100 90 80 70 60 50 40 30 20 10 0 10 20 30 40 50 60 70 80 90 100 110 120 130 140 150

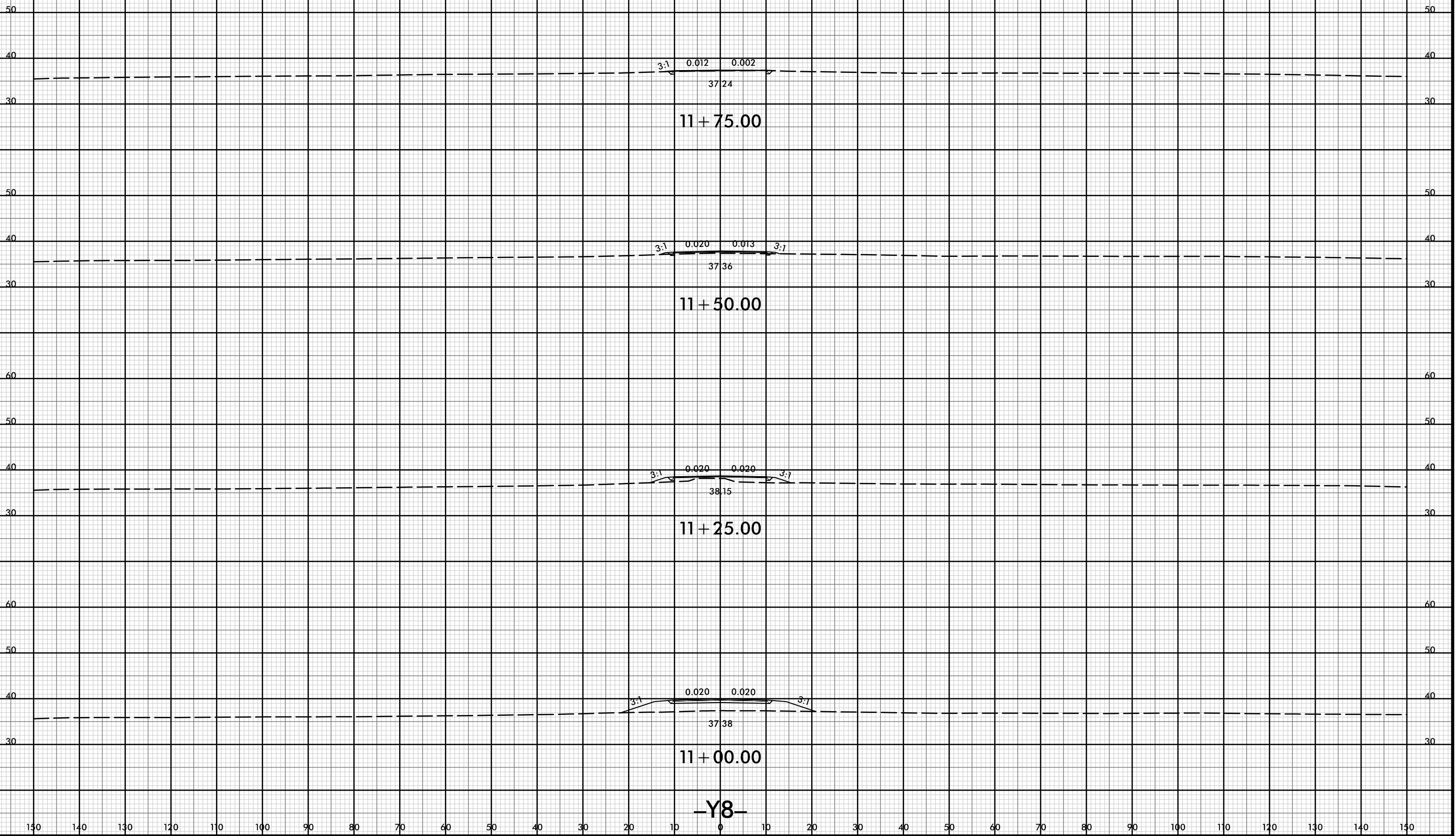

-Y8-



150 140 130 120 110 100 90 80 70 60 50 40 30 20 10 0 10 20 30 40 50 60 70 80 90 100 110 120 130 140 150

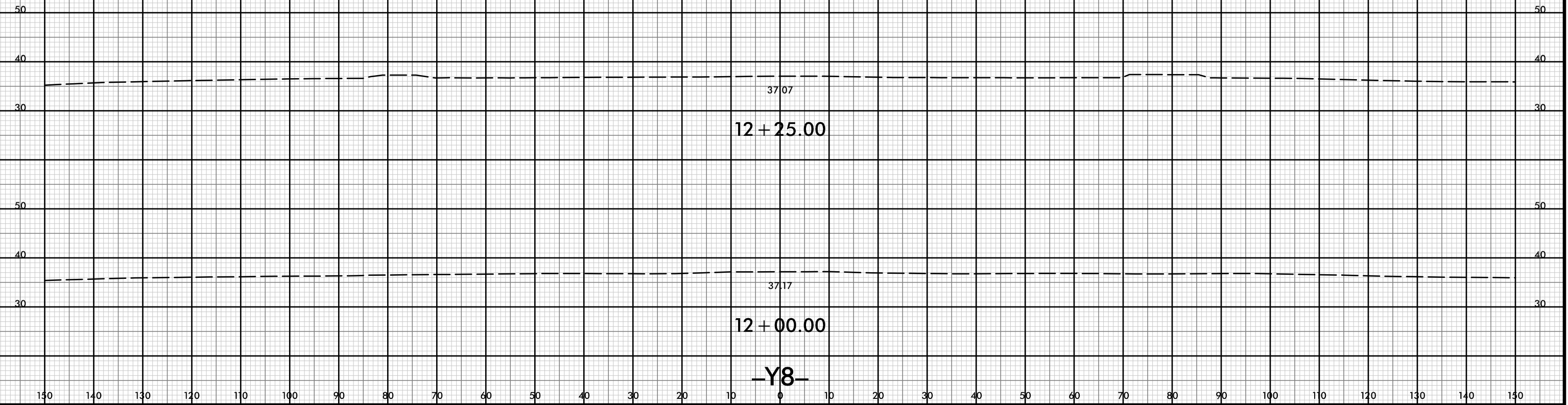

150 140 130 120 110 100 90 80 70 60 50 40 30 20 10 0 10 20 30 40 50 60 70 80 90 100 110 120 130 140 150

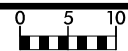

150 140 130 120 110 100 90 80 70 60 50 40 30 20 10 0 10 20 30 40 50 60 70 80 90 100 110 120 130 140 150

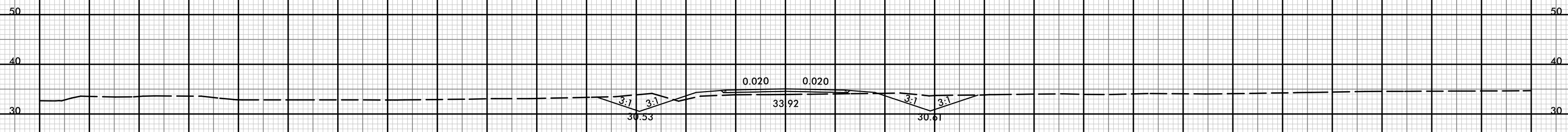

11 + 50.00

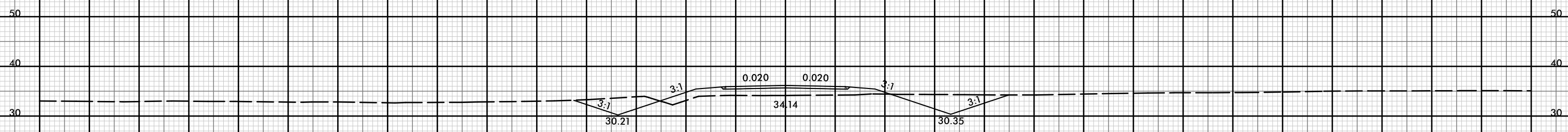

11 + 25.00

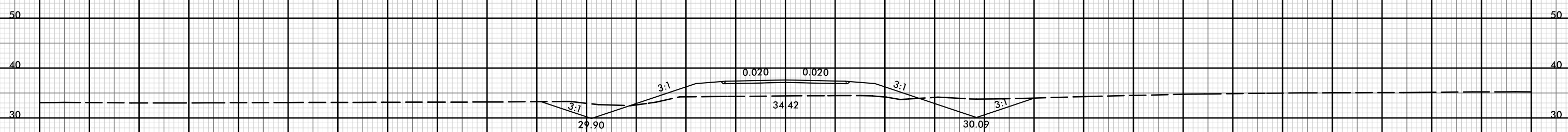

11 + 00.00

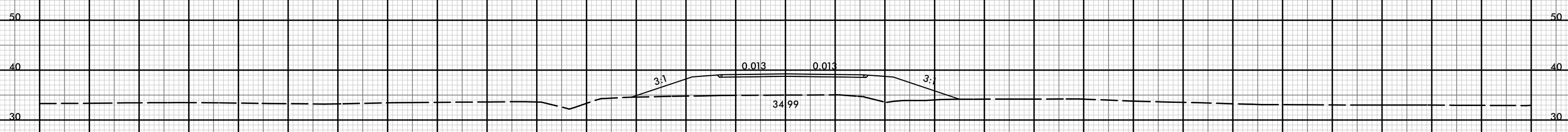

10 + 75.00

-Y9-

150 140 130 120 110 100 90 80 70 60 50 40 30 20 10 0 10 20 30 40 50 60 70 80 90 100 110 120 130 140 150

8/23/99



PROJ. REFERENCE NO.
R-5021

SHEET NO.
X-288

150 140 130 120 110 100 90 80 70 60 50 40 30 20 10 0 10 20 30 40 50 60 70 80 90 100 110 120 130 140 150

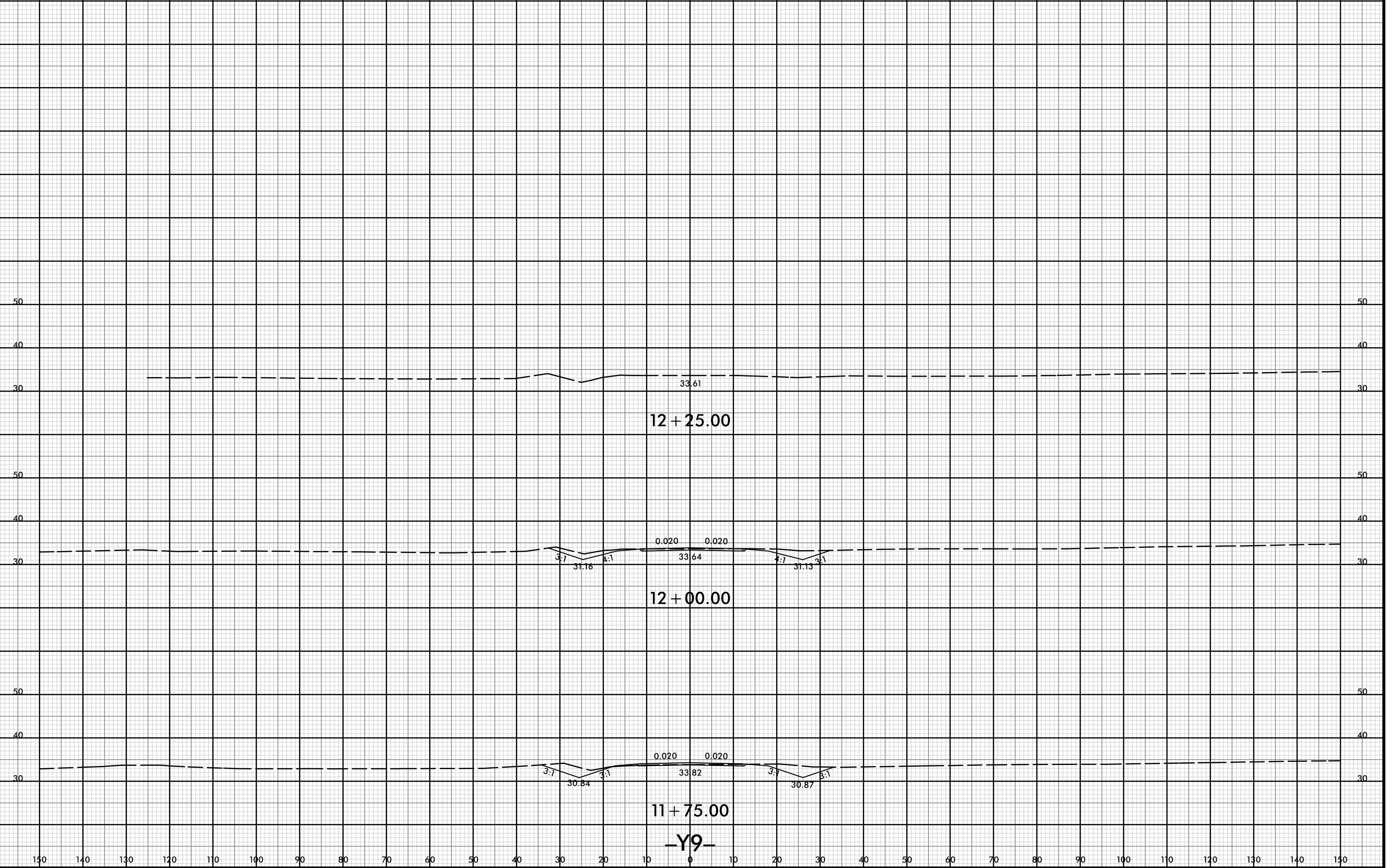

150 140 130 120 110 100 90 80 70 60 50 40 30 20 10 0 10 20 30 40 50 60 70 80 90 100 110 120 130 140 150

21-Jul-2021 10:38
P:\pawej\XSC\5021-rdy-yp-1-y9.dgn
HTB

8/23/99



PROJ. REFERENCE NO.
R-5021

SHEET NO.
X-289

150 140 130 120 110 100 90 80 70 60 50 40 30 20 10 0 10 20 30 40 50 60 70 80 90 100 110 120 130 140 150

50 50

40 40

30 30

10 + 75.00

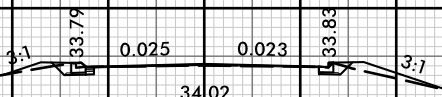

50 50

40 40

30 30

10 + 50.00

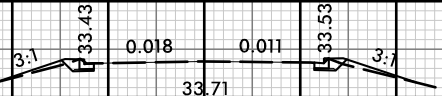

50 50

40 40

30 30

10 + 25.00

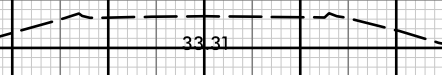

50 50

40 40

30 30

10 + 00.00

-Y9A-

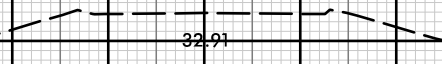

150 140 130 120 110 100 90 80 70 60 50 40 30 20 10 0 10 20 30 40 50 60 70 80 90 100 110 120 130 140 150

21-Jul-2021 10:38
\\P01dweu\XSC\5021-rdy-yp-l-y9a.dgn
HTB



150 140 130 120 110 100 90 80 70 60 50 40 30 20 10 0 10 20 30 40 50 60 70 80 90 100 110 120 130 140 150

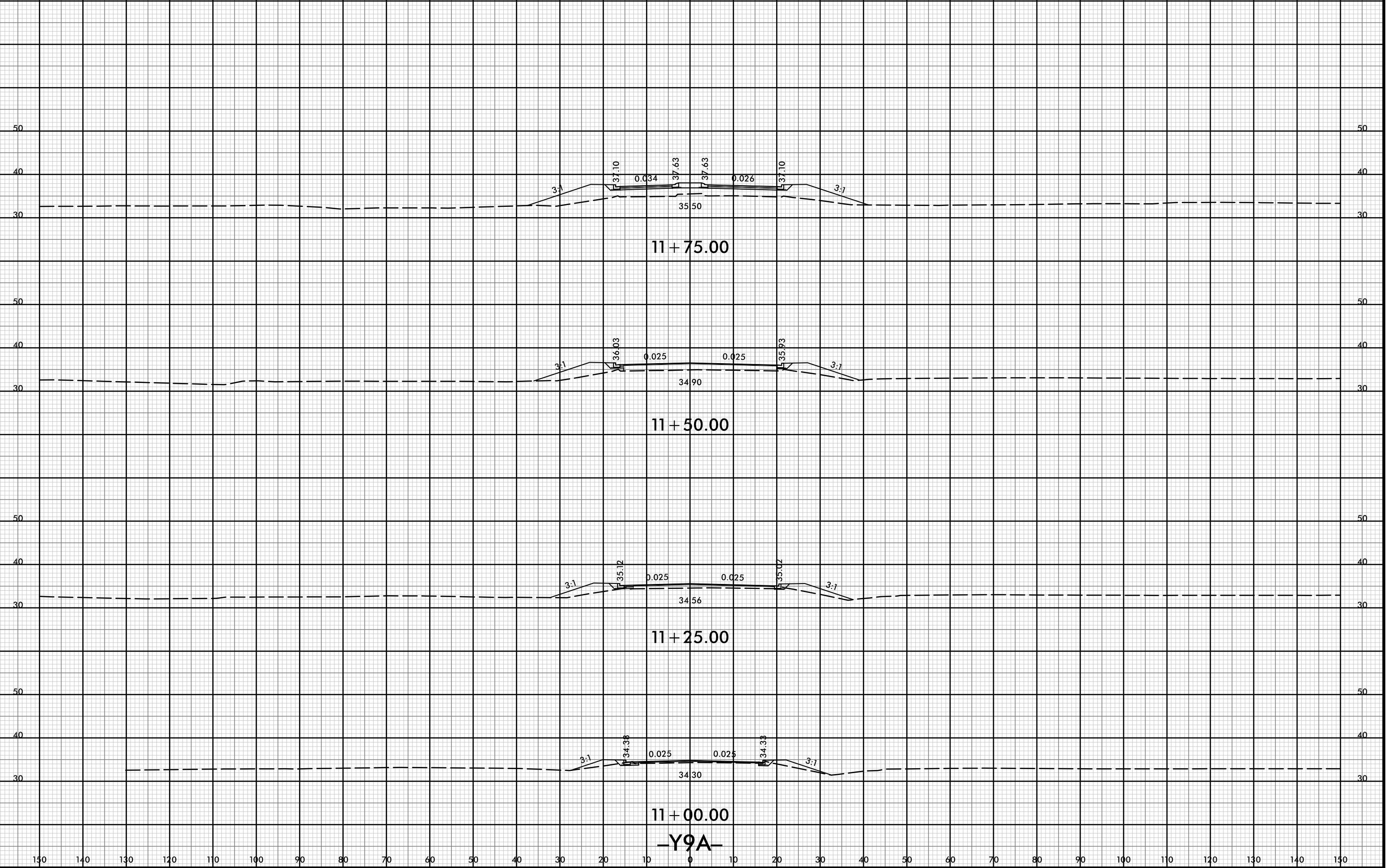

11+75.00

11+50.00

11+25.00

11+00.00

-Y9A-

8/23/99



| | |
|---------------------|-----------|
| PROJ. REFERENCE NO. | SHEET NO. |
| R-5021 | X-291 |

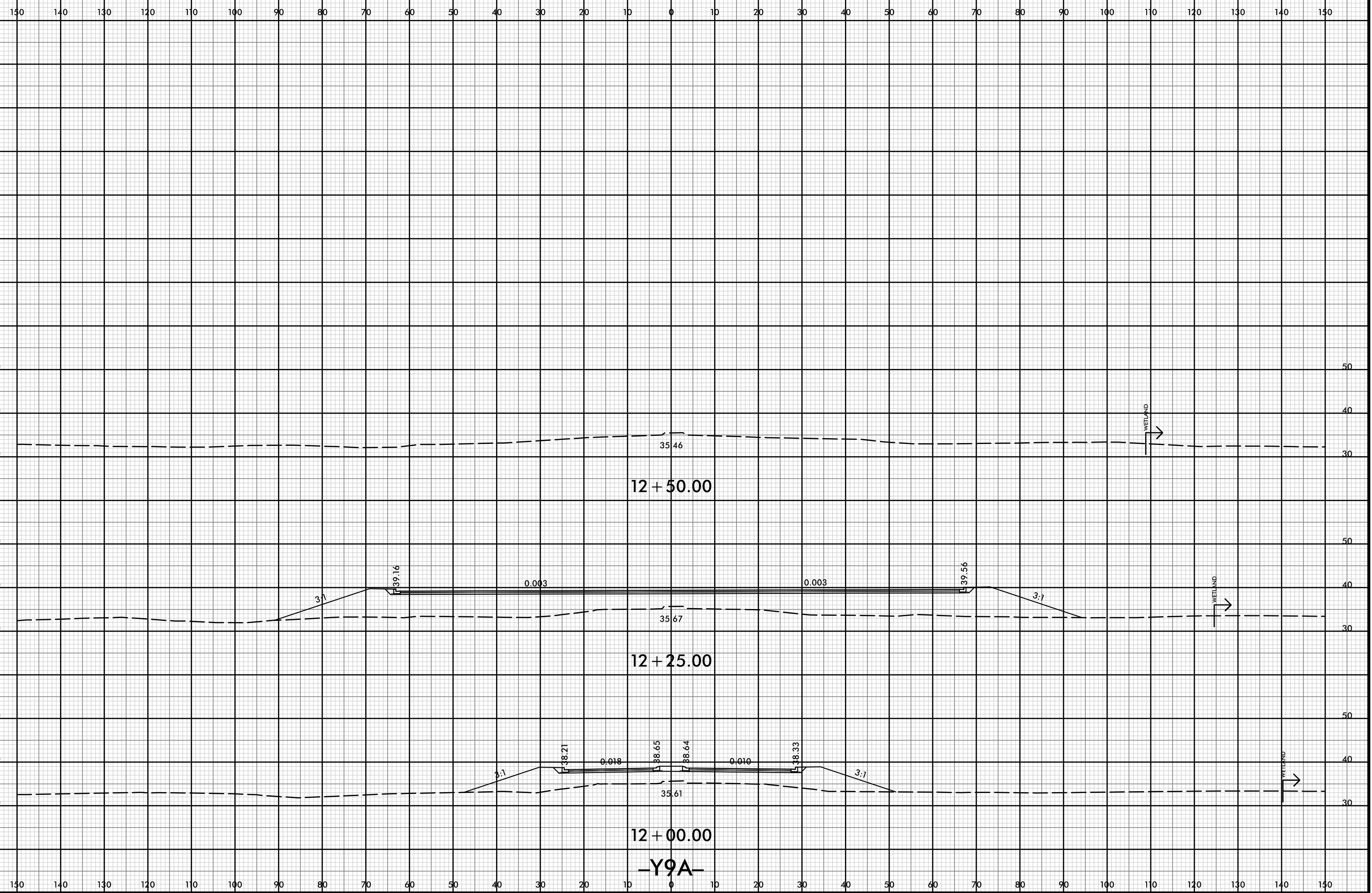

21-Jul-2021 10:38
 R:\p\dawej\XSCA\5021-rdy-yp-l-y9a.dgn
 HNTB



150 140 130 120 110 100 90 80 70 60 50 40 30 20 10 0 10 20 30 40 50 60 70 80 90 100 110 120 130 140 150

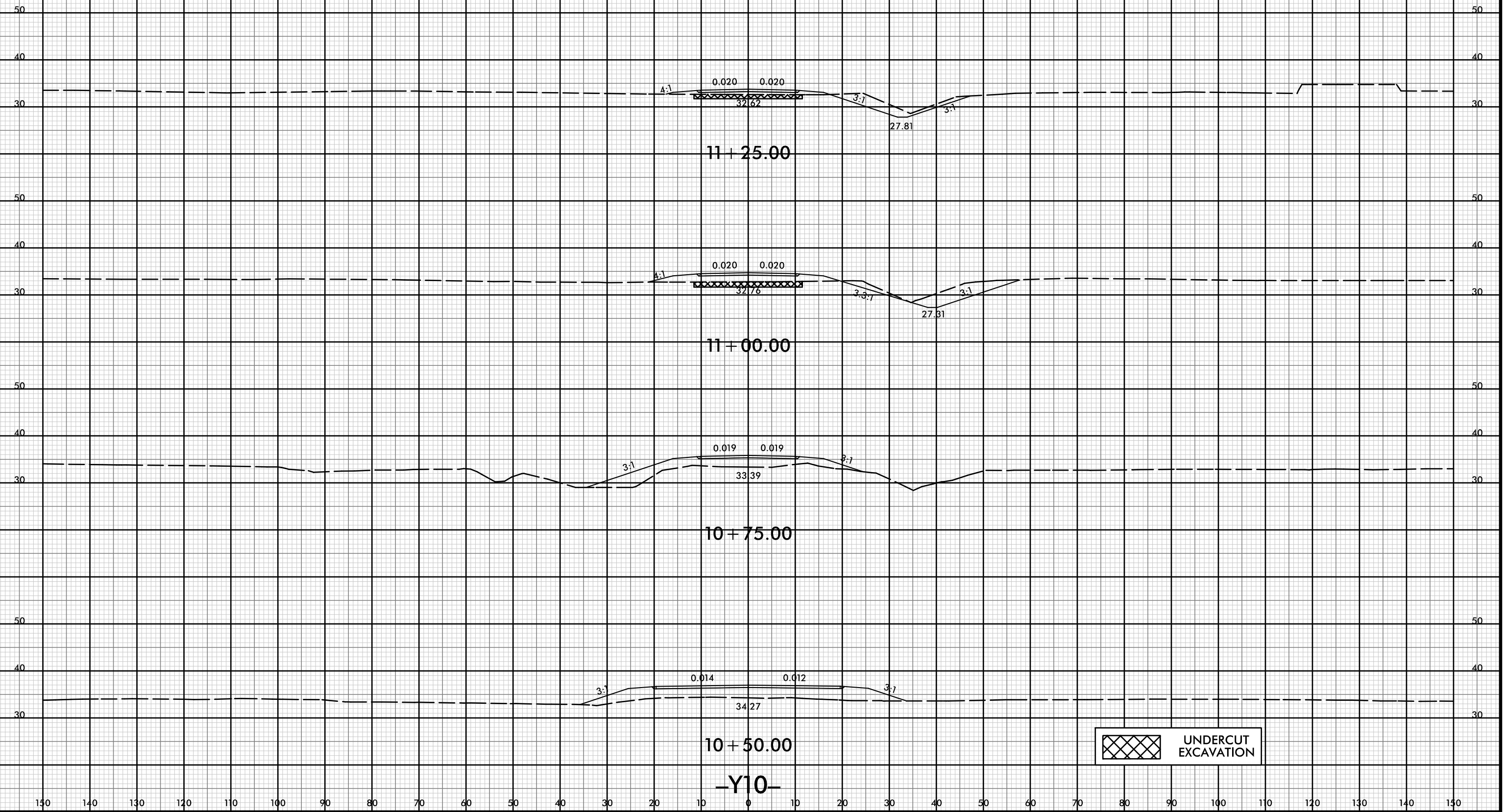

11 + 25.00

11 + 00.00

10 + 75.00

10 + 50.00

-Y10-

 UNDERCUT EXCAVATION

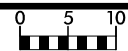

150 140 130 120 110 100 90 80 70 60 50 40 30 20 10 0 10 20 30 40 50 60 70 80 90 100 110 120 130 140 150

50 50

40 40

30 30

12 + 00.00

50 50

40 40

30 30

11 + 75.00

50 50

40 40

30 30

11 + 50.00

-Y10-

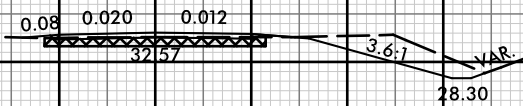
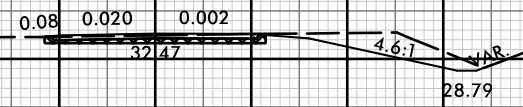

150 140 130 120 110 100 90 80 70 60 50 40 30 20 10 0 10 20 30 40 50 60 70 80 90 100 110 120 130 140 150

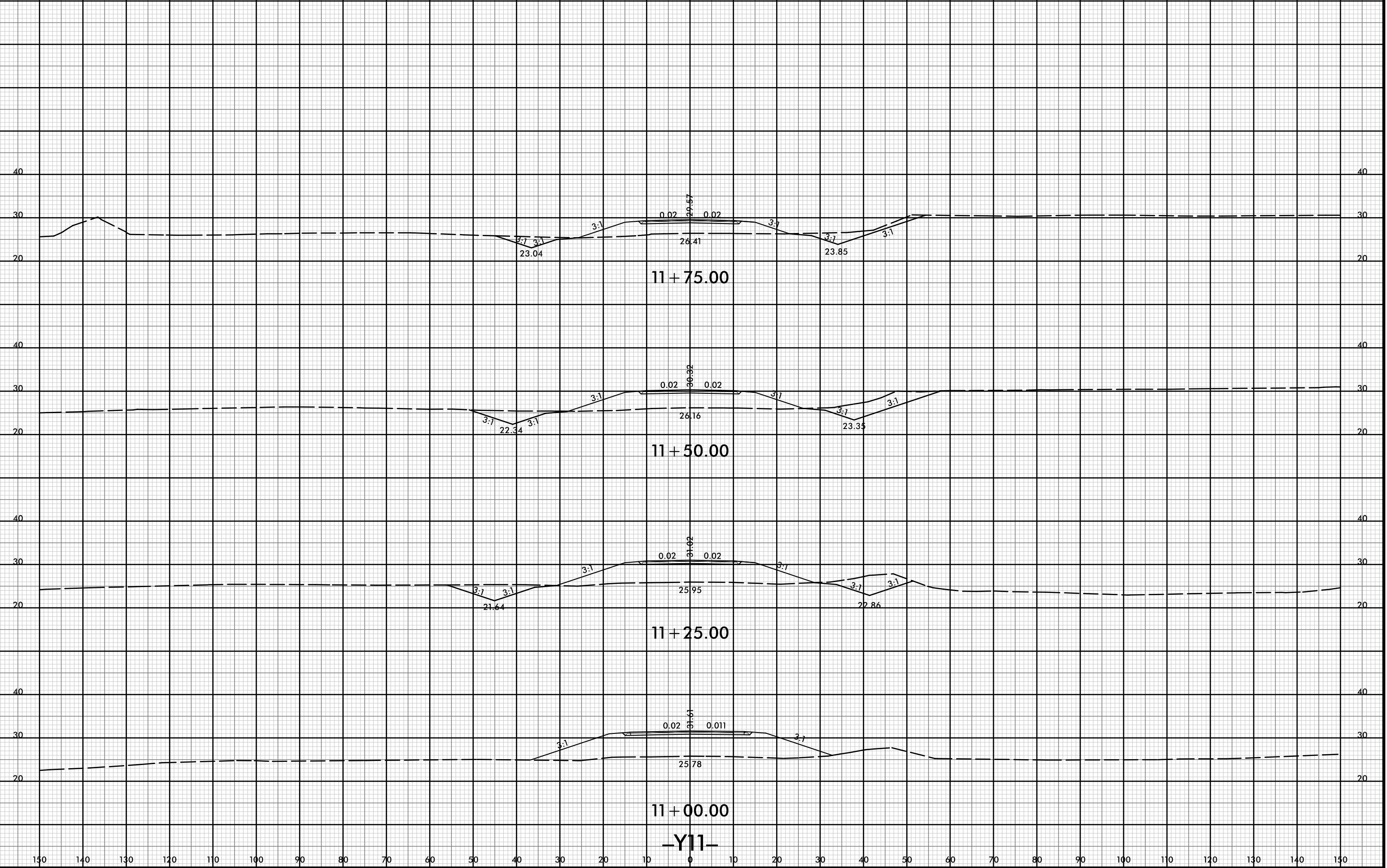

-Y11-



150 140 130 120 110 100 90 80 70 60 50 40 30 20 10 0 10 20 30 40 50 60 70 80 90 100 110 120 130 140 150

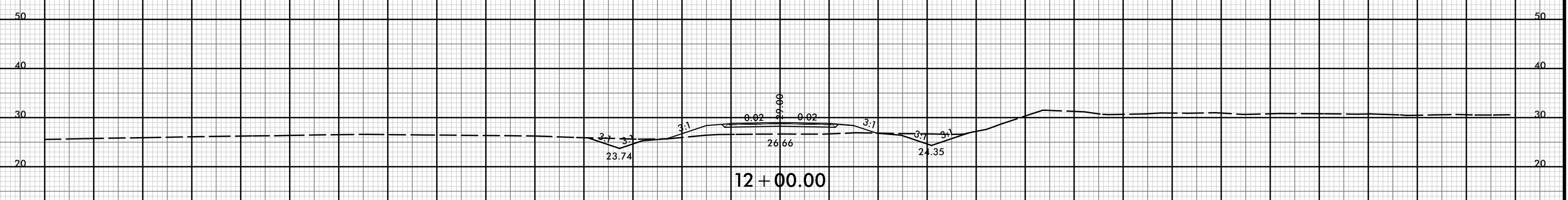
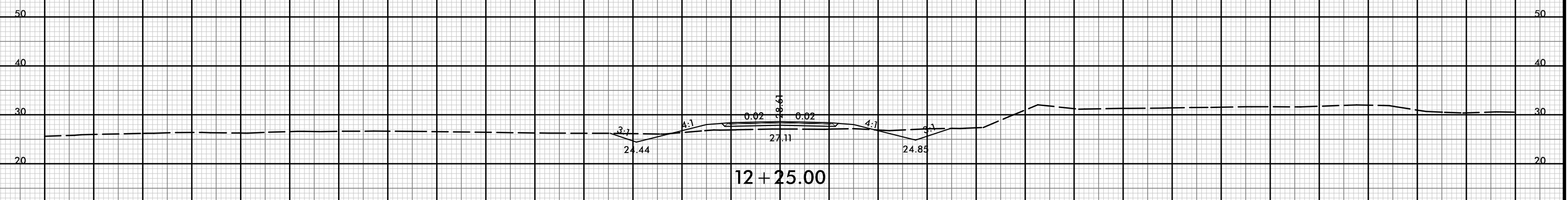
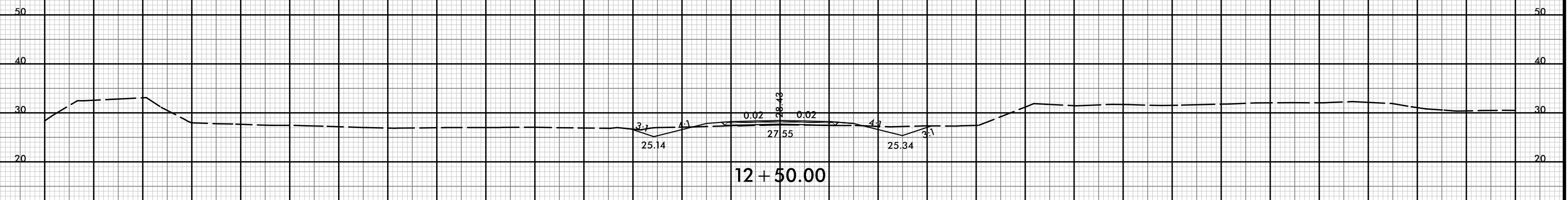

-Y11-



150 140 130 120 110 100 90 80 70 60 50 40 30 20 10 0 10 20 30 40 50 60 70 80 90 100 110 120 130 140 150

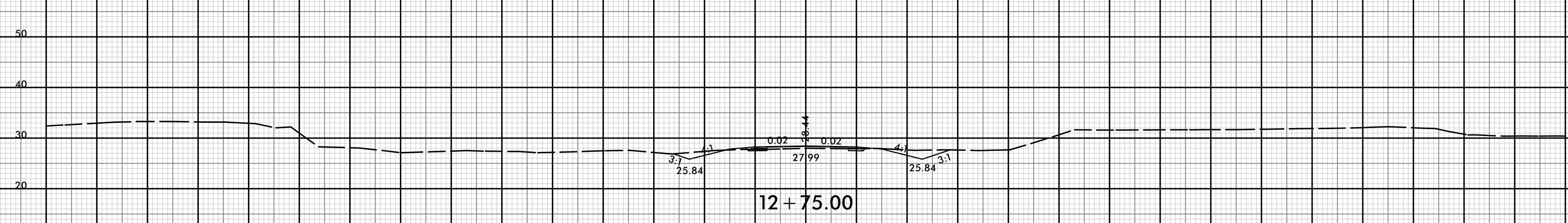
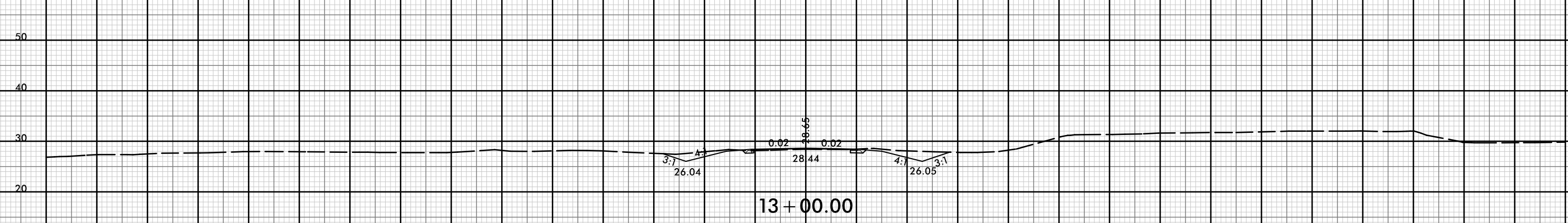
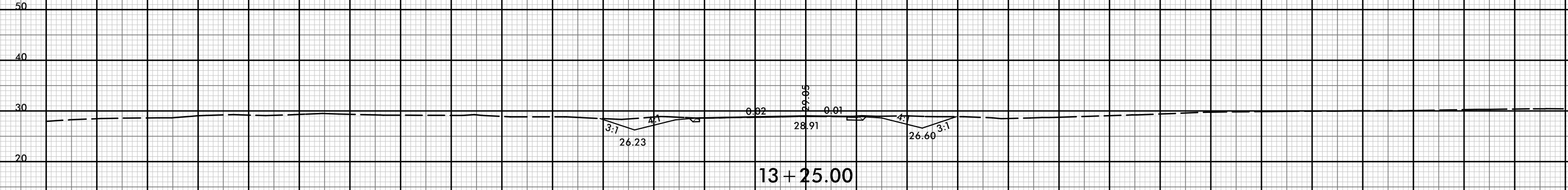
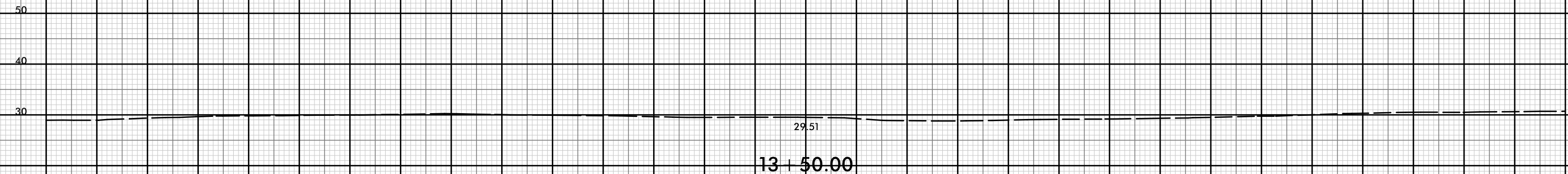

-Y11-

150 140 130 120 110 100 90 80 70 60 50 40 30 20 10 0 10 20 30 40 50 60 70 80 90 100 110 120 130 140 150



150 140 130 120 110 100 90 80 70 60 50 40 30 20 10 0 10 20 30 40 50 60 70 80 90 100 110 120 130 140 150

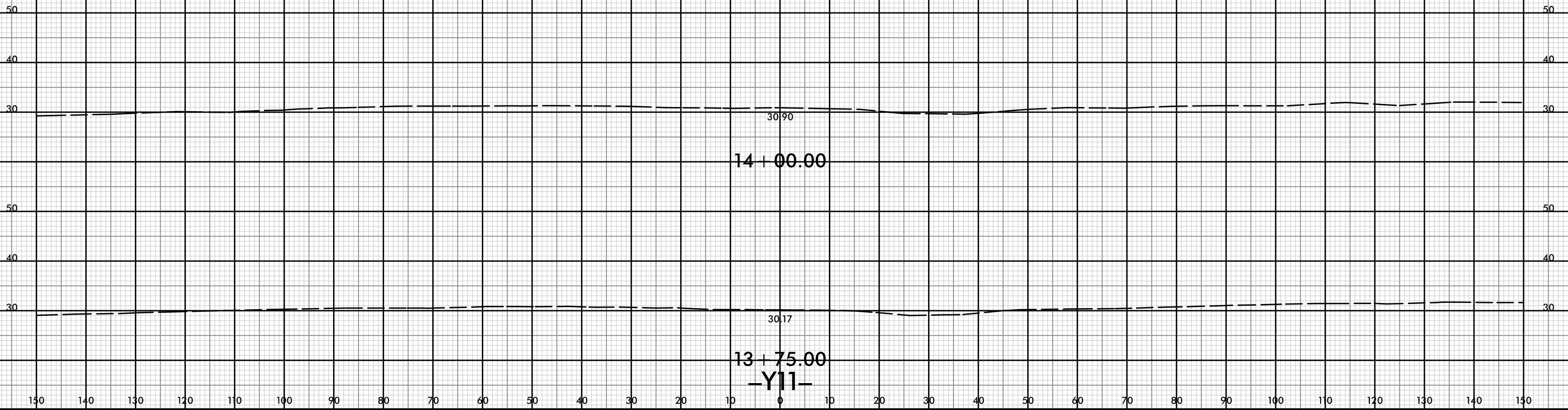

150 140 130 120 110 100 90 80 70 60 50 40 30 20 10 0 10 20 30 40 50 60 70 80 90 100 110 120 130 140 150



150 140 130 120 110 100 90 80 70 60 50 40 30 20 10 0 10 20 30 40 50 60 70 80 90 100 110 120 130 140 150

50 50

40 40

30 30

0.007 0.023
30.39 27.00
4:1 3:1

11 + 75.00

50 50

40 40

30 30

30.48

11 + 50.00

50 50

40 40

30 30

11 + 25.00

50 50

40 40

30 30

11 + 00.00

-Y12-

150 140 130 120 110 100 90 80 70 60 50 40 30 20 10 0 10 20 30 40 50 60 70 80 90 100 110 120 130 140 150

8/23/99



PROJ. REFERENCE NO.
R-5021

SHEET NO.
X-299

150 140 130 120 110 100 90 80 70 60 50 40 30 20 10 0 10 20 30 40 50 60 70 80 90 100 110 120 130 140 150

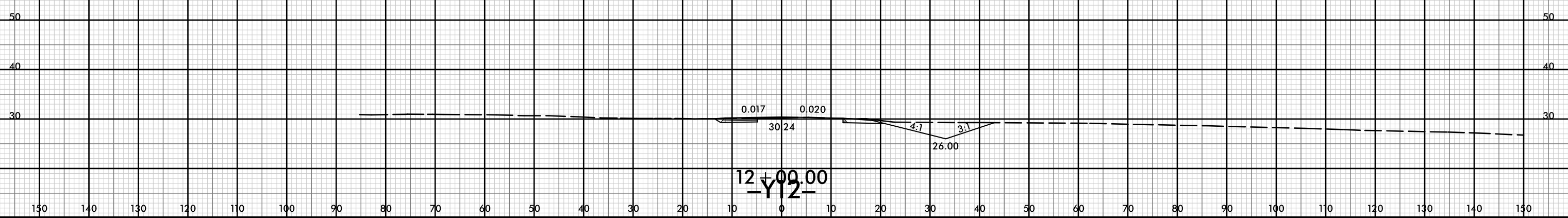
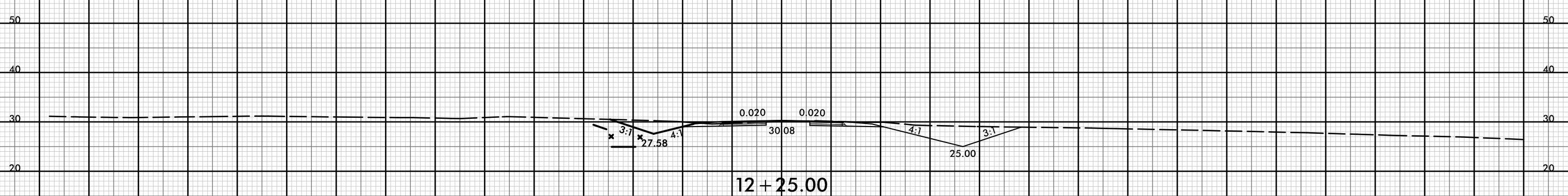
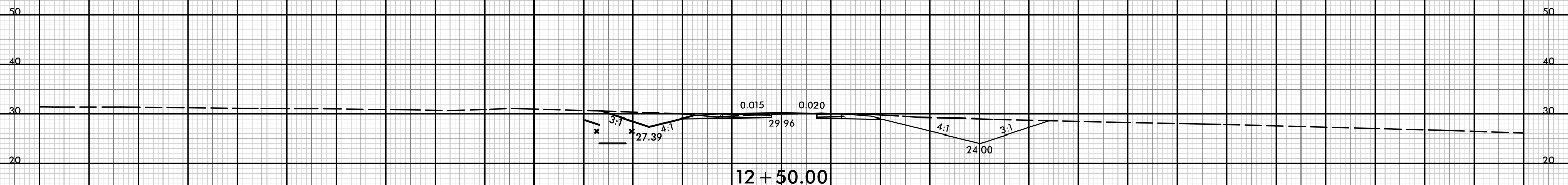
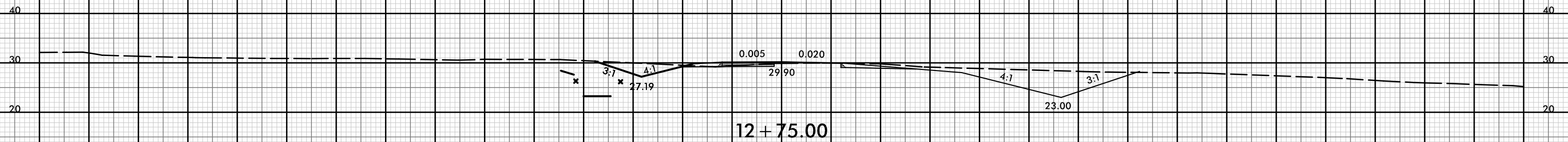

150 140 130 120 110 100 90 80 70 60 50 40 30 20 10 0 10 20 30 40 50 60 70 80 90 100 110 120 130 140 150

21-Jul-2021 10:38
R:\p\dawej\XSCA\5021-rdy-yp-1-Y12.dgn
HTB

8/23/99



PROJ. REFERENCE NO.
R-5021

SHEET NO.
X-300

150 140 130 120 110 100 90 80 70 60 50 40 30 20 10 0 10 20 30 40 50 60 70 80 90 100 110 120 130 140 150

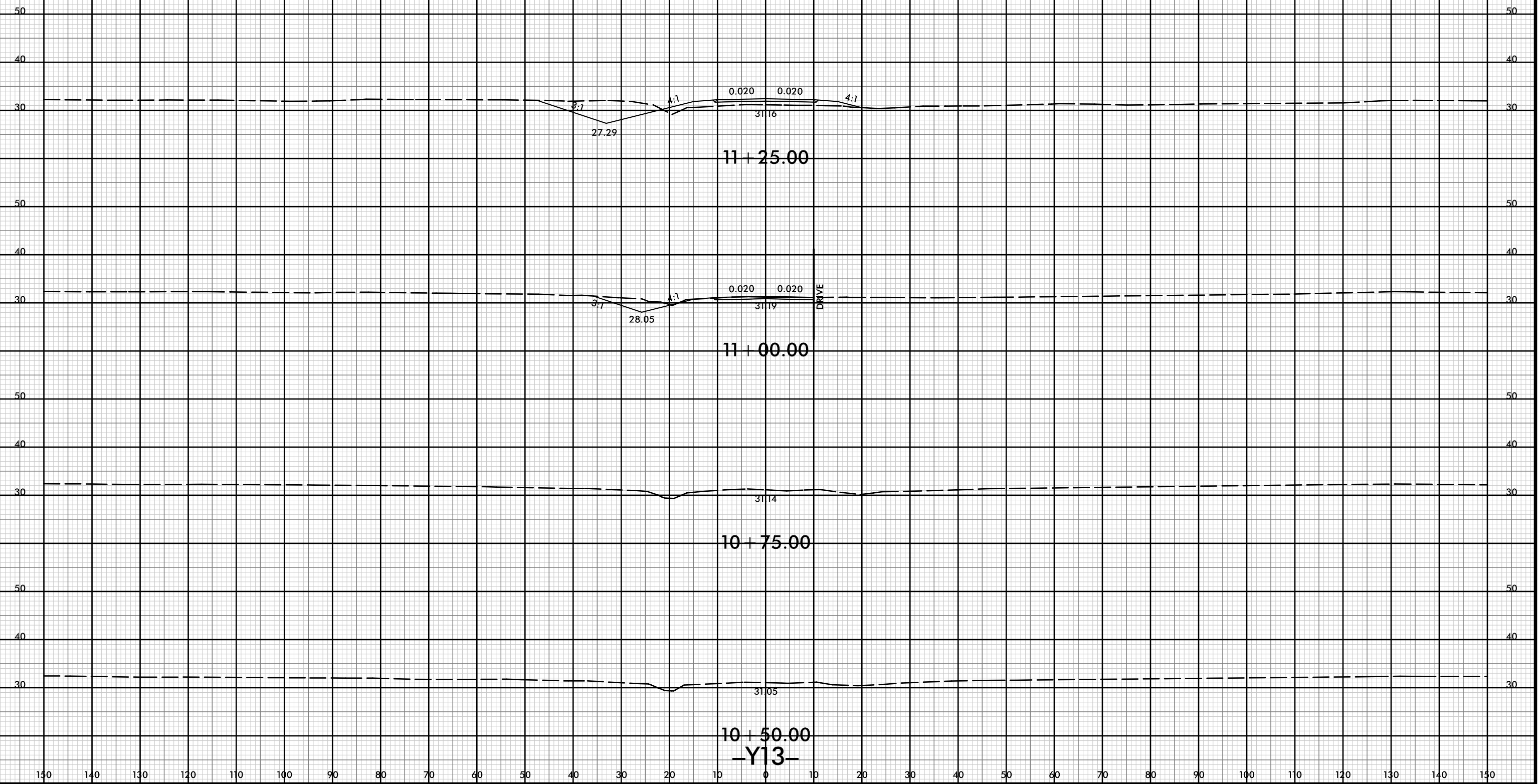

21-JUL-2021 10:38
R:\p\dawej\XSCA\5021-rdy-xp-l-Y13.dgn
HTFB

150 140 130 120 110 100 90 80 70 60 50 40 30 20 10 0 10 20 30 40 50 60 70 80 90 100 110 120 130 140 150

-Y13-

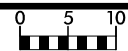

150 140 130 120 110 100 90 80 70 60 50 40 30 20 10 0 10 20 30 40 50 60 70 80 90 100 110 120 130 140 150

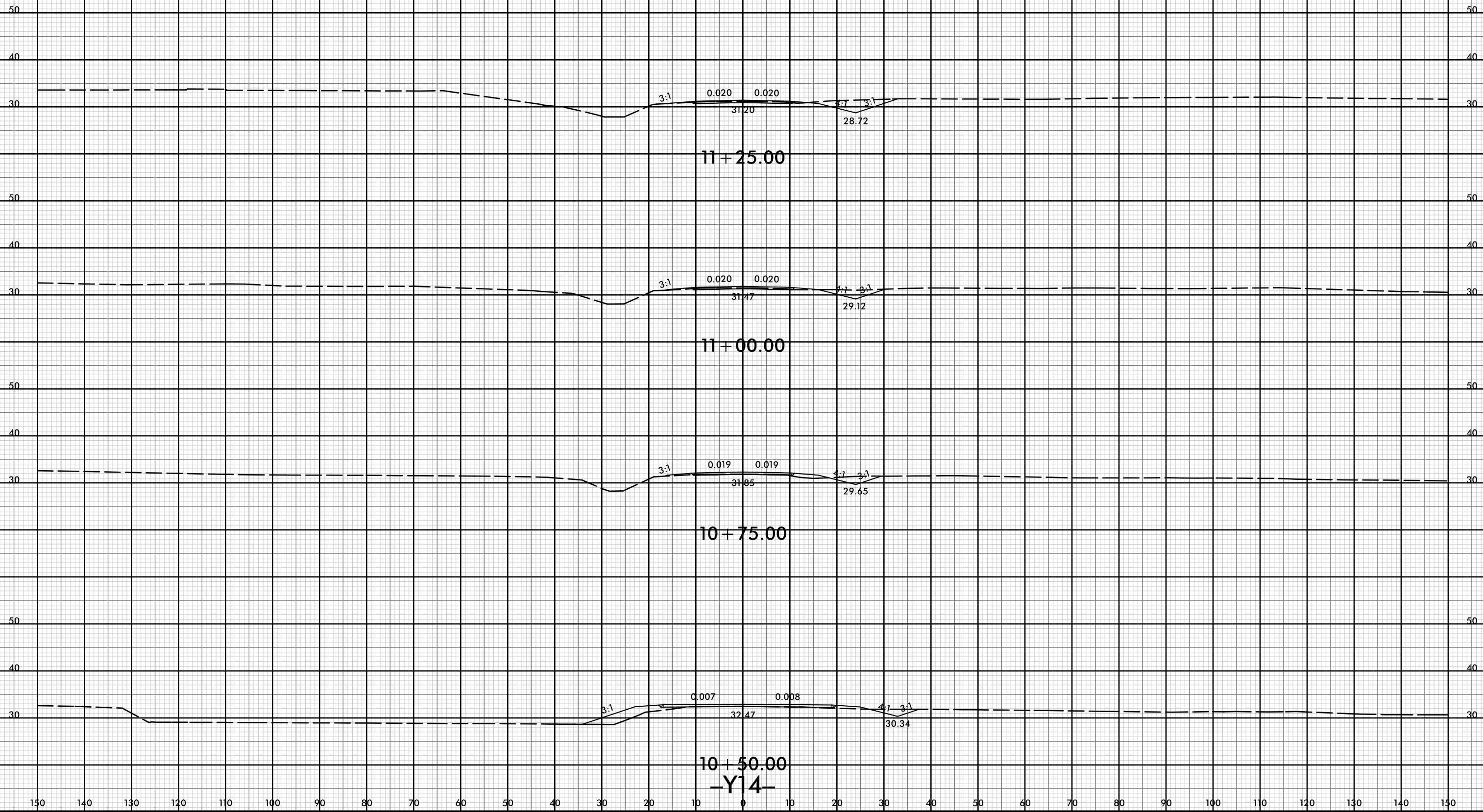

11 + 25.00

11 + 00.00

10 + 75.00

10 + 50.00

-Y14-



150 140 130 120 110 100 90 80 70 60 50 40 30 20 10 0 10 20 30 40 50 60 70 80 90 100 110 120 130 140 150

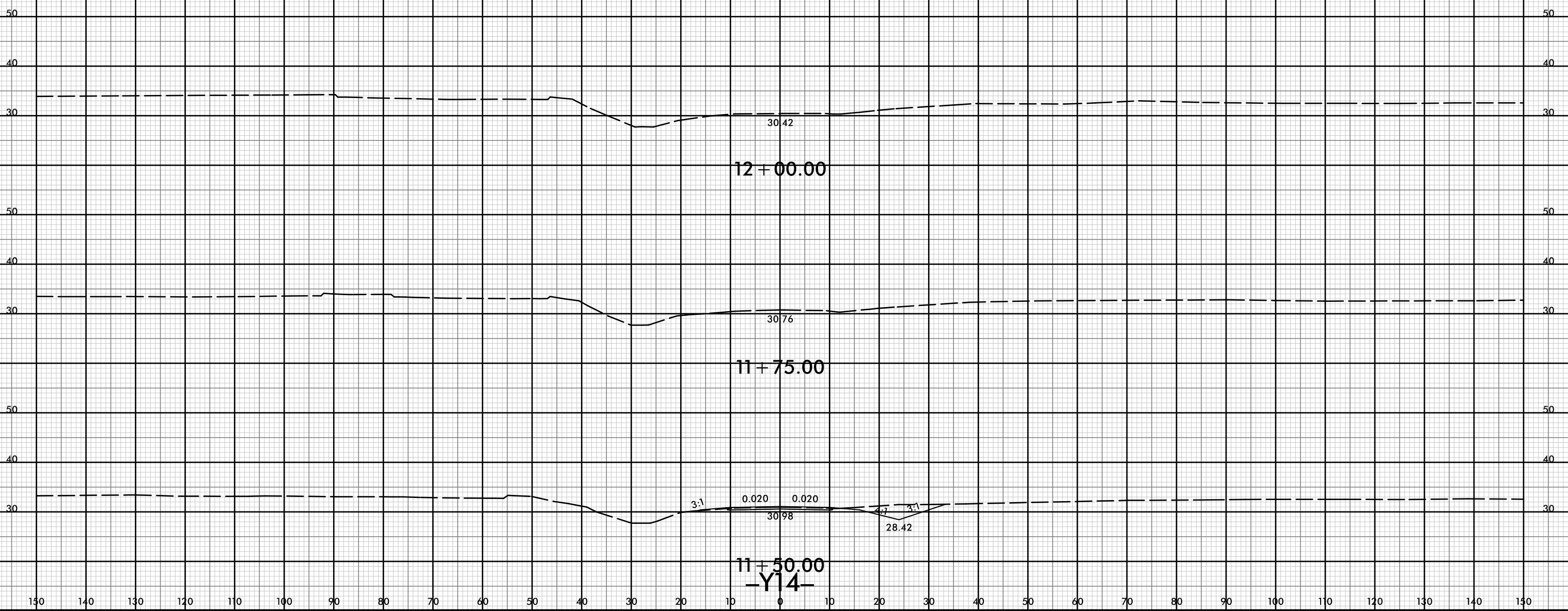



150 140 130 120 110 100 90 80 70 60 50 40 30 20 10 0 10 20 30 40 50 60 70 80 90 100 110 120 130 140 150

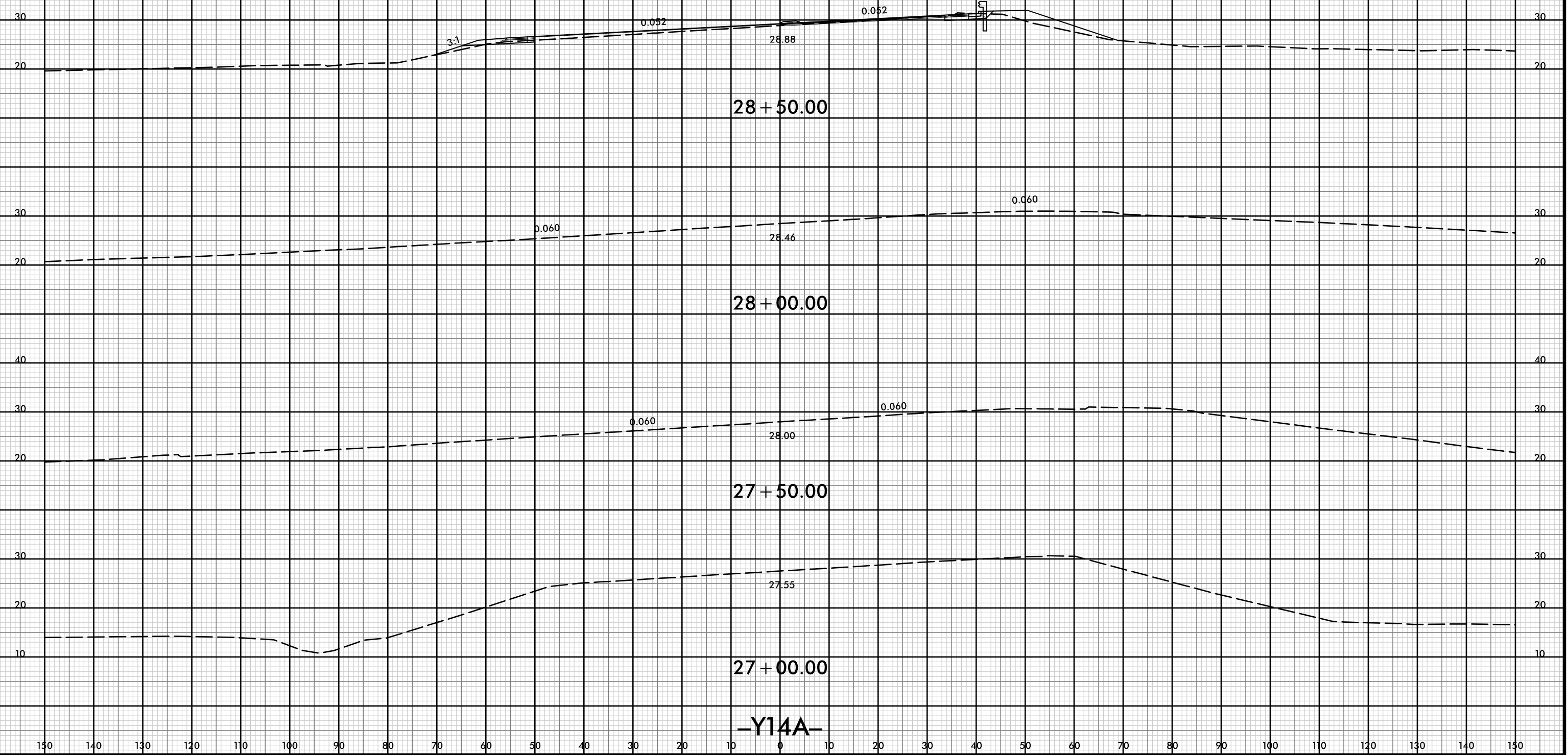

-Y14A-

150 140 130 120 110 100 90 80 70 60 50 40 30 20 10 0 10 20 30 40 50 60 70 80 90 100 110 120 130 140 150

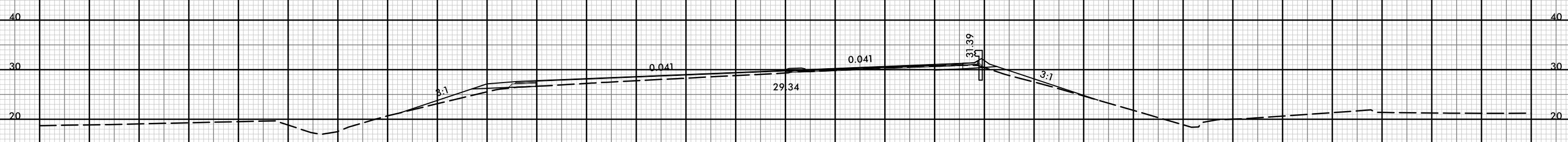
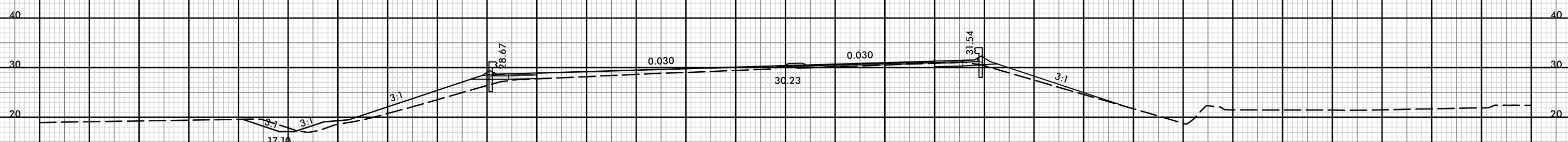
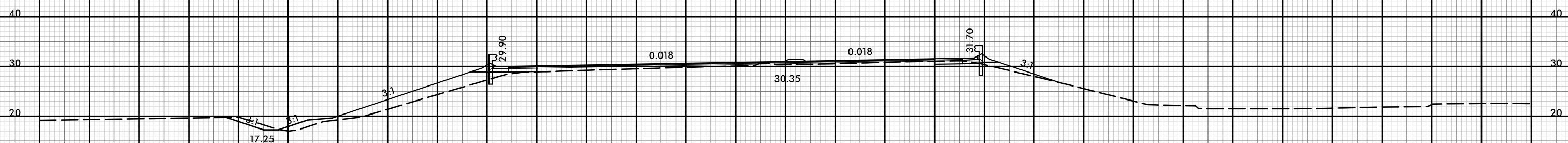
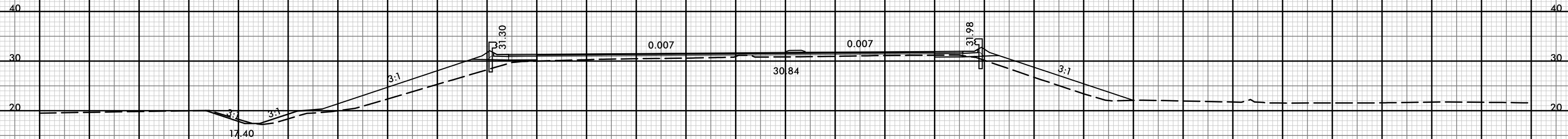

29 + 00.00
-Y14A-

150 140 130 120 110 100 90 80 70 60 50 40 30 20 10 0 10 20 30 40 50 60 70 80 90 100 110 120 130 140 150

8/23/99



| | |
|---------------------|-----------|
| PROJ. REFERENCE NO. | SHEET NO. |
| R-5021 | X-305 |

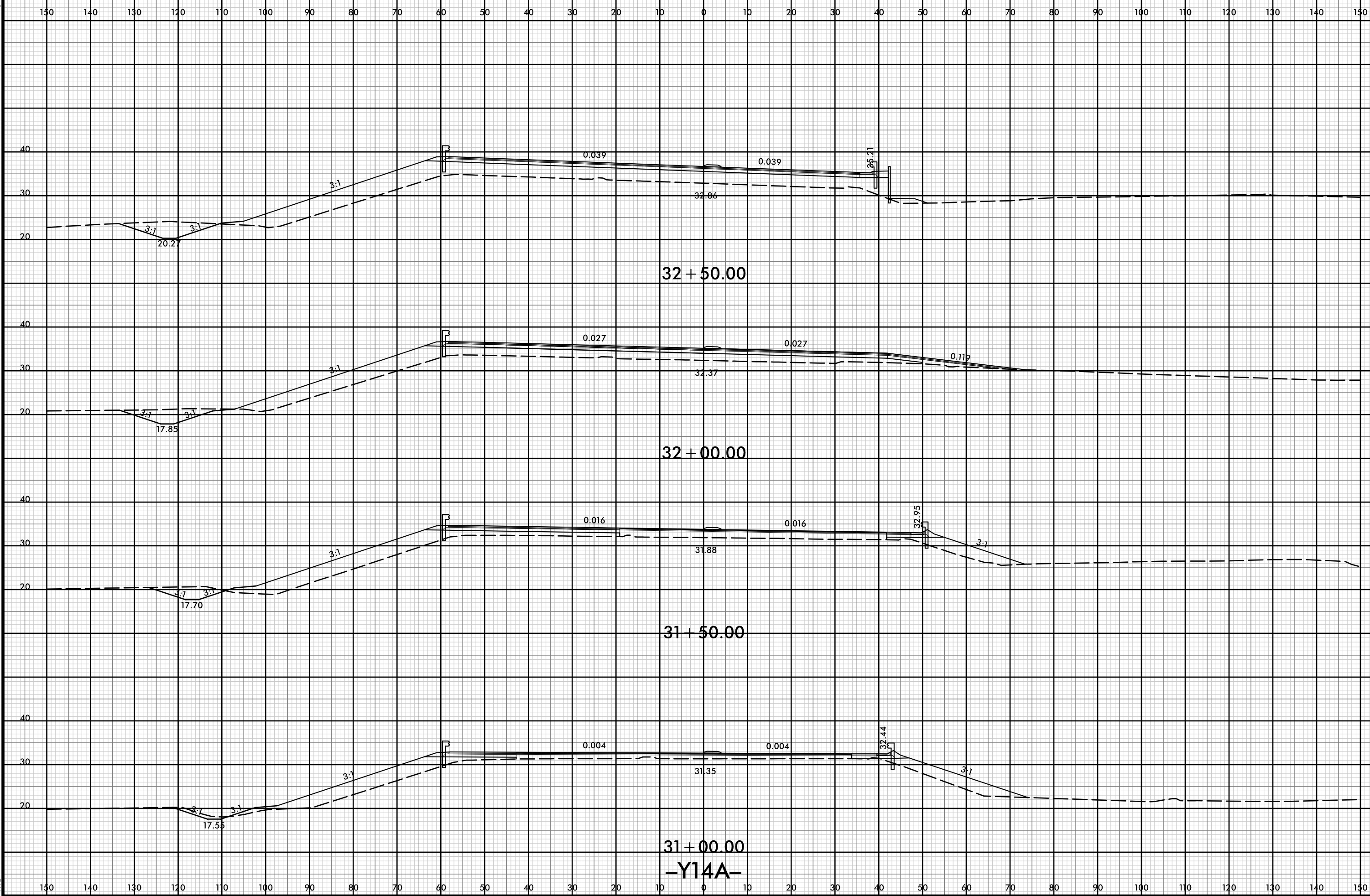

21-Jul-2021 10:39
R:\p\dawej\XSCA\5021-rdy-yp-l-Y14A.dgn
HNTB

8/23/99



| | |
|---------------------|-----------|
| PROJ. REFERENCE NO. | SHEET NO. |
| R-5021 | X-306 |

150 140 130 120 110 100 90 80 70 60 50 40 30 20 10 0 10 20 30 40 50 60 70 80 90 100 110 120 130 140 150

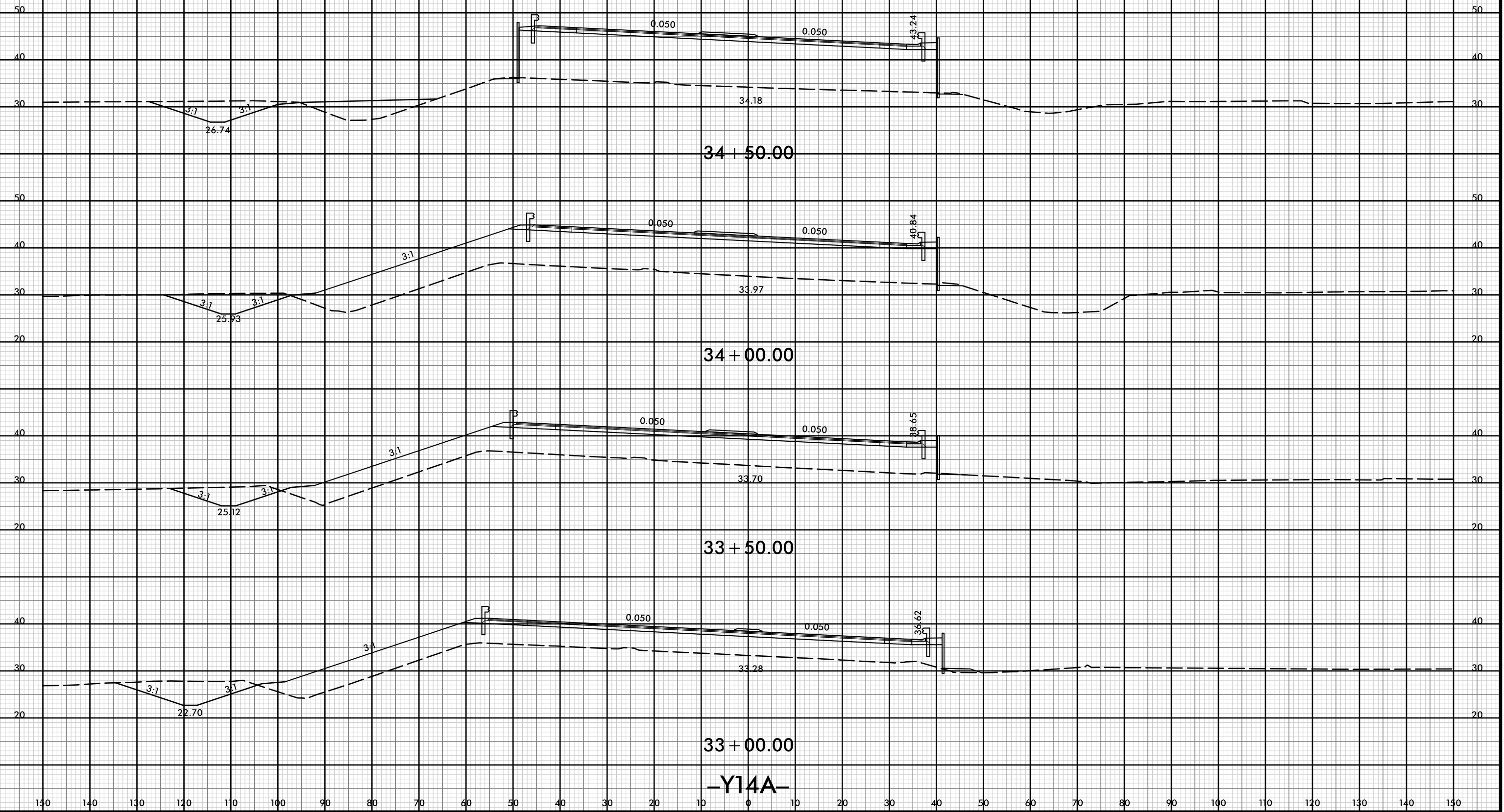

21-Jul-2021 10:39
 R:\pawej\XSCA\5021-rdy-xp-l\Y14A.dgn
 HNTB

150 140 130 120 110 100 90 80 70 60 50 40 30 20 10 0 10 20 30 40 50 60 70 80 90 100 110 120 130 140 150



150 140 130 120 110 100 90 80 70 60 50 40 30 20 10 0 10 20 30 40 50 60 70 80 90 100 110 120 130 140 150

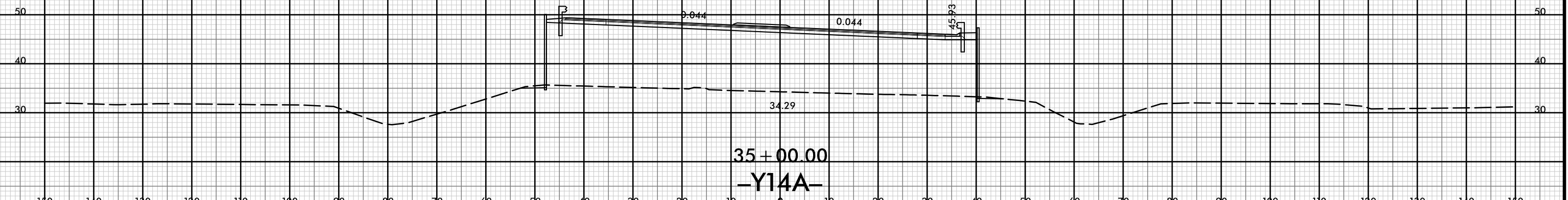
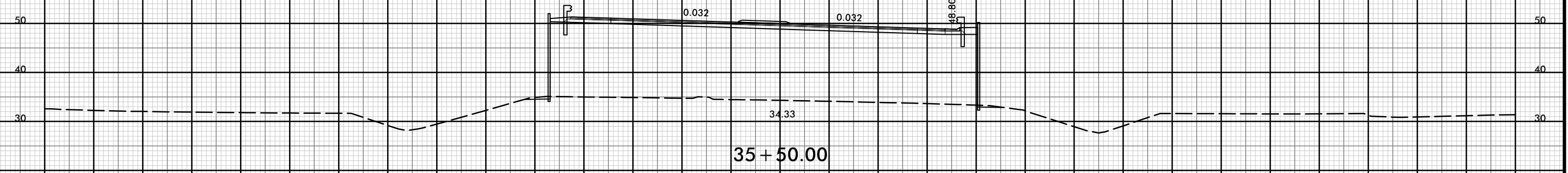
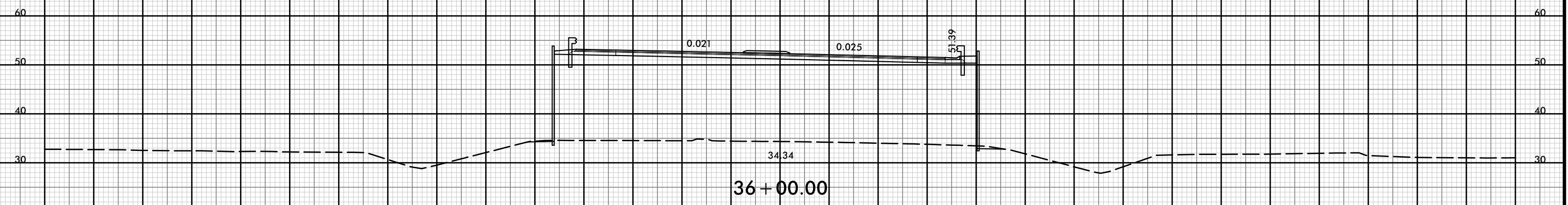
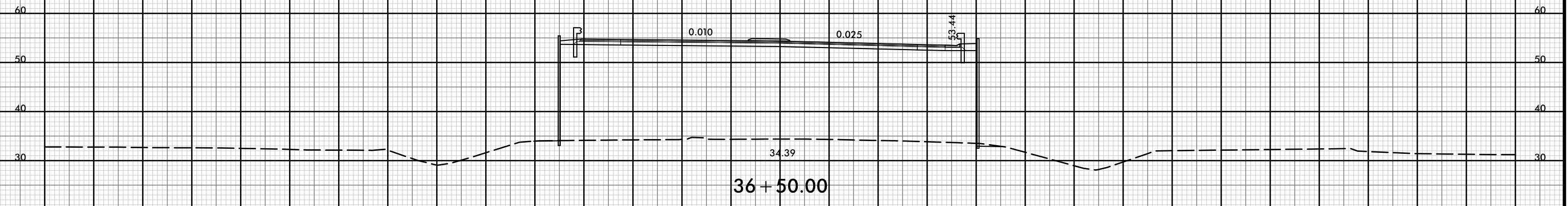

150 140 130 120 110 100 90 80 70 60 50 40 30 20 10 0 10 20 30 40 50 60 70 80 90 100 110 120 130 140 150

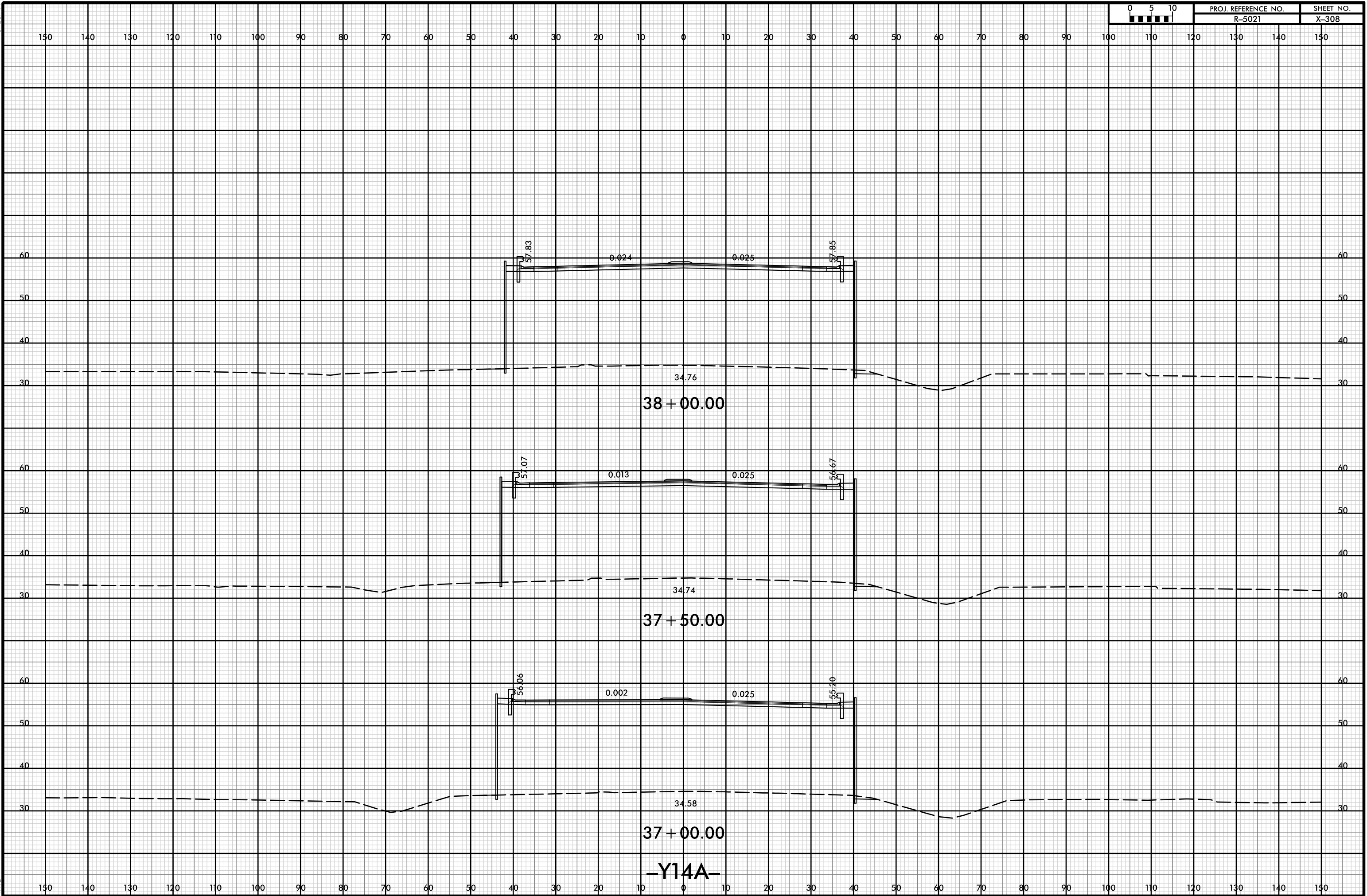

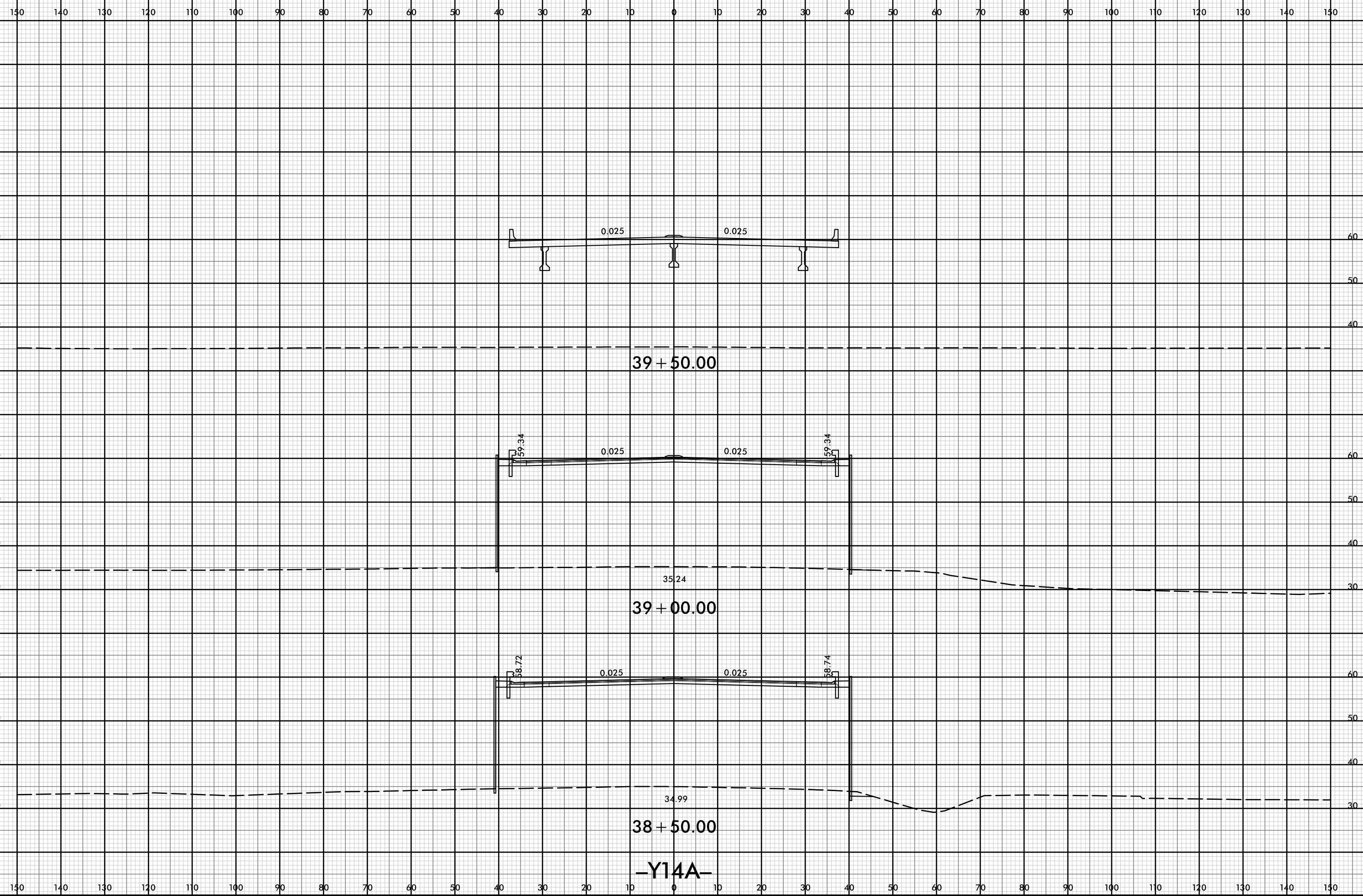

150 140 130 120 110 100 90 80 70 60 50 40 30 20 10 0 10 20 30 40 50 60 70 80 90 100 110 120 130 140 150

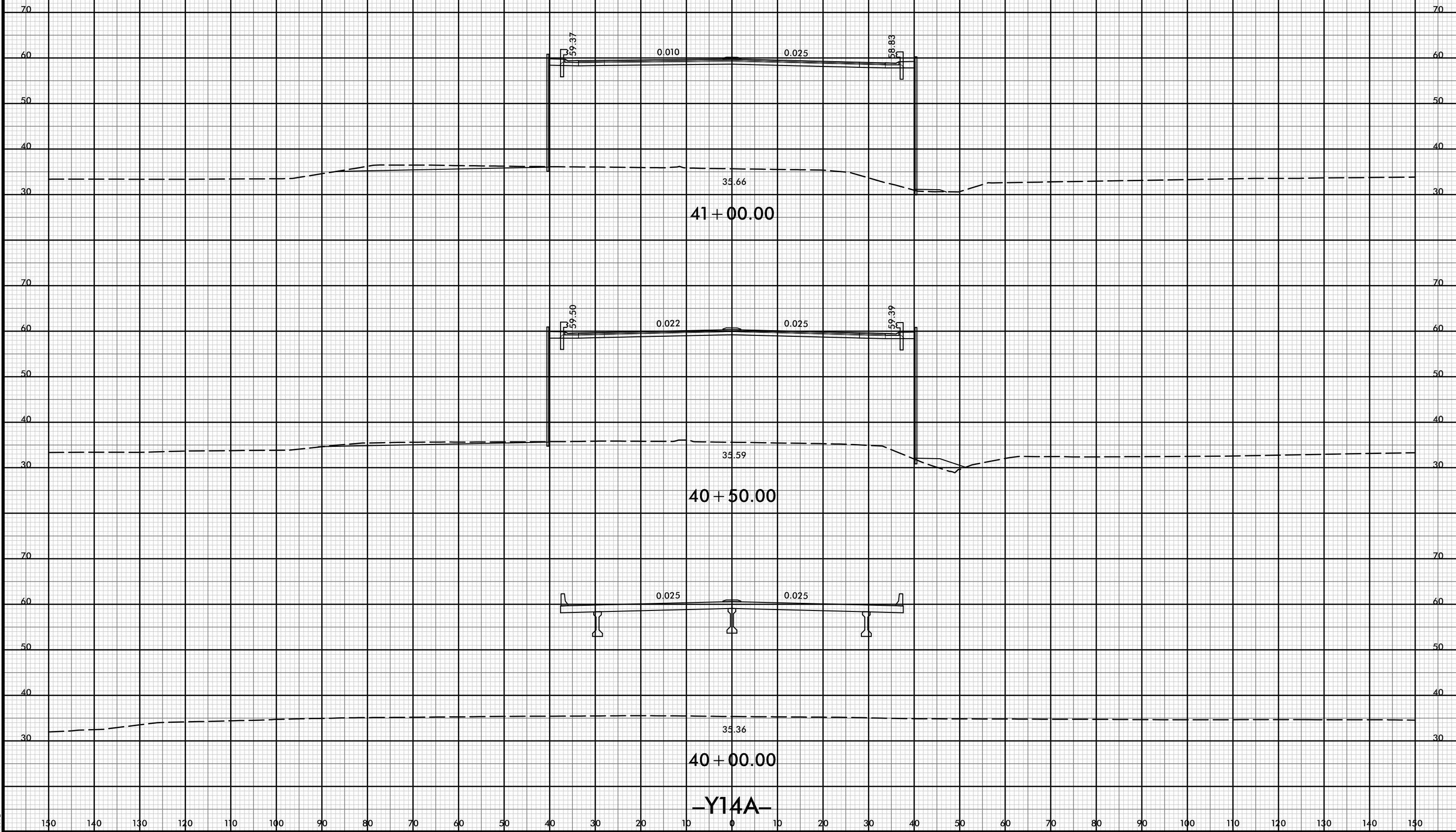



150 140 130 120 110 100 90 80 70 60 50 40 30 20 10 0 10 20 30 40 50 60 70 80 90 100 110 120 130 140 150

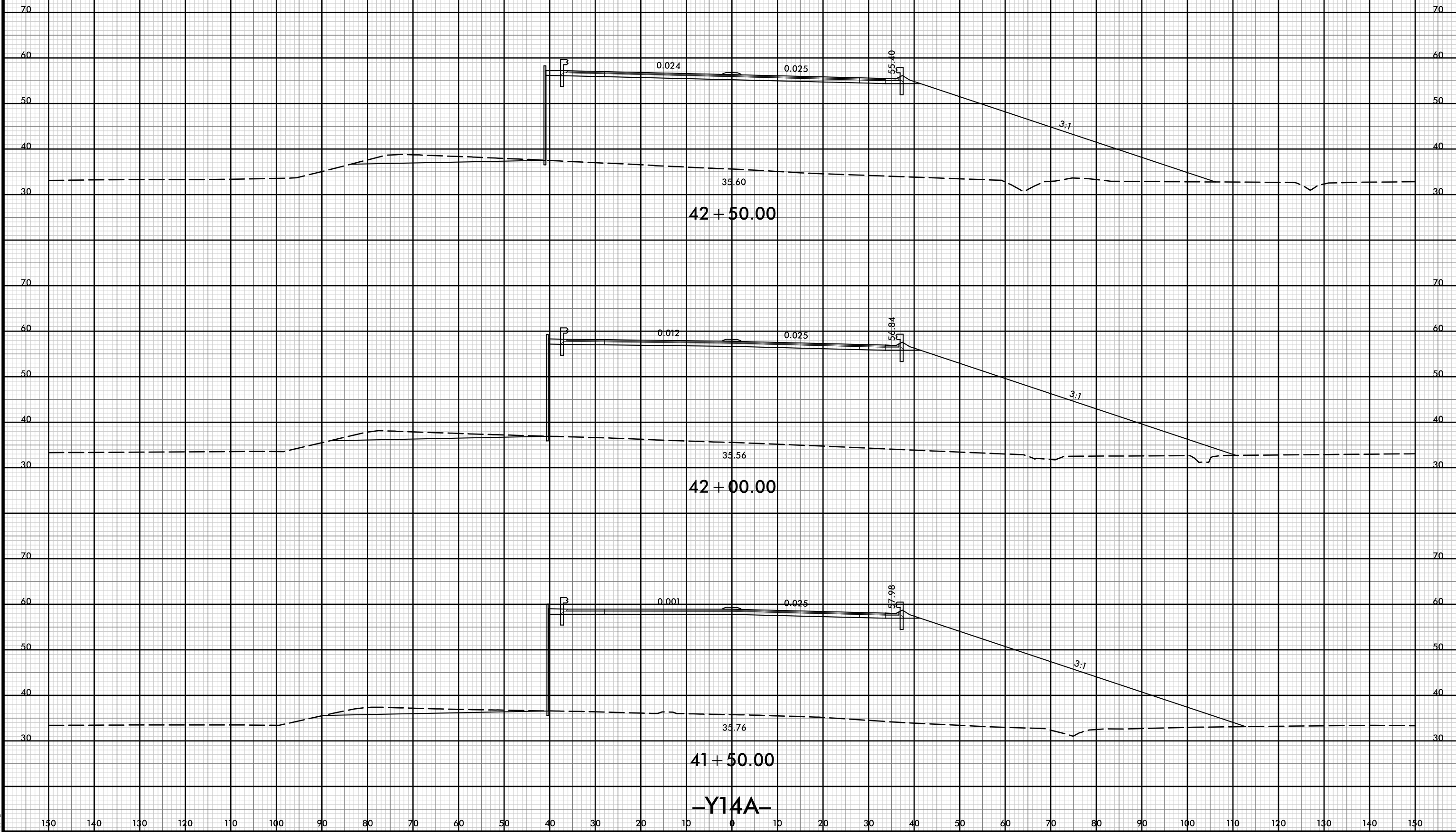

150 140 130 120 110 100 90 80 70 60 50 40 30 20 10 0 10 20 30 40 50 60 70 80 90 100 110 120 130 140 150

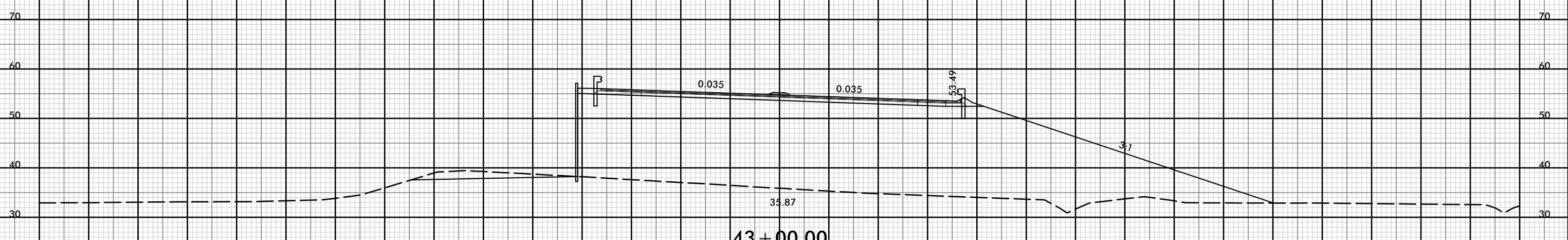
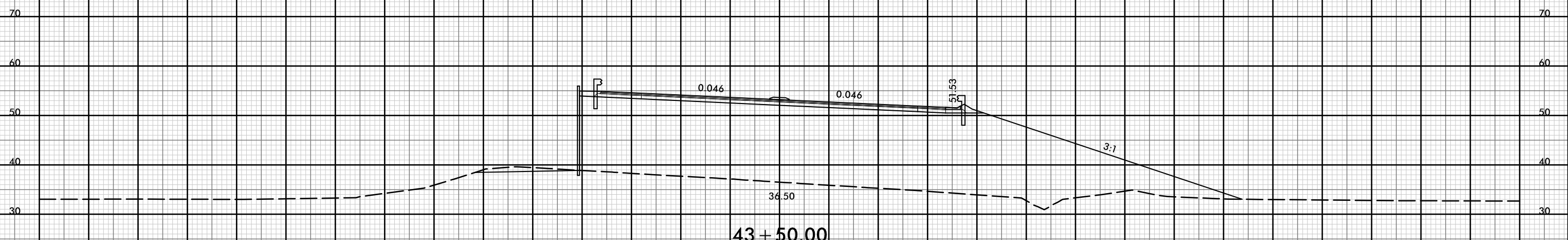
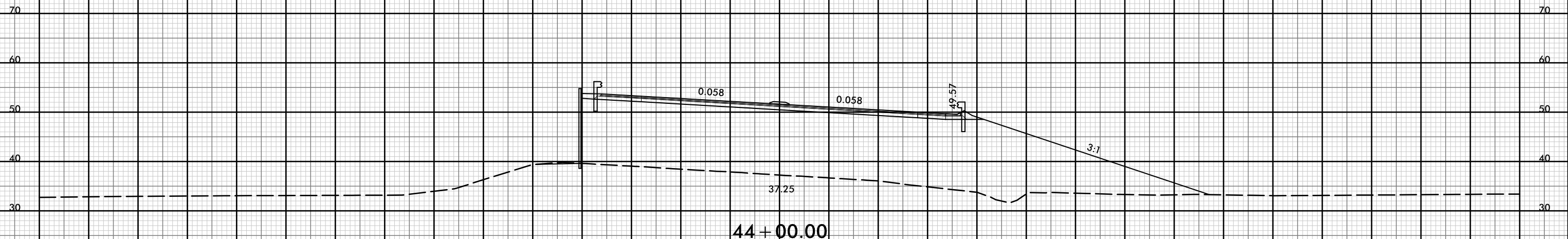

-Y14A-

150 140 130 120 110 100 90 80 70 60 50 40 30 20 10 0 10 20 30 40 50 60 70 80 90 100 110 120 130 140 150

150 140 130 120 110 100 90 80 70 60 50 40 30 20 10 0 10 20 30 40 50 60 70 80 90 100 110 120 130 140 150

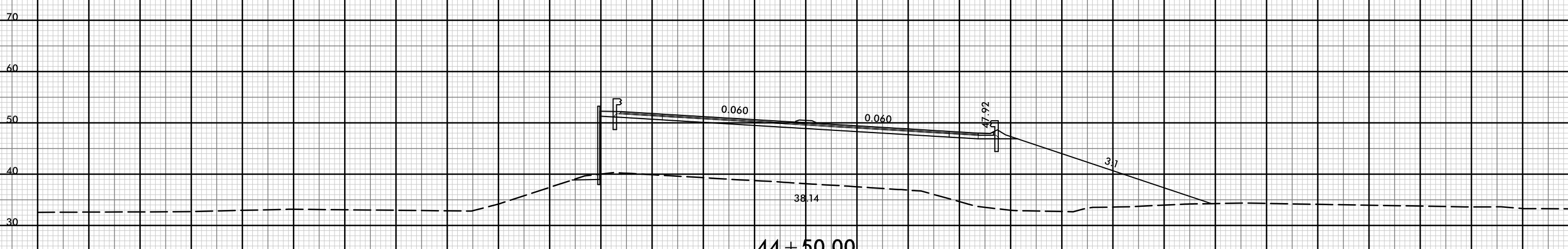
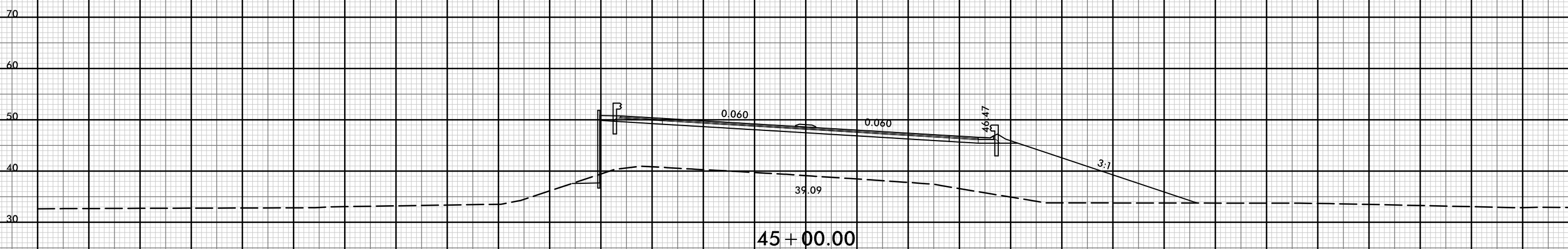
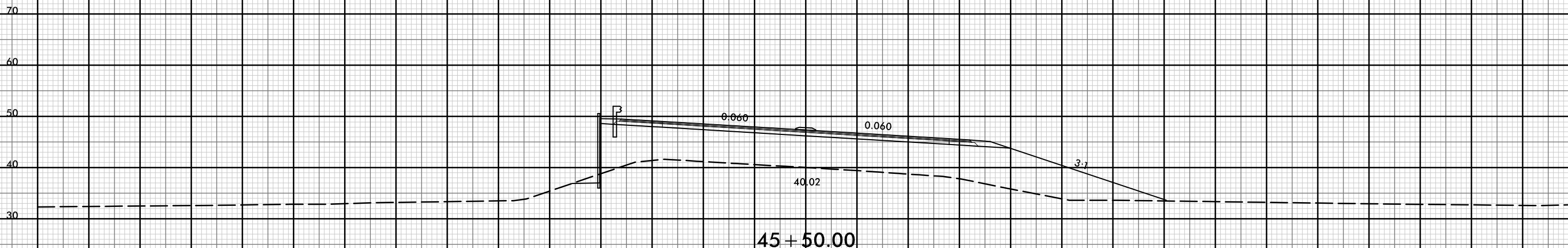

-Y14A-

150 140 130 120 110 100 90 80 70 60 50 40 30 20 10 0 10 20 30 40 50 60 70 80 90 100 110 120 130 140 150



150 140 130 120 110 100 90 80 70 60 50 40 30 20 10 0 10 20 30 40 50 60 70 80 90 100 110 120 130 140 150

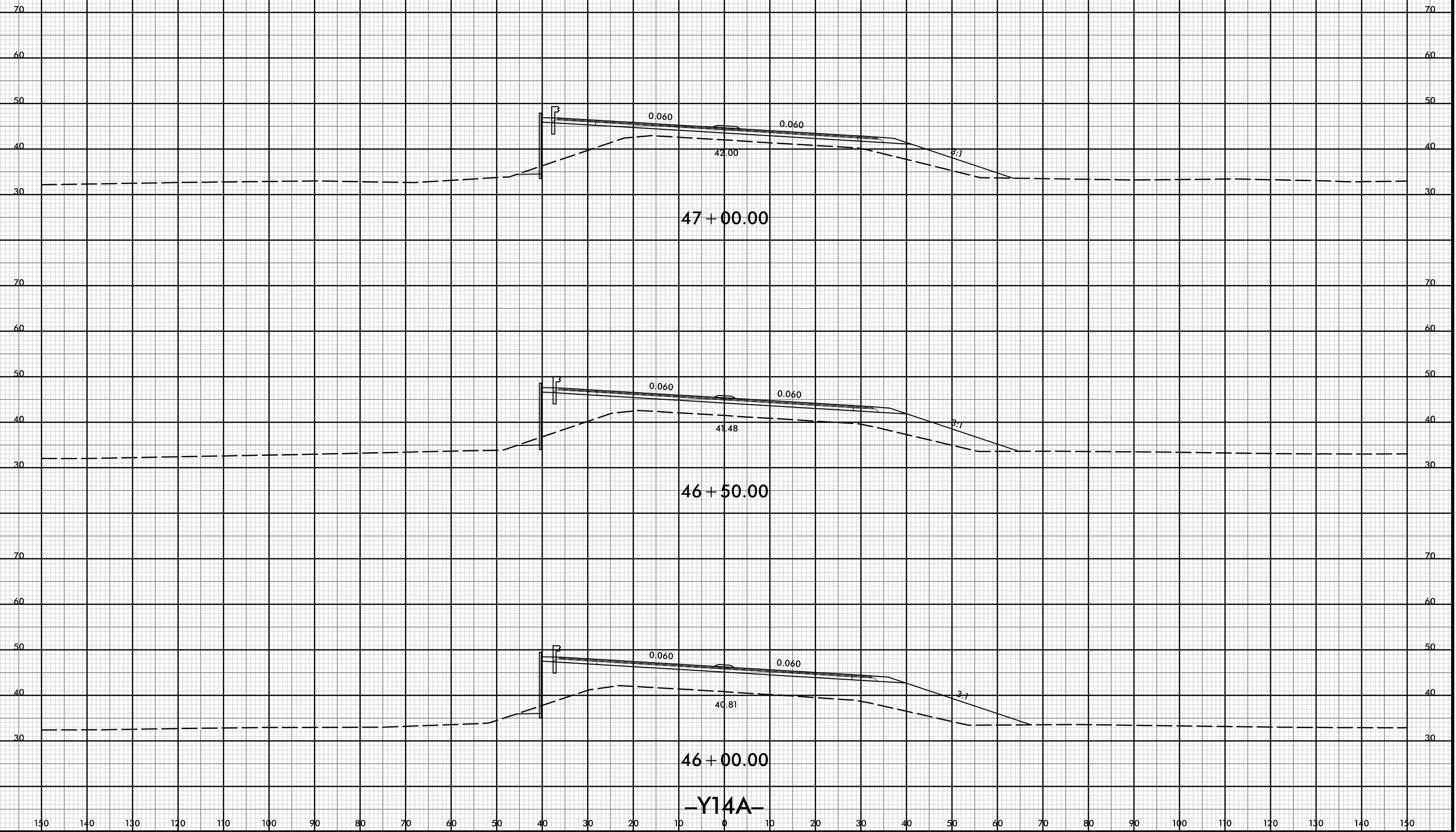

47 + 00.00

46 + 50.00

46 + 00.00

-Y14A-

150 140 130 120 110 100 90 80 70 60 50 40 30 20 10 0 10 20 30 40 50 60 70 80 90 100 110 120 130 140 150

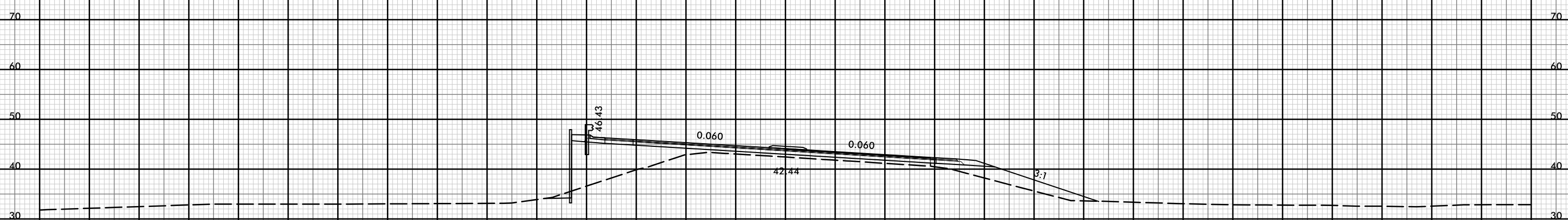
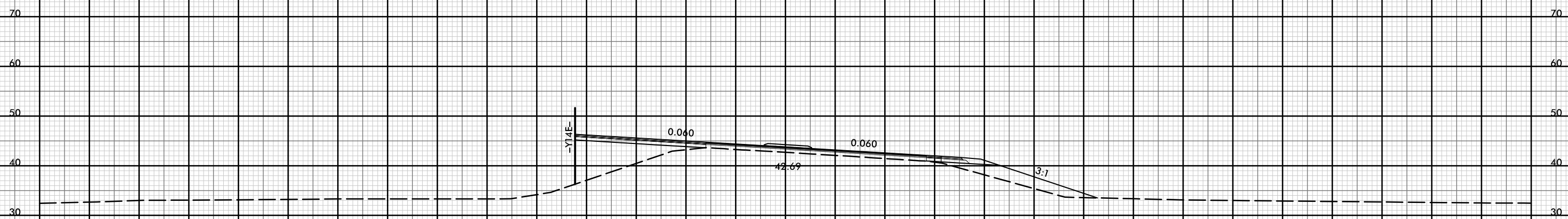

150 140 130 120 110 100 90 80 70 60 50 40 30 20 10 0 10 20 30 40 50 60 70 80 90 100 110 120 130 140 150

-Y14A-



150 140 130 120 110 100 90 80 70 60 50 40 30 20 10 0 10 20 30 40 50 60 70 80 90 100 110 120 130 140 150

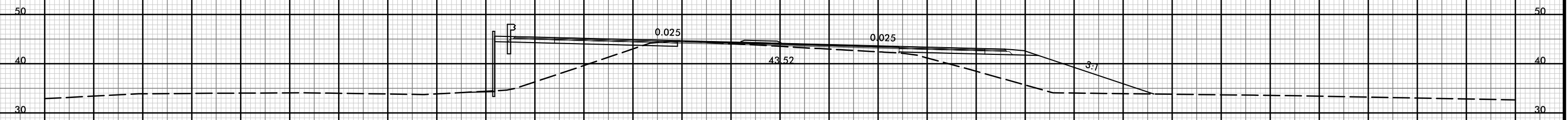

50 + 00.00

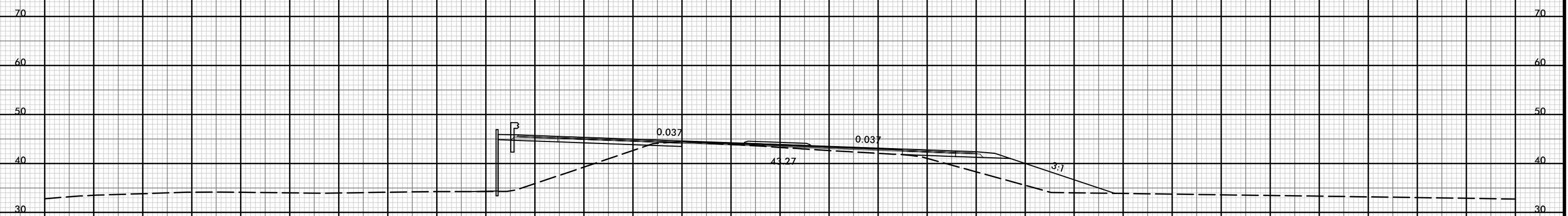

49 + 50.00



49 + 00.00

-Y14A-

150 140 130 120 110 100 90 80 70 60 50 40 30 20 10 0 10 20 30 40 50 60 70 80 90 100 110 120 130 140 150

150 140 130 120 110 100 90 80 70 60 50 40 30 20 10 0 10 20 30 40 50 60 70 80 90 100 110 120 130 140 150

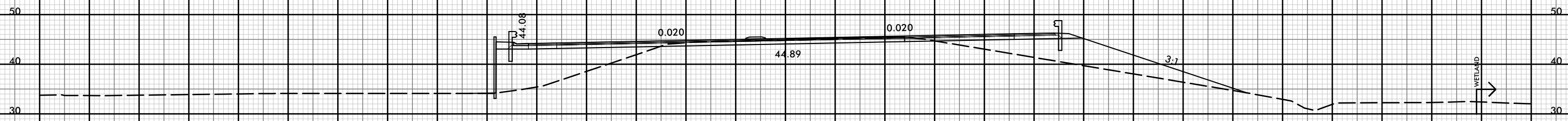

52 + 00.00

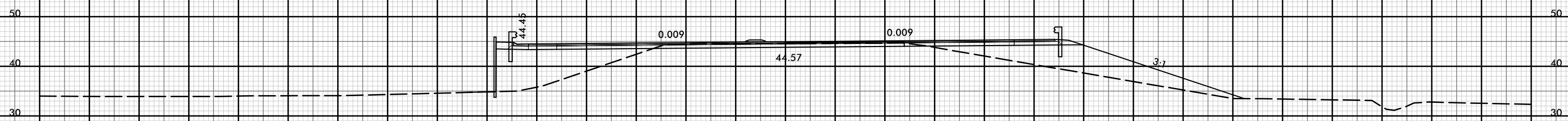

51 + 50.00

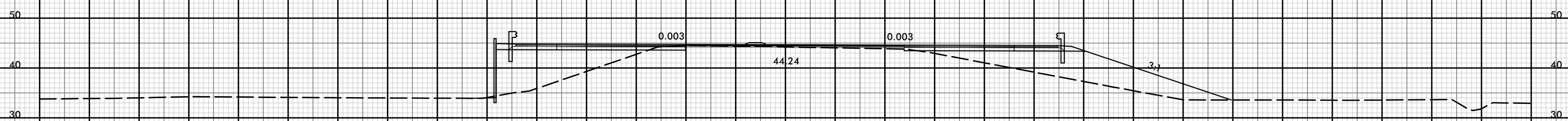

51 + 00.00

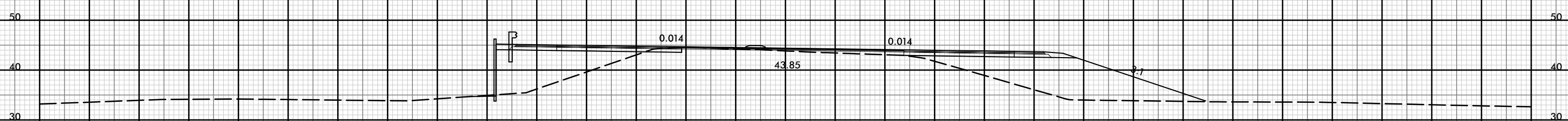

50 + 50.00

-Y14A-

150 140 130 120 110 100 90 80 70 60 50 40 30 20 10 0 10 20 30 40 50 60 70 80 90 100 110 120 130 140 150



150 140 130 120 110 100 90 80 70 60 50 40 30 20 10 0 10 20 30 40 50 60 70 80 90 100 110 120 130 140 150

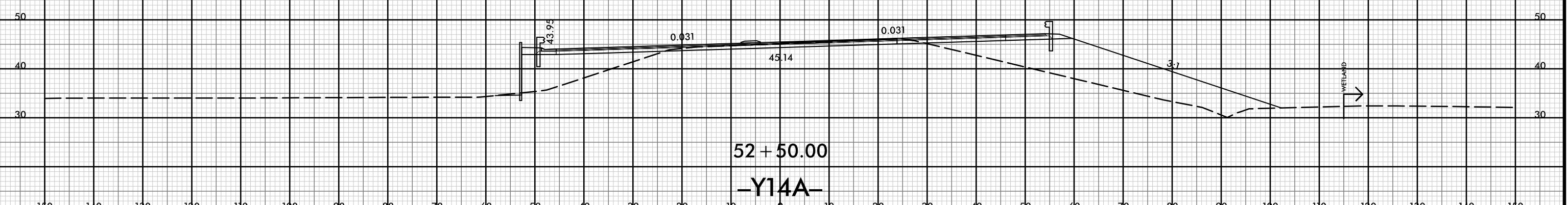
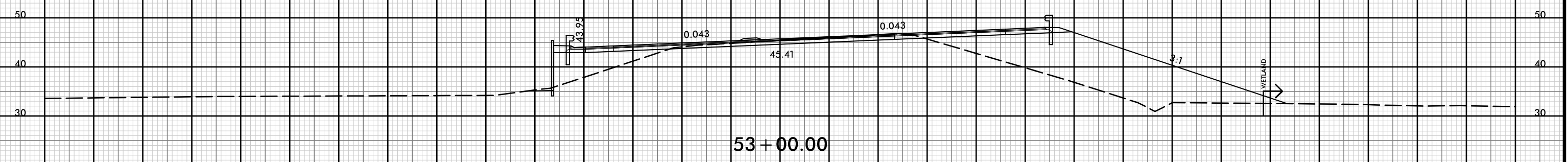
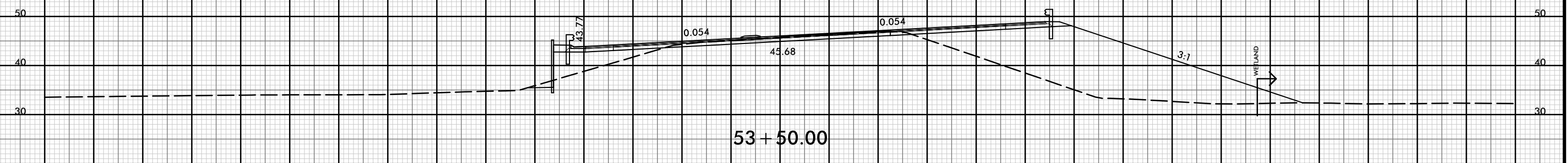
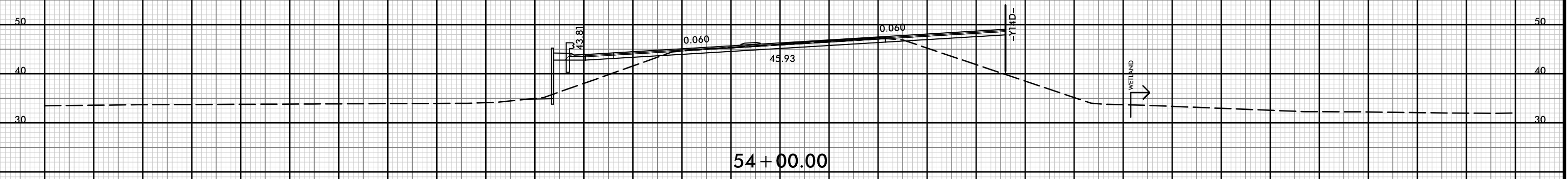

150 140 130 120 110 100 90 80 70 60 50 40 30 20 10 0 10 20 30 40 50 60 70 80 90 100 110 120 130 140 150

150 140 130 120 110 100 90 80 70 60 50 40 30 20 10 0 10 20 30 40 50 60 70 80 90 100 110 120 130 140 150



56 + 00.00

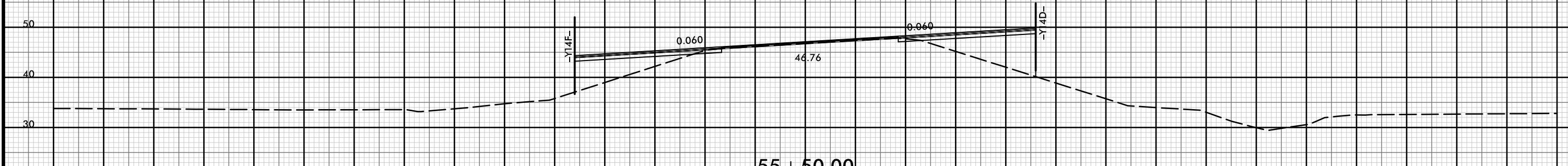

55 + 50.00

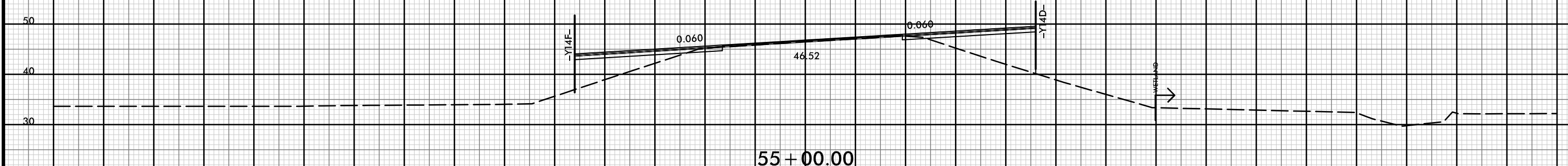

55 + 00.00

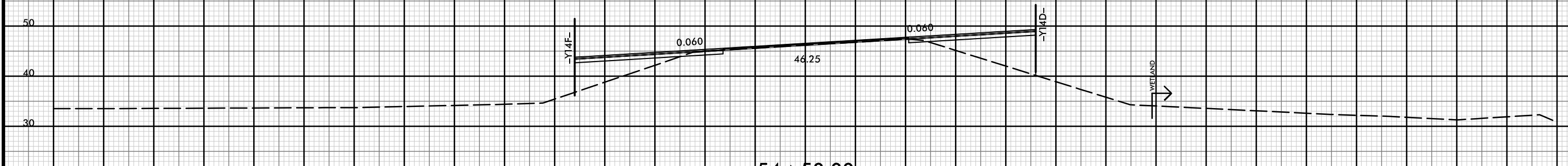

54 + 50.00

-Y14A-

150 140 130 120 110 100 90 80 70 60 50 40 30 20 10 0 10 20 30 40 50 60 70 80 90 100 110 120 130 140 150



150 140 130 120 110 100 90 80 70 60 50 40 30 20 10 0 10 20 30 40 50 60 70 80 90 100 110 120 130 140 150

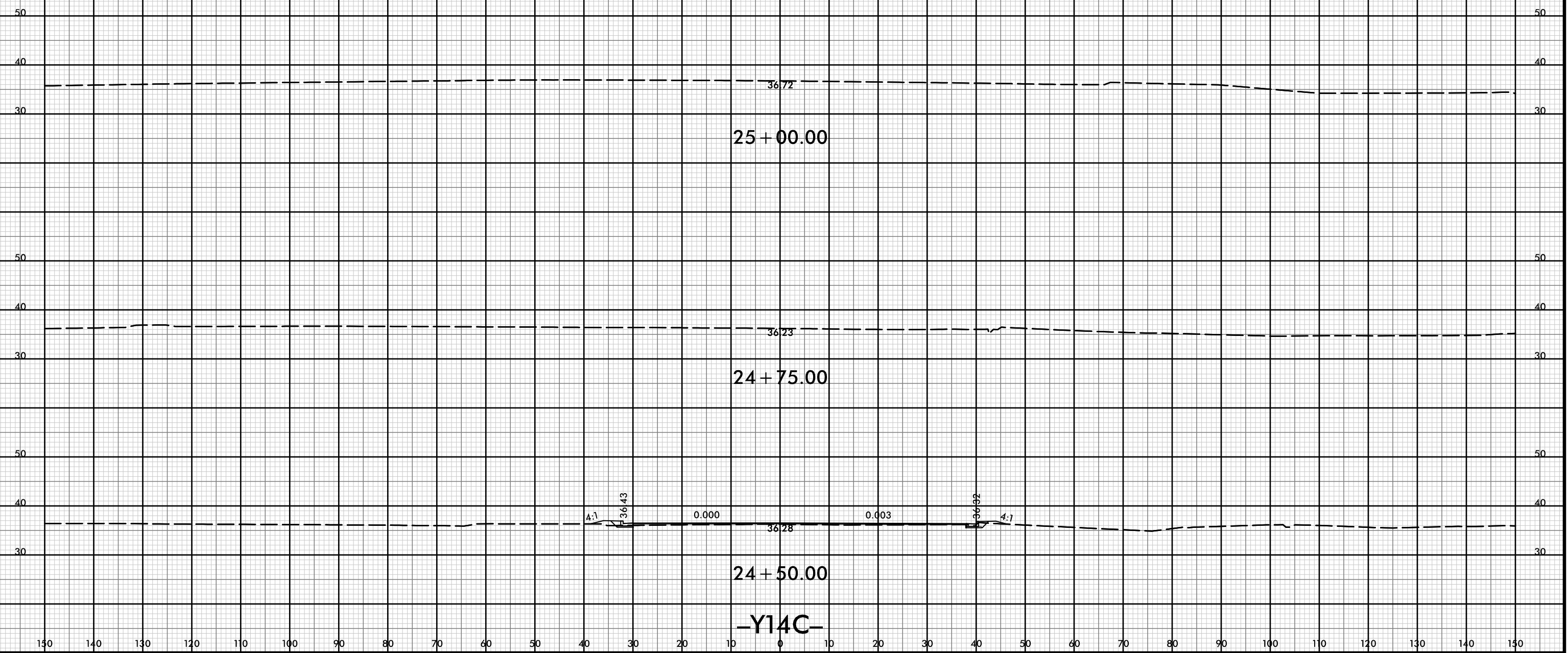

25 + 00.00

24 + 75.00

24 + 50.00

-Y14C-

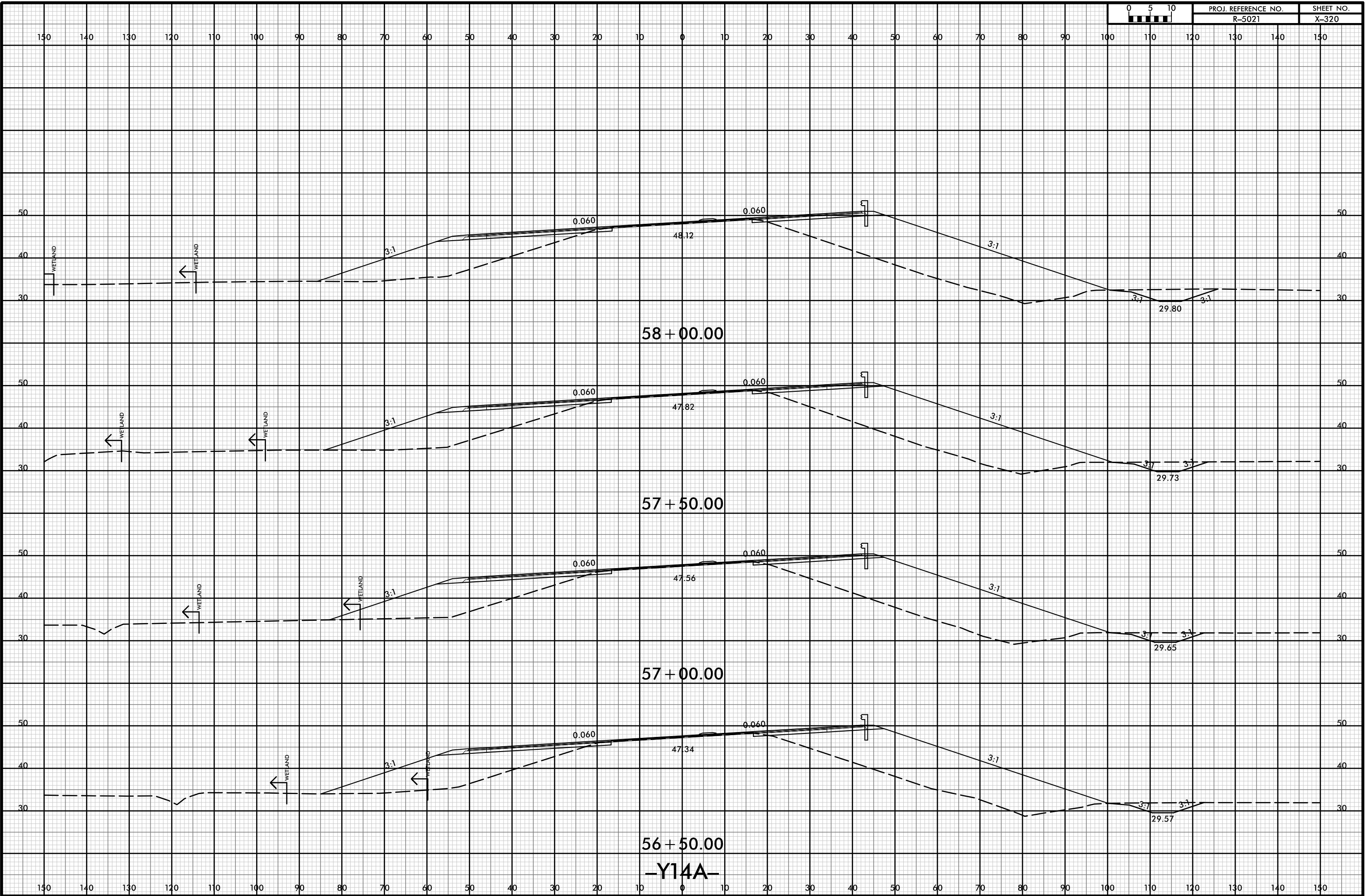

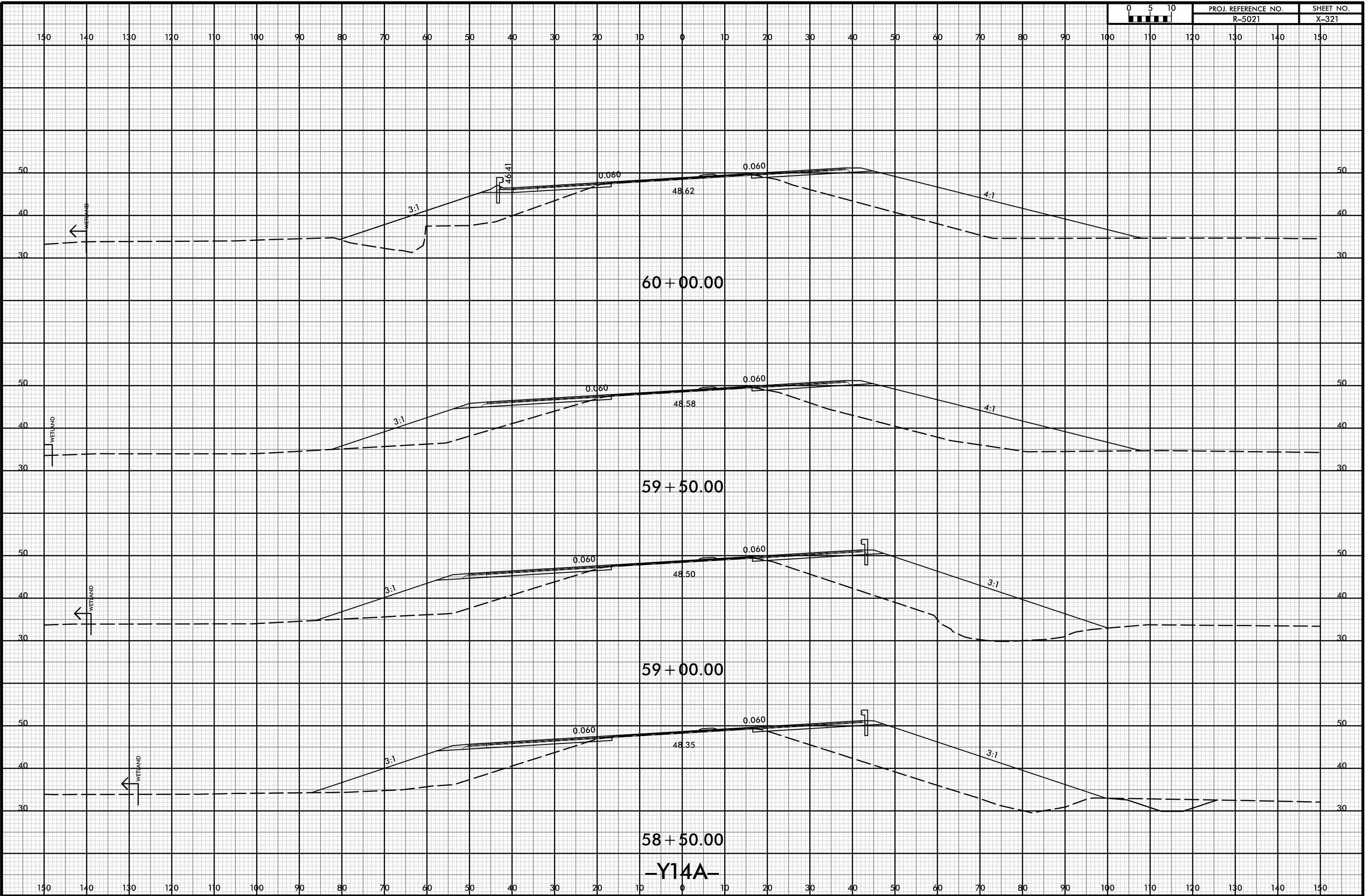



150 140 130 120 110 100 90 80 70 60 50 40 30 20 10 0 10 20 30 40 50 60 70 80 90 100 110 120 130 140 150

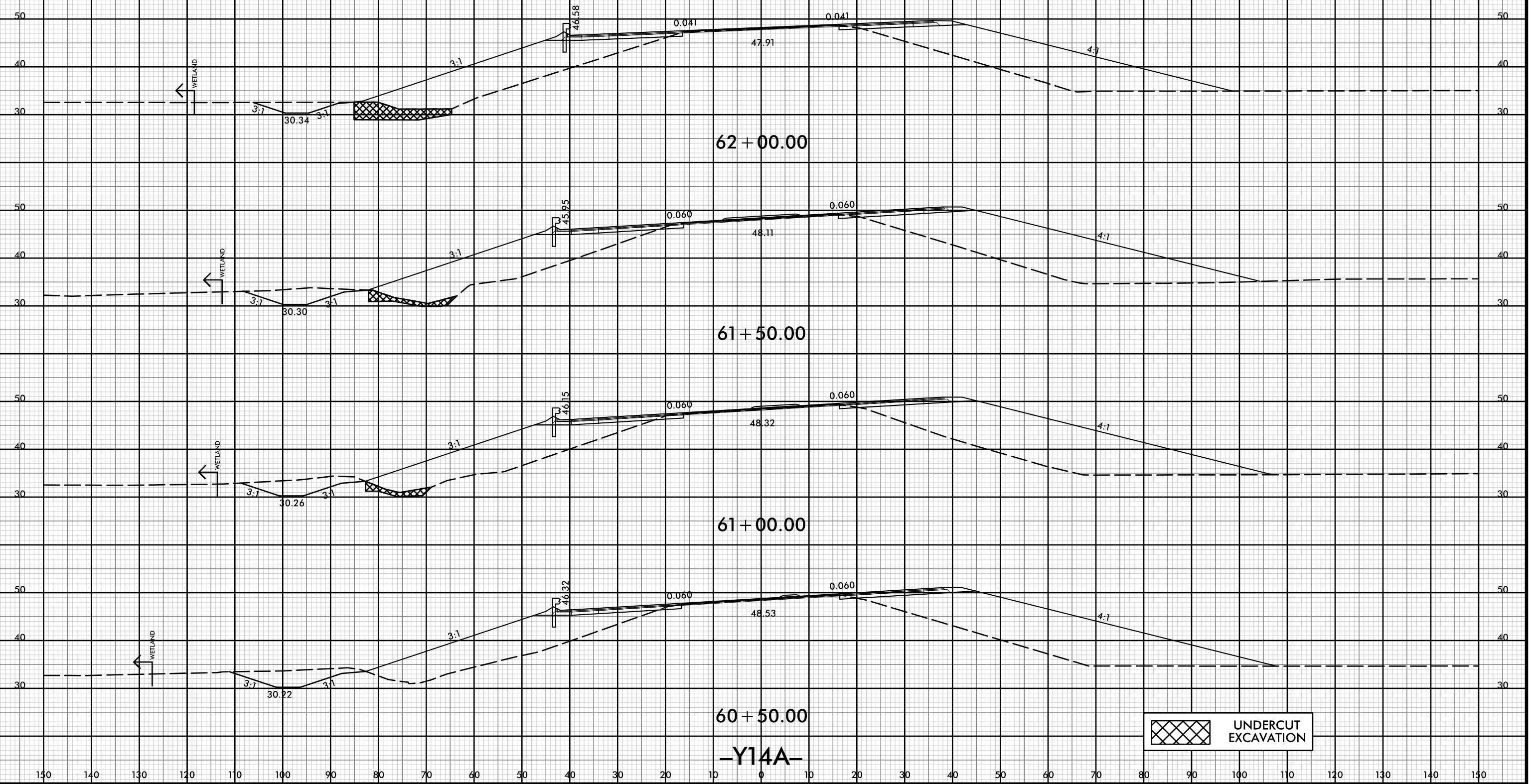

UNDERCUT EXCAVATION

-Y14A-

150 140 130 120 110 100 90 80 70 60 50 40 30 20 10 0 10 20 30 40 50 60 70 80 90 100 110 120 130 140 150



150 140 130 120 110 100 90 80 70 60 50 40 30 20 10 0 10 20 30 40 50 60 70 80 90 100 110 120 130 140 150

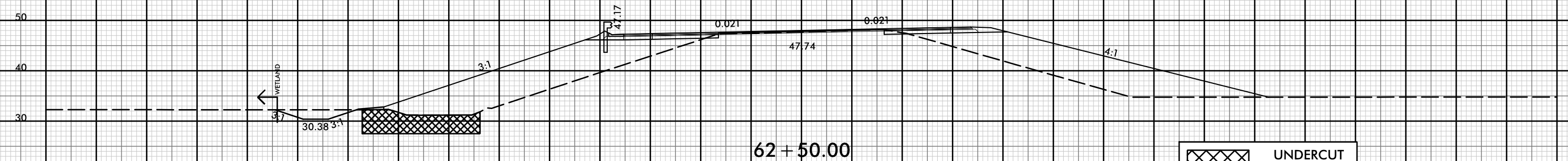
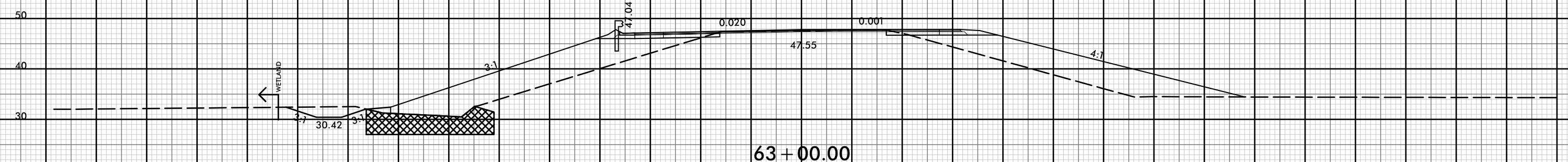
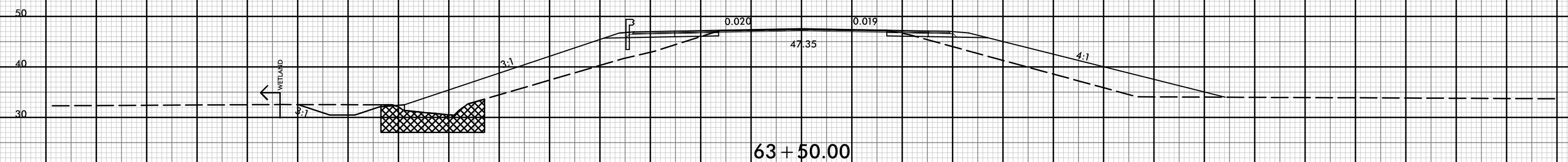
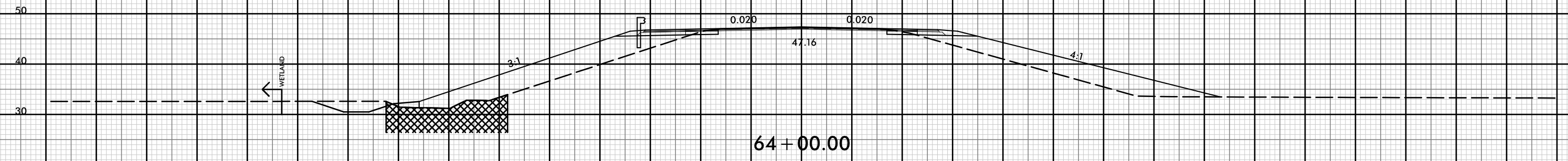

-Y14A-

 UNDERCUT EXCAVATION



150 140 130 120 110 100 90 80 70 60 50 40 30 20 10 0 10 20 30 40 50 60 70 80 90 100 110 120 130 140 150

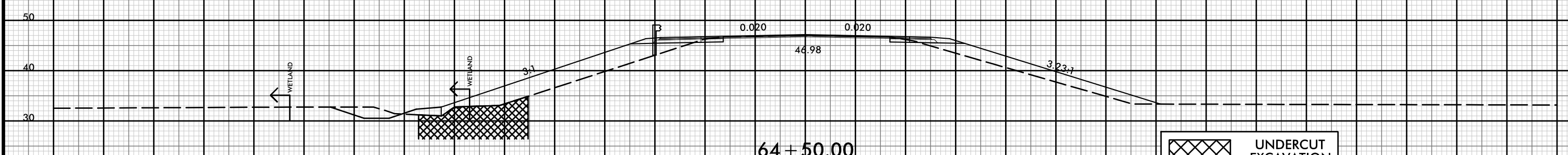
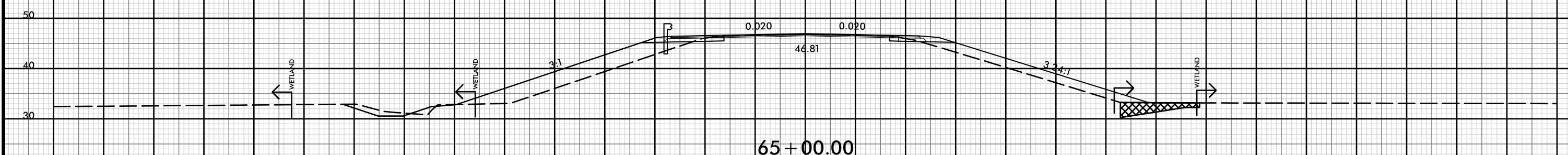
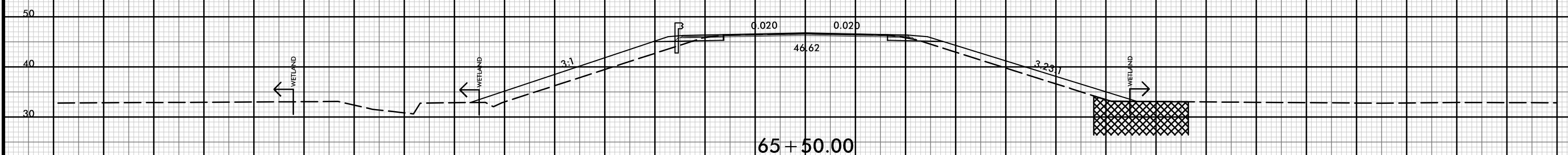
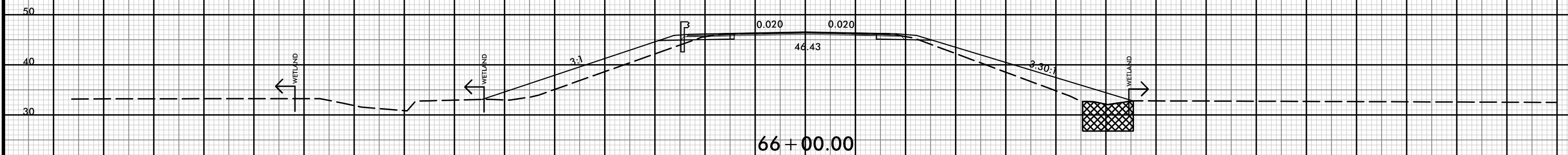

UNDERCUT EXCAVATION

-Y14A-

150 140 130 120 110 100 90 80 70 60 50 40 30 20 10 0 10 20 30 40 50 60 70 80 90 100 110 120 130 140 150

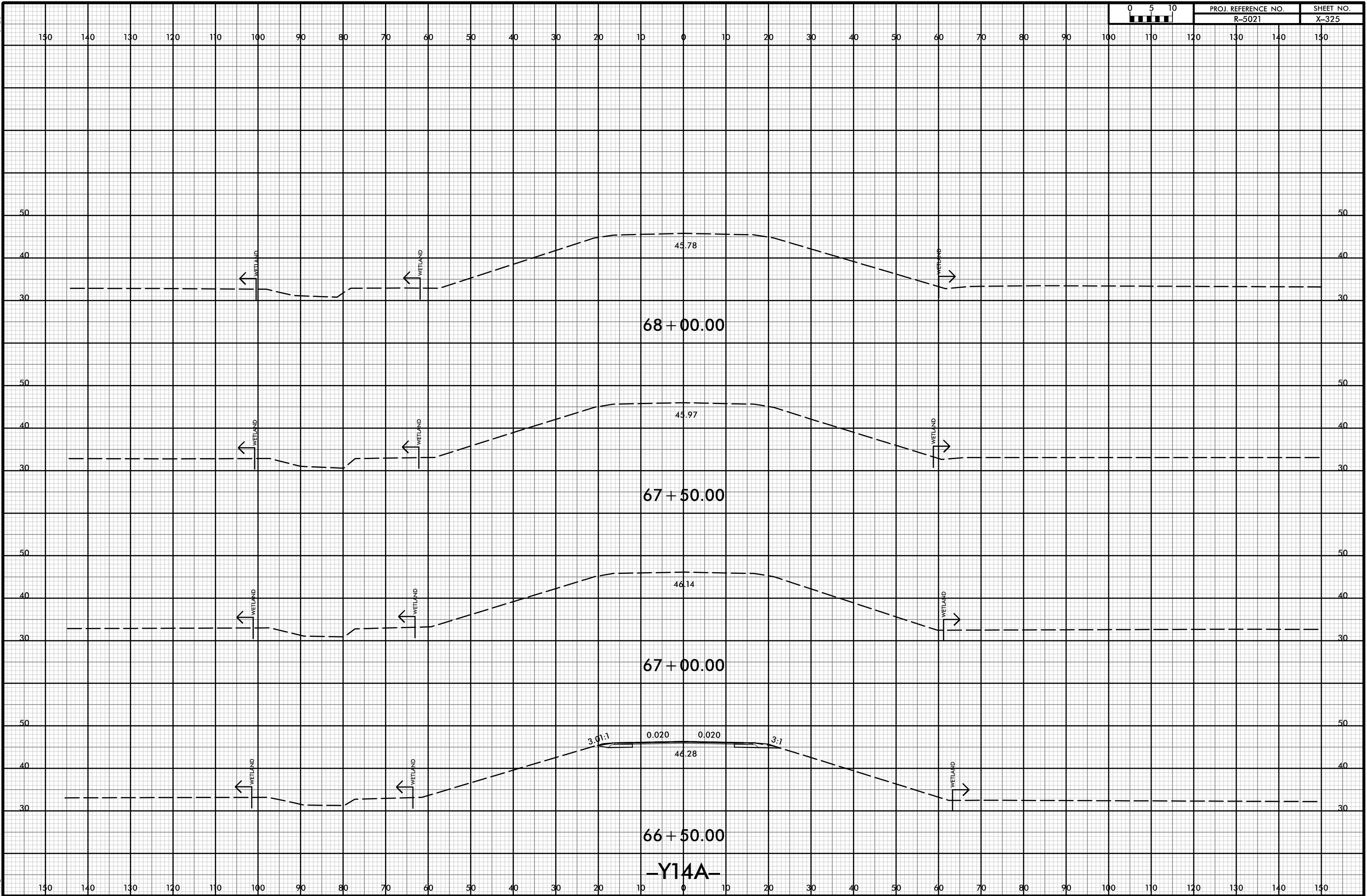

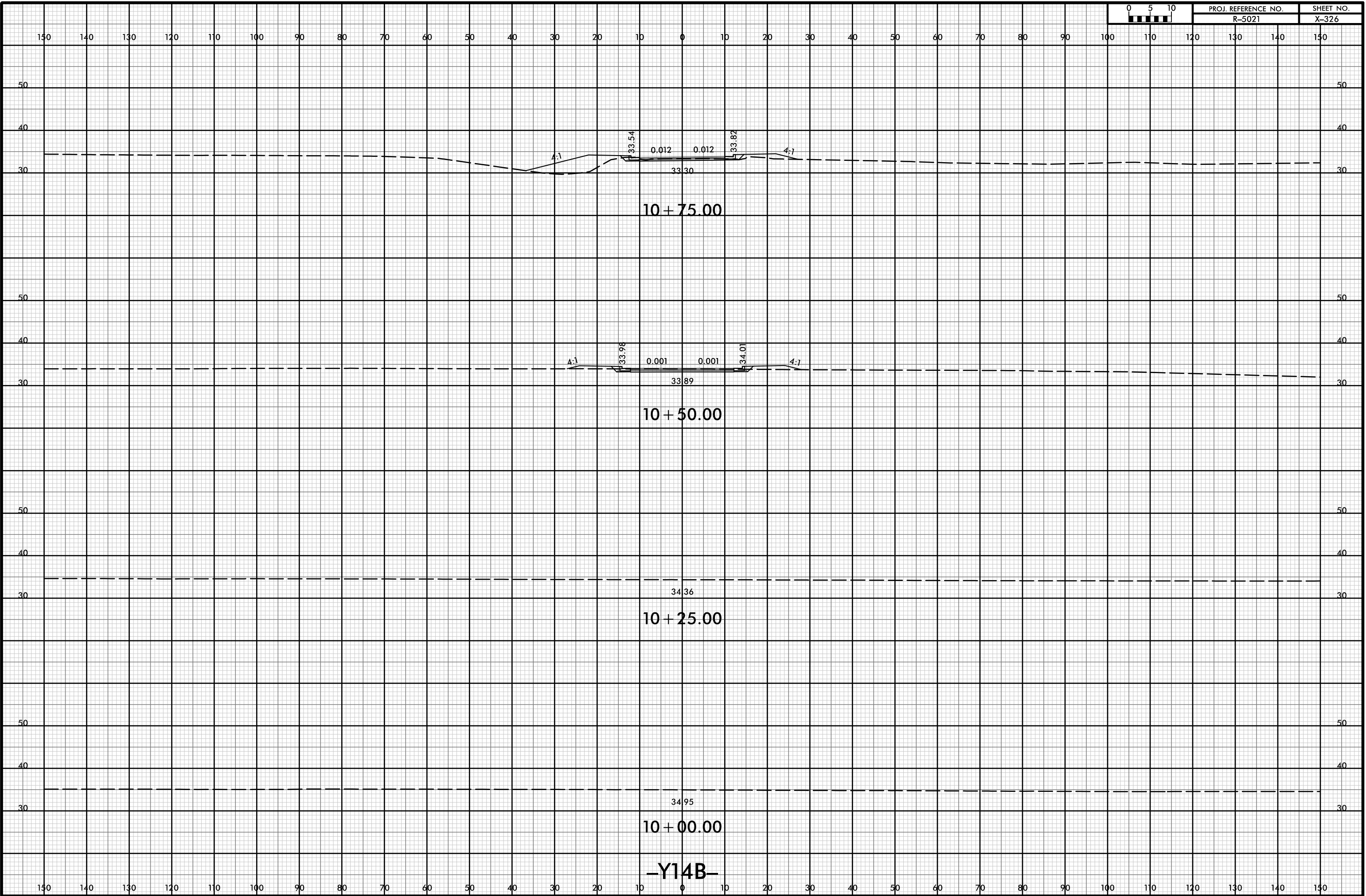



150 140 130 120 110 100 90 80 70 60 50 40 30 20 10 0 10 20 30 40 50 60 70 80 90 100 110 120 130 140 150

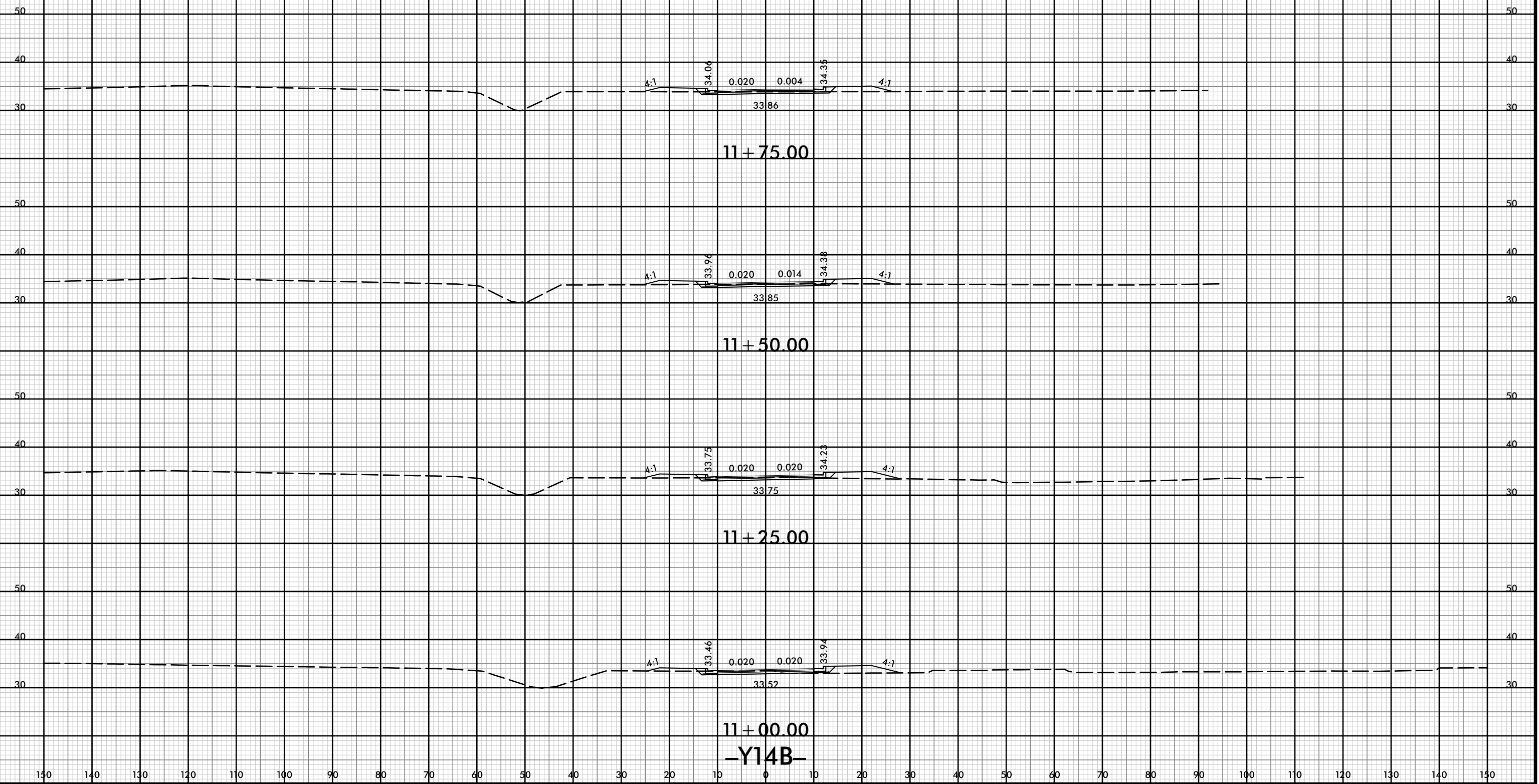



150 140 130 120 110 100 90 80 70 60 50 40 30 20 10 0 10 20 30 40 50 60 70 80 90 100 110 120 130 140 150

50 50

40 40

30 30

33.71
12 + 75.00

50 50

40 40

30 30

33.97
12 + 50.00

50 50

40 40

30 30

4:1 33.90 0.020 0.020 33.90 4:1
34.29
12 + 25.00

50 50

40 40

30 30

4:1 34.03 0.020 0.006 34.20 4:1
33.93
12 + 00.00

-Y14B-

150 140 130 120 110 100 90 80 70 60 50 40 30 20 10 0 10 20 30 40 50 60 70 80 90 100 110 120 130 140 150

8/23/99



PROJ. REFERENCE NO.
R-5021

SHEET NO.
X-329

150 140 130 120 110 100 90 80 70 60 50 40 30 20 10 0 10 20 30 40 50 60 70 80 90 100 110 120 130 140 150

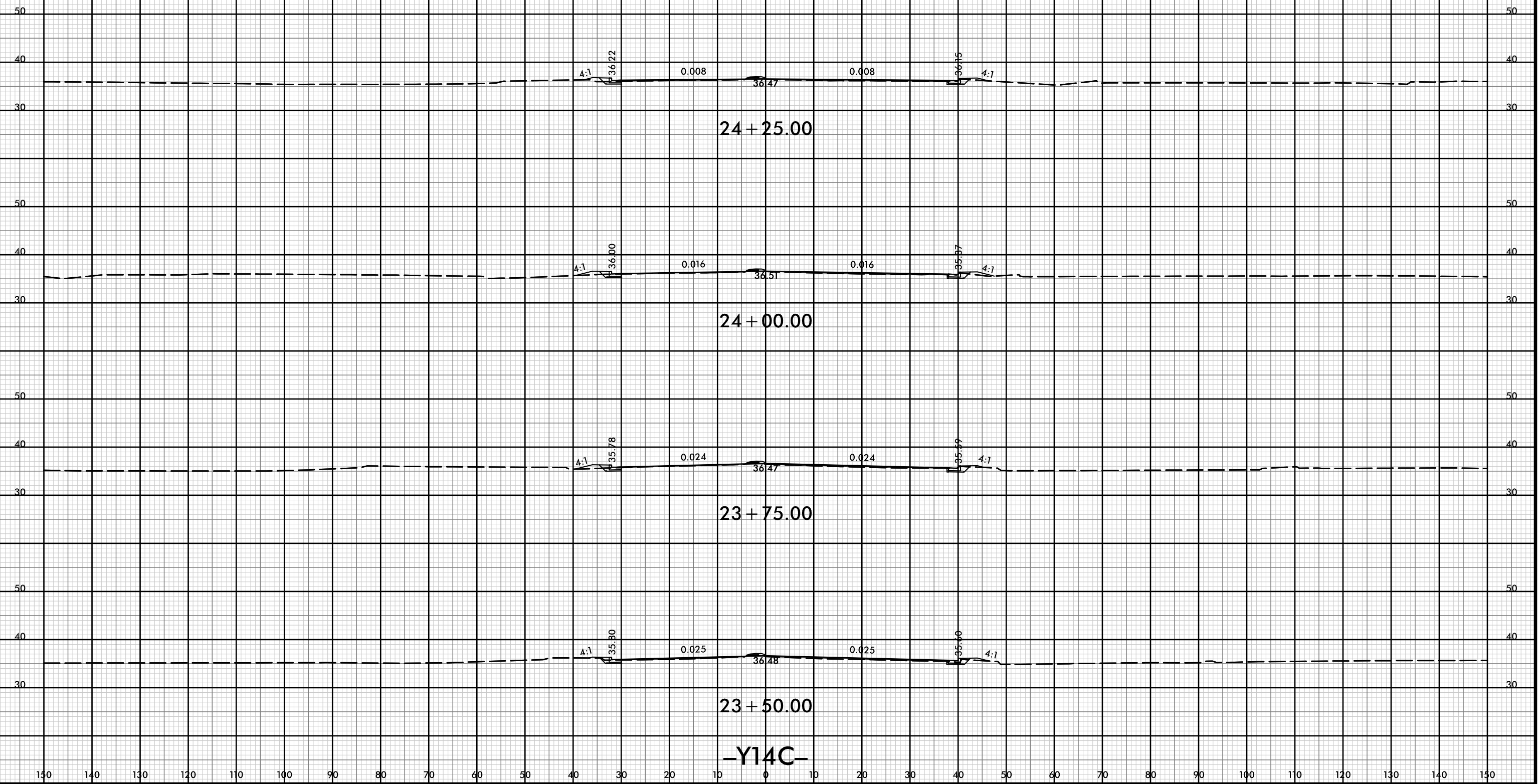

24 + 25.00

24 + 00.00

23 + 75.00

23 + 50.00

-Y14C-

21-Jul-2021 10:39
R:\pawej\XSCA\5021-rdy-yp-l-Y14C.dgn
HTB

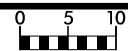

150 140 130 120 110 100 90 80 70 60 50 40 30 20 10 0 10 20 30 40 50 60 70 80 90 100 110 120 130 140 150

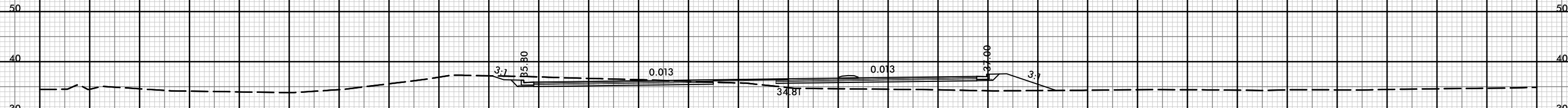

11 + 50.00

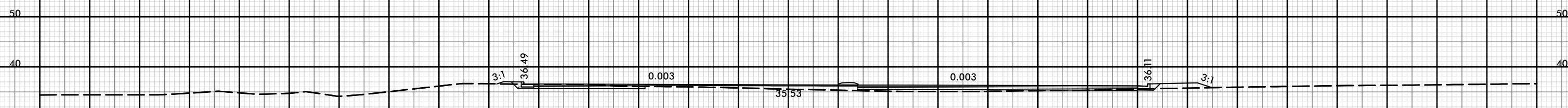

11 + 00.00

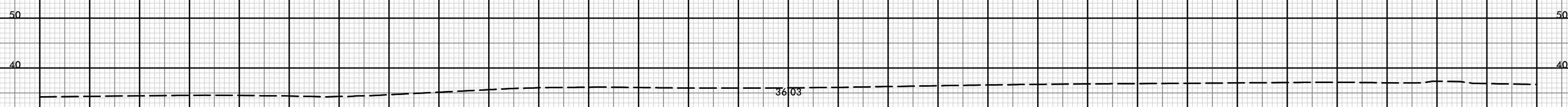

10 + 50.00

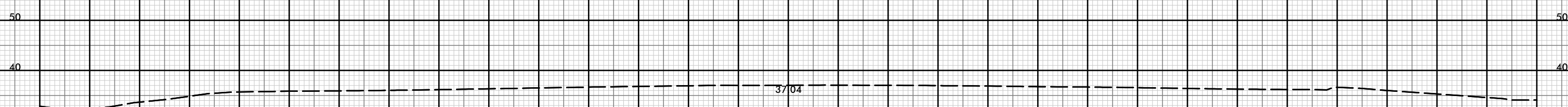

10 + 00.00

-Y14D-

150 140 130 120 110 100 90 80 70 60 50 40 30 20 10 0 10 20 30 40 50 60 70 80 90 100 110 120 130 140 150

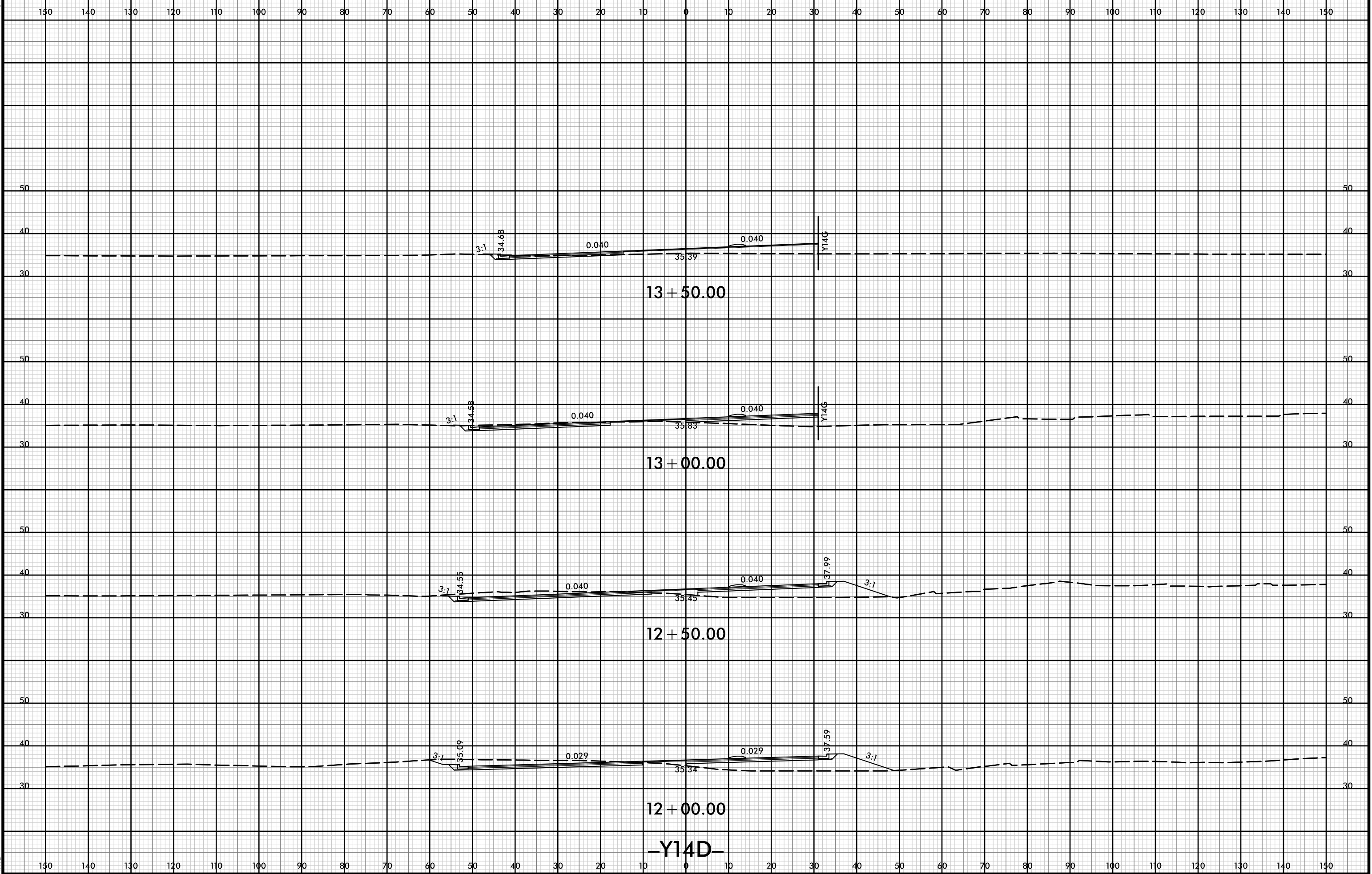

150 140 130 120 110 100 90 80 70 60 50 40 30 20 10 0 10 20 30 40 50 60 70 80 90 100 110 120 130 140 150

50 50

30 30

15 + 50.00

50 50

30 30

15 + 00.00

50 50

30 30

14 + 50.00

50 50

30 30

14 + 00.00

-Y14D-

150 140 130 120 110 100 90 80 70 60 50 40 30 20 10 0 10 20 30 40 50 60 70 80 90 100 110 120 130 140 150

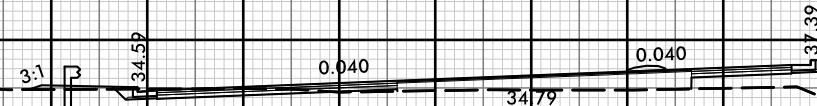
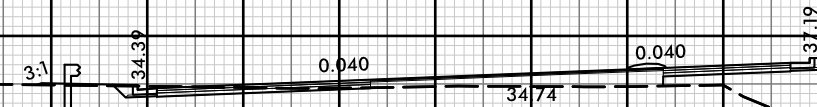
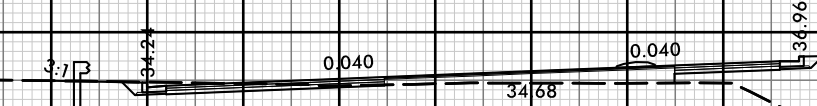
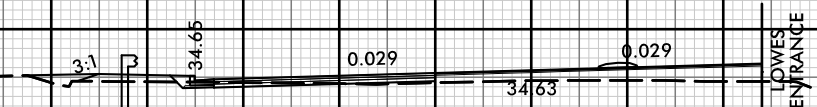

8/23/99



| | |
|---------------------|-----------|
| PROJ. REFERENCE NO. | SHEET NO. |
| R-5021 | X-334 |

150 140 130 120 110 100 90 80 70 60 50 40 30 20 10 0 10 20 30 40 50 60 70 80 90 100 110 120 130 140 150

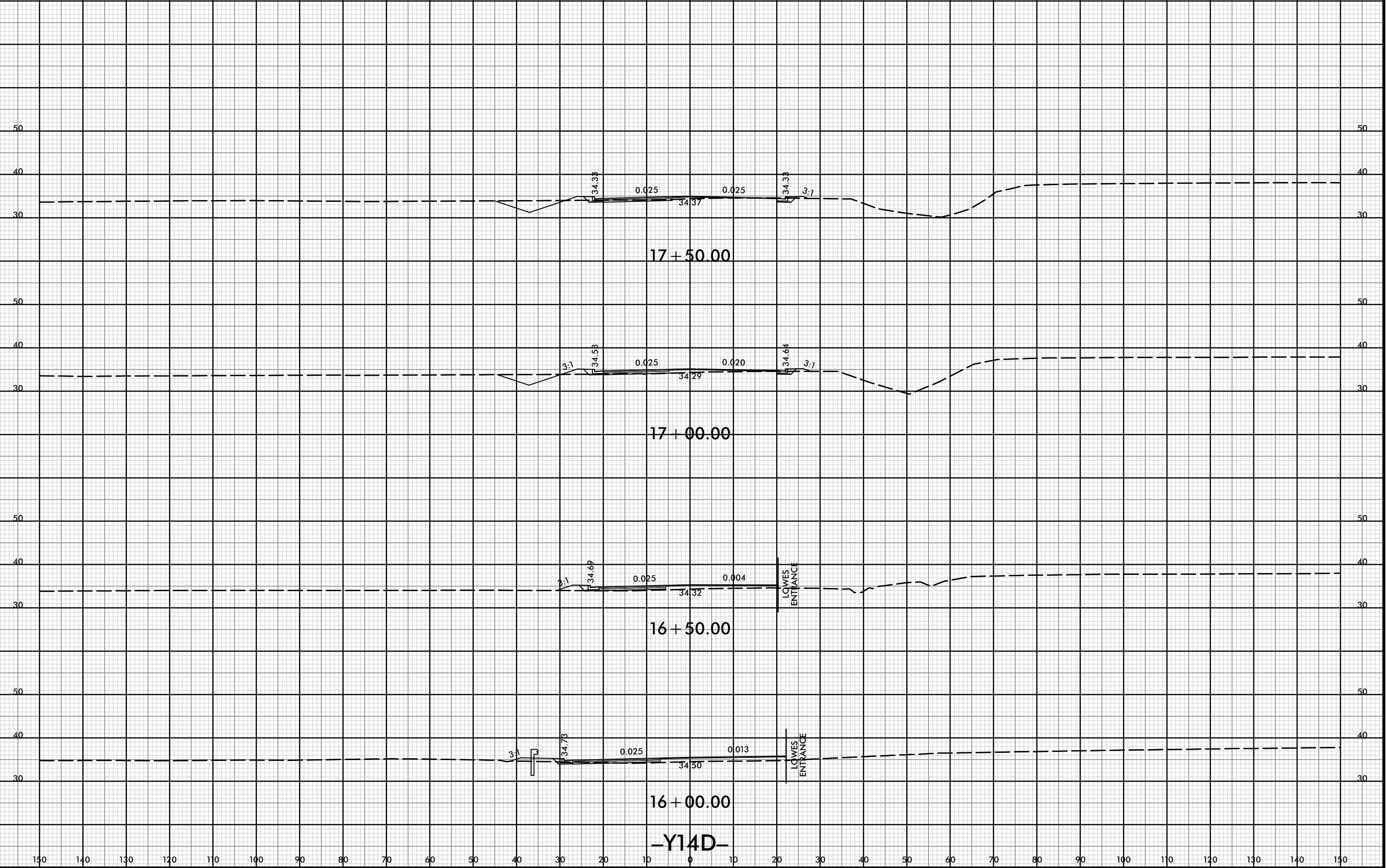

17+50.00

17+00.00

16+50.00

16+00.00

-Y14D-

21-Jul-2021 10:39
 R:\p\dawej\XSCA\5021-rdy-yp-l-Y14D.dgn
 HNTB



150 140 130 120 110 100 90 80 70 60 50 40 30 20 10 0 10 20 30 40 50 60 70 80 90 100 110 120 130 140 150

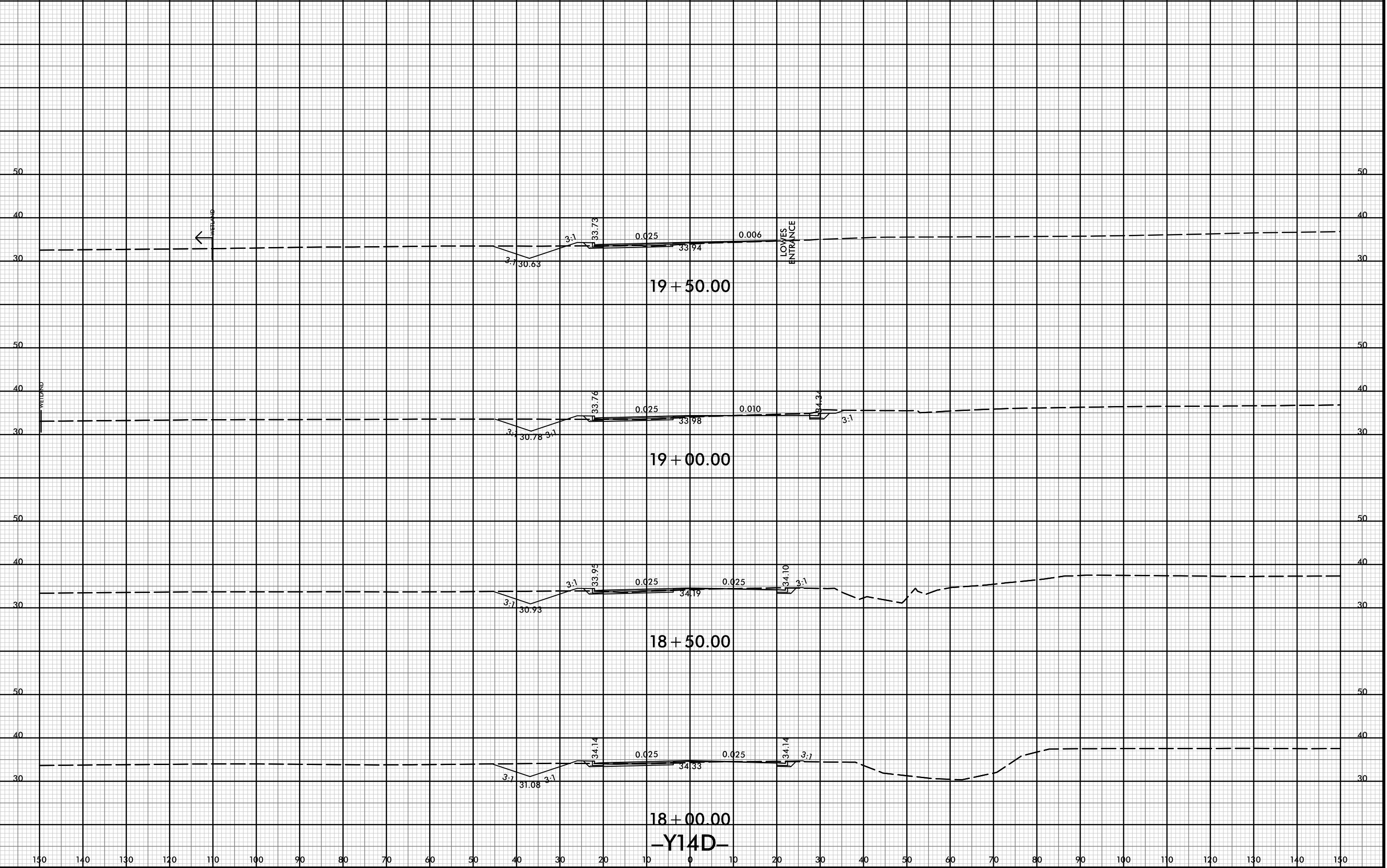

18+00.00
-Y14D-

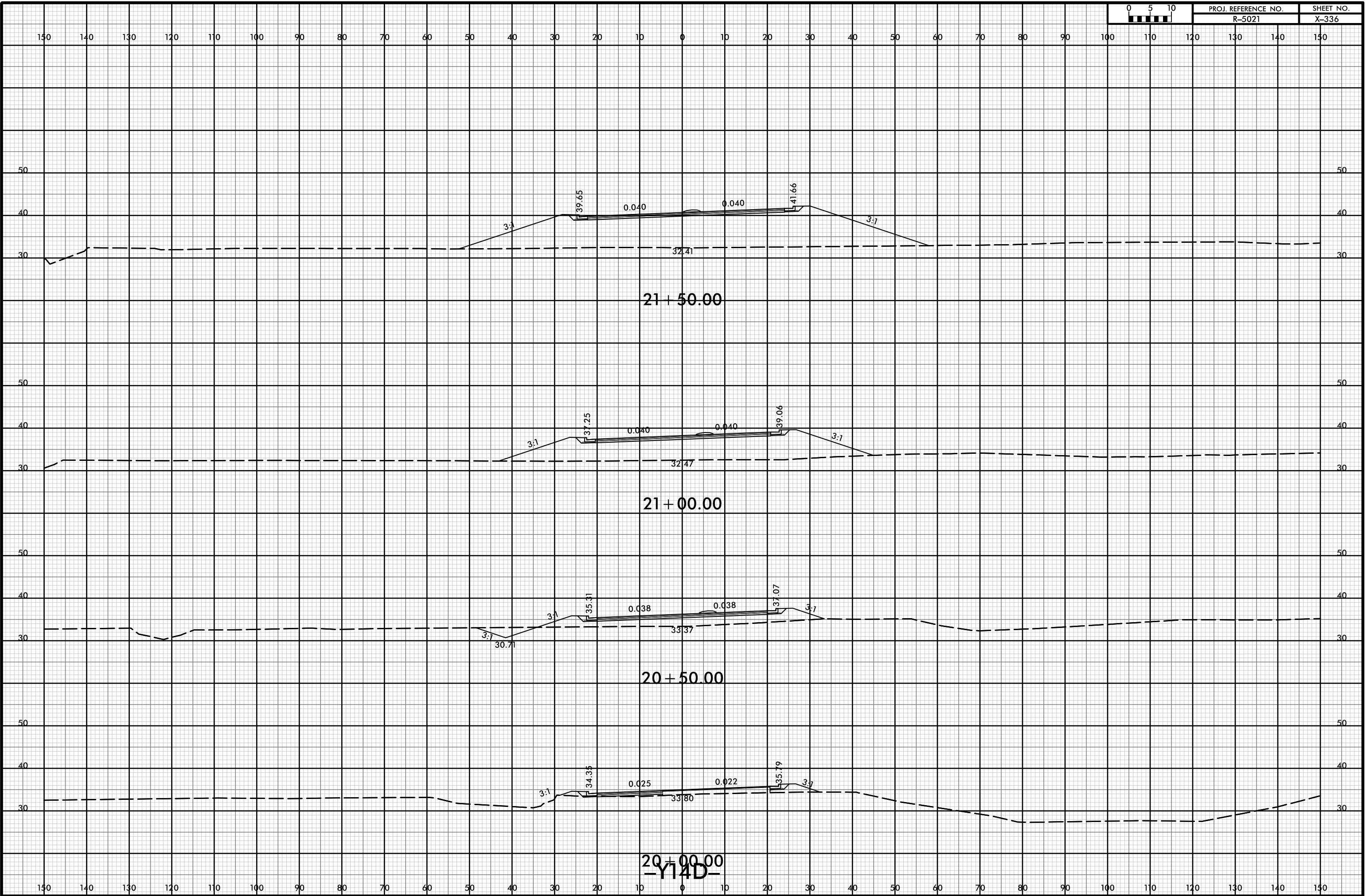



150 140 130 120 110 100 90 80 70 60 50 40 30 20 10 0 10 20 30 40 50 60 70 80 90 100 110 120 130 140 150

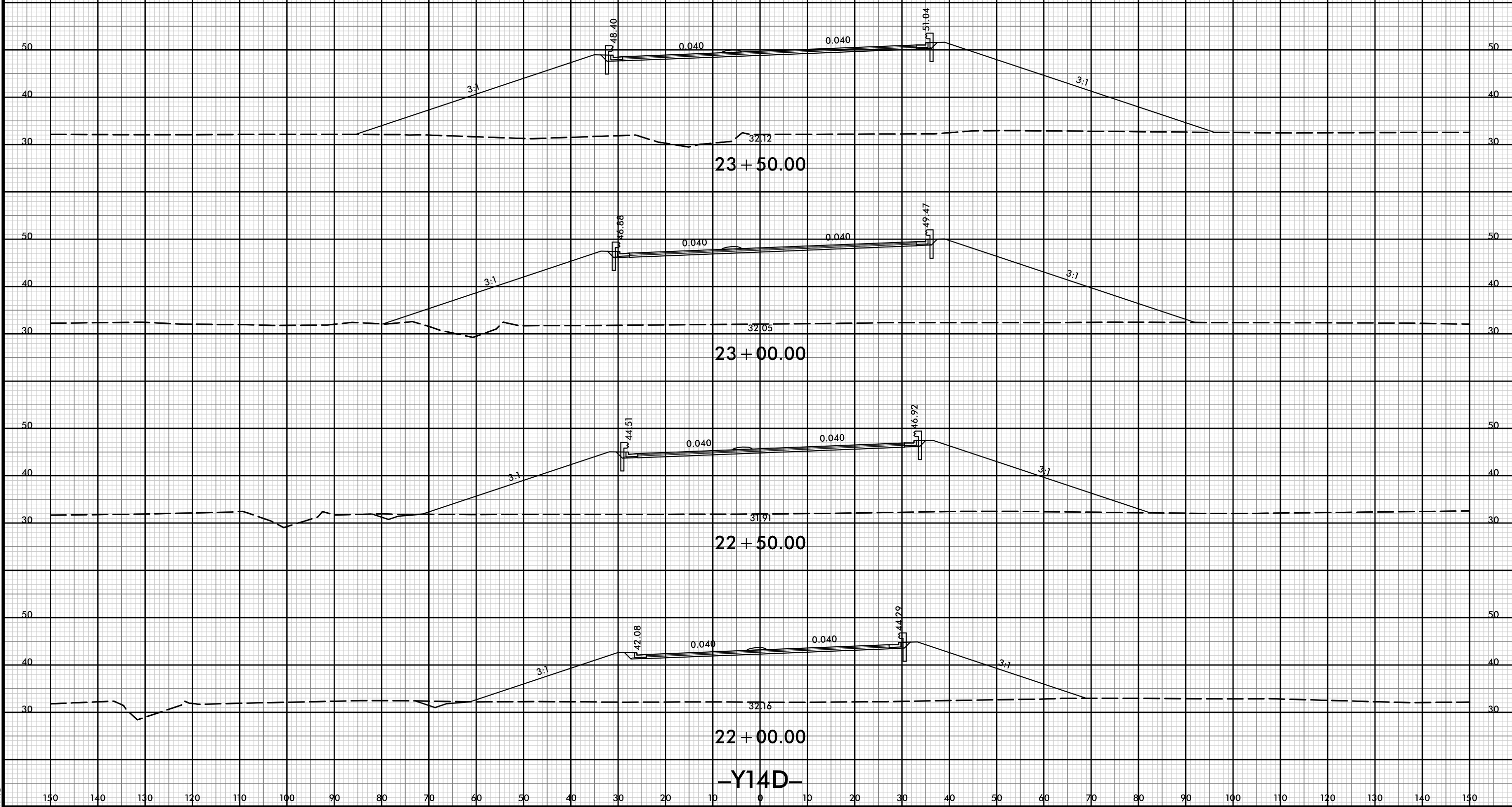

-Y14D-



150 140 130 120 110 100 90 80 70 60 50 40 30 20 10 0 10 20 30 40 50 60 70 80 90 100 110 120 130 140 150

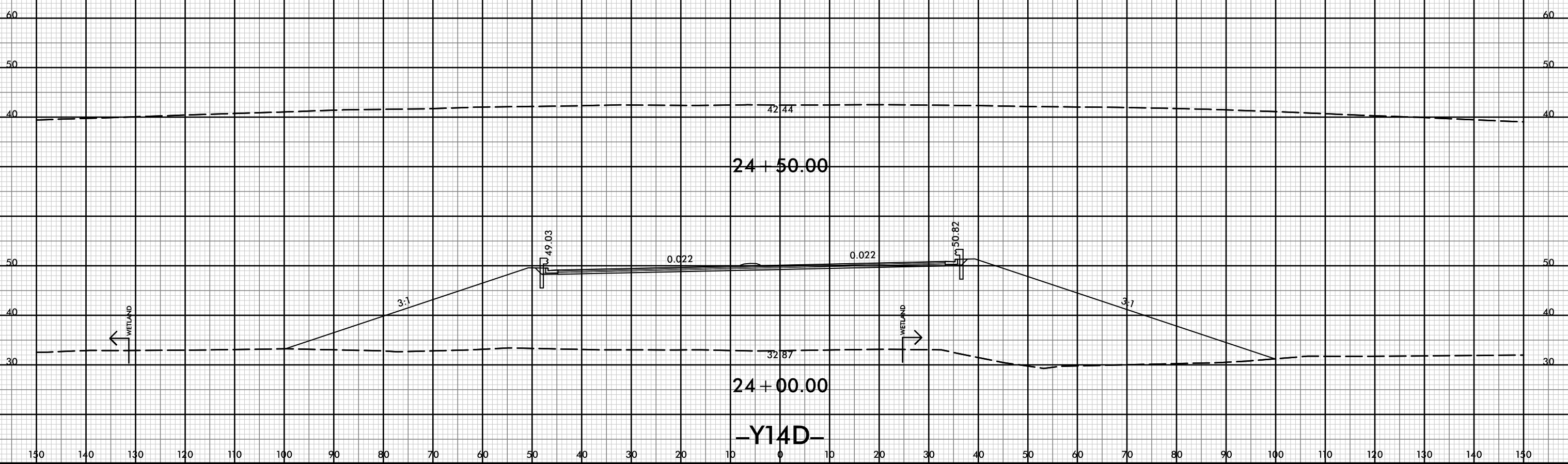

8/23/99



PROJ. REFERENCE NO.
R-5021

SHEET NO.
X-339

150 140 130 120 110 100 90 80 70 60 50 40 30 20 10 0 10 20 30 40 50 60 70 80 90 100 110 120 130 140 150

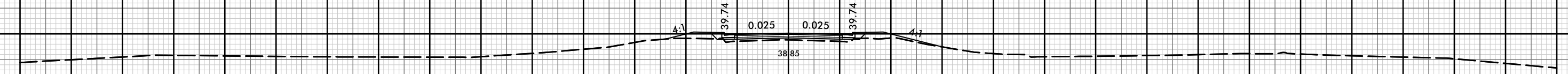

10 + 50.00

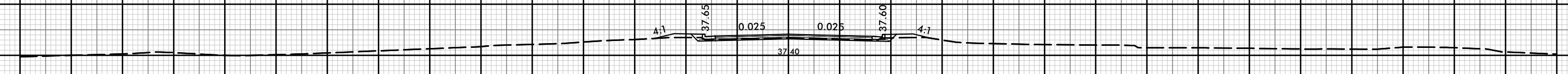

10 + 25.00

-Y14E-

150 140 130 120 110 100 90 80 70 60 50 40 30 20 10 0 10 20 30 40 50 60 70 80 90 100 110 120 130 140 150

27-OCT-2021 15:52
\\P01dwa\XSC\5021-rdy-yp-l-Y14E.dgn

8/23/99



PROJ. REFERENCE NO.
R-5021

SHEET NO.
X-340

150 140 130 120 110 100 90 80 70 60 50 40 30 20 10 0 10 20 30 40 50 60 70 80 90 100 110 120 130 140 150

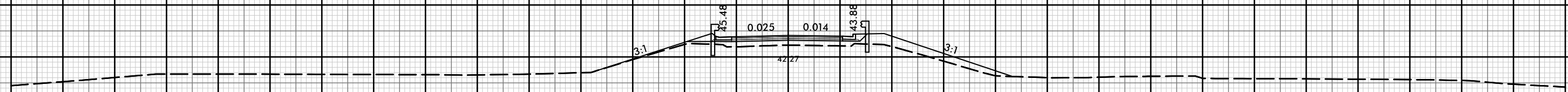

11 + 00.00

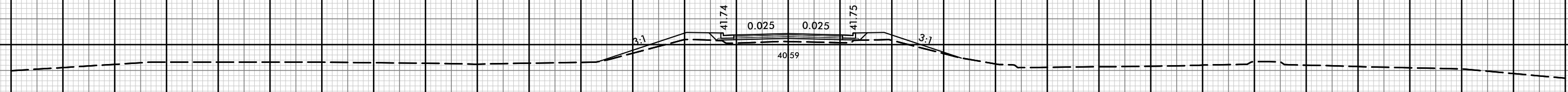

10 + 75.00
-Y14E-

150 140 130 120 110 100 90 80 70 60 50 40 30 20 10 0 10 20 30 40 50 60 70 80 90 100 110 120 130 140 150

27-OCT-2021 15:52
\\P01dwa\XSC\5021-rdy-yp-l-Y14E.dgn

8/23/99



PROJ. REFERENCE NO.
R-5021

SHEET NO.
X-400

150 140 130 120 110 100 90 80 70 60 50 40 30 20 10 0 10 20 30 40 50 60 70 80 90 100 110 120 130 140 150

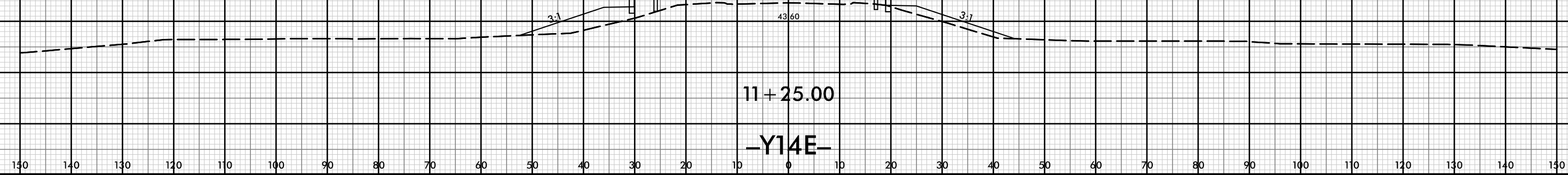

27-OCT-2021 15:52
R:\p\dwg\XSC\5021-rdy-114E.dgn

150 140 130 120 110 100 90 80 70 60 50 40 30 20 10 0 10 20 30 40 50 60 70 80 90 100 110 120 130 140 150



150 140 130 120 110 100 90 80 70 60 50 40 30 20 10 0 10 20 30 40 50 60 70 80 90 100 110 120 130 140 150

50 50

40 40

30 30

10 + 75.00

33.52

50 50

40 40

30 30

10 + 50.00

33.40

50 50

40 40

30 30

10 + 25.00

33.32

50 50

40 40

30 30

10 + 00.00

33.28

-Y14F-



150 140 130 120 110 100 90 80 70 60 50 40 30 20 10 0 10 20 30 40 50 60 70 80 90 100 110 120 130 140 150

150 140 130 120 110 100 90 80 70 60 50 40 30 20 10 0 10 20 30 40 50 60 70 80 90 100 110 120 130 140 150

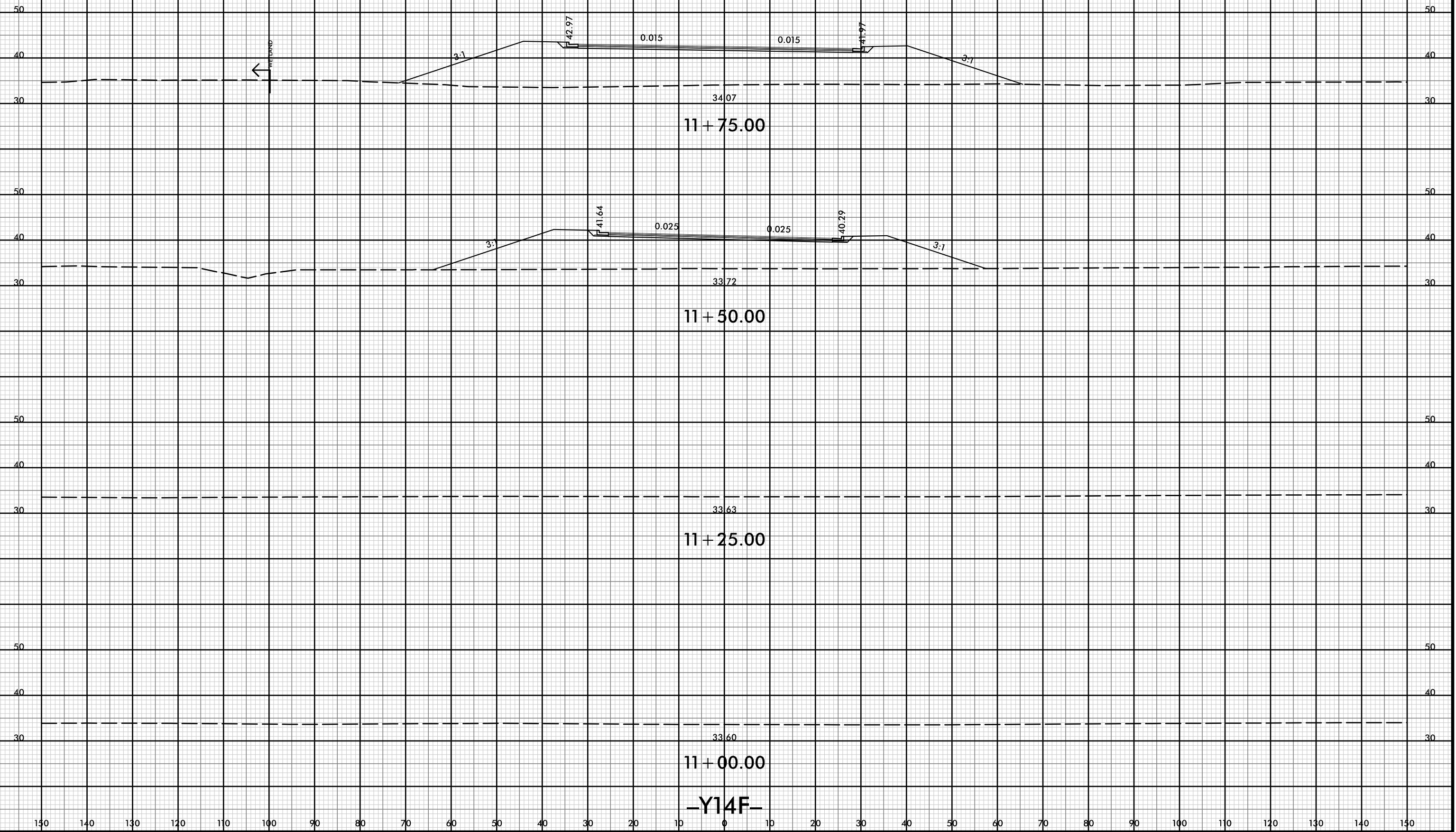



150 140 130 120 110 100 90 80 70 60 50 40 30 20 10 0 10 20 30 40 50 60 70 80 90 100 110 120 130 140 150

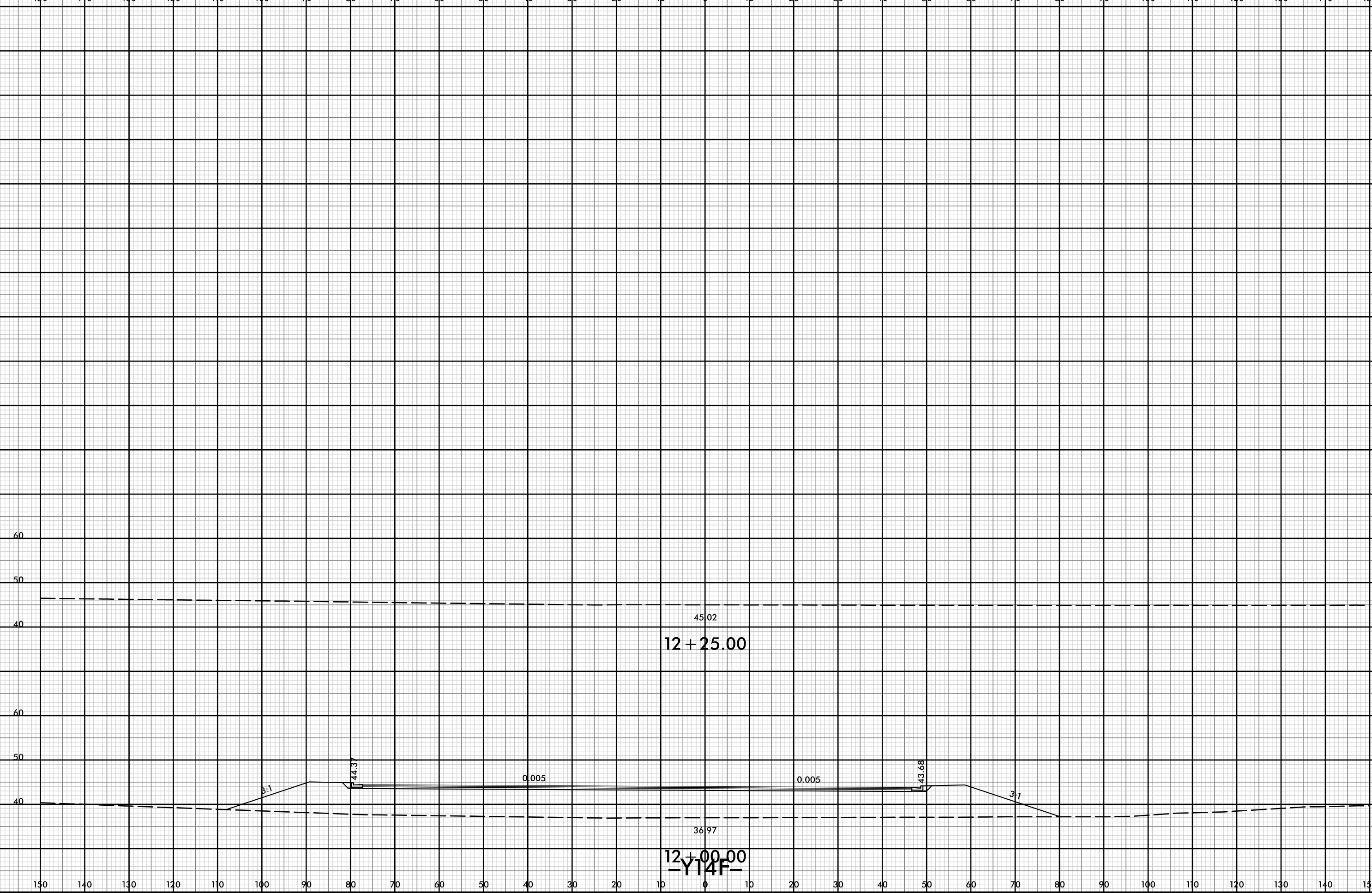

150 140 130 120 110 100 90 80 70 60 50 40 30 20 10 0 10 20 30 40 50 60 70 80 90 100 110 120 130 140 150



150 140 130 120 110 100 90 80 70 60 50 40 30 20 10 0 10 20 30 40 50 60 70 80 90 100 110 120 130 140 150

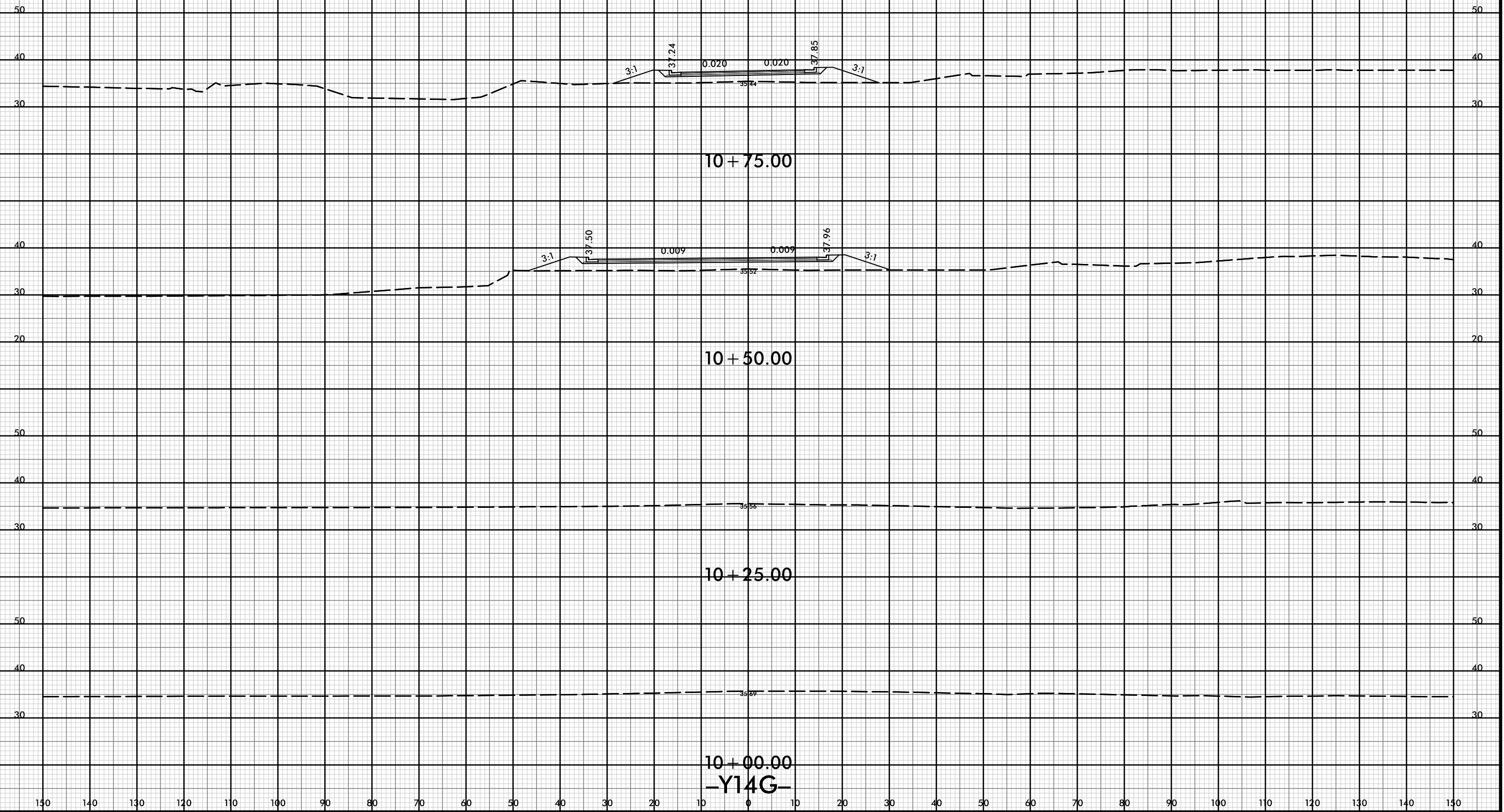



150 140 130 120 110 100 90 80 70 60 50 40 30 20 10 0 10 20 30 40 50 60 70 80 90 100 110 120 130 140 150

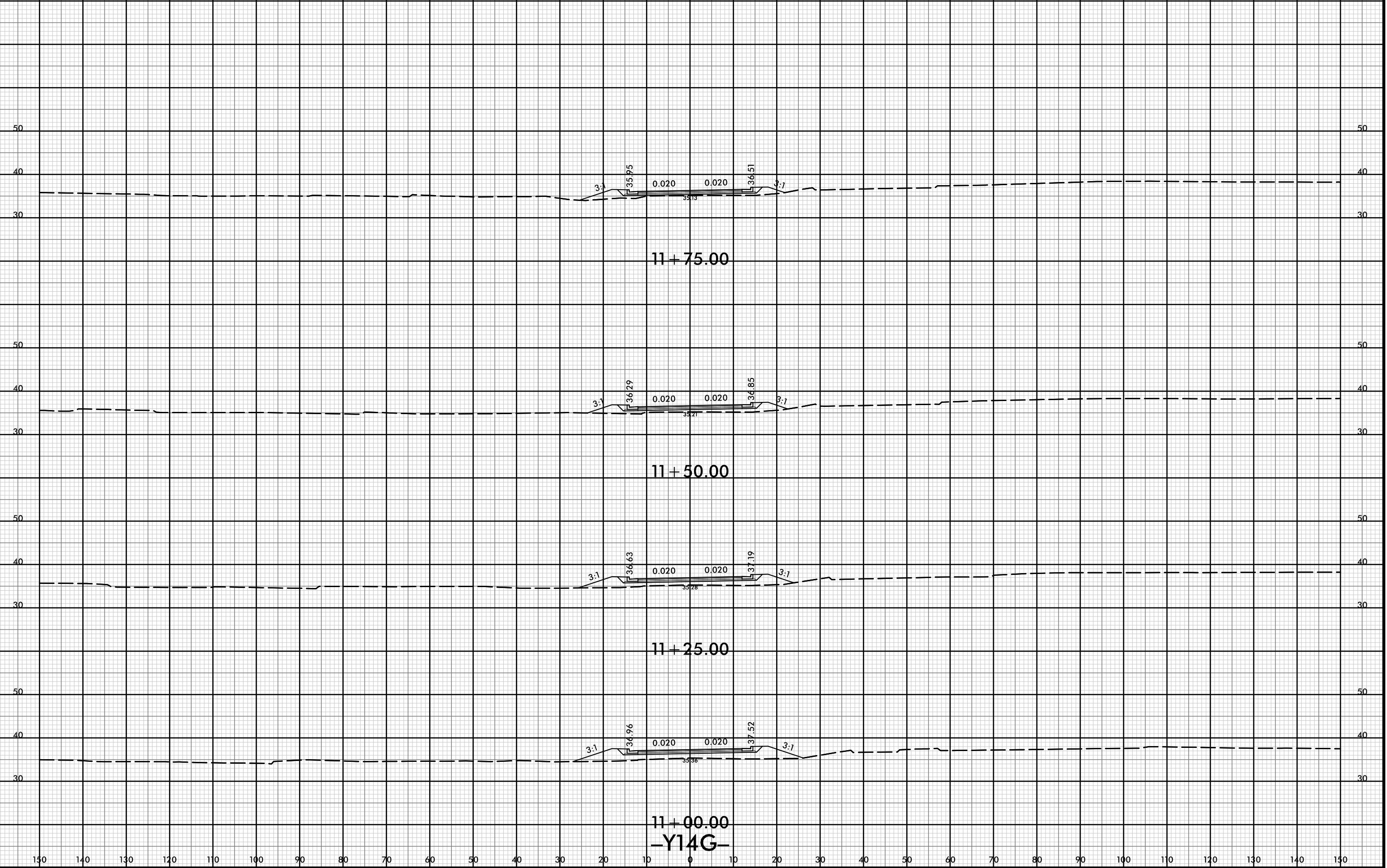

11+75.00

11+50.00

11+25.00

11+00.00

-Y14G-



150 140 130 120 110 100 90 80 70 60 50 40 30 20 10 0 10 20 30 40 50 60 70 80 90 100 110 120 130 140 150

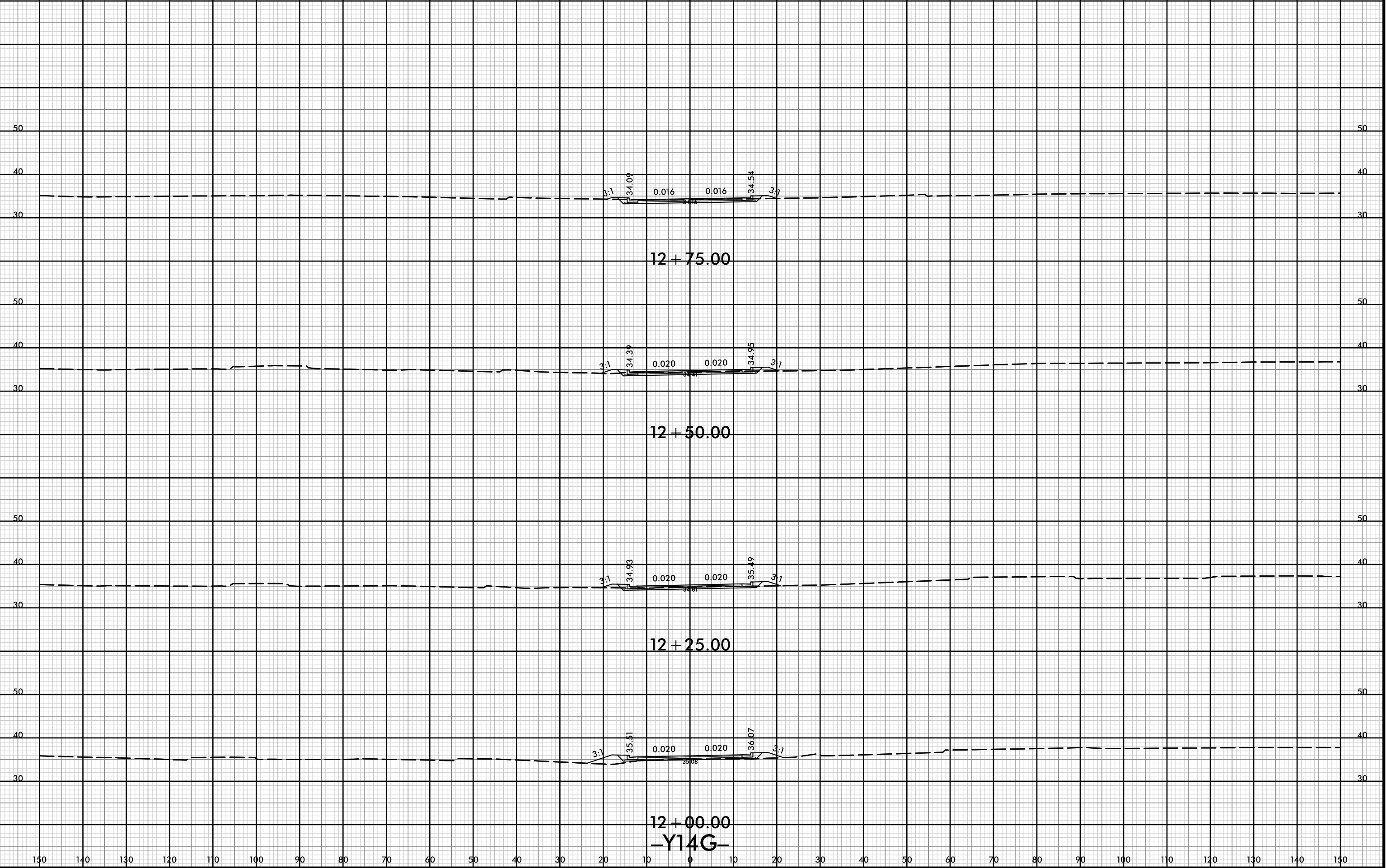

150 140 130 120 110 100 90 80 70 60 50 40 30 20 10 0 10 20 30 40 50 60 70 80 90 100 110 120 130 140 150

12 + 00.00
 -Y14G-

8/23/99



PROJ. REFERENCE NO.
R-5021

SHEET NO.
X-348

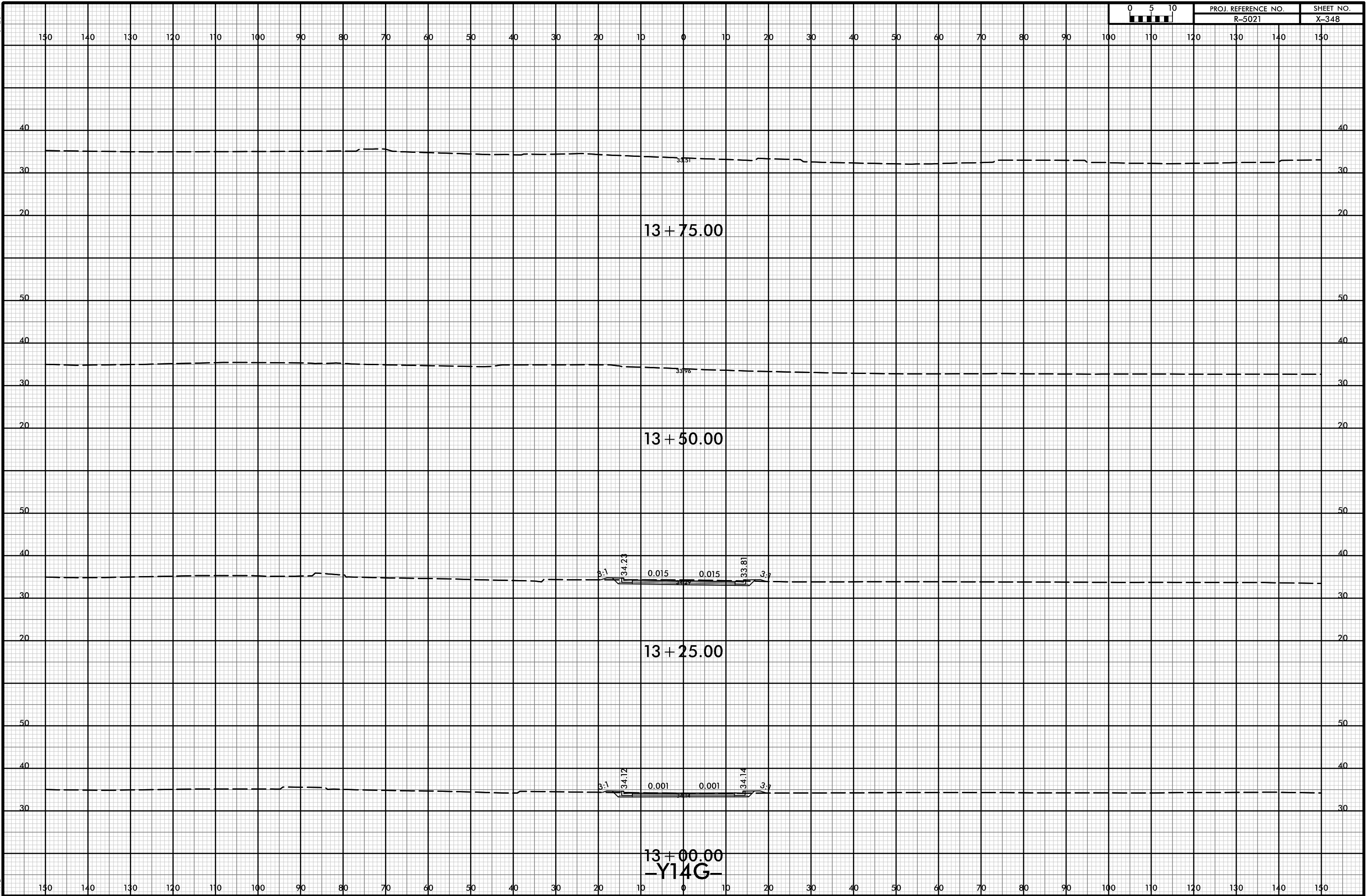

21-Jul-2021 10:39
 R:\p\dawej\XSCA\5021-rdy-yp-l-Y14G.dgn
 HNTB



150 140 130 120 110 100 90 80 70 60 50 40 30 20 10 0 10 20 30 40 50 60 70 80 90 100 110 120 130 140 150

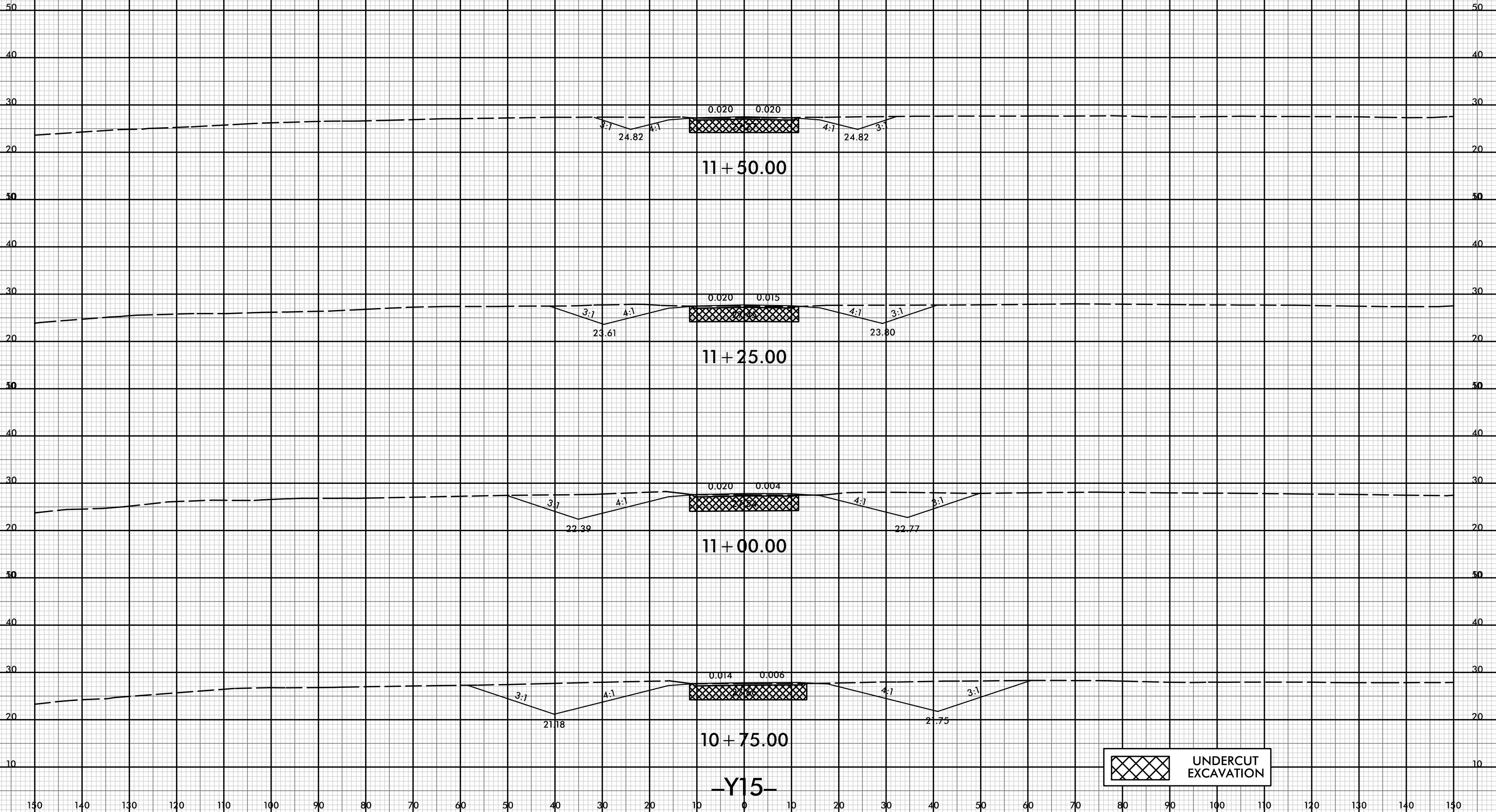

-Y15-



150 140 130 120 110 100 90 80 70 60 50 40 30 20 10 0 10 20 30 40 50 60 70 80 90 100 110 120 130 140 150

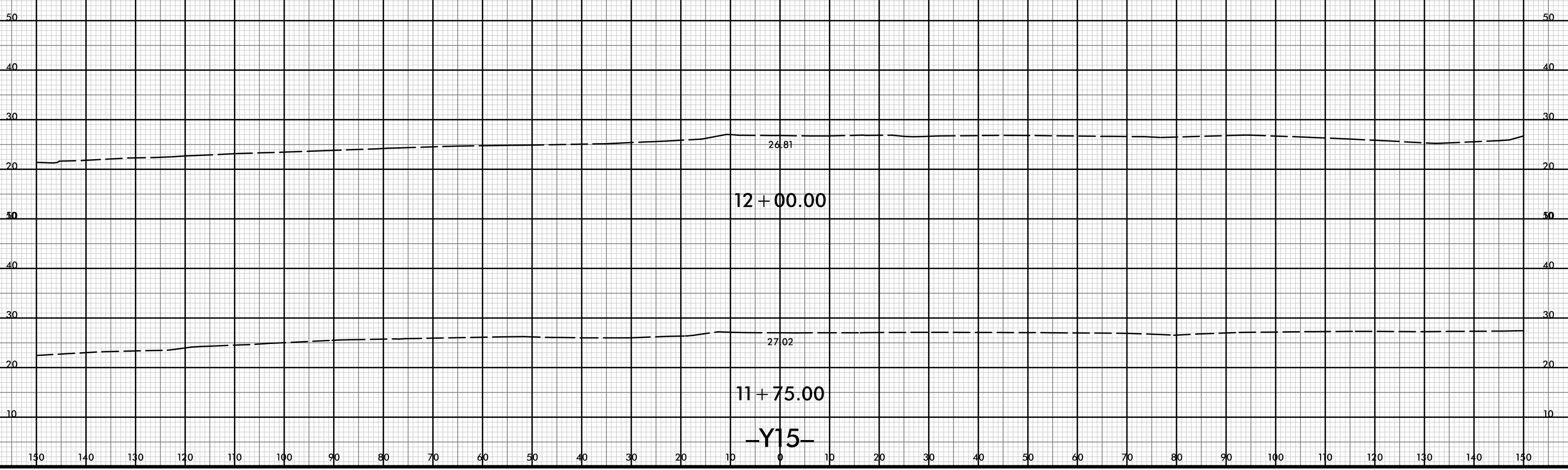



150 140 130 120 110 100 90 80 70 60 50 40 30 20 10 0 10 20 30 40 50 60 70 80 90 100 110 120 130 140 150

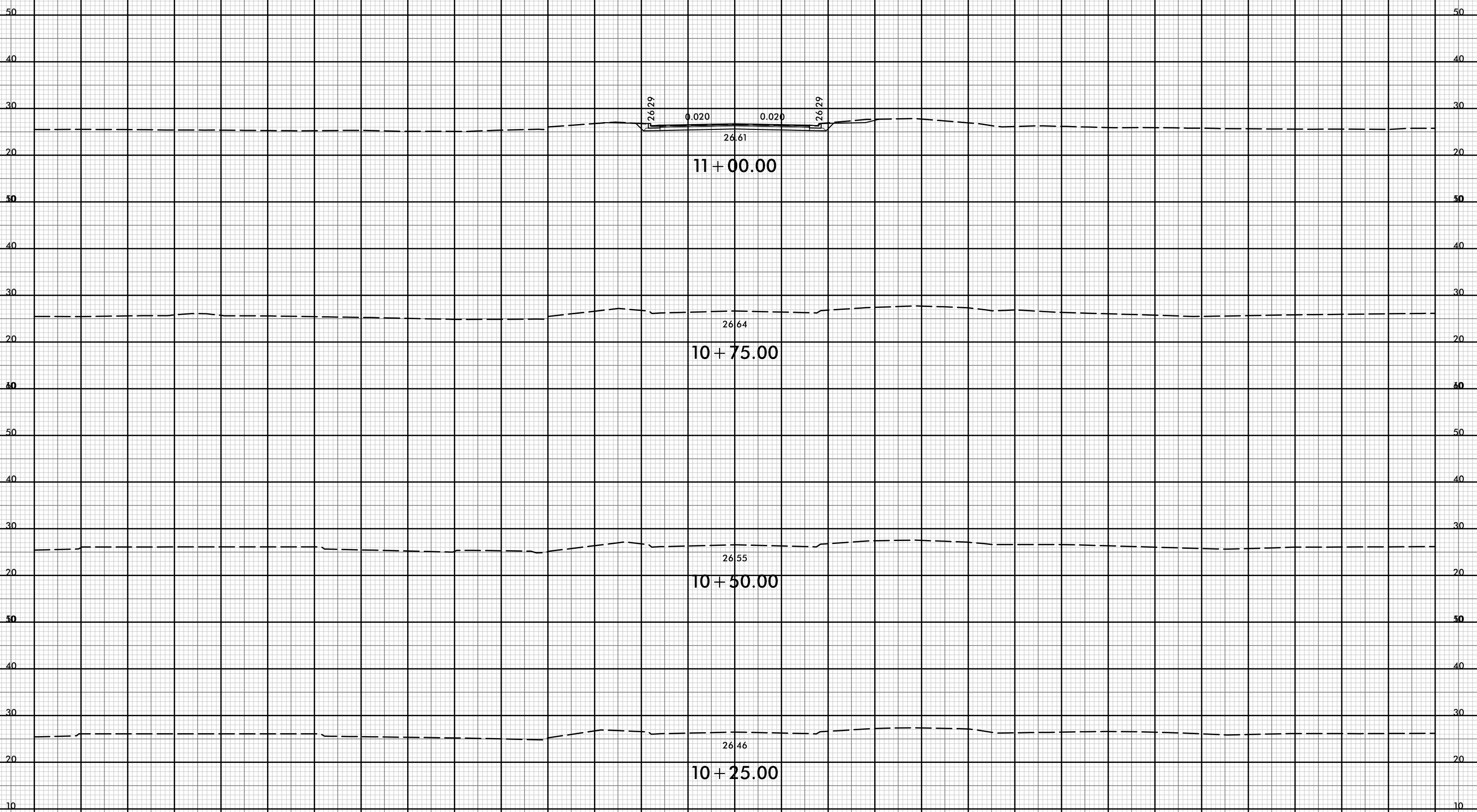

11+00.00

10+75.00

10+50.00

10+25.00

-Y16-

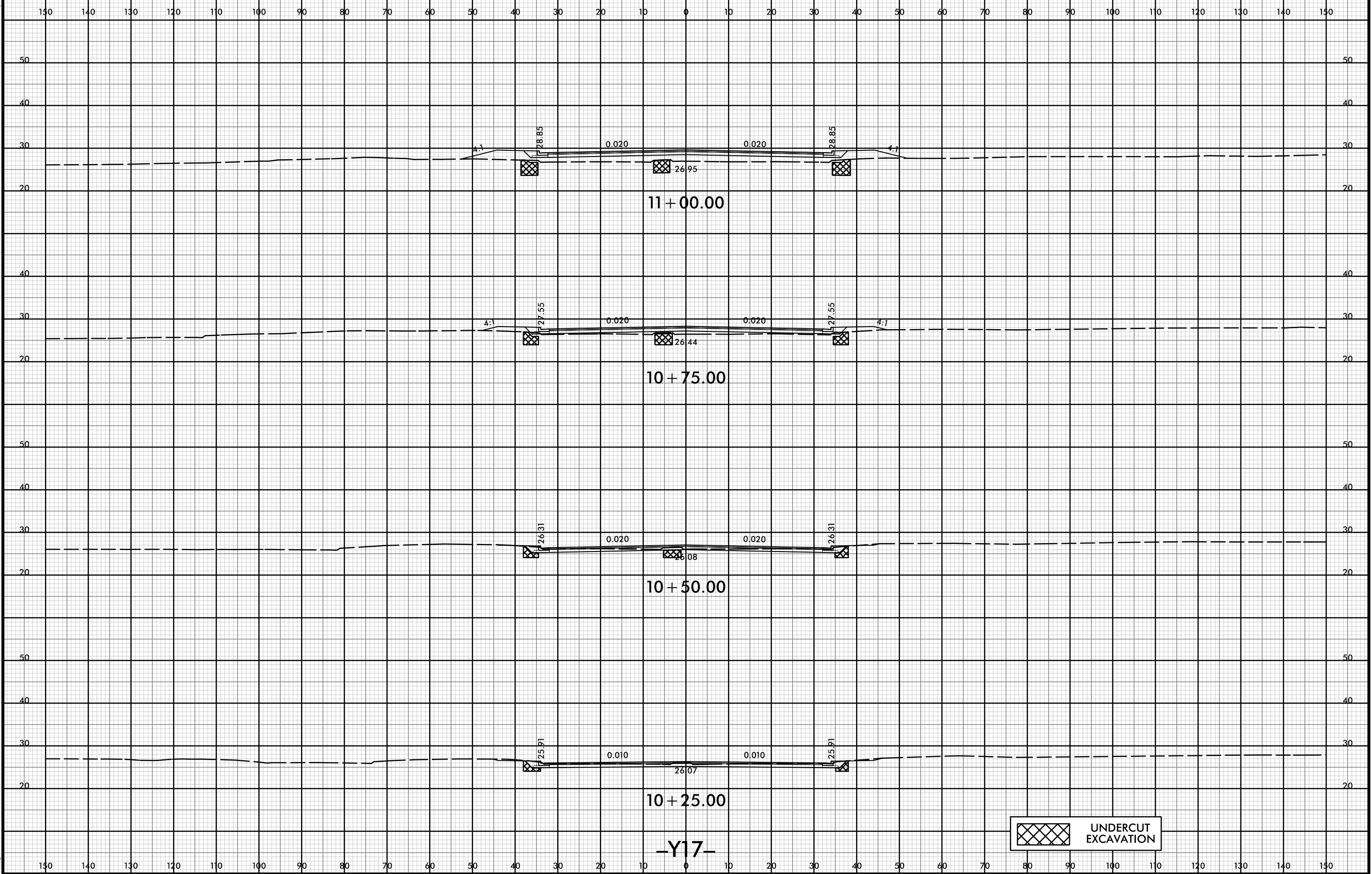

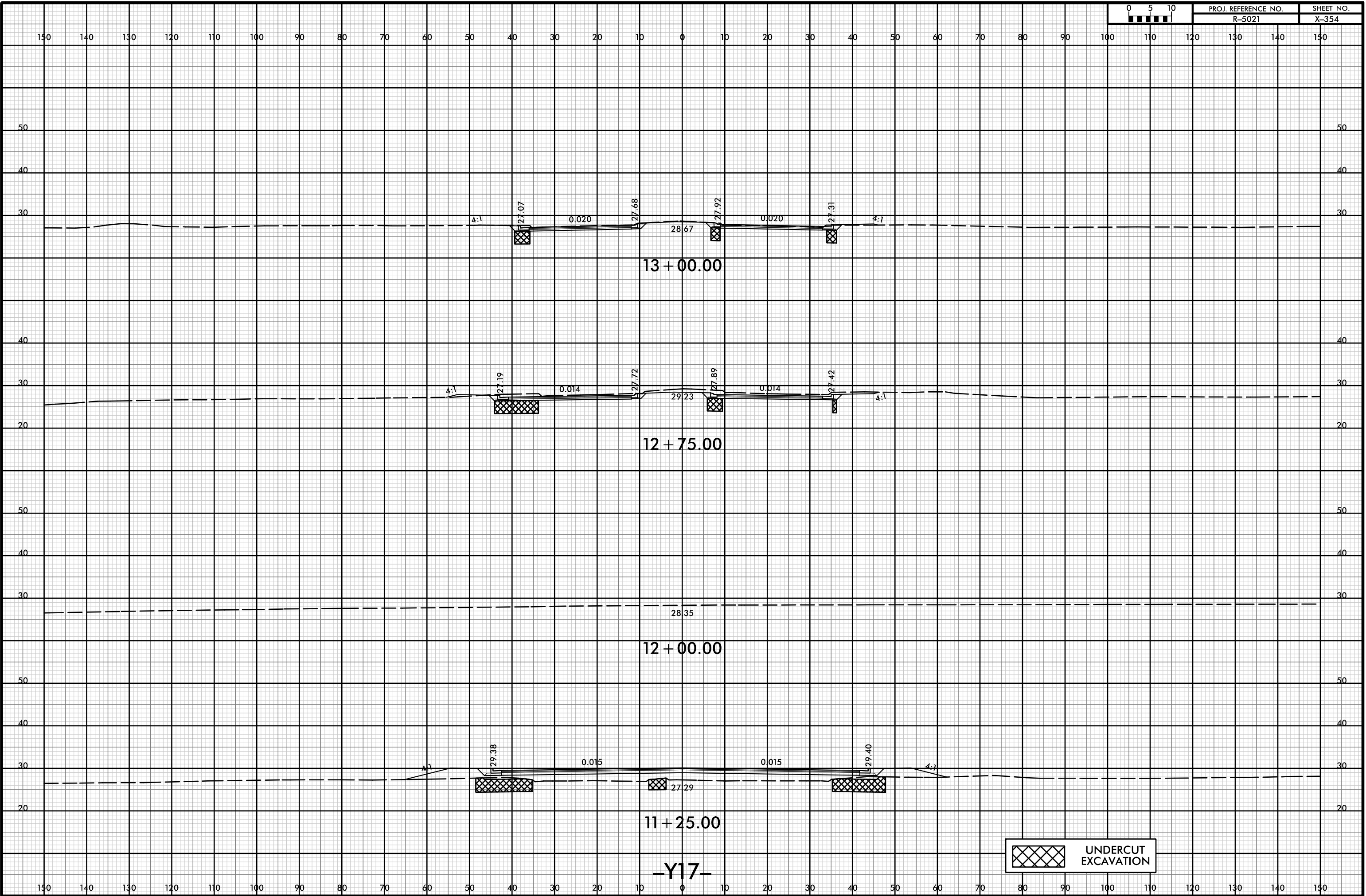

 UNDERCUT EXCAVATION



150 140 130 120 110 100 90 80 70 60 50 40 30 20 10 0 10 20 30 40 50 60 70 80 90 100 110 120 130 140 150

50 50

40 40

30 30

20 20

0.020

27.41

27.63

0.020

27.00

4:1

27.88

26.55

13 + 25.00

-Y17-



UNDERCUT EXCAVATION

150 140 130 120 110 100 90 80 70 60 50 40 30 20 10 0 10 20 30 40 50 60 70 80 90 100 110 120 130 140 150



150 140 130 120 110 100 90 80 70 60 50 40 30 20 10 0 10 20 30 40 50 60 70 80 90 100 110 120 130 140 150

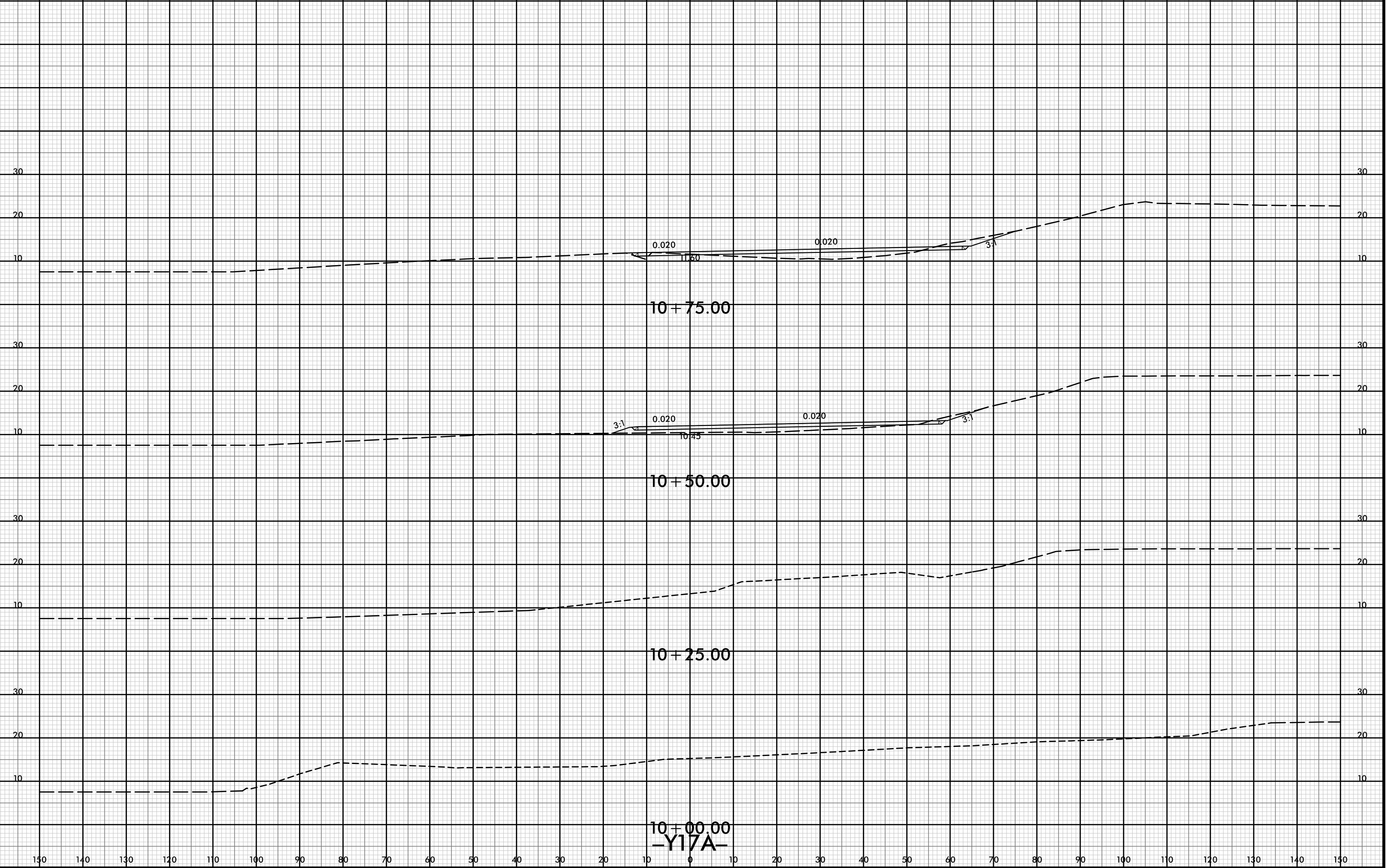

10+75.00

10+50.00

10+25.00

10+00.00

-Y17A-



150 140 130 120 110 100 90 80 70 60 50 40 30 20 10 0 10 20 30 40 50 60 70 80 90 100 110 120 130 140 150

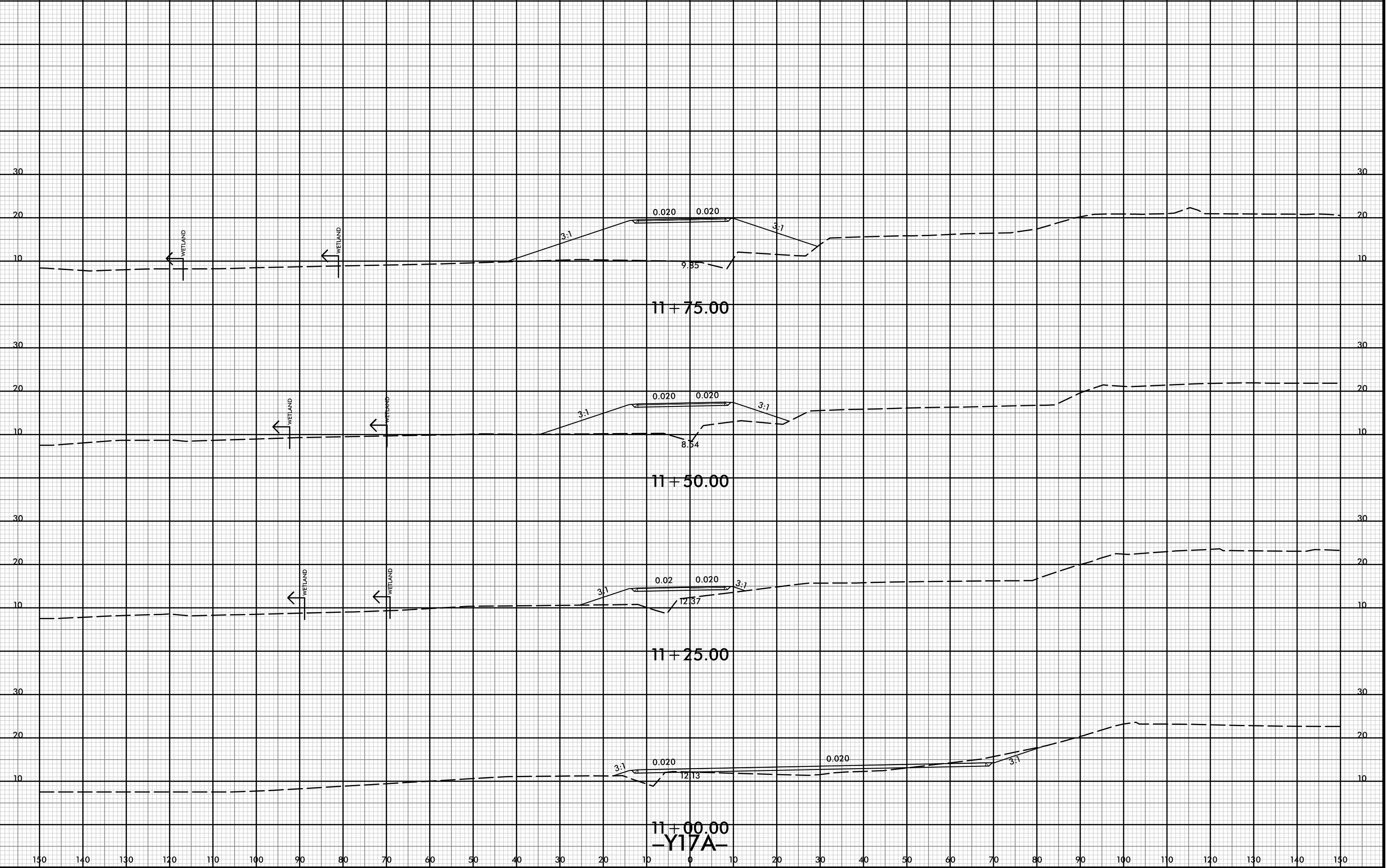

11+75.00

11+50.00

11+25.00

11+00.00

-Y17A-

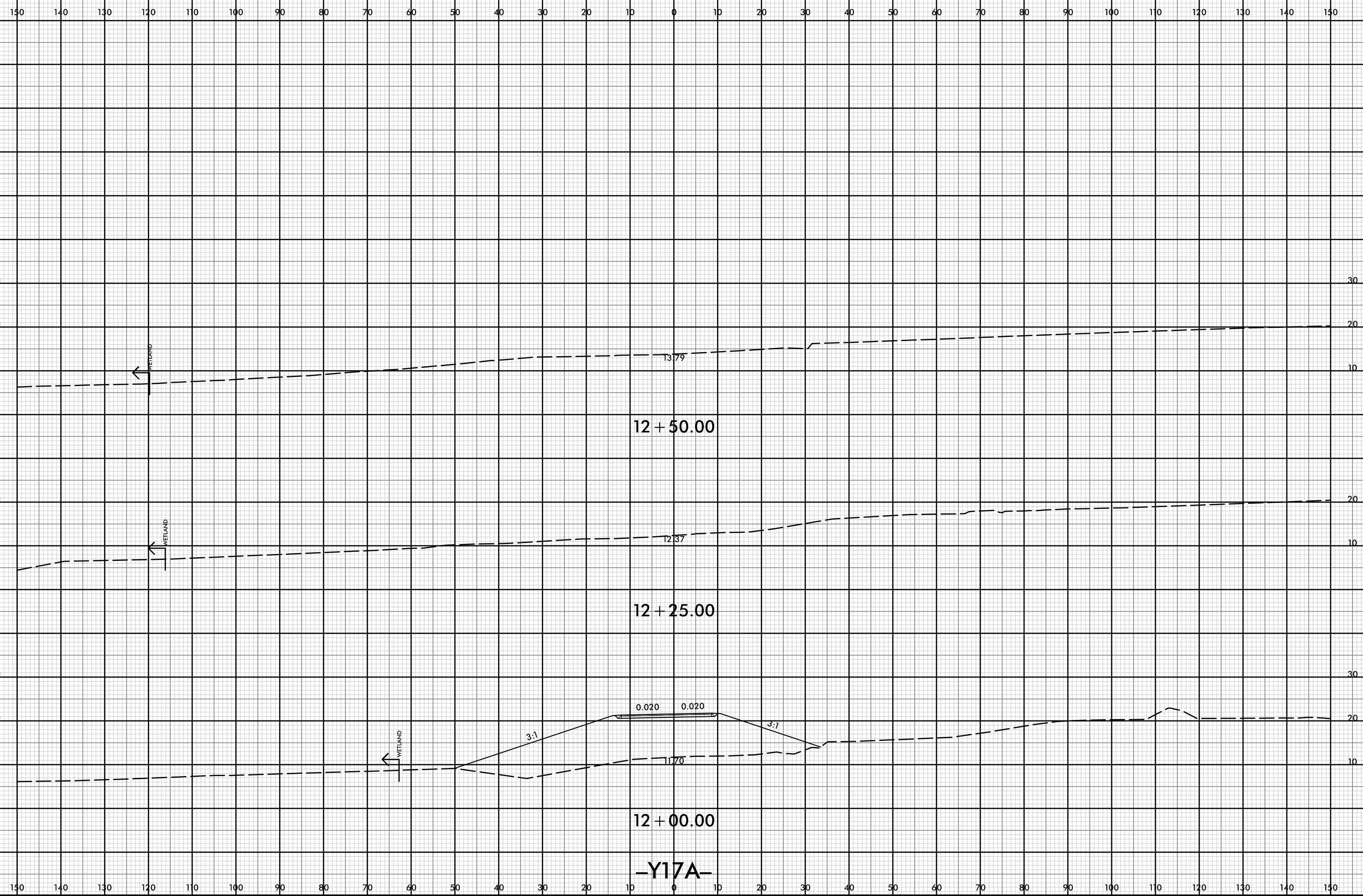

-Y17A-



150 140 130 120 110 100 90 80 70 60 50 40 30 20 10 0 10 20 30 40 50 60 70 80 90 100 110 120 130 140 150

40 40

30 30

20 20

40 40

30 30

20 20

40 40

30 30

20 20

10 + 75.00

40 40

30 30

20 20

10 + 50.00

-Y18A-

150 140 130 120 110 100 90 80 70 60 50 40 30 20 10 0 10 20 30 40 50 60 70 80 90 100 110 120 130 140 150

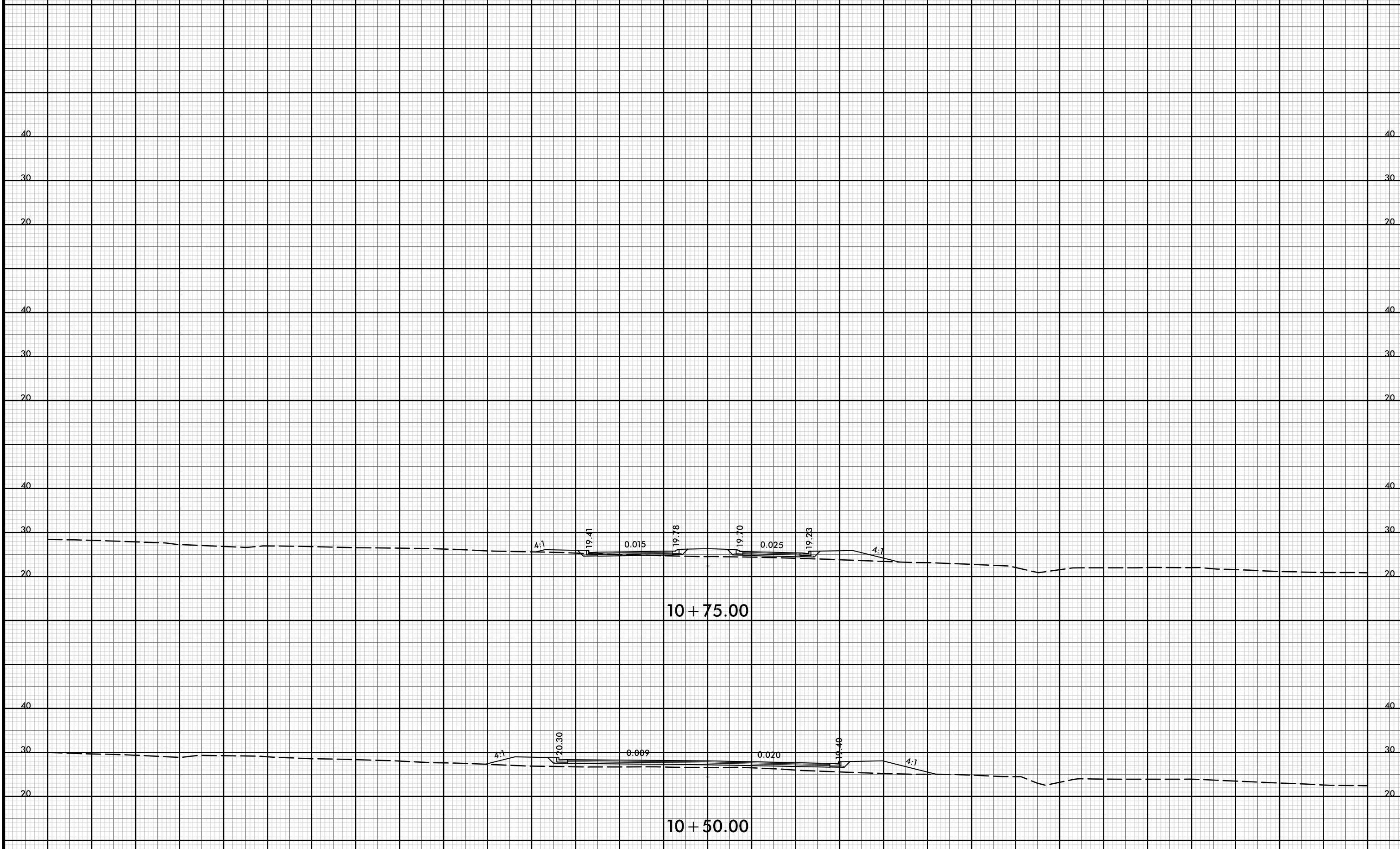

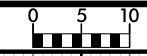

150 140 130 120 110 100 90 80 70 60 50 40 30 20 10 0 10 20 30 40 50 60 70 80 90 100 110 120 130 140 150

40 40

30 30

20 20

40 40

30 30

20 20

40 40

30 30

20 20

11 + 25.00

40 40

30 30

20 20

11 + 00.00

-Y18A-

150 140 130 120 110 100 90 80 70 60 50 40 30 20 10 0 10 20 30 40 50 60 70 80 90 100 110 120 130 140 150

8/23/99



PROJ. REFERENCE NO.
R-5021

SHEET NO.
X-361

150 140 130 120 110 100 90 80 70 60 50 40 30 20 10 0 10 20 30 40 50 60 70 80 90 100 110 120 130 140 150

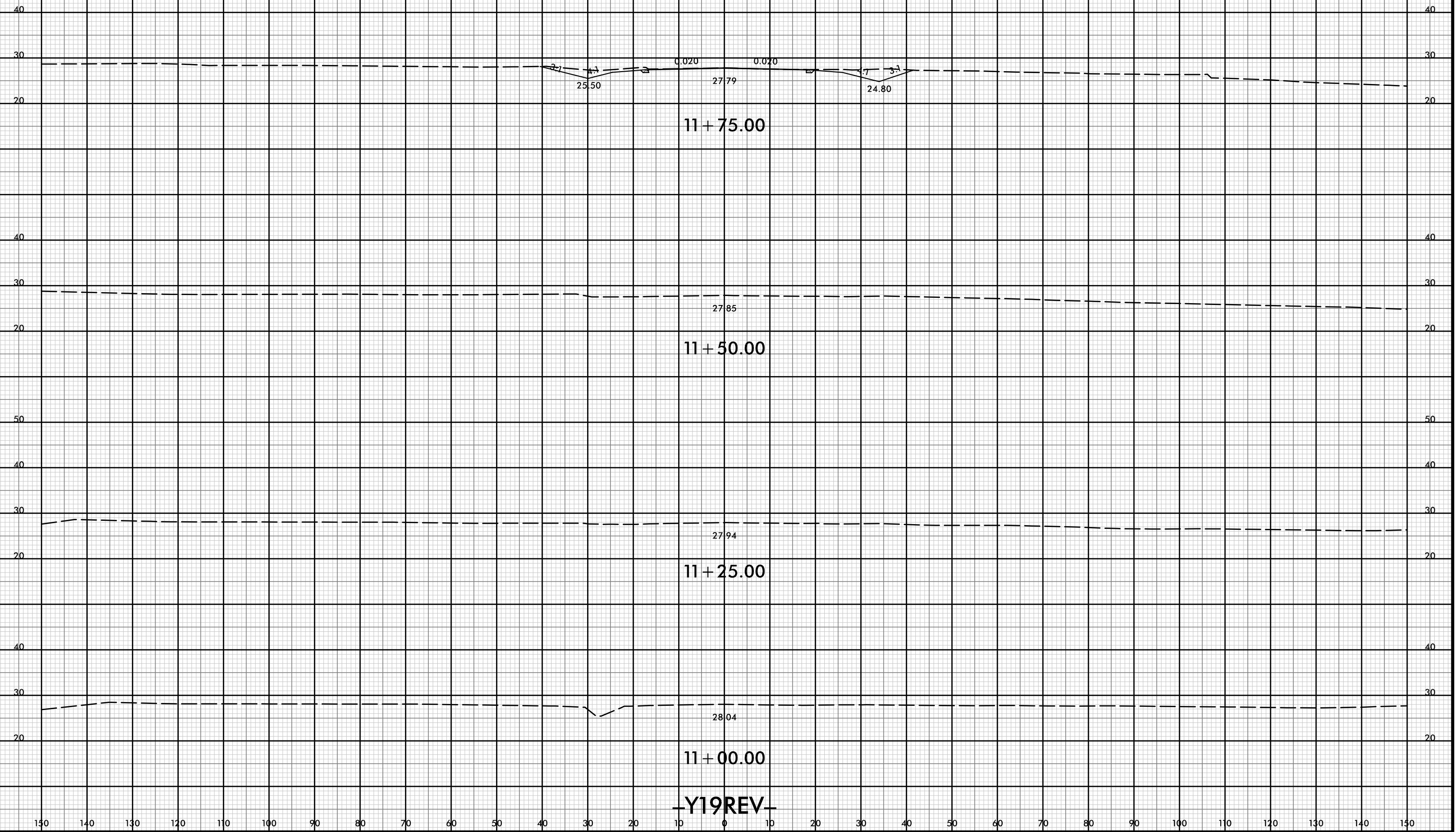

21-JUL-2021 10:39
 \\P01dweu\XSCA\5021-rdy-yp-l-Y19REV.dgn
 HNTB

150 140 130 120 110 100 90 80 70 60 50 40 30 20 10 0 10 20 30 40 50 60 70 80 90 100 110 120 130 140 150

8/23/99

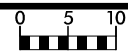

PROJ. REFERENCE NO.
R-5021

SHEET NO.
X-362

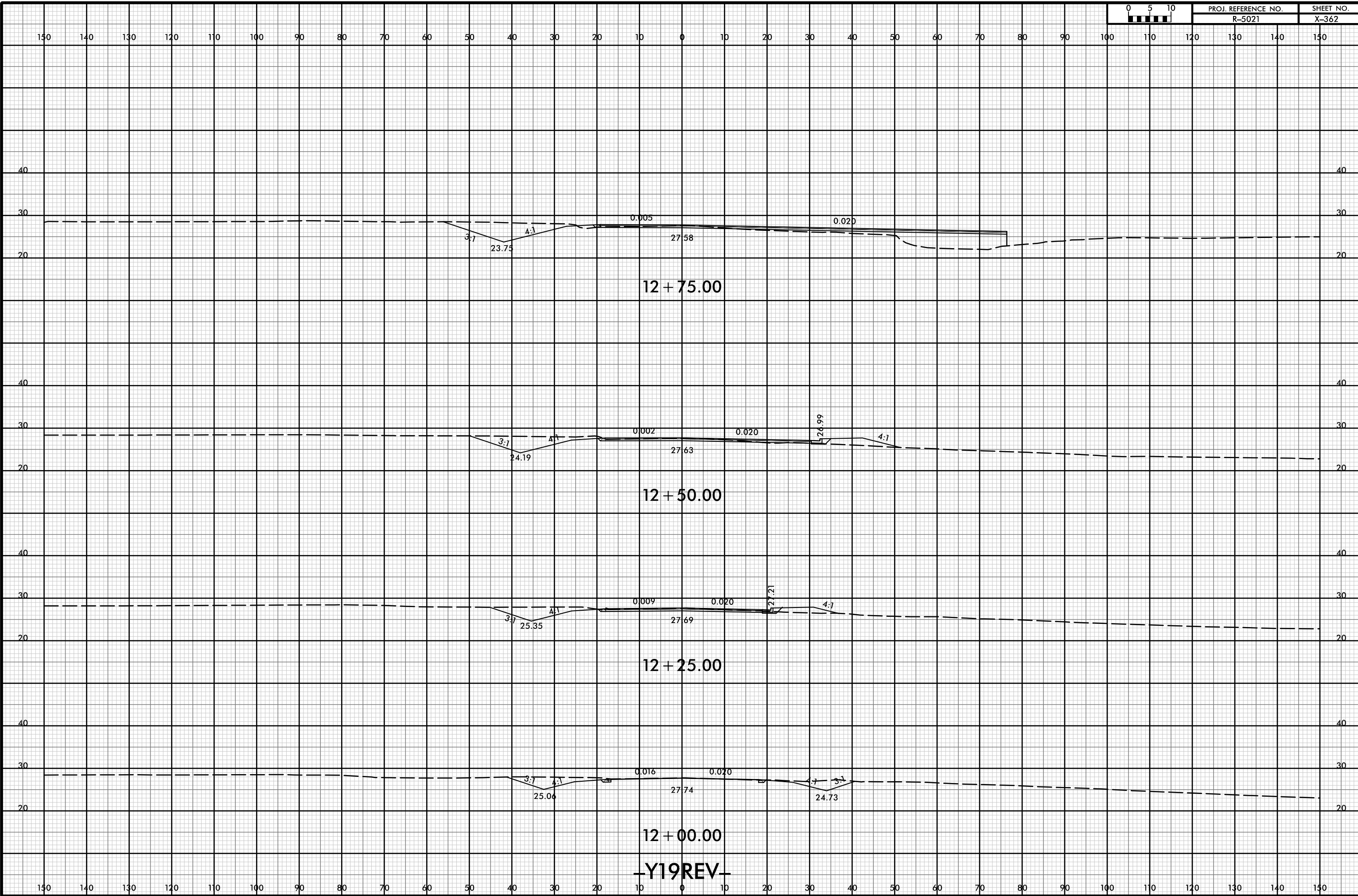

12 + 75.00

12 + 50.00

12 + 25.00

12 + 00.00

~~Y19REV~~

21 JUL 2021 10:39
 \\P01dweu\XSCA\5021_rdy_xp1_Y19REV.dgn
 HNTB

8/23/99



PROJ. REFERENCE NO.
R-5021

SHEET NO.
X-363

150 140 130 120 110 100 90 80 70 60 50 40 30 20 10 0 10 20 30 40 50 60 70 80 90 100 110 120 130 140 150

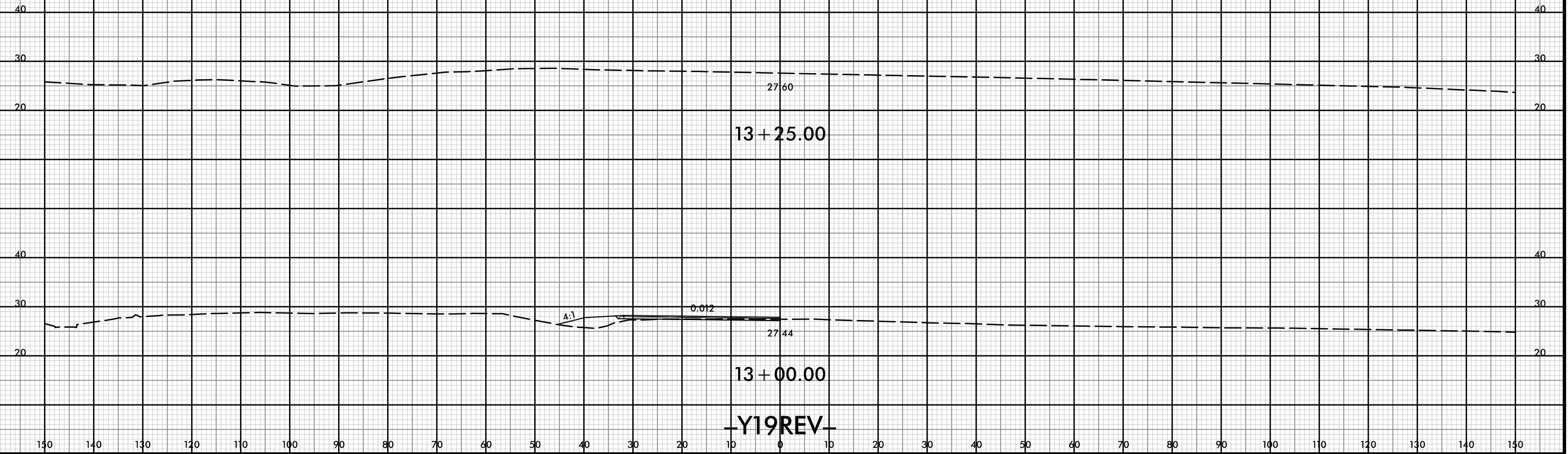

21-Jul-2021 10:39
 R:\p\dawej\XSCA\5021_rdy_xp1_Y19REV.dgn
 HNTB



150 140 130 120 110 100 90 80 70 60 50 40 30 20 10 0 10 20 30 40 50 60 70 80 90 100 110 120 130 140 150

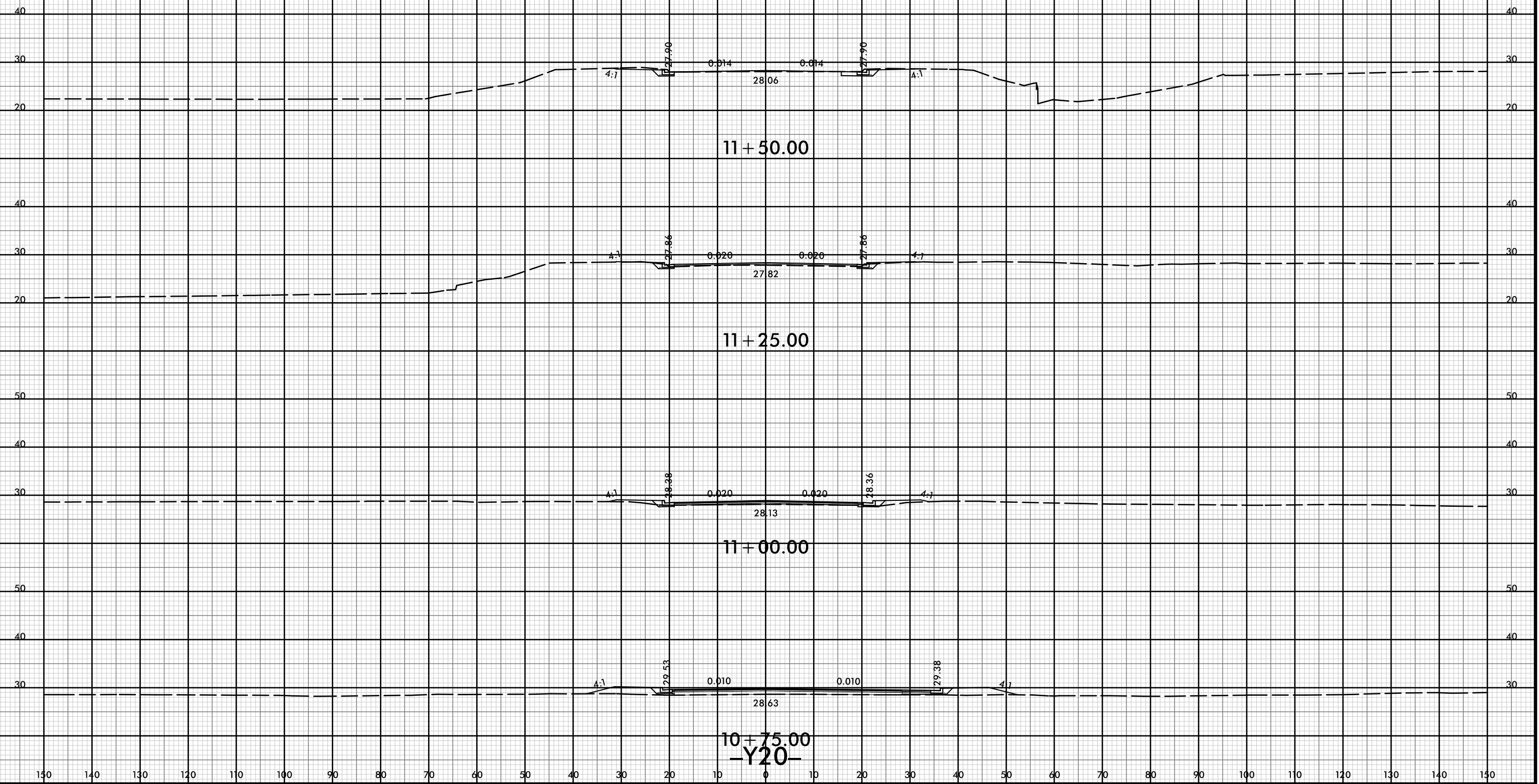

150 140 130 120 110 100 90 80 70 60 50 40 30 20 10 0 10 20 30 40 50 60 70 80 90 100 110 120 130 140 150



150 140 130 120 110 100 90 80 70 60 50 40 30 20 10 0 10 20 30 40 50 60 70 80 90 100 110 120 130 140 150

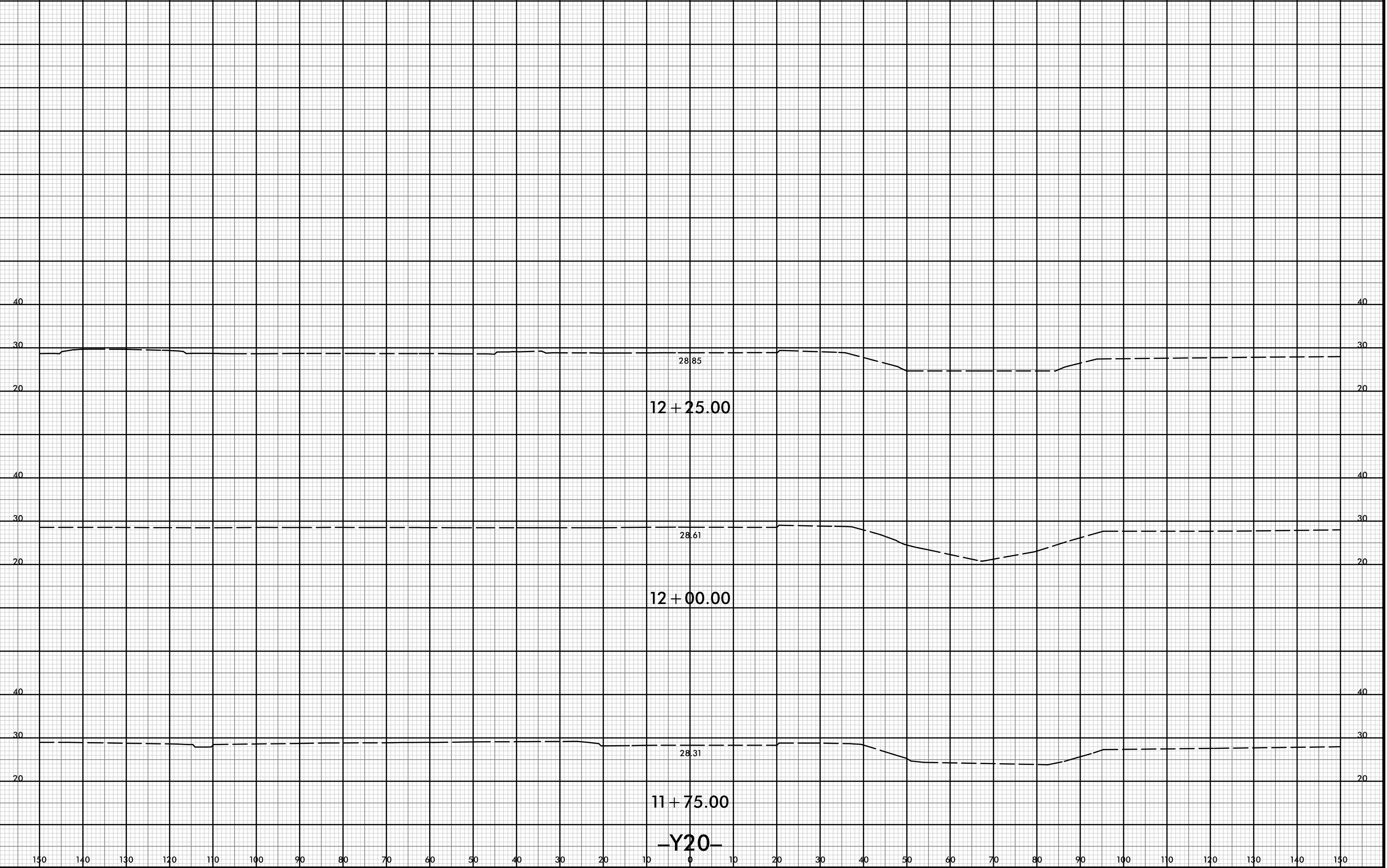

150 140 130 120 110 100 90 80 70 60 50 40 30 20 10 0 10 20 30 40 50 60 70 80 90 100 110 120 130 140 150

-Y20-



150 140 130 120 110 100 90 80 70 60 50 40 30 20 10 0 10 20 30 40 50 60 70 80 90 100 110 120 130 140 150

50 50

40 40

30 30

10 + 75.00

50 50

40 40

30 30

10 + 50.00

50 50

40 40

30 30

10 + 25.00

50 50

40 40

30 30

10 + 00.00

-Y21-

150 140 130 120 110 100 90 80 70 60 50 40 30 20 10 0 10 20 30 40 50 60 70 80 90 100 110 120 130 140 150

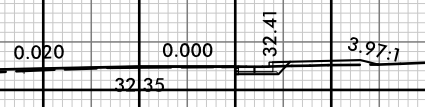
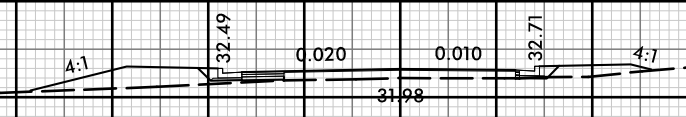

32.19

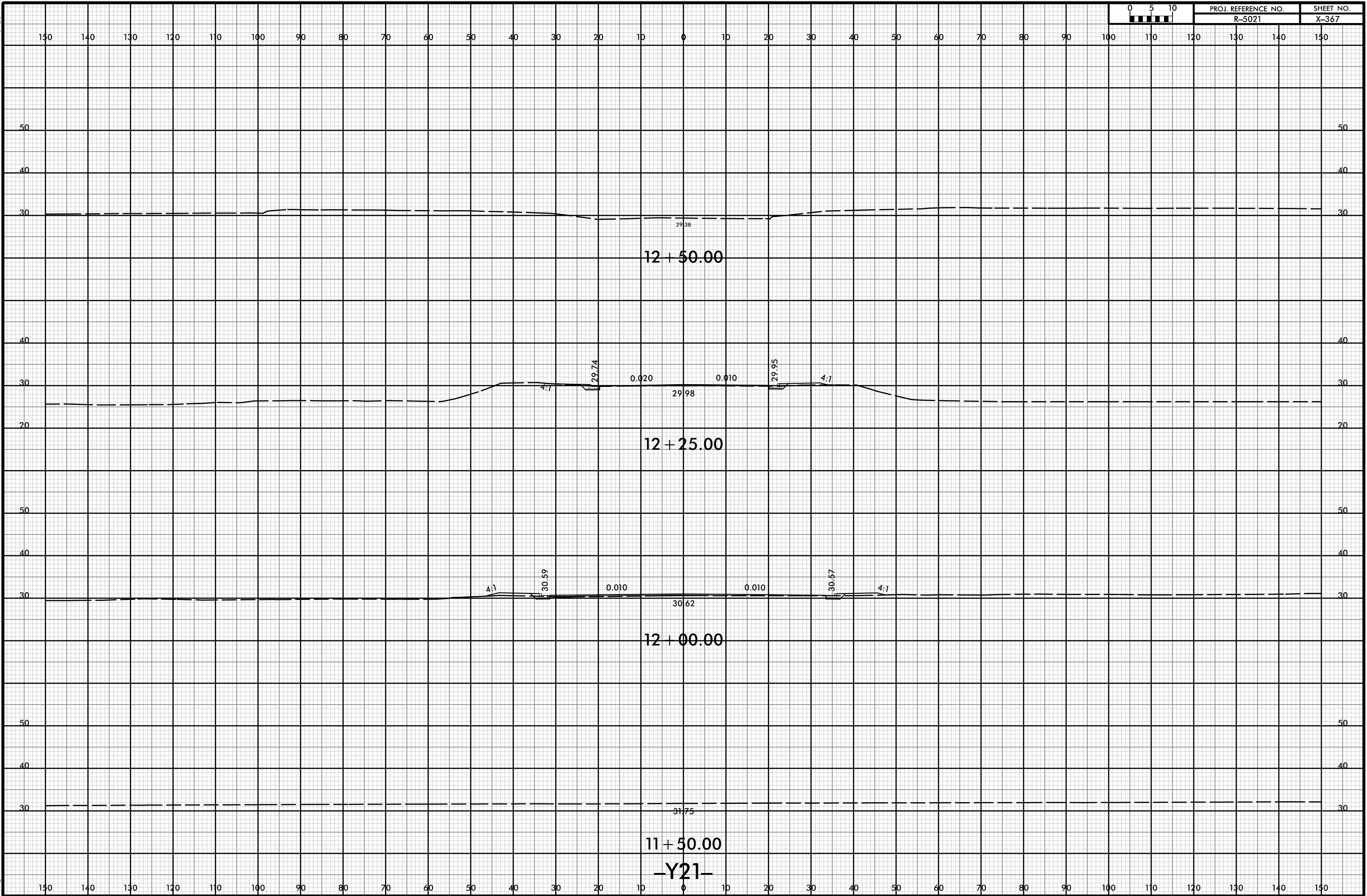

8/23/99



PROJ. REFERENCE NO.
R-5021

SHEET NO.
X-368

150 140 130 120 110 100 90 80 70 60 50 40 30 20 10 0 10 20 30 40 50 60 70 80 90 100 110 120 130 140 150

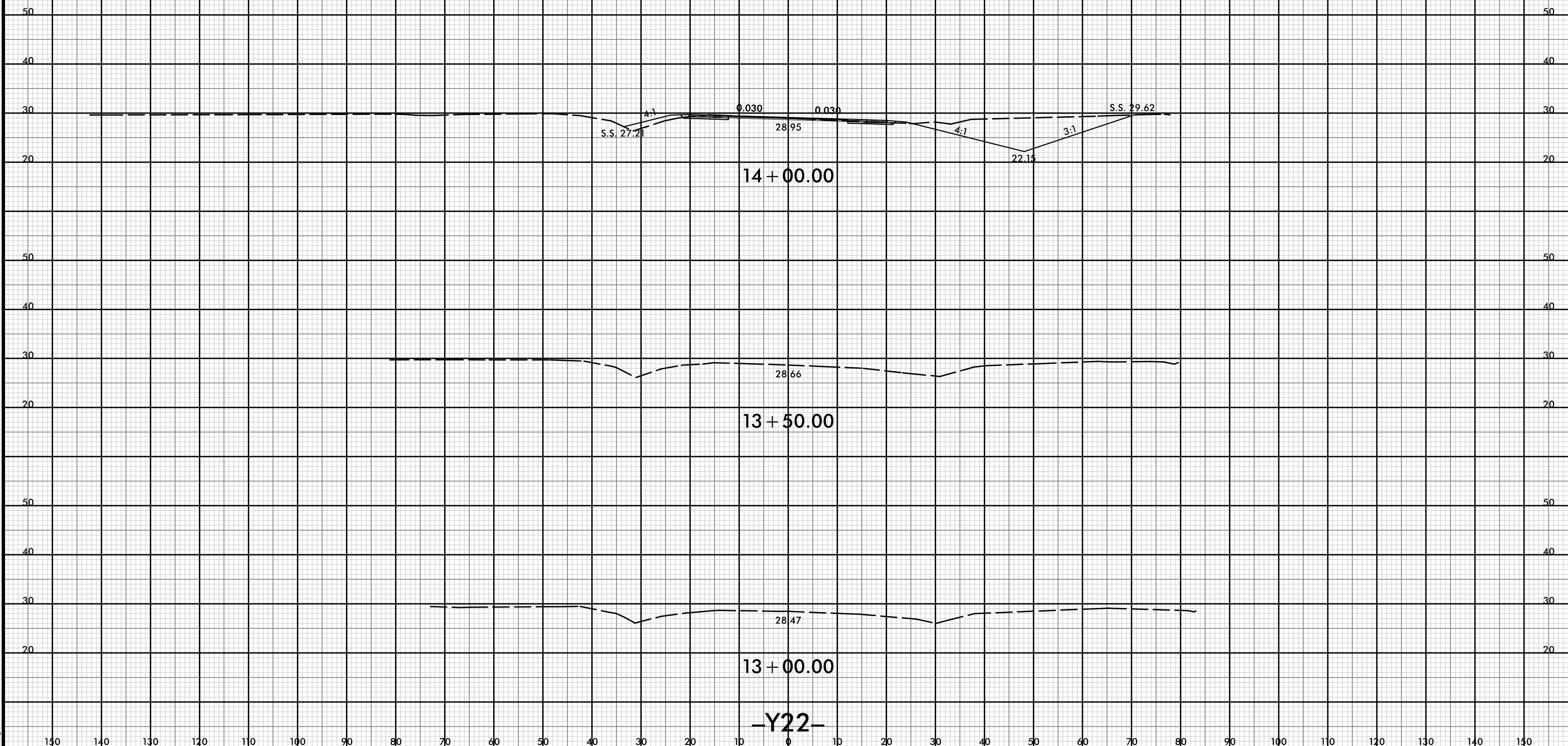

-Y22-

150 140 130 120 110 100 90 80 70 60 50 40 30 20 10 0 10 20 30 40 50 60 70 80 90 100 110 120 130 140 150

21-Jul-2021 10:40
R:\pawej\XSC\5021-rdy-yp-l\Y22.dgn
HTB

8/23/99



PROJ. REFERENCE NO.
R-5021

SHEET NO.
X-369

150 140 130 120 110 100 90 80 70 60 50 40 30 20 10 0 10 20 30 40 50 60 70 80 90 100 110 120 130 140 150

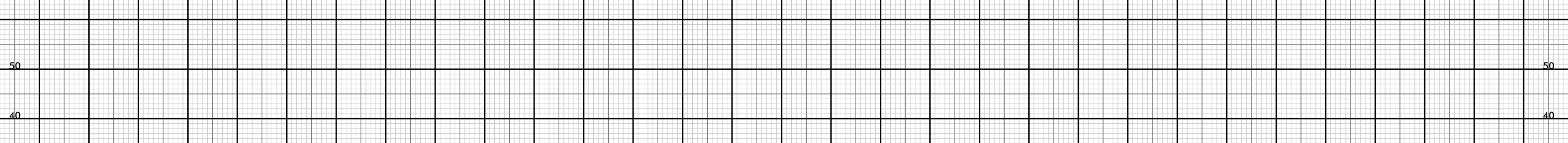
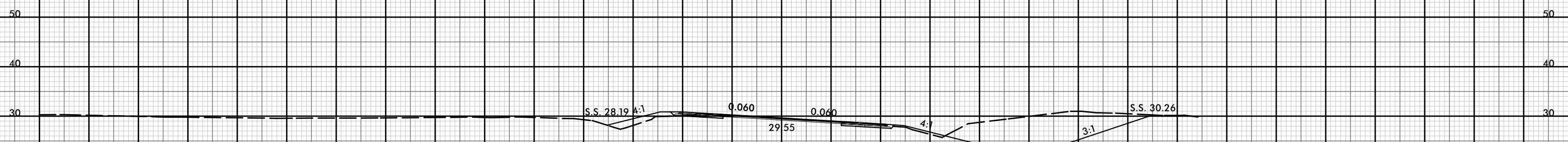
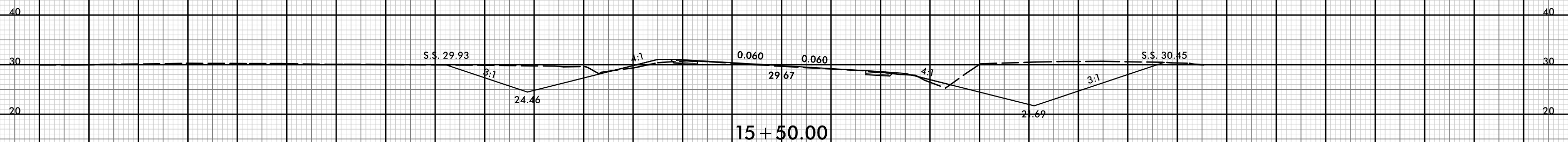
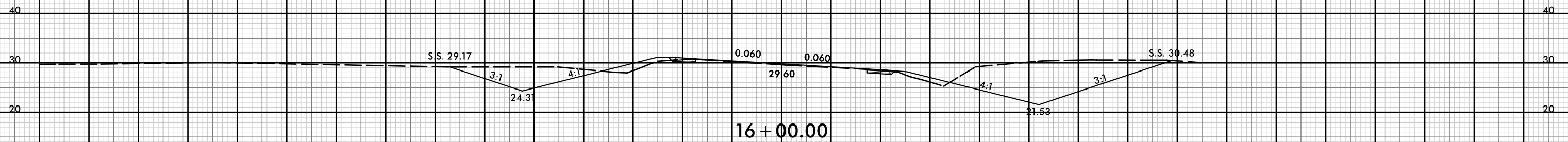

150 140 130 120 110 100 90 80 70 60 50 40 30 20 10 0 10 20 30 40 50 60 70 80 90 100 110 120 130 140 150

-Y22-

21-Jul-2021 10:40
R:\p\dawej\XSC\5021-rdy-yp-1-Y22.dgn
HTB

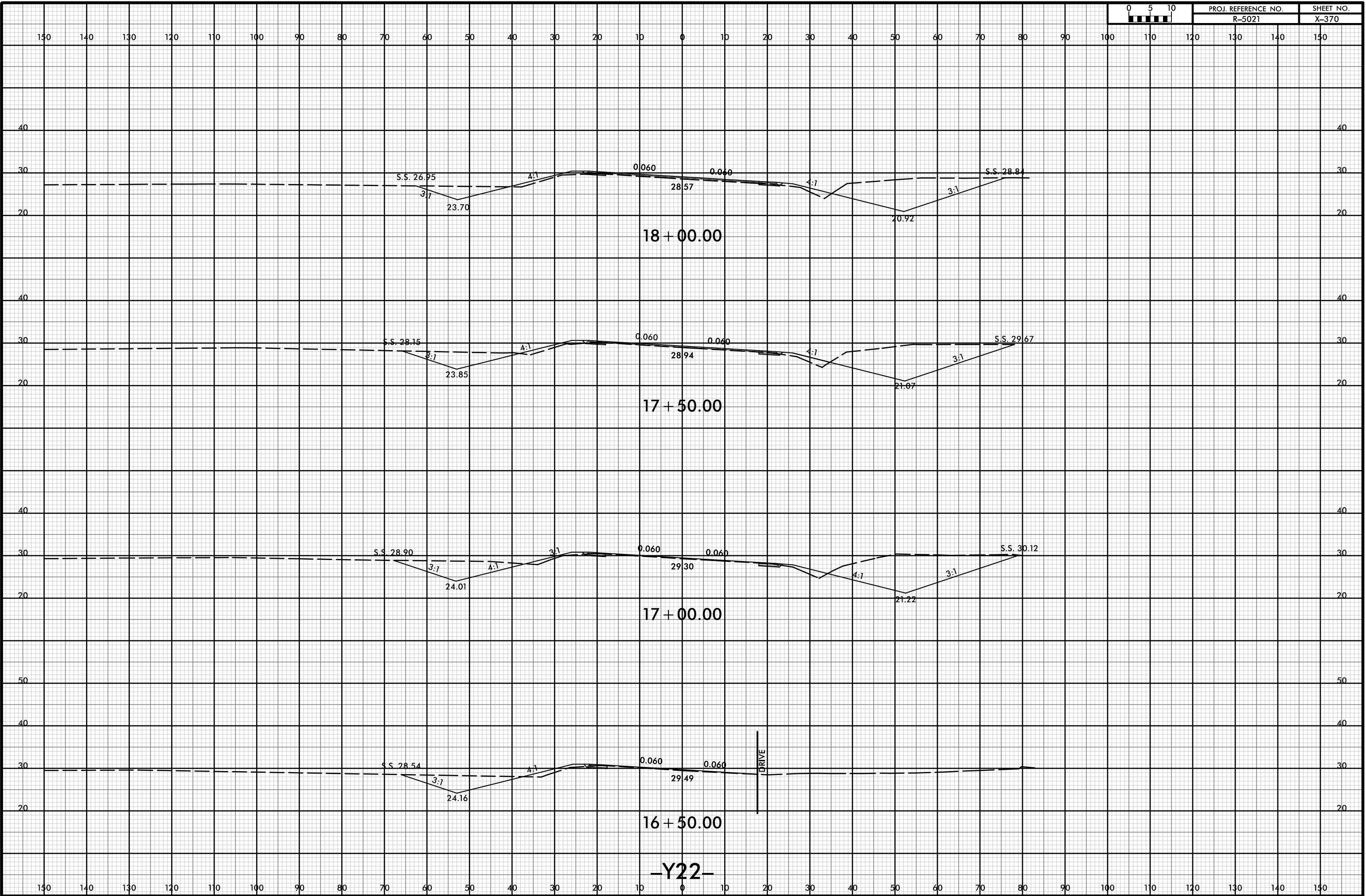

8/23/99



| | |
|---------------------|-----------|
| PROJ. REFERENCE NO. | SHEET NO. |
| R-5021 | X-371 |

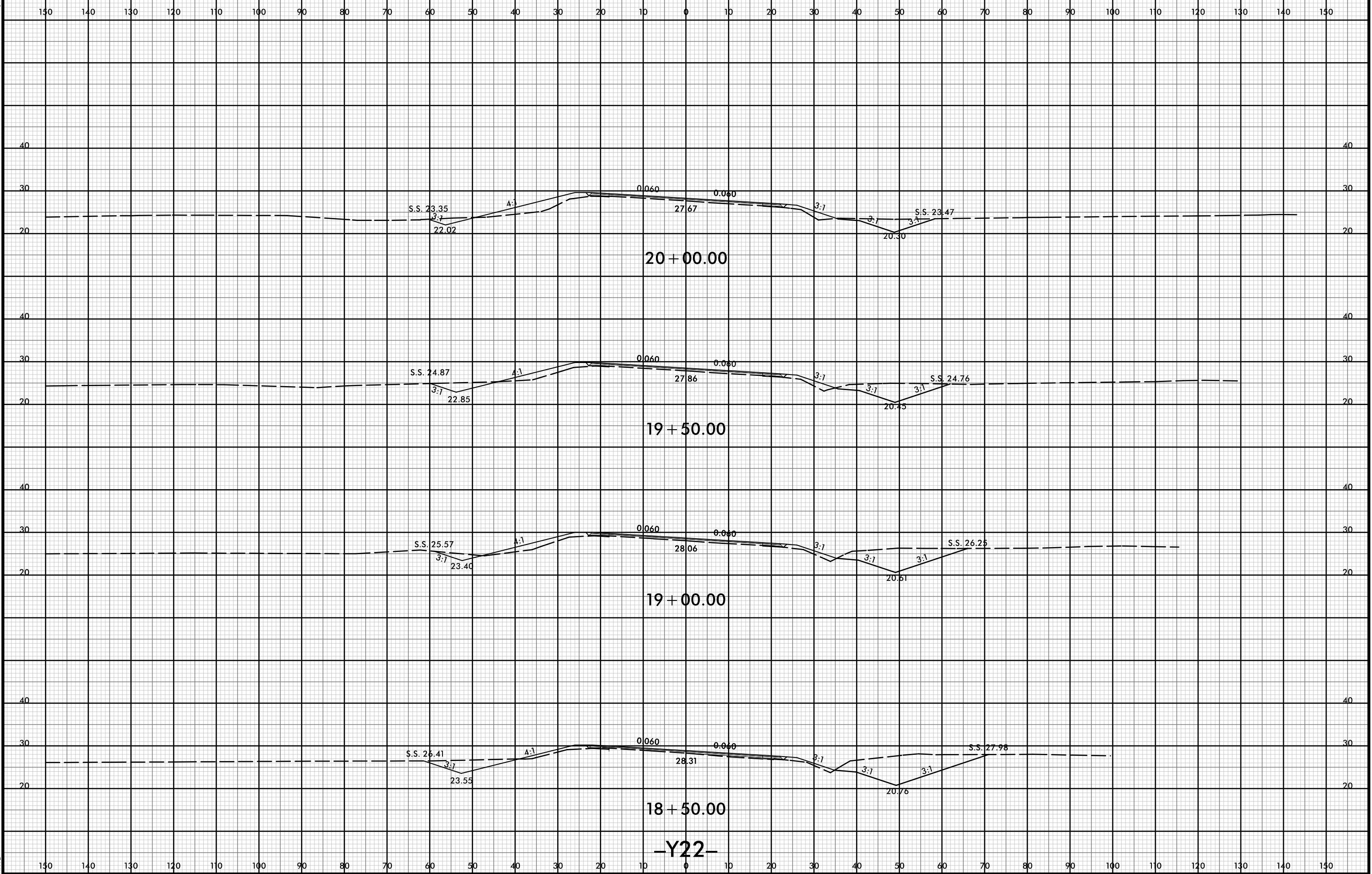

21 JUL 2001 10:40
R:\p\dawej\XSC\5021-rdy-yp1-Y22.dgn
HTB

-Y22-

8/23/99

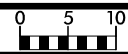

PROJ. REFERENCE NO.
R-5021

SHEET NO.
X-372

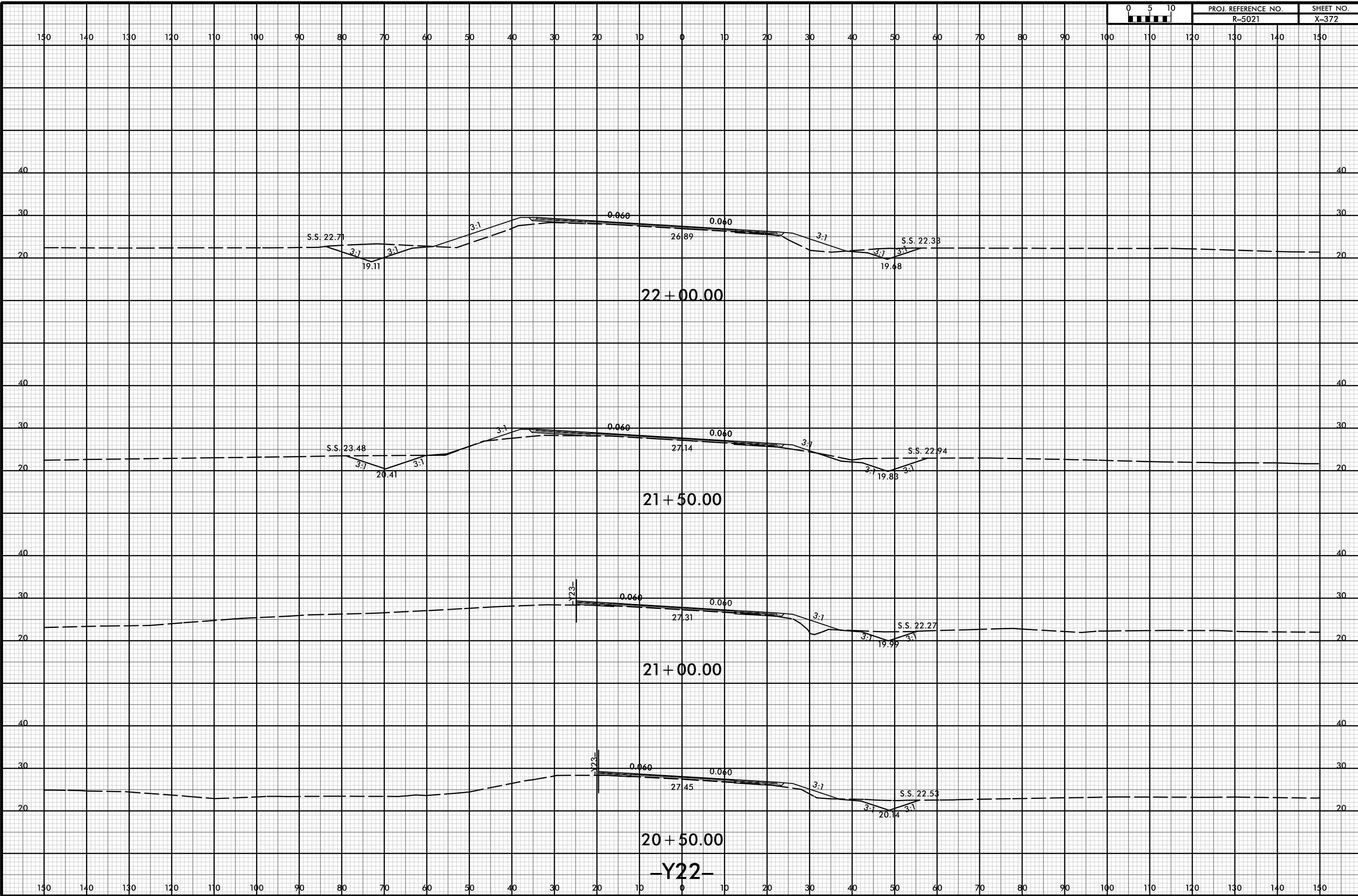

21-Jul-2021 10:40
 R:\pawej\XSC\5021-rdy-xp-1-Y22.dgn
 HNTB

8/23/99



PROJ. REFERENCE NO.
R-5021

SHEET NO.
X-373

150 140 130 120 110 100 90 80 70 60 50 40 30 20 10 0 10 20 30 40 50 60 70 80 90 100 110 120 130 140 150

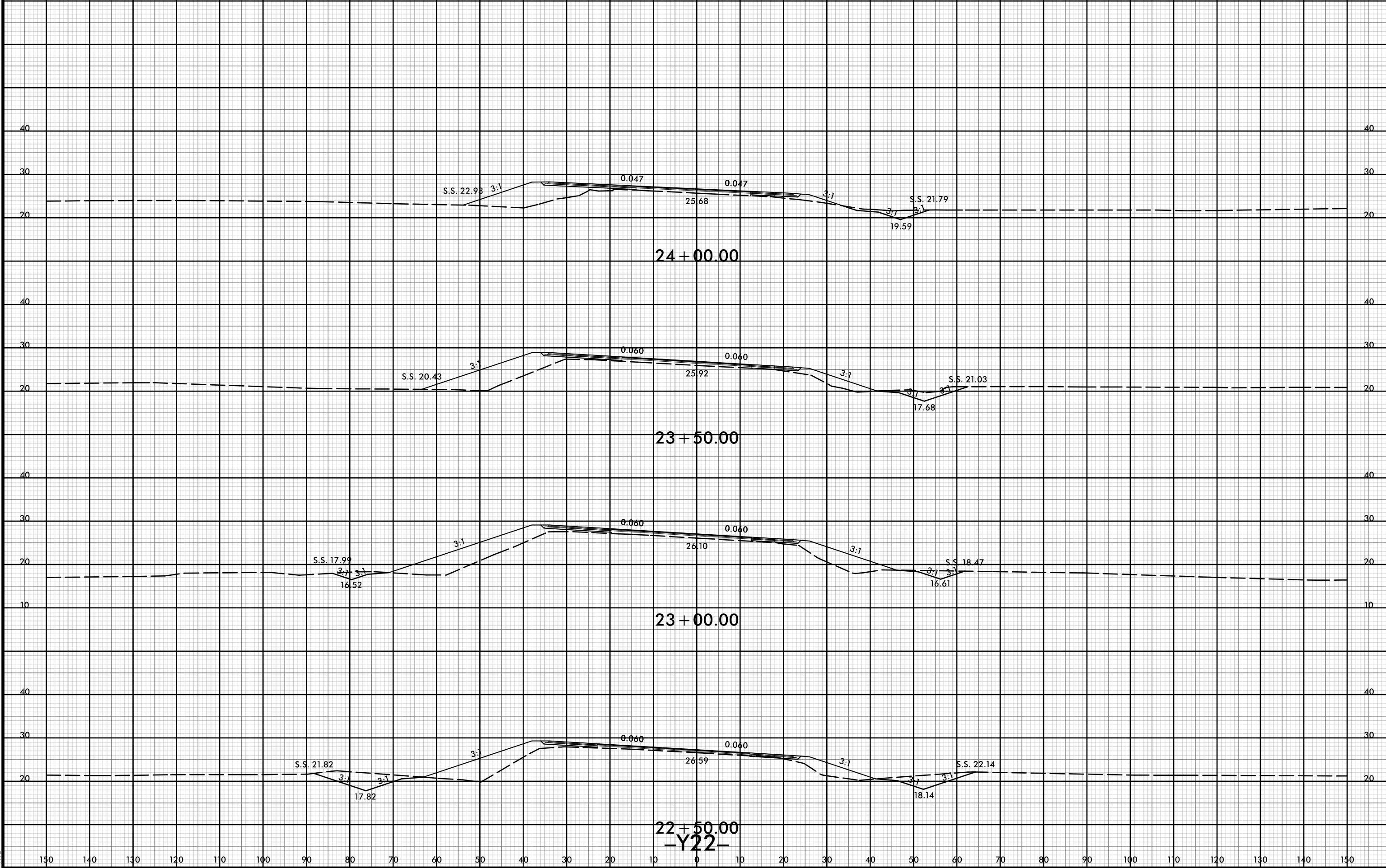

22+50.00
-Y22-

21-Jul-2021 10:40
R:\p\dawej\XSC\5021-r-dj-xp-1-Y22.dgn
HTB

8/23/99



| | |
|---------------------|-----------|
| PROJ. REFERENCE NO. | SHEET NO. |
| R-5021 | X-374 |

150 140 130 120 110 100 90 80 70 60 50 40 30 20 10 0 10 20 30 40 50 60 70 80 90 100 110 120 130 140 150

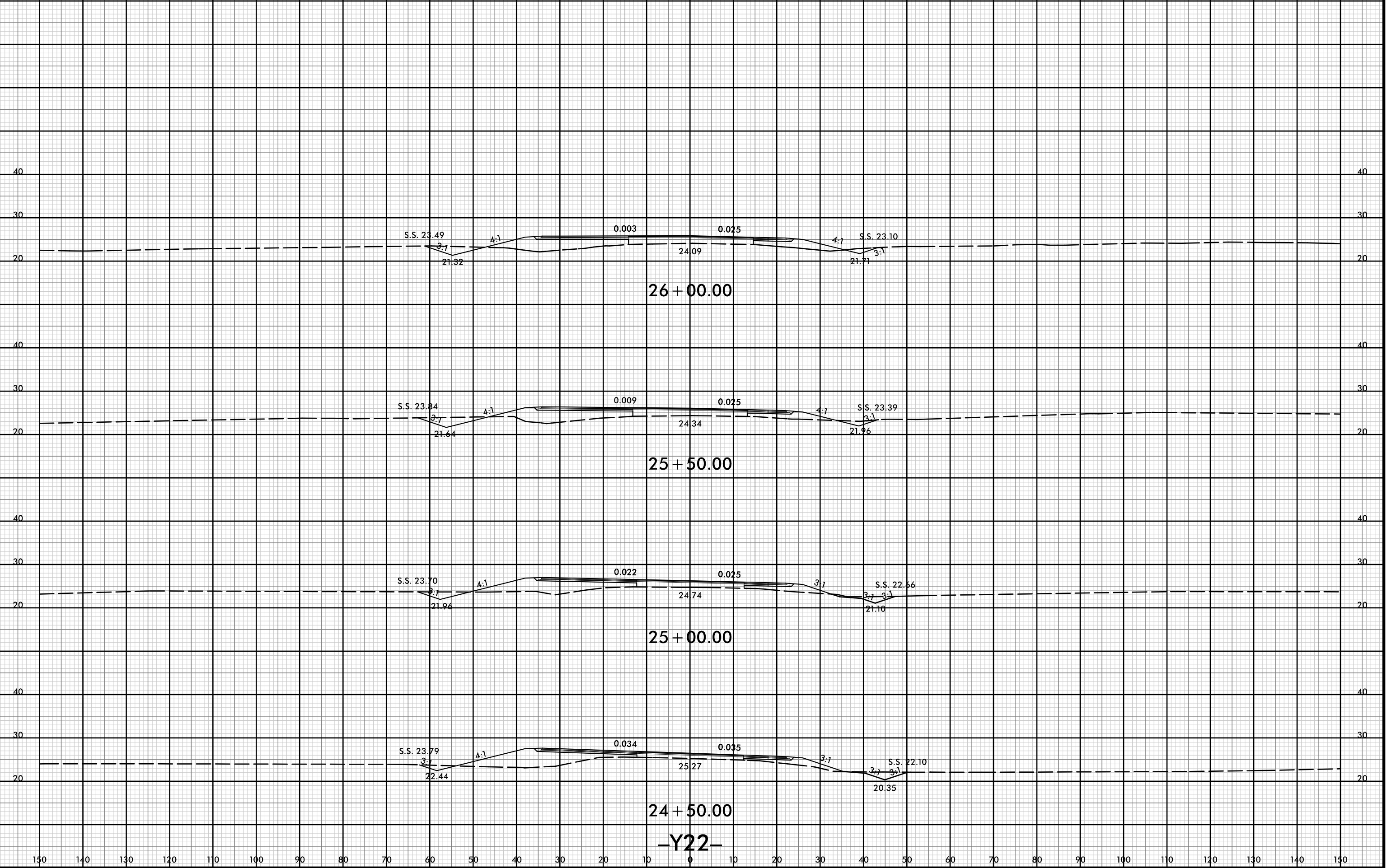

26 + 00.00

25 + 50.00

25 + 00.00

24 + 50.00

-Y22-

21-Jul-2021 10:40
R:\p\dawej\XSC\5021-rdy-xl-1\Y22.dgn

8/23/99



PROJ. REFERENCE NO.
R-5021

SHEET NO.
X-375

150 140 130 120 110 100 90 80 70 60 50 40 30 20 10 0 10 20 30 40 50 60 70 80 90 100 110 120 130 140 150

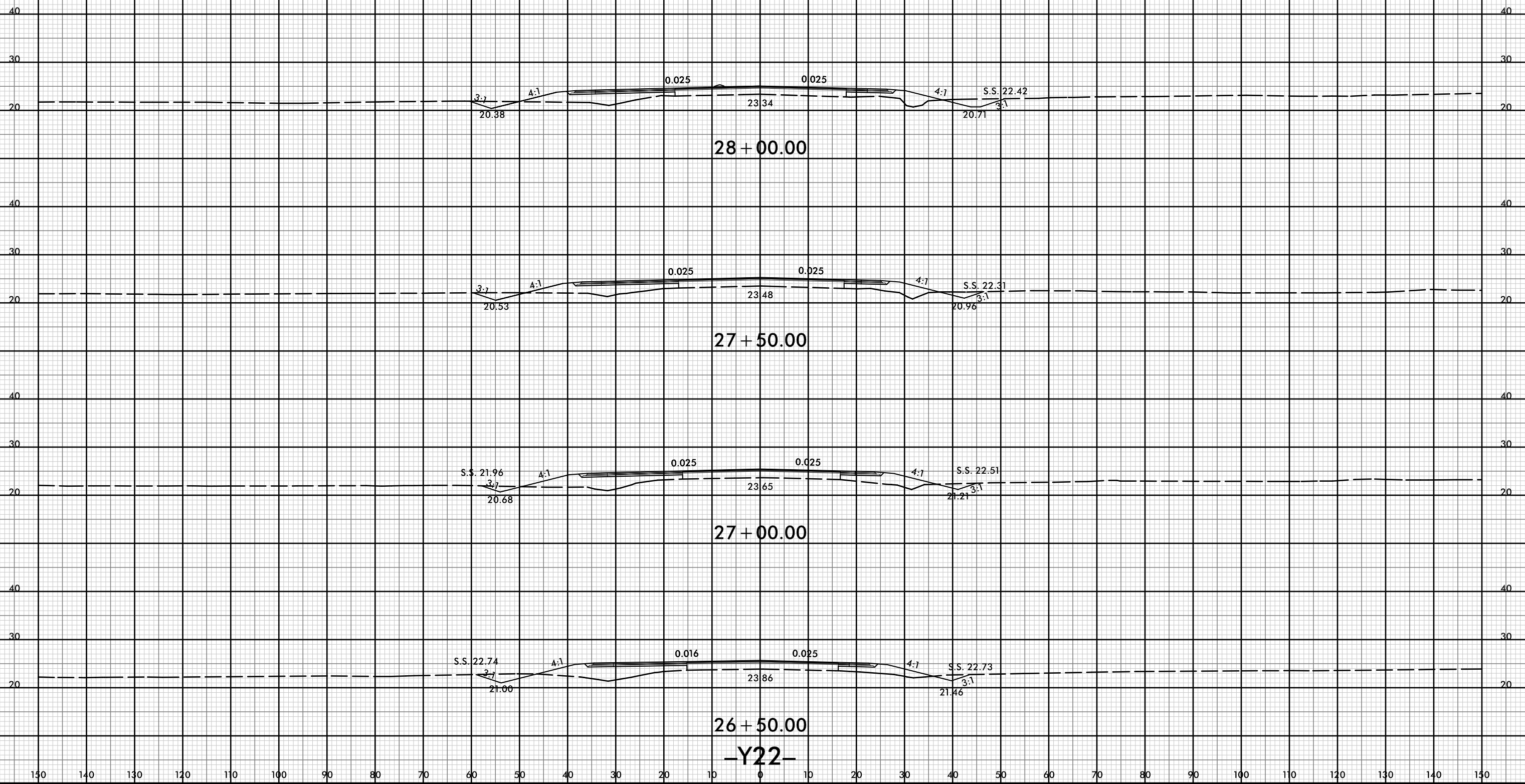

26 + 50.00
-Y22-

21-Jul-2021 10:40
R:\p\dawej\XSC\5021-rdy-1-Y22.dgn
HTB



150 140 130 120 110 100 90 80 70 60 50 40 30 20 10 0 10 20 30 40 50 60 70 80 90 100 110 120 130 140 150

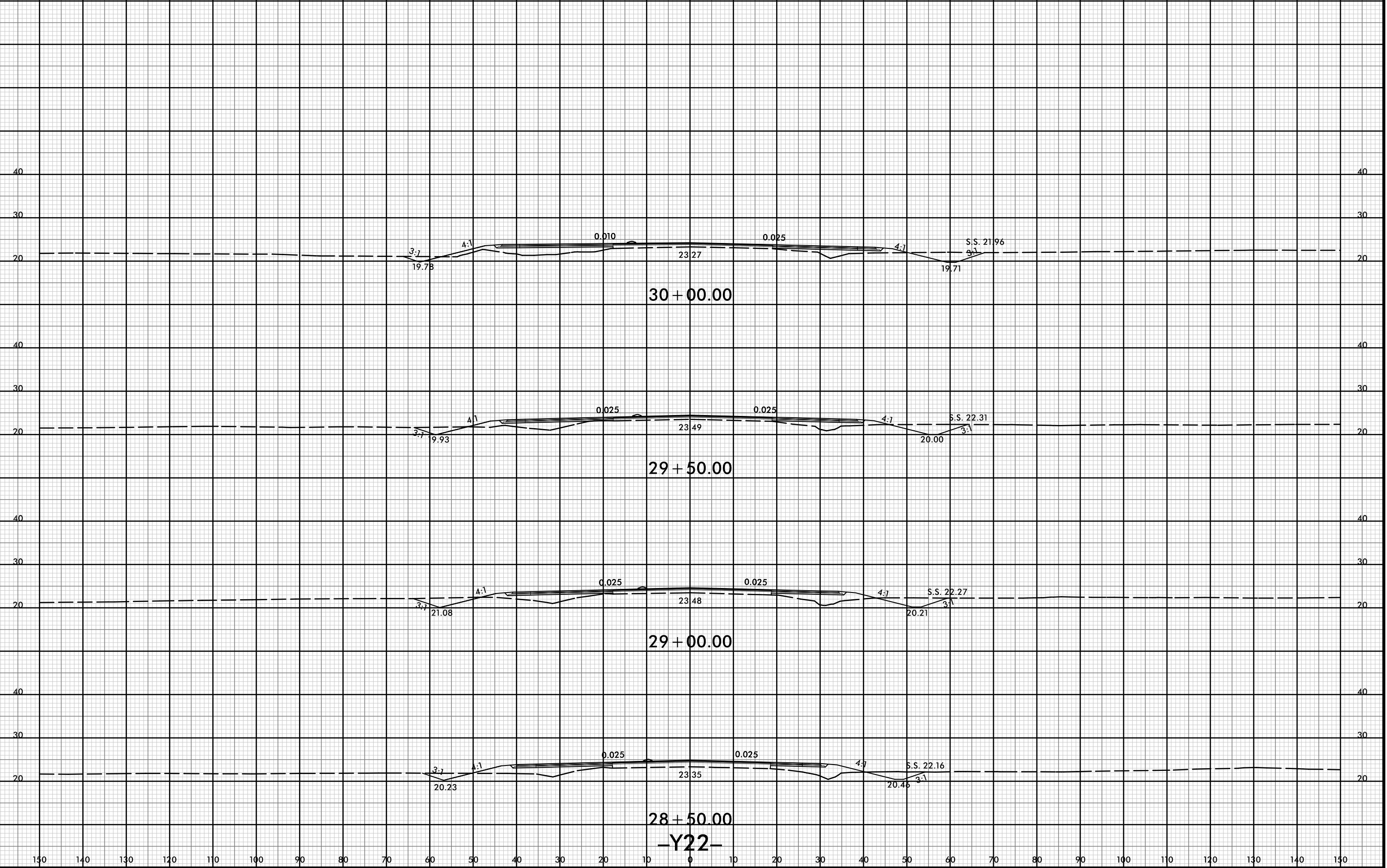

150 140 130 120 110 100 90 80 70 60 50 40 30 20 10 0 10 20 30 40 50 60 70 80 90 100 110 120 130 140 150

28+50.00
 -Y22-

150 140 130 120 110 100 90 80 70 60 50 40 30 20 10 0 10 20 30 40 50 60 70 80 90 100 110 120 130 140 150

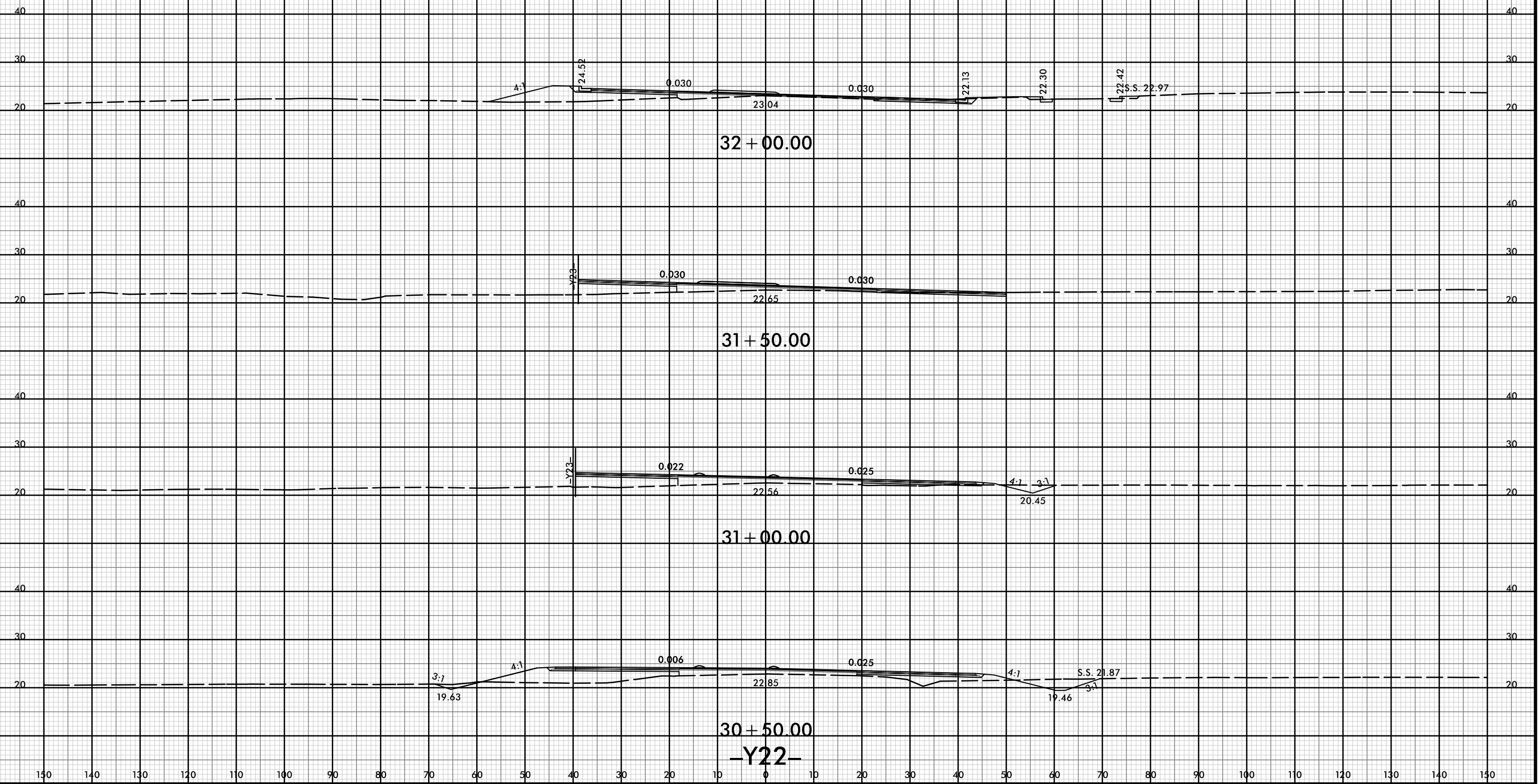

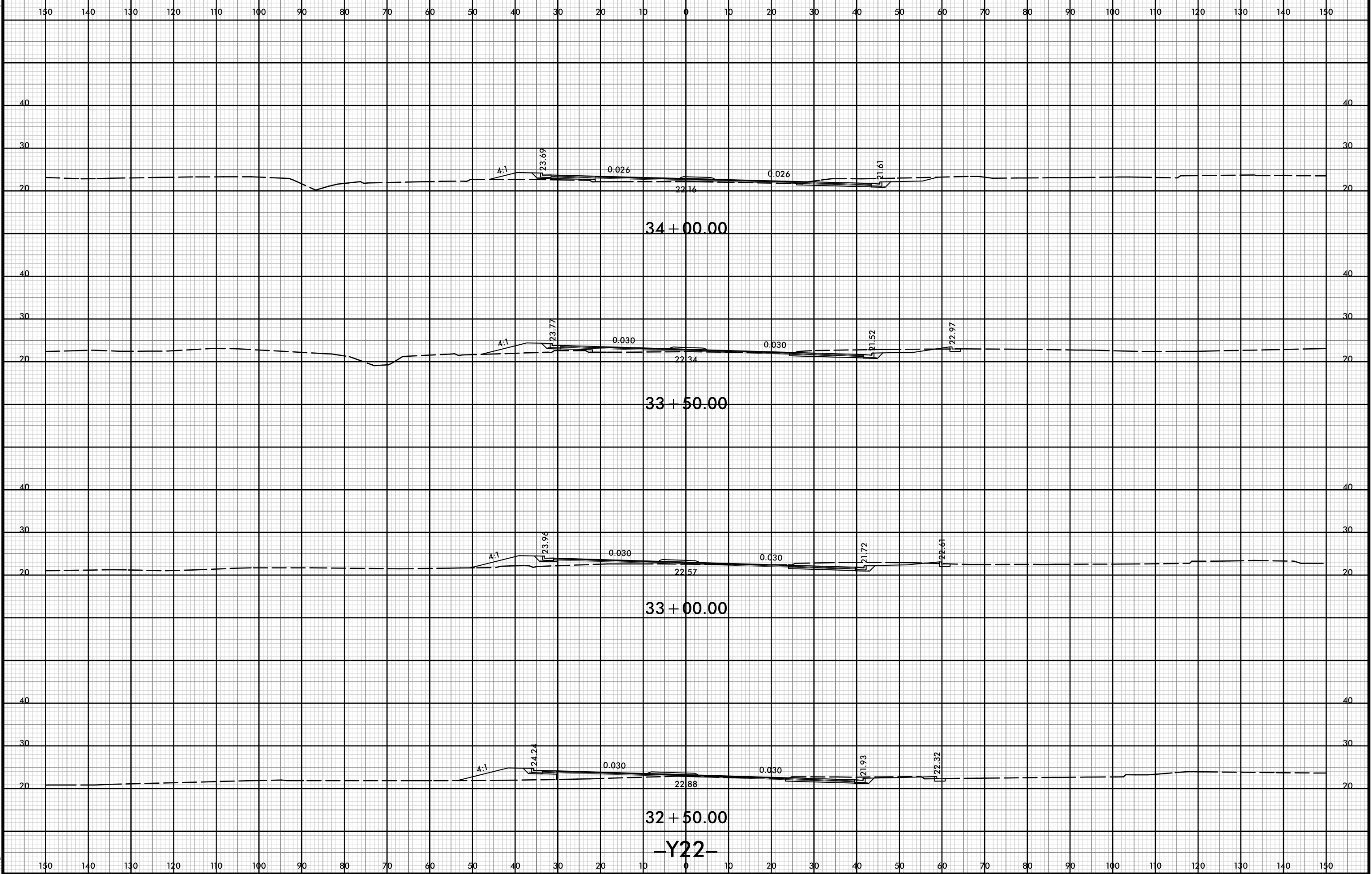

8/23/99



PROJ. REFERENCE NO. R-5021 SHEET NO. X-379

150 140 130 120 110 100 90 80 70 60 50 40 30 20 10 0 10 20 30 40 50 60 70 80 90 100 110 120 130 140 150

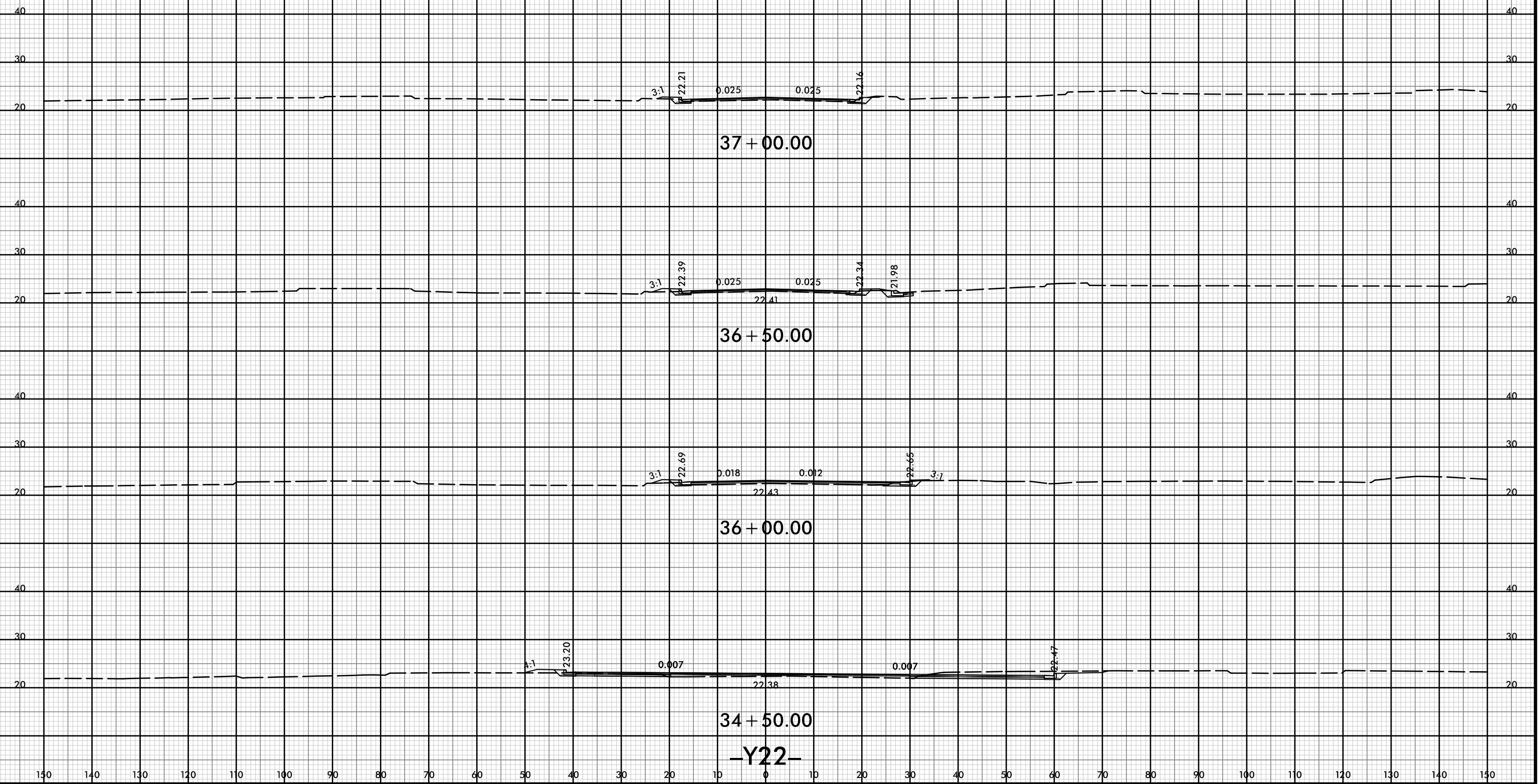

37 + 00.00

36 + 50.00

36 + 00.00

34 + 50.00

-Y22-

21-Jul-2021 10:40
R:\p\dawej\XSC\5021-rdy-xl-Y22.dgn
HTB

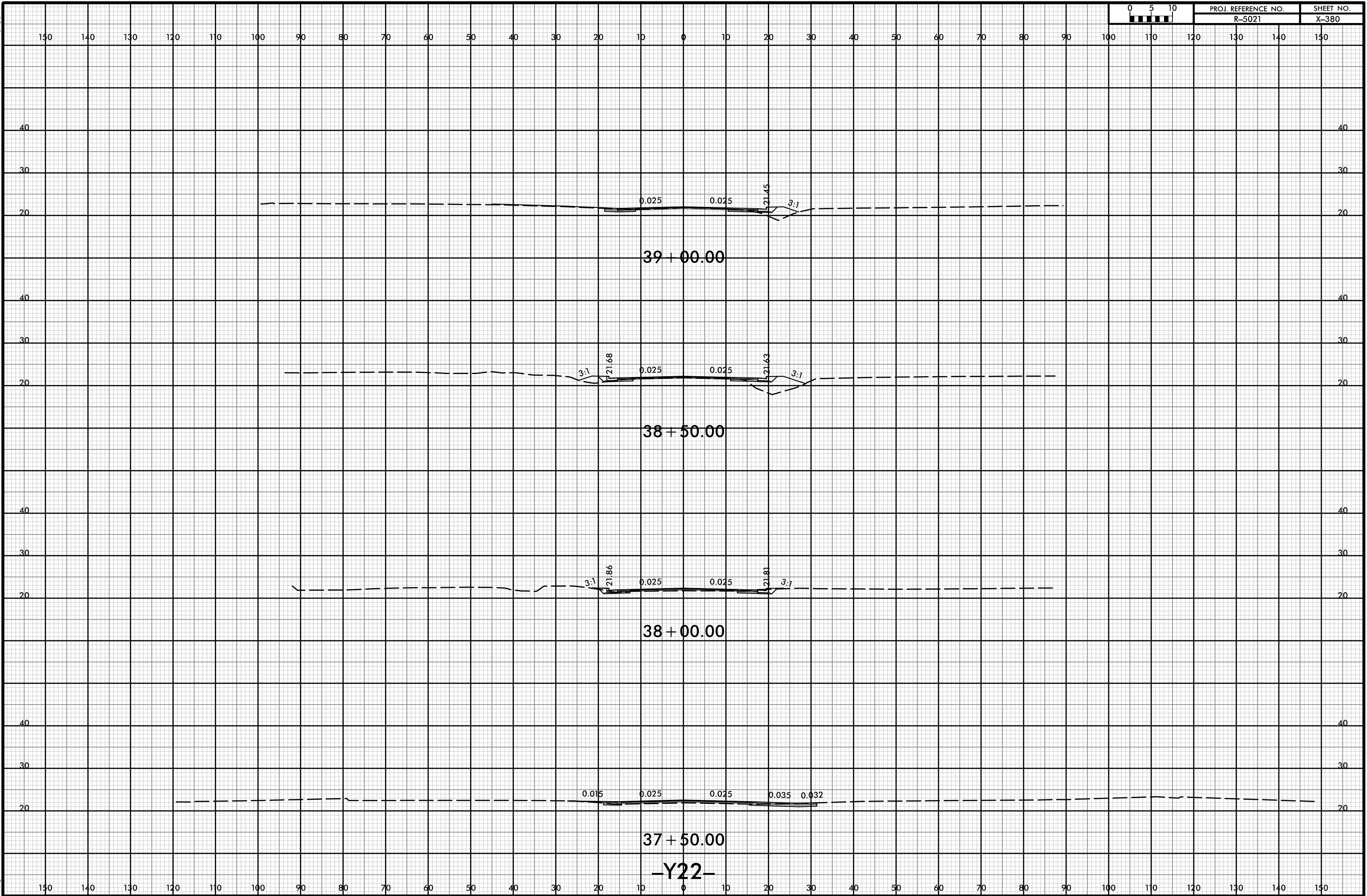

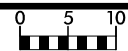

150 140 130 120 110 100 90 80 70 60 50 40 30 20 10 0 10 20 30 40 50 60 70 80 90 100 110 120 130 140 150

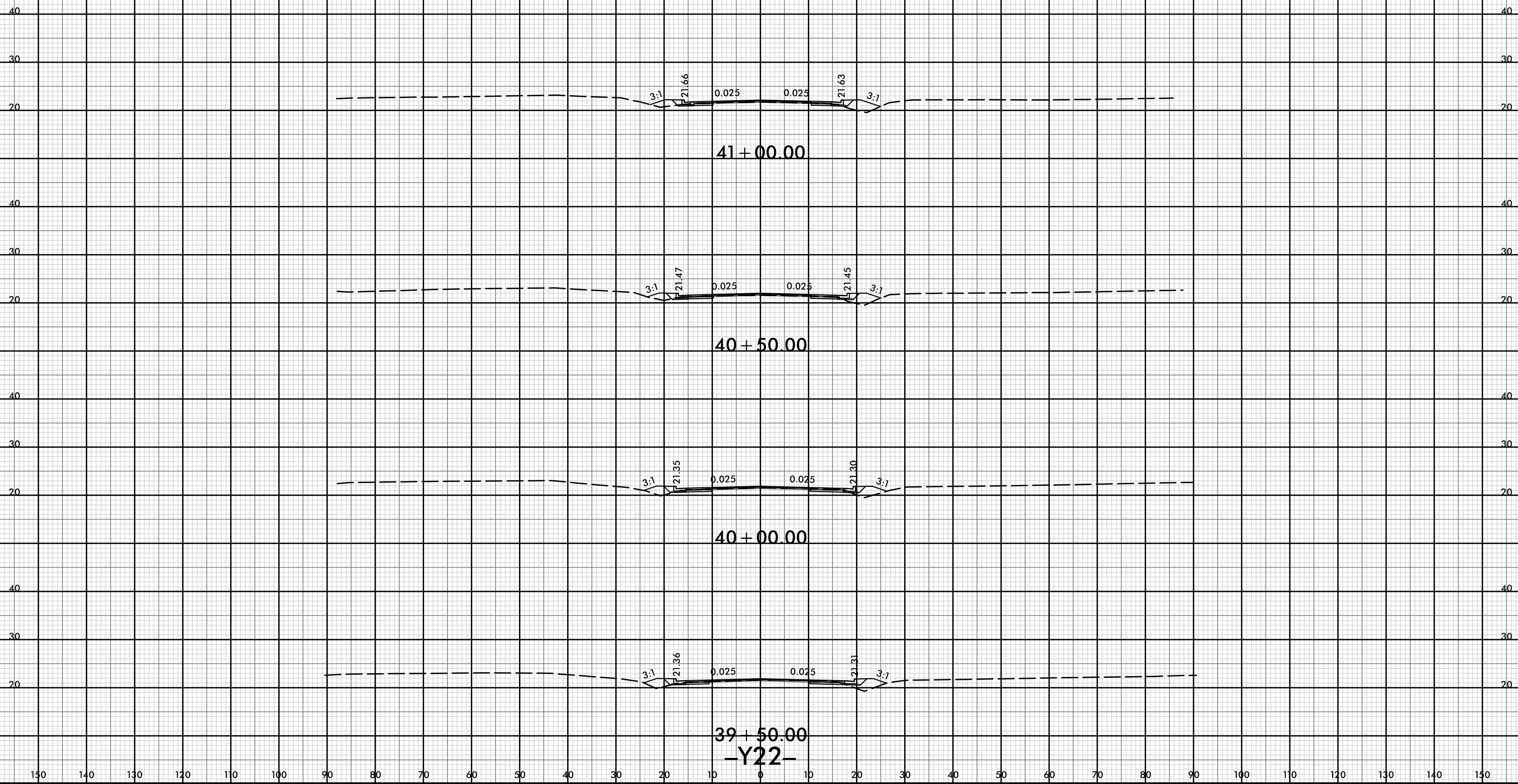

150 140 130 120 110 100 90 80 70 60 50 40 30 20 10 0 10 20 30 40 50 60 70 80 90 100 110 120 130 140 150



150 140 130 120 110 100 90 80 70 60 50 40 30 20 10 0 10 20 30 40 50 60 70 80 90 100 110 120 130 140 150

40 40

30 30

20 20

43 + 00.00

40 40

30 30

20 20

42 + 50.00

40 40

30 30

20 20

42 + 00.00

40 40

30 30

20 20

41 + 50.00

-Y22-

150 140 130 120 110 100 90 80 70 60 50 40 30 20 10 0 10 20 30 40 50 60 70 80 90 100 110 120 130 140 150



150 140 130 120 110 100 90 80 70 60 50 40 30 20 10 0 10 20 30 40 50 60 70 80 90 100 110 120 130 140 150

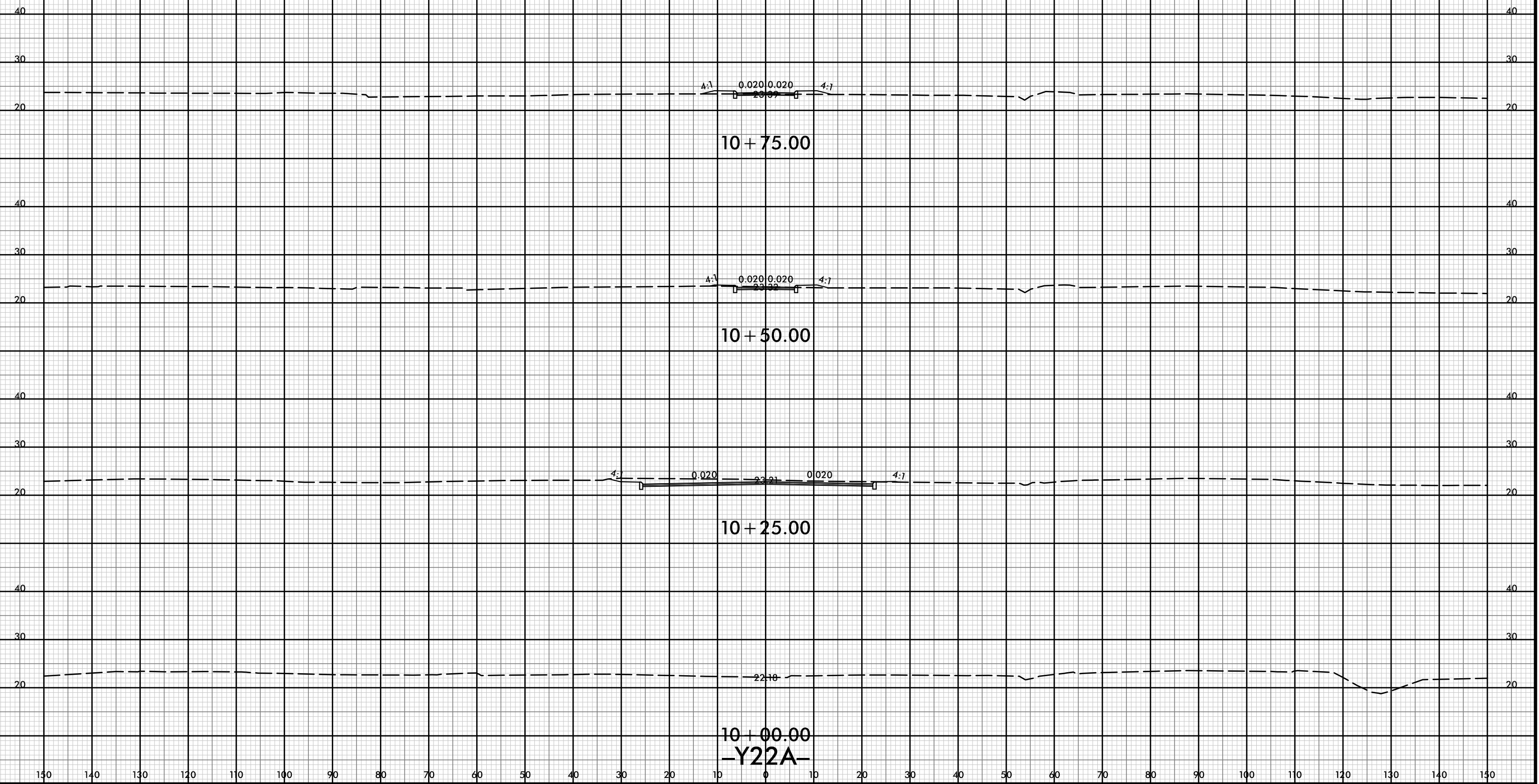



150 140 130 120 110 100 90 80 70 60 50 40 30 20 10 0 10 20 30 40 50 60 70 80 90 100 110 120 130 140 150

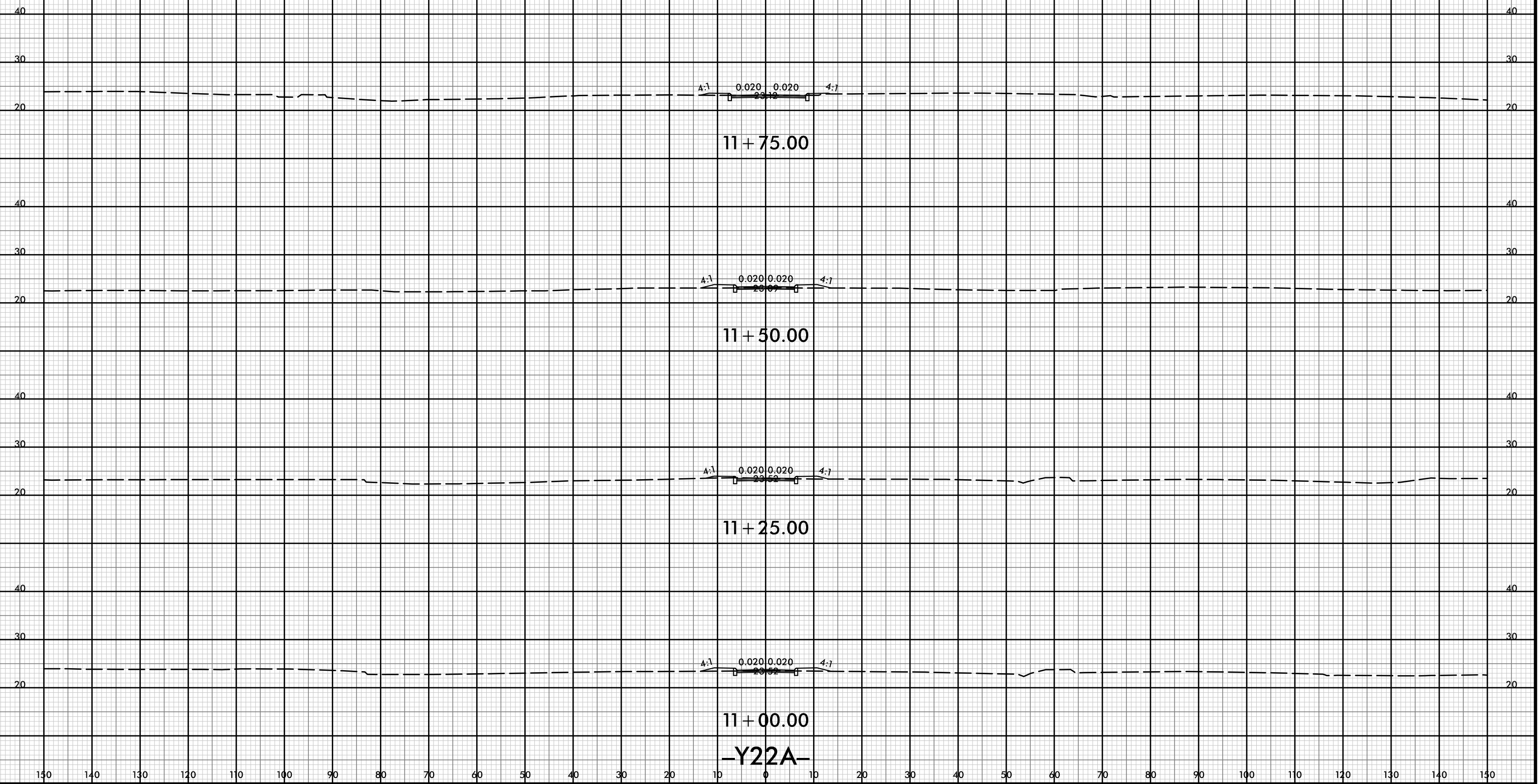

11 + 75.00

11 + 50.00

11 + 25.00

11 + 00.00

-Y22A-



150 140 130 120 110 100 90 80 70 60 50 40 30 20 10 0 10 20 30 40 50 60 70 80 90 100 110 120 130 140 150

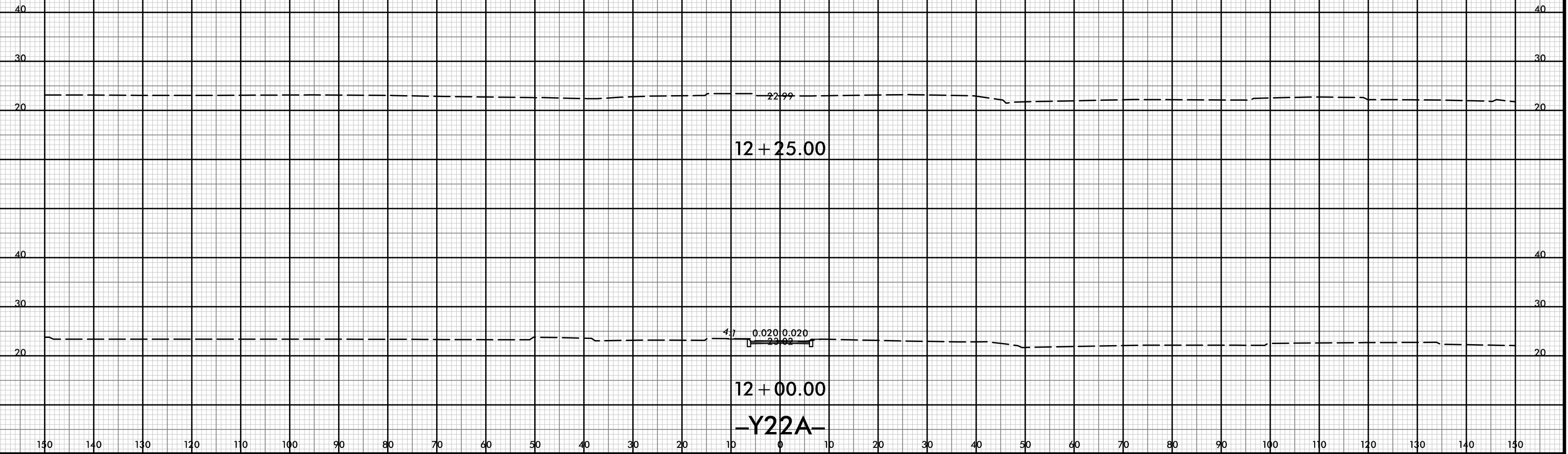

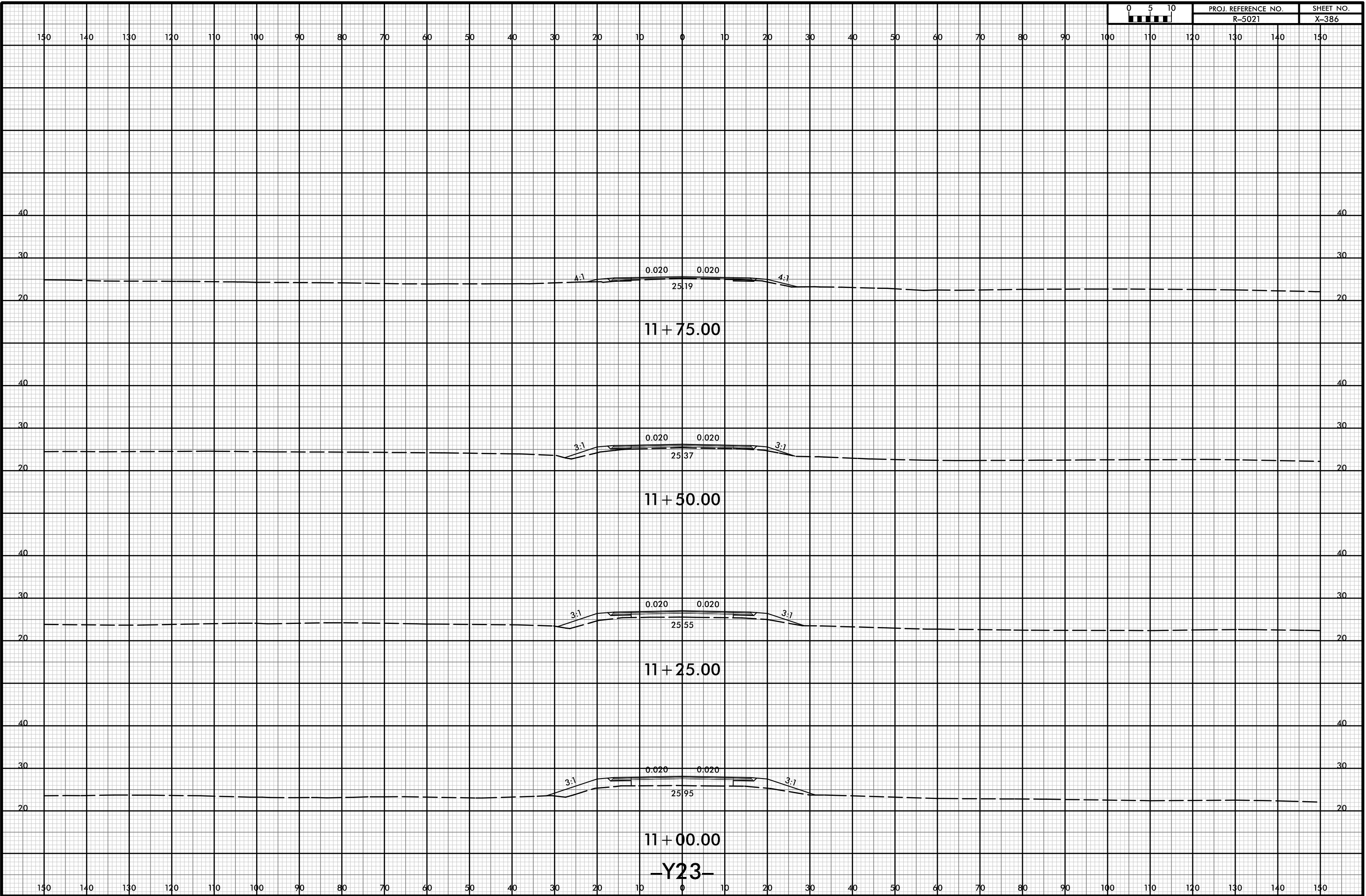

8/23/99

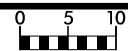

PROJ. REFERENCE NO.
R-5021

SHEET NO.
X-387

150 140 130 120 110 100 90 80 70 60 50 40 30 20 10 0 10 20 30 40 50 60 70 80 90 100 110 120 130 140 150

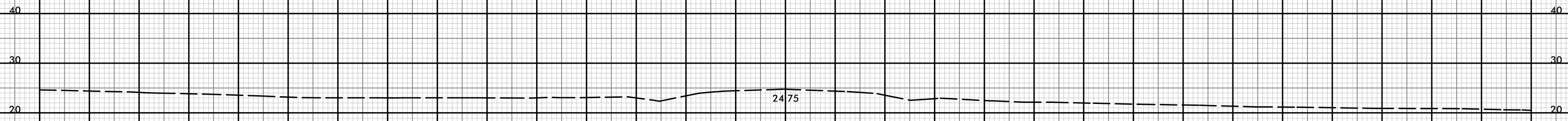

12 + 75.00

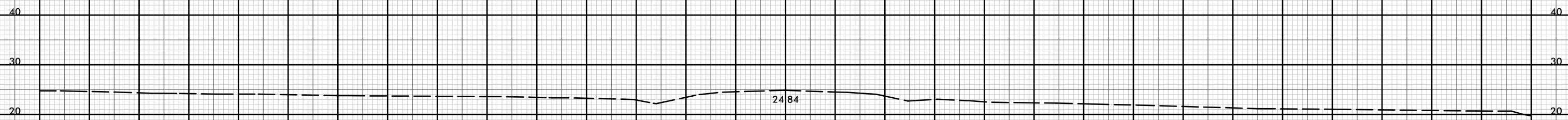

12 + 50.00

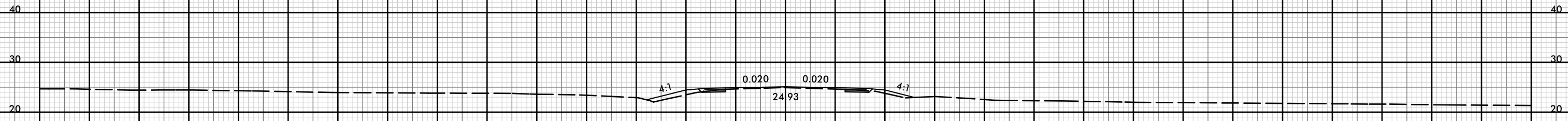

12 + 25.00

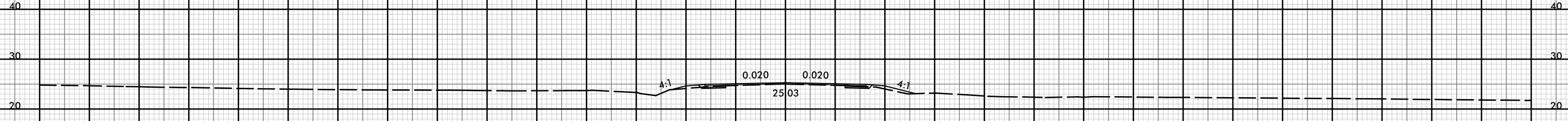

12 + 00.00

-Y23-

150 140 130 120 110 100 90 80 70 60 50 40 30 20 10 0 10 20 30 40 50 60 70 80 90 100 110 120 130 140 150

21-Jul-2021 10:40
R:\p\dawej\XSC\5021-r-dj-xp-1-Y23.dgn
HTB



150 140 130 120 110 100 90 80 70 60 50 40 30 20 10 0 10 20 30 40 50 60 70 80 90 100 110 120 130 140 150

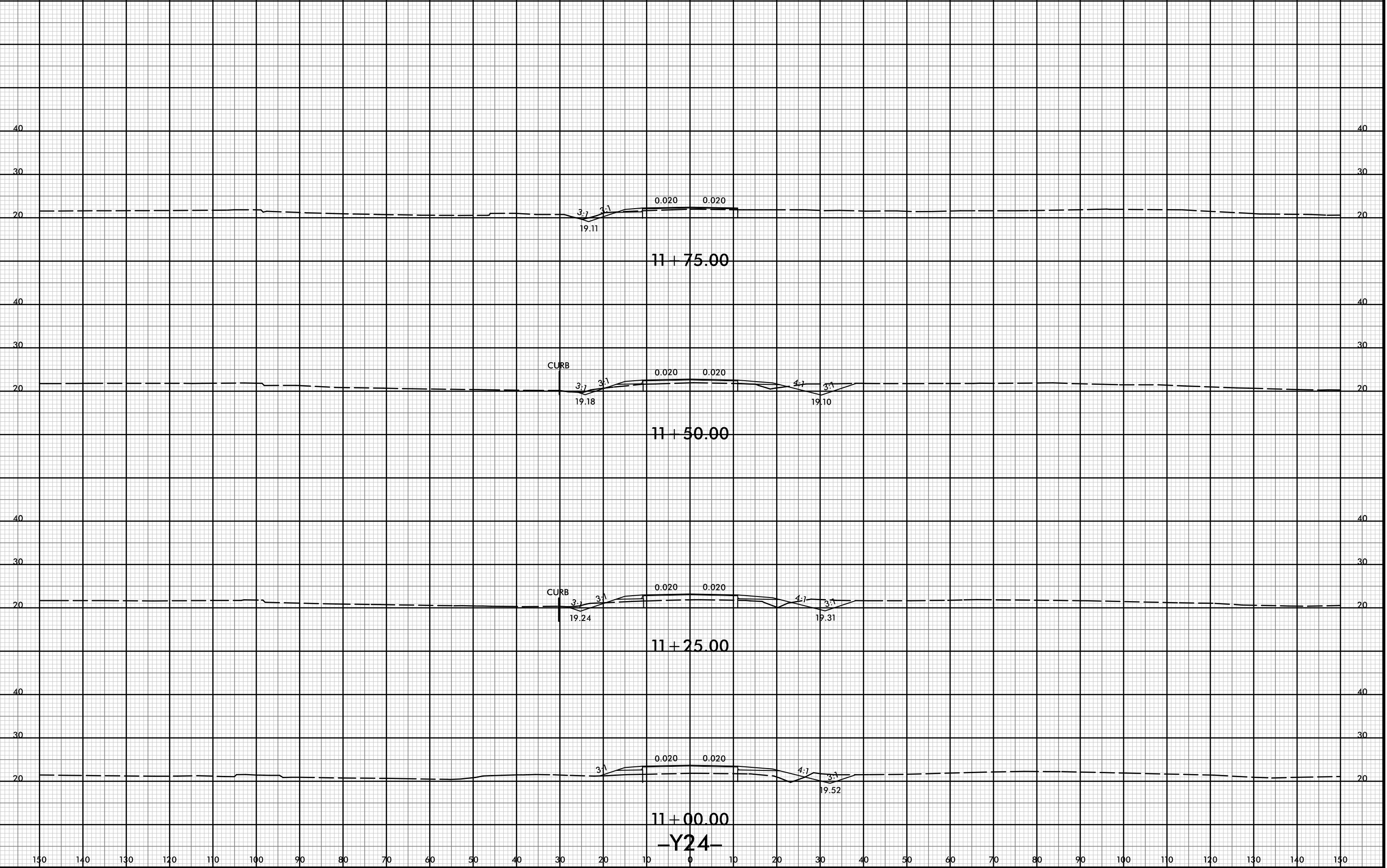

11+75.00

11+50.00

11+25.00

11+00.00

-Y24-

CURB

CURB

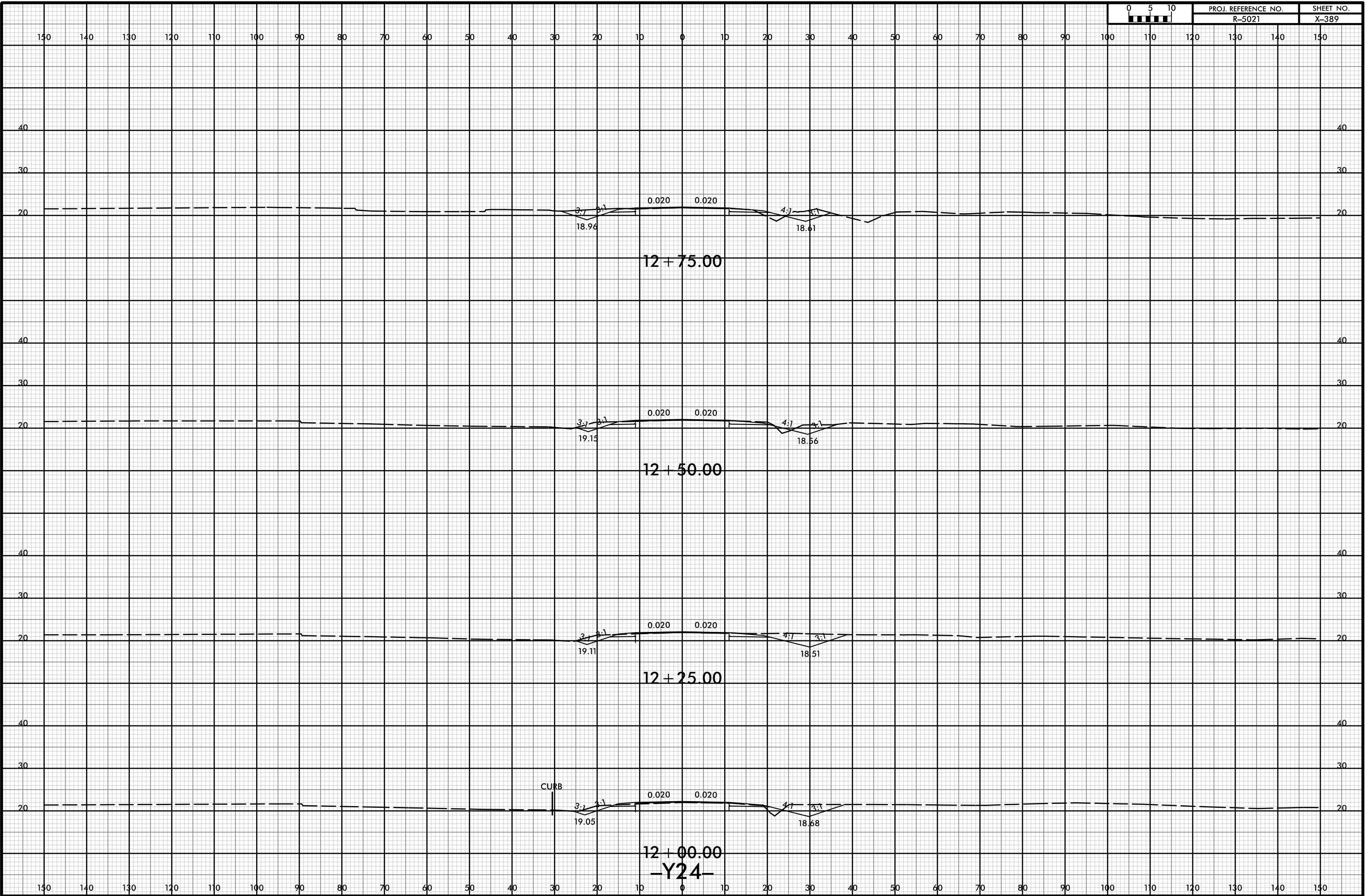



PROJ. REFERENCE NO.
R-5021

SHEET NO.
X-390

150 140 130 120 110 100 90 80 70 60 50 40 30 20 10 0 10 20 30 40 50 60 70 80 90 100 110 120 130 140 150

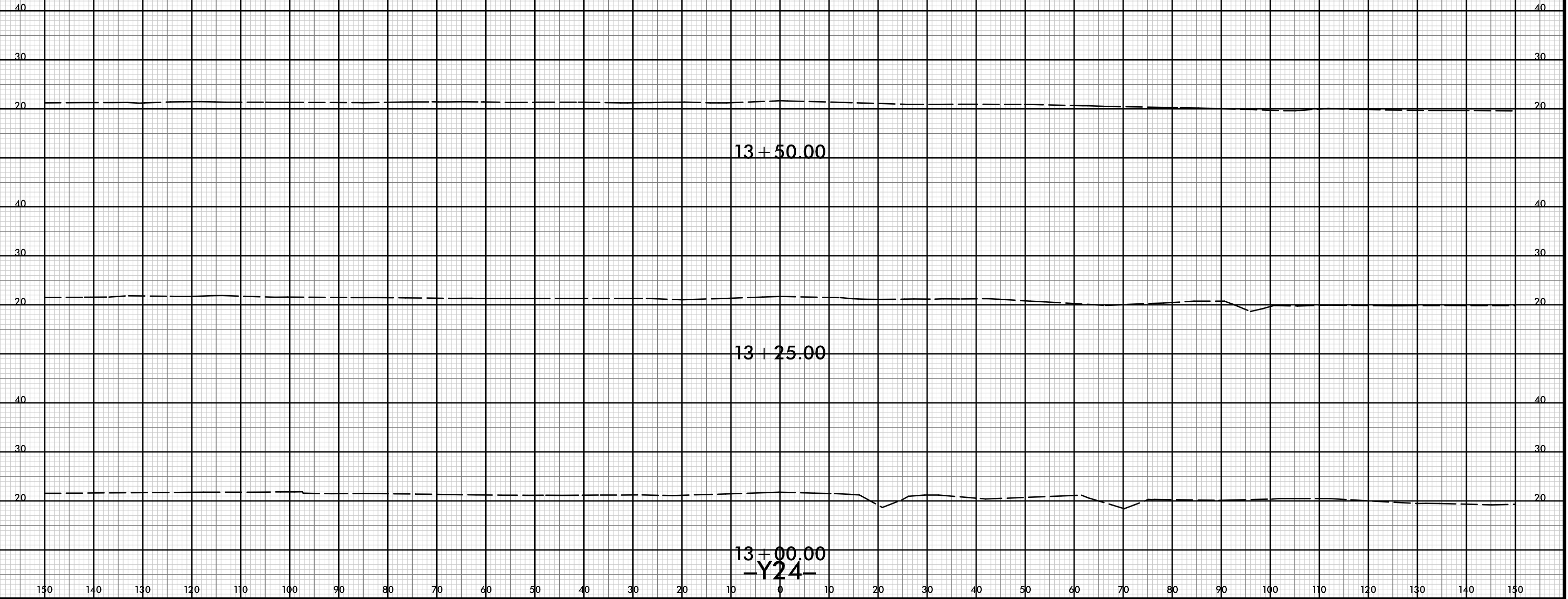

8/23/99



| | |
|-------------------------------|--------------------|
| PROJ. REFERENCE NO. R-5021 | SHEET NO. X-391 |
|-------------------------------|--------------------|

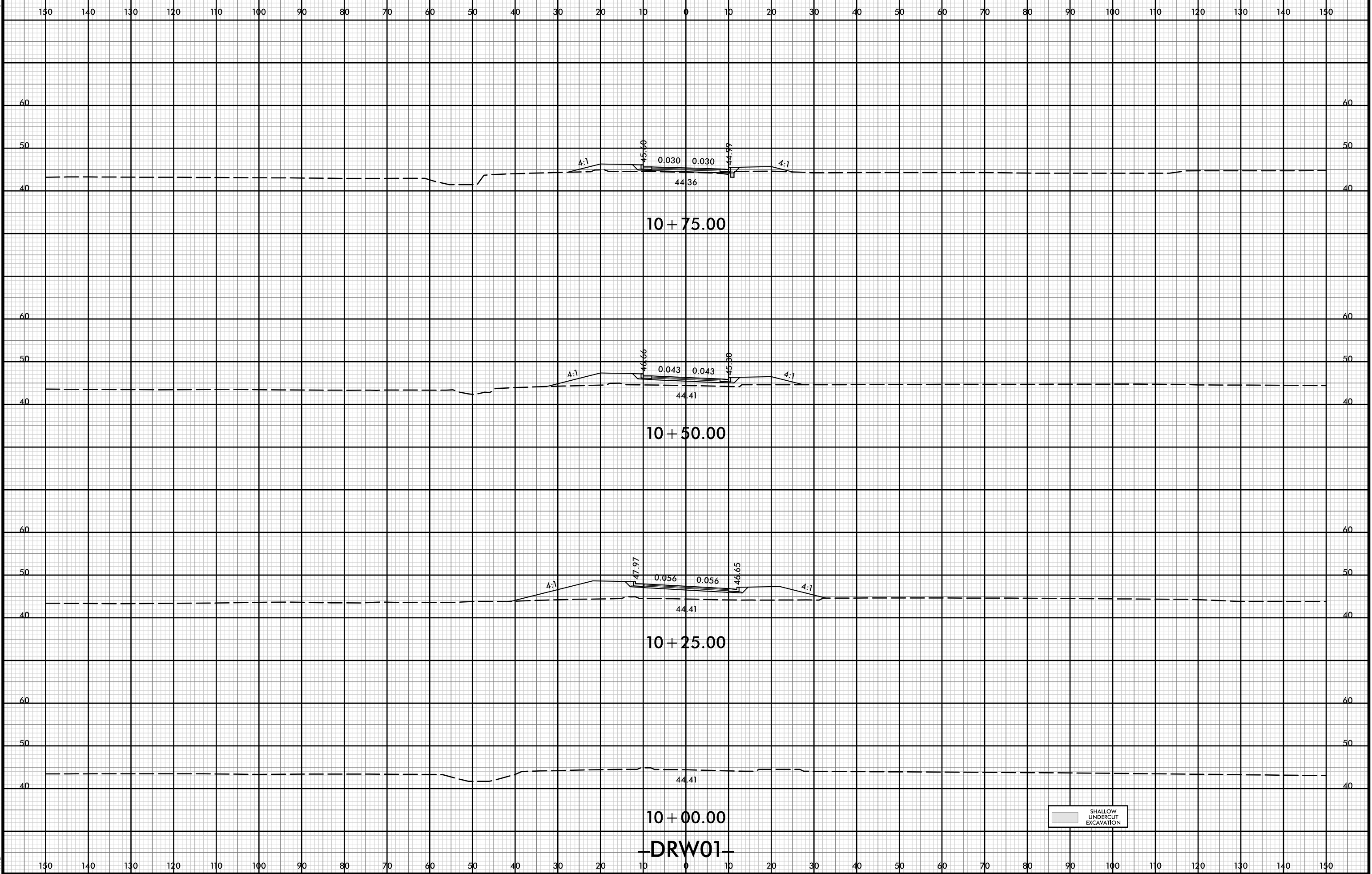

SHALLOW UNDERCUT EXCAVATION

DRW01

21 JUL 2001 10:40
X:\P\rdw01\XSC\5021-rdy-1-DRW01.dgn



150 140 130 120 110 100 90 80 70 60 50 40 30 20 10 0 10 20 30 40 50 60 70 80 90 100 110 120 130 140 150

60 60

50 50

40 40

11 + 50.00

60 60

50 50

40 40

11 + 25.00

60 60

50 50

40 40

11 + 00.00

DRW01

SHALLOW UNDERCUT EXCAVATION



150 140 130 120 110 100 90 80 70 60 50 40 30 20 10 0 10 20 30 40 50 60 70 80 90 100 110 120 130 140 150

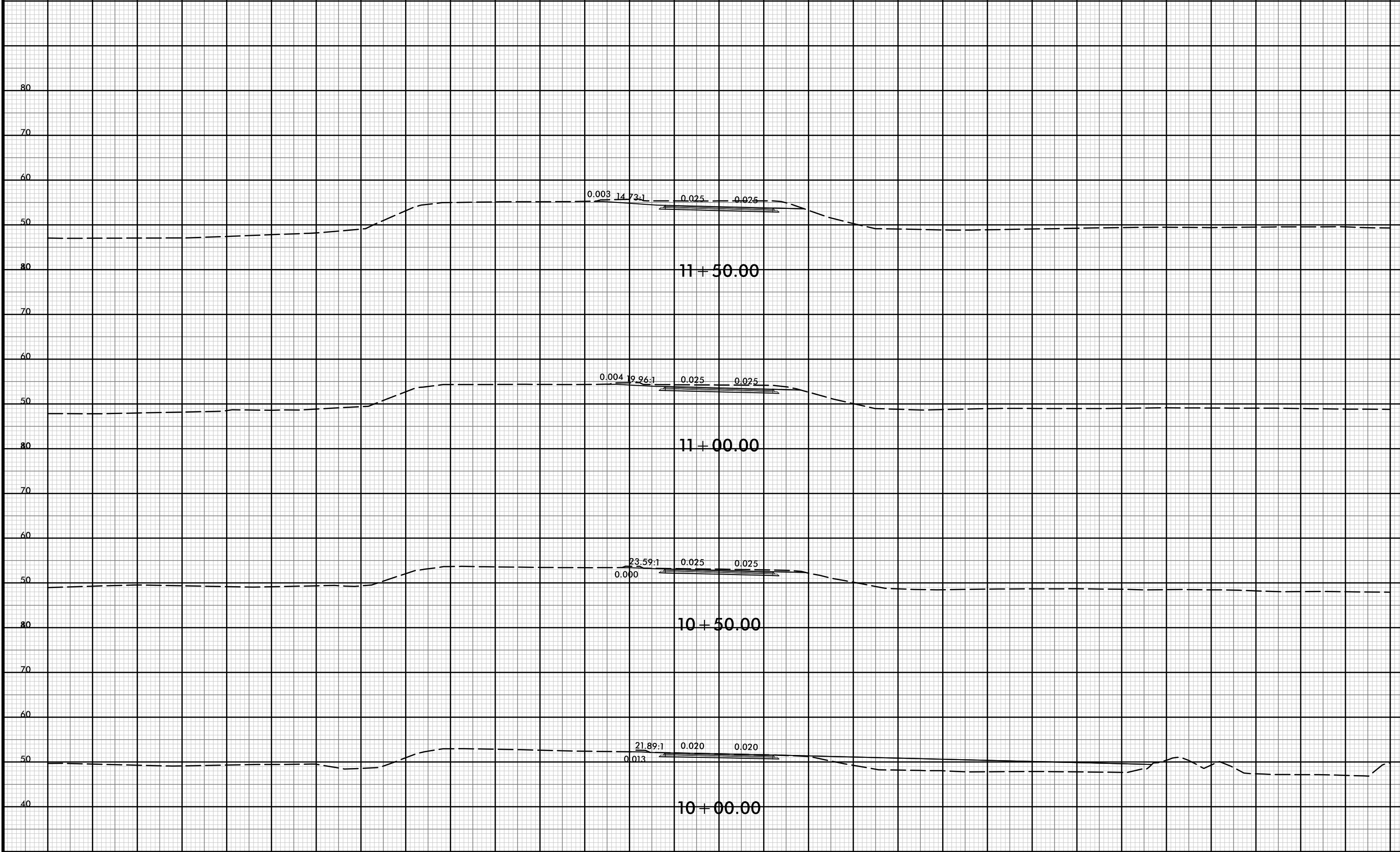

-YREVTCP1-

150 140 130 120 110 100 90 80 70 60 50 40 30 20 10 0 10 20 30 40 50 60 70 80 90 100 110 120 130 140 150

8/23/99



| | |
|---------------------|-----------|
| PROJ. REFERENCE NO. | SHEET NO. |
| R-5021 | X-394 |

150 140 130 120 110 100 90 80 70 60 50 40 30 20 10 0 10 20 30 40 50 60 70 80 90 100 110 120 130 140 150

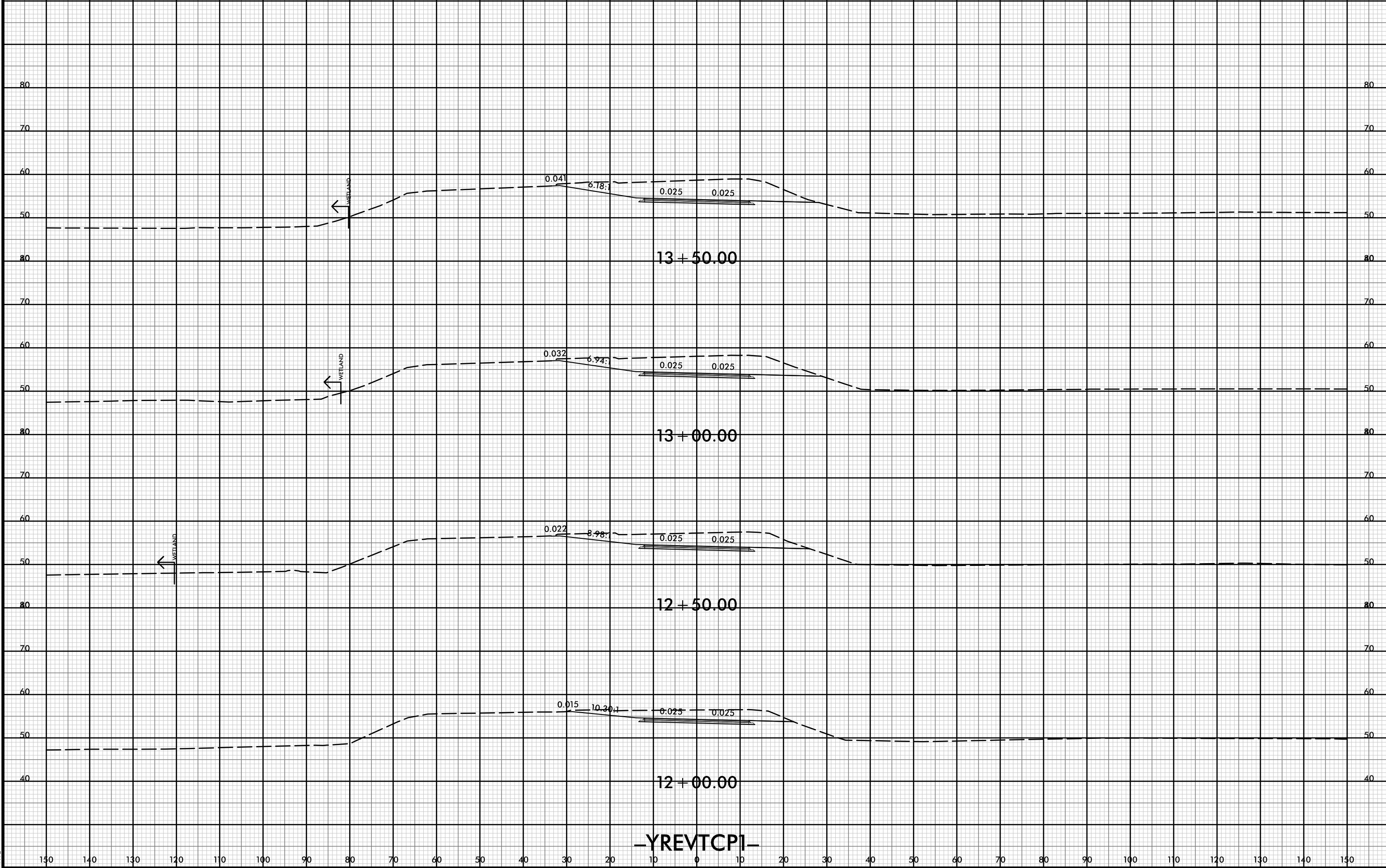

-YREVTCP1-

21 JUL 2021 10:40
R:\p\dawej\XSC\5021-rdy-xp1-YREVTCP1.dgn
HTFB



150 140 130 120 110 100 90 80 70 60 50 40 30 20 10 0 10 20 30 40 50 60 70 80 90 100 110 120 130 140 150

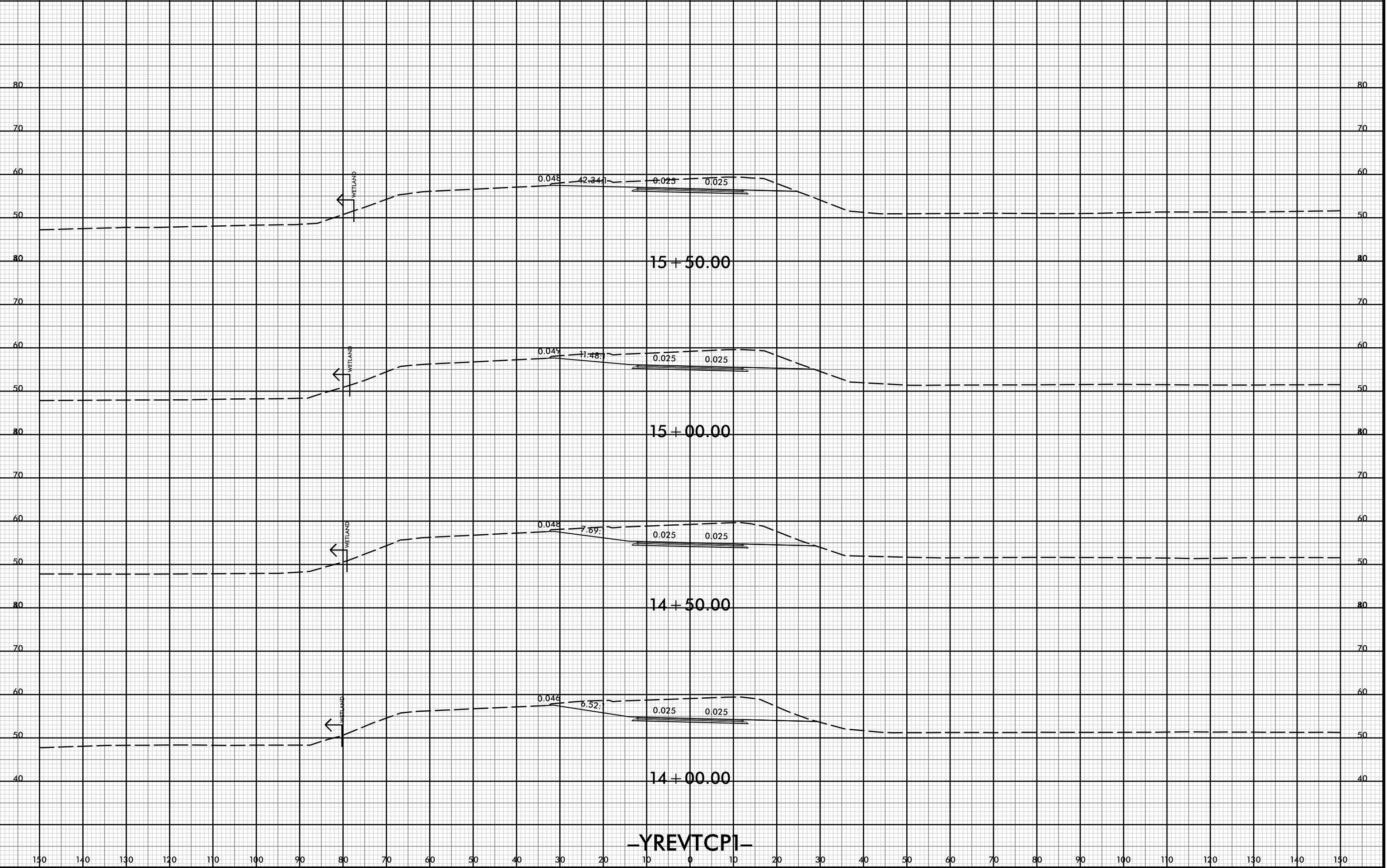

-YREVTCP1-

8/23/99



PROJ. REFERENCE NO.
R-5021

SHEET NO.
X-396

150 140 130 120 110 100 90 80 70 60 50 40 30 20 10 0 10 20 30 40 50 60 70 80 90 100 110 120 130 140 150

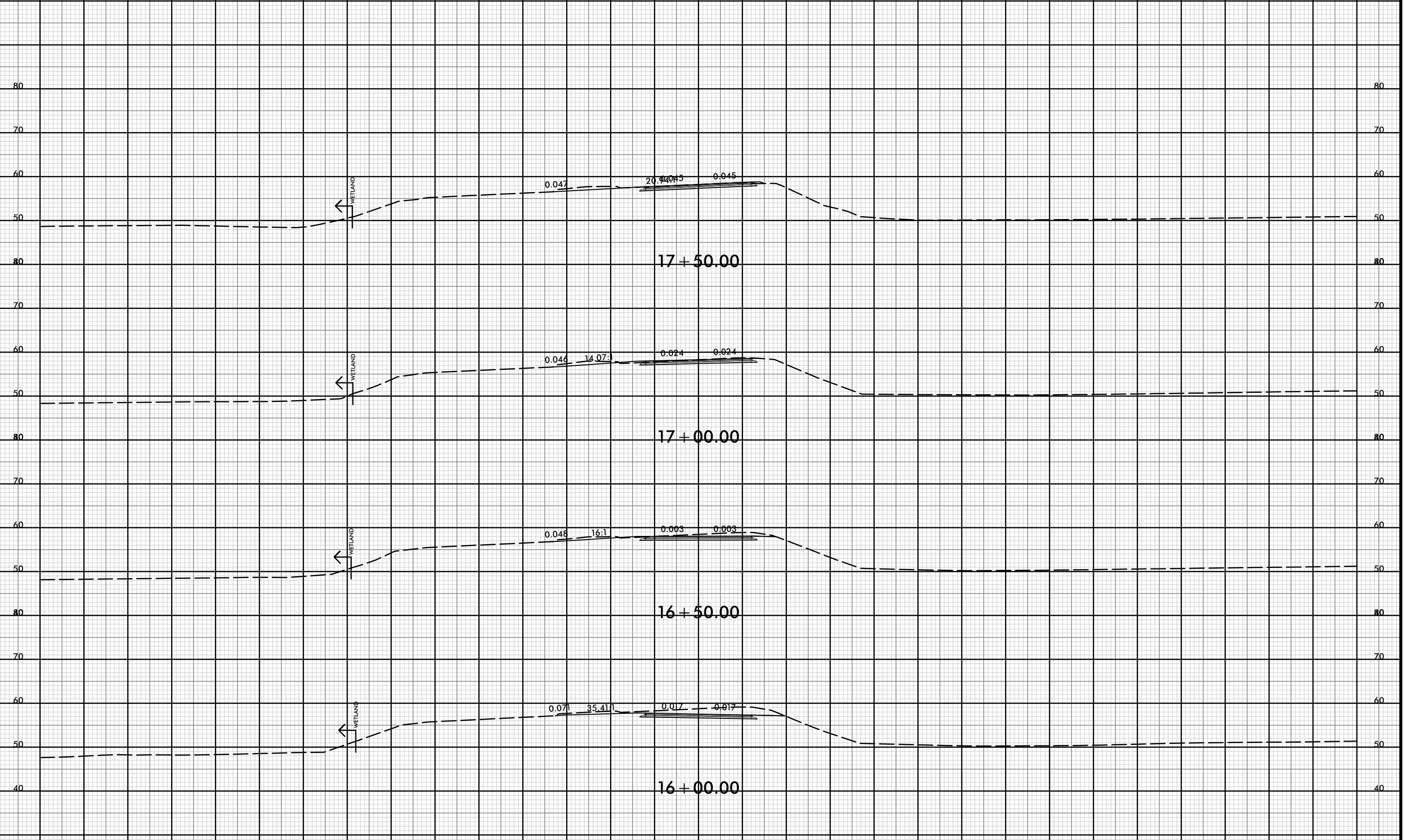

-YREVTCP1-

150 140 130 120 110 100 90 80 70 60 50 40 30 20 10 0 10 20 30 40 50 60 70 80 90 100 110 120 130 140 150

21-Jul-2021 10:40
R:\p\dawej\XSC\5021-rdy-xp1-YREVTCP1.dgn
HTFB



PROJ. REFERENCE NO.
R-5021

SHEET NO.
X-397

150 140 130 120 110 100 90 80 70 60 50 40 30 20 10 0 10 20 30 40 50 60 70 80 90 100 110 120 130 140 150

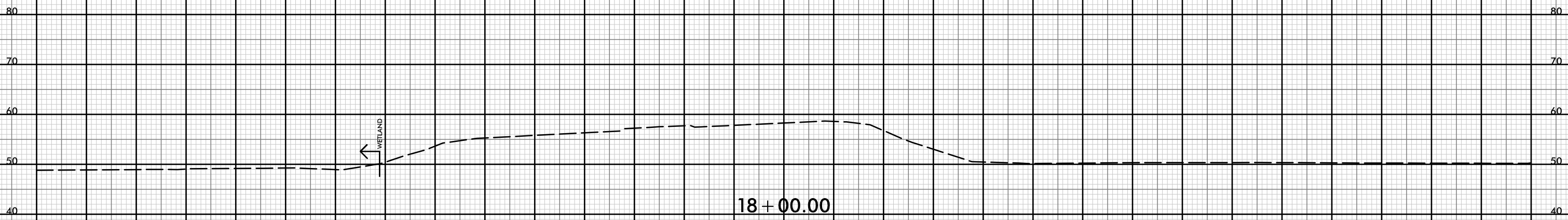

18 + 00.00
-YREVTCP1-



150 140 130 120 110 100 90 80 70 60 50 40 30 20 10 0 10 20 30 40 50 60 70 80 90 100 110 120 130 140 150

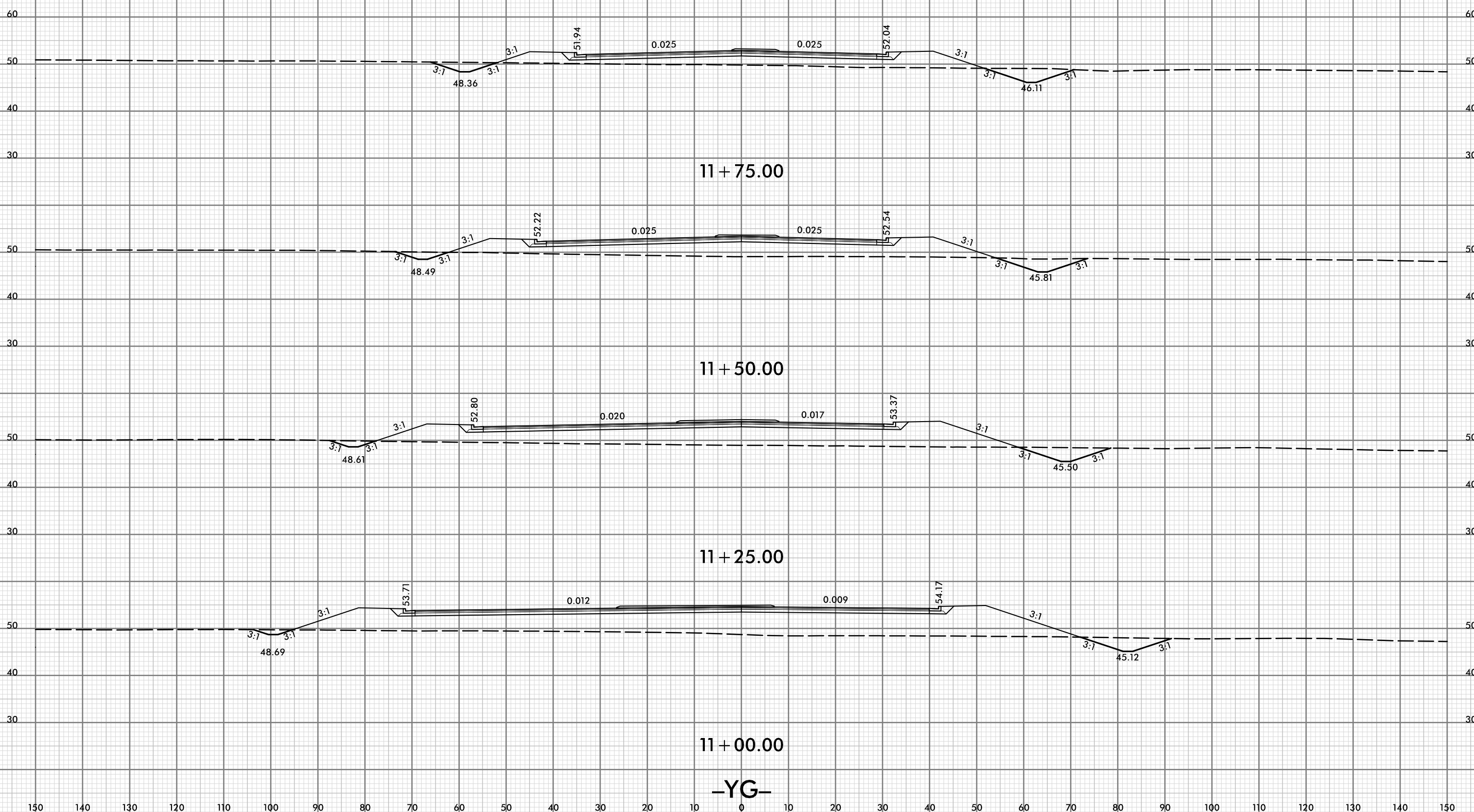

11 + 75.00

11 + 50.00

11 + 25.00

11 + 00.00

-YG-



150 140 130 120 110 100 90 80 70 60 50 40 30 20 10 0 10 20 30 40 50 60 70 80 90 100 110 120 130 140 150

60 60

50 50

40 40

12 + 75.00

60 60

50 50

40 40

12 + 50.00

60 60

50 50

40 40

12 + 25.00

60 60

50 50

40 40

12 + 00.00

-YG-

150 140 130 120 110 100 90 80 70 60 50 40 30 20 10 0 10 20 30 40 50 60 70 80 90 100 110 120 130 140 150

3:1

51.44

0.025

0.025

51.44

3:1

3:1

48.11

3:1

3:1

51.49

0.025

0.025

51.49

3:1

46.72

3:1

3:1

48.24

3:1

3:1

51.69

0.025

0.025

51.70

3:1

46.42

3:1



150 140 130 120 110 100 90 80 70 60 50 40 30 20 10 0 10 20 30 40 50 60 70 80 90 100 110 120 130 140 150

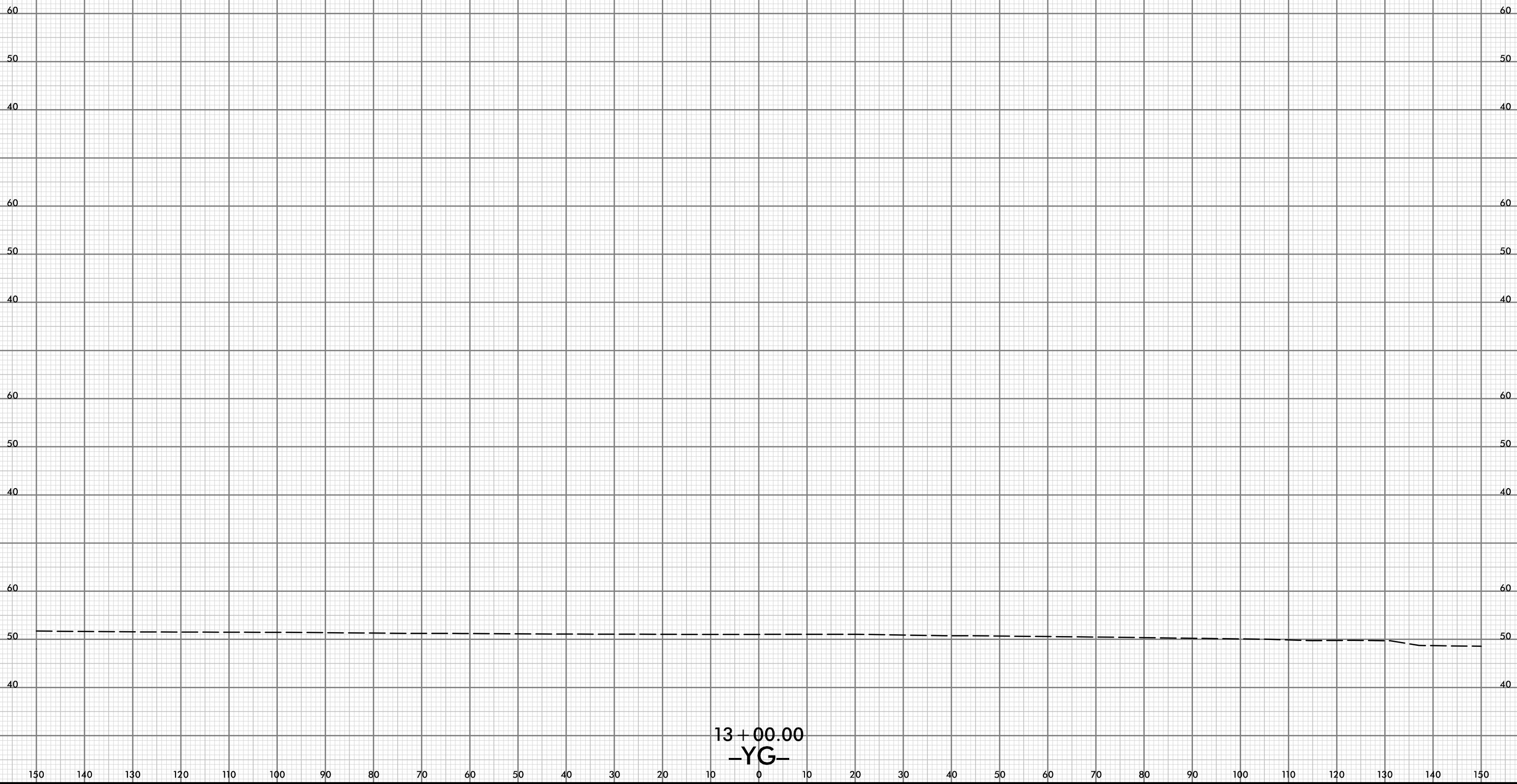

13 + 00.00
-YG-

150 140 130 120 110 100 90 80 70 60 50 40 30 20 10 0 10 20 30 40 50 60 70 80 90 100 110 120 130 140 150

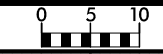

150 140 130 120 110 100 90 80 70 60 50 40 30 20 10 0 10 20 30 40 50 60 70 80 90 100 110 120 130 140 150

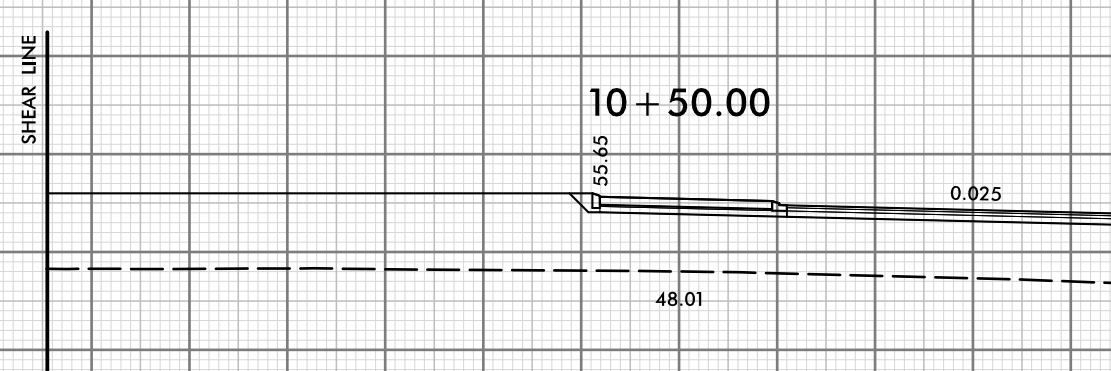
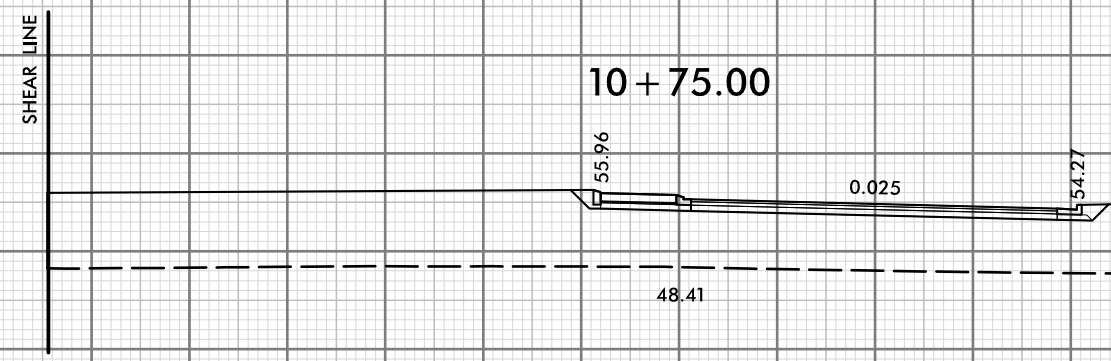
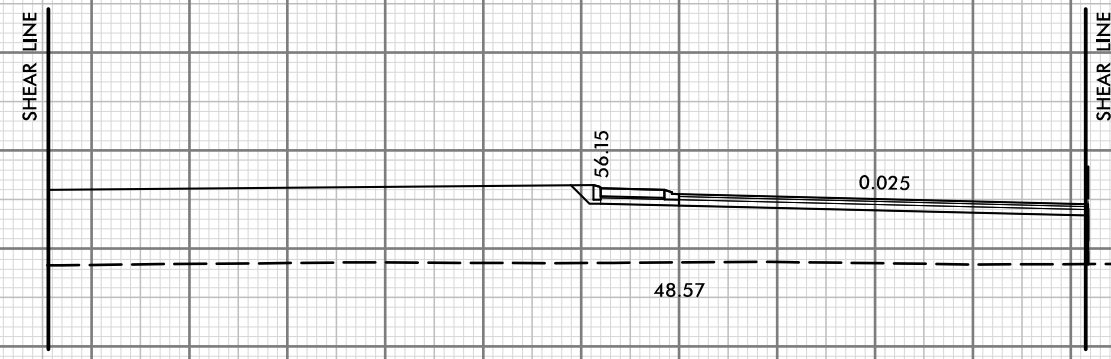

10 + 00.00
-RAB-

150 140 130 120 110 100 90 80 70 60 50 40 30 20 10 0 10 20 30 40 50 60 70 80 90 100 110 120 130 140 150



150 140 130 120 110 100 90 80 70 60 50 40 30 20 10 0 10 20 30 40 50 60 70 80 90 100 110 120 130 140 150

SHEAR LINE

SHEAR LINE

60

50

40

60

50

40

55.66

0.025

49.13

11 + 75.00

SHEAR LINE

SHEAR LINE

60

50

40

60

50

40

55.97

0.025

49.44

53.91

3:1

3:1

48.69

11 + 50.00

SHEAR LINE

SHEAR LINE

60

50

40

60

50

40

56.16

0.025

49.36

11 + 25.00

SHEAR LINE

SHEAR LINE

60

50

40

60

50

40

56.22

0.025

48.99

11 + 00.00

-RAB-

150 140 130 120 110 100 90 80 70 60 50 40 30 20 10 0 10 20 30 40 50 60 70 80 90 100 110 120 130 140 150

150 140 130 120 110 100 90 80 70 60 50 40 30 20 10 0 10 20 30 40 50 60 70 80 90 100 110 120 130 140 150

SHEAR LINE

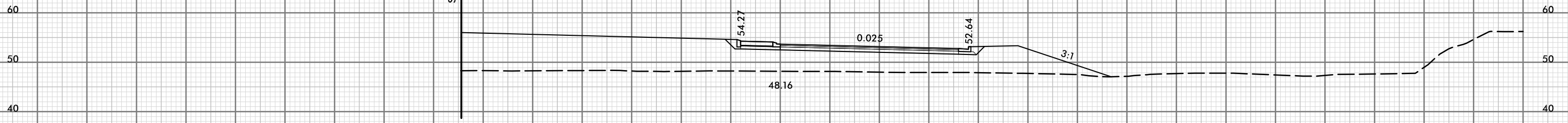

SHEAR LINE

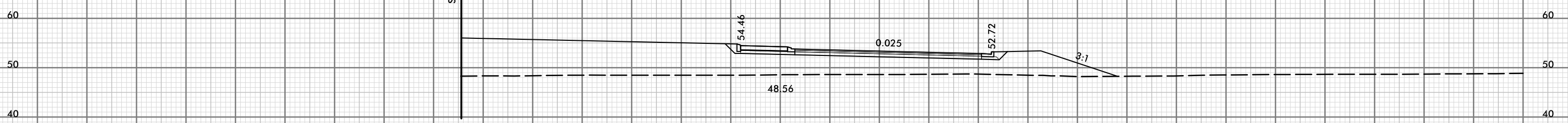

SHEAR LINE

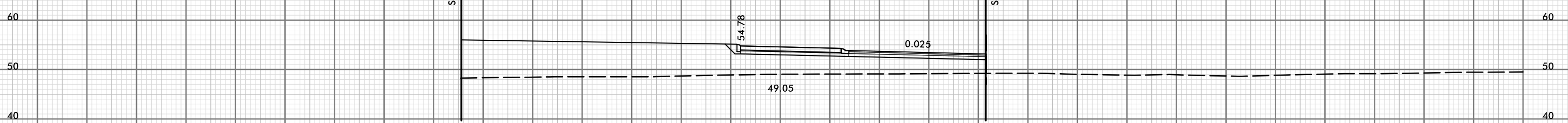

SHEAR LINE

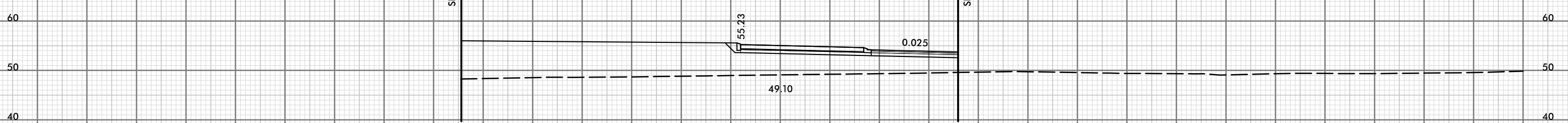

12 + 00.00
-RAB-

150 140 130 120 110 100 90 80 70 60 50 40 30 20 10 0 10 20 30 40 50 60 70 80 90 100 110 120 130 140 150

150 140 130 120 110 100 90 80 70 60 50 40 30 20 10 0 10 20 30 40 50 60 70 80 90 100 110 120 130 140 150

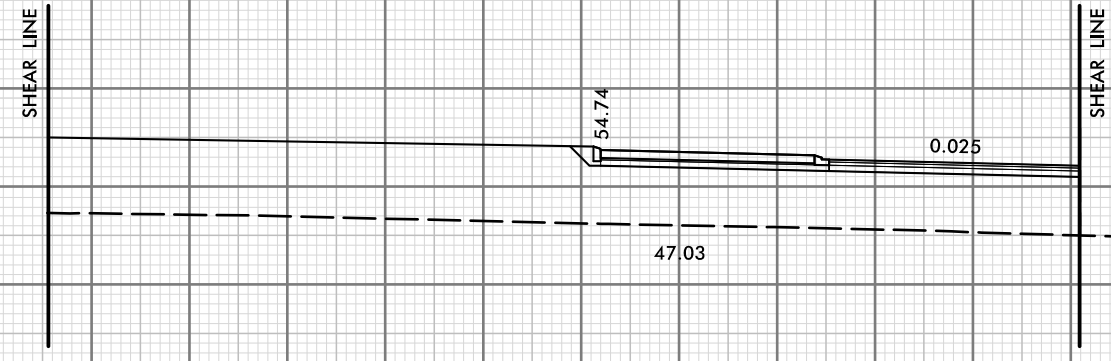

13 + 75.00

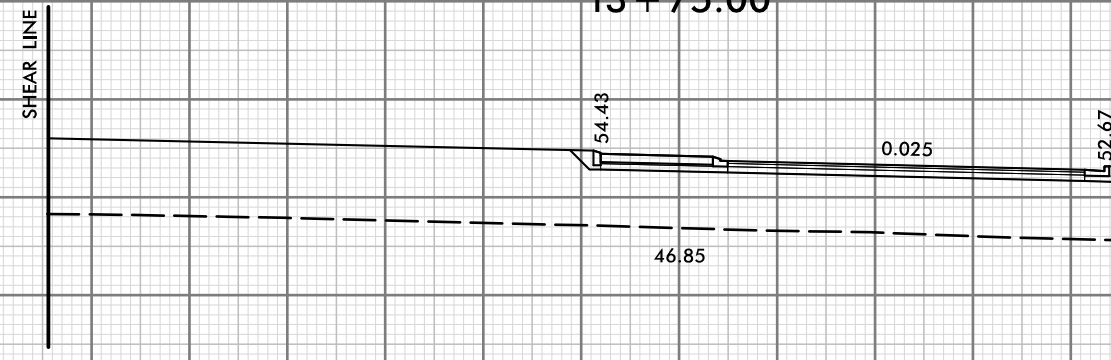

13 + 50.00

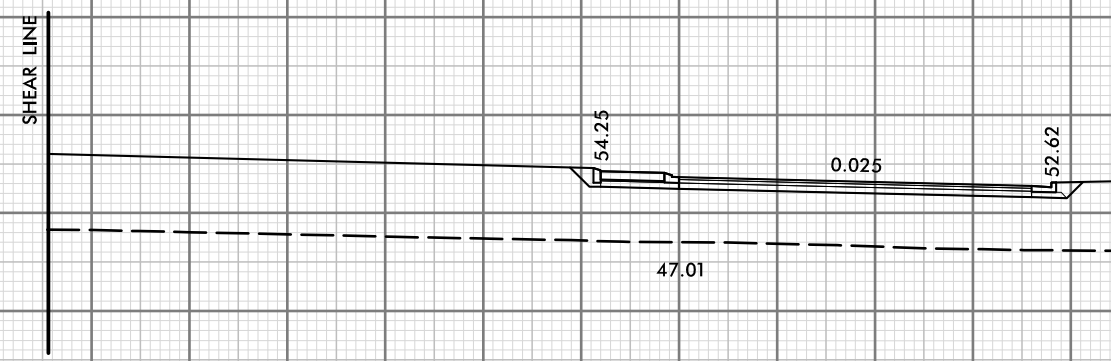

13 + 25.00

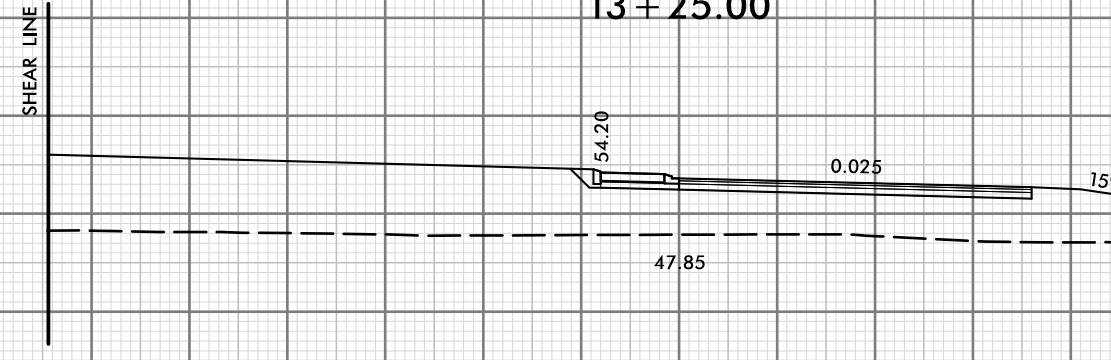

13 + 00.00

-RAB-

150 140 130 120 110 100 90 80 70 60 50 40 30 20 10 0 10 20 30 40 50 60 70 80 90 100 110 120 130 140 150



150 140 130 120 110 100 90 80 70 60 50 40 30 20 10 0 10 20 30 40 50 60 70 80 90 100 110 120 130 140 150

60 60

50 50

40 40

60 60

50 50

40 40

60 60

50 50

40 40

60 60

50 50

40 40

SHEAR LINE

SHEAR LINE

55.17

0.025

47.39

14 + 00.00
-RAB-

150 140 130 120 110 100 90 80 70 60 50 40 30 20 10 0 10 20 30 40 50 60 70 80 90 100 110 120 130 140 150