

LOGICAL I/O PROCESSOR PROGRAMMING DETAIL TO PRODUCE SPECIAL FYA-PPLT SIGNAL SEQUENCE

(program controller as shown below)

- FROM MAIN MENU PRESS '2' (PHASE CONTROL), THEN '1' (PHASE CONTROL FUNCTIONS). SCROLL TO THE BOTTOM OF THE MENU AND ENABLE ACT LOGIC COMMANDS 1, 2, 3, 4, 5, 6, 7, 8, AND 9.
- FROM MAIN MENU PRESS '6' (OUTPUTS), THEN '3' (LOGICAL I/O PROCESSOR).

LOGICAL I/O COMMAND #1 (+/-COMMAND#)
IF ACTIVE PHASE #1 IS ON
AND RED CLEAR ON PHASE #1 IS ON

SCROLL DOWN

THEN:
SET OUTPUT ASSIGNMENT #50 ON
SET OUTPUT ASSIGNMENT #51 OFF

PRESS '+'

NOTE: LOGIC FOR PHASE 1 RED CLEAR WHEN TRANSITIONING FROM PHASE 1 TO PHASE 2 (HEAD 11).

LOGICAL I/O COMMAND #2 (+/-COMMAND#)
IF ACTIVE PHASE #1 IS ON

SCROLL DOWN

THEN:
SET OUTPUT ASSIGNMENT #52 OFF

PRESS '+'

NOTE: LOGIC FOR SWITCHING FLASHING YELLOW ARROW "OFF" DURING PHASE 1 (HEAD 11).

LOGICAL I/O COMMAND #3 (+/-COMMAND#)
IF YELLOW ON PHASE #1 IS ON

SCROLL DOWN

THEN:
SET OUTPUT ASSIGNMENT #51 ON

PRESS '+'

NOTE: LOGIC FOR YELLOW ARROW CLEARANCE FROM PHASE 1 (HEAD 11).

LOGICAL I/O COMMAND #4 (+/-COMMAND#)
IF ACTIVE PHASE #5 IS ON
AND RED CLEAR ON PHASE #5 IS ON

SCROLL DOWN

THEN:
SET OUTPUT ASSIGNMENT #42 ON
SET OUTPUT ASSIGNMENT #43 OFF

PRESS '+'

NOTE: LOGIC FOR PHASE 5 RED CLEAR WHEN TRANSITIONING FROM PHASE 5 TO PHASE 6 (HEAD 51).

LOGICAL I/O COMMAND #5 (+/-COMMAND#)
IF ACTIVE PHASE #5 IS ON

SCROLL DOWN

THEN:
SET OUTPUT ASSIGNMENT #44 OFF

PRESS '+'

NOTE: LOGIC FOR SWITCHING FLASHING YELLOW ARROW "OFF" DURING PHASE 5 (HEAD 51).

LOGICAL I/O COMMAND #6 (+/-COMMAND#)
IF YELLOW ON PHASE #5 IS ON

SCROLL DOWN

THEN:
SET OUTPUT ASSIGNMENT #43 ON

PRESS '+'

NOTE: LOGIC FOR YELLOW ARROW CLEARANCE FROM PHASE 5 (HEAD 51).

LOGICAL I/O COMMAND #7 (+/-COMMAND#)
IF ACTIVE PHASE #3 IS ON
AND RED CLEAR ON PHASE #3 IS ON

SCROLL DOWN

THEN:
SET OUTPUT ASSIGNMENT #47 ON
SET OUTPUT ASSIGNMENT #48 OFF

PRESS '+'

NOTE: LOGIC FOR PHASE 3 RED CLEAR WHEN TRANSITIONING FROM PHASE 3 TO PHASE 4 (HEAD 31).

LOGICAL I/O COMMAND #8 (+/-COMMAND#)
IF ACTIVE PHASE #3 IS ON

SCROLL DOWN

THEN:
SET OUTPUT ASSIGNMENT #49 OFF

PRESS '+'

NOTE: LOGIC FOR SWITCHING FLASHING YELLOW ARROW "OFF" DURING PHASE 3 (HEAD 31).

LOGICAL I/O COMMAND #9 (+/-COMMAND#)
IF YELLOW ON PHASE #3 IS ON

SCROLL DOWN

THEN:
SET OUTPUT ASSIGNMENT #48 ON

PRESS '+'

NOTE: LOGIC FOR YELLOW ARROW CLEARANCE FROM PHASE 3 (HEAD 31).

LOGIC I/O PROCESSOR PROGRAMMING COMPLETE

OUTPUT REFERENCE SCHEDULE	
USE TO INTERPRET LOGIC PROCESSOR	
OUTPUT 42 =	Overlap C Red
OUTPUT 43 =	Overlap C Yellow
OUTPUT 44 =	Overlap C Green
OUTPUT 47 =	Overlap B Red
OUTPUT 48 =	Overlap B Yellow
OUTPUT 49 =	Overlap B Green
OUTPUT 50 =	Overlap A Red
OUTPUT 51 =	Overlap A Yellow
OUTPUT 52 =	Overlap A Green

THIS ELECTRICAL DETAIL IS FOR THE SIGNAL DESIGN: 03-0897T2
DESIGNED: June 2017
SEALED: 9/10/2021
REVISED: N/A

OVERLAP PROGRAMMING DETAIL FOR DEFAULT PHASING

(program controller as shown below)

FROM MAIN MENU PRESS '8' (OVERLAPS), THEN '1' (VEHICLE OVERLAP SETTINGS).

PAGE 1: VEHICLE OVERLAP 'A' SETTINGS
PHASE: :12345678910111213141516
VEH OVL PARENTS: :XX
VEH OVL NOT VEH: :
VEH OVL NOT PED: :
VEH OVL GRN EXT: :
STARTUP COLOR: - RED - YELLOW - GREEN
FLASH COLORS: - RED - YELLOW X GREEN
SELECT VEHICLE OVERLAP OPTIONS: (Y/N)
FLASH YELLOW IN CONTROLLER FLASH?...Y
GREEN EXTENSION (0-255 SEC)...0
YELLOW CLEAR (0=PARENT,3-25.5 SEC)...0.0
RED CLEAR (0=PARENT,0.1-25.5 SEC)...0.0
OUTPUT AS PHASE # (0=NONE, 1-16)...0

NOTICE GREEN FLASH

PAGE 1: VEHICLE OVERLAP 'C' SETTINGS
PHASE: :12345678910111213141516
VEH OVL PARENTS: : XX
VEH OVL NOT VEH: :
VEH OVL NOT PED: :
VEH OVL GRN EXT: :
STARTUP COLOR: - RED - YELLOW - GREEN
FLASH COLORS: - RED - YELLOW X GREEN
SELECT VEHICLE OVERLAP OPTIONS: (Y/N)
FLASH YELLOW IN CONTROLLER FLASH?...Y
GREEN EXTENSION (0-255 SEC)...0
YELLOW CLEAR (0=PARENT,3-25.5 SEC)...0.0
RED CLEAR (0=PARENT,0.1-25.5 SEC)...0.0
OUTPUT AS PHASE # (0=NONE, 1-16)...0

NOTICE GREEN FLASH

PRESS '+'

OVERLAP PROGRAMMING COMPLETE

PAGE 1: VEHICLE OVERLAP 'B' SETTINGS
PHASE: :12345678910111213141516
VEH OVL PARENTS: : XX
VEH OVL NOT VEH: :
VEH OVL NOT PED: :
VEH OVL GRN EXT: :
STARTUP COLOR: - RED - YELLOW - GREEN
FLASH COLORS: - RED - YELLOW X GREEN
SELECT VEHICLE OVERLAP OPTIONS: (Y/N)
FLASH YELLOW IN CONTROLLER FLASH?...N
GREEN EXTENSION (0-255 SEC)...0
YELLOW CLEAR (0=PARENT,3-25.5 SEC)...0.0
RED CLEAR (0=PARENT,0.1-25.5 SEC)...0.0
OUTPUT AS PHASE # (0=NONE, 1-16)...0

NOTICE GREEN FLASH

PRESS '+'

OVERLAP PROGRAMMING DETAIL FOR ALTERNATE PHASING

(program controller as shown below)

FROM MAIN MENU PRESS '8' (OVERLAPS), THEN '1' (VEHICLE OVERLAP SETTINGS). PRESS 'NEXT' TO ADVANCE TO PAGE 2.

PAGE 2: VEHICLE OVERLAP 'A' SETTINGS
PHASE: :12345678910111213141516
VEH OVL PARENTS: : X
VEH OVL NOT VEH: :
VEH OVL NOT PED: :
VEH OVL GRN EXT: :
STARTUP COLOR: - RED - YELLOW - GREEN
FLASH COLORS: - RED - YELLOW - GREEN
SELECT VEHICLE OVERLAP OPTIONS: (Y/N)
FLASH YELLOW IN CONTROLLER FLASH?...Y
GREEN EXTENSION (0-255 SEC)...0
YELLOW CLEAR (0=PARENT,3-25.5 SEC)...0.0
RED CLEAR (0=PARENT,0.1-25.5 SEC)...0.0
OUTPUT AS PHASE # (0=NONE, 1-16)...0

NOTICE PAGE 2

NOTICE PAGE 2

PRESS '+'

OVERLAP PROGRAMMING COMPLETE

PAGE 2: VEHICLE OVERLAP 'B' SETTINGS
PHASE: :12345678910111213141516
VEH OVL PARENTS: : XX
VEH OVL NOT VEH: :
VEH OVL NOT PED: :
VEH OVL GRN EXT: :
STARTUP COLOR: - RED - YELLOW - GREEN
FLASH COLORS: - RED - YELLOW X GREEN
SELECT VEHICLE OVERLAP OPTIONS: (Y/N)
FLASH YELLOW IN CONTROLLER FLASH?...N
GREEN EXTENSION (0-255 SEC)...0
YELLOW CLEAR (0=PARENT,3-25.5 SEC)...0.0
RED CLEAR (0=PARENT,0.1-25.5 SEC)...0.0
OUTPUT AS PHASE # (0=NONE, 1-16)...0

NOTICE GREEN FLASH

PRESS '+'

Electrical Detail - Sheet 2 of 5
Signal Upgrade
Temporary Design 2

DOCUMENT NOT CONSIDERED FINAL UNLESS ALL SIGNATURES COMPLETED

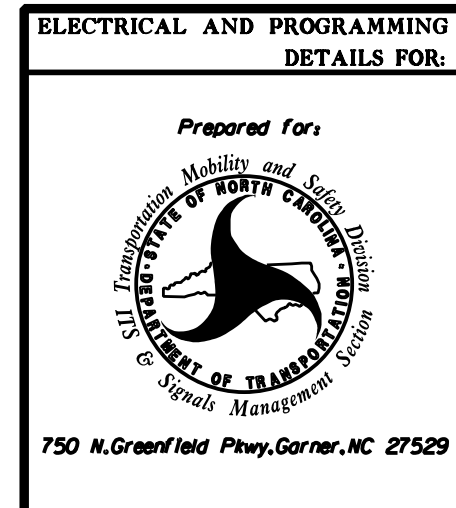

Prepared for: Department of Transportation and Safety Division of Signal Management		NC 211 (Howe Street) at Tidewater Plaza/Sandy Lane		SEAL NORTH CAROLINA PROFESSIONAL ENGINEER NATASHA R. SIMMONS	
Division 03 Brunswick Co. Southport		PLAN DATE: June 2017		REVIEWED BY: A.D. Klinsky	
PREPARED BY: A.H. Thornburg		REVIEWED BY: N.R. Simmons		DocuSign by: Natasha Simmons	
REVISIONS	INIT.	DATE	9/10/2021		
SIGNATURE		DATE			
SIG. INVENTORY NO. 03-0897T2					

HNTB HNTB NORTH CAROLINA, P.C.
343 E. Six Forks Road, Suite 200
Raleigh, North Carolina 27609
NC License No. C-1554
(919) 546-8997

INPUT PAGE 2 ASSIGNMENT PROGRAMMING DETAIL FOR ALTERNATE PHASING - LOOP 1A

(program controller as shown below)

- NOTES: 1. THIS PROGRAMMING APPLIES FOR INPUT PAGE 2 ONLY. INPUT PAGE 1 WILL USE STANDARD DEFAULT SETTINGS. THIS PROGRAMMING IS NECESSARY FOR PROPER DETECTOR OPERATION DURING ALTERNATE PHASING OPERATION.
2. THE FIRST TASK THIS PROGRAMMING ACCOMPLISHES IS THE DISABLING OF INPUT #10 (DETECTOR 26) SO THAT A VEHICLE CALL WILL NOT BE PLACED TO PHASE 6 DURING ALTERNATE PHASING OPERATION. THE SECOND TASK THIS PROGRAMMING ACCOMPLISHES IS THAT IT REASSIGNS DETECTOR 51 TO INPUT #18 SO THAT THE DELAY ON LOOP 1A CAN BE REDUCED FROM 15 SECONDS TO 3 SECONDS.

FROM MAIN MENU PRESS '5' (INPUTS). THEN PRESS 'NEXT' TO GET TO INPUT PAGE '2'. PRESS THE '+' KEY UNTIL INPUT 10 IS REACHED.

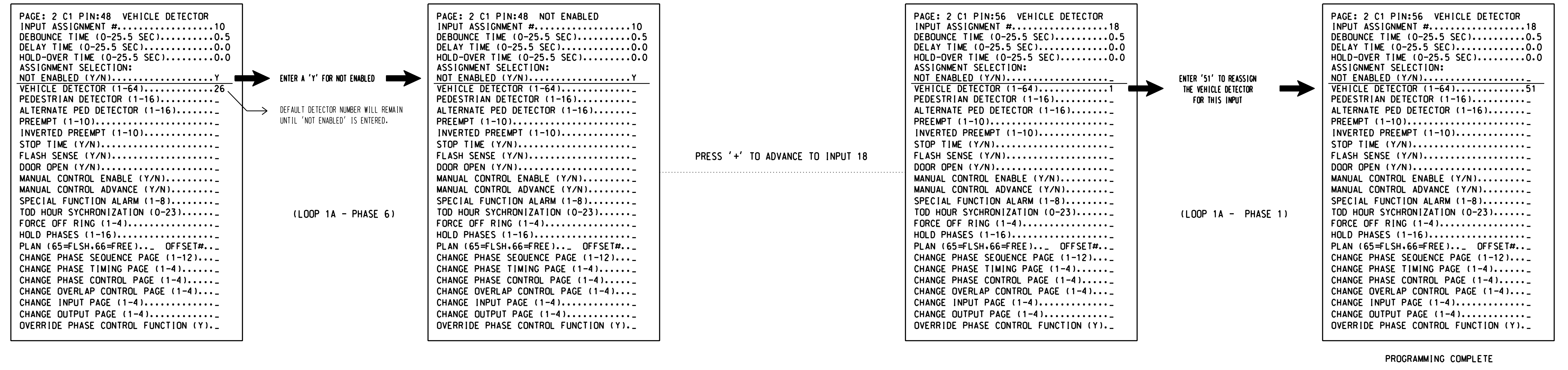

SPECIAL DETECTOR PROGRAMMING DETAIL - LOOP 1A (ALT.)

(program controller as shown below)

FROM MAIN MENU PRESS '7' (DETECTORS). THEN PRESS '1' FOR VEHICLE DETECTORS. PRESS THE '-' KEY TO GET TO VEHICLE DETECTOR #51.

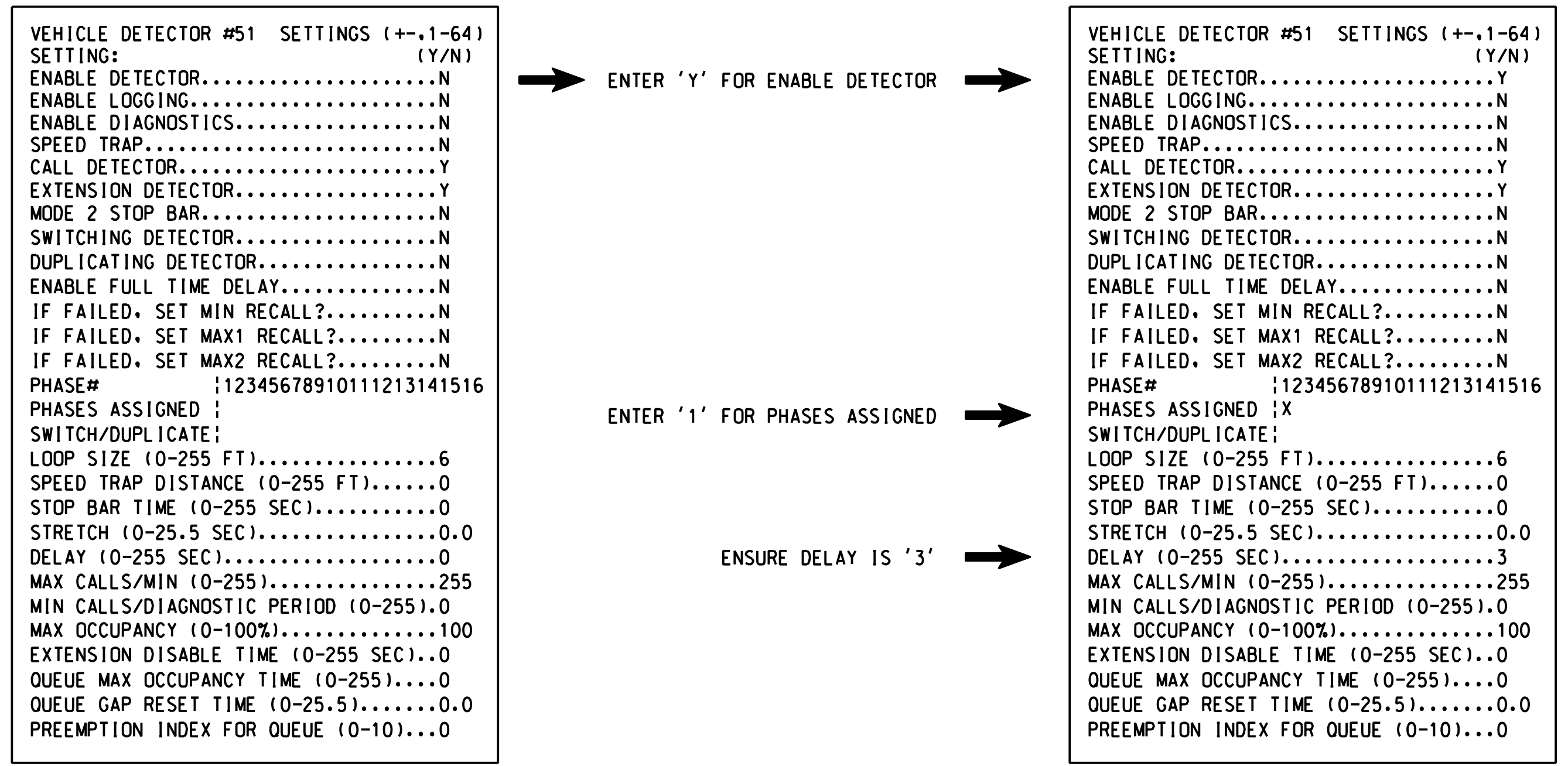

NOTE: DETECTOR IS PROGRAMMED PER THE INPUT FILE CONNECTION AND PROGRAMMING CHART SHOWN ON SHEET 1.

THIS ELECTRICAL DETAIL IS FOR THE SIGNAL DESIGN: 03-0897T2
DESIGNED: June 2017
SEALED: 9/10/2021
REVISED: N/A

Electrical Detail - Sheet 3 of 5
Signal Upgrade
Temporary Design 2

DOCUMENT NOT CONSIDERED FINAL UNLESS ALL SIGNATURES COMPLETED

	NC 211 (Howe Street) at Tidewater Plaza/Sandy Lane	
	Division 03 Brunswick Co. Southport	PLAN DATE: June 2017 PREPARED BY: A.H. Thornburg
REVISIONS	INIT.	DATE
_____	_____	_____
_____	_____	_____
_____	_____	_____

INPUT PAGE 2 ASSIGNMENT PROGRAMMING DETAIL FOR ALTERNATE PHASING - LOOP 5A

(program controller as shown below)

- NOTES: 1. THIS PROGRAMMING APPLIES FOR INPUT PAGE 2 ONLY. INPUT PAGE 1 WILL USE STANDARD DEFAULT SETTINGS. THIS PROGRAMMING IS NECESSARY FOR PROPER DETECTOR OPERATION DURING ALTERNATE PHASING OPERATION.
2. THE FIRST TASK THIS PROGRAMMING ACCOMPLISHES IS THE DISABLING OF INPUT #9 (DETECTOR 22) SO THAT A VEHICLE CALL WILL NOT BE PLACED TO PHASE 2 DURING ALTERNATE PHASING OPERATION. THE SECOND TASK THIS PROGRAMMING ACCOMPLISHES IS THAT IT REASSIGNS DETECTOR 55 TO INPUT #17 SO THAT THE DELAY ON LOOP 5A CAN BE REDUCED FROM 15 SECONDS TO 3 SECONDS.

FROM MAIN MENU PRESS '5' (INPUTS), THEN PRESS 'NEXT' TO GET TO INPUT PAGE '2'. PRESS THE '+' KEY UNTIL INPUT 9 IS REACHED.

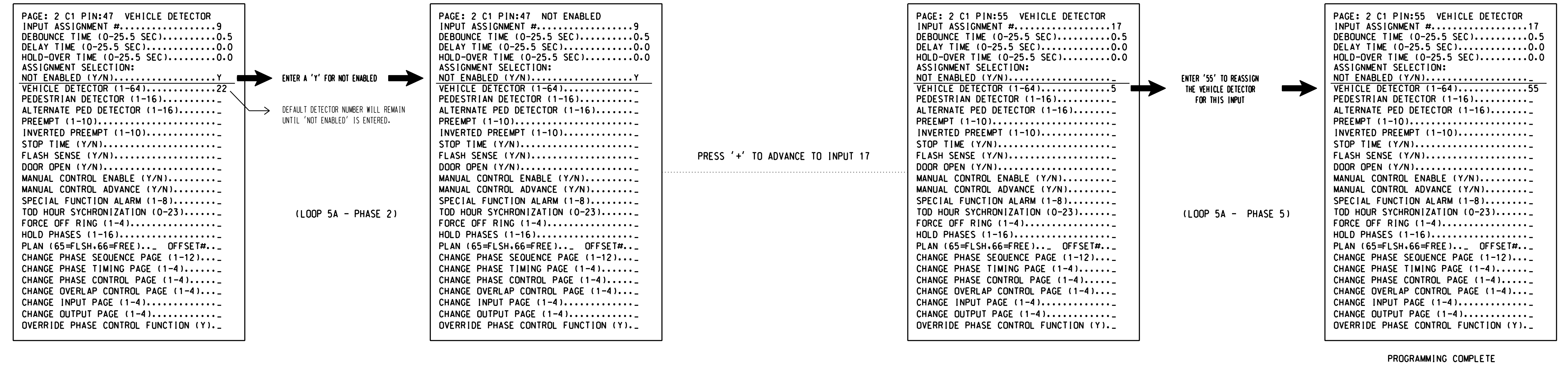

SPECIAL DETECTOR PROGRAMMING DETAIL - LOOP 5A (ALT.)

(program controller as shown below)

FROM MAIN MENU PRESS '7' (DETECTORS), THEN PRESS '1' FOR VEHICLE DETECTORS. PRESS THE '-' KEY TO GET TO VEHICLE DETECTOR #55.

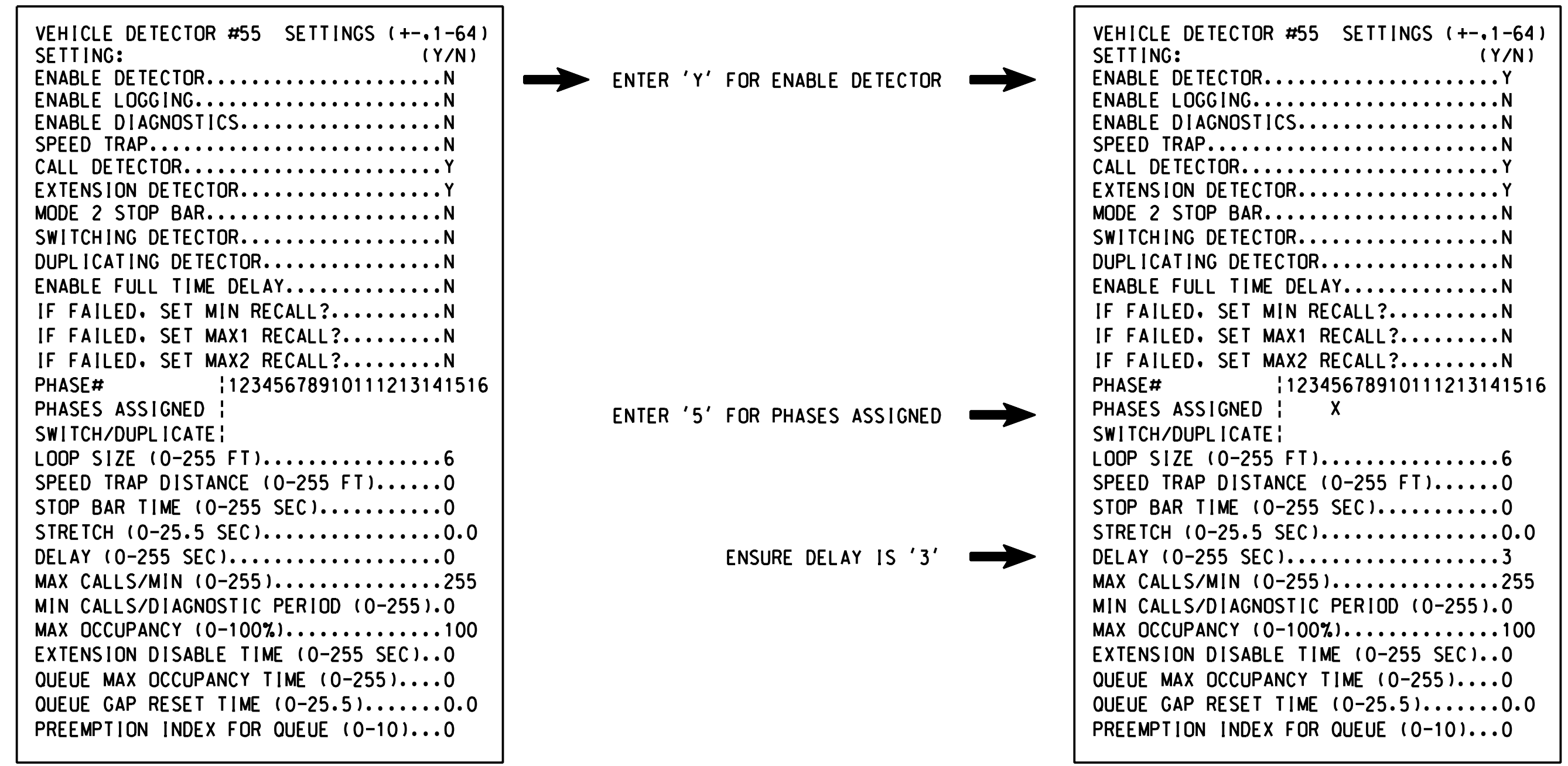

NOTE: DETECTOR IS PROGRAMMED PER THE INPUT FILE CONNECTION AND PROGRAMMING CHART SHOWN ON SHEET 1.

THIS ELECTRICAL DETAIL IS FOR THE SIGNAL DESIGN: 03-0897T2
DESIGNED: June 2017
SEALED: 9/10/2021
REVISED: N/A

Electrical Detail - Sheet 4 of 5
Signal Upgrade
Temporary Design 2

DOCUMENT NOT CONSIDERED FINAL UNLESS ALL SIGNATURES COMPLETED

	Prepared for: NC 211 (Howe Street) at Tidewater Plaza/Sandy Lane		
	Division 03 Brunswick Co. Southport PLAN DATE: June 2017 REVIEWED BY: A.D. Klinskiak PREPARED BY: A.H. Thornburg REVIEWED BY: N.R. Simmons		
Revisions Table: REVISIONS INIT. DATE		Signature: _____ DATE: 9/10/2021 SIG. INVENTORY NO. 03-0897T2	

ALTERNATE PHASING ACTIVATION DETAIL

TO RUN ALT. PHASING DURING COORDINATION - SELECT ALL PAGE CHANGES (AS SHOWN BELOW) WITHIN COORDINATION PLAN PROGRAMMING.

TO RUN ALT. PHASING DURING FREE RUN - PROGRAM PAGE CHANGES (SHOWN BELOW) IN SEPARATE TIME OF DAY EVENTS. IF PAGE 1 IS USED, NO EVENT PROGRAMMING IS NECESSARY FOR THAT PARTICULAR PAGE.

<u>PHASING</u>	<u>INPUTS PAGE</u>	<u>OVERLAPS PAGE</u>
ACTIVE PAGES REQUIRED TO RUN <u>DEFAULT PHASING</u>	1	1
ACTIVE PAGES REQUIRED TO RUN <u>ALTERNATE PHASING</u>	2	2

NOTE: PAGES NOT SHOWN (i.e. sequence, phase control, etc.) SHOULD REMAIN AS '1', OR AS DEFINED BY TIMING ENGINEER.

IMPORTANT: IF ALT. PHASING IS USED DURING FREE RUN AND COORDINATION, DO NOT OPERATE TIME OF DAY PAGE CHANGE EVENTS CONCURRENTLY WITH COORDINATION PLAN EVENTS IN THE EVENT SCHEDULER. (EX. FREE RUN PAGE CHANGE EVENT SHOULD END BEFORE COORDINATION PLAN EVENT STARTS AND VICE-VERSA).

ALTERNATE PHASING PAGE CHANGE SUMMARY

THE FOLLOWING IS A SUMMARY OF WHAT TAKES PLACE WHEN THESE OVERLAP/INPUT PAGE CHANGES ACTIVATE TO CALL THE "ALTERNATE PHASING":

OVERLAPS PAGE 2: Modifies overlap parent phases for heads 11 and 51 to run protected turns only.

INPUTS PAGE 2: Disables phase 6 call on loop 1A and reduces delay time for phase 1 call on loop 1A to 3 seconds.

Disables phase 2 call on loop 5A and reduces delay time for phase 5 call on loop 5A to 3 seconds.

FLASHER CIRCUIT MODIFICATION DETAIL

IN ORDER TO INSURE THAT SIGNALS FLASH CONCURRENTLY ON THE SAME APPROACH, MAKE THE FOLLOWING FLASHER CIRCUIT CHANGES:

1. ON REAR OF PDA - REMOVE WIRE FROM TERM. T2-4 AND TERMINATE ON T2-2.
2. ON REAR OF PDA - REMOVE WIRE FROM TERM. T2-5 AND TERMINATE ON T2-3.
3. REMOVE FLASHER UNIT 2.

THE CHANGES LISTED ABOVE TIES ALL PHASES AND OVERLAPS TO FLASHER UNIT 1.

DYNAMIC BACK-UP CONTROL PROGRAMMING

(program controller as shown below)

1. From Main Menu press '2' (Phase Control), then '1' (Phase Control Functions). Scroll to the bottom of the menu and enable Dynamic/Backup Control Function 1.
2. From Phase Control Functions Menu press '2' (Dynamic/Backup Control Functions).

```

DYNAMIC/BACKUP CONTROL FUNCTION #01
OVERLAPS: ABCDEFGHIJKLMNP
IF OVERLAPS ARE ACTIVE:
OR PHASES: 12345678910111213141516
IF PHASES ARE ON: X
OMIT PHASES: X
CALL PHASES:
    
```

BACKUP PROTECTION PROGRAMMING COMPLETE

THIS ELECTRICAL DETAIL IS FOR
 THE SIGNAL DESIGN: 03-0897T2
 DESIGNED: June 2017
 SEALED: 9/10/2021
 REVISED: N/A

Electrical Detail - Sheet 5 of 5
 Signal Upgrade
 Temporary Design 2

**DOCUMENT NOT CONSIDERED FINAL
 UNLESS ALL SIGNATURES COMPLETED**

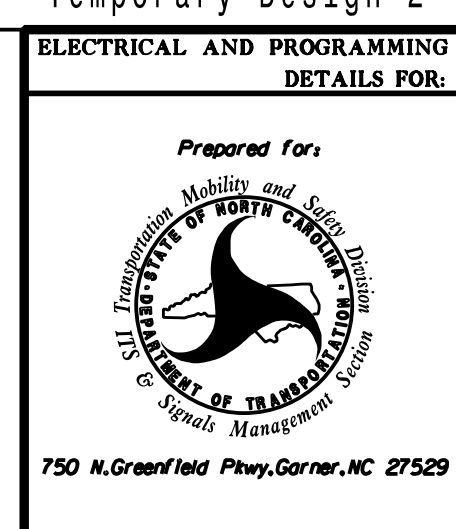

NC 211 (Howe Street) at Tidewater Plaza/Sandy Lane		
Division 03 Brunswick Co. Southport		
PLAN DATE: June 2017	REVIEWED BY: A.D. Klinksiek	
PREPARED BY: A.H. Thornburg	REVIEWED BY: N.R. Simmons	
REVISIONS	INIT.	DATE

SEAL

Natasha Simmons
 9/10/2021
 SIGNATURE DATE
 SIG. INVENTORY NO. 03-0897T2

DEFAULT PHASING DIAGRAM

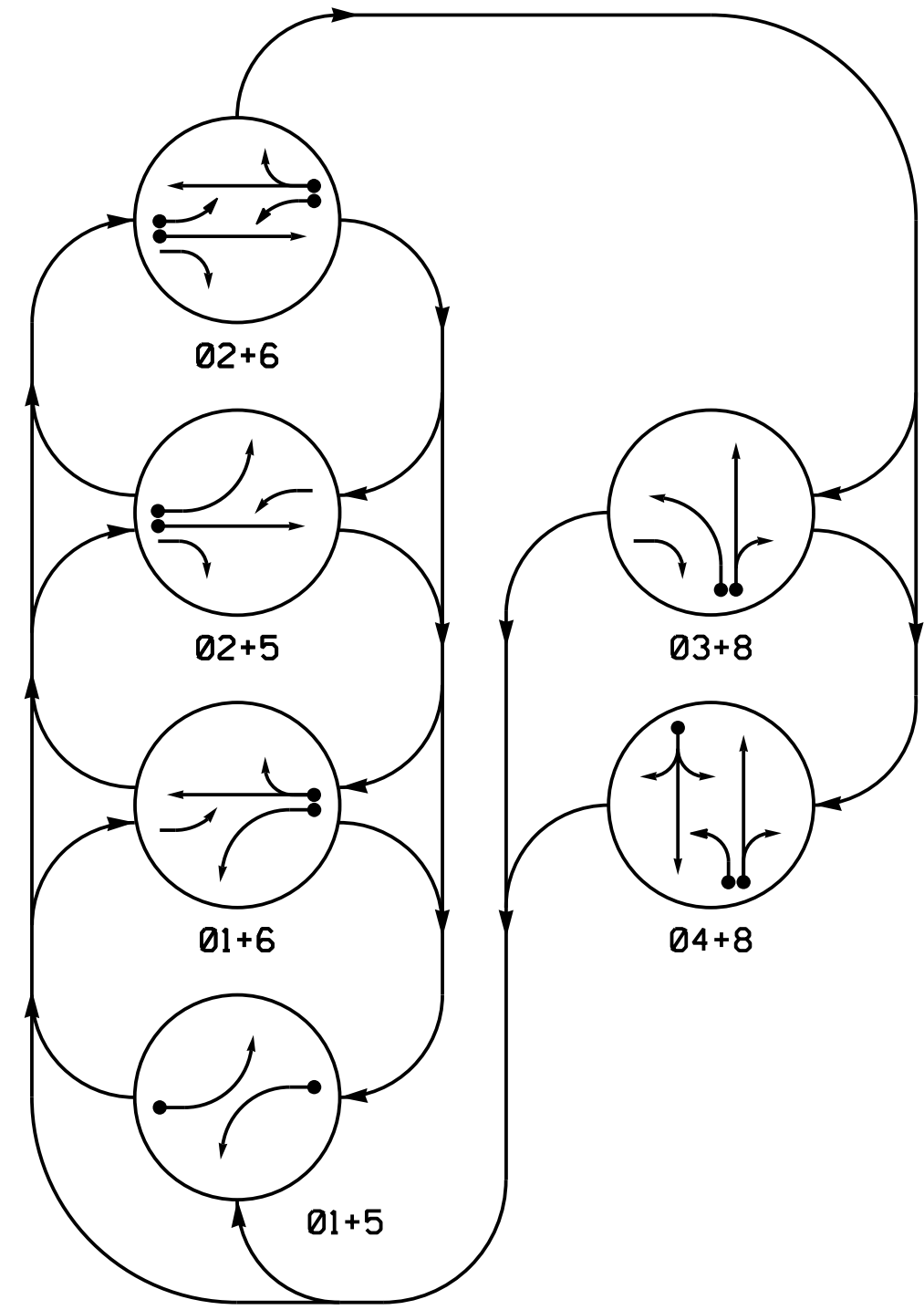

ALTERNATE PHASING DIAGRAM

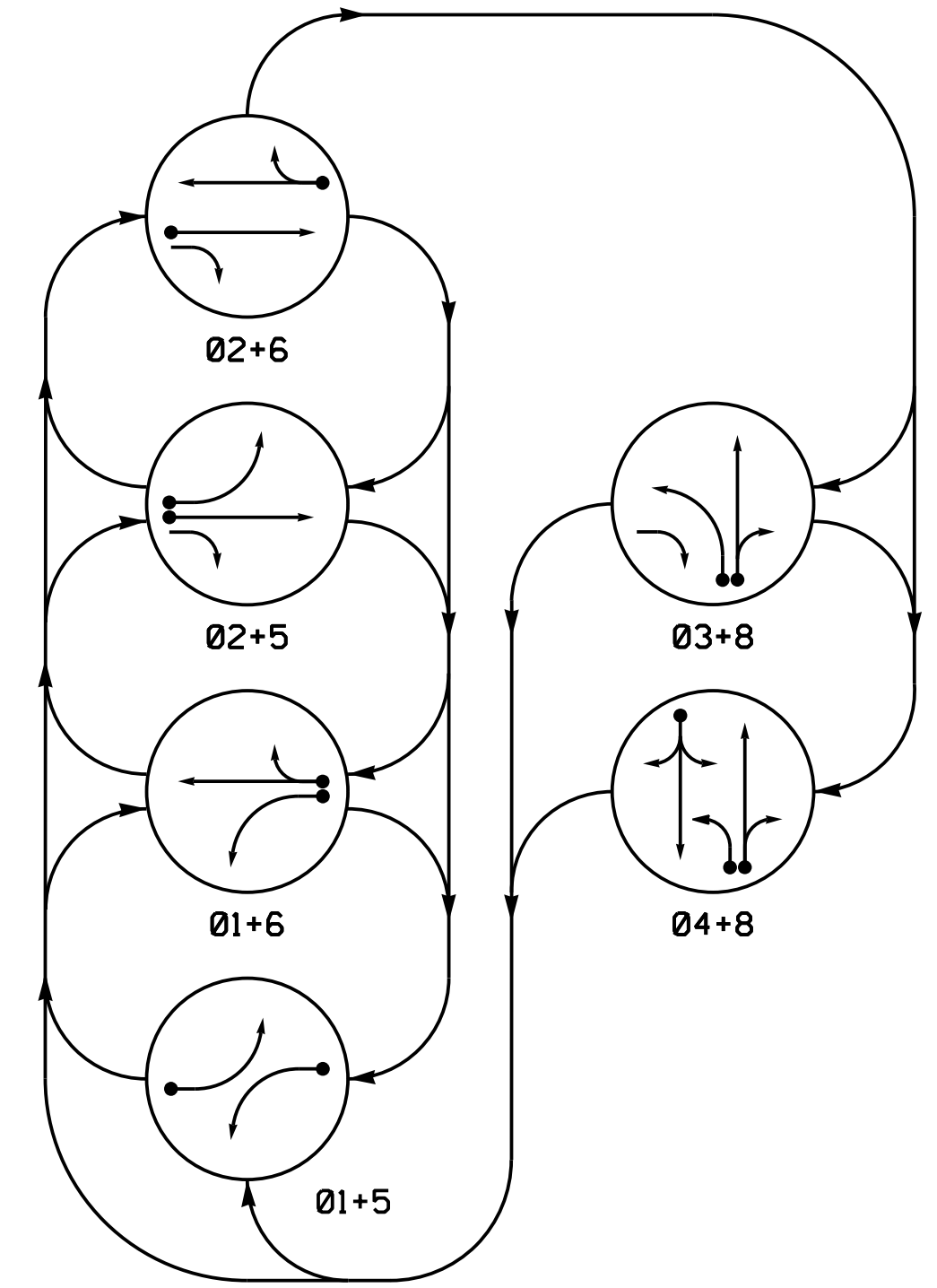

PHASING DIAGRAM DETECTION LEGEND

- ←●→ DETECTED MOVEMENT
- ←○→ UNDETECTED MOVEMENT (OVERLAP)
- ←...→ UNSIGNALIZED MOVEMENT
- ←---→ PEDESTRIAN MOVEMENT

DEFAULT PHASING TABLE OF OPERATION

SIGNAL FACE	PHASE							
	01+5	01+6	02+5	02+6	03+8	04+8	FL	TR
11	—	—	—	—	—	—	—	—
21	R	R	G	G	R	R	Y	Y
22	R	R	G	G	R	R	Y	Y
31	R	R	R	R	—	—	—	—
41,42	R	R	R	R	R	G	R	Y
51	—	—	—	—	—	—	—	—
61,62	R	G	R	G	R	R	Y	Y
81,82	R	R	R	R	G	G	R	Y

ALTERNATE PHASING TABLE OF OPERATION

SIGNAL FACE	PHASE							
	01+5	01+6	02+5	02+6	03+8	04+8	FL	TR
11	—	—	—	—	—	—	—	—
21	R	R	G	G	R	R	Y	Y
22	R	R	G	G	R	R	Y	Y
31	R	R	R	R	—	—	—	—
41,42	R	R	R	R	R	G	R	Y
51	—	—	—	—	—	—	—	—
61,62	R	G	R	G	R	R	Y	Y
81,82	R	R	R	R	G	G	R	Y

OASIS 2070 LOOP & DETECTOR INSTALLATION CHART

LOOP	SIZE (FT)	DISTANCE FROM STOPBAR (FT)	TURNS	NEW LOOP	DETECTOR PROGRAMMING				STRETCH TIME	DELAY TIME	SYSTEM LOOP	NEW CARD
					PHASE	CALLING	EXTENSION	FULL TIME DELAY				
1A	6X40	0	*	*	1	Y	Y	-	-	***15	-	-
2A	6X6	300	*	*	**6	Y	Y	-	-	3	-	-
3A	6X40	0	*	*	3	Y	Y	-	-	15	-	-
4A	6X40	0	*	*	8	Y	Y	-	-	3	-	-
5A	6X40	0	*	*	4	Y	Y	-	-	10	-	-
6A	6X6	300	*	*	5	Y	Y	-	-	***15	-	-
8A	6X40	0	*	*	**2	Y	Y	-	-	3	-	-
					6	Y	Y	-	-	-	-	-
					8	Y	Y	-	-	10	-	-

* Multizone Microwave Detection.
 ** Disable phase 2 and 6 call for 1A and 5A during alternate phasing operation.
 *** Reduce delay to 3 seconds during alternate phasing operation.

SIGNAL FACE I.D.

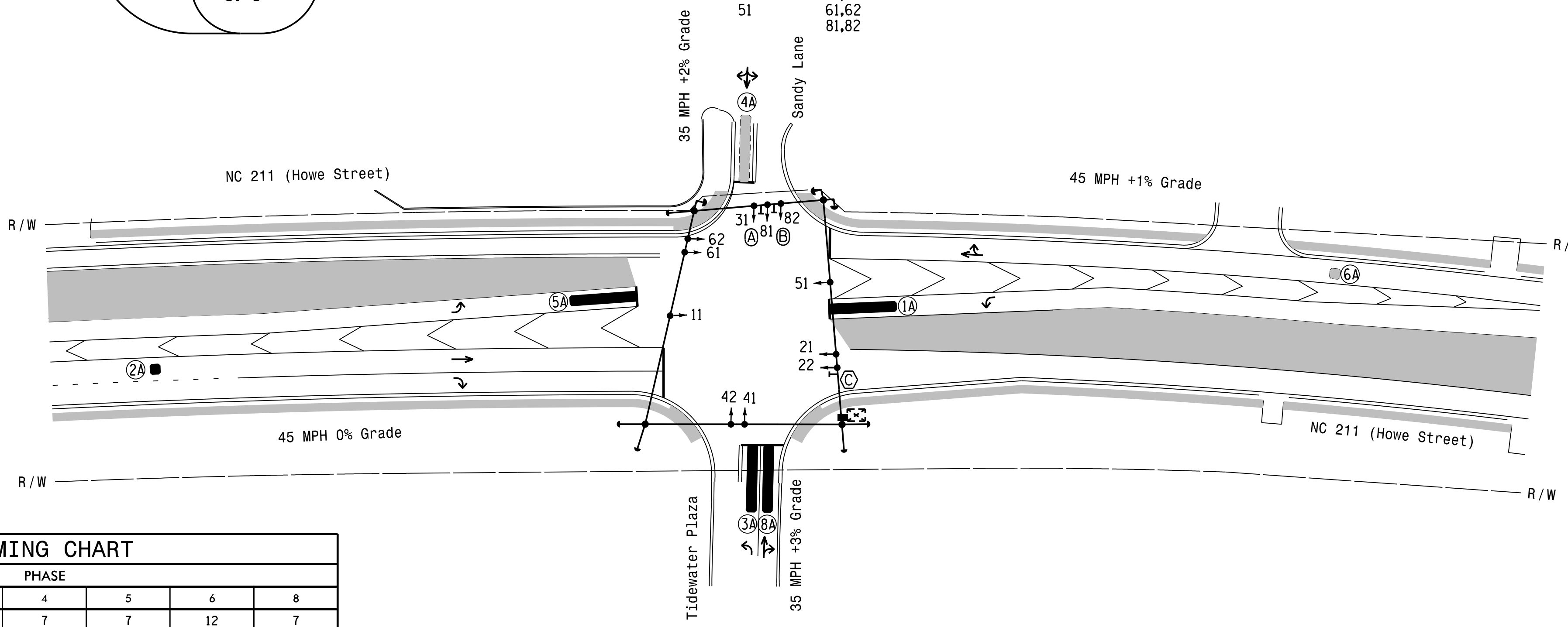
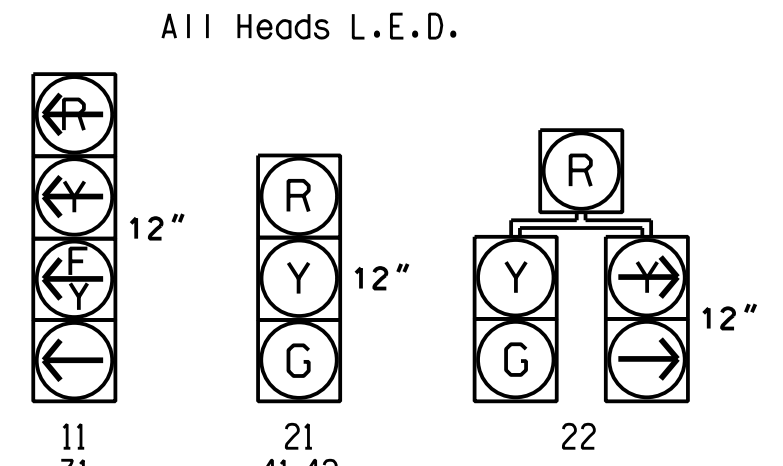

OASIS 2070 TIMING CHART

FEATURE	PHASE							
	1	2	3	4	5	6	7	8
Min Green 1 *	7	12	7	7	7	12	7	7
Extension 1 *	2.0	6.0	2.0	2.0	2.0	6.0	2.0	2.0
Max Green 1 *	20	90	20	25	20	90	25	25
Yellow Clearance	3.0	4.5	3.0	3.7	3.0	4.5	3.7	3.7
Red Clearance	2.6	1.4	3.5	2.8	2.9	1.4	2.8	2.8
Red Revert	2.0	2.0	2.0	2.0	2.0	2.0	2.0	2.0
Walk 1 *	-	-	-	-	-	-	-	-
Don't Walk 1	-	-	-	-	-	-	-	-
Seconds Per Actuation *	-	2.5	-	-	-	2.5	-	-
Max Variable Initial *	-	34	-	-	-	34	-	-
Time Before Reduction *	-	15	-	-	-	15	-	-
Time To Reduce *	-	30	-	-	-	30	-	-
Minimum Gap	-	3.0	-	-	-	3.0	-	-
Recall Mode	-	MIN RECALL	-	-	-	MIN RECALL	-	-
Vehicle Call Memory	-	YELLOW	-	-	-	YELLOW	-	-
Dual Entry	-	-	-	ON	-	-	-	ON
Simultaneous Gap	ON	ON	ON	ON	ON	ON	ON	ON

* These values may be field adjusted. Do not adjust Min Green and Extension times for phases 2 and 6 lower than what is shown. Min Green for all other phases should not be lower than 4 seconds.

6 Phase Fully Actuated (NC 133 Closed Loop System)

- NOTES**
- Refer to "Roadway Standard Drawings NCDOT" dated January 2018 and "Standard Specifications for Roads and Structures" dated January 2018.
 - Do not program signal for late night flashing operation unless otherwise directed by the Engineer.
 - Phase 1 and/or phase 5 may be lagged.
 - Omit Phase 3 during Phase 4 on.
 - Reposition existing signal heads numbered 11,21,22,and 51.
 - Set all detector units to presence mode.
 - The Division Traffic Engineer will determine the hours of use for each phasing plan.
 - Incorporate Microwave Detection system for vehicle detection.
 - Provide the Engineer with the Manufacturer's approved Microwave Detection locations and mounting heights to obtain detection zones as shown.
 - Maximum times shown in timing chart are for free-run operation only. Coordinated signal system timing values supersede these values.
 - Closed loop system data: Controller Asset #: 0897.

LEGEND

PROPOSED	EXISTING
○→ Traffic Signal Head	●→ Traffic Signal Head
○→ Modified Signal Head	○→ Modified Signal Head
⊥ Sign	⊥ Sign
⊥ Pedestrian Signal Head With Push Button & Sign	⊥ Pedestrian Signal Head With Push Button & Sign
○→ Signal Pole with Guy	○→ Signal Pole with Guy
⊥ Signal Pole with Sidewalk Guy	⊥ Signal Pole with Sidewalk Guy
⊠ Controller & Cabinet	⊠ Controller & Cabinet
⊠ Junction Box	⊠ Junction Box
--- 2-in Underground Conduit	--- 2-in Underground Conduit
N/A Right of Way	N/A Right of Way
→ Directional Arrow	→ Directional Arrow
▬ Microwave Detection Zone	▬ Microwave Detection Zone
Construction Zone	Construction Zone
(A) Left Arrow "ONLY" Sign (R3-5L)	(A) Left Arrow "ONLY" Sign (R3-5L)
(B) Combined Through and Right Arrow Sign (R3-6R)	(B) Combined Through and Right Arrow Sign (R3-6R)
(C) Right Arrow "ONLY" Sign (R3-5R)	(C) Right Arrow "ONLY" Sign (R3-5R)

Signal Upgrade
 Temporary Design 3
 Construction Phase 3

DOCUMENT NOT CONSIDERED FINAL UNLESS ALL SIGNATURES COMPLETED

	Prepared for: TRANSPORTATION MOBILITY AND SAFETY DIVISION NORTH CAROLINA DEPARTMENT OF TRANSPORTATION SIGNAL DESIGN SECTION		NC 211 (Howe Street) at Tidewater Plaza/Sandy Lane	SEAL
	750 N. Greenfield Pkwy, Garner, NC 27529			
SCALE 0 50 1"=50'		REVISIONS INIT. DATE SIGNATURE DATE 9/10/2021 SIG. INVENTORY NO. 03-0897T3		

HNTB
 HNTB NORTH CAROLINA, P.C.
 343 E. Six Forks Road, Suite 200
 Raleigh, North Carolina 27609
 NC License No: C-1554
 (919) 546-8997

EDI MODEL 2018ECL-NC CONFLICT MONITOR PROGRAMMING DETAIL

(remove jumpers and set switches as shown)

REMOVE DIODE JUMPERS 1-5, 1-6, 1-9, 1-11, 2-5, 2-6, 2-9, 2-11, 3-8, 3-10, 4-8, 4-10, 5-9, 5-11, 6-9, 6-11, 8-10 and 9-11.

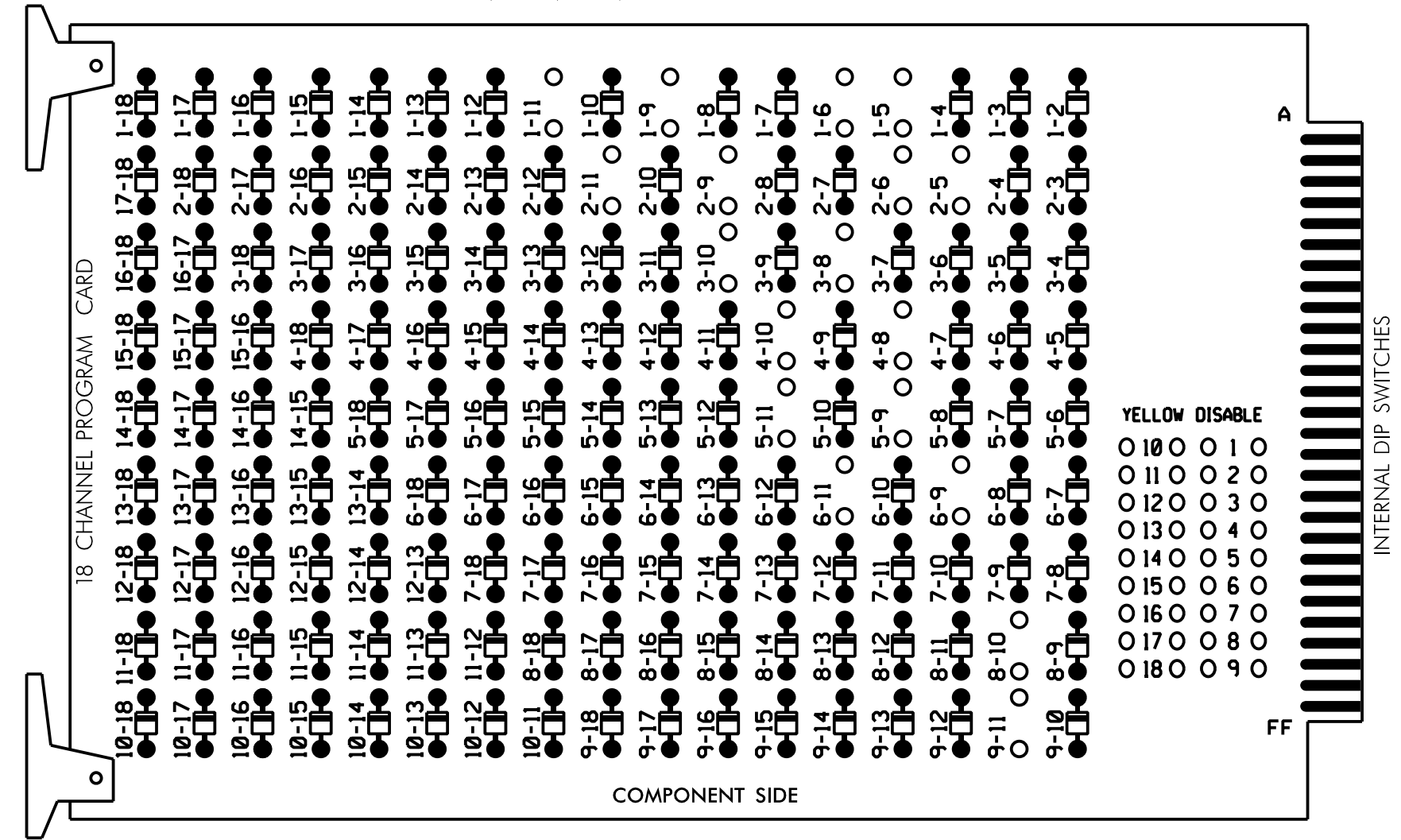

REMOVE JUMPERS AS SHOWN

NOTES:

- Card is provided with all diode jumpers in place. Removal of any jumper allows its channels to run concurrently.
- Ensure jumpers SEL2-SEL5 and SEL9 are present on the monitor board.
- Ensure that Red Enable is active at all times during normal operation.
- Connect serial cable from conflict monitor to comm. port 1 of 2070 controller. Ensure conflict monitor communicates with 2070.

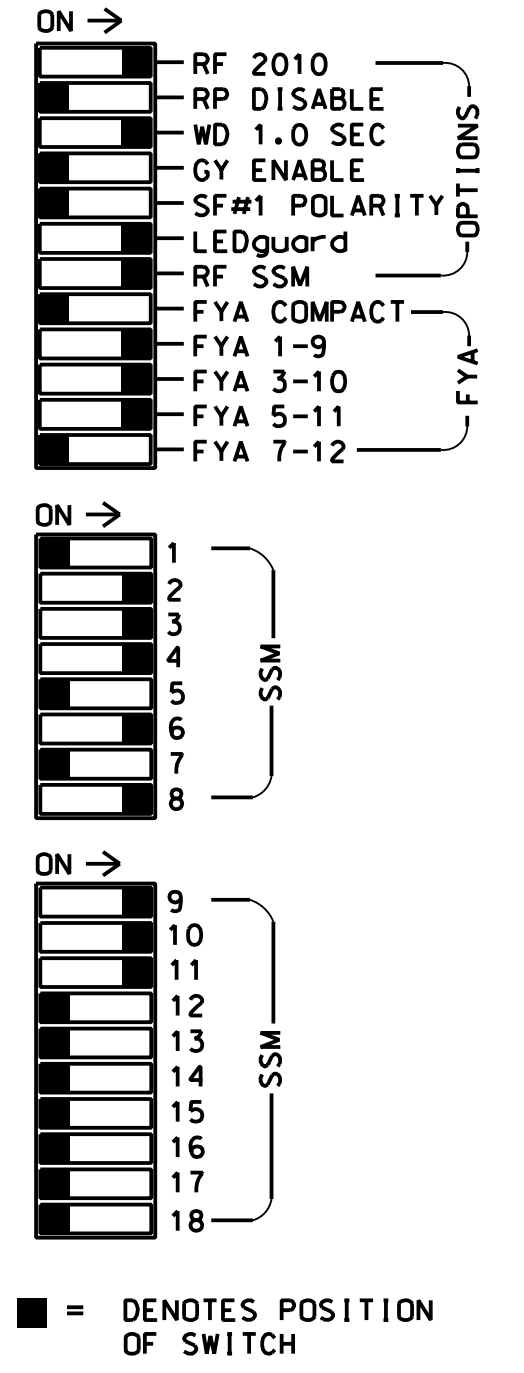

NOTES

- To prevent "flash-conflict" problems, insert red flash program blocks for all unused vehicle load switches in the output file. The installer shall verify that signal heads flash in accordance with the Signal Plans.
- Program phases 4 and 8 for Dual Entry.
- Enable Simultaneous Gap-Out for all Phases.
- Program phases 2 and 6 for Variable Initial and Gap Reduction.
- Program phases 2 and 6 for Startup In Green.
- Program phases 2 and 6 for Yellow Flash, and overlaps 1 and 2 as Wag Overlaps.
- If this signal will be managed by an ATMS software, enable controller and detector logging for all detectors used at this location.
- The cabinet and controller are part of the NC 133 Closed Loop System.

EQUIPMENT INFORMATION

CONTROLLER.....2070E
 CABINET.....332 W/AUX
 SOFTWARE.....ECONOLITE OASIS
 CABINET MOUNT.....BASE
 OUTPUT FILE POSITIONS...18 WITH AUX. OUTPUT FILE
 LOAD SWITCHES USED.....S1,S2,S4,S5,S7,S8,S11,
 AUX S1,AUX S2,AUX S4
 PHASES USED.....1,2,3,4,5,6,8
 OVERLAP "A".....1+2
 OVERLAP "B".....3+4
 OVERLAP "C".....5+6
 OVERLAP "D".....NOT USED

SIGNAL HEAD HOOK-UP CHART

LOAD SWITCH NO.	S1	S2	S3	S4	S5	S6	S7	S8	S9	S10	S11	S12	AUX S1	AUX S2	AUX S3	AUX S4	AUX S5	AUX S6
CMU CHANNEL NO.	1	2	13	3	4	14	5	6	15	7	8	16	9	10	17	11	12	18
PHASE	1	2	2 PED	3	4	4 PED	5	6	6 PED	7	8	8 PED	OLA	OLB	SPARE	OLC	OLD	SPARE
SIGNAL HEAD NO.	11	21,22	NU	22	31	41,42	NU	51	61,62	NU	NU	81,82	NU	11	31	NU	51	NU
RED		128		*	101				134			107						
YELLOW	*	129			102		*	135			108							
GREEN		130			103			136			109							
RED ARROW													A121	A124		A114		
YELLOW ARROW				117									A122	A125		A115		
FLASHING YELLOW ARROW													A123	A126		A116		
GREEN ARROW	127			118	118			133										

NU = Not Used

* Denotes install load resistor. See load resistor installation detail this sheet.
 * See pictorial of head wiring in detail this sheet.

INPUT FILE POSITION LAYOUT

(front view)

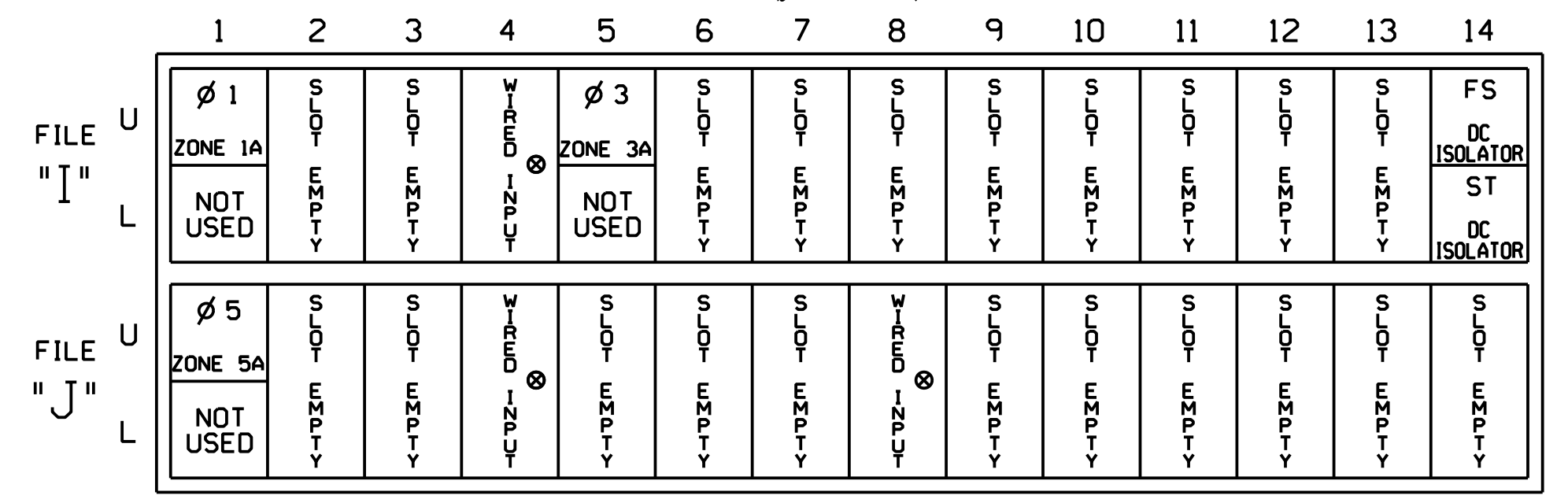

INPUT FILE CONNECTION & PROGRAMMING CHART

LOOP NO.	LOOP TERMINAL	INPUT FILE POS.	PIN NO.	INPUT ASSIGNMENT NO.	DETECTOR NO.	NEMA PHASE	CALL	EXTEND	FULL TIME DELAY	STRETCH TIME	DELAY TIME
ZONE 1A ¹	**	I1U	56	18	1	1	Y	Y			15
	-	J4U	48	10*	26	6	Y	Y			3
	-	I1U	56	18*	51	1	Y	Y			3
ZONE 3A ²	**	I5U	58	20	3	3	Y	Y			15
	-	J8U	50	12	28	8	Y	Y			3
ZONE 5A ³	**	J1U	55	17	5	5	Y	Y			15
	-	I4U	47	9*	22	2	Y	Y			3

- Add jumper from I1-W to J4-W, on rear of input file.
- Add jumper from I5-W to J8-W, on rear of input file.
- Add jumper from J1-W to I4-W, on rear of input file.

* See vehicle detector setup programming detail for alternate phasing on sheets 3 and 4.

** Multizone Microwave Detector Zone. See Special Detector Note.

INPUT FILE POSITION LEGEND: J2L

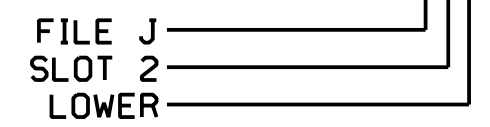

SPECIAL DETECTOR NOTE

Install a microwave detection system for vehicle detection. Perform installation according to manufacturer's directions and NCDOT engineer-approved mounting locations to accomplish the detection schemes shown on the Signal Design Plans.

For loops 1A, 3A, and 5A, detector card placement and slots reserved for wired inputs are typical for a NCDOT installation. Inputs associated with these slots are compatible with time of day instructions located on sheets 3, 4, and 5 of this electrical detail.

LOAD RESISTOR INSTALLATION DETAIL

(install resistors as shown)

VALUE (ohms)	WATTAGE
1.5K - 1.9K	25W (min)
2.0K - 3.0K	10W (min)

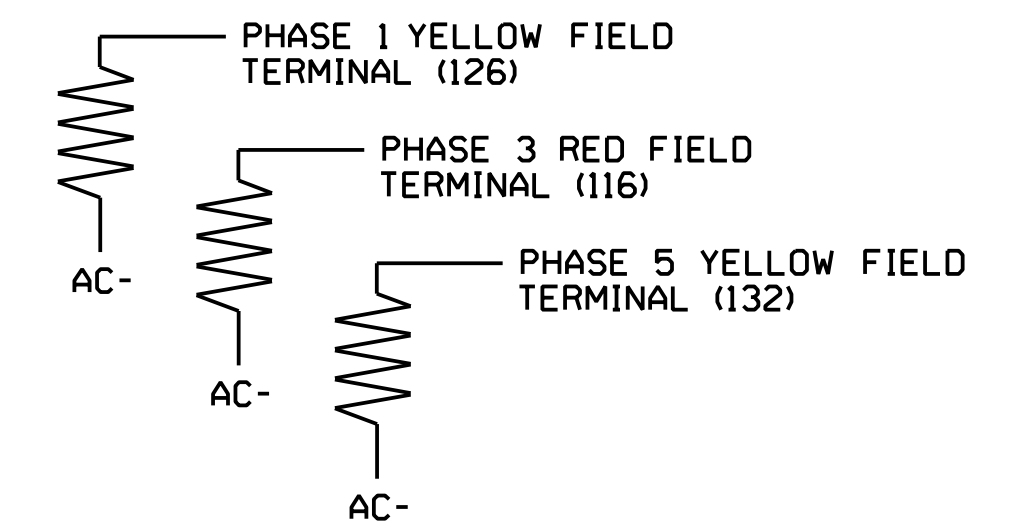

FYA SIGNAL WIRING DETAIL

(wire signal heads as shown)

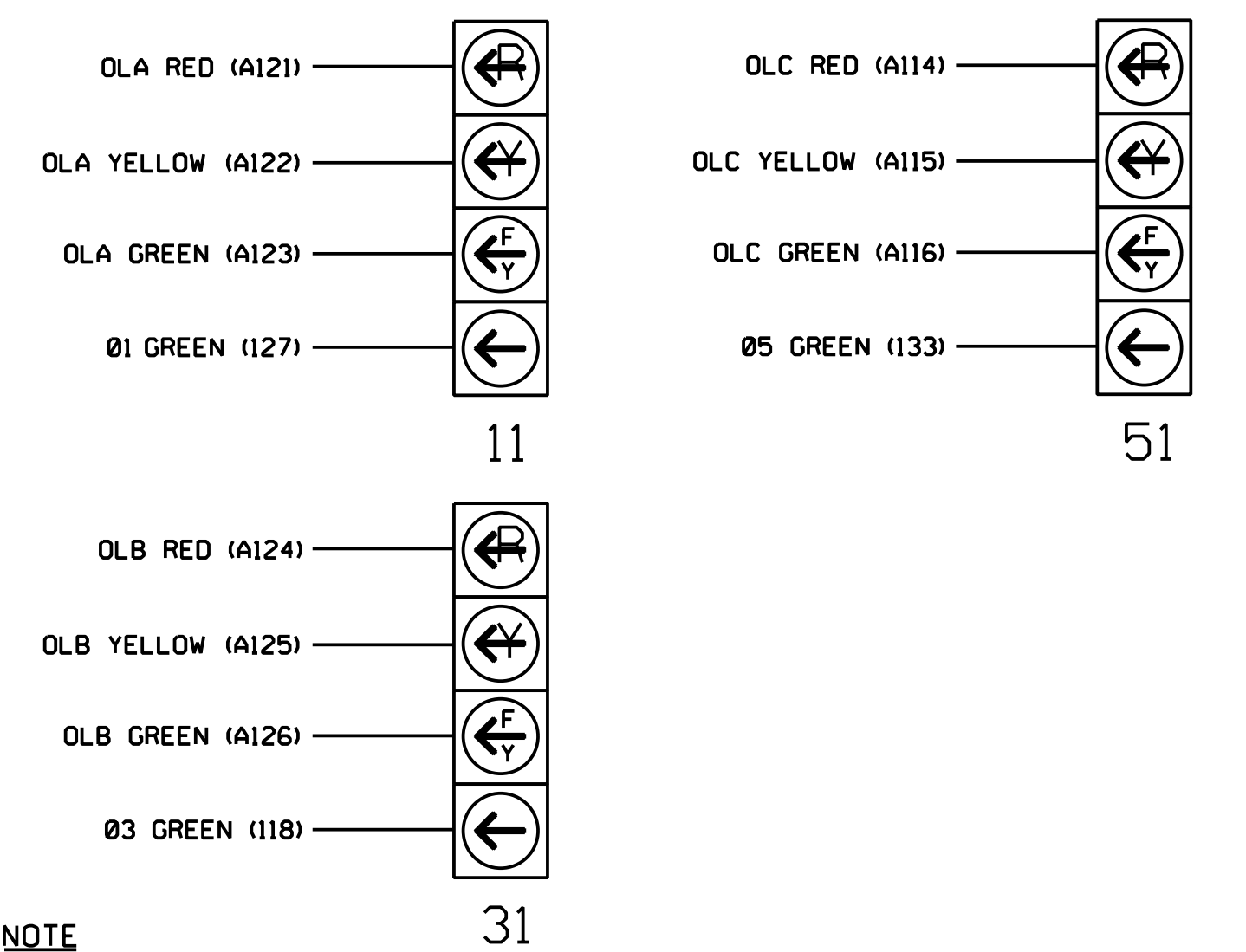

NOTE

The sequence display for signal heads 11, 31 and 51 requires special logic programming. See sheet 2 for programming instructions.

THIS ELECTRICAL DETAIL IS FOR THE SIGNAL DESIGN: 03-0897T3
 DESIGNED: June 2017
 SEALED: 9/10/2021
 REVISED: N/A

Electrical Detail - Sheet 1 of 5
 Signal Upgrade
 Temporary Design 3

DOCUMENT NOT CONSIDERED FINAL UNLESS ALL SIGNATURES COMPLETED

ELECTRICAL AND PROGRAMMING DETAILS FOR: 	NC 211 (Howe Street) at Tidewater Plaza/Sandy Lane		SEAL
	Prepared for: Division 03 Brunswick Co. Southport	PLAN DATE: June 2017 PREPARED BY: A.H. Thornburg	
Revisions table with columns: REVISIONS, INITI., DATE	Signature line for Natasha R. Simmons, dated 9/10/2021	Signature line for A.D. Klinsky, dated 9/10/2021	Inventory No. 03-0897T3

LOGICAL I/O PROCESSOR PROGRAMMING DETAIL TO PRODUCE SPECIAL FYA-PPLT SIGNAL SEQUENCE

(program controller as shown below)

- FROM MAIN MENU PRESS '2' (PHASE CONTROL), THEN '1' (PHASE CONTROL FUNCTIONS). SCROLL TO THE BOTTOM OF THE MENU AND ENABLE ACT LOGIC COMMANDS 1, 2, 3, 4, 5, 6, 7, 8, AND 9.
- FROM MAIN MENU PRESS '6' (OUTPUTS), THEN '3' (LOGICAL I/O PROCESSOR).

LOGICAL I/O COMMAND #1 (+/-COMMAND#)
IF ACTIVE PHASE #1 IS ON
AND RED CLEAR ON PHASE #1 IS ON

SCROLL DOWN

THEN:
SET OUTPUT ASSIGNMENT #50 ON
SET OUTPUT ASSIGNMENT #51 OFF

PRESS '+'

NOTE: LOGIC FOR PHASE 1 RED CLEAR WHEN TRANSITIONING FROM PHASE 1 TO PHASE 2 (HEAD 11).

LOGICAL I/O COMMAND #2 (+/-COMMAND#)
IF ACTIVE PHASE #1 IS ON

SCROLL DOWN

THEN:
SET OUTPUT ASSIGNMENT #52 OFF

PRESS '+'

NOTE: LOGIC FOR SWITCHING FLASHING YELLOW ARROW "OFF" DURING PHASE 1 (HEAD 11).

LOGICAL I/O COMMAND #3 (+/-COMMAND#)
IF YELLOW ON PHASE #1 IS ON

SCROLL DOWN

THEN:
SET OUTPUT ASSIGNMENT #51 ON

PRESS '+'

NOTE: LOGIC FOR YELLOW ARROW CLEARANCE FROM PHASE 1 (HEAD 11).

LOGICAL I/O COMMAND #4 (+/-COMMAND#)
IF ACTIVE PHASE #5 IS ON
AND RED CLEAR ON PHASE #5 IS ON

SCROLL DOWN

THEN:
SET OUTPUT ASSIGNMENT #42 ON
SET OUTPUT ASSIGNMENT #43 OFF

PRESS '+'

NOTE: LOGIC FOR PHASE 5 RED CLEAR WHEN TRANSITIONING FROM PHASE 5 TO PHASE 6 (HEAD 51).

LOGICAL I/O COMMAND #5 (+/-COMMAND#)
IF ACTIVE PHASE #5 IS ON

SCROLL DOWN

THEN:
SET OUTPUT ASSIGNMENT #44 OFF

PRESS '+'

NOTE: LOGIC FOR SWITCHING FLASHING YELLOW ARROW "OFF" DURING PHASE 5 (HEAD 51).

LOGICAL I/O COMMAND #6 (+/-COMMAND#)
IF YELLOW ON PHASE #5 IS ON

SCROLL DOWN

THEN:
SET OUTPUT ASSIGNMENT #43 ON

PRESS '+'

NOTE: LOGIC FOR YELLOW ARROW CLEARANCE FROM PHASE 5 (HEAD 51).

LOGICAL I/O COMMAND #7 (+/-COMMAND#)
IF ACTIVE PHASE #3 IS ON
AND RED CLEAR ON PHASE #3 IS ON

SCROLL DOWN

THEN:
SET OUTPUT ASSIGNMENT #47 ON
SET OUTPUT ASSIGNMENT #48 OFF

PRESS '+'

NOTE: LOGIC FOR PHASE 3 RED CLEAR WHEN TRANSITIONING FROM PHASE 3 TO PHASE 4 (HEAD 31).

LOGICAL I/O COMMAND #8 (+/-COMMAND#)
IF ACTIVE PHASE #3 IS ON

SCROLL DOWN

THEN:
SET OUTPUT ASSIGNMENT #49 OFF

PRESS '+'

NOTE: LOGIC FOR SWITCHING FLASHING YELLOW ARROW "OFF" DURING PHASE 3 (HEAD 31).

LOGICAL I/O COMMAND #9 (+/-COMMAND#)
IF YELLOW ON PHASE #3 IS ON

SCROLL DOWN

THEN:
SET OUTPUT ASSIGNMENT #48 ON

PRESS '+'

NOTE: LOGIC FOR YELLOW ARROW CLEARANCE FROM PHASE 3 (HEAD 31).

LOGIC I/O PROCESSOR PROGRAMMING COMPLETE

OUTPUT REFERENCE SCHEDULE	
USE TO INTERPRET LOGIC PROCESSOR	
OUTPUT 42 =	Overlap C Red
OUTPUT 43 =	Overlap C Yellow
OUTPUT 44 =	Overlap C Green
OUTPUT 47 =	Overlap B Red
OUTPUT 48 =	Overlap B Yellow
OUTPUT 49 =	Overlap B Green
OUTPUT 50 =	Overlap A Red
OUTPUT 51 =	Overlap A Yellow
OUTPUT 52 =	Overlap A Green

THIS ELECTRICAL DETAIL IS FOR THE SIGNAL DESIGN: 03-0897T3
DESIGNED: June 2017
SEALED: 9/10/2021
REVISED: N/A

OVERLAP PROGRAMMING DETAIL FOR DEFAULT PHASING

(program controller as shown below)

FROM MAIN MENU PRESS '8' (OVERLAPS), THEN '1' (VEHICLE OVERLAP SETTINGS).

PAGE 1: VEHICLE OVERLAP 'A' SETTINGS
PHASE: :12345678910111213141516
VEH OVL PARENTS: :XX
VEH OVL NOT VEH: :
VEH OVL NOT PED: :
VEH OVL GRN EXT: :
STARTUP COLOR: - RED - YELLOW - GREEN
FLASH COLORS: - RED - YELLOW X GREEN
SELECT VEHICLE OVERLAP OPTIONS: (Y/N)
FLASH YELLOW IN CONTROLLER FLASH?...Y
GREEN EXTENSION (0-255 SEC)...0.0
YELLOW CLEAR (0=PARENT,3-25.5 SEC)...0.0
RED CLEAR (0=PARENT,0.1-25.5 SEC)...0.0
OUTPUT AS PHASE # (0=NONE, 1-16)...0.0

NOTICE GREEN FLASH

PAGE 1: VEHICLE OVERLAP 'C' SETTINGS
PHASE: :12345678910111213141516
VEH OVL PARENTS: : XX
VEH OVL NOT VEH: :
VEH OVL NOT PED: :
VEH OVL GRN EXT: :
STARTUP COLOR: - RED - YELLOW - GREEN
FLASH COLORS: - RED - YELLOW X GREEN
SELECT VEHICLE OVERLAP OPTIONS: (Y/N)
FLASH YELLOW IN CONTROLLER FLASH?...Y
GREEN EXTENSION (0-255 SEC)...0.0
YELLOW CLEAR (0=PARENT,3-25.5 SEC)...0.0
RED CLEAR (0=PARENT,0.1-25.5 SEC)...0.0
OUTPUT AS PHASE # (0=NONE, 1-16)...0.0

NOTICE GREEN FLASH

OVERLAP PROGRAMMING COMPLETE

PAGE 1: VEHICLE OVERLAP 'B' SETTINGS
PHASE: :12345678910111213141516
VEH OVL PARENTS: : XX
VEH OVL NOT VEH: :
VEH OVL NOT PED: :
VEH OVL GRN EXT: :
STARTUP COLOR: - RED - YELLOW - GREEN
FLASH COLORS: - RED - YELLOW X GREEN
SELECT VEHICLE OVERLAP OPTIONS: (Y/N)
FLASH YELLOW IN CONTROLLER FLASH?...N
GREEN EXTENSION (0-255 SEC)...0.0
YELLOW CLEAR (0=PARENT,3-25.5 SEC)...0.0
RED CLEAR (0=PARENT,0.1-25.5 SEC)...0.0
OUTPUT AS PHASE # (0=NONE, 1-16)...0.0

NOTICE GREEN FLASH

PRESS '+'

PRESS '+'

OVERLAP PROGRAMMING DETAIL FOR ALTERNATE PHASING

(program controller as shown below)

FROM MAIN MENU PRESS '8' (OVERLAPS), THEN '1' (VEHICLE OVERLAP SETTINGS). PRESS 'NEXT' TO ADVANCE TO PAGE 2.

PAGE 2: VEHICLE OVERLAP 'A' SETTINGS
PHASE: :12345678910111213141516
VEH OVL PARENTS: : X
VEH OVL NOT VEH: :
VEH OVL NOT PED: :
VEH OVL GRN EXT: :
STARTUP COLOR: - RED - YELLOW - GREEN
FLASH COLORS: - RED - YELLOW - GREEN
SELECT VEHICLE OVERLAP OPTIONS: (Y/N)
FLASH YELLOW IN CONTROLLER FLASH?...Y
GREEN EXTENSION (0-255 SEC)...0.0
YELLOW CLEAR (0=PARENT,3-25.5 SEC)...0.0
RED CLEAR (0=PARENT,0.1-25.5 SEC)...0.0
OUTPUT AS PHASE # (0=NONE, 1-16)...0.0

NOTICE PAGE 2

NOTICE PAGE 2

PAGE 2: VEHICLE OVERLAP 'B' SETTINGS
PHASE: :12345678910111213141516
VEH OVL PARENTS: : XX
VEH OVL NOT VEH: :
VEH OVL NOT PED: :
VEH OVL GRN EXT: :
STARTUP COLOR: - RED - YELLOW - GREEN
FLASH COLORS: - RED - YELLOW X GREEN
SELECT VEHICLE OVERLAP OPTIONS: (Y/N)
FLASH YELLOW IN CONTROLLER FLASH?...N
GREEN EXTENSION (0-255 SEC)...0.0
YELLOW CLEAR (0=PARENT,3-25.5 SEC)...0.0
RED CLEAR (0=PARENT,0.1-25.5 SEC)...0.0
OUTPUT AS PHASE # (0=NONE, 1-16)...0.0

NOTICE GREEN FLASH

PRESS '+'

PRESS '+'

PAGE 2: VEHICLE OVERLAP 'C' SETTINGS
PHASE: :12345678910111213141516
VEH OVL PARENTS: : X
VEH OVL NOT VEH: :
VEH OVL NOT PED: :
VEH OVL GRN EXT: :
STARTUP COLOR: - RED - YELLOW - GREEN
FLASH COLORS: - RED - YELLOW - GREEN
SELECT VEHICLE OVERLAP OPTIONS: (Y/N)
FLASH YELLOW IN CONTROLLER FLASH?...Y
GREEN EXTENSION (0-255 SEC)...0.0
YELLOW CLEAR (0=PARENT,3-25.5 SEC)...0.0
RED CLEAR (0=PARENT,0.1-25.5 SEC)...0.0
OUTPUT AS PHASE # (0=NONE, 1-16)...0.0

OVERLAP PROGRAMMING COMPLETE

Electrical Detail - Sheet 2 of 5
Signal Upgrade
Temporary Design 3

DOCUMENT NOT CONSIDERED FINAL UNLESS ALL SIGNATURES COMPLETED

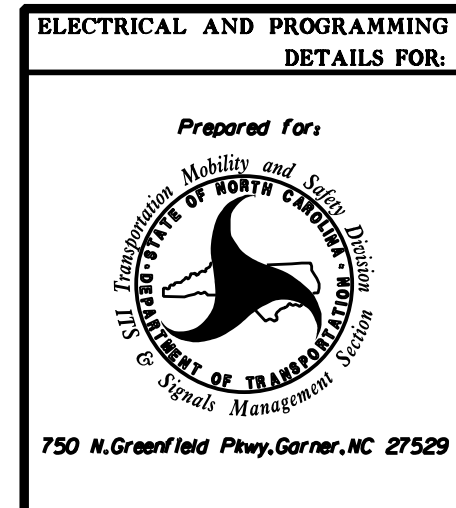

Prepared for:	
Department of Transportation and Safety Division	
Division 03 Brunswick Co. Southport	
PLAN DATE: June 2017	REVIEWED BY: A.D. Klinskiak
PREPARED BY: A.H. Thornburg	REVIEWED BY: N.R. Simmons
REVISIONS	INIT. DATE

SEAL	
NORTH CAROLINA PROFESSIONAL ENGINEER SEAL 031464	
NATASHA R. SIMMONS	
DocuSigned by: Natasha Simmons	
	9/10/2021
SIGNATURE	DATE

HNTB HNTB NORTH CAROLINA, P.C.
343 E. Six Forks Road, Suite 200
Raleigh, North Carolina 27609
NC License No. C-1554
(919) 546-8997

INPUT PAGE 2 ASSIGNMENT PROGRAMMING DETAIL FOR ALTERNATE PHASING - LOOP 1A
(program controller as shown below)

- NOTES: 1. THIS PROGRAMMING APPLIES FOR INPUT PAGE 2 ONLY. INPUT PAGE 1 WILL USE STANDARD DEFAULT SETTINGS. THIS PROGRAMMING IS NECESSARY FOR PROPER DETECTOR OPERATION DURING ALTERNATE PHASING OPERATION.
- 2. THE FIRST TASK THIS PROGRAMMING ACCOMPLISHES IS THE DISABLING OF INPUT #10 (DETECTOR 26) SO THAT A VEHICLE CALL WILL NOT BE PLACED TO PHASE 6 DURING ALTERNATE PHASING OPERATION. THE SECOND TASK THIS PROGRAMMING ACCOMPLISHES IS THAT IT REASSIGNS DETECTOR 51 TO INPUT #18 SO THAT THE DELAY ON LOOP 1A CAN BE REDUCED FROM 15 SECONDS TO 3 SECONDS.

FROM MAIN MENU PRESS '5' (INPUTS). THEN PRESS 'NEXT' TO GET TO INPUT PAGE '2'. PRESS THE '+' KEY UNTIL INPUT 10 IS REACHED.

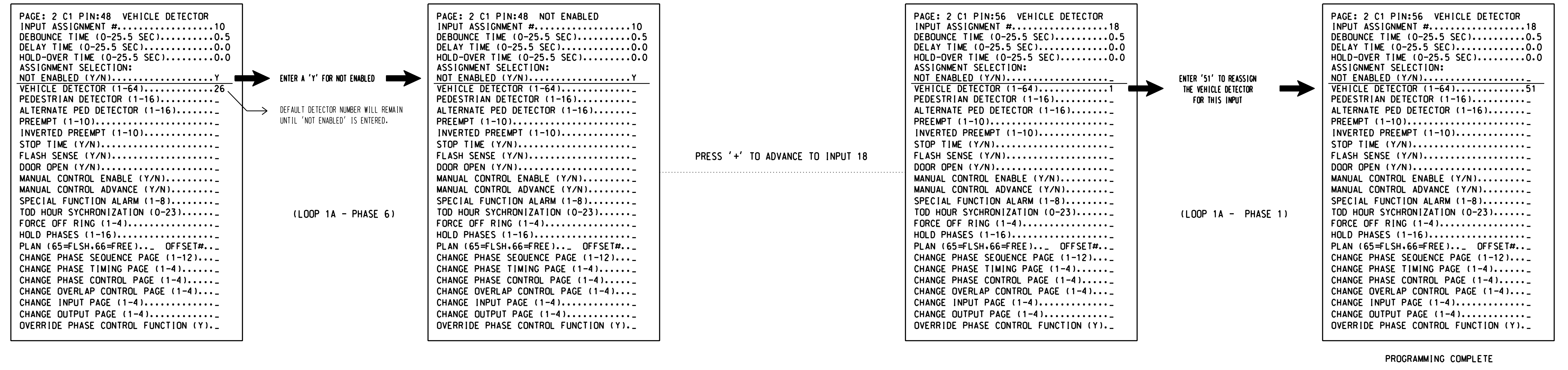

SPECIAL DETECTOR PROGRAMMING DETAIL - LOOP 1A (ALT.)

(program controller as shown below)

FROM MAIN MENU PRESS '7' (DETECTORS). THEN PRESS '1' FOR VEHICLE DETECTORS. PRESS THE '-' KEY TO GET TO VEHICLE DETECTOR #51.

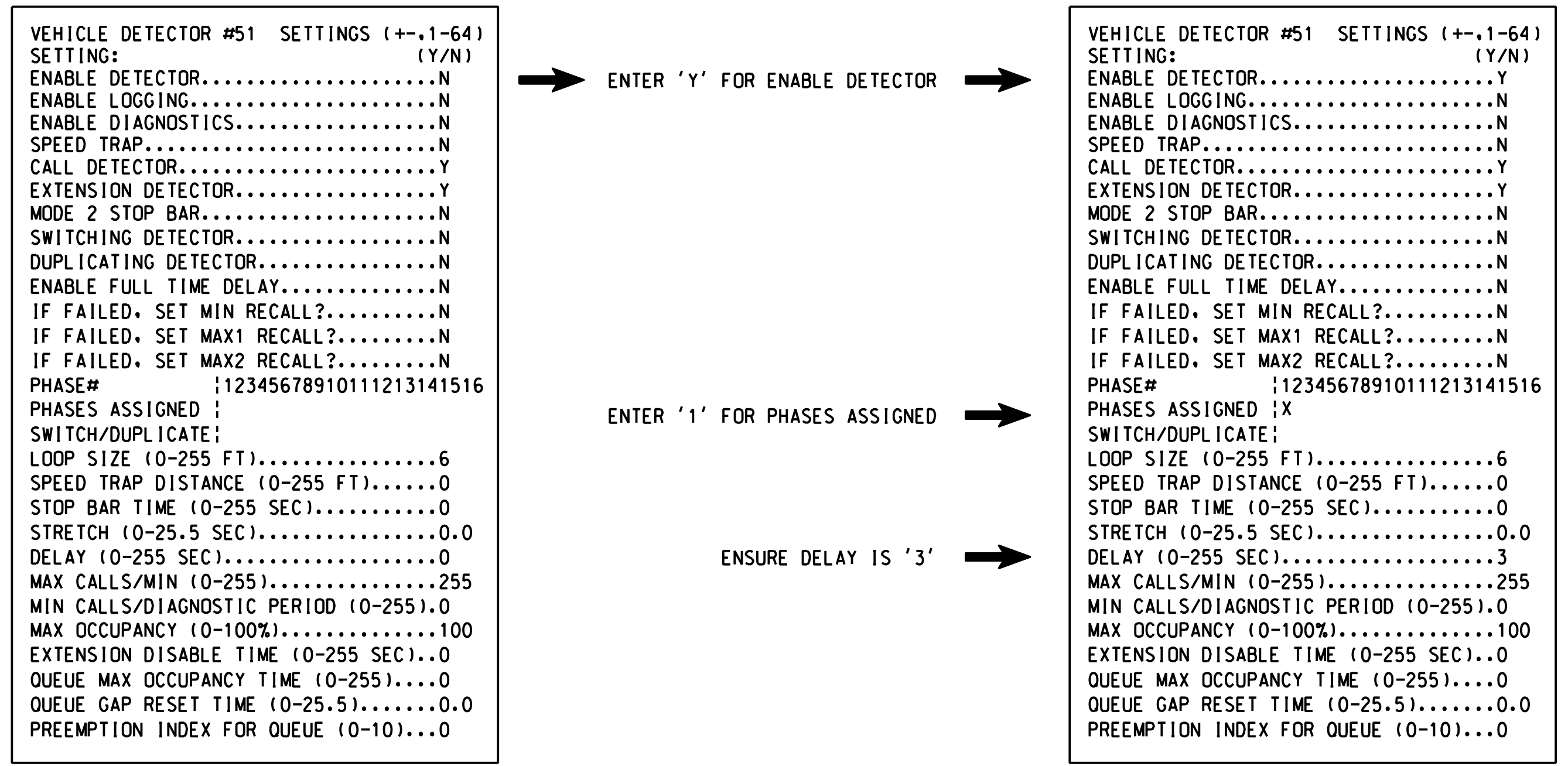

NOTE: DETECTOR IS PROGRAMMED PER THE INPUT FILE CONNECTION AND PROGRAMMING CHART SHOWN ON SHEET 1.

THIS ELECTRICAL DETAIL IS FOR THE SIGNAL DESIGN: 03-0897T3
DESIGNED: June 2017
SEALED: 9/10/2021
REVISED: N/A

Electrical Detail - Sheet 3 of 5
Signal Upgrade
Temporary Design 3

DOCUMENT NOT CONSIDERED FINAL UNLESS ALL SIGNATURES COMPLETED

NC 211 (Howe Street) at Tidewater Plaza/Sandy Lane

Division 03 Brunswick Co. Southport

PLAN DATE: June 2017 REVIEWED BY: A.D. Klinksiek

PREPARED BY: A.H. Thornburg REVIEWED BY: N.R. Simmons

Signature: Natasha Simmons, 9/10/2021

SIG. INVENTORY NO. 03-0897T3

INPUT PAGE 2 ASSIGNMENT PROGRAMMING DETAIL FOR ALTERNATE PHASING - LOOP 5A

(program controller as shown below)

- NOTES: 1. THIS PROGRAMMING APPLIES FOR INPUT PAGE 2 ONLY. INPUT PAGE 1 WILL USE STANDARD DEFAULT SETTINGS. THIS PROGRAMMING IS NECESSARY FOR PROPER DETECTOR OPERATION DURING ALTERNATE PHASING OPERATION.
2. THE FIRST TASK THIS PROGRAMMING ACCOMPLISHES IS THE DISABLING OF INPUT #9 (DETECTOR 22) SO THAT A VEHICLE CALL WILL NOT BE PLACED TO PHASE 2 DURING ALTERNATE PHASING OPERATION. THE SECOND TASK THIS PROGRAMMING ACCOMPLISHES IS THAT IT REASSIGNS DETECTOR 55 TO INPUT #17 SO THAT THE DELAY ON LOOP 5A CAN BE REDUCED FROM 15 SECONDS TO 3 SECONDS.

FROM MAIN MENU PRESS '5' (INPUTS), THEN PRESS 'NEXT' TO GET TO INPUT PAGE '2'. PRESS THE '+' KEY UNTIL INPUT 9 IS REACHED.

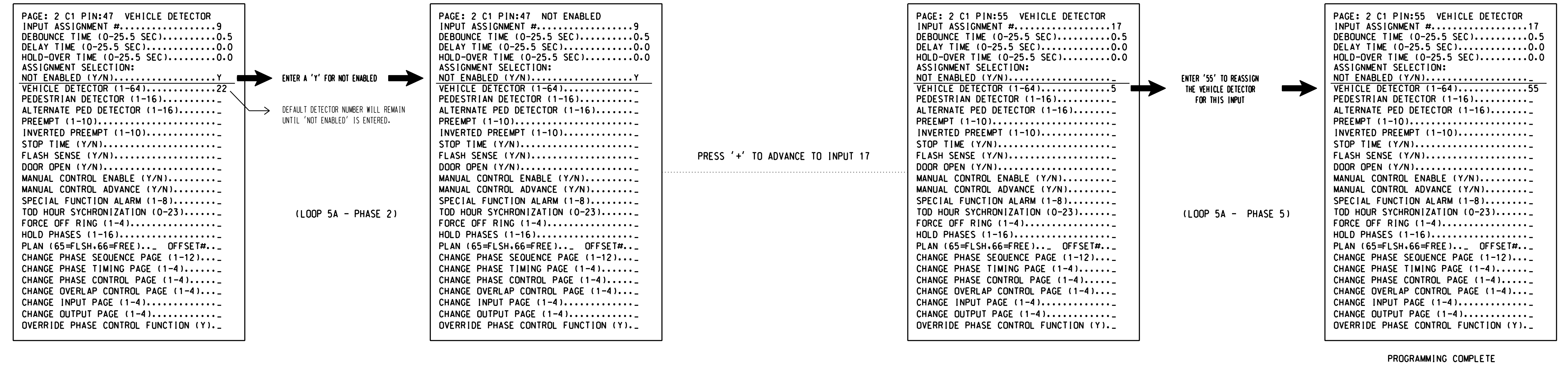

PROGRAMMING COMPLETE

SPECIAL DETECTOR PROGRAMMING DETAIL - LOOP 5A (ALT.)

(program controller as shown below)

FROM MAIN MENU PRESS '7' (DETECTORS), THEN PRESS '1' FOR VEHICLE DETECTORS. PRESS THE '-' KEY TO GET TO VEHICLE DETECTOR #55.

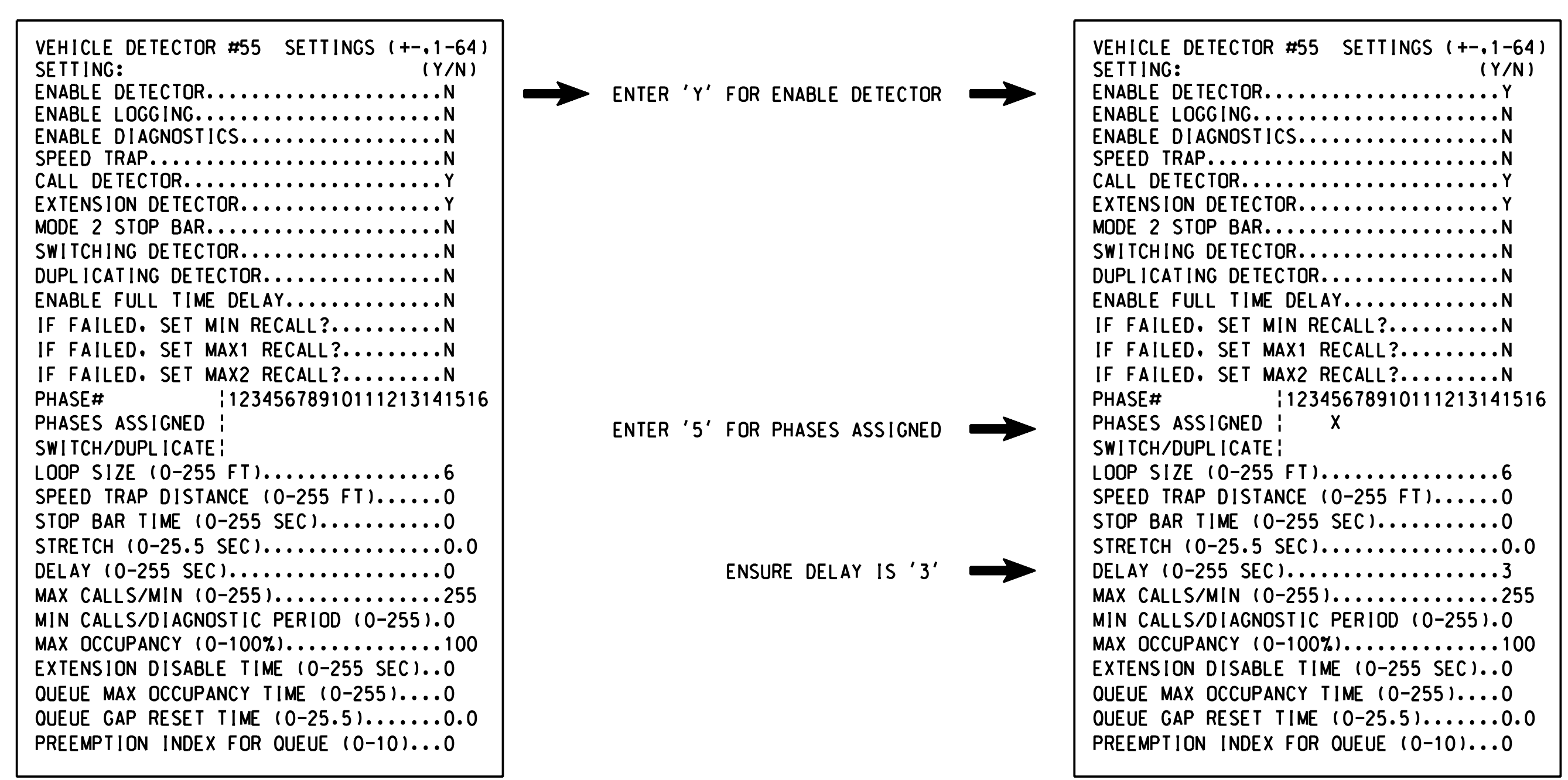

DETECTOR PROGRAMMING COMPLETE

NOTE: DETECTOR IS PROGRAMMED PER THE INPUT FILE CONNECTION AND PROGRAMMING CHART SHOWN ON SHEET 1.

THIS ELECTRICAL DETAIL IS FOR THE SIGNAL DESIGN: 03-0897T3
DESIGNED: June 2017
SEALED: 9/10/2021
REVISED: N/A

Electrical Detail - Sheet 4 of 5
Signal Upgrade
Temporary Design 3

DOCUMENT NOT CONSIDERED FINAL UNLESS ALL SIGNATURES COMPLETED

	Prepared for: Department of Transportation, Signal Management		NC 211 (Howe Street) at Tidewater Plaza/Sandy Lane		
	PLAN DATE: June 2017	REVIEWED BY: A.D. Klinksiek	Division 03 Brunswick Co. Southport	REVIEWED BY: N.R. Simmons	
PREPARED BY: A.H. Thornburg		REVIEWED BY: N.R. Simmons		DocuSigned by: Natasha Simmons 9/10/2021	
REVISIONS		INIT.	DATE	SIGNATURE DATE	
_____		_____	_____	_____	
_____		_____	_____	_____	
_____		_____	_____	_____	

ALTERNATE PHASING ACTIVATION DETAIL

TO RUN ALT. PHASING DURING COORDINATION - SELECT ALL PAGE CHANGES (AS SHOWN BELOW) WITHIN COORDINATION PLAN PROGRAMMING.

TO RUN ALT. PHASING DURING FREE RUN - PROGRAM PAGE CHANGES (SHOWN BELOW) IN SEPARATE TIME OF DAY EVENTS. IF PAGE 1 IS USED, NO EVENT PROGRAMMING IS NECESSARY FOR THAT PARTICULAR PAGE.

<u>PHASING</u>	<u>INPUTS PAGE</u>	<u>OVERLAPS PAGE</u>
ACTIVE PAGES REQUIRED TO RUN <u>DEFAULT PHASING</u>	1	1
ACTIVE PAGES REQUIRED TO RUN <u>ALTERNATE PHASING</u>	2	2

NOTE: PAGES NOT SHOWN (i.e. sequence, phase control, etc.) SHOULD REMAIN AS '1', OR AS DEFINED BY TIMING ENGINEER.

IMPORTANT: IF ALT. PHASING IS USED DURING FREE RUN AND COORDINATION, DO NOT OPERATE TIME OF DAY PAGE CHANGE EVENTS CONCURRENTLY WITH COORDINATION PLAN EVENTS IN THE EVENT SCHEDULER. (EX. FREE RUN PAGE CHANGE EVENT SHOULD END BEFORE COORDINATION PLAN EVENT STARTS AND VICE-VERSA).

ALTERNATE PHASING PAGE CHANGE SUMMARY

THE FOLLOWING IS A SUMMARY OF WHAT TAKES PLACE WHEN THESE OVERLAP/INPUT PAGE CHANGES ACTIVATE TO CALL THE "ALTERNATE PHASING":

OVERLAPS PAGE 2: Modifies overlap parent phases for heads 11 and 51 to run protected turns only.

INPUTS PAGE 2: Disables phase 6 call on loop 1A and reduces delay time for phase 1 call on loop 1A to 3 seconds.

Disables phase 2 call on loop 5A and reduces delay time for phase 5 call on loop 5A to 3 seconds.

FLASHER CIRCUIT MODIFICATION DETAIL

IN ORDER TO INSURE THAT SIGNALS FLASH CONCURRENTLY ON THE SAME APPROACH, MAKE THE FOLLOWING FLASHER CIRCUIT CHANGES:

1. ON REAR OF PDA - REMOVE WIRE FROM TERM. T2-4 AND TERMINATE ON T2-2.
2. ON REAR OF PDA - REMOVE WIRE FROM TERM. T2-5 AND TERMINATE ON T2-3.
3. REMOVE FLASHER UNIT 2.

THE CHANGES LISTED ABOVE TIES ALL PHASES AND OVERLAPS TO FLASHER UNIT 1.

DYNAMIC BACK-UP CONTROL PROGRAMMING

(program controller as shown below)

1. From Main Menu press '2' (Phase Control), then '1' (Phase Control Functions). Scroll to the bottom of the menu and enable Dynamic/Backup Control Function 1.
2. From Phase Control Functions Menu press '2' (Dynamic/Backup Control Functions).

```

DYNAMIC/BACKUP CONTROL FUNCTION #01
OVERLAPS: ABCDEFGHIJKLMNP
IF OVERLAPS ARE ACTIVE:
OR PHASES: 12345678910111213141516
IF PHASES ARE ON: X
OMIT PHASES: X
CALL PHASES:
    
```

BACKUP PROTECTION PROGRAMMING COMPLETE

THIS ELECTRICAL DETAIL IS FOR
 THE SIGNAL DESIGN: 03-0897T3
 DESIGNED: June 2017
 SEALED: 9/10/2021
 REVISED: N/A

Electrical Detail - Sheet 5 of 5
 Signal Upgrade
 Temporary Design 3

**DOCUMENT NOT CONSIDERED FINAL
 UNLESS ALL SIGNATURES COMPLETED**

HNTB HNTB NORTH CAROLINA, P.C.
 343 E. Six Forks Road, Suite 200
 Raleigh, North Carolina 27609
 NC License No: C-1554
 (919) 546-8997

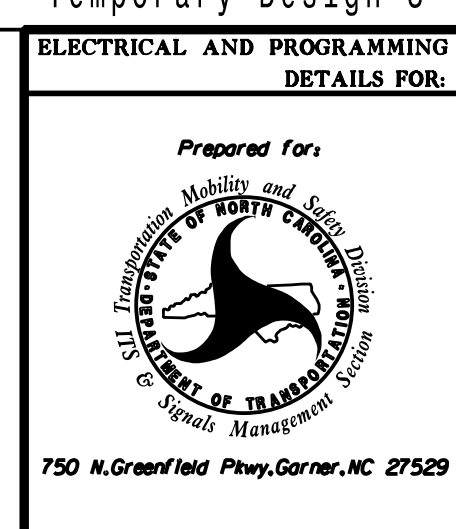

NC 211 (Howe Street)
 at
 Tidewater Plaza/Sandy Lane

Division 03 Brunswick Co. Southport

PLAN DATE: June 2017	REVIEWED BY: A.D. Klinksiek
PREPARED BY: A.H. Thornburg	REVIEWED BY: N.R. Simmons

REVISIONS	INIT.	DATE

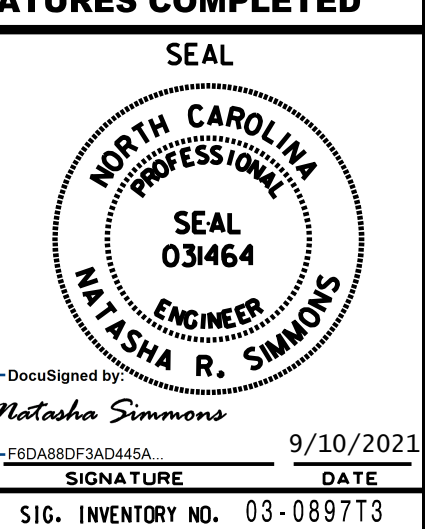

DEFAULT PHASING DIAGRAM

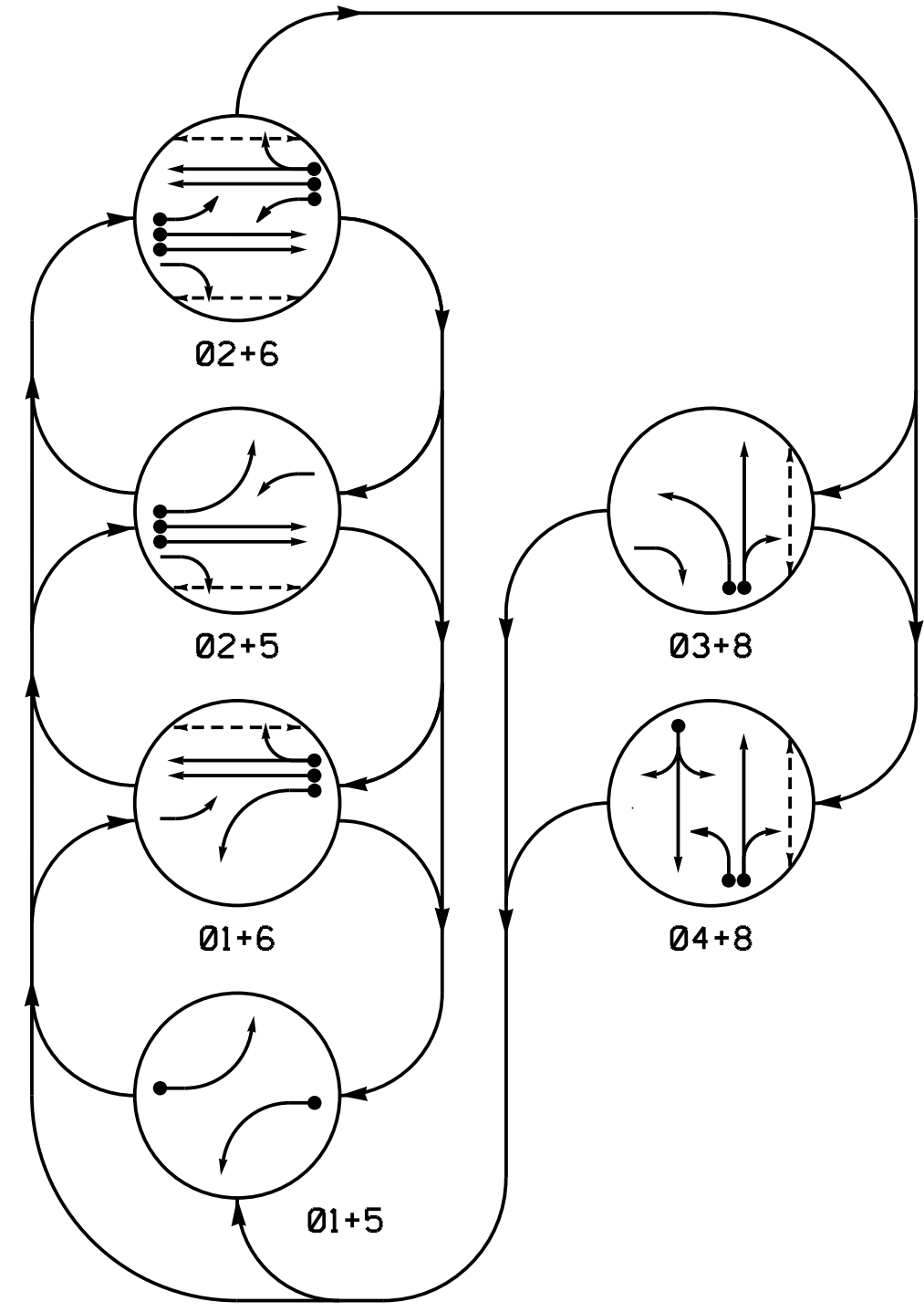

PHASING DIAGRAM DETECTION LEGEND

- DETECTED MOVEMENT
- UNDETECTED MOVEMENT (OVERLAP)
- ⋯ UNSIGNALIZED MOVEMENT
- ⚡ PEDESTRIAN MOVEMENT

ALTERNATE PHASING DIAGRAM

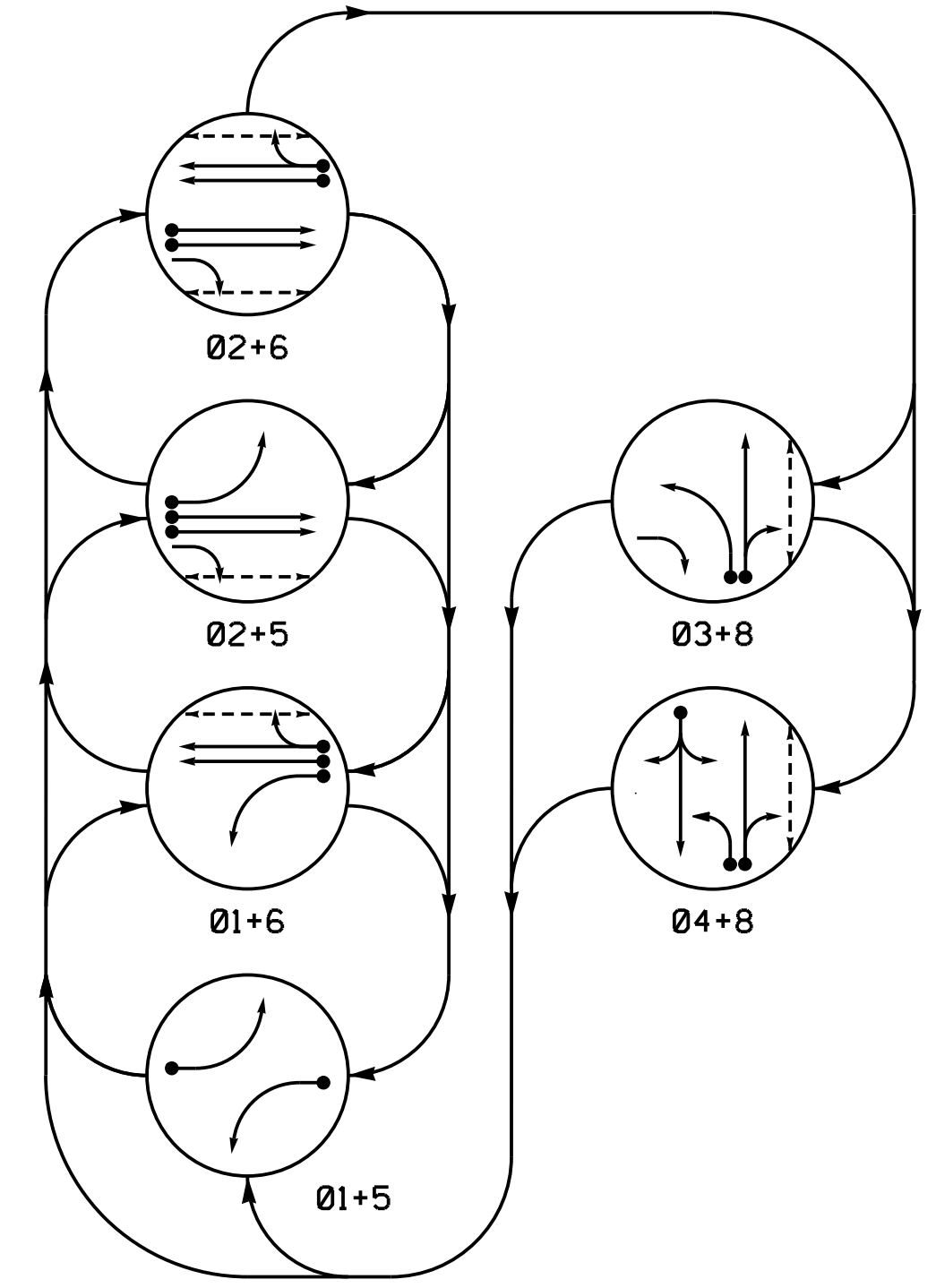

DEFAULT PHASING TABLE OF OPERATION

SIGNAL FACE	PHASE							
	01+5	01+6	02+5	02+6	03+8	04+8	FLASH	
11	-	-	F	F	R	R	-	-
21,22	R	R	G	G	R	R	Y	
23	R	R	F	F	-	-	R	-
31	R	R	R	R	-	-	F	-
41,42	R	R	R	R	R	R	G	
51	-	-	F	F	R	R	-	-
61,62	R	G	R	G	R	R	Y	
81,82	R	R	R	R	G	G	R	
P21,P22	DW	DW	W	W	DW	DW	DRK	
P61,P62	DW	W	DW	W	DW	DW	DRK	
P81,P82	DW	DW	DW	DW	W	W	DRK	

ALTERNATE PHASING TABLE OF OPERATION

SIGNAL FACE	PHASE							
	01+5	01+6	02+5	02+6	03+8	04+8	FLASH	
11	-	-	R	R	R	R	-	-
21,22	R	R	G	G	R	R	Y	
23	R	R	F	F	-	-	R	-
31	R	R	R	R	-	-	F	-
41,42	R	R	R	R	R	R	G	
51	-	-	R	R	R	R	-	-
61,62	R	G	R	G	R	R	Y	
81,82	R	R	R	R	G	G	R	
P21,P22	DW	DW	W	W	DW	DW	DRK	
P61,P62	DW	W	DW	W	DW	DW	DRK	
P81,P82	DW	DW	DW	DW	W	W	DRK	

OASIS 2070 LOOP & DETECTOR INSTALLATION CHART

LOOP	SIZE (FT)	DISTANCE FROM STOPBAR (FT)	TURNS	NEW LOOP	DETECTOR PROGRAMMING							
					PHASE	CALLING	EXTENSION	STRETCH TIME	DELAY TIME	SYSTEM LOOP	NEW CARD	
1A	6X40	0	2-4-2	Y	1	Y	Y	-	-	**15	-	Y
2A/S33	6X6	300	5	Y	*6	Y	Y	-	-	3	-	Y
2B/S34	6X6	300	5	Y	2	Y	Y	-	-	-	-	Y
3A	6X40	0	2-4-2	Y	3	Y	Y	-	-	15	-	Y
4A	6X40	0	2-4-2	Y	4	Y	Y	-	-	5	-	Y
5A	6X40	0	2-4-2	Y	5	Y	Y	-	-	**15	-	Y
6A/S35	6X6	300	5	Y	*2	Y	Y	-	-	3	-	Y
6B/S36	6X6	300	5	Y	6	Y	Y	-	-	-	-	Y
8A	6X40	0	2-4-2	Y	8	Y	Y	-	-	10	-	Y

* Disable 2 and 6 call for 1A and 5A during alternate phasing operation.
 ** Reduce delay to 3 seconds during alternate phasing operation.

6 Phase Fully Actuated (NC 133 Closed Loop System)

NOTES

- Refer to "Roadway Standard Drawings NCDOT" dated January 2018 and "Standard Specifications for Roads and Structures" dated January 2018.
- Do not program signal for late night flashing operation unless otherwise directed by the Engineer.
- Phase 1 and/or phase 5 may be lagged.
- Omit Phase 3 during Phase 4 on.
- Set all detector units to presence mode.
- Omit "WALK" and flashing "DON'T WALK" with no pedestrian calls.
- Program pedestrian heads to countdown the flashing "Don't Walk" time only.
- The Division Traffic Engineer will determine the hours of use for each phasing plan.
- Maximum times shown in timing chart are for free-run operation only. Coordinated signal system timing values supersede these values.
- Closed loop system data: Controller Asset #: 0897.

SIGNAL FACE I.D.

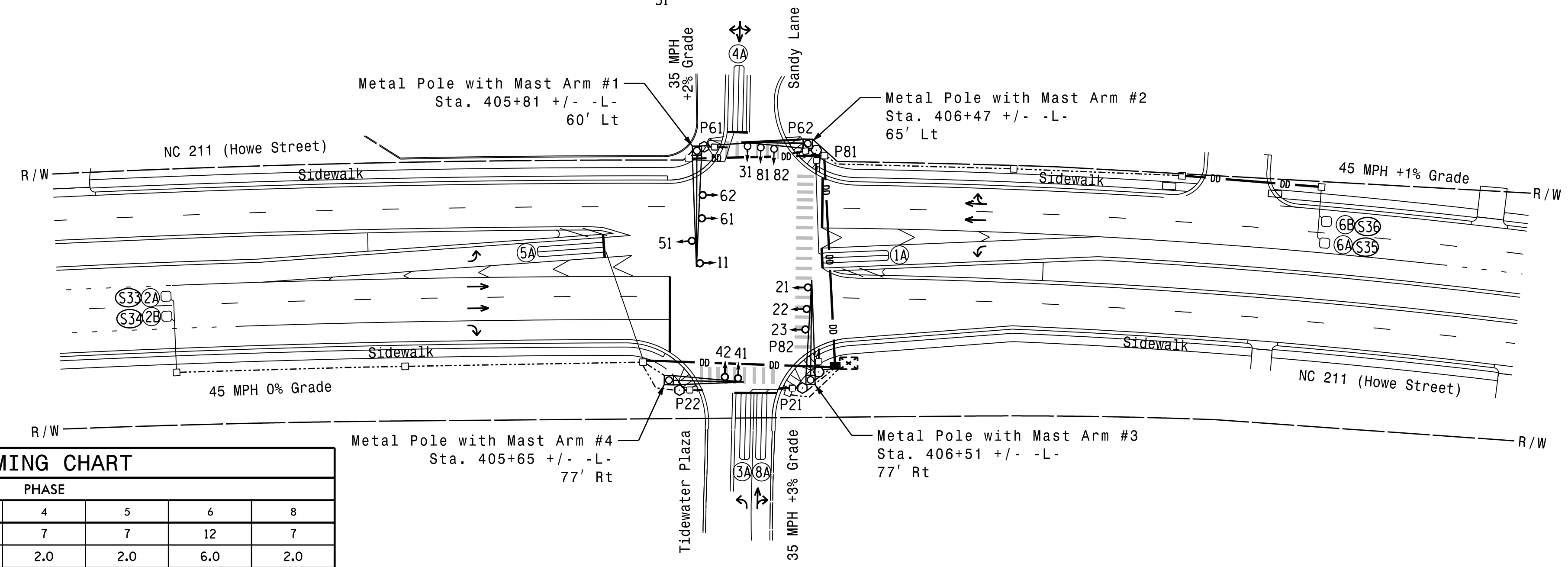
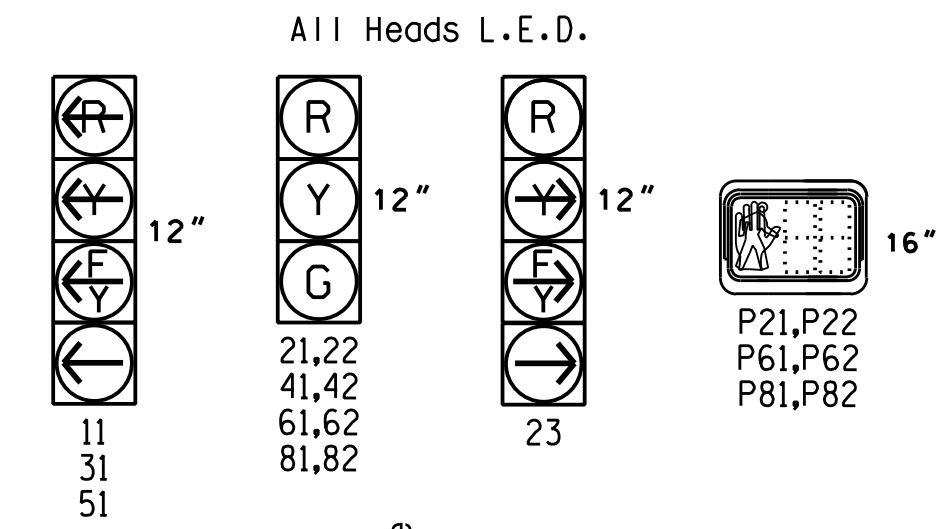

OASIS 2070 TIMING CHART

FEATURE	PHASE							
	1	2	3	4	5	6	8	
Min Green 1 *	7	12	7	7	7	12	7	
Extension 1 *	2.0	6.0	2.0	2.0	2.0	6.0	2.0	
Max Green 1 *	20	90	20	25	20	90	25	
Yellow Clearance	3.0	4.5	3.0	3.7	3.0	4.5	3.7	
Red Clearance	3.1	1.8	3.3	2.9	3.3	1.8	2.9	
Red Revert	2.0	2.0	2.0	2.0	2.0	2.0	2.0	
Walk 1 *	-	7	-	-	-	7	7	
Don't Walk 1	-	13	-	-	-	9	31	
Seconds Per Actuation *	-	1.5	-	-	-	1.5	-	
Max Variable Initial *	-	34	-	-	-	34	-	
Time Before Reduction *	-	15	-	-	-	15	-	
Time To Reduce *	-	30	-	-	-	30	-	
Minimum Gap	-	3.0	-	-	-	3.0	-	
Recall Mode	-	MIN RECALL	-	-	-	MIN RECALL	-	
Vehicle Call Memory	-	YELLOW	-	-	-	YELLOW	-	
Dual Entry	-	-	-	ON	-	-	ON	
Simultaneous Gap	ON	ON	ON	ON	ON	ON	ON	

* These values may be field adjusted. Do not adjust Min Green and Extension times for phases 2 and 6 lower than what is shown. Min Green for all other phases should not be lower than 4 seconds.

LEGEND

PROPOSED	EXISTING
○ → Traffic Signal Head	● → N/A
○ → Modified Signal Head	○ → N/A
⊥ Sign	⊥ Sign
⊥ Pedestrian Signal Head With Push Button & Sign	⊥ Pedestrian Signal Head With Push Button & Sign
○ Signal Pole with Guy	○ Signal Pole with Guy
○ Signal Pole with Sidewalk Guy	○ Signal Pole with Sidewalk Guy
⊠ Inductive Loop Detector	⊠ Inductive Loop Detector
⊠ Controller & Cabinet	⊠ Controller & Cabinet
⊠ Junction Box	⊠ Junction Box
⊠ 2-in Underground Conduit	⊠ 2-in Underground Conduit
N/A Right of Way	→ Right of Way
→ Directional Arrow	→ Directional Arrow
→ Directional Drill	→ Directional Drill
○ Metal Pole with Mastarm	○ Metal Pole with Mastarm
○ Type II Signal Pedestal	○ Type II Signal Pedestal
⊠ Wheelchair Ramp	⊠ Wheelchair Ramp

Signal Upgrade - Final Design **DOCUMENT NOT CONSIDERED FINAL UNLESS ALL SIGNATURES COMPLETED**

	NC 211 (Howe Street) at Tidewater Plaza/Sandy Lane		
	Division 03 Brunswick Co. Southport PLAN DATE: June 2017 PREPARED BY: A.H. Thornburg SCALE: 0 50 1"=50'	REVIEWED BY: A.D. Klinksiek REVIEWED BY: N.R. Simmons	

HNTB HNTB NORTH CAROLINA, P.C.
 343 E. Six Forks Road, Suite 200
 Raleigh, North Carolina 27609
 NC License No: C-1554
 (919) 546-8997

EDI MODEL 2018ECL-NC CONFLICT MONITOR PROGRAMMING DETAIL

(remove jumpers and set switches as shown)
 REMOVE DIODE JUMPERS 1-5, 1-6, 1-9, 1-11, 1-15, 2-5, 2-6, 2-7, 2-9, 2-11, 2-12, 2-13, 2-15, 3-7, 3-8, 3-10, 3-12, 3-16, 4-8, 4-10, 4-16, 5-7, 5-9, 5-11, 5-13, 6-7, 6-9, 6-12, 6-13, 6-15, 7-8, 7-9, 7-10, 7-11, 7-12, 7-13, 7-15, 8-7, 8-10, 8-12, 8-16, 9-11, 9-12, 9-13, 9-15, 10-12, 10-16, 11-12, 11-13, 11-15, 12-13, 12-15, 12-16, and 13-15.

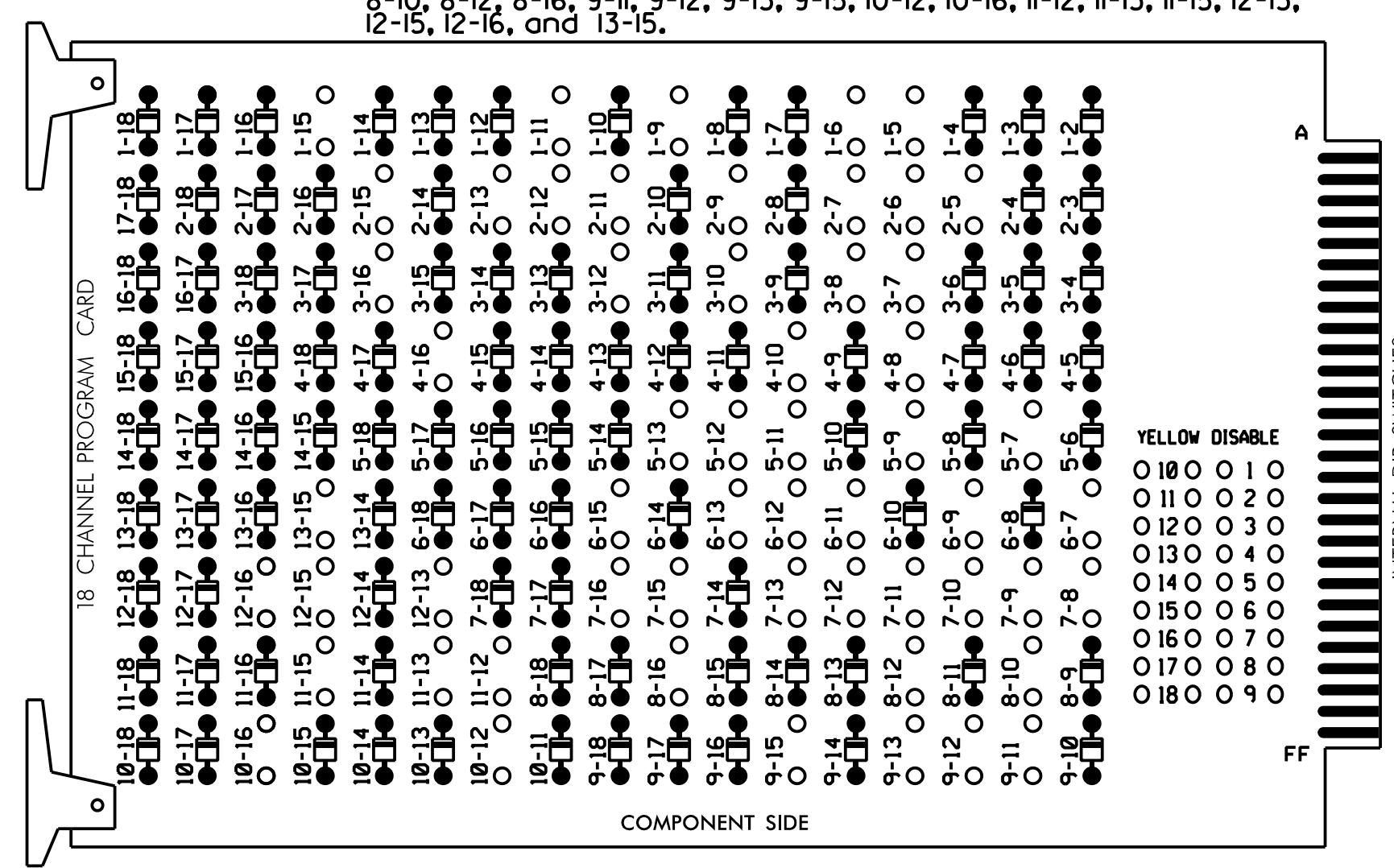

REMOVE JUMPERS AS SHOWN

- NOTES:
- Card is provided with all diode jumpers in place. Removal of any jumper allows its channels to run concurrently.
 - Ensure jumpers SEL2-SEL5 and SEL9 are present on the monitor board.
 - Ensure that Red Enable is active at all times during normal operation.
 - Connect serial cable from conflict monitor to comm. port 1 of 2070 controller. Ensure conflict monitor communicates with 2070.

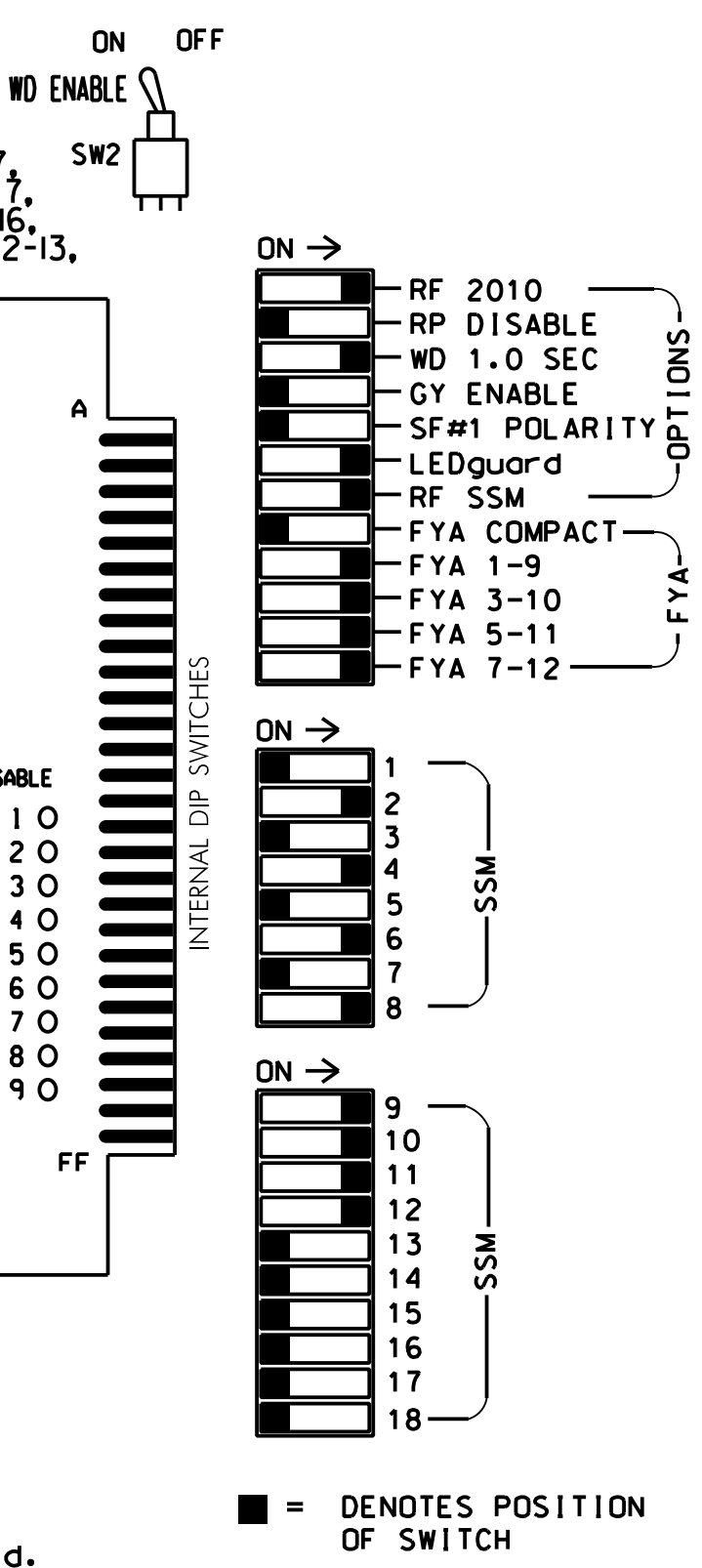

NOTES

- To prevent "flash-conflict" problems, insert red flash program blocks for all unused vehicle load switches in the output file. The installer shall verify that signal heads flash in accordance with the Signal Plans.
- Program phases 4 and 8 for Dual Entry.
- Enable Simultaneous Gap-Out for all Phases.
- Program phases 2 and 6 for Variable Initial and Gap Reduction.
- Program phases 2 and 6 for Startup In Green.
- Program phases 2, 6, and 8 for Startup Ped Call.
- Program phases 2 and 6 for Yellow Flash, and overlaps 1 and 2 as Wag Overlaps.
- If this signal will be managed by an ATMS software, enable controller and detector logging for all detectors used at this location.
- The cabinet and controller are part of the NC 133 Closed Loop System.

EQUIPMENT INFORMATION

CONTROLLER.....2070E
 CABINET.....332 W/AUX
 SOFTWARE.....ECONOLITE OASIS
 CABINET MOUNT.....BASE
 OUTPUT FILE POSITIONS...18 WITH AUX. OUTPUT FILE
 LOAD SWITCHES USED.....S1,S2,S3,S4,S5,S7,S8,S9,S10,S11,
 S12,AUX S1,AUX S2,AUX S4,AUX S5
 PHASES USED.....1,2,2 PED,3,4,5,6,6 PED,8,
 8 PED
 OVERLAP "A".....1+2
 OVERLAP "B".....3+4
 OVERLAP "C".....5+6
 OVERLAP "D".....2
 OVERLAP "E".....3

SIGNAL HEAD HOOK-UP CHART

LOAD SWITCH NO.	S1	S2	S3	S4	S5	S6	S7	S8	S9	S10	S11	S12	AUX S1	AUX S2	AUX S3	AUX S4	AUX S5	AUX S6
CMU CHANNEL NO.	1	2	13	3	4	14	5	6	15	7	8	16	9	10	17	11	12	18
PHASE	1	2	PED	3	4	PED	5	6	PED	8	8 PED	OLA	OLA	OLA	SPARE	DLA	DLA	SPARE
SIGNAL HEAD NO.	11	21,22	P21, P22	31	41,42	NU	51	61,62	P61, P62	23	81,82	P81, P82	11	31	NU	51	23	NU
RED	128			101				134			107							A101
YELLOW	*	129		*	102		*	135		*	108							
GREEN		130			103			136			109							
RED ARROW													A121	A124			A114	
YELLOW ARROW													A122	A125			A115	A102
FLASHING YELLOW ARROW													A123	A126			A116	A103
GREEN ARROW	127			118			133			124								
Hand				113						119			110					
Walking													121				112	

NU = Not Used
 * Denotes install load resistor. See load resistor installation detail this sheet.
 ★ See pictorial of head wiring in detail this sheet.

COUNTDOWN PEDESTRIAN SIGNAL OPERATION

Countdown Ped Signals are required to display timing only during Ped Clearance Interval. Consult Ped Signal Module user's manual for instructions on selecting this feature.

INPUT FILE POSITION LAYOUT

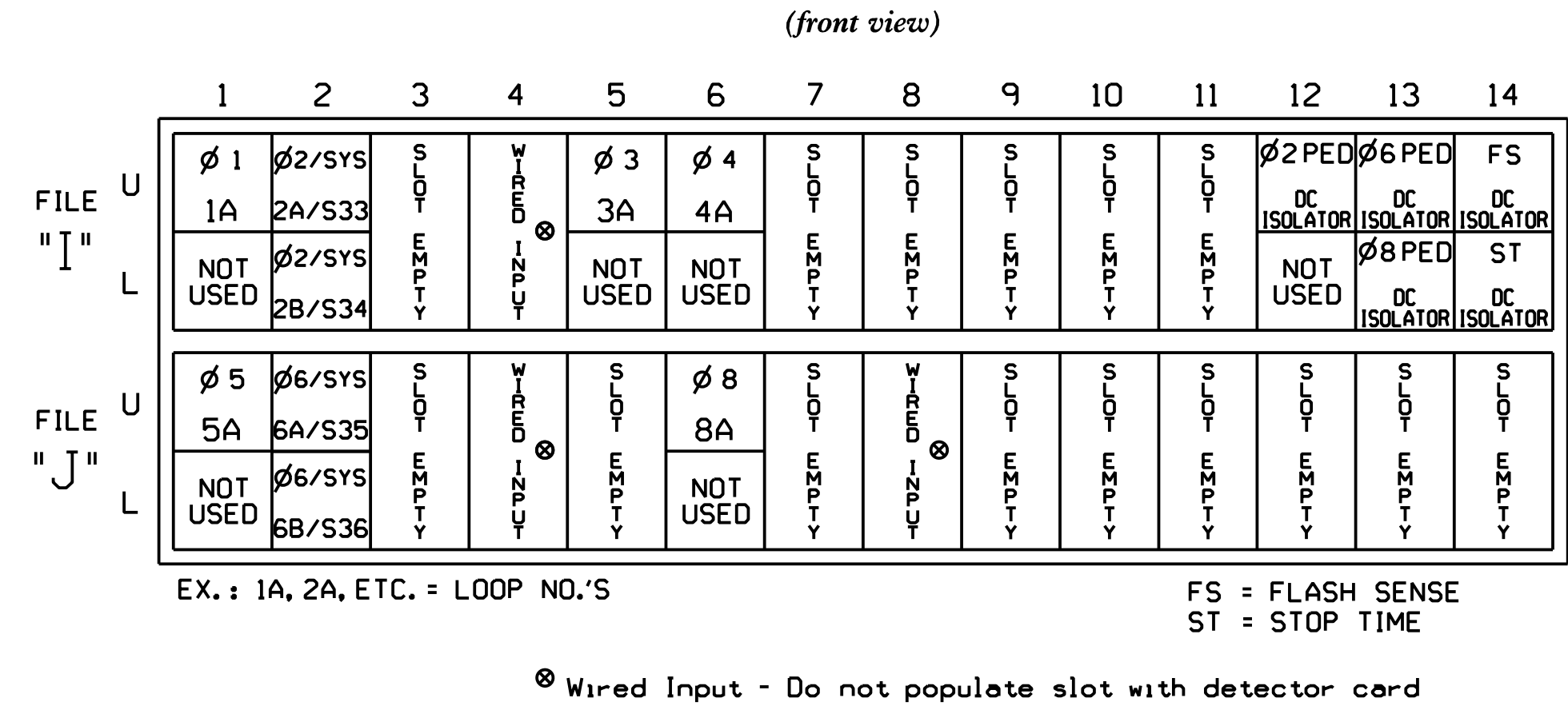

INPUT FILE CONNECTION & PROGRAMMING CHART

LOOP NO.	LOOP TERMINAL	INPUT FILE POS.	PIN NO.	INPUT ASSIGNMENT NO.	DETECTOR NO.	NEMA PHASE	CALL	EXTEND	FULL TIME DELAY	STRETCH TIME	DELAY TIME
1A ¹	TB2-1,2	I1U	56	18	1	1	Y	Y			15
	-	J4U	48	10★	26	6	Y	Y			3
	-	I1U	56	18★	51	1	Y	Y			3
2A/S33	TB2-5,6	I2U	39	1	2	2/SYS	Y	Y			
2B/S34	TB2-7,8	I2L	43	5	12	2/SYS	Y	Y			
3A ²	TB4-5,6	I5U	58	20	3	3	Y	Y			15
	-	J8U	50	12	28	8	Y	Y			3
4A	TB4-9,10	I6U	41	3	4	4	Y	Y			5
5A ³	TB3-1,2	J1U	55	17	5	5	Y	Y			15
	-	I4U	47	9★	22	2	Y	Y			3
	-	J1U	55	17★	55	5	Y	Y			3
6A/S35	TB3-5,6	J2U	40	2	6	6/SYS	Y	Y			
6B/S36	TB3-7,8	J2L	44	6	16	6/SYS	Y	Y			
8A	TB5-9,10	J6U	42	4	8	8	Y	Y			10
PED PUSH BUTTONS											
P21,P22	TB8-4,6	I12U	67	29	PED 2	2 PED					
P61,P62	TB8-7,9	I13U	68	30	PED 6	6 PED					
P81,P82	TB8-8,9	I13L	70	32	PED 8	8 PED					

- NOTE:
 INSTALL DC ISOLATORS IN INPUT FILE SLOTS 112 AND 113.
- Add jumper from I1-W to J4-W, on rear of input file.
 - Add jumper from I5-W to J8-W, on rear of input file.
 - Add jumper from J1-W to I4-W, on rear of input file.
- ★ See vehicle detector setup programming detail for alternate phasing on sheets 3 and 4.

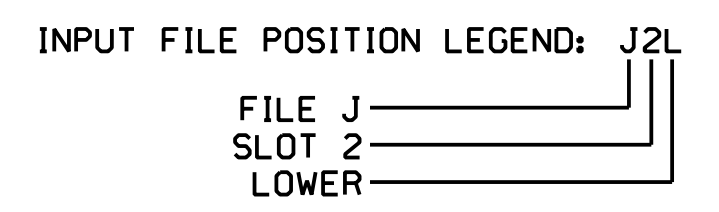

LOAD RESISTOR INSTALLATION DETAIL

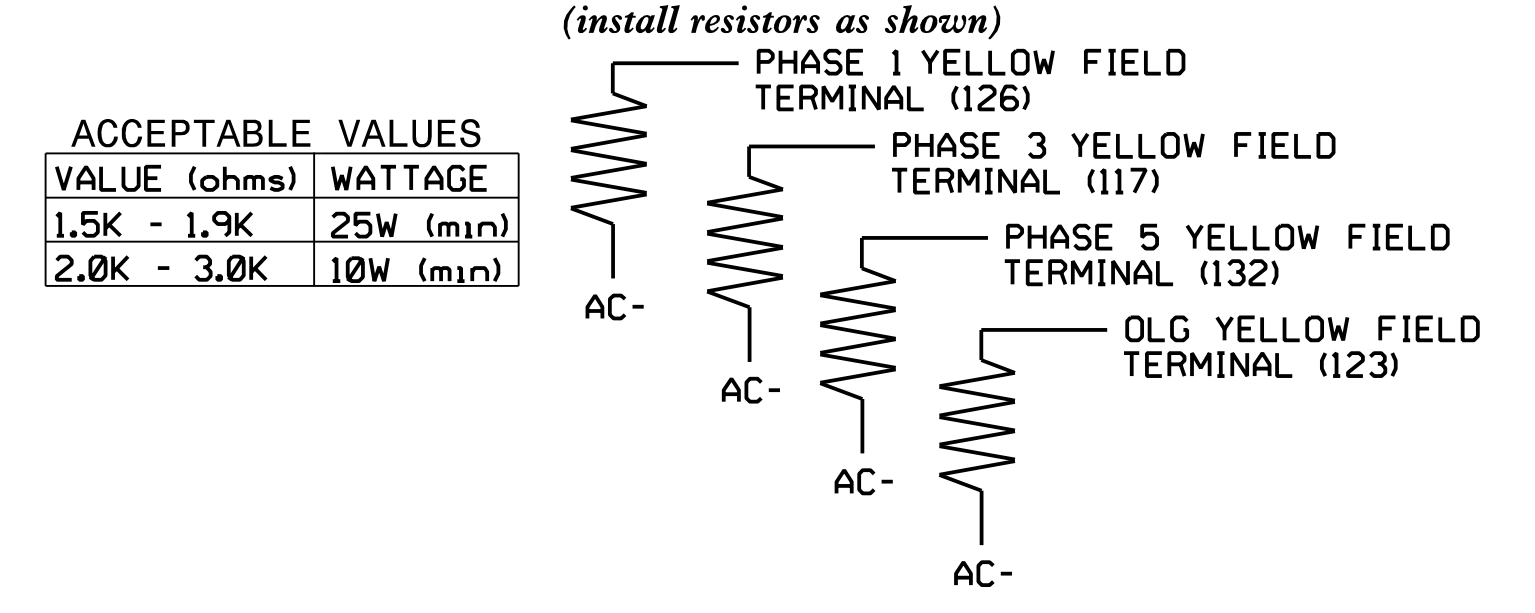

THIS ELECTRICAL DETAIL IS FOR THE SIGNAL DESIGN: 03-0897
 DESIGNED: June 2017
 SEALED: 9/10/2021
 REVISED: N/A

FYA SIGNAL WIRING DETAIL

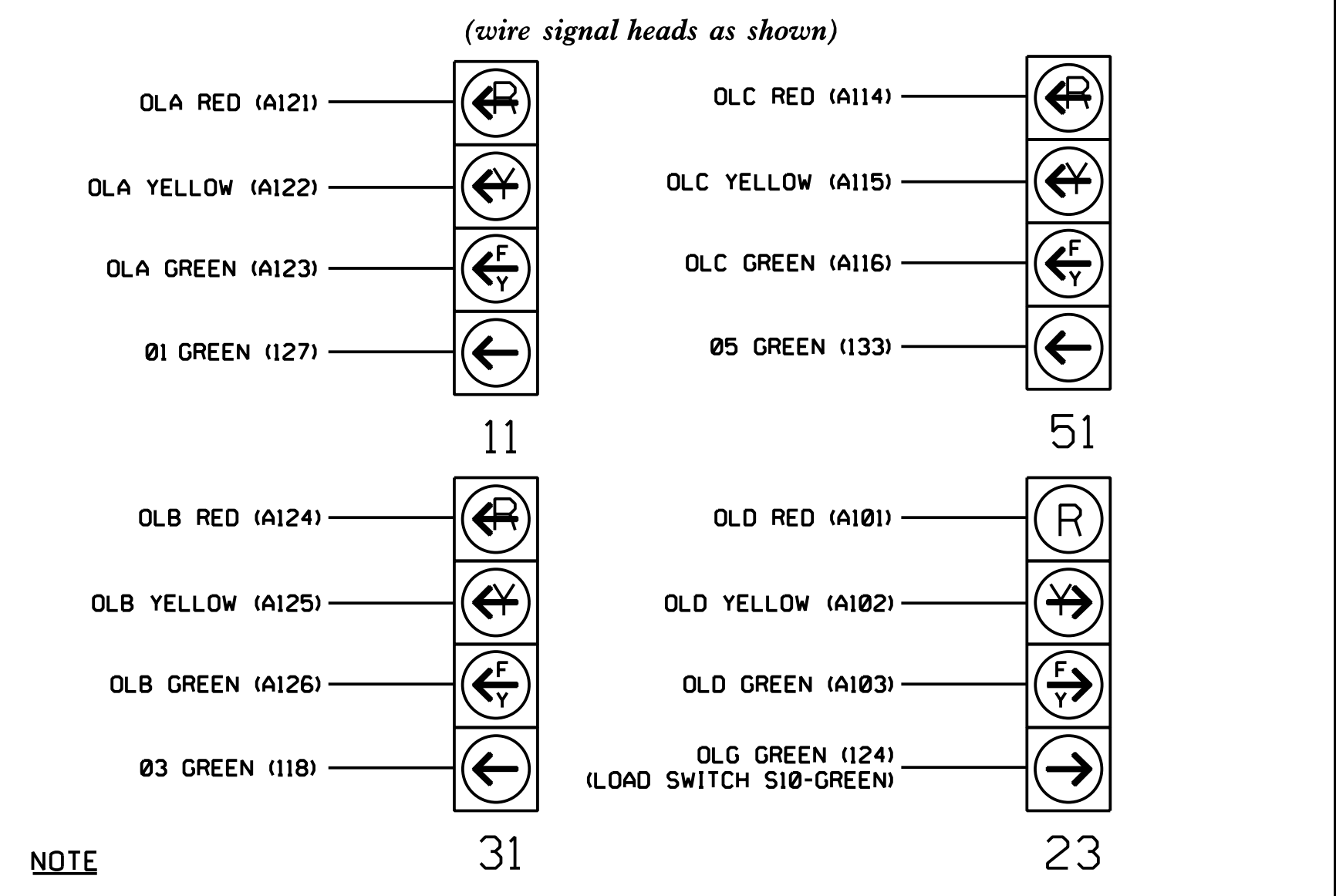

Electrical Detail - Sheet 1 of 7
 Signal Upgrade
 Final Design

DOCUMENT NOT CONSIDERED FINAL UNLESS ALL SIGNATURES COMPLETED

Prepared for:

NC 211 (Howe Street) at Tidewater Plaza/Sandy Lane

Division 03 Brunswick Co. Southport

PLAN DATE: June 2017 REVIEWED BY: A.D. Klinksiek

PREPARED BY: A.H. Thornburg REVIEWED BY: N.R. Simmons

REVISIONS: _____ INITI. _____ DATE _____

Signature:

9/10/2021

SIG. INVENTORY NO. 03-0897

LOGICAL I/O PROCESSOR PROGRAMMING DETAIL TO PRODUCE SPECIAL FYA-PPLT SIGNAL SEQUENCE

(program controller as shown below)

- FROM MAIN MENU PRESS '2' (PHASE CONTROL), THEN '1' (PHASE CONTROL FUNCTIONS). SCROLL TO THE BOTTOM OF THE MENU AND ENABLE ACT LOGIC COMMANDS 1, 2, 3, 4, 5, 6, 7, 8, 9, 10, 11, and 12.
- FROM MAIN MENU PRESS '6' (OUTPUTS), THEN '3' (LOGICAL I/O PROCESSOR).

LOGICAL I/O COMMAND #1 (+/-COMMAND#)
IF ACTIVE PHASE #1 IS ON
AND RED CLEAR ON PHASE #1 IS ON

↓
SCROLL DOWN

THEN:
SET OUTPUT ASSIGNMENT #50 ON
SET OUTPUT ASSIGNMENT #51 OFF

PRESS '+'

NOTE: LOGIC FOR PHASE 1 RED CLEAR WHEN TRANSITIONING FROM PHASE 1 TO PHASE 2 (HEAD 11).

LOGICAL I/O COMMAND #2 (+/-COMMAND#)
IF ACTIVE PHASE #1 IS ON

↓
SCROLL DOWN

THEN:
SET OUTPUT ASSIGNMENT #52 OFF

PRESS '+'

NOTE: LOGIC FOR SWITCHING FLASHING YELLOW ARROW "OFF" DURING PHASE 1 (HEAD 11).

LOGICAL I/O COMMAND #3 (+/-COMMAND#)
IF YELLOW ON PHASE #1 IS ON

↓
SCROLL DOWN

THEN:
SET OUTPUT ASSIGNMENT #51 ON

PRESS '+'

NOTE: LOGIC FOR YELLOW ARROW CLEARANCE FROM PHASE 1 (HEAD 11).

LOGICAL I/O COMMAND #4 (+/-COMMAND#)
IF ACTIVE PHASE #5 IS ON
AND RED CLEAR ON PHASE #5 IS ON

↓
SCROLL DOWN

THEN:
SET OUTPUT ASSIGNMENT #42 ON
SET OUTPUT ASSIGNMENT #43 OFF

PRESS '+'

NOTE: LOGIC FOR PHASE 5 RED CLEAR WHEN TRANSITIONING FROM PHASE 5 TO PHASE 6 (HEAD 51).

LOGICAL I/O COMMAND #5 (+/-COMMAND#)
IF ACTIVE PHASE #5 IS ON

↓
SCROLL DOWN

THEN:
SET OUTPUT ASSIGNMENT #44 OFF

PRESS '+'

NOTE: LOGIC FOR SWITCHING FLASHING YELLOW ARROW "OFF" DURING PHASE 5 (HEAD 51).

LOGICAL I/O COMMAND #6 (+/-COMMAND#)
IF YELLOW ON PHASE #5 IS ON

↓
SCROLL DOWN

THEN:
SET OUTPUT ASSIGNMENT #43 ON

PRESS '+'

NOTE: LOGIC FOR YELLOW ARROW CLEARANCE FROM PHASE 5 (HEAD 51).

LOGICAL I/O COMMAND #7 (+/-COMMAND#)
IF ACTIVE PHASE #3 IS ON
AND RED CLEAR ON PHASE #3 IS ON

↓
SCROLL DOWN

THEN:
SET OUTPUT ASSIGNMENT #47 ON
SET OUTPUT ASSIGNMENT #48 OFF

PRESS '+'

NOTE: LOGIC FOR PHASE 3 RED CLEAR WHEN TRANSITIONING FROM PHASE 3 TO PHASE 4 (HEAD 31).

LOGICAL I/O COMMAND #8 (+/-COMMAND#)
IF ACTIVE PHASE #3 IS ON

↓
SCROLL DOWN

THEN:
SET OUTPUT ASSIGNMENT #49 OFF

PRESS '+'

NOTE: LOGIC FOR SWITCHING FLASHING YELLOW ARROW "OFF" DURING PHASE 3 (HEAD 31).

LOGICAL I/O COMMAND #9 (+/-COMMAND#)
IF YELLOW ON PHASE #3 IS ON

↓
SCROLL DOWN

THEN:
SET OUTPUT ASSIGNMENT #48 ON

PRESS '+'

NOTE: LOGIC FOR YELLOW ARROW CLEARANCE FROM PHASE 3 (HEAD 31).

LOGICAL I/O COMMAND #10 (+/-COMMAND#)
IF ACTIVE OVERLAP #7 IS ON
AND RED CLEAR ON OVL #7 IS ON

↓
SCROLL DOWN

THEN:
SET OUTPUT ASSIGNMENT #39 ON
SET OUTPUT ASSIGNMENT #40 OFF

PRESS '+'

NOTE: LOGIC FOR RED CLEAR (HEAD 23).

LOGICAL I/O COMMAND #11 (+/-COMMAND#)
IF ACTIVE OVERLAP #7 IS ON

↓
SCROLL DOWN

THEN:
SET OUTPUT ASSIGNMENT #41 OFF

PRESS '+'

NOTE: LOGIC FOR SWITCHING FLASHING YELLOW ARROW "OFF" (HEAD 23).

LOGICAL I/O COMMAND #12 (+/-COMMAND#)
IF YELLOW ON OVERLAP #7 IS ON

↓
SCROLL DOWN

THEN:
SET OUTPUT ASSIGNMENT #40 ON

PRESS '+'

NOTE: LOGIC FOR YELLOW ARROW CLEARANCE (HEAD 23).

LOGIC I/O PROCESSOR PROGRAMMING COMPLETE

FLASHER CIRCUIT MODIFICATION DETAIL

IN ORDER TO INSURE THAT SIGNALS FLASH CONCURRENTLY ON THE SAME APPROACH, MAKE THE FOLLOWING FLASHER CIRCUIT CHANGES:

- ON REAR OF PDA - REMOVE WIRE FROM TERM. T2-4 AND TERMINATE ON T2-2.
- ON REAR OF PDA - REMOVE WIRE FROM TERM. T2-5 AND TERMINATE ON T2-3.
- REMOVE FLASHER UNIT 2.

THE CHANGES LISTED ABOVE TIES ALL PHASES AND OVERLAPS TO FLASHER UNIT 1.

DYNAMIC BACK-UP CONTROL PROGRAMMING

(program controller as shown below)

- From Main Menu press '2' (Phase Control), then '1' (Phase Control Functions). Scroll to the bottom of the menu and enable Dynamic/Backup Control Function 1.
- From Phase Control Functions Menu press '2' (Dynamic/Backup Control Functions).

```

DYNAMIC/BACKUP CONTROL FUNCTION #01
OVERLAPS: ABCDEFGHIJKLMNOP
IF OVERLAPS ARE ACTIVE:
OR PHASES: 12345678910111213141516
IF PHASES ARE ON: X
OMIT PHASES: X
CALL PHASES:
    
```

BACKUP PROTECTION PROGRAMMING COMPLETE

OUTPUT REFERENCE SCHEDULE	
USE TO INTERPRET LOGIC PROCESSOR	
OUTPUT 39	= Overlap D Red
OUTPUT 40	= Overlap D Yellow
OUTPUT 41	= Overlap D Green
OUTPUT 42	= Overlap C Red
OUTPUT 43	= Overlap C Yellow
OUTPUT 44	= Overlap C Green
OUTPUT 47	= Overlap B Red
OUTPUT 48	= Overlap B Yellow
OUTPUT 49	= Overlap B Green
OUTPUT 50	= Overlap A Red
OUTPUT 51	= Overlap A Yellow
OUTPUT 52	= Overlap A Green

THIS ELECTRICAL DETAIL IS FOR THE SIGNAL DESIGN: 03-0897
DESIGNED: June 2017
SEALED: 9/10/2021
REVISED: N/A

HNTB HNTB NORTH CAROLINA, P.C.
343 E. Six Forks Road, Suite 200
Raleigh, North Carolina 27609
NC License No: C-1554
(919) 546-8997

Electrical Detail - Sheet 2 of 7

Signal Upgrade
Final Design

**DOCUMENT NOT CONSIDERED FINAL
UNLESS ALL SIGNATURES COMPLETED**

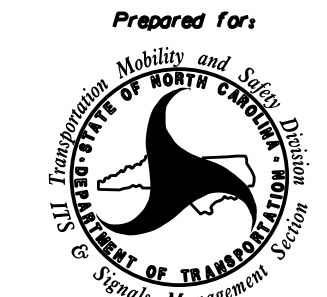
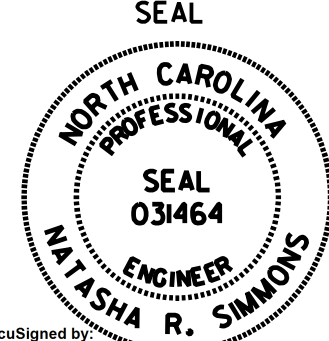
Prepared for: 	NC 211 (Howe Street) at Tidewater Plaza/Sandy Lane Division 03 Brunswick Co. Southport PLAN DATE: June 2017 REVIEWED BY: A.D. Klinksiek PREPARED BY: A.H. Thornburg REVIEWED BY: N.R. Simmons	SEAL 	
750 N. Greenfield Pkwy, Corner, NC 27529		DocuSigned by: Natasha Simmons 9/10/2021 SIGNATURE DATE SIG. INVENTORY NO. 03-0897	

OVERLAP PROGRAMMING DETAIL FOR DEFAULT PHASING

(program controller as shown below)

FROM MAIN MENU PRESS '8' (OVERLAPS), THEN '1' (VEHICLE OVERLAP SETTINGS).

```

PAGE 1: VEHICLE OVERLAP 'A' SETTINGS
PHASE: :12345678910111213141516
VEH OVL PARENTS: :XX
VEH OVL NOT VEH: :
VEH OVL NOT PED: :
VEH OVL GRN EXT: :
STARTUP COLOR: - RED - YELLOW - GREEN
FLASH COLORS: - RED - YELLOW X GREEN
SELECT VEHICLE OVERLAP OPTIONS: (Y/N)
FLASH YELLOW IN CONTROLLER FLASH?...Y
GREEN EXTENSION (0-255 SEC)...0.0
YELLOW CLEAR (0=PARENT,3-25.5 SEC)...0.0
RED CLEAR (0=PARENT,0.1-25.5 SEC)...0.0
OUTPUT AS PHASE # (0=NONE, 1-16)...0
  
```

← NOTICE GREEN FLASH

PRESS '+'

```

PAGE 1: VEHICLE OVERLAP 'B' SETTINGS
PHASE: :12345678910111213141516
VEH OVL PARENTS: :XX
VEH OVL NOT VEH: :
VEH OVL NOT PED: :
VEH OVL GRN EXT: :
STARTUP COLOR: - RED - YELLOW - GREEN
FLASH COLORS: - RED - YELLOW X GREEN
SELECT VEHICLE OVERLAP OPTIONS: (Y/N)
FLASH YELLOW IN CONTROLLER FLASH?...N
GREEN EXTENSION (0-255 SEC)...0.0
YELLOW CLEAR (0=PARENT,3-25.5 SEC)...0.0
RED CLEAR (0=PARENT,0.1-25.5 SEC)...0.0
OUTPUT AS PHASE # (0=NONE, 1-16)...0
  
```

← NOTICE GREEN FLASH

PRESS '+'

```

PAGE 1: VEHICLE OVERLAP 'C' SETTINGS
PHASE: :12345678910111213141516
VEH OVL PARENTS: :XX
VEH OVL NOT VEH: :
VEH OVL NOT PED: :
VEH OVL GRN EXT: :
STARTUP COLOR: - RED - YELLOW - GREEN
FLASH COLORS: - RED - YELLOW X GREEN
SELECT VEHICLE OVERLAP OPTIONS: (Y/N)
FLASH YELLOW IN CONTROLLER FLASH?...Y
GREEN EXTENSION (0-255 SEC)...0.0
YELLOW CLEAR (0=PARENT,3-25.5 SEC)...0.0
RED CLEAR (0=PARENT,0.1-25.5 SEC)...0.0
OUTPUT AS PHASE # (0=NONE, 1-16)...0
  
```

← NOTICE GREEN FLASH

PRESS '+'

```

PAGE 1: VEHICLE OVERLAP 'D' SETTINGS
PHASE: :12345678910111213141516
VEH OVL PARENTS: :X
VEH OVL NOT VEH: :
VEH OVL NOT PED: :
VEH OVL GRN EXT: :
STARTUP COLOR: - RED - YELLOW - GREEN
FLASH COLORS: - RED - YELLOW X GREEN
SELECT VEHICLE OVERLAP OPTIONS: (Y/N)
FLASH YELLOW IN CONTROLLER FLASH?...Y
GREEN EXTENSION (0-255 SEC)...0.0
YELLOW CLEAR (0=PARENT,3-25.5 SEC)...0.0
RED CLEAR (0=PARENT,0.1-25.5 SEC)...0.0
OUTPUT AS PHASE # (0=NONE, 1-16)...0
  
```

← NOTICE GREEN FLASH

PRESS '+' THREE TIMES

```

PAGE 1: VEHICLE OVERLAP 'G' SETTINGS
PHASE: :12345678910111213141516
VEH OVL PARENTS: :X
VEH OVL NOT VEH: :
VEH OVL NOT PED: :
VEH OVL GRN EXT: :
STARTUP COLOR: - RED - YELLOW - GREEN
FLASH COLORS: - RED - YELLOW - GREEN
SELECT VEHICLE OVERLAP OPTIONS: (Y/N)
FLASH YELLOW IN CONTROLLER FLASH?...N
GREEN EXTENSION (0-255 SEC)...0.0
YELLOW CLEAR (0=PARENT,3-25.5 SEC)...0.0
RED CLEAR (0=PARENT,0.1-25.5 SEC)...0.0
OUTPUT AS PHASE # (0=NONE, 1-16)...0
  
```

OVERLAP PROGRAMMING COMPLETE

OVERLAP PROGRAMMING DETAIL FOR ALTERNATE PHASING

(program controller as shown below)

FROM MAIN MENU PRESS '8' (OVERLAPS), THEN '1' (VEHICLE OVERLAP SETTINGS). PRESS 'NEXT' TO ADVANCE TO PAGE 2.

NOTICE PAGE 2 →

```

PAGE 2: VEHICLE OVERLAP 'A' SETTINGS
PHASE: :12345678910111213141516
VEH OVL PARENTS: :X
VEH OVL NOT VEH: :
VEH OVL NOT PED: :
VEH OVL GRN EXT: :
STARTUP COLOR: - RED - YELLOW - GREEN
FLASH COLORS: - RED - YELLOW - GREEN
SELECT VEHICLE OVERLAP OPTIONS: (Y/N)
FLASH YELLOW IN CONTROLLER FLASH?...Y
GREEN EXTENSION (0-255 SEC)...0.0
YELLOW CLEAR (0=PARENT,3-25.5 SEC)...0.0
RED CLEAR (0=PARENT,0.1-25.5 SEC)...0.0
OUTPUT AS PHASE # (0=NONE, 1-16)...0
  
```

PRESS '+'

NOTICE PAGE 2 →

```

PAGE 2: VEHICLE OVERLAP 'B' SETTINGS
PHASE: :12345678910111213141516
VEH OVL PARENTS: :XX
VEH OVL NOT VEH: :
VEH OVL NOT PED: :
VEH OVL GRN EXT: :
STARTUP COLOR: - RED - YELLOW - GREEN
FLASH COLORS: - RED - YELLOW X GREEN
SELECT VEHICLE OVERLAP OPTIONS: (Y/N)
FLASH YELLOW IN CONTROLLER FLASH?...N
GREEN EXTENSION (0-255 SEC)...0.0
YELLOW CLEAR (0=PARENT,3-25.5 SEC)...0.0
RED CLEAR (0=PARENT,0.1-25.5 SEC)...0.0
OUTPUT AS PHASE # (0=NONE, 1-16)...0
  
```

← NOTICE GREEN FLASH

PRESS '+'

NOTICE PAGE 2 →

```

PAGE 2: VEHICLE OVERLAP 'C' SETTINGS
PHASE: :12345678910111213141516
VEH OVL PARENTS: :X
VEH OVL NOT VEH: :
VEH OVL NOT PED: :
VEH OVL GRN EXT: :
STARTUP COLOR: - RED - YELLOW - GREEN
FLASH COLORS: - RED - YELLOW - GREEN
SELECT VEHICLE OVERLAP OPTIONS: (Y/N)
FLASH YELLOW IN CONTROLLER FLASH?...Y
GREEN EXTENSION (0-255 SEC)...0.0
YELLOW CLEAR (0=PARENT,3-25.5 SEC)...0.0
RED CLEAR (0=PARENT,0.1-25.5 SEC)...0.0
OUTPUT AS PHASE # (0=NONE, 1-16)...0
  
```

PRESS '+'

NOTICE PAGE 2 →

```

PAGE 2: VEHICLE OVERLAP 'D' SETTINGS
PHASE: :12345678910111213141516
VEH OVL PARENTS: :X
VEH OVL NOT VEH: :
VEH OVL NOT PED: :
VEH OVL GRN EXT: :
STARTUP COLOR: - RED - YELLOW - GREEN
FLASH COLORS: - RED - YELLOW X GREEN
SELECT VEHICLE OVERLAP OPTIONS: (Y/N)
FLASH YELLOW IN CONTROLLER FLASH?...Y
GREEN EXTENSION (0-255 SEC)...0.0
YELLOW CLEAR (0=PARENT,3-25.5 SEC)...0.0
RED CLEAR (0=PARENT,0.1-25.5 SEC)...0.0
OUTPUT AS PHASE # (0=NONE, 1-16)...0
  
```

← NOTICE GREEN FLASH

PRESS '+' THREE TIMES

NOTICE PAGE 2 →

```

PAGE 2: VEHICLE OVERLAP 'G' SETTINGS
PHASE: :12345678910111213141516
VEH OVL PARENTS: :X
VEH OVL NOT VEH: :
VEH OVL NOT PED: :
VEH OVL GRN EXT: :
STARTUP COLOR: - RED - YELLOW - GREEN
FLASH COLORS: - RED - YELLOW - GREEN
SELECT VEHICLE OVERLAP OPTIONS: (Y/N)
FLASH YELLOW IN CONTROLLER FLASH?...N
GREEN EXTENSION (0-255 SEC)...0.0
YELLOW CLEAR (0=PARENT,3-25.5 SEC)...0.0
RED CLEAR (0=PARENT,0.1-25.5 SEC)...0.0
OUTPUT AS PHASE # (0=NONE, 1-16)...0
  
```

OVERLAP PROGRAMMING COMPLETE

Electrical Detail - Sheet 3 of 7
Signal Upgrade
Final Design

DOCUMENT NOT CONSIDERED FINAL UNLESS ALL SIGNATURES COMPLETED

THIS ELECTRICAL DETAIL IS FOR THE SIGNAL DESIGN: 03-0897
DESIGNED: June 2017
SEALED: 9/10/2021
REVISED: N/A

HNTB HNTB NORTH CAROLINA, P.C.
343 E. Six Forks Road, Suite 200
Raleigh, North Carolina 27609
NC License No: C-1554
(919) 546-8997

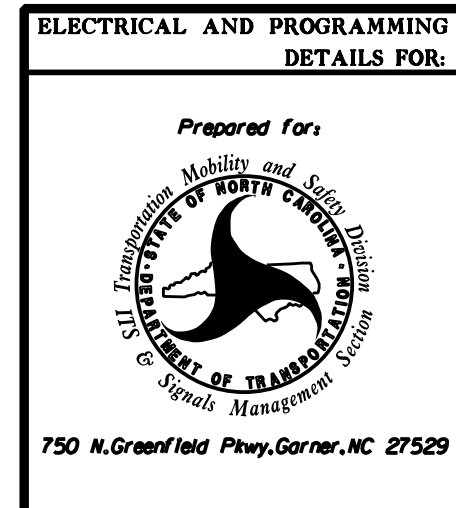

ELECTRICAL AND PROGRAMMING DETAILS FOR:		NC 211 (Howe Street) at Tidewater Plaza/Sandy Lane	
Prepared for:	Division 03	Brunswick Co.	Southport
PLAN DATE: June 2017	REVIEWED BY: A.D. Klinksiek	PREPARED BY: A.H. Thornburg	REVIEWED BY: N.R. Simmons
REVISIONS	INIT.	DATE	

SEAL
NORTH CAROLINA PROFESSIONAL ENGINEER
SEAL 031464
NATASHA R. SIMMONS
9/10/2021
SIG. INVENTORY NO. 03-0897

INPUT PAGE 2 ASSIGNMENT PROGRAMMING DETAIL FOR ALTERNATE PHASING - LOOP 1A

(program controller as shown below)

- NOTES: 1. THIS PROGRAMMING APPLIES FOR INPUT PAGE 2 ONLY. INPUT PAGE 1 WILL USE STANDARD DEFAULT SETTINGS. THIS PROGRAMMING IS NECESSARY FOR PROPER DETECTOR OPERATION DURING ALTERNATE PHASING OPERATION. 2. THE FIRST TASK THIS PROGRAMMING ACCOMPLISHES IS THE DISABLING OF INPUT #10 (DETECTOR 26) SO THAT A VEHICLE CALL WILL NOT BE PLACED TO PHASE 6 DURING ALTERNATE PHASING OPERATION. THE SECOND TASK THIS PROGRAMMING ACCOMPLISHES IS THAT IT REASSIGNS DETECTOR 51 TO INPUT #18 SO THAT THE DELAY ON LOOP 1A CAN BE REDUCED FROM 15 SECONDS TO 3 SECONDS.

FROM MAIN MENU PRESS '5' (INPUTS). THEN PRESS 'NEXT' TO GET TO INPUT PAGE '2'. PRESS THE '+' KEY UNTIL INPUT 10 IS REACHED.

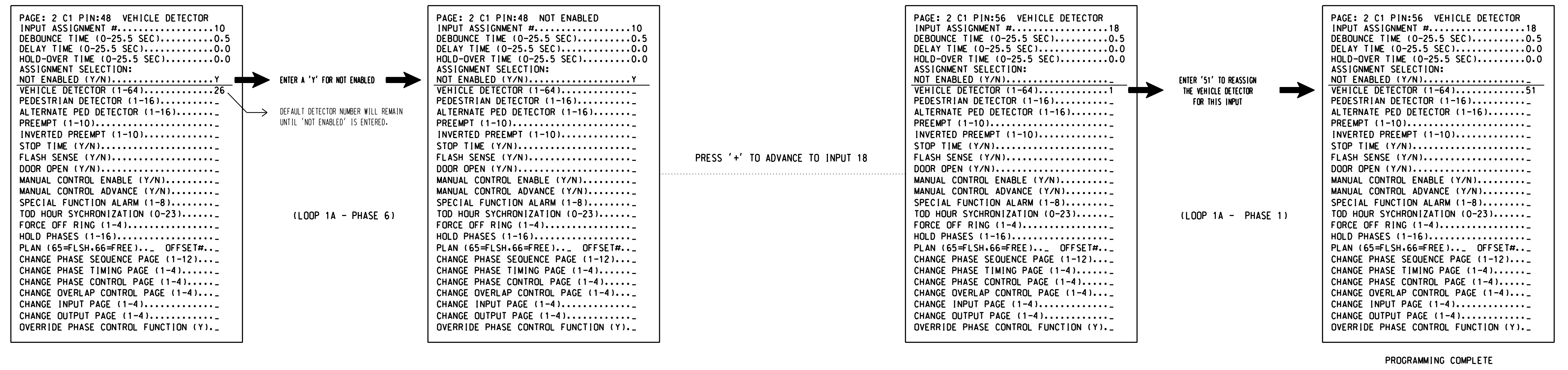

SPECIAL DETECTOR PROGRAMMING DETAIL - LOOP 1A (ALT.)

(program controller as shown below)

FROM MAIN MENU PRESS '7' (DETECTORS). THEN PRESS '1' FOR VEHICLE DETECTORS. PRESS THE '-' KEY TO GET TO VEHICLE DETECTOR #51.

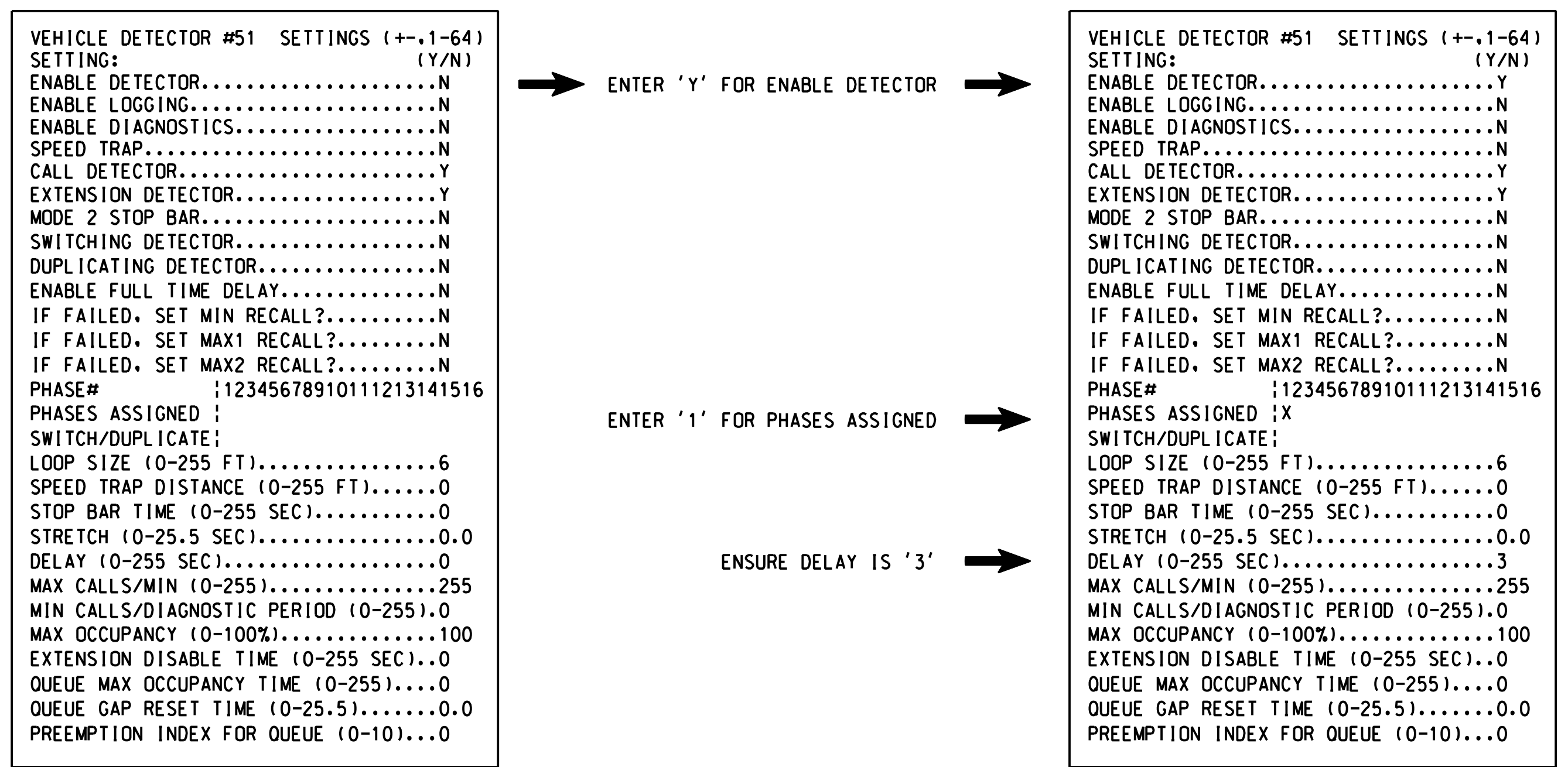

NOTE: DETECTOR IS PROGRAMMED PER THE INPUT FILE CONNECTION AND PROGRAMMING CHART SHOWN ON SHEET 1.

THIS ELECTRICAL DETAIL IS FOR THE SIGNAL DESIGN: 03-0897 DESIGNED: June 2017 SEALED: 9/10/2021 REVISED: N/A

Electrical Detail - Sheet 4 of 7 Signal Upgrade Final Design

DOCUMENT NOT CONSIDERED FINAL UNLESS ALL SIGNATURES COMPLETED

Professional Engineer Seal for Natasha R. Simmons, State of North Carolina, License No. 031464. Includes project details for NC 211 (Howe Street) at Tidewater Plaza/Sandy Lane, Brunswick Co., Southport. Prepared by A.H. Thornburg, reviewed by N.R. Simmons. Date: 9/10/2021. Includes a signature line for Natasha R. Simmons.

INPUT PAGE 2 ASSIGNMENT PROGRAMMING DETAIL FOR ALTERNATE PHASING - LOOP 5A

(program controller as shown below)

- NOTES: 1. THIS PROGRAMMING APPLIES FOR INPUT PAGE 2 ONLY. INPUT PAGE 1 WILL USE STANDARD DEFAULT SETTINGS. THIS PROGRAMMING IS NECESSARY FOR PROPER DETECTOR OPERATION DURING ALTERNATE PHASING OPERATION. 2. THE FIRST TASK THIS PROGRAMMING ACCOMPLISHES IS THE DISABLING OF INPUT #9 (DETECTOR 22) SO THAT A VEHICLE CALL WILL NOT BE PLACED TO PHASE 2 DURING ALTERNATE PHASING OPERATION. THE SECOND TASK THIS PROGRAMMING ACCOMPLISHES IS THAT IT REASSIGNS DETECTOR 55 TO INPUT #17 SO THAT THE DELAY ON LOOP 5A CAN BE REDUCED FROM 15 SECONDS TO 3 SECONDS.

FROM MAIN MENU PRESS '5' (INPUTS), THEN PRESS 'NEXT' TO GET TO INPUT PAGE '2'. PRESS THE '+' KEY UNTIL INPUT 9 IS REACHED.

PAGE: 2 C1 PIN:47 VEHICLE DETECTOR INPUT ASSIGNMENT #.....9 DEBOUNCE TIME (0-25.5 SEC).....0.5 DELAY TIME (0-25.5 SEC).....0.0 HOLD-OVER TIME (0-25.5 SEC).....0.0 ASSIGNMENT SELECTION: NOT ENABLED (Y/N).....Y VEHICLE DETECTOR (1-64).....22 PEDESTRIAN DETECTOR (1-16)..... ALTERNATE PED DETECTOR (1-16)..... PREEMPT (1-10)..... INVERTED PREEMPT (1-10)..... STOP TIME (Y/N)..... FLASH SENSE (Y/N)..... DOOR OPEN (Y/N)..... MANUAL CONTROL ENABLE (Y/N)..... MANUAL CONTROL ADVANCE (Y/N)..... SPECIAL FUNCTION ALARM (1-8)..... TOD HOUR SYNCHRONIZATION (0-23)..... FORCE OFF RING (1-4)..... HOLD PHASES (1-16)..... PLAN (65=FLSH,66=FREE)..... OFFSET#..... CHANGE PHASE SEQUENCE PAGE (1-12)..... CHANGE PHASE TIMING PAGE (1-4)..... CHANGE PHASE CONTROL PAGE (1-4)..... CHANGE OVERLAP CONTROL PAGE (1-4)..... CHANGE INPUT PAGE (1-4)..... CHANGE OUTPUT PAGE (1-4)..... OVERRIDE PHASE CONTROL FUNCTION (Y).....

ENTER A 'Y' FOR NOT ENABLED
DEFAULT DETECTOR NUMBER WILL REMAIN UNTIL 'NOT ENABLED' IS ENTERED.

(LOOP 5A - PHASE 2)

PAGE: 2 C1 PIN:47 NOT ENABLED INPUT ASSIGNMENT #.....9 DEBOUNCE TIME (0-25.5 SEC).....0.5 DELAY TIME (0-25.5 SEC).....0.0 HOLD-OVER TIME (0-25.5 SEC).....0.0 ASSIGNMENT SELECTION: NOT ENABLED (Y/N).....Y VEHICLE DETECTOR (1-64)..... PEDESTRIAN DETECTOR (1-16)..... ALTERNATE PED DETECTOR (1-16)..... PREEMPT (1-10)..... INVERTED PREEMPT (1-10)..... STOP TIME (Y/N)..... FLASH SENSE (Y/N)..... DOOR OPEN (Y/N)..... MANUAL CONTROL ENABLE (Y/N)..... MANUAL CONTROL ADVANCE (Y/N)..... SPECIAL FUNCTION ALARM (1-8)..... TOD HOUR SYNCHRONIZATION (0-23)..... FORCE OFF RING (1-4)..... HOLD PHASES (1-16)..... PLAN (65=FLSH,66=FREE)..... OFFSET#..... CHANGE PHASE SEQUENCE PAGE (1-12)..... CHANGE PHASE TIMING PAGE (1-4)..... CHANGE PHASE CONTROL PAGE (1-4)..... CHANGE OVERLAP CONTROL PAGE (1-4)..... CHANGE INPUT PAGE (1-4)..... CHANGE OUTPUT PAGE (1-4)..... OVERRIDE PHASE CONTROL FUNCTION (Y).....

PRESS '+' TO ADVANCE TO INPUT 17

PAGE: 2 C1 PIN:55 VEHICLE DETECTOR INPUT ASSIGNMENT #.....17 DEBOUNCE TIME (0-25.5 SEC).....0.5 DELAY TIME (0-25.5 SEC).....0.0 HOLD-OVER TIME (0-25.5 SEC).....0.0 ASSIGNMENT SELECTION: NOT ENABLED (Y/N)..... VEHICLE DETECTOR (1-64).....5 PEDESTRIAN DETECTOR (1-16)..... ALTERNATE PED DETECTOR (1-16)..... PREEMPT (1-10)..... INVERTED PREEMPT (1-10)..... STOP TIME (Y/N)..... FLASH SENSE (Y/N)..... DOOR OPEN (Y/N)..... MANUAL CONTROL ENABLE (Y/N)..... MANUAL CONTROL ADVANCE (Y/N)..... SPECIAL FUNCTION ALARM (1-8)..... TOD HOUR SYNCHRONIZATION (0-23)..... FORCE OFF RING (1-4)..... HOLD PHASES (1-16)..... PLAN (65=FLSH,66=FREE)..... OFFSET#..... CHANGE PHASE SEQUENCE PAGE (1-12)..... CHANGE PHASE TIMING PAGE (1-4)..... CHANGE PHASE CONTROL PAGE (1-4)..... CHANGE OVERLAP CONTROL PAGE (1-4)..... CHANGE INPUT PAGE (1-4)..... CHANGE OUTPUT PAGE (1-4)..... OVERRIDE PHASE CONTROL FUNCTION (Y).....

ENTER '55' TO REASSIGN THE VEHICLE DETECTOR FOR THIS INPUT

(LOOP 5A - PHASE 5)

PAGE: 2 C1 PIN:55 VEHICLE DETECTOR INPUT ASSIGNMENT #.....17 DEBOUNCE TIME (0-25.5 SEC).....0.5 DELAY TIME (0-25.5 SEC).....0.0 HOLD-OVER TIME (0-25.5 SEC).....0.0 ASSIGNMENT SELECTION: NOT ENABLED (Y/N)..... VEHICLE DETECTOR (1-64).....55 PEDESTRIAN DETECTOR (1-16)..... ALTERNATE PED DETECTOR (1-16)..... PREEMPT (1-10)..... INVERTED PREEMPT (1-10)..... STOP TIME (Y/N)..... FLASH SENSE (Y/N)..... DOOR OPEN (Y/N)..... MANUAL CONTROL ENABLE (Y/N)..... MANUAL CONTROL ADVANCE (Y/N)..... SPECIAL FUNCTION ALARM (1-8)..... TOD HOUR SYNCHRONIZATION (0-23)..... FORCE OFF RING (1-4)..... HOLD PHASES (1-16)..... PLAN (65=FLSH,66=FREE)..... OFFSET#..... CHANGE PHASE SEQUENCE PAGE (1-12)..... CHANGE PHASE TIMING PAGE (1-4)..... CHANGE PHASE CONTROL PAGE (1-4)..... CHANGE OVERLAP CONTROL PAGE (1-4)..... CHANGE INPUT PAGE (1-4)..... CHANGE OUTPUT PAGE (1-4)..... OVERRIDE PHASE CONTROL FUNCTION (Y).....

PROGRAMMING COMPLETE

SPECIAL DETECTOR PROGRAMMING DETAIL - LOOP 5A (ALT.)

(program controller as shown below)

FROM MAIN MENU PRESS '7' (DETECTORS), THEN PRESS '1' FOR VEHICLE DETECTORS. PRESS THE '-' KEY TO GET TO VEHICLE DETECTOR #55.

VEHICLE DETECTOR #55 SETTINGS (+,-,1-64) SETTING: (Y/N) ENABLE DETECTOR.....N ENABLE LOGGING.....N ENABLE DIAGNOSTICS.....N SPEED TRAP.....N CALL DETECTOR.....Y EXTENSION DETECTOR.....Y MODE 2 STOP BAR.....N SWITCHING DETECTOR.....N DUPLICATING DETECTOR.....N ENABLE FULL TIME DELAY.....N IF FAILED, SET MIN RECALL?.....N IF FAILED, SET MAX1 RECALL?.....N IF FAILED, SET MAX2 RECALL?.....N PHASE# :12345678910111213141516 PHASES ASSIGNED : SWITCH/DUPLICATE: LOOP SIZE (0-255 FT).....6 SPEED TRAP DISTANCE (0-255 FT).....0 STOP BAR TIME (0-255 SEC).....0 STRETCH (0-25.5 SEC).....0.0 DELAY (0-255 SEC).....0 MAX CALLS/MIN (0-255).....255 MIN CALLS/DIAGNOSTIC PERIOD (0-255).....0 MAX OCCUPANCY (0-100%).....100 EXTENSION DISABLE TIME (0-255 SEC).....0 QUEUE MAX OCCUPANCY TIME (0-255).....0 QUEUE GAP RESET TIME (0-25.5).....0.0 PREEMPTION INDEX FOR QUEUE (0-10).....0

ENTER 'Y' FOR ENABLE DETECTOR

ENTER '5' FOR PHASES ASSIGNED

ENSURE DELAY IS '3'

VEHICLE DETECTOR #55 SETTINGS (+,-,1-64) SETTING: (Y/N) ENABLE DETECTOR.....Y ENABLE LOGGING.....N ENABLE DIAGNOSTICS.....N SPEED TRAP.....N CALL DETECTOR.....Y EXTENSION DETECTOR.....Y MODE 2 STOP BAR.....N SWITCHING DETECTOR.....N DUPLICATING DETECTOR.....N ENABLE FULL TIME DELAY.....N IF FAILED, SET MIN RECALL?.....N IF FAILED, SET MAX1 RECALL?.....N IF FAILED, SET MAX2 RECALL?.....N PHASE# :12345678910111213141516 PHASES ASSIGNED : X SWITCH/DUPLICATE: LOOP SIZE (0-255 FT).....6 SPEED TRAP DISTANCE (0-255 FT).....0 STOP BAR TIME (0-255 SEC).....0 STRETCH (0-25.5 SEC).....0.0 DELAY (0-255 SEC).....3 MAX CALLS/MIN (0-255).....255 MIN CALLS/DIAGNOSTIC PERIOD (0-255).....0 MAX OCCUPANCY (0-100%).....100 EXTENSION DISABLE TIME (0-255 SEC).....0 QUEUE MAX OCCUPANCY TIME (0-255).....0 QUEUE GAP RESET TIME (0-25.5).....0.0 PREEMPTION INDEX FOR QUEUE (0-10).....0

DETECTOR PROGRAMMING COMPLETE

NOTE: DETECTOR IS PROGRAMMED PER THE INPUT FILE CONNECTION AND PROGRAMMING CHART SHOWN ON SHEET 1.

THIS ELECTRICAL DETAIL IS FOR THE SIGNAL DESIGN: 03-0897 DESIGNED: June 2017 SEALED: 9/10/2021 REVISED: N/A

Electrical Detail - Sheet 5 of 7
Signal Upgrade
Final Design

DOCUMENT NOT CONSIDERED FINAL UNLESS ALL SIGNATURES COMPLETED

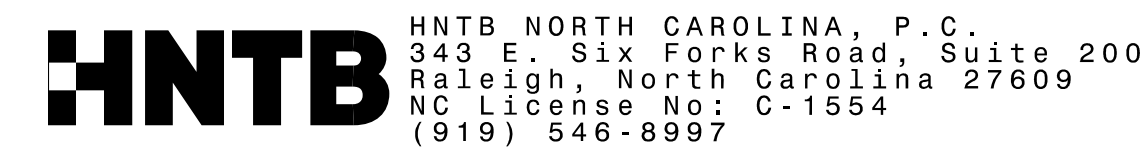

Professional Engineer Seal for Natasha R. Simmons, State of North Carolina, License No. 031464. Includes project details for NC 211 (Howe Street) at Tidewater Plaza/Sandy Lane, Brunswick Co., Southport. Prepared by A.H. Thornburg, reviewed by A.D. Klinksiek and N.R. Simmons. Date 9/10/2021. Inventory No. 03-0897.

ALTERNATE PHASING ACTIVATION DETAIL

TO RUN ALT. PHASING DURING COORDINATION - SELECT ALL PAGE CHANGES (AS SHOWN BELOW) WITHIN COORDINATION PLAN PROGRAMMING.

TO RUN ALT. PHASING DURING FREE RUN - PROGRAM PAGE CHANGES (SHOWN BELOW) IN SEPARATE TIME OF DAY EVENTS. IF PAGE 1 IS USED, NO EVENT PROGRAMMING IS NECESSARY FOR THAT PARTICULAR PAGE.

PHASING	INPUTS PAGE	OVERLAPS PAGE
ACTIVE PAGES REQUIRED TO RUN <u>DEFAULT PHASING</u>	1	1
ACTIVE PAGES REQUIRED TO RUN <u>ALTERNATE PHASING</u>	2	2

NOTE: PAGES NOT SHOWN (i.e. sequence, phase control, etc.) SHOULD REMAIN AS '1', OR AS DEFINED BY TIMING ENGINEER.

IMPORTANT: IF ALT. PHASING IS USED DURING FREE RUN AND COORDINATION, DO NOT OPERATE TIME OF DAY PAGE CHANGE EVENTS CONCURRENTLY WITH COORDINATION PLAN EVENTS IN THE EVENT SCHEDULER. (EX. FREE RUN PAGE CHANGE EVENT SHOULD END BEFORE COORDINATION PLAN EVENT STARTS AND VICE-VERSA).

ALTERNATE PHASING PAGE CHANGE SUMMARY

THE FOLLOWING IS A SUMMARY OF WHAT TAKES PLACE WHEN THESE OVERLAP/INPUT PAGE CHANGES ACTIVATE TO CALL THE "ALTERNATE PHASING":

OVERLAPS PAGE 2: Modifies overlap parent phases for heads 11 and 51 to run protected turns only.

INPUTS PAGE 2: Disables phase 6 call on loop 1A and reduces delay time for phase 1 call on loop 1A to 3 seconds.

Disables phase 2 call on loop 5A and reduces delay time for phase 5 call on loop 5A to 3 seconds.

THIS ELECTRICAL DETAIL IS FOR THE SIGNAL DESIGN: 03-0897
 DESIGNED: June 2017
 SEALED: 9/10/2021
 REVISED: N/A

Electrical Detail - Sheet 6 of 7
Signal Upgrade
Final Design

DOCUMENT NOT CONSIDERED FINAL UNLESS ALL SIGNATURES COMPLETED

HNTB HNTB NORTH CAROLINA, P.C.
 343 E. Six Forks Road, Suite 200
 Raleigh, North Carolina 27609
 NC License No: C-1554
 (919) 546-8997

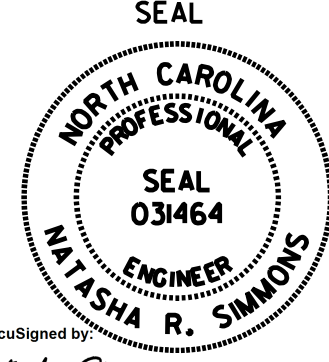
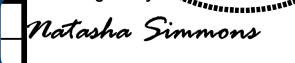
ELECTRICAL AND PROGRAMMING DETAILS FOR:  Prepared for: Department of Transportation State of North Carolina Signal Management Section 750 N. Greenfield Pkwy, Corner, NC 27529	NC 211 (Howe Street) at Tidewater Plaza/Sandy Lane		SEAL  SEAL 031464 ENGINEER NATASHA R. SIMMONS					
	Division 03 Brunswick Co. Southport PLAN DATE: June 2017 REVIEWED BY: A.D. Klinksiek PREPARED BY: A.H. Thornburg REVIEWED BY: N.R. Simmons	REVISIONS <table border="1"> <tr> <th>REVISIONS</th> <th>INIT.</th> <th>DATE</th> </tr> <tr> <td> </td> <td> </td> <td> </td> </tr> </table>		REVISIONS	INIT.	DATE		
REVISIONS	INIT.	DATE						
DocuSigned by:  Natasha Simmons 9/10/2021		SIGNATURE DATE _____ 9/10/2021 SIG. INVENTORY NO. 03-0897						

Design Loading for METAL POLE NO. 1

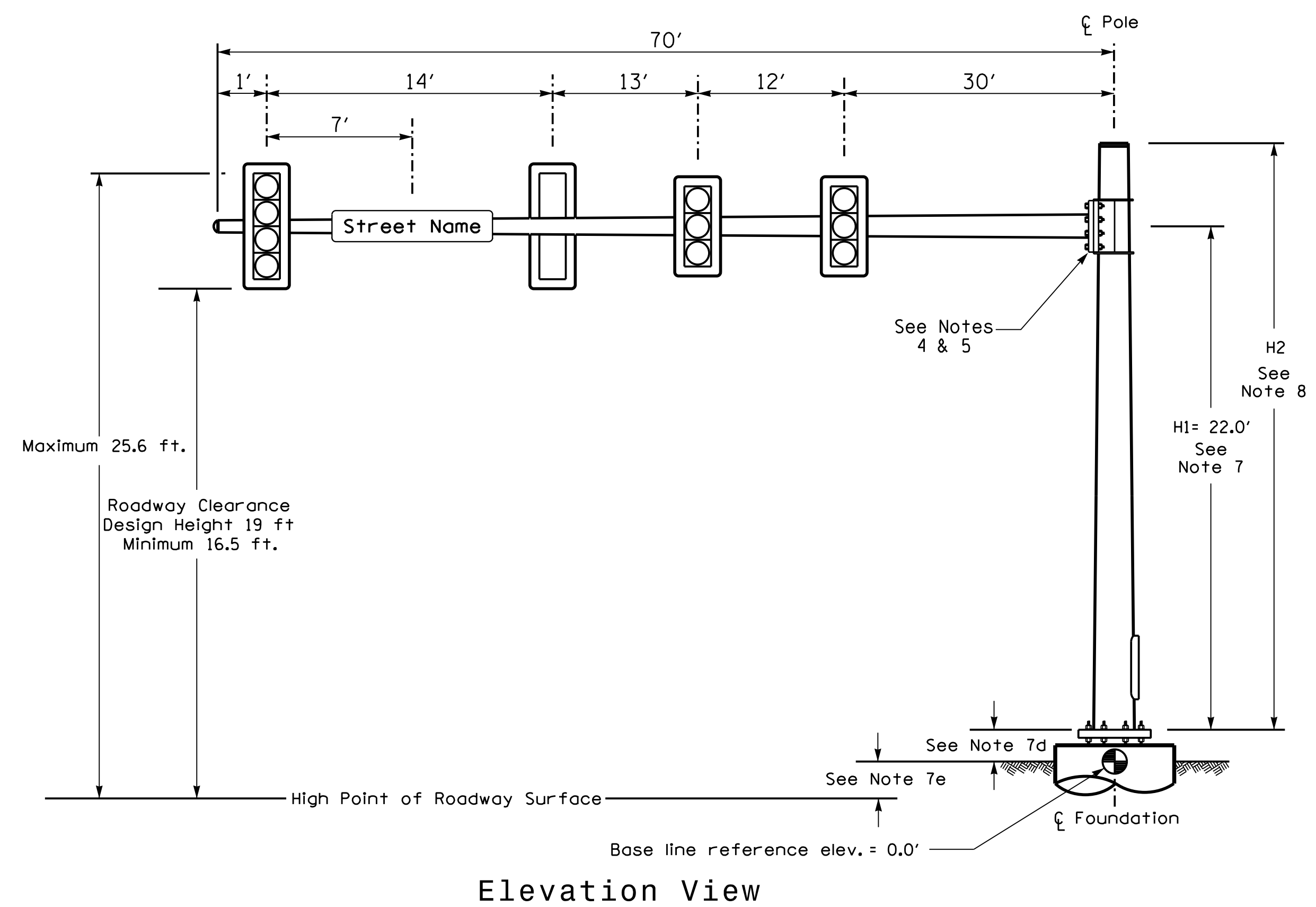

Elevation View

Design Loading for METAL POLE NO. 2

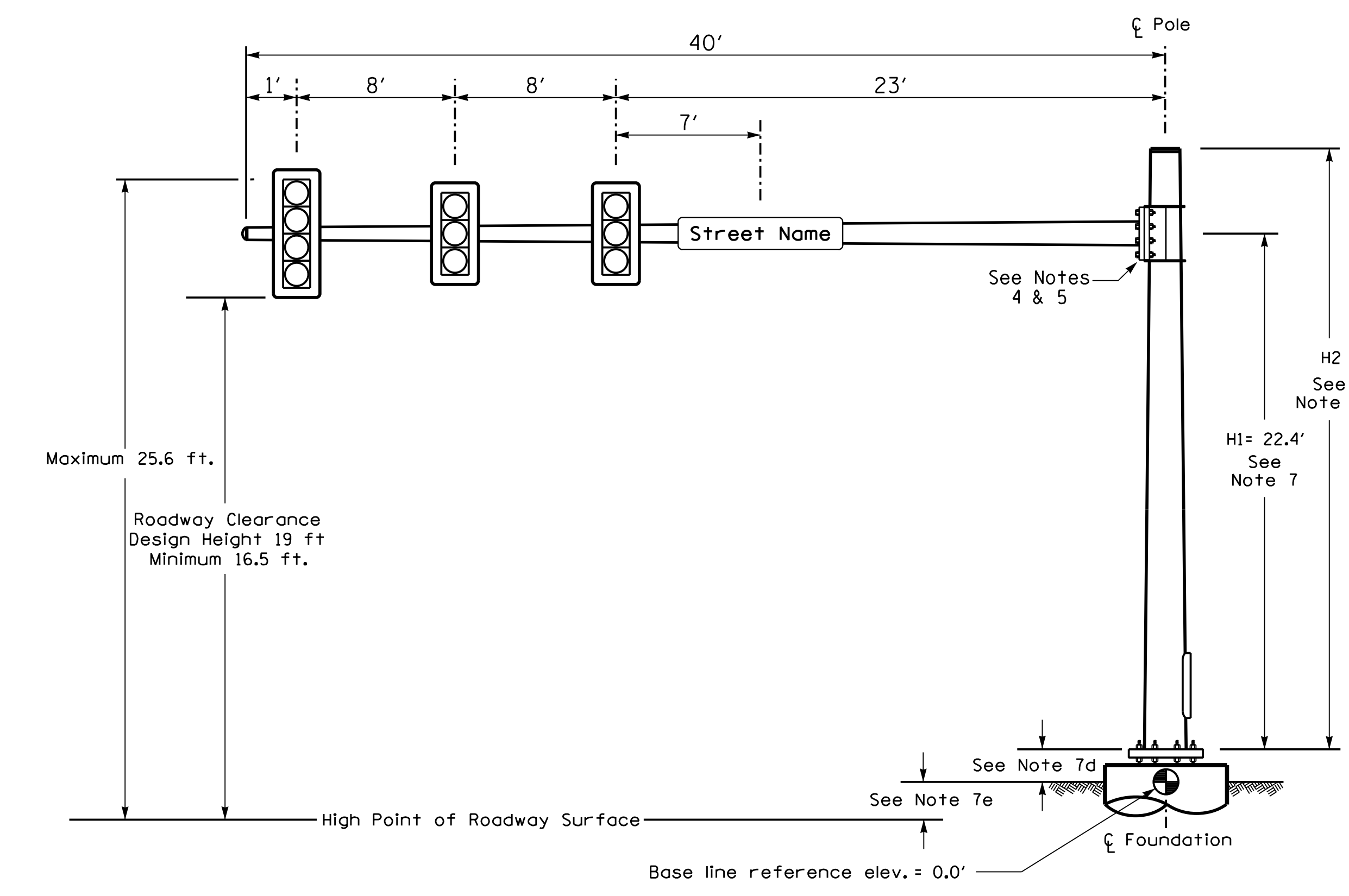

Elevation View

SPECIAL NOTE

The contractor is responsible for verifying that the mast arm attachment height (H1) will provide the "Design Height" clearance from the roadway before submitting final shop drawings for approval. Verify elevation data below which was obtained by field measurement or from available project survey data.

Elevation Data for Mast Arm Attachment (H1)

Elevation Differences for:	Pole 1	Pole 2
Baseline reference point at ϕ Foundation @ ground level	0.0 ft.	0.0 ft.
Elevation difference at High point of roadway surface	+0.95 ft.	+1.38 ft.
Elevation difference at Edge of travelway or face of curb	+0.92 ft.	+1.03 ft.

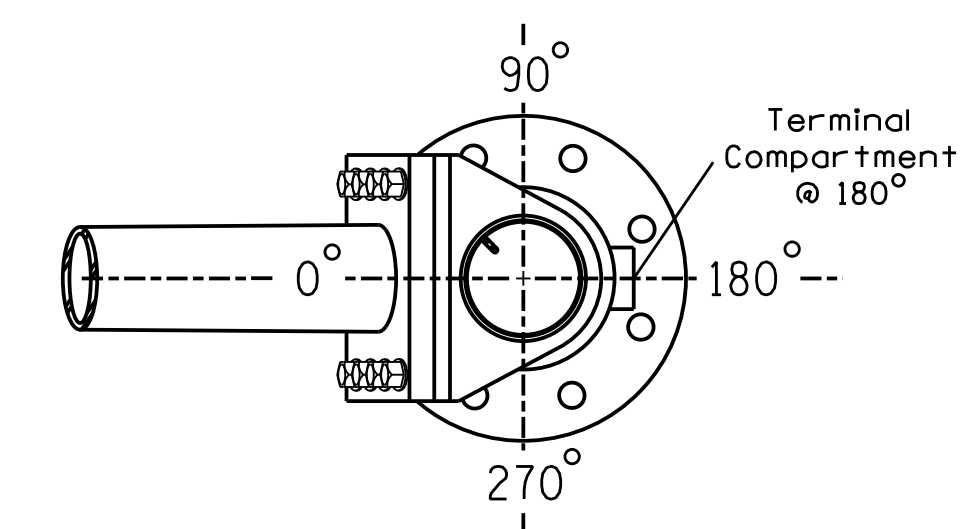

POLE RADIAL ORIENTATION

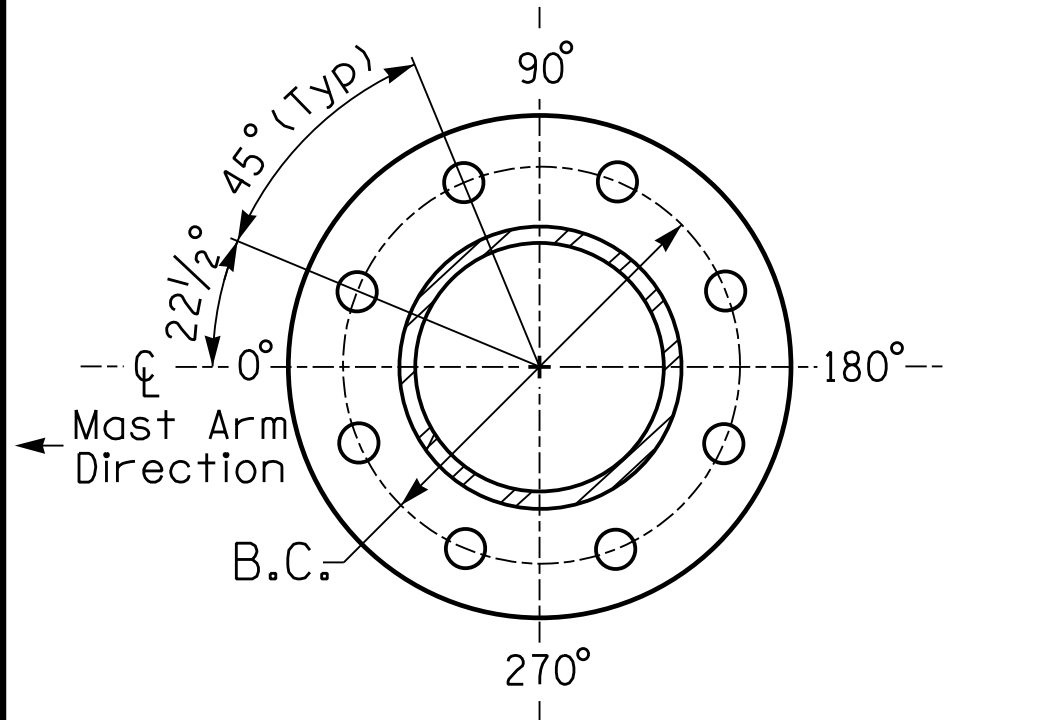

8 BOLT BASE PLATE DETAIL
See Note 6

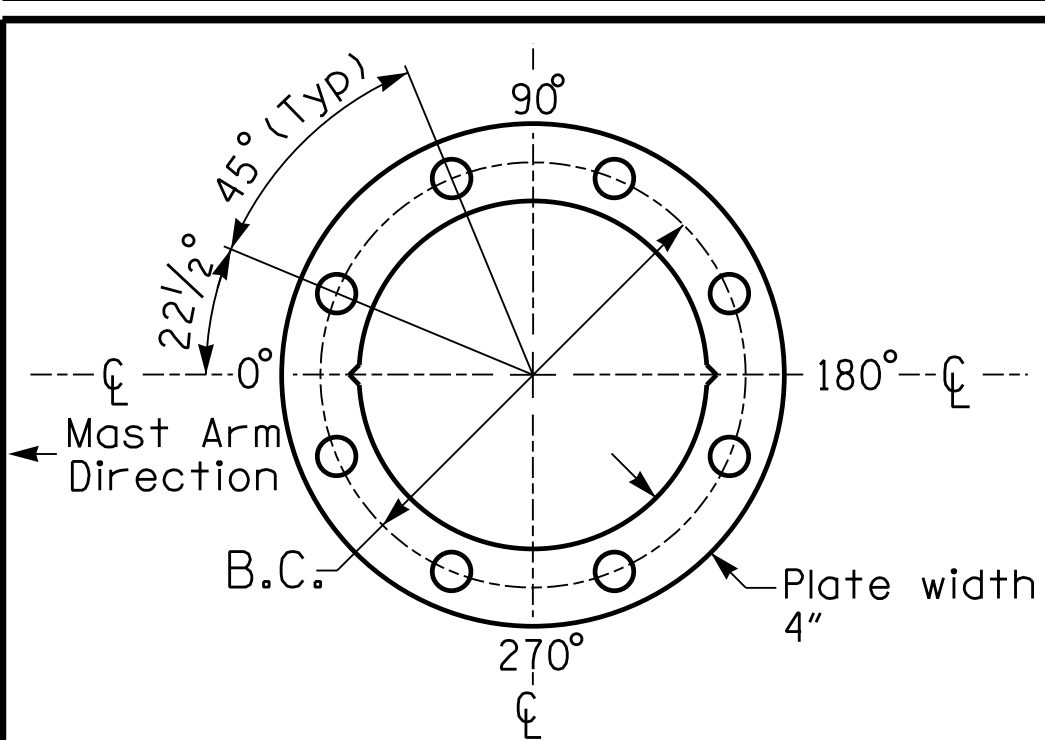

BASE PLATE TEMPLATE & ANCHOR BOLT LOCK PLATE DETAIL
For 8 Bolt Base Plate

METAL POLE No. 1,2

PROJECT REFERENCE NO.	SHEET NO.
R-5021	Sig. 38.8

MAST ARM LOADING SCHEDULE

LOADING SYMBOL	DESCRIPTION	AREA	SIZE	WEIGHT
	RIGID MOUNTED SIGNAL HEAD 12"-3 SECTION-WITH BACKPLATE	9.3 S.F.	25.5" W X 52.5" L	60 LBS
	RIGID MOUNTED SIGNAL HEAD 12"-4 SECTION-WITH BACKPLATE	11.5 S.F.	25.5" W X 66.0" L	74 LBS
	STREET NAME SIGN RIGID MOUNTED	16.0 S.F.	24.0" W X 96.0" L	36 LBS

NOTES

DESIGN REFERENCE MATERIAL

- Design the traffic signal structure and foundation in accordance with:
 - The 6th Edition 2013 AASHTO "Standard Specifications for Structural Supports for Highway Signs, Luminaires, and Traffic Signals, including all of the latest interim revisions.
 - The 2018 NCDOT "Standard Specifications for Roads and Structures." The latest addenda to the specifications can be found in the traffic signal project special provisions.
 - The 2018 NCDOT Roadway Standard Drawings.
 - The traffic signal project plans and special provisions.
 - The NCDOT "Metal Pole Standards" located at the following NCDOT website: <https://connect.ncdot.gov/resources/safety/Pages/ITS-Design-Resources.aspx>

DESIGN REQUIREMENTS

- Design the traffic signal structure using the loading conditions shown in the elevation views. These are anticipated worst case "design loads" and may not represent the actual loads that will be applied at the time of the installation. The contractor should refer to the traffic signal plans for the actual loads that will be applied at the time of the installation.
- Design all signal supports using stress ratios that do not exceed 0.9.
- The camber design for the mast arm deflection should provide an appearance of a low pitched arch where the tip or the free end of the mast arm does not deflect below horizontal when fully loaded.
- A clamp-type bolted mast arm-to-pole connection may be used instead of the welded ring stiffened box connection shown as long as the connection meets all of the design requirements.
- Design base plate with 8 anchor bolt holes. Provide 2 inch x 60 inch anchor bolts.
- The mast arm attachment height (H1) shown is based on the following design assumptions:
 - Mast arm slope and deflection are not considered in determining the arm attachment height as they are assumed to offset each other.
 - Signal heads are rigidly mounted and vertically centered on the mast arm.
 - The roadway clearance height for design is as shown in the elevation views.
 - The top of the pole base plate is 0.75 feet above the ground elevation.
 - Refer to the Elevation Data Chart for the elevation differences between the proposed foundation ground level and the high point of the roadway.
- The pole manufacturer will determine the total height (H2) of each pole using the greater of the following:
 - Mast arm attachment height (H1) plus 2 feet, or
 - H1 plus 1/2 of the total height of the mast arm attachment assembly plus 1 foot.
- If pole location adjustments are required, the contractor must gain approval from the Engineer as this may affect the mast arm lengths and arm attachment heights. The contractor may contact the Signal Design Section Senior Structural Engineer for assistance at (919) 814-5000.
- The contractor is responsible for verifying that the mast arm length shown will allow proper positioning of the signal heads over the roadway.
- The contractor is responsible for providing soil penetration testing data (SPT) to the pole manufacturer so site specific foundations can be designed.

NCDOT Wind Zone 2 (130 mph)

DOCUMENT NOT CONSIDERED FINAL UNLESS ALL SIGNATURES COMPLETED

	NC 211 (Howe Street) at Tidewater Plaza/Sandy Lane		
	Division 03 Brunswick Co. Southport	PLAN DATE: June 2017 REVIEWED BY: A.D. Klinskyk PREPARED BY: A.H. Thornburg REVIEWED BY: N.R. Simmons	
SCALE 0 N/A N/A	REVISIONS INIT. DATE	SIGNATURE _____ DATE 9/10/2021	SIG. INVENTORY NO. 03-0897

Design Loading for METAL POLE NO. 3

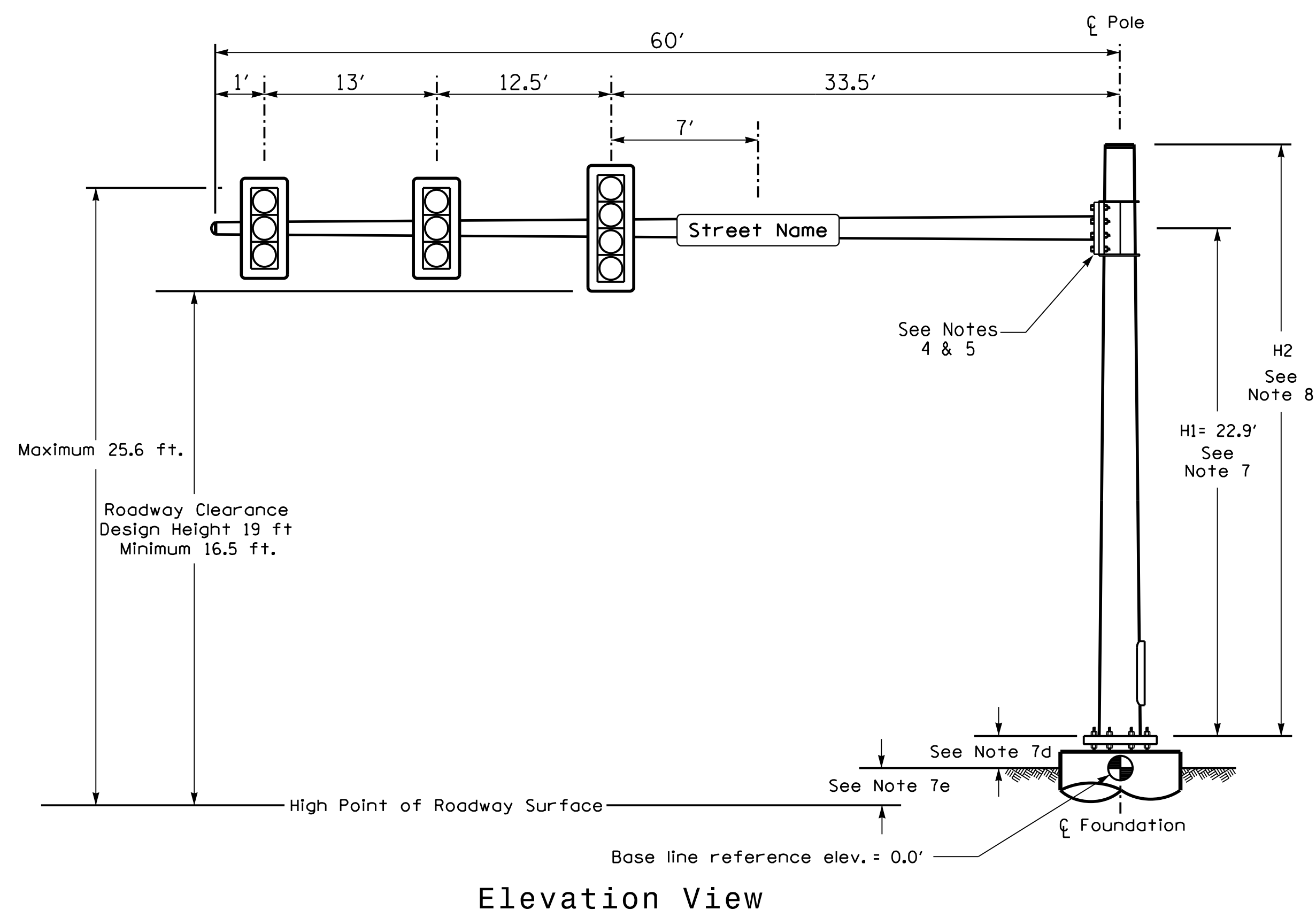

Elevation View

Design Loading for METAL POLE NO. 4

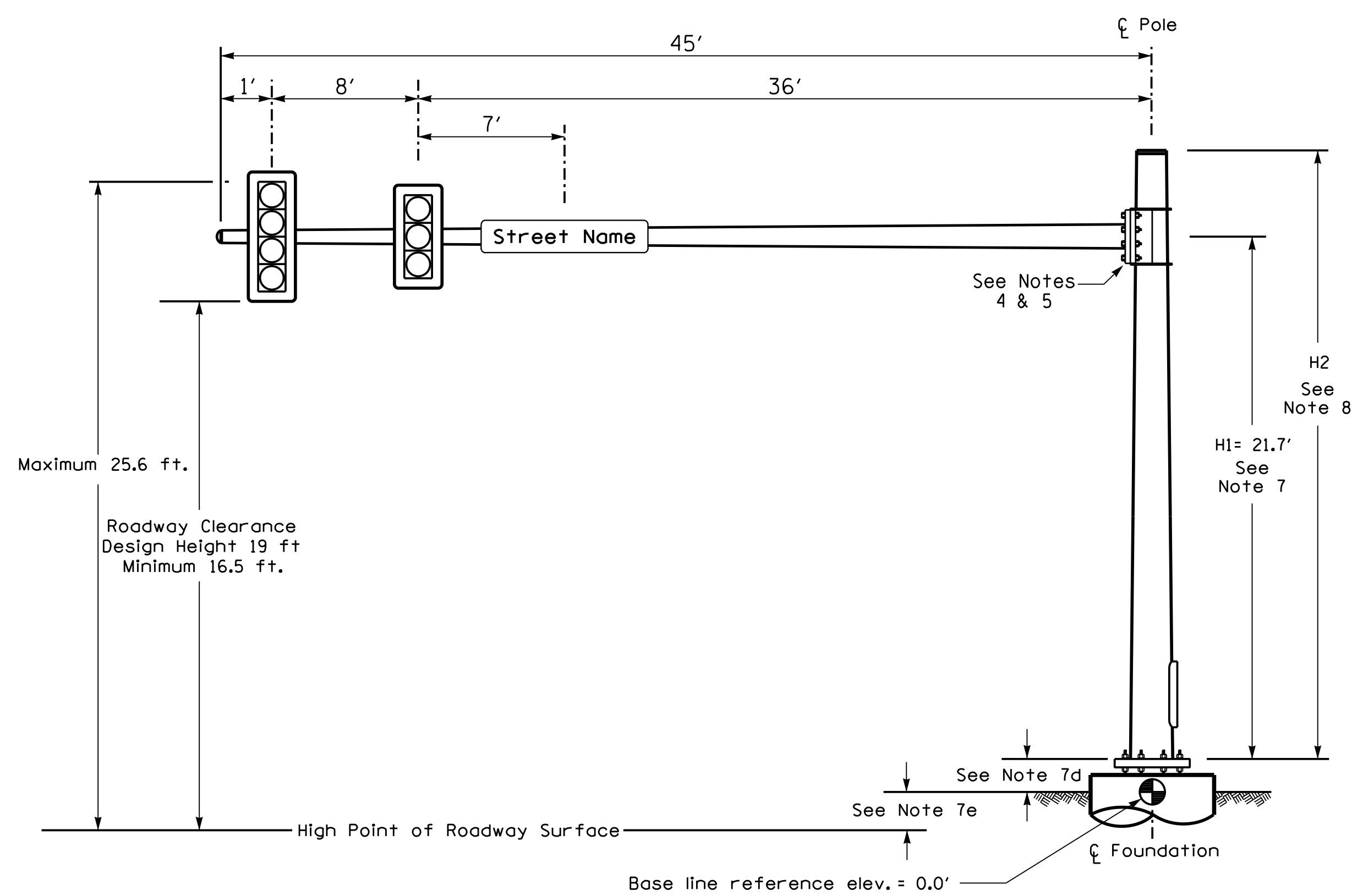

Elevation View

SPECIAL NOTE

The contractor is responsible for verifying that the mast arm attachment height (H1) will provide the "Design Height" clearance from the roadway before submitting final shop drawings for approval. Verify elevation data below which was obtained by field measurement or from available project survey data.

Elevation Data for Mast Arm Attachment (H1)

Elevation Differences for:	Pole 3	Pole 4
Baseline reference point at \odot Foundation \odot ground level	0.0 ft.	0.0 ft.
Elevation difference at High point of roadway surface	+1.90 ft.	+0.67 ft.
Elevation difference at Edge of travelway or face of curb	+0.88 ft.	+0.31 ft.

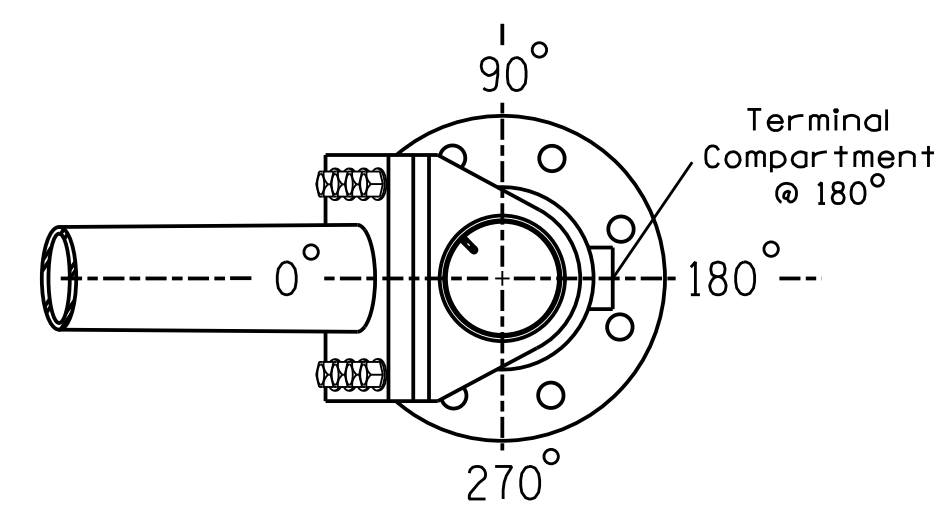

POLE RADIAL ORIENTATION

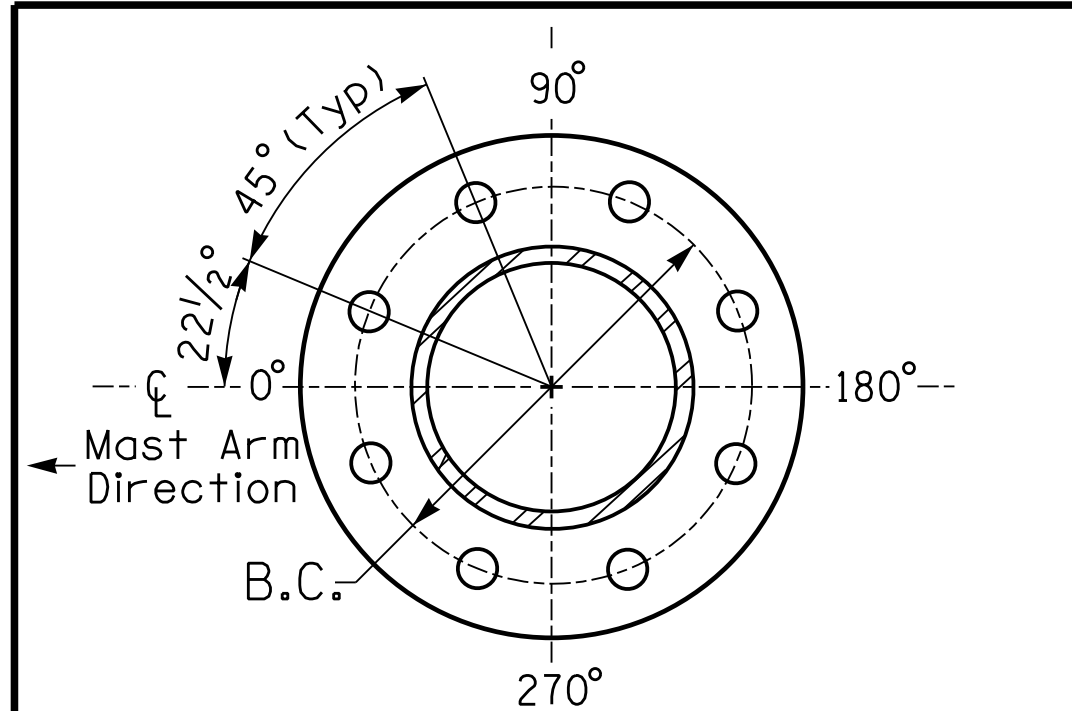

8 BOLT BASE PLATE DETAIL

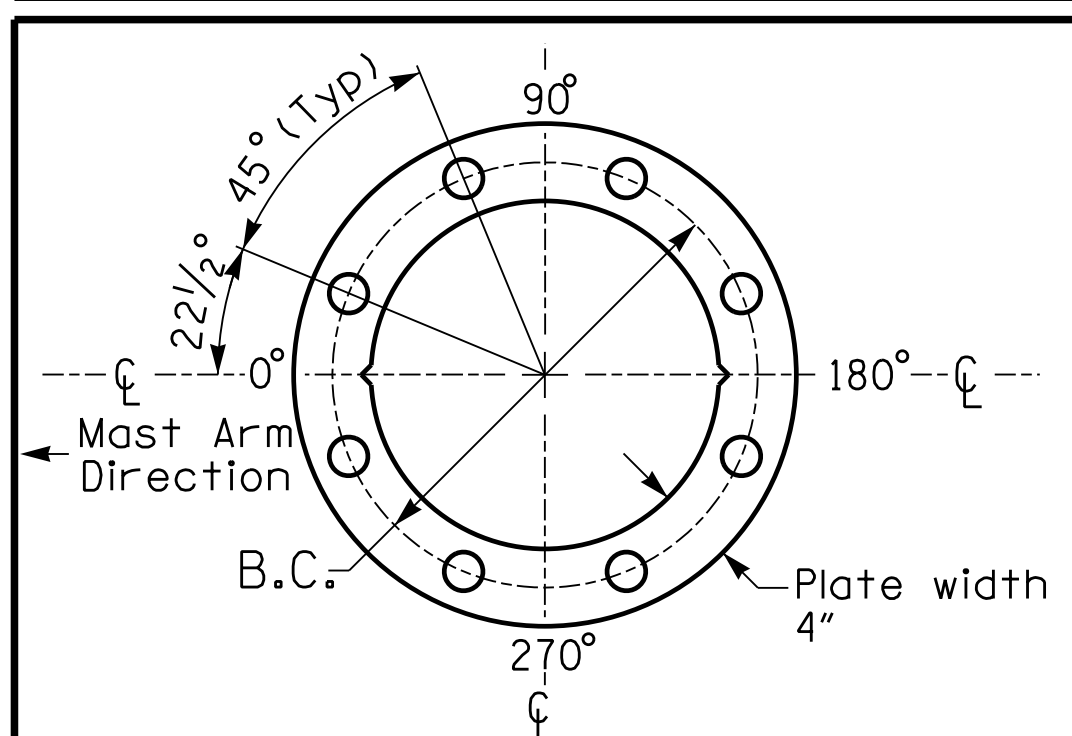

BASE PLATE TEMPLATE & ANCHOR BOLT LOCK PLATE DETAIL For 8 Bolt Base Plate

MAST ARM LOADING SCHEDULE

LOADING SYMBOL	DESCRIPTION	AREA	SIZE	WEIGHT
	RIGID MOUNTED SIGNAL HEAD 12"-3 SECTION-WITH BACKPLATE	9.3 S.F.	25.5" W X 52.5" L	60 LBS
	RIGID MOUNTED SIGNAL HEAD 12"-4 SECTION-WITH BACKPLATE	11.5 S.F.	25.5" W X 66.0" L	74 LBS
	STREET NAME SIGN RIGID MOUNTED	16.0 S.F.	24.0" W X 96.0" L	36 LBS

NOTES

DESIGN REFERENCE MATERIAL

- Design the traffic signal structure and foundation in accordance with:
 - The 6th Edition 2013 AASHTO "Standard Specifications for Structural Supports for Highway Signs, Luminaires, and Traffic Signals, including all of the latest interim revisions.
 - The 2018 NCDOT "Standard Specifications for Roads and Structures." The latest addenda to the specifications can be found in the traffic signal project special provisions.
 - The 2018 NCDOT Roadway Standard Drawings.
 - The traffic signal project plans and special provisions.
 - The NCDOT "Metal Pole Standards" located at the following NCDOT website: <https://connect.ncdot.gov/resources/safety/Pages/ITS-Design-Resources.aspx>

DESIGN REQUIREMENTS

- Design the traffic signal structure using the loading conditions shown in the elevation views. These are anticipated worst case "design loads" and may not represent the actual loads that will be applied at the time of the installation. The contractor should refer to the traffic signal plans for the actual loads that will be applied at the time of the installation.
- Design all signal supports using stress ratios that do not exceed 0.9.
- The camber design for the mast arm deflection should provide an appearance of a low pitched arch where the tip or the free end of the mast arm does not deflect below horizontal when fully loaded.
- A clamp-type bolted mast arm-to-pole connection may be used instead of the welded ring stiffened box connection shown as long as the connection meets all of the design requirements.
- Design base plate with 8 anchor bolt holes. Provide 2 inch x 60 inch anchor bolts.
- The mast arm attachment height (H1) shown is based on the following design assumptions:
 - Mast arm slope and deflection are not considered in determining the arm attachment height as they are assumed to offset each other.
 - Signal heads are rigidly mounted and vertically centered on the mast arm.
 - The roadway clearance height for design is as shown in the elevation views.
 - The top of the pole base plate is 0.75 feet above the ground elevation.
 - Refer to the Elevation Data Chart for the elevation differences between the proposed foundation ground level and the high point of the roadway.
- The pole manufacturer will determine the total height (H2) of each pole using the greater of the following:
 - Mast arm attachment height (H1) plus 2 feet, or
 - H1 plus 1/2 of the total height of the mast arm attachment assembly plus 1 foot.
- If pole location adjustments are required, the contractor must gain approval from the Engineer as this may affect the mast arm lengths and arm attachment heights. The contractor may contact the Signal Design Section Senior Structural Engineer for assistance at (919) 814-5000.
- The contractor is responsible for verifying that the mast arm length shown will allow proper positioning of the signal heads over the roadway.
- The contractor is responsible for providing soil penetration testing data (SPT) to the pole manufacturer so site specific foundations can be designed.

NCDOT Wind Zone 2 (130 mph)

DOCUMENT NOT CONSIDERED FINAL UNLESS ALL SIGNATURES COMPLETED

	NC 211 (Howe Street) at Tidewater Plaza/Sandy Lane		
	Division 03 Brunswick Co. Southport	PLAN DATE: June 2017 REVIEWED BY: A.D. Klinskyk PREPARED BY: A.H. Thornburg REVIEWED BY: N.R. Simmons	
SCALE 0 N/A N/A	REVISIONS INIT. DATE	SIGNATURE _____ DATE 9/10/2021	SIG. INVENTORY NO. 03-0897

DEFAULT PHASING DIAGRAM

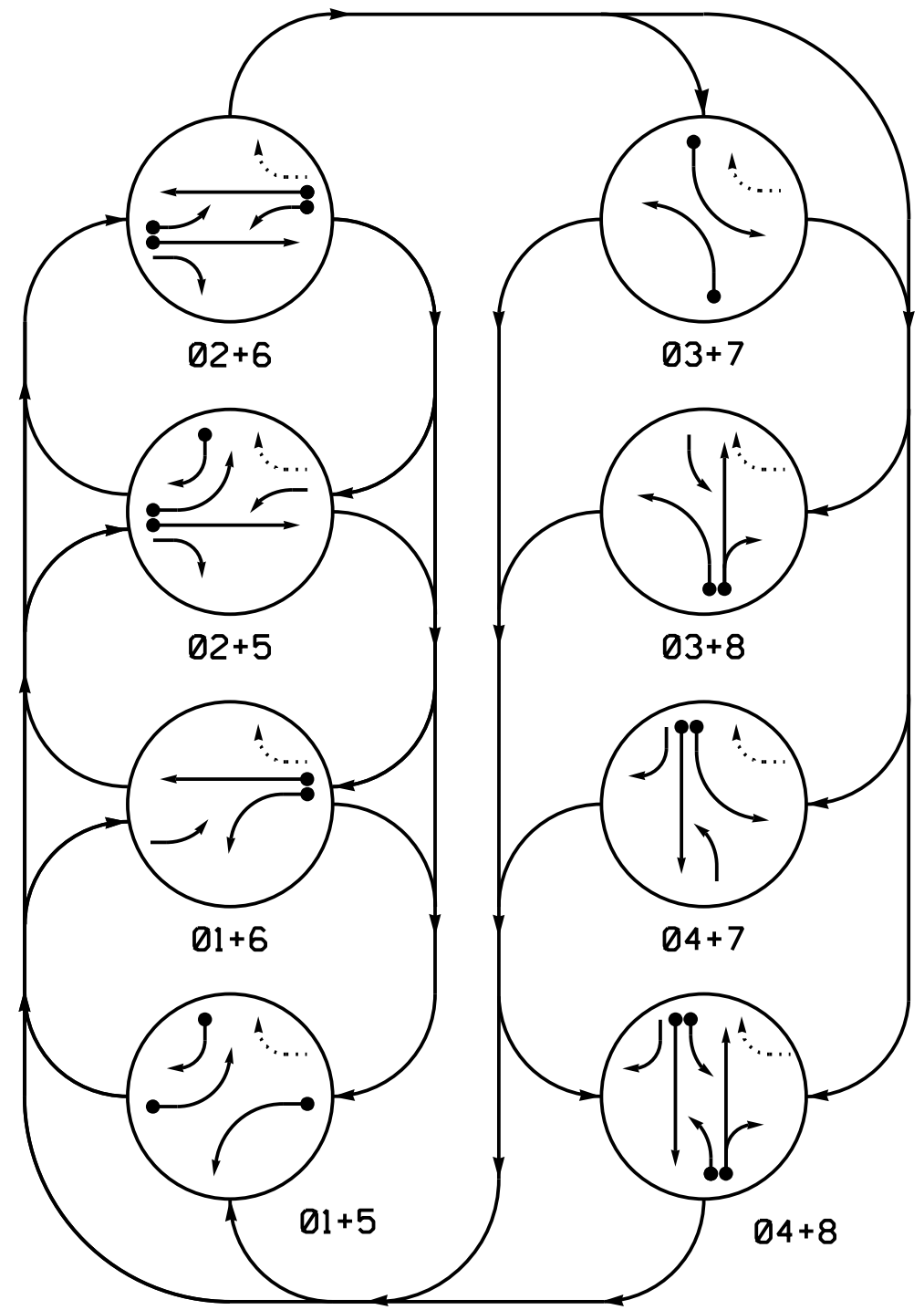

ALTERNATE PHASING DIAGRAM

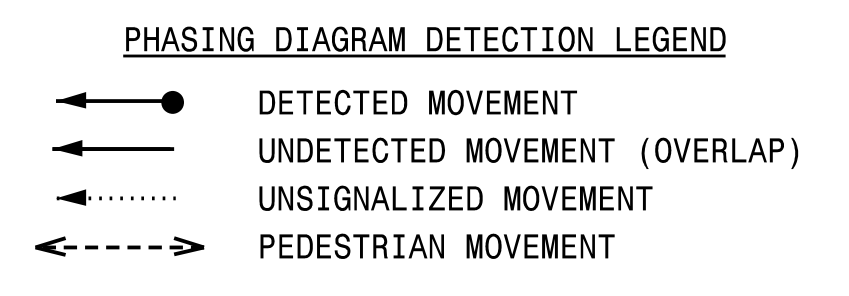
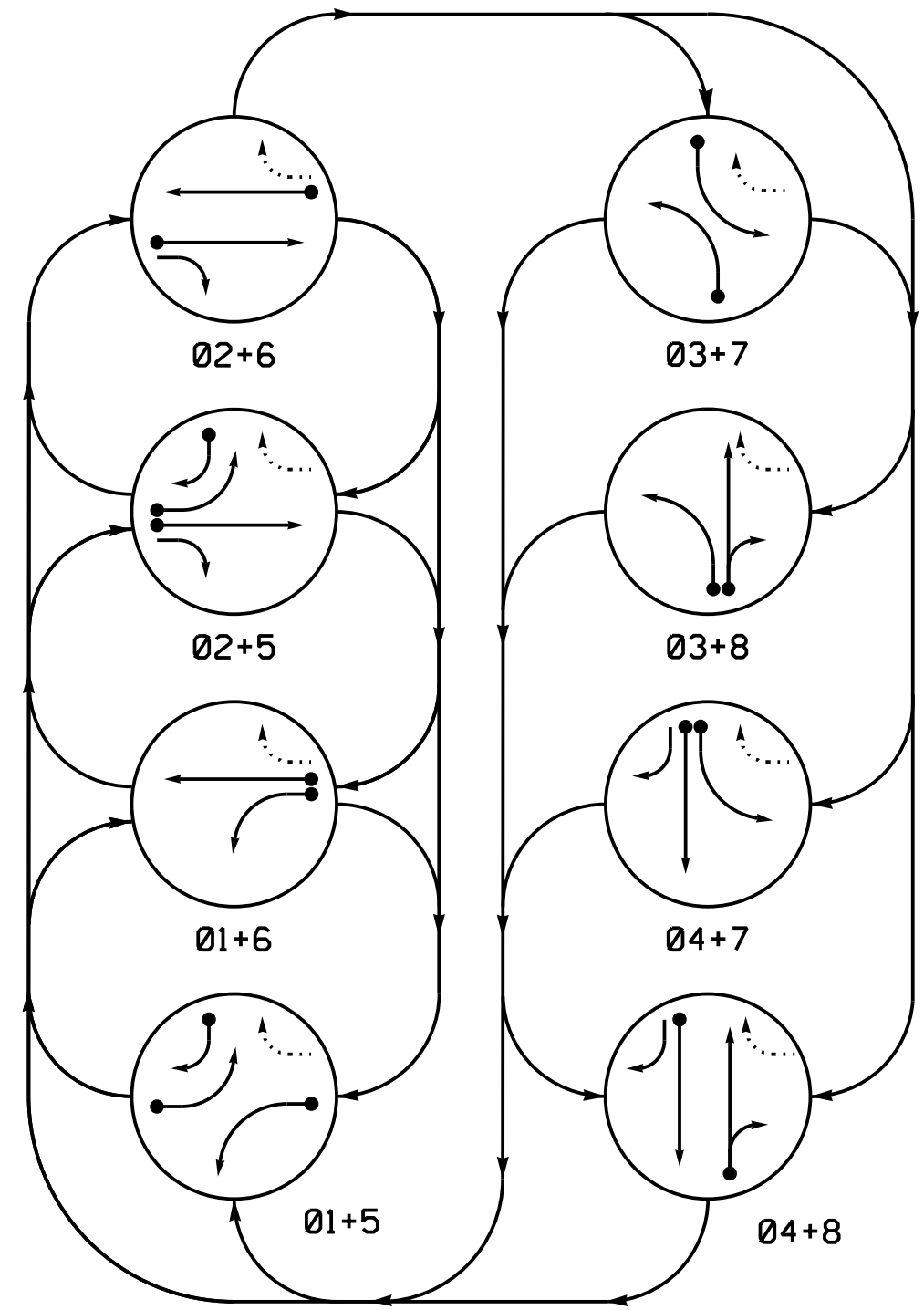

SIGNAL FACE I.D.

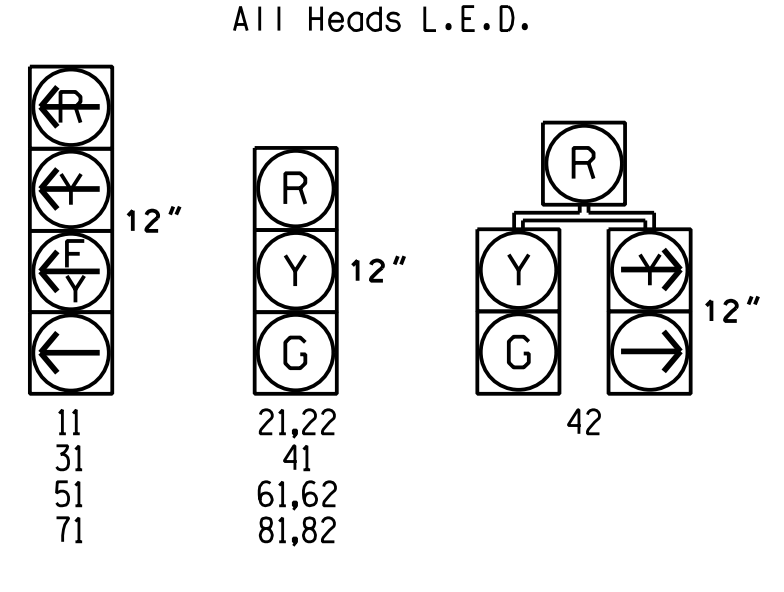

DEFAULT PHASING TABLE OF OPERATION

SIGNAL FACE	PHASE							
	01+5	01+6	02+5	02+6	03+7	03+8	04+7	04+8
11	—	—	—	—	—	—	—	—
21,22	R	R	G	G	R	R	R	R
31	R	R	R	R	—	—	—	—
41	R	R	R	R	R	G	G	R
42	R	R	R	R	R	G	G	R
51	—	—	—	—	—	—	—	—
61,62	R	G	R	G	R	R	R	Y
71	R	R	R	R	—	—	—	—
81,82	R	R	R	R	R	G	R	G

ALTERNATE PHASING TABLE OF OPERATION

SIGNAL FACE	PHASE							
	01+5	01+6	02+5	02+6	03+7	03+8	04+7	04+8
11	—	—	—	—	—	—	—	—
21,22	R	R	G	G	R	R	R	Y
31	R	R	R	R	—	—	—	—
41	R	R	R	R	R	G	G	R
42	R	R	R	R	R	G	G	R
51	—	—	—	—	—	—	—	—
61,62	R	G	R	G	R	R	R	Y
71	R	R	R	R	—	—	—	—
81,82	R	R	R	R	R	G	R	G

OASIS 2070 LOOP & DETECTOR INSTALLATION CHART

LOOP	SIZE (FT)	DISTANCE FROM STOPBAR (FT)	TURNS	NEW LOOP	DETECTOR PROGRAMMING		STRETCH TIME	DELAY TIME	SYSTEM	LOOP CARD
					PHASE	CALLING EXTENSION FULL TIME DELAY				
1A	6X40	0	*	*	1	Y	Y	—	**15	—
2A	6X6	300	*	*	2	Y	Y	1.6	—	—
2B	6X6	90	*	*	2	Y	Y	—	—	—
3A	6X40	0	*	*	3	Y	Y	—	**15	—
4A	6X40	0	*	*	4	Y	Y	—	—	—
5A	6X40	0	*	*	5	Y	Y	—	**15	—
5B	6X40	0	*	*	5	Y	Y	—	15	—
6A	6X6	70	*	*	6	Y	Y	—	—	—
7A	6X40	0	*	*	7	Y	Y	—	**15	—
8A	6X40	0	*	*	8	Y	Y	—	10	—

* Multizone Microwave Detection.
 ** Disable phase 2,4,6 and 8 call for 1A,3A,5A and 7A during alternate phasing operation.
 *** Reduce delay to 0 seconds for 1A and 5A and reduce delay to 3 seconds for 3A and 7A during alternate phasing operation.

8 Phase Fully Actuated (NC 133 Closed Loop System)

NOTES

- Refer to "Roadway Standard Drawings NCDOT" dated January 2018 and "Standard Specifications for Roads and Structures" dated January 2018.
- Do not program signal for late night flashing operation unless otherwise directed by the Engineer.
- Phase 1 and/or 5 may be lagged.
- Phase 3 and/or 7 may be lagged.
- Set all detector units to presence mode.
- Locate new cabinet so as not to obstruct sight distance of vehicles turning right on red.
- The Division Traffic Engineer will determine the hours of use for each phasing plan.
- Incorporate Microwave Detection system for vehicle detection.
- Provide the Engineer with the Manufacturer's approved Microwave Detection locations and mounting heights to obtain detection zones as shown.
- Maximum times shown in timing chart are for free-run operation only. Coordinated signal system timing values supersede these values.
- Closed loop system data: Controller Asset #: 0215.

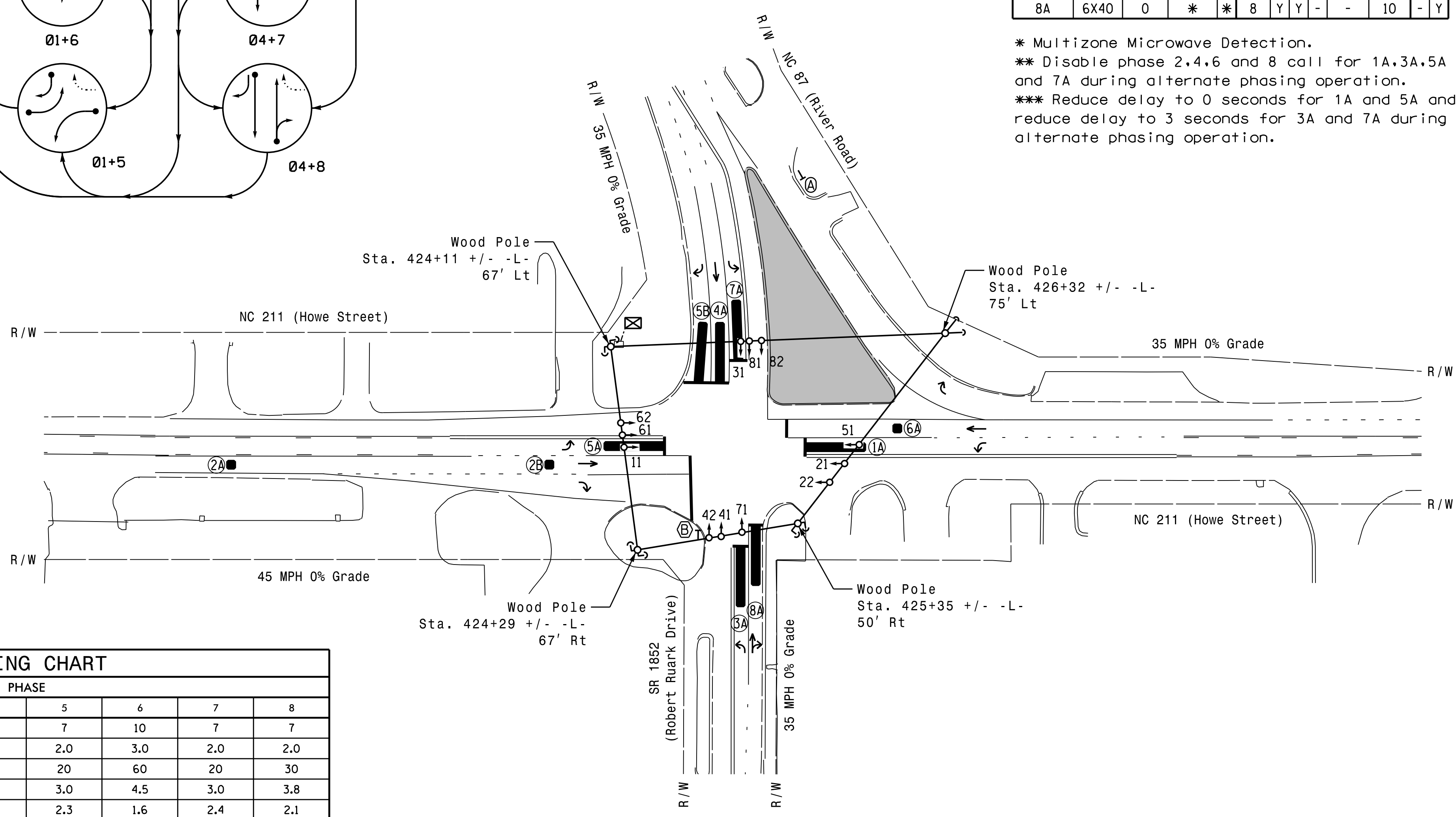

OASIS 2070 TIMING CHART

FEATURE	PHASE							
	1	2	3	4	5	6	7	8
Min Green 1 *	7	12	7	7	7	10	7	7
Extension 1 *	2.0	2.0	2.0	2.0	2.0	3.0	2.0	2.0
Max Green 1 *	20	60	20	30	20	60	20	30
Yellow Clearance	3.0	4.5	3.0	3.8	3.0	4.5	3.0	3.8
Red Clearance	2.4	1.6	2.9	2.1	2.3	1.6	2.4	2.1
Red Revert	2.0	2.0	2.0	2.0	2.0	2.0	2.0	2.0
Walk 1 *	-	-	-	-	-	-	-	-
Don't Walk 1	-	-	-	-	-	-	-	-
Seconds Per Actuation *	-	-	-	-	-	-	-	-
Max Variable Initial *	-	-	-	-	-	-	-	-
Time Before Reduction *	-	-	-	-	-	-	-	-
Time To Reduce *	-	-	-	-	-	-	-	-
Minimum Gap	-	-	-	-	-	-	-	-
Recall Mode	-	MIN RECALL	-	-	-	MIN RECALL	-	-
Vehicle Call Memory	-	YELLOW	-	-	-	YELLOW	-	-
Dual Entry	-	-	-	ON	-	-	-	ON
Simultaneous Gap	ON	ON	ON	ON	ON	ON	ON	ON

* These values may be field adjusted. Do not adjust Min Green and Extension times for phases 2 and 6 lower than what is shown. Min Green for all other phases should not be lower than 4 seconds.

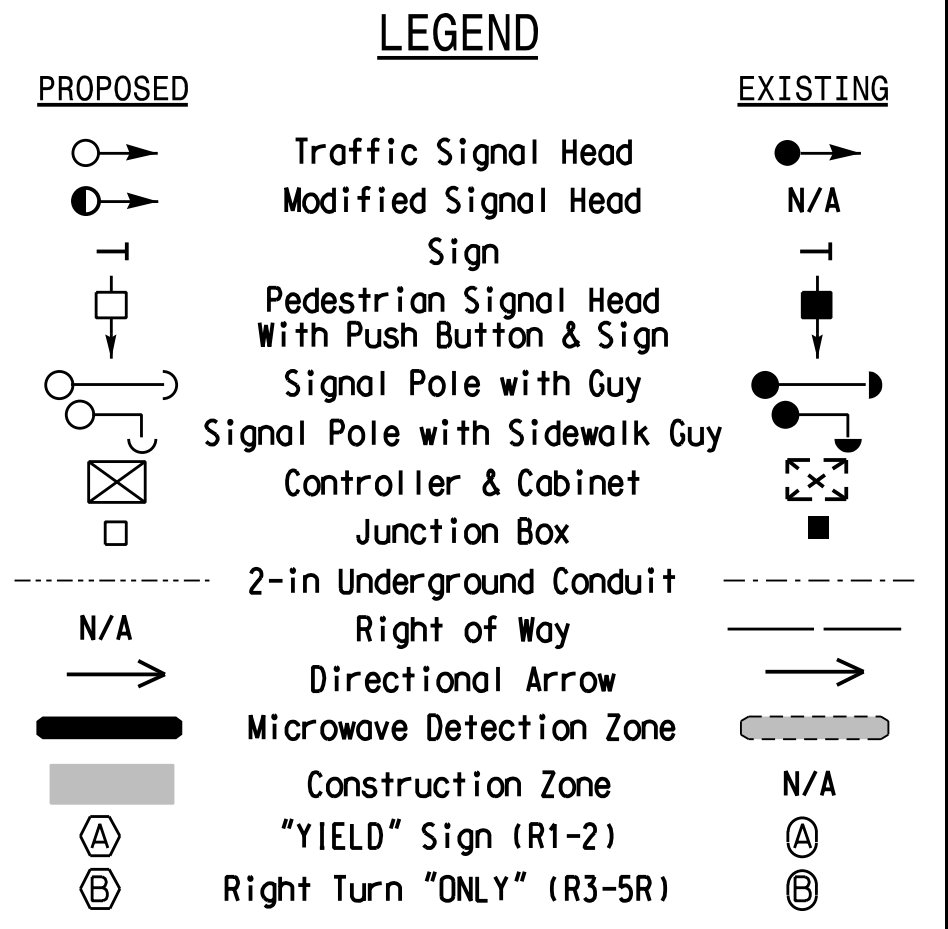

Signal Upgrade
 Temporary Design 1
 Construction Phase 1

DOCUMENT NOT CONSIDERED FINAL UNLESS ALL SIGNATURES COMPLETED

	Prepared for: NC 211 (Howe Street) at NC 87 (River Road)/ SR 1852 (Robert Ruark Drive)		SEAL
	Division 03 Brunswick Co. Southport PLAN DATE: June 2017 PREPARED BY: A.H. Thornburg REVIEWED BY: A.D. Klinksiek	REVIEWED BY: N.R. Simmons	

HNTB
 HNTB NORTH CAROLINA, P.C.
 343 E. Six Forks Road, Suite 200
 Raleigh, North Carolina 27609
 NC License No: C-1554
 (919) 546-8997

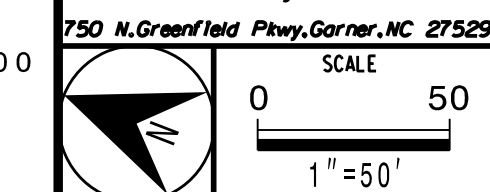

LOGICAL I/O PROCESSOR PROGRAMMING DETAIL TO PRODUCE SPECIAL FYA-PPLT SIGNAL SEQUENCE

(program controller as shown below)

- FROM MAIN MENU PRESS '2' (PHASE CONTROL), THEN '1' (PHASE CONTROL FUNCTIONS). SCROLL TO THE BOTTOM OF THE MENU AND ENABLE ACT LOGIC COMMANDS 1, 2, 3, 4, 5, 6, 7, 8, 9, 10, 11, AND 12.
- FROM MAIN MENU PRESS '6' (OUTPUTS), THEN '3' (LOGICAL I/O PROCESSOR).

LOGICAL I/O COMMAND #1 (+/-COMMAND#)
IF ACTIVE PHASE #1 IS ON
AND RED CLEAR ON PHASE #1 IS ON

↓
SCROLL DOWN

THEN:
SET OUTPUT ASSIGNMENT #50 ON
SET OUTPUT ASSIGNMENT #51 OFF

PRESS '+'

NOTE: LOGIC FOR PHASE 1 RED CLEAR WHEN TRANSITIONING FROM PHASE 1 TO PHASE 2 (HEAD 11).

LOGICAL I/O COMMAND #7 (+/-COMMAND#)
IF ACTIVE PHASE #3 IS ON
AND RED CLEAR ON PHASE #3 IS ON

↓
SCROLL DOWN

THEN:
SET OUTPUT ASSIGNMENT #47 ON
SET OUTPUT ASSIGNMENT #48 OFF

PRESS '+'

NOTE: LOGIC FOR PHASE 3 RED CLEAR WHEN TRANSITIONING FROM PHASE 3 TO PHASE 4 (HEAD 31).

LOGICAL I/O COMMAND #2 (+/-COMMAND#)
IF ACTIVE PHASE #1 IS ON

↓
SCROLL DOWN

THEN:
SET OUTPUT ASSIGNMENT #52 OFF

PRESS '+'

NOTE: LOGIC FOR SWITCHING FLASHING YELLOW ARROW "OFF" DURING PHASE 1 (HEAD 11).

LOGICAL I/O COMMAND #8 (+/-COMMAND#)
IF ACTIVE PHASE #3 IS ON

↓
SCROLL DOWN

THEN:
SET OUTPUT ASSIGNMENT #49 OFF

PRESS '+'

NOTE: LOGIC FOR SWITCHING FLASHING YELLOW ARROW "OFF" DURING PHASE 3 (HEAD 31).

LOGICAL I/O COMMAND #3 (+/-COMMAND#)
IF YELLOW ON PHASE #1 IS ON

↓
SCROLL DOWN

THEN:
SET OUTPUT ASSIGNMENT #51 ON

PRESS '+'

NOTE: LOGIC FOR YELLOW ARROW CLEARANCE FROM PHASE 1 (HEAD 11).

LOGICAL I/O COMMAND #9 (+/-COMMAND#)
IF YELLOW ON PHASE #3 IS ON

↓
SCROLL DOWN

THEN:
SET OUTPUT ASSIGNMENT #48 ON

PRESS '+'

NOTE: LOGIC FOR YELLOW ARROW CLEARANCE FROM PHASE 3 (HEAD 31).

LOGICAL I/O COMMAND #4 (+/-COMMAND#)
IF ACTIVE PHASE #5 IS ON
AND RED CLEAR ON PHASE #5 IS ON

↓
SCROLL DOWN

THEN:
SET OUTPUT ASSIGNMENT #42 ON
SET OUTPUT ASSIGNMENT #43 OFF

PRESS '+'

NOTE: LOGIC FOR PHASE 5 RED CLEAR WHEN TRANSITIONING FROM PHASE 5 TO PHASE 6 (HEAD 51).

LOGICAL I/O COMMAND #10 (+/-COMMAND#)
IF ACTIVE PHASE #7 IS ON
AND RED CLEAR ON PHASE #7 IS ON

↓
SCROLL DOWN

THEN:
SET OUTPUT ASSIGNMENT #39 ON
SET OUTPUT ASSIGNMENT #40 OFF

PRESS '+'

NOTE: LOGIC FOR PHASE 7 RED CLEAR WHEN TRANSITIONING FROM PHASE 7 TO PHASE 8 (HEAD 71).

LOGICAL I/O COMMAND #5 (+/-COMMAND#)
IF ACTIVE PHASE #5 IS ON

↓
SCROLL DOWN

THEN:
SET OUTPUT ASSIGNMENT #44 OFF

PRESS '+'

NOTE: LOGIC FOR SWITCHING FLASHING YELLOW ARROW "OFF" DURING PHASE 5 (HEAD 51).

LOGICAL I/O COMMAND #11 (+/-COMMAND#)
IF ACTIVE PHASE #7 IS ON

↓
SCROLL DOWN

THEN:
SET OUTPUT ASSIGNMENT #41 OFF

PRESS '+'

NOTE: LOGIC FOR SWITCHING FLASHING YELLOW ARROW "OFF" DURING PHASE 7 (HEAD 71).

LOGICAL I/O COMMAND #6 (+/-COMMAND#)
IF YELLOW ON PHASE #5 IS ON

↓
SCROLL DOWN

THEN:
SET OUTPUT ASSIGNMENT #43 ON

PRESS '+'

NOTE: LOGIC FOR YELLOW ARROW CLEARANCE FROM PHASE 5 (HEAD 51).

LOGICAL I/O COMMAND #12 (+/-COMMAND#)
IF YELLOW ON PHASE #7 IS ON

↓
SCROLL DOWN

THEN:
SET OUTPUT ASSIGNMENT #40 ON

PRESS '+'

NOTE: LOGIC FOR YELLOW ARROW CLEARANCE FROM PHASE 7 (HEAD 71).

LOGIC I/O PROCESSOR PROGRAMMING COMPLETE

OUTPUT REFERENCE SCHEDULE	
USE TO INTERPRET LOGIC PROCESSOR	
OUTPUT 39	= Overlap D Red
OUTPUT 40	= Overlap D Yellow
OUTPUT 41	= Overlap D Green
OUTPUT 42	= Overlap C Red
OUTPUT 43	= Overlap C Yellow
OUTPUT 44	= Overlap C Green
OUTPUT 47	= Overlap B Red
OUTPUT 48	= Overlap B Yellow
OUTPUT 49	= Overlap B Green
OUTPUT 50	= Overlap A Red
OUTPUT 51	= Overlap A Yellow
OUTPUT 52	= Overlap A Green

THIS ELECTRICAL DETAIL IS FOR
THE SIGNAL DESIGN: 03-0215T1
DESIGNED: June 2017
SEALED: 9/10/2021
REVISED: N/A

Electrical Detail - Sheet 2 of 8
Signal Upgrade
Temporary Design 1

DOCUMENT NOT CONSIDERED FINAL
UNLESS ALL SIGNATURES COMPLETED

HNTB HNTB NORTH CAROLINA, P.C.
343 E. Six Forks Road, Suite 200
Raleigh, North Carolina 27609
NC License No: C-1554
(919) 546-8997

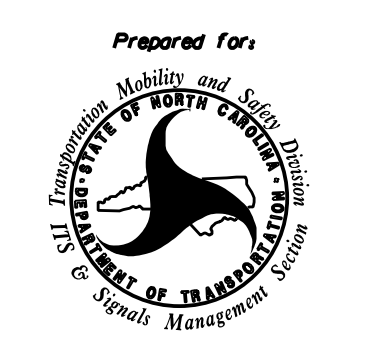
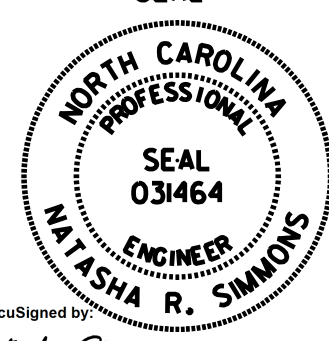
 Prepared for: Department of Transportation North Carolina Division of Signal Management	NC 211 (Howe Street) at NC 87 (River Road)/ SR 1852 (Robert Ruark Drive)		SEAL  NORTH CAROLINA PROFESSIONAL ENGINEER SEAL 031464 NATASHA R. SIMMONS
	Division 03 Brunswick Co. Southport	PLAN DATE: June 2017 PREPARED BY: A.H. Thornburg	
REVISIONS			INIT. DATE _____ _____ _____
750 N. Greenfield Pkwy, Corner, NC 27529			DocuSigned by: Natasha Simmons 9/10/2021 SIGNATURE DATE _____ _____ SIG. INVENTORY NO. 03-0215T1

INPUT PAGE 2 ASSIGNMENT PROGRAMMING DETAIL FOR ALTERNATE PHASING - LOOP 1A
(program controller as shown below)

- NOTES: 1. THIS PROGRAMMING APPLIES FOR INPUT PAGE 2 ONLY. INPUT PAGE 1 WILL USE STANDARD DEFAULT SETTINGS. THIS PROGRAMMING IS NECESSARY FOR PROPER DETECTOR OPERATION DURING ALTERNATE PHASING OPERATION.
2. THE FIRST TASK THIS PROGRAMMING ACCOMPLISHES IS THE DISABLING OF INPUT #10 (DETECTOR 26) SO THAT A VEHICLE CALL WILL NOT BE PLACED TO PHASE 6 DURING ALTERNATE PHASING OPERATION. THE SECOND TASK THIS PROGRAMMING ACCOMPLISHES IS THAT IT REASSIGNS DETECTOR 51 TO INPUT #18 SO THAT THE DELAY ON LOOP 1A CAN BE REDUCED FROM 15 SECONDS TO 0 SECONDS.

FROM MAIN MENU PRESS '5' (INPUTS), THEN PRESS 'NEXT' TO GET TO INPUT PAGE '2'. PRESS THE '+' KEY UNTIL INPUT 10 IS REACHED.

PAGE: 2 C1 PIN:48 VEHICLE DETECTOR
INPUT ASSIGNMENT #.....10
DEBOUNCE TIME (0-25.5 SEC).....0.5
DELAY TIME (0-25.5 SEC).....0.0
HOLD-OVER TIME (0-25.5 SEC).....0.0
ASSIGNMENT SELECTION:
NOT ENABLED (Y/N).....Y

ENTER A 'Y' FOR NOT ENABLED
DEFAULT DETECTOR NUMBER WILL REMAIN UNTIL "NOT ENABLED" IS ENTERED.

(LOOP 1A - PHASE 6)

PAGE: 2 C1 PIN:48 NOT ENABLED
INPUT ASSIGNMENT #.....10
DEBOUNCE TIME (0-25.5 SEC).....0.5
DELAY TIME (0-25.5 SEC).....0.0
HOLD-OVER TIME (0-25.5 SEC).....0.0
ASSIGNMENT SELECTION:
NOT ENABLED (Y/N).....Y

PRESS '+' TO ADVANCE TO INPUT 18

PAGE: 2 C1 PIN:56 VEHICLE DETECTOR
INPUT ASSIGNMENT #.....18
DEBOUNCE TIME (0-25.5 SEC).....0.5
DELAY TIME (0-25.5 SEC).....0.0
HOLD-OVER TIME (0-25.5 SEC).....0.0
ASSIGNMENT SELECTION:
NOT ENABLED (Y/N).....Y

ENTER '51' TO REASSIGN THE VEHICLE DETECTOR FOR THIS INPUT

(LOOP 1A - PHASE 1)

PAGE: 2 C1 PIN:56 VEHICLE DETECTOR
INPUT ASSIGNMENT #.....18
DEBOUNCE TIME (0-25.5 SEC).....0.5
DELAY TIME (0-25.5 SEC).....0.0
HOLD-OVER TIME (0-25.5 SEC).....0.0
ASSIGNMENT SELECTION:
NOT ENABLED (Y/N).....Y

PROGRAMMING COMPLETE

SPECIAL DETECTOR PROGRAMMING DETAIL - LOOP 1A (ALT.)

(program controller as shown below)

FROM MAIN MENU PRESS '7' (DETECTORS), THEN PRESS '1' FOR VEHICLE DETECTORS. PRESS THE '-' KEY TO GET TO VEHICLE DETECTOR #51.

VEHICLE DETECTOR #51 SETTINGS (+,-,1-64)
SETTING: (Y/N)
ENABLE DETECTOR.....N
ENABLE LOGGING.....N
ENABLE DIAGNOSTICS.....N
SPEED TRAP.....N
CALL DETECTOR.....Y
EXTENSION DETECTOR.....Y
MODE 2 STOP BAR.....N
SWITCHING DETECTOR.....N
DUPLICATING DETECTOR.....N
ENABLE FULL TIME DELAY.....N
IF FAILED, SET MIN RECALL?.....N
IF FAILED, SET MAX1 RECALL?.....N
IF FAILED, SET MAX2 RECALL?.....N
PHASE# :12345678910111213141516
PHASES ASSIGNED :
SWITCH/DUPLICATE:
LOOP SIZE (0-255 FT).....6
SPEED TRAP DISTANCE (0-255 FT).....0
STOP BAR TIME (0-255 SEC).....0
STRETCH (0-25.5 SEC).....0.0
DELAY (0-255 SEC).....0.0
MAX CALLS/MIN (0-255).....255
MIN CALLS/DIAGNOSTIC PERIOD (0-255).....0
MAX OCCUPANCY (0-100%).....100
EXTENSION DISABLE TIME (0-255 SEC).....0
QUEUE MAX OCCUPANCY TIME (0-255).....0
QUEUE GAP RESET TIME (0-25.5).....0.0
PREEMPTION INDEX FOR QUEUE (0-10).....0

ENTER 'Y' FOR ENABLE DETECTOR

ENTER '1' FOR PHASES ASSIGNED

ENSURE DELAY IS '0'

VEHICLE DETECTOR #51 SETTINGS (+,-,1-64)
SETTING: (Y/N)
ENABLE DETECTOR.....Y
ENABLE LOGGING.....N
ENABLE DIAGNOSTICS.....N
SPEED TRAP.....N
CALL DETECTOR.....Y
EXTENSION DETECTOR.....Y
MODE 2 STOP BAR.....N
SWITCHING DETECTOR.....N
DUPLICATING DETECTOR.....N
ENABLE FULL TIME DELAY.....N
IF FAILED, SET MIN RECALL?.....N
IF FAILED, SET MAX1 RECALL?.....N
IF FAILED, SET MAX2 RECALL?.....N
PHASE# :12345678910111213141516
PHASES ASSIGNED :X
SWITCH/DUPLICATE:
LOOP SIZE (0-255 FT).....6
SPEED TRAP DISTANCE (0-255 FT).....0
STOP BAR TIME (0-255 SEC).....0
STRETCH (0-25.5 SEC).....0.0
DELAY (0-255 SEC).....0.0
MAX CALLS/MIN (0-255).....255
MIN CALLS/DIAGNOSTIC PERIOD (0-255).....0
MAX OCCUPANCY (0-100%).....100
EXTENSION DISABLE TIME (0-255 SEC).....0
QUEUE MAX OCCUPANCY TIME (0-255).....0
QUEUE GAP RESET TIME (0-25.5).....0.0
PREEMPTION INDEX FOR QUEUE (0-10).....0

DETECTOR PROGRAMMING COMPLETE

NOTE: DETECTOR IS PROGRAMMED PER THE INPUT FILE CONNECTION AND PROGRAMMING CHART SHOWN ON SHEET 1.

THIS ELECTRICAL DETAIL IS FOR THE SIGNAL DESIGN: 03-0215T1
DESIGNED: June 2017
SEALED: 9/10/2021
REVISED: N/A

Electrical Detail - Sheet 4 of 8
Signal Upgrade
Temporary Design 1

DOCUMENT NOT CONSIDERED FINAL UNLESS ALL SIGNATURES COMPLETED

Table with project details: NC 211 (Howe Street) at NC 87 (River Road)/ SR 1852 (Robert Ruark Drive). Includes fields for PLAN DATE, REVIEWED BY, PREPARED BY, and a signature block for Natasha R. Simmons, dated 9/10/2021.

INPUT PAGE 2 ASSIGNMENT PROGRAMMING DETAIL FOR ALTERNATE PHASING - LOOP 3A

(program controller as shown below)

- NOTES: 1. THIS PROGRAMMING APPLIES FOR INPUT PAGE 2 ONLY. INPUT PAGE 1 WILL USE STANDARD DEFAULT SETTINGS. THIS PROGRAMMING IS NECESSARY FOR PROPER DETECTOR OPERATION DURING ALTERNATE PHASING OPERATION.
2. THE FIRST TASK THIS PROGRAMMING ACCOMPLISHES IS THE DISABLING OF INPUT #12 (DETECTOR 28) SO THAT A VEHICLE CALL WILL NOT BE PLACED TO PHASE 8 DURING ALTERNATE PHASING OPERATION. THE SECOND TASK THIS PROGRAMMING ACCOMPLISHES IS THAT IT REASSIGNS DETECTOR 53 TO INPUT #20 SO THAT THE DELAY ON LOOP 3A CAN BE REDUCED FROM 15 SECONDS TO 3 SECONDS.

FROM MAIN MENU PRESS '5' (INPUTS), THEN PRESS 'NEXT' TO GET TO INPUT PAGE '2'. PRESS THE '+' KEY UNTIL INPUT 12 IS REACHED.

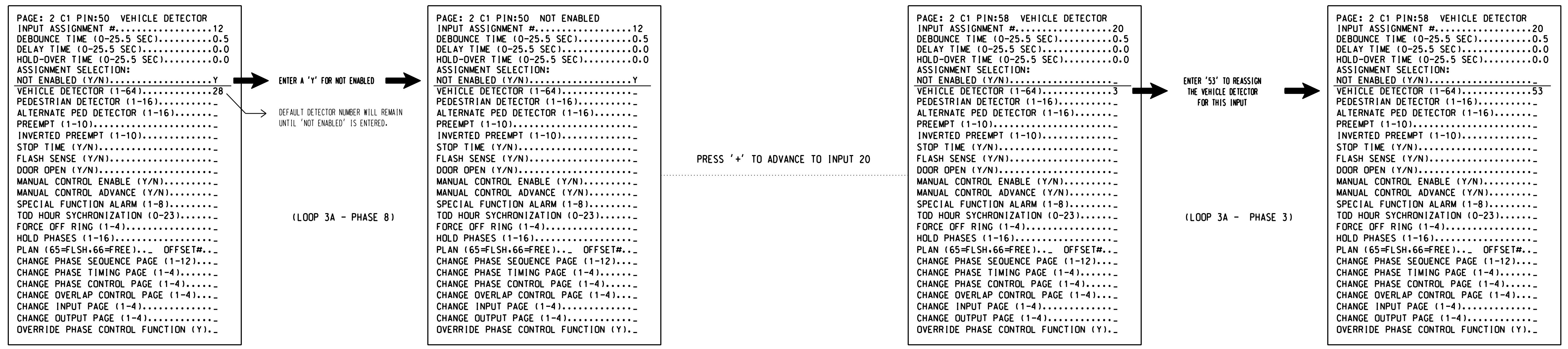

PROGRAMMING COMPLETE

SPECIAL DETECTOR PROGRAMMING DETAIL - LOOP 3A (ALT.)

(program controller as shown below)

FROM MAIN MENU PRESS '7' (DETECTORS), THEN PRESS '1' FOR VEHICLE DETECTORS. PRESS THE '-' KEY TO GET TO VEHICLE DETECTOR #53.

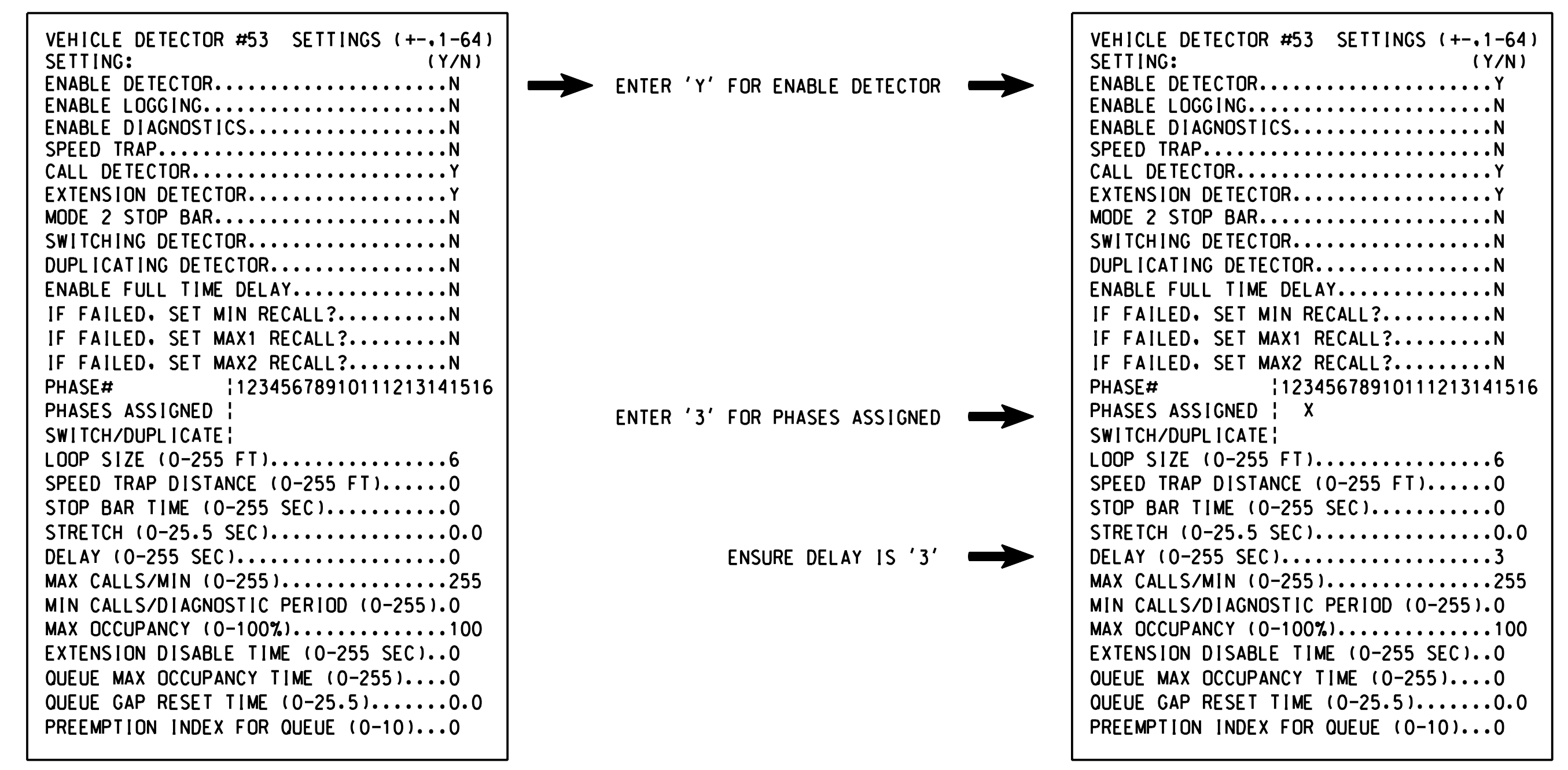

DETECTOR PROGRAMMING COMPLETE

NOTE: DETECTOR IS PROGRAMMED PER THE INPUT FILE CONNECTION AND PROGRAMMING CHART SHOWN ON SHEET 1.

THIS ELECTRICAL DETAIL IS FOR THE SIGNAL DESIGN: 03-0215T1
DESIGNED: June 2017
SEALED: 9/10/2021
REVISED: N/A

Electrical Detail - Sheet 5 of 8
Signal Upgrade
Temporary Design 1

DOCUMENT NOT CONSIDERED FINAL UNLESS ALL SIGNATURES COMPLETED

	Prepared for: 		NC 211 (Howe Street) at NC 87 (River Road)/ SR 1852 (Robert Ruark Drive)		
	750 N. Greenfield Pkwy, Corner, NC 27529		Division 03 Brunswick Co. Southport		
PLAN DATE: June 2017		REVIEWED BY: A.D. Klinksiek		DATE: 9/10/2021	
PREPARED BY: A.H. Thornburg		REVIEWED BY: N.R. Simmons		SIGNATURE: _____ DATE: _____	
REVISIONS		INIT.		DATE	
_____		_____		_____	

HNTB HNTB NORTH CAROLINA, P.C.
343 E. Six Forks Road, Suite 200
Raleigh, North Carolina 27609
NC license No: C-1554
(919) 546-8997

INPUT PAGE 2 ASSIGNMENT PROGRAMMING DETAIL FOR ALTERNATE PHASING - LOOP 5A (program controller as shown below)

- NOTES: 1. THIS PROGRAMMING APPLIES FOR INPUT PAGE 2 ONLY. INPUT PAGE 1 WILL USE STANDARD DEFAULT SETTINGS. THIS PROGRAMMING IS NECESSARY FOR PROPER DETECTOR OPERATION DURING ALTERNATE PHASING OPERATION. 2. THE FIRST TASK THIS PROGRAMMING ACCOMPLISHES IS THE DISABLING OF INPUT #9 (DETECTOR 22) SO THAT A VEHICLE CALL WILL NOT BE PLACED TO PHASE 2 DURING ALTERNATE PHASING OPERATION. THE SECOND TASK THIS PROGRAMMING ACCOMPLISHES IS THAT IT REASSIGNS DETECTOR 55 TO INPUT #17 SO THAT THE DELAY ON LOOP 5A CAN BE REDUCED FROM 15 SECONDS TO 0 SECONDS.

FROM MAIN MENU PRESS '5' (INPUTS), THEN PRESS 'NEXT' TO GET TO INPUT PAGE '2'. PRESS THE '+' KEY UNTIL INPUT 9 IS REACHED.

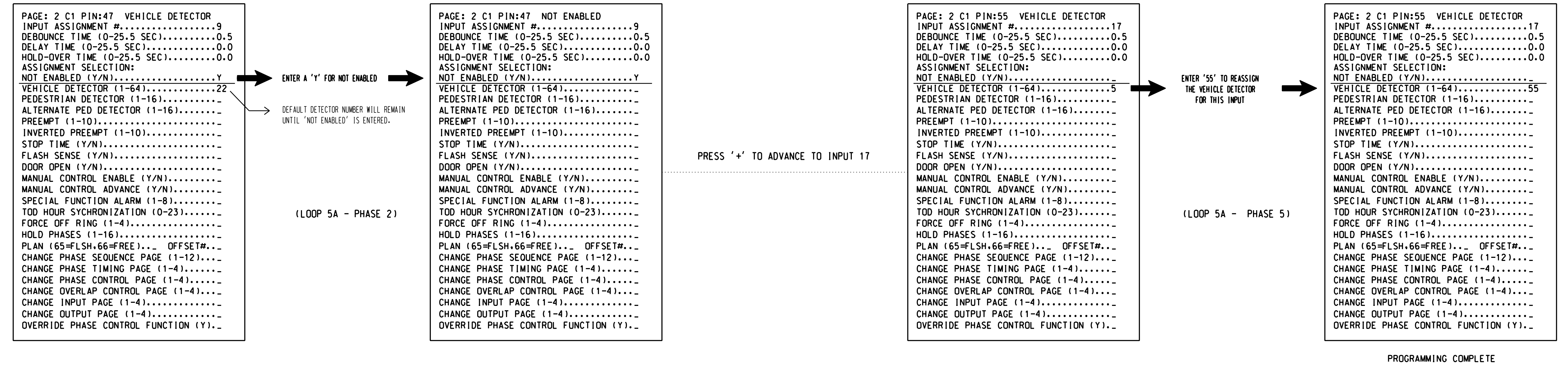

SPECIAL DETECTOR PROGRAMMING DETAIL - LOOP 5A (ALT.)

(program controller as shown below)

FROM MAIN MENU PRESS '7' (DETECTORS), THEN PRESS '1' FOR VEHICLE DETECTORS. PRESS THE '-' KEY TO GET TO VEHICLE DETECTOR #55.

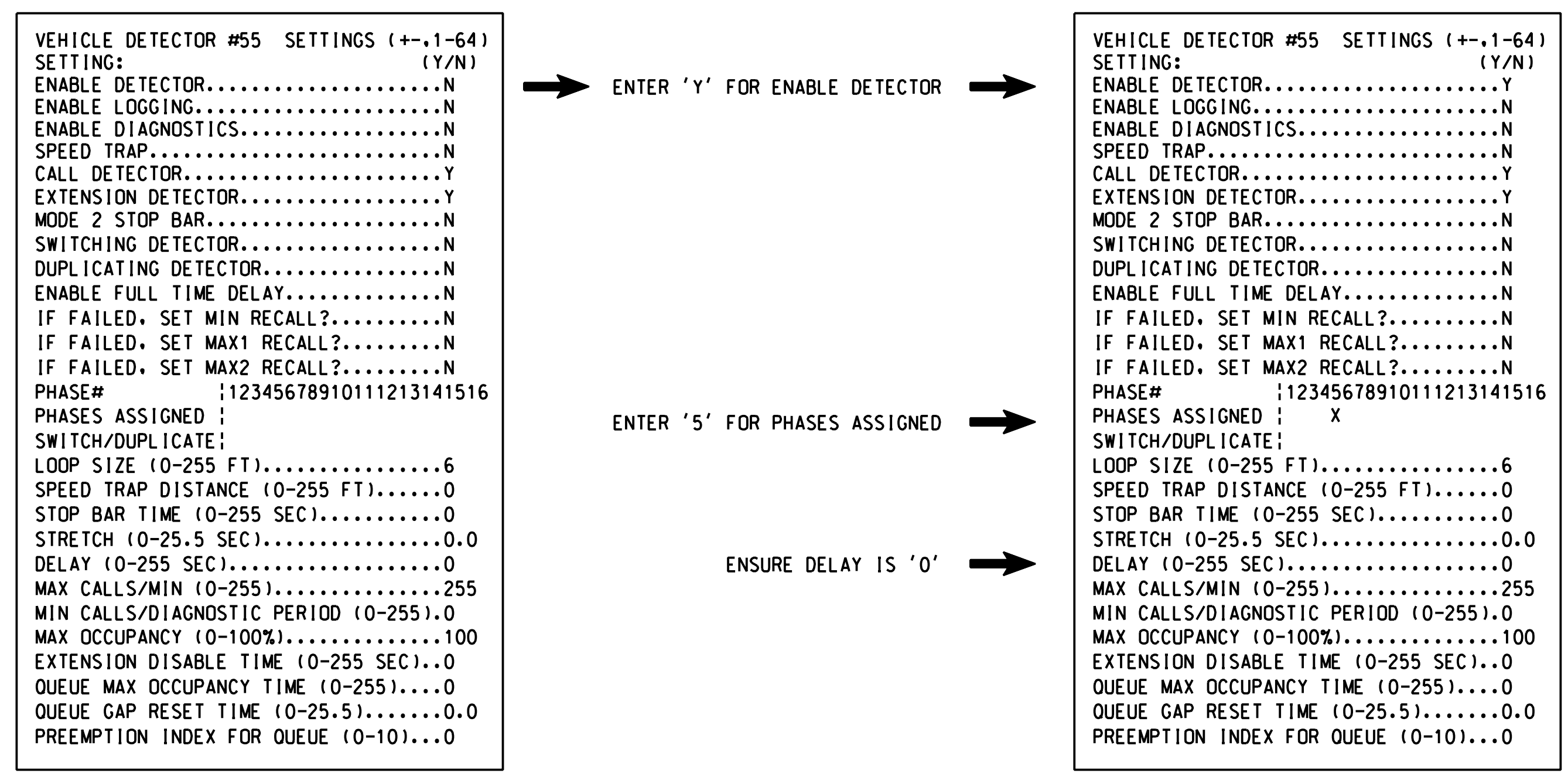

NOTE: DETECTOR IS PROGRAMMED PER THE INPUT FILE CONNECTION AND PROGRAMMING CHART SHOWN ON SHEET 1.

THIS ELECTRICAL DETAIL IS FOR THE SIGNAL DESIGN: 03-0215T1 DESIGNED: June 2017 SEALED: 9/10/2021 REVISED: N/A

Electrical Detail - Sheet 6 of 8 Signal Upgrade Temporary Design 1

DOCUMENT NOT CONSIDERED FINAL UNLESS ALL SIGNATURES COMPLETED

Project information table including address (NC 211 Howe Street, SR 1852 Robert Ruark Drive), dates (June 2017), and signatures (A.H. Thornburg, N.R. Simmons, Natasha Simmons). Includes logos for HNTB and North Carolina Professional Engineer.

INPUT PAGE 2 ASSIGNMENT PROGRAMMING DETAIL FOR ALTERNATE PHASING - LOOP 7A

(program controller as shown below)

- NOTES: 1. THIS PROGRAMMING APPLIES FOR INPUT PAGE 2 ONLY. INPUT PAGE 1 WILL USE STANDARD DEFAULT SETTINGS. THIS PROGRAMMING IS NECESSARY FOR PROPER DETECTOR OPERATION DURING ALTERNATE PHASING OPERATION.
2. THE FIRST TASK THIS PROGRAMMING ACCOMPLISHES IS THE DISABLING OF INPUT #11 (DETECTOR 24) SO THAT A VEHICLE CALL WILL NOT BE PLACED TO PHASE 4 DURING ALTERNATE PHASING OPERATION. THE SECOND TASK THIS PROGRAMMING ACCOMPLISHES IS THAT IT REASSIGNS DETECTOR 57 TO INPUT #19 SO THAT THE DELAY ON LOOP 7A CAN BE REDUCED FROM 15 SECONDS TO 3 SECONDS.

FROM MAIN MENU PRESS '5' (INPUTS), THEN PRESS 'NEXT' TO GET TO INPUT PAGE '2'. PRESS THE '+' KEY UNTIL INPUT 11 IS REACHED.

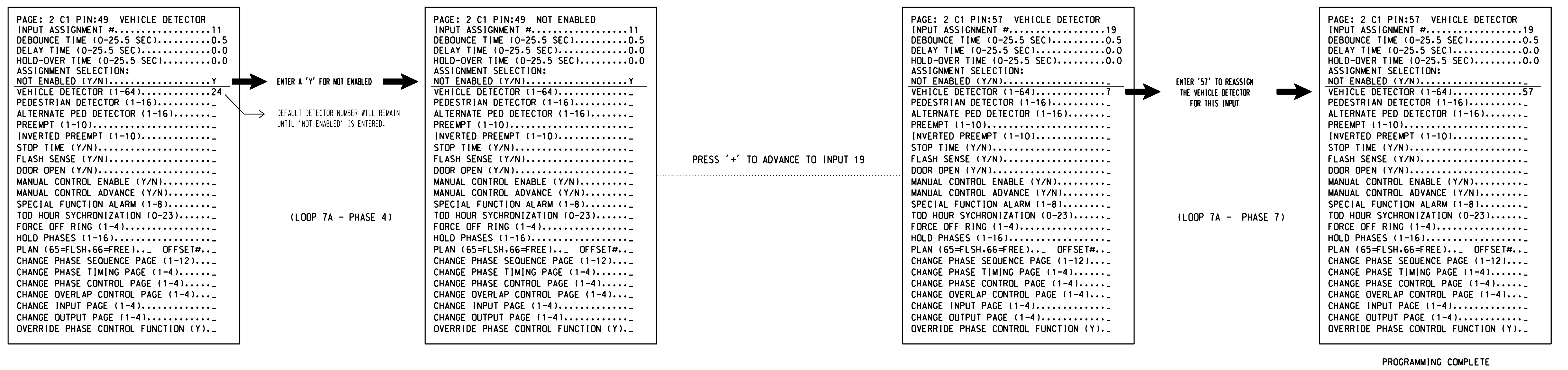

SPECIAL DETECTOR PROGRAMMING DETAIL - LOOP 7A (ALT.)

(program controller as shown below)

FROM MAIN MENU PRESS '7' (DETECTORS), THEN PRESS '1' FOR VEHICLE DETECTORS. PRESS THE '-' KEY TO GET TO VEHICLE DETECTOR #57.

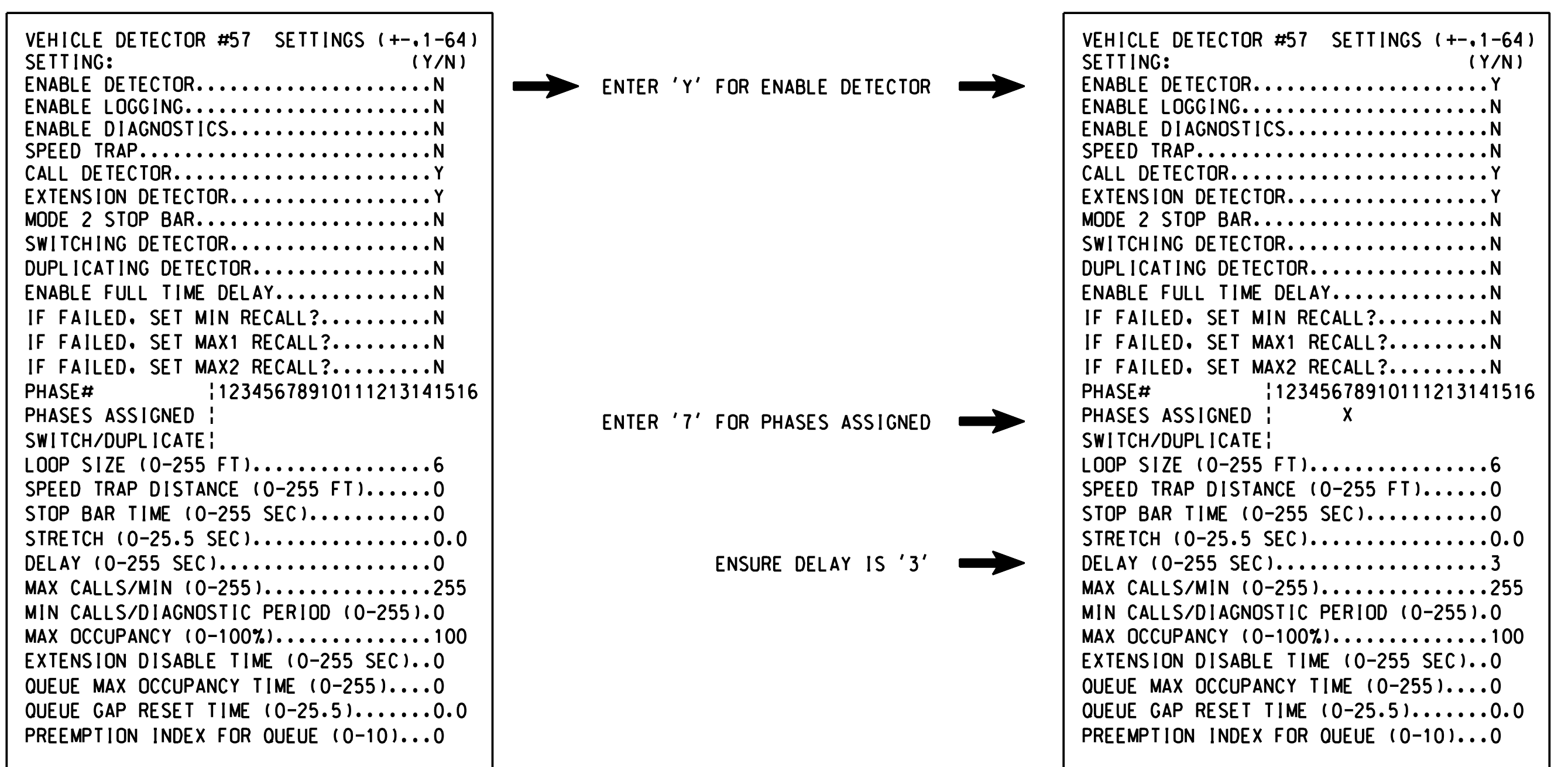

NOTE: DETECTOR IS PROGRAMMED PER THE INPUT FILE CONNECTION AND PROGRAMMING CHART SHOWN ON SHEET 1.

THIS ELECTRICAL DETAIL IS FOR THE SIGNAL DESIGN: 03-0215T1
DESIGNED: June 2017
SEALED: 9/10/2021
REVISED: N/A

Electrical Detail - Sheet 7 of 8
Signal Upgrade
Temporary Design 1

DOCUMENT NOT CONSIDERED FINAL UNLESS ALL SIGNATURES COMPLETED

	Prepared for: 		NC 211 (Howe Street) at NC 87 (River Road)/ SR 1852 (Robert Ruark Drive)		
	750 N. Greenfield Pkwy, Corner, NC 27529		Division 03 Brunswick Co. Southport		
PLAN DATE: June 2017 PREPARED BY: A.H. Thornburg		REVIEWED BY: A.D. Klinksiek REVIEWED BY: N.R. Simmons		DATE: 9/10/2021	
REVISIONS		INIT.		DATE	
SIGNATURE		DATE		SIG. INVENTORY NO. 03-0215T1	

ALTERNATE PHASING ACTIVATION DETAIL

TO RUN ALT. PHASING DURING COORDINATION - SELECT ALL PAGE CHANGES (AS SHOWN BELOW) WITHIN COORDINATION PLAN PROGRAMMING.

TO RUN ALT. PHASING DURING FREE RUN - PROGRAM PAGE CHANGES (SHOWN BELOW) IN SEPARATE TIME OF DAY EVENTS. IF PAGE 1 IS USED, NO EVENT PROGRAMMING IS NECESSARY FOR THAT PARTICULAR PAGE.

<u>PHASING</u>	<u>INPUTS PAGE</u>	<u>OVERLAPS PAGE</u>
ACTIVE PAGES REQUIRED TO RUN <u>DEFAULT PHASING</u>	1	1
ACTIVE PAGES REQUIRED TO RUN <u>ALTERNATE PHASING</u>	2	2

NOTE: PAGES NOT SHOWN (i.e. sequence, phase control, etc.) SHOULD REMAIN AS '1', OR AS DEFINED BY TIMING ENGINEER.

IMPORTANT: IF ALT. PHASING IS USED DURING FREE RUN AND COORDINATION, DO NOT OPERATE TIME OF DAY PAGE CHANGE EVENTS CONCURRENTLY WITH COORDINATION PLAN EVENTS IN THE EVENT SCHEDULER. (EX. FREE RUN PAGE CHANGE EVENT SHOULD END BEFORE COORDINATION PLAN EVENT STARTS AND VICE-VERSA).

FLASHER CIRCUIT MODIFICATION DETAIL

IN ORDER TO ENSURE THAT SIGNALS FLASH CONCURRENTLY ON THE SAME APPROACH, MAKE THE FOLLOWING FLASHER CIRCUIT CHANGES:

1. ON REAR OF PDA - REMOVE WIRE FROM TERM. T2-4 AND TERMINATE ON T2-2.
2. ON REAR OF PDA - REMOVE WIRE FROM TERM. T2-5 AND TERMINATE ON T2-3.
3. REMOVE FLASHER UNIT 2.

THE CHANGES LISTED ABOVE TIES ALL PHASES AND OVERLAPS TO FLASHER UNIT 1.

ALTERNATE PHASING PAGE CHANGE SUMMARY

THE FOLLOWING IS A SUMMARY OF WHAT TAKES PLACE WHEN THESE OVERLAP/INPUT PAGE CHANGES ACTIVATE TO CALL THE "ALTERNATE PHASING":

- OVERLAPS PAGE 2:** Modifies overlap parent phases for heads 11, 31, 51, and 71 to run protected turns only.
- INPUTS PAGE 2:** Disables phase 6 call on loop 1A and reduces delay time for phase 1 call on loop 1A to 0 seconds.
- Disables phase 8 call on loop 3A and reduces delay time for phase 3 call on loop 3A to 3 seconds.
- Disables phase 2 call on loop 5A and reduces delay time for phase 5 call on loop 5A to 0 seconds.
- Disables phase 4 call on loop 7A and reduces delay time for phase 7 call on loop 7A to 3 seconds.

THIS ELECTRICAL DETAIL IS FOR THE SIGNAL DESIGN: 03-0215T1
 DESIGNED: June 2017
 SEALED: 9/10/2021
 REVISED: N/A

Electrical Detail - Sheet 8 of 8
 Signal Upgrade
 Temporary Design 1

**DOCUMENT NOT CONSIDERED FINAL
 UNLESS ALL SIGNATURES COMPLETED**

HNTB HNTB NORTH CAROLINA, P.C.
 343 E. Six Forks Road, Suite 200
 Raleigh, North Carolina 27609
 NC License No: C-1554
 (919) 546-8997

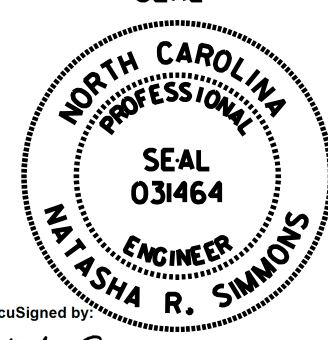
<p style="font-size: small;">ELECTRICAL AND PROGRAMMING DETAILS FOR:</p> <div style="text-align: center;">  </div> <p style="font-size: x-small;">750 N. Greenfield Pkwy, Corner, NC 27529</p>	<p>NC 211 (Howe Street) at NC 87 (River Road)/ SR 1852 (Robert Ruark Drive) Division 03 Brunswick Co. Southport</p> <p style="font-size: x-small;">PLAN DATE: June 2017 REVIEWED BY: A.D. Klinksiek PREPARED BY: A.H. Thornburg REVIEWED BY: N.R. Simmons</p>	<p style="text-align: center;">SEAL</p> <div style="text-align: center;">  </div> <p style="font-size: x-small;">9/10/2021</p>									
<table border="1" style="width: 100%; border-collapse: collapse;"> <thead> <tr> <th style="width: 50%;">REVISIONS</th> <th style="width: 25%;">INIT.</th> <th style="width: 25%;">DATE</th> </tr> </thead> <tbody> <tr> <td> </td> <td> </td> <td> </td> </tr> <tr> <td> </td> <td> </td> <td> </td> </tr> </tbody> </table>		REVISIONS	INIT.	DATE							<p style="font-size: x-small;">DocuSigned by: Natasha Simmons 9/10/2021</p> <p style="font-size: x-small;">SIGNATURE DATE</p> <p style="font-size: x-small;">SIG. INVENTORY NO. 03-0215T1</p>
REVISIONS	INIT.	DATE									

EDI MODEL 2018ECL-NC CONFLICT MONITOR PROGRAMMING DETAIL

(remove jumpers and set switches as shown)

REMOVE DIODE JUMPERS 1-5, 1-6, 1-9, 1-11, 2-5, 2-6, 2-9, 2-11, 3-7, 3-8, 3-10, 3-12, 4-7, 4-8, 4-10, 4-12, 5-9, 5-11, 6-9, 6-11, 7-10, 7-12, 8-10, 8-12, 9-11 and 10-12.

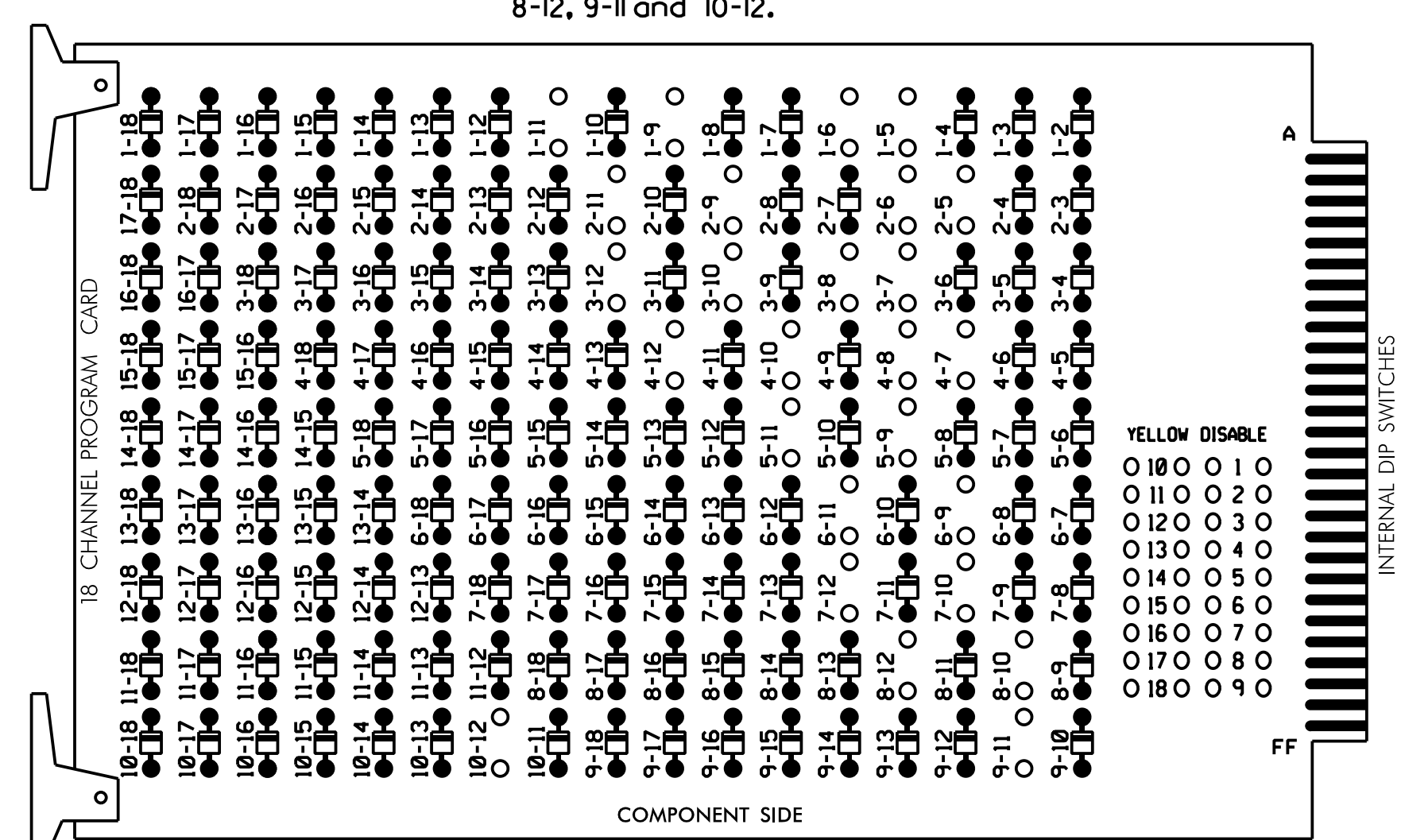

NOTES:

- Card is provided with all diode jumpers in place. Removal of any jumper allows its channels to run concurrently.
- Ensure jumpers SEL2-SEL5 and SEL9 are present on the monitor board.
- Ensure that Red Enable is active at all times during normal operation.
- Connect serial cable from conflict monitor to comm. port 1 of 2070 controller. Ensure conflict monitor communicates with 2070.

NOTES

- To prevent "flash-conflict" problems, insert red flash program blocks for all unused vehicle load switches in the output file. The installer shall verify that signal heads flash in accordance with the Signal Plans.
- Program phases 4 and 8 for Dual Entry.
- Enable Simultaneous Gap-Out for all Phases.
- Program phases 2 and 6 for Startup In Green.
- Program phases 2 and 6 for Yellow Flash, and overlaps 1 and 2 as Wag Overlaps.
- If this signal will be managed by an ATMS software, enable controller and detector logging for all detectors used at this location.
- The cabinet and controller are part of the NC 133 Closed Loop System.

EQUIPMENT INFORMATION

CONTROLLER.....2070E
 CABINET.....332 W/ AUX
 SOFTWARE.....ECONOLITE OASIS
 CABINET MOUNT.....BASE
 OUTPUT FILE POSITIONS...18 WITH AUX. OUTPUT FILE
 LOAD SWITCHES USED.....S1,S2,S4,S5,S7,S8,S10,S11,
 AUX S1,AUX S2,AUX S4,AUX S5
 PHASES USED.....1,2,3,4,5,6,7,8
 OVERLAP "A".....1+2
 OVERLAP "B".....3+4
 OVERLAP "C".....5+6
 OVERLAP "D".....7+8

SIGNAL HEAD HOOK-UP CHART

LOAD SWITCH NO.	S1	S2	S3	S4	S5	S6	S7	S8	S9	S10	S11	S12	AUX S1	AUX S2	AUX S3	AUX S4	AUX S5	AUX S6
CMU CHANNEL NO.	1	2	13	3	4	14	5	6	15	7	8	16	9	10	17	11	12	18
PHASE	1	2	2 PED	3	4	4 PED	5	6	6 PED	7	8	8 PED	OLA	OLB	SPARE	OLC	OLD	SPARE
SIGNAL HEAD NO.	11	21,22	NU	31	41,42	NU	42	51	61,62	NU	71	81,82	NU	11	31	NU	51	71
RED		128		101		*	134				107							
YELLOW	*	129		102			135		*	108								
GREEN		130		103			136			109								
RED ARROW													A121	A124		A114	A101	
YELLOW ARROW													A122	A125		A115	A102	
FLASHING YELLOW ARROW													A123	A126		A116	A103	
GREEN ARROW	127			118			133	133		124								

NU = Not Used

* Denotes install load resistor. See load resistor installation detail this sheet.

★ See pictorial of head wiring in detail this sheet.

INPUT FILE POSITION LAYOUT

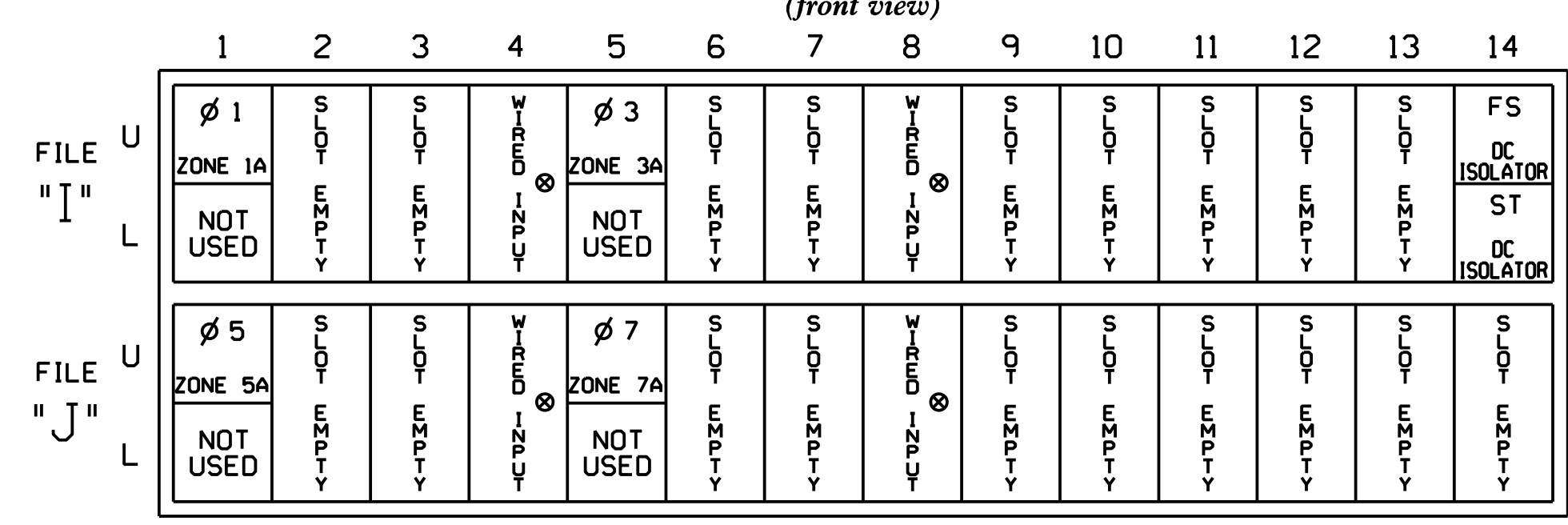

EX.: 1A, 2A, ETC. = LOOP NO.'S

FS = FLASH SENSE
 ST = STOP TIME

⊗ Wired Input - Do not populate slot with detector card

INPUT FILE CONNECTION & PROGRAMMING CHART

LOOP NO.	LOOP TERMINAL	INPUT FILE POS.	PIN NO.	INPUT ASSIGNMENT NO.	DETECTOR NO.	NEMA PHASE	CALL	EXTEND	FULL TIME DELAY	STRETCH TIME	DELAY TIME
ZONE 1A ¹	TB2-1,2	I1U	56	18	1	1	Y	Y			15
	-	J4U	48	10★	26	6	Y	Y			
ZONE 3A ²	TB4-5,6	I5U	58	20	3	3	Y	Y			15
	-	J8U	50	12★	28	8	Y	Y			3
ZONE 5A ³	TB3-1,2	J1U	55	17	5	5	Y	Y			15
	-	I4U	47	9★	22	2	Y	Y			3
ZONE 7A ⁴	TB5-5,6	J5U	57	19★	7	7	Y	Y			15
	-	I8U	49	11★	24	4	Y	Y			3
-	-	J5U	57	19★	57	7	Y	Y			3

- Add jumper from I1-W to J4-W, on rear of input file.
 - Add jumper from I5-W to J8-W, on rear of input file.
 - Add jumper from J1-W to I4-W, on rear of input file.
 - Add jumper from J5-W to I8-W, on rear of input file.
- * See Input Page Assignment programming details on sheets 4, 5, 6, and 7.

INPUT FILE POSITION LEGEND: J2L

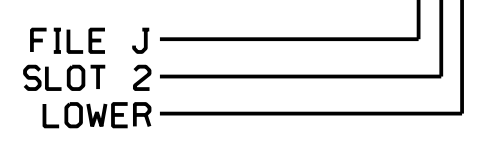

FYA SIGNAL WIRING DETAIL

(wire signal heads as shown)

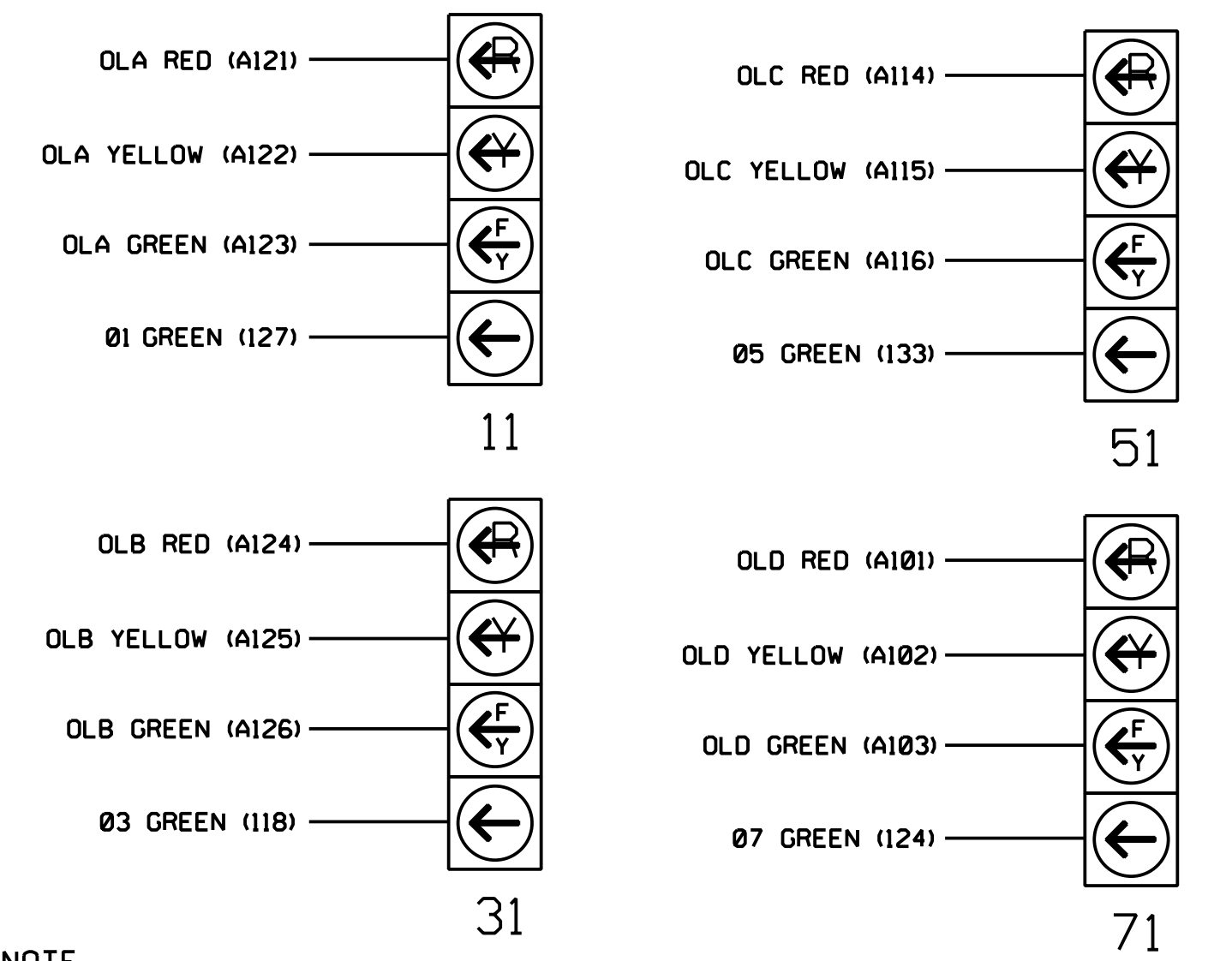

NOTE

The sequence display for signal heads 11, 31, 51, and 71 requires special logic programming. See sheet 2 for programming instructions.

LOAD RESISTOR INSTALLATION DETAIL

(install resistors as shown)

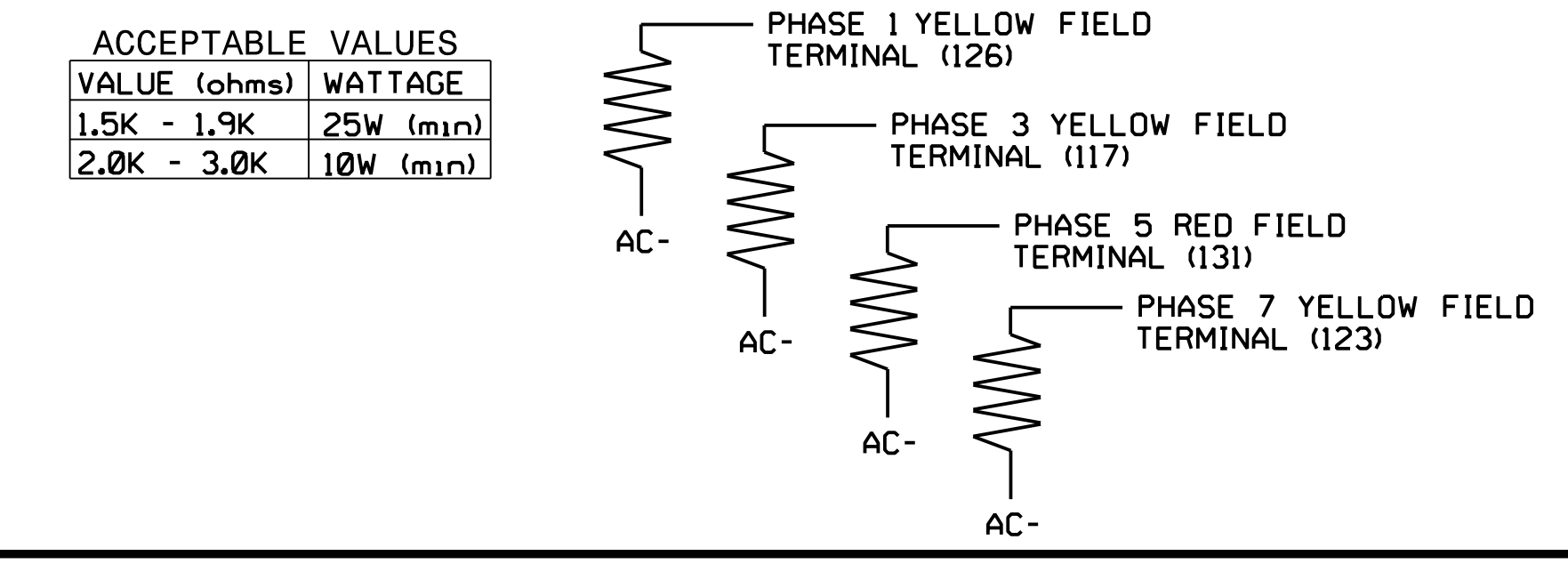

SPECIAL DETECTOR NOTE

Install a microwave detection system for vehicle detection. Perform installation according to manufacturer's directions and NCDOT engineer-approved mounting locations to accomplish the detection schemes shown on the Signal Design Plans.

For loops 1A, 3A, 5A, and 7A, detector card placement and slots reserved for wired inputs are typical for a NCDOT installation. Inputs associated with these slots are compatible with time of day instructions located on sheets 4, 5, 6, 7, and 8 of this electrical detail.



HNTB NORTH CAROLINA, P.C.
 343 E. Six Forks Road, Suite 200
 Raleigh, North Carolina 27609
 NC License No: C-1554
 (919) 546-8997

THIS ELECTRICAL DETAIL IS FOR THE SIGNAL DESIGN: 03-0215T2
 DESIGNED: June 2017
 SEALED: 9/10/2021
 REVISED: N/A

Electrical Detail - Sheet 1 of 8
 Signal Upgrade
 Temporary Design 2

DOCUMENT NOT CONSIDERED FINAL UNLESS ALL SIGNATURES COMPLETED

Prepared for: Department of Transportation Division of Signal Management	NC 211 (Howe Street) at NC 87 (River Road)/ SR 1852 (Robert Ruark Drive) Division 03 Brunswick Co. Southport		SEAL SEAL 031464 NATASHA R. SIMMONS ENGINEER
	PLAN DATE: June 2017 PREPARED BY: A.H. Thornburg	REVIEWED BY: A.D. Klinsky REVIEWED BY: N.R. Simmons	
REVISIONS			DATE
SIGNATURE			DATE
SIG. INVENTORY NO. 03-0215T2			

LOGICAL I/O PROCESSOR PROGRAMMING DETAIL TO PRODUCE SPECIAL FYA-PPLT SIGNAL SEQUENCE

(program controller as shown below)

- FROM MAIN MENU PRESS '2' (PHASE CONTROL), THEN '1' (PHASE CONTROL FUNCTIONS), SCROLL TO THE BOTTOM OF THE MENU AND ENABLE ACT LOGIC COMMANDS 1, 2, 3, 4, 5, 6, 7, 8, 9, 10, 11, AND 12.
- FROM MAIN MENU PRESS '6' (OUTPUTS), THEN '3' (LOGICAL I/O PROCESSOR).

LOGICAL I/O COMMAND #1 (+/-COMMAND#)
IF ACTIVE PHASE #1 IS ON
AND RED CLEAR ON PHASE #1 IS ON

↓

SCROLL DOWN

THEN:
SET OUTPUT ASSIGNMENT #50 ON
SET OUTPUT ASSIGNMENT #51 OFF

PRESS '+'

NOTE: LOGIC FOR PHASE 1 RED CLEAR WHEN TRANSITIONING FROM PHASE 1 TO PHASE 2 (HEAD 11).

LOGICAL I/O COMMAND #7 (+/-COMMAND#)
IF ACTIVE PHASE #3 IS ON
AND RED CLEAR ON PHASE #3 IS ON

↓

SCROLL DOWN

THEN:
SET OUTPUT ASSIGNMENT #47 ON
SET OUTPUT ASSIGNMENT #48 OFF

PRESS '+'

NOTE: LOGIC FOR PHASE 3 RED CLEAR WHEN TRANSITIONING FROM PHASE 3 TO PHASE 4 (HEAD 31).

LOGICAL I/O COMMAND #2 (+/-COMMAND#)
IF ACTIVE PHASE #1 IS ON

↓

SCROLL DOWN

THEN:
SET OUTPUT ASSIGNMENT #52 OFF

PRESS '+'

NOTE: LOGIC FOR SWITCHING FLASHING YELLOW ARROW "OFF" DURING PHASE 1 (HEAD 11).

LOGICAL I/O COMMAND #8 (+/-COMMAND#)
IF ACTIVE PHASE #3 IS ON

↓

SCROLL DOWN

THEN:
SET OUTPUT ASSIGNMENT #49 OFF

PRESS '+'

NOTE: LOGIC FOR SWITCHING FLASHING YELLOW ARROW "OFF" DURING PHASE 3 (HEAD 31).

LOGICAL I/O COMMAND #3 (+/-COMMAND#)
IF YELLOW ON PHASE #1 IS ON

↓

SCROLL DOWN

THEN:
SET OUTPUT ASSIGNMENT #51 ON

PRESS '+'

NOTE: LOGIC FOR YELLOW ARROW CLEARANCE FROM PHASE 1 (HEAD 11).

LOGICAL I/O COMMAND #9 (+/-COMMAND#)
IF YELLOW ON PHASE #3 IS ON

↓

SCROLL DOWN

THEN:
SET OUTPUT ASSIGNMENT #48 ON

PRESS '+'

NOTE: LOGIC FOR YELLOW ARROW CLEARANCE FROM PHASE 3 (HEAD 31).

LOGICAL I/O COMMAND #4 (+/-COMMAND#)
IF ACTIVE PHASE #5 IS ON
AND RED CLEAR ON PHASE #5 IS ON

↓

SCROLL DOWN

THEN:
SET OUTPUT ASSIGNMENT #42 ON
SET OUTPUT ASSIGNMENT #43 OFF

PRESS '+'

NOTE: LOGIC FOR PHASE 5 RED CLEAR WHEN TRANSITIONING FROM PHASE 5 TO PHASE 6 (HEAD 51).

LOGICAL I/O COMMAND #10 (+/-COMMAND#)
IF ACTIVE PHASE #7 IS ON
AND RED CLEAR ON PHASE #7 IS ON

↓

SCROLL DOWN

THEN:
SET OUTPUT ASSIGNMENT #39 ON
SET OUTPUT ASSIGNMENT #40 OFF

PRESS '+'

NOTE: LOGIC FOR PHASE 7 RED CLEAR WHEN TRANSITIONING FROM PHASE 7 TO PHASE 8 (HEAD 71).

LOGICAL I/O COMMAND #5 (+/-COMMAND#)
IF ACTIVE PHASE #5 IS ON

↓

SCROLL DOWN

THEN:
SET OUTPUT ASSIGNMENT #44 OFF

PRESS '+'

NOTE: LOGIC FOR SWITCHING FLASHING YELLOW ARROW "OFF" DURING PHASE 5 (HEAD 51).

LOGICAL I/O COMMAND #11 (+/-COMMAND#)
IF ACTIVE PHASE #7 IS ON

↓

SCROLL DOWN

THEN:
SET OUTPUT ASSIGNMENT #41 OFF

PRESS '+'

NOTE: LOGIC FOR SWITCHING FLASHING YELLOW ARROW "OFF" DURING PHASE 7 (HEAD 71).

LOGICAL I/O COMMAND #6 (+/-COMMAND#)
IF YELLOW ON PHASE #5 IS ON

↓

SCROLL DOWN

THEN:
SET OUTPUT ASSIGNMENT #43 ON

PRESS '+'

NOTE: LOGIC FOR YELLOW ARROW CLEARANCE FROM PHASE 5 (HEAD 51).

LOGICAL I/O COMMAND #12 (+/-COMMAND#)
IF YELLOW ON PHASE #7 IS ON

↓

SCROLL DOWN

THEN:
SET OUTPUT ASSIGNMENT #40 ON

PRESS '+'

NOTE: LOGIC FOR YELLOW ARROW CLEARANCE FROM PHASE 7 (HEAD 71).

LOGIC I/O PROCESSOR PROGRAMMING COMPLETE

OUTPUT REFERENCE SCHEDULE	
USE TO INTERPRET LOGIC PROCESSOR	
OUTPUT 39 =	Overlap D Red
OUTPUT 40 =	Overlap D Yellow
OUTPUT 41 =	Overlap D Green
OUTPUT 42 =	Overlap C Red
OUTPUT 43 =	Overlap C Yellow
OUTPUT 44 =	Overlap C Green
OUTPUT 47 =	Overlap B Red
OUTPUT 48 =	Overlap B Yellow
OUTPUT 49 =	Overlap B Green
OUTPUT 50 =	Overlap A Red
OUTPUT 51 =	Overlap A Yellow
OUTPUT 52 =	Overlap A Green

THIS ELECTRICAL DETAIL IS FOR
THE SIGNAL DESIGN: 03-0215T2
DESIGNED: June 2017
SEALED: 9/10/2021
REVISED: N/A

Electrical Detail - Sheet 2 of 8
Signal Upgrade
Temporary Design 2

DOCUMENT NOT CONSIDERED FINAL
UNLESS ALL SIGNATURES COMPLETED

HNTB HNTB NORTH CAROLINA, P.C.
343 E. Six Forks Road, Suite 200
Raleigh, North Carolina 27609
NC License No: C-1554
(919) 546-8997

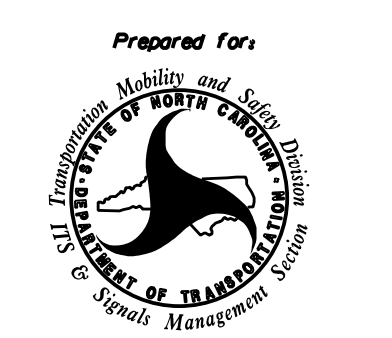
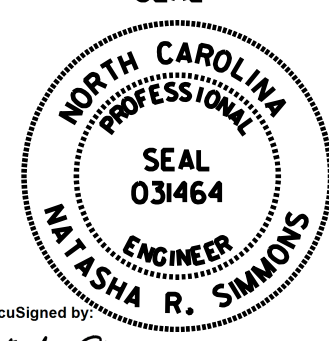
 Prepared for: Department of Transportation North Carolina Division of Transportation Management	NC 211 (Howe Street) at NC 87 (River Road)/ SR 1852 (Robert Ruark Drive) Division 03 Brunswick Co. Southport		SEAL  SEAL 031464 NATASHA R. SIMMONS ENGINEER
	PLAN DATE: June 2017 PREPARED BY: A.H. Thornburg	REVIEWED BY: A.D. Klinksiek REVIEWED BY: N.R. Simmons	

OVERLAP PROGRAMMING DETAIL FOR DEFAULT PHASING

(program controller as shown below)

FROM MAIN MENU PRESS '8' (OVERLAPS), THEN '1' (VEHICLE OVERLAP SETTINGS).

```

PAGE 1: VEHICLE OVERLAP 'A' SETTINGS
PHASE:           :12345678910111213141516
VEH OVL PARENTS: :XX
VEH OVL NOT VEH: :
VEH OVL NOT PED: :
VEH OVL GRN EXT: :
STARTUP COLOR:  - RED - YELLOW - GREEN
FLASH COLORS:   - RED - YELLOW X GREEN
SELECT VEHICLE OVERLAP OPTIONS: (Y/N)
FLASH YELLOW IN CONTROLLER FLASH?...Y
GREEN EXTENSION (0-255 SEC).....0
YELLOW CLEAR (0=PARENT,3-25.5 SEC)...0.0
RED CLEAR (0=PARENT,0.1-25.5 SEC)...0.0
OUTPUT AS PHASE # (0=NONE, 1-16)....0
  
```

← NOTICE GREEN FLASH

PRESS '+'

```

PAGE 1: VEHICLE OVERLAP 'B' SETTINGS
PHASE:           :12345678910111213141516
VEH OVL PARENTS: :XX
VEH OVL NOT VEH: :
VEH OVL NOT PED: :
VEH OVL GRN EXT: :
STARTUP COLOR:  - RED - YELLOW - GREEN
FLASH COLORS:   - RED - YELLOW X GREEN
SELECT VEHICLE OVERLAP OPTIONS: (Y/N)
FLASH YELLOW IN CONTROLLER FLASH?...N
GREEN EXTENSION (0-255 SEC).....0
YELLOW CLEAR (0=PARENT,3-25.5 SEC)...0.0
RED CLEAR (0=PARENT,0.1-25.5 SEC)...0.0
OUTPUT AS PHASE # (0=NONE, 1-16)....0
  
```

← NOTICE GREEN FLASH

PRESS '+'

```

PAGE 1: VEHICLE OVERLAP 'C' SETTINGS
PHASE:           :12345678910111213141516
VEH OVL PARENTS: :XX
VEH OVL NOT VEH: :
VEH OVL NOT PED: :
VEH OVL GRN EXT: :
STARTUP COLOR:  - RED - YELLOW - GREEN
FLASH COLORS:   - RED - YELLOW X GREEN
SELECT VEHICLE OVERLAP OPTIONS: (Y/N)
FLASH YELLOW IN CONTROLLER FLASH?...Y
GREEN EXTENSION (0-255 SEC).....0
YELLOW CLEAR (0=PARENT,3-25.5 SEC)...0.0
RED CLEAR (0=PARENT,0.1-25.5 SEC)...0.0
OUTPUT AS PHASE # (0=NONE, 1-16)....0
  
```

← NOTICE GREEN FLASH

PRESS '+'

```

PAGE 1: VEHICLE OVERLAP 'D' SETTINGS
PHASE:           :12345678910111213141516
VEH OVL PARENTS: :XX
VEH OVL NOT VEH: :
VEH OVL NOT PED: :
VEH OVL GRN EXT: :
STARTUP COLOR:  - RED - YELLOW - GREEN
FLASH COLORS:   - RED - YELLOW X GREEN
SELECT VEHICLE OVERLAP OPTIONS: (Y/N)
FLASH YELLOW IN CONTROLLER FLASH?...N
GREEN EXTENSION (0-255 SEC).....0
YELLOW CLEAR (0=PARENT,3-25.5 SEC)...0.0
RED CLEAR (0=PARENT,0.1-25.5 SEC)...0.0
OUTPUT AS PHASE # (0=NONE, 1-16)....0
  
```

← NOTICE GREEN FLASH

OVERLAP PROGRAMMING COMPLETE

OVERLAP PROGRAMMING DETAIL FOR ALTERNATE PHASING

(program controller as shown below)

FROM MAIN MENU PRESS '8' (OVERLAPS), THEN '1' (VEHICLE OVERLAP SETTINGS), PRESS 'NEXT' TO ADVANCE TO PAGE 2.

NOTICE PAGE 2 →

```

PAGE 2: VEHICLE OVERLAP 'A' SETTINGS
PHASE:           :12345678910111213141516
VEH OVL PARENTS: :X
VEH OVL NOT VEH: :
VEH OVL NOT PED: :
VEH OVL GRN EXT: :
STARTUP COLOR:  - RED - YELLOW - GREEN
FLASH COLORS:   - RED - YELLOW - GREEN
SELECT VEHICLE OVERLAP OPTIONS: (Y/N)
FLASH YELLOW IN CONTROLLER FLASH?...Y
GREEN EXTENSION (0-255 SEC).....0
YELLOW CLEAR (0=PARENT,3-25.5 SEC)...0.0
RED CLEAR (0=PARENT,0.1-25.5 SEC)...0.0
OUTPUT AS PHASE # (0=NONE, 1-16)....0
  
```

PRESS '+'

NOTICE PAGE 2 →

```

PAGE 2: VEHICLE OVERLAP 'B' SETTINGS
PHASE:           :12345678910111213141516
VEH OVL PARENTS: :X
VEH OVL NOT VEH: :
VEH OVL NOT PED: :
VEH OVL GRN EXT: :
STARTUP COLOR:  - RED - YELLOW - GREEN
FLASH COLORS:   - RED - YELLOW - GREEN
SELECT VEHICLE OVERLAP OPTIONS: (Y/N)
FLASH YELLOW IN CONTROLLER FLASH?...N
GREEN EXTENSION (0-255 SEC).....0
YELLOW CLEAR (0=PARENT,3-25.5 SEC)...0.0
RED CLEAR (0=PARENT,0.1-25.5 SEC)...0.0
OUTPUT AS PHASE # (0=NONE, 1-16)....0
  
```

PRESS '+'

NOTICE PAGE 2 →

```

PAGE 2: VEHICLE OVERLAP 'C' SETTINGS
PHASE:           :12345678910111213141516
VEH OVL PARENTS: :X
VEH OVL NOT VEH: :
VEH OVL NOT PED: :
VEH OVL GRN EXT: :
STARTUP COLOR:  - RED - YELLOW - GREEN
FLASH COLORS:   - RED - YELLOW - GREEN
SELECT VEHICLE OVERLAP OPTIONS: (Y/N)
FLASH YELLOW IN CONTROLLER FLASH?...Y
GREEN EXTENSION (0-255 SEC).....0
YELLOW CLEAR (0=PARENT,3-25.5 SEC)...0.0
RED CLEAR (0=PARENT,0.1-25.5 SEC)...0.0
OUTPUT AS PHASE # (0=NONE, 1-16)....0
  
```

PRESS '+'

NOTICE PAGE 2 →

```

PAGE 2: VEHICLE OVERLAP 'D' SETTINGS
PHASE:           :12345678910111213141516
VEH OVL PARENTS: :X
VEH OVL NOT VEH: :
VEH OVL NOT PED: :
VEH OVL GRN EXT: :
STARTUP COLOR:  - RED - YELLOW - GREEN
FLASH COLORS:   - RED - YELLOW - GREEN
SELECT VEHICLE OVERLAP OPTIONS: (Y/N)
FLASH YELLOW IN CONTROLLER FLASH?...N
GREEN EXTENSION (0-255 SEC).....0
YELLOW CLEAR (0=PARENT,3-25.5 SEC)...0.0
RED CLEAR (0=PARENT,0.1-25.5 SEC)...0.0
OUTPUT AS PHASE # (0=NONE, 1-16)....0
  
```

OVERLAP PROGRAMMING COMPLETE

THIS ELECTRICAL DETAIL IS FOR THE SIGNAL DESIGN: 03-0215T2
 DESIGNED: June 2017
 SEALED: 9/10/2021
 REVISED: N/A

Electrical Detail - Sheet 3 of 8
Signal Upgrade
Temporary Design 2

DOCUMENT NOT CONSIDERED FINAL UNLESS ALL SIGNATURES COMPLETED

HNTB HNTB NORTH CAROLINA, P.C.
 343 E. Six Forks Road, Suite 200
 Raleigh, North Carolina 27609
 NC License No: C-1564
 (919) 546-8997

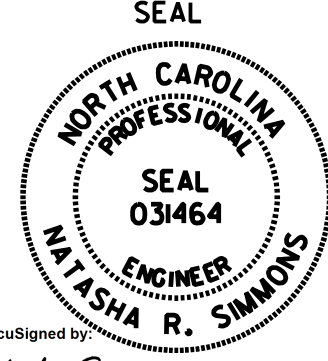
	Prepared for: NC 211 (Howe Street) at NC 87 (River Road)/ SR 1852 (Robert Ruark Drive) Division 03 Brunswick Co. Southport										
	PLAN DATE: June 2017 PREPARED BY: A.H. Thornburg	REVIEWED BY: A.D. Klinksiek REVIEWED BY: N.R. Simmons		SEAL DATE 9/10/2021							
REVISIONS <table border="1"> <thead> <tr> <th>NO.</th> <th>DESCRIPTION</th> <th>INIT.</th> <th>DATE</th> </tr> </thead> <tbody> <tr> <td> </td> <td> </td> <td> </td> <td> </td> </tr> </tbody> </table>			NO.	DESCRIPTION	INIT.	DATE					SIGNATURE DATE DATE DATE
NO.	DESCRIPTION	INIT.	DATE								

750 N. Greenfield Pkwy, Corner, NC 27529

INPUT PAGE 2 ASSIGNMENT PROGRAMMING DETAIL FOR ALTERNATE PHASING - LOOP 1A
(program controller as shown below)

- NOTES: 1. THIS PROGRAMMING APPLIES FOR INPUT PAGE 2 ONLY. INPUT PAGE 1 WILL USE STANDARD DEFAULT SETTINGS. THIS PROGRAMMING IS NECESSARY FOR PROPER DETECTOR OPERATION DURING ALTERNATE PHASING OPERATION.
2. THE FIRST TASK THIS PROGRAMMING ACCOMPLISHES IS THE DISABLING OF INPUT #10 (DETECTOR 26) SO THAT A VEHICLE CALL WILL NOT BE PLACED TO PHASE 6 DURING ALTERNATE PHASING OPERATION. THE SECOND TASK THIS PROGRAMMING ACCOMPLISHES IS THAT IT REASSIGNS DETECTOR 51 TO INPUT #18 SO THAT THE DELAY ON LOOP 1A CAN BE REDUCED FROM 15 SECONDS TO 0 SECONDS.

FROM MAIN MENU PRESS '5' (INPUTS), THEN PRESS 'NEXT' TO GET TO INPUT PAGE '2'. PRESS THE '+' KEY UNTIL INPUT 10 IS REACHED.

PAGE: 2 C1 PIN:48 VEHICLE DETECTOR INPUT ASSIGNMENT #.....10 DEBOUNCE TIME (0-25.5 SEC).....0.5 DELAY TIME (0-25.5 SEC).....0.0 HOLD-OVER TIME (0-25.5 SEC).....0.0 ASSIGNMENT SELECTION: NOT ENABLED (Y/N).....Y
VEHICLE DETECTOR (1-64).....26 PEDESTRIAN DETECTOR (1-16)..... ALTERNATE PED DETECTOR (1-16)..... PREEMPT (1-10)..... INVERTED PREEMPT (1-10)..... STOP TIME (Y/N)..... FLASH SENSE (Y/N)..... DOOR OPEN (Y/N)..... MANUAL CONTROL ENABLE (Y/N)..... MANUAL CONTROL ADVANCE (Y/N)..... SPECIAL FUNCTION ALARM (1-8)..... TOD HOUR SYNCHRONIZATION (0-23)..... FORCE OFF RING (1-4)..... HOLD PHASES (1-16)..... PLAN (65=FLSH,66=FREE)..... OFFSET#..... CHANGE PHASE SEQUENCE PAGE (1-12)..... CHANGE PHASE TIMING PAGE (1-4)..... CHANGE PHASE CONTROL PAGE (1-4)..... CHANGE OVERLAP CONTROL PAGE (1-4)..... CHANGE INPUT PAGE (1-4)..... CHANGE OUTPUT PAGE (1-4)..... OVERRIDE PHASE CONTROL FUNCTION (Y).....

ENTER A 'Y' FOR NOT ENABLED
DEFAULT DETECTOR NUMBER WILL REMAIN UNTIL "NOT ENABLED" IS ENTERED.

(LOOP 1A - PHASE 6)

PAGE: 2 C1 PIN:48 NOT ENABLED INPUT ASSIGNMENT #.....10 DEBOUNCE TIME (0-25.5 SEC).....0.5 DELAY TIME (0-25.5 SEC).....0.0 HOLD-OVER TIME (0-25.5 SEC).....0.0 ASSIGNMENT SELECTION: NOT ENABLED (Y/N).....Y
VEHICLE DETECTOR (1-64)..... PEDESTRIAN DETECTOR (1-16)..... ALTERNATE PED DETECTOR (1-16)..... PREEMPT (1-10)..... INVERTED PREEMPT (1-10)..... STOP TIME (Y/N)..... FLASH SENSE (Y/N)..... DOOR OPEN (Y/N)..... MANUAL CONTROL ENABLE (Y/N)..... MANUAL CONTROL ADVANCE (Y/N)..... SPECIAL FUNCTION ALARM (1-8)..... TOD HOUR SYNCHRONIZATION (0-23)..... FORCE OFF RING (1-4)..... HOLD PHASES (1-16)..... PLAN (65=FLSH,66=FREE)..... OFFSET#..... CHANGE PHASE SEQUENCE PAGE (1-12)..... CHANGE PHASE TIMING PAGE (1-4)..... CHANGE PHASE CONTROL PAGE (1-4)..... CHANGE OVERLAP CONTROL PAGE (1-4)..... CHANGE INPUT PAGE (1-4)..... CHANGE OUTPUT PAGE (1-4)..... OVERRIDE PHASE CONTROL FUNCTION (Y).....

PRESS '+' TO ADVANCE TO INPUT 18

PAGE: 2 C1 PIN:56 VEHICLE DETECTOR INPUT ASSIGNMENT #.....18 DEBOUNCE TIME (0-25.5 SEC).....0.5 DELAY TIME (0-25.5 SEC).....0.0 HOLD-OVER TIME (0-25.5 SEC).....0.0 ASSIGNMENT SELECTION: NOT ENABLED (Y/N).....
VEHICLE DETECTOR (1-64).....1 PEDESTRIAN DETECTOR (1-16)..... ALTERNATE PED DETECTOR (1-16)..... PREEMPT (1-10)..... INVERTED PREEMPT (1-10)..... STOP TIME (Y/N)..... FLASH SENSE (Y/N)..... DOOR OPEN (Y/N)..... MANUAL CONTROL ENABLE (Y/N)..... MANUAL CONTROL ADVANCE (Y/N)..... SPECIAL FUNCTION ALARM (1-8)..... TOD HOUR SYNCHRONIZATION (0-23)..... FORCE OFF RING (1-4)..... HOLD PHASES (1-16)..... PLAN (65=FLSH,66=FREE)..... OFFSET#..... CHANGE PHASE SEQUENCE PAGE (1-12)..... CHANGE PHASE TIMING PAGE (1-4)..... CHANGE PHASE CONTROL PAGE (1-4)..... CHANGE OVERLAP CONTROL PAGE (1-4)..... CHANGE INPUT PAGE (1-4)..... CHANGE OUTPUT PAGE (1-4)..... OVERRIDE PHASE CONTROL FUNCTION (Y).....

ENTER '51' TO REASSIGN THE VEHICLE DETECTOR FOR THIS INPUT

(LOOP 1A - PHASE 1)

PAGE: 2 C1 PIN:56 VEHICLE DETECTOR INPUT ASSIGNMENT #.....18 DEBOUNCE TIME (0-25.5 SEC).....0.5 DELAY TIME (0-25.5 SEC).....0.0 HOLD-OVER TIME (0-25.5 SEC).....0.0 ASSIGNMENT SELECTION: NOT ENABLED (Y/N).....
VEHICLE DETECTOR (1-64).....51 PEDESTRIAN DETECTOR (1-16)..... ALTERNATE PED DETECTOR (1-16)..... PREEMPT (1-10)..... INVERTED PREEMPT (1-10)..... STOP TIME (Y/N)..... FLASH SENSE (Y/N)..... DOOR OPEN (Y/N)..... MANUAL CONTROL ENABLE (Y/N)..... MANUAL CONTROL ADVANCE (Y/N)..... SPECIAL FUNCTION ALARM (1-8)..... TOD HOUR SYNCHRONIZATION (0-23)..... FORCE OFF RING (1-4)..... HOLD PHASES (1-16)..... PLAN (65=FLSH,66=FREE)..... OFFSET#..... CHANGE PHASE SEQUENCE PAGE (1-12)..... CHANGE PHASE TIMING PAGE (1-4)..... CHANGE PHASE CONTROL PAGE (1-4)..... CHANGE OVERLAP CONTROL PAGE (1-4)..... CHANGE INPUT PAGE (1-4)..... CHANGE OUTPUT PAGE (1-4)..... OVERRIDE PHASE CONTROL FUNCTION (Y).....

PROGRAMMING COMPLETE

SPECIAL DETECTOR PROGRAMMING DETAIL - LOOP 1A (ALT.)

(program controller as shown below)

FROM MAIN MENU PRESS '7' (DETECTORS), THEN PRESS '1' FOR VEHICLE DETECTORS. PRESS THE '-' KEY TO GET TO VEHICLE DETECTOR #51.

VEHICLE DETECTOR #51 SETTINGS (+,-,1-64) SETTING: (Y/N)
ENABLE DETECTOR.....N
ENABLE LOGGING.....N
ENABLE DIAGNOSTICS.....N
SPEED TRAP.....N
CALL DETECTOR.....Y
EXTENSION DETECTOR.....Y
MODE 2 STOP BAR.....N
SWITCHING DETECTOR.....N
DUPLICATING DETECTOR.....N
ENABLE FULL TIME DELAY.....N
IF FAILED, SET MIN RECALL?.....N
IF FAILED, SET MAX1 RECALL?.....N
IF FAILED, SET MAX2 RECALL?.....N
PHASE# :12345678910111213141516
PHASES ASSIGNED :
SWITCH/DUPLICATE:
LOOP SIZE (0-255 FT).....6
SPEED TRAP DISTANCE (0-255 FT).....0
STOP BAR TIME (0-255 SEC).....0
STRETCH (0-25.5 SEC).....0.0
DELAY (0-255 SEC).....0.0
MAX CALLS/MIN (0-255).....255
MIN CALLS/DIAGNOSTIC PERIOD (0-255).....0
MAX OCCUPANCY (0-100%).....100
EXTENSION DISABLE TIME (0-255 SEC).....0
QUEUE MAX OCCUPANCY TIME (0-255).....0
QUEUE GAP RESET TIME (0-25.5).....0.0
PREEMPTION INDEX FOR QUEUE (0-10).....0

ENTER 'Y' FOR ENABLE DETECTOR

ENTER '1' FOR PHASES ASSIGNED

ENSURE DELAY IS '0'

VEHICLE DETECTOR #51 SETTINGS (+,-,1-64) SETTING: (Y/N)
ENABLE DETECTOR.....Y
ENABLE LOGGING.....N
ENABLE DIAGNOSTICS.....N
SPEED TRAP.....N
CALL DETECTOR.....Y
EXTENSION DETECTOR.....Y
MODE 2 STOP BAR.....N
SWITCHING DETECTOR.....N
DUPLICATING DETECTOR.....N
ENABLE FULL TIME DELAY.....N
IF FAILED, SET MIN RECALL?.....N
IF FAILED, SET MAX1 RECALL?.....N
IF FAILED, SET MAX2 RECALL?.....N
PHASE# :12345678910111213141516
PHASES ASSIGNED :X
SWITCH/DUPLICATE:
LOOP SIZE (0-255 FT).....6
SPEED TRAP DISTANCE (0-255 FT).....0
STOP BAR TIME (0-255 SEC).....0
STRETCH (0-25.5 SEC).....0.0
DELAY (0-255 SEC).....0.0
MAX CALLS/MIN (0-255).....255
MIN CALLS/DIAGNOSTIC PERIOD (0-255).....0
MAX OCCUPANCY (0-100%).....100
EXTENSION DISABLE TIME (0-255 SEC).....0
QUEUE MAX OCCUPANCY TIME (0-255).....0
QUEUE GAP RESET TIME (0-25.5).....0.0
PREEMPTION INDEX FOR QUEUE (0-10).....0

DETECTOR PROGRAMMING COMPLETE

NOTE: DETECTOR IS PROGRAMMED PER THE INPUT FILE CONNECTION AND PROGRAMMING CHART SHOWN ON SHEET 1.

THIS ELECTRICAL DETAIL IS FOR THE SIGNAL DESIGN: 03-0215T2
DESIGNED: June 2017
SEALED: 9/10/2021
REVISED: N/A

Electrical Detail - Sheet 4 of 8
Signal Upgrade
Temporary Design 2

DOCUMENT NOT CONSIDERED FINAL UNLESS ALL SIGNATURES COMPLETED

Table with project details: NC 211 (Howe Street) at NC 87 (River Road)/ SR 1852 (Robert Ruark Drive). Includes fields for PLAN DATE, REVIEWED BY, PREPARED BY, and a signature block for Natasha Simmons dated 9/10/2021.

INPUT PAGE 2 ASSIGNMENT PROGRAMMING DETAIL FOR ALTERNATE PHASING - LOOP 3A

(program controller as shown below)

- NOTES: 1. THIS PROGRAMMING APPLIES FOR INPUT PAGE 2 ONLY. INPUT PAGE 1 WILL USE STANDARD DEFAULT SETTINGS. THIS PROGRAMMING IS NECESSARY FOR PROPER DETECTOR OPERATION DURING ALTERNATE PHASING OPERATION.
2. THE FIRST TASK THIS PROGRAMMING ACCOMPLISHES IS THE DISABLING OF INPUT #12 (DETECTOR 28) SO THAT A VEHICLE CALL WILL NOT BE PLACED TO PHASE 8 DURING ALTERNATE PHASING OPERATION. THE SECOND TASK THIS PROGRAMMING ACCOMPLISHES IS THAT IT REASSIGNS DETECTOR 53 TO INPUT #20 SO THAT THE DELAY ON LOOP 3A CAN BE REDUCED FROM 15 SECONDS TO 3 SECONDS.

FROM MAIN MENU PRESS '5' (INPUTS), THEN PRESS 'NEXT' TO GET TO INPUT PAGE '2'. PRESS THE '+' KEY UNTIL INPUT 12 IS REACHED.

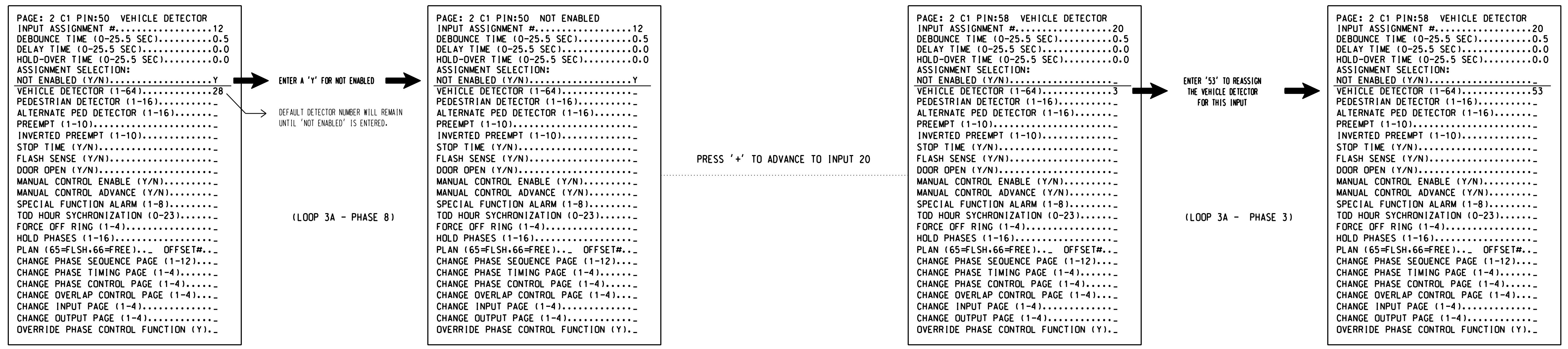

PROGRAMMING COMPLETE

SPECIAL DETECTOR PROGRAMMING DETAIL - LOOP 3A (ALT.)

(program controller as shown below)

FROM MAIN MENU PRESS '7' (DETECTORS), THEN PRESS '1' FOR VEHICLE DETECTORS. PRESS THE '-' KEY TO GET TO VEHICLE DETECTOR #53.

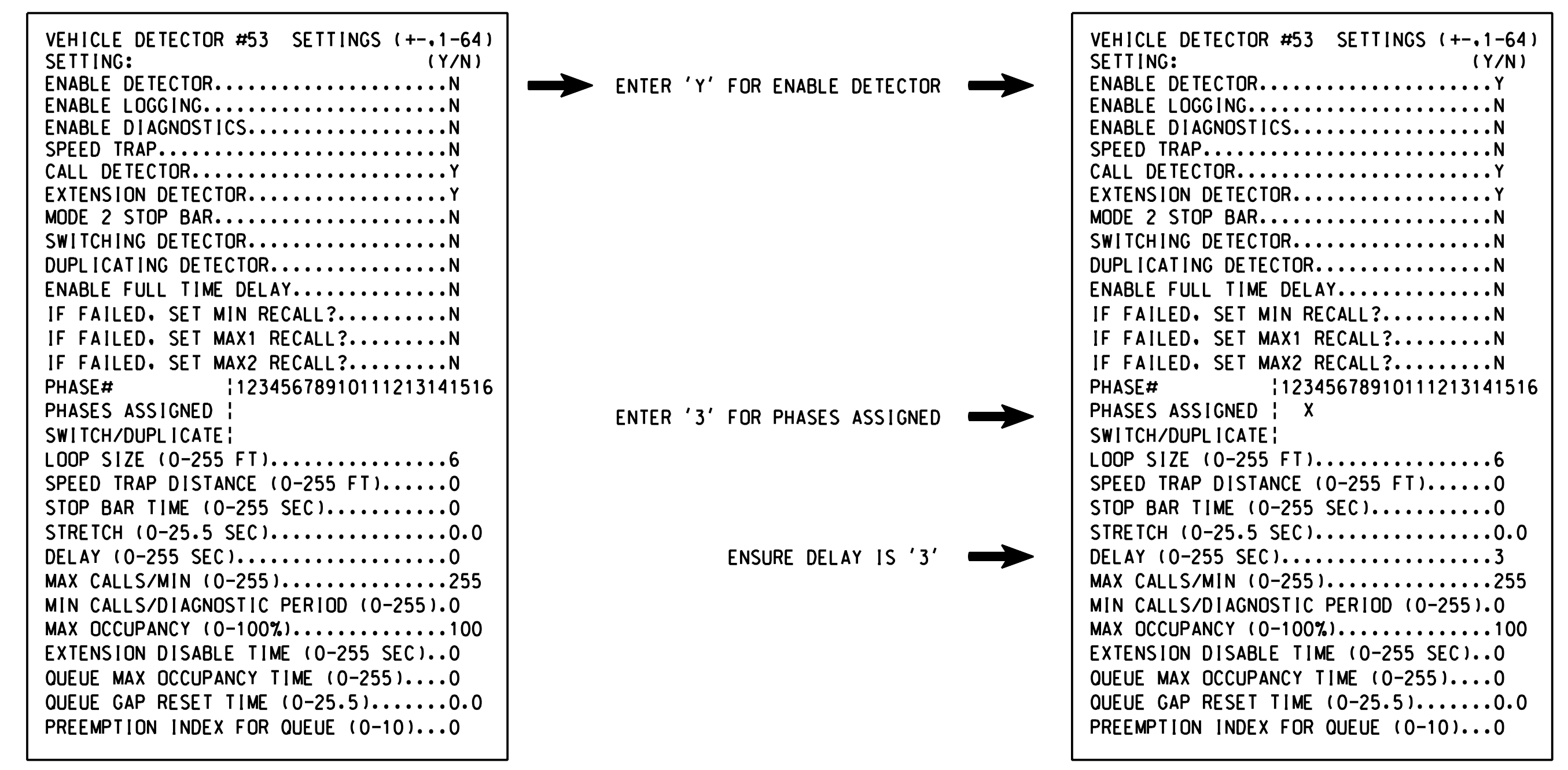

DETECTOR PROGRAMMING COMPLETE

NOTE: DETECTOR IS PROGRAMMED PER THE INPUT FILE CONNECTION AND PROGRAMMING CHART SHOWN ON SHEET 1.

THIS ELECTRICAL DETAIL IS FOR THE SIGNAL DESIGN: 03-0215T12
DESIGNED: June 2017
SEALED: 9/10/2021
REVISED: N/A

Electrical Detail - Sheet 5 of 8
Signal Upgrade
Temporary Design 2

DOCUMENT NOT CONSIDERED FINAL UNLESS ALL SIGNATURES COMPLETED

	Prepared for: 		NC 211 (Howe Street) at NC 87 (River Road)/ SR 1852 (Robert Ruark Drive)		SEAL
	750 N. Greenfield Pkwy, Corner, NC 27529		Division 03 Brunswick Co. Southport		
PLAN DATE: June 2017		REVIEWED BY: A.D. Klinksiek		DATE: 9/10/2021	
PREPARED BY: A.H. Thornburg		REVIEWED BY: N.R. Simmons		SIGNATURE: _____ DATE: _____	
REVISIONS		INIT.		DATE	
SIG. INVENTORY NO. 03-0215T2		9/10/2021			

HNTB HNTB NORTH CAROLINA, P.C.
 343 E. Six Forks Road, Suite 200
 Raleigh, North Carolina 27609
 NC license No: C-1554
 (919) 546-8997

INPUT PAGE 2 ASSIGNMENT PROGRAMMING DETAIL FOR ALTERNATE PHASING - LOOP 5A

(program controller as shown below)

- NOTES: 1. THIS PROGRAMMING APPLIES FOR INPUT PAGE 2 ONLY. INPUT PAGE 1 WILL USE STANDARD DEFAULT SETTINGS. THIS PROGRAMMING IS NECESSARY FOR PROPER DETECTOR OPERATION DURING ALTERNATE PHASING OPERATION. 2. THE FIRST TASK THIS PROGRAMMING ACCOMPLISHES IS THE DISABLING OF INPUT #9 (DETECTOR 22) SO THAT A VEHICLE CALL WILL NOT BE PLACED TO PHASE 2 DURING ALTERNATE PHASING OPERATION. THE SECOND TASK THIS PROGRAMMING ACCOMPLISHES IS THAT IT REASSIGNS DETECTOR 55 TO INPUT #17 SO THAT THE DELAY ON LOOP 5A CAN BE REDUCED FROM 15 SECONDS TO 0 SECONDS.

FROM MAIN MENU PRESS '5' (INPUTS), THEN PRESS 'NEXT' TO GET TO INPUT PAGE '2'. PRESS THE '+' KEY UNTIL INPUT 9 IS REACHED.

PAGE: 2 C1 PIN:47 VEHICLE DETECTOR INPUT ASSIGNMENT #.....9 DEBOUNCE TIME (0-25.5 SEC).....0.5 DELAY TIME (0-25.5 SEC).....0.0 HOLD-OVER TIME (0-25.5 SEC).....0.0 ASSIGNMENT SELECTION: NOT ENABLED (Y/N).....Y VEHICLE DETECTOR (1-64).....22 PEDESTRIAN DETECTOR (1-16)..... ALTERNATE PED DETECTOR (1-16)..... PREEMPT (1-10)..... INVERTED PREEMPT (1-10)..... STOP TIME (Y/N)..... FLASH SENSE (Y/N)..... DOOR OPEN (Y/N)..... MANUAL CONTROL ENABLE (Y/N)..... MANUAL CONTROL ADVANCE (Y/N)..... SPECIAL FUNCTION ALARM (1-8)..... TOD HOUR SYNCHRONIZATION (0-23)..... FORCE OFF RING (1-4)..... HOLD PHASES (1-16)..... PLAN (65=FLSH,66=FREE)..... OFFSET#..... CHANGE PHASE SEQUENCE PAGE (1-12)..... CHANGE PHASE TIMING PAGE (1-4)..... CHANGE PHASE CONTROL PAGE (1-4)..... CHANGE OVERLAP CONTROL PAGE (1-4)..... CHANGE INPUT PAGE (1-4)..... CHANGE OUTPUT PAGE (1-4)..... OVERRIDE PHASE CONTROL FUNCTION (Y).....

ENTER A 'Y' FOR NOT ENABLED
DEFAULT DETECTOR NUMBER WILL REMAIN UNTIL 'NOT ENABLED' IS ENTERED.

(LOOP 5A - PHASE 2)

PAGE: 2 C1 PIN:47 NOT ENABLED INPUT ASSIGNMENT #.....9 DEBOUNCE TIME (0-25.5 SEC).....0.5 DELAY TIME (0-25.5 SEC).....0.0 HOLD-OVER TIME (0-25.5 SEC).....0.0 ASSIGNMENT SELECTION: NOT ENABLED (Y/N).....Y VEHICLE DETECTOR (1-64)..... PEDESTRIAN DETECTOR (1-16)..... ALTERNATE PED DETECTOR (1-16)..... PREEMPT (1-10)..... INVERTED PREEMPT (1-10)..... STOP TIME (Y/N)..... FLASH SENSE (Y/N)..... DOOR OPEN (Y/N)..... MANUAL CONTROL ENABLE (Y/N)..... MANUAL CONTROL ADVANCE (Y/N)..... SPECIAL FUNCTION ALARM (1-8)..... TOD HOUR SYNCHRONIZATION (0-23)..... FORCE OFF RING (1-4)..... HOLD PHASES (1-16)..... PLAN (65=FLSH,66=FREE)..... OFFSET#..... CHANGE PHASE SEQUENCE PAGE (1-12)..... CHANGE PHASE TIMING PAGE (1-4)..... CHANGE PHASE CONTROL PAGE (1-4)..... CHANGE OVERLAP CONTROL PAGE (1-4)..... CHANGE INPUT PAGE (1-4)..... CHANGE OUTPUT PAGE (1-4)..... OVERRIDE PHASE CONTROL FUNCTION (Y).....

PRESS '+' TO ADVANCE TO INPUT 17

PAGE: 2 C1 PIN:55 VEHICLE DETECTOR INPUT ASSIGNMENT #.....17 DEBOUNCE TIME (0-25.5 SEC).....0.5 DELAY TIME (0-25.5 SEC).....0.0 HOLD-OVER TIME (0-25.5 SEC).....0.0 ASSIGNMENT SELECTION: NOT ENABLED (Y/N)..... VEHICLE DETECTOR (1-64).....5 PEDESTRIAN DETECTOR (1-16)..... ALTERNATE PED DETECTOR (1-16)..... PREEMPT (1-10)..... INVERTED PREEMPT (1-10)..... STOP TIME (Y/N)..... FLASH SENSE (Y/N)..... DOOR OPEN (Y/N)..... MANUAL CONTROL ENABLE (Y/N)..... MANUAL CONTROL ADVANCE (Y/N)..... SPECIAL FUNCTION ALARM (1-8)..... TOD HOUR SYNCHRONIZATION (0-23)..... FORCE OFF RING (1-4)..... HOLD PHASES (1-16)..... PLAN (65=FLSH,66=FREE)..... OFFSET#..... CHANGE PHASE SEQUENCE PAGE (1-12)..... CHANGE PHASE TIMING PAGE (1-4)..... CHANGE PHASE CONTROL PAGE (1-4)..... CHANGE OVERLAP CONTROL PAGE (1-4)..... CHANGE INPUT PAGE (1-4)..... CHANGE OUTPUT PAGE (1-4)..... OVERRIDE PHASE CONTROL FUNCTION (Y).....

ENTER '55' TO REASSIGN THE VEHICLE DETECTOR FOR THIS INPUT

(LOOP 5A - PHASE 5)

PAGE: 2 C1 PIN:55 VEHICLE DETECTOR INPUT ASSIGNMENT #.....17 DEBOUNCE TIME (0-25.5 SEC).....0.5 DELAY TIME (0-25.5 SEC).....0.0 HOLD-OVER TIME (0-25.5 SEC).....0.0 ASSIGNMENT SELECTION: NOT ENABLED (Y/N)..... VEHICLE DETECTOR (1-64).....55 PEDESTRIAN DETECTOR (1-16)..... ALTERNATE PED DETECTOR (1-16)..... PREEMPT (1-10)..... INVERTED PREEMPT (1-10)..... STOP TIME (Y/N)..... FLASH SENSE (Y/N)..... DOOR OPEN (Y/N)..... MANUAL CONTROL ENABLE (Y/N)..... MANUAL CONTROL ADVANCE (Y/N)..... SPECIAL FUNCTION ALARM (1-8)..... TOD HOUR SYNCHRONIZATION (0-23)..... FORCE OFF RING (1-4)..... HOLD PHASES (1-16)..... PLAN (65=FLSH,66=FREE)..... OFFSET#..... CHANGE PHASE SEQUENCE PAGE (1-12)..... CHANGE PHASE TIMING PAGE (1-4)..... CHANGE PHASE CONTROL PAGE (1-4)..... CHANGE OVERLAP CONTROL PAGE (1-4)..... CHANGE INPUT PAGE (1-4)..... CHANGE OUTPUT PAGE (1-4)..... OVERRIDE PHASE CONTROL FUNCTION (Y).....

PROGRAMMING COMPLETE

SPECIAL DETECTOR PROGRAMMING DETAIL - LOOP 5A (ALT.)

(program controller as shown below)

FROM MAIN MENU PRESS '7' (DETECTORS), THEN PRESS '1' FOR VEHICLE DETECTORS. PRESS THE '-' KEY TO GET TO VEHICLE DETECTOR #55.

VEHICLE DETECTOR #55 SETTINGS (+,-,1-64) SETTING: (Y/N) ENABLE DETECTOR.....N ENABLE LOGGING.....N ENABLE DIAGNOSTICS.....N SPEED TRAP.....N CALL DETECTOR.....Y EXTENSION DETECTOR.....Y MODE 2 STOP BAR.....N SWITCHING DETECTOR.....N DUPLICATING DETECTOR.....N ENABLE FULL TIME DELAY.....N IF FAILED, SET MIN RECALL?.....N IF FAILED, SET MAX1 RECALL?.....N IF FAILED, SET MAX2 RECALL?.....N PHASE# :12345678910111213141516 PHASES ASSIGNED : SWITCH/DUPLICATE : LOOP SIZE (0-255 FT).....6 SPEED TRAP DISTANCE (0-255 FT).....0 STOP BAR TIME (0-255 SEC).....0 STRETCH (0-25.5 SEC).....0.0 DELAY (0-255 SEC).....0 MAX CALLS/MIN (0-255).....255 MIN CALLS/DIAGNOSTIC PERIOD (0-255).....0 MAX OCCUPANCY (0-100%).....100 EXTENSION DISABLE TIME (0-255 SEC).....0 QUEUE MAX OCCUPANCY TIME (0-255).....0 QUEUE GAP RESET TIME (0-25.5).....0.0 PREEMPTION INDEX FOR QUEUE (0-10).....0

ENTER 'Y' FOR ENABLE DETECTOR

ENTER '5' FOR PHASES ASSIGNED

ENSURE DELAY IS '0'

VEHICLE DETECTOR #55 SETTINGS (+,-,1-64) SETTING: (Y/N) ENABLE DETECTOR.....Y ENABLE LOGGING.....N ENABLE DIAGNOSTICS.....N SPEED TRAP.....N CALL DETECTOR.....Y EXTENSION DETECTOR.....Y MODE 2 STOP BAR.....N SWITCHING DETECTOR.....N DUPLICATING DETECTOR.....N ENABLE FULL TIME DELAY.....N IF FAILED, SET MIN RECALL?.....N IF FAILED, SET MAX1 RECALL?.....N IF FAILED, SET MAX2 RECALL?.....N PHASE# :12345678910111213141516 PHASES ASSIGNED : X SWITCH/DUPLICATE : LOOP SIZE (0-255 FT).....6 SPEED TRAP DISTANCE (0-255 FT).....0 STOP BAR TIME (0-255 SEC).....0 STRETCH (0-25.5 SEC).....0.0 DELAY (0-255 SEC).....0 MAX CALLS/MIN (0-255).....255 MIN CALLS/DIAGNOSTIC PERIOD (0-255).....0 MAX OCCUPANCY (0-100%).....100 EXTENSION DISABLE TIME (0-255 SEC).....0 QUEUE MAX OCCUPANCY TIME (0-255).....0 QUEUE GAP RESET TIME (0-25.5).....0.0 PREEMPTION INDEX FOR QUEUE (0-10).....0

DETECTOR PROGRAMMING COMPLETE

NOTE: DETECTOR IS PROGRAMMED PER THE INPUT FILE CONNECTION AND PROGRAMMING CHART SHOWN ON SHEET 1.

THIS ELECTRICAL DETAIL IS FOR THE SIGNAL DESIGN: 03-0215T2 DESIGNED: June 2017 SEALED: 9/10/2021 REVISED: N/A

Electrical Detail - Sheet 6 of 8
Signal Upgrade
Temporary Design 2

DOCUMENT NOT CONSIDERED FINAL UNLESS ALL SIGNATURES COMPLETED

Table with project details: NC 211 (Howe Street) at NC 87 (River Road)/ SR 1852 (Robert Ruark Drive). Includes logos for HNTB and North Carolina Professional Engineer Seal, and a signature block for Natasha Simmons dated 9/10/2021.

INPUT PAGE 2 ASSIGNMENT PROGRAMMING DETAIL FOR ALTERNATE PHASING - LOOP 7A

(program controller as shown below)

- NOTES: 1. THIS PROGRAMMING APPLIES FOR INPUT PAGE 2 ONLY. INPUT PAGE 1 WILL USE STANDARD DEFAULT SETTINGS. THIS PROGRAMMING IS NECESSARY FOR PROPER DETECTOR OPERATION DURING ALTERNATE PHASING OPERATION. 2. THE FIRST TASK THIS PROGRAMMING ACCOMPLISHES IS THE DISABLING OF INPUT #11 (DETECTOR 24) SO THAT A VEHICLE CALL WILL NOT BE PLACED TO PHASE 4 DURING ALTERNATE PHASING OPERATION. THE SECOND TASK THIS PROGRAMMING ACCOMPLISHES IS THAT IT REASSIGNS DETECTOR 57 TO INPUT #19 SO THAT THE DELAY ON LOOP 7A CAN BE REDUCED FROM 15 SECONDS TO 3 SECONDS.

FROM MAIN MENU PRESS '5' (INPUTS), THEN PRESS 'NEXT' TO GET TO INPUT PAGE '2'. PRESS THE '+' KEY UNTIL INPUT 11 IS REACHED.

PAGE: 2 C1 PIN:49 VEHICLE DETECTOR INPUT ASSIGNMENT #.....11 DEBOUNCE TIME (0-25.5 SEC).....0.5 DELAY TIME (0-25.5 SEC).....0.0 HOLD-OVER TIME (0-25.5 SEC).....0.0 ASSIGNMENT SELECTION: NOT ENABLED (Y/N).....Y VEHICLE DETECTOR (1-64).....24 PEDESTRIAN DETECTOR (1-16)..... ALTERNATE PED DETECTOR (1-16)..... PREEMPT (1-10)..... INVERTED PREEMPT (1-10)..... STOP TIME (Y/N)..... FLASH SENSE (Y/N)..... DOOR OPEN (Y/N)..... MANUAL CONTROL ENABLE (Y/N)..... MANUAL CONTROL ADVANCE (Y/N)..... SPECIAL FUNCTION ALARM (1-8)..... TOD HOUR SYNCHRONIZATION (0-23)..... FORCE OFF RING (1-4)..... HOLD PHASES (1-16)..... PLAN (65=FLSH,66=FREE).. OFFSET#.. CHANGE PHASE SEQUENCE PAGE (1-12).... CHANGE PHASE TIMING PAGE (1-4)..... CHANGE PHASE CONTROL PAGE (1-4).... CHANGE OVERLAP CONTROL PAGE (1-4).... CHANGE INPUT PAGE (1-4)..... CHANGE OUTPUT PAGE (1-4)..... OVERRIDE PHASE CONTROL FUNCTION (Y)...

ENTER A 'Y' FOR NOT ENABLED
DEFAULT DETECTOR NUMBER WILL REMAIN UNTIL 'NOT ENABLED' IS ENTERED.

(LOOP 7A - PHASE 4)

PAGE: 2 C1 PIN:49 NOT ENABLED INPUT ASSIGNMENT #.....11 DEBOUNCE TIME (0-25.5 SEC).....0.5 DELAY TIME (0-25.5 SEC).....0.0 HOLD-OVER TIME (0-25.5 SEC).....0.0 ASSIGNMENT SELECTION: NOT ENABLED (Y/N).....Y VEHICLE DETECTOR (1-64)..... PEDESTRIAN DETECTOR (1-16)..... ALTERNATE PED DETECTOR (1-16)..... PREEMPT (1-10)..... INVERTED PREEMPT (1-10)..... STOP TIME (Y/N)..... FLASH SENSE (Y/N)..... DOOR OPEN (Y/N)..... MANUAL CONTROL ENABLE (Y/N)..... MANUAL CONTROL ADVANCE (Y/N)..... SPECIAL FUNCTION ALARM (1-8)..... TOD HOUR SYNCHRONIZATION (0-23)..... FORCE OFF RING (1-4)..... HOLD PHASES (1-16)..... PLAN (65=FLSH,66=FREE).. OFFSET#.. CHANGE PHASE SEQUENCE PAGE (1-12).... CHANGE PHASE TIMING PAGE (1-4).... CHANGE PHASE CONTROL PAGE (1-4).... CHANGE OVERLAP CONTROL PAGE (1-4).... CHANGE INPUT PAGE (1-4)..... CHANGE OUTPUT PAGE (1-4)..... OVERRIDE PHASE CONTROL FUNCTION (Y)...

PRESS '+' TO ADVANCE TO INPUT 19

PAGE: 2 C1 PIN:57 VEHICLE DETECTOR INPUT ASSIGNMENT #.....19 DEBOUNCE TIME (0-25.5 SEC).....0.5 DELAY TIME (0-25.5 SEC).....0.0 HOLD-OVER TIME (0-25.5 SEC).....0.0 ASSIGNMENT SELECTION: NOT ENABLED (Y/N).....Y VEHICLE DETECTOR (1-64).....7 PEDESTRIAN DETECTOR (1-16)..... ALTERNATE PED DETECTOR (1-16)..... PREEMPT (1-10)..... INVERTED PREEMPT (1-10)..... STOP TIME (Y/N)..... FLASH SENSE (Y/N)..... DOOR OPEN (Y/N)..... MANUAL CONTROL ENABLE (Y/N)..... MANUAL CONTROL ADVANCE (Y/N)..... SPECIAL FUNCTION ALARM (1-8)..... TOD HOUR SYNCHRONIZATION (0-23)..... FORCE OFF RING (1-4)..... HOLD PHASES (1-16)..... PLAN (65=FLSH,66=FREE).. OFFSET#.. CHANGE PHASE SEQUENCE PAGE (1-12).... CHANGE PHASE TIMING PAGE (1-4).... CHANGE PHASE CONTROL PAGE (1-4).... CHANGE OVERLAP CONTROL PAGE (1-4).... CHANGE INPUT PAGE (1-4)..... CHANGE OUTPUT PAGE (1-4)..... OVERRIDE PHASE CONTROL FUNCTION (Y)...

ENTER '57' TO REASSIGN THE VEHICLE DETECTOR FOR THIS INPUT

(LOOP 7A - PHASE 7)

PAGE: 2 C1 PIN:57 VEHICLE DETECTOR INPUT ASSIGNMENT #.....19 DEBOUNCE TIME (0-25.5 SEC).....0.5 DELAY TIME (0-25.5 SEC).....0.0 HOLD-OVER TIME (0-25.5 SEC).....0.0 ASSIGNMENT SELECTION: NOT ENABLED (Y/N).....Y VEHICLE DETECTOR (1-64).....57 PEDESTRIAN DETECTOR (1-16)..... ALTERNATE PED DETECTOR (1-16)..... PREEMPT (1-10)..... INVERTED PREEMPT (1-10)..... STOP TIME (Y/N)..... FLASH SENSE (Y/N)..... DOOR OPEN (Y/N)..... MANUAL CONTROL ENABLE (Y/N)..... MANUAL CONTROL ADVANCE (Y/N)..... SPECIAL FUNCTION ALARM (1-8)..... TOD HOUR SYNCHRONIZATION (0-23)..... FORCE OFF RING (1-4)..... HOLD PHASES (1-16)..... PLAN (65=FLSH,66=FREE).. OFFSET#.. CHANGE PHASE SEQUENCE PAGE (1-12).... CHANGE PHASE TIMING PAGE (1-4).... CHANGE PHASE CONTROL PAGE (1-4).... CHANGE OVERLAP CONTROL PAGE (1-4).... CHANGE INPUT PAGE (1-4)..... CHANGE OUTPUT PAGE (1-4)..... OVERRIDE PHASE CONTROL FUNCTION (Y)...

PROGRAMMING COMPLETE

SPECIAL DETECTOR PROGRAMMING DETAIL - LOOP 7A (ALT.)

(program controller as shown below)

FROM MAIN MENU PRESS '7' (DETECTORS), THEN PRESS '1' FOR VEHICLE DETECTORS. PRESS THE '-' KEY TO GET TO VEHICLE DETECTOR #57.

VEHICLE DETECTOR #57 SETTINGS (+,-,1-64) SETTING: (Y/N) ENABLE DETECTOR.....N ENABLE LOGGING.....N ENABLE DIAGNOSTICS.....N SPEED TRAP.....N CALL DETECTOR.....Y EXTENSION DETECTOR.....Y MODE 2 STOP BAR.....N SWITCHING DETECTOR.....N DUPLICATING DETECTOR.....N ENABLE FULL TIME DELAY.....N IF FAILED, SET MIN RECALL?.....N IF FAILED, SET MAX1 RECALL?.....N IF FAILED, SET MAX2 RECALL?.....N PHASE# :12345678910111213141516 PHASES ASSIGNED : SWITCH/DUPLICATE: LOOP SIZE (0-255 FT).....6 SPEED TRAP DISTANCE (0-255 FT).....0 STOP BAR TIME (0-255 SEC).....0 STRETCH (0-25.5 SEC).....0.0 DELAY (0-255 SEC).....0 MAX CALLS/MIN (0-255).....255 MIN CALLS/DIAGNOSTIC PERIOD (0-255).....0 MAX OCCUPANCY (0-100%).....100 EXTENSION DISABLE TIME (0-255 SEC).....0 QUEUE MAX OCCUPANCY TIME (0-255).....0 QUEUE GAP RESET TIME (0-25.5).....0.0 PREEMPTION INDEX FOR QUEUE (0-10).....0

ENTER 'Y' FOR ENABLE DETECTOR

ENTER '7' FOR PHASES ASSIGNED

ENSURE DELAY IS '3'

VEHICLE DETECTOR #57 SETTINGS (+,-,1-64) SETTING: (Y/N) ENABLE DETECTOR.....Y ENABLE LOGGING.....N ENABLE DIAGNOSTICS.....N SPEED TRAP.....N CALL DETECTOR.....Y EXTENSION DETECTOR.....Y MODE 2 STOP BAR.....N SWITCHING DETECTOR.....N DUPLICATING DETECTOR.....N ENABLE FULL TIME DELAY.....N IF FAILED, SET MIN RECALL?.....N IF FAILED, SET MAX1 RECALL?.....N IF FAILED, SET MAX2 RECALL?.....N PHASE# :12345678910111213141516 PHASES ASSIGNED : X SWITCH/DUPLICATE: LOOP SIZE (0-255 FT).....6 SPEED TRAP DISTANCE (0-255 FT).....0 STOP BAR TIME (0-255 SEC).....0 STRETCH (0-25.5 SEC).....0.0 DELAY (0-255 SEC).....3 MAX CALLS/MIN (0-255).....255 MIN CALLS/DIAGNOSTIC PERIOD (0-255).....0 MAX OCCUPANCY (0-100%).....100 EXTENSION DISABLE TIME (0-255 SEC).....0 QUEUE MAX OCCUPANCY TIME (0-255).....0 QUEUE GAP RESET TIME (0-25.5).....0.0 PREEMPTION INDEX FOR QUEUE (0-10).....0

DETECTOR PROGRAMMING COMPLETE

NOTE: DETECTOR IS PROGRAMMED PER THE INPUT FILE CONNECTION AND PROGRAMMING CHART SHOWN ON SHEET 1.

THIS ELECTRICAL DETAIL IS FOR THE SIGNAL DESIGN: 03-0215T2 DESIGNED: June 2017 SEALED: 9/10/2021 REVISED: N/A

Electrical Detail - Sheet 7 of 8 Signal Upgrade Temporary Design 2

DOCUMENT NOT CONSIDERED FINAL UNLESS ALL SIGNATURES COMPLETED

Table with project details: NC 211 (Howe Street) at NC 87 (River Road)/ SR 1852 (Robert Ruark Drive). Includes fields for PLAN DATE, REVIEWED BY, PREPARED BY, and a signature block for Natasha R. Simmons, dated 9/10/2021.

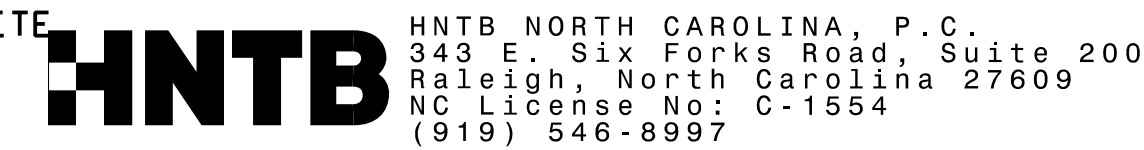

ALTERNATE PHASING ACTIVATION DETAIL

TO RUN ALT. PHASING DURING COORDINATION - SELECT ALL PAGE CHANGES (AS SHOWN BELOW) WITHIN COORDINATION PLAN PROGRAMMING.

TO RUN ALT. PHASING DURING FREE RUN - PROGRAM PAGE CHANGES (SHOWN BELOW) IN SEPARATE TIME OF DAY EVENTS. IF PAGE 1 IS USED, NO EVENT PROGRAMMING IS NECESSARY FOR THAT PARTICULAR PAGE.

<u>PHASING</u>	<u>INPUTS PAGE</u>	<u>OVERLAPS PAGE</u>
ACTIVE PAGES REQUIRED TO RUN <u>DEFAULT PHASING</u>	1	1
ACTIVE PAGES REQUIRED TO RUN <u>ALTERNATE PHASING</u>	2	2

NOTE: PAGES NOT SHOWN (i.e. sequence, phase control, etc.) SHOULD REMAIN AS '1', OR AS DEFINED BY TIMING ENGINEER.

IMPORTANT: IF ALT. PHASING IS USED DURING FREE RUN AND COORDINATION, DO NOT OPERATE TIME OF DAY PAGE CHANGE EVENTS CONCURRENTLY WITH COORDINATION PLAN EVENTS IN THE EVENT SCHEDULER. (EX. FREE RUN PAGE CHANGE EVENT SHOULD END BEFORE COORDINATION PLAN EVENT STARTS AND VICE-VERSA).

FLASHER CIRCUIT MODIFICATION DETAIL

IN ORDER TO ENSURE THAT SIGNALS FLASH CONCURRENTLY ON THE SAME APPROACH, MAKE THE FOLLOWING FLASHER CIRCUIT CHANGES:

1. ON REAR OF PDA - REMOVE WIRE FROM TERM. T2-4 AND TERMINATE ON T2-2.
2. ON REAR OF PDA - REMOVE WIRE FROM TERM. T2-5 AND TERMINATE ON T2-3.
3. REMOVE FLASHER UNIT 2.

THE CHANGES LISTED ABOVE TIES ALL PHASES AND OVERLAPS TO FLASHER UNIT 1.

ALTERNATE PHASING PAGE CHANGE SUMMARY

THE FOLLOWING IS A SUMMARY OF WHAT TAKES PLACE WHEN THESE OVERLAP/INPUT PAGE CHANGES ACTIVATE TO CALL THE "ALTERNATE PHASING":

- OVERLAPS PAGE 2:** Modifies overlap parent phases for heads 11, 31, 51, and 71 to run protected turns only.
- INPUTS PAGE 2:** Disables phase 6 call on loop 1A and reduces delay time for phase 1 call on loop 1A to 0 seconds.
- Disables phase 8 call on loop 3A and reduces delay time for phase 3 call on loop 3A to 3 seconds.
- Disables phase 2 call on loop 5A and reduces delay time for phase 5 call on loop 5A to 0 seconds.
- Disables phase 4 call on loop 7A and reduces delay time for phase 7 call on loop 7A to 3 seconds.

THIS ELECTRICAL DETAIL IS FOR THE SIGNAL DESIGN: 03-0215T2
DESIGNED: June 2017
SEALED: 9/10/2021
REVISED: N/A

Electrical Detail - Sheet 8 of 8
Signal Upgrade
Temporary Design 2

**DOCUMENT NOT CONSIDERED FINAL
UNLESS ALL SIGNATURES COMPLETED**

HNTB HNTB NORTH CAROLINA, P.C.
343 E. Six Forks Road, Suite 200
Raleigh, North Carolina 27609
NC License No: C-1554
(919) 546-8997

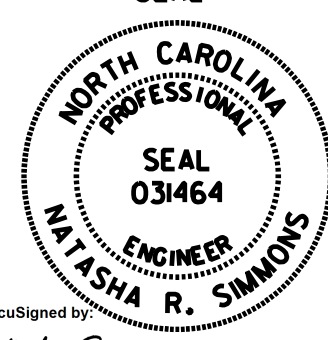
<p style="font-size: small;">ELECTRICAL AND PROGRAMMING DETAILS FOR:</p> <div style="text-align: center;">  <p style="font-size: x-small;">Prepared for: Department of Transportation State of North Carolina Signal Management</p> </div> <p style="font-size: x-small;">750 N. Greenfield Pkwy, Corner, NC 27529</p>	<p>NC 211 (Howe Street) at NC 87 (River Road)/ SR 1852 (Robert Ruark Drive) Division 03 Brunswick Co. Southport</p> <p style="font-size: x-small;">PLAN DATE: June 2017 REVIEWED BY: A.D. Klinksiek PREPARED BY: A.H. Thornburg REVIEWED BY: N.R. Simmons</p>	<p style="text-align: center;">SEAL</p> <div style="text-align: center;">  <p style="font-size: x-small;">NATASHA R. SIMMONS ENGINEER SEAL 031464</p> </div> <p style="font-size: x-small;">DocuSigned by: Natasha Simmons 9/10/2021</p>									
<table border="1" style="width: 100%; border-collapse: collapse;"> <thead> <tr> <th style="width: 50%;">REVISIONS</th> <th style="width: 25%;">INIT.</th> <th style="width: 25%;">DATE</th> </tr> </thead> <tbody> <tr> <td> </td> <td> </td> <td> </td> </tr> <tr> <td> </td> <td> </td> <td> </td> </tr> </tbody> </table>		REVISIONS	INIT.	DATE							<p style="font-size: x-small;">SIGNATURE DATE</p> <p style="font-size: x-small;">SIG. INVENTORY NO. 03-0215T2</p>
REVISIONS	INIT.	DATE									

DEFAULT PHASING DIAGRAM

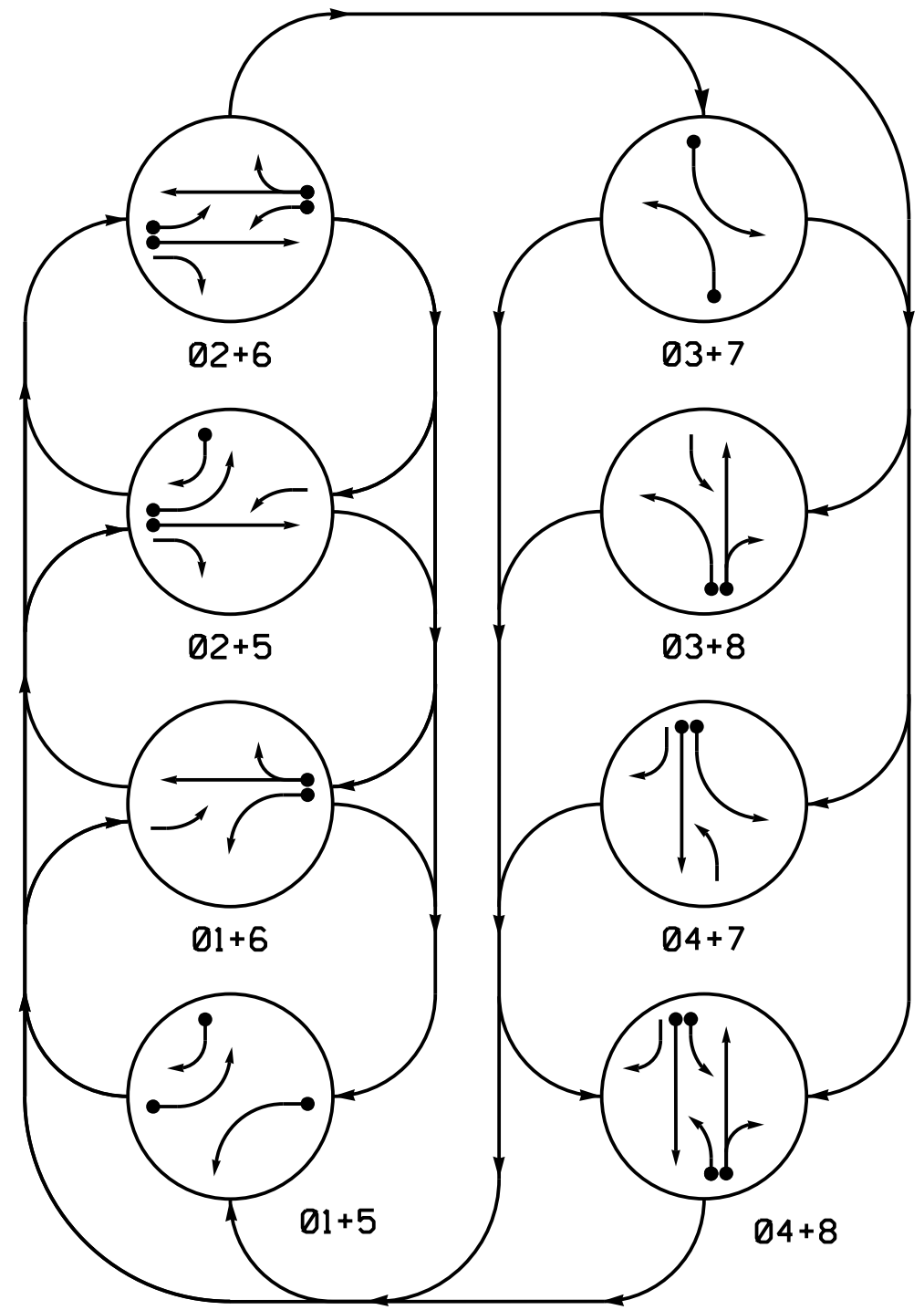

ALTERNATE PHASING DIAGRAM

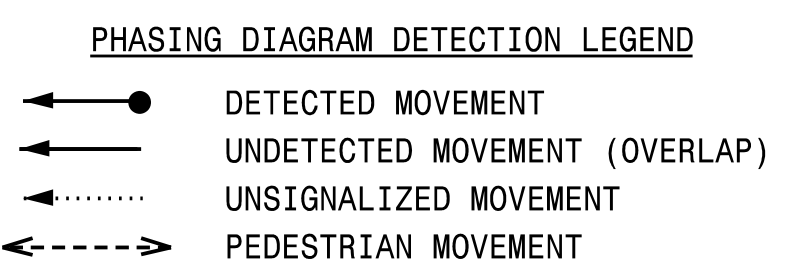
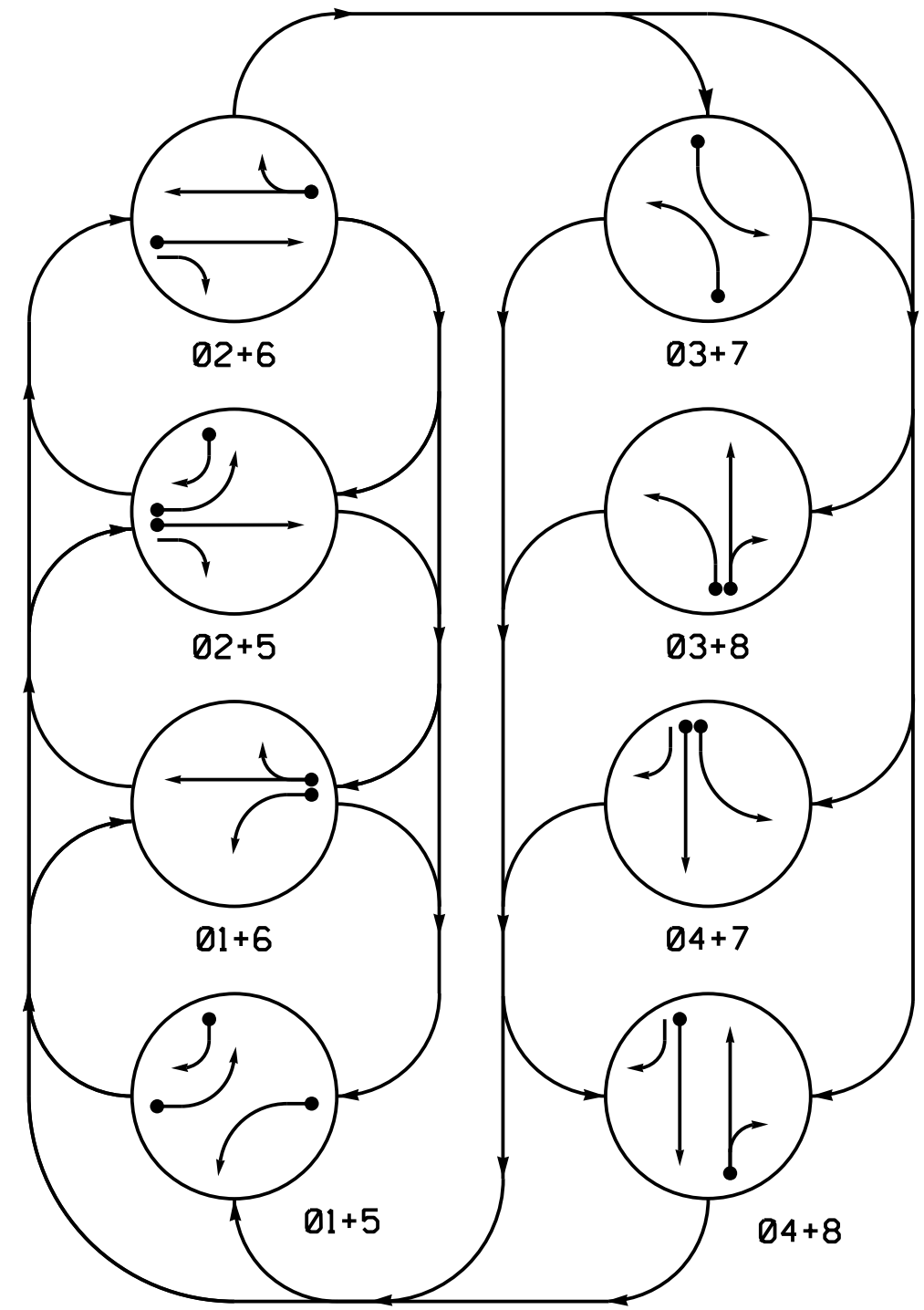

SIGNAL FACE I.D.

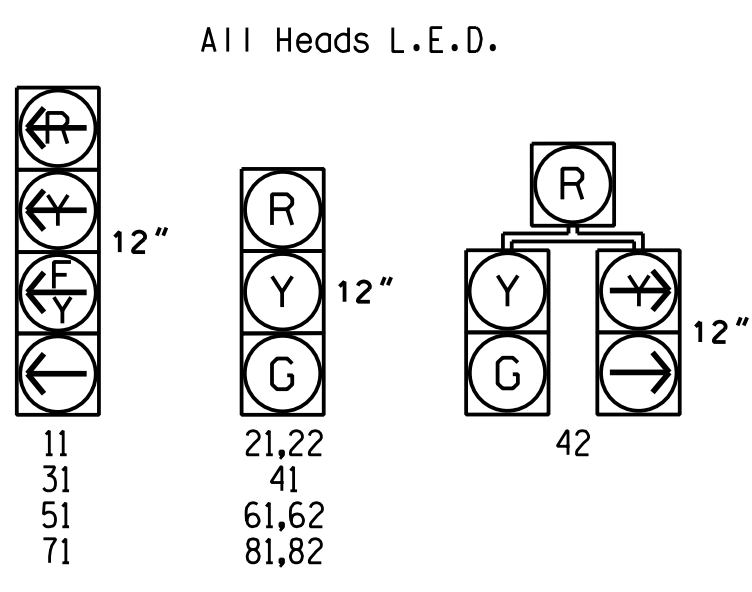

DEFAULT PHASING TABLE OF OPERATION

SIGNAL FACE	PHASE							
	01+5	01+6	02+5	02+6	03+7	03+8	04+7	04+8
11	—	—	—	—	—	—	—	—
21,22	R	R	G	G	R	R	R	Y
31	R	R	R	R	—	—	—	—
41	R	R	R	R	R	G	G	R
42	R	R	R	R	R	G	G	R
51	—	—	—	—	—	—	—	—
61,62	R	G	R	G	R	R	R	Y
71	R	R	R	R	—	—	—	—
81,82	R	R	R	R	R	G	G	R

ALTERNATE PHASING TABLE OF OPERATION

SIGNAL FACE	PHASE							
	01+5	01+6	02+5	02+6	03+7	03+8	04+7	04+8
11	—	—	—	—	—	—	—	—
21,22	R	R	G	G	R	R	R	Y
31	R	R	R	R	—	—	—	—
41	R	R	R	R	R	G	G	R
42	R	R	R	R	R	G	G	R
51	—	—	—	—	—	—	—	—
61,62	R	G	R	G	R	R	R	Y
71	R	R	R	R	—	—	—	—
81,82	R	R	R	R	R	G	G	R

OASIS 2070 LOOP & DETECTOR INSTALLATION CHART

LOOP	SIZE (FT)	DISTANCE FROM STOPBAR (FT)	TURNS	NEW LOOP	DETECTOR PROGRAMMING				SYSTEM LOOP	NEW CARD
					PHASE	CALLING	EXTENSION	STRETCH TIME		
1A	6X40	0	*	*	1	Y	Y	-	15	-
2A	6X6	300	*	*	2	Y	Y	-	1.6	-
2B	6X6	90	*	*	2	Y	Y	-	-	-
3A	6X40	0	*	*	3	Y	Y	-	15	-
4A	6X40	0	*	*	4	Y	Y	-	-	-
5A	6X40	0	*	*	5	Y	Y	-	15	-
5B	6X40	0	*	*	5	Y	Y	-	-	-
6A	6X6	70	*	*	6	Y	Y	-	-	-
7A	6X40	0	*	*	7	Y	Y	-	15	-
8A	6X40	0	*	*	8	Y	Y	-	10	-

* Multizone Microwave Detection.
 ** Disable phase 2,4,6 and 8 call for 1A,3A,5A and 7A during alternate phasing operation.
 *** Reduce delay to 3 seconds for 3A and 0 seconds for 1A,5A, and 7A during alternate phasing operation.

8 Phase Fully Actuated (NC 133 Closed Loop System)

NOTES

- Refer to "Roadway Standard Drawings NCDOT" dated January 2018 and "Standard Specifications for Roads and Structures" dated January 2018.
- Do not program signal for late night flashing operation unless otherwise directed by the Engineer.
- Phase 1 and/or 5 may be lagged.
- Phase 3 and/or 7 may be lagged.
- Reposition existing signal heads numbered 41,42,61,62 and 71.
- Set all detector units to presence mode.
- The Division Traffic Engineer will determine the hours of use for each phasing plan.
- Incorporate Microwave Detection system for vehicle detection.
- Provide the Engineer with the Manufacturer's approved Microwave Detection locations and mounting heights to obtain detection zones as shown.
- Maximum times shown in timing chart are for free-run operation only. Coordinated signal system timing values supersede these values.
- Closed loop system data: Controller Asset #: 0215.

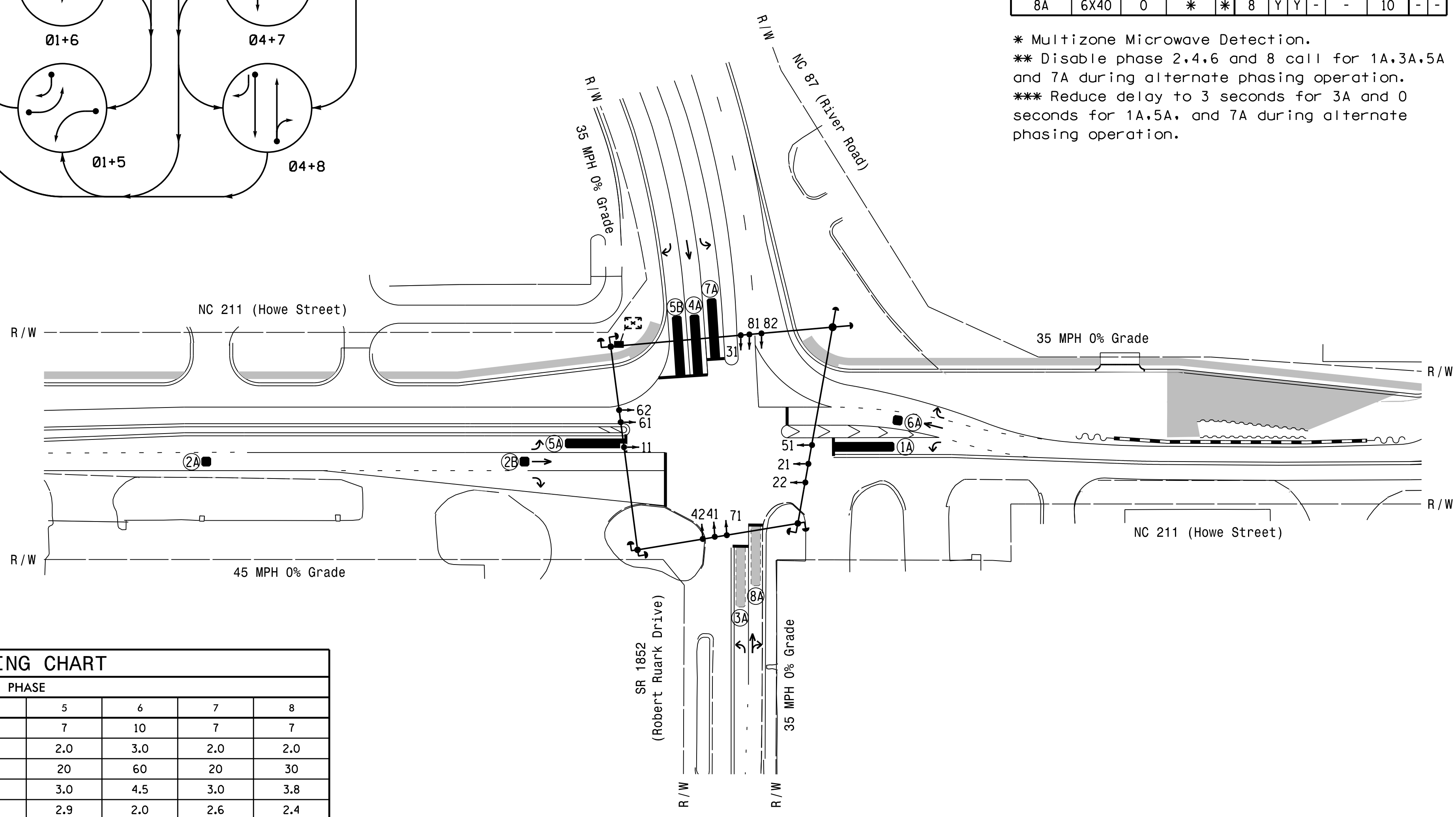

OASIS 2070 TIMING CHART

FEATURE	PHASE							
	1	2	3	4	5	6	7	8
Min Green 1 *	7	12	7	7	7	10	7	7
Extension 1 *	2.0	2.0	2.0	2.0	2.0	3.0	2.0	2.0
Max Green 1 *	20	60	20	30	20	60	20	30
Yellow Clearance	3.0	4.5	3.0	3.8	3.0	4.5	3.0	3.8
Red Clearance	2.8	2.0	3.2	2.4	2.9	2.0	2.6	2.4
Red Revert	2.0	2.0	2.0	2.0	2.0	2.0	2.0	2.0
Walk 1 *	-	-	-	-	-	-	-	-
Don't Walk 1	-	-	-	-	-	-	-	-
Seconds Per Actuation *	-	-	-	-	-	-	-	-
Max Variable Initial *	-	-	-	-	-	-	-	-
Time Before Reduction *	-	-	-	-	-	-	-	-
Time To Reduce *	-	-	-	-	-	-	-	-
Minimum Gap	-	-	-	-	-	-	-	-
Recall Mode	-	MIN RECALL	-	-	-	MIN RECALL	-	-
Vehicle Call Memory	-	YELLOW	-	-	-	YELLOW	-	-
Dual Entry	-	-	-	ON	-	-	-	ON
Simultaneous Gap	ON	ON	ON	ON	ON	ON	ON	ON

* These values may be field adjusted. Do not adjust Min Green and Extension times for phases 2 and 6 lower than what is shown. Min Green for all other phases should not be lower than 4 seconds.

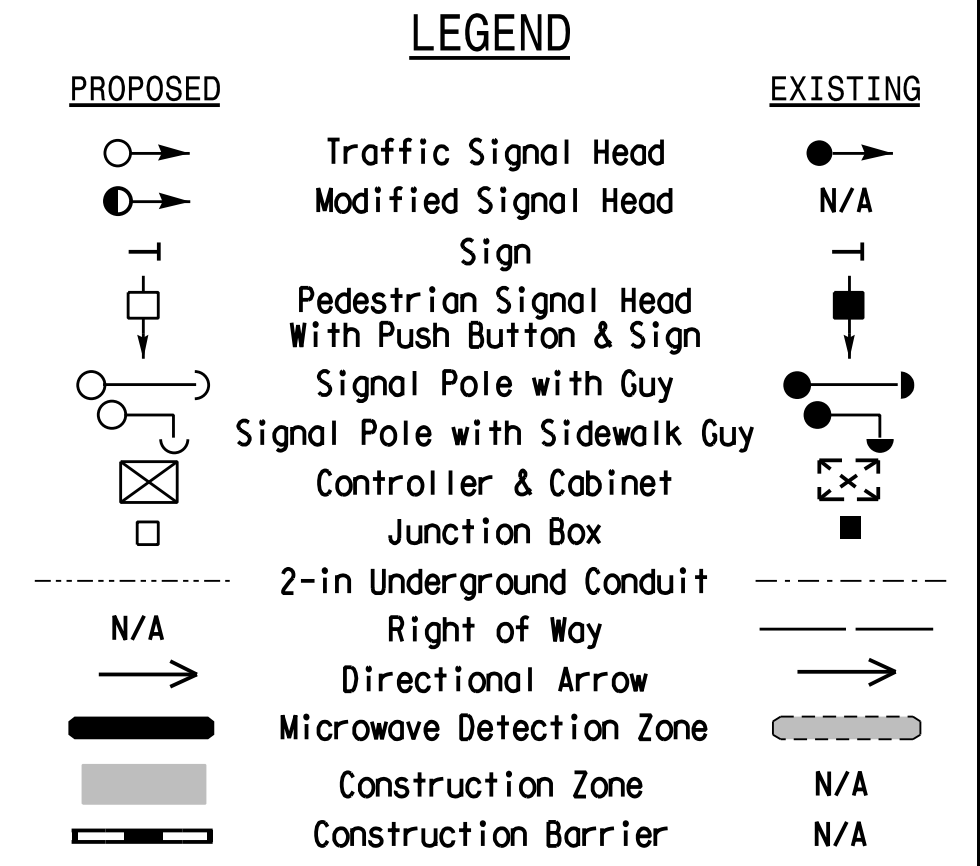

Signal Upgrade
 Temporary Design 3
 Construction Phase 1b

DOCUMENT NOT CONSIDERED FINAL UNLESS ALL SIGNATURES COMPLETED

	Prepared for: NC 211 (Howe Street) at NC 87 (River Road)/ SR 1852 (Robert Ruark Drive)		SEAL
	Division 03 Brunswick Co. Southport PLAN DATE: June 2017 PREPARED BY: A.H. Thornburg SCALE: 1"=50' REVISIONS:	REVIEWED BY: A.D. Klinksiek REVIEWED BY: N.R. Simmons DATE: 9/10/2021 SIGNATURE:	

EDI MODEL 2018ECL-NC CONFLICT MONITOR PROGRAMMING DETAIL

(remove jumpers and set switches as shown)

REMOVE DIODE JUMPERS 1-5, 1-6, 1-9, 1-11, 2-5, 2-6, 2-9, 2-11, 3-7, 3-8, 3-10, 3-12, 4-7, 4-8, 4-10, 4-12, 5-9, 5-11, 6-9, 6-11, 7-10, 7-12, 8-10, 8-12, 9-11 and 10-12.

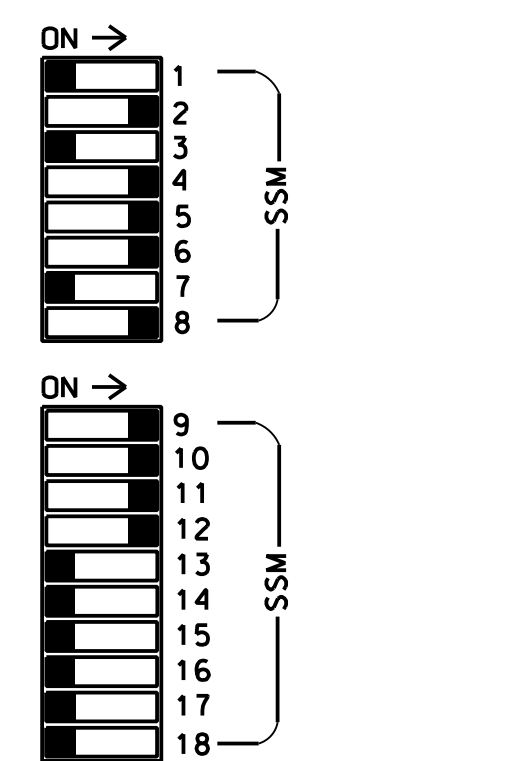
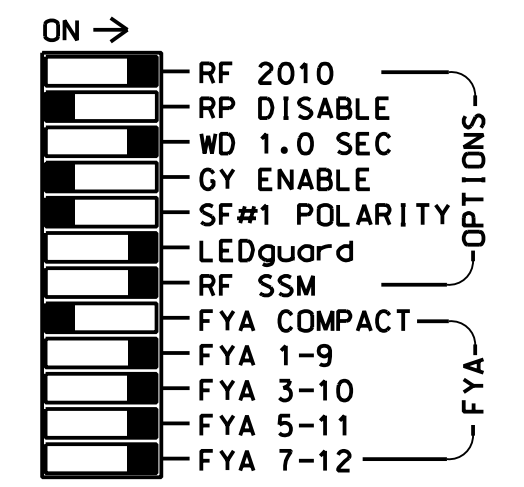
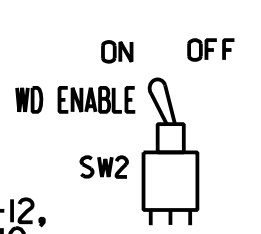
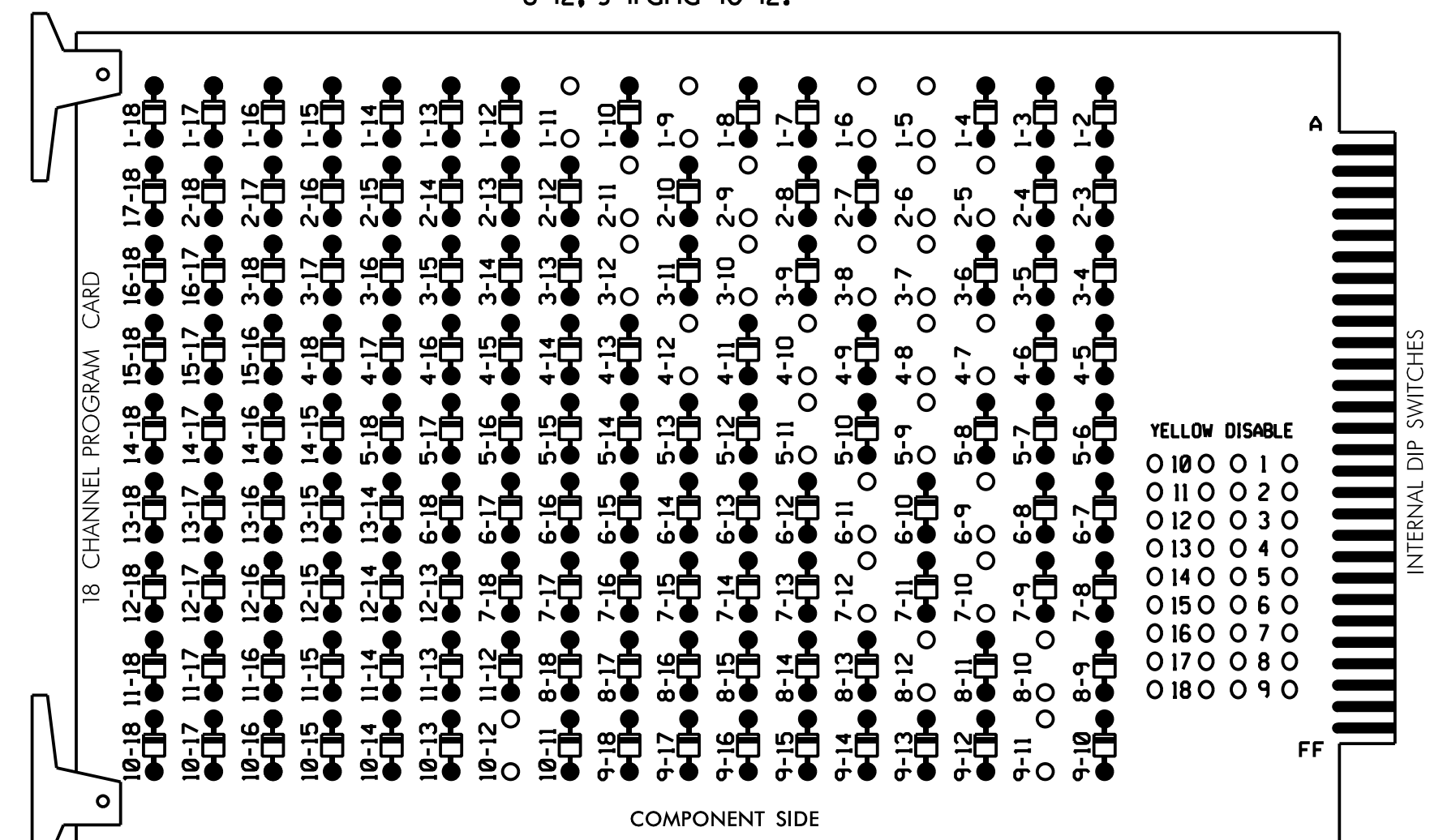

■ = DENOTES POSITION OF SWITCH

NOTES:

- Card is provided with all diode jumpers in place. Removal of any jumper allows its channels to run concurrently.
- Ensure jumpers SEL2-SEL5 and SEL9 are present on the monitor board.
- Ensure that Red Enable is active at all times during normal operation.
- Connect serial cable from conflict monitor to comm. port 1 of 2070 controller. Ensure conflict monitor communicates with 2070.

REMOVE JUMPERS AS SHOWN

NOTES

- To prevent "flash-conflict" problems, insert red flash program blocks for all unused vehicle load switches in the output file. The installer shall verify that signal heads flash in accordance with the Signal Plans.
- Program phases 4 and 8 for Dual Entry.
- Enable Simultaneous Gap-Out for all Phases.
- Program phases 2 and 6 for Startup In Green.
- Program phases 2 and 6 for Yellow Flash, and overlaps 1 and 2 as Wag Overlaps.
- If this signal will be managed by an ATMS software, enable controller and detector logging for all detectors used at this location.
- The cabinet and controller are part of the NC 133 Closed Loop System.

EQUIPMENT INFORMATION

CONTROLLER.....2070E
 CABINET.....332 W/ AUX
 SOFTWARE.....ECONOLITE OASIS
 CABINET MOUNT.....BASE
 OUTPUT FILE POSITIONS...18 WITH AUX. OUTPUT FILE
 LOAD SWITCHES USED.....S1,S2,S4,S5,S7,S8,S10,S11,
 AUX S1,AUX S2,AUX S4,AUX S5
 PHASES USED.....1,2,3,4,5,6,7,8
 OVERLAP "A".....1+2
 OVERLAP "B".....3+4
 OVERLAP "C".....5+6
 OVERLAP "D".....7+8

SIGNAL HEAD HOOK-UP CHART

LOAD SWITCH NO.	S1	S2	S3	S4	S5	S6	S7	S8	S9	S10	S11	S12	AUX S1	AUX S2	AUX S3	AUX S4	AUX S5	AUX S6
CMU CHANNEL NO.	1	2	13	3	4	14	5	6	15	7	8	16	9	10	17	11	12	18
PHASE	1	2	2 PED	3	4	4 PED	5	6	6 PED	7	8	8 PED	OLA	OLB	SPARE	OLC	OLD	SPARE
SIGNAL HEAD NO.	11	21,22	NU	31	41,42	NU	42	51	61,62	NU	71	81,82	NU	11	31	NU	51	71
RED		128			101		*		134			107						
YELLOW	*	129		*	102				135		*	108						
GREEN		130			103				136			109						
RED ARROW															A121	A124		A114
YELLOW ARROW															A122	A125		A115
FLASHING YELLOW ARROW															A123	A126		A116
GREEN ARROW	127			118			133	133		124								

NU = Not Used

* Denotes install load resistor. See load resistor installation detail this sheet.

★ See pictorial of head wiring in detail this sheet.

INPUT FILE POSITION LAYOUT

(front view)

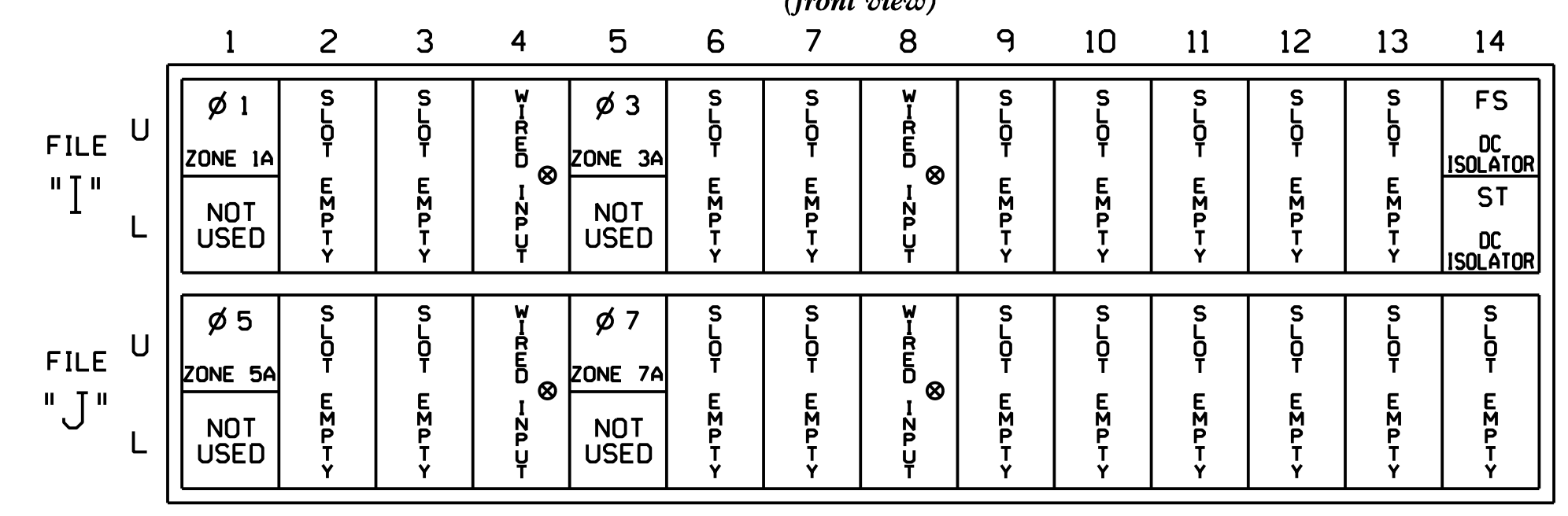

EX.: 1A, 2A, ETC. = LOOP NO.'S

FS = FLASH SENSE
 ST = STOP TIME

⊗ Wired Input - Do not populate slot with detector card

INPUT FILE CONNECTION & PROGRAMMING CHART

LOOP NO.	LOOP TERMINAL	INPUT FILE POS.	PIN NO.	INPUT ASSIGNMENT NO.	DETECTOR NO.	NEMA PHASE	CALL	EXTEND	FULL TIME DELAY	STRETCH TIME	DELAY TIME
ZONE 1A ¹	TB2-1,2	I1U	56	18	1	1	Y	Y			15
	-	J4U	48	10★	26	6	Y	Y			
	-	I1U	56	18★	51	1	Y	Y			
ZONE 3A ²	TB4-5,6	I5U	58	20	3	3	Y	Y			15
	-	J8U	50	12★	28	8	Y	Y			3
	-	I5U	58	20★	53	3	Y	Y			3
ZONE 5A ³	TB3-1,2	J1U	55	17	5	5	Y	Y			15
	-	I4U	47	9★	22	2	Y	Y			
	-	J1U	55	17★	55	5	Y	Y			
ZONE 7A ⁴	TB5-5,6	J5U	57	19	7	7	Y	Y			15
	-	I8U	49	11★	24	4	Y	Y			
	-	J5U	57	19★	57	7	Y	Y			

- Add jumper from I1-W to J4-W, on rear of input file.
 - Add jumper from I5-W to J8-W, on rear of input file.
 - Add jumper from J1-W to I4-W, on rear of input file.
 - Add jumper from J5-W to I8-W, on rear of input file.
- * See Input Page Assignment programming details on sheets 4, 5, 6, and 7.

INPUT FILE POSITION LEGEND: J2L

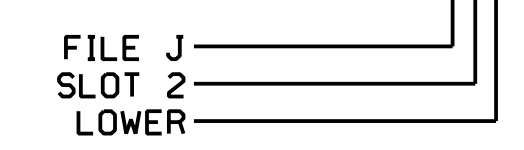

SPECIAL DETECTOR NOTE

Install a microwave detection system for vehicle detection. Perform installation according to manufacturer's directions and NCDOT engineer-approved mounting locations to accomplish the detection schemes shown on the Signal Design Plans.

For loops 1A, 3A, 5A, and 7A, detector card placement and slots reserved for wired inputs are typical for a NCDOT installation. Inputs associated with these slots are compatible with time of day instructions located on sheets 4, 5, 6, 7, and 8 of this electrical detail.

LOAD RESISTOR INSTALLATION DETAIL

(install resistors as shown)

VALUE (ohms)	WATTAGE
1.5K - 1.9K	25W (min)
2.0K - 3.0K	10W (min)

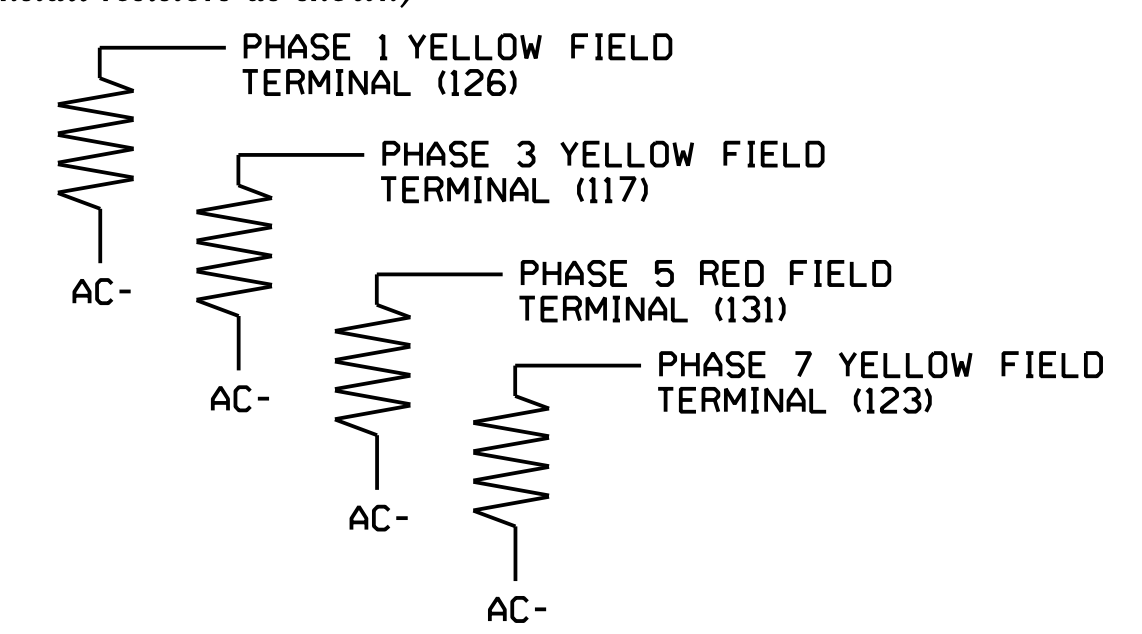

FYA SIGNAL WIRING DETAIL

(wire signal heads as shown)

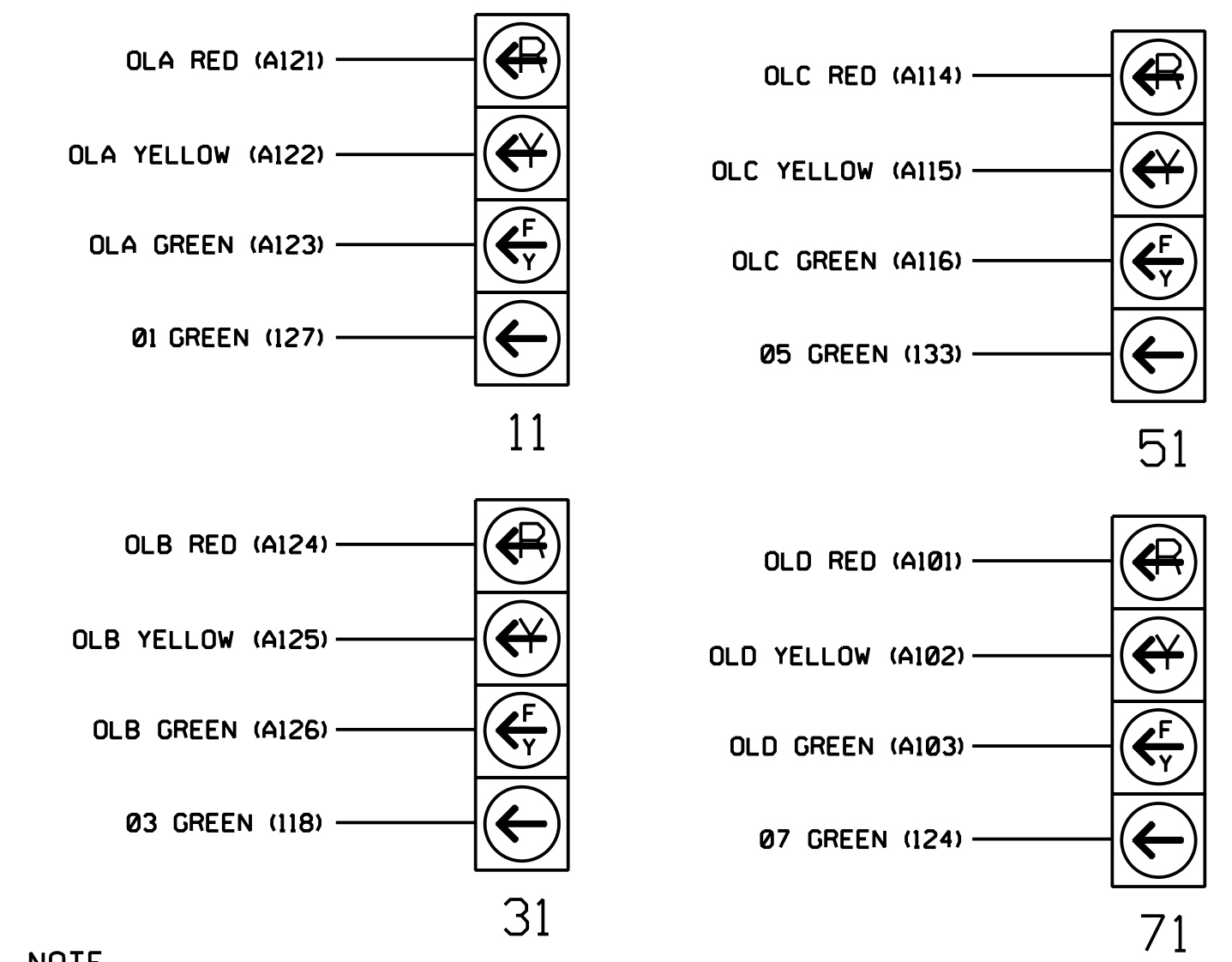

NOTE

The sequence display for signal heads 11, 31, 51, and 71 requires special logic programming. See sheet 2 for programming instructions.

THIS ELECTRICAL DETAIL IS FOR THE SIGNAL DESIGN: 03-0215T3
 DESIGNED: June 2017
 SEALED: 9/10/2021
 REVISED: N/A

Electrical Detail - Sheet 1 of 8
 Signal Upgrade
 Temporary Design 3

DOCUMENT NOT CONSIDERED FINAL UNLESS ALL SIGNATURES COMPLETED

	Prepared for: 	NC 211 (Howe Street) at NC 87 (River Road)/ SR 1852 (Robert Ruark Drive) Division 03 Brunswick Co. Southport	SEAL
	HNTB NORTH CAROLINA, P.C. 343 E. Six Forks Road, Suite 200 Raleigh, North Carolina 27609 NC License No: C-1564 (919) 546-8997	PLAN DATE: June 2017 PREPARED BY: A.H. Thornburg REVIEWED BY: A.D. Klinskiak REVIEWED BY: N.R. Simmons	REVISIONS INITI. DATE SIGNATURE DATE 9/10/2021 SIG. INVENTORY NO. 03-0215T3

LOGICAL I/O PROCESSOR PROGRAMMING DETAIL TO PRODUCE SPECIAL FYA-PPLT SIGNAL SEQUENCE

(program controller as shown below)

- FROM MAIN MENU PRESS '2' (PHASE CONTROL), THEN '1' (PHASE CONTROL FUNCTIONS). SCROLL TO THE BOTTOM OF THE MENU AND ENABLE ACT LOGIC COMMANDS 1, 2, 3, 4, 5, 6, 7, 8, 9, 10, 11, AND 12.
- FROM MAIN MENU PRESS '6' (OUTPUTS), THEN '3' (LOGICAL I/O PROCESSOR).

LOGICAL I/O COMMAND #1 (+/-COMMAND#)
IF ACTIVE PHASE #1 IS ON
AND RED CLEAR ON PHASE #1 IS ON

↓
SCROLL DOWN

THEN:
SET OUTPUT ASSIGNMENT #50 ON
SET OUTPUT ASSIGNMENT #51 OFF

PRESS '+'

NOTE: LOGIC FOR PHASE 1 RED CLEAR WHEN TRANSITIONING FROM PHASE 1 TO PHASE 2 (HEAD 11).

LOGICAL I/O COMMAND #7 (+/-COMMAND#)
IF ACTIVE PHASE #3 IS ON
AND RED CLEAR ON PHASE #3 IS ON

↓
SCROLL DOWN

THEN:
SET OUTPUT ASSIGNMENT #47 ON
SET OUTPUT ASSIGNMENT #48 OFF

PRESS '+'

NOTE: LOGIC FOR PHASE 3 RED CLEAR WHEN TRANSITIONING FROM PHASE 3 TO PHASE 4 (HEAD 31).

LOGICAL I/O COMMAND #2 (+/-COMMAND#)
IF ACTIVE PHASE #1 IS ON

↓
SCROLL DOWN

THEN:
SET OUTPUT ASSIGNMENT #52 OFF

PRESS '+'

NOTE: LOGIC FOR SWITCHING FLASHING YELLOW ARROW "OFF" DURING PHASE 1 (HEAD 11).

LOGICAL I/O COMMAND #8 (+/-COMMAND#)
IF ACTIVE PHASE #3 IS ON

↓
SCROLL DOWN

THEN:
SET OUTPUT ASSIGNMENT #49 OFF

PRESS '+'

NOTE: LOGIC FOR SWITCHING FLASHING YELLOW ARROW "OFF" DURING PHASE 3 (HEAD 31).

LOGICAL I/O COMMAND #3 (+/-COMMAND#)
IF YELLOW ON PHASE #1 IS ON

↓
SCROLL DOWN

THEN:
SET OUTPUT ASSIGNMENT #51 ON

PRESS '+'

NOTE: LOGIC FOR YELLOW ARROW CLEARANCE FROM PHASE 1 (HEAD 11).

LOGICAL I/O COMMAND #9 (+/-COMMAND#)
IF YELLOW ON PHASE #3 IS ON

↓
SCROLL DOWN

THEN:
SET OUTPUT ASSIGNMENT #48 ON

PRESS '+'

NOTE: LOGIC FOR YELLOW ARROW CLEARANCE FROM PHASE 3 (HEAD 31).

LOGICAL I/O COMMAND #4 (+/-COMMAND#)
IF ACTIVE PHASE #5 IS ON
AND RED CLEAR ON PHASE #5 IS ON

↓
SCROLL DOWN

THEN:
SET OUTPUT ASSIGNMENT #42 ON
SET OUTPUT ASSIGNMENT #43 OFF

PRESS '+'

NOTE: LOGIC FOR PHASE 5 RED CLEAR WHEN TRANSITIONING FROM PHASE 5 TO PHASE 6 (HEAD 51).

LOGICAL I/O COMMAND #10 (+/-COMMAND#)
IF ACTIVE PHASE #7 IS ON
AND RED CLEAR ON PHASE #7 IS ON

↓
SCROLL DOWN

THEN:
SET OUTPUT ASSIGNMENT #39 ON
SET OUTPUT ASSIGNMENT #40 OFF

PRESS '+'

NOTE: LOGIC FOR PHASE 7 RED CLEAR WHEN TRANSITIONING FROM PHASE 7 TO PHASE 8 (HEAD 71).

LOGICAL I/O COMMAND #5 (+/-COMMAND#)
IF ACTIVE PHASE #5 IS ON

↓
SCROLL DOWN

THEN:
SET OUTPUT ASSIGNMENT #44 OFF

PRESS '+'

NOTE: LOGIC FOR SWITCHING FLASHING YELLOW ARROW "OFF" DURING PHASE 5 (HEAD 51).

LOGICAL I/O COMMAND #11 (+/-COMMAND#)
IF ACTIVE PHASE #7 IS ON

↓
SCROLL DOWN

THEN:
SET OUTPUT ASSIGNMENT #41 OFF

PRESS '+'

NOTE: LOGIC FOR SWITCHING FLASHING YELLOW ARROW "OFF" DURING PHASE 7 (HEAD 71).

LOGICAL I/O COMMAND #6 (+/-COMMAND#)
IF YELLOW ON PHASE #5 IS ON

↓
SCROLL DOWN

THEN:
SET OUTPUT ASSIGNMENT #43 ON

PRESS '+'

NOTE: LOGIC FOR YELLOW ARROW CLEARANCE FROM PHASE 5 (HEAD 51).

LOGICAL I/O COMMAND #12 (+/-COMMAND#)
IF YELLOW ON PHASE #7 IS ON

↓
SCROLL DOWN

THEN:
SET OUTPUT ASSIGNMENT #40 ON

PRESS '+'

NOTE: LOGIC FOR YELLOW ARROW CLEARANCE FROM PHASE 7 (HEAD 71).

LOGIC I/O PROCESSOR PROGRAMMING COMPLETE

OUTPUT REFERENCE SCHEDULE	
USE TO INTERPRET LOGIC PROCESSOR	
OUTPUT 39 =	Overlap D Red
OUTPUT 40 =	Overlap D Yellow
OUTPUT 41 =	Overlap D Green
OUTPUT 42 =	Overlap C Red
OUTPUT 43 =	Overlap C Yellow
OUTPUT 44 =	Overlap C Green
OUTPUT 47 =	Overlap B Red
OUTPUT 48 =	Overlap B Yellow
OUTPUT 49 =	Overlap B Green
OUTPUT 50 =	Overlap A Red
OUTPUT 51 =	Overlap A Yellow
OUTPUT 52 =	Overlap A Green

THIS ELECTRICAL DETAIL IS FOR
THE SIGNAL DESIGN: 03-0215T3
DESIGNED: June 2017
SEALED: 9/10/2021
REVISED: N/A

Electrical Detail - Sheet 2 of 8
Signal Upgrade
Temporary Design 3

DOCUMENT NOT CONSIDERED FINAL
UNLESS ALL SIGNATURES COMPLETED

HNTB HNTB NORTH CAROLINA, P.C.
343 E. Six Forks Road, Suite 200
Raleigh, North Carolina 27609
NC License No: C-1554
(919) 546-8997

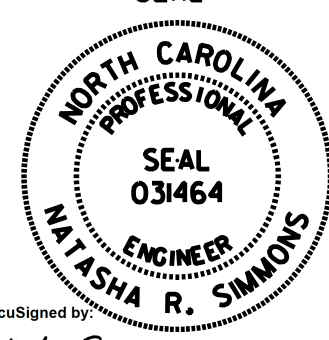
 Prepared for: Department of Transportation Division of Signal Management	NC 211 (Howe Street) at NC 87 (River Road)/ SR 1852 (Robert Ruark Drive)		SEAL  NORTH CAROLINA PROFESSIONAL ENGINEER NATASHA R. SIMMONS SEAL 031464
	Division 03 Brunswick Co. Southport	Prepared by: A.H. Thornburg Reviewed by: N.R. Simmons	
PLAN DATE: June 2017 REVIEWED BY: A.D. Klinksiek	REVISIONS INIT. DATE	DATE 9/10/2021	SIGNATURE DATE
750 N. Greenfield Pkwy, Corner, NC 27529			SIG. INVENTORY NO. 03-0215T3

INPUT PAGE 2 ASSIGNMENT PROGRAMMING DETAIL FOR ALTERNATE PHASING - LOOP 1A
(program controller as shown below)

- NOTES: 1. THIS PROGRAMMING APPLIES FOR INPUT PAGE 2 ONLY. INPUT PAGE 1 WILL USE STANDARD DEFAULT SETTINGS. THIS PROGRAMMING IS NECESSARY FOR PROPER DETECTOR OPERATION DURING ALTERNATE PHASING OPERATION.
- 2. THE FIRST TASK THIS PROGRAMMING ACCOMPLISHES IS THE DISABLING OF INPUT #10 (DETECTOR 26) SO THAT A VEHICLE CALL WILL NOT BE PLACED TO PHASE 6 DURING ALTERNATE PHASING OPERATION. THE SECOND TASK THIS PROGRAMMING ACCOMPLISHES IS THAT IT REASSIGNS DETECTOR 51 TO INPUT #18 SO THAT THE DELAY ON LOOP 1A CAN BE REDUCED FROM 15 SECONDS TO 0 SECONDS.

FROM MAIN MENU PRESS '5' (INPUTS), THEN PRESS 'NEXT' TO GET TO INPUT PAGE '2'. PRESS THE '+' KEY UNTIL INPUT 10 IS REACHED.

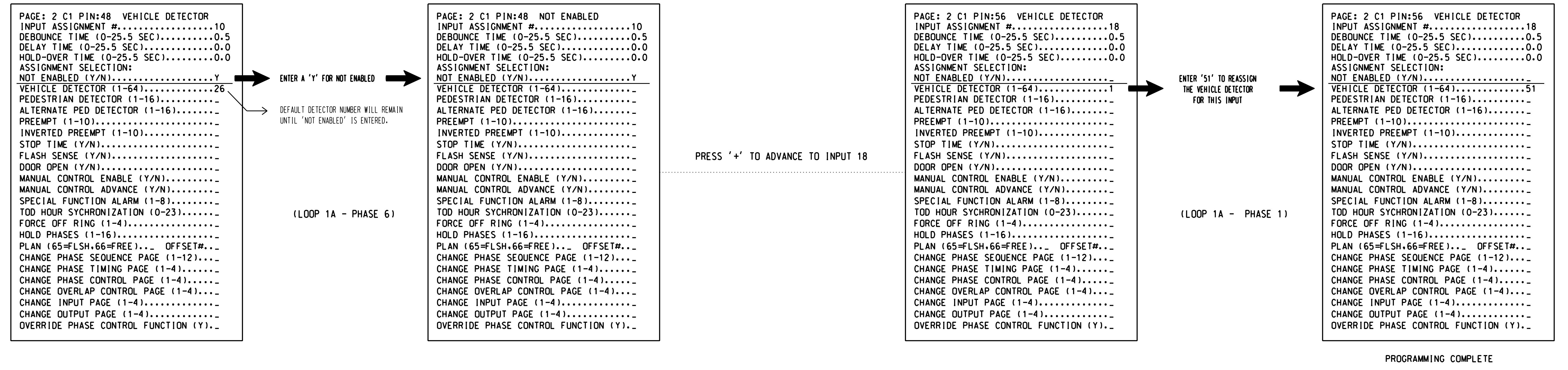

SPECIAL DETECTOR PROGRAMMING DETAIL - LOOP 1A (ALT.)
(program controller as shown below)

FROM MAIN MENU PRESS '7' (DETECTORS), THEN PRESS '1' FOR VEHICLE DETECTORS. PRESS THE '-' KEY TO GET TO VEHICLE DETECTOR #51.

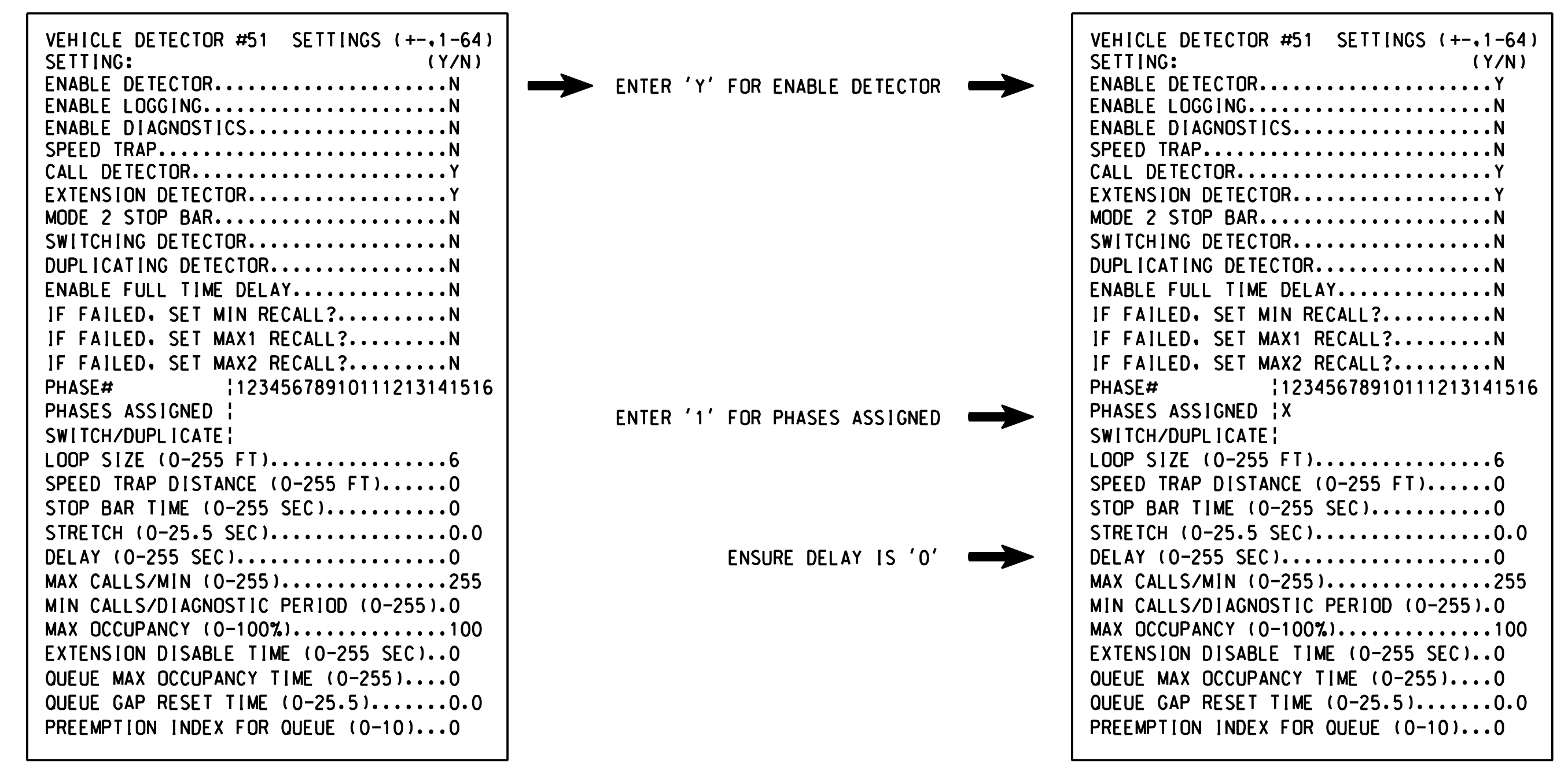

NOTE: DETECTOR IS PROGRAMMED PER THE INPUT FILE CONNECTION AND PROGRAMMING CHART SHOWN ON SHEET 1.

THIS ELECTRICAL DETAIL IS FOR THE SIGNAL DESIGN: 03-0215T3
DESIGNED: June 2017
SEALED: 9/10/2021
REVISED: N/A

Electrical Detail - Sheet 4 of 8
Signal Upgrade
Temporary Design 3

DOCUMENT NOT CONSIDERED FINAL UNLESS ALL SIGNATURES COMPLETED

	Prepared for: 		NC 211 (Howe Street) at NC 87 (River Road)/ SR 1852 (Robert Ruark Drive)		
	Prepared by: A.H. Thornburg		Reviewed by: A.D. Klinksiek		
PLAN DATE: June 2017		REVIEWED BY: N.R. Simmons		9/10/2021	
REVISIONS		INIT.		DATE	
SIGNATURE		DATE		9/10/2021	
SIG. INVENTORY NO. 03-0215T3					

INPUT PAGE 2 ASSIGNMENT PROGRAMMING DETAIL FOR ALTERNATE PHASING - LOOP 5A

(program controller as shown below)

- NOTES: 1. THIS PROGRAMMING APPLIES FOR INPUT PAGE 2 ONLY. INPUT PAGE 1 WILL USE STANDARD DEFAULT SETTINGS. THIS PROGRAMMING IS NECESSARY FOR PROPER DETECTOR OPERATION DURING ALTERNATE PHASING OPERATION.
2. THE FIRST TASK THIS PROGRAMMING ACCOMPLISHES IS THE DISABLING OF INPUT #9 (DETECTOR 22) SO THAT A VEHICLE CALL WILL NOT BE PLACED TO PHASE 2 DURING ALTERNATE PHASING OPERATION. THE SECOND TASK THIS PROGRAMMING ACCOMPLISHES IS THAT IT REASSIGNS DETECTOR 55 TO INPUT #17 SO THAT THE DELAY ON LOOP 5A CAN BE REDUCED FROM 15 SECONDS TO 0 SECONDS.

FROM MAIN MENU PRESS '5' (INPUTS), THEN PRESS 'NEXT' TO GET TO INPUT PAGE '2'. PRESS THE '+' KEY UNTIL INPUT 9 IS REACHED.

```

PAGE: 2 C1 PIN:47 VEHICLE DETECTOR
INPUT ASSIGNMENT #.....9
DEBOUNCE TIME (0-25.5 SEC).....0.5
DELAY TIME (0-25.5 SEC).....0.0
HOLD-OVER TIME (0-25.5 SEC).....0.0
ASSIGNMENT SELECTION:
NOT ENABLED (Y/N).....Y
VEHICLE DETECTOR (1-64).....22
PEDESTRIAN DETECTOR (1-16).....
ALTERNATE PED DETECTOR (1-16).....
PREEMPT (1-10).....
INVERTED PREEMPT (1-10).....
STOP TIME (Y/N).....
FLASH SENSE (Y/N).....
DOOR OPEN (Y/N).....
MANUAL CONTROL ENABLE (Y/N).....
MANUAL CONTROL ADVANCE (Y/N).....
SPECIAL FUNCTION ALARM (1-8).....
TOD HOUR SYNCHRONIZATION (0-23).....
FORCE OFF RING (1-4).....
HOLD PHASES (1-16).....
PLAN (65=FLSH,66=FREE)..... OFFSET#...
CHANGE PHASE SEQUENCE PAGE (1-12)....
CHANGE PHASE TIMING PAGE (1-4).....
CHANGE PHASE CONTROL PAGE (1-4)....
CHANGE OVERLAP CONTROL PAGE (1-4)....
CHANGE INPUT PAGE (1-4).....
CHANGE OUTPUT PAGE (1-4).....
OVERRIDE PHASE CONTROL FUNCTION (Y)....

```

ENTER A 'Y' FOR NOT ENABLED
DEFAULT DETECTOR NUMBER WILL REMAIN UNTIL 'NOT ENABLED' IS ENTERED.

(LOOP 5A - PHASE 2)

```

PAGE: 2 C1 PIN:47 NOT ENABLED
INPUT ASSIGNMENT #.....9
DEBOUNCE TIME (0-25.5 SEC).....0.5
DELAY TIME (0-25.5 SEC).....0.0
HOLD-OVER TIME (0-25.5 SEC).....0.0
ASSIGNMENT SELECTION:
NOT ENABLED (Y/N).....Y
VEHICLE DETECTOR (1-64).....
PEDESTRIAN DETECTOR (1-16).....
ALTERNATE PED DETECTOR (1-16).....
PREEMPT (1-10).....
INVERTED PREEMPT (1-10).....
STOP TIME (Y/N).....
FLASH SENSE (Y/N).....
DOOR OPEN (Y/N).....
MANUAL CONTROL ENABLE (Y/N).....
MANUAL CONTROL ADVANCE (Y/N).....
SPECIAL FUNCTION ALARM (1-8).....
TOD HOUR SYNCHRONIZATION (0-23).....
FORCE OFF RING (1-4).....
HOLD PHASES (1-16).....
PLAN (65=FLSH,66=FREE)..... OFFSET#...
CHANGE PHASE SEQUENCE PAGE (1-12)....
CHANGE PHASE TIMING PAGE (1-4).....
CHANGE PHASE CONTROL PAGE (1-4)....
CHANGE OVERLAP CONTROL PAGE (1-4)....
CHANGE INPUT PAGE (1-4).....
CHANGE OUTPUT PAGE (1-4).....
OVERRIDE PHASE CONTROL FUNCTION (Y)....

```

PRESS '+' TO ADVANCE TO INPUT 17

```

PAGE: 2 C1 PIN:55 VEHICLE DETECTOR
INPUT ASSIGNMENT #.....17
DEBOUNCE TIME (0-25.5 SEC).....0.5
DELAY TIME (0-25.5 SEC).....0.0
HOLD-OVER TIME (0-25.5 SEC).....0.0
ASSIGNMENT SELECTION:
NOT ENABLED (Y/N).....
VEHICLE DETECTOR (1-64).....5
PEDESTRIAN DETECTOR (1-16).....
ALTERNATE PED DETECTOR (1-16).....
PREEMPT (1-10).....
INVERTED PREEMPT (1-10).....
STOP TIME (Y/N).....
FLASH SENSE (Y/N).....
DOOR OPEN (Y/N).....
MANUAL CONTROL ENABLE (Y/N).....
MANUAL CONTROL ADVANCE (Y/N).....
SPECIAL FUNCTION ALARM (1-8).....
TOD HOUR SYNCHRONIZATION (0-23).....
FORCE OFF RING (1-4).....
HOLD PHASES (1-16).....
PLAN (65=FLSH,66=FREE)..... OFFSET#...
CHANGE PHASE SEQUENCE PAGE (1-12)....
CHANGE PHASE TIMING PAGE (1-4).....
CHANGE PHASE CONTROL PAGE (1-4)....
CHANGE OVERLAP CONTROL PAGE (1-4)....
CHANGE INPUT PAGE (1-4).....
CHANGE OUTPUT PAGE (1-4).....
OVERRIDE PHASE CONTROL FUNCTION (Y)....

```

ENTER '55' TO REASSIGN THE VEHICLE DETECTOR FOR THIS INPUT

(LOOP 5A - PHASE 5)

```

PAGE: 2 C1 PIN:55 VEHICLE DETECTOR
INPUT ASSIGNMENT #.....17
DEBOUNCE TIME (0-25.5 SEC).....0.5
DELAY TIME (0-25.5 SEC).....0.0
HOLD-OVER TIME (0-25.5 SEC).....0.0
ASSIGNMENT SELECTION:
NOT ENABLED (Y/N).....
VEHICLE DETECTOR (1-64).....55
PEDESTRIAN DETECTOR (1-16).....
ALTERNATE PED DETECTOR (1-16).....
PREEMPT (1-10).....
INVERTED PREEMPT (1-10).....
STOP TIME (Y/N).....
FLASH SENSE (Y/N).....
DOOR OPEN (Y/N).....
MANUAL CONTROL ENABLE (Y/N).....
MANUAL CONTROL ADVANCE (Y/N).....
SPECIAL FUNCTION ALARM (1-8).....
TOD HOUR SYNCHRONIZATION (0-23).....
FORCE OFF RING (1-4).....
HOLD PHASES (1-16).....
PLAN (65=FLSH,66=FREE)..... OFFSET#...
CHANGE PHASE SEQUENCE PAGE (1-12)....
CHANGE PHASE TIMING PAGE (1-4).....
CHANGE PHASE CONTROL PAGE (1-4)....
CHANGE OVERLAP CONTROL PAGE (1-4)....
CHANGE INPUT PAGE (1-4).....
CHANGE OUTPUT PAGE (1-4).....
OVERRIDE PHASE CONTROL FUNCTION (Y)....

```

PROGRAMMING COMPLETE

SPECIAL DETECTOR PROGRAMMING DETAIL - LOOP 5A (ALT.)

(program controller as shown below)

FROM MAIN MENU PRESS '7' (DETECTORS), THEN PRESS '1' FOR VEHICLE DETECTORS. PRESS THE '-' KEY TO GET TO VEHICLE DETECTOR #55.

```

VEHICLE DETECTOR #55 SETTINGS (+,-,1-64)
SETTING: (Y/N)
ENABLE DETECTOR.....N
ENABLE LOGGING.....N
ENABLE DIAGNOSTICS.....N
SPEED TRAP.....N
CALL DETECTOR.....Y
EXTENSION DETECTOR.....Y
MODE 2 STOP BAR.....N
SWITCHING DETECTOR.....N
DUPLICATING DETECTOR.....N
ENABLE FULL TIME DELAY.....N
IF FAILED, SET MIN RECALL?.....N
IF FAILED, SET MAX1 RECALL?.....N
IF FAILED, SET MAX2 RECALL?.....N
PHASE# :12345678910111213141516
PHASES ASSIGNED :
SWITCH/DUPLICATE :
LOOP SIZE (0-255 FT).....6
SPEED TRAP DISTANCE (0-255 FT).....0
STOP BAR TIME (0-255 SEC).....0
STRETCH (0-25.5 SEC).....0.0
DELAY (0-255 SEC).....0.0
MAX CALLS/MIN (0-255).....255
MIN CALLS/DIAGNOSTIC PERIOD (0-255).....0
MAX OCCUPANCY (0-100%).....100
EXTENSION DISABLE TIME (0-255 SEC).....0
QUEUE MAX OCCUPANCY TIME (0-255).....0
QUEUE GAP RESET TIME (0-25.5).....0.0
PREEMPTION INDEX FOR QUEUE (0-10).....0

```

ENTER 'Y' FOR ENABLE DETECTOR

ENTER '5' FOR PHASES ASSIGNED

ENSURE DELAY IS '0'

```

VEHICLE DETECTOR #55 SETTINGS (+,-,1-64)
SETTING: (Y/N)
ENABLE DETECTOR.....Y
ENABLE LOGGING.....N
ENABLE DIAGNOSTICS.....N
SPEED TRAP.....N
CALL DETECTOR.....Y
EXTENSION DETECTOR.....Y
MODE 2 STOP BAR.....N
SWITCHING DETECTOR.....N
DUPLICATING DETECTOR.....N
ENABLE FULL TIME DELAY.....N
IF FAILED, SET MIN RECALL?.....N
IF FAILED, SET MAX1 RECALL?.....N
IF FAILED, SET MAX2 RECALL?.....N
PHASE# :12345678910111213141516
PHASES ASSIGNED : X
SWITCH/DUPLICATE :
LOOP SIZE (0-255 FT).....6
SPEED TRAP DISTANCE (0-255 FT).....0
STOP BAR TIME (0-255 SEC).....0
STRETCH (0-25.5 SEC).....0.0
DELAY (0-255 SEC).....0.0
MAX CALLS/MIN (0-255).....255
MIN CALLS/DIAGNOSTIC PERIOD (0-255).....0
MAX OCCUPANCY (0-100%).....100
EXTENSION DISABLE TIME (0-255 SEC).....0
QUEUE MAX OCCUPANCY TIME (0-255).....0
QUEUE GAP RESET TIME (0-25.5).....0.0
PREEMPTION INDEX FOR QUEUE (0-10).....0

```

DETECTOR PROGRAMMING COMPLETE

NOTE: DETECTOR IS PROGRAMMED PER THE INPUT FILE CONNECTION AND PROGRAMMING CHART SHOWN ON SHEET 1.

THIS ELECTRICAL DETAIL IS FOR THE SIGNAL DESIGN: 03-0215T3
DESIGNED: June 2017
SEALED: 9/10/2021
REVISED: N/A

Electrical Detail - Sheet 6 of 8
Signal Upgrade
Temporary Design 3

DOCUMENT NOT CONSIDERED FINAL UNLESS ALL SIGNATURES COMPLETED

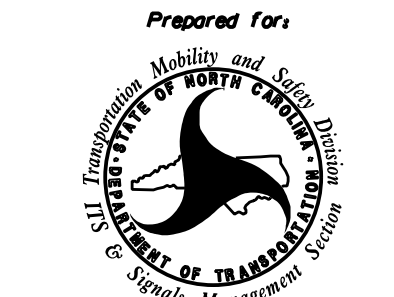
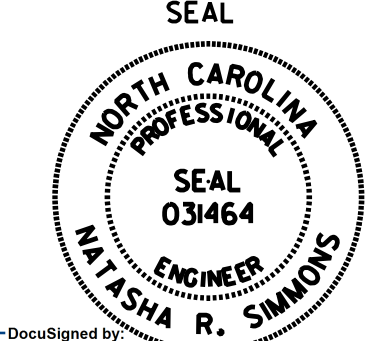
	NC 211 (Howe Street) at NC 87 (River Road)/ SR 1852 (Robert Ruark Drive)		
	Division 03 Brunswick Co. Southport	PLAN DATE: June 2017 REVIEWED BY: A.D. Klinksiek PREPARED BY: A.H. Thornburg REVIEWED BY: N.R. Simmons	
REVISIONS		INIT. DATE	9/10/2021
750 N. Greenfield Pkwy, Corner, NC 27529		SIG. INVENTORY NO. 03-0215T3	

INPUT PAGE 2 ASSIGNMENT PROGRAMMING DETAIL FOR ALTERNATE PHASING - LOOP 7A

(program controller as shown below)

- NOTES: 1. THIS PROGRAMMING APPLIES FOR INPUT PAGE 2 ONLY. INPUT PAGE 1 WILL USE STANDARD DEFAULT SETTINGS. THIS PROGRAMMING IS NECESSARY FOR PROPER DETECTOR OPERATION DURING ALTERNATE PHASING OPERATION.
2. THE FIRST TASK THIS PROGRAMMING ACCOMPLISHES IS THE DISABLING OF INPUT #11 (DETECTOR 24) SO THAT A VEHICLE CALL WILL NOT BE PLACED TO PHASE 4 DURING ALTERNATE PHASING OPERATION. THE SECOND TASK THIS PROGRAMMING ACCOMPLISHES IS THAT IT REASSIGNS DETECTOR 57 TO INPUT #19 SO THAT THE DELAY ON LOOP 7A CAN BE REDUCED FROM 15 SECONDS TO 0 SECONDS.

FROM MAIN MENU PRESS '5' (INPUTS), THEN PRESS 'NEXT' TO GET TO INPUT PAGE '2'. PRESS THE '+' KEY UNTIL INPUT 11 IS REACHED.

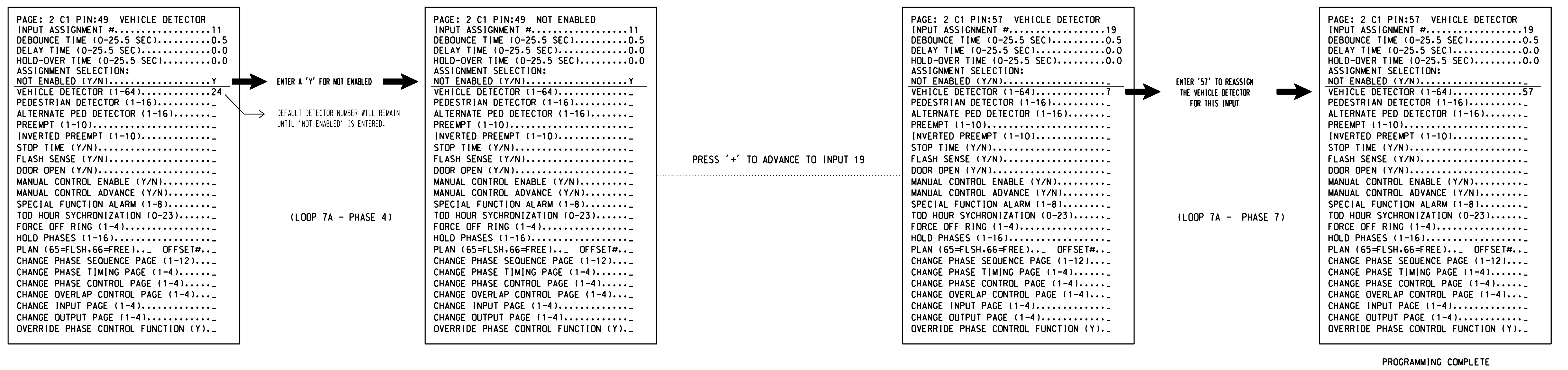

SPECIAL DETECTOR PROGRAMMING DETAIL - LOOP 7A (ALT.)

(program controller as shown below)

FROM MAIN MENU PRESS '7' (DETECTORS), THEN PRESS '1' FOR VEHICLE DETECTORS. PRESS THE '-' KEY TO GET TO VEHICLE DETECTOR #57.

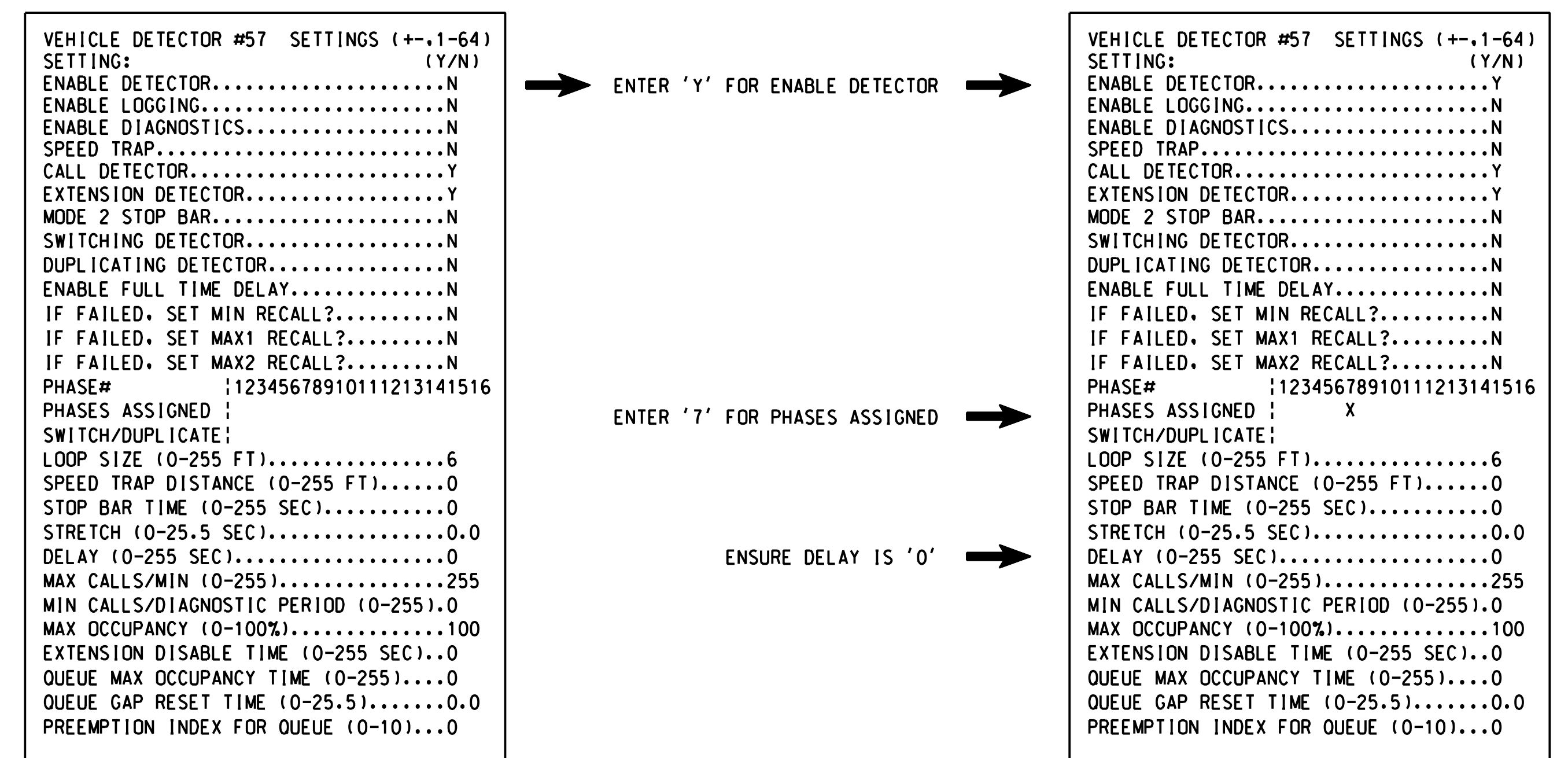

NOTE: DETECTOR IS PROGRAMMED PER THE INPUT FILE CONNECTION AND PROGRAMMING CHART SHOWN ON SHEET 1.

THIS ELECTRICAL DETAIL IS FOR THE SIGNAL DESIGN: 03-0215T3
DESIGNED: June 2017
SEALED: 9/10/2021
REVISED: N/A

Electrical Detail - Sheet 7 of 8
Signal Upgrade
Temporary Design 3

DOCUMENT NOT CONSIDERED FINAL UNLESS ALL SIGNATURES COMPLETED

	Prepared for: NC 211 (Howe Street) at NC 87 (River Road)/ SR 1852 (Robert Ruark Drive)		
	Division 03 Brunswick Co. Southport		
PLAN DATE: June 2017 PREPARED BY: A.H. Thornburg	REVIEWED BY: A.D. Klinksiek REVIEWED BY: N.R. Simmons	DATE: 9/10/2021	DATE:
REVISIONS		INIT.	DATE
750 N. Greenfield Pkwy, Corner, NC 27529		HNTB NORTH CAROLINA, P.C. 343 E. Six Forks Road, Suite 200 Raleigh, North Carolina 27609 NC License No: C-1554 (919) 546-8997	SIG. INVENTORY NO. 03-0215T3

ALTERNATE PHASING ACTIVATION DETAIL

TO RUN ALT. PHASING DURING COORDINATION - SELECT ALL PAGE CHANGES (AS SHOWN BELOW) WITHIN COORDINATION PLAN PROGRAMMING.

TO RUN ALT. PHASING DURING FREE RUN - PROGRAM PAGE CHANGES (SHOWN BELOW) IN SEPARATE TIME OF DAY EVENTS. IF PAGE 1 IS USED, NO EVENT PROGRAMMING IS NECESSARY FOR THAT PARTICULAR PAGE.

<u>PHASING</u>	<u>INPUTS PAGE</u>	<u>OVERLAPS PAGE</u>
ACTIVE PAGES REQUIRED TO RUN <u>DEFAULT PHASING</u>	1	1
ACTIVE PAGES REQUIRED TO RUN <u>ALTERNATE PHASING</u>	2	2

NOTE: PAGES NOT SHOWN (i.e. sequence, phase control, etc.) SHOULD REMAIN AS '1', OR AS DEFINED BY TIMING ENGINEER.

IMPORTANT: IF ALT. PHASING IS USED DURING FREE RUN AND COORDINATION, DO NOT OPERATE TIME OF DAY PAGE CHANGE EVENTS CONCURRENTLY WITH COORDINATION PLAN EVENTS IN THE EVENT SCHEDULER. (EX. FREE RUN PAGE CHANGE EVENT SHOULD END BEFORE COORDINATION PLAN EVENT STARTS AND VICE-VERSA).

FLASHER CIRCUIT MODIFICATION DETAIL

IN ORDER TO ENSURE THAT SIGNALS FLASH CONCURRENTLY ON THE SAME APPROACH, MAKE THE FOLLOWING FLASHER CIRCUIT CHANGES:

1. ON REAR OF PDA - REMOVE WIRE FROM TERM. T2-4 AND TERMINATE ON T2-2.
2. ON REAR OF PDA - REMOVE WIRE FROM TERM. T2-5 AND TERMINATE ON T2-3.
3. REMOVE FLASHER UNIT 2.

THE CHANGES LISTED ABOVE TIES ALL PHASES AND OVERLAPS TO FLASHER UNIT 1.

ALTERNATE PHASING PAGE CHANGE SUMMARY

THE FOLLOWING IS A SUMMARY OF WHAT TAKES PLACE WHEN THESE OVERLAP/INPUT PAGE CHANGES ACTIVATE TO CALL THE "ALTERNATE PHASING":

OVERLAPS PAGE 2: Modifies overlap parent phases for heads 11, 31, 51, and 71 to run protected turns only.

INPUTS PAGE 2: Disables phase 6 call on loop 1A and reduces delay time for phase 1 call on loop 1A to 0 seconds.

Disables phase 8 call on loop 3A and reduces delay time for phase 3 call on loop 3A to 3 seconds.

Disables phase 2 call on loop 5A and reduces delay time for phase 5 call on loop 5A to 0 seconds.

Disables phase 4 call on loop 7A and reduces delay time for phase 7 call on loop 7A to 0 seconds.

THIS ELECTRICAL DETAIL IS FOR THE SIGNAL DESIGN: 03-0215T3
DESIGNED: June 2017
SEALED: 9/10/2021
REVISED: N/A

Electrical Detail - Sheet 8 of 8
Signal Upgrade
Temporary Design 3

DOCUMENT NOT CONSIDERED FINAL UNLESS ALL SIGNATURES COMPLETED

HNTB HNTB NORTH CAROLINA, P.C.
343 E. Six Forks Road, Suite 200
Raleigh, North Carolina 27609
NC License No: C-1554
(919) 546-8997

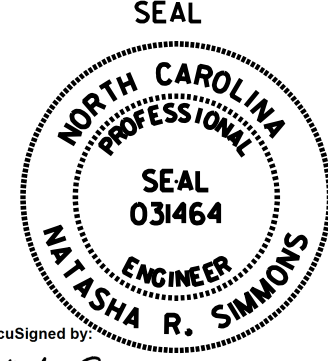
	Prepared for: NC 211 (Howe Street) at NC 87 (River Road)/ SR 1852 (Robert Ruark Drive)	
	Division 03 Brunswick Co. Southport PLAN DATE: June 2017 REVIEWED BY: A.D. Klinksiek PREPARED BY: A.H. Thornburg REVIEWED BY: N.R. Simmons	
750 N. Greenfield Pkwy, Corner, NC 27529	REVISIONS INIT. DATE	Documented by: <i>Natasha Simmons</i> 9/10/2021 _____ SIGNATURE DATE SIG. INVENTORY NO. 03-0215T3

DEFAULT PHASING DIAGRAM

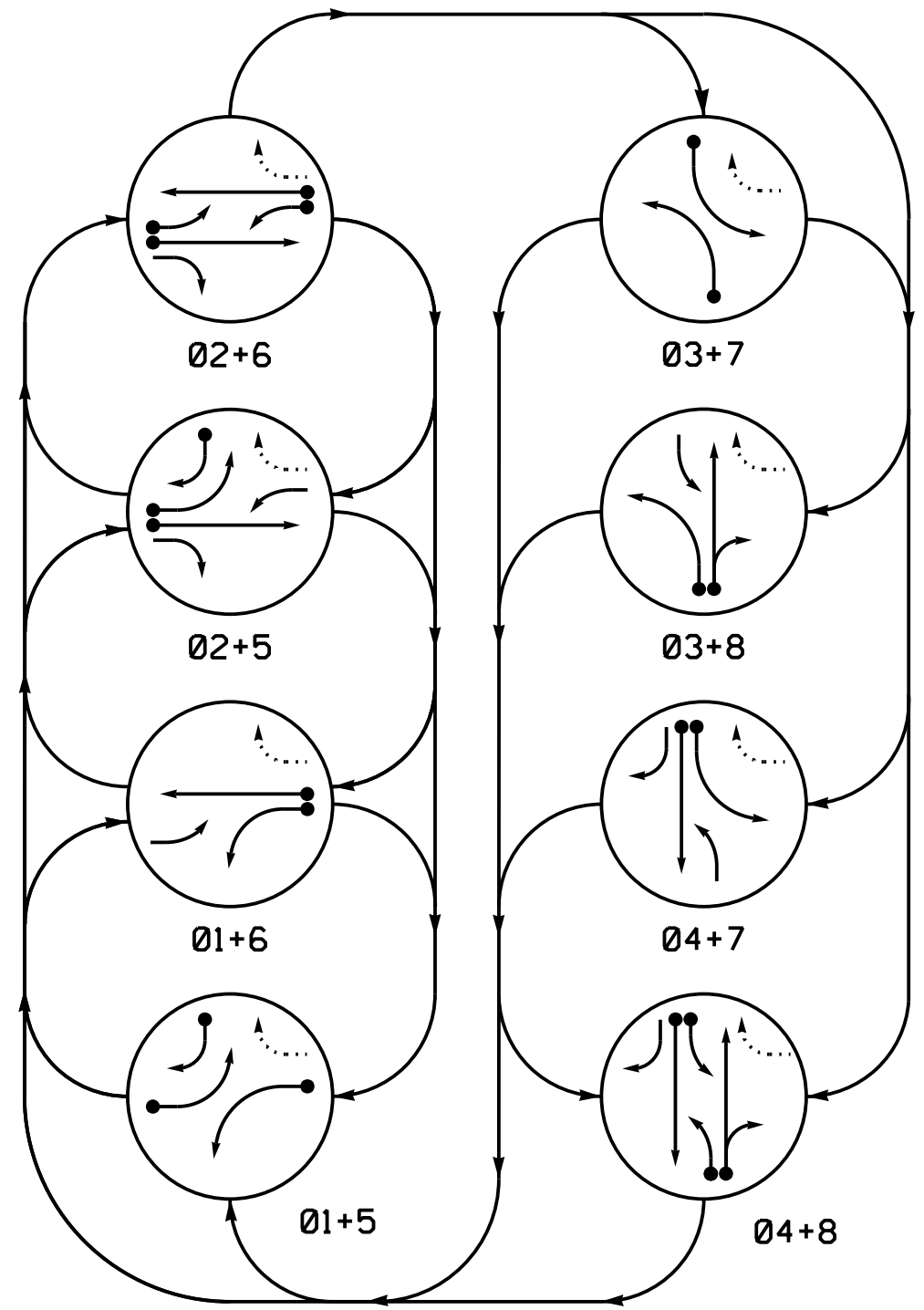

ALTERNATE PHASING DIAGRAM

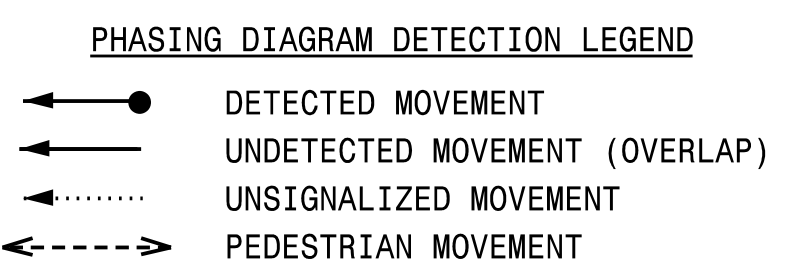
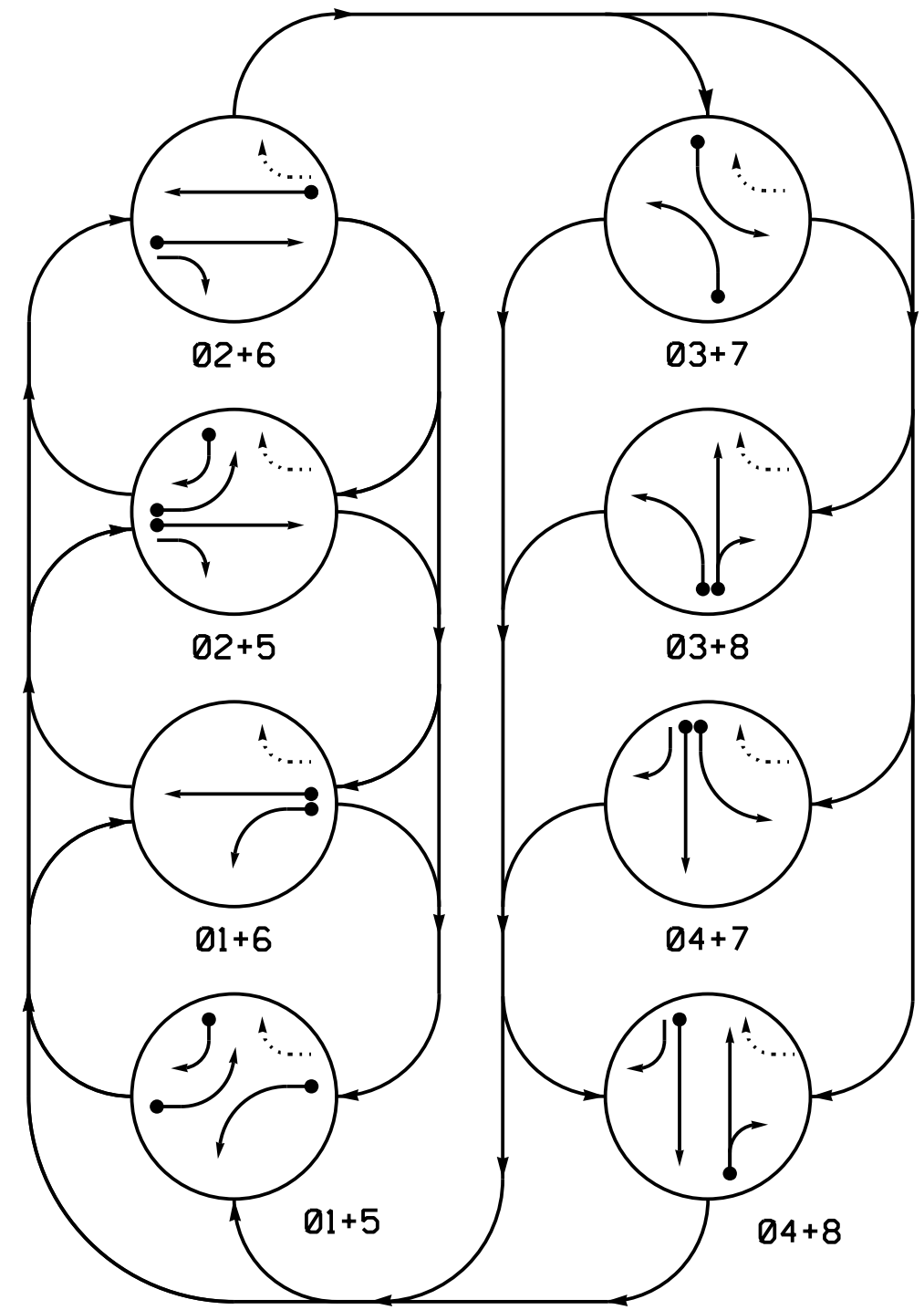

SIGNAL FACE I.D.

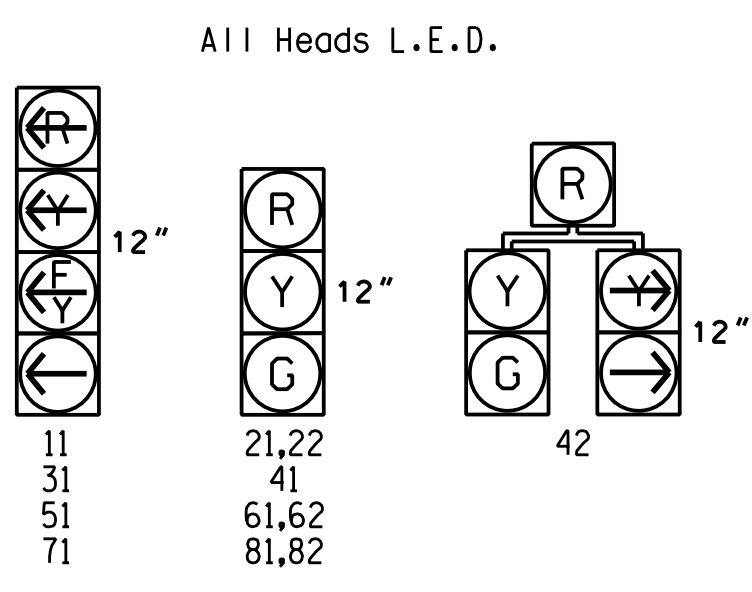

DEFAULT PHASING TABLE OF OPERATION

SIGNAL FACE	PHASE							
	01+5	01+6	02+5	02+6	03+7	03+8	04+7	04+8
11	-	-	F	F	R	R	R	Y
21,22	R	R	G	G	R	R	R	Y
31	R	R	R	R	-	-	F	Y
41	R	R	R	R	R	G	G	R
42	R	R	R	R	R	G	G	R
51	-	F	F	F	R	R	R	Y
61,62	R	G	R	G	R	R	R	Y
71	R	R	R	R	-	F	F	R
81,82	R	R	R	R	R	G	G	R

ALTERNATE PHASING TABLE OF OPERATION

SIGNAL FACE	PHASE							
	01+5	01+6	02+5	02+6	03+7	03+8	04+7	04+8
11	-	-	R	R	R	R	R	Y
21,22	R	R	G	G	R	R	R	Y
31	R	R	R	R	-	-	R	R
41	R	R	R	R	R	G	G	R
42	R	R	R	R	R	G	G	R
51	-	R	R	R	R	R	R	Y
61,62	R	G	R	G	R	R	R	Y
71	R	R	R	R	-	R	R	R
81,82	R	R	R	R	R	G	G	R

OASIS 2070 LOOP & DETECTOR INSTALLATION CHART

LOOP	SIZE (FT)	DISTANCE FROM STOPBAR (FT)	TURNS	NEW LOOP	DETECTOR PROGRAMMING				SYSTEM LOOP	NEW CARD
					PHASE	CALLING	EXTENSION	STRETCH TIME		
1A	6X40	0	*	*	1	Y	Y	-	**15	-
2A	6X6	300	*	*	2	Y	Y	-	-	-
2B	6X6	90	*	*	2	Y	Y	-	-	-
3A	6X40	0	*	*	3	Y	Y	-	**15	-
4A	6X40	0	*	*	4	Y	Y	-	-	-
5A	6X40	0	*	*	5	Y	Y	-	**15	-
5B	6X40	0	*	*	5	Y	Y	-	-	-
6A	6X6	70	*	*	6	Y	Y	-	-	-
7A	6X40	0	*	*	7	Y	Y	-	**15	-
8A	6X40	0	*	*	8	Y	Y	-	-	-

* Multizone Microwave Detection.
 ** Disable phase 2,4,6 and 8 call for 1A,3A,5A and 7A during alternate phasing operation.
 *** Reduce delay to 3 seconds for 3A and 0 seconds for 1A,5A, and 7A during alternate phasing operation.

8 Phase Fully Actuated (NC 133 Closed Loop System)

NOTES

- Refer to "Roadway Standard Drawings NCDOT" dated January 2018 and "Standard Specifications for Roads and Structures" dated January 2018.
- Do not program signal for late night flashing operation unless otherwise directed by the Engineer.
- Phase 1 and/or 5 may be lagged.
- Phase 3 and/or 7 may be lagged.
- Reposition existing signal head numbered 11.
- Set all detector units to presence mode.
- The Division Traffic Engineer will determine the hours of use for each phasing plan.
- Incorporate Microwave Detection system for vehicle detection.
- Provide the Engineer with the Manufacturer's approved Microwave Detection locations and mounting heights to obtain detection zones as shown.
- Maximum times shown in timing chart are for free-run operation only. Coordinated signal system timing values supersede these values.
- Closed loop system data: Controller Asset #: 0215.

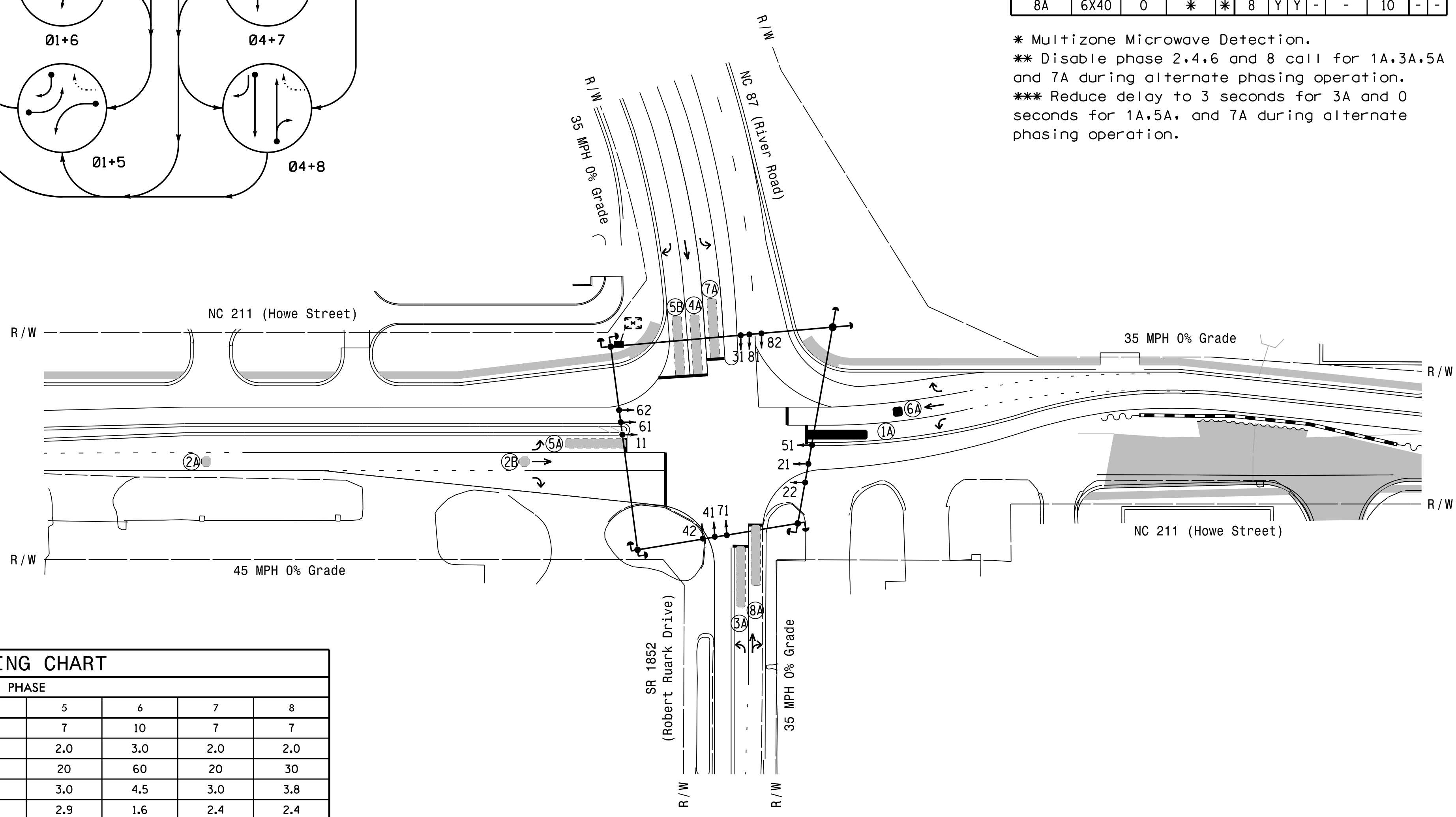

OASIS 2070 TIMING CHART

FEATURE	PHASE							
	1	2	3	4	5	6	7	8
Min Green 1 *	7	12	7	7	7	10	7	7
Extension 1 *	2.0	2.0	2.0	2.0	2.0	3.0	2.0	2.0
Max Green 1 *	20	60	20	30	20	60	20	30
Yellow Clearance	3.0	4.5	3.0	3.8	3.0	4.5	3.0	3.8
Red Clearance	2.4	1.6	3.2	2.4	2.9	1.6	2.4	2.4
Red Revert	2.0	2.0	2.0	2.0	2.0	2.0	2.0	2.0
Walk 1 *	-	-	-	-	-	-	-	-
Don't Walk 1	-	-	-	-	-	-	-	-
Seconds Per Actuation *	-	-	-	-	-	-	-	-
Max Variable Initial *	-	-	-	-	-	-	-	-
Time Before Reduction *	-	-	-	-	-	-	-	-
Time To Reduce *	-	-	-	-	-	-	-	-
Minimum Gap	-	-	-	-	-	-	-	-
Recall Mode	-	MIN RECALL	-	-	-	MIN RECALL	-	-
Vehicle Call Memory	-	YELLOW	-	-	-	YELLOW	-	-
Dual Entry	-	-	-	ON	-	-	-	ON
Simultaneous Gap	ON	ON	ON	ON	ON	ON	ON	ON

* These values may be field adjusted. Do not adjust Min Green and Extension times for phases 2 and 6 lower than what is shown. Min Green for all other phases should not be lower than 4 seconds.

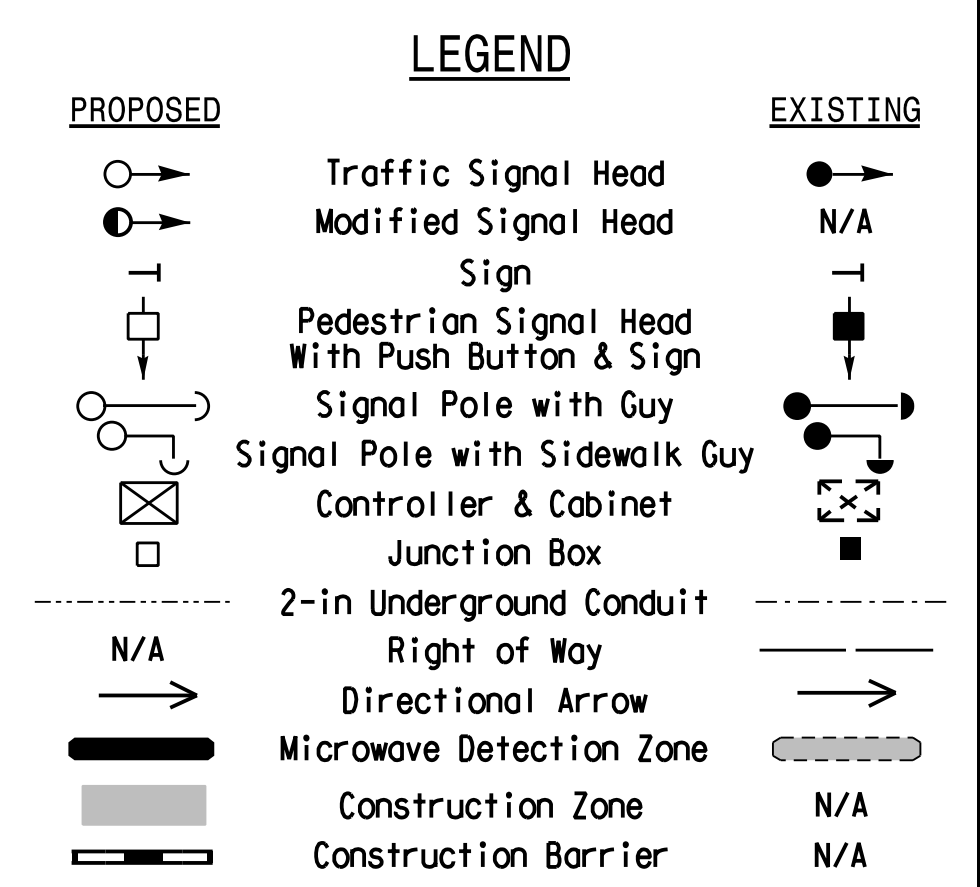

Signal Upgrade
 Temporary Design 4
 Construction Phase 1d

DOCUMENT NOT CONSIDERED FINAL UNLESS ALL SIGNATURES COMPLETED

 Prepared for: TRANSPORTATION MOBILITY AND SAFETY DIVISION STATE OF NORTH CAROLINA DEPARTMENT OF TRANSPORTATION Signal Design Section	NC 211 (Howe Street) at NC 87 (River Road)/ SR 1852 (Robert Ruark Drive)		SEAL Natasha R. Simmons ENGINEER No. 031464
	Division 03 Brunswick Co. Southport PLAN DATE: June 2017 REVIEWED BY: A.D. Klinksiek PREPARED BY: A.H. Thornburg REVIEWED BY: N.R. Simmons	SCALE 0 50 1"=50'	

HNTB
 HNTB NORTH CAROLINA, P.C.
 343 E. Six Forks Road, Suite 200
 Raleigh, North Carolina 27609
 NC License No: C-1554
 (919) 546-8997

EDI MODEL 2018ECL-NC CONFLICT MONITOR PROGRAMMING DETAIL

(remove jumpers and set switches as shown)

REMOVE DIODE JUMPERS 1-5, 1-6, 1-9, 1-11, 2-5, 2-6, 2-9, 2-11, 3-7, 3-8, 3-10, 3-12, 4-7, 4-8, 4-10, 4-12, 5-9, 5-11, 6-9, 6-11, 7-10, 7-12, 8-10, 8-12, 9-11 and 10-12.

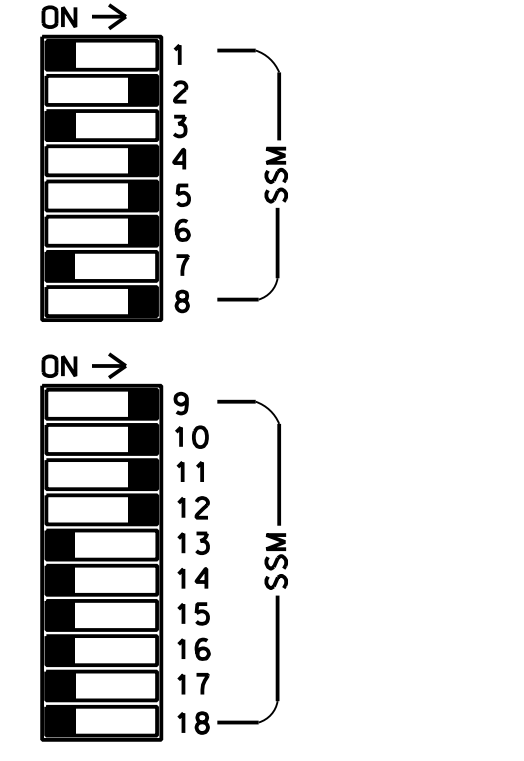
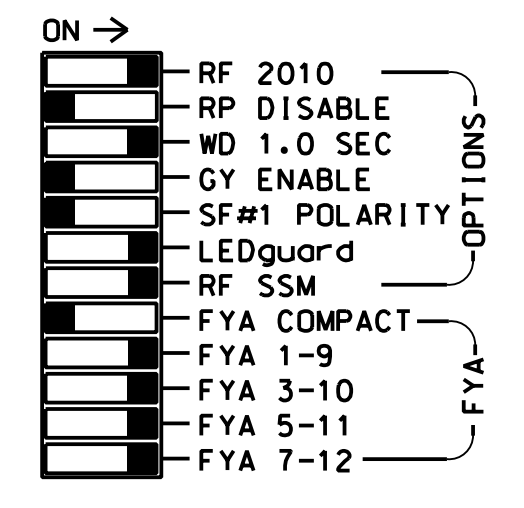
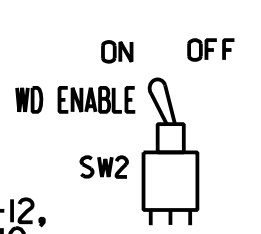
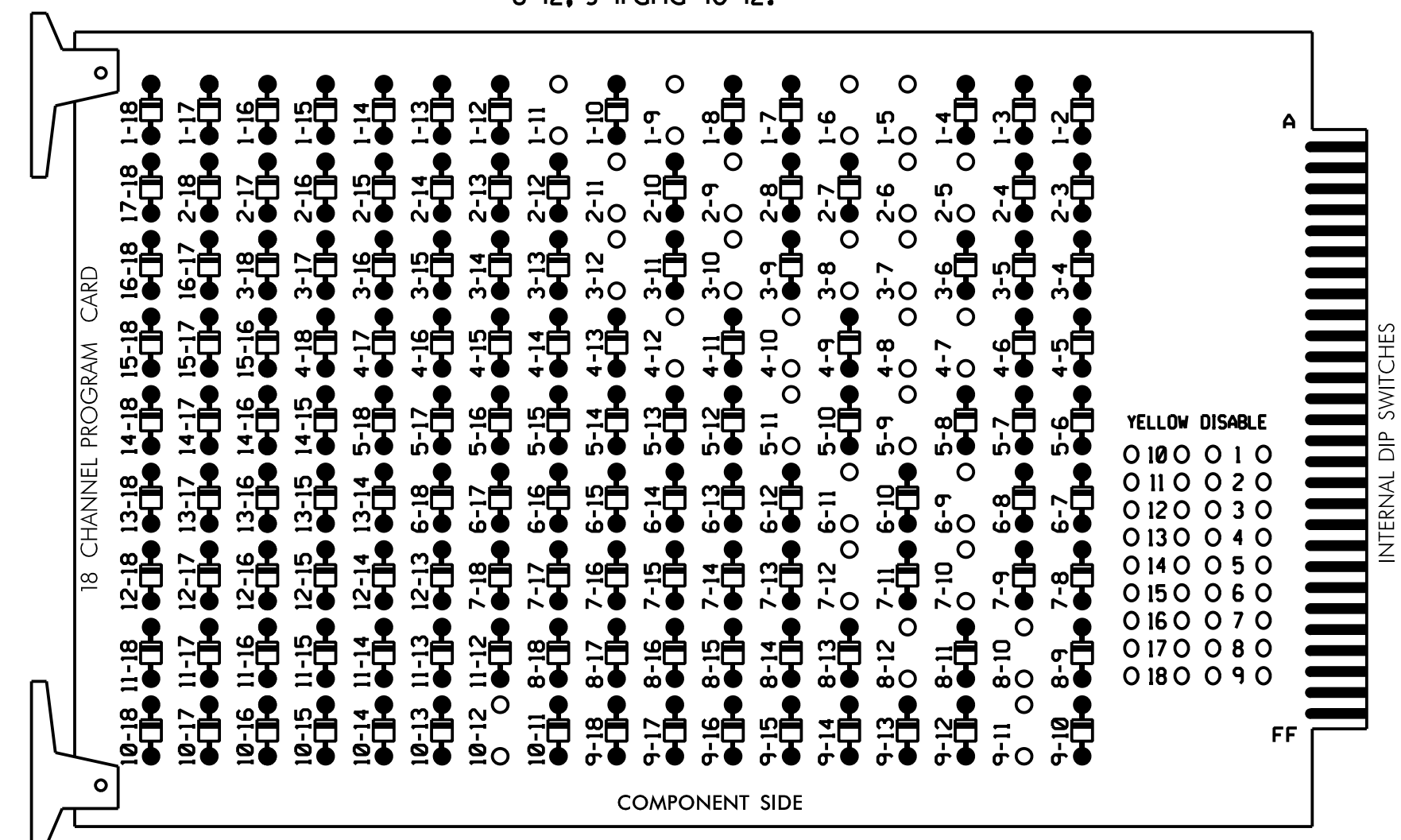

■ = DENOTES POSITION OF SWITCH

- REMOVE JUMPERS AS SHOWN
- Card is provided with all diode jumpers in place. Removal of any jumper allows its channels to run concurrently.
 - Ensure jumpers SEL2-SEL5 and SEL9 are present on the monitor board.
 - Ensure that Red Enable is active at all times during normal operation.
 - Connect serial cable from conflict monitor to comm. port 1 of 2070 controller. Ensure conflict monitor communicates with 2070.

NOTES

- To prevent "flash-conflict" problems, insert red flash program blocks for all unused vehicle load switches in the output file. The installer shall verify that signal heads flash in accordance with the Signal Plans.
- Program phases 4 and 8 for Dual Entry.
- Enable Simultaneous Gap-Out for all Phases.
- Program phases 2 and 6 for Startup In Green.
- Program phases 2 and 6 for Yellow Flash, and overlaps 1 and 2 as Wag Overlaps.
- If this signal will be managed by an ATMS software, enable controller and detector logging for all detectors used at this location.
- The cabinet and controller are part of the NC 133 Closed Loop System.

EQUIPMENT INFORMATION

CONTROLLER.....2070E
 CABINET.....332 W/ AUX
 SOFTWARE.....ECONOLITE OASIS
 CABINET MOUNT.....BASE
 OUTPUT FILE POSITIONS...18 WITH AUX. OUTPUT FILE
 LOAD SWITCHES USED.....S1,S2,S4,S5,S7,S8,S10,S11,
 AUX S1,AUX S2,AUX S4,AUX S5
 PHASES USED.....1,2,3,4,5,6,7,8
 OVERLAP "A".....1+2
 OVERLAP "B".....3+4
 OVERLAP "C".....5+6
 OVERLAP "D".....7+8

SIGNAL HEAD HOOK-UP CHART

LOAD SWITCH NO.	S1	S2	S3	S4	S5	S6	S7	S8	S9	S10	S11	S12	AUX S1	AUX S2	AUX S3	AUX S4	AUX S5	AUX S6
CMU CHANNEL NO.	1	2	13	3	4	14	5	6	15	7	8	16	9	10	17	11	12	18
PHASE	1	2	2 PED	3	4	4 PED	5	6	6 PED	7	8	8 PED	OLA	OLB	SPARE	OLC	OLD	SPARE
SIGNAL HEAD NO.	11	21,22	NU	31	41,42	NU	42	51	61,62	NU	71	81,82	NU	11	31	NU	51	71
RED		128			101		*		134			107						
YELLOW	*	129		*	102				135		*	108						
GREEN		130			103				136			109						
RED ARROW															A121	A124		A114
YELLOW ARROW															A122	A125		A115
FLASHING YELLOW ARROW															A123	A126		A116
GREEN ARROW	127			118			133	133			124							

NU = Not Used
 * Denotes install load resistor. See load resistor installation detail this sheet.
 ★ See pictorial of head wiring in detail this sheet.

INPUT FILE POSITION LAYOUT

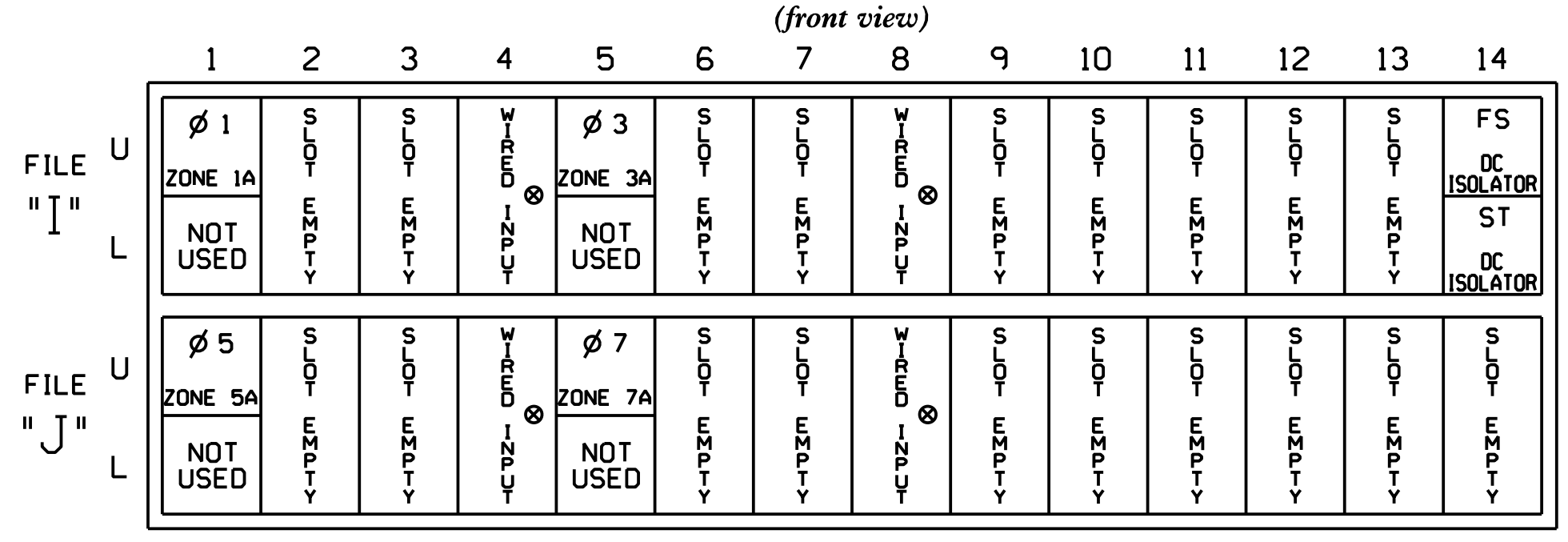

EX.: 1A, 2A, ETC. = LOOP NO.'S
 FS = FLASH SENSE
 ST = STOP TIME
 ⊗ Wired Input - Do not populate slot with detector card

INPUT FILE CONNECTION & PROGRAMMING CHART

LOOP NO.	LOOP TERMINAL	INPUT FILE POS.	PIN NO.	INPUT ASSIGNMENT NO.	DETECTOR NO.	NEMA PHASE	CALL	EXTEND	FULL TIME DELAY	STRETCH TIME	DELAY TIME
ZONE 1A ¹	TB2-1,2	I1U	56	18	1	1	Y	Y			15
	-	J4U	48	10★	26	6	Y	Y			
ZONE 3A ²	TB4-5,6	I5U	58	20	3	3	Y	Y			15
	-	J8U	50	12★	28	8	Y	Y			3
ZONE 5A ³	TB3-1,2	J1U	55	17	5	5	Y	Y			15
	-	J1U	55	17★	55	5	Y	Y			
ZONE 7A ⁴	TB5-5,6	J5U	57	19	7	7	Y	Y			15
	-	J5U	57	19★	57	7	Y	Y			

- Add jumper from I1-W to J4-W, on rear of input file.
 - Add jumper from I5-W to J8-W, on rear of input file.
 - Add jumper from J1-W to J4-W, on rear of input file.
 - Add jumper from J5-W to J8-W, on rear of input file.
- *See Input Page Assignment programming details on sheets 4, 5, 6, and 7.

INPUT FILE POSITION LEGEND: J2L

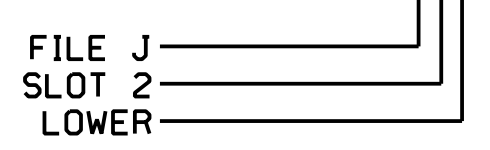

LOAD RESISTOR INSTALLATION DETAIL

(install resistors as shown)

VALUE (ohms)	WATTAGE
1.5K - 1.9K	25W (min)
2.0K - 3.0K	10W (min)

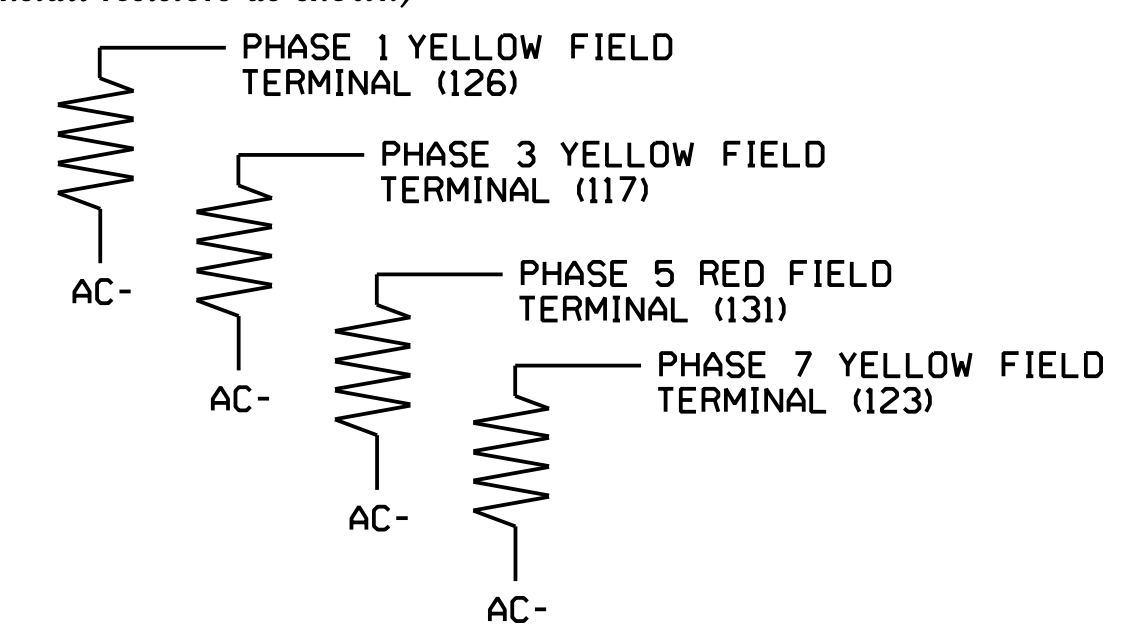

SPECIAL DETECTOR NOTE

Install a microwave detection system for vehicle detection. Perform installation according to manufacturer's directions and NCDOT engineer-approved mounting locations to accomplish the detection schemes shown on the Signal Design Plans.

For loops 1A, 3A, 5A, and 7A, detector card placement and slots reserved for wired inputs are typical for a NCDOT installation. Inputs associated with these slots are compatible with time of day instructions located on sheets 4, 5, 6, 7, and 8 of this electrical detail.



HNTB NORTH CAROLINA, P.C.
 343 E. Six Forks Road, Suite 200
 Raleigh, North Carolina 27609
 NC License No: C-1554
 (919) 546-8997

FYA SIGNAL WIRING DETAIL

(wire signal heads as shown)

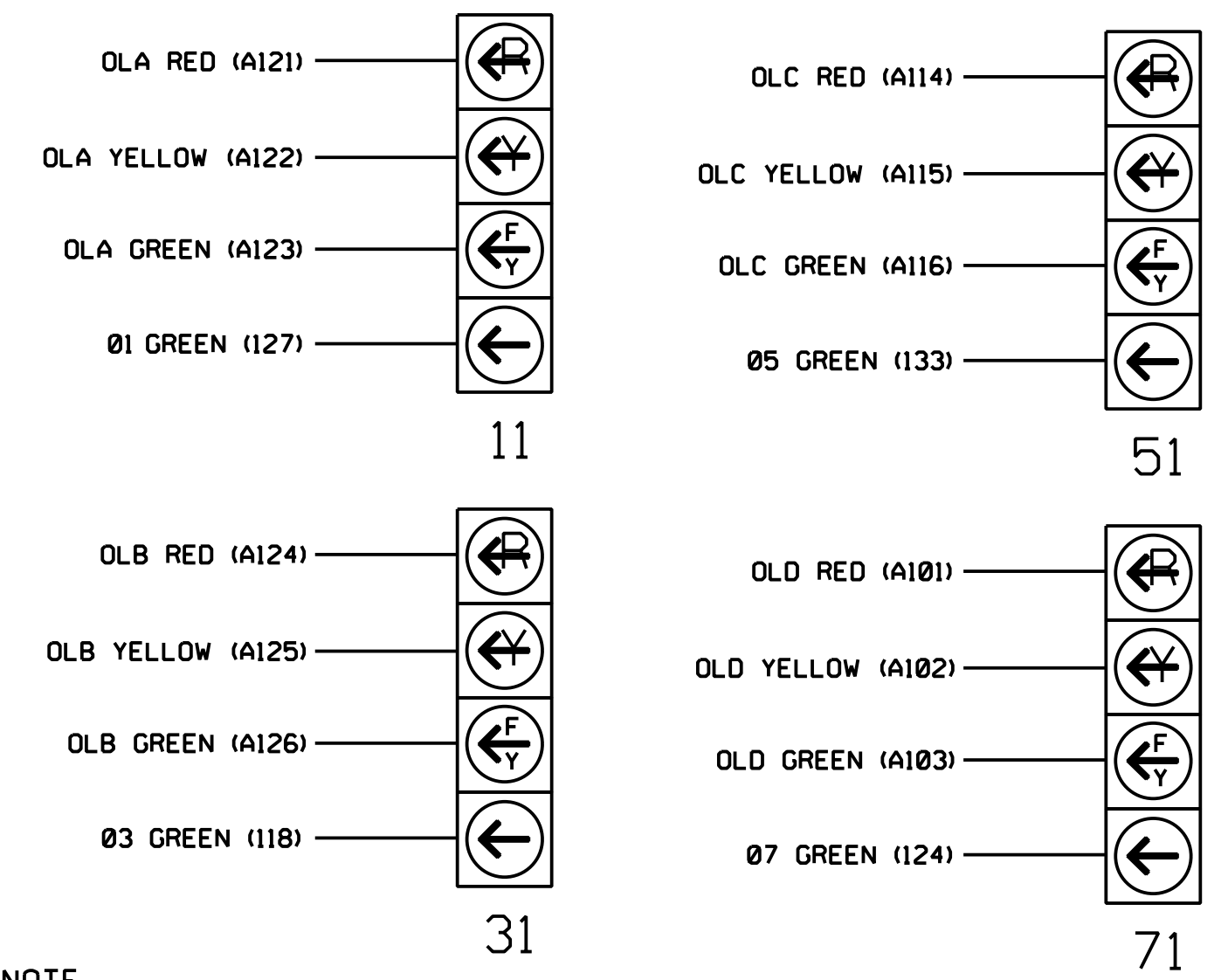

NOTE

The sequence display for signal heads 11, 31, 51, and 71 requires special logic programming. See sheet 2 for programming instructions.

THIS ELECTRICAL DETAIL IS FOR THE SIGNAL DESIGN: 03-0215T4
 DESIGNED: June 2017
 SEALED: 9/10/2021
 REVISED: N/A

Electrical Detail - Sheet 1 of 8
 Signal Upgrade
 Temporary Design 4

DOCUMENT NOT CONSIDERED FINAL UNLESS ALL SIGNATURES COMPLETED

 Prepared for: North Carolina Department of Transportation Division of Signal Management	NC 211 (Howe Street) at NC 87 (River Road)/ SR 1852 (Robert Ruark Drive) Division 03 Brunswick Co. Southport	SEAL SEAL NATASHA R. SIMMONS
	PLAN DATE: June 2017 PREPARED BY: A.H. Thornburg	REVIEWED BY: A.D. Klinskiak REVIEWED BY: N.R. Simmons

LOGICAL I/O PROCESSOR PROGRAMMING DETAIL TO PRODUCE SPECIAL FYA-PPLT SIGNAL SEQUENCE

(program controller as shown below)

- FROM MAIN MENU PRESS '2' (PHASE CONTROL), THEN '1' (PHASE CONTROL FUNCTIONS). SCROLL TO THE BOTTOM OF THE MENU AND ENABLE ACT LOGIC COMMANDS 1, 2, 3, 4, 5, 6, 7, 8, 9, 10, 11, AND 12.
- FROM MAIN MENU PRESS '6' (OUTPUTS), THEN '3' (LOGICAL I/O PROCESSOR).

LOGICAL I/O COMMAND #1 (+/-COMMAND#)
IF ACTIVE PHASE #1 IS ON
AND RED CLEAR ON PHASE #1 IS ON

↓
SCROLL DOWN

THEN:
SET OUTPUT ASSIGNMENT #50 ON
SET OUTPUT ASSIGNMENT #51 OFF

PRESS '+'

NOTE: LOGIC FOR PHASE 1 RED CLEAR WHEN TRANSITIONING FROM PHASE 1 TO PHASE 2 (HEAD 11).

LOGICAL I/O COMMAND #7 (+/-COMMAND#)
IF ACTIVE PHASE #3 IS ON
AND RED CLEAR ON PHASE #3 IS ON

↓
SCROLL DOWN

THEN:
SET OUTPUT ASSIGNMENT #47 ON
SET OUTPUT ASSIGNMENT #48 OFF

PRESS '+'

NOTE: LOGIC FOR PHASE 3 RED CLEAR WHEN TRANSITIONING FROM PHASE 3 TO PHASE 4 (HEAD 31).

LOGICAL I/O COMMAND #2 (+/-COMMAND#)
IF ACTIVE PHASE #1 IS ON

↓
SCROLL DOWN

THEN:
SET OUTPUT ASSIGNMENT #52 OFF

PRESS '+'

NOTE: LOGIC FOR SWITCHING FLASHING YELLOW ARROW "OFF" DURING PHASE 1 (HEAD 11).

LOGICAL I/O COMMAND #8 (+/-COMMAND#)
IF ACTIVE PHASE #3 IS ON

↓
SCROLL DOWN

THEN:
SET OUTPUT ASSIGNMENT #49 OFF

PRESS '+'

NOTE: LOGIC FOR SWITCHING FLASHING YELLOW ARROW "OFF" DURING PHASE 3 (HEAD 31).

LOGICAL I/O COMMAND #3 (+/-COMMAND#)
IF YELLOW ON PHASE #1 IS ON

↓
SCROLL DOWN

THEN:
SET OUTPUT ASSIGNMENT #51 ON

PRESS '+'

NOTE: LOGIC FOR YELLOW ARROW CLEARANCE FROM PHASE 1 (HEAD 11).

LOGICAL I/O COMMAND #9 (+/-COMMAND#)
IF YELLOW ON PHASE #3 IS ON

↓
SCROLL DOWN

THEN:
SET OUTPUT ASSIGNMENT #48 ON

PRESS '+'

NOTE: LOGIC FOR YELLOW ARROW CLEARANCE FROM PHASE 3 (HEAD 31).

LOGICAL I/O COMMAND #4 (+/-COMMAND#)
IF ACTIVE PHASE #5 IS ON
AND RED CLEAR ON PHASE #5 IS ON

↓
SCROLL DOWN

THEN:
SET OUTPUT ASSIGNMENT #42 ON
SET OUTPUT ASSIGNMENT #43 OFF

PRESS '+'

NOTE: LOGIC FOR PHASE 5 RED CLEAR WHEN TRANSITIONING FROM PHASE 5 TO PHASE 6 (HEAD 51).

LOGICAL I/O COMMAND #10 (+/-COMMAND#)
IF ACTIVE PHASE #7 IS ON
AND RED CLEAR ON PHASE #7 IS ON

↓
SCROLL DOWN

THEN:
SET OUTPUT ASSIGNMENT #39 ON
SET OUTPUT ASSIGNMENT #40 OFF

PRESS '+'

NOTE: LOGIC FOR PHASE 7 RED CLEAR WHEN TRANSITIONING FROM PHASE 7 TO PHASE 8 (HEAD 71).

LOGICAL I/O COMMAND #5 (+/-COMMAND#)
IF ACTIVE PHASE #5 IS ON

↓
SCROLL DOWN

THEN:
SET OUTPUT ASSIGNMENT #44 OFF

PRESS '+'

NOTE: LOGIC FOR SWITCHING FLASHING YELLOW ARROW "OFF" DURING PHASE 5 (HEAD 51).

LOGICAL I/O COMMAND #11 (+/-COMMAND#)
IF ACTIVE PHASE #7 IS ON

↓
SCROLL DOWN

THEN:
SET OUTPUT ASSIGNMENT #41 OFF

PRESS '+'

NOTE: LOGIC FOR SWITCHING FLASHING YELLOW ARROW "OFF" DURING PHASE 7 (HEAD 71).

LOGICAL I/O COMMAND #6 (+/-COMMAND#)
IF YELLOW ON PHASE #5 IS ON

↓
SCROLL DOWN

THEN:
SET OUTPUT ASSIGNMENT #43 ON

PRESS '+'

NOTE: LOGIC FOR YELLOW ARROW CLEARANCE FROM PHASE 5 (HEAD 51).

LOGICAL I/O COMMAND #12 (+/-COMMAND#)
IF YELLOW ON PHASE #7 IS ON

↓
SCROLL DOWN

THEN:
SET OUTPUT ASSIGNMENT #40 ON

PRESS '+'

NOTE: LOGIC FOR YELLOW ARROW CLEARANCE FROM PHASE 7 (HEAD 71).

LOGIC I/O PROCESSOR PROGRAMMING COMPLETE

OUTPUT REFERENCE SCHEDULE	
USE TO INTERPRET LOGIC PROCESSOR	
OUTPUT 39 =	Overlap D Red
OUTPUT 40 =	Overlap D Yellow
OUTPUT 41 =	Overlap D Green
OUTPUT 42 =	Overlap C Red
OUTPUT 43 =	Overlap C Yellow
OUTPUT 44 =	Overlap C Green
OUTPUT 47 =	Overlap B Red
OUTPUT 48 =	Overlap B Yellow
OUTPUT 49 =	Overlap B Green
OUTPUT 50 =	Overlap A Red
OUTPUT 51 =	Overlap A Yellow
OUTPUT 52 =	Overlap A Green

THIS ELECTRICAL DETAIL IS FOR
THE SIGNAL DESIGN: 03-0215T4
DESIGNED: June 2017
SEALED: 9/10/2021
REVISED: N/A

Electrical Detail - Sheet 2 of 8
Signal Upgrade
Temporary Design 4

DOCUMENT NOT CONSIDERED FINAL
UNLESS ALL SIGNATURES COMPLETED

HNTB HNTB NORTH CAROLINA, P.C.
343 E. Six Forks Road, Suite 200
Raleigh, North Carolina 27609
NC License No: C-1554
(919) 546-8997

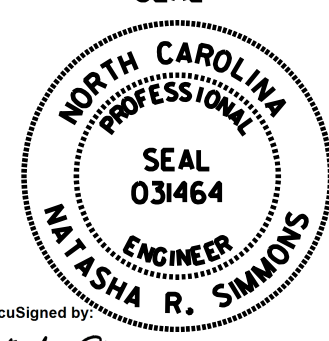
 Prepared for: Department of Transportation Division of Signal Management	NC 211 (Howe Street) at NC 87 (River Road)/ SR 1852 (Robert Ruark Drive) Division 03 Brunswick Co. Southport		SEAL  SEAL 031464 NATASHA R. SIMMONS ENGINEER
	PLAN DATE: June 2017 PREPARED BY: A.H. Thornburg	REVIEWED BY: A.D. Klinksiek REVIEWED BY: N.R. Simmons	

OVERLAP PROGRAMMING DETAIL FOR DEFAULT PHASING

(program controller as shown below)

FROM MAIN MENU PRESS '8' (OVERLAPS), THEN '1' (VEHICLE OVERLAP SETTINGS).

```

PAGE 1: VEHICLE OVERLAP 'A' SETTINGS
PHASE:           :12345678910111213141516
VEH OVL PARENTS: :XX
VEH OVL NOT VEH: :
VEH OVL NOT PED: :
VEH OVL GRN EXT: :
STARTUP COLOR:  - RED - YELLOW - GREEN
FLASH COLORS:   - RED - YELLOW X GREEN
SELECT VEHICLE OVERLAP OPTIONS: (Y/N)
FLASH YELLOW IN CONTROLLER FLASH?...Y
GREEN EXTENSION (0-255 SEC).....0
YELLOW CLEAR (0=PARENT,3-25.5 SEC)...0.0
RED CLEAR (0=PARENT,0.1-25.5 SEC)...0.0
OUTPUT AS PHASE # (0=NONE, 1-16)....0
  
```

← NOTICE GREEN FLASH

PRESS '+'

```

PAGE 1: VEHICLE OVERLAP 'B' SETTINGS
PHASE:           :12345678910111213141516
VEH OVL PARENTS: :XX
VEH OVL NOT VEH: :
VEH OVL NOT PED: :
VEH OVL GRN EXT: :
STARTUP COLOR:  - RED - YELLOW - GREEN
FLASH COLORS:   - RED - YELLOW X GREEN
SELECT VEHICLE OVERLAP OPTIONS: (Y/N)
FLASH YELLOW IN CONTROLLER FLASH?...N
GREEN EXTENSION (0-255 SEC).....0
YELLOW CLEAR (0=PARENT,3-25.5 SEC)...0.0
RED CLEAR (0=PARENT,0.1-25.5 SEC)...0.0
OUTPUT AS PHASE # (0=NONE, 1-16)....0
  
```

← NOTICE GREEN FLASH

PRESS '+'

```

PAGE 1: VEHICLE OVERLAP 'C' SETTINGS
PHASE:           :12345678910111213141516
VEH OVL PARENTS: :XX
VEH OVL NOT VEH: :
VEH OVL NOT PED: :
VEH OVL GRN EXT: :
STARTUP COLOR:  - RED - YELLOW - GREEN
FLASH COLORS:   - RED - YELLOW X GREEN
SELECT VEHICLE OVERLAP OPTIONS: (Y/N)
FLASH YELLOW IN CONTROLLER FLASH?...Y
GREEN EXTENSION (0-255 SEC).....0
YELLOW CLEAR (0=PARENT,3-25.5 SEC)...0.0
RED CLEAR (0=PARENT,0.1-25.5 SEC)...0.0
OUTPUT AS PHASE # (0=NONE, 1-16)....0
  
```

← NOTICE GREEN FLASH

PRESS '+'

```

PAGE 1: VEHICLE OVERLAP 'D' SETTINGS
PHASE:           :12345678910111213141516
VEH OVL PARENTS: :XX
VEH OVL NOT VEH: :
VEH OVL NOT PED: :
VEH OVL GRN EXT: :
STARTUP COLOR:  - RED - YELLOW - GREEN
FLASH COLORS:   - RED - YELLOW X GREEN
SELECT VEHICLE OVERLAP OPTIONS: (Y/N)
FLASH YELLOW IN CONTROLLER FLASH?...N
GREEN EXTENSION (0-255 SEC).....0
YELLOW CLEAR (0=PARENT,3-25.5 SEC)...0.0
RED CLEAR (0=PARENT,0.1-25.5 SEC)...0.0
OUTPUT AS PHASE # (0=NONE, 1-16)....0
  
```

← NOTICE GREEN FLASH

OVERLAP PROGRAMMING COMPLETE

OVERLAP PROGRAMMING DETAIL FOR ALTERNATE PHASING

(program controller as shown below)

FROM MAIN MENU PRESS '8' (OVERLAPS), THEN '1' (VEHICLE OVERLAP SETTINGS), PRESS 'NEXT' TO ADVANCE TO PAGE 2.

NOTICE PAGE 2 →

```

PAGE 2: VEHICLE OVERLAP 'A' SETTINGS
PHASE:           :12345678910111213141516
VEH OVL PARENTS: :X
VEH OVL NOT VEH: :
VEH OVL NOT PED: :
VEH OVL GRN EXT: :
STARTUP COLOR:  - RED - YELLOW - GREEN
FLASH COLORS:   - RED - YELLOW - GREEN
SELECT VEHICLE OVERLAP OPTIONS: (Y/N)
FLASH YELLOW IN CONTROLLER FLASH?...Y
GREEN EXTENSION (0-255 SEC).....0
YELLOW CLEAR (0=PARENT,3-25.5 SEC)...0.0
RED CLEAR (0=PARENT,0.1-25.5 SEC)...0.0
OUTPUT AS PHASE # (0=NONE, 1-16)....0
  
```

PRESS '+'

NOTICE PAGE 2 →

```

PAGE 2: VEHICLE OVERLAP 'B' SETTINGS
PHASE:           :12345678910111213141516
VEH OVL PARENTS: :X
VEH OVL NOT VEH: :
VEH OVL NOT PED: :
VEH OVL GRN EXT: :
STARTUP COLOR:  - RED - YELLOW - GREEN
FLASH COLORS:   - RED - YELLOW - GREEN
SELECT VEHICLE OVERLAP OPTIONS: (Y/N)
FLASH YELLOW IN CONTROLLER FLASH?...N
GREEN EXTENSION (0-255 SEC).....0
YELLOW CLEAR (0=PARENT,3-25.5 SEC)...0.0
RED CLEAR (0=PARENT,0.1-25.5 SEC)...0.0
OUTPUT AS PHASE # (0=NONE, 1-16)....0
  
```

PRESS '+'

NOTICE PAGE 2 →

```

PAGE 2: VEHICLE OVERLAP 'C' SETTINGS
PHASE:           :12345678910111213141516
VEH OVL PARENTS: :X
VEH OVL NOT VEH: :
VEH OVL NOT PED: :
VEH OVL GRN EXT: :
STARTUP COLOR:  - RED - YELLOW - GREEN
FLASH COLORS:   - RED - YELLOW - GREEN
SELECT VEHICLE OVERLAP OPTIONS: (Y/N)
FLASH YELLOW IN CONTROLLER FLASH?...Y
GREEN EXTENSION (0-255 SEC).....0
YELLOW CLEAR (0=PARENT,3-25.5 SEC)...0.0
RED CLEAR (0=PARENT,0.1-25.5 SEC)...0.0
OUTPUT AS PHASE # (0=NONE, 1-16)....0
  
```

PRESS '+'

NOTICE PAGE 2 →

```

PAGE 2: VEHICLE OVERLAP 'D' SETTINGS
PHASE:           :12345678910111213141516
VEH OVL PARENTS: :X
VEH OVL NOT VEH: :
VEH OVL NOT PED: :
VEH OVL GRN EXT: :
STARTUP COLOR:  - RED - YELLOW - GREEN
FLASH COLORS:   - RED - YELLOW - GREEN
SELECT VEHICLE OVERLAP OPTIONS: (Y/N)
FLASH YELLOW IN CONTROLLER FLASH?...N
GREEN EXTENSION (0-255 SEC).....0
YELLOW CLEAR (0=PARENT,3-25.5 SEC)...0.0
RED CLEAR (0=PARENT,0.1-25.5 SEC)...0.0
OUTPUT AS PHASE # (0=NONE, 1-16)....0
  
```

OVERLAP PROGRAMMING COMPLETE

THIS ELECTRICAL DETAIL IS FOR THE SIGNAL DESIGN: 03-0215T4
 DESIGNED: June 2017
 SEALED: 9/10/2021
 REVISED: N/A

Electrical Detail - Sheet 3 of 8
Signal Upgrade
Temporary Design 4

DOCUMENT NOT CONSIDERED FINAL UNLESS ALL SIGNATURES COMPLETED

HNTB HNTB NORTH CAROLINA, P.C.
 343 E. Six Forks Road, Suite 200
 Raleigh, North Carolina 27609
 NC License No: C-1564
 (919) 546-8997

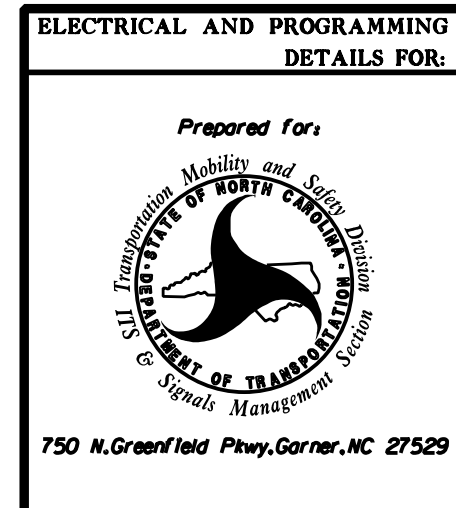

ELECTRICAL AND PROGRAMMING DETAILS FOR:		NC 211 (Howe Street)	
Prepared for:		at	
SR 1852 (Robert Ruark Drive)		Division 03 Brunswick Co. Southport	
PLAN DATE: June 2017	REVIEWED BY: A.D. Klinksiek	REVISIONS	
PREPARED BY: A.H. Thornburg	REVIEWED BY: N.R. Simmons	INIT.	DATE
9/10/2021		9/10/2021	
SIG. INVENTORY NO. 03-0215T4			

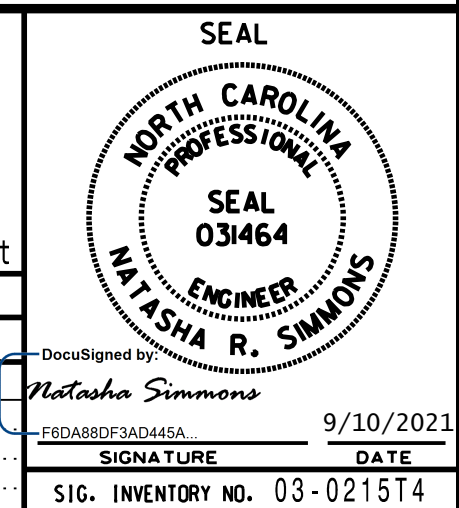

INPUT PAGE 2 ASSIGNMENT PROGRAMMING DETAIL FOR ALTERNATE PHASING - LOOP 1A
(program controller as shown below)

- NOTES: 1. THIS PROGRAMMING APPLIES FOR INPUT PAGE 2 ONLY. INPUT PAGE 1 WILL USE STANDARD DEFAULT SETTINGS. THIS PROGRAMMING IS NECESSARY FOR PROPER DETECTOR OPERATION DURING ALTERNATE PHASING OPERATION.
2. THE FIRST TASK THIS PROGRAMMING ACCOMPLISHES IS THE DISABLING OF INPUT #10 (DETECTOR 26) SO THAT A VEHICLE CALL WILL NOT BE PLACED TO PHASE 6 DURING ALTERNATE PHASING OPERATION. THE SECOND TASK THIS PROGRAMMING ACCOMPLISHES IS THAT IT REASSIGNS DETECTOR 51 TO INPUT #18 SO THAT THE DELAY ON LOOP 1A CAN BE REDUCED FROM 15 SECONDS TO 0 SECONDS.

FROM MAIN MENU PRESS '5' (INPUTS), THEN PRESS 'NEXT' TO GET TO INPUT PAGE '2'. PRESS THE '+' KEY UNTIL INPUT 10 IS REACHED.

PAGE: 2 C1 PIN:48 VEHICLE DETECTOR INPUT ASSIGNMENT #.....10 DEBOUNCE TIME (0-25.5 SEC).....0.5 DELAY TIME (0-25.5 SEC).....0.0 HOLD-OVER TIME (0-25.5 SEC).....0.0 ASSIGNMENT SELECTION: NOT ENABLED (Y/N).....Y
VEHICLE DETECTOR (1-64).....26 PEDESTRIAN DETECTOR (1-16)..... ALTERNATE PED DETECTOR (1-16)..... PREEMPT (1-10)..... INVERTED PREEMPT (1-10)..... STOP TIME (Y/N)..... FLASH SENSE (Y/N)..... DOOR OPEN (Y/N)..... MANUAL CONTROL ENABLE (Y/N)..... MANUAL CONTROL ADVANCE (Y/N)..... SPECIAL FUNCTION ALARM (1-8)..... TOD HOUR SYNCHRONIZATION (0-23)..... FORCE OFF RING (1-4)..... HOLD PHASES (1-16)..... PLAN (65=FLSH,66=FREE)..... OFFSET#..... CHANGE PHASE SEQUENCE PAGE (1-12)..... CHANGE PHASE TIMING PAGE (1-4)..... CHANGE PHASE CONTROL PAGE (1-4)..... CHANGE OVERLAP CONTROL PAGE (1-4)..... CHANGE INPUT PAGE (1-4)..... CHANGE OUTPUT PAGE (1-4)..... OVERRIDE PHASE CONTROL FUNCTION (Y).....

ENTER A 'Y' FOR NOT ENABLED
DEFAULT DETECTOR NUMBER WILL REMAIN UNTIL "NOT ENABLED" IS ENTERED.

(LOOP 1A - PHASE 6)

PAGE: 2 C1 PIN:48 NOT ENABLED INPUT ASSIGNMENT #.....10 DEBOUNCE TIME (0-25.5 SEC).....0.5 DELAY TIME (0-25.5 SEC).....0.0 HOLD-OVER TIME (0-25.5 SEC).....0.0 ASSIGNMENT SELECTION: NOT ENABLED (Y/N).....Y
VEHICLE DETECTOR (1-64)..... PEDESTRIAN DETECTOR (1-16)..... ALTERNATE PED DETECTOR (1-16)..... PREEMPT (1-10)..... INVERTED PREEMPT (1-10)..... STOP TIME (Y/N)..... FLASH SENSE (Y/N)..... DOOR OPEN (Y/N)..... MANUAL CONTROL ENABLE (Y/N)..... MANUAL CONTROL ADVANCE (Y/N)..... SPECIAL FUNCTION ALARM (1-8)..... TOD HOUR SYNCHRONIZATION (0-23)..... FORCE OFF RING (1-4)..... HOLD PHASES (1-16)..... PLAN (65=FLSH,66=FREE)..... OFFSET#..... CHANGE PHASE SEQUENCE PAGE (1-12)..... CHANGE PHASE TIMING PAGE (1-4)..... CHANGE PHASE CONTROL PAGE (1-4)..... CHANGE OVERLAP CONTROL PAGE (1-4)..... CHANGE INPUT PAGE (1-4)..... CHANGE OUTPUT PAGE (1-4)..... OVERRIDE PHASE CONTROL FUNCTION (Y).....

PRESS '+' TO ADVANCE TO INPUT 18

PAGE: 2 C1 PIN:56 VEHICLE DETECTOR INPUT ASSIGNMENT #.....18 DEBOUNCE TIME (0-25.5 SEC).....0.5 DELAY TIME (0-25.5 SEC).....0.0 HOLD-OVER TIME (0-25.5 SEC).....0.0 ASSIGNMENT SELECTION: NOT ENABLED (Y/N).....Y
VEHICLE DETECTOR (1-64).....1 PEDESTRIAN DETECTOR (1-16)..... ALTERNATE PED DETECTOR (1-16)..... PREEMPT (1-10)..... INVERTED PREEMPT (1-10)..... STOP TIME (Y/N)..... FLASH SENSE (Y/N)..... DOOR OPEN (Y/N)..... MANUAL CONTROL ENABLE (Y/N)..... MANUAL CONTROL ADVANCE (Y/N)..... SPECIAL FUNCTION ALARM (1-8)..... TOD HOUR SYNCHRONIZATION (0-23)..... FORCE OFF RING (1-4)..... HOLD PHASES (1-16)..... PLAN (65=FLSH,66=FREE)..... OFFSET#..... CHANGE PHASE SEQUENCE PAGE (1-12)..... CHANGE PHASE TIMING PAGE (1-4)..... CHANGE PHASE CONTROL PAGE (1-4)..... CHANGE OVERLAP CONTROL PAGE (1-4)..... CHANGE INPUT PAGE (1-4)..... CHANGE OUTPUT PAGE (1-4)..... OVERRIDE PHASE CONTROL FUNCTION (Y).....

ENTER '51' TO REASSIGN THE VEHICLE DETECTOR FOR THIS INPUT

(LOOP 1A - PHASE 1)

PAGE: 2 C1 PIN:56 VEHICLE DETECTOR INPUT ASSIGNMENT #.....18 DEBOUNCE TIME (0-25.5 SEC).....0.5 DELAY TIME (0-25.5 SEC).....0.0 HOLD-OVER TIME (0-25.5 SEC).....0.0 ASSIGNMENT SELECTION: NOT ENABLED (Y/N).....Y
VEHICLE DETECTOR (1-64).....51 PEDESTRIAN DETECTOR (1-16)..... ALTERNATE PED DETECTOR (1-16)..... PREEMPT (1-10)..... INVERTED PREEMPT (1-10)..... STOP TIME (Y/N)..... FLASH SENSE (Y/N)..... DOOR OPEN (Y/N)..... MANUAL CONTROL ENABLE (Y/N)..... MANUAL CONTROL ADVANCE (Y/N)..... SPECIAL FUNCTION ALARM (1-8)..... TOD HOUR SYNCHRONIZATION (0-23)..... FORCE OFF RING (1-4)..... HOLD PHASES (1-16)..... PLAN (65=FLSH,66=FREE)..... OFFSET#..... CHANGE PHASE SEQUENCE PAGE (1-12)..... CHANGE PHASE TIMING PAGE (1-4)..... CHANGE PHASE CONTROL PAGE (1-4)..... CHANGE OVERLAP CONTROL PAGE (1-4)..... CHANGE INPUT PAGE (1-4)..... CHANGE OUTPUT PAGE (1-4)..... OVERRIDE PHASE CONTROL FUNCTION (Y).....

PROGRAMMING COMPLETE

SPECIAL DETECTOR PROGRAMMING DETAIL - LOOP 1A (ALT.)

(program controller as shown below)

FROM MAIN MENU PRESS '7' (DETECTORS), THEN PRESS '1' FOR VEHICLE DETECTORS. PRESS THE '-' KEY TO GET TO VEHICLE DETECTOR #51.

VEHICLE DETECTOR #51 SETTINGS (+,-,1-64) SETTING: (Y/N)
ENABLE DETECTOR.....N
ENABLE LOGGING.....N
ENABLE DIAGNOSTICS.....N
SPEED TRAP.....N
CALL DETECTOR.....Y
EXTENSION DETECTOR.....Y
MODE 2 STOP BAR.....N
SWITCHING DETECTOR.....N
DUPLICATING DETECTOR.....N
ENABLE FULL TIME DELAY.....N
IF FAILED, SET MIN RECALL?.....N
IF FAILED, SET MAX1 RECALL?.....N
IF FAILED, SET MAX2 RECALL?.....N
PHASE# :12345678910111213141516
PHASES ASSIGNED :
SWITCH/DUPLICATE:
LOOP SIZE (0-255 FT).....6
SPEED TRAP DISTANCE (0-255 FT).....0
STOP BAR TIME (0-255 SEC).....0
STRETCH (0-25.5 SEC).....0.0
DELAY (0-255 SEC).....0.0
MAX CALLS/MIN (0-255).....255
MIN CALLS/DIAGNOSTIC PERIOD (0-255).....0
MAX OCCUPANCY (0-100%).....100
EXTENSION DISABLE TIME (0-255 SEC).....0
QUEUE MAX OCCUPANCY TIME (0-255).....0
QUEUE GAP RESET TIME (0-25.5).....0.0
PREEMPTION INDEX FOR QUEUE (0-10).....0

ENTER 'Y' FOR ENABLE DETECTOR

ENTER '1' FOR PHASES ASSIGNED

ENSURE DELAY IS '0'

VEHICLE DETECTOR #51 SETTINGS (+,-,1-64) SETTING: (Y/N)
ENABLE DETECTOR.....Y
ENABLE LOGGING.....N
ENABLE DIAGNOSTICS.....N
SPEED TRAP.....N
CALL DETECTOR.....Y
EXTENSION DETECTOR.....Y
MODE 2 STOP BAR.....N
SWITCHING DETECTOR.....N
DUPLICATING DETECTOR.....N
ENABLE FULL TIME DELAY.....N
IF FAILED, SET MIN RECALL?.....N
IF FAILED, SET MAX1 RECALL?.....N
IF FAILED, SET MAX2 RECALL?.....N
PHASE# :12345678910111213141516
PHASES ASSIGNED :X
SWITCH/DUPLICATE:
LOOP SIZE (0-255 FT).....6
SPEED TRAP DISTANCE (0-255 FT).....0
STOP BAR TIME (0-255 SEC).....0
STRETCH (0-25.5 SEC).....0.0
DELAY (0-255 SEC).....0.0
MAX CALLS/MIN (0-255).....255
MIN CALLS/DIAGNOSTIC PERIOD (0-255).....0
MAX OCCUPANCY (0-100%).....100
EXTENSION DISABLE TIME (0-255 SEC).....0
QUEUE MAX OCCUPANCY TIME (0-255).....0
QUEUE GAP RESET TIME (0-25.5).....0.0
PREEMPTION INDEX FOR QUEUE (0-10).....0

DETECTOR PROGRAMMING COMPLETE

NOTE: DETECTOR IS PROGRAMMED PER THE INPUT FILE CONNECTION AND PROGRAMMING CHART SHOWN ON SHEET 1.

THIS ELECTRICAL DETAIL IS FOR THE SIGNAL DESIGN: 03-0215T4
DESIGNED: June 2017
SEALED: 9/10/2021
REVISED: N/A

Electrical Detail - Sheet 4 of 8
Signal Upgrade
Temporary Design 4

DOCUMENT NOT CONSIDERED FINAL UNLESS ALL SIGNATURES COMPLETED

Table with project details: NC 211 (Howe Street) at NC 87 (River Road)/ SR 1852 (Robert Ruark Drive). Includes fields for Plan Date, Prepared By, Reviewed By, and a signature block for Natasha Simmons dated 9/10/2021.

INPUT PAGE 2 ASSIGNMENT PROGRAMMING DETAIL FOR ALTERNATE PHASING - LOOP 3A

(program controller as shown below)

- NOTES: 1. THIS PROGRAMMING APPLIES FOR INPUT PAGE 2 ONLY. INPUT PAGE 1 WILL USE STANDARD DEFAULT SETTINGS. THIS PROGRAMMING IS NECESSARY FOR PROPER DETECTOR OPERATION DURING ALTERNATE PHASING OPERATION.
2. THE FIRST TASK THIS PROGRAMMING ACCOMPLISHES IS THE DISABLING OF INPUT #12 (DETECTOR 28) SO THAT A VEHICLE CALL WILL NOT BE PLACED TO PHASE 8 DURING ALTERNATE PHASING OPERATION. THE SECOND TASK THIS PROGRAMMING ACCOMPLISHES IS THAT IT REASSIGNS DETECTOR 53 TO INPUT #20 SO THAT THE DELAY ON LOOP 3A CAN BE REDUCED FROM 15 SECONDS TO 3 SECONDS.

FROM MAIN MENU PRESS '5' (INPUTS), THEN PRESS 'NEXT' TO GET TO INPUT PAGE '2'. PRESS THE '+' KEY UNTIL INPUT 12 IS REACHED.

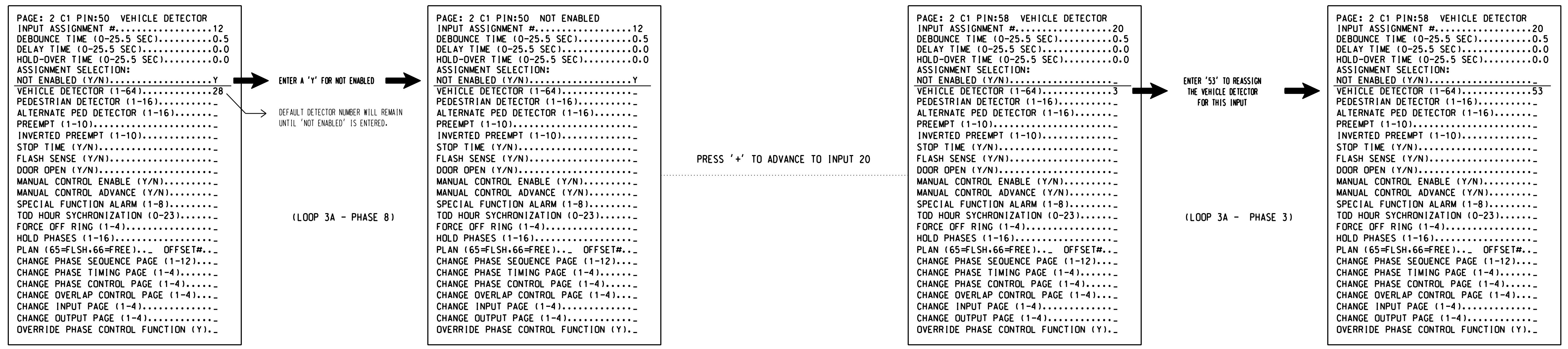

PROGRAMMING COMPLETE

SPECIAL DETECTOR PROGRAMMING DETAIL - LOOP 3A (ALT.)

(program controller as shown below)

FROM MAIN MENU PRESS '7' (DETECTORS), THEN PRESS '1' FOR VEHICLE DETECTORS. PRESS THE '-' KEY TO GET TO VEHICLE DETECTOR #53.

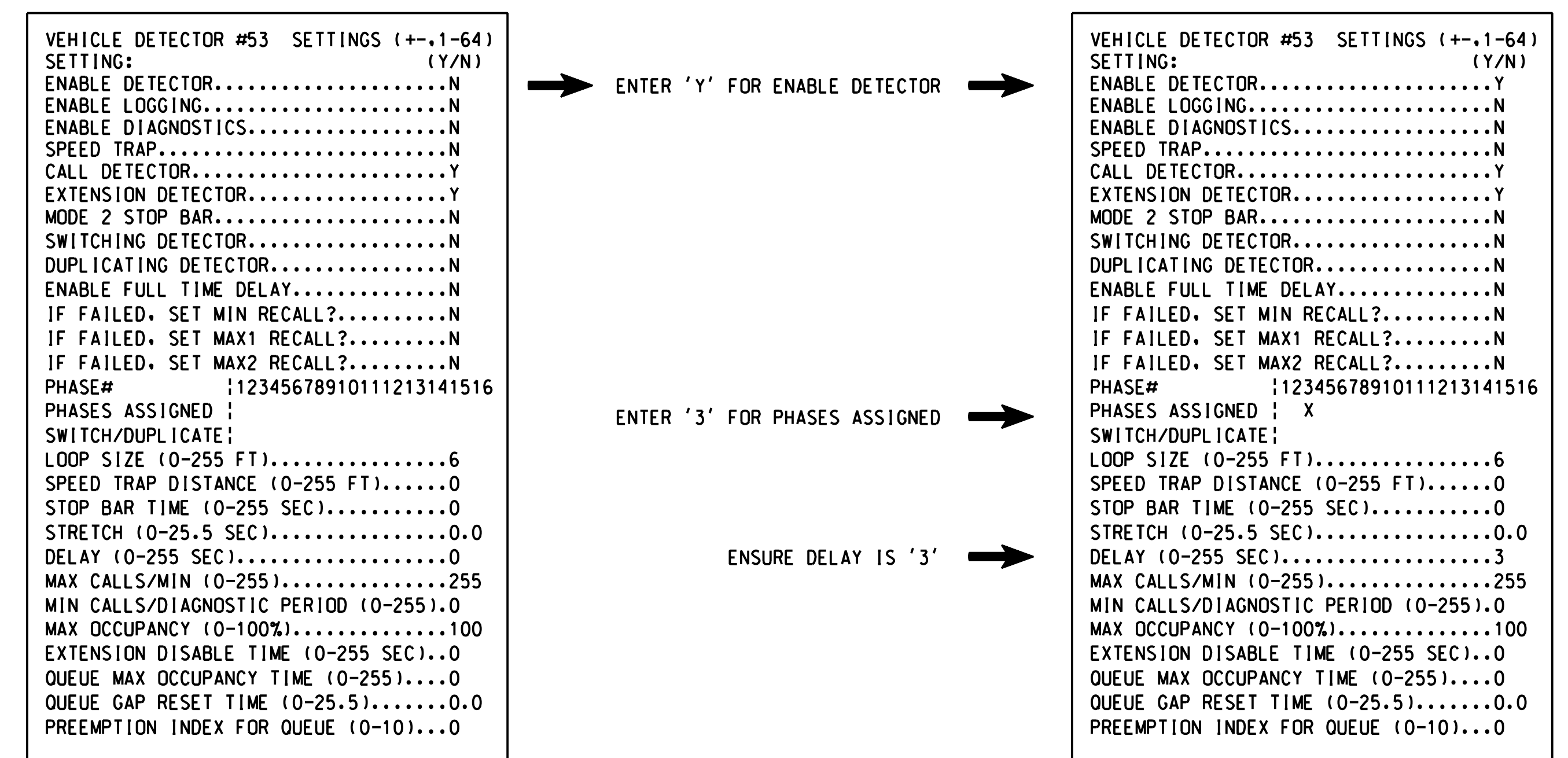

NOTE: DETECTOR IS PROGRAMMED PER THE INPUT FILE CONNECTION AND PROGRAMMING CHART SHOWN ON SHEET 1.

THIS ELECTRICAL DETAIL IS FOR THE SIGNAL DESIGN: 03-0215T4
DESIGNED: June 2017
SEALED: 9/10/2021
REVISED: N/A

Electrical Detail - Sheet 5 of 8
Signal Upgrade
Temporary Design 4

DOCUMENT NOT CONSIDERED FINAL UNLESS ALL SIGNATURES COMPLETED

	Prepared for: 		NC 211 (Howe Street) at NC 87 (River Road)/ SR 1852 (Robert Ruark Drive)		
	750 N. Greenfield Pkwy, Corner, NC 27529		Division 03 Brunswick Co. Southport		
PLAN DATE: June 2017 PREPARED BY: A.H. Thornburg		REVIEWED BY: A.D. Klinksiek REVIEWED BY: N.R. Simmons		DATE: 9/10/2021 SIGNATURE: _____ DATE: _____	

INPUT PAGE 2 ASSIGNMENT PROGRAMMING DETAIL FOR ALTERNATE PHASING - LOOP 5A

(program controller as shown below)

- NOTES: 1. THIS PROGRAMMING APPLIES FOR INPUT PAGE 2 ONLY. INPUT PAGE 1 WILL USE STANDARD DEFAULT SETTINGS. THIS PROGRAMMING IS NECESSARY FOR PROPER DETECTOR OPERATION DURING ALTERNATE PHASING OPERATION.
2. THE FIRST TASK THIS PROGRAMMING ACCOMPLISHES IS THE DISABLING OF INPUT #9 (DETECTOR 22) SO THAT A VEHICLE CALL WILL NOT BE PLACED TO PHASE 2 DURING ALTERNATE PHASING OPERATION. THE SECOND TASK THIS PROGRAMMING ACCOMPLISHES IS THAT IT REASSIGNS DETECTOR 55 TO INPUT #17 SO THAT THE DELAY ON LOOP 5A CAN BE REDUCED FROM 15 SECONDS TO 0 SECONDS.

FROM MAIN MENU PRESS '5' (INPUTS), THEN PRESS 'NEXT' TO GET TO INPUT PAGE '2'. PRESS THE '+' KEY UNTIL INPUT 9 IS REACHED.

```

PAGE: 2 C1 PIN:47 VEHICLE DETECTOR
INPUT ASSIGNMENT #.....9
DEBOUNCE TIME (0-25.5 SEC).....0.5
DELAY TIME (0-25.5 SEC).....0.0
HOLD-OVER TIME (0-25.5 SEC).....0.0
ASSIGNMENT SELECTION:
NOT ENABLED (Y/N).....Y
VEHICLE DETECTOR (1-64).....22
PEDESTRIAN DETECTOR (1-16).....
ALTERNATE PED DETECTOR (1-16).....
PREEMPT (1-10).....
INVERTED PREEMPT (1-10).....
STOP TIME (Y/N).....
FLASH SENSE (Y/N).....
DOOR OPEN (Y/N).....
MANUAL CONTROL ENABLE (Y/N).....
MANUAL CONTROL ADVANCE (Y/N).....
SPECIAL FUNCTION ALARM (1-8).....
TOD HOUR SYNCHRONIZATION (0-23).....
FORCE OFF RING (1-4).....
HOLD PHASES (1-16).....
PLAN (65=FLSH,66=FREE)..... OFFSET#...
CHANGE PHASE SEQUENCE PAGE (1-12)....
CHANGE PHASE TIMING PAGE (1-4).....
CHANGE PHASE CONTROL PAGE (1-4).....
CHANGE OVERLAP CONTROL PAGE (1-4)....
CHANGE INPUT PAGE (1-4).....
CHANGE OUTPUT PAGE (1-4).....
OVERRIDE PHASE CONTROL FUNCTION (Y)...

```

ENTER A 'Y' FOR NOT ENABLED
DEFAULT DETECTOR NUMBER WILL REMAIN UNTIL 'NOT ENABLED' IS ENTERED.

(LOOP 5A - PHASE 2)

```

PAGE: 2 C1 PIN:47 NOT ENABLED
INPUT ASSIGNMENT #.....9
DEBOUNCE TIME (0-25.5 SEC).....0.5
DELAY TIME (0-25.5 SEC).....0.0
HOLD-OVER TIME (0-25.5 SEC).....0.0
ASSIGNMENT SELECTION:
NOT ENABLED (Y/N).....Y
VEHICLE DETECTOR (1-64).....
PEDESTRIAN DETECTOR (1-16).....
ALTERNATE PED DETECTOR (1-16).....
PREEMPT (1-10).....
INVERTED PREEMPT (1-10).....
STOP TIME (Y/N).....
FLASH SENSE (Y/N).....
DOOR OPEN (Y/N).....
MANUAL CONTROL ENABLE (Y/N).....
MANUAL CONTROL ADVANCE (Y/N).....
SPECIAL FUNCTION ALARM (1-8).....
TOD HOUR SYNCHRONIZATION (0-23).....
FORCE OFF RING (1-4).....
HOLD PHASES (1-16).....
PLAN (65=FLSH,66=FREE)..... OFFSET#...
CHANGE PHASE SEQUENCE PAGE (1-12)....
CHANGE PHASE TIMING PAGE (1-4).....
CHANGE PHASE CONTROL PAGE (1-4).....
CHANGE OVERLAP CONTROL PAGE (1-4)....
CHANGE INPUT PAGE (1-4).....
CHANGE OUTPUT PAGE (1-4).....
OVERRIDE PHASE CONTROL FUNCTION (Y)...

```

PRESS '+' TO ADVANCE TO INPUT 17

```

PAGE: 2 C1 PIN:55 VEHICLE DETECTOR
INPUT ASSIGNMENT #.....17
DEBOUNCE TIME (0-25.5 SEC).....0.5
DELAY TIME (0-25.5 SEC).....0.0
HOLD-OVER TIME (0-25.5 SEC).....0.0
ASSIGNMENT SELECTION:
NOT ENABLED (Y/N).....
VEHICLE DETECTOR (1-64).....5
PEDESTRIAN DETECTOR (1-16).....
ALTERNATE PED DETECTOR (1-16).....
PREEMPT (1-10).....
INVERTED PREEMPT (1-10).....
STOP TIME (Y/N).....
FLASH SENSE (Y/N).....
DOOR OPEN (Y/N).....
MANUAL CONTROL ENABLE (Y/N).....
MANUAL CONTROL ADVANCE (Y/N).....
SPECIAL FUNCTION ALARM (1-8).....
TOD HOUR SYNCHRONIZATION (0-23).....
FORCE OFF RING (1-4).....
HOLD PHASES (1-16).....
PLAN (65=FLSH,66=FREE)..... OFFSET#...
CHANGE PHASE SEQUENCE PAGE (1-12)....
CHANGE PHASE TIMING PAGE (1-4).....
CHANGE PHASE CONTROL PAGE (1-4).....
CHANGE OVERLAP CONTROL PAGE (1-4)....
CHANGE INPUT PAGE (1-4).....
CHANGE OUTPUT PAGE (1-4).....
OVERRIDE PHASE CONTROL FUNCTION (Y)...

```

ENTER '55' TO REASSIGN THE VEHICLE DETECTOR FOR THIS INPUT

(LOOP 5A - PHASE 5)

```

PAGE: 2 C1 PIN:55 VEHICLE DETECTOR
INPUT ASSIGNMENT #.....17
DEBOUNCE TIME (0-25.5 SEC).....0.5
DELAY TIME (0-25.5 SEC).....0.0
HOLD-OVER TIME (0-25.5 SEC).....0.0
ASSIGNMENT SELECTION:
NOT ENABLED (Y/N).....
VEHICLE DETECTOR (1-64).....55
PEDESTRIAN DETECTOR (1-16).....
ALTERNATE PED DETECTOR (1-16).....
PREEMPT (1-10).....
INVERTED PREEMPT (1-10).....
STOP TIME (Y/N).....
FLASH SENSE (Y/N).....
DOOR OPEN (Y/N).....
MANUAL CONTROL ENABLE (Y/N).....
MANUAL CONTROL ADVANCE (Y/N).....
SPECIAL FUNCTION ALARM (1-8).....
TOD HOUR SYNCHRONIZATION (0-23).....
FORCE OFF RING (1-4).....
HOLD PHASES (1-16).....
PLAN (65=FLSH,66=FREE)..... OFFSET#...
CHANGE PHASE SEQUENCE PAGE (1-12)....
CHANGE PHASE TIMING PAGE (1-4).....
CHANGE PHASE CONTROL PAGE (1-4).....
CHANGE OVERLAP CONTROL PAGE (1-4)....
CHANGE INPUT PAGE (1-4).....
CHANGE OUTPUT PAGE (1-4).....
OVERRIDE PHASE CONTROL FUNCTION (Y)...

```

PROGRAMMING COMPLETE

SPECIAL DETECTOR PROGRAMMING DETAIL - LOOP 5A (ALT.)

(program controller as shown below)

FROM MAIN MENU PRESS '7' (DETECTORS), THEN PRESS '1' FOR VEHICLE DETECTORS. PRESS THE '-' KEY TO GET TO VEHICLE DETECTOR #55.

```

VEHICLE DETECTOR #55 SETTINGS (+,-,1-64)
SETTING: (Y/N)
ENABLE DETECTOR.....N
ENABLE LOGGING.....N
ENABLE DIAGNOSTICS.....N
SPEED TRAP.....N
CALL DETECTOR.....Y
EXTENSION DETECTOR.....Y
MODE 2 STOP BAR.....N
SWITCHING DETECTOR.....N
DUPLICATING DETECTOR.....N
ENABLE FULL TIME DELAY.....N
IF FAILED, SET MIN RECALL?.....N
IF FAILED, SET MAX1 RECALL?.....N
IF FAILED, SET MAX2 RECALL?.....N
PHASE# :12345678910111213141516
PHASES ASSIGNED :
SWITCH/DUPLICATE :
LOOP SIZE (0-255 FT).....6
SPEED TRAP DISTANCE (0-255 FT).....0
STOP BAR TIME (0-255 SEC).....0
STRETCH (0-25.5 SEC).....0.0
DELAY (0-255 SEC).....0.0
MAX CALLS/MIN (0-255).....255
MIN CALLS/DIAGNOSTIC PERIOD (0-255).....0
MAX OCCUPANCY (0-100%).....100
EXTENSION DISABLE TIME (0-255 SEC).....0
QUEUE MAX OCCUPANCY TIME (0-255).....0
QUEUE GAP RESET TIME (0-25.5).....0.0
PREEMPTION INDEX FOR QUEUE (0-10).....0

```

ENTER 'Y' FOR ENABLE DETECTOR

ENTER '5' FOR PHASES ASSIGNED

ENSURE DELAY IS '0'

```

VEHICLE DETECTOR #55 SETTINGS (+,-,1-64)
SETTING: (Y/N)
ENABLE DETECTOR.....Y
ENABLE LOGGING.....N
ENABLE DIAGNOSTICS.....N
SPEED TRAP.....N
CALL DETECTOR.....Y
EXTENSION DETECTOR.....Y
MODE 2 STOP BAR.....N
SWITCHING DETECTOR.....N
DUPLICATING DETECTOR.....N
ENABLE FULL TIME DELAY.....N
IF FAILED, SET MIN RECALL?.....N
IF FAILED, SET MAX1 RECALL?.....N
IF FAILED, SET MAX2 RECALL?.....N
PHASE# :12345678910111213141516
PHASES ASSIGNED : X
SWITCH/DUPLICATE :
LOOP SIZE (0-255 FT).....6
SPEED TRAP DISTANCE (0-255 FT).....0
STOP BAR TIME (0-255 SEC).....0
STRETCH (0-25.5 SEC).....0.0
DELAY (0-255 SEC).....0.0
MAX CALLS/MIN (0-255).....255
MIN CALLS/DIAGNOSTIC PERIOD (0-255).....0
MAX OCCUPANCY (0-100%).....100
EXTENSION DISABLE TIME (0-255 SEC).....0
QUEUE MAX OCCUPANCY TIME (0-255).....0
QUEUE GAP RESET TIME (0-25.5).....0.0
PREEMPTION INDEX FOR QUEUE (0-10).....0

```

DETECTOR PROGRAMMING COMPLETE

NOTE: DETECTOR IS PROGRAMMED PER THE INPUT FILE CONNECTION AND PROGRAMMING CHART SHOWN ON SHEET 1.

THIS ELECTRICAL DETAIL IS FOR THE SIGNAL DESIGN: 03-0215T4
DESIGNED: June 2017
SEALED: 9/10/2021
REVISED: N/A

Electrical Detail - Sheet 6 of 8
Signal Upgrade
Temporary Design 4

DOCUMENT NOT CONSIDERED FINAL UNLESS ALL SIGNATURES COMPLETED

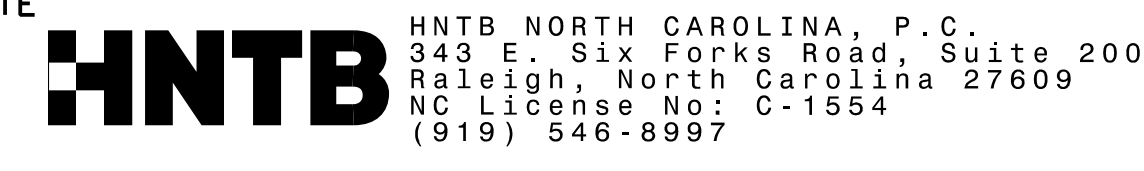

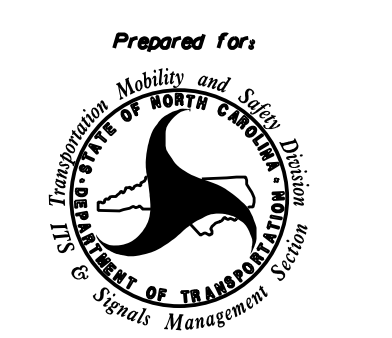
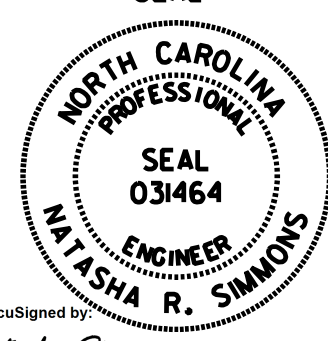
	NC 211 (Howe Street) at NC 87 (River Road)/ SR 1852 (Robert Ruark Drive) Division 03 Brunswick Co. Southport		
	PLAN DATE: June 2017 PREPARED BY: A.H. Thornburg	REVIEWED BY: A.D. Klinksiek REVIEWED BY: N.R. Simmons	
REVISIONS			INIT. DATE
SIGNATURE			DATE

SIG. INVENTORY NO. 03-0215T4

INPUT PAGE 2 ASSIGNMENT PROGRAMMING DETAIL FOR ALTERNATE PHASING - LOOP 7A

(program controller as shown below)

- NOTES: 1. THIS PROGRAMMING APPLIES FOR INPUT PAGE 2 ONLY. INPUT PAGE 1 WILL USE STANDARD DEFAULT SETTINGS. THIS PROGRAMMING IS NECESSARY FOR PROPER DETECTOR OPERATION DURING ALTERNATE PHASING OPERATION.
2. THE FIRST TASK THIS PROGRAMMING ACCOMPLISHES IS THE DISABLING OF INPUT #11 (DETECTOR 24) SO THAT A VEHICLE CALL WILL NOT BE PLACED TO PHASE 4 DURING ALTERNATE PHASING OPERATION. THE SECOND TASK THIS PROGRAMMING ACCOMPLISHES IS THAT IT REASSIGNS DETECTOR 57 TO INPUT #19 SO THAT THE DELAY ON LOOP 7A CAN BE REDUCED FROM 15 SECONDS TO 0 SECONDS.

FROM MAIN MENU PRESS '5' (INPUTS), THEN PRESS 'NEXT' TO GET TO INPUT PAGE '2'. PRESS THE '+' KEY UNTIL INPUT 11 IS REACHED.

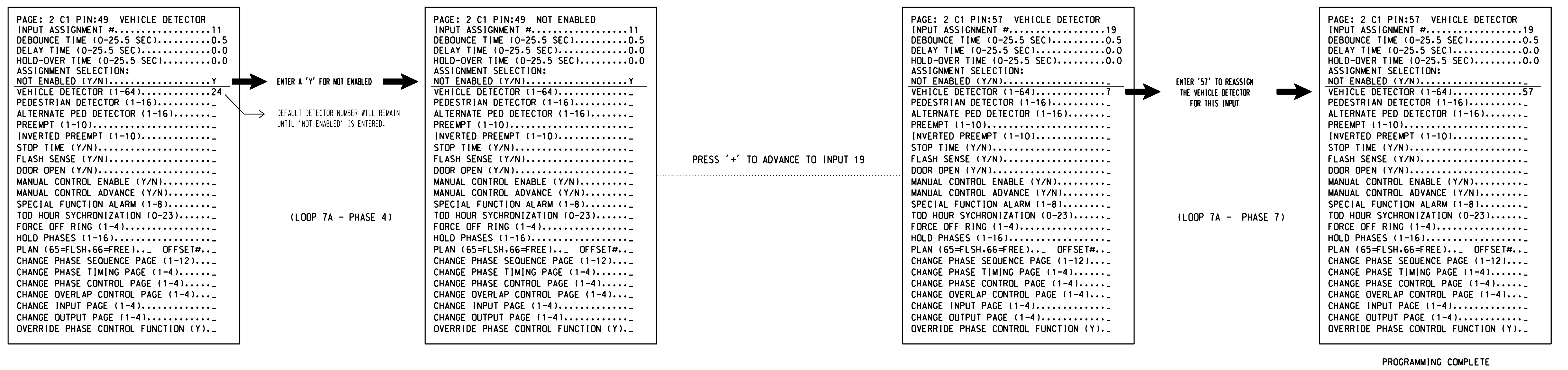

SPECIAL DETECTOR PROGRAMMING DETAIL - LOOP 7A (ALT.)

(program controller as shown below)

FROM MAIN MENU PRESS '7' (DETECTORS), THEN PRESS '1' FOR VEHICLE DETECTORS. PRESS THE '-' KEY TO GET TO VEHICLE DETECTOR #57.

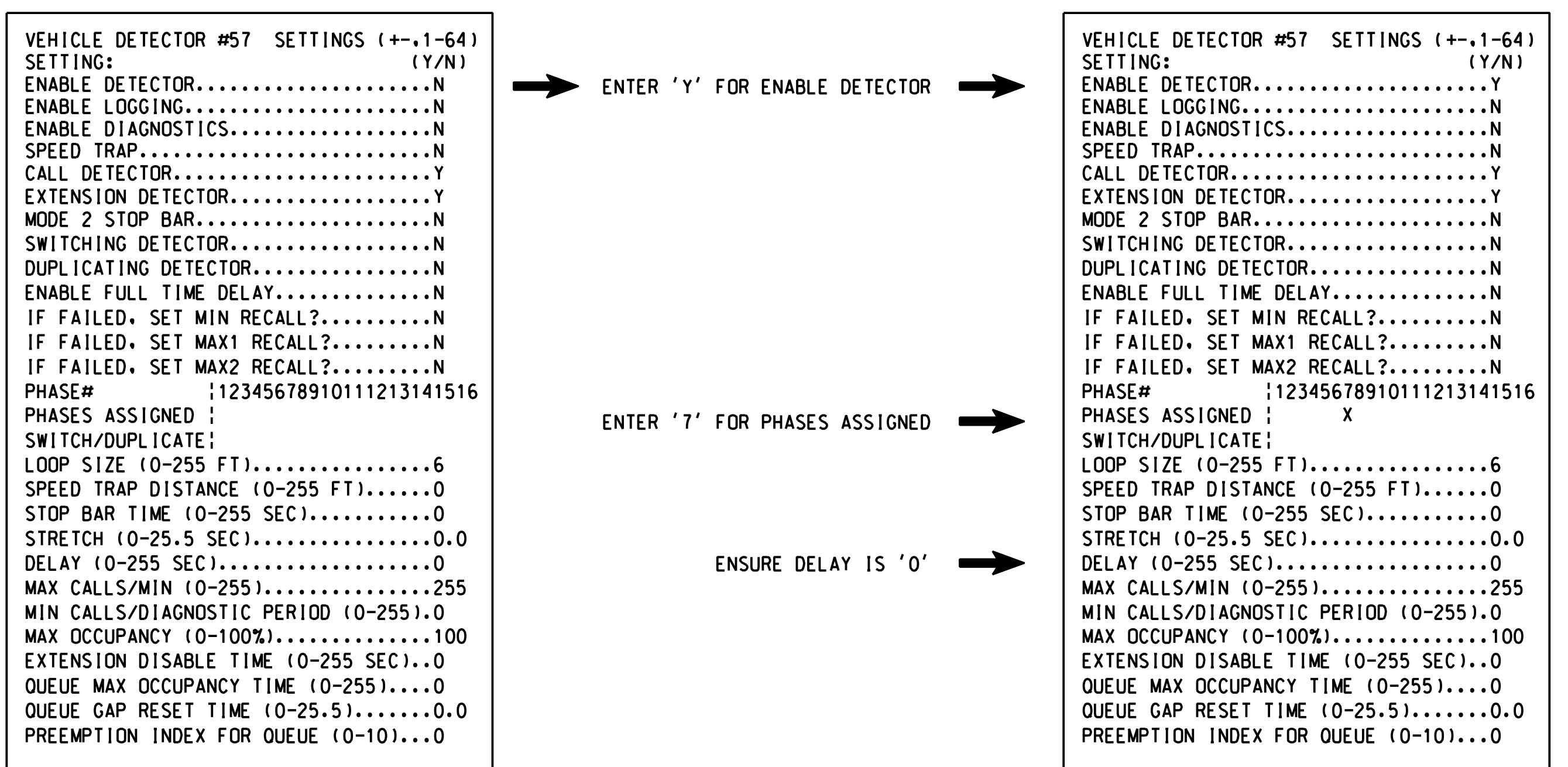

NOTE: DETECTOR IS PROGRAMMED PER THE INPUT FILE CONNECTION AND PROGRAMMING CHART SHOWN ON SHEET 1.

THIS ELECTRICAL DETAIL IS FOR THE SIGNAL DESIGN: 03-0215T4
DESIGNED: June 2017
SEALED: 9/10/2021
REVISED: N/A

Electrical Detail - Sheet 7 of 8
Signal Upgrade
Temporary Design 4

DOCUMENT NOT CONSIDERED FINAL UNLESS ALL SIGNATURES COMPLETED

	Prepared for: NC 211 (Howe Street) at NC 87 (River Road)/ SR 1852 (Robert Ruark Drive)		
	Division 03 Brunswick Co. Southport		
PLAN DATE: June 2017 PREPARED BY: A.H. Thornburg	REVIEWED BY: A.D. Klinksiek REVIEWED BY: N.R. Simmons	DATE: 9/10/2021	DATE:
REVISIONS		INIT.	DATE
SIGNATURE		DATE	DATE

DETECTOR PROGRAMMING COMPLETE

HNTB NORTH CAROLINA, P.C.
343 E. Six Forks Road, Suite 200
Raleigh, North Carolina 27609
NC License No: C-1554
(919) 546-8997

ALTERNATE PHASING ACTIVATION DETAIL

TO RUN ALT. PHASING DURING COORDINATION - SELECT ALL PAGE CHANGES (AS SHOWN BELOW) WITHIN COORDINATION PLAN PROGRAMMING.

TO RUN ALT. PHASING DURING FREE RUN - PROGRAM PAGE CHANGES (SHOWN BELOW) IN SEPARATE TIME OF DAY EVENTS. IF PAGE 1 IS USED, NO EVENT PROGRAMMING IS NECESSARY FOR THAT PARTICULAR PAGE.

<u>PHASING</u>	<u>INPUTS PAGE</u>	<u>OVERLAPS PAGE</u>
ACTIVE PAGES REQUIRED TO RUN <u>DEFAULT PHASING</u>	1	1
ACTIVE PAGES REQUIRED TO RUN <u>ALTERNATE PHASING</u>	2	2

NOTE: PAGES NOT SHOWN (i.e. sequence, phase control, etc.) SHOULD REMAIN AS '1', OR AS DEFINED BY TIMING ENGINEER.

IMPORTANT: IF ALT. PHASING IS USED DURING FREE RUN AND COORDINATION, DO NOT OPERATE TIME OF DAY PAGE CHANGE EVENTS CONCURRENTLY WITH COORDINATION PLAN EVENTS IN THE EVENT SCHEDULER. (EX. FREE RUN PAGE CHANGE EVENT SHOULD END BEFORE COORDINATION PLAN EVENT STARTS AND VICE-VERSA).

FLASHER CIRCUIT MODIFICATION DETAIL

IN ORDER TO ENSURE THAT SIGNALS FLASH CONCURRENTLY ON THE SAME APPROACH, MAKE THE FOLLOWING FLASHER CIRCUIT CHANGES:

1. ON REAR OF PDA - REMOVE WIRE FROM TERM. T2-4 AND TERMINATE ON T2-2.
2. ON REAR OF PDA - REMOVE WIRE FROM TERM. T2-5 AND TERMINATE ON T2-3.
3. REMOVE FLASHER UNIT 2.

THE CHANGES LISTED ABOVE TIES ALL PHASES AND OVERLAPS TO FLASHER UNIT 1.

ALTERNATE PHASING PAGE CHANGE SUMMARY

THE FOLLOWING IS A SUMMARY OF WHAT TAKES PLACE WHEN THESE OVERLAP/INPUT PAGE CHANGES ACTIVATE TO CALL THE "ALTERNATE PHASING":

- OVERLAPS PAGE 2:** Modifies overlap parent phases for heads 11, 31, 51, and 71 to run protected turns only.
- INPUTS PAGE 2:** Disables phase 6 call on loop 1A and reduces delay time for phase 1 call on loop 1A to 0 seconds.
- Disables phase 8 call on loop 3A and reduces delay time for phase 3 call on loop 3A to 3 seconds.
- Disables phase 2 call on loop 5A and reduces delay time for phase 5 call on loop 5A to 0 seconds.
- Disables phase 4 call on loop 7A and reduces delay time for phase 7 call on loop 7A to 0 seconds.

THIS ELECTRICAL DETAIL IS FOR THE SIGNAL DESIGN: 03-0215T4
DESIGNED: June 2017
SEALED: 9/10/2021
REVISED: N/A

Electrical Detail - Sheet 8 of 8
Signal Upgrade
Temporary Design 4

**DOCUMENT NOT CONSIDERED FINAL
UNLESS ALL SIGNATURES COMPLETED**

HNTB HNTB NORTH CAROLINA, P.C.
343 E. Six Forks Road, Suite 200
Raleigh, North Carolina 27609
NC License No: C-1554
(919) 546-8997

<p style="font-size: small;">ELECTRICAL AND PROGRAMMING DETAILS FOR:</p> <div style="text-align: center;">  <p style="font-size: x-small;">Prepared for: Department of Transportation Mobility and Safety Division STATE OF NORTH CAROLINA Office of Signal Management</p> </div> <p style="font-size: x-small;">750 N. Greenfield Pkwy, Corner, NC 27529</p>	<p style="text-align: center;">NC 211 (Howe Street) at NC 87 (River Road)/ SR 1852 (Robert Ruark Drive)</p> <p style="font-size: x-small;">Division 03 Brunswick Co. Southport</p> <table style="width: 100%; border-collapse: collapse;"> <tr> <td style="width: 50%; border-bottom: 1px solid black;">PLAN DATE: June 2017</td> <td style="width: 50%; border-bottom: 1px solid black;">REVIEWED BY: A.D. Klinksiek</td> </tr> <tr> <td style="border-bottom: 1px solid black;">PREPARED BY: A.H. Thornburg</td> <td style="border-bottom: 1px solid black;">REVIEWED BY: N.R. Simmons</td> </tr> </table>	PLAN DATE: June 2017	REVIEWED BY: A.D. Klinksiek	PREPARED BY: A.H. Thornburg	REVIEWED BY: N.R. Simmons	<p style="font-size: x-small;">SEAL</p> <div style="border: 1px solid black; border-radius: 50%; padding: 5px; width: 60px; margin: 0 auto;"> <p style="font-size: x-small; margin: 0;">NORTH CAROLINA PROFESSIONAL ENGINEER SEAL 031464 NATASHA R. SIMMONS</p> </div> <p style="font-size: x-small;">Documented by: <i>Natasha Simmons</i> 9/10/2021</p> <p style="font-size: x-small;">SIGNATURE DATE</p> <p style="font-size: x-small;">SIG. INVENTORY NO. 03-0215T4</p>
PLAN DATE: June 2017	REVIEWED BY: A.D. Klinksiek					
PREPARED BY: A.H. Thornburg	REVIEWED BY: N.R. Simmons					

DEFAULT PHASING DIAGRAM

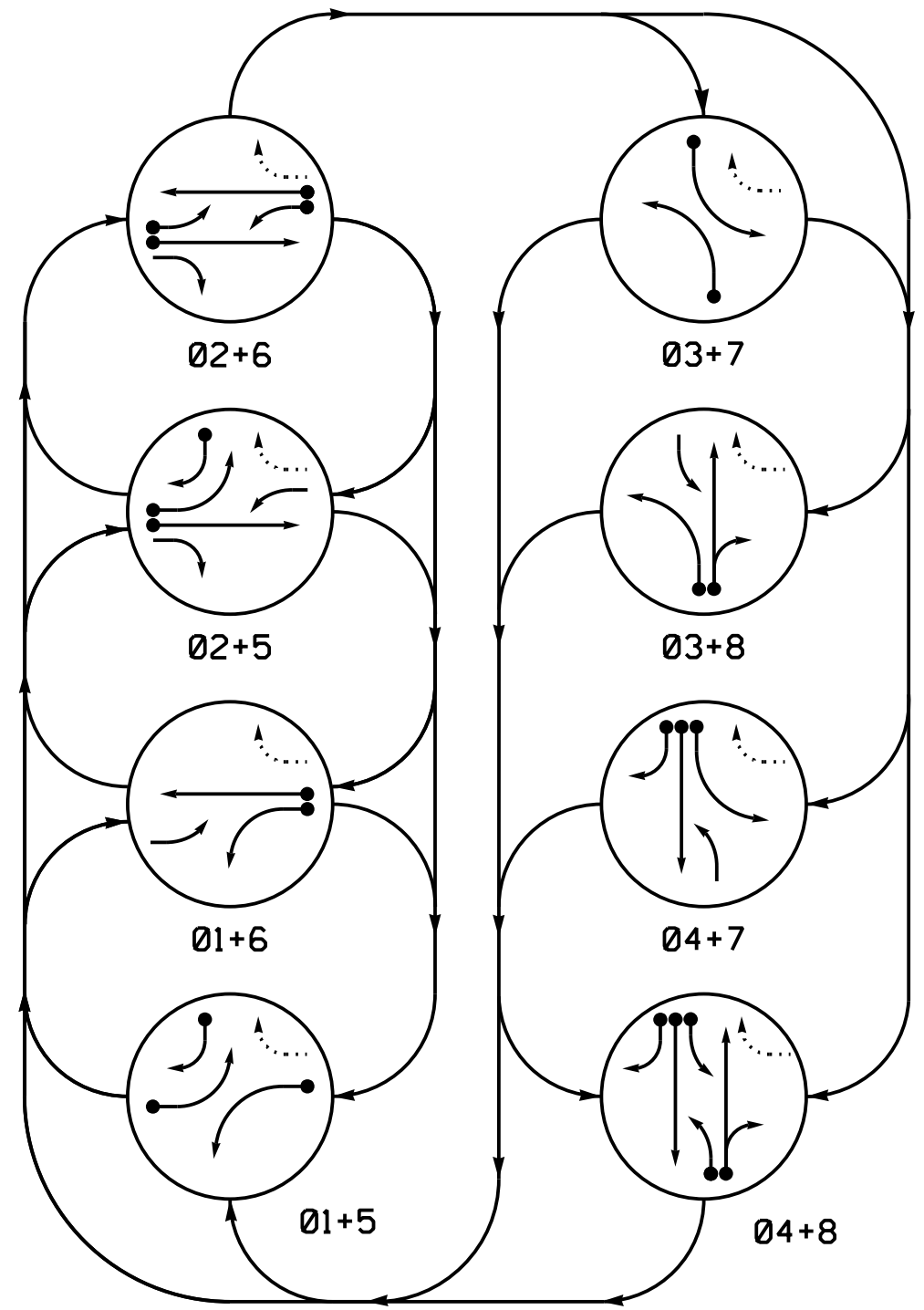

ALTERNATE PHASING DIAGRAM

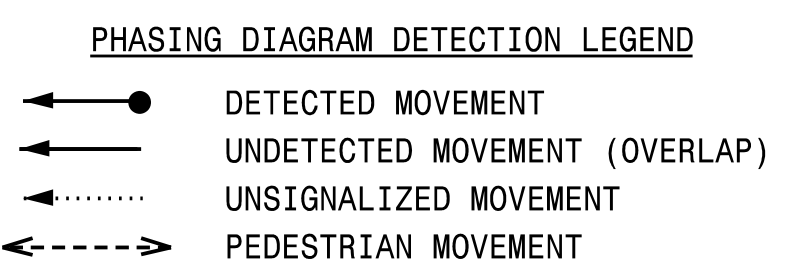
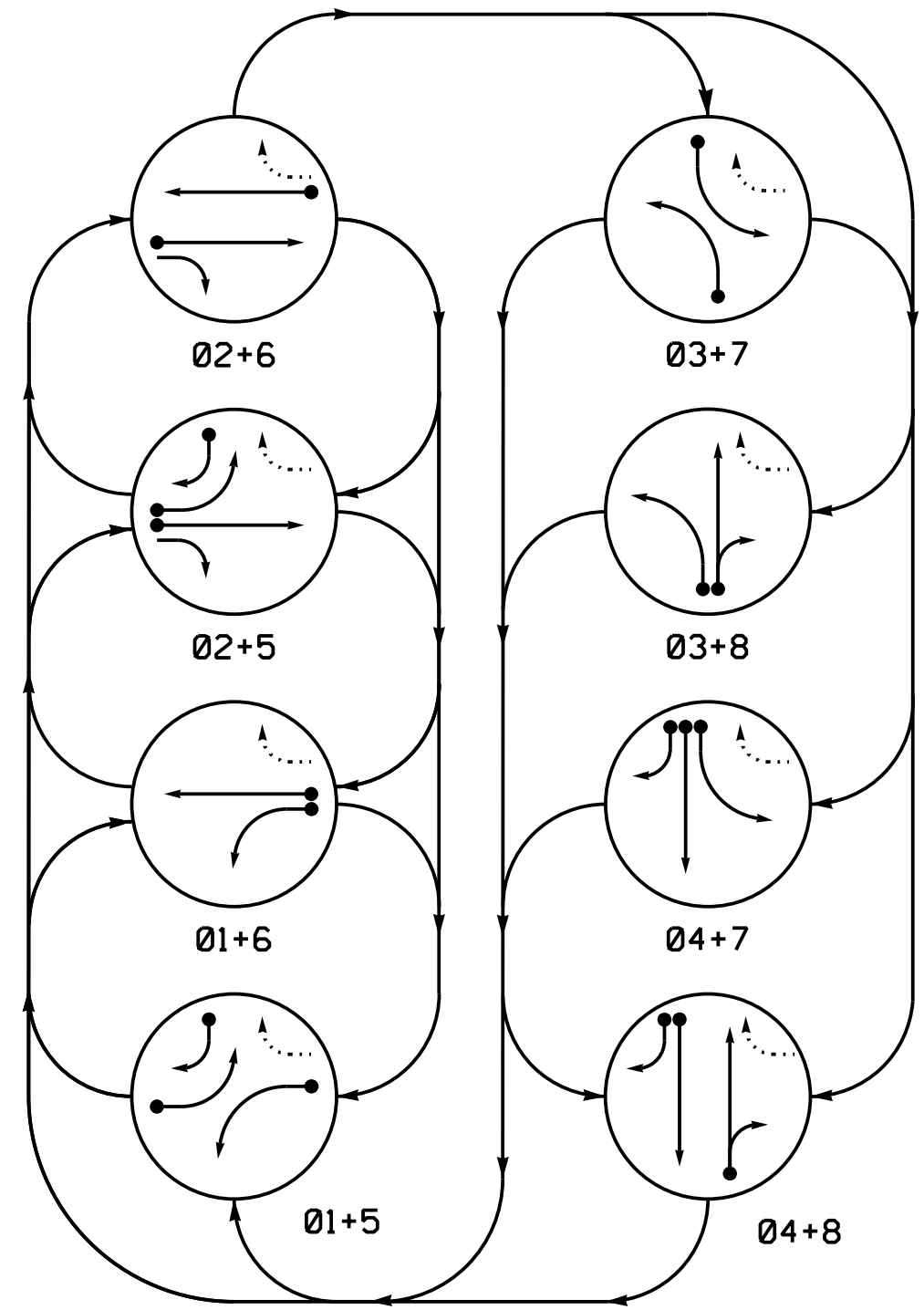

SIGNAL FACE I.D.

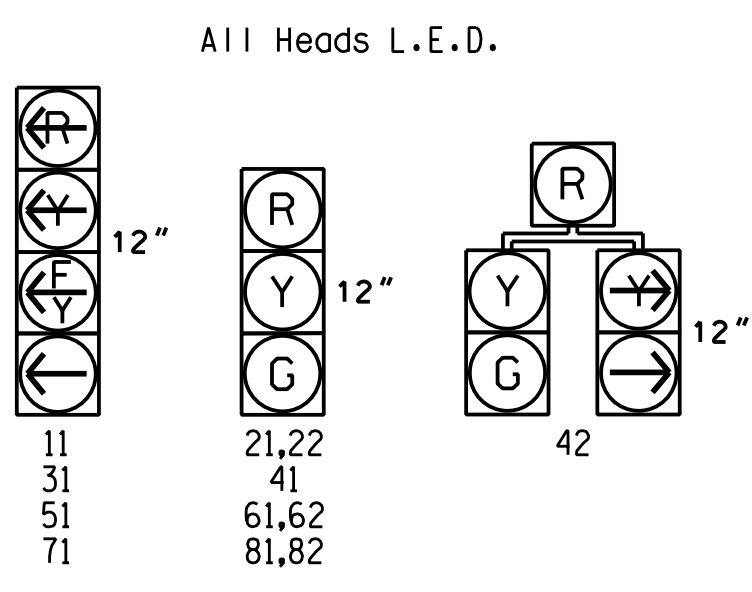

DEFAULT PHASING TABLE OF OPERATION

SIGNAL FACE	PHASE								F L
	01+5	01+6	02+5	02+6	03+7	03+8	04+7	04+8	
11	-	-	F	F	R	R	R	R	Y
21,22	R	R	G	G	R	R	R	R	Y
31	R	R	R	R	-	-	F	F	Y
41	R	R	R	R	R	R	G	G	R
42	R	R	R	R	R	R	G	G	R
51	-	-	F	F	R	R	R	R	Y
61,62	R	G	R	G	R	R	R	R	Y
71	R	R	R	R	-	-	F	F	Y
81,82	R	R	R	R	R	G	R	G	R

ALTERNATE PHASING TABLE OF OPERATION

SIGNAL FACE	PHASE								F L
	01+5	01+6	02+5	02+6	03+7	03+8	04+7	04+8	
11	-	-	R	R	R	R	R	R	Y
21,22	R	R	G	G	R	R	R	R	Y
31	R	R	R	R	-	-	R	R	Y
41	R	R	R	R	R	R	G	G	R
42	R	R	R	R	R	R	G	G	R
51	-	-	R	R	R	R	R	R	Y
61,62	R	G	R	G	R	R	R	R	Y
71	R	R	R	R	-	-	R	R	Y
81,82	R	R	R	R	R	G	R	G	R

OASIS 2070 LOOP & DETECTOR INSTALLATION CHART

LOOP	SIZE (FT)	DISTANCE FROM STOPBAR (FT)	TURNS	NEW LOOP	DETECTOR PROGRAMMING				SYSTEM LOOP	NEW CARD
					PHASE	CALLING	EXTENSION	STRETCH TIME		
1A	6X40	0	*	*	1	Y	Y	-	**15	-
2A	6X6	300	*	*	2	Y	Y	-	1.6	-
2B	6X6	90	*	*	2	Y	Y	-	-	-
3A	6X40	0	*	*	3	Y	Y	-	**15	-
4A	6X40	0	*	*	4	Y	Y	-	-	-
5A	6X40	0	*	*	5	Y	Y	-	**15	-
5B	6X40	0	*	*	5	Y	Y	-	15	-
6A	6X6	70	*	*	6	Y	Y	-	-	-
7A	6X40	0	*	*	7	Y	Y	-	**15	-
8A	6X40	0	*	*	8	Y	Y	-	10	-

* Multizone Microwave Detection.
 ** Disable phase 2,4,6 and 8 call for 1A,3A,5A and 7A during alternate phasing operation.
 *** Reduce delay to 3 seconds for 3A and 0 seconds for 1A,5A, and 7A during alternate phasing operation.

8 Phase Fully Actuated (NC 133 Closed Loop System)

NOTES

- Refer to "Roadway Standard Drawings NCDOT" dated January 2018 and "Standard Specifications for Roads and Structures" dated January 2018.
- Do not program signal for late night flashing operation unless otherwise directed by the Engineer.
- Phase 1 and/or 5 may be lagged.
- Phase 3 and/or 7 may be lagged.
- Set all detector units to presence mode.
- The Division Traffic Engineer will determine the hours of use for each phasing plan.
- Incorporate Microwave Detection system for vehicle detection.
- Provide the Engineer with the Manufacturer's approved Microwave Detection locations and mounting heights to obtain detection zones as shown.
- Maximum times shown in timing chart are for free-run operation only. Coordinated signal system timing values supersede these values.
- Closed loop system data: Controller Asset #: 0215.

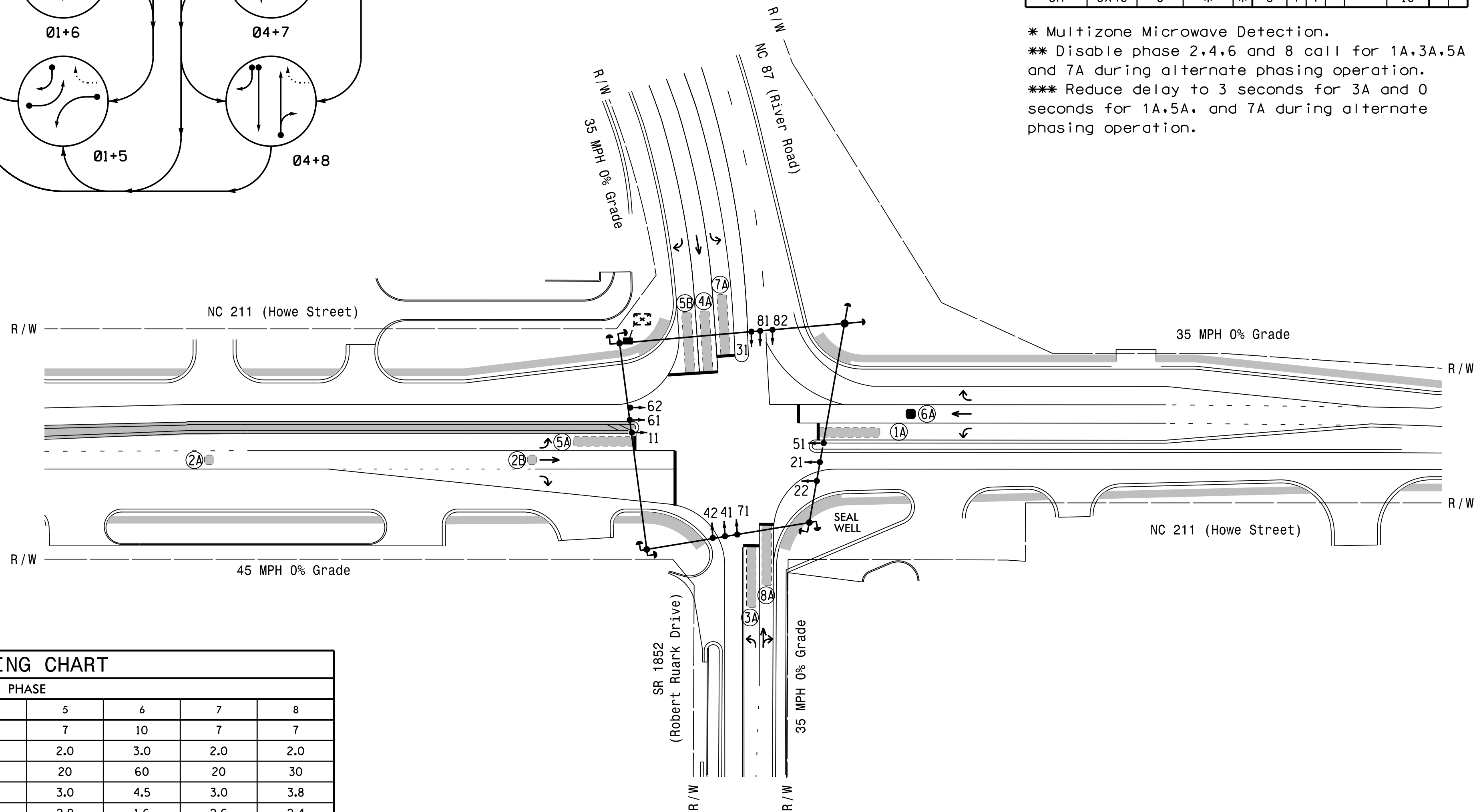

OASIS 2070 TIMING CHART

FEATURE	PHASE							
	1	2	3	4	5	6	7	8
Min Green 1 *	7	12	7	7	7	10	7	7
Extension 1 *	2.0	2.0	2.0	2.0	2.0	3.0	2.0	2.0
Max Green 1 *	20	60	20	30	20	60	20	30
Yellow Clearance	3.0	4.5	3.0	3.8	3.0	4.5	3.0	3.8
Red Clearance	2.4	1.6	3.2	2.4	2.9	1.6	2.6	2.4
Red Revert	2.0	2.0	2.0	2.0	2.0	2.0	2.0	2.0
Walk 1 *	-	-	-	-	-	-	-	-
Don't Walk 1	-	-	-	-	-	-	-	-
Seconds Per Actuation *	-	-	-	-	-	-	-	-
Max Variable Initial *	-	-	-	-	-	-	-	-
Time Before Reduction *	-	-	-	-	-	-	-	-
Time To Reduce *	-	-	-	-	-	-	-	-
Minimum Gap	-	-	-	-	-	-	-	-
Recall Mode	-	MIN RECALL	-	-	-	MIN RECALL	-	-
Vehicle Call Memory	-	YELLOW	-	-	-	YELLOW	-	-
Dual Entry	-	-	-	ON	-	-	-	ON
Simultaneous Gap	ON	ON	ON	ON	ON	ON	ON	ON

* These values may be field adjusted. Do not adjust Min Green and Extension times for phases 2 and 6 lower than what is shown. Min Green for all other phases should not be lower than 4 seconds.

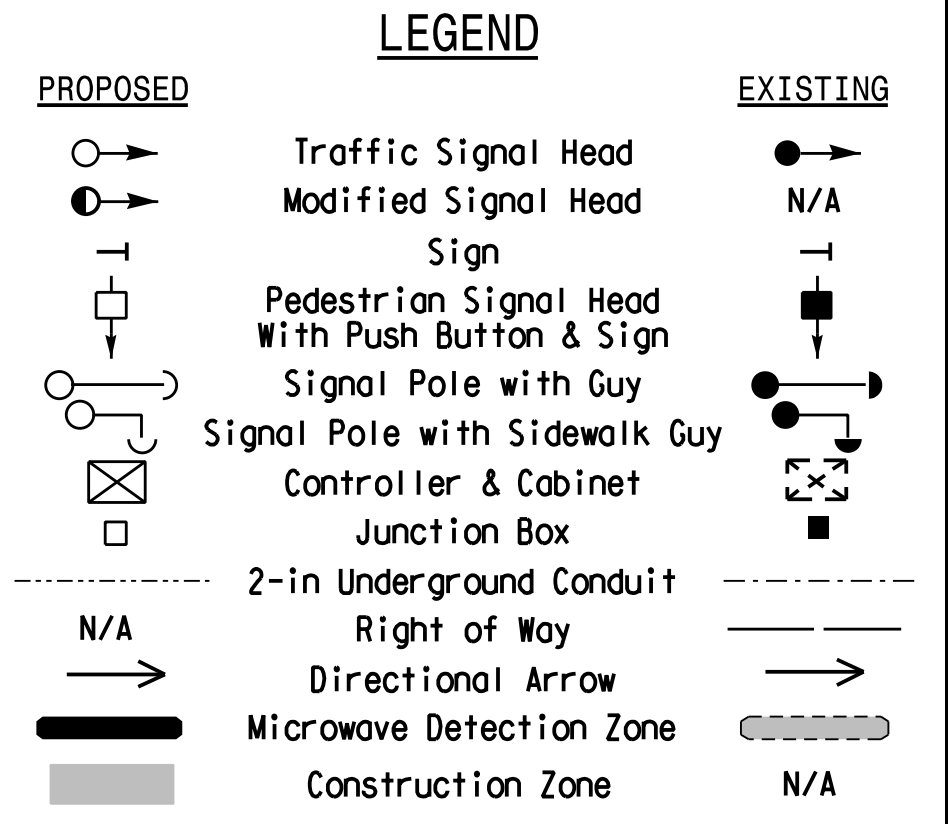

Signal Upgrade
 Temporary Design 5
 Construction Phase 1e

DOCUMENT NOT CONSIDERED FINAL UNLESS ALL SIGNATURES COMPLETED

	Prepared for: NC 211 (Howe Street) at NC 87 (River Road)/ SR 1852 (Robert Ruark Drive)		SEAL
	Division 03 Brunswick Co. Southport PLAN DATE: June 2017 PREPARED BY: A.H. Thornburg REVISIONS:	REVIEWED BY: A.D. Klinksiek REVIEWED BY: N.R. Simmons DATE:	

HNTB
 HNTB NORTH CAROLINA, P.C.
 343 E. Six Forks Road, Suite 200
 Raleigh, North Carolina 27609
 NC License No: C-1554
 (919) 546-8997

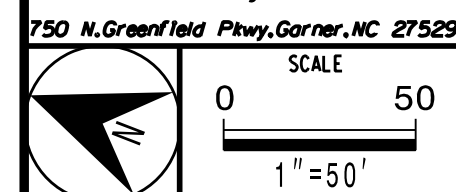

EDI MODEL 2018ECL-NC CONFLICT MONITOR PROGRAMMING DETAIL

(remove jumpers and set switches as shown)

REMOVE DIODE JUMPERS 1-5, 1-6, 1-9, 1-11, 2-5, 2-6, 2-9, 2-11, 3-7, 3-8, 3-10, 3-12, 4-7, 4-8, 4-10, 4-12, 5-9, 5-11, 6-9, 6-11, 7-10, 7-12, 8-10, 8-12, 9-11 and 10-12.

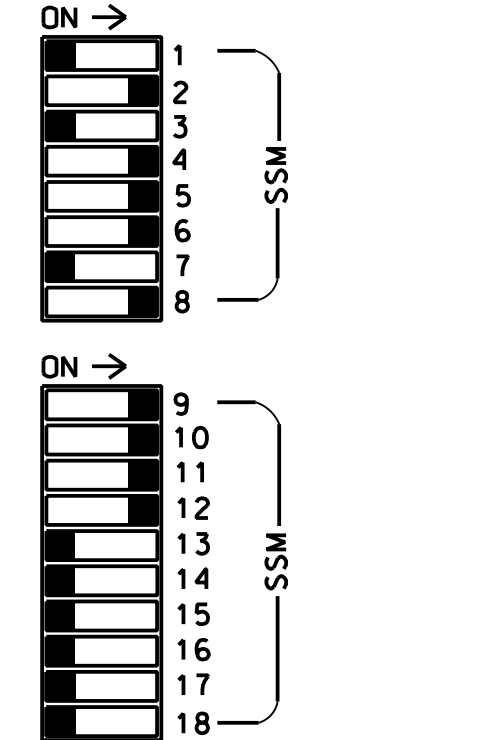
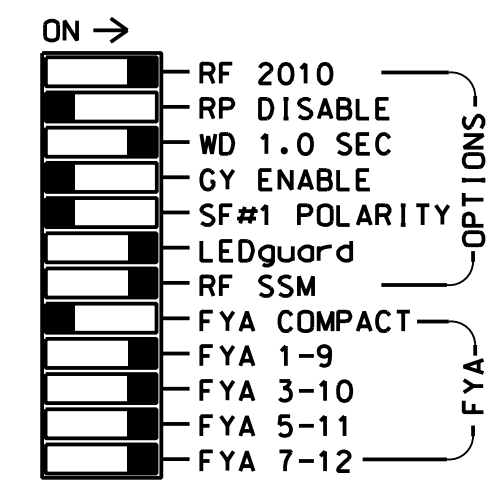
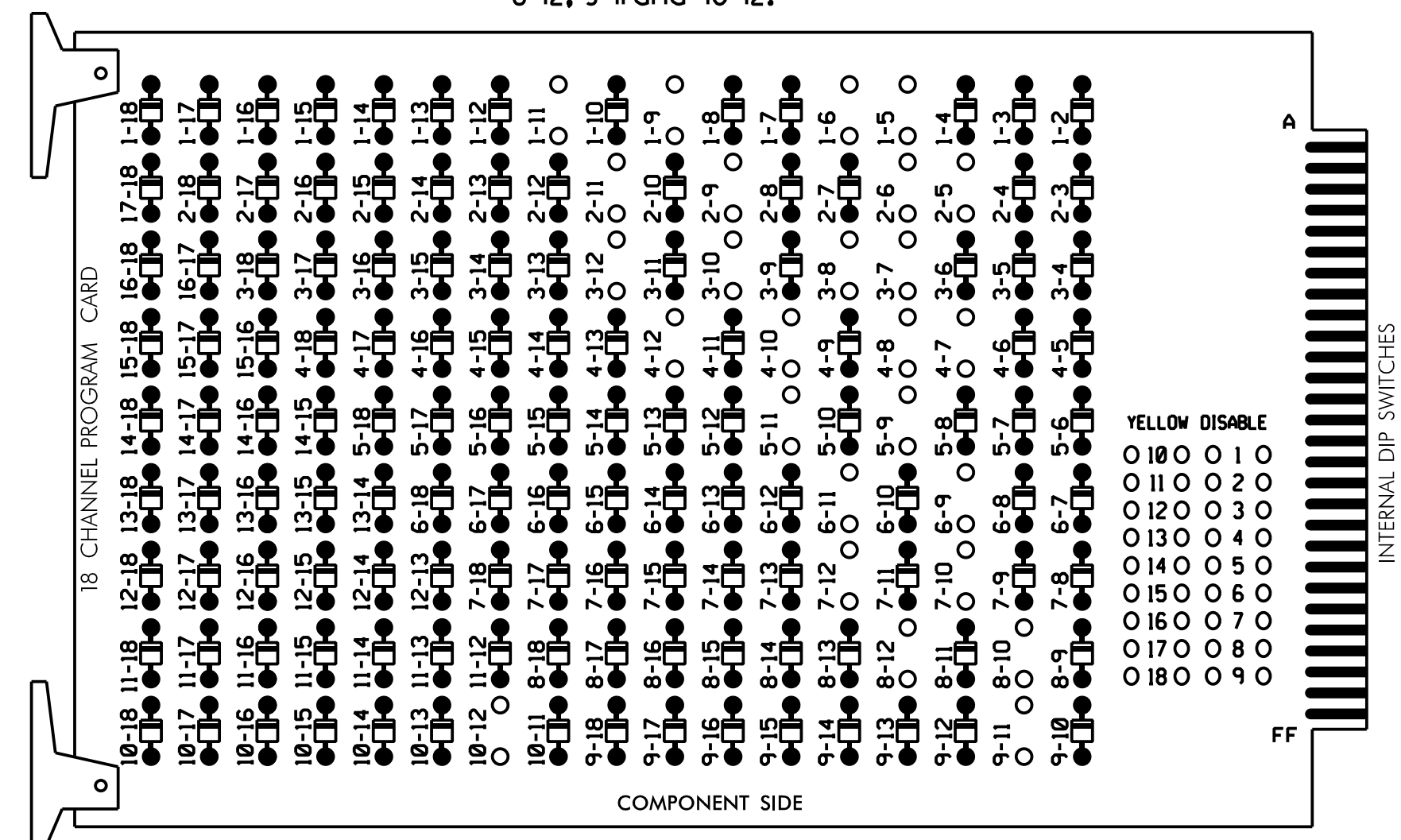

■ = DENOTES POSITION OF SWITCH

- REMOVE JUMPERS AS SHOWN
- Card is provided with all diode jumpers in place. Removal of any jumper allows its channels to run concurrently.
 - Ensure jumpers SEL2-SEL5 and SEL9 are present on the monitor board.
 - Ensure that Red Enable is active at all times during normal operation.
 - Connect serial cable from conflict monitor to comm. port 1 of 2070 controller. Ensure conflict monitor communicates with 2070.

NOTES

- To prevent "flash-conflict" problems, insert red flash program blocks for all unused field load switches in the output file. The installer shall verify that signal heads flash in accordance with the Signal Plans.
- Program phases 4 and 8 for Dual Entry.
- Enable Simultaneous Gap-Out for all Phases.
- Program phases 2 and 6 for Startup In Green.
- Program phases 2 and 6 for Yellow Flash, and overlaps 1 and 2 as Wag Overlaps.
- If this signal will be managed by an ATMS software, enable controller and detector logging for all detectors used at this location.
- The cabinet and controller are part of the NC 133 Closed Loop System.

EQUIPMENT INFORMATION

CONTROLLER.....2070E
 CABINET.....332 W/ AUX
 SOFTWARE.....ECONOLITE OASIS
 CABINET MOUNT.....BASE
 OUTPUT FILE POSITIONS...18 WITH AUX. OUTPUT FILE LOAD SWITCHES USED.....S1,S2,S4,S5,S7,S8,S10,S11, AUX S1,AUX S2,AUX S4,AUX S5
 PHASES USED.....1,2,3,4,5,6,7,8
 OVERLAP "A".....1+2
 OVERLAP "B".....3+4
 OVERLAP "C".....5+6
 OVERLAP "D".....7+8

SIGNAL HEAD HOOK-UP CHART

LOAD SWITCH NO.	S1	S2	S3	S4	S5	S6	S7	S8	S9	S10	S11	S12	AUX S1	AUX S2	AUX S3	AUX S4	AUX S5	AUX S6	
CMU CHANNEL NO.	1	2	13	3	4	14	5	6	15	7	8	16	9	10	17	11	12	18	
PHASE	1	2	2 PED	3	4	4 PED	5	6	6 PED	7	8	8 PED	OLA	OLB	SPARE	OLC	OLD	SPARE	
SIGNAL HEAD NO.	11	21,22	NU	31	41,42	NU	42	51	61,62	NU	71	81,82	NU	11	31	NU	51	71	
RED		128			101		*		134			107							
YELLOW	*	129		*	102				135		*	108							
GREEN		130			103				136			109							
RED ARROW																A121	A124	A114	A101
YELLOW ARROW																A122	A125	A115	A102
FLASHING YELLOW ARROW																A123	A126	A116	A103
	127			118			133	133			124								

GREEN ARROW = Not Used

* Denotes install load resistor. See load resistor installation detail this sheet.
 ★ See pictorial of head wiring in detail this sheet.

INPUT FILE POSITION LAYOUT

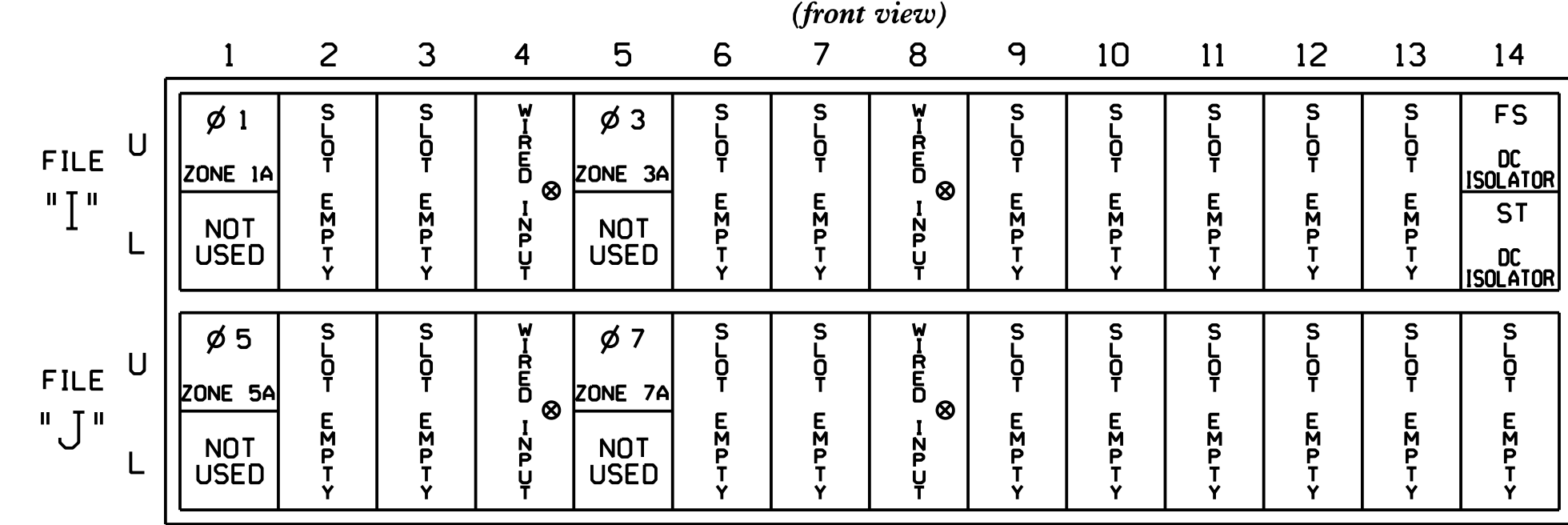

EX.: 1A, 2A, ETC. = LOOP NO.'S
 FS = FLASH SENSE
 ST = STOP TIME
 ⊗ Wired Input - Do not populate slot with detector card

INPUT FILE CONNECTION & PROGRAMMING CHART

LOOP NO.	LOOP TERMINAL	INPUT FILE POS.	PIN NO.	INPUT ASSIGNMENT NO.	DETECTOR NO.	NEMA PHASE	CALL	EXTEND	FULL TIME DELAY	STRETCH TIME	DELAY TIME
ZONE 1A ¹	TB2-1,2	I1U	56	18	1	1	Y	Y			15
	-	J4U	48	10★	26	6	Y	Y			
ZONE 3A ²	TB4-5,6	I5U	58	20	3	3	Y	Y			15
	-	J8U	50	12★	28	8	Y	Y			3
ZONE 5A ³	TB3-1,2	J1U	55	17	5	5	Y	Y			15
	-	I4U	47	9★	22	2	Y	Y			
ZONE 7A ⁴	TB5-5,6	J5U	57	19	7	7	Y	Y			15
	-	I8U	49	11★	24	4	Y	Y			

- Add jumper from I1-W to J4-W, on rear of input file.
 - Add jumper from I5-W to J8-W, on rear of input file.
 - Add jumper from J1-W to I4-W, on rear of input file.
 - Add jumper from J5-W to I8-W, on rear of input file.
- * See Input Page Assignment programming details on sheets 4, 5, 6, and 7.

INPUT FILE POSITION LEGEND: J2L

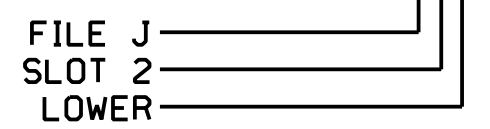

LOAD RESISTOR INSTALLATION DETAIL

(install resistors as shown)

ACCEPTABLE VALUES

VALUE (ohms)	WATTAGE
1.5K - 1.9K	25W (min)
2.0K - 3.0K	10W (min)

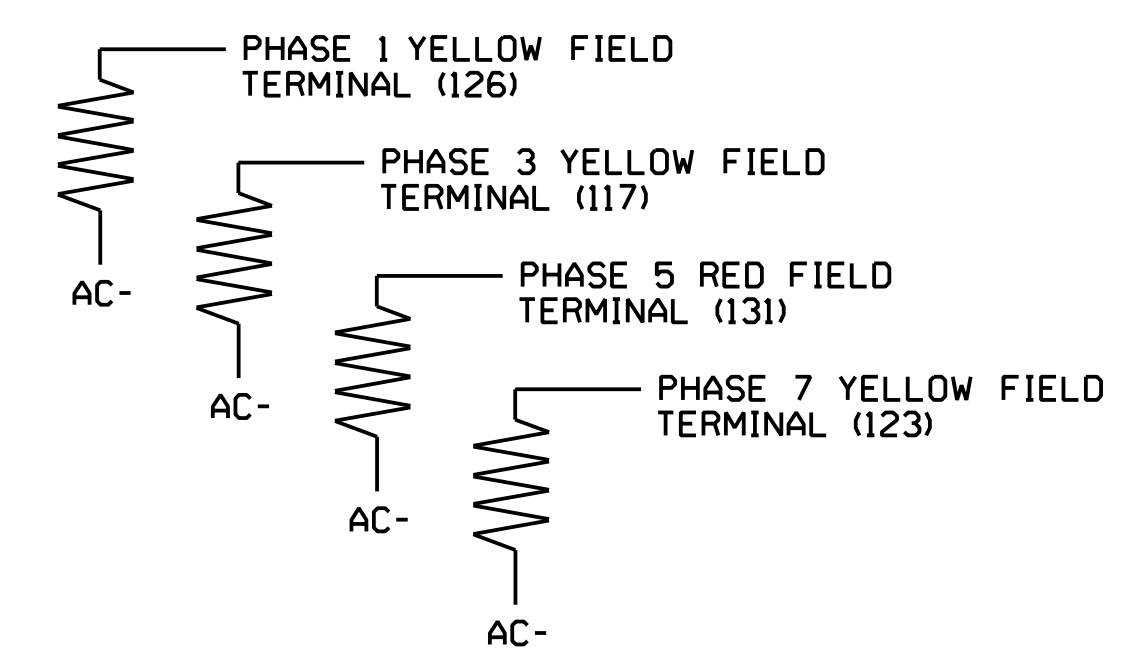

SPECIAL DETECTOR NOTE

Install a microwave detection system for vehicle detection. Perform installation according to manufacturer's directions and NCDOT engineer-approved mounting locations to accomplish the detection schemes shown on the Signal Design Plans.

For loops 1A, 3A, 5A, and 7A, detector card placement and slots reserved for wired inputs are typical for a NCDOT installation. Inputs associated with these slots are compatible with time of day instructions located on sheets 4, 5, 6, 7, and 8 of this electrical detail.

HNTB HNTB NORTH CAROLINA, P.C.
 343 E. Six Forks Road, Suite 200
 Raleigh, North Carolina 27609
 NC License No: C-1554
 (919) 546-8997

FYA SIGNAL WIRING DETAIL

(wire signal heads as shown)

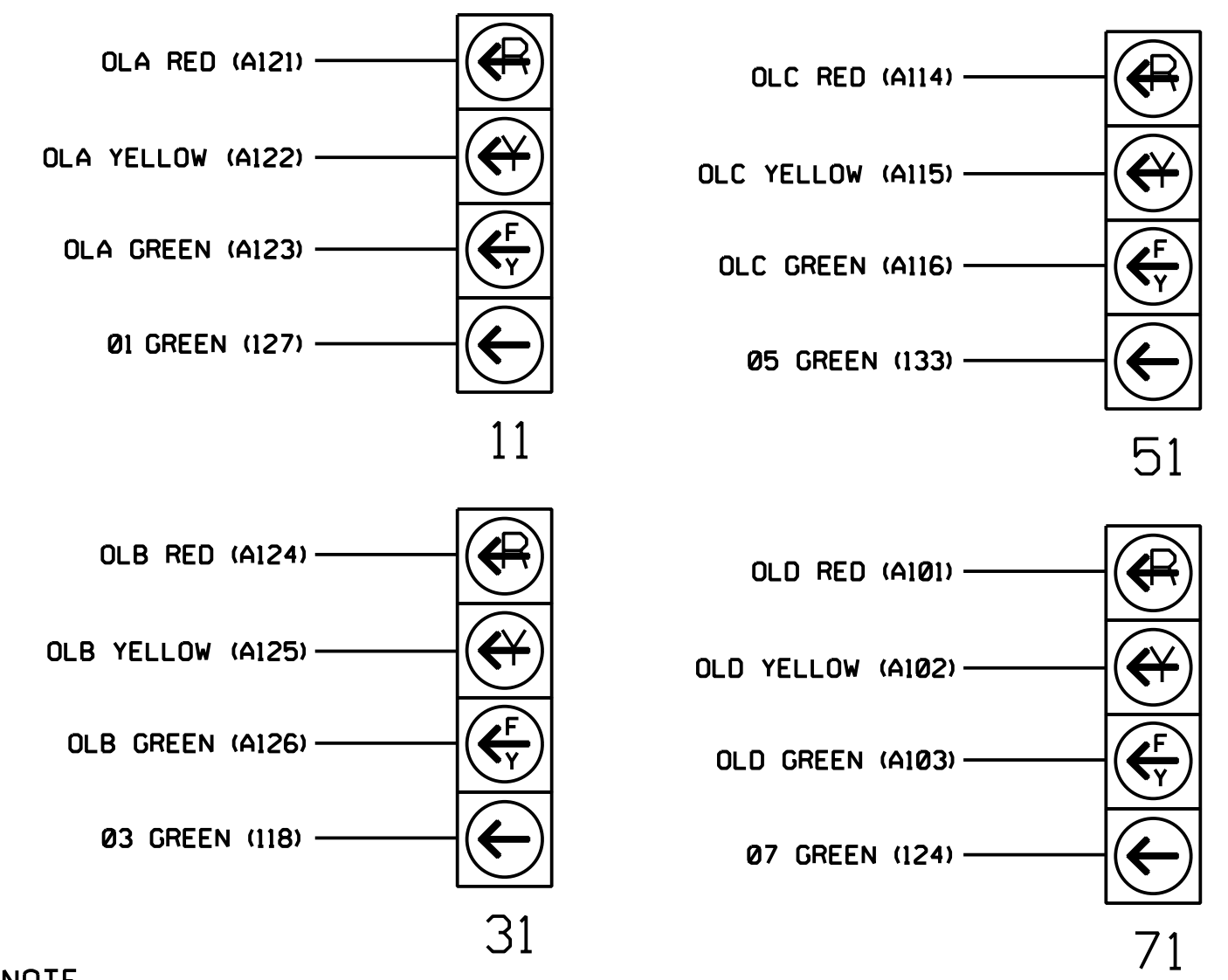

NOTE

The sequence display for signal heads 11, 31, 51, and 71 requires special logic programming. See sheet 2 for programming instructions.

THIS ELECTRICAL DETAIL IS FOR THE SIGNAL DESIGN: 03-0215T5
 DESIGNED: June 2017
 SEALED: 9/10/2021
 REVISED: N/A

Electrical Detail - Sheet 1 of 8
 Signal Upgrade
 Temporary Design 5

DOCUMENT NOT CONSIDERED FINAL UNLESS ALL SIGNATURES COMPLETED

	Prepared for: 	NC 211 (Howe Street) at NC 87 (River Road)/ SR 1852 (Robert Ruark Drive) Division 03 Brunswick Co. Southport	SEAL
	PLAN DATE: June 2017 PREPARED BY: A.H. Thornburg	REVIEWED BY: A.D. Klinskiak REVIEWED BY: N.R. Simmons	REVISIONS INIT. DATE

LOGICAL I/O PROCESSOR PROGRAMMING DETAIL TO PRODUCE SPECIAL FYA-PPLT SIGNAL SEQUENCE

(program controller as shown below)

- FROM MAIN MENU PRESS '2' (PHASE CONTROL), THEN '1' (PHASE CONTROL FUNCTIONS), SCROLL TO THE BOTTOM OF THE MENU AND ENABLE ACT LOGIC COMMANDS 1, 2, 3, 4, 5, 6, 7, 8, 9, 10, 11, AND 12.
- FROM MAIN MENU PRESS '6' (OUTPUTS), THEN '3' (LOGICAL I/O PROCESSOR).

LOGICAL I/O COMMAND #1 (+/-COMMAND#)
IF ACTIVE PHASE #1 IS ON
AND RED CLEAR ON PHASE #1 IS ON

↓
SCROLL DOWN

THEN:
SET OUTPUT ASSIGNMENT #50 ON
SET OUTPUT ASSIGNMENT #51 OFF

PRESS '+'

NOTE: LOGIC FOR PHASE 1 RED CLEAR WHEN TRANSITIONING FROM PHASE 1 TO PHASE 2 (HEAD 11).

LOGICAL I/O COMMAND #2 (+/-COMMAND#)
IF ACTIVE PHASE #1 IS ON

↓
SCROLL DOWN

THEN:
SET OUTPUT ASSIGNMENT #52 OFF

PRESS '+'

NOTE: LOGIC FOR SWITCHING FLASHING YELLOW ARROW "OFF" DURING PHASE 1 (HEAD 11).

LOGICAL I/O COMMAND #3 (+/-COMMAND#)
IF YELLOW ON PHASE #1 IS ON

↓
SCROLL DOWN

THEN:
SET OUTPUT ASSIGNMENT #51 ON

PRESS '+'

NOTE: LOGIC FOR YELLOW ARROW CLEARANCE FROM PHASE 1 (HEAD 11).

LOGICAL I/O COMMAND #4 (+/-COMMAND#)
IF ACTIVE PHASE #5 IS ON
AND RED CLEAR ON PHASE #5 IS ON

↓
SCROLL DOWN

THEN:
SET OUTPUT ASSIGNMENT #42 ON
SET OUTPUT ASSIGNMENT #43 OFF

PRESS '+'

NOTE: LOGIC FOR PHASE 5 RED CLEAR WHEN TRANSITIONING FROM PHASE 5 TO PHASE 6 (HEAD 51).

LOGICAL I/O COMMAND #5 (+/-COMMAND#)
IF ACTIVE PHASE #5 IS ON

↓
SCROLL DOWN

THEN:
SET OUTPUT ASSIGNMENT #44 OFF

PRESS '+'

NOTE: LOGIC FOR SWITCHING FLASHING YELLOW ARROW "OFF" DURING PHASE 5 (HEAD 51).

LOGICAL I/O COMMAND #6 (+/-COMMAND#)
IF YELLOW ON PHASE #5 IS ON

↓
SCROLL DOWN

THEN:
SET OUTPUT ASSIGNMENT #43 ON

PRESS '+'

NOTE: LOGIC FOR YELLOW ARROW CLEARANCE FROM PHASE 5 (HEAD 51).

LOGICAL I/O COMMAND #7 (+/-COMMAND#)
IF ACTIVE PHASE #3 IS ON
AND RED CLEAR ON PHASE #3 IS ON

↓
SCROLL DOWN

THEN:
SET OUTPUT ASSIGNMENT #47 ON
SET OUTPUT ASSIGNMENT #48 OFF

PRESS '+'

NOTE: LOGIC FOR PHASE 3 RED CLEAR WHEN TRANSITIONING FROM PHASE 3 TO PHASE 4 (HEAD 31).

LOGICAL I/O COMMAND #8 (+/-COMMAND#)
IF ACTIVE PHASE #3 IS ON

↓
SCROLL DOWN

THEN:
SET OUTPUT ASSIGNMENT #49 OFF

PRESS '+'

NOTE: LOGIC FOR SWITCHING FLASHING YELLOW ARROW "OFF" DURING PHASE 3 (HEAD 31).

LOGICAL I/O COMMAND #9 (+/-COMMAND#)
IF YELLOW ON PHASE #3 IS ON

↓
SCROLL DOWN

THEN:
SET OUTPUT ASSIGNMENT #48 ON

PRESS '+'

NOTE: LOGIC FOR YELLOW ARROW CLEARANCE FROM PHASE 3 (HEAD 31).

LOGICAL I/O COMMAND #10 (+/-COMMAND#)
IF ACTIVE PHASE #7 IS ON
AND RED CLEAR ON PHASE #7 IS ON

↓
SCROLL DOWN

THEN:
SET OUTPUT ASSIGNMENT #39 ON
SET OUTPUT ASSIGNMENT #40 OFF

PRESS '+'

NOTE: LOGIC FOR PHASE 7 RED CLEAR WHEN TRANSITIONING FROM PHASE 7 TO PHASE 8 (HEAD 71).

LOGICAL I/O COMMAND #11 (+/-COMMAND#)
IF ACTIVE PHASE #7 IS ON

↓
SCROLL DOWN

THEN:
SET OUTPUT ASSIGNMENT #41 OFF

PRESS '+'

NOTE: LOGIC FOR SWITCHING FLASHING YELLOW ARROW "OFF" DURING PHASE 7 (HEAD 71).

LOGICAL I/O COMMAND #12 (+/-COMMAND#)
IF YELLOW ON PHASE #7 IS ON

↓
SCROLL DOWN

THEN:
SET OUTPUT ASSIGNMENT #40 ON

PRESS '+'

NOTE: LOGIC FOR YELLOW ARROW CLEARANCE FROM PHASE 7 (HEAD 71).

LOGIC I/O PROCESSOR PROGRAMMING COMPLETE

OUTPUT REFERENCE SCHEDULE	
USE TO INTERPRET LOGIC PROCESSOR	
OUTPUT 39	= Overlap D Red
OUTPUT 40	= Overlap D Yellow
OUTPUT 41	= Overlap D Green
OUTPUT 42	= Overlap C Red
OUTPUT 43	= Overlap C Yellow
OUTPUT 44	= Overlap C Green
OUTPUT 47	= Overlap B Red
OUTPUT 48	= Overlap B Yellow
OUTPUT 49	= Overlap B Green
OUTPUT 50	= Overlap A Red
OUTPUT 51	= Overlap A Yellow
OUTPUT 52	= Overlap A Green

THIS ELECTRICAL DETAIL IS FOR
THE SIGNAL DESIGN: 03-0215T5
DESIGNED: June 2017
SEALED: 9/10/2021
REVISED: N/A

Electrical Detail - Sheet 2 of 8
Signal Upgrade
Temporary Design 5

DOCUMENT NOT CONSIDERED FINAL
UNLESS ALL SIGNATURES COMPLETED

HNTB HNTB NORTH CAROLINA, P.C.
343 E. Six Forks Road, Suite 200
Raleigh, North Carolina 27609
NC License No: C-1554
(919) 546-8997

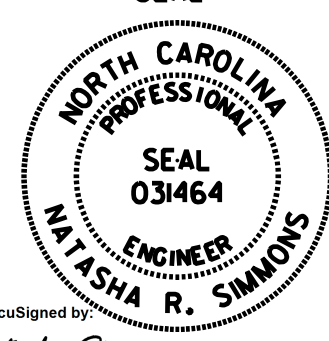
 Prepared for: Department of Transportation North Carolina Division of Signal Management	NC 211 (Howe Street) at NC 87 (River Road)/ SR 1852 (Robert Ruark Drive)		SEAL  NORTH CAROLINA PROFESSIONAL ENGINEER SEAL 031464 NATASHA R. SIMMONS
	Division 03 Brunswick Co. Southport	PLAN DATE: June 2017 PREPARED BY: A.H. Thornburg	
REVISIONS INIT. DATE	DATE Signature: <i>Natasha Simmons</i> 9/10/2021	DATE DATE	DATE DATE
750 N. Greenfield Pkwy, Corner, NC 27529			SIG. INVENTORY NO. 03-0215T5

OVERLAP PROGRAMMING DETAIL FOR DEFAULT PHASING

(program controller as shown below)

FROM MAIN MENU PRESS '8' (OVERLAPS), THEN '1' (VEHICLE OVERLAP SETTINGS).

```

PAGE 1: VEHICLE OVERLAP 'A' SETTINGS
PHASE:           :12345678910111213141516
VEH OVL PARENTS: :XX
VEH OVL NOT VEH: :
VEH OVL NOT PED: :
VEH OVL GRN EXT: :
STARTUP COLOR:  - RED - YELLOW - GREEN
FLASH COLORS:   - RED - YELLOW X GREEN
SELECT VEHICLE OVERLAP OPTIONS: (Y/N)
FLASH YELLOW IN CONTROLLER FLASH?...Y
GREEN EXTENSION (0-255 SEC).....0
YELLOW CLEAR (0=PARENT,3-25.5 SEC)...0.0
RED CLEAR (0=PARENT,0.1-25.5 SEC)...0.0
OUTPUT AS PHASE # (0=NONE, 1-16)....0
  
```

← NOTICE GREEN FLASH

PRESS '+'

```

PAGE 1: VEHICLE OVERLAP 'B' SETTINGS
PHASE:           :12345678910111213141516
VEH OVL PARENTS: :XX
VEH OVL NOT VEH: :
VEH OVL NOT PED: :
VEH OVL GRN EXT: :
STARTUP COLOR:  - RED - YELLOW - GREEN
FLASH COLORS:   - RED - YELLOW X GREEN
SELECT VEHICLE OVERLAP OPTIONS: (Y/N)
FLASH YELLOW IN CONTROLLER FLASH?...N
GREEN EXTENSION (0-255 SEC).....0
YELLOW CLEAR (0=PARENT,3-25.5 SEC)...0.0
RED CLEAR (0=PARENT,0.1-25.5 SEC)...0.0
OUTPUT AS PHASE # (0=NONE, 1-16)....0
  
```

← NOTICE GREEN FLASH

PRESS '+'

```

PAGE 1: VEHICLE OVERLAP 'C' SETTINGS
PHASE:           :12345678910111213141516
VEH OVL PARENTS: :XX
VEH OVL NOT VEH: :
VEH OVL NOT PED: :
VEH OVL GRN EXT: :
STARTUP COLOR:  - RED - YELLOW - GREEN
FLASH COLORS:   - RED - YELLOW X GREEN
SELECT VEHICLE OVERLAP OPTIONS: (Y/N)
FLASH YELLOW IN CONTROLLER FLASH?...Y
GREEN EXTENSION (0-255 SEC).....0
YELLOW CLEAR (0=PARENT,3-25.5 SEC)...0.0
RED CLEAR (0=PARENT,0.1-25.5 SEC)...0.0
OUTPUT AS PHASE # (0=NONE, 1-16)....0
  
```

← NOTICE GREEN FLASH

PRESS '+'

```

PAGE 1: VEHICLE OVERLAP 'D' SETTINGS
PHASE:           :12345678910111213141516
VEH OVL PARENTS: :XX
VEH OVL NOT VEH: :
VEH OVL NOT PED: :
VEH OVL GRN EXT: :
STARTUP COLOR:  - RED - YELLOW - GREEN
FLASH COLORS:   - RED - YELLOW X GREEN
SELECT VEHICLE OVERLAP OPTIONS: (Y/N)
FLASH YELLOW IN CONTROLLER FLASH?...N
GREEN EXTENSION (0-255 SEC).....0
YELLOW CLEAR (0=PARENT,3-25.5 SEC)...0.0
RED CLEAR (0=PARENT,0.1-25.5 SEC)...0.0
OUTPUT AS PHASE # (0=NONE, 1-16)....0
  
```

← NOTICE GREEN FLASH

OVERLAP PROGRAMMING COMPLETE

OVERLAP PROGRAMMING DETAIL FOR ALTERNATE PHASING

(program controller as shown below)

FROM MAIN MENU PRESS '8' (OVERLAPS), THEN '1' (VEHICLE OVERLAP SETTINGS), PRESS 'NEXT' TO ADVANCE TO PAGE 2.

NOTICE PAGE 2 →

```

PAGE 2: VEHICLE OVERLAP 'A' SETTINGS
PHASE:           :12345678910111213141516
VEH OVL PARENTS: :X
VEH OVL NOT VEH: :
VEH OVL NOT PED: :
VEH OVL GRN EXT: :
STARTUP COLOR:  - RED - YELLOW - GREEN
FLASH COLORS:   - RED - YELLOW - GREEN
SELECT VEHICLE OVERLAP OPTIONS: (Y/N)
FLASH YELLOW IN CONTROLLER FLASH?...Y
GREEN EXTENSION (0-255 SEC).....0
YELLOW CLEAR (0=PARENT,3-25.5 SEC)...0.0
RED CLEAR (0=PARENT,0.1-25.5 SEC)...0.0
OUTPUT AS PHASE # (0=NONE, 1-16)....0
  
```

PRESS '+'

NOTICE PAGE 2 →

```

PAGE 2: VEHICLE OVERLAP 'B' SETTINGS
PHASE:           :12345678910111213141516
VEH OVL PARENTS: :X
VEH OVL NOT VEH: :
VEH OVL NOT PED: :
VEH OVL GRN EXT: :
STARTUP COLOR:  - RED - YELLOW - GREEN
FLASH COLORS:   - RED - YELLOW - GREEN
SELECT VEHICLE OVERLAP OPTIONS: (Y/N)
FLASH YELLOW IN CONTROLLER FLASH?...N
GREEN EXTENSION (0-255 SEC).....0
YELLOW CLEAR (0=PARENT,3-25.5 SEC)...0.0
RED CLEAR (0=PARENT,0.1-25.5 SEC)...0.0
OUTPUT AS PHASE # (0=NONE, 1-16)....0
  
```

PRESS '+'

NOTICE PAGE 2 →

```

PAGE 2: VEHICLE OVERLAP 'C' SETTINGS
PHASE:           :12345678910111213141516
VEH OVL PARENTS: :X
VEH OVL NOT VEH: :
VEH OVL NOT PED: :
VEH OVL GRN EXT: :
STARTUP COLOR:  - RED - YELLOW - GREEN
FLASH COLORS:   - RED - YELLOW - GREEN
SELECT VEHICLE OVERLAP OPTIONS: (Y/N)
FLASH YELLOW IN CONTROLLER FLASH?...Y
GREEN EXTENSION (0-255 SEC).....0
YELLOW CLEAR (0=PARENT,3-25.5 SEC)...0.0
RED CLEAR (0=PARENT,0.1-25.5 SEC)...0.0
OUTPUT AS PHASE # (0=NONE, 1-16)....0
  
```

PRESS '+'

NOTICE PAGE 2 →

```

PAGE 2: VEHICLE OVERLAP 'D' SETTINGS
PHASE:           :12345678910111213141516
VEH OVL PARENTS: :X
VEH OVL NOT VEH: :
VEH OVL NOT PED: :
VEH OVL GRN EXT: :
STARTUP COLOR:  - RED - YELLOW - GREEN
FLASH COLORS:   - RED - YELLOW - GREEN
SELECT VEHICLE OVERLAP OPTIONS: (Y/N)
FLASH YELLOW IN CONTROLLER FLASH?...N
GREEN EXTENSION (0-255 SEC).....0
YELLOW CLEAR (0=PARENT,3-25.5 SEC)...0.0
RED CLEAR (0=PARENT,0.1-25.5 SEC)...0.0
OUTPUT AS PHASE # (0=NONE, 1-16)....0
  
```

OVERLAP PROGRAMMING COMPLETE

THIS ELECTRICAL DETAIL IS FOR THE SIGNAL DESIGN: 03-0215T5
 DESIGNED: June 2017
 SEALED: 9/10/2021
 REVISED: N/A

Electrical Detail - Sheet 3 of 8
Signal Upgrade
Temporary Design 5

DOCUMENT NOT CONSIDERED FINAL UNLESS ALL SIGNATURES COMPLETED

HNTB HNTB NORTH CAROLINA, P.C.
 343 E. Six Forks Road, Suite 200
 Raleigh, North Carolina 27609
 NC License No: C-1564
 (919) 546-8997

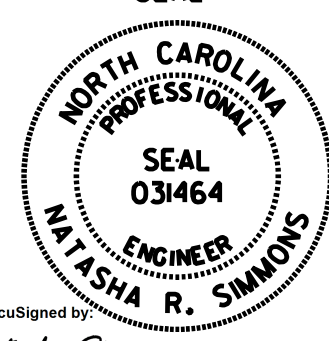
	Prepared for: NC 211 (Howe Street) at NC 87 (River Road)/ SR 1852 (Robert Ruark Drive)		
	Division 03 Brunswick Co. Southport	PLAN DATE: June 2017 REVIEWED BY: A.D. Klinksiek PREPARED BY: A.H. Thornburg REVIEWED BY: N.R. Simmons	
750 N. Greenfield Pkwy, Corner, NC 27529		REVISIONS _____	INIT. DATE _____
9/10/2021		DATE _____	
SIG. INVENTORY NO. 03-0215T5			

INPUT PAGE 2 ASSIGNMENT PROGRAMMING DETAIL FOR ALTERNATE PHASING - LOOP 1A (program controller as shown below)

- NOTES: 1. THIS PROGRAMMING APPLIES FOR INPUT PAGE 2 ONLY. INPUT PAGE 1 WILL USE STANDARD DEFAULT SETTINGS. THIS PROGRAMMING IS NECESSARY FOR PROPER DETECTOR OPERATION DURING ALTERNATE PHASING OPERATION. 2. THE FIRST TASK THIS PROGRAMMING ACCOMPLISHES IS THE DISABLING OF INPUT #10 (DETECTOR 26) SO THAT A VEHICLE CALL WILL NOT BE PLACED TO PHASE 6 DURING ALTERNATE PHASING OPERATION. THE SECOND TASK THIS PROGRAMMING ACCOMPLISHES IS THAT IT REASSIGNS DETECTOR 51 TO INPUT #18 SO THAT THE DELAY ON LOOP 1A CAN BE REDUCED FROM 15 SECONDS TO 0 SECONDS.

FROM MAIN MENU PRESS '5' (INPUTS), THEN PRESS 'NEXT' TO GET TO INPUT PAGE '2'. PRESS THE '+' KEY UNTIL INPUT 10 IS REACHED.

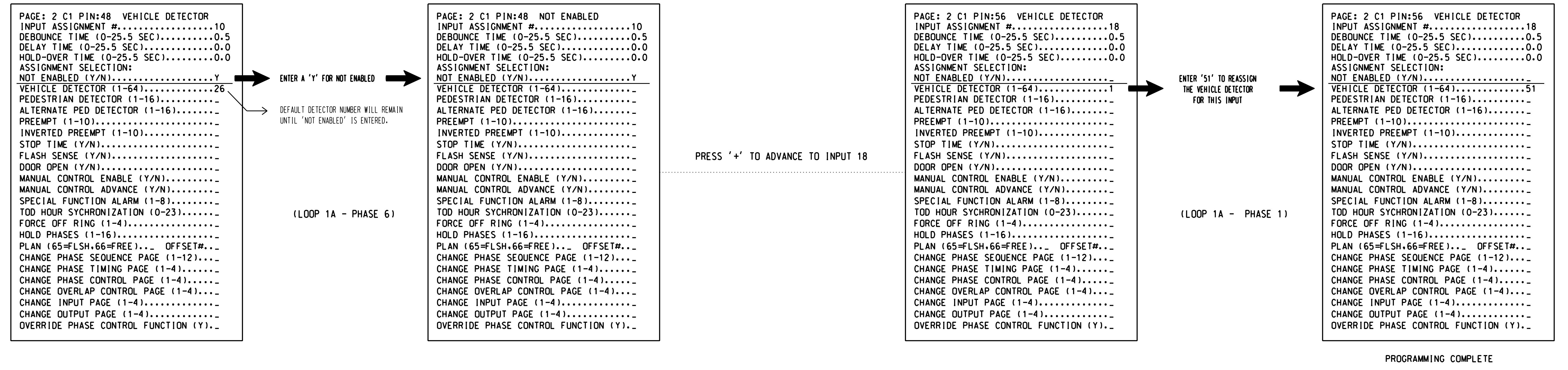

SPECIAL DETECTOR PROGRAMMING DETAIL - LOOP 1A (ALT.) (program controller as shown below)

FROM MAIN MENU PRESS '7' (DETECTORS), THEN PRESS '1' FOR VEHICLE DETECTORS. PRESS THE '-' KEY TO GET TO VEHICLE DETECTOR #51.

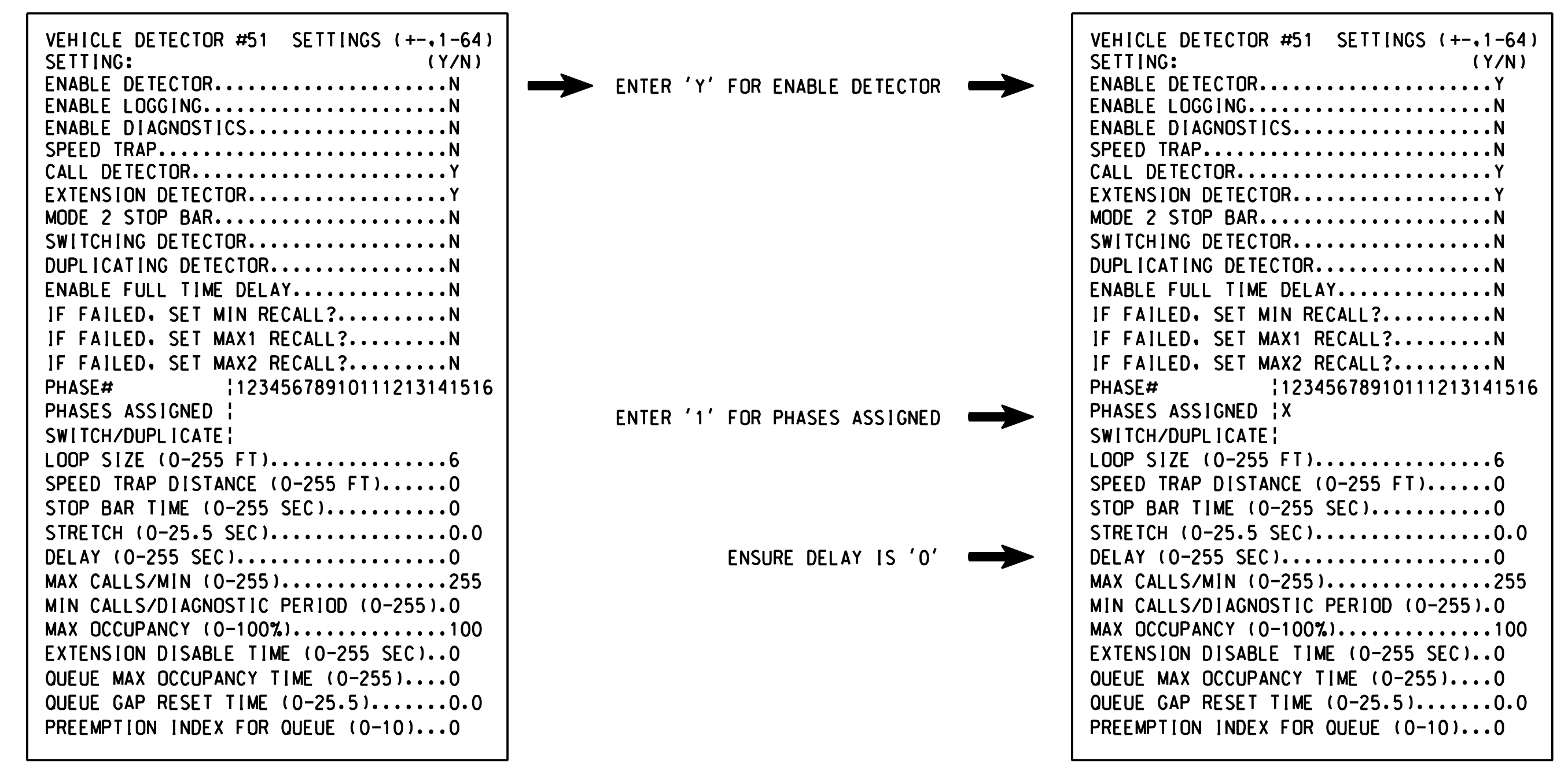

NOTE: DETECTOR IS PROGRAMMED PER THE INPUT FILE CONNECTION AND PROGRAMMING CHART SHOWN ON SHEET 1.

THIS ELECTRICAL DETAIL IS FOR THE SIGNAL DESIGN: 03-0215T5 DESIGNED: June 2017 SEALED: 9/10/2021 REVISED: N/A

Electrical Detail - Sheet 4 of 8 Signal Upgrade Temporary Design 5

DOCUMENT NOT CONSIDERED FINAL UNLESS ALL SIGNATURES COMPLETED

Professional seal and signature block for Natasha R. Simmons, Engineer, North Carolina. Includes project address (NC 211 Howe Street, SR 1852 Robert Ruark Drive), date (9/10/2021), and signature.